

NOVEMBER 1965

# TAPE

RECORDING MAGAZINE



**IN THIS ISSUE**  
**HOW WE MADE THE**  
**'TAPE OF THE YEAR'**

*Special feature*

ALSO

- Pictorial feature of 1965 British Tape Recording Contest Presentation Party
- PARADISE for the tape enthusiast
- RECORDING television on tape

*Second class postage paid at  
New York Post Office, N.Y.*



# SONY<sup>®</sup> RESEARCH MAKES THE DIFFERENCE— THE VITAL DIFFERENCE IN TAPE RECORDERS



Technical brilliance and outstanding design have made SONY Tape Recording Equipment a world known example of superb Japanese radio engineering. This high quality is achieved through SONY'S policy that places highest priority on Research—Research that makes a difference to you, the owner... a difference that can be seen and heard in SONY.

A COMPACT STEREO  
TAPE RECORDER OF  
OUTSTANDING QUALITY  
... SONY TC 200

**"Professional sound" with these Features:**

Complete 4 track stereo and mono recording. 2 V.U. meters. TWO full range balanced satellite speakers. Instant Stop. Sound on Sound and Trick Recording. Variable Tone Control. Transistorised Pre-amplifier. Recording monitor through speakers. Public Address facilities. Individual Level Controls on each channel. Complete with two F-96 dynamic microphones.

**SONY<sup>®</sup> U.K. SALES DIVISION,**  
Debenhams Electrical & Radio Distribution Co. Ltd., Eastbrook Road, Gloucester.  
Phone: Gloucester 26841/2/3/4  
Northern Ireland Distributor: Messrs. Solomon & Peres Limited, Belfast 1.  
Distributor for Scotland: Bryterlite Electrical Co. (Glasgow) Ltd., Glasgow C.2.

Available only through appointed dealers of quality. Sony products are on permanent exhibition at our new London Showroom 70/71 Welbeck St., London, W.1.

SONY<sup>®</sup>



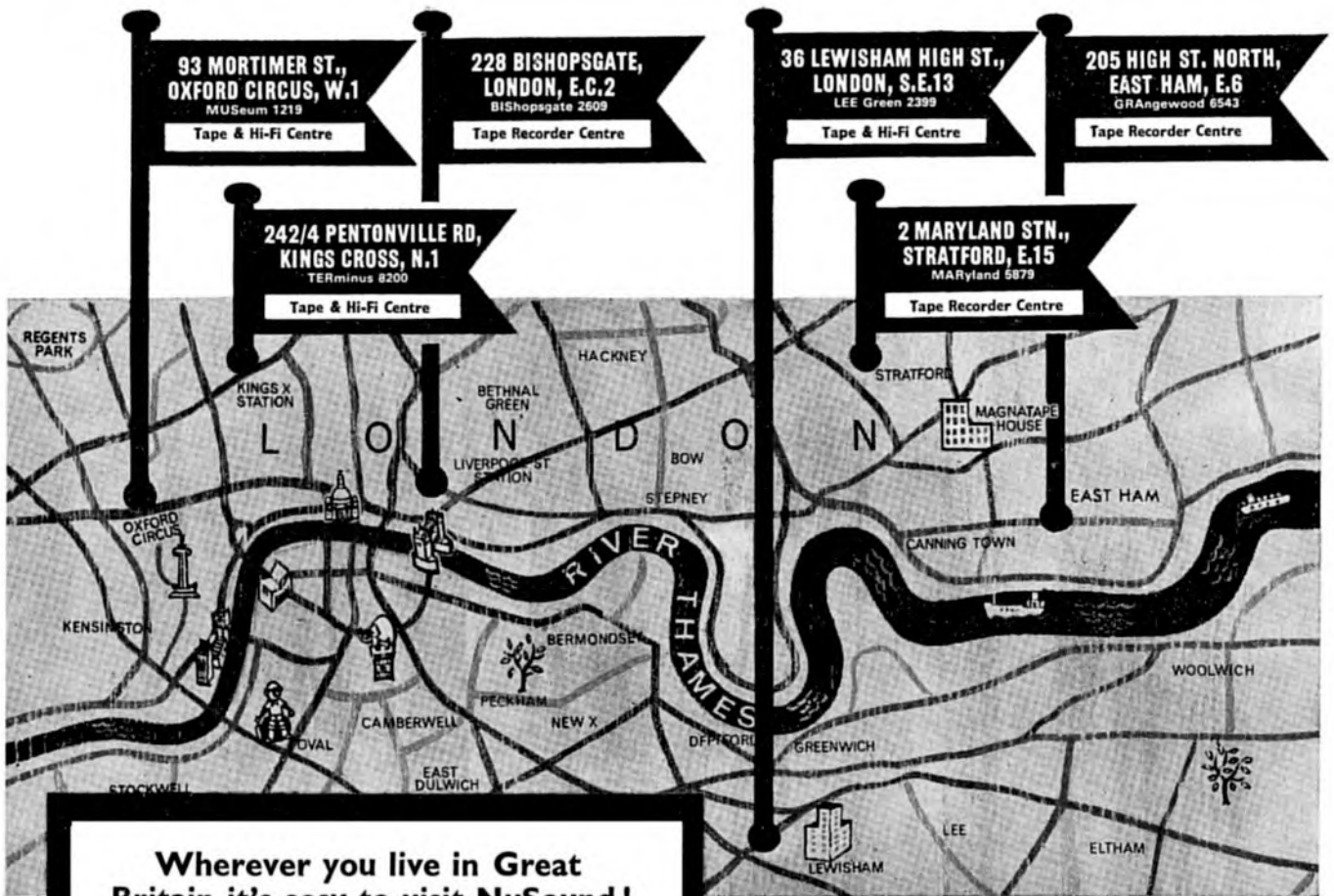

**Wherever you live in Great Britain it's easy to visit NuSound!**

Whatever your means of transport or point of arrival, be it Oxford Circus, Kings Cross or Liverpool Street Stations there is a NuSound showroom within easy reach. The position of each showroom has been carefully selected to be just a few minutes away from these well known Central London landmarks.

**HOURS OF BUSINESS**

**KINGS CROSS, STRATFORD, LEWISHAM, EAST HAM:**  
Monday to Saturday 9 a.m. to 6 p.m. Halfday Thursday.

**BISHOPSGATE:**  
Monday to Friday 9 a.m. to 6 p.m. Closed all day Saturday.  
Open Sunday 9.30 a.m. to 2 p.m.

**OXFORD CIRCUS:**  
Monday to Friday 9 a.m. to 6 p.m. Saturday 9 a.m. to 2 p.m.

● **TRAVEL FREE TO NUSOUND**

To all our customers residing outside the Greater London Area, NuSound offer a unique Free Travel facility. Simply write today to our Oxford Circus Showroom (Dept. FTV) for full details by return post.

● **YOU CAN SAVE £ £ £ £ £ £ £ . . . . .**

Not only will you see (and hear) the biggest collection of brand new tape recorders at NuSound, but you'll also find a wonderful selection of used and shop soiled tape recorders in first-class condition. And all at substantially reduced prices.

*In some cases you can save over 50% of the usual price.*

**OVER 1000 MODELS ON DISPLAY**

They're all here . . . every kind of Tape Recorder and HI-FI unit on the market. Nowhere else can you see such an all embracing display as that which awaits you at NuSound.

As Britain's largest Tape Recorder and Hi-Fi sales organisation with over 10 years experience in this specialised field NuSound have built up a reputation that is "second to none".

Only from NuSound can you obtain the benefits of all these invaluable features—The most comprehensive range of equipment on display in this country, expert staff, free technical advice, immediate demonstration of any model, the finest after sales servicing available.

**WHY YOU'RE WISE TO GO TO NUSOUND**

- Over 1,000 models to choose from.
- Advice from specialists—all freely available.
- Highest part-exchange allowances.
- The finest after sales servicing.
- Attractive easy H.P. terms.

*Britain's Largest Tape and Hi-Fi specialists*

# NOW! 20,000 CHANCES TO TRY KODAK TAPE



Ample supplies of all Kodak Tapes have been released for the British amateur market. This means you can now obtain these famous tapes through any of 20,000 Kodak photo dealers (there's one in *your* town).

Try the Kodak tape of your choice this week — and prove for yourself how justified are the 'rave' reviews you've read in the country's audio press!

Kodak tapes—Standard, Long, Double, Triple and *Quadruple* Play—are available in all standard reel sizes.

THERE'S A **Kodak** TAPE SUPPLIER IN **YOUR** TOWN

Kodak Limited, London



# Brenell

## The tape recorders made for enthusiasts-by enthusiasts

Everyone concerned with the manufacture of Brenell tape recorders is an enthusiast, taking infinite care and patience with each facet of production. Constant research ensures that every possible, worthwhile, refinement is incorporated and that each Brenell machine is built to the stringent specifications laid down. This is why the name Brenell is synonymous with quality and reliability.

### Features common to all Brenell models:-

4 tape speeds  $1\frac{7}{8}$ ,  $3\frac{3}{4}$ ,  $7\frac{1}{2}$  and 15 ips • 3 Papst outer rotor motors (hysteresis synchronous for capstan drive) frequency correction at all speeds • pause control • monitoring and superimposing •  $8\frac{1}{4}$ " dia. reels • fast rewind (1200 ft. in 60 secs.) • all deck switches interlocked • unique, reliable braking system • digital rev. counter hinged decks.

### STB 2/5/2



### MARK 5 Series 3



### MARK 5 Type M Series 3

### A NEW model—The STB 2/5/2

This versatile mono/stereo recorder has numerous features which will delight the advanced amateur or the professional. Here is a brief specification :-

Especially designed for use with high fidelity stereo installations adjustable attenuators on all input channels to ensure perfect matching with all auxiliary equipment • dual concentric recording level and playback level controls • cathode follower output four channel mixing on mono programme sources • twin recording and twin playback pre-amplifiers • comparison of original and recorded signal • adjustable bias level • recording facilities for 1/2 and 2/2 track • playback facilities for 1/2, 2/2, 1/4 and 2/4 track • sound on sound facilities • two edgewise meters for recording level, tape output level and bias level • optional extra:- stereo power amplifiers and monitoring speakers.

ALTERNATIVE MODEL STB 2/510/2 has special deck to accommodate  $10\frac{1}{2}$ " N.A.B. reels.

Narrow gapped record/playback head for extended frequency response • double gapped ferrite erase head to minimise erase noise • magic eye recording level indicator (meter at extra cost) high quality amplifier (can be used independently of tape recorder) headphone monitoring.

All the features of the Mark 5/3 plus:- Separate record and playback heads • separate record and playback amplifiers • recording level meter • mixing of input signals • tape monitoring whilst recording • separate bass and treble controls.

For full details of these recorders write to the sole manufacturers:-

GD 997

# Brenell

**BRENELL ENGINEERING CO. LTD.**  
231/5 Liverpool Road, London, N.1  
Telephone: NORTH 8271 (5 lines)

**New from**  
**FERGUSON**  
**a tape recorder**  
**for the real enthusiast**



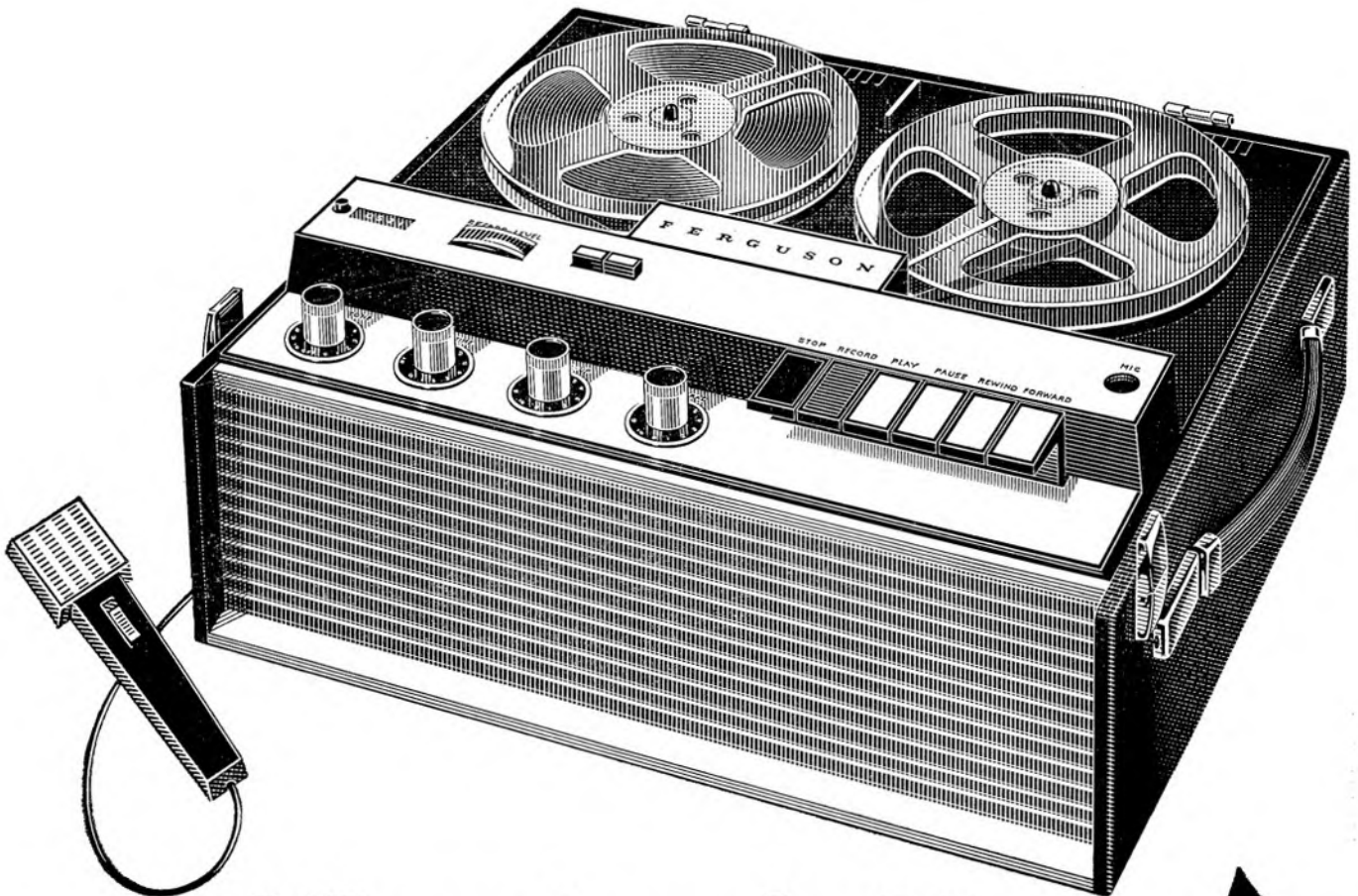

... and it costs only 44gns

**GREAT  
ENTERTAINMENT  
VALUE**

Just look at the big-price features on this new low-cost Ferguson Model 3214 tape-recorder: three speeds, four tracks, 7" self-threading spools and up to 17 hours playing time per reel of double-play tape (8½ hours on the tape supplied). This is the recorder with the real professional touch: mixing facilities, two-way tape inching, double-track replay for special effects pause key, remote control microphone, and interlocking keys to prevent accidental

erasure. The output is 3 watts feeding into a 7" x 4" speaker with a frequency response of 40 c/s to 18 Kc/s at 7½ i.p.s.; 40 c/s to 14 Kc/s at 3¾ i.p.s.; and 40 c/s to 7 Kc/s at 1⅞ i.p.s. Leathercloth covered wood cabinet with silver-trim panels. Beautifully designed and beautifully finished. With 1200 ft of free long-play tape, remote control microphone, and connecting leads.

Great, great value. Great entertainment, too.

**FREE!** Post this coupon now for full details of the Ferguson Tape Recorder range.

TO: FERGUSON DIVISION  
Thorn House·Upper Saint Martin's Lane·London, WC2

NAME \_\_\_\_\_

ADDRESS \_\_\_\_\_

TM

# FERGUSON MODEL 3214

ONE OF THE RANGE OF 26 HOME ENTERTAINMENT PRODUCTS MADE BY FERGUSON: TELEVISION · RADIOGRAMS · RECORD PLAYERS · TAPE RECORDERS · TRANSISTOR RADIOS  
See the full range at your local dealers or send for free colour leaflet. To: Ferguson Division · Thorn House · Upper Saint Martin's Lane · London, W.C.2.

Heard  
any  
good  
books  
lately?

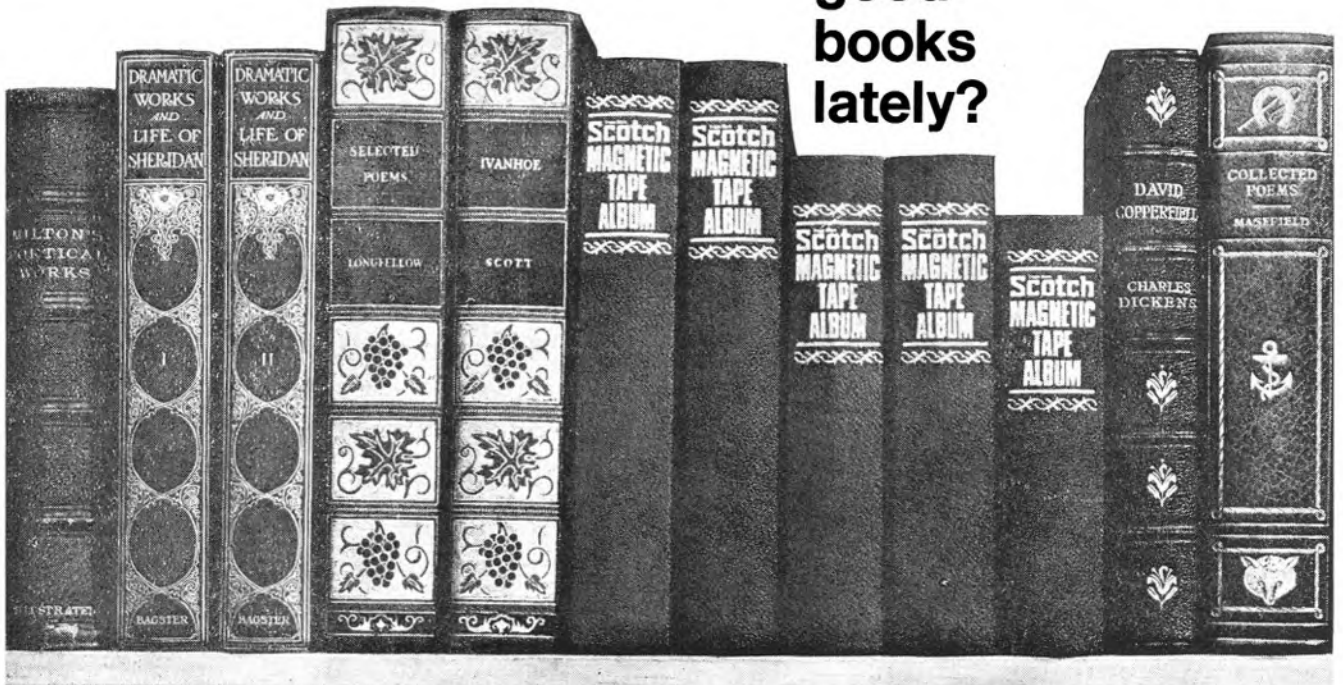

# Inexpensive New <sup>Trade Mark</sup> Scotch Magnetic Tape Albums look good—store tape perfectly

Not just a pretty cover, but sensible with it. These new Album packs, luxuriously bound in green leatherette with real gold block lettering, store your tapes in the correct position, upright. Built like books, to last a lifetime, their strength will give more protection to your precious recordings. Each Album contains one reel of 'SCOTCH' Magnetic Tape with space for another, plus a set of labels for spine and spool identification. For all this they cost just marginally more than usual. Available in 5", 5 $\frac{3}{4}$ " and 7" spool sizes for all types of 'SCOTCH' Magnetic Tape.

And don't forget the complete range of 'SCOTCH' Magnetic Tape is still available in the familiar standard packs. All 'SCOTCH' Magnetic Tape (except type 111) has Superlife coating, to give improved frequency response,

less tape recorder head wear, great reduction of 'rub-off' and increased tape life. **Start building your 'Scotch' Magnetic Tape Library now.**

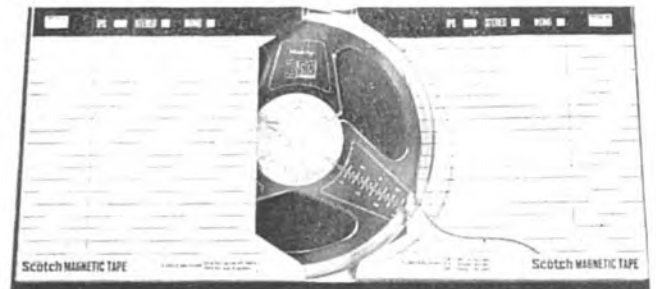

Minnesota Mining and Manufacturing Co. Ltd., 3M House, Wigmore St., London, W.1. 3M and SCOTCH are trademarks of Minnesota Mining & Manufacturing Co.





**FI-CORD IS EVERYTHING IN SOUND REPRODUCTION**

**FI-CORD**



**202A**

Built to the same specification which made the Fi-Cord 202 the first choice of broadcasting and film companies. The new Fi-Cord 202A offers still more refinements. Among these are a button-operated battery tester with separate indicator scale, and a redesigned control panel, giving greater ease of operation. With a frequency response of 50—12000 c.p.s.  $\pm$  3db at 7½ i.p.s., this hand portable battery/mains recorder captures every sound as faithfully as studio equipment: rechargeable batteries: long life mercury batteries: power pack for use with 12 v. car battery: power pack for use with AC mains 110-240 v.



**FI-CORD 801**

Omni-directional studio microphone (dynamic moving coil). Shockproof and proof against changes in temperature. Frequency response 50 to 18,000 c.p.s.



**BEYER M119**

Moving coil omni-directional microphone very good for interviewing and general background recordings smooth response. Frequency response 50-16000 c.p.s.



**BEYER M260**

Dynamic Ribbon Microphone. A cardioid pattern studio quality microphone at a price the amateur can afford. Frequency response 50—18000 c.p.s.

*For further details, please complete and post this coupon to:*

**FI-CORD INTERNATIONAL**

Charlwoods Road • East Grinstead • Sussex  
Telephone: East Grinstead 21351

Please send information and literature on the full range of microphones and the Fi-Cord 202A.

NAME.....

ADDRESS .....

.....

.....

.....

TRM 2

## OWNERS of automatic SLIDE PROJECTORS

give your shows the professional touch with a tape recorder and the famous SYNCHROSLIDE — synchronised music, commentary, etc., for the cost of only 14 gns. (or easy terms). Send for FREE illustrated literature today!

SYNCHRODEK (1964) Ltd., Dept. No. 27,  
Binfield, Bracknell, Berks.

## INTERNATIONAL BRAND TAPE

Finest quality American made	Tape—at lowest ever prices!	Fully g'reed
3 in. Message tape, 150 ft. ....	3/6	5½ in. Long play, 1,200 ft. Acetate 12/6
3 in. Message tape, 225 ft. ....	4/11	7 in. Stand. play, 1,200 ft. Mylar... 12/6
3 in. Message tape, 300 ft. ....	7/6	7 in. Long play, 1,800 ft. Mylar... 19/6
3½ in. Triple play, 600 ft. Mylar... 15/-		7 in. Double play, 2,400 ft. Mylar... 25/-
5 in. Double play, 1,200 ft. Mylar... 15/-		7 in. Long play, 1,800 ft. Acetate... 15/-
5 in. Long play, 900 ft. Acetate... 10/-		7 in. Triple play, 3,600 ft. Mylar... 58/6
5 in. Standard play, 600 ft. PVC... 8/6		Post 1/- per reel—4 reels & over Post Free
5 in. Triple play, 1,800 ft. Mylar... 35/-		Clear Plastic Spools (empty): 3" 1/6,
5½ in. Double play, 1,800 ft. Mylar 22/6		4" 2/-, 5" 2/-, 5½" 2/3, 7" 2/6. Post 6d.

BROCKLEY TRADING CO., (Dept. TM), 378 Harrow Road, Paddington, London, W.9. CUN 9530

# If you like... TAPE

give a recordist friend this Christmas

## A GIFT SUBSCRIPTION

NOW is the time to do something definite about it! Simply send us your cheque or postal order with your own and your friend's name and address. The gift sub. will commence with our JAN. 1966 issue which will be mailed to your friend BEFORE CHRISTMAS.

1 Year's Sub. (12 issues), 25s. (USA \$3.75). NO EXTRAS!  
Tape Recording Magazine, 7, TUDOR ST., LONDON, E.C.4.

# A WHOLE WORLD OF USERS CAN'T BE WRONG!

One of the really outstanding microphones in the medium-price range, the DP/4 is enjoying unparalleled success. Small wonder, for the DP/4 is wonderfully reliable and sensitive to an extremely wide range of sounds. Uniform frequency response 50 c/s to 15 kc/s.

It is in world-wide use for high-quality broadcasting, recording and public address both by the amateur and professional.

The Parabolic Reflector is its natural partner; it focuses a distant sound-source onto the microphone head, greatly amplifying it without loss of realism and without unwanted side-noises.

Low impedance microphone, complete with connector and 18 ft. screened lead.

Medium and high impedance models. Parabolic Reflector 2ft. diameter complete with microphone holders.

FURTHER DETAILS FROM  
YOUR DEALER OR FROM:—

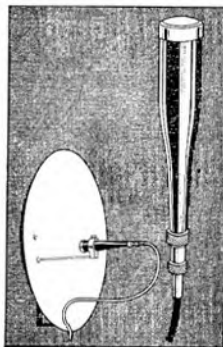

GRAMPIAN REPRODUCERS LTD.,  
Hanworth Trading Estate,  
Feltham, Middx. FEL 2657

**Grampian**

# \* TAPE RECORDERS \*

# \* ALL HI-FI EQPT. \*

BUY FROM THE BIGGEST MAIL-ORDER SPECIALISTS in the U.K.

\* BEST CASH & H.P. TERMS \*

FREE Servicing \* FREE Delivery Anywhere

FREE Brochures: (indicate interests)

# HOWARD

## TAPE RECORDERS

218 HIGH St.  
BROMLEY. KENT.

RAV. 4000



## GET IT INTO YOUR SYSTEM!

### This brilliant new F.M. Tuner from Truvox

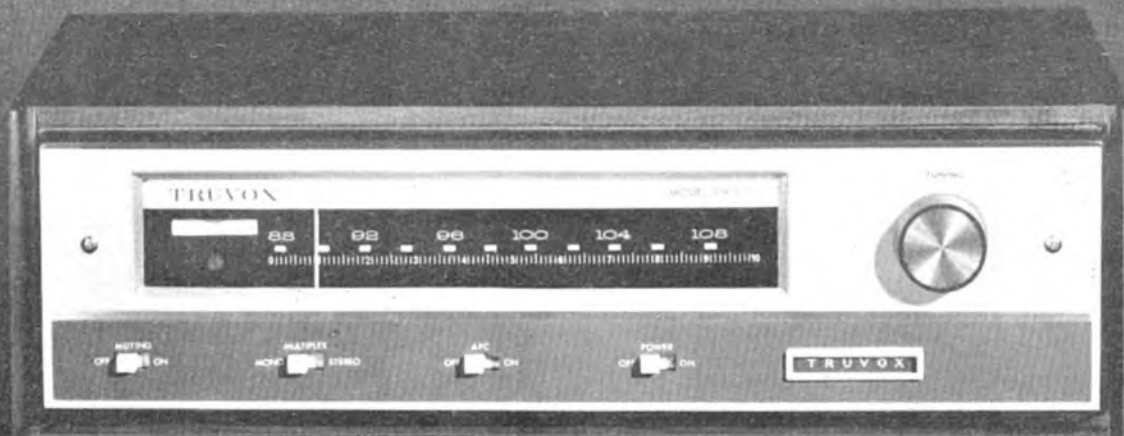

Here, without question, is Britain's most advanced Tuner—the splendid completion of the trend-setting Truvox Series 100 System.

The reliable, *self-powered*, all-transistor circuit ensures minimum distortion and background noise, and includes provision for fitting a low-cost, plug-in Multiplex Unit at any time for stereo reception.

Among the many advanced features are a unique Rotary Meter and a wide-range, switched, Automatic Frequency Control for high accuracy tuning. A Stereo Beacon lights automatically on reception of stereo broadcasts. Two output signals are taken from the rear of the Tuner via twin phono-sockets. Input sockets are arranged for any type of aerial feeder.

#### SPECIFICATION FM100

Tuning Range 87.5 Mc/s to 108.5 mc/s  
Sensitivity 2 micro V. Sensitivity for 20 db quieting  
Frequency response:  
Mono 20 c/s to 20 Kc/s  $\pm$  1 db Very steep cut Notch  
MPX Stereo 20 c/s to 20 Kc/s  $\pm$  1 db filters operate at MPX  
carrier frequency  
Stereo separation—38 db at 1 Mc/s  
Aerial Inputs—balanced 300 ohms, unbalanced 75 ohms  
AFC holding range  $\pm$  200 Kc/s  
Switched AFC  
Switched power  
Switched inter-station muting control  
Automatic stereo switching with manual over-riding  
stereo-mono switch  
Automatic stereo beacon  
Outputs variable to 0-1 volt emitter follower  
Voltage 100-120 A.C. 50-60 cps or 200-250 A.C. 50-60 cps.  
Fused.

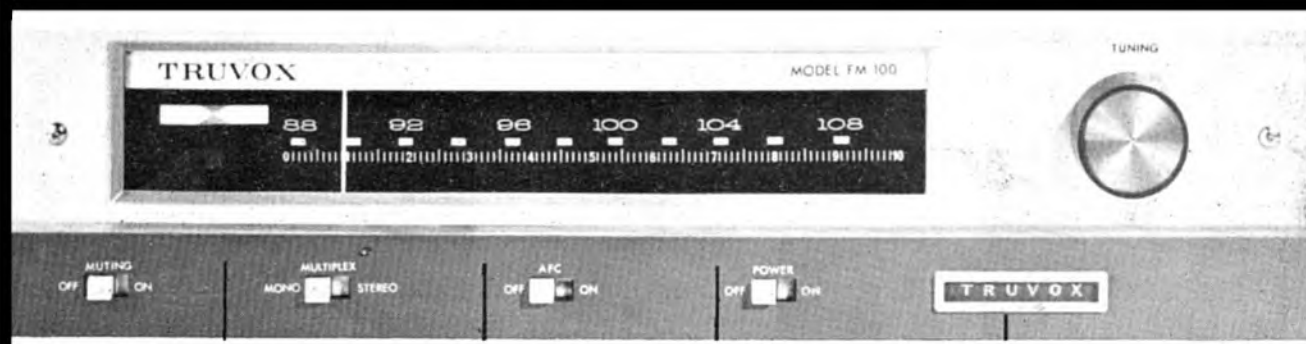

#### Muting Switch

A muting circuit completely eliminates inter-station noise, and prevents false activation of the Stereo Beacon.

#### Automatic Stereo Switch

The Tuner will produce a mono signal through both outputs. When a stereo broadcast is received, the Tuner will switch automatically to stereo reception. A slide switch on the front panel allows selection of a mono broadcast in place of stereo where the stereo signal is weak, resulting in a better signal-to-noise ratio.

#### The AFC Control

This holds over a particularly wide band and is controllable for really accurate tuning. Also weak signals adjacent to strong signals may be received without pulling into the stronger signal.

The output from the rear panel phono-sockets is controllable by a ganged potentiometer and thus all possibility of overloading sensitive input stages is obviated.

The Tuning Scale is handsomely styled, illuminated and fully calibrated. The complete tuner is the same size as the TRUVOX TSA100 Amplifier and is fitted in a matching afrormosia case.

#### Precision Tuning

A large balanced flywheel is fitted to the tuning control to ensure smoother, more exact tuning.

**TRUVOX**

Write to K. C. Smith for further information.  
TRUVOX LIMITED • NEASDEN LANE  
LONDON NW10 • Tel: DOLlis Hll 8011

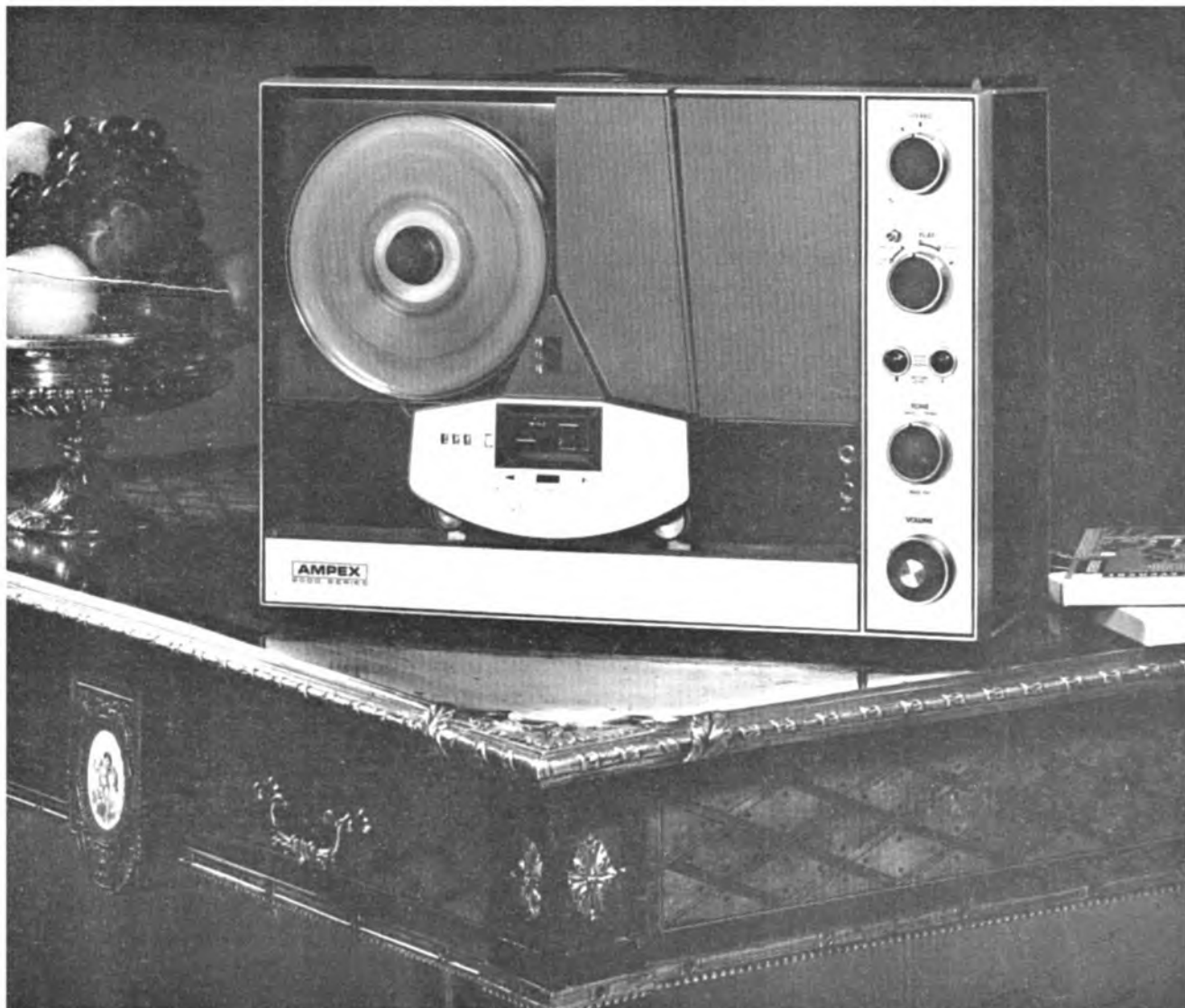

## STRICTLY FOR THE EARS OF PERFECTIONISTS —the Ampex 2000 series stereo tape recorders

If you can tolerate sound distortions when you listen to music, you need read no further. But if you are a lover of sound reproduced at its best, the Ampex 2000 Series has been made for you. Designed and built by dedicated sound engineers for the connoisseur, the Ampex 2000 Series is beyond comparison. It has dual capstan drive, automatic reverse for extra-long play and *exclusive* automatic loading. Special "Sleep Switch"

allows automatic shut off of everything—recorder, motor, amplifiers. 3 Ampex professional quality heads, coupled with rigid block suspension, guarantee perfect head alignment under all conditions. 3 playing speeds offer maximum fidelity at greatest tape economy. Automatic lifters are included and self-contained or separate speakers with solid state power amplification are offered. Automatic slide synchronisation is optional.

**AMPEX**

Ampex sales and service facilities are conveniently located throughout Europe and the Middle East. For more information write to: Ampex Great Britain Ltd., Acre Road, Reading, Berkshire, England. Telephone Reading 84411 • Ampex S.A. Via Berna 2, Lugano, Switzerland. Telephone 091/3.81.12 • Ampex Europa G.m.b.H., 6 Frankfurt Main, Düsseldorf Strasse 24, Germany. Telephone 25.20.01-05 • Ampex, 41 Avenue Bosquet, Paris 7e, France. Telephone 705.38.10.

# TEMPOTAPE

**SUPERB PROFESSIONALLY RECORDED MUSIC—PLUS 600 ft OF EXTRA TAPE FOR YOUR OWN HOME RECORDINGS ALL FOR 21/- (3 $\frac{3}{4}$  I.P.S.  $\frac{1}{2}$  track) MONO**

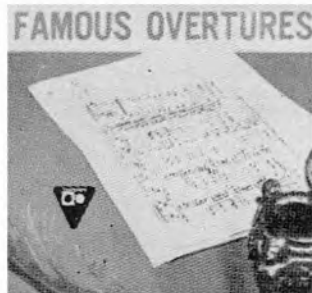

Why consider ordinary magnetic recording tape when you can buy the wonderful new TEMPOTAPE, 600 ft. of super quality long play polyester on 5" reel, with the top track professionally recorded by skilled engineers on the latest Danish Lyrec equipment costing many thousands of pounds.

Here is the list of titles available:

1 EROTIC PERCUSSION. 2 BIG BAND BLAST. 3 GUITAR BOOGIE. 4 TCHAIKOVSKY'S PIANO CONCERTO. 5 THE KING AND I. 6 CAMELOT. 7 FEATURING BILLY DANIELS. 8 HAPPY HARMONICA. 9 SOUTH PACIFIC. 10 ANDRE PREVIN. 11 GREAT THEMES FROM GREAT MOVIES. 12 BIG BAND SWINGS THE CLASSICS. 13 TRIBUTE TO DUKE ELLINGTON. 14 FLAMENCO. 15 UNDER PARIS SKIES. 16 ROMEO AND JULIET OVERTURE. 17 ORGAN POP CLASSICS JOHN KILEY. 18 TCHAIKOVSKY'S 1812 OVERTURE. 19 L'AMORE D'ITALIA. 20 OKLAHOMA. 21 FAMOUS OVERTURES. 22 MUSIC FROM IRVING BERLIN. 23 MUSIC FOR LOVERS. 24 THE GOLD RECORD. 25 SOUND OF MUSIC. 26 TRIBUTE TO WOODY HERMAN.

All are specially selected for your enjoyment and equivalent in playing time to both sides of an L.P. record.

In addition to providing you with a pre-recorded tape of superlative quality, TEMPOTAPE provide a bonus of 600 feet of blank tape, and all you do is turn over the reel and make your own recordings on the bottom track. You can later erase the top pre-recorded track making a further 600 ft. available for your own use and at 21/- you can afford to do this.

Ask your dealer for details or write to: Dept. X2, Tempotape Division, A. C. Farnell Limited, 81 Kirkstall Road, Leeds 3. Telephone: Leeds 35111 (7 lines).

## TAPE

RECORDING  
MAGAZINE

Vol. 9 No. 11 November 1965

### IN THIS ISSUE

- Tape trends and tape talk 422  
*By the Editor*
- B.T.R.C. Presentation Party 423  
*Pictorial feature*
- How we made the 1965 "Tape of the Year" 424  
Richard K. Partridge
- Finding fame as a 'hooter' suitor 425  
Ray S. King
- Paradise for tape enthusiasts 428  
John Whittaker
- A glossary of tape terms 430  
Harry Mack
- Tape recording television 432  
John Valentine
- Test Bench 435  
*Sound TRE.40*
- Dramatape Miscellany 437  
*By Perspective*
- Tape records reviewed 440  
Edward Greenfield
- Popular music on tape 440  
Don Wedge
- Jazz on tape 441  
Mike J. Gale
- New Products 442
- News from the clubs 445
- Tape Exchanges 445
- Advertisement Inquiries Service 453

**COVER PHOTOGRAPH:** Professional and amateur recording experts, seen at the recent Presentation Party for the 1965 British Tape Recording Contest. Our illustration this month shows (left to right): Disc-jockey Alan Freeman, winner in the Novice Section, Jack de Manio of the B.B.C. programme "Today," Ray King, winner in the Humour section, Douglas Brown, Editor of "TAPE Recording Magazine," Richard Partridge, producer of the "Tape of the Year," seen with the Emitape Challenge Cup, and Timothy Eckersley, Assistant Head of Centr 1 Programme (Operations) B.B.C. Richard Partridge and Ray King describe how they made their award-winning tapes in the special feature on page 424.

"TAPE Recording Magazine" is published on the third Wednesday in the month, by Print and Press Services Ltd., from 7, Tudor Street, London, E.C.4.

"TAPE Recording Magazine" is available by a postal subscription of 25s. per annum (U.S.A. \$3.75) including postage, or it can be obtained at newsagents, bookstalls and radio and music dealers. In the event of difficulty, write to the Publishers at 7, Tudor Street, E.C.4.

Back numbers, if still in print, are available at 2s. 6d. per copy.

Address all communications

7 TUDOR STREET, LONDON, E.C.4

### EDITORIAL

FLEet Street 1455

Editor,  
R. DOUGLAS BROWN

### ADVERTISING

LUDgate 9088

Assistant Editor,  
FRED CHANDLER



# Tape trends and tape talk

By the Editor

NEXT YEAR LOOKS like being an exciting one in the world of tape recording—but not all the expected developments will be happy ones. I revealed last month the appearance on the continent of a new tape cassette sponsored by Grundig, Telefunken and Blue Spot. I announced that the new cassette would be used for a repertoire of tape records to be released by Teldec.

And I asked a question: will the various cassettes on sale next year be compatible—interchangeable between one machine and another?

I can now reveal the answer. They will not.

I was wrong when I reported that the new Grundig cassette is designed to play at  $1\frac{1}{2}$  ips. I was led to this conclusion by a reasonable mathematical deduction, because it never occurred to me that we were to see the introduction, at this stage, of a non-standard tape speed. But it is so. The Grundig equipment plays at 2 ips.

Furthermore, the size of the cassette is different to that of the already available Philips cassette, which plays at  $1\frac{1}{2}$  ips. So it is unlikely that both types of cassette will be playable on a single machine.

The Philips cassette has, of course, been on sale here for about 18 months—since it was introduced with the EL 3300 battery portable recorder. And next year, I understand, Philips hope to market in this country a repertoire of tape records in this form.

They have been available in Germany and Holland for several months past and I understand that they have had phenomenal success. They sell at about two guineas each and almost a hundred titles are now available.

The surprising and—exciting—thing is that since the tape cassette records came on the market the sale of tape recorders designed to play them has leapt up to a totally unexpected level.

I repeat the view expressed last month: that we are approaching a moment of break-through for domestic tape recording. But I am utterly dismayed to learn that two giant concerns have adopted different standards and gone into production with them, so that a battle seems inevitable.

It is difficult to see who can benefit. It will certainly do nothing to encourage the potential recruit to tape recording. So often in the past the failure to agree on standards has led thousands of people to hold off buying until "things settle down."

One hoped that the lesson had been learned. I have reason to believe, in fact the Philips and Grundig concerns began to develop cassettes in close consultation one with another, so that the present situation would be avoided. What went wrong, I cannot tell, but amateurs will regret the failure to produce a standard product.

It seems quite certain that the Philips tape cassette records will arrive in Britain first, just as did the cassette itself. I have seen some of the cassette records marketed on the continent and they are irresistibly attractive.

Already Philips have marketed here a "car deck" which enables their EL 3300 recorder to be mounted in a car and to play recorded music from a cassette through the car radio. This is selling well, I understand. For the present, of course, users must record their own music for play-back, but the eventual appearance of the tape cassette records will give a boost to this special market.

Many of my friends in the trade have assured me dogmatically over the years that tape records will never oust the disc. I wonder if they can be so sure in view of the latest development? It is indisputable that it is easier to put on a tape cassette than a disc.

## BRITAIN'S BEST TAPE AMATEURS CELEBRATE AT LONDON PARTY

THE TAPE RECORDING champions of 1965—the men who produced the prize-winning tapes in this year's British Tape Recording Contest—gathered at the Criterion in Piccadilly Circus, London, last month for the presentation party.

It was the most successful event of its kind since the Contest was established in 1957, with a big turnout of celebrities, judges, leading figures in the trade, and representatives of the press.

Jo Douglas, famous TV producer, who has been closely associated with the Contest since it began, presented the prizes. Alan Freeman, the disc-jockey, was present as a prize-winner—as a newcomer to tape recording, he made the winning entry in the novice section of the Contest!

Conductor Eric Robinson came along as one of the judges. And from the BBC came Jack de Manio, compere of the "Today" programme (which has featured some of the Contest tapes) and Timothy Eckersley, Assistant Head of Central Programmes Operations (Recording).

C. Rex Hassan, Chairman of the Organising Committee, introduced a play-back of all the winning tapes and after each item the appropriate prizes were presented and the winners spoke briefly.

A general opinion was heard among those who had attended each year that the winning tapes this year showed a marked improvement on previous years—perhaps a reflection of the greatly increased entry attracted by more widespread publicity and promotion of the 1965 Contest.

At the party Alan Stableford (Chairman of the Federation of British Tape Recording Clubs) told me that the British entries for the International Amateur Recording Contest had been chosen. Five entries, plus one schools' tape are eligible from each country. The British tapes to go through to the International are as follows:

"Mushrooms" by Richard Partridge and Jeremy cestershire (Schools Section); "No Title" by Trevor Gibson of Hertford College, Oxford (Compositions Section); "The Nose" by Ray S. King (Documentary Section); "Thos. Mortier Organ" by Peter Lawson-Smith (Music Section); "A Day at Grange School" by the pupils of Grange School, Stourbridge, Wor-F. Holmes (Technical Experiment); and John Bradley's "The Real Thing" (Actuality Section).

These will compete with tapes from fourteen other countries at the International Contest to be held at Broadcasting House, London, at the end of October. This year, Alan Stableford and I will be joined on the International Jury by Arnold Highcazony (Federation secretary) and Fred Chandler of *TAPE*.



**SCENES** at the Criterion Hotel in Piccadilly Circus as TV producer Miss Jo Douglas—who has been associated with the Contest since its beginning in 1957—presents the awards to this year's winners.

From left to right above: Richard Partridge receives the Emitape Challenge Cup and £50 cash for "The Tape of the Year" on behalf of himself and Jeremy Gibson. (Their tape "Mushrooms" also received the Amphlett Shield donated by the Federation of British Tape Recording Clubs for the best entry in the Group Section); disc-jockey Alan Freeman, winner in the Novice Section, receives his Philips Shield; and Peter Cox holds the Agfa Cup, his award for the Best Amateur tape, as he waits to receive the Acos Cup, for the best tape in the Music Section.

Right, lofty Ray King, 1964 "Tape of the Year" producer, received the Master-tape Shield for "The Nose," best Humour tape.

Below (left to right): Dr. Albert Watt admires the Kodak Shield awarded to his "Portrait of Callela," best Documentary tape; Mrs. Peter Lawson-Smith receives the Irish Trophy for the best entry in the Stereo section, on behalf of her husband who was unable to attend the party; and Mr. Low receives the B.A.S.F. Shield on behalf of his 12- and 13-year-old pupils of Grange School who won the Schools section of the Contest.



Two of the winners in the 1965 British Tape Recording Contest describe how they made their award-winning tapes. Below, Richard Partridge, winner of the Amphlett Shield and Emitape Challenge Cup (see previous page), describes the production of "Mushrooms." Opposite, the winner of the Mastertape Shield describes how he made "The Nose". Both tapes now go forward to the International Contest being held at the end of October.

## How we made the 1965 'Tape of the Year'

**H**OW often does a good idea for a tape happen to come to the very bloke who is in a position to record it? I suspect rather rarely. Certainly, my mind was its usual empty self as the Oxford University Broadcasting Society's annual tape recorded Cuppers approached, so it was a good thing that I was not the only member of Hertford College's Dramatic Society to have heard of them.

Jeremy Gibson wanted to make a tape, and having a Repts R.10 tape recorder (my father's), I was the obvious technician.

Also available were a Reslo microphone (my own) and the necessary E.M.I. splicing equipment, not to mention Heathkit amplifier and a pair of A.K.G. headphones. These items were all in much too frequent use in a convenient College room specially chosen to be as far away from unwanted noises as possible. And Jerry had an idea.

The first problem was time. Jerry was President of the Dramatic Society, which was embarking upon a major production, and he was also involved in other dramatic enterprises; he had very little time. Both of us had work to do, of course, but mine involved set times away from College to a large extent, so it was hard work arranging a meeting. This difficulty was never really overcome, and I am sure that the tape could have been improved with more time; as it was, many small technical faults had to be passed. But I suppose all amateur group efforts come up against this. Things seemed fairly easy when only two people were required, but more than two had to meet sometimes, and the result was a last-minute rush.

The tape was to concern "The Future," in a large-scale sense—bombs, famine, overpopulation and so on, and depended largely

on the thoughts of some interviewees. No story, no "line," simply a few ideas, and what better than to get those ideas from someone else?

Late one afternoon in, I think, February, five semi-suspecting undergraduates arrived at my room one after the other, to be interviewed from a sheet of questions Jerry had prepared. Questions ranged from their feelings during the Cuban crisis, to their attitude to the population explosion.

The approach was more or less subjective—the interest was in their attitudes to the problems, rather than the problems themselves. Jerry's questions were to be edited out, so microphone balance favoured our guests, a little experiment having been carried out to find what position gave a reasonable signal level without too much "boom." No hints of the questions had been given out beforehand, so the comments were genuinely spontaneous. I recorded about fifteen minutes with each of them, using 3½ ips for reasons of economy.

The next stage was the preparation of a script, using the comments as a starting-point. Jerry listened through all the interviews and noted down the juicy bits (and there were plenty of them—our subjects had some splendid ideas). During the next week or two we thought up a script consisting of a series of almost disconnected items, each a few seconds long. Some were serious, some funny. In particular, use was made of stanzas from Louis MacNeice's lovely poem "Prayer before Birth" to link the material together. The central humorous episode was to be a confession by the President of the USA of his annihilation of the human race (including himself), in laconic Presidential style. By the first recording session, the end had not been worked out.

Jerry had had some ideas on casting, and had persuaded a group of acquaintances to come round after dinner one Sunday. All but one of them did eventually arrive, and an attempt was made to start, finding which voice was most suitable for which section and making a few recordings. Unhappily, the funny bits just didn't come off, and two of the cast dissolved into uncontrollable laughter and had to be evacuated. This left us with three speakers, the remains of a script, and three days to the deadline for the competition; things looked a little glum.

However, we had in Michael Dobson an actor with a voice just suited to the poem;

there was no problem there. Several of the earlier sections had already been recorded before the jovial section of the cast had been called upon, and all the comments of our interviewees were safely in the bag. Reorganisation of the script was clearly called for, and the three of us worked it out in consultation, the final decision resting with Jerry. Humorous sections were dropped, with the exception of the President's speech, which Jerry, using a very passable American accent, improvised in serious vein, using the original script only as a basis. This scene was never written down in its final form, and its impression of spontaneity was quite real; Jerry really was searching for words in the pauses. This was quite a stroke of luck; without the misfiring of the original script, the scene would have lost a lot.

With the interview, comments and a section of script to follow, the President satisfactorily completed, we were almost home. So near and yet . . . ! Searching for an ending proved quite a task. The last interview comment had been religious in character, so we ransacked Bible and Prayer Book for a suitable well-known quote. Finally, we settled for a selection of responses from the order for Morning Prayer, cunningly leaving the final response unsaid so as to hold the audience's attention, and then Michael and I persuaded Jerry to use the final verse of "Prayer before Birth" as conclusion. But for a nonsensical section of the improvised President's speech, which had to be corrected the next day, all the material was now on tape, and all I had to do was join it up in the right order, a long task, but a perfectly straightforward one.

Most of the problems of recording technique had been in microphone positioning. The Repts is a lovely machine considering its price, and capable of an excellent-sounding recording, but I was none too happy about the signal-to-noise ratio on the microphone input, and there's nothing like speech for showing up noise. (Incidentally, I have since managed to straighten out the record-replay characteristic quite a lot, and noise levels have shrunk accordingly; I should also point out that the Mark II version of the machine uses quite different circuitry—ECC83s instead of EF86s—and that the manufacturers have been most co-operative when faults have arisen.) Since noise was rather high, I had to try



and get as much signal into the microphone as possible, without coming too close and causing boom. At the same time, it was important not to make the actors shout; the script just would not allow it. With three conflicting criteria, one had more or less to be ignored, and I opted for neglecting the noise level, except in one case where a distant voice had to be recorded with a close one; most people are prepared to put up with the noise on AM radio when necessary, but I, for one, hate that microphone boom.

The President's speech was in some ethereal court-room, and an echoey acoustic was required (oh, for stereo!). This was not too difficult, a suitable staircase being right outside my door. The same echo was used later on for a church acoustic, quite effectively. Distance effects took a little experimenting, and here it was very useful to have headphones available on a separate amplifier; some precision was necessary when a voice was close to the microphone, and it was good to be able to position someone and then record before he had time to move. (Once someone did move when there was no time for a repeat, hence one of the booms on the finished tape.)

The only sound effect required were some footsteps and a bang, and happily I had a bang in stock from an earlier occasion. It had been manufactured, after a good deal of experiment, by dropping a metal waste-paper basket on to the concrete landing of the echoey staircase by which I lived, then replaying at a speed eight times slower. Lovely!

Some copying was necessary to take a couple of portions of the interviews from a tape I didn't want to cut, but otherwise the whole tape apart from the bang was made up from original material. Not having the very best equipment at hand, I find the quality loss on copying unacceptable unless it cannot be helped, especially when an already noisy recording is being copied, and in any case a machine to copy with always has to be borrowed, which is very awkward if it is needed for any length of time.

The finished tape was tried out on a small audience, who seemed quite impressed, and it only remained to think of a title. Eventually, one of the audience came up with "Mushrooms," which seemed so completely right that discussion stopped immediately, and the tape was packed off to the Oxford Cuppers just in time (no one noticed that none of us was a member of the Broadcasting Society!)

Readers who saw the July, 1965 issue of *Tape* will have read the result of the competition. Mr. Geoffrey Hodson, who judged the contest, was most kind, and in the course of discussion after the adjudication, recommended us to enter the BTRC, of which we had never heard. He suggested an alteration to the start of the tape, which he did not think clear, and advised copying it at 7½ ips, to impress the judges! I should be most interested to know how much there was in that last suggestion! Anyway, it was still March, so we could go away and forget about the tape, then come back to it fresh the next term.

For the BTRC entry, all the material that could be was remade at 7½ ips, but the interviews, the President's speech and the responses were copied; in the first case, it was clearly impossible to re-record, and in the latter cases we thought performance would suffer. We were once again dreadfully short of time.

The unrepeatable material was copied from the original using a Ferrograph 5 A/N, and correcting the tone with my Heathkit USC-1 pre-amplifier. The new material was  
(continued on page 427)

# Finding fame as a 'hooter' suitor

By RAY KING

**S**HERBERT FOUNTAINS! Yes, Sherbert Fountains are directly responsible for the idea of recording nose noises!—a collection of which has resulted in my winning the Humour section of the 1965 British Tape Recording Contest. It happened quite simply.

Sherbert Fountains have always been my weakness, those delightful tubular yellow cartons with the liquorice sucking straw. I had heard that my local sweet-shop had received fresh supplies and it was whilst I was deciding how many a man of my years could reasonably purchase, that a local clergyman came into the shop, perhaps after purchasing some for himself!

Embarrassed at making my request in front of him I played for time, I lit my pipe, and, as though reluctant to let me overhear his request, he played for time by blowing his nose about four times!

Now I am always on the lookout for fresh noises to "point" as it were. The enthusiastic creative recordist develops a special listening power for just such occasions.

This was it! His four blasts were instrumental in their tonal quality, the first better than the average French-horn, the remainder rather like a muted trombone. I was overjoyed. Here was a possibility for a sound recording study. I rushed home and told my wife. She thought I was nuts—and still does!

I went out of my way after that to listen to nose noises. In pubs, restaurants, shops, cinemas I was overjoyed at the variety of delightful performances which were rendered. The problem was the treatment.

My first thoughts were to record many nose noises, to hear if there were specifically similar types. For example, it may have been that a policeman's horn may have had a characteristic hoot, or perhaps an executive's beak when blown (to give thinking time during a conference) may have been similar to an undertaker's when expressing sympathy to a prospective client at his sad bereavement. This however turned out not to be the case, and necessitated quick re-thinking later on.

The next problem was the method by which nose blows could be obtained in high quality, and, confident that my

battered Fi-Cord 1a and DP6 microphone would be up to the task I tried stalking folks whose hooters seemed in a likely condition to necessitate frequent exercise. Unfortunately I could never get switched on or near enough in time to get a good rendering, and some pretty embarrassing moments were experienced when from under my coat I produced a microphone and thrust it under a stranger's nose, usually after the shnozzel had passed it's best!

I decided to come clean. I would interview, explain my project, and ask for co-operation.

Some of those interviews were gems. I have them all safely stored, and have edited them down to an amusing ten minute tape which I think is much more funny than the nose project as entered in this year's competition.

The *Daily Express* is fortunate in having the services of one Peter Chambers who, it seems, somehow came to hear of my endeavour. He did in fact call on me, and whilst providing one of the finest lunches it has ever been my pleasure to eat, probed further into this nose noise search. Confident that his editor would throw out his story, I enjoyed my lunch, thanked him for his most excellent company, and forgot all about it.

Three days later, two complete strangers called on me and offered their services! Having read about my search, both thought they had performances which might in-



The author seen during his recent trip to America—his prize in last year's Contest. The recorder is a Fi-Cord 1A, used with the Grampian DP6 and windshield

terest me! As it happened they both developed nose fright at the sight of a microphone and dried up—metaphorically that is! Such is the power of publicity.

It was about this time that I had to be interviewed on a BBC Television Show called "Time Out." It was in connection with "Sink Symphony" with which I was so fortunate to win the Contest last year. Great fun this TV business. I loved every moment of it, though to me it seems so very technical. I constantly wonder how they ever get a programme out. My "lash ups" at home are nothing compared to theirs! However, to get to the point, Peter Haigh who interviewed me, introduced me to Gay Burne who so often appears on television, and after the show, which they

(continued on page 427)

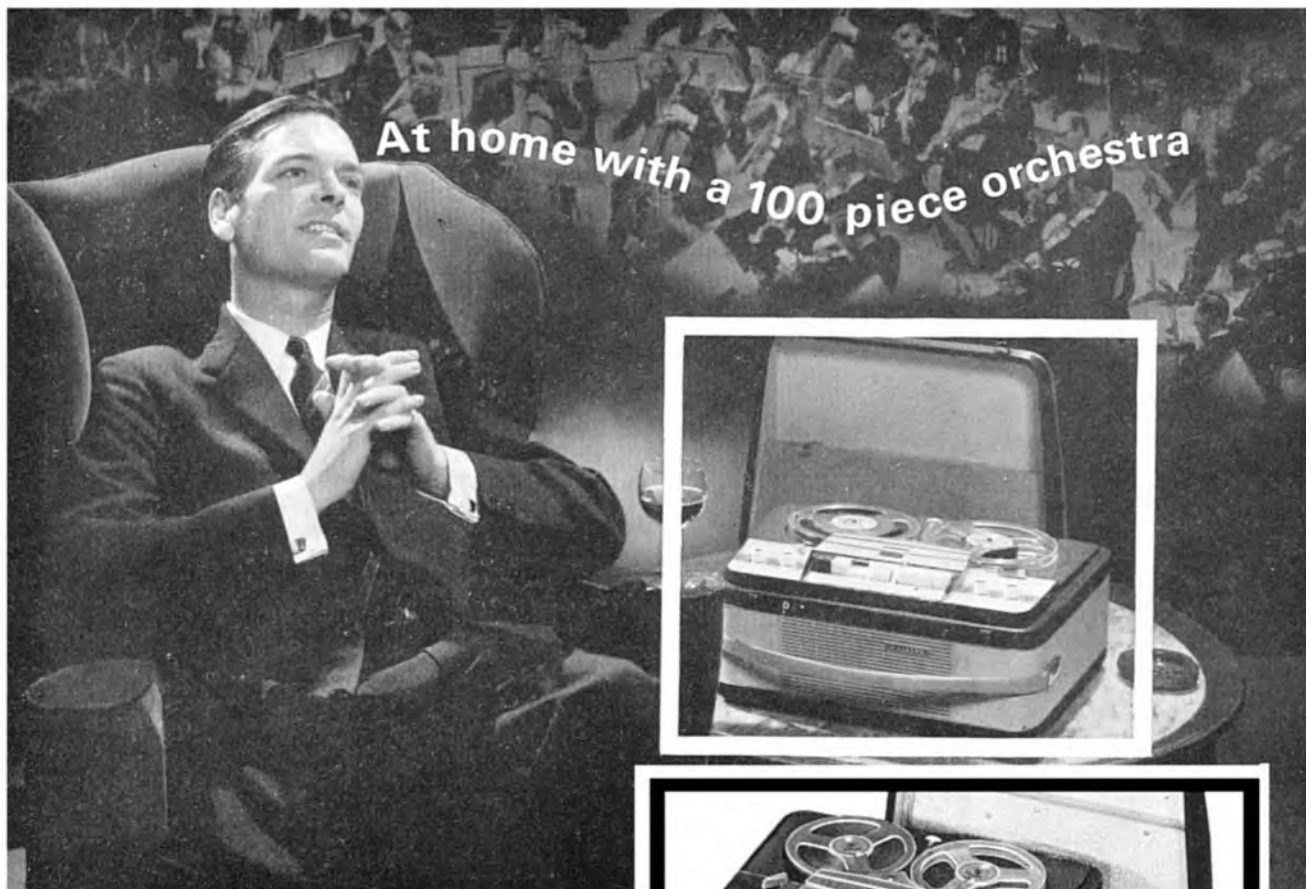

At home with a 100 piece orchestra

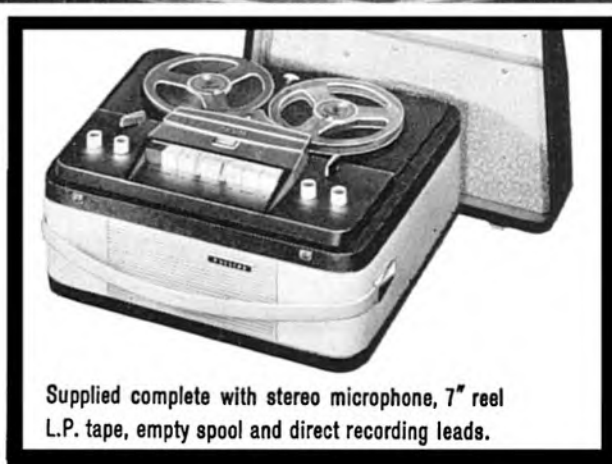

Supplied complete with stereo microphone, 7" reel L.P. tape, empty spool and direct recording leads.

re-created by Philips  
**Stereo Tape Recorder**  
**Model EL3534: 92 gns**

THIS MAN is enjoying a performance by a 100-piece orchestra. And Philips Stereo Tape Recorder is reproducing the music so faithfully that he could very well be sitting in the auditorium itself. That's because model EL3534 records sounds in the same way as the human ear—by registering their position and direction. In this way, Model EL3534 not only preserves on tape all those moments that are worth remembering—it re-creates them in all their original richness and depth. See and hear for yourself this and other wonderful Philips Tape Recorders at your Philips dealer today!

**EXPERTS CHOOSE  
 PHILIPS TAPE**

Follow the example of professionals in recording and broadcasting studios all over the world—use Philips Tape, the tape that's made by the world's leading tape recorder manufacturer! A product of Philips unrivalled experience and know-how, Philips Tape has all the qualities needed to make your recordings perfect every time.

ANOTHER FAITHFUL PRODUCT FROM  **PHILIPS**—the friend of the family

# Finding fame as a 'hooter' suitor

(continued from page 425)

jointly and so beautifully compered, we got together in what is to my mind a very fine BBC institution. It is called the Hospitality Room! What goes *down* there is nobody's business, and having had more than my fair share, I was impertinent enough to ask Mr. Peter Haigh to blow for me. He was charming, and after giving me a few moments to set up my Fi-Cord, rendered what can only be described as a truly professional performance!

He then talked Mr. Gay Burne into having a blow, whereupon again I was amazed at the tonal quality, without any distortions, of both Mr. Burne's beak, and my resultant Fi-Cord recording.

In my tape, "The Nose," it is in fact their noses which play "Three Blind Mice" so happily.

By this time I had on record a very large collection of nose noises, and came to the most enjoyable task of selecting the finest

## 'TAPE OF THE YEAR'

(continued from page 425)

recorded rather carefully with a different start, using as before a lot of short takes, and quality was distinctly improved. But the noise in the background was really dreadful, and the change from new to copied material horribly noticeable. Since the speech quality had been improved, though, I thought it better to hope that the judges would assume I couldn't help it (I couldn't), and use a mixture of new and old. Copyright permission for the use of "Prayer before Birth" arrived just in time, and I sent off the tape to arrive on the very last possible day, but assuming that it would be ruled out on technical grounds. The result was thus quite shattering, especially as I could not be sure the tape had even arrived in time.

Reasons for success? Difficult to judge. The tape used no music, and almost no effects, but variety in sound had been achieved by the use of interviews and the variation in acoustic; all the sections were quite short. Technical quality was not of the best, but care had been taken in microphone placing, albeit certain faults could not be corrected for lack of time. I think it likely that no other entry was similar to it, and yet it lasted over nine minutes, and did not move fast, though the interviews gave a change of pace. I can think of no other medium in which the same material could have been presented, and perhaps this was the important point.

The idea was Jerry's and his was the effective script; though the speaking was divided between us, the tape would have suffered greatly without Michael Dobson's fine reading of the poem: I was the only one who knew how to put it onto tape. It was a joint effort, and without this co-operation between "artist and scientist" could not have been made; is this something we can teach other enthusiasts?

recordings for the final rough cut. My method is always to make a copy of my original recordings, sifting, cutting, and assembling their order, and then finally cutting the "master" to match my cutting copy.

Soon after reaching this stage I sadly realised that although I undoubtedly had the finest collection of hooters in the country, many were similar. It was evident that it was not going to be possible to carry out my original idea of comparing nose noises from profession to profession or craftsman to craftsman. Some quick re-thinking had to be done since time was running out and I so desperately wanted to make this year's Contest.

I spent about a week of evenings drafting commentary to tie up the nose sounds. After listening many times to my original interviews, I decided to "play it straight," and use the interviews as my script line. Although keeping nearly all of the nose noises to the professions and jobs that their authors actually did, I did take author's licence here and there. But I felt it was right since it seemed to fall easily into place.

I had been invited to talk to the Tape Society of Abingdon School in Berkshire. This most progressive group have built a delightful studio within the school buildings. This was my opportunity for a "sneak preview."

I waffled through my chat, played extracts from some of my American recordings, then slipped on my nose "epic" and retired to a safe distance!

Whether they were being polite or not I shall never know, but there were howls of laughter here and there, and as far as I could judge it seemed to go down well. I made one or two final alterations and then reached the point which is so difficult to attain. This was it. Cut the master, fill up the form and dispatch.

That is the story of "The Nose." For those who are interested technically I will briefly outline my equipment and approach to some of the problems encountered, though I wish to stress that basically I do not believe it is necessary or a good thing for the creative recordist to know how equipment works. His job, is to use it and leave technical and design features to the specialists. Although good, well-designed and often expensive equipment makes the job a little easier, I am sure that many enthusiasts get so engrossed in the performance of their equipment, they forget completely the fun that can be had out of just having a go at creating something worth listening to.

The choice of microphone was easy. I only have two! My Grampian DP6, was obviously designed for the job. Grampians recommend it for speech, and now possibly for noses! It is small and compact and I found strangers so less likely to get "mike fright" when the DP6 microphone could hardly be seen in my hand.

A tricky part of final assembly of the noises was the close cutting necessary at each side of the nose blow since they were all recorded in different places and room

reverberations are each so very different as to give a completely different quality to similar sounds. I cropped the tape to about a quarter of an inch at 7½ ips at each side of the blows. I wanted to emulate "studio quality" where possible to give higher contrast to outdoor and special location effects.

The sewer man's "homing call" for his gang was a most interesting and enjoyable creation. I wanted a convincing sewer noise, dripping water, running water and echo. This proved troublesome since having half filled the bath, leaving the tap running produced the high pressure "sissing" noise from the tap. I called upon my wife's help, and she ended up in the bath, swirling water with her feet whilst holding two jugs and tipping small controlled amounts of water from above her head height. Fortunately she is most co-operative since it took two hours for me to get the right sound, and I had forgotten that the water was cold!

I cut a tape loop of the sewer man's nose noise, set this running on my Fi-Cord whilst feeding the water noises straight from the DP4 microphone into the Vortexion. A controlled amount of recorded sound from the third or playback head was fed back into the radio input socket on the Vortexion together with the output from the Fi-Cord and the whole sound picture of a sewer man calling his gang with his nose was made.

I use a shepherd's nose noise for him to call his flock of sheep. I went into the country to get my sheep noises, but not only did all sheep seem to take an instant dislike to me, but also seemed to cease their bleating long before I got near enough to get even the slightest twitter on my magic eye level indicator.

I found a likely farmhouse, and explained my predicament. Fortunately the lady farmer was pleased to help and drove me on her tractor to take a bale of hay to the sheep. This did the trick. They flocked round and bleated enthusiastically—one more in the bag over which I superimposed the suitable nose noise.

I desperately wanted to get a nose or two playing a tune, and as previously mentioned had two "three part" blows which were suitable. Now I do play the piano in three selected keys which come easily to me. Would the noses be in tune? I was lucky since they were almost exactly in the key of G. I dubbed and repeated the noses to the tune of "Three Blind Mice" (which I guess is out of copyright), and fed the tape through the Fi-Cord to a pair of headphones from the Fi-Cord monitor socket, whilst connecting the hi-fi output of the Fi-Cord to the Vortexion. I then set up my Grampian DP4 microphone underneath my small grand piano (it gives a good recording when so placed), and played a background of the tune.

It came over better than expected and to my mind is one of the most amusing pieces on the tape.

The "Blow your nose for Oxfam" section was simple. Coins rattled in a tin and previously collected busy street traffic noises were joined in a manner similar to those above mentioned. I found it necessary to cut straight into the traffic noise with the nose sounds, but the loss of traffic background is not missed whilst the noses are blowing.

There it is then—The Nose. The script asked: "Do we really appreciate this turned up, turned down, button shaped, bulbous, round, hooked, square, balloon and beautiful NOSE?" Well I certainly do!



with a tape recorder: Continuing our series of articles on location recording, JOHN WHITTAKER describes his earliest recording activities and how they led to his spending a year in Aden which he describes as:

## A paradise for the tape recording enthusiast

**C**AN you imagine yourself standing on the tip of Arabia, capturing the exciting magical atmosphere of an eastern bazaar, on tape? Or think of yourself round an Arab campfire recording fascinating Arabian music? Maybe not, but until September last year neither could I. Since then I have proved that this place could be known as one of the paradises of the tape recording enthusiast.

It was as recently as 1958 when I first became keenly interested in tape-recording. The son of a Yorkshire parson, naturally enough my first projects were to record the Sunday evening services and to take them round to the local hospitals and old folk. Seeing how much this was appreciated, a group of us visited an old folks' home to find out which special sounds the residents wanted to hear. One old lady longed to hear her old parrot, another old gentleman who had worked for 35 years on British Railways longed to hear the sounds of a steam locomotive, and so on.

I shall always remember the beam on that old lady's face as I played my recording of her parrot to her, and could I ever forget the hours I waited on that cold station platform to obtain the hiss of a loco.

These were early beginnings but my experience broadened somewhat when I was called on to initiate and run the Audio-Visual Aids Department of the Northamptonshire Association of Youth Clubs.

It became necessary to produce some kind of film programme, with a punch, to promote the work. The best medium I could see to use was that of a "sound-slides" programme. While the refinements of stop-frame projection, complete with recorded impulse signal automatically activating the movement of transparencies, may be beyond the reach of the amateur, it is relatively easy to make up a sound track to match the order of pictures loaded in the magazine. With each picture or series of shots having



**In the famous Bazaar the author found a jovial sort of Arab in charge of a tiny shop. Much bargaining led to the purchase of a Grundig TK6 battery portable**



a relevant track on tape, the operator simply matched the speed of picture projection to the accompanying sound track. Recorded "atmosphere" from the place where the picture was taken, played back simultaneously, has an amazing effect of bringing the scene to life. It's natural for one to describe the shots as they come on to the screen, so why not record a commentary and, where possible, back the narration with "natural sound," and music to suit the mood, dubbed behind the voice.

So I produced a programme on these lines and it was so highly successful that within one year it had been shown on 200 occasions to some 6,000 young people. The medium of "Sound slides" was so popular that inside the three years I was operating, we produced six such other programmes ranging from Hair Styles to Voluntary Service Overseas.

I guess I must have made the one on Voluntary Service Overseas (which we incidentally called "Get Cracking") so challenging that I challenged myself to do some such service. I was accepted to do social work for one year in Aden beginning in September 1964, under the auspices of the V.S.O. Seeing this as a tremendous opportunity to extend my tape recording experience even further, I approached E.M.I. Tape Ltd. for help on a project to obtain sounds appertaining to South Arabia. They kindly

consented to help and provided me with a considerable amount of equipment. Every little nook and cranny in my suitcase seemed to be stuffed with Emitape, every pocket in my suit contained either instruction tapes, splicing blocks or earphones as I set off for the Airport in that fall of last year.

### Arrival in Aden

On arrival in Aden my first task (after exchanging my thick suit for a pair of shorts) was to buy a tape recorder. As Aden is a free port this presented little difficulty, as tape recorders and cameras abound. The problem was finding the best machine for the job.

Back in Britain I had been using the Truvox Series 90 machine, but here I needed something far more portable, capable of working either from internal batteries or mains and being able to carry large spools. It was also essential to have good reproduction on the machine and a dynamic microphone with omni-directional characteristics for outdoor recording.

So down into the famous bazaar I went and began my search through the little back street shops, all smelling with the now familiar scent of animals! Every one of these little hovels of shops seemed packed with cameras, radios, eastern carpets and numer-

ous pieces of hi-fi equipment. Eventually I came across one with a jovial sort of Arab gentleman in charge. The shop, no larger than ten square yards seemed to be bulging with tape recorders of every type and description. Herein I leapt and after a good deal of reasoning, arguing and bargaining I came away the proud possessor of a Grundig TK6E! Much to my disgust I found out later that I could have bought this same machine ten shillings cheaper at the recognised dealer!

## Sheikh Othman

I soon found myself being transported to my project, in an unspoilt Arab township, some six miles north of Aden, known as Sheikh Othman. I was to work up there with a colleague from "over the border" for the next twelve months. Our work was to be among the local Arab young people and was to take place in the Approved School, the Youth Club and the Intermediate School. We were given an old classroom in the Approved School, and this was to be our home for the rest of our stay. Between us we were given a wide range of subjects to teach including English, Maths, Art, Model Making and practical skills such as metalwork, woodwork, painting and decorating, and physical training. Living and working with a people gives one a tremendous insight into their habits, culture and social outlook, and gives one a wonderful opportunity to see and hear a people as they really are.

My first project with the tape recorder was to record a greetings tape to a young people's weekend back in my old home town of Northampton. We rigged up a makeshift studio and set to work on a previously prepared script. After several hours of work a feature tape was produced in a style which we called "informative humour."

As my work progressed I soon discovered the talent of the local boys for singing the wonderful songs of Arabia, some of them with great feeling, others using a tremendous beat. This was ideal "meat" for my tape recorder and it was not long before I had a group of them singing into the microphone. On one occasion I was recording



The author seen at the gates of Lake Lines Federal Regular Army Camp. Later that day—armed with tape recorders and cameras—he was mistaken for an official of the BBC, and treated as a VIP

lads in a classroom, singing to the accompaniment of a lad on a "soup basin." Alas, the Arabic teacher would insist on breaking into the song and making some funny remark in Arabic, sending the boys into fits of laughter. However, I suppose this is the price you have to pay for an authentic recording.

### NEXT MONTH

**JOHN WHITTAKER describes how he recorded the magical sounds of the Eastern Bazaar, his future teaching projects in the Boys Club and memories of an Arab concert, in which he recorded the local "pop" singer.**

One of the highlights of December's work in the Youth Club was the camp in Sheikh Othman Gardens. Beneath Sheikh Othman are huge underground lakes and rivers, and from these water is drawn to supply the whole of Aden. Thus Sheikh Othman is quite an oasis and has a very beautiful park with a considerable amount of vegetation. These gardens were the venue of our camp to which we took 25 boys for two days.

Here, my recorder really came into its own at the evening camp fire when each of the lads stood and did a turn. There was a truly fascinating atmosphere about the whole thing as the flames licked up into the Arabian night sky, as the hurricane lamps hissed away and the melodic voices of these Arab lads mingled through the air. To capture the real atmosphere of such an occasion is a virtual impossibility but with the mediums of tape and camera I had before me I did my best. One lad in particular, excelled himself. He was an expert on the "awood" a stringed instrument like a lute, and he played and sang with great gusto, giving me some excellent recordings. These outdoor recordings are fun to make and I find the Grundig tape recorder ideal. It is robust and yet not too heavy, it is very handy to operate and the automatic switch-over from mains to battery is a boon. The double-play Emitape 100 is superb in every way.

## Military display

The date was November 29, the time was 2.30 p.m. My colleague and I were heading for the Federal Regular Army Camp at Lake Lines, Sheikh Othman, armed to the teeth with tape recorders and cameras. It was Army Day in the camp and there was to be a large military display complete with Camel Corps, Arab Pipe and Brass Bands, Armoured Cars, foot soldiers and P.T. display and an inspection by the Minister of Defence. Our first task was gaining admission to the camp as only specially invited guests were to be allowed in! We soon overcame this problem when we found that the guard on the main gate happened to be the local Boys Clubs' organiser. Once inside everybody seemed to think that we were the official BBC men and we were treated like VIP's! We were able to nip out onto the parade field, get right up to the camel corps and bands for photographs and recordings. Walk about in front of the official party and take film and sounds of the armoured cars! It was a very exciting afternoon and the products both on film and tape were excellent. As we reminded ourselves, its not every day that you are able to record indelibly the atmosphere of an Arab military display in South Arabia, so we had seized the opportunity whilst we had it. The fine, beautifully groomed camels in their



One of the guards at the Approved School where the author worked became keenly interested in tape recording. Here he is receiving a three-inch spool of tape as a reward

(Continued on page 439)

WHEN this rather irregular series of articles began, my brief was to deal with certain readers' queries that the Editor thought of general interest. Mainly, the emphasis was on service; hence the title.

Since those early days, correspondence has caused a concentration upon specific subjects each time. It is clear from the way certain questions crop up that a few words of explanation of the "special" terms used in tape recording will not come amiss. All very well for those of us who are up to our necks in the subject all day to take these terms for granted: not so much fun for the fellow who has only his own precious machine and reads articles which bandy terms freely without fully defining them. He has neither standards of comparison nor the comprehensive shelf of reference books with which this office is blessed.

The following notes, therefore, are given as an alphabetic list of the queries that have been raised most frequently in my mail. Obviously, not a full reference list of terms, which would take more space than the Editor would allow me—simply the terms that cause the most confusion.

\* \* \*

**A-B.** There are two possible meanings. With stereo amplifiers, the A-B switch allows individual selection of channels for balancing purposes. But as applied specifically to tape recorders, the A-B switch is a Comparator which allows direct monitoring of the input signal which is being fed to the recording head, and the signal which has subsequently been recorded on the tape. Therefore, a three-head system is needed, with separate Record and Play amplifiers. The Playback head comes after the Recording head (in the sense of tape travel direction), picks up the signal which has been recorded on the tape and feeds it to the Replay amplifier for monitoring. This gives a direct check on recorded quality and enables rapid setting of equalisation and bias. Interesting echo effects can be made with this switch, using a microphone and the internal loudspeaker of the tape recorder.

\* \* \*

**AUTOMATIC RECORDING LEVEL.** This is no more than it says, but the production of a control voltage from the input signal is not quite so simple in tape recording as it is in radio or television systems, where automatic gain control is a commonplace.

Some purists deprecate the use of Auto. This is a matter of taste, and many machines

that incorporate Auto circuits have a switch that "kills" the Auto and allows the operator to twiddle the knobs to his heart's content.

The system eliminates the need for a recording level meter or magic eye indicator.

From the amplified input (see Fig. 1), a control voltage is derived and fed to a stage which is so designed that the gain is altered by a change in bias. The control voltage, in proportion to the signal, changes the bias and reduces the gain of the stage on strong signals, allowing the stage to work at full gain on weak signals. Because of the need to retain wanted variations in level, i.e., between successive loud and soft sounds, a delay circuit has to be incorporated, preventing rapid fluctuations of the bias.

\* \* \*

**AUTO-STOP.** There are two principal methods of automatically stopping the tape transport. One, as used by Truvox, Telefunken and others, is a pin which presses against the moving tape and which is coupled to a microswitch. If the tape breaks, or comes to the end of the reel, the pin completes its travel, operates the microswitch and either open-circuits the motor feed or operates a relay or solenoid. This withdraws pressure roller, etc., and applies brakes.

The first system is purely a safety device. The alternative is a split, insulated tape guide which is short-circuited by a metal foil, as a tape leader might be, performing

the same "end-of-play" function, but omitting the safety device of automatic stopping if the tape should brake. Philips and Grundig both use this method. Again, the switch action is completed by the electrical short-circuit, generally actuating a relay.

The experimenter wishing to get the best of both worlds, could fit both systems quite easily. The advantage is that tapes can be stopped during travel by inserting a section of metal foil in the tape.

A further system is the photo-electric method, whereby a light is arranged to fall on a photo-electric cell when the tape is absent, again actuating switching. A refinement is the reflection of light to a cell from metal leader or light tape. Stop action can be arranged by cleaning the oxide from the tape, forming a "window."

\* \* \*

**AZIMUTH.** The tilt of a head to allow the gap to be at right angles to tape travel (see Fig. 2). Incorrect tilt causes loss of high frequencies and a roughness of sound. Adjustment is best carried out with the constant high frequency band of a test tape, using a meter to measure playback signal. For separate Record and Playback heads, the A-B switch (see above) allows easy adjustment of the Record head by setting this for maximum Playback signal while recording a constant tone.

\* \* \*

**BALANCED INPUT.** A form of transformer coupling where the winding is centre-tapped, the tap sometimes being connected to earth. The earthed centre-tap circuit should only be coupled to another of similar circuitry, but the "floating tap" type can be connected in other ways. This method, necessarily of low impedance, allows longer cables to be used for microphones, etc., reducing hum and noise problems considerably.

\* \* \*

**BIAS.** A method of overcoming the non-linear characteristics of a magnetic head by imposing a high frequency voltage on the recording signal. The frequency of the bias signal should be as high as possible, allowing for r.f. heating losses, etc., a practical rule being about four times the highest frequency needed to be recorded. Between 50 and 60 kc/s is normal. Bias level is important (see Service Bureau, July issue) to obtain efficient recording.

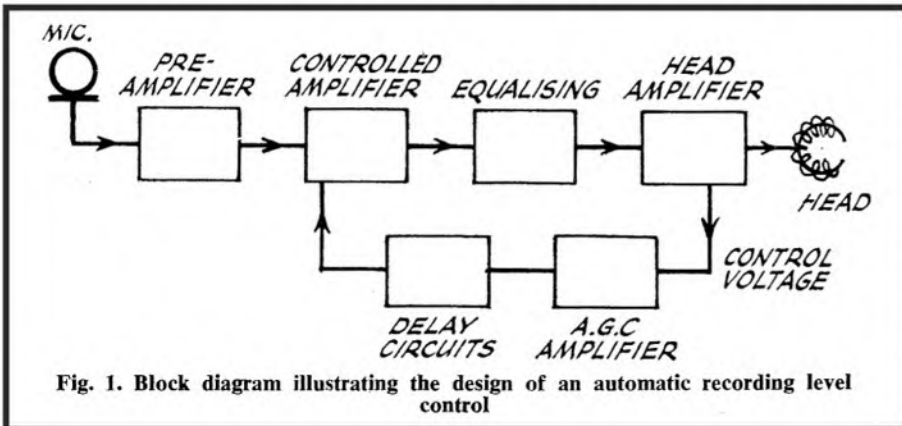

Fig. 1. Block diagram illustrating the design of an automatic recording level control



\* \* \*

**CROSS-TALK.** Where a multi-channel system is used, as with parallel track or stereo recording, adequate separation between the adjacent channels must be maintained to prevent an excess of background noise. This separation is often expressed in dB difference, and a typical figure might be 40 dB. The cross-talk effect is more noticeable at middle and high frequencies.

\* \* \*

**CROSS-TRACK RECORDING.** Known also as *Multiplay* or "*Sound-on-Sound*" techniques, this consists of playing back one output into another input from a parallel

back channel to achieve a level response. High frequency losses in the replay head are also compensated, and the pre-emphasis applied during recording, which is applied to boost high frequencies, and also "tailor" the signal to overcome noise levels, must be allowed for.

Standards are given in microseconds, and these have recently been the subject of some discussion and change. Principal standards that concern us are the CCIR and NARTB, the former being used on most British machines. Differences are slight, but quite noticeable, giving the effect of an increase in extremes of bass and treble when an

**FADE-ERASE.** A control of erasing power, enabling the extent of erasure to be altered, which can be useful when superimposing.

\* \* \*

**FREQUENCY RESPONSE.** The variation of output, at different frequencies, with a constant input level. Usual standards require a 1,000 cps input, and the output at the extreme frequencies, if not stated, is understood to be 3 dB down. The response can be stated as a graph, being appreciably level over the greater portion of its curve, with limits, as  $\pm 2$  dB, given by the makers of the equipment.

Frequency range, or Bandwidth, may be used to describe an amplifier's limits, but unless tolerances are stated, the figures given can be misleading. Response should be defined within close tolerances, or shown as a graph.

\* \* \*

**GAP-WIDTH.** Recording heads are made by winding a number of turns of fine wire on a laminated core, with the polepieces close together to form a fine gap and concentrate the magnetic field. This gap is filled by a metallic, non-magnetic shim, to assist in forcing the lines of magnetic flux toward the tape surface, and make a firm mechanical finish to the head facing. A typical metal for this purpose is beryllium copper, and typical gap widths are 1/1,000 inches for the recording head and 15/1,000 inches for an erase head.

Playback heads require a finer gap, to maintain good frequency response, the width of the gap ( $\frac{1}{2}$  thou. or less) needing to be less than the shortest wavelength to be replayed, i.e., the wavelength of the note having the highest frequency. (See also *Wavelength*.) In addition, the signal level to be handled by the Playback head is much smaller than that of the Record head, requiring more stringent design.

Combination heads have design factors to a large extent determined by Playback conditions. The advantage is that the same gap is used for Recording and Playback and this eliminates separate alignment.

A back gap is incorporated in the design to keep the mechanical and electrical symmetry of the heads, and reduce dimensions. This gap may be ten times the width of the front gap, and is also filled with a shim.

The gap length is the vertical dimension (in normal domestic machines), and depends on the track to be recorded or replayed. (See also *Tracks*.)

(To be continued)

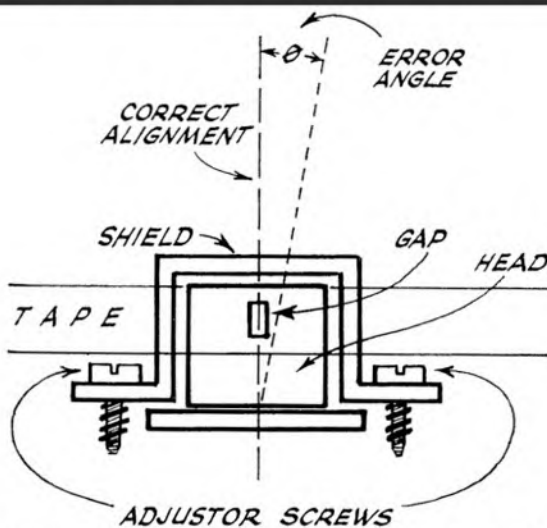

Fig. 2. Azimuth: the tilt of a head to ensure the gap is at right angles to tape travel

track machine, then mixing the input with new recordings. Thus, a complete range of sound effects can be superimposed, with direct control of comparative levels.

\* \* \*

**DE-GAUSSING.** This simply means demagnetising or defluxing, and is usually applied to the removal of unidirectional magnetism by applying a varying field from an external source. Popular defluxers consist of a transformer or solenoid with projecting polepieces, these being applied near the parts such as heads, guides, capstan, etc., and gradually removed while energised.

Automatic defluxing of heads is achieved by allowing bias or erase voltage to die away gradually, and can be done by switching to the recording mode and removing the power supply several times; but this only demagnetises heads, and does not "clean" guides, shields, etc. A magnetised head results in increased noise level; in an advanced state, giving a pronounced hiss.

\* \* \*

**DOUBLE-GAP.** A certain amount of misconception exists here. This is generally taken to refer to the erase head, where a second gap also applies an erasing field after a few milliseconds, as the tape passes, increasing the erase efficiency. (See also *Gap-width*.)

\* \* \*

**DUOPLAY.** A method of replaying two parallel tracks into a single amplifying channel.

\* \* \*

**EQUALISING** (see Fig. 3). There is a rising frequency response of a tape system which must be compensated in the play-

NARTB tape is replayed on a CCIR equalised machine.

\* \* \*

**ERASURE.** The magnetised track on the tape is "wiped clean" by causing the magnetic particles to assume a random disposition, instead of the "pattern" which a signal imposes during recording. This is effected by a strong AC field at the erase head, or by a DC field, which may give a hiss level after some time, and also a permanent magnet erasure, which has the same defect.

Bulk erasure of tape is effected by placing the spool in an AC field which is then caused to die away gradually.

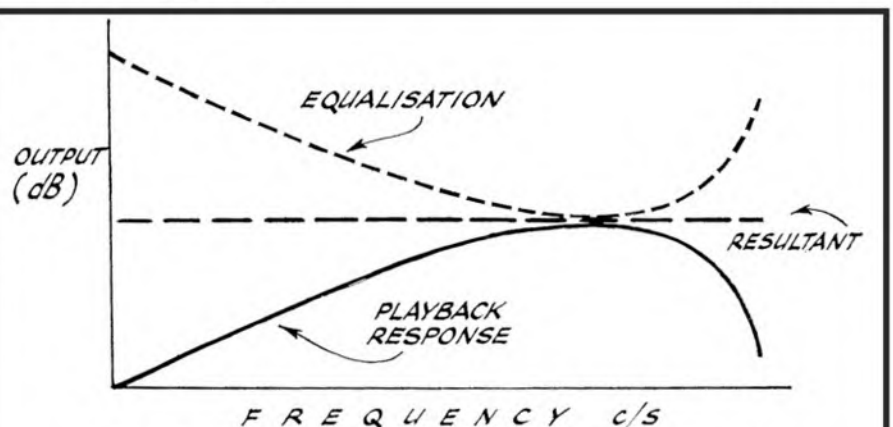
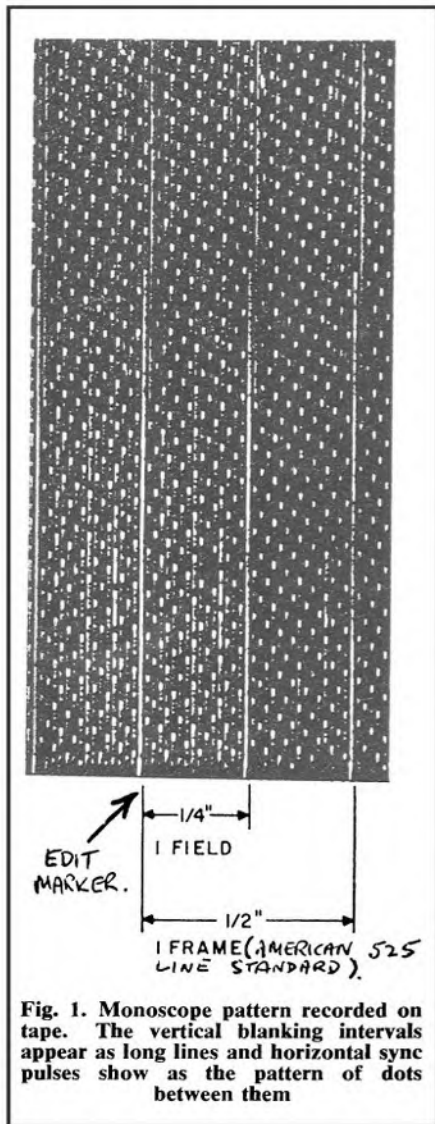

Fig. 3. Equalisation: The system of compensating high frequency losses in the replay head

**C**ONVENIENT and flexible editing is essential in TV recording practice both for the professional and the amateur—probably even more so for the latter, since he will probably have only one camera, and many fewer technical resources generally than the professionals.

Of the three main systems of recording television at present, the Ampex VR1000 has been described as an example of the transverse scan FM Video Carrier type. It uses fast rotating heads scanning across the width of a two-inch wide tape, recording video impressed on an FM radio type carrier in side by side tracks. Audio and control tracks are recorded conventionally, i.e., longitudinally, in narrow tracks along the two tape edges.

The advantages: superb audio and video fidelity on any line standard, including the ill-starved French 819 line standard. Editing and assembling need only simple equipment, and a little skill and practice. The Ampex R.C.A. system



**Fig. 1. Monoscope pattern recorded on tape. The vertical blanking intervals appear as long lines and horizontal sync pulses show as the pattern of dots between them**

# TAPE RECORDING TELEVISION

Concluding his series of articles on recording television images on tape, JOHN VALENTINE summarises the series to date and provides notes on one of the most important aspects—editing and assembling the recorded material into a composite programme.

has been described at some length, deliberately, in the series, since although at £30,000 this sort of equipment is obviously far beyond normal financial means, an adaptation of this method must be the method of the future.

The disadvantages include high cost; fairly complex head switching—the retrace tracking electronics, and the headwheel and capstan drive apparatus are high performance servo mechanisms; and largish physical size—though succeeding models get progressively smaller. The latest Ampex model VR2000 is about the size of a writing desk, and is fully transistorised.

The Sony, Philips and Loewe-Opta systems use wide tapes also, although they vary between one and two inches wide. Employing, once again, an FM video carrier, they scan long diagonal tracks across the tape, and are portable.

The video quality obtained from them was passably good, in the case of the Philips' model, very good. The sparkle of "live" quality, characteristic of Ampex R.C.A. models is lost, but was definitely no worse than average 16 mm television film programme—especially for definition and picture "jitter" in which they were better.

Editing these tapes is disappointing. A carefully-made cut across the tape gave rise to a slow "wipe" from shot to shot. Fine as a gimmick perhaps, but annoying after a few repetitions. It is not practical to cut and join along the length of a diagonal video track, so obtaining a "picture cut." Electronic editing is simple, but requires extra equipment and another unit. Once again, the cost mounts up.

For recording entire telecasts, however, these machines are excellent, and their cost must reduce in the passage of time to something practical.

The Wesgrove and Telcan machines are designed specifically for the home enthusiast. The unit examined was the Wesgrove VKR500 at £150 fully assembled (£97 in kit form). It was well made and good (intrinsic) value for money.

These machines rely on very high tape speed—like 150 ips—to get the detail of the picture; at the cost of rather poor low frequency (coarse detail) performance, and unsteady pictures. Triple-play quarter-inch tape is used. Audio will not record at such high speeds directly, so it must be modulated onto an FM carrier. We can't get away from them, can we?

Editing Wesgrove tapes proved difficult, for the reasons that frame syncs of the vision track on the tape could not be made recognisably visible with magnetic developer, nor would the sound track make sense unless the tape was running at high speed.

Cuts made in the tape, and spliced with special thin backing tape were inaccurate,

caused bad frame rolls on picture and "thumps" on the audio output. However, interesting equipment.

## EDITING

The key to videotape editing is visible development of the video and control tracks. **FIG. 1** shows a "developed" section of videotape.

The picture on the tape is a still test-card "monoscope." Note the 250 c/s control track at the bottom with the edit marker (arrowed) showing the physical position of frame sync on the tape.

The specimen shown is of an American tape, where the physical dimensions are a little smaller than ours, the principles are similar, however.

The method of visible development is simple. Very finely powdered iron or iron carbide, preferably, mixed up with petrol is swabbed gently on to the tape, and allowed to dry. The recorded magnetic tracks attract the fine particles of iron, and when the "solvent" evaporates away the iron dust is left high and dry, visible to the naked eye. When the develop is finished with, the iron dust is simply wiped off the

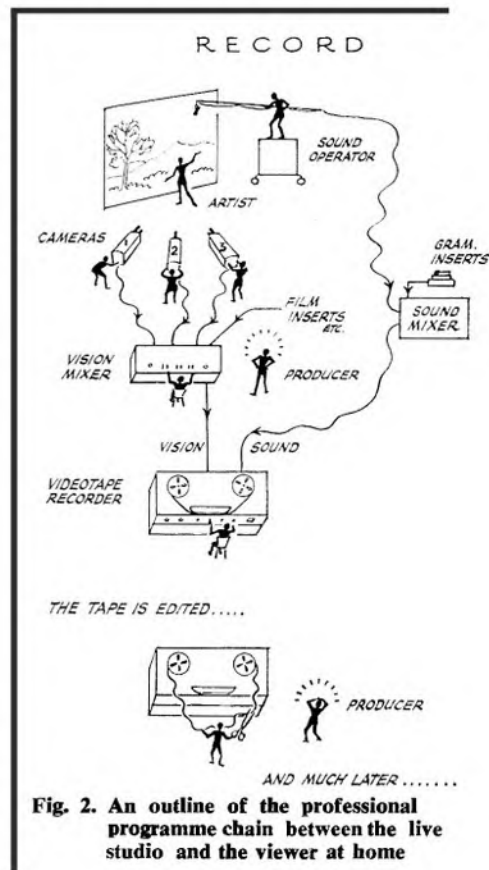

**Fig. 2. An outline of the professional programme chain between the live studio and the viewer at home**

# TAPE RECORDING TELEVISION

tape with a clean cloth.

The picture shown was prepared by putting the specimen of videotape into an iron dust/petrol bath and shaken gently. It was then taken out and allowed to dry.

A piece of sellotape was then carefully laid on the developed surface. The iron dust stuck to the goo on the sellotape, the videotape was peeled off, and the sellotape stuck face down on a white card. Bingo.

In practical development it is merely necessary to slosh the developer on to the tape and blow on it gently.

The object of development is to avoid a jump in frame synchronism, when the tape is replayed. If this should happen through random joining up of tapes (frame sync occurs every quarter-inch approximately with Ampex videotape), the replayed picture will "roll over," perhaps several times, while the displaying receiver time base is unscrambling itself from the confusing sync-information.

Also, the control track phase might suddenly change randomly. The recorder will "lose track" for a few seconds and the headwheel will retrace the recorded tracks any-old-how until it settles down

again. This causes an objectionable picture disturbance.

To avoid this, an edit pulse is superimposed opposite the physical position of recorded frame sync and the editor cuts right through it.

Provided he is careful, the joint should go through the recorder without causing a frame roll or an off-track, and the effect should be the same as that of a camera cut or a film edit—a comparatively simple affair. Current television plays go on the air with anything up to fifty joints in the tape.

One snag with Ampex-type editing is the fact that, as you may recall from illustrations in previous articles, the audio heads are further along the tape threading path from the video head position.

This means that an editor and the producer of the programme must agree on specific edit positions, otherwise, for example, a visual "jump cut" may be necessary in order that the sound track shall make sense. The difference in time is only 0.6 seconds but it is about two words at normal speech rate.

Mr. Paul Beard (September issue of *TAPE*) has rather stolen my thunder as regards editing. His directions for finding words, notes of music or even syllables are explicit. Need I say more?

With the Wesgrove, once again, this trick of "rocking" the tape is unfortunately not possible. The audio track just won't make sense, since it is on a carrier. But generally, the VTR editor will find significant points on the audio track and mark the exact position of his proposed cut in grease pencil or, better still, "Magic Marker" felt-tip pen.

He would then play the tape through and observe what happens on video at the instant his mark passes the video head. In this way he can avoid "jump" cuts, and periods when the artist shown on the screen "mouths" unheard words—the audio is in every case in a different place from the video, remember.

If all else fails, it is possible to dub off the audio track on to quarter-inch tape using an ordinary audio recorder, then edit sound and vision separately, and re-apply the edited audio back to videotape by recording with it in the "audio only" mode.

Provided the period of time is short, accurate synchronism between the two will obtain.

## A PROFESSIONAL PROGRAMME CHAIN

An outline of the professional programme chain between the live studio and the viewer (or recordist) at home is given in Fig. 2. The figure as supplied is meant to be self-explanatory, and, of course, is for interest only. The amateur will not have to bother with vision mixers or transmission chains. He will almost certainly mount his programmes by means of edited sequences—and it is this supposition that

has led me to stress the facility for editing throughout the last articles in this series.

## ELECTRONIC EDITING

Having discussed physical splicing, let us now turn to the latest development, electronic editing.

As already stated, it is not practical to join up programme sequences with tapes recorded on machines such as the Philips and Sony. The alternative here is to use electronic editors which are adaptable for all types of machines.

There are two types currently available, both by Ampex. The Electronic Editor allows a complete programme to be assembled using only one camera.

First the control track of the entire tape is recorded, then the first sequence of the programme is put on the tape. At the end of this sequence, or at any other time in fact, switching a button will actuate the master erase head which proceeds to wipe everything except the control track. The next sequence can then be recorded immediately following the first without any pause or disturbance.

The system relies on the pre-recorded control track controlling the recorder's capstan and head-wheel servos in both record and replay modes.

The recorder operator records, say, the first sequence of a programme, and when this is finished he winds back a few seconds to replay the end. In the meantime, any scenery, costume or camera alteration are made. The previous recording is then played back, and, on a cue, the video recorder "flips" into the "record" mode and the performers begin the next sequence.

The erase and record sequences are not made instantaneously, the electronic editor has a circuit which waits for (1) a frame sync pulse to occur, and (2) for the very beginning of the erased tape following the previous sequence. This section of the tape has to reach the video and audio heads before recording starts.

It is of course necessary that in the replay mode the capstan and headwheel servos are "locked" to the camera's synchronism output at the instant of flip-over to "record." At present, only the Ampex 1000C, RCA, and Sony machines offer this facility; no doubt others will be adapted in future.

Their second system, the "Editec," is even more sophisticated. It even allows for cartoon type animation. Using the Editec, the recorder changes mode automatically upon picking up a previously recorded tone burst. The position of this tone burst can be varied by the operator so finely that a single 1/25 second frame can be recorded thus providing still frame animation facilities. The Editec can be fairly regarded as the true ultimate in any form of facsimile editing, including film.

It is of interest to note, however, that even the BBC do not possess an Editec unit as yet. They have one electronic editor, though, which is used experimentally on "R3," their futuristic science programme.

So there it is. Home video recording has to come, and the steps taken professionally suggest less time to wait now than formerly expected. The remarks made by "Perspective" in the August issue make out an eloquent case indeed.

I have attempted to present the progress to date in video recording, with a particular view to exciting amateur interest in the subject. It can really be summed up very briefly: The good systems are very very expensive, the cheap systems are doubtful—but only as yet.

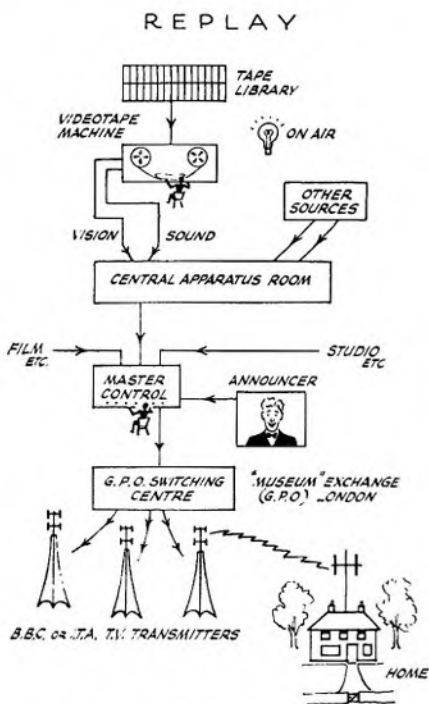
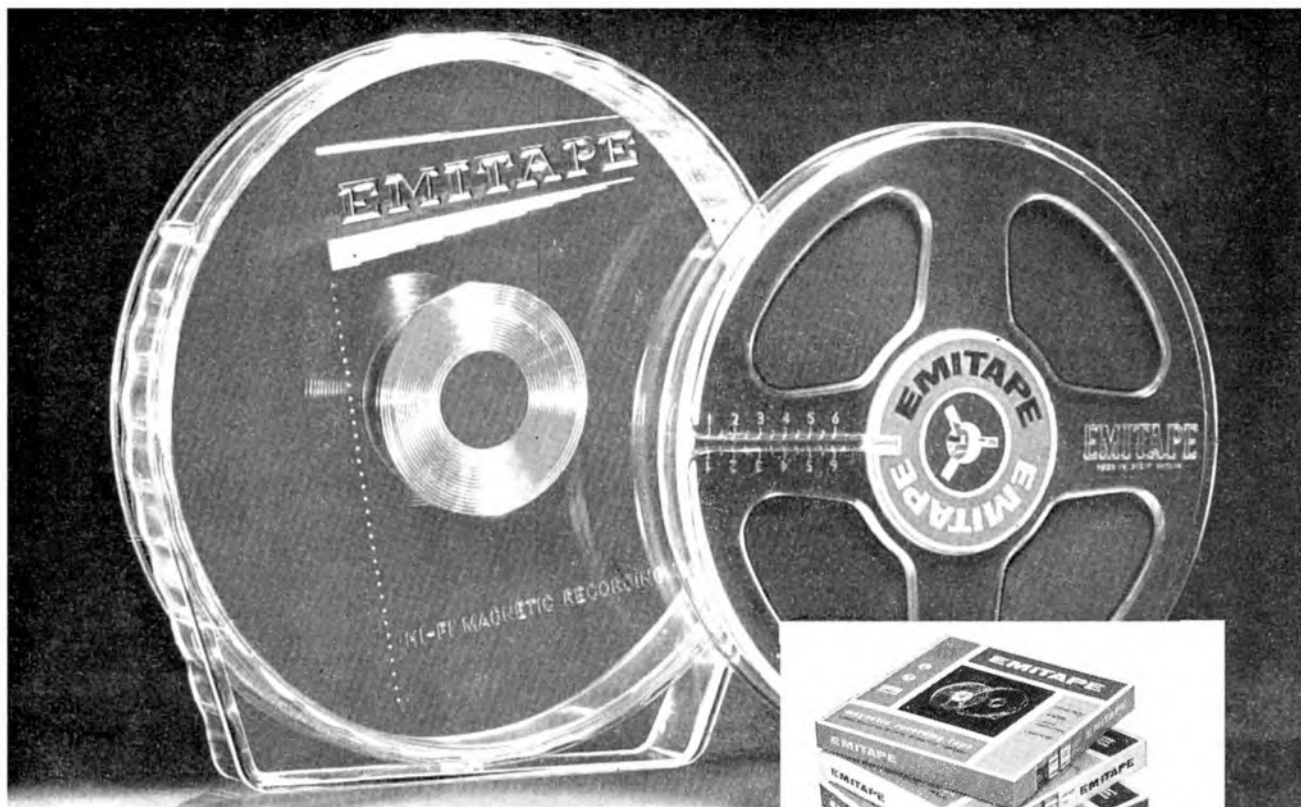

Fig. 2a. An outline of the programme chain between the viewer at home



# EMITAPE

## SETS A NEW SOUND STANDARD



### NEW TAPE

NEW EMITAPE the most advanced magnetic recording tape in the world. Automated control and rigid inspection at all stages of manufacture, using the most specialised equipment in the latest magnetic tape factory in Europe, ensures that every reel of the new range of EMITAPE is of superlative quality for your recorder.

New magnetic oxide coating techniques, combined with new high strength polyester base films, provide:

- ★ WIDER FREQUENCY RANGE
- ★ IMPROVED UNIFORMITY
- ★ GREATER STRENGTH
- ★ SUPER LONG-LIFE

— together with all the long established EMITAPE features acknowledged by the BBC and other leading broadcasting and recording organisations throughout the world.



*The tape that stands on its own*

**AT YOUR LOCAL DEALER NOW**

### NEW PACKS

All four grades of EMITAPE – Standard, Long, Double, and the new Triple Play are packed in special dustproof library cases at *No Extra Cost*. These library cases have the added advantage of being self-standing for compact storage and transparent for easy reference.

TRY THE NEW EMITAPE NOW!

Send off this coupon now for a leaflet giving full details of NEW EMITAPE.

NAME .....

ADDRESS .....

c

E.M.I. TAPE LIMITED · HAYES · MIDDLESEX

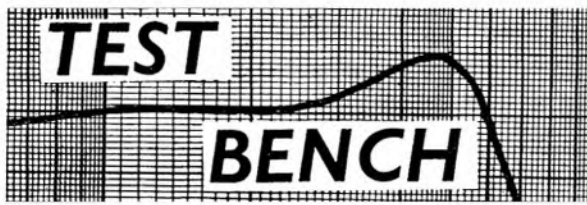
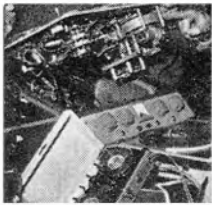

## SOUND TRE40

By H. B. Hadden

**T**HE Sound TRE40 is a portable mains-operated tape recorder in the medium-price range. It is a four-track, monophonic machine, and will record and play back at three speeds,  $7\frac{1}{2}$ ,  $3\frac{1}{2}$ ,  $1\frac{7}{8}$  ips. It is housed in an attractive lightweight wooden case, with two-tone grey plastic imitation leather covering. The dimensions are 17 x  $16\frac{1}{2}$  x  $7\frac{1}{2}$  inches. A similar machine, the TRE42, is available with two-track heads.

The tape transport mechanism of the TRE 40 is the latest version of the now well-known BSR TD 10 tape deck, and all the controls for the movement of the tape are on the deck panel. On the right-hand side is the single knob which starts the tape in the record and replay modes, the same control also acting as the fast forward and rewind switch. The rewind time for the machine set for review was two minutes and 25 seconds, for a seven-inch reel of standard-play tape (1,200 ft.). On the left-hand side of the machine is the speed control for the three tape speeds, and the record switch, which must be used in conjunction with the play control in order to set the machine in the recording condition. This automatically returns to the play condition when the machine is stopped, so that accidental erasure of tapes is avoided.

Also on this side of the deck is the digital-type tape position indicator with its thumbwheel zero reset. The rear head cover is quickly removable so that the heads can easily be cleaned, but, as I think I have mentioned before, the front cover is

a fixed part of the deck moulding and so cannot be removed. This is rather a pity, since it tends to make editing rather difficult.

All the other controls are on a panel below the deck, and are very simply arranged. The first two controls, starting on the left-hand side, are the recording gain controls. The first of these is for microphone, and the second for radio or other high impedance input at 250 K ohms. The sensitivity at this high impedance is 250 millivolts. The microphone sensitivity is  $2\frac{1}{2}$  mV. A low impedance at 5K ohms



with a sensitivity of 10 mV is also provided, but it is a pity that when this is in use the microphone fader has to be used, and no mixing facility is possible.

The other three controls operate on replay only, and are quite independent of the record controls so that both functions can be preset, a very useful feature. These remaining controls are volume, treble and bass. Also on this control panel are two miniature slide switches, one to select which of the four tracks is to be used, and the other a facility for paralleling both the replay heads, so that two tracks can be played simultaneously. This last is a very useful feature, especially when compiling sound tracks for amateur film or slide shows. The record level indicator, also on this panel, is of the straight-line magic-eye type.

All the input and output connections are made by the now almost universal DIN-type plugs and sockets, and all, except the microphone socket, are grouped on a small

panel at the rear of the machine, together with the mains voltage adjuster panel. Here are to be found the high/low impedance input socket, and also the standard DIN socket for record and reproduction from a suitably-equipped radio set. The output from this socket to feed a high-quality amplifier is 250mV in 33K ohms. There is also a socket to feed an external loudspeaker at 3 ohms, and the available output power is three watts. The microphone socket, on the control panel, is designed for a high impedance microphone. A simple crystal microphone is provided with the machine.

The machine was given the usual practical and technical tests. Before commenting on these I must draw attention to the fact that the manufacturers do not give any tolerances for their quoted frequency response, and give a frequency range only for the  $7\frac{1}{2}$  ips speed. Neither do they give any figure for signal-to-noise ratio. Personally, I just would not buy a machine if the makers did not give these figures. I would be very suspicious immediately. The performance of the machine could be very good, but the inference could be that the makers were afraid that it was not good enough to sell. Quite apart from this, the lack of an accurate specification makes the reviewer's job much more difficult. The only thing to do is to fall back on the tolerances that have become accepted as standard for domestic equipment. In the case of frequency response, this is usually taken as  $\pm 3$  dB, and if this is applied to the  $7\frac{1}{2}$  ips curve it will be seen that the TRE40 is within these limits except for an unpleasant rise at 8 Kc/s, over the range 40c—14,000 cps, a good average, but not so good as some machines in this class.

On replay only, however, this rise does not occur, and although the machine is not as good as it might be at the high frequency end, it is quite possible to get good reproduction from pre-recorded tapes.

At  $3\frac{1}{2}$  ips the picture is not as good as might be expected from modern techniques, the response being 3 dB down at only 7,500 cps. In fact the curve for  $1\frac{7}{8}$  is much worse, the same loss occurring at 2,000 cps. I do not think these figures are very impressive; figures of -3 dB for 16,000 cps at  $3\frac{1}{2}$  and 7,000 cps at  $1\frac{7}{8}$  can be found on other machines. The measured signal-to-noise ratio at  $7\frac{1}{2}$  ips was 37 dB, again falling rather short of the figure hoped for. It may well be that the manufacturers cannot do better than this for the price; if they had said so in their specification, by giving their own figures, then I would not have been able to make these comments!

On music, the machine performed well at  $7\frac{1}{2}$  ips, except for the high frequency rise, especially when played through an external loudspeaker.

The most pleasing reproduction seemed to be obtained at  $3\frac{1}{2}$  ips, and the machine would appear to have been designed for use at this speed; there seems to be no provision for changing the equalisation at the other speeds. At  $1\frac{7}{8}$  ips the reproduction was rather woolly on music, but with suitable adjustment of the bass control was fairly good on speech.

Again, no specification was given for wow and flutter, but this machine performed very well in this respect. No trouble was experienced, even at  $1\frac{7}{8}$  ips.

I find it difficult to give an overall assessment of this machine. As one of the few in this price range to have the  $7\frac{1}{2}$  ips speed it deserves commendation, and at this speed performs quite well. However, I feel that otherwise it could be a lot better. If only the makers had given a proper specification!

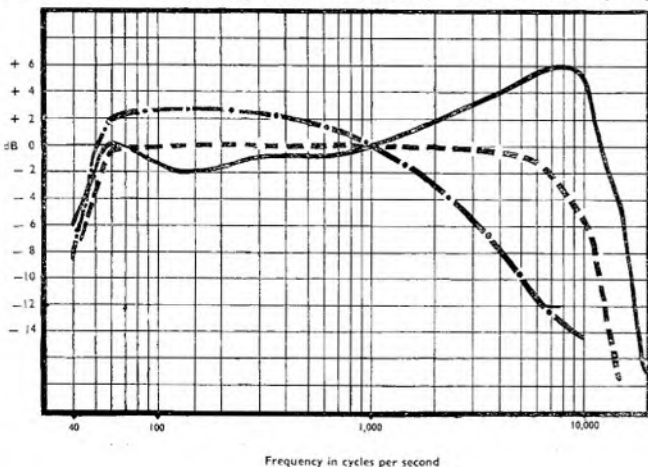

**Record/replay characteristics of the Sound TRE 40 tape recorder:**  
 $7\frac{1}{2}$  ips —————;  
 $3\frac{1}{2}$  ips - - - - -; and  
 $1\frac{7}{8}$  ips - · - · - ·

# FRANCIS OF STREATHAM

## MAINS TAPE RECORDERS

*Beocord 2000 ... ..	112 gns.
*Beocord 1500 ... ..	89 gns.
*Brenell STB2 ... ..	£150
*Brenell Mk. 5/M Series 3	93 gns.
*Brenell Mk. V Series 3...	74 gns.
Cossor 4 Tr. 1604, 2 speed	39 gns.
Cossor 4 Tr. 1605, 4 speed	62 gns.
Cossor 4 Tr. 1606 ... ..	29 gns.
Cossor 4 Tr. Stereo 1607	57 gns.
Elizabethan LZ24 ... ..	34 gns.
Elizabethan Auto ... ..	26 gns.
Elizabethan LZ32 ... ..	29 gns.
Elizabethan LZ34 ... ..	32 gns.
Elizabethan 4 Tr. 511 St...	65 gns.
*Ferroglyph 631 ... ..	88 gns.
*Ferroglyph 632 Stereo...	115 gns.
Fidelity Major ... ..	35 gns.
Fidelity Playmaster 2 Tr.	21 gns.
Fidelity Playmaster 4 Tr.	23 gns.
Grundig TK14L ... ..	37 gns.
Grundig TK17L ... ..	43 gns.
Grundig TK18L ... ..	41 gns.
Grundig 23L Auto ... ..	49 gns.
Grundig TK40 4 Tr. ... ..	87 gns.
Grundig TK41 2 Tr. ... ..	83 gns.
*Grundig TK46 4 Tr. St...	107 gns.
Philips 4 Tr. 3549 ... ..	62 gns.
Philips 4 Tr. 3534 Stereo...	92 gns.
Philips 4 Tr. 3548, 2 speed	39 gns.
Philips 2 Tr. 3552 Auto ...	24 gns.
*Revox 736 ... ..	124 gns.
*Saba Stereo TK230 ... ..	94 gns.
Sony 200 ... ..	72 gns.
Sony 500 ... ..	105 gns.
Sony 600 ... ..	127 gns.
Stella 4 Tr. 458 ... ..	39 gns.
Stella 4 Tr. 459 ... ..	62 gns.
*Tandberg Series 6 ... ..	110 gns.
*Tandberg Series 7 ... ..	93 gns.
*Tandberg Series 8, 2 Tr.	54 gns.

*Tandberg Series 8, 4 Tr.	59 gns.
Telefunken 55 ... ..	43 gns.
*Telefunken 85 de luxe ...	83 gns.
*Telefunken 96, 4 Tr. ...	69 gns.
*Telefunken 98, 1/2 Tr. St...	95 gns.
*Truvox R.102 ... ..	76 gns.
*Truvox R.104 ... ..	79 gns.
*Truvox PD102 St. ... ..	93 gns.
*Truvox PD104 St. ... ..	89 gns.
*Vortexion WVA, 3 speed	£96.7.0
*Vortexion WVB, 3 speed	£115.10.0
*Vortexion CBL Stereo...	£172.0.0
Wyndor Sabre ... ..	23 gns.
Wyndor 2 Tr. 707 ... ..	29 gns.
Wyndor 4 Tr. 707 ... ..	32 gns.

## BATTERY PORTABLES

Akai X-IV, 4 Tr. Stereo...	131 gns.
*Butoba ... ..	59 gns.
Cossor 1621 ... ..	26 gns.
*Fi-Cord 202/A ... ..	66 gns.
Grundig EN3 Notebook	23 gns.
Grundig TK6 ... ..	69 gns.
Loewe Opta 408 ... ..	39 gns.
Loewe Opta 414 ... ..	51 gns.
Philips EL3301 ... ..	26 gns.
Philips 3586 ... ..	26 gns.
Stella 471 ... ..	26 gns.
Telefunken 300 ... ..	49 gns.
Uher 4000S ... ..	99 gns.

\*Microphone extra

## MAINS POWER PACKS

Butoba ... ..	11 gns.
Fi-Cord ... ..	£7.10.0
Philips, Stella or Cossor...	£5.12.0
Uher 4000, with cell ...	18 gns.
Telefunken 300, with cell	£19.10.0

TAPE DECKS by Brenell, Wearite, TAPE-TO-DISC and Copy Service.

## LEADING STOCKISTS OF EQUIPMENT FOR TAPE and HI-FI

... and NO EXTRA FOR CREDIT TERMS

- ★ Minimum Deposit
- ★ No Interest or Service Charges on H.P. up to 18 months
- ★ Free Service during Guarantee Period

Prices subject to alteration as announced by manufacturers

## MICROPHONES, MIXERS, etc.

AKG D119 ... ..	£24.10.0
AKG D77A Stereo ... ..	£15.10.0
AKG D19C ... ..	£17.10.0
AKG K50 Headphones ... ..	£7.10.0
Eagle Mixer ... ..	£2.19.6
Fi-Cord TM-II Mixer ... ..	£11.5.0
Grampian Reflector ... ..	£6.15.0
Grampian DP/4 Dynamic ...	£8.5.0
Grampian Ribbon ... ..	£11.10.0
Grundig Mixer (Stereo) ...	18 gns.
Philips Preamp ... ..	£6.10.0
Reslo Ribbon ... ..	£10.12.6
Reslo Pencil Dynamic ... ..	£11.12.6
Simon "Cadenza" Ribbon ...	£10.10.0

Also in stock: microphones by ACOS, BEYER, FILM INDUSTRIES, TELEFUNKEN, etc.

● All WALGAIN Products

## TAPE AND ACCESSORIES

Standard, Long, Double, Triple Play in all sizes by all leading makers.

● DEFLUXERS by Wearite, Walgain

## PRE-RECORDED TAPES

by Columbia, H.M.V. and all E.M.I. labels, Crown, Phonoband, etc.

TAPE SPlicERS by Bib, Bond, E.M.I. Matching transformers, plugs, sockets, etc.

STANDS for all types

## Hi-Fi Dept.

- AMPLIFIERS (mono & stereo)
    - Quad Scott Tripletone
    - Leak Rogers Cadet Mk III
    - Armstrong B. & O. Pye
    - Loewe Opta CSL
  - TUNERS
    - Quad Rogers B. & O. Leak
    - Armstrong Pye Tripletone
  - LOUDSPEAKERS
    - Quad Pye W.B. Wharfedale
    - Goodmans Tannoy Leak
    - Lowther Kef Rogers Elac
    - Eagle Kelly S.H.B. Tandberg B. & O.
  - MOTORS, PICKUPS
    - Garrard incl. Acos ADC
    - AT6, 401, etc. Thorens
    - Goldring Tannoy EMI
    - Connoisseur Lenco
    - Decca incl. Shure
    - ffss Mk. III Ronette
    - Deram, etc. Sonotone
    - Philips B. & O. BSR
    - Ortofon SME Mk. 11
- All types of Diamond and Sapphire styli, stereo and mono. Microlifts, Garrard, Goldring, Acos Pressure Gauges; Disc Prener, Acos Dust Bug
- CABINETS—Record Housing and GKD

Please note our only address as below

169-173 STREATHAM HIGH ROAD, LONDON, S.W. 16

Between St. Leonard's Church and Streatham Station

STreatham 0466/0192

OPEN ALL DAY SATURDAY—1 p.m. Weds. ●FREE CAR PARK, Prentis Rd.

TAPE DECKS - RECORD PLAYERS - HI-FI EQUIPMENT - MICS - RADIOS - SPEAKER SYSTEMS



## HI-FI EQUIPMENT LIKE CONTEST WINNERS USE!

ONE CANNOT COMPROMISE WITH HIGH-FIDELITY. THE ONLY WAY TO SAVE MONEY IS BY BUILDING THE MODELS YOURSELF!

### Compare any Heathkit model for price, performance, quality

Ease of assembly is guaranteed—even for those without previous experience—by the comprehensive yet simple step-by-step construction manuals supplied with every Heathkit model.

Because you build them yourself—Heathkit units cost considerably less than comparable pre-assembled equipment. You cannot buy the parts any other way as cheaply.

Every Heathkit product—assembled in accordance with our instruction manuals is guaranteed to meet published performance specifications, or your money will be cheerfully refunded.

By taking advantage of our convenient credit terms—you can enjoy your model right away—and pay for it in easy monthly instalments.

### OUR WIDE RANGE INCLUDES:—

#### AUDIO

Cabinets, Turntable Units, Mono and Stereo Amplifiers, Pickups, Speaker Systems Mono and Stereo Control Units, Tape Pre-amplifiers, Tape Decks, Mixers, etc.

#### RADIO

AM/FM and FM Tuners, Transistor Radios, SW and Communication Receivers.

#### TEST INSTRUMENTS

A range of Audio Test, Home Workshop, Service, and Laboratory Instruments.

#### MISCELLANEOUS

Children's Hobby Kits, Tool Kits, Intercom, Electric Organs, and a wide range of Amateur Radio Gear.

## SEE THE COMPLETE HEATHKIT RANGE IN THE FREE CATALOGUE



STEREO AMPLIFIERS from £13.7.6 kit



TAPE PRE-AMPLIFIERS from £19.18.0 kit



AM/FM TUNERS from £16.8.0 kit



CABINETS from £11.12.6 incl. P. T.



TAPE DECKS from £14.19.6



SPEAKER SYSTEMS from £11.17.6 kit



Without obligation please send me

### FREE BRITISH HEATHKIT CATALOGUE

Full details of Model(s) .....

Name .....

Address .....

(Block capitals please) .....

T.11

ALL MODELS also available assembled. Prices on request. Deferred Terms available in the U.K. over £10!

# DAYSTROM LTD.

Dept. T-11  
Gloucester, England



# Dramatape

## Miscellany

### By PERSPECTIVE

ONE of drama-on-tape's advantages is spectacle-in-sound. Battles, storms at sea, air-raids—all these scenic effects can be created on tape by the solo worker. But the simple rules of aural perspective must be followed if you want good results.

Try building a crowd scene. The process is very easy—although it is complicated to describe in print. The same principles apply to all scenic effects.

Forget about rhubarb. Build your crowd on the two simple words in the language—"yes" and "no."

First, set your gain-control to record your voice at a very-close microphone-position. Say the word "yes"—and then step backwards a few feet. Stand still and say "no." Then step back still further and say "yes"—then back even further for a final "no." Leave the gain-control at the same setting throughout.

On playback, you'll hear a succession of four voices—each speaking from a separate voice-position. It's more effective, of course, if you disguise each voice. And do put some gusto into the exercise: a flat, monotone voice is useless. Draw out the vowels heartily, sadly, aggressively—it is this that creates the mood (or variety of mood) of your crowd. But ensure that each voice is well-contrasted against the others in scale of volume. There won't be any contrast if (a) the gain-control is too high; or (b), your voice-positions are too close together.

So far so good. Make a small mark (in tailor's chalk) on the carpet to indicate each of the four voice-positions. Now carry on recording "yes" and "no" for as long as you need—stepping to-and-fro on the chalk marks. Avoid excessive pauses between each word; but allow slight pauses.

You can now super-impose or mix this tape with a fresh recording—thus creating two levels of crowd-voices. And this will sound quite a crowd! You then use this

tape as a "background" for the "foreground" action—that is, it is mixed with the microphone at the final drama-recording session.

Your exact treatment, of course, will depend on the scene and your own production-ideas. For example, I am producing the crowd-tape for the funeral scene in "Julius Caesar" (Act III, Sc. II). At the start, the crowd is anti-Antony and pro-Brutus. Then, during the oration, they switch sides—swayed by Antony's oratory. To emphasise this change, I have placed Antony in the *background* at the start of his oration—with the crowd in the foreground. We hear Antony from the distance; and can scarcely hear his words amid the hostile shouting of the crowd. Then, during the oration, I gradually reverse these positions. Antony speaks from the *foreground*—i.e., from a close-microphone voice-position. This position is the most powerful in a perspective construction. Towards the finish, Antony is virtually cooing in the ear of the listener; the crowd (so to speak) are at his feet—that is, they are relegated to the background.

Such a construction entails much interesting editing and mixing. A little thought will soon reveal how you can adapt the same technique for other types of scene. For example, you can create a factory by spacing out small mechanical gadgets; similarly, by whacking cushions at suitable distances, you can have ships' cannon firing on a rolling sea. But it will all be a hopeless mess if the sounds are jumbled up anyhow!

### KEEP ON LAUGHING

Should there be laughter during the recording of a dramatape? Or should the actors keep quiet on pain of expulsion?

Personally, I am only too glad if the actors laugh during a sketch—provided they are not acting at the time. Also, depending on the type of material, it is most helpful to have the presence of a few studio guests. Their laughter contributes to the occasion—and drama-on-tape, after all, is primarily a social activity. We read plays and sketches to enjoy ourselves—not to entertain or edify an anonymous public.

Plays are a different matter. Laughter, even in a downright comedy, can be out of place. But I sometimes like a recording to open with the "settling down" of the actors—the ruffling of scripts, the ironic remarks about the weather, etc. It is all part of the social occasion—which (I repeat) is the primary function of the dramatape.

However, I am surprised to hear that amateurs are copying a so-called "professional" ruse—that of dubbing laughter and applause from a tape-loop. Such laughter is generally recognisable for being hysterical and indiscriminate—as on certain TV shows and comedy-discs. From the professional, such a ruse is cynical; but, from the amateur, it is merely pathetic. I would prefer to produce all my dramatapes in stony silence if I had no friends to applaud them. Pre-recorded laughter and applause (I suggest) are only legitimate when included as a conventional sound-effect.

## Two-minute tape sketch by David Haines

A monthly exercise in perspective, acoustics, and sound-effects.

THIS is an exercise in simple voice-positions. *1st Voice* is closest to the microphone and the *8th Voice* is the most distant.

Enact these voices yourself. Move progressively backwards—from one voice-position to the next. One reaching the eighth (and most distant) voice, return voice-by-voice to the microphone.

Note carefully the order of numbers; avoid footsteps; and keep the voices well-contrasted.

### IN THE REFECTORY

**1st VOICE:** Those peaches I picked in the monastery garden look delicious. But I don't think the bowl should stay down the other end of the table. I haven't had a single one! Brother Michael, will you pass the word to pass the peaches?

**2nd VOICE:** Certainly, Brother John. Pass the peaches, please!

**3rd VOICE:** Pass the peaches, Brother Thomas.

**4th VOICE:** Pass the peaches, Brother Henry.

**5th VOICE:** The peaches? Ah, yes—pass the peaches, Brother Nicholas.

**6th VOICE:** Pass the peaches, Brother William.

**7th VOICE:** Certainly. Peaches, please!

**8th VOICE:** What? Speak up!

**7th VOICE:** The peaches—pass the peaches!

**8th VOICE:** I haven't had one myself yet.

**7th VOICE:** Well, take one and pass the bowl.

**8th VOICE:** All right. Here you are—I've taken mine.

**7th VOICE:** And I might as well take mine.

**6th VOICE:** And I'll have mine.

**5th VOICE:** Me, too. Fresh fruit is essential to health.

**4th VOICE:** and I'll have one.

**3rd VOICE:** And I'll have mine.

**2nd VOICE:** Me, too. There you are, Brother John—there's the bowl.

**1st VOICE:** But it's empty!

**2nd VOICE:** That's life, Brother John—that's life.

## ENDURANCE AND RELIABILITY

To record and reproduce faithfully are important requisites of any Tape Recorder, but alone they are not enough.

The ability to do these things for long periods—under the most arduous conditions of usage—withstanding the rigours of unfavourable climates and robust handling, pinpoints another important Ferrograph feature—Endurance.

Many Ferrographs, supplied 12 years ago, are still in daily use by Government Departments, Broadcast Authorities and in educational establishments. They have endured and the modern Ferrograph, built in the same tradition, will similarly endure.

Ferrograph offers a simple and indeed clinical presentation. Ferrograph offers expert engineering and a thorough-going specification that will stand up to any test and evaluation.

Ferrograph is an instrument for the music lover—for the discerning recordist—for the professional user and for the man to whom *reliability* and *endurance* are features that mean much, and that will reward him for the extra price he will be called upon to pay.

THERE'S  
MORE IN  
FERROGRAPH



THAN MEETS THE EAR

*The Complete Manual of the Ferrograph, a sixty-four page illustrated quarto volume, bound in cloth, and containing full operational and technical data is supplied without charge to every Ferrograph owner on receipt of a completed registration card. It can be made available in advance to others interested however, price £1 on direct application. This sum will be refunded on the return of the registration card of any instrument subsequently purchased. (State Stereo or Mono).*

Please send me a copy of the "Manual of the Ferrograph" for which I enclose £1.

Please send me a copy of the Ferrograph leaflet.

NAME.....

ADDRESS.....

TRM-10

The Enduring **Ferrograph**

THE FERROGRAPH COMPANY LTD., 84, Blackfriars Road, London S.E.1. Telephone: WATerloo 1981

# A paradise for the tape recording enthusiast

(continued from page 429)

smart green and gold rig-out, standing majestically upright, the white sun-drenched parade ground, set off by rank upon rank of Arab soldiers and dark green shining armoured cars—is indeed a fine spectacle.

Those of you who know anything about Islam will know that the Muslim calendar is dotted with Holy Days. The average Arab has no idea what they commemorate, but more often than not they are in memory of various famous sheikhs and Sultans, who are long-since dead. On these days the schools in the area usually hold an impromptu concert in the school playground.

In the course of my teaching in the Intermediate School, several of these days have cropped up. It is a most interesting affair, all the 760 pupils take chairs onto the play area and place them round a makeshift stage, made from several large tables. The proceedings are led by the Religious teacher, usually decked in a long flowing nightgown affair and the school band. Amid cheering and hearty laughter, various boys and the more confident teachers, jump in turn up onto the stage and sing a song or tell a joke or story. Every so often the Religious

teacher says a few prayers and then the proceedings continue as before.

The five-piece school band are "in their element" on these days and are put to good use playing Arab "pop" tunes. The band comprises a set of drums and four Hohner Melodicas. They practice regularly and by Arab standards are first class. Not content on Arabic music I have now got them playing several British numbers, including "Never on Sunday." Again these concert days and the band have made fine material for my recordings and you can be sure I have jumped at every opportunity. The lads enjoy a personal interest such as I and my recorder are taking and so always excel themselves when the "mike" is on.

Again looking back at the Muslim calendar we see that the fasting month of Ramadan has just ended. During this month Muslims fast and pray from 6 a.m. till 6 p.m. each day and then feast the whole night. As I am taking down the whole story of my work here on film and tape, I slipped into the Approved School Mosque several evenings to record and film the prayers and recitations of the Koran. How-

ever contrary it may be to my own spiritual beliefs, I nevertheless found it a most interesting experience. The mumblings of the Koran are accompanied by the droning of the priest and the answer of the congregation. Sometimes said upright, sometimes on bended knee, sometimes prostrate on the ground, but always pointing towards Mecca. One could not help thinking how dead and formal it all seemed and nothing of the peace, happiness and contentment of the heart, when Christ is in charge, existed.

Immediately after Ramadan comes Id, a two-day holiday. Id can be likened to our Christmas from the point of view that the Muslims give each other presents and goodwill abounds. All my tape recording activities and enthusiasm have obviously gained the interest of the local Arabs. In particular one of the guards at the Approved School, a young fellow from the Yemen, has become keenly interested in the subject.

This Id he treated himself to a Philips portable tape recorder. No doubt imitating myself, he has been spending much of his time since, recording the school choral society and has been playing his recordings to me at meal times! With his fanatical enthusiasm and my coaching he will soon be well on the way to getting the quality right. I was so thrilled at having my first successful Arab pupil that in front of the whole school I presented him with a three-inch spool of tape. This he accepted with gratitude but, as is the Arab custom, repaid me in kind by sending me a large box of fruit round to my room. His enthusiasm of course repaid me in mind.

These are just some of the exciting experiences one can enjoy tape-recording in South Arabia. Next month I shall be recalling further adventures in Aden.

## TAPE 70

### Professional Recording Tape

A vastly superior British P.V.C. professional audio tape now made available to the discriminating enthusiast.

### Unconditionally Guaranteed

#### STANDARD PLAY

3 in.	150 ft....	3/3
4 in.	300 ft....	6/6
5 in.	600 ft....	11/6
5½ in.	900 ft....	14/6
7 in.	1,200 ft....	17/6

#### DOUBLE PLAY

3 in.	300 ft....	6/6
4 in.	600 ft....	12/-
5 in.	1,200 ft....	22/6
5½ in.	1,800 ft....	29/6
7 in.	2,400 ft....	37/6

#### LONG PLAY

3 in.	225 ft....	4/3
4 in.	450 ft....	7/6
5 in.	900 ft....	14/6
5½ in.	1,200 ft....	17/6
7 in.	1,800 ft....	25/-

#### TRIPLE PLAY

3 in.	600 ft....	13/-
4 in.	900 ft....	17/6
5 in.	1,800 ft....	35/-
5½ in.	2,400 ft....	48/6
7 in.	3,600 ft....	62/6

● Ask your usual dealer or order DIRECT (p. & p. 2/- per order)  
FROM THE SOLE DISTRIBUTORS

**LEDA TAPES (T), 30 Baker St., London, W1**

\* only the best  
is good enough...

FOR YOUR RECORDER

### metrostroke

For checking the accuracy of tape recorder playing speeds (3½, 7½ and 15 i.p.s.). Reversible dial for 50/60 cycles.

PRICE 12/6



### klenzatape

The only tape head cleaning system in the world approved by and recommended by all leading manufacturers.

PRICE 13/6

other accessories

metro-tabs 4/- per set  
metro-stop 17/6 per set  
metro-splicer 15/- per kit

Always ask for metrosound tape and audio accessories  
**metrosound manufacturing co. ltd.**  
bridge works, wallace road, london, n.1. canonbury 8641 (3 lines)

◆ **metrosound**



**YOUR LOCAL DEALER**

**LONDON**

● **WEST END SELECTION  
in NORTH-WEST LONDON!**

TAPE RECORDER  
AND HI-FI CENTRE

Part Exchange, H.P. and Credit facilities

- **TAPE RECORDERS PURCHASED  
FOR CASH**  
Second-Hand BARGAINS—SPARES  
and REPAIRS
- TRUVOX, BRENELL, FERROGRAPH,  
BANG & OLUFSEN, PHILIPS, etc.

**GREENE & COOPER Ltd.**

211 Kenton Rd., **WOR 8006**  
Kenton, Harrow.

**Lee Electronics**

THE TAPE RECORDER & HI-FI AUDIO SPECIALISTS  
400, EDGWARE RD., LONDON, W.2 (PAD 5521)

London's leading Stockists of High-Fidelity  
and Audio Equipment. Many bargains in  
new and reconditioned equipment.

SEND FOR FREE LISTS OF RECORDING  
TAPES, RECORDERS, AMPLIFIERS, ETC.



APPOINTED B. & O. AGENTS

- ★ TAPE RECORDER HIRE
- ★ TAPE TO DISC 78 & LP
- ★ RECORDING STUDIO
- ★ TAPE RECORDER  
REPAIRS
- ★ SALES—EXCHANGES

**MAGNEGRAPH**

1, Hanway Place, London, W.1.  
Tel.: LANgham 2156

**Masseys Centre  
of Sound**

West London's Hi-Fi Tape Recorder Specialist  
—Demonstration Room with Comparator  
APPOINTED FERROGRAPH DEALER

**AT  
CHISWICK, W.4**

Accessories, All Kinds—Servicing—Pre-Recorded  
Tapes Mono/Stereo  
121-123 High Road—10 a.m.—7 p.m.

◀ **TEL: CHI 2082** ▶

(not closed for lunch)

## Tape records reviewed

**CLASSICS** **Richness,**



By Edward  
Greenfield

**warmth  
and  
religious  
dedication**

**BRAHMS** Symphony No. 2. **SMETANA.**  
From Bohemia's Woods and Fields.  
Bamberg Symphony Orchestra con-  
ducted by Rudolf Kempe. WRC  
(TT 424), 3½ ips, mono, 29s.

As we know from his work with British orchestras, above all the Royal Philharmonic, Rudolf Kempe's conducting of Brahms shines out with a rare incandescence. If Klemperer plays Brahms with uncompromisingly rugged strength, if Karajan refines it, makes it athletic, Kempe underlines its richness and warmth without ever falling into the usual trap of vulgarity or sentimentality.

Kempe's richness and warmth have nothing over inflated about them, nothing of nineteenth-century opulence, but are linked with a sense of almost religious dedication. Kempe by his own personal dedication can turn even so hackneyed a work as Dvorak's "New World" Symphony into a new and higher experience, and it is the same with Brahms.

Normally you would not expect a performance of the finest world class from the Bamberg Orchestra, worthy as the players are. But Kempe's magic transforms it, and there are a few more rewarding performances recorded in whatever form. In any case this is the only tape version available, and at so reasonable a price, it should remain unrivalled for a long time.

Smetana's symphonic poem is one of the most attractive from the cycle of six which he entitled "Ma Vlast" (My Country) and again Kempe brings out the warmth and colour in this vivid music. Recording (originally by Ariola in its Eurodisc series) is not of the clearest, but still rich enough to match the performances.

**BRUCH.** Violin Concerto No. 1 in G minor. **MENDELSSOHN.** Violin Concerto in E minor. Julian Olevsky with the Vienna State Opera Orchestra conducted by Julius Rudel. WRC (TT 427), 3½ ips, mono, 29s.

Julian Olevsky is a young American violinist who I have long thought should be far better known in this country than he is. On record at least the performance of his I have heard rival any by the most famous violinists in the world, and these of two of the most popular romantic concertos follow that pattern.

The performance of the Bruch Concerto is specially fine, among the richest and most expressive ever recorded (among the current disc versions I would rate only David Oistrakh higher). Olevsky has an extraordinarily rich tone, and he uses it with

spontaneous flair, so that the moment he starts to play the phrasing gives you a sense of a live performance. A natural performer therefore for the recording studio, and as a sample the slow movement of the Bruch could hardly be bettered. Olevsky gives it all the warmth of emotion it needs without ever spilling over into sentimentalism.

The Mendelssohn is not quite so well done. It sounds to me as though Olevsky was a little pent up at the beginning of the first and last movements where the flights of virtuosity required would be enough to daunt any young violinist. But in the first movement you have only to get to the lyrical second subject, and Olevsky's quality at once becomes apparent in the richness and ease of the phrasing. In the finale he settles down even quicker, and though the recording balance favours the soloist too much (this was originally a Westminster issue) I would certainly count this preferable to the other tape version of both these works by Menuhin on HMV. In any case it is considerably cheaper.

**A singer  
who is  
easy  
on  
the ear**

**POPULAR**



By Don  
Wedge

**SWINGING FOR YOU.** Danny Williams and Nelson Riddle. WRC (TT 487), 3½ ips, mono. 29s. 6d.

Nelson Riddle spent his 1963 summer in Britain working on film scores and recording albums with some of our leading singers. This was one of them. It's quite superb.

Though not very original, Danny Williams is a more than competent singer. He's very easy on the ear, and has a confident way with song lyrics. He is excellently managed as a disc artist by Norman Newell.

Nelson Riddle is probably the world's most brilliant arranger in the enlarged dance band idiom—brass, saxes, rhythm predominating with strings used for colour. Williams justifies such high-class accompaniment.

The songs Williams, Riddle and Newell chose include *In Love for the Very First Time, No Love, No Nothing, What Kind of Fool Am I?* and, as a poignant closer, *Everytime We Say Goodbye*. Also very classy.

Alma Cogan contributes a warm, unglushing tribute in an accompanying leaflet (such notes are now an interesting feature of all WRC tape boxes). "This is an exciting tape . . . a great step in Williams' career. One for all to be proud of" she concludes. She is very right.

**THE DIVINE ONE.** Sarah Vaughan. Accompaniment directed by Jimmy Jones. WRC (TT 488), 3½ ips, mono. 29s. 6d.

The autumn's releases from WRC are the most interesting the label has yet produced. The "cosy concert" concept, which has dominated so many of the label's pop releases, has gone in favour of more conventional record albums featuring real stars.

Sarah Vaughan, of course, is at the top of her tree. Jimmy Jones has arranged for

her in an unconventional way, using few instrumentalists—sometimes only a rhythm group, sometimes adding to it just one trumpeter. There is nothing more full than a woodwind section.

So it becomes a virtuoso performance with Sarah Vaughan standing almost alone. No dressing from big band or strings. It's music to sit and listen to, to appreciate and to marvel at her brilliance.

**THE SEEKERS. WRC (TT 422), 3½ ips, mono, 29s. 6d.**

The Australian group which soared to the top of Britain's hit parade last spring with "A World of Our Own" would not get further chart success with the straightforward folk songs featured on this album.

It's main-stream folk music which makes pleasant listening but is never likely to start a revolution or become a Top Twenty staple.

The Seekers draw mainly on the folk music of the American groups but include their "national anthem," *Waltzing Matilda*.

If you like your work songs—like *Cotton Fields*—as spirited and jolly sounds, then you'll go for this record. I will settle for Judy Durham's *Danny Boy*.

**GREAT COUNTRY FAVOURITES. Connie Francis and Hank Williams, Jr. MGM (TA-MGM-C-1003), 3½ ips, mono, 35s.**

When Connie Francis' turn came to make a LP in Nashville, someone came up with the idea to team her with Hank Williams Jr., the son of the greatest singer-composer of country and western music.

But none of the songs they chose for the album were written by Williams senior. But they include such well known c-and-w standards as *Wolverton Mountain*, *Mule Skinner Blues* and *Send Me the Pillow That You Dream On*.

Very familiar from the hit parade though are *Wabash Cannonball*, once a hit for Lonnie Donegan, the Everly Brothers' *Bye Bye Love* and *Singing the Blues*, object of a terrific 1957 chart battle between Tommy Steele and Guy Mitchell.

It comes up sounding almost a different song as a duet. The old strong beat versions are abandoned in favour of a much more meaningful treatment.

**50 GUITARS GO SOUTH OF THE BORDER. The 50 Guitars of Tommy Garrett. Liberty (TA-LBY 1064), 3½ ips, mono, 35s.**

Here is Volume 2 of snuff Garrett's new look at Mexican-type music. Fretted instruments carrying the melody hold no appeal for me. I like to hear more of *Green Eyes* and *Estralita* than there is on this rather slow, uninspiring album.

**PARIS EXTRAVAGANZA. Jean Paul Chevallier and his Orchestra. WRC (TT 405), 3½ ips, mono, 29s. 6d.**

Is this really the music played in Paris? Gay, frivolous, melodious . . . but so corny! May be tradition dies hard. But if this is the current music of France, the economic recovery has passed by the musicians.

What about "ye-ye." Francoise Hardy, Johnny Hallyday, Richard Anthony and Petula Clark?

The tapes reviewed this month are issued by the following companies:

"Liberty" and "M.G.M.": E.M.I. Records Ltd., 20, Manchester Square, London, W.1.

"W.R.C.": World Record Club, Box 11, Parkbridge House, The Little Green, Richmond, Surrey.

Nevertheless, "Paris Extravaganza" is a collection of beautiful songs and makes undemanding listening. Lots of people will like it, but not me. Though even I can enthuse over the hilarious broadsheet enclosed by World Record Club.

**The superb band of Count Basie** JAZZ



By Mike J. Gale

**COUNT BASIE PLAYS NEAL HEFTI.**

Personnel: Basie, pno; J. Newman, T. Jones, W. Culley, E. Young, tpts; B. Powell, H. Coker, A. Grey, tbn; M. Royal, F. Wess, alts; W. Mitchell, F. Foster, tens; C. Fowlkes, bar; F. Greene, gtr; E. Jones, sbs, and S. Payne, dms. WRC (TT 492), 3½ ips, mono, 29s. 6d.

Many so-called stars have inflated reputations which are fanned by the hysterical and the phoney build-up which precedes them. Adjectives, in our consumer conscious society, have lost their meaning and when, as in this case, they can be fully employed without any exaggeration, they seem totally inadequate.

Well, the 1958 Basie band was superb, the rhythm department dynamic and the brass and reed section magnificent as they go through eleven items sensitively tailored to reveal the band's finest points. The continuity of feeling is remarkable considering that the first sessions were held on April 3 and 4 (1958) and the concluding one ten days later.

Messrs. Grey, Wess, Young and Thad Jones are especially exciting adding extraordinary colour to many of the arrangements with that very special quality of being both an integral part of the team while retaining an individual identity. The brass and reed section, of course, had reached a particular apex in their development by being able to play with a thrilling but controlled abandon. It is on items like *Pony Tail* where the band's genius is indisputable.

The attractive and worthwhile set consists of: *Has anyone here seen Basie*, *Cute*, *Pensive Miss*, *Sloo Foot*, *It's Awfully Nice to be with You*, *Scout*, *A Little Tempo Pleas*, *Late Date*, *Count Down*, and *Bag 'a Bones*.

**THE DUKE MEETS COLEMAN HAWKINS. Personnel: Ray Nance, cnt and vin; Lawrence Brown, tbn; Johnny Hodges, alt; Harry Carney, bar and bclt; Coleman Hawkins, ten; Duke Ellington, pno; Aaron Bell, bass; Sam Woodyard, dms. WRC (TT 489), 3½ ips, mono, 29s. 6d.**

Both Ellington and Hawkins are at their best at this session recorded without interruption in August 1962. There is some fine up-tempo work under the excellent fronting of Ellington, while Sam Woodyard especially responds with imaginative interpretation and a great deal of solid support. The result is powerful and irresistible with a vitality that is rarely matched.

**YOUR LOCAL DEALER**

**LONDON**

**NuSound**  
A MAGNETAPE COMPANY

**BRITAIN'S LARGEST TAPE & HI-FI SPECIALISTS**

93 Mortimer St., Oxford Circus, W.1 MUS 1219  
36 Lewisham High St., S.E.13 LEE 2399  
242/4 Pentonville Rd., Kings Cross, N.1 TER 8200  
228 Bishopsgate, London, E.C.2 BIS 2609  
2 Maryland Station, Stratford, E.15 MAR 5879  
205 High St. North, East Ham, E.6 GRA 6543  
(SEE PAGE 411)

**SHEEN**

**TAPE RECORDER HI-FI CENTRE**

— The Centre for —  
FRIENDLY HELP—SALES—SERVICE  
DEMONSTRATIONS ANY TIME—ALL PRE-RECORDED TAPES—STEREO—MONO  
LANGUAGES—DANCE—JAZZ—SHOWS  
CLASSICS, etc.—2 and 4 TRACK—STOCKISTS  
OF ALL MAKES AND MODELS OF RECORDERS  
AND HI-FI—Add sound to your movies with  
Synchrodek—WE ARE STOCKISTS OF  
SYNCHRODEK  
TERMS—EXCHANGES, ETC.

**8 STATION PARADE, SHEEN LANE  
SHEEN, LONDON, S.W.14**  
(Opposite Mortlake Station, S.R.)  
Showroom: PROspect 0985  
10 a.m.—7 p.m.

**WIMBLEDON'S**

**TAPE RECORDER CENTRE**

Agents for:  
FERROGRAPH, VORTEXION,  
REVOX, BRENELL, GRUNDIG,  
TRUVOX, SABA, AMPEX,  
REFLECTOGRAPH, ETC.

**GET IT TAPED THE EXPERT WAY**  
—By letting us install your apparatus

**TEL-LEE-RADIO**

220 The Broadway, Wimbledon, S.W.19  
LIBerty 4946

**THE SOUTH**

PLYMOUTH

**TOM MOLLAND LTD.**

102 CORNWALL STREET  
Phone: 69282

FERROGRAPH, REVOX, TAND-  
BERG, SIEMENS, AKAI, UHER,  
SONY, B & O STEREOMASTER,  
FI-CORD, AND

The largest selection of Hi-Fi equipment  
in the West

## YOUR LOCAL DEALER

### THE SOUTH

#### SOUTHAMPTON

##### Tape Recorder Specialists

APPROVED AGENTS FOR:—  
PHILIPS - GRUNDIG - FERROGRAPH  
VORTEXION, ETC.

- ALL MAKES OF TAPE RECORDERS SUPPLIED
- ACCESSORIES AND HI-FI EQUIPMENT
- PART EXCHANGES AND SECOND-HAND MACHINES
- PROMPT AND SKILLED SERVICING

##### RECORDING MACHINES LTD.

79 Queensway, Southampton

Telephone: 27092

#### WORTHING TAPE RECORDER CENTRE

- Tape and Hi-Fi Experts
- Agents for all types of machines and equipment
- SERVICING & REPAIRS

THE MUSIC SHOP

22 NEW BROADWAY,

Tarring Road, Worthing, Sussex.

Telephone: Worthing 3630

### MIDLANDS

STOCKPORT

#### FAIRBOTHAM & CO. LTD.

47 Lower Hillgate STO 4872

FERROGRAPH, REVOX,  
TANDBERG, BRENELL, SIMON,  
TRUVOX, SONY, PHILIPS,  
MAGNAVOX, GRUNDIG,  
TELEFUNKEN

All models on comparison demonstration  
Evening demonstrations by appointment

#### SOUND BUSINESS

Specialists in  
Sound Reproducing Equipment  
Stockists of Butoba, Grundig, Sony,  
Tandberg, Vortexion, etc.

Backed by a  
First-Class Service Department

#### TYSONIC

W. M. Tyson, M.Brit.I.R.E.  
41 Russell St., Leamington Spa  
phone 24935

## NEW PRODUCTS

### NEW STEREO MODEL BY TELEFUNKEN

SEEN for the first time at the Welmec trade show during the recent audio exhibition is a four-track fully transistorised stereo tape recorder by Telefunken.

The recorder (illustrated July issue) has two speeds,  $3\frac{1}{2}$  and  $1\frac{1}{4}$  ips. The quoted frequency response is  $40-15,000 \pm 3$  dB at  $3\frac{1}{2}$  ips, and  $40-8,000$  cps  $\pm 3$  dB at  $1\frac{1}{4}$  ips. Wow and flutter is given as less than 0.2 per cent and 0.3 per cent at the two speeds, and signal-to-noise ratio is rated as better than 50 and 45 dB.

The Magnetophon 203 will accommodate seven-inch spools, providing a playing time of 64 minutes for each track using standard-play tape (1,200 ft.) at  $3\frac{1}{2}$  ips.

A wide range of facilities are incorporated. These include a VU meter recording level indicator, pause control, automatic tape end stop, push-button controls, safety erase lock, digital rev. counter with zero reset, tone control, and facilities for track-to-track transcription with built-in mixing control, multi-play recording, parallel track playback, and editing facilities.

Separate inputs are provided for radio, gram, and microphone, and outputs for earphones and extension loudspeaker with muting switch for built-in speaker.

The power output is given as  $2\frac{1}{2}$  watts. Power supply required is 110/127/220/240 volts AC, 50 cycles, adaptable for 60 cycles. Power consumption is approximately 2.5 watts.

Housed in a wooden case covered with leatherette, it has a metal deck, and a quick release high impact plastic lid. It measures  $15 \times 12 \times 6\frac{1}{2}$  inches, and weighs 21 lb. The price is 79 guineas.

Also introduced by Telefunken is a four-track version of their battery/mains operated M300 tape recorder. The price for the new model, designated M301, has still to be announced.

Welmec Corporation Limited, Lonsdale Chambers, 27, Chancery Lane, London, W.C.2.

### 3M INTRODUCE TAPE STORAGE PACK

TO overcome the perennial problem of storing and indexing tape recordings, the 3M Company has introduced a new Album Pack.

Taking up just over half the space normally required for storage, their Album has the appearance of a well-bound book with a leather-like finish and gold block lettering. It opens like a book to reveal two pockets, each of which can hold a reel of tape.

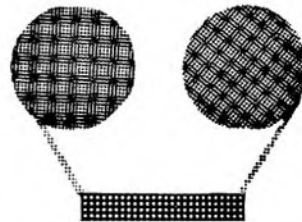

Available in three sizes to take 5,  $5\frac{1}{2}$  and 7-inch reels, the Album Pack is sold containing one reel, the other pocket is for the storage of existing tapes. Additional to the price of the tape bought, the Albums cost 2s. 9d., 3s. and 3s. 3d. respectively.

Inside the pack is ample space for each reel to be indexed in detail; self-adhesive labels are supplied for the spools and for the spine of the "book."

Minnesota, Mining and Manufacturing Co. Limited, 3M House, Wigmore Street, London, W.1.

### MORE RECORDERS FROM ELIZABETHAN

THREE new recorders were introduced by Elizabethan who entertained the trade at the Mayfair Hotel with the customary breakfast.

First of these is the Auto/Man 2 which is similar to the Automatic 2 (*New Products, February issue*). Manual control of the recording level is additional on the latest version of this 27-guinea recorder. It has a single playing speed of  $3\frac{1}{2}$  ips, and a quoted frequency response of 60-10,000 cps. Accommodating  $5\frac{1}{2}$ -inch spools, the Auto/man 2, provides a playing time of 45 minutes per track, using standard-play tape (850 ft.).

Among the features are facilities for superimposed, safety erase lock, power output of  $3\frac{1}{2}$  watts handled through the recorder's  $7 \times 4$  inch elliptical loudspeaker, and inputs for microphone, radio/gram, and telephone adaptor. The outputs are for extension loudspeaker, low impedance (3-5 ohms), and monitoring and external amplifier, high impedance (220 K ohms).

Measuring  $15 \times 15 \times 7$  inches, and weighing 19 lb., the Auto/Man 2 has a four-track version selling at 29 guineas.

Higher up the price scale is their third model, the solid state LZ102 at 49 guineas. This has three speeds,  $7\frac{1}{2}$ ,  $3\frac{1}{2}$ ,  $1\frac{1}{4}$  ips, and will accommodate seven-inch reels. Quoted frequency response ( $\pm 4$  dB) of this four-track model is 60-15,000, 60-8,000, and 60-5,000 cps at the respective speeds. Wow and flutter is given as not greater than 0.15 at  $7\frac{1}{2}$  ips, and 0.25 per cent at  $3\frac{1}{2}$  ips, signal-to-noise ratio is rated at 40 dB unweighted.

Using standard-play tape (1,200 ft.), 64 minutes playing time is available per track. Rewind being achieved within two minutes.

Among the features are separate bass and treble controls, VU meter recording level indicator, digital rev. counter, inputs for microphone (2mV sensitivity) and radiogram (200mV), and outputs for external amplifier (250mV) and monitoring earphones or extension loudspeaker (15 ohms).

The transistor line-up includes an AC107, OC75, OC81, OC44 and an AD140. The





amplifier output is stated as four watts, handled by the loudspeakers, a 9 x 4½-inch elliptical and a four-inch round tweeter.

LZ102 (illustrated above) measures 16½ x 16 x 9 inches, and weighs 26 lb.

Largest and most expensive in their current range is the LZ711 priced at 75 guineas. This is a three-speed two and four-track stereo recorder (illustrated below), accommodating seven-inch reels.

It will record and play back mono or stereo in the four track mode, but plays back only in the two-track mode. The quoted frequency response at the three tape speeds are 60-14,000 cps at 7½ ips, 60-10,000 cps at 3¾ ips, and 60-4,000 cps at 1½ ips. Wow and flutter is rated as not greater than 0.15 per cent at 7½ ips, and signal-to-noise ratio as better than 40 dB.

Suitable for use as a public address system, the LZ711 features separate channel

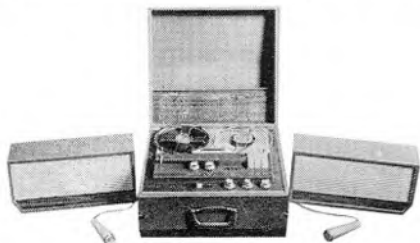

selector switches, facilities for loudspeaker monitoring, parallel-track playback, sound-on-sound recording, two VU meter recording level indicators, digital rev. counter, and two 8 x 5 detachable loudspeakers with eight-foot leads, handling the power output of three watts per channel.

It measures 25 x 16 x 9 inches, and weighs 40 lb. As with all the above-mentioned models, it is supplied complete with microphones, reel of tape, spare reel and recording leads.

*Elizabethan Tape Recorders Limited, Crow Lane, Romford, Essex.*

## CAR MOUNTING UNIT FOR PHILIPS PORTABLE

A CAR mounting unit for their EL3300 battery portable tape recorder has been introduced by Philips Electrical Ltd.

The new unit, Type EL3794D/00 (illustrated above), enables the recorder to operate in a car from the car battery supply and through the car radio and speaker system.

Among its features are facilities for direct recording and playback through the car radio, and a sliding tray with a simple lever operation for "ejecting" the recorder for cassette changing. Of all metal construction, the new unit can be mounted anywhere in

the car, even at an angle. When in the mounting unit, the internal tape recorder batteries are cut out and power comes from

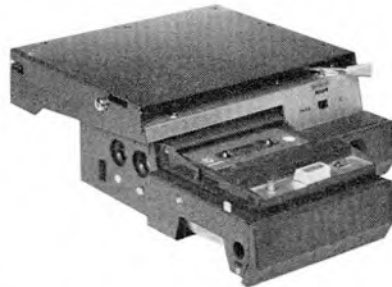

the car battery, but the recorder is ready for instant use when removed from the mounting unit.

The mounting unit measures 9 x 8¾ x 3¾ inches, weighs 5½ lb., and costs £12 10s. Fitted and connected with the recorder, it measures 12 x 8¾ x 3¾ inches, weighs approx. 9 lb., and costs 40 guineas.

*Philips Electrical Ltd., Century House, Shaftesbury Avenue, London, W.C.2.*

## MORE SPARES BY T.R. MAINTENANCE

A MUCH-INCREASED range of tape recorder spares is announced by Tape Recorder Maintenance Ltd. who recently introduced their latest pre-packed spares catalogue. The previous list of 100 spare parts and connecting leads, plugs and sockets now has a further 45 items.

Drive belts (ranging in price from 5s. to 13s. 6d.) for the latest Philips, Coscor and Stella recorders have been added to their earlier range for the Grundig, BSR, Walter, Korting, and Minivox recorders; plus a complete new introduction of fully surge resisting fuses as used in all leading Continental makes (5 x 20 mm).

Among the new plugs are a three-pin mains plug (5s.), single point co-axial (2s. 6d.), and phono to screw top, fully-screened (3s.).

Nine new connecting leads feature 5 mm jack to male phono and matching female phono to 5 mm jack (8s. 6d. each); single point co-axial plug to male phono, and matching female phono to single point co-axial plug (6s. 6d. each); a new adaptor lead with a loudspeaker socket to phono plug (10s.); 3 ft. lead with phono socket (3s. 6d.); 3 ft. lead, phono plug to two crocodile clips (5s. 6d.); 6 ft. individually screened four-core lead five-pin stereo plug to four colour coded phono plugs (16s. 6d.); 6 ft. lead with ¼-inch standard jacks each end (9s. 9d.); or one end only (7s. 3d.); and a 12-ft. extension lead, loudspeaker plug to socket (12s. 6d.).

Miscellaneous additions include a head demagnetiser, twin fader, double-ended phono socket, attenuator phono plug, two adaptor plugs, and various line sockets.

*Tape Recorder Maintenance Limited, 323 Kennington Road, London, S.E.11.*

\* \* \*

We must apologise for confusion in the "Test Bench" review of the Optacord 408 (October issue). The maximum playing time available using triple-play tape is 64 minutes per track. The thirty minutes per track mentioned in the review refers to the playing time of the tape supplied with the recorder.

## YOUR LOCAL DEALER

### THE NORTH

## CUSSINS & LIGHT LTD.

YORK'S LEADING RADIO TV & ELECTRICAL STORE

Visit our First Floor TAPE RECORDER CENTRE

LARGEST RANGE OF RECORDERS & ACCESSORIES IN THE NORTH

KING'S SQ. YORK



TEL. 55666

## TAPE RECORDER CENTRE (Halifax)

stock all the best tape recorders and hi-fi equipment. Agents for Revox, Tandberg, Ferrograph, etc. Demonstrations by expert staff. Two years' free service on recorders over £35.

30 King Cross St., Halifax. Phone 66832

## SCOTLAND

## GLASGOW

Tape Recorder Specialists

APPROVED AGENTS FOR:— PHILIPS - GRUNDIG - FERROGRAPH - VORTEXION, ETC.

- ALL MAKES OF TAPE RECORDERS SUPPLIED
- ACCESSORIES AND HI-FI EQUIPMENT
- PART EXCHANGES AND SECOND-HAND MACHINES
- PROMPT AND SKILLED SERVICING

RECORDING MACHINES LTD.

60 ST. VINCENT STREET, GLASGOW, C.2  
Telephone: City 3847/8

## TAPE-TO-DISC SERVICES

# RAPID RECORDING SERVICE

70s AND LPs FROM YOUR OWN TAPES  
48 HOUR SERVICE

MASTER DISCS AND PRESSINGS  
RECORDING STUDIO  
DEMONSTRATION DISCS  
MOBILE RECORDINGS—ANY DISTANCE

Brochure on request from

Rapid Recording Service  
21, BISHOPS CLOSE, LONDON, E.17

PHILIPS  
**EXPERTS CHOOSE PHILIPS MAGNETIC TAPE**

—for perfect recordings of every sound

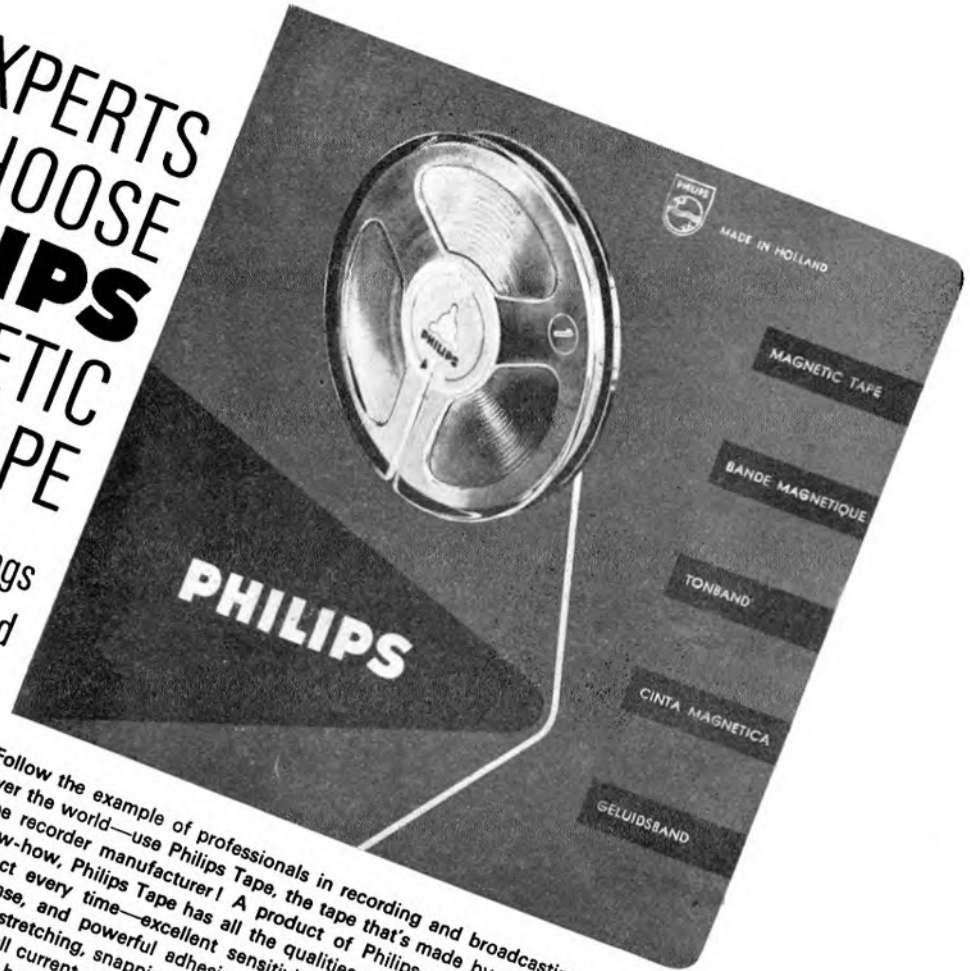

Follow the example of professionals in recording and broadcasting studios all over the world—use Philips Tape, the tape that's made by the world's leading tape recorder manufacturer! A product of Philips unrivalled experience and know-how, Philips Tape has all the qualities needed to make your recordings perfect every time—excellent sensitivity, low noise level, uniform frequency response, and powerful adhesion of the magnetic coating. It's tough, too—resists stretching, snapping and tearing. Philips Tape is available in four types and in all current reel sizes; apart from the special Audio Letter message tapes all types have metallized switching foil and leader tape with writing surfaces. What's more, each type comes in a colour-coded box for easy identification. Ask for Philips Tape next time you buy a new reel.

- GREEN for standard
- RED for longplay
- BLUE for doubleplay
- GREY for tripleplay

More fine products from **PHILIPS**—the friend of the family

PHILIPS ELECTRICAL LIMITED,  
 ELECTRO-ACOUSTICS DIVISION,  
 CENTURY HOUSE · SHAFESBURY  
 AVENUE · LONDON, W.C.2.





## CROYDON

What was perhaps one of the greatest amateur recordings stints ever reported in this magazine arose from a request received at this office during the early part of June.

Approached by a Repertory Company for sound recording assistance regarding a forthcoming production I contacted John Bradley of the Thornton Heath tape recording club. He eventually undertook to provide the necessary equipment and know-how for the required "sound effects." Later he found that in fact the production of Terence Rattigan's "Adventure Story" was to be mimed by the actors, who required a complete recording of the whole play. Accurate timing was obviously essential, and Mr. Bradley, together with a colleague, who temporarily formed the Croydon Sound Recording Group, lived with the production for four weeks before beginning the mammoth task of recording.

Truvox Ltd. loaned them three R102 tape recorders. Clarke and Smith provided the 25-watt amplifier and loud-speaker system, and 3M provided ample supplies of recording tape. Roger Aslin of the Federation of British Tape Recording Clubs assisted with technical advice.

The three-hour play, performed in the open air in Central London, was handicapped by traffic noise and low flying aircraft but the Croydon couple successfully overcame these problems. In all 11 miles of tape was used for the dialogue and approx. 31 miles for the music and effects.

They provided music, sound effects, a PA system plus the speech recorders which required the use of four loud-speakers hidden in scenic pillars about the stage. The wide stage was to be divided into four separate acting areas, requiring the sound to move from speaker column one to the other as action demanded. The entire programme was recorded within five days (and nights!).

Many technical and practical problems were met—and most were eventually solved. We have asked Mr. Bradley to provide greater details of the production for a future article in *TAPE*.

Secretary: John Bradley, 33 Fairlawnes, Maldon Road, Wallington, Surrey.

## DARTFORD

A return visit to the scene of a successful recording activity twelve months previously was made by members of the Dartford tape society who recently converged on the Dartford Thames tunnel. Last year they toured the tunnel prior to its opening and recorded details of its construction and features. During the return visit they recorded an interview with general manager Captain Milne, who spoke about the way the tunnel had stood up to one year's traffic. Among the interesting features gleaned from Mr. Milne was the fact that Whittle had used the pilot tunnel to test his early jet engines during the war.

Two machines, a Fi-Cord 202 battery portable and the chairman's home-made unit using a Brenell deck, recorded the interview. A second tunnel is to be built to accommodate the tremendous increase in traffic, and the Dartford members are planning to record its construction from start to finish.

Two manufacturer's demonstrations

followed this location recording. At the first of these held in conjunction with the local cine club, members saw and heard three of the Grundig recorders. On view and demonstrated were the TK6 battery portable, the TK41 and the TK46 stereo machine. At their following meeting Mr. George Pontzen of Lustraphone described and demonstrated some of his company's mono and stereo microphones. The members were particularly fascinated by the radio-microphone and another unit designed for medical use to record heart beats, etc.

The club's AGM was held during August.

Secretary: E. H. Foreman, 117 Westgate Road, Dartford, Kent.

## FERROGRAPH OWNERS

Well-known contributors to *TAPE Recording Magazine*, including John Borwick, Norman Paul, Peter Bastin, Richard Margoschis, and Pat Copinger, are among the speakers on "Ferro-sound" a sound magazine issued by the British Ferrograph Owners' Club.

To be issued quarterly, the first issue of the magazine coincides with the completion of the club's first year in formation. Designed to complement their printed newsletter "Ferro," "Ferro-sound" features articles covering production of documentary and other features tape, tape exchanges, hints on entering contests, and cine hints and tips. Also available is a collection of sound effects for members' use.

In preparation for future circulation will be a further tape designed for the home construction enthusiast. The organisers hope to supply projects in kit form at a competitive price.

Secretary: R. D. Luttler, "Kingswood," Silverne Drive, Ellesmere Port, Cheshire.

## GLASGOW

A series of lectures on various aspects of tape recording have been arranged by members of the tape section of the Radio Club of Scotland. Six consecutive Monday evenings are to be devoted to lectures designed to encourage new recorder owners to use their machines effectively. Publicity campaigns were launched with the help of local newspapers and retailers inviting their customers to join the course.

Earlier, the members had devoted an evening to the design and use of mixer units.

More recent meetings have included a joint venture with the members meeting the enthusiasts from the Dundee club. Members planned the day's outing with their wives very much in mind; and afternoon and evening brought a selection of tapes, games, quizzes and films. Its success led to plans to make this an annual event. Another excursion from their recently extended clubrooms was to Glasgow's Museum of Transport, where a substantial number of recordings were made.

The club's first "Auction Night" proved very successful also. Both sellers and buyers had a great time including a few laughs from deputy chairman Gordon Calder who was elected auctioneer. During that evening the more practical aspect of tape recording led to a lecture on magnetic tape. John Douglas spoke at length on the subject, and he was followed by John Wood who gave information on tape records. John Knowles then demonstrated the Philips car-mounting unit for their EL3300 cassette-loaded battery portable (see page 443), and the evening concluded with tips on recorder maintenance and cleanliness.

Secretary: J. A. Douglas, 113 Novar Drive, Glasgow, W.2, Scotland.

## GLOBAL TAPE EXCHANGES

Latest report of the American-based international tape exchange organisation, Global Tape Exchanges, accompanied a newspaper clipping taken from the *American Herald News*. This featured Mrs. Trix Cosier, a Global member from Orpington, Kent, who was visiting some of her tape contacts in New York. Mrs. Cosier had exchanged tapes and postcard shows for almost a year, and her hosts delighted in showing her the places she had only heard about during their correspondence.

Before she returned to this country, an area meeting of the club was arranged so that she could meet members from surrounding areas, who have been receiving Mr. Cosier's own postcard shows of Canterbury and other parts of England.

Secretary: Roy Patrick, 8 Sidney Street, Derby, Derbyshire.

## LONDON

A change of secretary for the London club is imminent, with Douglas Morris relinquishing the post he has occupied for two years. His successor is to be elected on October 14 when the club held their 8th AGM. Planned for that evening is a demonstration of microphones by Reslosound Ltd.

At their August meeting, the London members were joined by Friern Barnet and North London club members. Owing to ill-health, Mr. Conn Ryan, Senior Producer for the Central Office of Information, was unable to attend to give the planned talk on the production of documentary programmes.

Fortunately, the judging of the British Tape Recording Contest had just been completed the previous evening, and I was able to fill the gap by hurriedly arranging a programme of the winning tapes for the three clubs.

A practical music recording session was also organised for the same evening, and the enthusiasts were entertained to a programme played on his Flamenco Guitar by Brian Hyatt of the Troubadour Club. Later, Ron Tucker went the rounds with his interviewing microphone.

Another visit by a nearby club was arranged for the following meeting, when members of the Southall Club journeyed into the centre of London. Mainstay of the evening was a programme of members' tapes.

Secretary: Douglas Morris, 80 Tangier Road, Richmond, Surrey.

## MIDDLETON

Since the Middleton tape society reformed itself into a group with limited membership, their recording activities have multiplied. In the past nine months individual members have made numerous visits to places of interest with their recorders, including the local BBC Sound Studios and the *Daily Express* offices. Outstanding among their recording activities was the stereo recording made in a cathedral. Entitled "The Glorious Minor," this tape was eventually entered as the club's entry in the British Tape Recording Contest. Three other tapes, produced by individual members were also entered in the Contest.

Secretary: J. R. Wits, 119 Heywood Old Road, Rhodes, Middleton, Lancashire.

## WORLD TAPES FOR EDUCATION

A change of U.K. Representative for the international tape exchange organisation, World Tape for Education, is announced. John Davies has relinquished the post after two years, and his place has been taken by Mr. R. H. Henry.

UK Representative: R. H. Henry, 1 Caernarvon Walk, Swindon, Wiltshire.

## TAPE EXCHANGES

**TAPE** recorder owners who wish to contact others with similar interests, to exchange news and views by tape are invited to fill in and return the form on page 448 giving their name, age, address, special hobby or interest for this free service.

Details given here also include speeds and spool size to be used, name of recorder, and special area to be contacted.

**Kluger, Peter** (24). 119, Redston Road, Hornsey, London N.8. Photography, theatre, travel. 7½, 3½, 1½, 15/16 ips. Five-inch spool. Uher 4000 Report S. English, French, German, and Spanish spoken.

**Lansbury, Basil** (45). 6, Granville Road, Hillingdon, Middlesex. Photography, travel, music. 7½, 3½, 1½ ips. Seven-inch spool. Philips, four-track stereo, and Vogue recorder. Europe, USA, UK.

**Lander, Ronald H.** (25). 27, Elsham Road, London, W.14. Photography, railways, cinema, music. 3½, 1½ ips. Seven-inch spool. Philips EL3548. Female contacts preferred in UK, Continent, Scandinavia.

**Lane, John M.** (21). 14, Bracken Avenue, Hellesdon, Norwich, Norfolk. Modern jazz music. 15, 7½, 3½, 1½ ips. 8-inch spool. Brenell Mk 5 Series III. Female contacts in UK; musicians in UK, USA.

**Langley, Michael** (43). 44, Elm-hurst Court, St. Peter's Road, Croydon, Surrey. Italian language, Catholic recordings, Gregorian chant, classical music. 3½, 1½ ips. Seven-inch spool. Philips EL3548. UK, Italy, USA, Canada.

**Lethby, R.** (55). 8, Orchard Place, Weston-super-Mare, Somerset, Opera, Operetta, light music. 3½ ips. 5½-inch spool. Grundig TK14. UK only.

**Lockie, Miss Fiona** (32). 4, Maryfield Place, Bonnyrigg, Midlothian, Scotland. 35mm colour photography, travel, philately, historical places. 3½ ips. Five-inch spool. Philips and Cossor recorders. France, Spain, Israel, Lebanon, Germany.

**Lowe, Thomas** (22). c/o Lennox Hotel, Faslane, Helensburgh, Dunbartonshire, Scotland. Old-time and pop music. 3½, 1½ ips. 5½-inch spool. Ultra, four-track and Philips battery portable. Trinidad, Latin America.

**Macdonald, John** (22). 2, Bethel Road, Sevenoaks, Kent. Photography, scootering, pop music. 7½, 3½ ips. Seven-inch spool, Simon SP5. Male contacts only in UK, USA.

**Macnamara, John** (22). 147, Brandon Road, Drimagh, Dublin 12, Eire. German language, classical and folk music. 7½, 3½ ips. Seven-inch spool. Sony TC200.

**McCannell, David** (?). Basement, 8, Nightingale Place, London, S.E.18. 15, 7½, 3½ ips. Seven-inch spool. Elizabethan Essex. Male contacts only.

**McLoughlin, Patrick** (26). 4/6, Pennywell Place, Muirhouse, Edinburgh, Scotland. Photography, travel, films, music. 3½, 1½ ips. 5½-inch spool. HMV, four-track. Male contacts preferred, UK only.

## TEENAGE READERS

**Balmbra, Robert V.** (17). 61, Hummersknott Avenue, Darlington, Co. Durham. Photography, yachting, pop and classical music. 7½, 3½, 1½ ips. Seven-inch spool. Fidelity Playmaster, four-track and Collaro deck with Mullard "A" stereo amplifier. UK only, female contacts in South Hampshire. Letters first please.

**Bingle, Alan W.** (17). 134, Thrupp Lane, Thrupp, near Stroud, Gloucestershire. Photography, pop music. 7½, 3½, 1½ ips. Seven-inch spool. Chal-

(Continued on page 448)



# TAPE Bookshop offers YOU the kind of books other Tape Recordists have most requested!

Check through this list. Normal retail prices—we pay the postage on all orders.

3. **A to Z in Audio** by Gilbert A. Briggs (1960). 224 pages, 160 illustrations. **15s. 6d.**  
*A first-class book of reference for the subject.*
4. **Audio and Acoustics** by Gilbert A. Briggs (1963). 168 pages, 140 illustrations. **12s. 6d.**  
*Acoustical Consultant James Moir as sub-editor. A revised but basically original work from the well known "Sound Reproduction."*
5. **Audio Biographies** by Gilbert A. Briggs and 64 collaborations (1961). 344 pages, 112 photographs and illustrations. **19s. 6d.**
7. **Cabinet Handbook** by Gilbert A. Briggs (1963). 112 pages, 90 illustrations. **7s. 6d.**  
*Intended for the do-it-yourself man, and contains vital information on design and acoustic principles particularly in relation to compact enclosures which are now so popular for stereo.*
8. **Direct Current and Magnetism.** Edited by Edgar J. Black (1964). 120 pages, 92 illustrations. **10s. 6d.**  
*Gives a very simple account of basic electrical theory.*
10. **High Fidelity Pocket Book** by W. E. Pannett. 304 pages. **40s.**  
*Clear explanations of each item in the chain of a high fidelity installation are accompanied by practical hints for the enthusiast.*
11. **High Fidelity Sound Engineering** by Norman Crowhurst. 336 pages, 262 illustrations. **50s.**  
*Comprehensive coverage on the engineering of modern single-channel and stereophonic sound equipment.*
27. **Stereo and Hi-Fi as a Pastime** by Douglas Gardner (1959). 148 pages. **15s.**
15. **Loudspeakers (Fifth edition)** by Gilbert A. Briggs (1963). 336 pages, 230 illustrations. **25s.**  
*All aspects of the design and performance of loudspeakers and enclosures are dealt with in non-technical terms.*
20. **More About Loudspeakers** by Gilbert A. Briggs (1963). 136 pages, 112 illustrations. **8s. 6d.**  
*Deals with the latest trends in non-technical terms, and takes a new look at questions such as response and impedance, load matching, adding a speaker, listening tests, stereo.*

36. **The Grundig Book** by Frederick Purves. Comprehensive 1964 edition. **15s. 6d.**  
*Includes working instructions and data sheets for individual Grundig models.*
37. **Tape Recording for Pleasure** by Wallace Sharps. 128 pages. **3s. 6d.**
38. **Ribbons of Sound** by Karl Barleben. A U.S.A. publication and guide. **8s. 6d.**
40. **Simple Radio Circuits** by A. T. Collins, editor of Practical Wireless. **3s. 6d.**
41. **Hi-Fi and Audio** by A. T. Collins. Useful introductory paperback. **3s. 6d.**

29. **Tape Recording and Hi-Fi** by Douglas Brown (1961). 160 pages. **5s.**  
*Now as a paperback this interesting book by the Editor of "TAPE Recording Magazine" is very good value.*
33. **You and Your Tape Recorder** by Norman Paul (1962). **4s.**  
*Very good value by a past winner of the British Amateur Tape Recording Contest.*
12. **High Fidelity Sound Reproduction (Second edition).** Edited by E. Molloy. 212 pages. **20s.**  
*Contains a mass of valuable data for the serious amateur, and the maintenance engineer, and covers the expensive and complex equipment now on the market. Chapters on amplifiers and preamplifiers, dynamic loudspeakers.*

## TAPE HANDBOOKS

no newcomer to the hobby, or enthusiast, should be without!

**Advice on Buying a Tape Recorder** by J. F. Ling.

**2s. 6d. (U.S.A. \$0.65) post free.**

*Chapters on preliminary considerations, tape deck, amplifier, etc.*

**Introduction to the Tape Recorder** by C. Langton.

**3s. 6d. (U.S.A. \$0.75) post free.**

*Also, ideal for the apprentice in Radio servicing.*

**Sound Effects on Tape** by Alan Edward Beeby.

**3s. 6d. (U.S.A. \$0.75) post free.**

*How to achieve realistic effects simply and economically.*

**Tape and Cine** by John Aldred.

**3s. (U.S.A. \$0.70) post free.**

*With practical advice on synchronising methods, etc.*

**How to Record Weddings** by Paul Addinsell.

**3s. (U.S.A. \$0.70) post free.**

*Illustrated. Covers preparation, mike positioning, equipment, etc.*

**Hi-Fi for the Music Lover** by Edward Greenfield.

**3s. (U.S.A. \$0.70) post free.**

*Aims at giving the music lover basic technical know-how.*

25. **Sound Recording Works Like This** by Clement Brown. Illustrated. **10s. 6d.**  
*Part of "Science Works Like This" Series the book is intended for the younger members of the family.*

39. **Tape Recorder Manual** by Wallace Sharps. (New cheap edition). **10s. 6d.**  
*Sections on its uses in business, education and pleasure, how it works, etc.*

2. **Alternating Current and Acoustics.** Edited by Edgar J. Black (1964). 116 pages, 86 illustrations. **10s. 6d.**  
*Deals in simple terms with the origin and generation of alternating current, construction of coils and capacitors. The second part deals with the nature of acoustics and construction and operation of devices used for sound recording and reproduction.*

21. **Practical Hi-Fi Handbook** by Gordon J. King. 224 pages. **25s.**  
*A guide to choice, installation and servicing of equipment, for dealer, engineer, and amateur enthusiast.*

22. **Practical Stereophony** by H. Burrell Hadden (1964). 159 pages. **37s. 6d.**  
*The author, an instructor at the BBC, has been actively engaged for many years in research in this field, as a result the book is mainly directed towards those who make this art their profession, but there is much for the amateur enthusiast.*

35. **Tape Recording Yearbook 1965.** **7s. 6d.**  
*The 1965 edition contains all the well-known facts and figures of earlier editions, revised to date, as well as important contents vital to all interested in this field. Compiled by the staff of "TAPE Recording Magazine" this Yearbook is a must.*

REMITTANCE MUST ACCOMPANY ORDERS!

# TAPE

## BOOKSHOP

Catalogue numbers may be used when ordering

Catalogue numbers may be used when ordering

MAIL ORDER ONLY

7 TUDOR STREET, LONDON, E.C.4

Cheques & postal orders should be made payable to Print & Press Services Ltd.

NORMAL RETAIL PRICES  
NO CHARGE FOR POSTAGE

# The foremost name in microphones and sound accessories

## L U S T R A P H O N E

The many Public Authority and Service users of Lustraphone equipment appreciate the quality and reliability resulting from our extensive experience as specialists in the design and manufacture of microphones and associated equipment.

Microphones for all purposes incorporating the newest techniques ● portable P/A systems for indoor and outdoor use ● noise cancelling intercom systems ● audio equipment accessories and components.

### L U S T R A P H O N E L I M I T E D

St. George's Works  
Regents Park Road, London, N.W.1  
PR1mrose 8844



## ALL OVER THE WORLD

recorder players are reading the only magazine devoted to teaching and playing the recorder . . . the instrument which is fast becoming more popular than the guitar !

**NOVEMBER ISSUE  
NOW ON SALE . . . 3s.**

Or apply for free specimen copy from :  
**48 GREAT MARLBOROUGH STREET, LONDON, W.1**

# THE RECORDER CO.

*for best machines on advantageous terms*

	Deposit	12 Monthly	Cash
	£ s. d.	Payments	Price
		£ s. d.	Gns.
<b>4-TRACK STEREO/MONAUROAL</b>			
Coscor CR 1607	9 0 0	4 4 9	57
Sony TC 200	11 7 0	5 7 1	72
Beocord 1500	14 0 6	6 12 5	89
Philips EL 3534	14 10 0	6 16 10	92
Tandberg 74	14 13 0	6 18 4	93
Sony TC 500	16 10 9	7 16 3	105
Grundig TK 46	16 17 1	7 19 2	107
Beocord 2000 T. Mod.	17 13 0	8 6 7	112
Beocord 2000 S/Model	18 9 0	8 14 0	117
Akai M8	23 0 0	10 17 2	146

	Deposit	12 Monthly	Cash
	£ s. d.	Payments	Price
		£ s. d.	Gns.
<b>MAINS 2-TRACK</b>			
Ferguson 3210	3 15 9	1 15 9	24
Philips EL 3552	3 15 9	1 15 9	24
Wyndors "707 11"	5 1 0	2 7 7	32
Grundig TK 18L	6 9 6	3 1 0	41
Tandberg 823	8 10 3	4 0 4	54
Reps R 10 Mark II	9 6 0	4 7 9	59
Tandberg 92	10 17 6	5 2 8	69
Brenell Mark V Series 3	11 13 6	5 10 1	74
Truvox R. 102	11 19 6	5 13 1	76
Brenell 5/3 (Meter)	12 9 0	5 17 6	79
Ferrograph 631	13 17 3	6 10 11	88
Brenell 5/3 "M"	14 13 0	6 18 4	93
Revox 736	19 11 0	9 4 5	124

	Deposit	12 Monthly	Cash
	£ s. d.	Payments	Price
		£ s. d.	Gns.
<b>STEREO TAPE UNITS</b>			
Truvox PD 104	14 0 6	6 12 5	89
Ferrograph 632 2-T	18 18 0	8 18 6	120
Ferrograph 634	18 18 0	8 18 6	120
Brenell STB 2/5/2-T	22 10 0	10 12 6	£150

Open Saturday 6 p.m.—Friday 6-30 p.m.  
H.P. also over 18 and 24 months

If unable to call, write for free brochure, or send deposit now for quick delivery.

FREE DELIVERY  
PART EXCHANGE

**THE RECORDER CO.**

	Deposit	12 Monthly	Cash
	£ s. d.	Payments	Price
		£ s. d.	Gns.
<b>MAINS 4-TRACK</b>			
Elizabethan Auto 4	4 8 3	2 1 8	28
Elizabethan LZ34	5 1 0	2 7 7	32
Ferguson Super 3212	5 4 0	2 9 1	33
Fidelity Major 4	5 10 3	2 12 1	35
Wyndors "707 IV"	5 10 3	2 12 1	35
Philips EL 3548	6 3 0	2 15 6	39
Grundig TK 17L	6 15 6	3 4 0	43
Grundig TK 23L	7 14 6	3 12 11	49
Tandberg 843	9 6 0	4 7 9	59
Philips EL 3549	9 15 6	4 12 3	62
Reps R 10 Mark II	10 17 6	5 2 8	69
Truvox R 104	12 9 0	5 17 6	79
Grundig TK 40	13 14 6	6 9 5	87

**SPECIAL OFFER**  
**STANDARD UNICORDER**  
Battery or Mains 2-Speed Portable  
No external mains unit required, completely self-contained. 2 Built-in L/speakers. Remote control. Capstan drive. Batt./Mod., Meter. Up to 2 hours playing time using 3" Triple-play tape.  
Brand New. Guaranteed. Supplied complete with Leather Carrying Case, Shoulder Strap, Microphone, Tape, 2 Recording Leads and Earphone.  
**LIST PRICE 36 GNS. REDUCED TO 24 GNS.**  
Deposit £3. 16. 0. 12 M'thly payments £1. 17. 6.

	Deposit	12 Monthly	Cash
	£ s. d.	Payments	Price
		£ s. d.	Gns.
<b>BATTERY</b>			
Philips "Pocket"	4 2 0	1 18 8	26
Philips EL3586	4 2 0	1 18 8	26
Optacord 408 Bat/Mns	6 3 0	2 15 6	39
Telefunken 300	7 14 6	3 12 11	49
Ficord 202A	10 8 0	4 18 2	66
Grundig TK6 Bat/Mns	10 17 6	5 2 8	69
Uher 4000S Report	16 14 6	7 13 3	103



## AKAI Model X 4 STEREO BATTERY PORTABLE

131 gns.



Deposit £21.11.0  
12 monthly payments £9.13.4

Four-speed, four-track Stereo/Monaural operation 15/16, 1 1/2, 3/4, 7/8 i.p.s. Only the AKAI exclusive Crossfield Head is capable of recording 30-6000 cycles at the unusually slow tape speed of 15/16 i.p.s. Output of 2 watts per channel. Two VU meters. Up to 16 hours playing time using 5" reels. 2 microphones. Rechargeable battery on any mains unit.

### AKAI M-8

Cross-Field Head. 4-Speed 4-Track. Vertical Stereo. 146 gns. Terms over 12, 18 or 24 months.

We will be pleased to demonstrate these fine models or send full details.

(DEPT. T) 188 WEST END LANE,  
WEST HAMPS TEAD, LONDON, N.W.6

Telephone: SW1 4977

# CLASSIFIED ADVERTISEMENTS

Rate—Ninence per word; box numbers, one shilling extra. Payment with copy, which should be sent to Advertising Department, "TAPE Recording Magazine," 7, Tudor Street, London, E.C.4.

## TAPE EXCHANGES

AUSTRALIANS are telling their story the World over as members of The Australian Tape Recordists Association. TUNE-IN via Hon. Secretary, P.O. Box 67, Eastwood, N.S.W., Australia.

FRIENDLY FOLK ASSOCIATION, Torquay (Est. 1943). Social introductions, Pen-friends, Book-lovers, Stamp, Photography, Tapesponding. Members 100 countries.

LET BRITAIN'S largest Tape Exchange introduce you to Today's Most Fascinating Hobby! Particulars from WORLDWIDE TAPETALK, 35, The Gardens, Harrow.

Make interesting new friends UK and overseas, all ages. Join Victory Club, 34, Honeywell Road, London, S.W.11. Details free. Established 20 years.

"TAPEMATES INTERNATIONAL" opens the world to you! Club and recording booths, 6 p.m.-10.30 p.m. except Mondays, 6, Holland Park Avenue, W.11.

## MISCELLANEOUS

HIGHEST CASH PRICES offered for good quality Tape Recorders and Hi-Fi. See our advert., page 450, this issue. R.E.W., 266-8, Upper Tooting Road, London, S.W.17.

YOU OUGHT to send for a copy of "Psychology and Whisper Teaching" to York House, New North Road, Huddersfield. (5s. 9d. post free).

1,000 PERSONAL gummed labels (1 1/2 x 1/2) name and address, 17s. 6d., Dept. 82, Brimer Printers, Ken. Church Walk, London, W.8.

## TAPE EXCHANGES

(Continued from page 445)

lenge 44, four-track. Female contacts preferred.

**Bohler, John** (15). 43, Fowler Avenue, Aberdeen, Scotland. Travel, sport, folk and pop music. 3 1/2 ips. 5 1/2-inch spool. Civic recorder, U.K., U.S.A., New Zealand, Australia, Canada.

**Carr, James C.** (18). 10, Bellgrove Street, Glasgow, E.1. Scotland. Short story writing, reading, chess. 3 1/2, 1 1/2 ips. 5 1/2-inch spool. Ferguson 3204, four-track. Female contacts required, same age. U.K. only.

**Del Bravo, Paul** (16). 53, Wood End Gardens, Northolt Park, Middlesex. Hi-fi, colour photography, sketching. 7 1/2, 3 1/2, 1 1/2 ips. Seven-inch spool. Truvox R102. Australasia, Pacific.

**Horton, Brian** (19). 51, Broadway Grange Park, St. Helens, Lancashire. Shooting, judo. 3 1/2 ips. 5 1/2-inch spool. Philips EL3552.

**Joad, Russell** (16). "Ravensdale," Ansbury Road, Coxheath, Maidstone, Kent. Cars, jazz and folk music. 7 1/2, 3 1/2, 1 1/2 ips. Seven-inch spool. Truvox R94, four-track. Germany, Scandinavia.

**Peter Levy** (19). 27, St. George's Road, London, N.W.11. Colour

## EDUCATIONAL

A.M.I.E.R.E., A.M.I. Mech. E., City & Guilds, G.C.E., etc. Become a Technician or Technologist with high pay and security. Thousands of passes. For details of Exams and Courses in all branches of Electronics, Engineering, etc., WRITE for 156-page Handbook—FREE. B.I.E.T. (Dept. 302), London, W.8.

LISTEN AND LEARN IN RECORD TIME. L.P. Discs and Tape Records. The new and easy, time-saving way to learn. Courses on: Book-keeping, Banking, Economics, English Law, Income Tax, Statistics, Shorthand, Good Speech, and Secretarial Subjects. FOREIGN LANGUAGES: French, German, Italian, Russian, Spanish. Write now for the FREE Catalogue Handbook to: STUDENTS RECORDINGS LTD., (Dept. TRM), 15, Devon Square, Newton Abbot, Sth. Devon.

## OPPORTUNITIES

SHAREHOLDINGS amounting in total to a 10 per cent interest in a Videotape Manufacturing Company (visual and sound recording of TV programmes, etc., on ordinary tape) offered for sale in whole or part. Least expensive equipment on the market. Estimated net profits of the Company on the basis of anticipated production and sales may reach £450,000 per annum in the near future. Opportunity to acquire an interest in an entirely new industry, with virtually unlimited prospects of expansion. Reply Box 459, TRM.

WANTED Club or Amateur in London area to copy 4-inch tapes. Write, giving indication of charges, to BOX 460, TRM.

## NEW EQUIPMENT

TAPE RECORDERS. SAVE FROM 30 per cent to 60 per cent on the original price. Large stocks of second-hand, new, shop-soiled machines. All guaranteed. Obtainable on our NO INTEREST TERMS. Best part exchange allowances on your existing equipment. CALL, WRITE, PHONE today for free list. Quotation and details. Our Mail Order covers the whole Country.—R. E. W. Earlsfield Ltd., 266, Upper Tooting Road, London, S.W.17. BALHAM 9174-5.

TO GIVE THE AMATEUR the PROFESSIONAL TOUCH! Splicing Kits 21s. each (contain cutter, splicer, stop foil, jointing and leader tape). Plus MASTERTAPE and ZONA-TAPE. S.a.c.: SEWARD, 16, Longley St., Newcastle-upon-Tyne 4.

photography, humour, tramcar preservation. 3 1/2 ips. 5 1/2-inch spool. Ferguson 441TR. Commonwealth, U.S.A. (especially California).

**Shaw, J.** (19). 71, The Uplands, Biddulph, Stoke-on-Trent, Staffordshire. 3 1/2, 1 1/2 ips. 5 1/2-inch spool. Ultra 6202. Female contacts only.

**Wilson, Andrew** (18). 1, Melgund Terrace, Edinburgh 7, Scotland. 3 1/2 ips. Five-inch spool. Philips EL3541, four-track.

## OVERSEAS READERS

**Hermans, Lambert** (16). Kerkstratt 149, Weert, Holland. English language, reading, films, pop music. 3 1/2 ips. 5 1/2-inch spool. Nova recorder. Female

## TAPE DUBBING

J. & B. RECORDINGS. Tape/disc. Mobile unit. Quality recording. 14, Willows Avenue, Morden, Surrey. Mitcham 9952.

JOHN HASSELL RECORDINGS. Tape to Disc Service using latest high level disc-cutting system. Quality pressings made. Studio with Bechstein Grand. Mobile unit. 21, Nassau Road, London, S.W.13. RIVERSIDE 7150.

RAPID Recording Service. Records made from your own tapes (48-hour service). Master discs and pressings. Recording Studio—Demo discs. Mobile recordings, any distance. Brochure from: 21, Bishops Close, E.17.

SOUNDTRACKS LTD. High Speed Tape-to-Tape copying. Soundtracks Ltd., 9, Kew Green, Richmond, Surrey. RICHMOND 7368.

TAPE TO DISC RECORDING. Finest professional quality. 10-inch LP—42s. (32 mins.). 12-inch LP—48s. (45 mins.). 7-inch EP—21s.

40 FT. RECORDING STUDIO. S.a.c. for leaflet to Deroy Sound Service, 52, Hest Bank Lane, Hest Bank, Lancaster. Tel.: H.B. 2444.

Tape to Disc Recording Service, photographic sleeves with all recordings. High speed tape copying. E.R.S., 162, Shirland Road, London, W.9.

TAPE TO DISC. Highest quality. 7-inch, 21s.; 12-inch, 42s.; post free. TEMPLE, 12, BEECH HOUSE RD., CROYDON, Surrey.

## FOR SALE

GEVAERT new boxed Recording Tapes: 600 ft. (5 1/2 in. spool) at 9s. each or 6 for 50s. GRUNDIG 2-transistor Pre-amplifiers suitable for boosting microphones and tape head monitoring —listed at 41 gns.—OFFERED NEW and boxed at 57s. 6d. each. LEE ELECTRONICS, 400, Edgware Road, W.2. PADDINGTON 5521.

Pre-Sleep Study. Learn difficult lessons or parts or improve your mental powers while you sleep! SEND NOW for price list of materials including the perfect Tape Machine, Time Switch, Pillow Speakers, Endless Tape Cassettes, Pre-recorded Tapes for learning or Therapy, Language Courses, etc. Psychology Tapes Limited, Dept. TRM, 16, Kings College Rd., LONDON, N.W.3 (PRI 3314)—Foremost suppliers of Sleep-Learning Equipment in Britain!

contacts only in U.K. and U.S.A. Letters first please.

**McNeill, Gordon** (19). 1, Macphail Street, Petersfield Springs, Transvaal, South Africa. Electronics, parachuting, sport, pop music. 3 1/2 ips. Five-inch spool. Philips EL3514V, four-track. U.K., U.S.A., Sweden, Canada. Letters not required.

**Parsen, Gunter** (18). 3353, Gandersheim, Hoherweg 19, Germany. People, countries, opinions, reading. 1 1/2 ips. Special cassette. Philips EL3300. Not Europe.

**Walden, B. P.** (21). P.O. Box 762, Kitwe, Zambia. Photography, travel, music. 7 1/2, 3 1/2, 1 1/2 ips. Seven-inch spool. Philips EL3534, four-track stereo.

## MAGNETIC TAPE

A UNIQUE TAPE BUY! Top brand 7 in., 2,400 ft., 25s.; 5 1/2 in., 15s.; P. & P.: 1 at 2s., 2 at 2s. 9d., 3 to 6 at 3s. 6d. BARGAINS in all sizes. S.A.E. for list. E. C. KINGSLEY & Co. Ltd., 93, Tottenham Court Road, LONDON, W.1. EUSton 6500.

## TAPE RECORDS

AMERICAN 4-TRACK STEREO TAPES covering most famous labels at REALISTIC prices. Why pay more? Imported directly by us, saving distributors' profits. Vast selection at 75s. each. Send S.A.E. for free lists or call at London showrooms, TELETAPE of Marble Arch, 33, Edgware Road, W.2.

LEARN WHILE YOU SLEEP. Learn languages, memorise speeches and sales presentations, absorb business statistics or the Highway Code while asleep with Learnasleep Equipment. Details from: SLEEP LEARNING SUPPLIES (Dept. T.R.M.), 245, Capworth Street, Leyton, E.10.

TAPE RECORD CENTRE. The NEW tape record centre at Kew is now open to supply tapes by CAPITOL, COLUMBIA, LIBERTY, MGM, Music On Tape, PARLOPHONE, STATESIDE and a wide selection of labels. Send 1s. in stamps for lists to: MAGNETIC TRACKS LTD. (TRM), 9, KEW GREEN, Richmond-on-Thames.

TEMPOTAPES—MUSIC 3 1/2 ips and CASTLE COPYRIGHT FREE SOUND EFFECTS, 45 RPM DISCS. Wide selection, 6d. STAMP for CATALOGUES to RECORDED TUITION LIMITED, 174, Maybank Road, South Woodford, London, E.18. (BUC 9315).

LEARN WHILE YOU SLEEP. Free booklet from THE SLEEP-LEARNING ASSOCIATION, 14, Belsize Crescent, Hampstead, N.W.3. Tel.: SWI 6160.

## INDEX TO ADVERTISERS

A. Brown & Son Ltd.....	450
A. C. Farnell Ltd.....	421
Agfa Ltd.....	Back cover
Ampex (Great Britain) Ltd.....	420
Brenell Engineering Co. Ltd.....	413
Brockley Trading Co.....	418
Cussins & Light Ltd.....	443
Daystrom Ltd.....	436
Educational Recordings Ltd.....	453
E.M.J. Tape Ltd.....	434
Fairbotham & Co. Ltd.....	442
Ferguson Division.....	414 and 415
Fi-Cord International.....	417
Francis of Streatham.....	436
Global Products.....	453
Grampian Reproducers Ltd.....	418
Green & Cooper Ltd.....	440
Grundig (Great Britain) Ltd.....	451
Hightate Acoustics.....	449
Howard Tape Recorders.....	418
Kodak Ltd.....	412
K.J. Enterprises.....	450
Leda Tapes.....	439 and 453
Lee Electronics.....	440
Lustraphone Ltd.....	447
Magraph.....	440
Massey's Centre of Sound.....	440
Metrosound Manufacturing Co. Ltd.....	439
Minnesota, Mining & Manufacturing Co. Ltd.....	416
NuSound.....	411 and 441
Philips Electrical Ltd.....	426 and 444
Rapid Recording Service.....	443
Recording Machines Ltd.....	442 and 443
Recotape Recordings Ltd.....	455
R.E.W. (Earlsfield) Ltd.....	450
Sheen Tape Recorder Centre Ltd.....	441
Sony U.K. Sales Division.....	410
Synchrodek (1964) Ltd.....	418 and 453
Tape Recorder Centre (Halifax) Ltd.....	443
Tel-Lee-Radio.....	441
The Ferrograph Co. Ltd.....	438
The Recorder Co.....	447
"The Recorder and Music Magazine".....	447
Tom Molland Ltd.....	441
Transatlantic Music Tapes (Dist.) Ltd.....	452
Truvox Ltd.....	419
Tysonic.....	442
Worthing Tape Recorder Centre	442





**LOEWE OPTA**

# Hi-Fi Tape Recorders

**FOR PERFECTION IN SOUND**

## THE NEW OPTACORD 408 THE MOST COMPACT MAINS AND BATTERY RECORDER

Single Speed 3 $\frac{3}{4}$  i.p.s. Twin Track. For use on Mains, Batteries and Car Batteries. **39 GNS.**

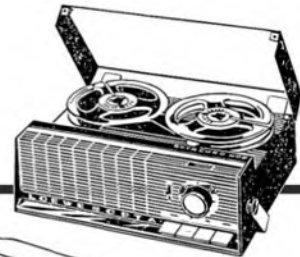

## THE LATEST OPTACORD 416

**OPTACORD 416**  
Specification as Optacord 408 plus dig. counter, tone and volume controls, 2 speeds 3 $\frac{3}{4}$  i.p.s. and 1 $\frac{1}{2}$  i.p.s. Twin Track **51 GNS.**

**OPTACORD 416 DIA**  
As Optacord 416, with built-in Synchronisation for Automatic Slide Projector. **62 GNS.**



**THREE-IN-ONE MAINS—BATTERIES—CAR BATTERIES**

## HIGHGATE ACOUSTICS

Telephone: MUSeum 2901/5

71/73 GT. PORTLAND STREET, LONDON, W.1

Approved Loewe-Opta Stockists

Alexanders, Holburn Street, Aberdeen.	Bristol & Cardiff Tape Recorder Centres.	Gilbert Pianos Ltd., 37, Southchurch Road, South-end.	Joplings Ltd., John Street, Sunderland.	Piercy's, 60-62 Lupus Street, S.W.1.	G. H. Steel, 141, St. Georges Road, Glasgow.
I. J. Allen Ltd., The Quadrant, Bournemouth.	A. Brown & Son Ltd., 24/28, George Street, Hull.	Grimes Ltd., King Street, Wigan, Lancs.	Kendal Milne & Co., Deansgate, Manchester 3.	Rackhams Ltd., Corporation Street, Birmingham 2.	Tape Recorder Centre, 82, High Holborn, W.C.1.
Arding & Hobbs Ltd., Clapham Junction, S.W.11.	Brown, Muff's Bradford, 1.	Guildhall Tape Recorders, 33, Guildhall Street, Folkestone.	John King (Films) Ltd., Film House, East Street, Brighton, 1.	Recording Machines Ltd., 119, Victoria Street, S.W.1.	Tape Recorder Centre, 30, King Cross Street, Halifax.
Audiocraft, 20, Kettering Road, Northampton.	Camera Thorpe, 6/8, Osmaston Road, Derby.	J. E. Hargreaves Ltd., 1, Railway Road, Blackburn.	R. S. Kitchen Ltd., 22, King Edward Street, Leeds, 1.	Tom Reckie Ltd., 10, Bridge Street, Stafford.	J. H. Tate & Co. Ltd., 45, Crowtree Road, Sunderland.
Barkers Ltd., 31, Oxford Road, Worthing.	Camplins Audio, 21, Market St., Cambridge.	Harveys, High Street, Guildford, Surrey.	Lancashire Hi-Fi Ltd., Tape Centre, 8, Deansgate, Manchester 3.	REW Earlsfield, 266, Upper Tooting Road, S.W.17.	Tele-Sales & Service Ltd., 9, Alexandria Drive, St. Annes, Lancs.
Barretts of Canterbury.	Chelsea Record Centre, 203, Kings Road, S.W.3.	Hamilton Electronics, 35, London Rd., Southampton.	Leech & Haige Ltd., 112, London Road, Oxford.	Ryland Huntley, 15, Old Bond Street, Bath.	Teletape, 33, Edgware Road, W.2.
Battys (Rhyl) Ltd., Rhyl (Tel.: 2621).	Chiesmans Ltd., Lewisham, S.E.23.	J. Harris, 231, Baker Street, N.W.1.	Massey's 121/3, High Road, Chiswick, W.4. CHI 2082	Selfridges Ltd., Oxford Street, W.1.	The Recorder Co., 188, West End Lane, N.W.6.
Wilf Plant, Asfordby, Melton Mowbray Leicester.	City & Essex Tape Recorder Centres, 228, Bishopsgate, E.C.2.	House & Son Ltd., Blake Street, York.	James McKenzie Ltd., Grange Road West, Birkenhead.	Sheen Tape Recorder Centre, 8, Station Parade, Sheen, S.W.14.	Turners Photographic Ltd., 9, The Walk, Ipswich.
Bon Marche, Northgate Street, Gloucester.	Courtney Davies, 12, Station Road, Harpenden.	Howard Tape Recorders, 218, High Street, Bromley, Kent.	Misons, Hi-Fi Specialist, Citadel Row, Carlisle.	Sheffield High Fidelity, 10, West Street, Sheffield, 1.	Radio Maintenance, (Leicester) Ltd., 111, Queens Rd., Leicester.
Leonard Booth, 35, South Street, Eastbourne.	Croasdales (Nelson) Ltd., 41 & 58, Every Street, Nelson, Lancs.	R. H. O. Hills Ltd., Bank Hey Street, Blackpool.	Fairbotham & Co. Ltd., 58-62 Lower Hillgate, Stockport, Cheshire.	J. Smith & Sons, 184, The Rock, Bury, Lancs.	Lloyd & Keyworth, 26, Downing Street, Farnham.
Bourne Radio, 4, Albert Road, Bournemouth.	Dingles, Royal Parade, City Centre, Plymouth.	Imhofs Ltd., New Oxford Street, W.C.2.	Aldridges (Music) Ltd., 14/16 Hoghton Street, Southport.	Stanwood Radio Ltd. (All Branches.) London-Essex-Herts-Suffolk.	Bristol-Hi-Fi, 28, Upper Maulding Street, Bristol.
<b>LOEWE OPTA</b>	Francis of Streatham, 169, Streatham High Road, S.W.16.	Jones & Higgins, 1-41, Rye Lane, Peckham, S.E.15.	Parish & Co., 130, Union Street, Torquay.	Sport & Radio, 26/29, Aldwich Road, Bognor Regis.	J. W. Mansfield, 18, Liverpool Road, Worthing

You're guaranteed  
a better deal  
when you

# PART EXCHANGE

your  
TAPE RECORDER or  
HI-FI EQUIPMENT

## with R·E·W

A friendly welcome awaits you at our recently extended showrooms where you will find a large array of fine equipment at all price levels. With a comprehensive service geared to your personal satisfaction we can provide generous part exchange facilities, immediate delivery and—if you cannot visit us—a fast and friendly Mail Order Service. Remember, your guarantee of a better deal is in the name and reputation of R.E.W. (Earlsfield) Ltd.

### MACHINE OF THE MONTH

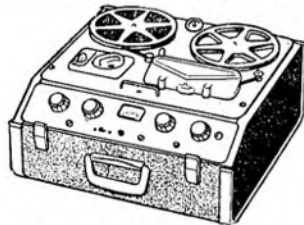

### FERROGRAPH 631

PRICE **88** gns.

The magnificent Ferrograph 631, complete with its own superior quality elliptical speaker.

- Speeds 1½, 3½ and 7½ i.p.s.
- Separate tone controls for bass and treble cuts.
- Frequency response (7½ i.p.s.) 40-15,000 c.p.s. + 3 db.

This superb machine can be yours NOW for only £13.8.0 deposit and 12 monthly payments of £6.11.8.

### Bargain Basement!

We have an unrivalled stock of leading makes of new and used machines at unbeatable bargain prices—30%-60% reductions on original prices! Make a point of asking for our Special Bargain List.

You're guaranteed maximum satisfaction with the R·E·W

## "PLUS FIVE" SERVICE

- ★ Generous part exchange allowances.
- ★ No interest terms—lowest deposits.
- ★ Off-the-Shelf delivery from the biggest range under one roof.
- ★ Free servicing and free delivery.
- ★ Optional personal insurance.

### INTEREST FREE TERMS!

Take your pick from our wide range and have any machine you want for the minimum deposit, balance twelve months and no interest charged. (18-24 months H.P. terms also available).

**OPTIONAL INSURANCE** at nominal rates against Unemployment, Sickness or Accident during term of H.P. Agreement. Premium 6d. in £—gives cover over 2 years.

**LOWEST DEPOSITS**

**CASH for YOUR TAPE RECORDER or HI-FI**  
Highest cash offers for good equipment . . . get in touch today!

Home demonstrations in the London area gladly arranged by return enquiry service. Agents for all makes.



# R·E·W

(EARLSFIELD) LTD.  
Mail Order Department  
266/268 (TRM) Upper Tooting Road,  
London, S.W.17  
Telephone: BALham 9174-5

## TAPE RECORDER COVERS



Smart, waterproof cover to give complete protection to your tape recorder. Made from rubberised canvas in navy, wine, tan, grey and bottle green with white contrasting pipings, reinforced base, handy zip microphone pocket and name panel.

Grundig TK.1	...	49/6	Philips 3534	...	87/-
" TK.5	...	55/-	" 3548	...	79/6
" TK.6	...	67/6	" 3549	...	79/6
" TK.8	...	63/-	" 3585	...	57/-
" TK.14, 18 & 23	...	59/6	" 3514	...	66/-
" TK.14L, 17L, 18L,	...		" EL3515	...	57/6
" TK.400 & 23L	...	67/6	" EL3541/15	...	57/6
" TK.20	...	52/6	" 3541H	...	72/-
" TK.24	...	55/-	Cossor 1602	...	57/6
" TK.25	...	55/-	" 1601	...	63/-
" TK.30	...	60/-	" 1604	...	79/-
" TK.35	...	63/-	" 1605	...	84/-
" TK.40 & 41	...	66/-	Stella ST455	...	63/-
" TK.46	...	82/-	" ST454	...	57/6
" TK.55	...	63/-	" ST458	...	79/-
" TK.60	...	75/-*	" ST459	...	84/-
" TK.830/3D	...	63/-*	Saba 2305	...	79/6
Telefunken 85	...	35/-	Elizabethan LZ29	...	75/-
" 75/15 & 76K	...	55/-	" FT.1	...	66/-
" 95 & 96	...	49/6	Brenell Mk. 5	...	77/-
Philips EL3538	...	63/-	" 3 star	...	69/-
" EL3542	...	63/-	Robuk RK.3 & RK.4...	...	67/6
" EL3536	...	70/-	Sony 521	...	90/-
" Without pocket.	...		Ferrograph	...	84/-
			Revox F model	...	84/-
			Optacord 412, 414 & 416	...	63/-
			Truvox 92 & 94	...	99/-
			Tandberg 72, 72b, 74, 74b,	...	
			62, 62b, 64, 64b	...	
			(hard case)	...	£7/1/8
			Soft case	...	£5/12/6
			92 (hard case)	...	£7/1/8

**A. BROWN & SONS LTD.**

24-28, GEORGE STREET, HULL Tel.: 25413, 25412

## TAPE BARGAINS

### SCOTCH

A special purchase of brand new, top quality, double coated, Scotch Magnetic tape (type 150D/C) Polyester L/P. Spooled to a special length for industrial purposes and now available from us for domestic consumption. Don't miss this rare opportunity, 900' on 7" reel. Normally 27/6. Only 15/6d. P. & P. 1/6d. Three reels for 45/- post free. Six reels for 84/- post free. Boxed add 1/- per reel. LIMITED QUANTITIES AVAILABLE—SEND NOW!

### AGFA

An exceptional offer of brand new P.V.C. Tape, with full leader, stop foil, and polythene sealed. A chance to obtain one of the best quality tapes at nearly half the usual price. 1200' on 7" reel. Normally 35/-.

## NEW FROM GERMANY! ORWO TAPE

Brand new P.V.C. magnetic recording tape, fully leadered at both ends. Exceptionally well-boxed in sturdy cassette-type vertical flip opening carton. Available in long-play base only at a sensationally low price.

<b>1800' on 7" reel</b>	<b>1200' on 5½" reel</b>	<b>900' on 5" reel</b>	
One for..... 22/6	One for..... 19/6	One for..... 16/6	
Three for..... 63/-	Three for..... 55/-	Three for..... 47/-	
Six for..... 120/-	Six for..... 105/-	Six for..... 90/-	

POSTAGE AND PACKING . . . FREE!

### Don't forget our other HALF-PRICE ACCESSORY BARGAINS!

Tape Head Demagnetiser, essential for any enthusiast! Ready for immediate use. Fully guaranteed. Worth 50/- . . . Only 27/6. P. & P. 1/6  
Tape Splicer, fully auto., no razor blades. Worth 32/6 . . . Only 16/6. P. & P. 1/6  
Semi-Professional Bulk Eraser—operated by revolving spool around a spindle. Takes up to 7" reels. Worth 7 gns. . . . . Only 79/6. P. & P. 4/6  
Full Pro. Model taking 10" reels . . . . . Only 119/6. P. & P. 5/6

**OUR "UNIVERSAL" EQUIPMENT CASE** which is a plinth, designed to take almost ALL TAPE DECKS, GRAM TURNABLES, and TRANSCRIPTION UNITS, is now available at the NEW LOW PRICE of 45/- . . . CARRIAGE FREE! Dimensions: 18" x 18" x 4½"; Clearance below motor board: 3½". 2-tone grey or walnut

**K. J. ENTERPRISES (Dept. T8) 7 Mason's Ave., Wealdstone, Middx. HAR 0395 (closed P.M. WED. and SAT.) REFUND GUARANTEE**  
● 24-HOUR RETURN MAIL ORDER SERVICE  
● ALL MAKES OF AUDIO EQUIPMENT SUPPLIED

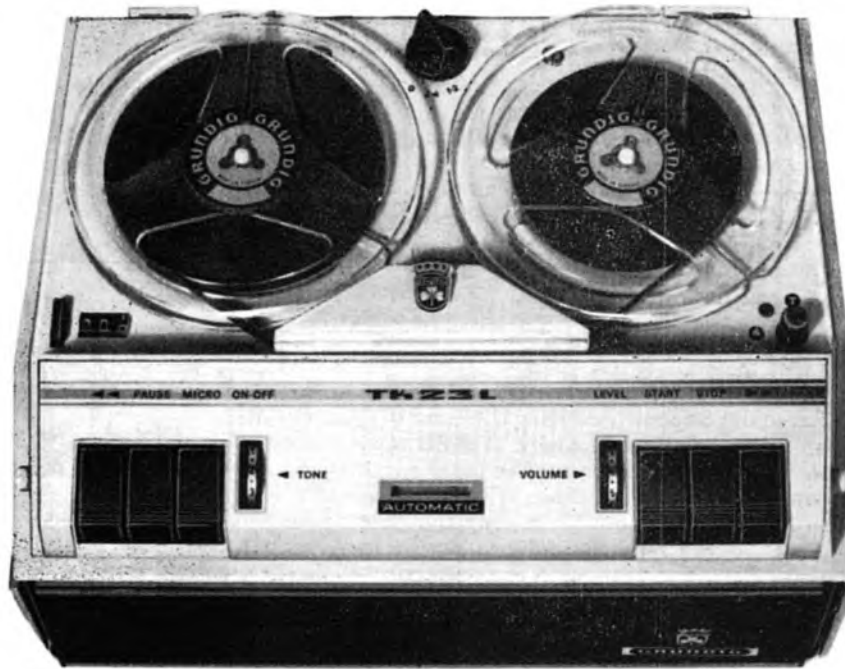

Let's face it, what could be simpler than a Grundig tape recorder.

## An automatic Grundig tape recorder!

The Grundig TK23L is a highly professional tape recorder. It records on four tracks, plays back for up to six hours on a spool of double-play tape.

Yet, for all its intricate insides, it remains a simple, robust Grundig. Whether you wish to recapture a sigh or a symphony, it records what you want—with feeling.

The TK23L has a further advantage. It's automatic.

This doesn't mean you switch it on and come back to find the dinner cooked. But it means that when you're putting something onto tape, the Grundig

'Magic Ear' adjusts the recording level automatically. *Forte* or *pianissimo*, you get balanced sound all the time.

With the TK23L you can superimpose, make trick recordings too. It costs 49 gns.—comes complete with over a quarter of a mile of tape and a microphone worth seven guineas.

Listen to it soon. And in case you're a person who likes twiddling knobs while you record—relax! There's a switch that turns off the automatic 'Magic Ear.'

Grundig think of everything.

**Valuable - but free  
if you post now!**

Grundig make first-class tape recorders from 37 gns., radios from 15½ gns. Send today for a free 20-page colour book about them, called 'The Grundig World of Sound.' Post this coupon to Grundig, London, S.E.26.

Name .....  
(Block letters, please)

Address .....

TRM I

**GRUNDIG**



**NEW** FOR **STEREO** ENTHUSIASTS

**AT LAST! A REAL BREAKTHROUGH**

WITH  **RECOTAPE** 

**STEREO TEST TAPE . . .**



All the boffins have talked about producing this kind of tape, but no one has done up to now. Everyone with a STEREO recorder needs to have this tape; it is not just a technical test tape, but a fascinating musical entertainment at the same time. This is the tape that will tell you all you want to know about stereo and the effects you are, or are not, getting. It will show you how to get the very best out of your equipment. Part one deals with the perfection of balance, a sine wave test tone, at high and low frequencies. A sweep test tone then it deals with phasing and finally an interesting channel separation check. Part two brings spectacular performances and breathtaking stereo in such items as Rakoczy March, March from Aida, Polovtsian Dances, March from le Coq d'Or and Russian Sailor's Dance.

HIGH FIDELITY 

**STEREO SPECTACULAR**

**STEREO**

A MULTI CHANNEL RECORDING

**DEMONSTRATION & SOUND EFFECTS**

HIGH FIDELITY 

**STEREO TEST TAPE**

SEPARATION CHECK SYSTEM WITH MEASURED CYCLES LEFT AND RIGHT CHANNEL TEST TONES

TEST  TAPE 

*Wanna Symphony Orchestra*

**STEREO SPECTACULAR . . .**

Recotape is first again with this most fabulous tape, something which every stereo owner has dreamed of. It brings a spectacular series of 27 different startling stereo effects from Drumbeats, Sound Effects, Bands and Orchestras to Jets, Cars, Underground trains, a Bullfight, an Escalator and ten magnificent musical items produced by a wide variety of musical instruments. Here's a must for every stereo owner.

**EVERY TAPE IS UNCONDITIONALLY GUARANTEED AGAINST PROCESSING FAULTS.**

**4-TRACK STEREO 50/- 7 1/2 i.p.s.**      **2-TRACK STEREO 65/- 7 1/2 i.p.s.**

**TRADE ENQUIRIES INVITED**

**This tape for 15/- to all who buy STEREO SPECTACULAR**

HIGH FIDELITY 

**SOUNDS SPECTACULAR**

**CAPRICCIO ITALIEN GRANADA HORA STACCATO**

**and STEREO TEST TAPE**

**POST THIS COUPON TO DAY**

Please forward the tapes noted below for which full remittance and postage charge is enclosed. State in BOX whether 2-Track or 4-Track is required.

STEREO TEST TAPE

STEREO SPECTACULAR

SOUNDS SPECTACULAR

Transatlantic Music Tapes (Distributors) Ltd., 250 Grand Buildings, 1 Strand, London, W.C.2.

Please mail me the tapes selected in the boxes on left. I enclose £.....including 1/6 packing and postage for EACH tape ordered.

NAME.....

ADDRESS .....

..... (TRM-11-65)

## GLOBAL PRODUCTS

● **Global PRE-RECORDED TAPES. NEW RELEASES**  
 3 1/2 ips 2-track. 12/- each plus 1/- postage and packing  
**SAM BASS SINGS GEORGE FORMBY** with uke & Or. 6571, 20 min.  
**HARRY J. JENKINS.** American Cinema Organ ..... 6562, 30 min.  
**JACK HELYER** plays the mighty Conacher organ ..... 6561, 25 min.  
**JACK HELYER.** Conacher organ favourites ..... 6581, 30 min.  
 These tapes are available from stock. Ask for the list of other Pre-recorded Tapes and Accessories.

14, UNDERWOOD ROAD, ROTHWELL, NORTHANTS.

## Ferrodynamics' "INTERNATIONAL" Tape

Highest Quality ★ Cello Wrapped ★ Colour Coded ★ Guaranteed

Standard Play		Long Play	
5 in. 600 ft. Acetate	7/9	7 in. 1,800 ft. Polyester	19/-
7 in. 1,200 ft. Acetate	11/9	<b>Double Play</b>	
<b>Long Play</b>		5 in. 1,200 ft. Polyester	14/-
5 in. 900 ft. Acetate	9/9	5 1/2 in. 1,800 ft. Polyester	20/-
5 1/2 in. 1,200 ft. Acetate	11/9	7 in. 2,400 ft. Polyester	22/6
7 in. 1,800 ft. Acetate	13/9		

Also message and triple-play tapes. S.A.E. for list. Special terms for Clubs. Trade inquiries welcomed. LEDA TAPES, 30 Baker Street, London, W.1

## Wish YOU could have AUDIOSCOPE?

If you own an automatic slide projector and tape recorder, you can have perfectly synchronised sound with your slide shows. The famous automatic SYNCHROSLIDE does it all for you. Direct from the makers for only 14 gns. (or easy terms). Write for knowhow and FREE literature.

**SYNCHRODEK (1964) Ltd., Dept. No. 30,**  
 Binfield, Bracknell, Berks.

## A BINDER FOR YOUR TRM'S!

Keep your copies of Tape Recording Magazine always tidy and handy for immediate reference in a specially made Binder. Two-tone green, gold-stamped on sturdy spine, each copy can be inserted as received to form a complete volume.

● An ideal Christmas gift for a TRM reader

ORDER from PRINT & PRESS SERVICES LTD., 7 TUDOR STREET, E.C.4

**14/6**  
 POST  
 FREE  
**16/3**  
 outside U.K.

## "PIONEERS IN SLEEP-LEARNING"

### THE COMPLETE PORTABLE SLEEP-O-MATIC UNIT

Comprising two speed transistorised tape recorder, auto time switch, under pillow speaker and microphone. Price £27 10s., p. & p. 7s. 6d. Batteries 5s. extra. Mains Power Pack 50s. extra.

Specialists in Sleep-Learning and Audio Learning, tapes on Mind Management; Positive Personality; Memory Training; How to Pass Examinations, etc.

Free booklet of the above equipment, list of tapes and discs sent on receipt of postcard.

### EDUCATIONAL RECORDINGS LTD.

Dept. T.R.M., 21, Bishops Close, Church Lane, London, E.17

# ADVERTISEMENT INQUIRIES SERVICE

I should like further information about the

.....  
 .....  
 (product) mentioned on page.....of the  
 ..... issue of TAPE  
 Recording Magazine.

NAME.....

ADDRESS .....

November 1965

*This is a special service for readers of TAPE Recording Magazine. It enables you—without cost—to get fuller information about those products in which you are particularly interested. Fill in one coupon below for each inquiry, with your name and address in block capitals in each case. Then cut out the whole of this section, following the dotted line, fold as indicated overleaf and post to us.*

I should like further information about the

.....  
 .....  
 (product) mentioned on page.....of the  
 ..... issue of TAPE  
 Recording Magazine.

NAME.....

ADDRESS .....

November 1965

I should like further information about the

.....  
 .....  
 (product) mentioned on page.....of the  
 ..... issue of TAPE  
 Recording Magazine.

NAME.....

ADDRESS .....

November 1965

I should like further information about the

.....  
 .....  
 (product) mentioned on page.....of the  
 ..... issue of TAPE  
 Recording Magazine.

NAME.....

ADDRESS .....

November 1965

I should like further information about the

.....  
 .....  
 (product) mentioned on page.....of the  
 ..... issue of TAPE  
 Recording Magazine.

NAME.....

ADDRESS .....

November 1965

# POST COUPON NOW!

To: **TAPE Recording Magazine, 7 TUDOR STREET, LONDON, E.C.4**

Please send me.....copy(ies) of **TAPE Recording YEAR BOOK 1965** at 7s. 6d. (\$1.25) a copy (incl. postage). I enclose remittance.

NAME .....

ADDRESS .....



## TAPE YEAR BOOK 1965 the Recordist's Reference Book!

★ The only available up-to-date catalogue of **EVERY TAPE RECORDER** on the market with full specifications, price, etc., plus photographs.

### Features include

- ★ Review of tape developments during the past year.
- ★ Function, maintenance and design of tape recorders.
- ★ Advice on correct use of Acoustics.
- ★ Producing a feature tape. ★ Recording as a Group activity.
- ★ Manufacturers, dealers and Club Secretaries' addresses.
- ★ GLOSSARY of technical terms, "at-a-glance" tabulated catalogues of microphones, radio tuners, mixer units and associated equipment.

**PRICE**  
**7/6**

*Latest edition on sale at bookstalls or direct from publishers using coupon above*

CUT ALONG DOTTED LINE

POSTAGE  
WILL BE  
PAID BY  
PRINT AND  
PRESS  
SERVICES  
LIMITED

TAP  
E  
R  
E  
C  
O  
R  
D  
I  
N  
G  
M  
A  
G  
A  
Z  
I  
N  
E,  
7,  
T  
U  
D  
O  
R  
S  
T  
R  
E  
E  
T,  
L  
O  
N  
D  
O  
N,  
E  
C  
4

B  
U  
S  
I  
N  
E  
S  
S  
R  
E  
P  
L  
Y  
F  
O  
L  
D  
E  
R  
L  
i  
c  
e  
n  
c  
e  
N  
o.  
N  
D  
9  
2  
2

THIRD FOLD HERE

SECOND FOLD HERE

FLAP A

N  
O  
P  
O  
S  
T  
A  
G  
E  
S  
T  
A  
M  
P  
N  
E  
C  
E  
S  
S  
A  
R  
Y  
I  
F  
P  
O  
S  
T  
E  
D  
I  
N  
G  
R  
E  
A  
T  
B  
R  
I  
T  
A  
I  
N  
O  
R  
N  
O  
R  
T  
H  
E  
R  
N  
I  
R  
E  
L  
A  
N  
D

FLAP B

FIRST FOLD ALONG THIS LINE

Fold along lines as indicated and then tuck Flap A into Flap B





# SAVE A HALF OFFER . . .

ANY TWO OF THESE MONO OR 4-TRACK STEREO TAPES FOR **35/-**



**TOP BRASS**  
Harry Mortimer, O.B.E., conducts "All Star Brass Band" in Intro Act III Lohengrin, Trumpet Tune by Purcell, Music for the Royal Fireworks and many others.

Tape No. 204



**BAND ORGAN**  
Fascinating and unique Dutch Band Organ plays Cuddle Up A Little Closer, Tennessee Waltz, Blue Tango, Under the Double Eagle and seven others.

Tape No. 902



**MERRY-GO-ROUND**  
Merry Go Round plays Moulin Rouge, Around the World Theme, Rio Rita, Old Comrades, Twelfth Street Rag and many others.

Tape No. 203



**Tapecraft**  
Principals of recording, c.p.s. decibels, frequency response, balance, distortion. All demonstrated and explained on this fascinating tape.

Tape No. 300



**ESOTERIC**  
SOUND ADVENTURE  
Explanations and demonstrations of acoustic phenomena, sound vibrations, standing waves, fundamentals and other interesting facts about sound reproduction.

Tape No. 202



**Rhapsodies and Dances . . .**  
Authentic Hungarian interpretations of Liszt's famous Hungarian Rhapsody No. 2 and Brahms's Hungarian Dances. Unusual instruments—a different sound.

Tape No. 209



**ESOTERIC**  
ORIGINAL DIXIELAND JAZZ BAND  
Traditional Dixieland, Tiger Rag, Sensation Rag, Clarinet Marmalade Blues, Skeleton Jangle and many others all played by dedicated men.

Tape No. 102



**THE ART OF THE ACCORDION**  
Wonderful and unique performances on an accordion of Bach's Toccata and Fugue in D Minor, Ritual Fire Dance, Finlandia, Flight of the Bumble Bee and many others.

Tape No. 201



**The Genius of George Wright**  
Genius at work on the mighty Wurlitzer, Hernando's Hideaway, Song of the Islands, Tea for Two, Strike Up the Band and many others by George Wright.

Tape No. 713

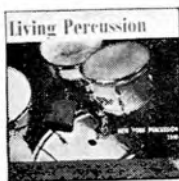

**Living Percussion**  
Fascinating percussive arrangements of Turkey in the Straw, Yank Doodling, Easter Parade, Sleigh Ride, and many others by the New York Percussion Trio.

Tape No. 103

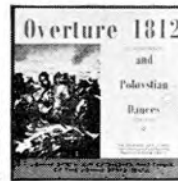

**Overture 1812**  
Wonderful performance and recording of 1812 Overture and a choral version of the Polovtsian Dances, all by the Vienna State Opera Choir and Vienna Symphony Orchestra.

Tape No. 208



**AMERICAN MARCHES . . .**  
Massed Military Bands play the greatest marches, Anchors Aweigh, High School Cadets, U.S. Air Force Song etc. Marches played in fine swinging American style.

Tape No. 104



**HAMMOND ORGAN SWING**  
Fabulous Hammond Organ playing, fascinating arrangements of Heatwave, Black Magic, Lullaby of Broadway, It's Magic, Softly as in a Morning Sunrise and many others.

Tape No. 239



**THE ORIGINAL RAY CHARLES**  
Enchanting Ray Charles sings Ain't that Fine, Honey, Honey, Can Anyone Ask for More, Sittin' on Top of the World and many others.

Tape No. 24



**Sentimental Journey**  
Jackie Brown plays the mighty Wurlitzer, Far Away Places, Slow Boat to China, April in Paris, Love is the Sweetest Thing and many others of the same vintage.

Tape No. 210



**THE STEAM ORGAN**  
Ancient Steam Caliope plays MacNamara's Band, There's a Tavern in the Town, When Irish Eyes are Smilin', Daisy Bell, Entry of the Gladiators and many others.

Tape No. 205



**DANCING TIME FOR SQUARES**  
Old-timers such as Grandfather's Clock, Sweet Rosie O'Grady, After the Ball, Bird in a Gilded Cage, The Band Played On and many others.

Tape No. 206



**FABULOUS BRASS**  
Fabulous Brass arrangements of Mood Indigo, Orchids in the Moonlight, Parade of the Wooden Soldiers, Toy Trumpet, Holiday for Strings, etc.

Tape No. 231



**SONGS OF A GOLDEN AGE**  
Some of the most popular music of all time for orchestra and piano, Tenderly, September Song, Body and Soul, Begin the Beguine and many others.

Tape No. 238



**ECHOES OF PARIS**  
Lovely music reminiscent of Paris played by star pianist George Feyer, La Vie en Rose, April in Portugal, La Mer, Domino, Cerisier Rose and many others.

Tape No. 200



**STAN GETZ GREATEST HITS**  
Stan Getz at his greatest, playing Indian Summer, There's a Small Hotel, Too Marvellous for Words, I've Got You Under My Skin, The Lady in Red and many others.

Tape No. 7256



offers you, in addition to this range of wonderful tapes, duplicated on the latest and most advanced equipment, another most interesting recording of three evergreen numbers played in a sensational manner. Sounds Spectacular, really is, and you can get it for 15/-.

Just complete the coupon on the right.

Tape No. 109



Choose any two of these fabulous tapes, Mono 3 $\frac{3}{4}$  or 4 track Stereo 3 $\frac{3}{4}$  i.p.s. Take advantage now of this unrepeatable offer. Every tape unconditionally guaranteed against processing faults. Money back if not satisfied. **TRADE INQUIRIES INVITED**

## POST THIS COUPON TO DAY

Please supply the undernoted tapes. I have deleted inapplicable instructions.

To: RECOTAPE RECORDINGS LTD.,  
250 Grand Buildings, 1 Strand, London, W.C.2.

Mono 3 $\frac{3}{4}$   
Stereo 4 Track  
3 $\frac{3}{4}$

Please mail to me the tapes noted on this coupon. I enclose £..... which includes 1/6 Post and Packing for each tape ordered.

Mono 3 $\frac{3}{4}$   
Stereo 3 $\frac{3}{4}$   
4 Track

Name .....

Mono 3 $\frac{3}{4}$   
Stereo 3 $\frac{3}{4}$   
4 Track

 109

Address .....

(TRM-11-65)



AGFA THE PERFECTLY  
BALANCED TAPE



## AGFA-GEVAERT

Agfa tape is produced to give perfectly balanced reproduction over the whole tonal range. It is manufactured in three basic types all on pre-stressed polyester base.

**PE31** Long play with great strength and high output.

**PE41** Double play. Highly recommended for 4 track and 2 track recordings.

**PE65** Triple record with a thickness of only 0.7 mil. developed for use on small portable recorders. Spools will hold three times as much PE65 compared with standard tape. PE65 is especially suitable for 4 track recordings.

Our magazine 'Magnetron Illustrated' containing many items of general interest is free on request. Please fill in coupon for your copy.

**AGFA**

**AGFA LIMITED**  
27 Regent Street,  
London S.W.1  
Tel: REGent 8581



Please send me a copy of  
'Magnetron Illustrated'

NAME .....

ADDRESS .....

GL 2559