

TAPE

RECORDING AND HI-FI MAGAZINE

SCOTCH BOY POLYESTER TAPES

...the first, and still the best!

'SCOTCH BOY' 150 was the *first* polyester based magnetic recording tape to be introduced to Britain 3 years ago. It's still way out ahead!

'SCOTCH BOY' 150 gives you fifty per cent more playing time; 1800 ft. on a 7" spool, and in all lengths is *splice free*. It is an all-weather tape which stores indefinitely. 'Scotch Boy' 150's extra thin, extra tough polyester base is practically unbreakable in use.

'SCOTCH BOY' 150 Extra Play conforms more readily to recording heads, giving true high quality reproduction.

'SCOTCH BOY' 150 first and best polyester tape, is made in Great Britain by the 3M Company, world's largest and most experienced manufacturer of recording tapes.

150 EXTRA PLAY POLYESTER

3"	— 300 ft.	9/6
5"	— 900 ft.	28/-
5½"	— 1275 ft.	35/-
7"	— 1800 ft.	50/-
8½"	— 2400 ft.	72/6

Scotch | MAGNETIC TAPES
BOY
do the job BETTER!



MINNESOTA MINING AND MANUFACTURING COMPANY LIMITED, 3M HOUSE, WIGMORE STREET, LONDON, W.1.
AND BIRMINGHAM · MANCHESTER · GLASGOW

BRITAIN'S LEADING PUBLICATION IN THIS FIELD



Another winner from Wyndсор



**The
Wyndсор
'Viscount'—a
brilliant new
portable at
only 49 gns.**

The Wyndсор "Viscount" is the brilliant new portable the electronic industry is talking about: brilliant in design and brilliant in performance. The Wyndсор Recording Company—makers of the Wyndсор "Regent" one of the most popular tape recorders ever—have excelled themselves in the "Viscount" by creating a successor worthy to come from the same stable. Yet they have kept the cost below fifty guineas, which is an achievement in itself.

It has three speeds—15", 7½" or 3¾" per second—and carries up to 7" spools (giving up to 3 hours recording on one L.P. tape) with location of position by digital counter.

The two tracks are immediately available by push-button control; there is an independent set of "Record/Play-back" and "Erase" heads for each track, halving the wear and facilitating instantaneous switching from one to the other.

Additional facilities include the speaker's being detachable. This means that cine-camera enthusiasts—and others—can place the source of the sound well away from the point of operation.

There are two inputs, one high and one low gain. And only two electronic controls; a master gain control and a tone control.

Every recording can be monitored because the moment you push the "Record" button, the tone-control automatically becomes a volume-control for hearing whatever you are recording at the same time. At this point the "Viscount's" frequency response conforms to C.C.I.R. standards.

Finally, the instrument can quite simply be used either in conjunction with a subsequent amplification system if desired, or as a self-contained straight-through amplifier.

The "Viscount" looks good, too. It is tastefully styled in coffee and cream colours with gold-coloured inlay and grill and matching cream-and-gold controls.

It is fitted complete with a 7" spool of Emitape and an "Acos" high-sensitivity crystal microphone in matching colours. The price, remarkably, is only 49 guineas.

BRIEF TECHNICAL DATA

Frequency Response: 50 c/s to 12 kc/s ± 3dB at 7½ ips.
50 c/s to 9 kc/s ± 3dB at 3¾ ips.

Inputs: Two: High and Low sensitivity both at 1 megohm.

Outputs: Low impedance: 3 ohms feeding 10" × 6" elliptical Goodman Speaker. High impedance: 1v at 10 K ohms (conforming to C.C.I.R. standards).

Record/Playing Time: ½ hour at 15 ips. 1 hour at 7½ ips.
2 hours at 3¾ ips. Using long-play tape times are increased by 50 per cent.

Weight: Approximately 35 lbs.

THE WYNDSOR RECORDING COMPANY LIMITED

2, Bellevue Road, Friern Barnet, London, N.11 : Telephone: ENTerprise 2226/7 : Telegraphic Address: Wyndreco

THE WYNDSOR DAUPHIN

The Wyndсор Dauphin is a logical and up-to-date approach to the problem of getting hi-fi performance without the usual hi-fi paraphernalia: superb reproduction with a single piece of equipment instead of having to connect up two or three separate items. Be sure to see the Wyndсор Dauphin before you invest in a tape recorder. We'll be pleased to send you a leaflet giving you full particulars.

BRIEF TECHNICAL DATA

Tape Speeds..... 7½ and 3¾ ips.
Frequency response... 50—15,000 c/s ± 3dB at 7½ ips.
50—8,000 c/s ± 3dB at 3¾ ips.

Wow and Flutter..... better than 0.1 of 1 per cent.

Signal/Noise ratio ... better than 40dB unweighted.

Output 3 watts ultra-linear at 15 ohm.

3 matched speakers, base, elliptical and tweeter. Actual tape-monitoring through third head. Independent record and playback amplifiers.

89 GNS. Complete, including Stand, Microphone and Tape.



I SELL THE **FINEST**

TAPE RECORDERS ON INTEREST-FREE TERMS

Yes, no interest, and that is not all—for my personal attention, advice, and help, are freely given. Full demonstrations at any time (evenings and weekends by arrangement) and in addition to the superb Harting you can see and hear a selection of the most interesting recorders available. Remember, I am here to help you. Leaflets gladly sent if you are unable to call.

Model	Deposit		8 Monthly Payments		Cash Price
	£	s. d.	£	s. d.	
Philips A.G.8109	4	19 0	4	10 0	39gns.
Elizabethan Escort.....	7	5 0	5	0 0	45gns.
Verdik S.I.....	7	5 0	5	0 0	45gns.
Magnaon	8	8 0	5	5 0	48gns.
Wyndor Regent.....	8	8 0	5	7 6	49gns.
Grundig T.K.20	8	10 0	5	10 0	50gns.
Dulci Harting Deck (with pre-amp.)	7	15 0	6	5 0	55gns.*
Saja Export	7	16 0	6	7 6	56gns.
Brenell 3 Star	7	18 0	6	12 6	58gns.
Veritone Venus	9	6 0	7	10 8	66gns.
Baird	10	7 0	7	10 0	67gns.
Brenell Mk. V with Mic.	9	9 0	7	17 6	69gns.
Truvox R2.....	9	9 0	7	17 6	69gns.
Elizabethan Essex	12	15 0	8	5 0	75gns.
Harting H.M.5	14	2 0	9	0 0	82gns.*
Wyndor Dauphin	15	9 0	9	15 0	89gns.
Reflectograph	18	14 6	10	0 0	94gns.*
Grundig T.K.830/30.....	25	0 0	10	0 0	100gns.*

All machines are complete with tape and microphone, except those marked *, which are less microphone.

Please note that the Dulci Harting Deck is for use only with existing Hi-Fi equipment and is supplied without mic. or tape.



COME AND SEE THE MAGNIFICENT NEW HARTING HM. THE RECORDER WITH THE OUTSTANDING SPECIFICATION.

● We are also demonstrating the Dulci Harting Deck with pre-amplifier.

● C.Q. Speakers.

● The Wyndor Dauphin and Console Model with the Harting Deck.

● The Tandberg recorder Stereophonic reproducer.

Dickinsons of Pall Mall Ltd.

11, Royal Opera Arcade, Pall Mall, S.W.1. TRA 2881

The Royal Opera Arcade lies behind Her Majesty's Theatre in the Haymarket. One minute from Piccadilly Circus or Trafalgar Square.

ANNOUNCING THE SECOND AND LARGER

AUDIO FAIR

IN THE
NORTH

This will again be the most comprehensive demonstration of High Fidelity ever to be staged in the North, with the new equipment, as shown at the London Audio Fair and at Earls Court.

All the leading manufacturers will be exhibiting and demonstrating under conditions akin to your own home the latest developments in audio reproduction including all branches of stereophonics.

Lovers of music of all types, if they are true to their enthusiasm should hear for themselves how exactly and faithfully their favourite passages can be played back to them.

Complimentary tickets for admission are available from your audio, photographic, radio, music or record dealer. If you have any difficulty send stamped addressed envelope to: Exhibition Office, 42, Manchester Street, London, W.1. (Dealers, please state quantities and dates).

OCTOBER
1958

on

FRIDAY 24th
SATURDAY 25th
SUNDAY 26th

at the

GRAND HOTEL
HARROGATE

11 a.m. . 9 p.m.
DAILY



TUBA BY BOOSEY & HAWKES

THE *Elizabethan* PLAYS THE LOW NOTE

Take a really low note—a tuba down a man-hole or a tom-tom down a mine. Record it on the Elizabethan, and you'll hear the original note, the whole note, and nothing but the note. Take any note, any instrument in the orchestra, any sound in the world, and the Elizabethan will play it back true to life. It is designed and made in England to give you all the pleasure and economy of a good tape recorder and many unique Elizabethan features as well, good looks and excellent value (Model 56, 54 gns: the Essex, 75 gns). Ask your dealer to demonstrate the Elizabethan to you.



The Elizabethan Essex



Elizabethan FOR SOUND, NATURALLY

For **FREE** illustrated literature, please let us have your name and address

E.A.P. (TAPE RECORDERS) LTD Oldchurch Road, Romford, Essex Tel: Romford 62366/7

EVERY LEADING MAKE
OF TAPE RECORDER
IN STOCK AT

THE TAPE RECORDER CENTRE



Elizabethan Escort
45 gns. Only £4 10s. dep.
and 9 monthly
payments of £4 15s.

plus a complete range of Hi-Fi Amplifiers, Tape Decks, Tuners, Transcription Motors, Speakers, Pick-up Arms, Cartridges, etc. Complete range of saga — Elizabethan recorded tapes.

Send now for our FREE illustrated 20-page catalogue. Unbeatable NO-INTEREST terms on all recorders (except Ferrograph and Vortexion): all you pay is the nett cash price, over 9, 12 or 18 months. Deposits from only 10%. No extras.

Delivered free British Isles. Excellent after-sales service. You cannot do better than buy from the Recorder and Hi-Fi specialists—

THE TAPE RECORDER CENTRE

Sypha Sound Sales Ltd. (Dept. T)
75 Grand Parade, Haringay, London, N.4
Tel.: STAmford Hill 1146
Open Mon. to Sat. 9-6, Wed. 9-1

MICROPHONES FOR RECORDERS

The quality of reproduction from your recorder depends upon the type and quality of the microphone used with it. That is why it is best to specify LUSTRAPHONE. There are a number of models particularly suitable for recorders of all types at prices from 67/6 for the popular all-purpose Lustrette Moving Coil Microphone to £9.19.6 for Model VR/53 Ribbon Velocity Microphone for broadcast studio standards. Shown here is Model VR/64 Ribbon Velocity Microphone at £7.17.6.

Brochure showing complete Lustraphone range free on request. We will also gladly advise on the Lustraphone Microphone best suited to your requirements.



ST. GEORGES WORKS,
REGENTS PARK ROAD,
LONDON, N.W.1.

LUSTRAPHONE LTD. Telephone: PRImrose 8844

WE'VE GOT IT TAPED—20 NEW MACHINES FROM STOCK

Item	Make and Type	Delivery	Price		No Interest Terms 6 Monthly Payments of	Credit Sale Terms 9 Monthly Payments of	Hire Purchase Terms 12 Monthly Payments of
			£ s. d.	£ s. d.			
1	Ferrograph, 3/AN	Stock	82 19 0	13 16 6	Dep: 9 4 11	Dep: 41 9 8	
2	Ferrograph, 66/H	2/3 weeks	90 6 0	15 1 0	9 @ 9 0 2	12 @ 3 17 9	
3	Ferrograph, 3 AN/H	Stock	96 12 0	16 2 0	9 @ 10 1 0	Dep: 45 3 8	
4	Ferrograph, 3/SH	6 weeks	93 9 0	15 11 6	9 @ 9 16 2	12 @ 4 4 7	
5	Ferrograph, 3/SN	6 weeks	100 16 0	16 16 0	9 @ 10 15 2	Dep: 48 6 9	
6	Ferrograph Adaptor, 3 A/S.	10/12 weeks	31 10 0	5 5 0	9 @ 10 9 10	12 @ 4 10 6	
7	Vortexion, WVB	Stock	93 13 6	15 12 3	9 @ 10 8 1	Dep: 46 14 9	
8	Vortexion, WVB	Stock	110 3 0	18 7 2	9 @ 10 3 0	12 @ 4 7 7	
9	Reflectograph, Stereo	6 weeks	141 15 0	23 12 6	9 @ 11 4 2	Dep: 50 8 0	
10	Reflectograph, 400	Stock	88 4 0	14 14 0	9 @ 10 19 0	12 @ 4 14 6	
11	Reflectograph, 500	Stock	98 14 0	16 9 0	9 @ 10 19 0	Dep: 15 15 4	
12	Grundig, TK20	Stock	52 10 0	8 15 0	9 @ 3 8 5	12 @ 1 9 6	
13	Grundig, TK30	Stock	75 12 0	12 12 0	9 @ 10 8 6	Dep: 46 17 7	
14	Grundig, TK35	Stock	86 2 0	14 7 0	9 @ 10 3 6	12 @ 4 7 9	
15	E.A.P., Escourt	Stock	47 5 0	7 17 6	9 @ 12 4 9	Dep: 55 1 8	
16	E.A.P., Elizabethan	Stock	68 5 0	11 7 6	9 @ 11 19 4	12 @ 5 3 3	
17	Spectone	Stock	78 15 0	13 2 6	9 @ 15 15 0	Dep: 70 18 2	
18	Brennel	Stock	67 4 0	11 4 0	9 @ 15 8 0	12 @ 6 12 10	
19	Verdik	Stock	56 14 0	9 9 0	9 @ 9 16 6	Dep: 44 2 3	
20	Wyndson	Stock	51 9 0	8 11 6	9 @ 9 11 7	12 @ 4 2 8	
21	Sound	Stock	57 15 0	9 12 6	9 @ 10 19 8	Dep: 49 7 0	
22	Truvox	Stock	68 5 0	11 7 6	9 @ 10 14 5	12 @ 4 12 6	

The most comprehensive Tape Service in the London Area.

NEW machines, Decks, Amplifiers, Heads, Motors, Tapes, Spools, Splicers, Components, Accessories and Reconditioned Machines.

EVERYTHING FOR THE TAPE ENTHUSIAST

CLASSIC ELECTRICAL CO. LTD.

"The Tape Recorder Specialists"

352, 354, 364, Lower Addiscombe Rd., Croydon, Surrey.

Tel: ADD 6061/6062
Telegrams: CLASSIFI, Croydon, Surrey

ASK FOR DETAILS OF OUR NO INTEREST TERMS

Full Mail Order and Export Facilities

Full H.P. and C/S Facilities

sight, sound and taste

Sight, sound and taste . . .
The styling of a recorder is an important consideration to the prospective buyer. Does it suit your particular taste? Will it harmonize with existing furniture or equipment? At QM we stock recorders to satisfy the most exacting demands in both performance and appearance. Come along and see for yourself!

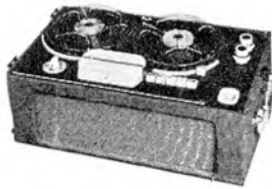

MAGNAFON MI

The new improved version of the Magnafon MI gives even better quality at the same price—48 gns! This British made recorder incorporates a new Acos crystal microphone and the newest 3-speed MOTEK K.9 deck with record safety catch. An interesting feature is that it will play pre-recorded tapes.



CADENZA RIBBON MICROPHONE

Guaranteed to get the best out of the finest recorder. The Cadenza Ribbon Microphone is a superb instrument—a worthy counterpart to the finest recorders. By no means expensive, it has a clarity of styling to match its performance. Microphone (dual impedance head) in presentation case. 8½ gns. Microphone (dual impedance head) and tripod desk stand with 11ft. of cable. 10 gns.

TANDBERG

The superb Tandberg deluxe recorder also reproduces stereo tapes. It is a 3-speed recorder—7½, 3¾ and 1¾ i.p.s. on 7in. reels and has a precision place indicator. It is housed in a polished, veneered cabinet and there is a pigskin leather-cloth carrying case. Price

114 gns.

For stereo reproduction QM can supply suitable external speakers from 12 gns. to 57 gns.



STUZZI MAGNETTE

Some comparatively tiny recorders have been forced to make great sacrifices in quality. The Stuzzi combines genuine portability and a first-class performance. It is fully transistorised and battery operated—the running cost is about 1d. an hour! Price 69 gns.



TAPE LIBRARY

Here is a new QM service that opens up a whole world of entertainment for tape enthusiasts. You can hire one, two or three tapes—monaural or stereo—and you can change any one of them up to twelve times within a six-month period. Ask for details and charges. Incidentally, fifty new tapes have recently been added! QM stock all the accessories the tape enthusiast requires.



VERITONE VENUS

Something British—and really new! Outstanding exhibit at this year's Radio Show this 7½/3¾ i.p.s. recorder built into a handsome 'chairside' cabinet. Separate record and replay heads and amplifiers—2 speakers—storage space for mic., tapes, etc. And all for 66 gns.!—the Veritone 'V' F.M. radio unit (16 gns.) slips into one of the compartments!

Quality Mart

8, DARTMOUTH PARK AVENUE, LONDON, N.W.5.

GULLiver 1131

Our showroom is open for demonstrations daily 9-30—6. Friday 1-30—9. Closed Monday.

Only 16 minutes from Charing Cross by Northern Underground or Bus 27, 134, 137 to Tufnell Park Station, thence 4 minutes' walk.

★ See and hear the new Grundig recorders at QM.



'I'm using this instrument myself'—says

Felix Rieg

'As you know, tape recording is used a lot these days in my profession, particularly when trying out new numbers, and excellence of reproduction is, of course, essential. That's why I have chosen the Verdik S1 to help me in my work.'

A fully monitored **QUALITY** tape recorder with features hitherto unobtainable only in equipment costing double the price. Separate Record and Play-back amplifiers and a 3 head system allows play-back as you record—no more ruined recordings. Speeds $3\frac{3}{4}$ " /sec., $7\frac{1}{2}$ " /sec. Five valves plus magic eye level indicator. High flux internal speaker. Frequency 40 c/s to 12 kcs. Corrected out-put for play-back through your Hi-Fi amplifier. Provision for 15ohm external speaker. Complete with 1200 ft. tape and microphone. **45 gns**

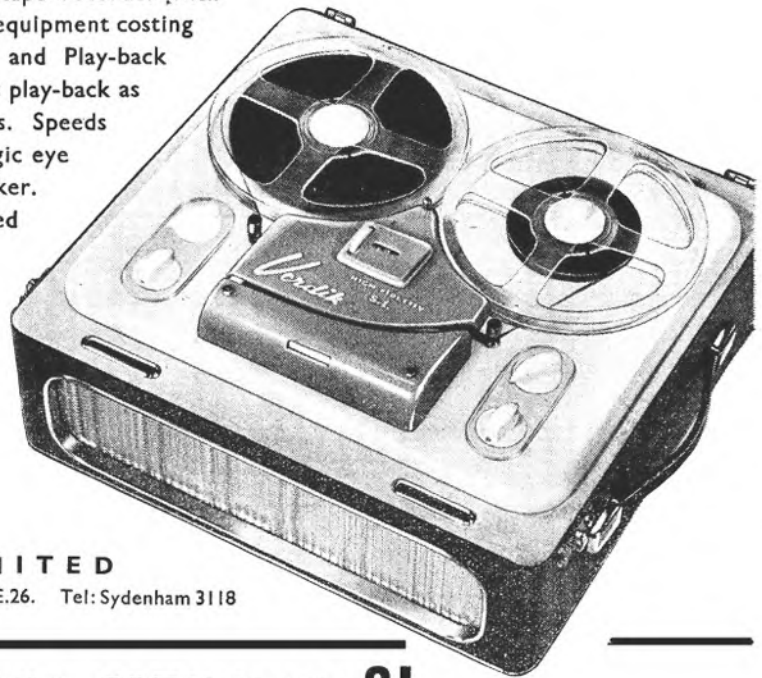

VERDIK SALES LIMITED

139/143, Sydenham Road, Sydenham, London, S.E.26. Tel: Sydenham 3118

make the most of your VERDIK S1

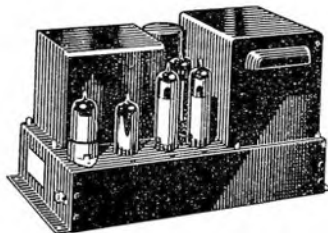

Verdik "Quality Ten" 10 watt push pull, ultra-linear amplifier. 14 gns.



Standard control unit and pre-amplifier. Suitable for use with crystal and other high gain pick-ups. 6 gns.



High Gain control unit and pre-amplifier. Suitable for use with any pick-up generally available. 9 gns.

Tape Library?

You should get
PHILIPS

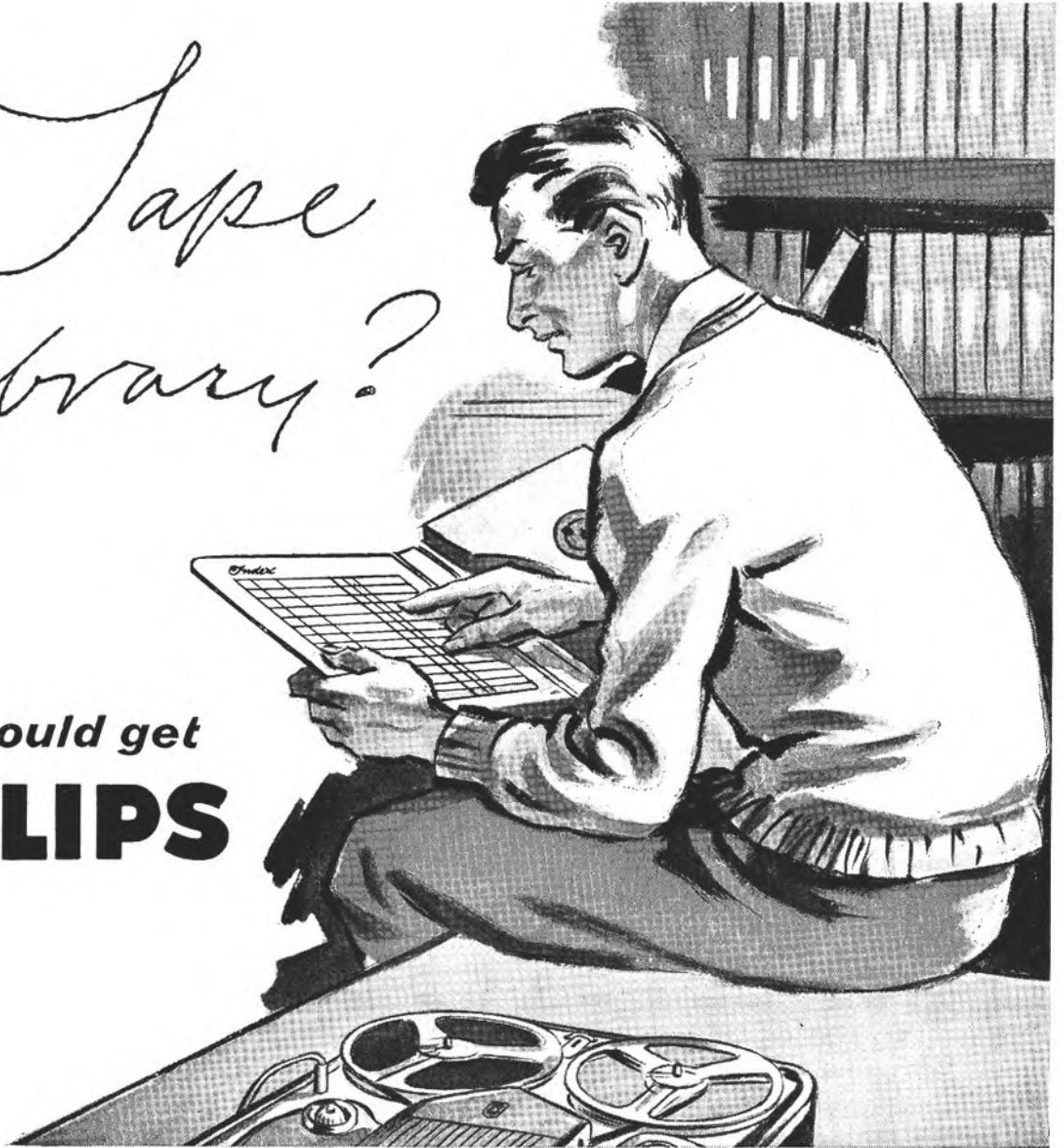

... it fits all Tape Recorders!



(Made in Holland)

Philips tape will fit *your* tape recorder — and give you really superlative reproduction, even of music in High Fidelity. Also, if you're building up a library of tape, there's another reason for choosing Philips — the way it's packed. The Philips 7" reels are packed in durable books with an index page ready for your notes. Philips tape is also available in 5" reels packed in plastic containers and 4" reels. It offers you high sensitivity, wide frequency range, low noise level — all at a competitive price. All good reasons why you should stock *your* tape library with Philips tape!



PHILIPS ELECTRICAL LIMITED • CENTURY HOUSE • SHAFTESBURY AVENUE • LONDON • W. C. 2



RIBBON MICROPHONE M.9.
In this new Microphone—

Our popular assembly is used mounted in a more economical manner.
 The magnet system is very generous and comprises three substantial U magnets to provide the high field necessary for good frequency response and efficiency.
 The ribbon is of specially formed aluminium alloy 0.0001" thick.

Price £6. 12. 6.

FILM INDUSTRIES LTD.

90 Belsize Lane, London, N.W.3

HAM 9632-3

Telegrams: Troosound Haver

THE VIKING TAPE RECORDER

Uses the MOTEK K9 deck. 3-speeds, "Pause" Counter. Hatfield oscillator. Switch for Amplifier. 2 inputs. Vol. control scale. Unique method of super-imposing recording. Accessibility for service. C.C.I.R. linked equalisation. Detachable lid.



46 GNS.

OR TERMS

Send now for leaflet to:—

HATFIELD RADIO

78, STROUD GREEN ROAD, LONDON, N.4

Tape specialists since 1952

WE HAVE THE

**LARGEST SALES
 IN ENGLAND!**

WHY?

BECAUSE WE GUARANTEE YOU THE BEST TERMS

Any make only 2s. 6d. in £ deposit, balance of retail price only, by 9 monthly payments with **NO INTEREST CHARGES** * H.P. over 2 years * Special cash terms—most makes * Free delivery anywhere in U.K. (we are the biggest Mail Order Specialists with thousands of sales over the whole country) * Free service for 12 months * Part-exchanges * Free demonstrations in your own home, etc.

100 machines, 25 models on permanent demonstration in our showrooms * Open all day Saturday * Credit deals completed on the spot * All accessories in stock or sent by Mail Order * Main Agents for all the best makes.

You may purchase from us by post, in complete confidence.



**H O W A R D
 P H O T O G R A P H I C**

WRITE, PHONE OR CALL FOR FREE BROCHURES AND DETAILS OF OUR TERMS:

190, HIGH ST. • BROMLEY • KENT • RAV 4477

TAPE RECORDER AND CAMERA CENTRE

A microphone by **acos**

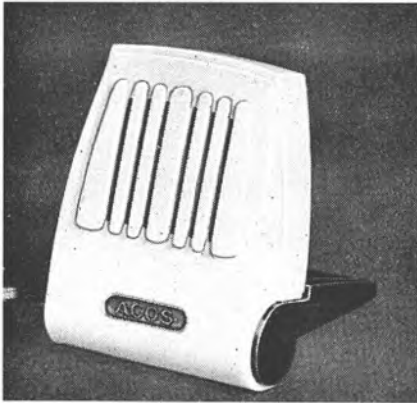

Two-position stand
for use either free-standing
or held in the hand

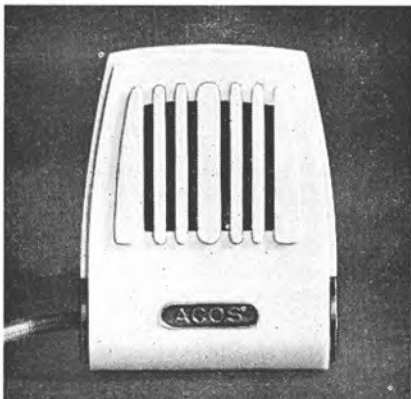

Model MIC 40 A neat and handy pack-away microphone designed particularly for use with tape recorders. Pleasant appearance and good performance.

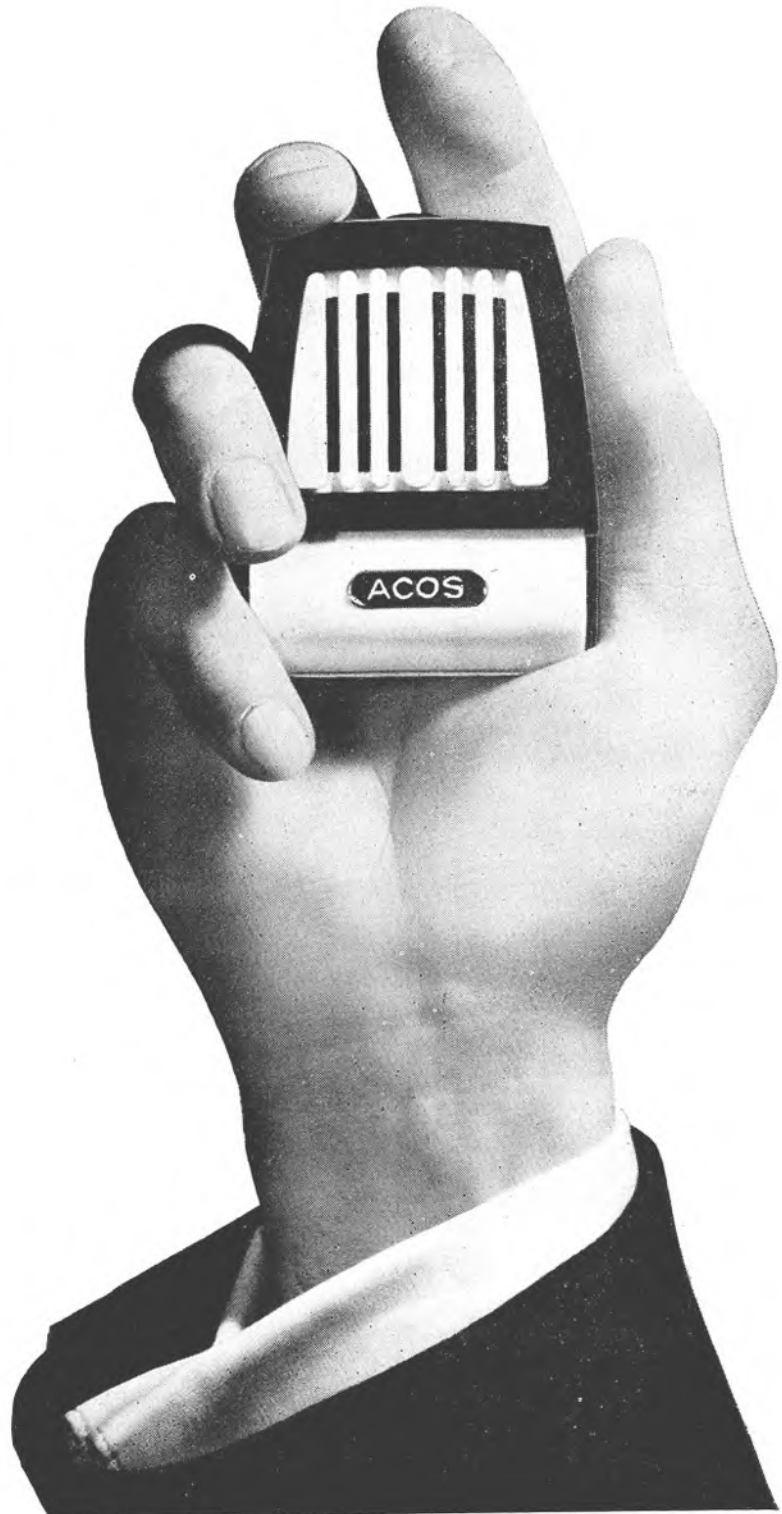

COSMOCORD LTD WALTHAM CROSS HERTS. TEL: WALTHAM CROSS 5206 (London telephone subscribers dial WA4 5206)

Our range is on the grand scale

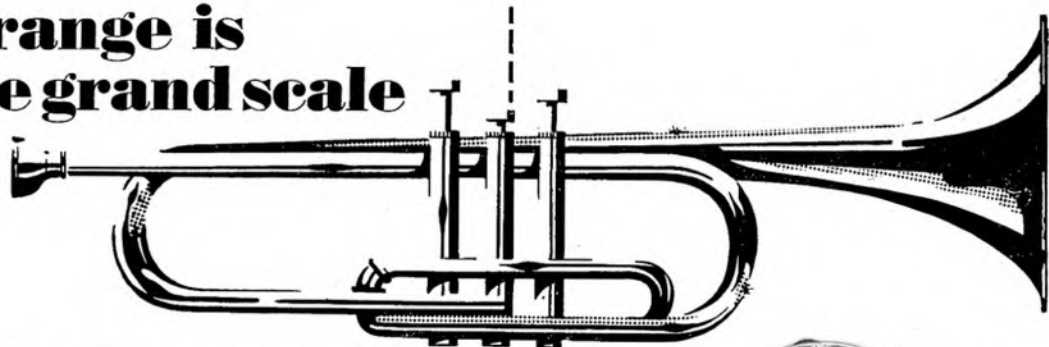

Like that versatile musical instrument the trumpet, we satisfy all tastes whether for melodies old or new. Quality sound reproduction is always Sonomag's first consideration and their tape recorders are designed to achieve true high fidelity. There are models to suit all tastes. Ask your stockist for Sonomag leaflets on these fine models.

- THE GAIETY** 46 gns.
- THE CLASSIC** 54 gns.
- THE CONTINENTAL** 56 gns.
- PORCHESTER CONSOLE** 70 gns.
- THE ADAPTATAPE** 40 gns.
- and the NEW CONCERTO** 66 gns.



THE ELON DE-LUXE 65 gns.

Sole wholesale distributors:

J. E. Dallas & Sons Ltd., Clifton St., E.C.2.

BIShopsgate 9981



SONOMAG LIMITED

2, St. Michael's Road, Stockwell, London, S.W.9.

BRI. 5441/3

TeleTape

FAST AND DEPENDABLE MAIL ORDER DELIVERY. ALL TYPES OF TAPE RECORDERS AVAILABLE ON CREDIT TERMS WITHOUT INTEREST OR CHARGES

THE NEW Veritone Venus

The new shape for sound. This beautifully designed console made a sensational debut at the Radio Show. Sound reproduction is superb. It has a completely new deck with an exclusive 3-head system, twin speakers and amplifiers and provision for specially designed V/F.M. radio and V.Hi-Fi amplifier.



**ONLY
66gns.**

Write now for free illustrated leaflet

TeleTape Britain's Largest Tape Recorder Specialists

Every make of Tape Recorder is available from our branches. Our experience and independent advice are freely available to all Tape Recorder enthusiasts.

Machine	Deposit		Nine Payments		Cash
	£	s. d.	£	s. d.	
Veritone Venus.....	8	13 6	6	14 10	66 gns.†
Truvox R.2 (With Rev. Counter)	9	0 0	7	1 0	69 gns.*
Truvox R.2 (With Timing Scale)	8	13 6	6	14 10	66 gns.*
Walter 303.....	5	3 6	3	19 6	39 gns.*
Philips A.G. 8109.....	5	3 6	3	19 6	39 gns.*
Sound 777.....	5	15 6	4	9 10	44 gns.†
Verdik.....	5	18 6	4	11 10	45 gns.*
Elizabethan Escort.....	5	18 6	4	11 10	45 gns.*
Grundig T.K.20.....	6	11 6	5	2 0	50 gns.*
Veritone Type V.....	6	16 6	5	6 2	52 gns.*
Sound A.20.....	7	4 0	5	12 4	55 gns.*
Brenell 3 Star.....	7	12 3	5	18 5	58 gns.*
Elon J.C.20.....	8	10 3	6	12 9	65 gns.*
Philips A.G. 8108.....	8	2 9	6	6 7	62 gns.*
Elizabethan Essex.....	8	10 3	6	12 9	65 gns.†
Baird.....	8	16 0	6	16 10	67 gns.*
Winston Thoroughbred.....	9	0 0	7	1 0	69 gns.*
Grundig T.K.8/3D.....	9	9 0	7	7 0	72 gns.†
Harting.....	10	15 3	8	7 5	82 gns.†
Wyndor Dauphin.....	11	13 8	9	1 9	89 gns.*
Grundig T.K.830/3D.....	13	2 6	10	4 2	100 gns.†

*Including microphone †Less microphone.

Demonstrations daily; open until 6 p.m. Saturdays. Phone or write for the address of your nearest branch, or order direct from:

59A, Edgware Road (2 mins. Marble Arch), W.2. ☎

Tel.: PADDington 1942

scintillating sound

There are more features in the new Simon SP.4 than have ever before been gathered into any portable tape recorder. Exclusive to the SP.4 is the fully 'push-button-controlled' Simon Automatic Deck and a 10-watt ultra-linear amplifier. Automatic tape reversal allows not only 3 hours' continuous recording but continuous replay indefinitely *without attention*. This technical excellence, matched by elegant styling, makes the SP.4 an instrument that you will be thrilled to hear if you really appreciate first-class sound.

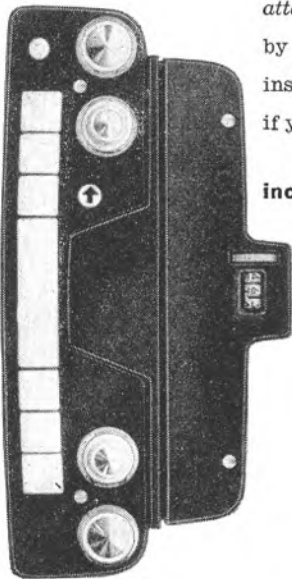

incorporating the new Simon fully automatic tape deck and these outstanding features:

- AUTOMATIC TAPE REVERSAL** *without button pressing or spool transposing*
- CONTINUOUS REPLAY** and 3 hours continuous recording without attention
- 3-WAY MIXING FACILITIES** on both record and playback
- 10 WATTS OUTPUT** from ultra-linear push-pull amplifier
- PUSH-PULL OSCILLATOR** reduces noise and hum to minimum
- BASS AND TREBLE LIFT AND CUT** with independent controls
- ERASE/RECORD 'safety button'**
- SYNCHRONOUS MOTOR** mains frequency-controlled for accurate speed
- ACCURATE TAPE POSITION INDICATOR** based on linear tape scale
- CATHODE RAY MAGIC EYE** for 'pin-point' modulation

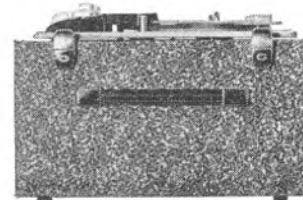
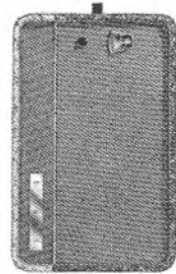

The lid is detachable. Both case and lid are covered with genuine Rexine in attractive dual tone colours. Styling: Peter Bell, M.S.I.A.

simon SP.4

high fidelity **TAPE RECORDER**

CADENZA

ribbon microphone

... to do justice to the excellence of the SP.4.

Dual impedance head, output sensibly flat between 50-12,000 cps. In handsome presentation case, head only 8½ gns. or with tripod desk stand 10 gns.



Send this coupon now for illustrated literature on the Simon SP.4

To SIMON SOUND SERVICE LTD.

46-50 George Street, Portman Square, London W.1

Please send me literature on the Simon SP.4

NAME _____

ADDRESS _____

95 GNS

My nearest dealer is

NAME _____

ADDRESS _____

E.8.

OUTSTANDING TAPE RECORDER VALUE!

A small neat Recorder offering two speeds 3½ in. and 7½ in., 5 in. reels giving up to 1½ hours recording time, outstanding "live" recording facilities as well as top quality Radio and Gram-recording of all your favourite music, etc. Monitoring facilities through crystal ear-piece. Dimensions 11 ins. x 9 ins. x 6 ins. Weight only 17 lbs.



Never before such value at

29 Gns.

Specially matched high grade moving coil mike. 3gns. **YOURS FOR**

£3 13 3

Deposit

and 9 monthly payments of **£3 13s. 3d.** (includes mike and tape).

Available only from:

E. C. KINGSLEY & CO.

(Dept. T.R.), 132, TOTTENHAM COURT ROAD (Corner of Warren Street), LONDON, W.1. EUSton 6500

FOR THE BEST REPRODUCTION FROM YOUR RECORDER—

USE A ...

Cadenza



RIBBON MICROPHONE

SENT FOR ONLY

10/- FIRST PAYMENT

and 17 further payments of 13/6 every 2 weeks

CASH PRICE 10 GNS.

This Ribbon Microphone comes to you complete and ready for use. Beautifully cased. As used by many well-known T/V personalities.

All leading makes of tape recorders on the easiest of terms

AND IMMEDIATE DELIVERY

SEND DEPOSIT TODAY FOR SPEEDY DELIVERY

"HATHERLEY" Dept. T.R.

134 UXBRIDGE ROAD, SHEPHERD'S BUSH, LONDON W.12
Open all day Saturday

RECORDING TAPE

RETURN OF POST SERVICE

All the following items are normally kept in stock for delivery by return of post. In the event of supplies being held up from the makers we advise delivery position by return.

BASF

Standard PVC Base. 150ft. (3") 8/-. 300ft. (4") 13/6d. 600ft. (5") 21/-. 850ft. (5½") 28/-. 1,200ft. (7") 35/-.
LONG PLAY. P.V.C. Base. 210ft. (3") 9/-. 850ft. (5") 28/-. 1,200ft. (5½") 35/-. 1,700ft. (7") 50/-.
On Hublock Reels. 200ft. (3½") 12/6d. 600ft. (5") 26/9d. 1,200ft. (7") 45/-. 1,750ft. (8½") 63/-.
"88" PVC Base. Message 175ft. (3") 7/6d. Junior 600ft. (5") 21/-. Continental 850ft. (5½") 28/-. Standard 1,200ft. (7") 35/-. Professional 1,800ft. (8½") 57/6d.
"99" LONG PLAY. PVC Base. Message 250ft. (3") 9/6d. Junior 850ft. (5") 28/-. Continental 1,200ft. (5½") 35/-. Standard 1,800ft. (7") 50/-. Professional 2,400ft. (8½") 72/6d.

BRITISH FERROGRAPH

On Hublock Reels. 200ft. (3½") 12/6d. 600ft. (5") 26/9d. 1,200ft. (7") 45/-. 1,750ft. (8½") 63/-.
"88" PVC Base. Message 175ft. (3") 7/6d. Junior 600ft. (5") 21/-. Continental 850ft. (5½") 28/-. Standard 1,200ft. (7") 35/-. Professional 1,800ft. (8½") 57/6d.
"99" LONG PLAY. PVC Base. Message 250ft. (3") 9/6d. Junior 850ft. (5") 28/-. Continental 1,200ft. (5½") 35/-. Standard 1,800ft. (7") 50/-. Professional 2,400ft. (8½") 72/6d.

EMITAPE

EMITAPE IN EMICASES
Emitape packed in the new plastic containers.
"88" Junior 600ft. (5") 23/6d. Continental 850ft. (5½") 30/6d. Standard 1,200ft. (7") 37/6d.
"99" LONG PLAY. Junior 850ft. (5") 30/6d. Continental 1,200ft. (5½") 37/6d. Standard 1,800ft. (7") 52/6d.

EMITAPE IN EMICASES

EMITAPE IN EMICASES
Emitape packed in the new plastic containers.
"88" Junior 600ft. (5") 23/6d. Continental 850ft. (5½") 30/6d. Standard 1,200ft. (7") 37/6d.
"99" LONG PLAY. Junior 850ft. (5") 30/6d. Continental 1,200ft. (5½") 37/6d. Standard 1,800ft. (7") 52/6d.

GELOSO

3" Spools. Standard 12/-. Long Play 16/-.
T4. 120ft. (3") 7/9d. T2. 850ft. (5½") 27/6d. T3. 1,200ft. (7") 35/-. Long Play. TLP1. 1,200ft. (5½") 35/-. TLP2. 1,700ft. (7") 50/-.
PM/15. 150ft. (3") 5/6d. 300ft. (4") 10/6d. 600ft. (5") 20/-. 850ft. (5½") 27/6d. 1,200ft. (7") 35/-. 1,750ft. (8½") 55/-.
LONG PLAY. 225ft. (3") 8/6d. 450ft. (4") 14/6d. 850ft. (5") 28/-. 12,000ft. (5½") 35/-. 1,800ft. (7") 50/-. 2,400ft. (8½") 75/-.
300ft. (4") 13/6d. 600ft. (5") 21/-. 1,200ft. (7") 35/-.
LONG PLAY. 850ft. (5") 28/-. 1,800ft. (7") 50/-.
No. 111A. Acetate Base. 200ft. (3") 6/3d. 600ft. (5") 16/-. 850ft. (5½") 22/-. 1,200ft. (7") 27/-.
No. 150. LONG PLAY. Polyester Base. 300ft. (3") 9/6d. 900ft. (5") 28/-. 1,275ft. (5½") 35/-. 1,800ft. (7") 50/-.
No. 120 High Output. Acetate Base. 600ft. (5") 23/-. 850ft. (5½") 31/-. 1,200ft. (7") 39/-.
No. 111V. Super Base. PVC Base. 200ft. (3") 7/6d. 600ft. (5") 21/-. 850ft. (5½") 28/-. 1,200ft. (7") 35/-.
EXTRA PLAY TAPE. Supplied on 5" reels only. These contain TWICE the length of standard tape. 1,200ft. on 5" spool 35/-.
NOTE.—All Tapes are Standard Play except where shown as Long Play.

GRUNDIG

EXTRA PLAY TAPE. Supplied on 5" reels only. These contain TWICE the length of standard tape. 1,200ft. on 5" spool 35/-.
NOTE.—All Tapes are Standard Play except where shown as Long Play.

MSS MASTERTAPE

EXTRA PLAY TAPE. Supplied on 5" reels only. These contain TWICE the length of standard tape. 1,200ft. on 5" spool 35/-.
NOTE.—All Tapes are Standard Play except where shown as Long Play.

PHILIPS

EXTRA PLAY TAPE. Supplied on 5" reels only. These contain TWICE the length of standard tape. 1,200ft. on 5" spool 35/-.
NOTE.—All Tapes are Standard Play except where shown as Long Play.

SCOTCH BOY

EXTRA PLAY TAPE. Supplied on 5" reels only. These contain TWICE the length of standard tape. 1,200ft. on 5" spool 35/-.
NOTE.—All Tapes are Standard Play except where shown as Long Play.

TELEFUNKEN

EXTRA PLAY TAPE. Supplied on 5" reels only. These contain TWICE the length of standard tape. 1,200ft. on 5" spool 35/-.
NOTE.—All Tapes are Standard Play except where shown as Long Play.

Wide range of Tapes Accessories in stock. Detailed list free on request

TERMS OF BUSINESS.—Cash with order or C.O.D. All tape is post free, but postage is extra on orders under £3 for accessories. C.O.D. fees are charged on C.O.D. orders under £5.

CREDIT TERMS are available on orders or Tape and Accessories over £5 in value. Send for details.

WATTS RADIO (MAIL ORDER) LTD.

54 Church Street, Weybridge, Surrey
Telephone WEYBRIDGE 4556

PLEASE NOTE—Post orders only to the above address

**IT'S SPECTACULAR!
THE STUZZI 'MAGNETTE'**



A fully transistorised battery operated recorder with all the features expected from a mains operated recorder of advanced design.

NEW waterproof covers to protect your valuable recorders. Choice of colours: navy blue, tan and wine with white piping. Specials made to order. Full range to suit.

Popular models in preparation:
TK5 Cover complete with microphone pocket. Price now only 36s.
TK8 Cover complete with microphone pocket. Price now only 39s.
TK 830/3D Cover. Price now only 40s. 6d.
TRADE ENQUIRIES INVITED

- * Size 11" x 4½" x 8" Weight 8lbs.
- * Twin Speed 1½ and 3½.
- * Twin Track.
- * Frequency 80-9000 cycles.
- * Up to two hours per reel playtime.
- * Magic Eye.
- * Position Indicator.
- * Amplifier Facilities.
- * Id. an hour to run—approx.

69gns. complete with microphone and radio connecting leads.



also the
minifon

One of the world's smallest wire recorders

TAPE RECORDERS BY

Grundig, Gelson, Telefunken, Truvox, Elizabethan, Wyndson, Simon, Phonotrix, Tutor and last but not least the **STUZZI MAGNETTE and MAMBO**

TAPE DECKS.

MICROPHONES AND STANDS. Grundig, Cadenza, Gelson, Cosmocord, Lustraphone, Reslo, etc.

CRYSTAL PEN STAND MICROPHONE complete with ball point pen—suit Gelson TR 175. Price £6 18s. 0d.

TAPES. Grundig, B.A.S.F., Emitape, Scotch Boy and Telefunken Double Play.

JOINTING AND EDITING ACCESSORIES. Mixers, Tuners, Amplifiers, Converters, Speakers, Record Transcription Units, Spares.

★ No Interest Terms ★ Free Delivery

A. BROWN & SONS LTD. TAPE RECORDING DEPT.
24-28 George Street, Hull, E. YORKS
Telephone: 15412, 15413



The safety record button is only one of the features which keep this famous tape-deck way out ahead. It is designed especially to combine all that is best with the minimum of maintenance. Illustrated literature on request. Patents pending.

LIST 21 GNS.

M O T E K

The Five Star Tape Deck

MODERN TECHNIQUES
WEDMORE STREET LONDON N.19 Tel: ARCHway 3114

A FINE CASE

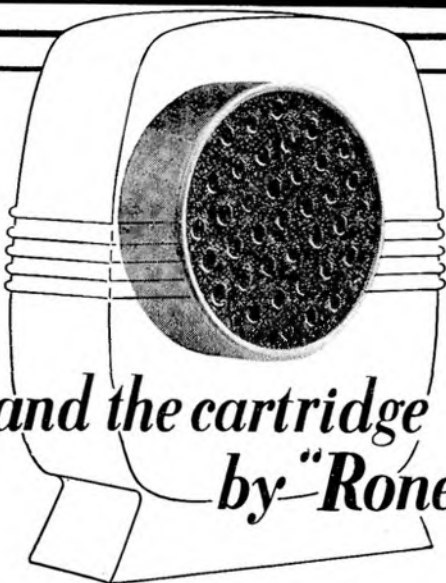

and the cartridge
by "Ronette"

Manufacturers of recording and public address equipment who wish to have a microphone of their own personal style and who prefer to manufacture the housings themselves, can choose from a variety of RONETTE microphone inserts.

A.o. RONETTE has available type MC-65 which is the most outstanding and which features small dimensions, high output, and fine frequency response (30-10,000 cps.) without peaks. RONETTE further manufactures the famous "Filtercell" inserts which can be supplied with several kinds of frequency characteristics.

For details and prices please contact:

TRIANON ELECTRIC LTD.

95, Cobbold Road, Willesden

LONDON, N. W. 10.

Phone: Willesden 2116

TAPE RECORDERS

THE COMPLETE TAPE RECORDER
SPECIALISTS

We stock the largest Selection of Recorders in London
Main Agents for:

BRENELL ● TRUVOX ● PHILIPS ● TELEFUNKEN
HARTING ● ELIZABETHAN ● FERROGRAPH
VORTEXION ● WYNDSOR ● SOUND ● MAGNAFON
GRUNDIG TK 830, TK 30, TK 20 ● WALTER ● VERDIK
PERTH SAJA ● STUZZI ● PHONOTRIX ● GELOSO
UHER ● SIMON, etc.

Over 30 different models to choose from, all the latest from the Show

All available on Credit or H.P.
Terms with NO INTEREST or
CHARGES whatsoever. + Free
Service whilst under guarantee.

All available sizes: E.M.I. ● GRUNDIG ● BASF
TELEFUNKEN ● PHILIPS ● SCOTCH BOY ● GELOSO
● STENORETTE ● Tapes and empty spools. Complete range
Tape Recorder Accessories ● all available, Mail Order Post Free.

Comprehensive Range of Microphones by:—

CADENZA ● LUSTRAPHONE ● RESLO ● ACOS ● PHILIPS
GRUNDIG. TUNERS ● AMPLIFIERS ● TRANSCRIPTION UNITS

FRANCIS OF STREATHAM

169/171 STREATHAM HIGH RD., S.W.16
STR 0466,0392 Open all day Saturdays

THE
ONE
PLACE
TO
GO
TO

THE RECORDER Co.

A great many enthusiasts visit us each week, inspecting, testing, comparing the unrivalled selection of Tape Recorders we have on display. We give advice and make a point here and there, but there is no salesmanship—indeed we are but enthusiasts together. Perhaps this, together with the best possible terms such as monthly instalments free of interest, free insurance and free delivery, etc., accounts for the fact that more and more people are finding that the one place to go to for Tape Recorders and equipment is

THE RECORDER Co. (Dept. T.)
188, West End Lane, West Hampstead,
London, N.W.6. Telephone: SW1 4977

We are mail-order specialists—free catalogues
and full information sent on request.
Open all day Saturday

A Question of Policy...

Before introducing our 1959 range of Tape Recorders we would like to put forward this company's policy.

We believe the intending purchaser of today is becoming very discriminating in his choice of a Tape Recorder. This we feel is primarily due to a number of the machines on the market which although branded as "High Fidelity" do in fact, sound no better than a pocket radio, plus the ever increasing number of different makes now available.

With this in mind it was decided to produce a machine based on our highly successful schools model, with three variations to cover individual requirements. The emphasis being not only on fidelity of reproduction but also reliability in use. The cost has been made very competitive by very efficient methods of manufacture and not by using second grade materials. Repts Tape Recorders introduce with confidence their reliability range of Quality Tape Recorders backed by a TWO-YEAR GUARANTEE. The individual models are as follows:—

R20 62gns with magic eye record indicator.

R30 66gns with meter record level indicator.

R40 70gns as R30 but with push/pull sound output.

TECHNICAL SPECIFICATION

Amplifier 30 — 25,000 cps + or — 2 dbs
3½ ips @ 60 — 5,000 cps + or — 3 dbs
7½ ips @ 50 — 10,000 cps + or — 3 dbs
15 ips @ 40 — 16,000 cps + or — 3 dbs

(Signal/Noise ratio at 7½ ips = 47 dbs)
The frequency range in the treble region has been limited to obtain the maximum signal/noise ratio compatible to a low distortion factor. Distortion introduced in the recording process is so small that the magnetic tape becomes the limiting factor.

600 ohms at cathode follower line output socket for feeding external amplifier

ALL MODELS

- ★ Separate bass and treble controls
 - ★ Range of treble control at 10 kcs + or — 12 dbs
 - ★ Range of bass control at 60 cps — 15 dbs
 - ★ Push/pull bias and erase oscillator, for low background noise and minimum interference with radio reception
 - ★ Loudspeaker 9" × 5" hi-flux magnet with extended treble response
 - ★ Amplifier output 6 watts peak on models R20 and R30—10 watts peak R40
 - ★ Mains on-off indicator lamp
 - ★ Supplied complete with Acos 39/1 microphone, stand, and 1,200 feet of PVC tape
- ★ These recorders can be adapted for Stereo tapes



Model R30

For demonstration write or phone 9 a.m.—6 p.m. Monday—Friday By appointment Saturday

REPS (TAPE RECORDERS) LTD

118 Park Road North, Acton, London W 3

Phone: ACOrn 4141

Associate Editors:
IAN ARNISON
R. BROWN

Technical Advisory Editor:
CHARLES LANGTON,
A.M.Brit. I.R.E.

Advertisement Department:
1, Crane Court, Fleet St.,
London, E.C.4
Telephone: **FLEet Street 8197**



Published on the 20th of each month from 426, Camden Road, London, N.7. NORTH 3419

CONTENTS

A SOUND PORTRAIT OF YOUR TOWN OR VILLAGE
A feature by G. Holmes Tolley
Pages 18 & 19

HOMO TAPIENS
Page 21

IDEAS POOL
Page 28

FIFTY PER CENT MORE TAPE ON SMALL SPOOLS
By Ian Gibson, B.Sc.
Page 29

TAKING THE PULSE OF A NUCLEAR DETECTOR
By Dr. P. E. Cavanagh
Page 31

SOUND AND CINE
By John Aldred
Page 33

RADIO SHOW, MANUFACTURERS NEWS
Pages 34, 35 & 37

MICROPHONES
By Charles Langton, A.M.Brit.I.R.E.
Pages 38 & 39

REVIEW OF AMPLIFIERS
Pages 40 & 41

KNOW YOUR RECORDER: No. 9
Pages 42, 43 & 45

VISION ON TAPE, CLUB NEWS
Pages 46 onwards

THE EDITORS' VIEW

Still a lot to learn

THE RADIO SHOW has concentrated attention on stereo in a big way. The industry has now committed itself to pushing the "new sound" and we understand that the B.B.C. is about to make a new series of experimental stereo transmissions. They will go out between 11 a.m. and noon on alternate Saturday mornings for the next few months.

While valuable practical experience is thus being acquired on the transmission side, the number of homes equipped with dual amplifying channels is bound to increase rapidly and the prospect of large-scale participation in the new medium is greatly improved.

It is common sense, of course, to recognise that many problems have yet to be solved.

We find it surprising that so much of the recent discussion of stereo in the popular press has been exclusively devoted to disc reproduction. It is a matter of elementary fact that the work done on the new discs, brilliant as it has been, has not produced such perfect results as we have long been able to enjoy by the use of tape.

But a lot of money is tied up in disc equipment—and we do not refer now to the capital investments of the firms in the industry so much as to the natural conservatism of millions of record enthusiasts whose homes were equipped for disc before the merits of tape were widely known.

Manufacturers of tape and tape equipment have a duty now to press their claims to attention. We concede it may be possible that manufacturing costs may give discs a price advantage for many years yet; but the stereo hi-fi enthusiast, to whom price is a secondary consideration, will inevitably turn to tape sooner or later for his reproductions of the classics.

And now we have assurances from authoritative quarters of the certain appearance, in the course of a few years of magnetic tape and associated machines for visual recording and playback. The opportunities ahead suggest dazzling excitement.

But we must not run before we are walking well. There is still room for improvement in technique with simple monaural sound recording. Manufacturers need to concentrate on continued improvement in design. Individual users of equipment need to experiment and learn. The judges in the British Amateur Tape Recording Contest were greatly impressed by the improvements in the standard of entry, compared with the previous year.

They found, however, that there is still a need for greater technical skill in recording and for greater discipline in compiling tape features. If there is one golden rule suggested by the Contest entries it is this: Keep your tapes short. It applies to elaborate features as well as to simple message tapes. The medium offers a constant temptation to over-enthusiasm. If the resulting tapes lack clarity, crispness and sparkle, they will lack interest to outsiders. To that extent they might prove bad propaganda for tape recording.

A SOUND PORTRAIT OF YOUR TOWN OR VILLAGE

.....

The individual enthusiast or the local tape club can get immense enjoyment by making a "sound portrait" of the home town—or village.

In two special articles, G. Holmes Tolley tells you how to go about it. In the first instalment, about the initial planning which should precede recording, he calls upon his own experience in making a sound picture of Stratford-upon-Avon.



THE idea of recording a portrait in sound of a village, town, or city, is not entirely a new one. Dr. Ludwig Koch, well known for his recordings of wild birds and animals, states in his interesting autobiography, *Memoirs of a Bird-man* (a book which should be read by all recording enthusiasts) that he was once commissioned to make "sound books" of two cities, Cologne and Leipzig, capturing for posterity the typical noises and sounds associated with each place.

To quote Dr. Koch: "Nearly every city has its characteristic sounds. From both cities I now have recordings of sounds that will probably never be heard again, because of action during the war."

At that period all recordings were being cut principally on wax blanks, and the recording equipment was rather heavy and often difficult to transport from one place to another. Within recent years, tape recording equipment has been developed to such an extent that the small midget lightweight portable machines now being used by recording enthusiasts, enable them to make many actuality features. In the past, outdoor recordings of this nature would have created many technical problems.

As I specialise in recording natural sounds, sound effects and actualities, I decided to produce a *Sound Picture of Stratford-upon-Avon* some eighteen months ago. Stratford-upon-Avon has much to offer the sound enthusiast. There are obviously many interesting events and personalities, while the Shakespearean association adds colour to a project of this type.

I think that the exciting part of recording a "sound picture" of this description is the extraordinary amount of material to be found and heard in most localities.

With a little assistance from local authorities and associations, you will soon discover people who are willing to cooperate; particularly if it is suggested that a copy of the completed programme will be placed in the local library or archive.

Mention your project to other recording enthusiasts in the vicinity. Often, by pooling knowledge and equipment, many problems which arise can be overcome and a programme of operations arranged.

Unfortunately, a project of this nature is often limited by the type of recording equipment available. Your final "sound picture" will be much more accurate and interesting if it includes outdoor events and sounds, although you may not always consider these necessary.

A portable battery-operated tape recorder is an added advantage, but a power pack attached to a car battery will enable a mains-operated machine to be used as a mobile unit.

The two photographs show the author at work on his Sound Picture of Stratford-upon-Avon. On the right he is seen interviewing a young tourist visitor; the photograph on the opposite page shows him recording the sounds of the river near the Shakespeare Memorial Theatre.



At the start, it is important to draw up a plan which the "sound picture" will follow. This will be governed principally by the size of the town, village or city you are recording as well as the number of activities, sounds and personalities you have to include in the finished programme.

Having decided upon the length (in my case I have chosen half-an-hour for the Stratford-upon-Avon programme) a shooting script should be prepared. This will include sounds, events and personalities associated with the locality. Against each item you propose to record mark the approximate time you consider each voice or sound should last. This will enable you to keep a check on the timing during each stage of recording. Regarding the length of each item, this will usually depend on the subject matter. For instance, where speeches, musical and dramatic events are scheduled for recording, it may be helpful to allow about five minutes of additional material. You will find this useful when editing your tapes.

With regard to the items to be included in the shooting script, you may find the following suggestions helpful:—

(1) Civic and public functions: local elections, processions, fairs, ancient charter ceremonies and the town crier.

(2) Local societies: dramatic, choral, debating and musical events.

(3) Folk music and dancing.

(These will depend very much on the locality you are recording.)

(4) Dialects: an important feature of a "sound picture." Local voices, or the oldest inhabitant, are the ideal sort of material for this category.

(5) Miscellaneous sounds with definite associations: clock chimes, peals of bells, street and river sounds, sports, local markets, and the local railway station will all have much to offer.

Once the material has been collected, the next step is to decide who will narrate the story. A local voice will usually be chosen, but occasionally an impartial voice may be considered more acceptable.

The next important item is the narrator's script. A member of the local historical or antiquarian society might be asked to compile it, as the script should contain factual and historical details of the locality. This can be recorded separately, and finally spliced into the "sound picture" as required. If two recorders are available, the sounds and interviews can be fed into the second machine through a mixer unit. In this way they can come into and under the narration, producing a professional touch to the finished production.

Next month I shall discuss methods of obtaining the material as well as the final production of the recording.



Photographs by Jeremy Brownlow of Stratford-upon-Avon

Build your own HI-FI

— with an
entirely
NEW
range
of Hi-Fi
units
and
cabinets!



Imagine the pleasure of having this magnificent Hi-Fi equipment in its beautiful contemporary style furniture for your home... and experiencing an entirely new realism in sound reproduction. Yet the Emistructor Hi-Fi will save you money and give you all the extra fun and satisfaction of building it yourself—and being able to service and maintain it afterwards. Special instruction manuals guide you at each stage and teach you all about the equipment in simple terms as you build. No skill or experience is needed—only a few simple tools.

Emistructor equipment is made to the highest quality standards and is a product of E.M.I. Institutes Ltd.—part of a company world famous for sound recording and reproducing equipment.

There is a wide variety of equipment and cabinets at different price levels to suit individual tastes and requirements. The range varies from a complete Hi-Fi installation with separate speaker enclosures to a simple all-in-one compact system for those with more modest requirements. All equipment is suitable for stereo or non-stereo reproduction of records. Full details and complete specifications will be sent with our free Brochure.

EMISTRUCTOR

(Dept. H.F.453), 43 Grove Park Road, London, W.4

Associated with one of the World's largest recording organisations comprising—
"HIS MASTER'S VOICE"·CAPITOL·COLUMBIA·PARLOPHONE·MGM·etc.



recapture
it with a
WALTER 505

High Fidelity tape recorder

The Walter 505 gives you an orchestra in your hand—all the extra features you've been hoping for, and it's light enough to be *really* portable into the bargain. You'll be as thrilled with its superb quality as with its handsome modern styling. It has the new Walter Mark II Deck;

2 speeds, 2 speakers, 2 inputs, 2 outputs. **57 gns.**

Write now for free folders describing the 505 and the other Walter models.

WALTER 303 DE LUXE, with the 2 speed Walter Mark II Deck and many other attractive features. **42 gns.**

WALTER 101—a full-size tape recorder with a first class performance. **29 gns.**

All models complete with microphone, tape, radio/gram recording lead, instruction manual and 12 months guarantee.

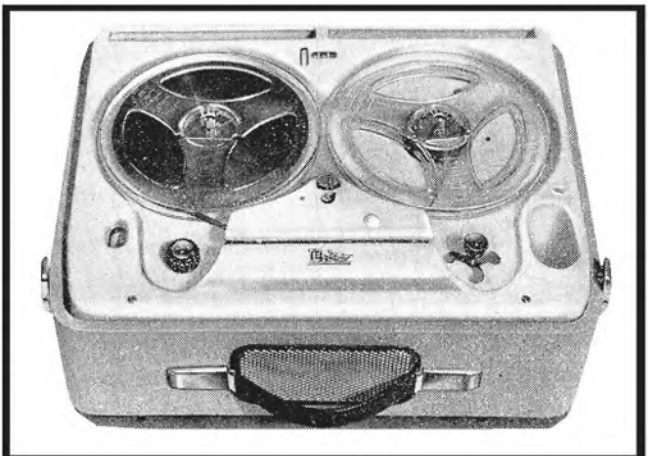

WALTER INSTRUMENTS LIMITED · MORDEN · SURREY · TELEPHONE: DERwent 4421

It was tough but stimulating

MAY I thank everyone who sent in a tape for the British Amateur Tape Recording Contest for giving the judges a tough but stimulating time. Listening with a critical ear does not prevent one from enjoying the good things that emerged, and there were many delightful moments all along the line.

You will be reading about the winners elsewhere, but the impression I am left with, apart from a consciousness of the very high standards achieved, is of an exciting, collective exploration of the world of sound. In this sense it did not seem to matter who was producing the best tape. Everyone was working in a special way according to his, or her, personality and experience.

The tapes as a whole proved that the art of amateur sound recording is in good hands in this country. Among many of the losing entries one could detect the makings of future winners. And in the most unexpected quarters original ideas emerged to suggest that the whole movement is gathering momentum rapidly.

I feel that I have been privileged to get a glimpse of a great number of people working very hard at a very worth-while occupation and enjoying every minute of it. Entering the competition and hoping to be among the winners is a proper and valuable incentive, but I do not believe that anyone will grieve that they have not carried off an award. They have something to show for their efforts, and they will have learned a good deal for future reference.

Keep it up

WE derived a lot of pleasure and satisfaction from the large number of entries by people who may not have reached a very high all-round standard but who have certainly discovered that tape offers a splendid outlet for creative self-expression. Some of these competitors read their own poetry, composed and played their own music, and sung their own songs: some recited and played the work of others.

It pleased me immensely to know that all this is going on, and if it were possible I would congratulate every entrant individually. I hope they will all keep up the good work, win or lose, and send in their best tapes every year.

The best piece of advice I can offer these people is to keep an eye on general presentation. Good tape recording technique is not simply a matter of good equipment and mechanical control: an important factor is the overall shape of the programme:

Jo wants to know

ONE of the things Josephine Douglas wanted to know was why there were not more women among the entrants and prize-winners. The only answer I could give her on the spot was to the effect that it is the natural inclination of man to

regard all mechanical things as his special province. But that is not quite a good enough answer, especially when you think of the number of girls who are coping very nicely with dictating machines and complicated telephone switchboards that make a three-way-mixer look like a tiny tots toy.

It is true, of course, that women are both modest and diplomatic and might insist that the husband's name should go on the entry form in cases where the tape was a joint effort. Moreover, in the space provided for the purpose many en-

HOMO TAPIENS

by

Josephine Douglas

trants gallantly indicated that assistance was given by "my wife."

I wonder how many of them helped by saying things like "Shouldn't the microphone be plugged in, dear?" and "Why are you working on playback when we are supposed to be recording?"

But do tell me, ladies, why you are not sending in more tapes, so that I can give Jo Douglas an authoritative answer. Better still, write and tell me that you have all resolved to show her what you can do next year.

Who wants them?

SEVERAL readers have asked if the winning entries in this year's contest are going to be made generally available, and we are now going into the question of whether this can be arranged. Will clubs and individuals who would like a tape of the winners in each of the four categories of the Individual Section write and let us know so that we can assess the number likely to be required. The price for the complete tape would be in the neighbourhood of 35s.

I like them

THE more I see of top-grade professional recording people the more I like them, and one of the chief reasons is their wholehearted interest in the work of the struggling amateur—and their quickness to recognise, and enthusiastically acknowledge, signs of good work even if it is accompanied by many faults. It is this friendly, positive attitude that makes the frank, penetrating criticisms of Tony Gibson, a source of encouragement rather than of despair. Mr. Harley, told me he cannot over-stress how much his success again this year stems from the comments made on his winning 1957 entry; and I am quite sure that the all-round improvement this time follows from the same cause.

Tony Gibson's comments at Earls Court should help to accelerate the trend of improvement, especially if all competitors take to heart the two principal lines of criticism I detected—the need for yet more cutting, and the need to emerge from time to time from the tape-tangle of personal enthusiasm for certain kinds of sounds and achieve, by hook or crook, a detached view of the programme, to ensure that a definite point is made.

Echo-hunter

I FOUND precisely the same readiness to treat the amateur seriously in Mr. Angus McKenzie, of Olympic Sound. I took our tapes to him for dubbing at obviously the worst possible time in the world as far as he was concerned for he was slap in the middle of a battle to get his new studio finished for a session (Carton Hall, Carton Street, London, W.1 is the address). Nevertheless, he climbed down from the top of a ladder in the main 40 ft. x 40 ft. studio, where he was giving some personal attention to a detail of sound-proofing, and gave meticulous attention to the problem of doing absolute justice to our mixed bag of tapes with azimuths all over the place.

And he gave the same concentration to the selection of the best tape from the strictly technical point of view among the non-winners.

Before I left, too, he played me some splendid stereo tapes he has been making recently in cathedrals, and introduced me to a new echo machine that had just arrived—which is so big that it had got itself stuck on the stairs leading down to some ancient vaults that he is turning into echo chambers. Mr. McKenzie seems to like echoes (in the right place), in the same way that Mr. Harley likes cats. Mr. Copinger likes trains and Mr. O'Dwyer and his "offbeat" collaborators like "slithering, dithering, pushing and pulsating." They all make such beautiful noises.

The local press can help

ANYONE keen to see a club started locally should not hesitate to tell the local Press about it; this is exactly the kind of story most local papers are looking for. Probably the best approach is to write a "letter to the Editor" telling him you think a tape-recording club for the town, or area, would be a good thing, and discussing some of the activities of such an organisation, including making recordings of important events in the district. Touch on some of the things you do with the recorder yourself, and conclude by inviting people who are interested to get in touch with you.

If there is enough response and you decide to call a meeting, the papers who published your first letter can be told about it, so that others may be invited to come along. You would naturally mention that the publicity they gave was a great help.

THE SECOND BRITISH CONTEST

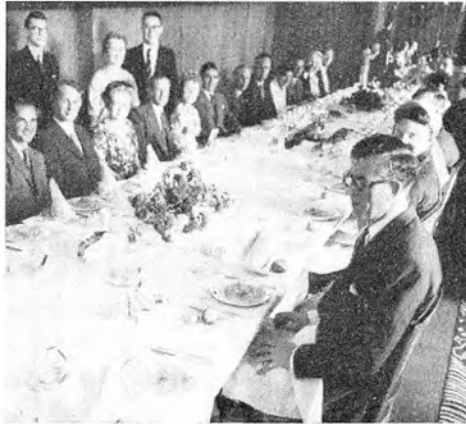

The Emitape Luncheon at the Savoy Hotel was a highlight of the British Amateur Tape Recording Contest. Left: Mr. Peter Wetherill of E.M.I. (standing), who proposed "The Guests," and Mr. J. Wooler (also of E.M.I.), who took the chair, watch Miss Josephine Douglas, famous TV star (and a Contest judge), and Miss Nancy Spain, the newspaper columnist, sharing the launching of the loving-cup ceremony. Centre: A general view of the table. Right: Miss Douglas responding for the guests



Above, left: Mr. Tony Gibson, one of the judges commenting on the winning tapes (also in the picture): Miss Nancy Spain and Mr. Douglas Gardner, another of the judges). Centre: Mr. and Mrs. B. W. Harley with the Emitape Cup. Right: Mr. W. Copinger carrying off his Elizabethan tape recorder. Below, left: A group after the playback, with Mr. R. Charlton (winner of Group 3), on the extreme left. Below, right: Miss Spain presents the Grundig Cup to Mr. John Weston, whose school won the Schools Section of the contest

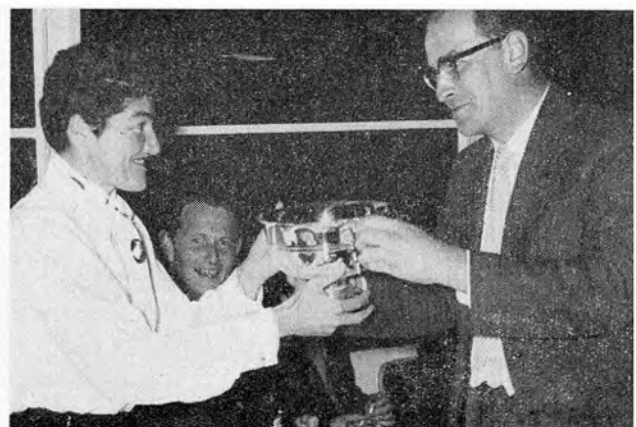



Mr. and Mrs. B. W. Harley, whose "Dialogue for Cats" was chosen as the Tape of the Year, are seen here with the Savoy Hotel model cat. Mr. Harley, who is a recording enthusiast, is the 43-year-old education officer of G.F.C. at Birmingham. He spent nine months on his winning tape.

HARLEY'S TRIUMPH

"Dialogue for cats" is the Tape of the Year

THE first two years of the British Amateur Tape Recording Contest will take their place in history as the epoch of Harley's Triumph. Mr. B. W. Harley, of Birmingham, winner of the inaugural Contest last year, again walked away with the first prizes and the honour of producing the Tape of the Year.

More than that, he submitted the best entries in two of the four categories for individual efforts.

His "Dialogue for Cats"—an imaginative treatment of human-pussy relationships, with an extraordinary blend of sound effects from both quarters—was judged the best entry in the Documentary section, and in the Contest as a whole.

As the Tape of the Year it won for Mr. Harley the handsome Emitape Challenge Cup, a trip to the International Contest in Berne in October as guest of Emitape, a Fi-Cord battery portable recorder, four disc copies of the tape, and a couple of *Tape Recording Magazine* certificates.

In the Actuality Section, Mr. Harley triumphed again, with a brief, but brilliantly evocative recording called "Dawn Chorus," recorded at Whitby at 5.30 a.m. For this he was awarded a Film Industries ribbon microphone, and a special certificate.

Mr. W. P. Copinger, of Southall, another winner in last year's contest, appeared in the prize list again. His "Escape Fantasy" was judged the best entry in the Composition Section, and won for him an Elizabethan Essex tape recorder, and *Tape Recording Magazine* certificate.

The Speech and Music Section was won by Mr. Roger Charlton, of Whitley Bay, with a delightful recording of harpsichord music. He was awarded a Simon Sound Cadenza microphone.

There were a large number of other excellent recordings, and twelve of these were recognised. In the Composition Section, Mr. J. O'Dwyer, of Hampstead, was awarded an Acos microphone for his entry, "This Offbeat Generation." In the Documentary Section Mr. P. M. Davies, of Sittingbourne, was runner-up with a recording titled "Navy Day," for which he won a Truvox radio jack. Radio jacks went also to the runners-up in the other two sections—Mr. E. G. Halse, of London, in Speech and Music, for "Love and Mr. Pennington," and Mr. John Walters, of Kidderminster, in Actuality, for "Circus, 1958."

Among other highly-commended entries, awarded Bib splicers, were: "Supernatural Encounter," by Peter A. H. Harris; "The Polish Jews' Winter," by Norman Paul; "The Youth Hosteller," by 14-year old Nigel Rees; "Coracle King," by Richard Margoschis; "The Vanishing Haggis," by Charles Aitken; "Chorus from Messiah," by Derek Redgrove; "Guitar," by Donal Andrew; and "Dawn Chorus," by William Haynes.

FORTY JOLLY TEN-YEAR-OLDS WIN THE SCHOOLS SECTION

THE audience at the playback and presentation ceremony at the Radio Show at Earls Court gave an enthusiastic reception to the 15-minute feature tape with which the Meeching Junior School, of Newhaven, won the special Schools Section of the Contest.

Mr. John Weston, the teacher who submitted the tape, was presented with the magnificent Grundig Challenge Cup and a year's supply of Philips' magnetic tape.

The winning recording, which reconstructed a typical day in the life of a medieval town, was made by a class of forty, nine and ten-year-olds, who performed with an infectious verve and enthusiasm.

Runners-up were the pupils of Whitsome School, Berwickshire, and Mr. Robert Ellis, the master who submitted the tape, was present to receive the special certificate and a Truvox radio jack.

Patrons who backed the Contest

THE second British Amateur Tape Recording Contest marked a big step forward. Mr. John Amplett, chairman of the Federation of British Tape Recording Clubs, made special reference to the progress which, in so short a time, had carried it to the heart of the Radio Show.

He presided at the Earls Court gathering at which the tapes were played back and the prizes presented by Miss Nancy Spain.

On arrival at Earls Court, the winners were welcomed by a representative of the Radio Industry Council.

A big audience heard the tapes with interest and was delighted with the wise and witty commentary on them provided by Mr. Tony Gibson, B.B.C. documentary writer and producer, who was one of the panel of judges.

The Contest had the most generous support of the industry and *Tape Recording* and *Hi-Fi Magazine* wishes to express its deep appreciation of the support of the following, who provided prizes:

Messrs. E.M.I. (the Emitape Challenge Cup, air ticket to Berne, Emitape luncheon, etc.);

Messrs. Grundig (Great Britain) Ltd. (the Grundig Challenge Cup, special celebration later in the year for the winners);

Messrs. E.A.P. (Tape Recorders) Ltd. (Elizabethan Essex recorder);

Messrs. Fi-Cord Ltd. (Fi-Cord portable recorder and re-charger);

Messrs. Film Industries Ltd., Simon Sound Service Ltd., and Cosmocord Ltd. (microphones);

Messrs. Philips Electrical Ltd. (magnetic tape);

Messrs. Truvox Ltd. (five radio jacks); Messrs. Multimusic Ltd. (seven Bib splicers); Messrs. Lustraphone Ltd. (subscriptions to *Tape Recording* and *Hi-Fi Magazine*); Olympic Sound Studios (disc copies of winning tapes).

Mr. G. R. Nicholls and Mr. L. Goddard, of E.M.I. are thanked for their assistance in providing playback facilities.

REPRINT NOW AVAILABLE

Tape Recording and
Hi-Fi Magazine
YEARBOOK



- Specifications of tape recorders
- Lists of makers of machines and hi-fi equipment
- Catalogue of tape records
- Tape clubs and societies
- Glossary of tape and audio terms
- Chart of playing times
- Frequency range chart
- Advice on choosing and using a recorder
- Articles on copyright, hi-fi, cine, etc.

5s.

*Obtainable from all booksellers or
5s. 9d. post free direct from
Tape Recording and Hi-Fi Magazine,
426, Camden Road, London, N.7*



Our latest arrival

THERE are no fairies at the bottom of our garden—but there's a whacking great tape recorder bang in the middle of our house. Right now I'd rather have the fairies.

A sad little smile touches the corners of my mouth when I turn to Aunt Fanny's page in my weekly ladies' magazine and read a heart-rending letter from some poor wife who is sure her husband's affections are turning elsewhere because he comes home late with powder on his collar.

The rival for my husband's affections stays with us night and day . . . and sits there mocking me!

Our friends the S—s arrive for supper one evening and,

FOR BETTER... FOR WORSE...

By a Tape Widow

sighing, apologise for being late. Little Johnny has been a bit trying and took a long time to "go down." Children can be such a nuisance at times!

My sympathetic smile becomes a bit strained when I recall how our "latest arrival" kept us up till after twelve, night after night, when there was a feature tape to be made.

There are golf widows, football widows, cricket widows, bridge widows, chess widows—even grass widows, but by far the most wretched of the lot are the tape widows.

Do you know what "dubbing" means? I foolishly thought it meant simply transferring something from one tape to another. It doesn't! "I'll just drop round and see Smith for half-an-hour and get this tape dubbed." Three hours later and he's back, complete with dubbing, and a very interesting seven-inch, long-playing tape of Smith's which we listen to until one a.m.

You can, of course, avoid this, if you say goodbye to your washing machine and invest in that very essential accessory . . . another tape recorder! Plus a mixer, plus an F.M. tuner, plus a studio mike, etc., etc. But even then, he won't be satisfied, and the fateful day will come when he joins "The CLUB." Then he can make bigger and better dubbings, enter competitions, visit places of interest, take part in exhibitions, get acquainted with a couple of dozen more people he can "go and see for half-an-hour."

I do wish there were fairies at the bottom of our garden. When I had my shot at those three wishes, d'you know what my first one would be? And I wouldn't care if the motor did get overheated and the tape melted, for I have suffered the worst fate of all . . . I've been bitten by the bug myself!

First release of Saga-Elizabethan tape records

THE name "Elizabethan," long one of the foremost in the tape recorder field, is now associated with tape records, through the distribution by E.A.P. (Tape Recorders) Ltd., Recorded Tape Division, of Saga-Elizabethan high-fidelity recorded tapes.

Arrangements have been made for these tapes to be fully reviewed. Meanwhile, here is the monaural September Release list, consisting mainly of recordings by the Royal Danish Orchestra, the Bolshoi Theatre Orchestra, the Soviet State Radio Symphony Orchestra, the Hamburg Pro Musica, the Hamburg Kammerorchester, and the Leipzig Gewandhaus Orchestra.

Monaural

Brahms: Symphony No. 4 in E Minor, STB. 8010.

Beethoven: Violin Concerto in D Major, Op. 61 (Alan Loveday, violin), STB. 8019.

Grieg: Piano Concerto in A Minor, Op. 16, and piano solos (Eileen Joyce, piano), STA. 7017.

Concert of Overtures, STA. 7001.
Bach: Violin Concerto in E Major and Partita in E Major, STA. 7014.
Tchaikovsky: Overtures, and excerpt from "Swan Lake," STA. 7002.
Prokofiev: Violin Concerto and Solos (David Oistrakh, violin), STA. 7007.
Tchaikovsky: Ballet Suite "Swan Lake," STA. 7003.
Rimsky-Korsakov: Scheherazade Symphonic Suite, Op. 35, STB. 8001.
Tchaikovsky: Violin Concerto and Valse Scherzo, Op. 34 (Leonid Kogan, violin), STB. 8002.
Tchaikovsky: Symphony No. 6 in B Minor and "Pathétique," Op. 74, STB. 8003.
Beethoven: Symphony No. 5, STA. 7011.
Schumann: Piano Concerto in A Minor, Op. 54 (Sergio Fiorentino, piano), STA. 7015.
Mozart: Eight Overtures, STB. 8012.
Tchaikovsky: Serenade for Strings, Op. 48, STA. 7012.
Liszt: Piano Concerto No. 1 in E Flat

(Sergio Fiorentino, piano), STB. 8007.
Bach: Brandenburg Concertos (Vol. 1), STB. 8013.
Johann Strauss: Concert, incl. Blue Danube, Pizzicato Polka, STA. 7009.
Gershwin: Rhapsody in Blue; American in Paris, STB. 8004.
Songs of the Shows, Selections from Oklahoma, South Pacific and My Fair Lady, STB. 8011.
Die Fledermaus Excerpts, STA. 7010.
Arne: "The Cooper," STA. 8009.
Schubert: Lazarus, Act 1, STB. 8013.
Beethoven: Violin Sonata in C Minor, Op. 32 (Alan Loveday, violin), STA. 7005.
Piano Recital—Eileen Joyce, STA. 7006.
The prices are: STA (600 ft. on 5 in. spool), 35s.; STB (900 ft. on 5 in. spool), 50s.; STC (stereo: 600 ft. on 5 in. spool), 40s.; STD (stereo: 900 ft. on 5 in. spool), 55s.; STE (stereo: 1,200 ft. on 7 in. spool), 70s.; STF (stereo: 1,800 ft. on 7 in. spool), 84s.

The stereo list will be given in our next issue.

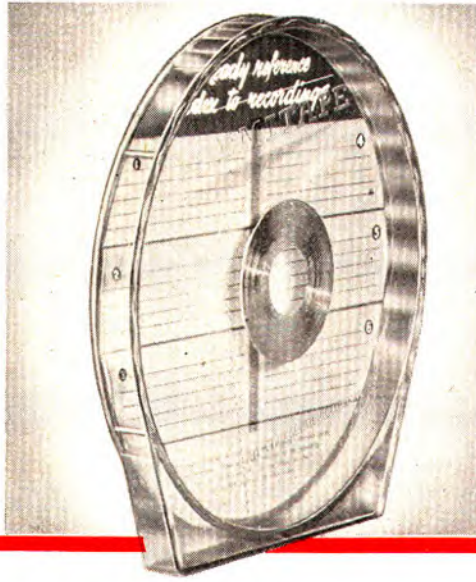

EMICASE

available separately!

Protect your recordings

- * Emicase gives easy identification of leader tapes
- * Has visible index
- * Solves your storage problem

EMICASES :

5" - 3/6 each • 5 3/4" - 3/6 each • 7" - 4/- each

EMITAPE accessories for jointing and editing

Tape Jointing Block and Cutter AP 46

Provides for the accurate alignment and splicing of the tape. The non-magnetic cutting blade ensures a soundless joint. 17/6

Range of Empty Plastic Spools in Cartons

For programme storage and other special purposes

- AP 93 3" 'Message' Spool 3/-
- AP 85 5" 'Junior' Spool 4/6
- AP 89 5 1/2" 'Continental' Spool 4/6
- AP 87 7" 'Standard' Spool 5/-
- AP 118 7" Metal Spool 12/6

Non-Magnetic Scissors AP 39

Made from non-ferrous metal these scissors prevent magnetisation when cutting the tape. AP 39 16/-

P.V.C. Editing and Marker Tapes

A range of coloured tapes for colour coding when editing, indexing, etc.

- White AP 38/1 Blue AP 38/4
 - Red AP 38/2 Orange AP 38/5
 - Yellow AP 38/3 Green AP 38/6
- 4/6 per reel

Jointing Tape AP 103

Specially prepared adhesive jointing tape for simple jointing, splicing and editing of magnetic recording tape. 7/6 per reel.

Tape Jointing Compounds

P.V.C. Type AP 77 C.A. Type AP 35
Special fluids (2 oz. bottle with brush) to provide welded joints for either P.V.C. or Cellulose Acetate base tapes. 7/6 per bottle.



(RECORDING MATERIALS DIVISION)

HAYES • MIDDLESEX

Any Hi-Brows Around?



HIGH QUALITY



Model KL 65/KS

57 gns. (mic extra)
Complete with 5'
Double Extended Play
Tape (4 hrs. 20 mins)
at $1\frac{7}{8}$ ips the portable
version of KL 65/TS.
2 speeds. Beautifully
finished. $6\frac{1}{4} \times 15 \times 13\frac{1}{2}$
ins. Weight 18 lbs.

For one who is interested in quali first . . . whose ears are finely a tuned to timbre and delicacy in sound . . . who looks for high precision in craftsmanship and finish at low cost.

TELEFUNKEN TAPE RECORDERS

will merit his grudging approval. Telefunken models designed with wide frequency range to ensure faithful reproduction of music even at $3\frac{3}{4}$ ips. High-quality moving-coil Microphone extra. D9/A 5 gns. D11/H1B 9 gns.

★ AUDIO FAIR?

WE INVITE YOU TO VISIT THE
TELEFUNKEN

HI-FI TAPE RECORDING EXHIBITION AT
BUSH HOUSE RESTAURANT
Aldwych W.C.2
(Opposite the Audio Fair)

HIGH PRECISION



Model 65/TS

Table model for use with amplifiers and radio sets. Tape speeds $3\frac{3}{4}$ ips and $1\frac{7}{8}$ ips. Max. playing time 4 hrs. 20 mins. Twin track. Weight 14 lbs. $5\frac{1}{4} \times 12\frac{3}{4} \times 9\frac{1}{4}$ ins. 45 gns.

HIGH FIDELITY Model KL 35



Professional model (40—16,000 cycles level) 2 speeds ($7\frac{1}{2}$ ips— $3\frac{3}{4}$ ips) Max. playing time 180 mins using dual tracks. 3 separate intermixable input channels. 2 loudspeakers. "Trick" button enables speech, music and sound effects to be superimposed on previous recordings. $8 \times 20 \times 15\frac{1}{2}$ ins. Weight 41 lbs. 100 gns.

POST THIS COUPON NOW!

Please send me illustrated leaflet

NAME.....

ADDRESS.....

..... (Key No. T.R. Aud.)

WELMEC CORPORATION LIMITED

147 STRAND, LONDON W.C. 2

'Phone TEMple Bar 3357

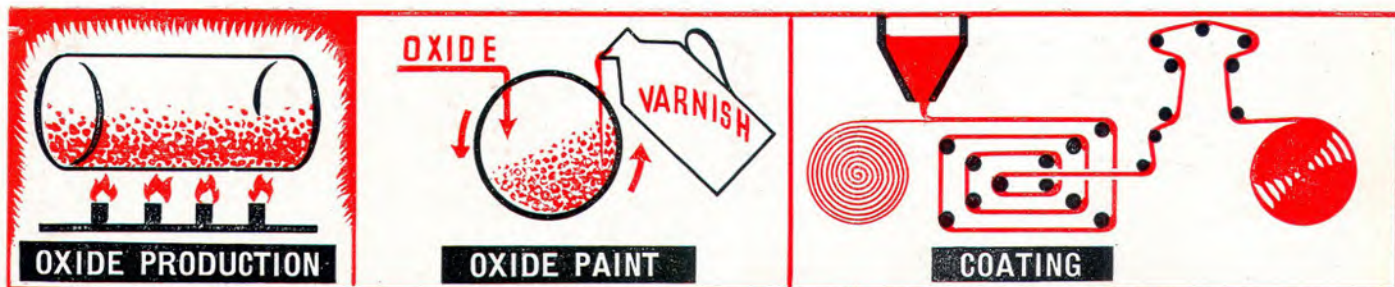

THE MAKING OF **EMITAPE**

The fifth stage in the making of Emitape is the visual inspection of the tape and its simultaneous re-spooling from the larger reels taken from the slitting machines on to the familiar Emitape spools of various sizes.

The re-spooling machine (seen in operation in the foreground of the illustration) provides automatic inspection of the coating by a photo-electric system. This ensures that any minute variations, local to the $\frac{1}{4}$ " tape and not observed on the measuring devices operating on the full width film

at the coating stage, are easily detected.

In the background can be seen the machines for "pen-testing" Emitape. "Pen-testing" consists of recording a signal on Emitape and then reproducing a continuous pen recorder graph of any variations in output. This method maintains close uniformity of output from tape to tape and from year to year and means that when Emitapes of varying ages are joined together, recordings made on them can be replayed without any noticeable change in output level.

EMITAPE *the world's finest magnetic recording tape*

EMITAPE is produced at Hayes, Middlesex, by E.M.I. in the largest magnetic tape factory in Europe. E.M.I.'s technical skill and accuracy and over 60 years of research in sound recording ensure that EMITAPE is the finest magnetic recording tape in the world.

EMITAPE consists of a PVC base film coated with magnetic oxide particles. Heat treatment first renders the oxide particles magnetic and they are then mixed with special varnish for adhesion to the base. The coating

process is a highly critical operation where every effort has to be made to ensure that the tape surface is completely free from foreign particles.

In the next stages, the coated film is slit by precision cutters to standard $\frac{1}{4}$ " widths and wound on to the various size spools. Individual visual inspection and thorough laboratory tests for possible electrical defects ensure the consistently high quality of recording which only EMITAPE can give you.

E. M. I. SALES & SERVICE LTD

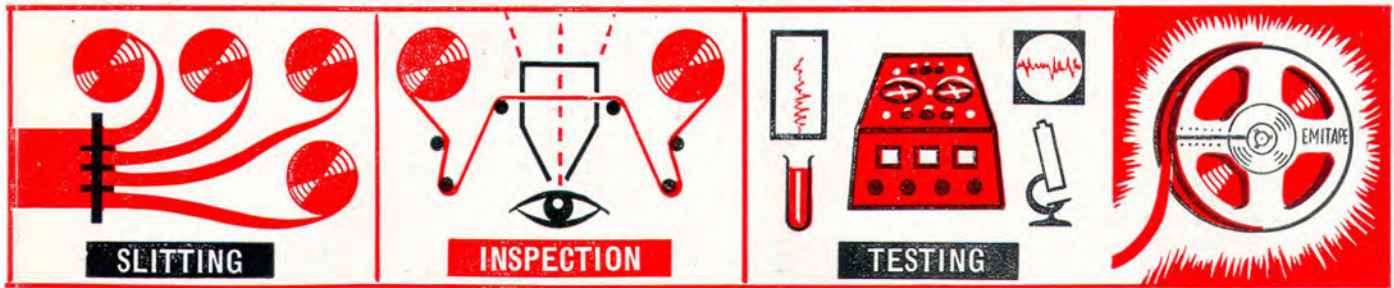

STAGE 5

INSPECTION



A typical graph of "pen-tested" Emitape showing the uniformity in output level.

HERE ARE EMITAPE'S OUTSTANDING TECHNICAL FEATURES:

- * High sensitivity.
- * Low noise level.
- * Low print through factor.
- * Anti-static.
- * Freedom from curl and stretch.

- * The new polystyrene container, EMICASE, solves your tape storage problems. Emicase can be placed upright on a shelf or between bookends, protecting spools from dust and damage, and giving easy identification of leader tapes.

EMITAPE "88" General Purpose. EMITAPE "99" Long Play, giving 50% increased playing time.

HAYES · MIDDLESEX

ES176

New

Veritone

IT'S ONE LONG AUDIO FAIR AT VERITONE

To wholesalers, retailers, to everyone interested in seeing and hearing the finest value in tape recorders. You are heartily invited to the Veritone Showrooms at 5 Avenue Parade, Ridge Avenue, London, N.21.

value that speaks for itself!

Brand new and brilliant Veritone model. Compact and completely portable, with Rola Celestion hi-fi speaker, remarkably high quality amplifier and Lane deck — the most reliable of all. Dual input with separate volume controls and monitor for perfect sound mixing. Also possible to superimpose without erasing a previous recording. Two speeds. Magic eye. Can be used as a public address system.

In handsome carrying case with exclusive new Acos microphone

52 gns



VERITONE *the reliable tape recorder*

Order from your retailer or write for more details to:—

VERITONE LTD., Tape Recorder Manufacturers,
5, Avenue Parade, Ridge Avenue, London, N. 21,
Tel.: LABurnum 6641/2

ANOTHER BRIGHT DO-IT-YOURSELF IDEA

You can put fifty per cent more tape on small spools

THOSE who have small tape recorders which only take 3¼-inch reels will doubtless have wished that they could get bigger reels on their machines. The idea set out below uses the obvious method of putting more tape on the reels by using a hub smaller than that on any reel on the market. I find that the best reels for this work are Scotch Boy 3¼-inch reels.

To make the former for the new hubs, take an old-type 3-inch E.M.I. reel (with 1¼-inch diameter hubs) and gently twist the reel into two parts. Each half of the reel should have a complete hub attached to it, but we shall only need the half with the smallest diameter hub attached.

Next, reduce the *inside radius* of this hub by 1-16th inch. This is done by taking some 1-inch brown gummed paper, cutting off 18 in., and then cutting down the centre, giving two strips 18 in. x ½-inch. Stick the ends together and roll round a pencil with the gummed side *outside*.

Making a former

Now, wet the inside of the hub of the original reel, remove the paper roll from the pencil, put inside the hub and let it uncoil; press firmly to the hub and stick the inside end of the roll to the rest of the roll to prevent it coming loose.

Trim off the surplus, flush with top of the hub. The *inside diameter* should now have been reduced by ¼-inch. If it has been reduced more than this, remove some of the paper. This coil of paper *must* be stuck firmly inside the hub. This is the former for the new hubs.

To make the new hubs, take a 36 in. length of the 1-inch gummed paper and coil it round a pencil. Remove the coil from the pencil and put it inside the hub of the former and let it uncoil. Tap firmly down, tear back ½-inch off the outside, wet it, and stick it back. This prevents the roll uncoiling after removal from the inside of the former.

SAYS IAN GIBSON B.Sc.

Now, remove from hub, make the roll into a cone shape by pushing out the centre of the roll approximately 1 inch. Wet the inside of the cone and push it back into its cylindrical shape. The cylinder, after drying should be quite firm.

Return the roll to the former (gummed edge of the roll first), trim flush with the hub, and take the surplus and repeat the process to make another hub. The new hub can now be removed from the former.

You should now take a Scotch Boy 3¼-inch reel and separate it into two halves. Break off the old hub and sandpaper smooth. *Do not remove the lip around the mounting hole.*

Stick the new hub on to the smooth reel plates using Polystyrene plastic cement (obtainable from model shops). Make sure the hub is in the centre of the plates. The hub should fit round the lip mentioned above.

Fill the new reel from a 7 inch reel of your favourite tape, using the guide below.

	Feet	Tape	1½ in. per sec.	3¾ in. per sec.	7½ in. per sec.	
Using Standard Commercial 3¼ in. Reel	200	111A or 111V Standard Tape	21m. 20s.	10m. 40s.	5m. 20s.	} Standard Scotch Boy Reels. By filling a Scotch Boy Reel with Double Extended Play Tape.
	300	150 P.E. L.P. Tape	32m.	16m.	8m.	
	400	Extra Thin Tape	42m. 40s.	21m. 20s.	10m. 40s.	
Using Reel with New Hub	300	Standard Tape	32	16	8	} Equivalent to a 4in. Reel of Standard Tape. Equivalent to a 4in. Reel of Long Play Tape. Equivalent to a 5in. Reel of Standard Tape.
	450	Long Play Tape	48	24	12	
	600	Double Extended Play Tape	64	32	16	

10 points prove



BASF is the leading Magnetic Recording Tape!



- 1** Extra-smooth recording surface
- 2** Exceptional magnetic properties
- 3** Superb frequency response
- 4** Extra-long life
- 5** No background noise — even after long use
- 6** Withstands extremes of heat, cold, damp
- 7** Great tensile strength and dimensional stability
- 8** Free from curl
- 9** First-class spooling
- 10** Standard and long play — for recorders of all types

BASF MAGNETIC RECORDING TAPE

The original . . . and still the Best

P. A. HUGHES & CO LTD DEVONSHIRE HOUSE PICCADILLY LONDON W1 MAYFAIR 8867

By Dr.

P. E. CAVANAGH

THE building of any large accelerating machine for nuclear research is almost always front page news, and many people are now familiar with the idea that fast particles, such as neutrons and protons, provide one of the most potent tools for the exploration of nucleus. The nucleus itself is composed of neutrons and protons, and the central problem of nuclear physics is to determine what cohesive forces exist to bind them together to form nuclei.

This problem is still very far from solution. As a result of experimental work over a number of years, various characteristics of nuclei have been recognised, and it is the observation of certain trends and regularities in these characteristics which has led to the most fundamental advances in our understanding of the structure of the nucleus.

Many of these experiments are concerned with the observation of what happens when nuclei are bombarded by fast particles. There are a variety of possibilities—the particle may emerge unscathed, so to speak, or it may lose a certain amount of its energy. Alternatively, a nuclear reaction may take place in which the particle is swallowed up by nucleus, which then may eject a different kind of particle. In all these measurements the physicist is concerned with determining the energies of these particles and also identifying them.

Similar problems arise in studying the radiations produced by radio-isotopes. It is possible to produce these in great variety, especially in nuclear reactors, and this has given a tremendous impetus to the study of the beta particles and gamma rays emitted. Not only is this information of importance in the understanding of the nucleus, but also it is of direct interest to the ever-increasing number of users of radio-isotopes.

From all this, it is evident that of equal importance with the often spectacular means of producing fast particles is their detection. One of the earliest detectors, one of which is still in widespread use because of its simplicity and reliability, is the geiger counter. This, whenever a particle passes through it, produces a short burst of electric charge which may be made to operate a counting device. The size of the burst does not depend on the nature or energy of the particle, so, although it is detected and counted, no further information is obtained about it.

More elaborate detectors have been developed in recent years, which are of a variety of forms, but, ultimately, on the passage of a particle, they all produce a short burst of charge, the size of which is determined by its energy. Ideally, it is proportional to it. One example of such a detector is the scintillometer, which plays an increasing part in prospecting for radioactive ores.

Often, particles of many different energies may be present, and these will give rise to a range of size of the bursts of charge—or pulses, as we shall refer to them—produced by the detector. One of the things of most interest to the physicist is the way in which the intensity of the particles depends on the energy. This is called the energy spectrum (in analogy to the spectrum of light) it may be determined by a measurement of the corresponding size, or amplitude spectrum, of the pulses from the detector. Very complicated electronic equipments, called multi-channel pulse analysers, have been developed for use in this work. These are not only expensive, but because of the large number of components in them, not very reliable. So the nuclear physicist is frequently limited in the amount of data he can extract from his experiments by the sheer complexity in the electronic instruments required in the analysis.

It is only within the past year or so that a system has been developed which circumvents this difficulty. This relies on making a permanent record of the pulses produced by the detectors and analysing the record after the experiment. This separation of the performance of the experiment from the analysis of the data has a number of important advantages.

Taking the pulse of a nuclear detector

At first sight, magnetic tape may not seem a very promising medium for recording nuclear pulses, which are usually less than a few microseconds long. Provided that these pulses are suitably lengthened, however, they may be recorded by amplitude modulation of the tape magnetisation in a precisely similar manner to audio recording.

The problems which arise are somewhat different from those in audio work, where a flat frequency response, good frequency stability, and freedom from harmonic distortion are all-important. In recording nuclear pulses, one must have a good amplitude stability and preferably a linear amplitude response.

As might be expected, the known possible causes for variations in the playback pulse amplitude are numerous. To mention just a few, there are the effects of D.C. tape noise, and of variations in the tape transport, and also the amplifier gain. There are also a number of unknown effects, and it appears that altogether new characteristics of the recording system may be involved. It is necessary to reduce the variation to a minimum because it limits the smallest separation which can be distinguished in the energy of the particles striking the detector. The problems presented by these requirements have to a very large extent been solved, and in magnetic tap we have a practicable system of recording the pulses from the great majority of nuclear detectors.

If we consider the advantages which follow from recording, the most obvious is that the data can be presented for analysis any number of times, so that, if the analyser is found to be at fault, the data is not wasted. There is a further advantage when the rate of arrival of the pulses one wishes to record is small, for it is then possible to have the tape moving very slowly. If it is played back at normal speed into the pulse analyser, the actual time of analysis may be reduced by a very large factor. Reductions of up to two hundred to one have been employed. Under these circumstances the tape moves so slowly that three days' recording can be accommodated on one standard reel.

The use of multi-track recording opens up a new vista of possibilities, since this enables the pulses from a number of detectors, either working independently or together, to be recorded simultaneously on the same tape. If the measurements are being made in conjunction with an accelerating machine, this could lead to a very much more efficient use of the running time. As another example, in the field of routine radioactive assaying it holds out the promise that many detectors can be run in parallel without undue complication in the necessary equipment.

The technique is so new that it is at present being used in only a few laboratories. But it has aroused widespread interest, and there can be little doubt that, as in other specialised fields, magnetic tape recording will prove its worth also in nuclear physics.

**TELEFUNKEN
KL 75**

THE BEST IN HI-FI YET!



- ★ 60-16,000 cps **FREQUENCY RANGE** at 3½ ips and 60-10,000 at 1½ ips.
- ★ **REMOTE CONTROL** Stop/Start switch facility allows use as dictation machine, etc.
- ★ **LIGHTWEIGHT HARD-WEARING CASE** of Styrol. Total weight approximately 20lbs.
- ★ **PUSH BUTTON CONTROLS** including fast rewind and quick stop button.
- ★ **NEW MAGNETIC HEADS** with superfine alignment allow fidelity at low speeds.
- ★ **SUPERSENSITIVE MECHANICAL SYSTEM** (no pressure pads). Prolongs life of magnetic heads and protects tape.
- ★ **MODULATOR CONTROL** for Radio and microphone inputs combined in one control.
- ★ **OVER 4 HOURS PLAY** on one tape at 1½ ips.

Microphone from 5 gns.

50 GNS
(Excluding Microphone)



HARROGATE AUDIO FAIR

Be sure to see and hear these amazing Hi-Fi sets for yourself at Stand 235, October 24-26, Grand Hotel.

2 NEW AMAZING MODELS FROM TELEFUNKEN

**TELEFUNKEN
KL 85**

**QUALITY—
IN EVERY FEATURE**
and look at the prices!

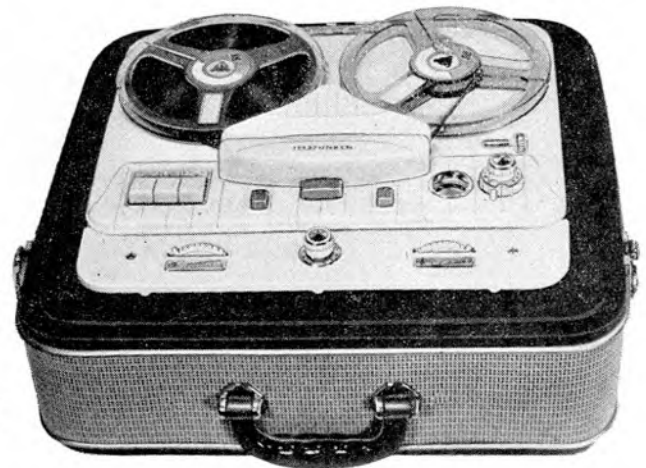

- ★ **UNPRECEDENTED FREQUENCY RANGE NEVER BEFORE ACHIEVED**
30-20,000 cps at 7½ ips ± 3 db.
30-15,000 cps frequency at 3½ ips.
- ★ **CERTIFICATE WITH EVERY MACHINE.**
Test certificate presented with every machine guaranteeing frequency response figures.
- ★ **NEW TECHNICAL ACHIEVEMENT DC**
Heated pre-amplifier valves eliminate hum and background noise.
- ★ **2 OVAL LOUD-SPEAKERS TREBLE BASS TONE CONTROLS** with 3 separate input controls for mic/radiogram.
- ★ **5 PUSH BUTTONS** give instant control on all operations including quick stop button.
- ★ **TRICK BUTTON** allows superimposing on existing recordings.
- ★ **OVER 4 HOURS PLAY** (when using Telefunken L.P. Tape)
at 7½ ips gives 2 hrs. 10 mins.
at 3½ ips gives 4 hrs. 20 mins.
(7½ inch reels).
- ★ Can be used as straight through amplifier. Loudspeakers can be used for monitoring recording. Magic Eye recording level control.
- ★ **BUILT-IN SPLICER** for editing and joining tapes on both models.

TELEFUNKEN were the originators of tape recording and supply equipment to Europe's leading Broadcasting Stations.

75 GNS
(Excluding Microphone)

Table Model for direct use with Hi-Fi equipment and radiogram **75T 45 GNS.** (excluding microphone).

Table Model for direct use with Hi-Fi equipment and radiogram **85T 63 GNS.** (excluding microphone).

KL 65—Specification as for 75 above but with provision for microphone, extra tapes and accessories. **57 GNS.** (not including microphone)

WELMEC CORPORATION LIMITED 147 Strand, London, W.C.2

Tel: Temple Bar 3357

SOUND AND CINE

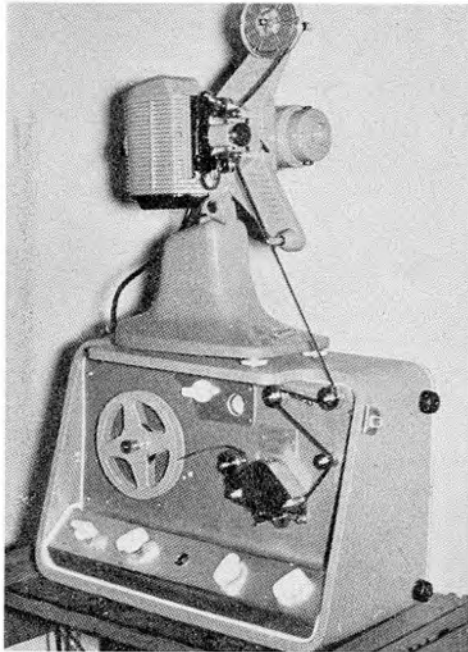

The new Peterson Magnetic Stripe recorder is designed to stand underneath a projector, and is suitable for use with any machine having a variable speed motor. It is available in two models, 8mm and 16mm.

The 8mm version has three spare rollers for adapting the machine for use with 1/4-inch tape. The 16mm version can be adapted for 9.5 film.

There is no sprocket drive, the film being fed between the capstan and pinch roller, both of which are rubber-covered. The capstan has its own induction motor drive and control of the projector speed is accomplished by a loop synchronising roller. This is attached to a variable resistance, which is connected in series with the projector motor. Two speeds are provided—18 and 24 frames.

The 3-watt amplifier has separate volume controls for mixing inputs from microphone and gram; also a tone control which operates on playback. There is a jack on the front panel for headphone monitoring during recording.

It is possible to achieve lip-sync with the Peterson by post-synchronising any dialogue: the sound is always in the same position on the film relative to the picture.

The speaker is mounted in the detachable lid, with sufficient lead to place it near the screen.

This recorder, complete with microphone, leads, test loop, instruction book and a 12 month guarantee is priced at 57 guineas. Headphones cost an extra two guineas, and a rewind arm for 1/4-in. tape, £2 9s. 6d.

Manufacturers are Avondale Developments Ltd., 9a, Bickley Park Road, Bickley, Kent.

Many cine enthusiasts are adding sound by using tape recorders in synchronisation. There is another method, which John Aldred describes below—and a new machine offering this facility is announced this month

MMAGNETIC STRIPE is the term used to describe a narrow band of iron oxide which you can have applied to ciné films to add sound. The thought of having sound and picture on one roll of film is attractive. There is no separate reel of tape to get mislaid, and your film will always play back in synchronism, if run on the same type of equipment that made the recording.

All three film gauges can be successfully coated. 8mm. and 9.5mm. have a narrow edge stripe, and 16mm. can have an edge, half or full stripe. The quality of sound to be expected depends mainly on the gauge of the film. 16mm. running at 24 frames per second will produce excellent sound from either full or half stripe. The rather narrow edge stripe suffers from having to be amplified more on play-back, so that there is a noticeable increase in the background noise and tape hiss. The 8 mm. gauge suffers from a loss of high frequencies, due to the slow film speed of 2.4 in. per second. But quite acceptable results can be obtained, even if they do not reach the modern conception of Hi-Fi.

There are two types of equipment for handling magnetic stripe. First, attachments for adapting silent projectors. These consist of a magnetic sound head which is introduced into the film path, either above or below the picture gate. Secondly, projectors with a magnetic sound head integral with the mechanism, and a record-playback amplifier in the same case. The cost of these projectors is rather high, especially in the 16 mm. gauge. But the attachments for your silent projectors, if you already own one, cost no more than an ordinary tape recorder.

A popular attachment is the Italian made Cirsevox, designed to fit any 8 mm. projector with a top spool arm. A 16 mm. model is becoming available. No modifications are needed to the projector. A similar British-made unit is the Marriott, which costs slightly less.

Both units are supplied with an amplifier which will handle and mix to separate inputs, such as music and commentary, record them on the magnetic stripe, or play them through the amplifier and speaker.

Then there is the Pathscope Aurator,

for 8 mm., 9.5 mm. or 16 mm., which stands beneath the projector, with the film threaded back into the take-up sprocket and spool in the normal way.

Magnetic projectors are more satisfactory from a sound reproduction point of view, but cost anything from £135 to £600. For 8 mm. gauge, there is the Cometson, with the sound head built into the projector base and incorporating a large diameter flywheel. The carrying case is also the speaker baffle.

For users of 9.5 mm., there is the Pathe Marginan, which is made in France and retails here for £190.

In 16 mm., almost without exception, magnetic sound is a feature added to an existing sound projector designed for playing off a photographic track. This complicates the amplifier design and results in rather a high retail price. There are several models to choose from, such as the Ampro, B.T.H., Debrie, and G.B. Bell and Howell. A new model of the G.B. called the 640, sells for £348 and incorporates the latest developments in projection and recording techniques.

If you really wish to go in for magnetic stripe, you must be prepared for expensive equipment. If you already own a silent projector, consult your cine dealer, who will advise you what to buy, according to the size of your pocket. As with all recording equipment, it will pay you to buy the best you can afford.

● **When writing to manufacturers mention that you "saw it in Tape Recording and Hi-Fi Magazine"**

Accent on stereo equipment and console models

STEREO again predominated at the Radio Show at Earls Court. Discs tended to be stressed partly because of their newness; but it was significant that tape was used widely to demonstrate stereo amplifiers and loudspeakers, and clearly more attention is going to be given to tape in this field when the disc has settled down.

Another point that emerged was the developing appreciation of built-in tape recording equipment. Consoles for which there has so far not been a great deal of enthusiasm have suddenly become distinctly popular, and a great deal of interest was shown too in cabinets with room for tape decks and equipment.

Here are some details obtained from a mid-show exploration of Earls Court.

★ ★ ★

On the Walter stand an impressive item in addition to the recently augmented tape recorder range was the Walter "1000" console at 130 guineas. This is a handsome piece of furniture with the Walter 505 deck mounted practically vertically behind a flap. It is powered by a 10-watt output ultra-linear, push-pull amplifier, and the carefully lagged cabinet contains 5 speakers—two 10 in., one 9 in. x 5 in. and two 4 in. tweeters. The claimed frequency response is 14,000 cps, and from the amplifier the top response is given as 20,000 cps.

★ ★ ★

Causing quite a lot of comment in the demonstration room of C.Q. Audio Ltd. was the demonstration of two senior reproducers in conjunction with the C.Q. stereo amplifier at 19 guineas. The special feature was the use of two tetraq speakers on extended leads either side.

console models

This arrangement, it was found, provided an excellent distribution of the higher frequencies—and it is the higher frequencies which normally tend to pinpoint the sound unduly.

★ ★ ★

Soundrite Ltd. were showing their new amplifiers including one of the smallest pre-amplifiers in the show. They have also designed a very handsome set of three matching cabinets, the centre piece for equipment being large enough to take most tape decks. The speaker cabinets are very nearly identical to the one for equipment and if two of these are used a complete stereo outfit becomes available in a very presentable form.

★ ★ ★

Goodmans Industries Ltd. reported a good deal of interest in their recently released Axiette reflex enclosure kit with the 8 in. axiette speaker.

With the aid of only a screwdriver this speaker can be assembled at home, ready for connection, in 30 minutes. The finish is in selected walnut veneers and hard wax polished, with the exception of the front columns which are shaped from solid Abura wood. The baffle board is covered ready for fitting with a gold Lurex threaded cream silk weave material.

The dimensions are: width 26½ in., height 25½ in., side 18½ in. Demonstrations were also being given of the new bowl speaker.

★ ★ ★

The new TR60 tape console introduced by Portogram is offered with an eye to the completion of a system usable for stereo by disc and tape. The TR60 uses the Collaro deck and has two speakers (one 10 in. elliptical, and one 4 in. tweeter). The frequency response at 7½ ips is given as 50 to 10,000 cps. The companion arrangement is the RG60 using an identical cabinet and containing a gramophone unit and FM tuner. Suitable wiring enables them to be used in conjunction with each other, and a slight modification would provide stereo from disc or tape.

★ ★ ★

Appropriately, Brenell Engineering Co., Ltd., were demonstrating the value of their tape recorders when used in connection with radio, and there were some impressive examples of tapes taken during B.B.C. stereo broadcasts with the Brenell Mark V stereo equipment. The 3-Star tape recorder, available any moment now, was the subject of much attention.

★ ★ ★

Pilot Radio were showing a new combined amplifier and control unit (SAF/15) for stereo which will be ready about the middle of October at a price of about 35 guineas. This unit conforms with the general rule of the organisation to provide for tape, in and out, wherever possible.

Left: Mr. P. Copinger, who won an Elizabethan tape recorder in the British Amateur Tape Recording Contest, visits the stand of E.A.P. (Tape Records) Ltd., with Mrs. Copinger and chats with Mr. S. Larholt (left) and Mr. H. Lubin (right). Right: Three matching cabinets by Soundrite Ltd., designed to house stereo equipment—tape or disc—and the two loudspeaker units



Stereo turns the spotlight on speakers



Left: The new Goodmans Stereophonic bowl (8½ gns.), designed to handle frequencies above 300 cps, and provide uniform radiation horizontally, enabling it to be used as one of the stereo channels while a full range hi-fi speaker looks after the bass and the other high frequency sounds. It is based on the fact that the ear depends mainly on the upper frequencies for locating the sound source

Right: The Duchess high-fidelity reflex enclosure by Richard Allan Radio Ltd. It is 27½ ins. high and costs 15 guineas, the recommended units being £11 11s. 10d. extra

Below: The Axiette reflex enclosure

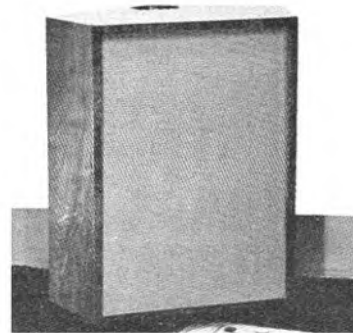

Among many interesting exhibits in the demonstration room of Beam-Echo Ltd., were two new speakers the SL71 and the SL12-21. A neat cabinet, known as the "stereo-line," is to be priced at about 18 guineas.

+

Sonomag are among those who report a growing interest in consoles. Enthusiasts were remarking on the fact that the cabinet of their console model contains three high-quality speakers in a well thought-out arrangement. All the Sonomag models were being demonstrated by request.

+

On the Collaro stand a significant piece of news was that there had been more inquiries about the Mark IV deck than any other single item of equipment. On the Regentone stand their new tape recorder was much in evidence.

+

At the stand of Tape Recorders (Electronics) Ltd., there were many keen eyes on the new 26-guinea "Belle," and every effort was being made to satisfy the curious by showing all the inner workings of the machine as clearly as possible. There were very favourable comments on the engineering so revealed.

+

Demonstrations were being given by Richard Allan Radio Ltd., of all three of the new range of speakers working on monaural and stereo reproduction. The models are the Empress (30 ins. high, two speakers) at 36 gns.; the Duchess (27½ ins.) at 15 gns., without speakers; and the Princess (25 ins.), 11 gns., without speaker.

+

The name which B.T.H. have built up in the professional audio world ensured that there were plenty of people to see their new equipment for the domestic hi-fi market. A new speaker is the DC12, and another new piece of equipment is a 20 watt amplifier and control unit.

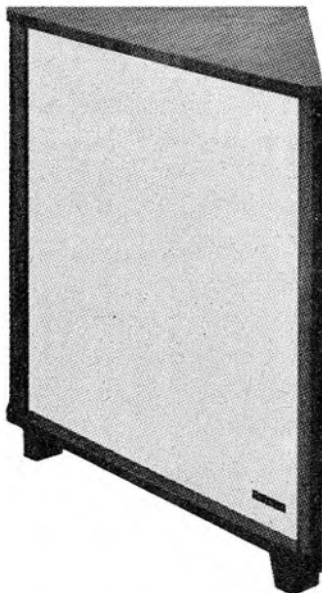

Attracting special attention on the Lustraphone stand was the new VR65 stereo amplifier. Another very attractive exhibit was a new microphone boom priced at 16 guineas with floor stand, and 11 guineas without—a most impressive piece of equipment for any home, or even professional studio. Two other new items were a bracket for stereo microphones and a 15-watt transistor amplifier.

+

Dynatron were showing a wide range of speakers and other equipment. An excellent idea is emphasised in a new cabinet ostensibly of the normal radio-gram type but with a flap covering a sliding base for containing a complete portable recorder.

+

Two important Audiomaster exhibits from the point of view of the tape recording enthusiast were a complete tape amplifier with separate playback section, enabling full advantage to be

taken of decks provided with a monitoring head; and a combined stereo power and pre-amplifier designed either for table-top use or panel mounting.

+

On the Magnafon stand we learned of very favourable reactions to the demonstrations of the Courier tape recorder at 49 guineas, and the portable stereo version of the same machine in which the second channel is provided by a second amplifier unit and speaker built into the lid.

+

Truvox reported considerable interest in the build-it-yourself programme which they are putting forward. They indicated that many sceptics were being converted to stereo by their simple presentation of the type of listening they would enjoy at home.

+

Many paths crossed at the exhibits of E.M.I. Sales and Service Ltd. where this organisation's top-quality professional recording equipment and the display of Emitape and Emitape accessories attracted enthusiasts of all grades. The RS 101 High Fidelity Record Reproducer for monaural and stereo records, introduced under the Capitol trademark and costing 83 gns., including speaker, made a big impression. An important feature of this model, as well as of the Capitol RS 100 De Luxe High Fidelity Stereophonic Record Reproducer, at 200 gns., is the "S.A." switch enabling the equipment to be used in connection with a tape deck for reproducing stereo tapes.

+

Further indication that amateurs are closely watching stereo recording equipment was provided by the well-attended Reflectograph Stereorecorder demonstrations. Model 560, in lowboy cabinet with four speakers, costs 156 gns. Model 460, without the speakers and cabinet, costs 137 gns. In both cases there are two record amplifiers and two playback amplifiers permitting instant monitoring of monaural or stereo tapes. Crosstalk is given as less than -45dB.

BRADMATIC

LIMITED

STEREOPHONIC HEADS

We have pleasure in announcing another BRADMATIC high class product—the type ST-RP Stereophonic Magnetic Head for Recording or Reproducing stereophonic magnetic tapes

This unit is complete in its own screen can and is available with or without a fixing stem.

RETAIL PRICE:

£6 . 0 . 0

(Without fixing stem)

BRADMATIC for quality tape decks, magnetic heads, tape amplifiers and accessories.

ENQUIRIES INVITED — TRADE OR PRIVATE

from

BRADMATIC LIMITED

Station Road, Witton Lane, Aston, Birmingham, 6

Telephone : East 2881-2

Telegrams : Bradmatic Birmingham

Now! it's easy to edit tapes — economically

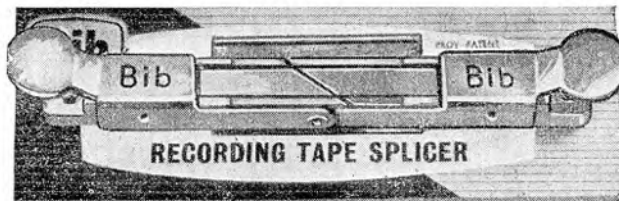

USE A PROFESSIONAL TYPE RECORDING TAPE SPLICER FOR EDITING AND MENDING RECORDING TAPE

On the new Mark II Bib Recording Tape Splicer both clamps are now of the easy lift type and are fitted on the same side to facilitate rapid removal of the jointed tapes. These improvements ensure even easier and quicker precise jointing of tapes. Because you can use all odd lengths of tape, you soon save the cost of the Splicer. If desired the Splicer can be attached directly to a tape recorder deck.

The technical experts say . . . "Everyone who uses a tape recorder will need this little tool. It is indispensable." P. WILSON, Gramophone.

"As a test I asked a non-technical person to splice some tapes and, after a couple of practice joints, perfect splices were made. A really useful gadget." D. W. ALDOUS, M.INST.E., M.B.K.S., Gramophone Record Review.

"The Bib Tape Splicer . . . produces a perfect joint with the minimum of effort." WIRELESS WORLD.

18/6
each (subject)



RECORDING TAPE SPLICER

Get one from your local stockist today. In case of difficulty write to us giving his name and address. Send stamped addressed envelope for helpful leaflet on tape editing.

Multicore Solders Ltd., Dept. T.R.3, Multicore Works, Hemel Hempstead, Herts.

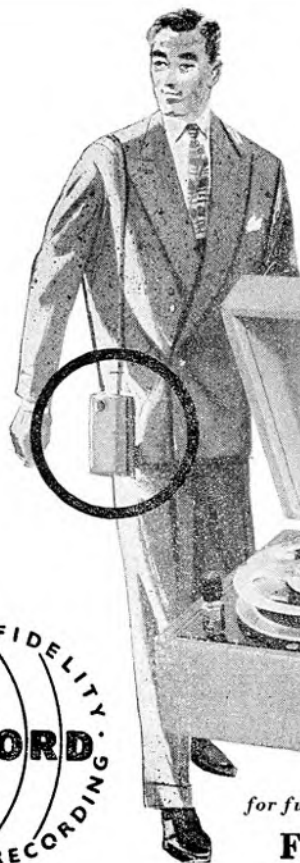

now
79
guineas
complete

Fi-Cord hi-fi tape recorder

- weighs only 4½ lbs. ★
- 50 to 12,000 cps
± 3 db. ★
- 7½ and 1⅞ ips. ★
- completely transistorised ★
- rechargeable batteries ★
- complete with dynamic microphone ★
- long-play tape batteries ★
- and battery charger ★



for full details write to:

FI-CORD LTD., 40a DOVER STREET, LONDON, W1

72 guinea Grundig offers superimposition

GRUNDIG (Great Britain) Ltd., have added the TK-30 to their present range of tape recorders. A frequency response is claimed of 50-10,000 cps at 3½ ips and 50-15,000 cps at 7½ ips.

Other features include facilities for superimposition without erasure (previously only available on the more expensive TK-830); facilities for use with remote control; push-button operation; a more positive and easier to read magic eye; and a permanent magnet dynamic speaker which incorporates an advanced design stated to achieve a 25 per cent improvement. The TK-30, a two-speed model, has a blue-grey case measuring 18 in. x 15½ in. x 9 in. and weighs 31 pounds. The price is 72 guineas without microphone.



Compact 18lb. Elektron at 46 guineas

A FREQUENCY response of 50 to 11,000 cps ± 2.5dB is claimed for the German-made Elektron EMG 9/1, which is now being distributed in this country by Broadwood Supplies Ltd., 27, Nassau Street, London, W.1.

The EMG 9/1 is a dual track machine conforming to international standards. It has a speed of 3½ ips, takes spools up



to 5½ in., and has an elliptical speaker which can be disconnected, monitoring facilities, magic eye, tape indicator and press-button controls with safety device for record. The weight is 18 lb. and the size is 13 in. x 10½ in. x 6½ in. Output is 3 watts.

The price of the Elektron is 46 gns., complete with microphone and spool of tape.

MANUFACTURERS NEWS ROUND-UP

ARMSTRONG Wireless and Television Co., Ltd., are celebrating the completion of 25 years of manufacturing radiogram chassis by introducing the "Jubilee" chassis—suitable as the basis for a reproducing system which can include tape record and replay as well as AM and FM radio reception and record reproduction. The price is 29 guineas.

* * *

To link the manufacturing company with the trade-name of its products, the Magnetic Recording Company has now been incorporated in the Wyndson Recording Co., Ltd. Mr. H. M. Creek, proprietor of the original company, is the Managing Director of the Limited Company, and production continues, as before, at 2, Bellevue Road, Friern Barnet, London, N.11.

* * *

Goodmans Industries Ltd. and E. Gomme Ltd., makers of G-Plan furniture, have collaborated in the design of further cabinets for high-fidelity equipment. In one arrangement the equipment cabinet is placed above the loudspeaker cabinet and vibration is eliminated by the use of brass supports with rubber filling. In another arrangement the units are incorporated in a Librenza. Goodmans have also assisted in the design of an acoustically-engineered loudspeaker enclosure for incorporation in the long, low G-Plan cabinet.

* * *

Philip Woolfson Ltd., 33, Cadogan Street, Glasgow, C.2, have been appointed sole Scottish representatives for the products of Simond Sound Service Ltd. Mr. S. Pauson, 29, Eastwood Avenue, Giffnock, nr. Glasgow, has been re-appointed by Perth Radios Ltd., on his return from U.S.A., as the company's agent for Scotland and Northern Ireland.

Tape to Disc Services

TAPE TO DISC

78 r.p.m.

R. C. MILLER

TAPE TO DISC SERVICE

136, Crown Street, Aberdeen

TAPE TO DISC SERVICE

78's or L.P.

QUEENSWAY RECORDING STUDIOS
123, Queensway, London, W.2.

Tel.: BAYswater 4992

TAPE RECORDERS FOR HIRE

TAPE TO DISC RECORDING

Microgroove L.P. (30 mins.)

27/6, 78 rpm. 13/6

S.a.e. for leaflet: Deroy Sound Service (A.D. Marsh), Little Place, Moss Delph Lane, Aughton, Ormskirk, Lancs.

RECORD LENDING LIBRARY

"SUPERSTORES" 73, Grand Parade,
Harringay

THE IDEAL SERVICE FOR TAPE
RECORDING ENTHUSIASTS

OVER 10,000 RECORDS TO CHOOSE FROM

TAPE RECORDER HIRE

TAPE TO DISC 78-LP
RECORDING STUDIO
SALES—EXCHANGES

MAGNEGRAPH

1 Hanway Place, London, W.1.

s.a.e. for leaflet or
telephone LAN 2156

Portable Cases

FOR ALL TRADES

COVERED LEATHERCLOTH

Cases made especially for—

Record Players and

Tape Recorders

Manufacturers enquiries to:—

A. E. Puxley Ltd.

Albron Works, King Henry's Walk,
Ball's Pond Road, London, N.1
CLIssold 5277/7597

Microphones for Tape Recording

MICROPHONES.—A microphone is the name given to a device which is capable of converting sound vibrations (speech and music) into electrical voltages. These voltages may be amplified as described earlier and reproduced back into sound waves by a loudspeaker. A loudspeaker is, therefore the reverse of a microphone.

A good microphone should be capable of producing an accurate conversion of any sound signal into its electrical counterpart. In order to do this, it must respond to all frequencies equally well, from the lowest audible of about 15 cps up to the highest, around 15 kc/s. This is attainable only in the most expensive microphones, and generally the response of a commercial microphone varies from about 75 cps to 6 kc/s for the cheaper variety, and between 15 cps to 15 ks/s for the more expensive models.



Microphones may have a high or low impedance, depending on the particular type. High impedance microphones may be connected directly to the grid of an amplifier (fig. 1), whereas low impedance types have to be matched to the amplifier by means of a step-up transformer. In addition, certain microphones only

operate when a polarising voltage is applied. The features of the more popular types will now be discussed.

CARBON MICROPHONE.—There are two types, the carbon button microphone and the transverse current type, which is the better of the two. Both contain two electrodes in a small con-

current in that circuit will also vary in sympathy with the sound waves.

Carbon microphones are about the cheapest, and although very sensitive and robust, have a very poor frequency response, and produce a high background hiss. They are used for speech only and find their greatest use in post office telephones. A polarising battery is required for this type of microphone, of about 3 to 6 volts. As the microphone impedance is low, a matching transformer is also required. In general, their poor fidelity and high level of background noise make them unsuitable for use with tape recorders.



In passing it may be added that a carbon microphone is a pressure operated device; the output depends upon the pressure of the air on its diaphragm, and it responds almost equally well to sounds coming from all directions. It is, in fact, omni-directional.

MOVING COIL MICROPHONES.—These are constructed in a very similar manner to a moving coil loudspeaker, and in fact, in an emergency a permanent magnet loudspeaker (especially a small one) may be used as a microphone. A cross section of a M.C. microphone is shown in (fig. 2). The sound vibrations push the cone backwards and forwards, which in turn causes the coil to move in and out of the magnetic gap. Because of this movement, a voltage is induced in the coil. For good results at the

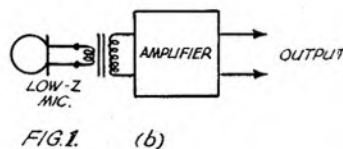
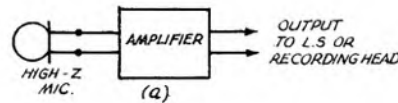

FIG. 1

tainer filled with carbon granules. One side of the container is flexible, so that sound waves arriving at the microphone will cause this flexible diaphragm to vibrate, thereby causing the carbon granules to be alternately compressed and relaxed.

Thus, the electrical resistance of the granules as measured between the two electrodes will fluctuate in sympathy with the sound waves, and if the microphone is in series with an electrical circuit, the

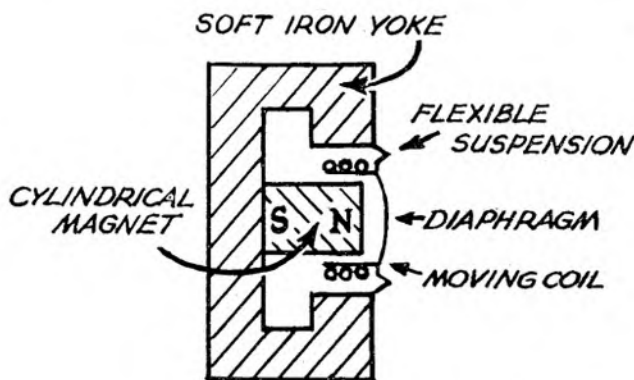

FIG. 2

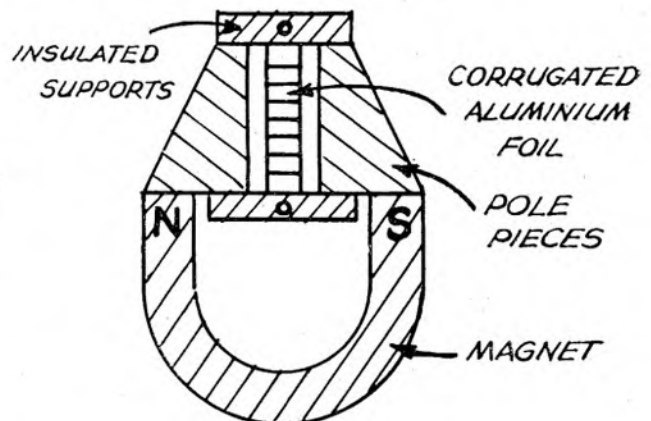

FIG. 3

CHARLES LANGTON,
A.M.Brit.IRE., in the fifth article
in this series, continues his
survey of the component
parts of a recorder

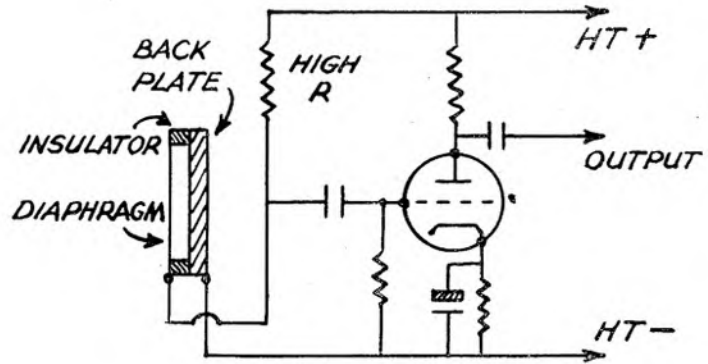

FIG. 4

higher audio frequencies, the diaphragm, coil, and suspension must be very light in weight.

The M.C. microphone is a low impedance and requires a transformer, but does not require a polarising battery. It is therefore sometimes called a "self energised" microphone. The diaphragm results in good sensitivity, but tends to spoil the fidelity somewhat. Quite good results may be had with this type of microphone.



RIBBON MICROPHONE.—The principle is shown in (fig. 3). The sound waves cause the aluminium ribbon to vibrate in the magnetic field. A voltage is induced between the ends of the ribbon which may be amplified in the usual way.

As no diaphragm is used in this type, it may be looked upon as a moving coil having only one turn (the ribbon). Thus, although the sensitivity is very low, the fidelity is very high, and this is probably the most superior microphone for high fidelity use. It is also one of the most expensive.

The ribbon microphone has a very low impedance, and low output voltage. It is a velocity modulated microphone, as distinct from pressure operated. This means that it is directional to sounds coming from the front or back, but not from the sides, top, or bottom. With suitable modification to the simple type shown, the back response can be eliminated also which leaves a uni-directional microphone very useful for commentating amidst a noisy background, etc.

CONDENSER MICROPHONE.—This is another high quality microphone. It is a high impedance pressure operated device, and requires a polarising voltage. Basically, it consists of a simple two-plate air spaced capacitor, or condenser, the back plate being part of the framework. The front plate is in the form of a thin metallic diaphragm mounted very close to, but insulated from, the back plate (fig. 4). Sound waves will cause this diaphragm to vibrate, and therefore the capacitance of the microphone will vary in sympathy with the sound. This microphone is connected to the polarising voltage of about 100-200 volts through a high value resistance.

The resistance is so high that the charge on the capacitance of the microphone remains constant even though the capacitance varies. Therefore, as the voltage output will be equal to charge divided by capacitance, this voltage will vary as the diaphragm vibrates.

The output from a condenser microphone is extremely low and for best results a pre-amplifier is often used actually within the microphone head. This is called a head amplifier.



CRYSTAL MICROPHONE.—This type is very popular, and can give good results for a reasonable outlay. There are two classes of crystal microphone, the more expensive being generally of the "sound cell" construction, which results in good quality performance, although the output voltage is rather low. The cheaper type often use a diaphragm, and, although this increases the sensitivity, it

also affects the response, and so the quality is not as good.

Both types rely on the piezo-electric effect of certain crystals, such as Rochelle salt. When two thin slices of the crystal are cemented back to back in a certain way, and they are made to vibrate, a voltage is generated between the faces of the crystal, which varies in sympathy with the vibration.



In the sound cell microphone, two pairs of these plates are mounted with faces parallel, so that there is an air space between them (fig. 5). When sound waves arrive at the microphone, the crystal plates vibrate and the audio frequency voltages thus generated are taken from the plates by means of electrodes.

The diaphragm type uses one pair of crystal plates only, one end of the plates being fixed to the framework. A diaphragm is connected to the opposite end of the plates, and as the diaphragm vibrates when receiving sound waves, this movement will be conveyed to the crystal plates, thereby producing an audio frequency voltage across the plates which may be tapped off as before. As the area of the diaphragm is comparatively large, it will pick up a greater amount of sound energy, and hence will cause the crystal to vibrate more vigorously than if the diaphragm had not been incorporated.

Crystal microphones have a high output impedance which is capacitive, a microphone transformer being unnecessary.

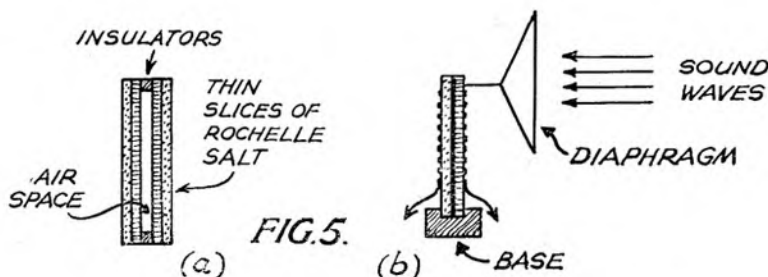

FIG. 5.

Next Month—

In his next article
in this series, Charles
Langton will write
about loud-speakers.

Amplifiers for one and two channels

IF 1957 saw a noticeable increase in the variety of amplifiers available to high fidelity enthusiasts, the developments of 1958 revealed an even wider choice. There is a noticeable tendency for manufacturers to produce their amplifiers in two separate sections, the main power amplifier in one cabinet or chassis, preceded by a high gain pre-amplifier unit.

Apart from other advantages, this arrangement allows the enthusiast more flexibility, for having settled on a power amplifier to suit his requirements of volume, he may select a pre-amplifier, control unit, or mixer unit according to whether he is solely interested in listening to high quality broadcasting, tape recording, disc, or a combination of the three.

Equalisation to match the different inputs (tape, radio, microphone, or disc), takes place in the pre-amplifier, which also contains tone and volume controls in most cases. In some instances the pre-amplifier may be used as a remote control unit to feed the main amplifier.

Power amplifiers are available with maximum outputs of between 4 watts and 50 watts, or even higher, although those of 10-15 watts predominate. The excellent performance of the better models is largely due to the use of grain orientated steel cored output transformers and carefully applied negative feedback.

The ultra-linear output stage has established itself very firmly, push-pull output being used in all but the very smallest amplifiers. Because of these and other improvements, all the amplifiers that follow have stated total harmonic distortion figures at full rated volume of better than .1 per cent.

A 20 watt amplifier by Dynatron, type LF20, has a frequency response almost flat from 30-30,000 cps, hum and noise being 90 dB down at full output. An input of .8 volts is required to give 20 watts output. A feature of this amplifier is that two separate power outlets are provided to supply H.T. and L.T. to a pre-amplifier and an F.M. tuner unit. A 230 v. A.C. outlet is also fitted for convenient connection to a gramophone motor. The provisional price is £29 15s.

A matching pre-amplifier, type TC20, is also manufactured by this firm, and is an excellent example of the versatile functions that can be obtained in an instrument of this kind. The outstanding features are: handles all inputs; four indepen-

dently controlled input channels; mixing facilities; equalisation for all inputs and frequency control. Maximum sensitivity is 2 mv. for max. output. The provisional price is £29.

Several new instruments have been displayed by Gramplan, including their 10-15 amplifiers with a peak output of 15 watts. Easy matching by plug and socket selection to the loudspeaker is claimed, and provision is made for the use of electrostatic speakers. Separate H.T. and L.T. supplies for radio and pre-amplifiers are included. To match this, a pre-amplifier control unit, type 582, may be used with low output microphones and pick-ups, whilst the type 580 control unit may be used when a crystal pick-up is employed.

Kolster-Brandes are one of the few manufacturers producing a printed circuit amplifier and pre-amplifier. The amplifier has a maximum power output of 16 watts and a frequency response flat to within 1 dB between 20 cps and 20,000 cps at

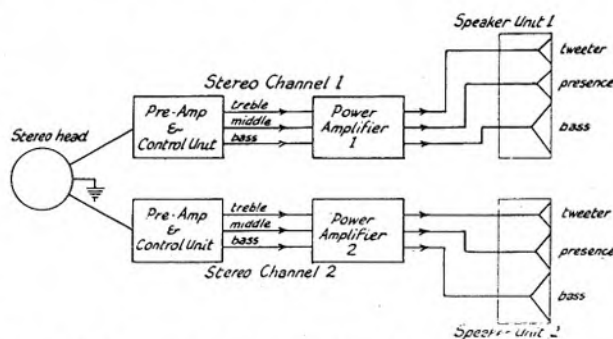

Block diagram of the Sound Sales Stereophonic Tri-channel equipment

full volume. H.T. and L.T. outlets are provided. The price is £20. A corresponding control-unit-pre-amplifier is available at £18, a feature being the push-button selection of any one of six different input channels. Treble and bass filters are incorporated giving a choice of frequency characteristic.

The air of caution which was, understandably, the policy of many manufacturers last year when the subject of stereophonic amplifiers was broached has cleared almost entirely. The present position is that almost all amplifier manufacturers are actively working on stereophony, and several complete units are now available.

In general, it is necessary to obtain two speakers, two standard power amplifiers, and a stereo-pre-amplifier. Thus, when changing over from monaural to stereo listening it is usual to buy an additional power amplifier and speaker, and replace the existing pre-amplifier by a stereo model. Such pre-amplifiers have inputs suitable for stereo tape, disc, and radio ready for use when each medium becomes readily available.

A complete stereo amplifier system by Leak is claimed to be the most advanced available in the world. The "Point One Stereo" pre-amplifier may be fed from any stereo or monaural source, and is suitably equalised for each input. The pre-amplifier output then feeds the "Stereo 20" twin power amplifier, each channel supplying 12 watts maximum output. Thus the total output is 24 watts. Overall frequency response



The Leak Point One Stereo pre-amplifier

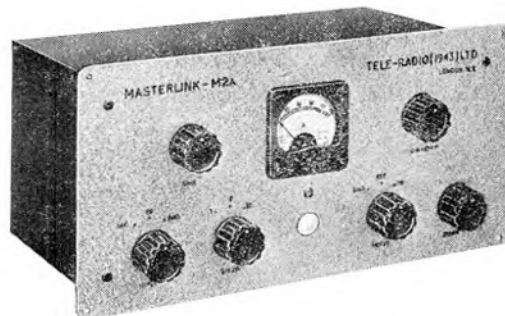

Left: The Astronic A 1434, stereo pre-amplifier, with selector and controls for presence, bass treble, rumble and volume.
 Right: The Tele-Radio Masterlink M2A, suitable for tape recording as well as playback

20 cps to 20 kc/s. The price of the power amplifier is 29 gns., the pre-amplifier being 20 gns.

The "Point One Plus" pre-amplifier priced at 12 gns. created considerable interest, and is designed for any input. It is recommended for use in conjunction with any Leak power amplifier, such as the TL/12 Plus (12 watts) at 18 gns.

Goodsell have tackled the stereo situation by producing a stereo pre-amplifier which is basically two of their well-known UL/FTC models. Both channels have their controls in tandem so that one knob effects an identical change in both units. Inputs are designed for any source. The output from the pre-amplifier may feed a pair of GW25 (20 watt) amplifiers at approximately £32 each, or if greater power is required, two GW50 (40 watt) amplifiers at about £42 each.

Anyone prepared to spend £300 on a complete High Fidelity amplifier system will be very interested in the Sound Sales Stereophonic Tri-Channel equipment. This comprises a stereo tone colour pre-amplifier, each channel of which contains an electronic cross-over circuit so as to supply three output channels, bass, middle, and treble frequencies. The pre-amplifier then feeds two power amplifiers, each of which is really three amplifiers in one, to provide a completely separate channel for bass, middle, and treble. Thus each main amplifier has three inputs and three outputs, and is used with a matching speaker unit comprised of bass, presence, and treble speakers. Two such speaker units are, of course, used for stereo.

In cases where performance and lavishness is of primary importance, and an output of nearly 100 watts is required, the serious enthusiast would undoubtedly give careful consideration to this equipment.

Beam-Echo make a stereo amplifier with built in pre-amplifier and control unit. This is the Avantic SPL12-D21 which sells for the very reasonable price of £48 10s. The peak power per channel is stated to be 20 watts, whilst an extremely wide frequency of 10 cps to 30 kc/s is claimed. The pre-amplifier may be obtained as a separate unit, if desired, at a cost of £28 10s.

One of the few amplifiers which are suitable for recording on tape is the Tele-Radio masterlink M2A. This is self contained with power pack and H.F. oscillator, and includes equalisation adjustable to C.C.I.R. characteristic, recording level meter, erase facilities and a D.C. supply for operating recorder solenoids, etc. The frequency response is adequate for all tape speeds, and the price is 27 gns.

The recently released "Stereo Eight" Dulci Stereo/Dual channel pre-amplifier has been designed primarily to work with two Dulci power amplifiers, Model DPA10 (10-14 watts each), but it can be used with other good amplifiers. It has twin tape channels for direct connection to tape deck heads, CCIR equalisation being provided. There is also an input for recorders converted for stereo. The unit is suitable for playing tape records and has twin pick-up channels, twin radio channels and twin microphone channels. The price is 22 gns.

The Astronic pre-amplifier type A1434 has been designed for the reproduction of stereo tapes and records when used in conjunction with two Astronic 10-watt amplifiers, type A1333. A selector switch adjusts the input circuits for stereophonic reproduction of tape, disc or radio, and for monaural reproduction of tape, disc, radio, microphone and auxiliary. The unit will accept the output of any good tape head without a separate pre-amplifier, and has the necessary compensating network built in.

Charles Langton

Other new amplifiers will be dealt with in a subsequent issue.

Call it a tape pre-amplifier

JUDGING from the many queries received from time to time, there is confusion in the minds of many people regarding pre-amplifiers.

Much of this confusion is no doubt due to the fact that some manufacturers and retailers fail to differentiate between the various types available, and call them all "pre-amplifiers."

Let us consider the amplifying requirements for sundry signal sources.

In every case a power (sometimes termed "main," not "mains"), amplifier is required to operate the loudspeaker system. This amplifier is easily distinguishable from a glance at the specification for there will be reference to the output power in watts (4, 10, 25, 50, etc.), and to the output impedance (3, 8, 15, etc.), indicating the matching requirements of the loudspeaker system.

Some power amplifiers are designed to give their output (in watts) from quite a small input signal, and have an incorporated tone and volume control system.

However, the modern tendency is to make available a power amplifier without tone and volume controls and to house these in a separate case. If tone and volume circuitry, without the use of valves, is used in this equipment, it is generally termed a "tone control unit" but when valves or transistors are used it is rightly called a "pre-amplifier."

So a "pre-amplifier" in this sense is a tone control unit with volume control, the unit giving some degree of amplification, according to the requirements of the signal input.

Multiple tone (frequency correction) circuits are included to enable various types of pickups, records, radio, microphone and tape recording signals to be controlled or corrected, enabling output of high fidelity to be produced.

Now comes the confusion. The tape recording equipment must include oscillators for bias and erasure, amplifiers for recording purposes which have special high frequency accentuation circuits, and playback amplifiers with special low frequency accentuation circuits. This is to enable recordings to be made and played back to a recognised standard, C.C.I.R., etc., and for sundry technical reasons.

This type of special amplifying equipment is often loosely referred to as a pre-amplifier, so who can blame the newcomer to tape recording who innocently says "I already have a 'pre-amplifier,' so I shall only need a tape deck."

The obvious solution is to describe this equipment simply as a "tape pre-amplifier" for it is: (a) suitable and necessary for tape record playback; (b) amplifying equipment; (c) definitely not power amplifying equipment, as the signal from a tape pre-amplifier is usually only sufficient to drive the standard pre-amplifier, which in turn needs its power amplifier.

J. W. Raine

KNOW YOUR RECORDER No. 9

THE REPS

DESCRIPTION

THE following circuit description embraces models manufactured by Reps Tape Recorders under the names of Reps JC20, Pilgrim 1000T and Excello MkIV up to the 31st August, 1958. As the machines are used under exacting conditions such as the live recording of organs, pianos or choirs, and as the period of use often exceeds that of an ordinary domestic machine, features normally unassociated with this type of machine have been included both in the circuit design and mechanical construction of the cabinet.

The circuit consists of seven valves plus one metal rectifier. V1 and V2 are located on the pre-amplifier chassis attached to the tape deck; V3 to V7 including MR1 are contained on a separate main amplifier chassis located below the pre-amplifier.

V1 is the play back pre-amplifier valve only and is selected for low hum and microphonic content. The adjustment of R44 is very important to reduce heater hum and should be re-adjusted whenever V1 is replaced. Noise generated in this stage is reduced by running the valve at a low anode voltage and using a one watt H.S. resistor for R4. Filter components R3, C3, R14, C4, prevent low frequency instability.

The bass boost to conform with CCIR recommendations is controlled by R6, R7, R10.

C10, C11, C12 and R8, determine the frequency at which the boost starts at the three speeds. The value of C6 is adjusted on each machine to give a pre-set amount of treble boost to allow for variation in output of the playback heads.

Tone control R11 varies both bass and treble. When rotated fully clockwise (that is to say towards the junction of C8, C9) the treble response at 10Kc/s is boosted by +12Dbs in reference to IKc/s. When control is in centre position, response on all three speeds is level within the range of frequencies stated. In the anti-clockwise position treble at 10Kc/s is attenuated by -12Dbs.

R12 is bass cut control and reduces response at 60c/s by -15Dbs with

reference to IKc/s. When microphone jack plug is connected into MIC input socket the output of V1 is disconnected. This prevents the possibility of bias picked up by V1 being fed into the record channel. Noise generated in the first stage is also removed from the recording, with an improvement in signal to noise ratio. S2 and S3 prevent the trouble previously described, occurring when using the RADIO input socket.

R15 is the grid to earth return for V2 of 2.2M. 1M was used on earlier models resulting in bass attenuation due to the low loading when recording from the crystal microphone. Microphone signals are amplified by V2 and fed to gain control R20 across which high level signals are fed via RADIO socket. To mix MIC and RADIO inputs a resistor of 220K should be connected in series with the microphone signals being damped. This resistor should also be used when recording from a crystal pick-up and could with advantage be increased to 500k. V3 is triode connected with an anode load of 68k (R21). This low value will increase the point where high frequency attenuation starts due to the anode to grid capacity. Signal is then fed via C19 and grid stopper R25 to output valve V4.

Negative feed back is affected from anode V4 by C22, C18 and R24 to cathode V3. R24 controls the amount of feed-back, C22 affects the bass and C18 the treble response. The value of C22 (.04mf) was chosen to make the bass roll off at 45c/s to reduce low frequency tape rumble. The range may be extended by decreasing the value of C22.

S4 mutes the internal loudspeaker when recording from a microphone or when using external loudspeaker from "15ohms out" socket. R30 prevents high peak voltages appearing across primary of L2 during recording with internal speaker muted.

R31, R32 attenuates the audio signal to the correct record level while C27 effectively removes any bias voltage present, without affecting the audio signal. MR1 (WX6) rectifies the audio signal to a fluctuating D.C. current. This charges C28 rapidly to the peak value of this

current. The discharge time is controlled by R33 and to some extent by the high back resistance of MR1. The voltage so produced by the discharge of C28 into R33 is proportional to the peak signal level and is applied as a negative bias to record level indicator V5 (EM71 valve).

The audio signal is fed to the record head via constant current resistor R29. This ensures the record amplifier offers a high impedance to the record head and swamps the increase in impedance of this head with frequency, so ensures constant current (producing the recording flux) with frequency. C25 gives treble boost to compensate for recording losses, L3 and C26 resonate at the bias frequency 65Kc/s to prevent V4 loading the bias and erase oscillator V6. This valve and V5 function only in the record position, H.T. being supplied via S8 or S9 depending of whether upper or lower track is used. The purpose of S7 (which is gauged to the gain control R12) is to allow the bias to die away in the record head before the stop bar is depressed, so preventing the heads becoming magnetised by a sudden interruption of the bias current. S5 and S6 switched in the relevant erase heads L9, L10.

The erase link disconnects the erase head current during recording to allow for superimposing. R40 is the bias pre-set control and is adjusted for 75 volts R.M.S. measured across the record heads with a valve volt-meter. This corresponds to a record current of 1m/A. L6 and L7 are the record/playback heads L5, L8 hum balancing coils.

DISMANTLING

TO obtain access to the main amplifier and pre-amplifier in order to change valves and so on, the front baffle board is removed by unscrewing two wing nuts located in each front pocket.

To remove tape transcriptor containing pre-amplifier proceed as follows: Remove baffle board containing loudspeaker, and unsolder twin brown leads on loudspeaker tags, ensure that wire going to the earthy side of loudspeaker is marked, otherwise reversal of this connection will cause instability on reconnection. Next unsolder twin brown lead from pre-amplifier to output transformer and note connections. The record level indicator EM71 is removed by pushing valve out of clamp or if this is not possible, slacken clamp off by unscrewing 4BA nut and bolt attached to clamp.

IMPORTANT: over tightening of this screw will damage valve; adjustment is correct when valve is a hard push fit. Two four-pin plugs located on right and one two-pin plug on the left of the main amplifier are then removed. To lift off

(Continued on page 45)

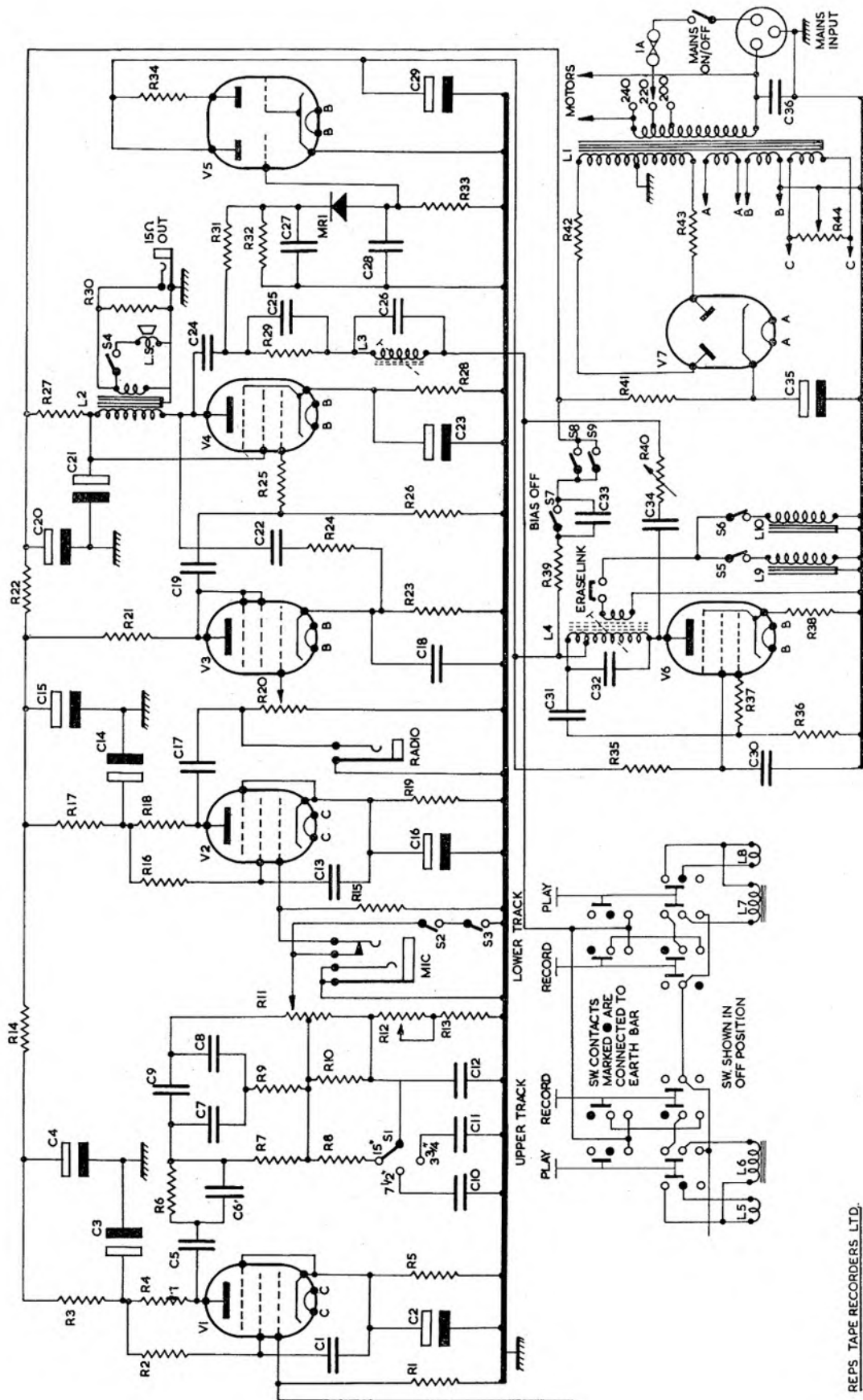

REPS TAPE RECORDERS LTD.







- Elizabethan

Elizabethan now bring you the most important addition to your tape library for years: The world's leading orchestras and artistes, superbly reproduced on the new Saga-Elizabethan high-fidelity recorded tapes. Available from your local dealer, in both monaural and stereophonic versions.

 From 35/- for a complete work

E.A.P. (Tape Recorders) Ltd.
 Recorded Tapes Division,
 Bridge Close, Old Church Road, Romford, Essex Tel: Romford 62366/7

Some samples of the current releases :

Prokofiev, Violin Concerto,
 STA 7007, David Oistrakh, violin.
 The Soviet State Symphony Orchestra.
Brahms, Symphony No. 4 in E,
 STB 8010, Royal Danish Orchestra,
 Conductor—John Frandsen.
Beethoven, Violin Concerto
 in D Major, Op. 61 STB 8019,
 Alan Loveday, violin.
 Royal Danish Orchestra,
 Conductor—George Hurst.
Gershwin, Rhapsody in Blue
 and American in Paris STB 8004,
 Joyce Hatto, piano. Hamburg
 Pro Musica, Conductor—George Byrd.
*New issues are published monthly.
 Please write for full catalogue.*

THE REPS

(Continued from page 42)

the plastic cover of the tape transcriber, pull off the speed change knob and unscrew the seven "Philips" screws.

To remove the tape mechanism slacken off three wood screws housed in rubber bushes. Place three fingers of each hand under the upper and lower track head assemblies, and lift the mechanism 2 in. or 3 in. clear of the cabinet, then hinge up, so the rear end of the deck rests vertically on the back top face of the cabinet; the mains lead may now be disconnected from the terminal block. A note should be taken of the relevant position of these wires, as reversal when reconnected may adversely affect the hum level.

Finally, to remove main amplifier unscrew six 4BA nuts and washers, bend rear panel back to clear fixing screws and lift amplifier clear.

The reverse procedure should be adopted for reassembly.

Voltage Readings, $\pm 10\%$, using AVO Model 8 on 1000 volt and 10 volt ranges, taken in *Record* position.

Pin No.	1	2	3	6	7	9
V1	90	—	1.5	100	—	—
V2	100	—	1.5	100	—	—
V3	—	—	2	100	—	—
V4	—	—	8	—	250	250
V5	—	275	—	—	—	—
V6	—	—	7.7	—	275	150
V7	345 AC	—	350	—	345 AC	—

Bias Voltage across L6 or L7: 75 volts RMS. Erase Voltage across L9 or L10: 25 volts RMS. Both measured with valve voltmeter.

COMPONENT VALUES

RESISTORS

R1 1M; R2 4M; R3 100K; R4 100K H.S.; R5 2.2K; R6 220K; R7 100K; R8 7.5K; R9 500K; R10 7.5K; R11 " M.Variable C.T.; R12 500K variable; R13 15K; R14 33K; R15 2.2M; R16 1M; R17 33K; R18 220K; R19 22K; R20 500K variable; R21 68K; R22 15K; R23 1K; R24 500K; R25 2.2K; R26 500K; R27 2K; R28 180 ohms; R29 500K; R30 47K; R31 220K; R32 1M; R33 15M; R34 220K; R35 47K; R36 47K; R37 22K; R38 390 ohms; R39 2.2K; R40 25K; R41 470 ohms; R42 120 ohms; R43 120 ohms; R44 50 ohms.

CONDENSERS

C1 0.1mfd; C2 50mfd; C3 16mfd; C4 16mfd; C5 0.1mfd; C6 200pf; C7 50pf; C8 pf; C9 10 pf; C10 0.01mfd; C11 0.05mfd; C12 0.01mfd; C13 0.5mfd; C14 16mfd; C15 16mfd; C16 50 mfd; C17 0.1mfd; C18 0.02mfd; C19 0.1mfd; C20 16mfd; C21 16mfd; C22 0.04mfd; C23 50mfd; C24 0.1mfd; C25 56pf; C26 500pf; C27 0.001mfd; C28 0.1mfd; C29 16mfd; C30 0.01mfd; C32 500pf; C33 0.01mfd; C34 200pf; C35 16mfd; C36 0.1mfd.

L1 Mains transformer MT20; L2 Output transformer OT20; L3 Bias rejector BR20; L4 oscillator coil OC20; V1 EF86; V2 EF86; V3 EF86; V4 EL 84; V5 EM71; V6 EL84; V7 EZ80; MRI WX6.

TAPE YEARBOOK—A GREAT RECEPTION

THE publishers tell me that the first edition of *Tape Recording and Hi-Fi Magazine Yearbook* sold out in ten days—before the end of the Radio Show. There is no more eloquent testimony to the value of this pioneer publication, a second edition of which is now about to appear, 5s. 9d. post free, from the publishers, or direct from newsagents and booksellers.

The first thing to be said about the *Yearbook* is that it provides a mass of basic information of interest to all tape enthusiasts that is available nowhere else. There is the complete list of tape recorders on the market, with the essential details of specifications. There is the directory of manufacturers and of specialist dealers. There is the catalogue of tape records.



This *Yearbook* is not a technical text-book. It offers facts of interest to everyone—the dealer, for example, will find its directory section of great value—but the feature articles are directed specifically at the layman, particularly those who are novices with tape. In this sense, the introductory survey of the development of tape, and the article explaining the place of tape in a hi-fi system are extremely well done. They are supplemented by shorter contributions on such matters as editing and splicing; the law of copyright; tape and ciné; and the choice and use of recorders.

Those who are thinking of buying new equipment will find it well worthwhile studying the market, through the pages of this book, before they start spending money.

The next thing to be said about the *Yearbook* is that it is most attractively produced. It is bound in a blue plastic spiral which is decorative and utilitarian—it enables the book to be opened flat at any page. Individual sections are printed on tinted paper.

The final virtue of this book is its price. At only five shillings it is one of the best buys on the bookstalls today. All the evidence is that the second edition will sell out quickly. I would advise readers to invest without delay

if they want to be in at the birth of a publication which will, without doubt, go from strength to strength and become an indispensable handbook to everyone interested in tape and hi-fi.

R. DYNER.

INVITATION

To a Demonstration of

- STEREO DISC
- STEREO TAPE

THE MANOR HOUSE
HOTEL
(Next to Manor House
Tube Station
623, 641, 629, 29, 171,
653, 627, 621, 521 buses)
TIME: 8—10-30 p.m.
DATE: 16th October

The Tape Recorder Centre invite you to a special demonstration of the latest stereophonic record players and stereophonic tape recorders introduced at the Radio Show. It is hoped that you will be interested in this unique opportunity of comparing and studying the very best of stereo sound both on tape and on records.

● Admission Free

Accommodation is limited. Please write, phone or call for tickets as soon as possible.

Department T

THE TAPE RECORDER CENTRE

Sypha Sound Sales Limited Tel.: STAmford Hill 1146
75 Grand Parade, Harringay, London, N.4.



In this feature every month you can check

YOUR LOCAL DEALER

who gives special attention to tape

LONDON

Hi-Fi Consultants and Dealers

STUDIO RECORDING & DUBBING FACILITIES

Studio A, 40 ft. x 40 ft.

TAPE to DISC

professional standards

OLYMPIC SOUND STUDIOS

Carton Hall, Carton Street, London, W.1.

Tel. HUN. 1635

FRANCIS OF STREATHAM

Tape Recorder Specialists.—Largest selection of Recorders in London.

No interest. No Charges on Terms.
Free service whilst under guarantee.

Mail Order Dept. for all available sizes, E.M.I. Grundig, Philips, Scotch Boy, Gelo, Telefunken, B.A.S.F. Soundrite. Tapes-Spools and accessories, post free.

169/171 STREATHAM HIGH ROAD,
LONDON S.W.16 Tel: STR 0466/0192

TAPE RECORDERS SPECIALISTS

best

PART EXCHANGE

allowance on your machine

- ★ No Interest Terms
- ★ Your recorder taken as a down payment
- ★ The largest selection in London
- ★ Free maintenance

BEST CASH OFFERS for Good Quality Recorders Immediate Settlement

R.E.W. EARLSFIELD Ltd.

545, GARRATT LANE, S.W.16 Tel.: WIM 0709

BUS STOP OUTSIDE 100 yds. from EARLSFIELD STN.

HOME TAPE PICTURES ON THE WAY

OPTIMISTIC forecasts of magnetic tape to record vision as well as sound were offered by leading figures in the industry recently. At the Emitape Luncheon at the Savoy Hotel to greet the winners of the British Amateur Tape Recording Contest, Mr. Peter Wetherill Recording Materials Division Sales Manager of E.M.I Sales and Service Ltd., struck a confident note.

He referred to the creative value of the type of recording encouraged by the Contest. "People don't want their entertainment to be made for them entirely," he commented.

"I feel it won't be very many years now before we shall be gathered here to consider tapes submitted in the Contest carrying not only sound, but a picture—and a picture in colour.

"I believe this very sincerely. We as a group have some few ideas about this. I believe this will be the ultimate thing and then it will be even more fun."

* * *

The prospect of a domestic tape recorder "within a year or so" which will record TV programmes, both sound and vision, was indicated by Mr. A. E. Johnson, Chairman of Grundig (Great Britain) Ltd, at a special meeting at the Waldorf Hotel on the eve of the Grundig Festival in a statement made to the Press.

He predicted that the machine would be about the size of a portable radiogram and cost between 80 and 100 guineas. He said that it would be possible to connect it to almost any existing TV set just as tape recorders today are connected to radio sets. Mr. Johnson added that the Grundig development of the idea is "laboratorily perfect." He continued, "just as you have records for your gramophone, so too will you be able to have your own tape recording library for your television set."

Grundig "Thank You" Party

ABOUT 2,500 Grundig dealers attended a gathering in the Festival Hall on August 28th. They were addressed by Mr. A. E. Johnson (Chairman), Mr. G. S. Taylor (Commercial Director), Mr. V. P. Coles, Sales Manager and Mr. P. Earl, Publicity Manager.

The talks were interspersed with top-line variety acts including Cyril Fletcher, Yana and Channing Pollock, compered by Eric Robinson.

A banquet luncheon was served to all the dealers, wholesalers and the Press at the Royal Festival Hall and the Connaught Rooms. The entertainment and talks continued throughout the afternoon and in the evening the gathering visited the first house at the London Palladium of "Large as Life."



Vera Lynn, with George Clouston conducting, entertains Grundig dealers at the Festival Hall "Thank You" party



In these attractive new premises of Teletape at 59a, Edgware Road, London, W.2, customers are quickly able to study the performances of various recorders. Each machine on the bench is connected directly to FM radio and extension speaker systems

CORRESPONDENCE

Mr. Berridge replies

MAY I crave a small space to answer the correspondence about my article on binaural listening. Mr. Jeater suggests that listening with headphones is no alternative to using headphones for stereo listening. With this I entirely agree, despite the remarkably realistic results that can be obtained from a pair of headphones. They do have their own peculiar advantages.

What I was suggesting was that binaural sound is a very acceptable substitute for stereo for those whose bank account is far from elastic. A high quality binaural headset is far cheaper than two amplifiers and two speaker systems.

May I also correct Mr. Jeater on a couple of points. I was not suggesting pocket transmitters, but miniature receivers as a means of eliminating the long cable needed for headphones. Two one-valve transmitters, set to different frequencies, and two receivers, consisting of very little more than a pair of semiconductor diodes apiece, would do the job admirably.

May I also point out that my suggestion of using many microphones, and loudspeakers, gathered in a circle around the listener is obviously an ideal arrangement and as such completely impracticable, although highly desirable. However, Mr. Jeater's arrangement of three microphones spaced 120° apart is also impracticable, mainly because the greater majority of the sounds we wish to hear come from a relatively narrow angle in front of us. Mr. Jeater's arrangement would not give us the directionality we require for stereo.

In answer to "Optician's" suggestion regarding the reversal of channels on playback, I have tried it, and the results depend on the listener. A musician would find the reversal of an orchestra quite disturbing, whereas an untrained ear would notice little difference. The physiological and psychological effects depend entirely on your familiarity with the recorded sound to which you are listening.

The analogy of stereoscopic vision does not hold, I'm afraid, since vision deals in tangibles which can be assimilated by one or more of the other senses; but hearing deals only in abstracts which cannot always be cross-checked with other senses, particularly in the case of recorded sound.

JOHN BERRIDGE.

London, S.W.10.

AUTUMN AUDIO FAIR

THIS year's Audio Fair for the North—re-designated the Autumn Audio Fair—is to take place on October 24, 25 and 26 at the Grand Hotel, Harrogate. Ready support is again being given by the trade, and visitors will—as on the previous occasion—be able to study the equipment in the exhibition hall and hear performances in the demonstration rooms.

LONDON

★★★★ LEE ELECTRONICS ★★★★★

(The Tape and Hi-Fi Specialists)

400, EDGWARE ROAD, LONDON, W.2

present their - ★ Five-Star Special ★ available on all Tape Recorders :-

- ★ Free Technical Advice.
- ★ Free Insurance and Delivery.
- ★ Free Home Demonstrations.
- ★ Free Maintenance whilst under guarantee.
- ★ Free of Interest Charges.

All Machines demonstrated for performance on Record and Playback

All leading makes of Hi-Fi equipment from stock

★★★★ PADDINGTON 5521 ★★★★★

LEWORTHY'S LTD.

Largest local stockists—Tape and all accessories. All deliveries S.E.4, S.E.6, S.E.12, S.E.13, same day. Postal tape orders free per return. We specialise for the builder with Parts—Pieces—Valves. Ring your query—we will be delighted to help.

407, 411 & 413, Hither Green Lane, S.E.13
Telephone: HITHER GREEN 4212

SCOTLAND

for SOUND
value SEE US

Hear and test the latest Philips, Simon Vortexion, Elizabethan, Grundig, etc. You're safer with the specialists (fully equipped service department). Terms arranged.



M^cCORMACK'S

7 COWCADDENS ST.

(Opp. Buchanan St. Railway Stn.)

GLASGOW C.2 Phone: DOUGLAS 2846

THE NORTH-EAST

Your HALIFAX Agent For

SIMON—FERROGRAPH—GRUNDIG
GELOSO—TELEFUNKEN—SAJA—WALTER
WYNDSOR—BRENELL—HARTING—STUZZI
and many others

Service Agent for TELEFUNKEN

TREVOR FAWTHROP

THE TAPE RECORDER SHOP
17 RAWSON STREET

Telephone: HALIFAX 66832



In this feature every month you can check

YOUR LOCAL DEALER

who gives special attention to tape

THE SOUTH

TAPE RECORDERS (Bournemouth) LTD.

specialists in

ALL TAPE RECORDERS

main area dealers for

Grundig • Philips • Stuzzi

Authorised Telefunken Service Agents

Tapes and Accessories by return

Terms available on New or Reconditioned Sets
(Largest stockists in Southern Counties)

Write or phone: Seamoor Road, Westbourne 64292

THE NORTH-WEST

JOHN SHINN & SONS LTD. Electronic Engineers

TOWN CENTRE, LEIGH, LANCs.

Also at MELODY HOUSE, 109 HIGH STREET,
BANGOR, N. WALES.

and MELODY HOUSE, 43, HALLGATE,
TOWN CENTRE, WIGAN, LANCs.

Pioneers in Tape Recorders since 1946

ALL MAKES STOCKED - TERMS AVAILABLE

All customers are made honorary members of the John Shinn Recording Club, with its attendant benefits

THE MIDLANDS

R-E-S OF COVENTRY

SPECIALISTS IN HIGH FIDELITY
and all makes of Tape Recorders

- ★ Stocks of Stereophonic and Pre-Recorded Tapes.
- ★ Demonstrations always available by fully qualified staff
- ★ The Best Selection—Terms or After Sales Service in the MIDLANDS

R-E-S (COVENTRY) LTD.
128 FAR GOSFORD ST. Coventry 60913

NEWS FROM THE CLUBS

Federation of British Tape Recording Clubs

A STATEMENT on the functions of the Federation, issued by the Secretary, Mr. R. Penfold, indicates that its work can be divided into three parts as follows:—

(a) The Federation will assist and encourage the formation of new tape recording clubs. To this end individual recorder owners are invited to write to the Federation with a view to starting clubs in their localities. Help is forthcoming in the form of suggestions for advertising, the running of a meeting, the election of officers, the drawing up of a constitution and the planning of various activities in which the members of the club can indulge. This assistance is free and in no way puts an obligation on the newly-formed club to join the Federation.

(b) The Federation will give technical and legal assistance to all established clubs and help in many other ways to develop the clubs' interests and activities. Being a national organisation, the Federation is in a better position than any local club to obtain and pass on advice of this type. It also can be a "clearing house" for news and ideas so that clubs can benefit from each other's work. It is the wish of the Federation, and indeed it is incorporated in its Constitution, that it "shall not control the internal affairs of the member-clubs." These clubs are free to conduct their own programmes but they know the Federation is there to give help where needed.

(c) The Federation will represent tape recording clubs on a national scale. In this the Federation is also in a strong position. It can keep abreast of all big developments in the field of sound recording and reproduction and pass information on to member-clubs; it can constantly review new commercial products in tape and allied equipment, and it can keep those concerned in touch with the requirements and wishes of tape recorder enthusiasts through their respective clubs.

Edinburgh

THE first September meeting of the ETRC during September included a talk on editing by pioneer enthusiast Sir Mark Dalrymple. Sir Mark has been tape recording for quite a few years and has a library containing over forty miles of tape. He has quite a selection of recorders too, including an Elpico, an E.M.I. and a Ferrograph.

After the meeting members were invited to take part in an editing contest, each being issued with the same short recording which contained a number of faults to be cut out.

Coventry

MR. PETER C. WARDEN has been elected as the new Chairman of the Coventry Tape Club. There have been some well-attended meetings recently, and varied programmes have been provided including a demonstration by Mr. Howard Freer of his home-constructed tape recorder. A demonstration of film with sound was planned for the meeting on September 4th provided by the Birmingham Ciné Society. A suggestion has been made that a technical group should be formed as a new club amenity.

Midland Counties

THE Sound Magazine compiled by the Midland Counties Tape Society has been in trouble again. One copy was returned by the G.P.O. with an explanation that it had been set on fire by Teddy boys.

The second edition of Technical Tape Topics is being produced on 5 in. spools at 7½ ips.

Sheffield

HIGHLIGHT of a recent meeting was a visit from Mr. Philip Rogers who brought with him some recordings "from outer space" which were recently the subject of an interview on television. A more complete programme of his mysterious recordings is promised for later in the year.

West Middlesex

THE meeting of the West Middlesex Tape Club on August 28th showed a record attendance and included seven ladies and five new prospective members. Philip Mead gave an interesting demonstration of the Reflectograph recorder played back through a Goodmans Axiette Speaker.

Coventry

A HIGH level of attendance has been achieved recently and this is regarded as an indication of the success of the committee in presenting programmes which meet with general approval. Mr. R. Penfold, secretary of the club, played his second "Sounds of the Sea" tape at one of the August meetings, and also a non-commercial tape of some Bing Crosby recordings. The secretary and Mr. Skingley recently visited the Coventry Theatre and interviewed Miss Beryl Reid and Mr. Bernard Miles. These recorded interviews will be played back to club members. A library of tape records has been started by a subscription scheme, and members who have not subscribed will be able to borrow the tapes on payment of a charge.

Discussions are in hand on the possibility of forming a Birmingham branch of the club.

Windhoek

Tonband/Tape Recorder Club, Windhoek, South West Africa Post Box 386, are seeking to arrange an exchange of tapes with clubs in England. They are in need of one or two tapes for a musical entertainment of two or three hours, which would be returned, freight prepaid. In turn they would be able to furnish items such as the Windhoek Madrigal-chorus, the Gruber-chorus Grahamstown, the Native Band Competition, and the German Carnival at Windhoek. They also expect to have available in the near future some sounds of wild animals and songs and voices of natives recorded by an expedition which recently left for an area where no European has previously been.

BTRS

A COPY of the American tape "All about tape on tape" has been made available to the Society, and copies will be supplied on members' own tapes if sent to H.Q. Chester together with return postage. No further copies of BTRS Tape Bulletins are to be issued until the Bulletins issued during the early part of this year are returned to the Bulletin Managers. The results have been announced of "the election of 'officials' for President and Council as held by 'postal ballot' of members," the names given being: Mr. Francis K. Oliver (Hon. President for BTRS); Mr. Ted Yates (Vice-President/Executive Secretary, unopposed); Mr. Jack Talling (Deputy Secretary, Bulletin Editor, unopposed); and Messrs Alan Lovell, Frank Micallef, Royston Henry, Bill Rawle and Arthur L. Mallory.

Rugby

A DEMONSTRATION of microphone and recording technique is scheduled for the September meeting. Mr. Longmore, of Coventry Tape Club was a visitor at the August meeting, and he played some tapes made by the Coventry secretary. A membership drive is under way and all readers in the Rugby area who wish to join, or would like details, should write to the Hon. Secretary, Mr. Mike Brown, 219, Clifton Road, Rugby.

Dundee

THE club recently had a letter from a Dundee man living in New Jersey, U.S.A., asking for a tape of all the sounds he and other ex-Dundonians there would like to hear. It was quite a long list and will take the club most of the Autumn to make up. It includes an auction at the cattle market, the sound of riveters at the shipyards, a jute mill, trains coming off the Tay Bridge into the station, goods wagon being shunted, a fishmonger crying his wares, a local pub on Saturday night, a local dance hall, the city centre church bells, newsvendors shouting and the Tay ferry-boat whistle. The winter programme is now planned up to the end of December with fortnightly meetings all the way. Tapes are being exchanged with two other clubs, London and Bournemouth. A tape from John Amphlett, of London, on sound effects was considered to be one of the most impressive tapes the club has heard and has given members plenty to think about. Mr. Charles Aitken reported that his entry in the documentary section of the British Amateur Tape Recording Contest had been highly commended.

THE MIDLANDS

TAPE RECORDERS ON 'NO-INTEREST' TERMS!

Buy your new Tape Recorder without touching CAPITAL! Grundig, British Ferrograph, Vortexion, Baird, Philips, etc. NO EXTRA CHARGES — Nine months to pay the balance of Retail Price Only.

JEWKES & CO. LTD.

The Midlands Tape Recorder Specialists

285, BROAD ST., BIRMINGHAM 1. MID 4829/20.

"TAPE RECORDERS ONLY"

ALL POPULAR MAKES, CASH OR TERMS

Specialists in GRUNDIG and Service and Guarantee implemented without return to the manufacturers.

TAPES Service spares

DIXON'S ELECTRONICS

227 OXFORD ROAD, MANCHESTER 13

(Telephone: ARDwick 4269)

TAPE RECORDERS AND HI-FI

Large selection, including Ferrograph, Grundig, Philips, Simon, Telefunken, Elizabethan, Truvox, etc.

Hi-Fi units by Quad, Leak, Goodmans, etc.
Daily Demonstrations,

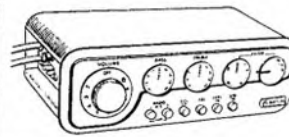

**HOLDINGS
OF BLACKBURN LTD.**
39-41, MINCING LANE,
BLACKBURN.

MANCHESTER



THE NORTH'S
Sound Reproduction Specialists

for TAPE RECORDERS

FERROGRAPH: Brenell: Harting: Simon: Dauphin: Sonomag:
Tandberg STEREO: Grundig etc.

also

ALL MAKES OF HI-FI EQUIPMENT
Hire Purchase and Credit Sales

HIGH FIDELITY DEVELOPMENTS LTD.

8, DEANSGATE, MANCHESTER 3.
(Near Grosvenor Hotel)

DEA 3825

Classified advertisements

Rate—Sixpence per word (minimum 5s.); Trade, ninepence per word (minimum 10s.); box numbers, one shilling extra. Payment with copy. Copy should be sent to Advertisement Department, "Tape Recording Magazine," 1 Crane Court, Fleet Street, London, E.C.4.

LEARNING GERMAN? Conversational tape with script and translation. Native speakers. Standard 3 in. spool recorded at 3½ ips, price 17s.; at 7½ ips, 19s. 6d. Post free from Dept. T.R., BCM/AIDS, London, W.C.1.

COMPREHENSIVE 78/LP Tape to Disc Recording Facilities. Rendezvous Records, 19, Blackfriars Street, Manchester 3.

TAPE RECORDERS—The largest selection in London. Top service after sales. Few perfect condition used machines: Sound 777 30 gns., Wyndsor Regent 37 gns., Geloso 25 gns., Philips AG8106 39 gns., Grundig TK5 39 gns. R. E. W. (Earlsfield) Ltd., 545 Garratt Lane, S.W.18. WIM. 0709. The largest part-exchange allowance on your tape recorder.

UNBEATABLE TAPE DECK BARGAIN! EMI Tape Reproducers fitted with famous EMI Deck, 7½ ips, 7 in. reels. Self-powered pre-amp 200/250 v. A.C. All in walnut cabinet. Brand new. Plugs into any amplifier or radio, ideal for dubbing. Easily converted to quality Tape Recorder. Listed at £68. Our price 22 gns. or 9 equal monthly payments of £2 17s. 6d. Also many second-hand recorders and a Specialist Repair Service. E. C. KINGSLEY & CO. (Dept. T.R.), 132, Tottenham Court Road (corner of Warren Street), London, W.1. Tel.: EUS 6500.

UNREPEATABLE MICROPHONE SNIP! Half price offer of famous makers Stick Microphone listed at £5 5s. Our price £2 12s. 6d., p. & p. 2s. Brand new in original cartons. Limited quantity. Also 7 in. 1,200 ft. P.V.C. Tape by leading American maker, brand new in original cartons (not surplus), £1 10s. post free. Send at once to E. C. KINGSLEY & CO., address as above.

Young married couple would like to correspond by tape. Recorder speeds 3½ in. and 7½ in. Box 247, *Tape Recording Magazine*, 1, Crane Court, E.C.4.

EMIL2.—Professional battery-operated recorder. Highest offer secures. Box No. 243, *Tape Recording Magazine*, 1, Crane Court, Fleet Street, London, E.C.4.

PROFESSIONAL KIT—E.M.I. L2B, 3½ and 7½. Battery for superb recording in the field. Power pack for mains operation. Accessories: bulk erasure, speaker, earphones, microphones, spare valves, tapes and spools. Offers, please: Manley, Church Lane, Claverdon, nr. Warwick. Claverdon 514.

AT LAST! A tape recorder you can afford. Small and neat and offering 3½ in. and 7½ in. per sec. at the amazing price of 29 gns. Terms available. Send for details. **OUTSTANDING TAPE SALE.** Heavy stocks, must be cleared. **LONG PLAY** 1,800 ft. on 7 in. reel in carton. Recorded once only. By leading maker, cost 50s. Our price 29/6. A pleasant surprise awaits you when using this tape and you will want to buy more! **STANDARD PLAY** 1,200 ft. 7 in. reel, guaranteed unused. By leading American maker 29/6. Both plus P. and P. 1/6 up to 3 spools. E. C. KINGSLEY & CO. (Dept. T.R.), 132, Tottenham Court Road (Corner of Warren Street), London, W.1. EUS 6500.

Proposed Literary Tape Circle. Poetry readings etc. Discussion. Enquire Albert Chapman, 31 Dulwich Village, London, S.E.21.

"Elizabethan de Luxe" recorder with accs. Perfect. £45. Write R. Kenna, 38 Lancaster Gate, W.2.

JOHN HASSELL RECORDINGS. Tape/Disc. All Speeds, C.C.I.R. Studio, 21, Nassau Road, London, S.W.13. RIVERSIDE 7150.

FRIENDLY FOLK ASSOCIATION, 87, Terrace, Torquay.—Leading International Correspondence Hobby Club since 1943. Now included, facilities for Tapesponding. Details free.

PROFESSIONAL'S EMI L2 Portable Battery Tape Recorder. Virtually unused; works overhauled; 65 guineas. Box 246, *Tape Recording Magazine*, 1, Crane Court, Fleet Street, London, E.C.4.

TAPE RECORDERS, Players, Radios, etc., wanted for cash. Particulars or callers. Cooks, 159 and 187, Praed Street, W.2 (opp. Paddington Station). PAD 6464.

LEADING FIRM of T. Recorder Retailers, shortly opening a branch in the West End of London, require a Manager. Applications are invited for the position from enthusiasts with a sound knowledge and experience. Sales ability, character and appearance are of utmost importance. Good prospects with expanding firm. Write stating age, experience and salary required to Box 258, *Tape Recording Magazine*, 1, Crane Court, Fleet Street, London, E.C.4.

SAVE MONEY when buying your new Tape Recorder by using our generous Part-Exchange Service. 75 per cent of Retail List Price allowed against old Gramophone Records, Players, Radios, Tuners, Amplifiers, Tape Recorders, etc. Full details of Terms in Booklet C/33/TR, price 1s. (in stamps). **ARCADE RECORDING CIRCUIT,** Arcadian Gardens, London, N.22.

GRUNDIG TK8/3D, 2 speeds, 3 speakers, absolutely brand new, unused, £56. Evenings: 7, Deanery Rd., Stratford.

WANTED. MINIFON, Write 8, Coleherne Court, S.W.5, or phone between 6/7 p.m. FRE 8749.

REPAIRS to all tape recorders. Grundig specialists. Bruce-Miller Company, 65, Fortess Road, N.W.5. GUL. 2468.

INDEX TO ADVERTISERS

	Page
Bradmatic Ltd.	36
Brown, A. & Son Ltd.	14
Classic Electrical Co. Ltd.	5
Cosmocord Ltd.	10
Dickinson's of Pall Mall Ltd.	3
E.A.P. (Tape Recorders) Ltd.	4
E.M.I. Institutes Ltd.	19
E.M.I. Sales and Service Ltd.	26 & 27
Fi-Cord Ltd.	9
Film Industries Ltd.	36
Francis of Streatham	15
Harrogate Audio Fair	3
"Hatherley"	13
Howard Photographic	9
Hughes, F. A. & Co. Ltd.	30
Kingsley, E. C. & Co.	13
Lustraphone Ltd.	5
Minnesota Mining & Manufacturing Co. Ltd.	Front Cover
Modern Techniques	14
Multicore Solders Ltd.	36
Newnes, G. & Co. Ltd.	Inset
Perth Radios Ltd.	51
Philips Electrical Ltd.	8
Quality Mart	6
Reps (Tape Recorders) Ltd.	16
Saga—Elizabethan	44
Simon Sound Service Ltd.	12 & 51
Sonomag Ltd.	11
Sypha Sound Sales Ltd.	5 & 45
Tape Recorders (Electronics) Ltd.	52
TeleTape	11
The Recorder Company	15
Trianon Electric Ltd.	15
Verdik Sales Ltd.	7
Walter Instruments Ltd.	20
Watts Radio (Mail Order) Ltd.	13
Welmac Corporation Ltd.	32
Wyndsor Recording Co. Ltd.	2

SUPERSON RECORDINGS. Tape/Disc all speeds. Studios, 1, Abingdon Road, Leicester. Granby 204.

8½ in. spools used Ferrotape 35s. Other makes and sizes available. Callers only. Olympic Sound Studios — see Dealer column.

AT LAST! A tape recorder you can afford. E. C. KINGSLEY & CO. See our display advertisement on page 13.

GRUNDIG TK820 tape recorder/transcriber, foot-control, earphones, microphone. As new. Offers. HAM 9609.

USED RECORDERS BOUGHT FOR CASH. Tip-top allowances against a new machine. Easy payments. Largest selection in the North. SIMMON, 35, NORTHGATE, HALIFAX. Phone 2240.

KNOW WHAT AND WHEN TO RECORD WITH "EUROPEAN RADIO." All the top music programmes from the Continent. By subscription only. 13 weeks 12s. Sample copy 9d. **A MUST for Tape Recording readers.** 71, Stoke Newington Road, N.16.

BATTERY TAPE RECORDER. Home constructed; speed 7½ (variable); two E.M.I. heads; separate record and playback amplifier spring driven. Bargain for parts alone, £10. Also VALRADIO power unit; input 12v. output 230v. 150 watts hardly used £12. Steel, 11, Ann Street, Edinburgh.

GRUNDIG TK/830/3D

Brand New in Carton
List £105. Sell £75.

108, Childwall Valley Road, Liverpool 16
Telephone: Childwall 6436

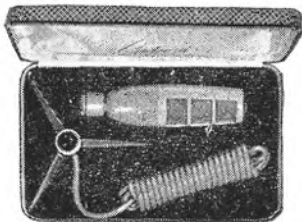

the
perfectionist's
microphone

The thrilling acoustic quality of the Cadenza Ribbon Microphone is something that every recording enthusiast has wished for. This is no microphone for the mediocre—the Cadenza is a superb instrument that will do full justice to the finest performers and the best of recording equipment alike. With a virtually flat output over the entire 50 - 12,000 cps range, gems of tone and clarity that make the original performance sparkle are caught and held by the wonderful Cadenza ribbon microphone. Yet it is not in the 'expensive' price class; its moderate cost places it within the reach of every discriminating devotee of recorded sound.

Cadenza
REGD.

ribbon microphone

designed and manufactured in England

Microphone with dual impedance head, in presentation case, 8½ gns.

Microphone (dual impedance head) and tripod desk stand, with 11 ft. of cable, 10 gns.



Styling: Peter Bell, M.S.I.A.

Send now for illustrated folder or ask your radio dealer

Simon Sound Service Ltd

46-50 George Street, London W.1
Telephone: WELbeck 2371

more features in PERTH-SAJA

Made in Germany to exacting specifications

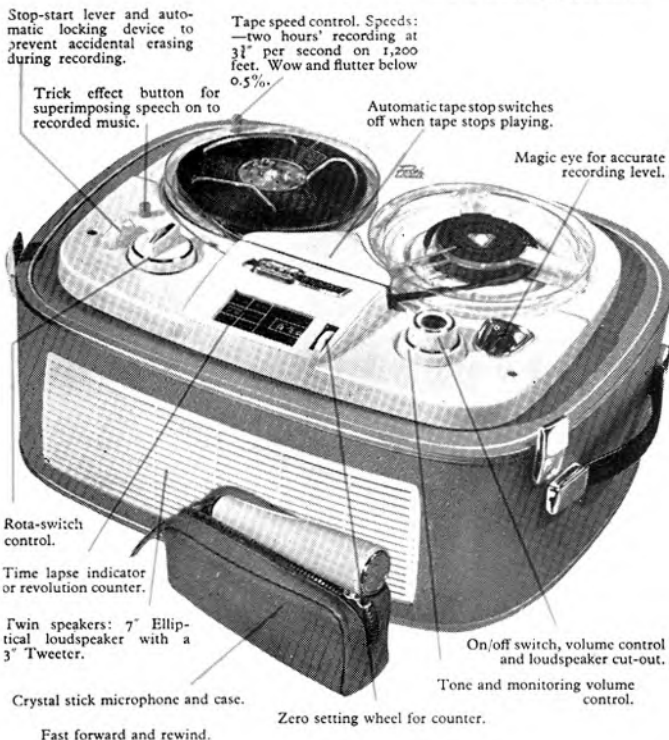

Lovelier styling *plus* extra features make the Perth-Saja Tape Recorder the finest value money can buy. Send coupon for illustrated literature and name of nearest stockist.



Beautifully styled two-tone carrying case.
Easy to carry.

56 guineas complete with Microphone and Tape. Easy terms at your dealer's.

Dimensions: 15½" x 12½" x 7". Frequency Range: 50-12,000 cycles at 3½" per second, 50-16,000 cycles at 7½" per second. 5 valves. Input Sensitivity 3mV. Output Voltage 800mV at 10 kilo-ohms, Power Output 3 Watts.

To **PERTH RADIOS LTD., Marten House, 39-47 East Road, London, N.1**

Please send me literature on the Perth-Saja Tape Recorder

Name.....

Address

**SOMEONE ELSE HAS DISCOVERED
THE FINEST TAPE RECORDERS
ON THE MARKET**

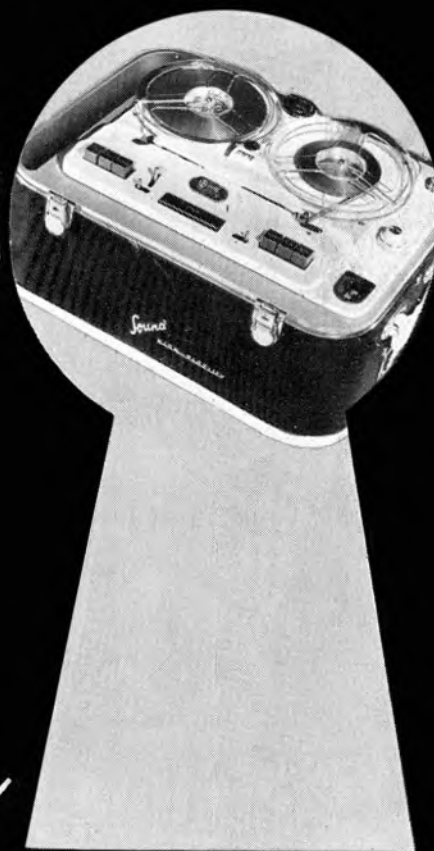

ONCE YOU HAVE HEARD a 'Sound' Tape Recorder you will know that you too have found the finest—finest for quality, finest for performance, finest for versatility, finest for sheer value. Whichever Sound Model you choose you will feel a great pride of ownership.

Sound Belle—at only 26 gns. the lowest cost, fully automatic, quality tape recorder in the world! Full frequency response, top class musical reproduction, built-in speaker, 3 watts output.

Sound 444—a high performance lightweight 3-speed recorder with newest high fidelity transcrip-

tor deck; 3 hrs. playing time. Complete in two-tone carrying case 45 gns.

Sound 555—the supreme recording instrument with a luxury specification—but a moderate price. Matched 3 loudspeaker system, 4 watts output. Complete with Dynamic Microphone and Stethoset for only 65 gns.

As illustrated above.

If the human ear can hear it . . . Sound can reproduce it



**Full range of accessories and tape available
TAPE RECORDERS (Electronics) LTD.,
784-788 High Road, Tottenham, London, N.17**