

T. & R. Bulletin

Incorporating

The Journal of the Inc. Radio Society of Great Britain

(BRITISH EMPIRE RADIO UNION)



Vol. 4. No. 8. February, 1929 (Copyright)

Price 1/6



Type 587-B.

The 587-B. Filter is superior to most devotees' requirements. Where the consumption of the last stage does not exceed 30-40 MA. the Type 387-A. SPEAKER FILTER suffices. Currents up to 40 MA. will not affect audio fidelity.

Constants of the Instrument: (Single choke-condenser).
Choke, 30 Hys @ 35 MA. Condenser, foil wound, 750 v. DC.
Capacity of Condenser, 2 MFD. Usual GR drawn steel casing.
Dimensions: $3\frac{1}{2}'' \times 4\frac{1}{2}'' \times 4\frac{1}{2}''$. Weight: 3 lbs.

Reduced Price, Cge. Paid - - £1 7s. 6d.

ACTUALLY IN STOCK.

The New GR. Type 527-A., 1,000 volt Rectifier System £4 7s. 6d.

Power Transformers: Double Filter Chokes. Transmitting Condensers 2,000 volt (Peak) Variable Transmitting Condensers, R.F. and Transmitting Chokes, Stand-off Insulators, Raytheon Tubes.

Full range of the World-famous "Clarostat" Resistances, etc., etc. State Requirements, etc., etc.

SOMETHING GOOD! THE NEW GR. 587-B Power Speaker-Filter

Intended for use in Super-Power Output Stages. This Unit contains an especially wound choke coil having an effective Inductance of 15 Hys, with 100 MA flowing. DC Resistance of Choke only 175 Ohms, reducing the voltage lost to a minimum. The DC component may reach 100 MA. without the slightest impairment of audio fidelity. A 4 MFD, genuine wax-impregnated, foil-wound, 2,000 volt DC Test (1,000 v. DC continuous service) condenser is inserted in each Speaker lead.

Dimensions: $4\frac{1}{2}'' \times 3\frac{1}{2}'' \times 4\frac{1}{2}''$. Weight $4\frac{1}{2}$ lbs.
Code Word "FATTY." Price, Cge. paid £2 5s.



Type 387-A.

FREE
Our New, Revised,
Enlarged, 184-Page
Illustrated Catalogue.
Send 4d. Stamps for mail.

CLIX

A Better TERMINAL

A CLIX TERMINAL

is better in many ways. It takes Spade, Pin, or bare wire connection quickly and gives perfect contact. Has polished insulated knob with metal inserts. The non-soldering wiring device gives excellent contact and makes set assembly much easier. Is highly nickel-plated and improves the appearance and performance of any receiver.

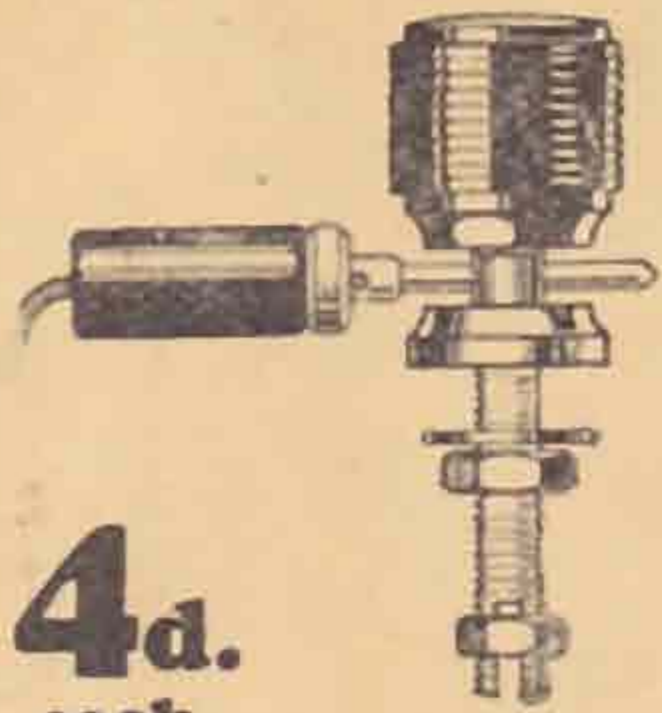

4d.
each.

CLIX WOOD SCREW SOCKETS

As their name implies, these are excellent for extension work, wherever plug-in contact is used, and for mounting on baseboards as coil bases, etc. Numerous other uses can be found for these extremely useful sockets. Complete with Red or Black Insulators and Ring Tag

2d.

each for connections.

Clix Spade Terminals, Spiral Wander Plugs and Terminal Brackets can now be obtained lead-plated as well as nickel-plated. These three can therefore be used for all connections to accumulators without fear of corrosion at the same time obtaining a better connection.

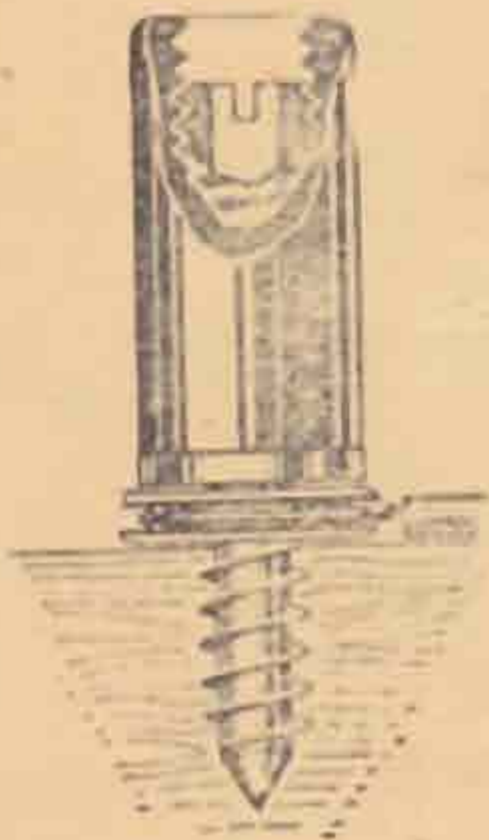

Write for the "Clix" Catalogue

LECTRO LINX Ltd. 254, Vauxhall Bridge Rd.
LONDON, S.W.1.

Quartz Crystals

Harmonic Control

If you are interested in this form of crystal control, which uses a crystal connected across the grid coil of a TP-TG transmitter, we have some IMPORTANT information for you and it will pay you to drop us a post card.

Details of our 1929 crystals appeared in last month's issue of the "Bull."

The Quartz Crystal Co.,

[G2NH. & G5MA.]

63a, Kingston Road, New Malden, Surrey.

"T. & R. Bulletin."

ADVERTISEMENT RATES.

	Per insertion.		Per insertion.
Full Page	£5 0 0	Half Page	£2 10 0
Quarter Page	1 5 0	Eighth Page	0 12 6

Series Discounts—5% for 6 or 10%, for 12 consecutive insertions.

Advertisements specified for Facing Matter Positions are not subject to series discounts.

The T. & R. BULLETIN is published on the 14th of each month. Orders, Copy and Blocks should be received by us on the 30th of each month preceding month of issue.

All applications for space or specimen copies should, please, be sent to Advertisement Manager,

PARRS ADVERTISING, LTD.,

Craven House, Kingsway, W.C.2.

Telephone: Holborn 2494.

GRADUAL PAYMENT

on all Wireless & Gramophone Goods

Why wait—take advantage of our scheme of gradual payments. You can have gramophone or wireless goods to the value of £5 or over without financial worry or embarrassment.

AN EXAMPLE

£5 worth of goods supplied on DEPOSIT OF **20/-** and 9/- per month for 10 months.

The new "MOGEN" generator entirely eliminates accumulators and High Tension Batteries and is more economical.

No. 3 Set. Any voltage input and 400 volts 200 milliamps D.C. H.T. output with 8 volts 7 amps. Low Tension output.

D.C. starter £6 10 0 extra. **£40.**

HIGH TENSION ONLY.

No. 1 Set. Suitable for 100 or 200 volt D.C. input and 400 volt 200 milliamps output.

D.C. Starter £4 10 0 extra. **£20.**

No. 2 Set. 200 volt A.C. input and 400 volts 200 milliamps D.C. output

A.C. starter £2 10 0 extra. **£22.**

All Short Wave sets and components can be supplied—prices on application.

Please write for full details.

For the Best in Radio

WILL DAY LTD.

(THE BEST IN THE WEST)

LISLE STREET, LEICESTER SQUARE, LONDON, W.C.2.

Telephone: (2 lines) Regent 0921 and 0922

Telegrams: Willday, London

ALWAYS MENTION "R.S.G.B." WHEN PURCHASING.

TRAR

BULLETIN.

The only British Wireless Journal Published by Amateur Radio Experimenters

*All correspondence and matter for publication to be addressed to the Hon. Secretary, 53, Victoria St., London, S.W.1.
Tel.: Victoria 4412.*

Officers and Council for year 1929.

President : GERALD MARCUSE, ESQ. (G2NM).

Acting Vice-President : H. BEVAN SWIFT, ESQ. (G2TI).

Honorary Treasurer : E. J. SIMMONDS, ESQ. (G2OD).

Honorary Secretary : G. F. GREGORY, ESQ. (G5PZ).

Honorary Editor : G. W. THOMAS, ESQ. (G5YK).

COUNCIL :

K. ALFORD, ESQ. (G2DX), D. P. BAKER, ESQ.

(20Q), J. CLARRICOATS, ESQ. (G6CL) A. HAMBLING, ESQ. (G2MK), CAPTAIN K. HARTRIDGE (G5CB), A. HINDERLICH, ESQ. (G2QY), E. MEGAW, ESQ. (GI6MU), J. W. MATHEWS, ESQ. (G6LL), E. D. OSTERMEYER, ESQ. (G5AR), R. L. ROYLE, ESQ. (G2WJ),

FEBRUARY, 1929.

Vol. 4. No. 8.

SOCIETY NOTES

In taking over the Editorship of this most unique of British technical journals, I must express my own personal regret that we have lost, temporarily we hope, the assistance of Mr. Bevan Swift. That all at Headquarters will miss him almost goes without saying, but his absence from active work in connection with the Society will be an even greater loss to those in the provinces, for who has not at some time or other had to fall back on him for assistance? However, we wish him good luck with his new work, and assure him that whenever he is able to again help there will be many to welcome him back to "Active Service."

* * *

Talking of active service reminds us of the new Committee's motto for 1929—Progress. Progressive policy is the only one which will bring the Society into that predominance which it must have if it is to be recognised as the premier Amateur Radio Society within the Empire. Let us get to it during this new year and see if we cannot make the title "British Empire Radio Union" a name to be considered wherever Amateur Radio is discussed. Most of our Dominions are already represented in the Society's membership with perhaps one or two names from each, but this is not sufficient. We want more and more of our Colonial friends to join in with us and help us to give the B.E.R.U. a place in the sun of publicity.

* * *

The BULLETIN is our only outward and visible sign of life to those overseas; its preparation is

costly, but the work is worth while if it will be read with interest wherever Amateur Radio abounds.

To our present Colonial members we ask that they will give the Union every ounce of publicity they are able so to do, and to our British members we ask that when you hook a Colonial you tell him of the BULLETIN and of the B.E.R.U.

Our President has stated that he wants a big increase in membership this year; let us try to prove that it is possible to attain.

Remember that a larger membership means a bigger and better BULLETIN, more facilities and greater prestige.

* * *

The matter of district representation reports requires reconsideration. In response to requests in bygone days those responsible decided to publish each month a few personal remarks concerning the activities or otherwise of members. Those "News and Notes" columns have gone on month by month—sometimes flourishing, sometimes flagging—but as time passes those of us who read them must often wonder whether they really are worth while continuing. Month after month some of the representatives have pleaded for more support—some have threatened, others have flattered, but mostly one finds that the same small few remain contributors. And so we must really at this stage give the matter every consideration and ask ourselves whether they are worth continuing. Some there are who say that they are

the very soul of the Society—others have said that the space occupied is wasted, and more valuable information could be inserted. We who control the destinies of *your* BULLETIN wish to do the right thing. We do not propose "cutting" this feature without very careful consideration, but we feel that the time is now ripe to receive opinions so that we may be in a position when opportunity comes along to say the Area Notes are or are not wanted.

A postcard to Headquarters or to your district representative is all that we ask.

* * *

This month has seen the departure from England of two well-known amateurs. Cecil Goyder has left for South America on business until next winter, whilst Jack Witty (G5WQ) is out China way with a bigger set to control than the one which has for long months put so fine a signal out from Great Crosby.

We hope that the medium of Amateur Radio will help these two fellows to keep in touch with their many friends in Great Britain. Good luck to you both.

* * *

With Easter but a few weeks ahead the idea of a District Conventionette should appeal to all new representatives. By such gatherings are we able to appreciate the other man's point of view, and we take the liberty of suggesting to all our district representatives that they endeavour to organise a gathering at Easter, "be it ever so humble." By the time these notes appear another Mid-Britain Conventionette will have taken place. We heartily congratulate Mr. Baker and his friends for their untiring efforts to make amateurs within their areas meet around the table of conviviality and good comradeship.

* * *

We have been asked to call attention to a certain amount of slovenly operating procedure that is

being carried on by stations both in Great Britain and abroad. We refer to the use of the signal strength scale. It is very confusing to stations to meet first with the old scale and then with the new. Imagine the state of affairs in, say, a year's time, or even in a month. A new amateur station starts up and possibly he has a copy of the Provisions of the International Radiotelegraphic Convention, 1927; in this he sees how stations should be operated, and very rightly he assumes that amateurs keep to these provisions; he arrives on the air to find a completely different operating procedure in use by amateurs, the exact details of which are very unlikely to appear in print in the future. Now is the time to prevent any possible chaos next year. If you have not already done so, start straight away on the new procedure. Copies of the Provisions of the Convention can be obtained from Headquarters, price 3s., post free.

* * *

It should be a matter of honour for members to see that they buy only from "T. & R." advertisers, and at the same time mention the BULLETIN. You have probably seen those words before. But whether you remember them when wanting a small fixed condenser is doubtful. It is not meant that you should all write away to the manufacturers for everything you require; having procured the necessary article from the shop round the corner, it would not take long, nor cost more than a penny, to drop a line to the advertiser concerned, and pointing out to him that through his advertisement in the BULLETIN you have purchased so-and-so, and are very satisfied with it. It is only by these means that the advertisers can possibly know that their advertisements are having the intended effect, and any one of you connected with the publication of journals must know that the advertisers are the mainstay of any publication of this type, and without them we should not be able to carry on.

K.C.-Metre Charts.

To those members who have recently ordered a K.C.-Metre chart from us, we tender our apologies. For some reason beyond our control the delivery of these charts has been delayed, and we can only ask members to be patient and wait. At the present time we can give no guarantee as to when these charts will be available. For those members who have not seen previous announcements we would say that the chart gives the conversion of K.C. to metres, or *vice versa*, at a glance, the conversion factor being taken as 3. It extends from 10 to 30,000 K.C. or metres, and there are in all 3,000 conversions worked out. The price is 6d., from this office.

Wanted.

The name of a British manufacturer who can supply a good "peaked" L.F. transformer.

Forthcoming Events.

FEBRUARY 15.—Debate at City Electric Restaurant, Ludgate Hill, London, E.C. Subject: Should Telephony on the 7,000 KC. Band be Abolished? The debate will be opened by Mr. J. Clarricoats and Mr. G. W. Thomas will oppose. 6.30 p.m.

MARCH 22.—Lecture at the Institution of Electrical Engineers. Subject: The Tuning of Radiating Systems, by Mr. F. Aughtie (G6AT). 6.15 p.m.

Citizens Radio Call Book.

Members are reminded that if they wish to avail themselves of the special reduced terms at which the above is now issued to members, orders for the March issue must be sent in to headquarters, together with remittance, before the end of February. As only orders will be placed with the publishers in accordance with the orders received from members, no guarantee can be given for orders placed after the 28th inst.

"Far Niente."

By F. RODMAN, 2KT (India) and G2FN.

All transmitting amateurs are very gratified when the "other man" gives a good report on their transmission, and they will take any amount of time and trouble with their transmitter to obtain such a report. Do they, in their turn, do all they can to please the other man by taking the trouble to build a reliable receiver which enables justice to be done to the "other man's" signals? With regret one is forced to the conclusion that the answer is, in many cases, in the negative. This practice is hardly "cricket" and is to be deplored. In my opinion the correct policy is to do justice to the other man's signals, first, by building an efficient receiver, then go all out for transmitter efficiency.

On commencing reception in Central India, a land where QRN is QRN, it was very quickly realised that no useful work could be accomplished with a transmitter, even if it were capable of producing strength 5 reports from all over the world, unless a reliable receiver was made which was capable of cutting down the "unwanted noises" in favour of desired signals and thereby enabling the aforesaid reports to be copied under adverse conditions.

An appreciation of the problem presented by atmospherics may be estimated from the following facts. For nine consecutive months in 1927 only a short indoor aerial enabled copiable amateur signals to be produced, it being quite common for an R9 (old scale) commercial station to be completely unreadable when using a two-valve receiver, although every precaution had been taken to reduce the unwanted noises in favour of signals. In 1927 the 10 M.C. band could not be used, except on one or two nights per month, from April to September inclusive, on account of QRN. During this period the 14 M.C. band provided more workable conditions to the extent of about seven or eight QSO's per month.

My profession demands that I must be prepared for changes of location at short notice, considering that the distances involved are great, compared with English standards, it is undesirable that the station equipment should be bulky or complicated. In 1926 my station was moved seven times and the distance travelled well in excess of five thousand miles.

The problem of design was worked out in accordance with the foregoing facts, and the receiver limited to a detector stage followed by a transformer coupled L.F. amplifier.

When the receiver requirements were realised tests were carried out with average Service operators, and the fact established that it is easier and less tiring to read a weak signal against a low "noise level" than a strong signal against an unchecked "noise level." Signal strength could, therefore, be sacrificed to obtain a quiet background of unwanted noises.

Circuits were tested simultaneously, and it was found that the normal straight circuit gave as good

a signal strength as any other. Valve tests followed, and an attempt was made to combine three desirable features, (a) silent operation, (b) maximum signal strength, (c) a reduction of static level. It was thought that a D.E.Q. valve as a detector and a valve of the DE5B class as an L.F. amplifier would partially fulfil features (b) and (c). Tests proved that this combination of valves most successfully combined the three desirable features.

Placing a grid-leak across the output of the L.F. transformer further reduced the unwanted noise level in favour of a given signal, the signal naturally being weaker than without the grid-leak. The value of the resistance which produced the results nearest to those desired was found by trial, in my receiver, 2 megohms (makers' value).

Aerial coupling tests were then made, and the method finally selected being a single turn of wire coupled to the grid coil, the turn being kept as far away from the grid coil as it could be consistent with a sufficient transfer of signal energy, the "earth end" of the aerial turn being left free.

Should the unwanted noise level be such that reception, using an outdoor aerial, is impossible, a short indoor vertical aerial rarely failed to produce working conditions given an R2 (old scale) steady signal, which was generally 95 per cent. copiable, this degree being possible owing to a quiet background. This achievement is worth attaining, especially when the classification of the old R2 signal is considered and the conditions under which it is attained.

With a receiver of this description, work was commenced in 1926 on 28 M.C., using a commercial station for comparative purposes. This station happened to be discovered testing during experiments to discover the oscillating capabilities of the receiver. The receiver performed creditably and signals were of good strength. A few minor alterations were undertaken, the chief being (a) improved lay-out, (b) detector valve grid circuit L/C ratio.

The lay-out was very carefully considered and attention paid to minimising all losses and unwanted capacity, a new receiver gave superior results to the old one on 28 M.C. when tested simultaneously. It was found that a high L/C ratio for the detector valve grid circuit gave the greatest signal strength and easiest tuning on 28 M.C. The tuning condenser finally chosen was a G.E.C. .0002 mfd., stripped down to one fixed and one moving vane, quadruple spaced. For really silent operation it is advisable to add a pig-tail connection as indicated by the makers, and keep all moving parts and rubbing surfaces well oiled.

The object of the receiver being to copy amateur signals, listen to amateur telephony on the 28, 14 and 7 M.C. bands, and telephone reception of broadcasting stations operating between 7 and 28 M.C., the disadvantage of a given coil only covering a narrow frequency band was therefore of no importance.

On arrival in England the final change of housing the receiver in an aluminium box, with the detector valve and its associated apparatus screened from the L.F. stage, was carried out with provision for a compartment to accommodate an H.F. stage using a screened grid valve. This change still further assisted in reducing the unwanted noises and signal strength is all that one would wish for copying purposes. Body and hand capacity are also avoided without the use of R.F. chokes or extension handles, although no part of the receiving apparatus is directly earthed. Before this last change was made the receiver was dubbed a "graveyard," now it is more silent than ever.

It cannot be claimed that maximum signal strength has been produced, but maximum "copiability" under adverse conditions has been attained. At the same time, judging by C.B. Budget letters, conversation with other amateurs and contents of the BULLETIN, my reception of U.S.A. and Canadian amateurs on 28 M.C., when using a horizontal aerial only 12—15 ft. above ground, and badly screened, appears to be above the average for a two-valve receiver. For example, taking the reports in the January BULLETIN, G5ML reports the most stations (15), and hears W 1st, 2nd, 4th, 5th and 8th Districts. My log shows 24 American stations in the above mentioned districts, plus the 6th District.

The usual straight circuit with capacity reaction is used, and a sketch plan of the lay-out adopted is shown in Fig. 1.

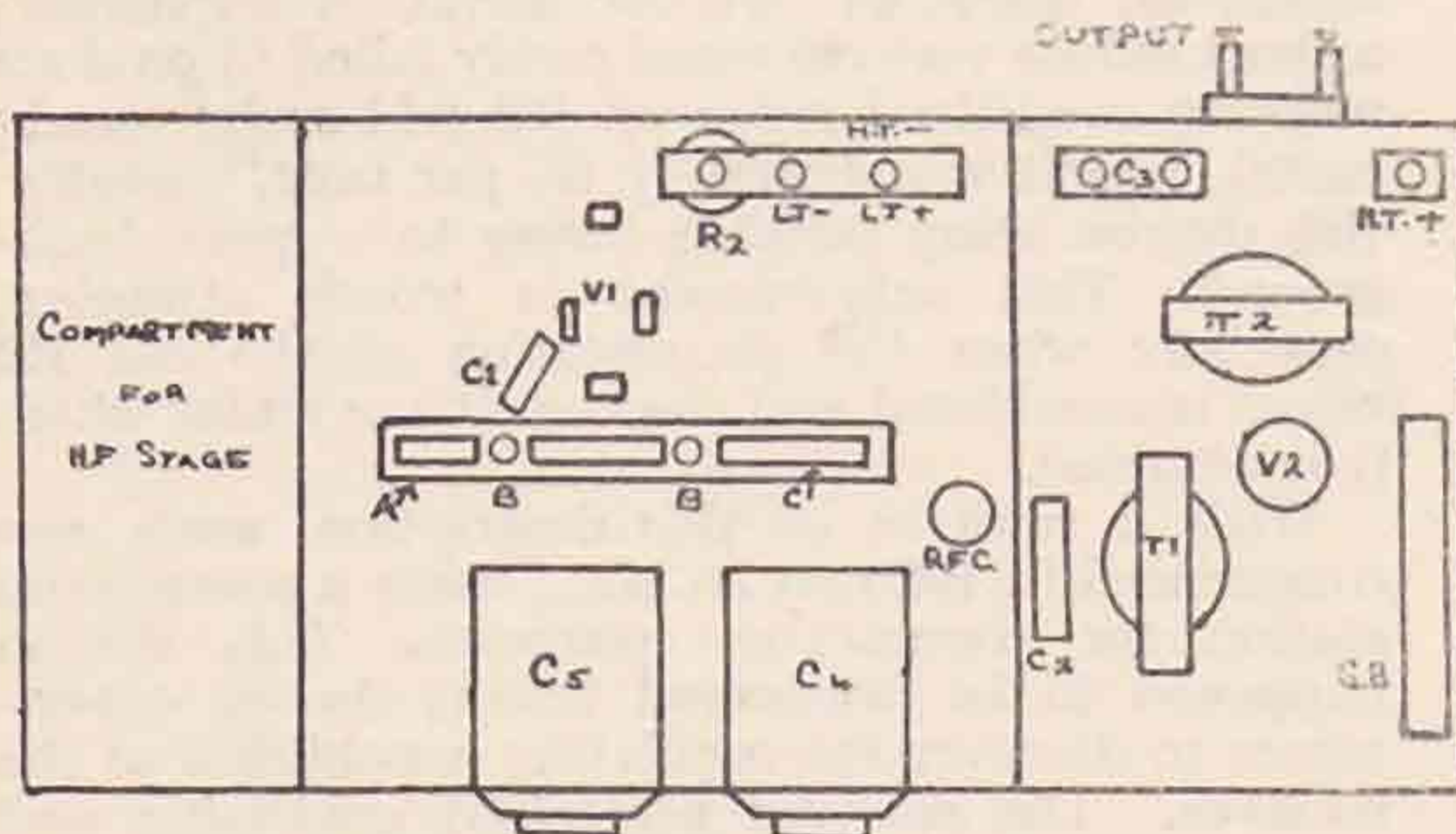

FIG 1

- KEY.
- | | | | |
|----|--|-----|---|
| C1 |0001 mfd. | R1 | 5 megohms. |
| C2 |0005 mfd. | V1 | Osram DEQ. |
| C3 | ... 2 mfd. | V2 | Osram DEH610. |
| C4 |0005 mfd. | RFC | 40 turns spaced 1" diam., No. 36 S.S.C. |
| C5 | ... See subject matter. | | |
| T1 | ... Marconiphone "Ideal," Ratio 4:1 (A 6:1 is preferred). | | |
| T2 | ... Telephone Transformer. | | |
| R2 | ... A filament rheostat (6 ohms) plus a suitable fixed resistance. | | |

NOTES.
Although C5 and C4 are mounted direct on the front panel, it is considered advisable to make a direct connection from the condensers to the bottom of the aluminium box.

R1 is mounted under C1.
BB: Sockets for Grid Coil. 2 1/2" Centres. Grid Coil 8 turns per inch.

A: Slot for aerial coil adjustment.
C: Slot for reaction coil adjustment.
Coil mounting made from 1/2" x 3/4" ebonite, sockets BB, Brass rod 1/4" in diam., and drilled to give a sliding fit for No. 16 SWG wire, are let into the coil mounting with 1-16" projecting on the under side for connecting purposes. If desired, SBA screws can be used to lock the grid coil in the sockets. Coil spacers made from 1/4" thin walled ebonite tube drilled by aid of a jig. The lower grid

coil spacer drilled as in Fig. 2, the ends of the wire being passed through the two holes XX and about 1/4" left projecting for insertion into the sockets.

For transmission purposes three main factors have influenced design—a "one voltage" H.T. supply from a rotary transformer; a scarcity of suitable components obtainable locally (locally being anywhere in India, and to obtain supplies from England takes from two to three months); and the necessity for compact and easily moved apparatus. The first and third factors force the adoption of a self-excited oscillator, and the second frequently means making the best of a bad job.

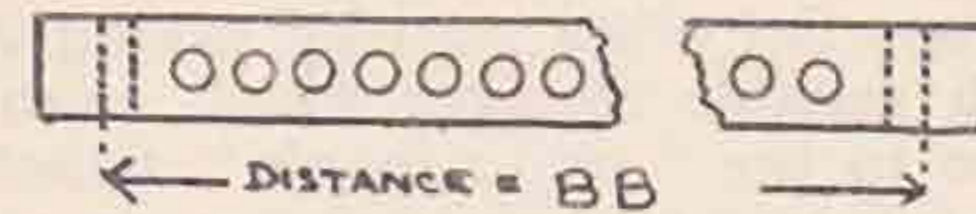

FIG 2

Early in 1928 I made attempts to obtain contact with Australian 6SA on 28 M.C., with my 14 M.C. transmitter working at this frequency with extreme inefficiency. In view of the frequency bands to be at the disposal of amateurs in 1929 experiments were carried out to try and evolve a transmitter with fair efficiency.

Various circuits were tried with the type of valve at my disposal, a bright emitter rated at 100 watts; the best output for a given input was obtained by using a split Hartley circuit series fed. Inputs up to 50 watts were tried, but trouble was experienced in reducing the "no load" feed to a reasonable value and overcoming a bad frequency creep during keying. Up to the time I left India these problems remained unsolved to my satisfaction.

At the same time a low-power transmitter, using an LS5 valve in a similar circuit, was constructed and tested out locally, using 80 volts on the anode. The performance of the transmitter was satisfactory in all respects.

Owing to no contacts being made outside the ground wave radius, no aerial tests could be made of any "DX-producing" value. Faith was pinned in a half-wave vertical radiator, as this type, apart from other considerations, for a given input produced the greatest aerial current at the point where the greatest current should be.

On arrival in England the best possible aerial was erected in the limited space at my disposal with due regard to the short period it would be in use and the avoidance of unnecessary expense on this account. The system being a half-wave radiator for 14 M.C., with twin feeders arranged for voltage feed. On coupling up the low-power transmitter, supplied with power by an ML type D machine, and adjusting for the 28 M.C. band, disappointing results were obtained, and the LS5 died a violent death.

An LS5 D valve was obtained and the battle renewed, with little satisfaction as far as efficiency and aerial power were concerned.

The split Hartley circuit was apparently not suitable for the LS5 D valve on 28 M.C., as it was found impossible to reduce the "no load" feed to a point where, on coupling the aerial, neither the valve nor the M.L. machine was overloaded.

The next circuit tested was TPTG, with more encouraging results, the "no load" feed being reduced to a figure only slightly in excess of that obtained with a similar input on 14 M.C. by having

a high L/C ratio in the plate circuit and a high C/L ratio in the grid circuit. On coupling the radiator either as shown in Fig. 3 on page 90 of the October, 1928, BULLETIN, or by using twin feeders, power was satisfactorily transferred to the aerial with fair efficiency. Inputs up to 14 watts were tried without any visible sign of the valve elements overheating, but inputs exceeding 11 watts caused a rather bad frequency creep, and accordingly, for actual transmission work, the input was kept at 10 watts or below. Even with inputs of this order a slight frequency creep is noticeable whilst the valve elements are warming up, but of the reports received on various transmissions only once or twice has this frequency creep been reported.

Mechanical vibration caused an unsteadiness of note; after a lot of trouble had been taken this was cured, and the note is generally reported as steady D.C.

The circuit of the transmitter, as shown in Fig. 3 on page 90 of the October, 1928, BULLETIN, has only been changed in the following particulars: R1 variable in 2,000-ohm stages between 8 and 20 thousand ohms, RFC's 1 and 2 now 50 turns, spaced 1 in. diameter.

A sketch plan of the transmitter lay-out is shown in Fig. 3. Wiring shown by dotted line.

It has been found that the best work is done when the aerial feeder current is 90 per cent. of its maximum value.

The transmitter is adjusted in the normal manner for a TPTG circuit, but on coupling the aerial it will be found that the frequency has changed and slight readjustment is necessary.

Quite enough has been said elsewhere on the results obtained with this transmitter, and further comments will not be made.

In conclusion, I should like to express the hope that any theoretical blunders which may have been made will be excused as the general run of the

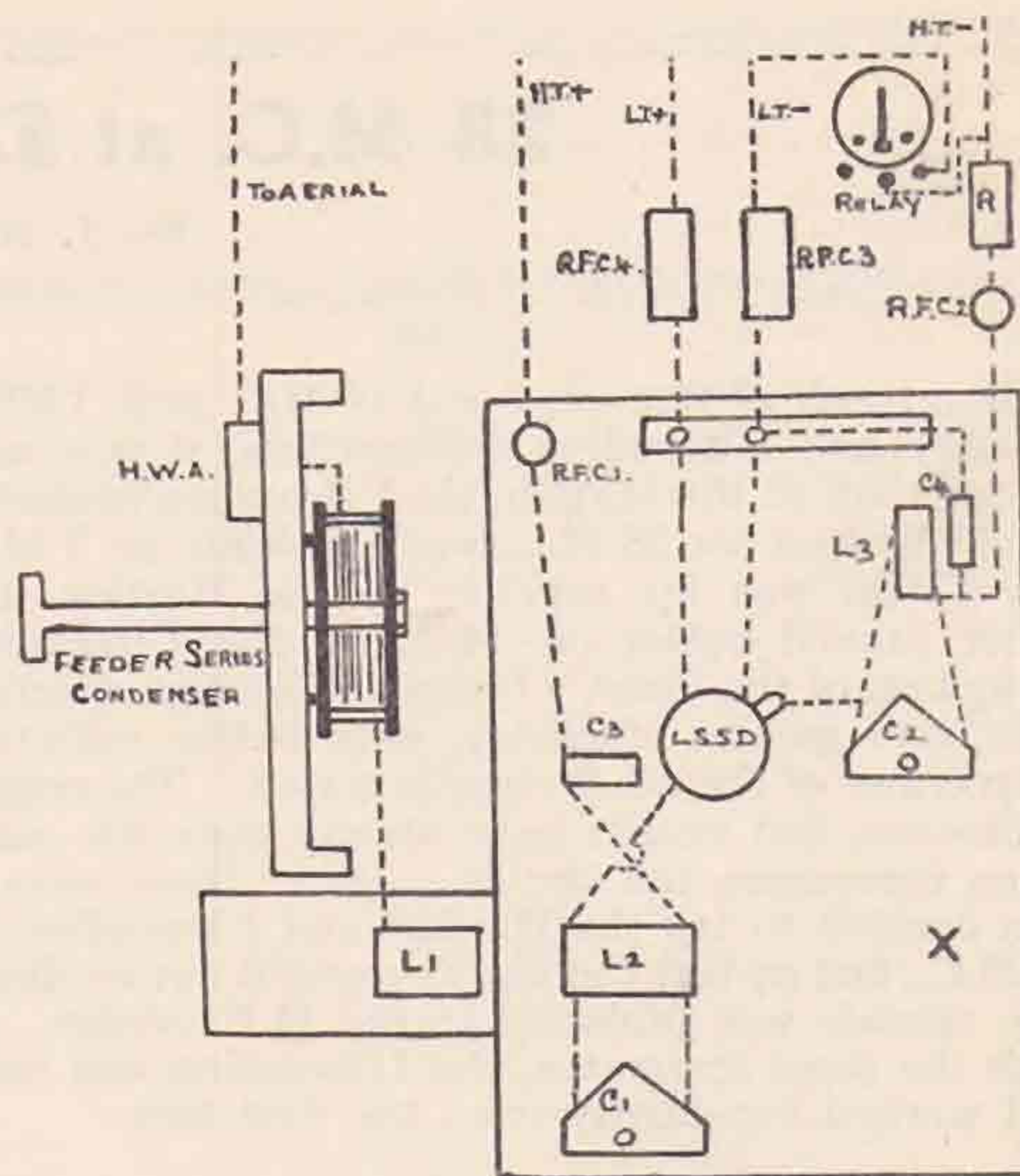

FIG 3

NOTES.

A second ammeter and feeder series condenser for the dead end feeder are mounted directly underneath those shown.

See Fig. 3, page 90, of October (1928) BULLETIN for references.

The condenser C4 is mounted underneath L3.

It is intended to try moving RFC1 to a position about X, thus avoiding the anode lead crossing the wire joining L2 and C3. The connection between C3 and LT negative omitted for clearness.

Indian climate and theoretical reasoning are only in conjunction for a short period during the year as far as I am concerned. My usual mode of procedure is the application of my limited theoretical knowledge to the problem (if I can keep awake long enough), and then wrestle with the practical side when refreshed, it being far less trying to apply brawn than brain.

Receiver at G2AUX.

While I can claim nothing new for this receiver, it may possibly be interesting, containing as it does a good few dodges extracted from the "BULL." and other papers. The Hartley circuit is used, and the receiver will readily oscillate well below 5 metres, or should I say above 56 M.C., although the only thing I can get down there is the harmonic of my transmitter. Referring to the circuit diagram, and starting at the tuning apparatus, you will see that coil is tuned by two condensers in series. This is really one condenser *a la* 5MQ. There are three sets of vanes, two sets fixed and insulated from each other and one set moving, insulated from both fixed sets. Owing to the fact that there are no "pigtailed" or friction contacts, this condenser is absolutely noiseless.

The grid leak goes to a potentiometer across the L.T. accumulator (which is 8 volts for the TX) and two four-volt valves are used, filaments in series. Reaction control is obtained by a differential condenser, the spindle being connected to the plate of the detector valve, one set of fixed vanes to earth, and the other to the reaction end of coil. As the reaction is lessened, so the capacity to earth increases, thus providing an outlet to the H.F.

current in the plate circuit. In the ordinary course of events, this current would have to leak away somewhere or get lost in the L.F. side and cause all manner of trouble. Two H.F. chokes are fitted in the fone leads, and all chokes are wound fieldless, that is half right-hand and half left-hand. Reaction control is perfectly smooth and the whole set is noiseless in operation. An Ormonde slow-motion dial is fitted to the reaction condenser and two slow-motion dials in series are fitted to the tuning condenser. I mean, that one drives on to the knob of the other, and they give a ratio of about 250 to 1 reduction. Six-inch extension pieces are fitted to condenser spindles and the set is rather free from hand capacity effects.

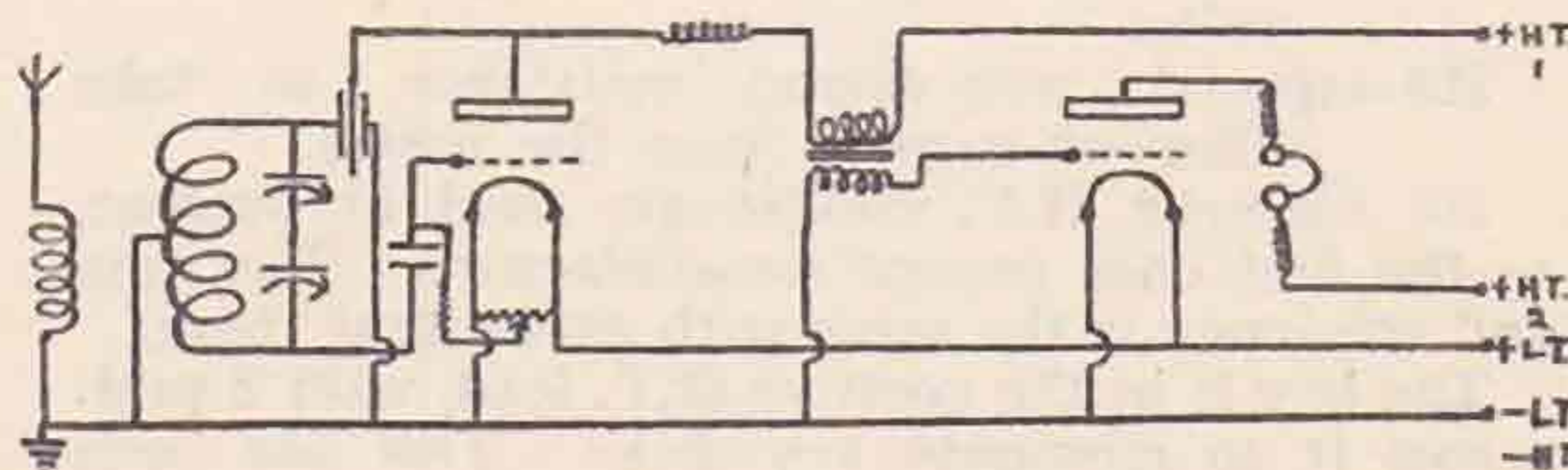

28 M.C. at EI7C (Old GW17C).

By J. B. and R. D. SCOTT.

As a result of tests on 7 and 14 M.C. with TPTG, Hartley and Ultraudion transmitters, it was concluded that, at this station, the Ultraudion probably would be best for 28 M.C. work. While on 7 M.C. the TPTG was far superior to the Hartley, the latter proved better on 14 M.C., the Ultraudion being best of the three. It gives a cleaner, steadier, note, and greater efficiency, with better radiation than either of the other circuits tested. The reason is obscure, but results have always been the same when comparing the circuits. After these tests it was decided to try the Hartley and Ultraudion on 28 M.C., but on test the Hartley would not oscillate. The trouble was probably in the H.F. chokes, so, with the same apparatus, the Ultraudion was built and worked excellently from the first test.

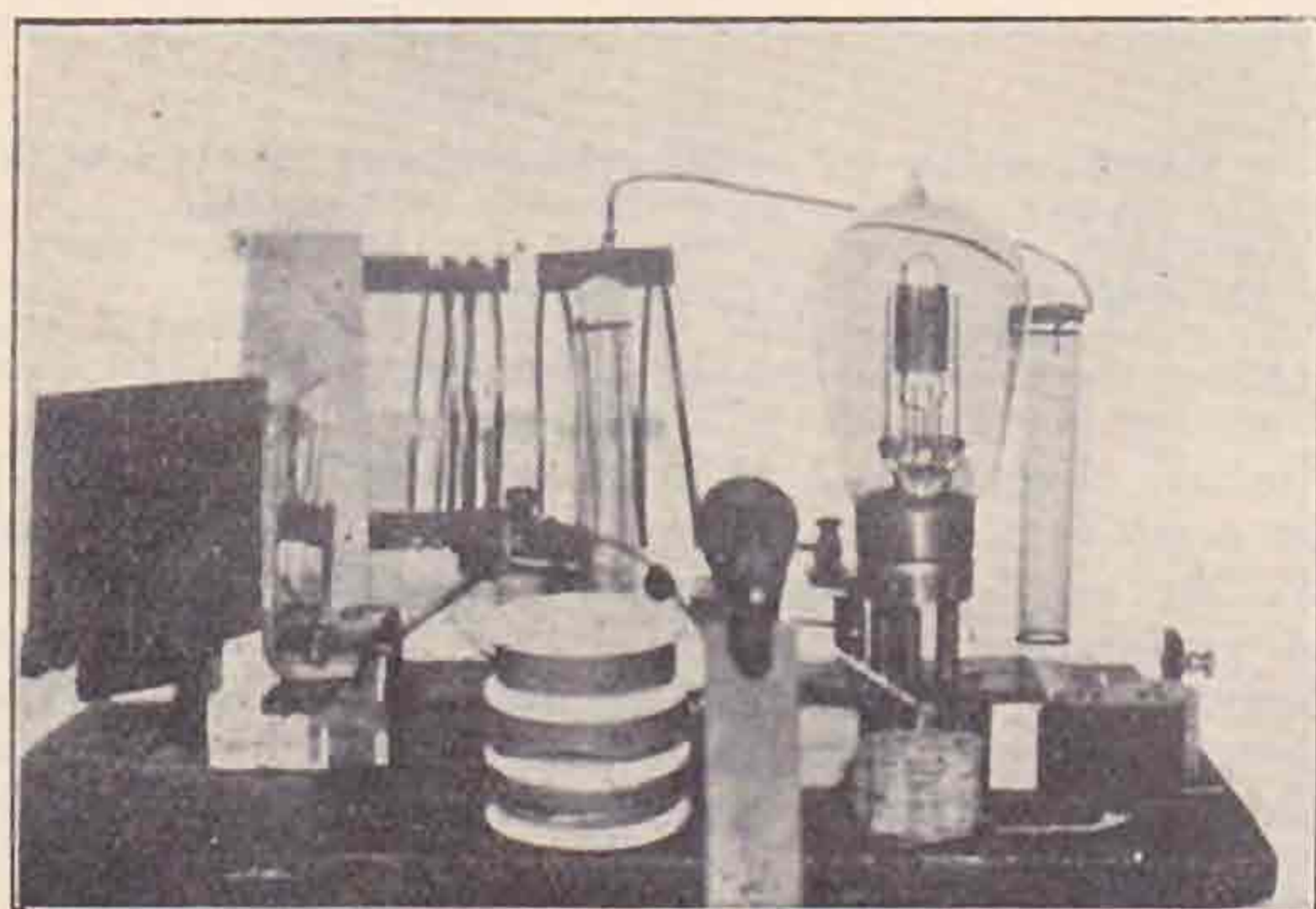

The apparatus in the transmitter is:—

L.S.5 valve.

C1=2 plates of 12 gauge, 3 ins × 3 ins.

C2=0.002 mfd.

C3=small neutralising condenser. This was not used at first, but input without load was always high. This condenser reduces no-load input very considerably.

L1 and L2=each 3 turns, 3 ins. diameter, 12 gauge copper wire, and absolutely essential to have rigid mounting.

L3 and L4=each 120 turns on ½-in. diameter test-tube. 36 s.s.c. wire, turns spaced about 1/32 in.

R1=7,000 ohms wire-wound. Any greater resistance tends to cause pronounced harmonics, and radiation may take place on several frequencies, close to the fundamental.

R2=400-ohm potentiometer, to regulate filament volts.

R3=special wire-wound resistance, to take filament current from the mains.

No filament H.F. chokes are used at present, as the first ones proved unsatisfactory. The note and efficiency is the same with or without them.

The key is in the positive H.T. lead, with 2 mfd. across it to eliminate key-clicks. This has been

found satisfactory on all waves, there being no interference in a B.C.L. crystal receiver, 15 ft. distant from the transmitters.

The set is mounted on a base-board, taking the usual precautions about spacing of wires and components. It lies on pieces of Sorbo rubber, the whole outfit resting on top of a frame mounted on the wall, into which the 14 M.C. transmitter is built. This lessens the vibration which is inevitable if the transmitter is mounted on a table or other stand.

The aerial system is a half-wave Zeppelin, almost vertically suspended from the radiator of the 14 M.C. aerial, the highest point being about 25 ft. from the ground. The feeders are three-quarter wave long, spaced 3½ ins., running horizontally through the window to the pick-up coil. About one-third of their length is inside the room. This aerial is the only one on which any U.S.A. stations have been worked, the other systems, such as horizontal C.F. and V.F. aerials, having proved unsatisfactory.

The regeneration control C3 is very useful for improving efficiency, and is used in the following manner: The transmitter is adjusted to work as efficiently as possible on the required frequency, without the aerial coupled up, and C3 at minimum. When this has been done C3 is slowly moved towards maximum, the milliammeter reading being noted all the time. As maximum capacity is approached, the milliamps. drop slowly, and can be brought down very considerably. At this station there is a definite optimum capacity, at which the milliamps. are lowest, and on passing this point they rise again. No matter what changes were made in the transmitter, this regeneration control effect was obtained. On coupling up the aerial and retuning, if necessary, the radiation will be found to be as good as that of the inefficient set which has no regeneration control, though the input might be only half that obtained previously. This point is worth bearing in mind, for much higher inputs may be put on the valve, as it is now running efficiently, with all the benefits mentioned above. In our case, with 300 volts D.C. on the plate, the valve gave 34 milliamps., a useful figure for 10-watt stations. If two valves could be paralleled, and only 5 watts taken from each, the valve would undoubtedly have a longer life, but that is not possible here at present.

As far as tests have shown, the important things about 28 M.C. transmission are the note, and the aerial system. The note must be dead steady, and it is better to use ebonite or glass for mounting coils, with a view to obtaining a good note, even if there is dielectric loss, than to have an ultra-efficient transmitter with a poor note.

We hold the opinion that the aerial system is the most important point on any frequency, and requires most experiment to obtain good results. The vertical Zepp., up to the present, seems best for 28 M.C., and it, in conjunction with an Ultraudion transmitter, is recommended.

The receiver is as formidable, if not more formid-

able, a problem than that presented by the erection of the transmitter and its aerial system. It certainly has proved so at our station. The aerial which gives best signals is the 28 M.C. transmitting one, though it is much shorter and lower than that used for reception on 7 and 14 M.C. It has always been our experience that an aerial which bears some harmonic relationship to the frequency on which reception is made will give the strongest signals. Also, the nearer the length of the aerial to this frequency, the stronger signals will be. On 28 M.C. such an aerial is easily erected on account of its short length. It gives a more silent background than the big 7 M.C. aerial, and, as well, the signals received are actually increased in strength. It is worth erecting, for reception, if not already there for transmission. We already had one up, so had no difficulties waiting in this direction.

Fading is very marked on this frequency, and the two-valve Reinartz did not give any factor of safety on days when fading was bad. A third RCC stage was built, and has the desirable effect of making readable a signal which has faded, and which would be unreadable on the ordinary two-valve set. Otherwise there is nothing much to be gained by the use of the third valve. The straight Reinartz has been found most satisfactory, and, with a little trouble, can be made into an excellent 28 M.C. receiver. The following tips may be of assistance to those who have not been able to make their receivers work, some care being necessary to avoid hand-capacity and our old enemy "Threshold Howl," both of which have been eliminated in our case: The coils are wound on a valve base, mounted at the back of the baseboard. The tuning and reaction condensers are, as usual, mounted on the panel, and behind them is a piece of sheet zinc, whose area is approximately equal to that of the dials. It is neither earthed nor connected to any component in the receiver. The grid-tuning condenser has three plates, and a friction-drive vernier incorporated, and the band is covered by 140 degrees. The tuning is very easy indeed. The reaction condenser is 0.00025 mfd., and there is no change in frequency when both hands are taken

from the tuning dials. An 150-turn H.F. choke is in series with each 'phone lead, so one can move round in comfort, or plug in a second pair of 'phones, without effect on tuning. As in this case there are 10-ft. 'phone cords, this is important. Power valves make the best detectors, and oscillate easiest on all bands, with stronger signals than the usual detector type of valve gives. A 0.003 mfd. condenser across the primary of the L.F. transformer makes the set oscillate beautifully on 28 M.C. With a loosely-coupled aerial, 2 mfd. across the H.T., choke-condenser output filter, one transformer and one RCC stage of L.F. amplification, there should not be threshold howl on any band. A variable grid-leak may also be of assistance. The receiver here is not shielded, except for the plate behind the tuning dials. The H.T. is taken, by an eliminator, from the D.C. mains, the output being dead smooth. The lay-out and wiring of the receiver was planned to meet requirements, but does not need description.

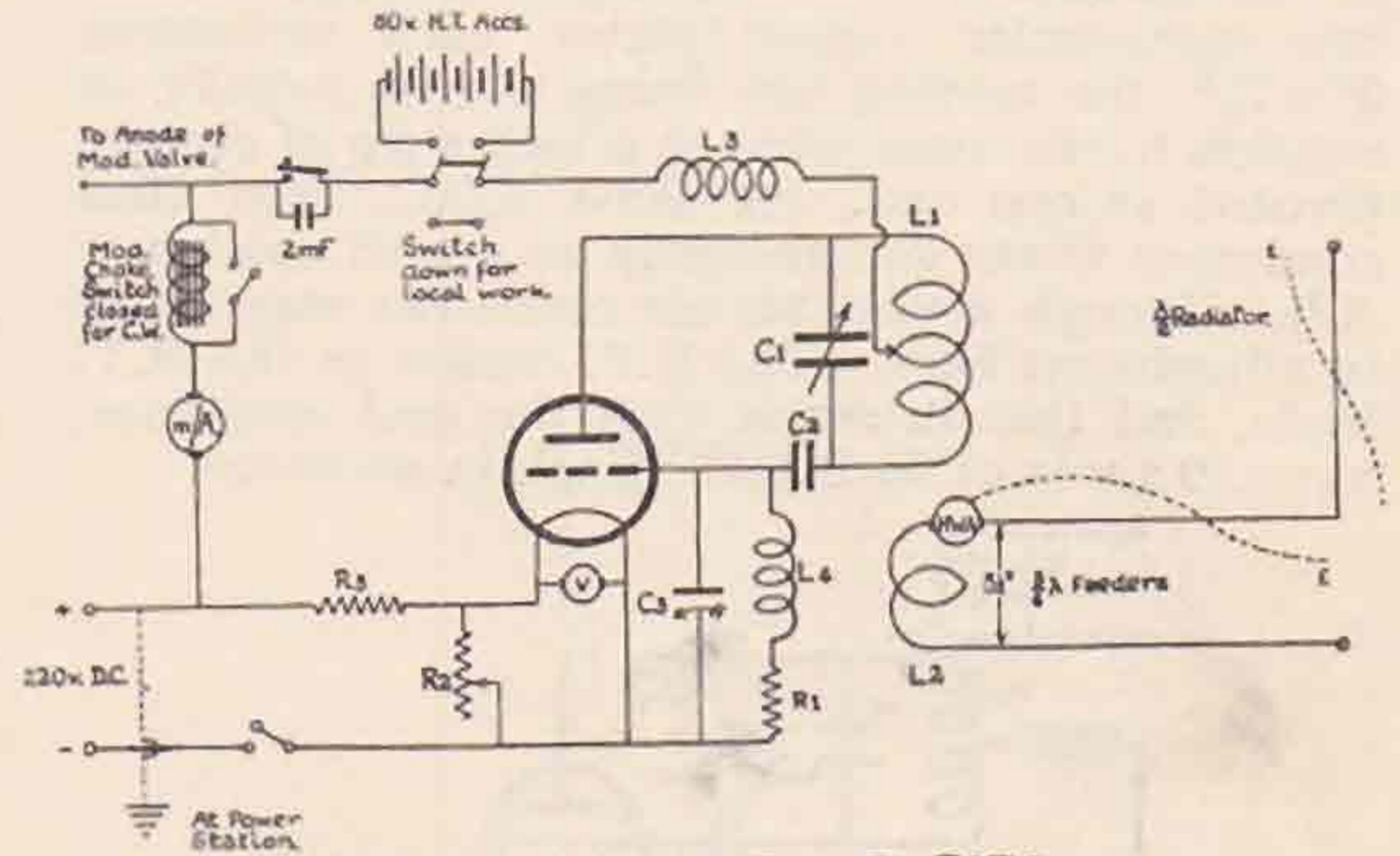

28 M.C. TRANSMITTER AT E17C.

We recommend anyone who is thinking of building a separate receiver for the 28 M.C. and other bands to try some or all those things mentioned here, as it is really not necessary to have a special receiver for 28 M.C. work. A little care and some ingenuity may be required, but the finished article should be well worth while, and easily up to "1929 standard."

Pentode Receiver Working from the Mains.

By R. H. N. JOHNSON (B.R.S.147).

A new receiver has just been constructed at this station, employing a pentode valve, and deriving its H.T. from D.C. mains.

The coils used are standard Colvern short-wave type, tuned by a Cyldon .00015 short-wave condenser, and the reaction condenser is an Ormond .00025.

A Ferranti AF5 transformer is used, in conjunction with an old Varley H.F. choke, and no signs of threshold howl have been experienced on any wave.

The detector valve is a Mullard P.M.3, and the pentode used is a P.M.24.

The two smoothing chokes in the H.T. circuit have an inductance of 32 henries each, and are used in conjunction with two 6 mfd. condensers.

Stations are brought in at excellent strength,

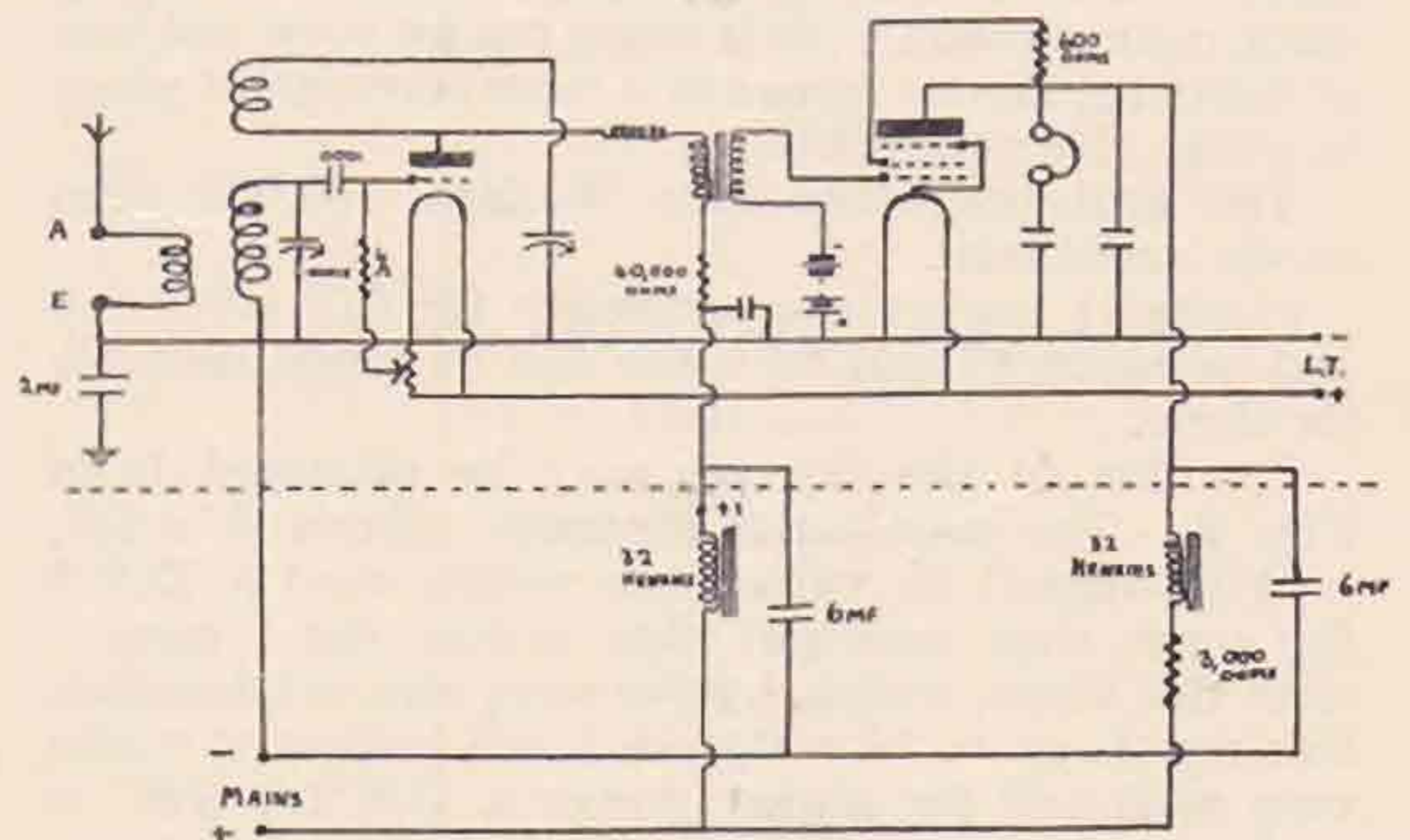

equal to an ordinary 3-valve circuit, and the hum due to the source of H.T. is so slight that extremely weak signals can be read with ease.

The circuit used is shown in the accompanying diagram.

Low Power 28 M.C. Transmitter.

By D. W. HEIGHTMAN (G6DH).

Since about January, 1928, the writer has been successfully using the Ultraudion circuit for transmission on frequencies around 28 M.C. It is therefore thought that, although no particular advantages are claimed for it, a description of the present 28 M.C. transmitter at G6DH will be of some interest.

The circuit is shown in Fig. 1. L^1 consists of 6 turns of No. 10 S.W.G. copper wire, spaced $\frac{3}{8}$ inch and $2\frac{1}{2}$ inches in diameter. It is supported at each end by a 'phone type terminal on a piece of ebonite which is in turn screwed on the edge of a slot cut in the baseboard. The tuning condenser, C^1 , has two rectangular copper plates, each measuring $3" \times 2\frac{1}{4}"$, the moving one being moved radially in relation to the fixed plate on a long strip of ebonite pivoted at one end. A .0003 T.C.C. fixed mica condenser works satisfactorily as a grid condenser (C^2), although a variable air condenser may assist in adjustment here. The R.F. chokes in the H.T. leads, and that in series with the grid resistance, have 50 turns of 26 D.C.C. $1\frac{1}{2}$ inch in diameter.

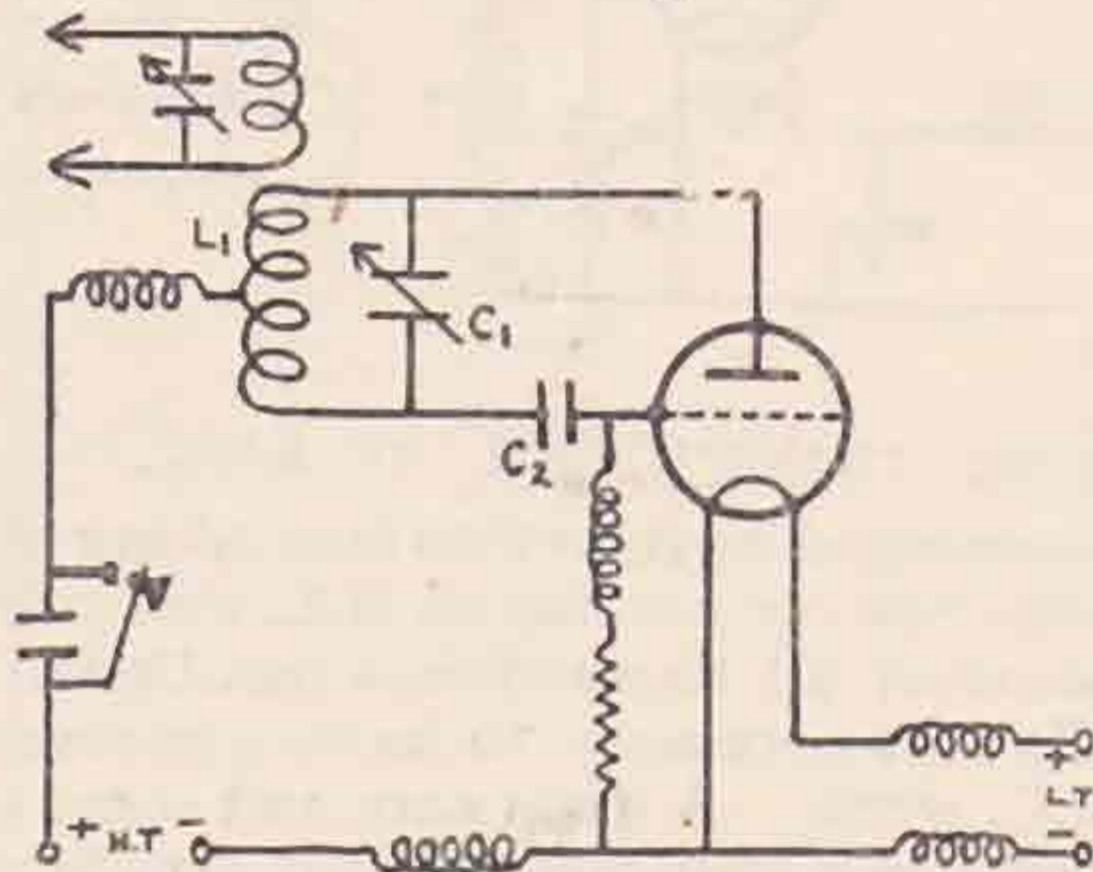

FIG. 1.

Somewhere in the region of the centre of the coil there is a voltage node and to save time the H.T. positive is connected to the exact centre, this being quite near enough. As the coil has an even number of turns the centre comes in a very convenient place to make this connection.

The grid resistance is a Mullard 100,000 ohm anode resistance.

Filament chokes are necessary for full efficiency and between 40 and 50 turns will be found suitable for these.

An idea of the lay-out may be obtained from Fig. 2. The baseboard measures about $6" \times 18"$.

With regard to valves the writer used a D.E.5 for some time and put sigs. across the "pond" with this valve, which, by the way, was not debased. For inputs up to 10 watts an L.S.5 (debased) works very well and for higher power a D.E.T.1 SW is fairly satisfactory. Personally the writer has never used inputs exceeding 4 watts on 28 M.C., although shortly it is hoped to raise this to 10 watts, which would seem to be quite sufficient.

Now we come to the antenna, and the one that appears to be giving best results at a number of stations is the vertical $\frac{1}{2}$ λ Zeppelin. During the

summer it was possible for the writer to erect one of this type and have the transmitter in a box at the back of the house by remotely controlling it from the radio room at the top of the house; but weather does not now permit. Luckily, one day the horizontal Zepp. used for 14 and 7 M.C. was tried and W2JN happened to hear the signals, since then this antenna has been used. It is approximately 64 feet long and the feeders are tuned by a condenser across them. The antenna coupling coil has four turns of the same diameter as L^1 . If the antenna is working properly the coupling will be very loose and not less than 4 inches. The writer often connects the centre of the antenna coil to H.T. minus but whether this is an improvement or not cannot be definitely stated at present.

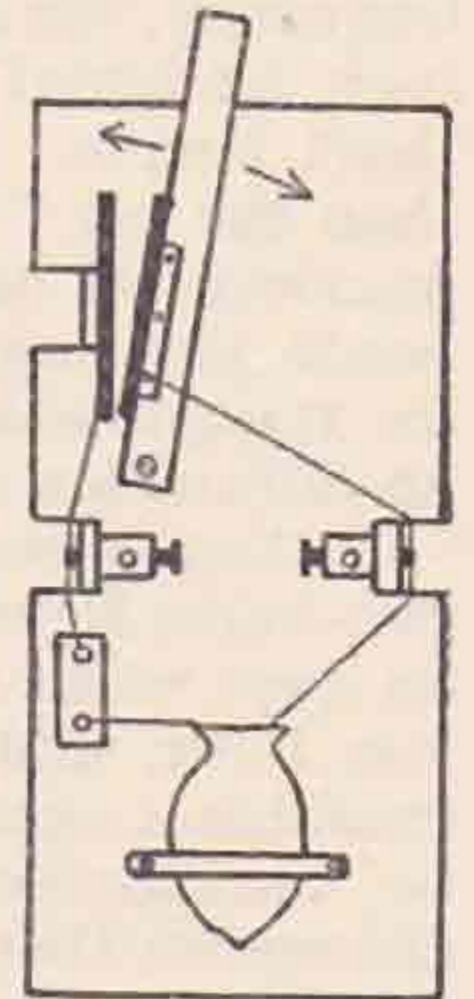

FIG. 2.

Keying is simply carried out by breaking the positive H.T. lead, with a condenser, just large enough to make clicks negligible, across the key. For higher power it would be perhaps advisable to key in the negative H.T. lead with a resistance across the key to minimise sparking.

That, I think, concludes the general outline of the 28 M.C. transmitting apparatus and perhaps, as the receiving circuit is not particularly well known, a short description of the receiver at G6DH for frequencies around 28 M.C. would be of interest.

Fig. 3 shows the circuit. L^1 has five turns of brass strip $2\frac{1}{2}$ inches diameter and space approximately $\frac{3}{8}$ inch. It is tapped at one end to assist in adjustment of frequency. The tuning condenser has two plates, and, by the way, it is advisable to use a condenser in which no metal parts rub together

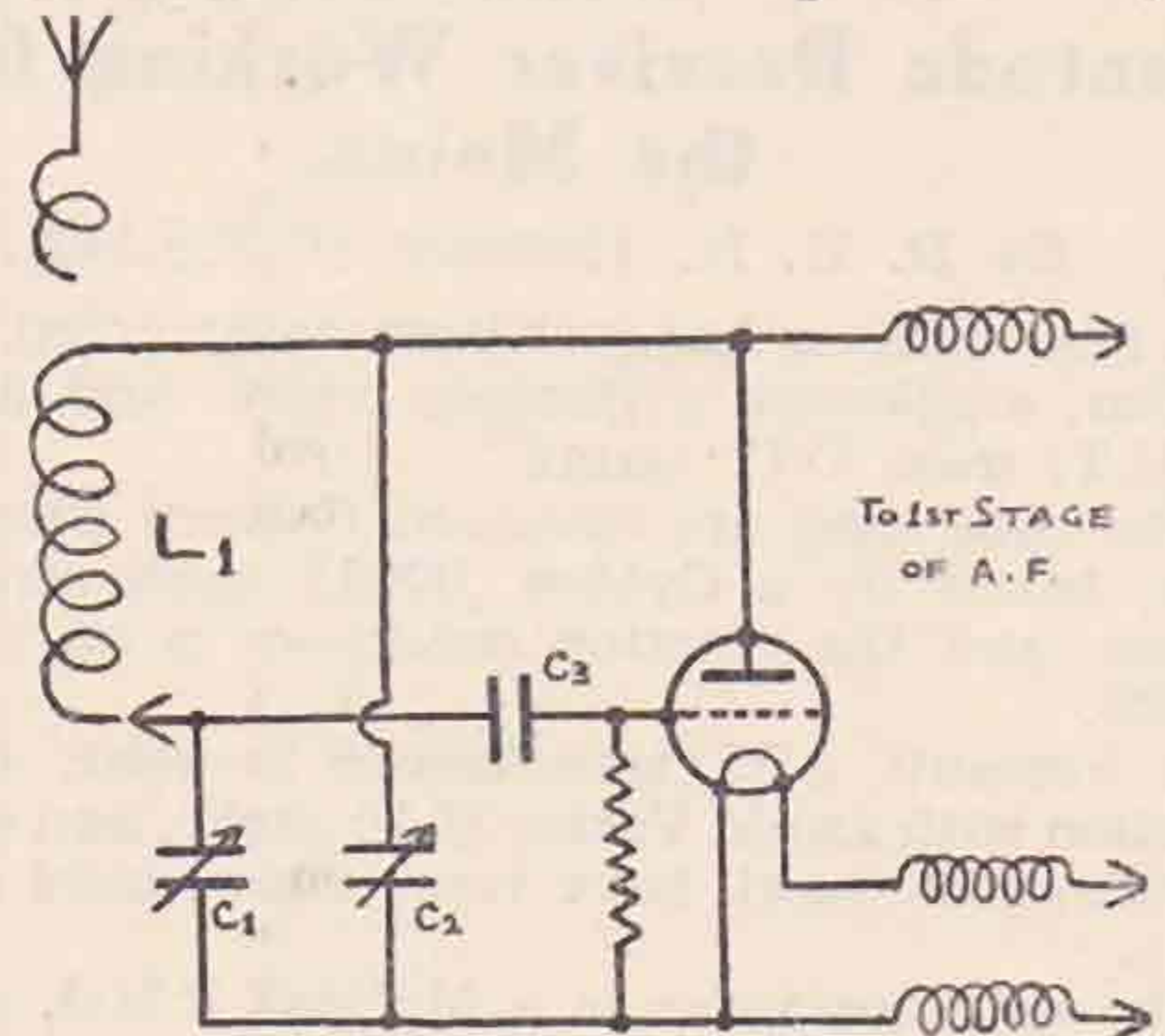

FIG. 3.

during motion as there will often be horrible crackling otherwise. C^2 has a maximum capacity of
(Continued at foot of next page.)

G5VL.

By H. J. POWDITCH.

When I received a request for a description of the 28 M.C. gear at G5VL I replied that it was probably too simple to be of general interest. On second thoughts, however, there may be a chance that some who have previously considered that work on this band requires too much expensive and complicated gear, will see that this is not the case. In the hope that any such stations will possibly tackle the job this description is written.

Directly the Washington Conference settled the band, arrangements were made for trying out most of the published circuits without radiating. The main points which were considered were simplicity and ease of control with efficient working over a fairly large frequency band.

Later, when the official ban was lifted, most of this work was repeated with a half wave indoor aerial plentifully adorned with H.F. meters and neon lamps. Both series of tests led back to the Hartley with centre feed to plate coil, and this circuit was standardised and has been used since in many contacts with U.S.A. From October 28 to December 23 it reached across consistently each Sunday.

No special virtue is claimed for this series of contacts except to show that a plain self-excited circuit, such as many of us have used for years, will work consistently on the higher frequencies and that there is nothing required beyond a little extra care in planning and constructing the set. The writer has great sympathy with the C.C. brigade, but a lack of L.T. amps. caused him to look for a simpler circuit for experimental work.

The circuit shown works evenly from 9 metres to over 20 metres with the single control across the plate coil. The efficiency as a self-excited oscillator seems to vary little over the range, although for a coupled radiating circuit a "big tank" circuit has not proved efficient. By only a change of plate coil it gives a quick change to the other bands, and seems equally efficient there.

(Continued from previous page.)

.0001 and the grid condenser (C^3) consists of two ordinary fixed vanes of a variable condenser spaced between $\frac{1}{8}$ " and $\frac{1}{16}$ " to suit the valve. A grid leak of 1 Meg. value is used. There appears to be no need to debase the detector valve. Power valves generally give best results and the writer is using a Mullard PM2DX at present. An antenna which is vertical most of its length is used and is coupled loosely by means of a two turn coil. This antenna happens to be the dead end feeder of the Zeppelin and is about 26 feet long to the RX.

The first DX signals had on this receiver were those of W2BGC in March, 1928; during the same month and the next EU15RA was heard several times, also WSALY at R6. From April to October no signals were heard except one or two commercial 14 M.C. stations' harmonics, particularly that of 5UZ. Although it cannot be definitely said, conditions on 28 M.C. appear to be best when the barometer is below 30 inches and when the moon is

The transmitter was first arranged to give, as easy as possible, means for trying out various circuits. The coils are carried on a wooden platform 2 ins. by $\frac{3}{8}$ in. mounted 6 ins. above the baseboard. They are wound with $\frac{1}{4}$ in. by $\frac{1}{16}$ in. copper strip, well annealed. This is easy to wind and has little natural springiness to cause vibration. The ends are drilled and bolted down tightly over the screws of pillar insulators.

The sketch gives the actual arrangement of the parts except that the coils are mounted above and slightly behind their respective condensers. The pillar insulators for the aerial coupling coil are on a thin ebonite strip which swivels on a central screw to give variations of coupling. A spare pair of insulators and condenser are fitted for use with circuits requiring a third coil. All tank circuit connections are of $\frac{1}{4}$ in. strip.

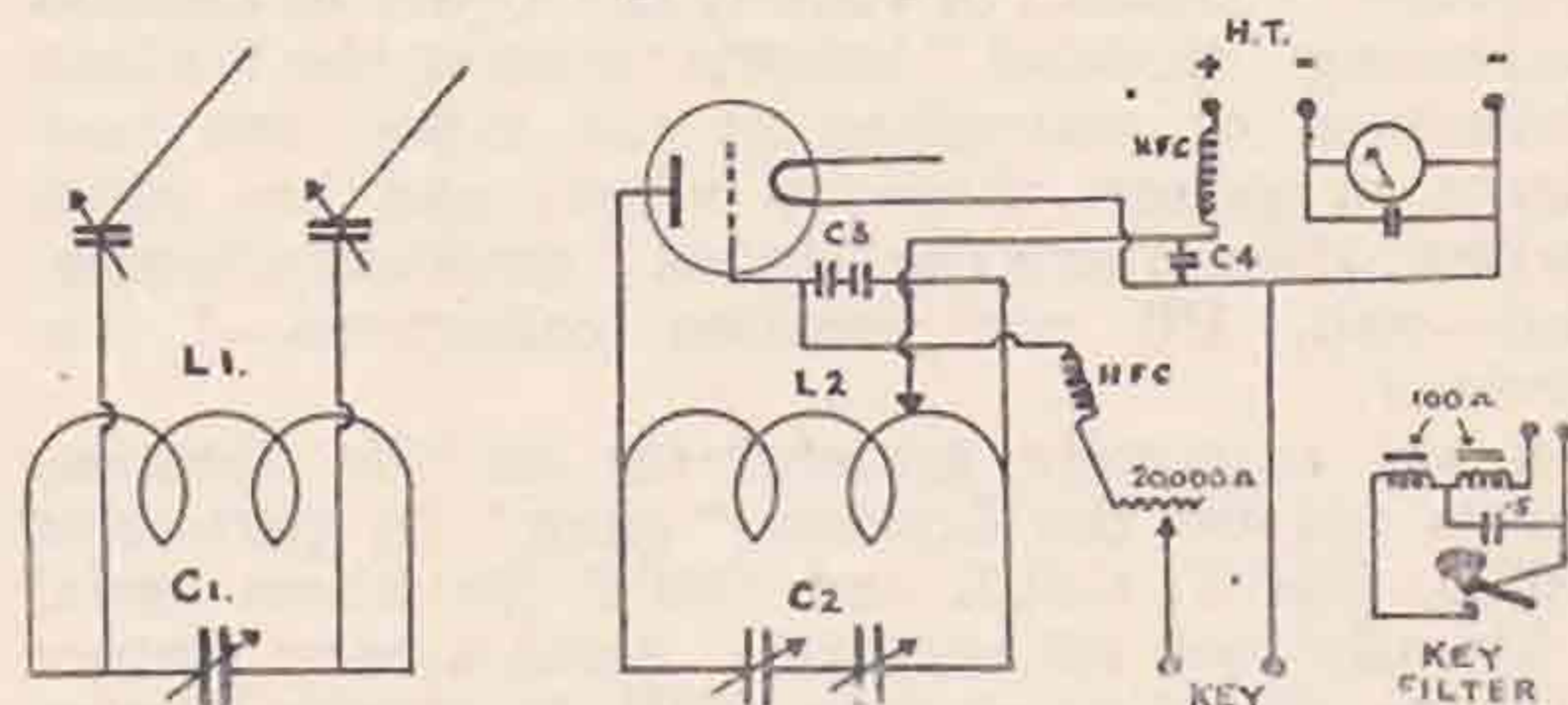

The values of the parts are: C_1 , .00013mf.; C_2 , two .00035mf. in series, ganged together on one control; C_3 , two receiving type .00025mf. in series; C_4 , .0001mf.; L_1 , 4 turns, 2-in. diameter, spaced $\frac{1}{8}$ in. of $\frac{1}{4}$ in. strip; L_2 has three turns of the same size; H.F.C., 2-in. close wound of 36D.S.C. on $\frac{3}{8}$ in. former. Keying is in the grid circuit through the filter sketched.

A D.E.T.1 S.W. valve is used with about 600 plate volts. This has stood up well to very rough treatment while experiments have been in progress.

The whole set is mounted on 1-in. rubber corks. The receiver has been described fully by Gi6YW in the "C.B." notes for November last, and is a straight, tube base affair. Although both a Superhet and SG high frequency stage are available, the plain set is usually used, probably as the most familiar.

about full; also conditions are not necessarily poor on 28 M.C. if they are bad on 14 M.C. Another thing that might be of interest is the fact that the writer has heard G6HP several times on 28 M.C., his distance from G6DH being approximately 80 miles and yet it seems impossible to hear other stations known to be on at the same time and only a mile or so from G6HP.

The writer had been told that the ground wave of 28 M.C. signals did not carry much farther than 20 miles and yet these signals can hardly be going right round the world as there is absolutely no fading or echo.

That is about all the writer has to say on the subject of 28 M.C. for the time being. A TP-TG transmitter will shortly be compared to the one described in this article.

In conclusion we ask you to try the 28 M.C. band as it is very interesting and there is quite a lot to be found out about it, also it is not quite so like a graveyard as it used to be.

Contact Bureau Notes.

By T. P. ALLEN (G16YW), MANAGER.

Since last writing these notes I have met many of the members in London, and I hope that I will be forgiven if I start this month on a personal note. It was three years since I last visited London, and I was not then an amateur transmitter. Though I worked in London for some time, I found that in the three years' absence I had made ten times more friends than in the period I lived there. This is entirely due to amateur radio, and what a difference it makes! Instead of visiting the Tower of London and seeing "shielded" knights; visiting the Wallace Collection, or marvelling at the tubes, one now meets in person those to whom one has often spoken, visits where the "tubes" work even harder, and—well, I'll not mention collections—I am envious!

I am extremely grateful for all the kindness shown me by the London "gang," in particular G6CL, G6UN, G6LL and G6PP (to whose aerial I literally took off my hat). Amid a hazy picture of $\frac{1}{2}$ -kw. ships' spark sets, 5SW, Marconi's Works, sleeping (*sic*) coaches, sausages, "Metropolis" at Piccadilly station, 1929 waves in the Irish Sea going, and $\frac{1}{2}$ @/ $\frac{1}{8}$ % waves coming back, I am left with a happy memory of good fellowship and "amateur spirit" which will not easily be forgotten. Mr. Clarricoats has my sincere appreciation and thanks for his hospitality during my enjoyable week-end.

This issue gives the details of the 28 M.C. tests, and it is hoped to have the co-operation of many stations abroad. These tests are not in the form of a competition, and there are no prizes, but they offer an opportunity to transmitter and receiver alike to do some useful research work and help to unravel some of the mysteries of this band. But no amount of organisation will ensure success. That depends upon the members—and the conditions on that band during this period. The period is fairly long, so that there is a reasonable chance of hitting a good spot.

In previous tests I understand several reports did not go to H.Q. because the members concerned did not think them of sufficient value.

This is a bad policy, as one never knows when a report will verify some other work.

Let's make these tests a success by doing everything possible to listen or transmit at every opportunity during the period, and by returning a good log to C.B. immediately on their conclusion. Please state all the details of your apparatus in your report.

I welcome Mr. J. Johnson (New Zealand 2GA) to the ranks of C.B. 2GA is vice-president of N.Z.A.R.T., and has started a C.B. for them. Good luck to them, and we hope to hear more about our contemporary, and perhaps arrange some tests with them. 2GA is interested in skip distance and low-power long-distance work. He has kept a daily sked with CTIAE for two and a half years, with only occasional gaps due to his work taking him from home. But even then 2GA does not leave radio, for he takes a portable set with

him on his trips into the back country for the N.Z. State Forest Service.

This set uses 45 volts dry batteries and three large dry cells, and is all that is required for reliable communication over 600 miles. A more recent design, measuring 14" x 14" x 7", with 90-volt D.B.'s, has been putting signals into France! The RX and TX are both contained in the one aluminium box, and ready for operation on the aerial being connected.

This is wonderful work, and I have written Mr. Johnson and asked him to give us some further details of his work and conditions in New Zealand.

BRS90 tells me that ZS4A (old FOA40) wants skeds with G for 28 M.C. work, and these can be arranged through BRS90 or directly with ZS4A, C. P. Tennant, P.O. Box 610, Kimberley. He uses a split Colpitt's TX with LS5 on 14 M.C., but no information is available about his 28 M.C. gear.

W9BGQ is on 28 M.C. every Sunday at 17.00 G.M.T. and desires G QSO. His signals are QSA at G16YW.

L'Union Radiotélégraphique Scientifique Internationale requests co-operation from British amateurs in some tests which they propose to carry out on the utility of various waves and the reasons for their difference.

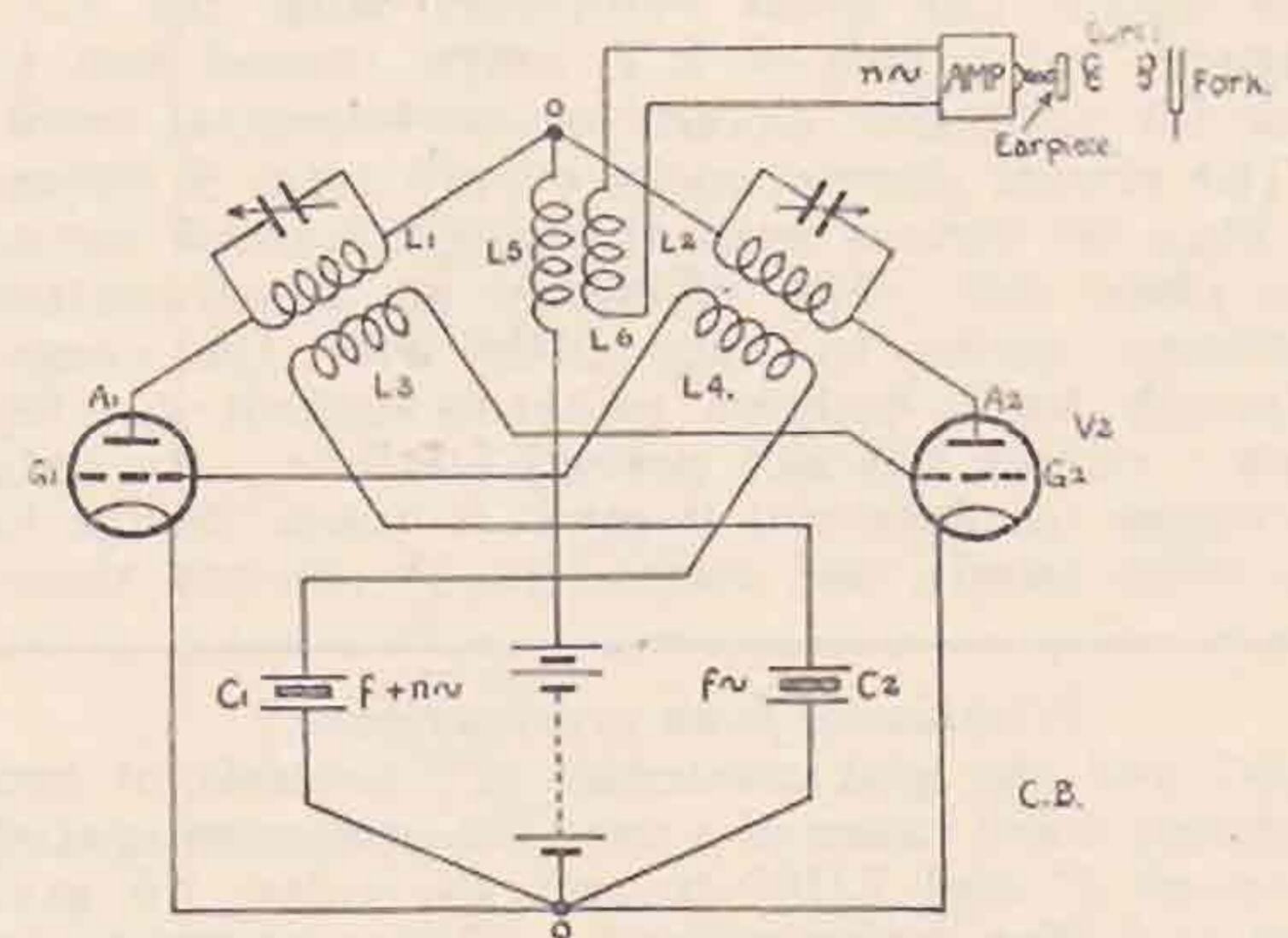

Fig. 1.

They request that British amateurs group themselves under a Centre for ease in reporting, and follow daily or bi-weekly transmissions from a fixed or portable station. The strength and code message of each transmission is required, and the U.R.S.I. will send time-tables and logs, which the Centre would have to return monthly. If any members are interested will they please apply to F8EB, B.P.I., Avranches (Manche), France, for further particulars.

In reply to G2QY's queries 9 and 7 in last month's Notes, G16TB has sent me a diagram of a suggested scheme for testing crystals against a standard and obtaining possibly a matched pair.

GI6TB warned me that he had not had time to think the affair out to his own satisfaction, but offers the following: C1 is the standard crystal, and C2 the crystal to be tested. At a given instant the voltage across L1 is in phase with that in L3; $1/2n$ seconds later it is tending towards 180 degrees out of phase with it, due to the beat, but this opposes the in-phase voltages due to the valves. Therefore grid-excitation of both valves is simultaneously being reinforced and then diminished at n cycles per second (the beat frequency).

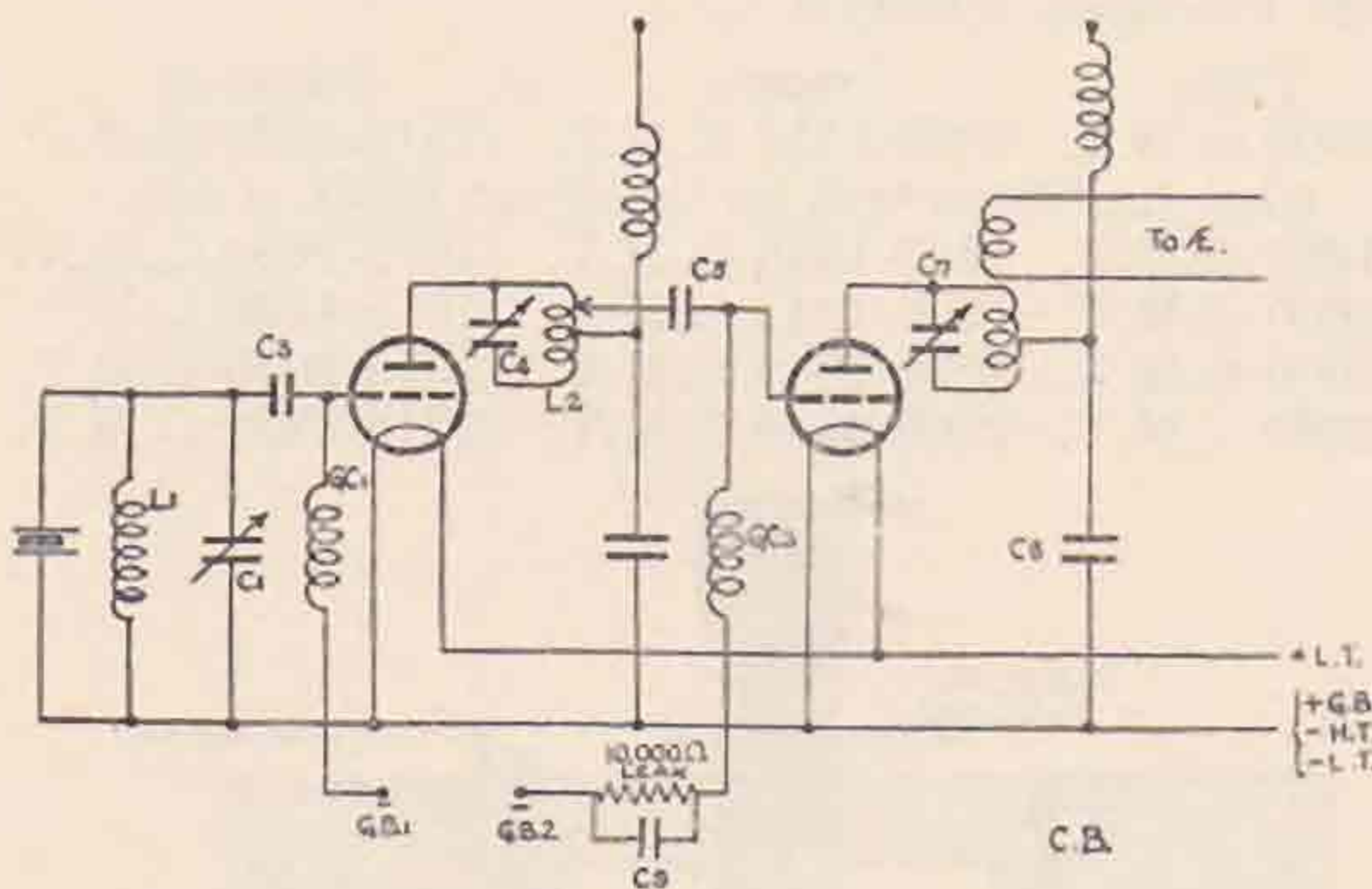

Fig. 2.

If the crystals have similar characteristics the drift due to temperature rise should change at the same, or very nearly the same, rate, and the beat frequency n should remain constant within exceedingly close limits. This induced frequency in L6, due to the fluctuating anode current in L5, can be multiplied for use in stabilising long-wave transmitters, say for B.C. work, with probably as great an accuracy at a less initial cost than a temperature-corrected tuning-fork arrangement. With series-connected filaments it would be independent of changes in H.T. and L.T. voltages.

As shown in Fig. 1, it might be used as a means of final frequency measurement, or, rather, comparison, of crystals during grinding.

G5PL sends a diagram of a crystal holder as used and made by himself, but says that permission must be obtained for manufacture for profit.

A is the ebonite housing, and B, C and D are of brass. Adjustment plate B and fixed plate D must have dead flat surfaces and mounted in perfect alignment. All screws are 4BA. In place of the hole for lead to bottom plate, a 4BA terminal can be tapped into plate itself. Ebonite must be good, or acid fumes will oxidise the metal surfaces. With careful construction it will be perfectly dust-tight and almost air-tight.

BRS125, whose S.G. receiver appeared in last month's Notes, has now been able to make it function nicely on 28 M.C., but required 90 volts on the detector.

Mr. Dedman, G2NH, has kindly offered a small cup for annual competition. It is to be awarded annually to the member who has been responsible for the most outstanding crystal control development. The decision, according to G2NH's wishes, is to be made by a committee of three including himself, and the Manager of C.B., and will be decided upon three weeks before each annual Convention.

I am notifying Committee of this very kind offer at the earliest opportunity, but I must thank him personally for this gift, which I am sure will be of great help in encouraging research in this subject.

G6VP is receiving W stations well on 28 M.C., and intends to use a shunt-fed transmitter with a variable grid condenser and a dual condenser across the coil. The centre of the dual is connected to the centre tap of the filament transformer.

G6VP has been able to measure waves as short as 0.42 metre in his laboratory, and admire the rainbow effects of the valves as they "cash in"!

G6CA thinks that a list giving the working frequencies of a dozen or more members would be of use in checking receivers, etc., and gives his transmission frequency as 7,090 kilocycles.

I have received three complaints recently from the "man in blue" that my letters are addressed to any number in Marlborough Park North that has a 9 in it. The real number is FIFTY-NINE, but I get "fifty-seven varieties" on the letters: one good friend has tried several numbers without getting it right.

GROUP 1A.

G2NH sends an interesting circuit for crystal "governed" 28 M.C. transmission. The crystal "controls" the oscillation, but does not supply the excitation, and the circuit is not recommended for other than 28 M.C.

The diagram is given, and the values are as follows:—Xtal—4666.6 kc.; L1C2—14,000 kc.; L2C4—14,000 kc.; L3C7—28,000 kc.; GC1—60/70 turns space wound on a 1-in. test tube; GC2—30 turns ditto; C3—0.0002 mfd.; C5—0.0003 mfd.; C6—0.001 mfd.; C8—0.001 mfd.; C9—0.0005 mfd.; first valve—DE5B with 260 volts at 30 m.a.; and second valve an LS5D with 400 volts at 20 m.a.

G2NH has a few points about crystals too. He says that a 3,000-kc. crystal across the grid coil will control within certain limits, but it is dangerous for the crystal if the voltage exceeds about 250. An unground lens will sometimes control on harmonics of the fundamental, but failure has often resulted when one tries to make a 3,550 crystal control 7,100 kc.

He tried 50, but not a single one would control at twice the frequency. But 70 per cent. controlled at three times the frequency . . . perfectly. When employed in this manner it is possible to use higher plate voltages and hence control more power. G2NH has used 40 watts at 1,000 volts to a DET1 on 7,000 kc., and only once did a crystal break.

G6QT says that conditions on 7, 14 and 28 M.C. are worst ever. G2FN says "good-bye," and hopes to be heard as VT(?)2KT from India. He has found conditions during December "very curate's eggish," but thinks that it is best for RX and TX when weather is dull, damp and with rain falling or in the offing. He finds WICMF, W2ACN, W2JN and W8ZG the most consistent stations.

GROUP 1B.

G5VL finds that when he is getting worst fading there is little trouble from this in London. G6WT is using a $\frac{1}{2}$ -wave vertical copper tube with Zepp feed for this frequency, i.e., 28 M.C. G6OH has had to resign from this group as he has business QRM. G5VL and G6LL both find that W signals fade out between 15.00 and 15.30 G.M.T., but sometimes come back later. Most of this report refers

to November, as it was not included in the January BULLETIN, but IB, like others, found December poor for 28 M.C. work.

GROUP 1D.

Another illustrated number! This time a series of photographs of W 28 M.C. stations, which were very interesting. GI5MO, while aerial was blown down, changed from TPTG to Ultraaudion with improved results, confirming EI7C's results on 14 and 7 M.C. G6GC is using Mesny, and finds that when he shunts M/A. meter in plate circuit the aerial current drops to almost one-half its normal value . . . how cum?

2AAK is having bother with an A.C. eliminator for RX.

EI4D has been theorising on the Heaviside layer and angles of radiation. EI7C had negative results from 28 M.C. skeds with Holland and Poland. He thinks that fading affects the whole 28 M.C. band at any time, and that it is mainly due to WX effects at the RX end.

GROUP 1F.

OCX has not heard anything except motor cars and the harmonics of PCRR which fade out at dusk. G6TZ is QRL. BRS25 has been making observations on barometric heights and 28 M.C. signals, and wants co-operation from W stations. G6HP is using a special choke circuit in the output of his receiver, and has reduced body capacity. G5WK, using a DET 1/SW and an "Act of God" aerial, clipped directly to the plate turns, has raised a W station, but missed the reply, which is reported by BRS25. Hard luck, OM.

G2CX has no results to report yet, but wants a sked with a DX 28 M.C. station.

Group 1G is getting under steam, and I hope to have a good report next month from them.

GROUP 2B (skip).

G6PP reports peculiar conditions on November 1 between 22.00 and 23.00 G.M.T., when only one amateur station was heard between 6 M.C. and 9 M.C. He would like to know if any member has a log for this period.

K4DK concludes from observations on G and W signals on 14 M.C. that on December 30 the strength of the sun-flashes was less than on December 16 and the ionisation of the upper layers less. He

states that the $\frac{dN}{dH}$ is important (I presume that the N represents $4\pi E$, where E is given in volts per centimetre?—GI6YW).

G2ZC advances a theory that there are wave motions or other undulations in the upper layers which affect the angle of reflection and cause fading.

G2AGC is making observations on fading and (a) barometric pressure, (b) weather, (c) moon phases.

GROUP 3A (Quartz).

This Group now consists of 2QY, 5MU, 6TZ, 6XC, and the Centre 2BFA. 2QY has given them something to think about in the first budget, and I hope that some articles on C.C. will be forthcoming when they have got into their stride.

GROUP 4A.

2AUH continues the good work, and his Group supply us with another DX forecast, reproduced herewith.

LATER NOTES.

Mr. Huber, assistant to Mr. Handy of the ARRL, sends me some interesting information for our 28 M.C. men.

WSBWW, of Columbus, Ohio, expects to have a C.C. transmitter on 28,040 kc. His input will be about 600 watts at 2,500 volts from an unfiltered mercury arc. This gives a pleasant note on this wave. The last valve is a 204a. This valve is now working self-excited as low as 5 metres. WSBWW will be transmitting on Monday, Tuesday, Wednesday, Thursday, Saturday and Sunday at the following schedule:—

TIME.	SEND.	RECEIVE.
1500 G.M.T.	1500-1515 G.M.T.	1515-1530 G.M.T.
(One half-hour will be taken for QSO, if any.)		
1600 G.M.T.	1600-1615 G.M.T.	1615-1630 G.M.T.
1800 G.M.T.	1800-1815 G.M.T.	1815-1830 G.M.T.
2000 G.M.T.	2000-2015 G.M.T.	2015-2030 G.M.T.
2200 G.M.T.	2200-2215 G.M.T.	2215-2230 G.M.T.

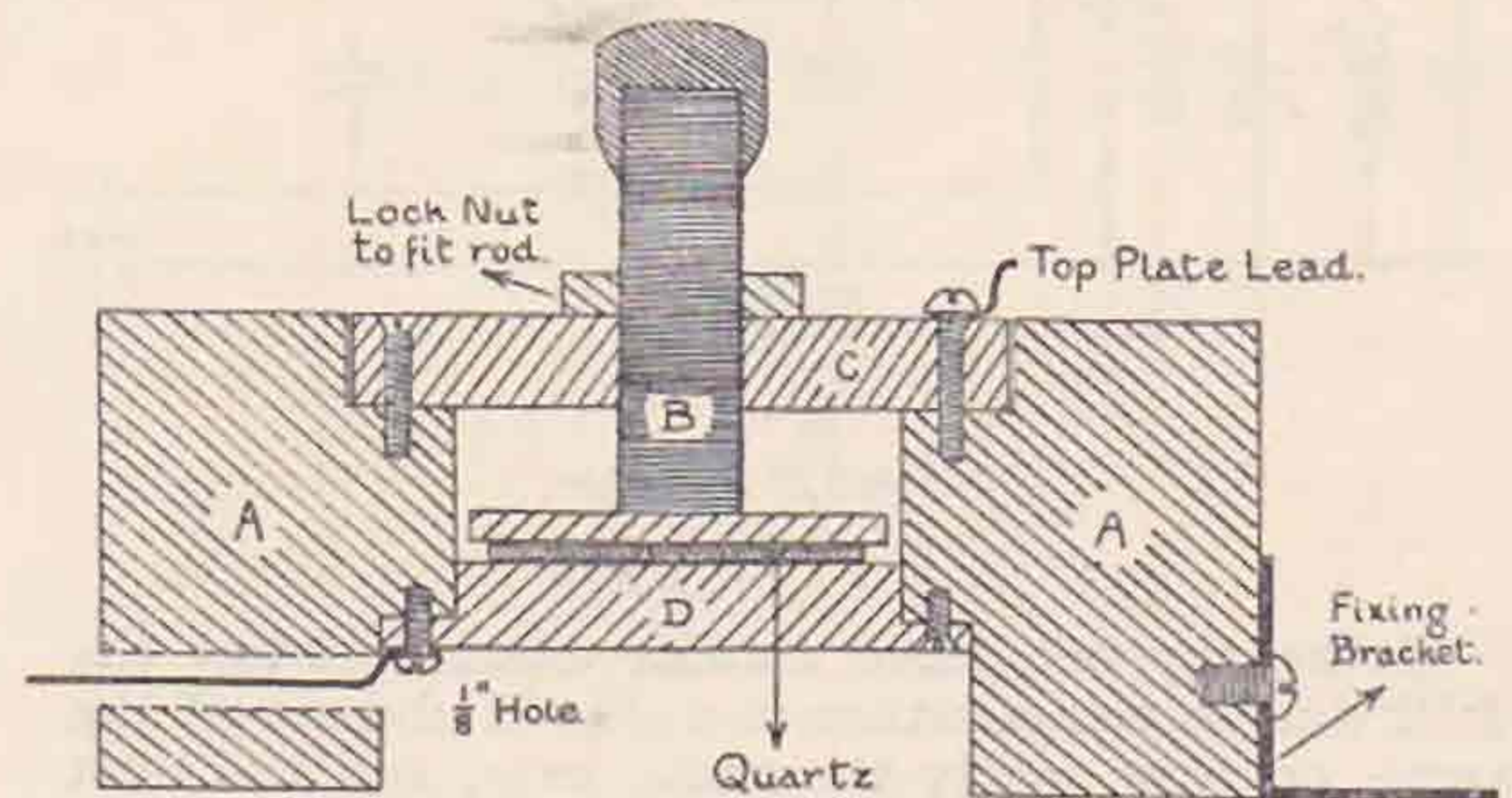
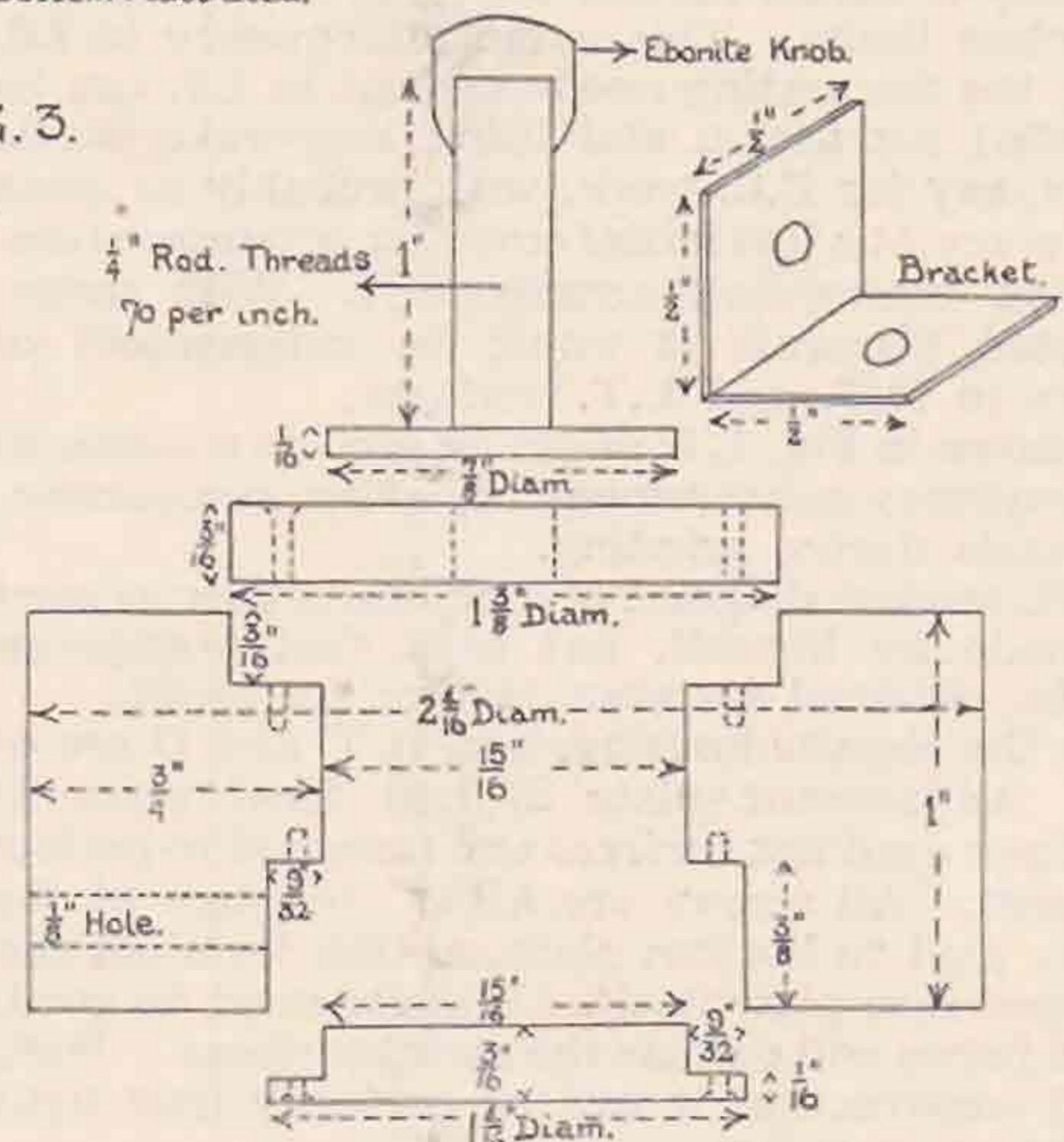

FIG. 3.

C.B.



This schedule is for January and February. Various aerials will be used, particular attention being given to the types of beams described in QST. WSBWW will try to operate every Sunday continuously (for QSO) from 12.00 G.M.T. to 18.00 G.M.T. on 28,040 kc.

The receiver used is a regular S.W. one built from Mr. Westman's article in December QST. WSBWW is anxious to arrange tests with reliable stations, and I am sure that some of the Group people would be glad of another schedule at this frequency.

Weston sets the world's standard



Model 506.—Pin Jack Voltmeter with High Range Stand, measures High and Low Tension Voltages. Price: £2 10 0
The Weston Free Booklet "Radio Control" explains the uses of this and other Western Radio Instruments. Write for your copy.

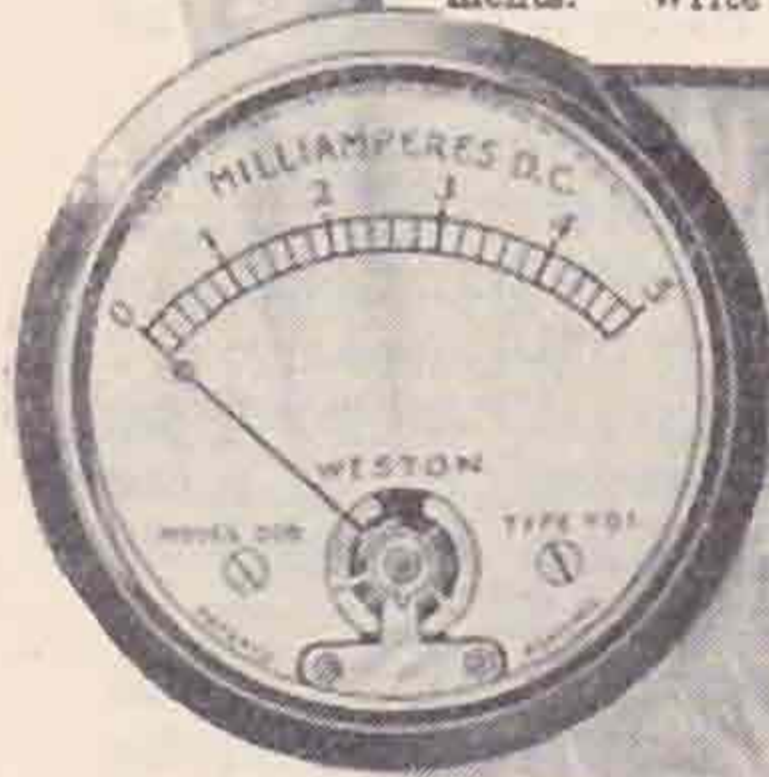

Model 506.—Mil-Ammeter should be placed in the H.T. circuit of the valve to ensure correct operation and check distortion. Panel mounting type. Prices: £1 15 0
£2 15 0

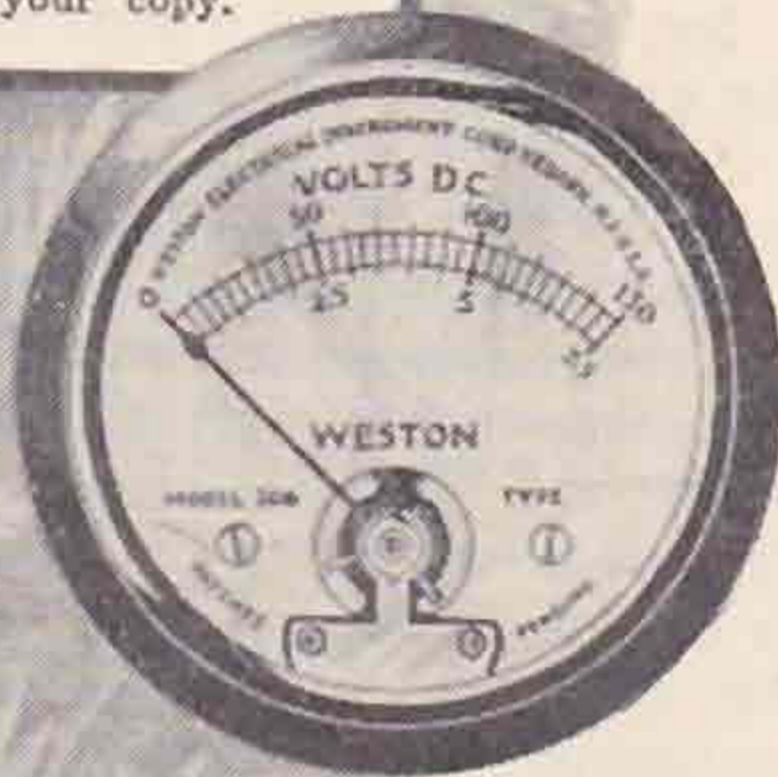

Model 506.—Panel Voltmeters ensure permanent accuracy. With a high internal resistance of 125 ohms per volt, they make practically no load on the batteries. Neat and compact. Prices: £1 15 0
£2 15 0



Model 489.—Double Range D.C. Voltmeter is a necessary portable testing instrument for every radio enthusiast. It is of great use in tracing circuit troubles. Made in various ranges with different sensitivities. Similar instrument for A.C. Model 528. Prices: £3 15 0 £7 5 0

WESTON

STANDARD THE WORLD OVER
Pioneers since 1888

WESTON ELECTRICAL INSTRUMENT CO., Ltd.
15, GT. SAFFRON HILL, E.C.1.

£10,000 BARGAINS

The Biggest Sale of Radio and Electrical Goods enables us to offer "Hams" their opportunity of a lifetime, at almost scrap prices.

SPECIAL OFFER TO "HAMS"

PYE'S WHEATSTONE-BRIDGE, Galvo and Universal Shunt, £3 set (40/-, 12/6, 15/1, 67/6). Siemens' Cell Testers, 2-range, M.C., with test load switch, 15/-. H.W. Milliammeters, 0-500, new, G.E.C., 2/6. Wind Speed Indicators, new, complete, 5/-. Direction Finders, new, £3 10s. 1,000-ohm 1/2-amp. Vacuo Resistances, 6/- doz.
WAVEMETERS, Gambrell, 4 to 14,000, L.S. buzzer type, with chart, 15/-. Het. Wavemeters, Mark II, with chart, 10/-. W/T. Hand Micros, 5/- and 15/-.
VALVES. Great Bargains.—4-pin A.T. 40-watters, brand new, M.O., B.T.H. or Mullard for 4/6. Make fine power amplifiers passing 50 m/a. plate. Specify hard or soft for 200 to 1,000 volts. 4/6 each, guaranteed. Two-Electrode Cossor Rectifier, same price. 250-watt Bottles, M.O. or Mullard's, 12v. 5a. filament, 1,500v. plate, 55/-; 450 watts, 60/-.
RECORDERS, almost new, Morse inkers, by Siemens, etc. Just what you want for permanent sig. records. Just a few soiled at £4 10s. Spotless, new, £7 10s. Enclosed type, £8 10s. Junk Recorders for picture machines, 35/-.
H.T. GENERATORS. Here is a snip for Hams. The well-known B.T.H. and Mackie Sets, giving 8v. 2a. L.T. on one commutator, 600v. 80 m/a. on the other, for 60/-, less 20% for one or 25% discount if two or more ordered at once. Special price for 1 doz. lots. These are all tested O.K.
STAR TURN!—Spanking brand new G.E.C. 960v. 60 m/a. and 8v. 3a. Generators, similar to above, but all in original makers' carton, not unpacked, complete with 1/2 mfd. 2,000v. Mica Condenser, £10 each, less 20%, or 25% for two or more. Evershed Hand Generators or 1,000 v. 50 m/a. Mangies at £5 10s. A cheap G.T. Generator, off 6v. cells, is the T.V.T. Unit, giving 1,000v. 50 m/a. A.C., for 25/-. A full Wave Rectifier, with condensers and 2 valves, for this is only 28/-.
SMOOTHING CONDENSERS, 2,000v. mica in 1/2 mfd. blocks, at 5/- each. Pack in parallel for any value. 20% off six or more.
CHOKES, L.F., good hefty fellows, 10/- each; 1/4 kw. size, 30/-. Varley Double 50 H. 400 and 1,000w. Spark Coils, 1" Sterling, new and O.K., 6/-; 2" large Coils, 15/-.
MOTORS AND DYNAMOS.—100-volt D.C. Motors, 10/-; Elliott Gramo. type, with gear-box, 20/-; Lucas 12-volt 8-amps., 25/-; 50-volt 20-amp. L.W., £8, etc., etc.
SUNDRIES.—Lucas Auto. Cut-in and -out, 12/20v. 8a., 7/6; Morse Keys, 2/6, 6/-, 7/6 and 12/6; Phone Earpieces for home pick-ups, 1/6; 220v. Soldering Irons, 5/6; Rubber Lead-in Wire, 2/- per doz. yards; Wire Resistances, 3/6; Brown's "A" Phones, 12/6 pair; Exide Unspillable Accumulators, 2v. 60a., 6/6.

A 5-page printed foolscap Sale Catalogue will be sent to any "Hams" on receipt of a stamped envelope. If you cannot call order early as we are already sold out in some lines.

ELECTRADIX RADIOS

218, UPPER THAMES ST., E.C.4.

Blackfriars Sta. Met. Rly.

City 0191

VE2AC, P.O. Box 221, Thetford Mines, Quebec, Canada, is ready for tests on 28 M.C. daily at 1300, 1830 and 0015 G.M.T.

G5PL gets the starred rectangle for the best reply to last month's queries:—

£ £ £ £ 4 £ £ £ £
 £ G5PL. £
 £ £ £ £ £ £ £ £

This month one list of questions has been sent in, and I want to have short answers in simple language; of course, the answers to most are known to a great number of readers, but how can they be most easily explained?

Send a pen-name if you do not wish to have your call-sign published.

"Mr. Z." asks the following:—

- (a) In a transmitting circuit, should the feed current go up or down when oscillations take place?
- (b) In a receiving system current is collected by the aerial, passes through the tuned or untuned aerial coil, and goes to earth. Where does the current go to in a receiver worked off a frame aerial?
- (c) How can one measure the output POWER (not the aerial current) of a transmitter?
- (d) What should be the ratio between the natural wave-length of a choke and the wave-length it is intended to stop?
- (e) What sort of report does a transmitter like to receive from a BRS station?

"Mr. Z." is a well-known transmitter, and these questions are genuine.

THIS MONTH'S FAIRY STORY.
(With apologies to D.B.W.L.)

"The QRM—er—THE QRM is—er—wheep-who—The QRM is—da. da. dit. da.—awful—er—meow—on—er—Sundays, and—er—wheepwhoopwow—I will be—dadit dit dit dit da—on code in future."

NEW MEMBERS.

G5LU, G2AYN, G6VP, ZL2GA. Total 147.

I acknowledge, with thanks, contributions of stamps from G2CX, GI2WK and G2NH.

C.B. DX Forecast.

FEBRUARY 20—MARCH 20. ALI, TIMES G.M.T.

	14mc.	7mc.
Asia	15.00-19.00	13.00-20.00 scarce
Australasia ...	11.00-19.00	19.30-22.00 06.30-09.00
North	11.00-14.00	08.30-09.30
Africa		18.00-23.00
South	17.00-20.30	and various 18.00
N. America ...	12.30-21.00 West Coast 16.30-20.00	19.00-09.30 West Coast 06.00-08.00
S. America ...	18.00-20.30	19.00-23.00 or later
Europe	Fade at dark	Fade for an hour or so after dark

SPECIAL NOTE.

The December Issue of the Radio Citizens' Radio Call Book can now be obtained from Headquarters. Price 4s. 6d. (4s. to Members).

**28 Megacycle Tests,
March, 1929.**

OBJECTS.

1. To determine if simultaneous reception of distant stations is obtained at different places in Great Britain.
2. To determine the comparative effectiveness of low power and high power.
3. To determine the possibility of communication with other Continents.
4. To investigate the suitability of various transmitting circuits.
5. To investigate the practical value of amplification at signal frequency on the receiver.
6. To investigate the possible relation between solar and magnetic conditions and propagation.

OPERATING REGULATIONS.

1. The tests will run from 00.00 G.M.T. on March 9 to 24.00 G.M.T. on March 24.
2. A five letter code-word must be used during each transmission, and be changed each day. A list of the code words used to be sent to C.B. at the end of the test.
3. Licence regulations must be strictly observed.
4. As this is an organised investigation and not a competition, no prizes are offered, but details of the most successful work will be published.
5. Schedules may be arranged if the stations concerned limit their transmissions to a mere exchange of technical reports. This is necessary to ensure that one British station will not occupy the entire attention of a distant station to the exclusion of other British stations. Schedules must be mentioned when reporting.
6. Stations are requested to reduce power, where possible, during a contact, and to report the effect.
7. Reports must reach C.B. before 24.00 G.M.T. on March 28, and must be fully detailed, including (a) code-word, (b) type and dimensions of aerial (c) details of receiver, (d) details of transmitter, (e) power to output valve during each transmission.

C.B. has already communicated with some of the more important amateur organisations abroad and asked for the co-operation of their members.

Listeners' reports will be of the greatest value (see Object 1), and these are earnestly requested.

The unconfirmed results will, it is hoped, be published in the April BULLETIN, and the confirmed results as soon as possible afterwards.

The success of these tests lies, mainly, in the hands of British amateurs, and it is hoped that even negative reports will be returned rather than none at all. Here is your opportunity—what will be the result?

No notification of intention to participate is required or wanted: just go ahead and tune the "box of tricks" up a bit for March 9.

SPECIAL NOTICE TO FOREIGN MEMBERS.

Your reports will be of extreme value, and it is recognised that it may not be possible for you to have them here for the closing date. They will be very welcome just as soon as you can get them to C.B.

All reports to 59, Marlborough Park North, Belfast, Ireland.

Notes on 28 M.C.

By G6LL.

No, this has nothing to do with T9 reports, just a few random notes, on subjects that may interest some of you who are contemplating making a start on 28 M.C.

The chief thing about 28 M.C. is not to be discouraged by prolonged spells of non-success. Just because the "other man" gets "over" and you don't, don't say "This frequency is no good." Just stick at it and success must come sooner or later.

It would seem that at present there is no valve on the market that is really suitable for use at this frequency.

For inputs up to about 50 watts, which is an average for most stations, the S.W.D.E.T.1 is certainly fairly satisfactory, but does not seem to give the "pep" it should. The S.W.50 is also quite a good valve, but is really no more satisfactory than the S.W.D.E.T.1, except, perhaps, as a self-oscillator.

It seems, therefore, that it is up to the manufacturers to take the next step, and produce a valve capable of handling, say, 80 watts at this frequency.

For more low-power work, the old L.S.5 is a very satisfactory valve, provided it is not seriously overloaded. The L.S.5.D., which is a modified L.S.5.B., is also quite satisfactory. There is really no need to de-base the valve, provided a good valve holder is used. These remarks chiefly apply to self-oscillators.

To those contemplating a start on 28 M.C., I would say, "Use crystal control if you possibly can." It will make all the difference in the readability of your sigs at a distance. Some of the delightful scale exercises one hears on Sundays on 28 M.C. could be practically cured without using C.C., and totally cured by its adoption. Admittedly it means using another valve or two, but think, wouldn't you rather have a good note, copyable through QSS, than a wobbly affair, not always readable even though it is strength 4 or 5? G stations, generally, take a pride in their notes, and it may be said that, as a whole, we have the best notes in the world. So live up to it, OM's!

A word or two about aerials. This is a very important matter, and it is not good enough to sling up a length of wire and feed it any old how. On 7 or 14 M.C. almost anything will work, and give sufficiently good results to merit its being used; but on 28 M.C. we have a different tale. The chief controversy at the moment is, "Shall I use a vertical or horizontal aerial?" The answer is, "Which is the most convenient?" A good horizontal is better than a bad vertical. A vertical aerial should be fairly high, whereas with a horizontal one it does not seem to matter if it is only about 15-20 feet up, but in any case should be cut very carefully, after the fashion indicated in last month's BULLETIN by G5LF.

A few words about receivers. I am afraid that not enough attention is paid to the receiver by the average amateur. On 7 M.C. anything seems to work, and similarly on 14 M.C., but when people

try and get their receivers to oscillate on 28 M.C., nothing happens. Obviously they are inefficient somewhere. A high L/C ratio is, of course, best, and careful thought should be given to the layout. As a very efficient receiver is described elsewhere in this issue, further remarks are unnecessary.

One point that seems to stand out in all reports received is that local conditions affect reception and transmission as well as local surroundings, or situation. American stations not audible in one part are worked by amateurs in other parts of the country, and also even when W stations are audible, it is by no means certain that your own signals will get over, even though you may be in the habit of working W's. On one occasion, last month, five London stations replied to a CQ call from W2JN. No reply was received, and W2JN was heard later telling G5ML that he was the only G he had heard that day! It would seem, therefore, that the conditions surrounding London were unsuitable for DX transmission on that occasion. So don't get discouraged, chaps, if you don't get over straight away. Don't keep scrapping the RX and TX. Make it as efficient as possible and give it a fair trial. Put up a proper aerial, the best you can in your circumstances, and "keep on trying." When we have found out the truth about all this local condition business we shall have made a great stride towards conquering the difficulties of this frequency. Give DX a rest for once and try your hand at something nobody knows anything about, and see if you can't contribute just a little towards common knowledge. After all, it is a bit tame just working DX when you know you can do it fairly easily, and so can the "other fellow," but there is a lot of fun to be obtained when you are all "in the same boat" and nobody has done much.

And all the low-power people needn't be discouraged either. Look at G6DH—got across the "pond" on 3 watts! So get to it, OM's!

No. 2 District Conventionette.

G5CX and G6WD are hoping to arrange a Conventionette for March 9, most likely at Leeds. Will any interested and who have not been notified please write to 81, East Parade, Harrogate.



CLAROSTAT

VARIABLE RESISTANCES FOR VOLUME, TONE, DISTANT CONTROL, ELIMINATORS ETC.,

As frequently specified by "The Experts."
• HIGH QUALITY • LOW PRICE •
 New 20 Page Brochure free on request.
Many unique circuits.

CLAUDE LYONS LTD.
76, OLDHALL ST., LIVERPOOL.

Activities on 28 M.C.

Judging from the few reports received, very little has been done on 28 M.C. this month. As a whole, general conditions have been bad, very few U.S.A. stations being heard over here, and still less of our stations being heard in America.

It is interesting to note that on January 6, when G5UL of the London area heard absolutely nothing, G5ML was able to work W2JN.

On January 20, G5YK was successful in making his first contact on this band, using a reflector. He worked W2JN and got an R7 report.

The list of calls heard includes the latter part of December, when apparently all the stations were heard. During January, only about four different W stations have been logged on the average.

Two interesting short distance reports have been received, one from G6DH, who reports hearing G6HP, and the other from G6HP, who reports hearing G5UL. This is the second time that comparatively local stations have been heard on this band. Is it a freak reception?

G6LL has had a report from ZU6G of Johannesburg, S.A., reporting sigs. R7 on October 21.

A report from EC2YD states that he has heard G2OD and G6DH, but no W stations.

Calls heard on 28 M.C. during December-January:
By G2CX.—W1XAM, 2AYR, 2BDA, 2BVG, 2BRB, 2BG, 2AOL, 2NM, 2JN, 2ACN, 2MD, 2XG, 2XT, 6UF, 6XV, 8ZG.

By BRS188.—W2BG, 2JN, 8ZG.

By BRS25.—W2JN, 2BJV, 2BG, 4NH, 2AYR, 8ZG, 8AXA.

By G5ML.—W2JN, twice only, and worked each time.

By G6CI.—W2JN, 2BG, NKF.

By G5UL.—W2JN, 2AYR, 2BJV, 8ZG, 4WE, 3BJM.

By G6DH.—W2JN, 8AXA, NKE.

By BRS181.—W2JN, NKF.

By G6LL.—W2JN, 8ZG, 2AYR, 2BG, 2BDA, 2BVL.

It is still felt that *all* the active stations on 28 M.C. have not sent in their reports this month.

Now OM's please look to it and let us make this little list as complete and informative as possible. Let us have a list of your failures as well as your successes, as from these we can probably learn more than from just a string of successes.

All reports by 25th of the month, please.

G6HP has also had a contact with America, though details are lacking.

January 27 appeared fairly good. G5YK was heard R5 by W2JN at 13.00 G.M.T., but did not work until 15.15 G.M.T., when he was still R5, but slow fading. At 13.50 G.M.T. E17C was R6 at W2JN and at 15.00 G.M.T., G5ML was R3 then R5 at W2JN, and had been hearing other W stations earlier. G2OD worked W2JN at 15.50 G.M.T., being R4, gradually rising to R7 at about 16.50 G.M.T.

On January 27 G5ML worked W1BVL, W2JN, W2AOL and was called by W8AXA and W3ADM. G6DH has heard W1BVL, W2JN, W2AOL, W2AYR, W2ALW, W2NM, W8AXA and NKF. BRS10 logged W1AQD, W1BVL, W1BW, W1CMF.

Apparatus Tested.

We have received from the Robinson & Hands Electric Co., Ltd., of Birmingham, a sample of their "Raytrak" pick-up carrier for test. As its name implies, this carrier is so designed that radial tracking is obtainable; i.e., the pick-up is moved across the record in such a manner that the needle is always at right-angles to the radius, thus providing a system of tracking which is unobtainable with a tone-arm which swivels as the needle nears the centre of the record.

The device consists of a horizontal arm rigidly mounted on a short vertical pillar, at the base of which are holes for three fixing screws by which it is secured to the gramophone case at some convenient point. The actual pick-up carrier is in the form of a small carriage running freely along this horizontal rod by means of two grooved wheels which run with the minimum of friction. The bearings, being of special design, require no lubrication.

Thus the pick-up is free to move vertically, accommodating itself to the slight variations in the record face, and horizontally across the record as the latter is being played over.

On test the "Raytrak" carrier gave results distinctly superior to those obtained with the standard tone-arm on a small portable gramophone, and showed only the slightest tendency to rattle on really heavily-modulated passages. The form of suspension is such that record life would probably be materially increased in addition to the other benefits of the system.

A good point is that practically any make of pick-up can be used with but the most simple adjustment of the carrier, and the angle at which the pick-up is used may be set as desired, and then left.

Taken as a whole, the apparatus is of neat and pleasing design, and is British throughout, thus making a strong appeal to the pick-up enthusiast.

The Editor regrets that one or two slight errors occurred in the diagrams of Mr. Secretan's article in the last issue.

(Continued from next page.)

the reception of telephony, but for C.W. a lower value—about 3 volts—was found to give greater signal strength, but this is uneconomical with dry batteries.

AERIAL.

Tests have been made on several types of aerials, but providing the total span exceeded 30 feet, no appreciable difference was noted.

The addition of an earth gave only very slightly superior results, and no sign of threshold howl has been experienced without this capacity.

The aerial is loosely coupled inductively by means of an 8-turn coil, which can be swung away from the grid coil if desired. This is made possible by the adjustable feature incorporated in the special Colvern coil support.

The Schnell Receiver at G5QF.

By SEYMOUR BUCKINGHAM.

From time to time we have been told that descriptive articles on receiver design are required, and with that fact in mind this article has been prepared. No original ideas are put forward, but three main ideals have been aimed at, and from the results obtained these have been achieved.

GENERAL.

In the first place, due consideration has been given to signal strength, it being desired that this should be of a reasonably high order, without having to resort to ultra high μ valves.

Stability of signals and freedom from hand capacity effects have both been sought after and obtained.

LAYOUT AND WIRING.

Before describing in detail the construction, attention is drawn to Fig. 1, which shows the layout and wiring scheme. From this it will be noted that the detecting circuit is mechanically screened from the low frequency and output circuits by means of aluminium sheet, whilst the tuning controls are again well removed from all H.F. and L.F. components.

Considerable time has been spent in deciding on the most suitable location of apparatus bearing in mind throughout that the wiring to the radio frequency components, especially, should be made as short as possible and as free from coupling effects as circumstances would permit.

CHOICE OF COMPONENTS.

It is not intended to recommend any particular type of components, but for the information of those who may wish to build an identical set, the following list of parts used may be of interest:—

Valves : Cossor Detector 210-H.F. and Stentor 2.
Transformer : U.S. Super.
Tuning Condensers : Etherplus (cut down).
Grid Condenser and Leak : Dubilier.
Valve Sockets : Benjamin.

CONSTRUCTION DETAILS.

Baseboard : White wood, 18 ins. by 12 ins. by $\frac{1}{2}$ in.

Front panel : Aluminium sheet, No. 16 gauge, 7 ins. by 12 ins.

Terminal board : Ebonite, 6 ins. by 1 in. by $\frac{1}{4}$ in.

Condensers : These were originally .0003 M.F., but were cut down to one moving and two fixed vanes for grid tuning and two moving and three fixed for reaction control.

Extension handles : These are $\frac{1}{2}$ in. ebonite rod, 10 ins. long, turned down at front end for one inch to $\frac{1}{4}$ in. diameter.

L.F. Screen : Aluminium sheet, 12 ins. by 4 ins. by No. 16 gauge.

Detector valve supports : Ebonite rod, 2 $\frac{1}{2}$ ins. by $\frac{1}{2}$ in.

WIRING.

The set is wired throughout with No. 16 S.W.G. bare copper and all connections passing through the aluminium screen are bushed with small ebonite collars.

CHOKES AND COILS.

The chokes finally decided upon were wound with 38 S.W.G. D.S.C. wire on glass test tubes $\frac{1}{2}$ in. diameter, and were mounted vertically by means of small rubber corks fitted at one end.

The windings consist of 100 turns, spaced in sections of 10, 20, 30 and 40 turns, with $\frac{1}{8}$ -in. gap between sections.

The coils used were Colvern short-wave type, and were found to be extremely efficient on all waves from 7,000 to 30,000 K.C.

WAVE-LENGTH RANGES.

The following wave-length ranges have been obtained with the above-mentioned coils.

Grid Coil	8 Turns	46 to 32 Metres
Reaction Coil	4 Turns	
Grid Coil	3 Turns	23 to 15 Metres
Reaction Coil	2 Turns	
Grid Coil	1 Turn	12 to 8 Metres.
Reaction Coil	2 Turns	

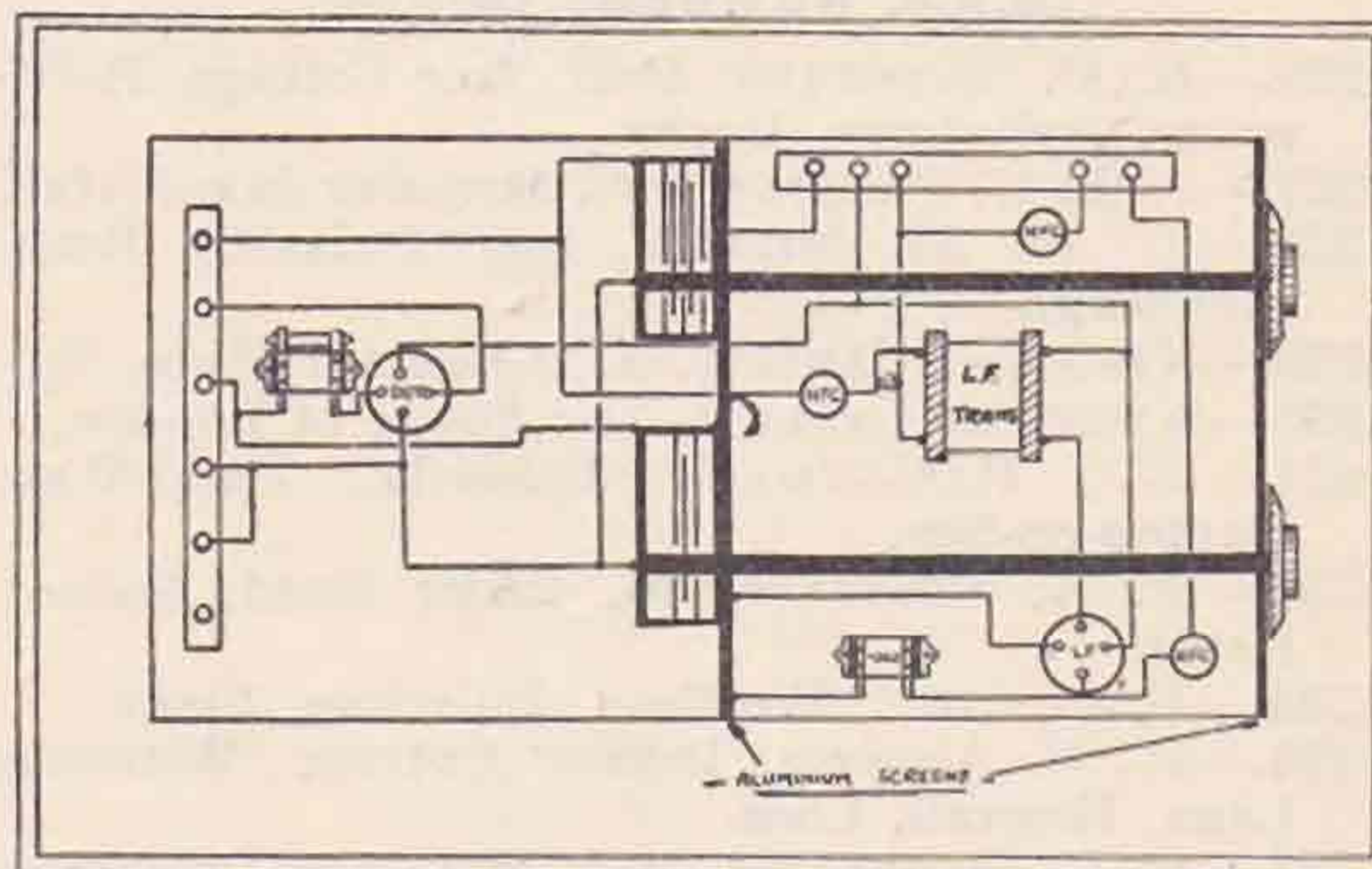

It was found with the above coils and tuning condensers that the amateur bands in all cases were covered within the centre of the grid tuning condenser—an ideal which should be aimed at in all receiver design, as it is a generally known fact that with very low minimum and small capacity condenser, the bottom end effects are liable to cause signals to appear flatly tuned.

OPERATING VOLTAGES.

It is not intended to make definite suggestions about voltages, but from results obtained with the values specified above, it has been found advisable to use a value of about 60 volts on the detector and about 120 volts on the power amplifier. For several months past a battery made by Messrs. A.F.A. Accumulators, Ltd., has been used. These batteries—Pertrix—can be recommended to give entirely satisfactory results, as the use of sal ammoniac has been dispensed with in their construction. Grid bias has been used throughout all tests, a value of 9 volts being found the most suitable for

(Continued at foot of previous page).

Membership.

NEW MEMBERS.

- E. D. HASBERRY, Pear Tree Cottage, Hardwicke, Aylesbury, Bucks.
 A. W. ALLISTON (Associate), "Corners" Cross Road, Tadworth.
 A. F. U. PARSONS, 358, Beverley Road, Hull.
 F. BLAKE (Associate), Monard, Langley Avenue, Surbiton.
 T. W. M. MILLAR, 103, Dalkeith Road, Edinburgh.
 A. KOMAROW, Post Engineers Depot, Marghee, Basra, Iraq.
 E. T. PETHERS (G6QC), 3, Conley Street, Greenwich, S.E.10.
 K. J. HEIGHTMAN, "Belowda," Park Way, Clacton-on-Sea.
 J. B. H. HUM (Associate), 17, Eastwood Road, N.10.
 VISCOUNT CARLOW (G2BMT and G2ARL), 37, Chesham Place, W.
 F. K. BRITAIN, 16, Puller Road, Barnet, Herts.
 B. COSTIN, "Westlea," Billericay, Essex.
 H. M. ARNOLD, Dorney Cottage, Wittering Lane, Heswall, Ches.
 T. R. RAWLINGS (Associate), 48, Canford Road, Clapham, S.W.11.
 H. C. BROWNLOW, Mansfield Lane, Culverton, Notts.

B.R.S. NUMBERS ISSUED.

- 226.—E. D. HASBERRY, Pear Tree Cottage, Hardwicke, Aylesbury, Bucks.
 227.—A. F. U. PARSONS, 358, Beverley Road, Hull.
 228.—T. W. M. MILLAR, 103, Dalkeith Road, Edinburgh.
 229.—VISCOUNT CARLOW, 37, Chesham Place, W.
 230.—VISCOUNT CARLOW, The Tower of London.
 231.—K. J. HEIGHTMAN, "Belowda," Park Way, Clacton-on-Sea.
 232.—F. K. BRITAIN, 16, Puller Road, Barnet, Herts.
 233.—B. COSTIN, "Westlea," Billericay, Essex.
 234.—H. M. ARNOLD, Dorney Cottage, Wittering Lane, Heswall, Ches.
 235.—H. C. BROWNLOW, Mansfield Lane, Culverton, Notts.

B.R.S. NUMBERS RELINQUISHED.

- 220.—Miss A. J. BURNS (now G2IA), Alhambra, Carlisle, N.B.
 102.—R. L. VARNEY (now 2ARV), "Fairview," The Avenue, Sunbury-on-Thames.

Calibration Service.

Calibration signals will be transmitted from G5YK on February 24 and March 24 as follows:—

14.00 G.M.T. 7,050 K.C. (nominal).
 14.05 G.M.T. 7,250 K.C. (nominal).

A similar schedule will be transmitted on March 10, commencing at 10.00 G.M.T. The call is R.S.G.B. DE G5YK, followed by the frequency used and a two-minute dash.

Notes and News from the British Isles.

District Representative Reports.

The Editor and his colleagues urge that in future the following points receive especial attention when reports are drawn up:—

1. Head the report:

District Number

Area Representative(G...).

Address.....

2. Refer to each station as G—.

3. Refer to wavebands as 56000 KC, 28000 KC, 14000 KC, 7000 KC, 3500 KC, and 1750 KC.

4. Subdivide your reports if you have appointed "county representatives," heading each one as follows:—

(County).

Representative(G.....).

Address

5. Use only abbreviations recognised by the International Convention at Washington.

6. Omit "asides" as much as possible.

7. Forward to H.Q. all reports by the 25th of each month.

Attention to these details by each District Representative will assist the Editor in his work. It is his intention to make these notes uniform in set up and will appreciate the co-operation of all representatives.

DISTRICT No. 1.

Area Representative: G5XY, J. C. HARRISON, Highcroft, Burnley.
 Well, we have eight reports this month, which is as good as last month, so I suppose that no kick should be forthcoming. Please, OM's, do try and keep up with the notes—they are the only way other hams can get to know of your activities. Make an effort!

G2AHV sends in his first—and welcome—report, and offers a solution to the problem of T.H. He says that a substitution of L.F. transformers often effects a cure. He is keen on some open aerial brass pounding, and is soon going to apply for a full permit. Good luck, OM!

G2AJC also has a cure for T.H. His is a high resistance—about 30,000 ohms—instead of a H.F. choke. He is now using a screen grid for H.F. amplification and finds a great improvement. (I must apologise for suggesting that you join CB, OM, I didn't know that you were already a member.)

G6CA is using 9 watts C.C.—using G5YK's circuit—and has worked most of Europe and has high hopes of crossing the pond very soon.

BRS195 has just got his A.A. permit through, and is now G2AXN. He is trying out various circuits in an endeavour to find the best for 28 mc. Reception on 28 mc. during December has been very poor.

G5KL.—His business has been interfering with radio lately. (Obvious cure for that, OM!) Transmitting has been almost nil, but has his receiver working prettily down to six metres. Wave climb has been very troublesome with the transmitter on these frequencies. He promises to continue with his reports. Do, OM, by all means!

G5MS, after his hectic few months, is rebuilding.

G5XY seems to have forsaken ham radio for B.C. stuff, as after eight years he has his first B.C. receiver! He wants a solution to the problem of keying 2,000 volts from a generator with poor regulation, to a tube with an impedance of 3,000 ohms, without any chirp, and without key clicks, and without spacer!

G5XD has been using a MOPA with only 6 watts input, and has had some fine results, including a W QSO on 14 MC, but has now installed a Colpitts, using 220 volts on the plate of either one or two LS5's. Results seem quite as good as the MOPA. Conditions on 14 MC have been very good and quite a large number of Europeans have been worked. He is continuing experiments with the Colpitts and would welcome reports.

REST.—Large blank space here, Mr. Printer, black-edged and tear-stained, in memory of the rest of the District's 200 odd licensed transmitters!

DISTRICT 2.

The notes which appear from Mr. S. R. Wright cover activities in several separate areas which are now separated under the new District scheme. Will all members see that in future their reports are sent to their district representative. Full addresses are contained in the January issue of the BULLETIN.

The appointment of a new No. 2 District representative will be made by the Committee, but for the present members in Northumberland, Durham and Yorkshire should be sent direct to headquarters headed "District 2 Report."

By S. R. WRIGHT (G2DR) (late Northern Area Manager).

I have to apologise for the non-appearance of these notes last month, as I was away at the time they should have been sent in, with the result that they had to be held over.

As this is the last time I shall pen the Notes for the Northern District, I should just like to place on record my thanks to all the sub-area managers and members for all the assistance they have given me during the past two or three years. I may have become mildly sarcastic or even vituperative at times during that period, but if so, it has all been for the good of the cause. I tried hard to resign my position in October last, but Mr. Swift would have none of it, and I had no other course open but to continue until January. Now, however, pressure of business has become so great that I am prevented from touching a key; indeed, 2DR has been silent for nearly two years.

I feel, therefore, that the time has come to hand over the reins of office to one more worthy of the name of "ham" than I. Even though I am compelled to take a back seat, the interests of the Society will always be my interests, and anything that I can do to further the amateur's cause will be done. Again my thanks to all, not forgetting those at H.Q. who have come to my aid more than once. Good luck to you and may your aerial amps. grow bigger and bigger!

DURHAM AND NORTHUMBERLAND.

Representative: A. S. O. MILLARD, 1, Holmlands, Monkseaton, Northumberland (G2AIZ).

G2AUX is busy with a transmitter and receiver for 28-mc. work. He has had bad luck with "lenses": all he had ground have turned out dud. A crystal oscillator and heterodyne wavemeter are in course of construction.

G6GC has been QSO G6YV on 28 mc., but has been unable to raise anyone else on this wave. He reports having worked AG7AE and FM8KIK on 7 mc., also a number of stations in Southern Spain.

G6QT has heard nothing on 28 mc so far. This month he has had no luck with crystals, and to crown all, his aerial gave way.

G6YV is working on 28 mc. and has heard several W's signals. Conditions reported "not good."

2AIZ is busy with a generator, and has nothing of interest to report.

YORKSHIRE.

G6BR is now working on a new outfit, CC on 41.94 and 20.97 metres. Reports show that everything is as it should be considering the excellent gear I know has gone into this station. Some headway is being made with angular propagation tests. QSO's have been effected with W9ENR, W8MQ and many others, average report from U.S.A. being R5, while European test reports indicate R8 on this wave (20.97 metres). AG7AA (Tiflis) has been worked on 41 metres and reported signals R4. The results of many experiments on the right type of aerial for 20-metre work look like bearing fruit here at an early date.

G6TZ is old 6BY in disguise! In other words, 6BY is now 6TZ. He is rebuilding to a CC circuit for 42, 21 and 5 metres.

G2XY sends a cheery letter saying he is having a great clear-up ready for the new order of things, particularly 10-metre work. Weekly schedules with G5UB and G5CX are being kept, NE8FD8AE having now returned to England. 73 to you, OM.

G5LT reports a few low-power contacts. Grinding crystals here and a good heterodyne wavemeter circuit is required. Will anyone oblige? Christmas gales wrecked the aerial system. He reports that G5HK of Sheffield has come to life again.

BRS162 reports little doing except on the 160-metre band, which, he says, is getting more popular. Schedules on this band would be welcome.

BRS164 has tried a new one-valve set on the 160-metre band and finds it satisfactory. Best work on this band with above receiver has been 150 miles 'phone and 160 miles C.W.

G6OO advocates the use of the 160-metre band for 'phone and local work, and I agree with him what the QRM on the 42-metre band is fearful. It is remarkable how signals from this station get out of Europe. 6OO reports many interesting QSO's with this area when using 8 watts CC. No QSO's on 10 metres, and he reports conditions on all waves except 160 metres very bad during November, especially after 17.00 G.M.T. No W stations were heard for over three weeks.

G2DR still continues with fading work and some interesting results are being compiled. Has anyone ever tried reading a mirror galvanometer single-handed during the early hours of the morning? Fine thing for keeping one awake! He took three hours at a stretch recently of 6 second readings with a few 3 second ones when necessary, making about 2,000 readings for the three hours. This is the longest period done single-handed yet.

G6TW is busy finding the best modulation systems for the new bands. Forty and 20 metres are O.K., but the 10-metre band is giving a little trouble. Measuring instruments are receiving attention. (Don't use moving irons, OM!)

DISTRICT No. 3.

Representative: J. NODEN (G6TW), Coppice Road, Willaston, Nantwich.

CHESHIRE.

First I must apologise for the absence of the Cheshire reports from the "BULL." for the last two months. Do not blame me, for I passed them through the right course (Northern Area).

Now we are on our own. Please pull together, OM's, and let me have reports by the 15th of each month, also will each of you do a little canvassing. Thanks.

G2SO is off the air indefinitely, but is building a C.C.P.A. set ready for when he can get at it again, also a receiver has been built to go down, or I should say up, to the 28 mc.

G5BR is using at present 12 watts to a T15 valve in the 7 mc. band, C.C. power amplifier fed by a crystal oscillating in the 3.5 mc. band, and frequency doubler both DE5b. Hoping to have a rotary transformer going soon for 50 watts and a big valve. Half wave rect. A.C. on P.A. at present.

BRS126 has been busy, and is now constructing set for the 28mc. band.

BR1527.—Nothing doing this last month, but hopes to be at it again soon.

BRS90 is working schedule re skip distance under Group 2A.

BRS152 now down on 28mc., the first station heard being OZ7T QSA5, but he is troubled by petro-electric buses worse than Fords. He says that the SP and SU are coming in well and that the following countries are the most regular workers: Spanish, Portuguese, Swedish and Roumanian. This is the month's bag: FK, SB, OZ, AG, XO, VE, FR, FM, CT2AA, AU, SU, VH, VO, and FO. (Very good, OM).

G6TW.—The usual 7 mc. working on phone, also have been trying the 14 mc. band, but find it very quiet, and there does not seem to be anything like the working on this band as there was three years ago on the 23-metre band. Will shortly be trying the 28 mc. band.

SHROPSHIRE.

Representative: Offers, please.

County contains three members and two transmitters (non-members.)

HEREFORD.

County contains only one transmitter, a non-member.

MONMOUTH.

Representative: Offers, please.

County contains six members and three transmitters (non-members.)

WORCESTER.

Representative: Offers, please.

County contains eight transmitters and not one a member of the R.S.G.B. (Can anything be done?)

DISTRICT No. 4.

Area Representative: E. R. MARTIN (G6MN), Castlemount, Worksop.

BRS103 is experimenting with cone speakers.

G5BD.—Little to report. Seven-metre band useless for DX, and is not getting out on 14 mc. Roumania and Portugal only DX.

G5CY (ex G2BOW) has been busy amongst Europeans and Morocco on 7 mc.

G6LN.—Been very active this month. New aerial erected and Czecho-Slovakia added to list of QSO's. Hoping to continue skip tests.

G6MN having trouble with PA. Gets CO working O.K., but cannot get the PA to amplify.

There are now only seven active transmitters in this district, but I should be glad if they will send me some word of their activities; also, I should be glad of reports from the BRS men—before the 20th of the month.

DISTRICT No. 5.

Area Representative: D. P. BAKER (G2OQ), Crescent House, Newbridge Crescent, Wolverhampton.

By the time these notes appear in print, the Midland Conventionette will be a thing of the past, and from the applications for tickets up to the present, should be a huge success; but I shall have more to say about this in the next issue.

It is very disappointing to me to see how my own county, Staffs, has fallen off in keenness in comparison with Warwickshire of late: no one seems to be doing much and we shall really have to liven up a little.

I should be pleased to receive reports from people in Oxfordshire and Northamptonshire. I should also be pleased to hear from anyone who would be prepared to act as sub-area representative for these counties. Please let me hear from you as soon as possible.

Staffordshire.

Representative: G5UW.

G6UZ has been unwell of late, and in consequence has not had much time for radio.

G6SO has spent much time grinding crystals, but has not had good results as yet, but hopes for better in the near future.

G5UW has now got his MOPA working well, but owing to weather conditions has not been able to alter his aerial to the new conditions, but it is expected that he will be going strong in the near future.

G2OQ has just had his main supply changed from D.C. to A.C.; this has caused some interference with work, but he has now got going again, and results are quite up to his expectations.

Warwickshire.

County Representative: G6CC.

G2AK is in the midst of changing over to crystal-control. It is too early to report results yet.

G2ZW is to be congratulated on working his first Yank in W2BLK on December 5 at 20.40 G.M.T., using 9.2 watts. Tests with screened grid H.F. receiver show excellent results. Festivities have interfered with further work.

G2ABA will shortly be on the air with a new call and an open permit.

G5GR has been busy changing QRA. He is planning a F.B. outfit in the new shack.

G6CC has at last managed to clean up the bad note. This was managed without using the crystal in the transmitter, and no further work has been done since Christmas week.

G6XJ is rebuilding his transmitter completely. Some experiments have been carried out with crystal wave-meters.

G2AJO is the call allotted to the Coventry Transmitters' Association. This Association is increasing its activity and hopes to have a clubroom soon.

G6XJ and G6YD have been working together; they have been experimenting with crystal oscillation. G6XJ's transmitter has been rebuilt. Reports give perfect note.

G5NH has installed a new crystal in transmitter; results are excellent. Reports come back as pure note.

G6CI has been carrying out reception tests on 2,800 KC band; conditions were very bad. Suggestion is that dark evenings have adverse effect. In support of this, it is noted that no stations have been received after dark.

G5ML.—Conditions, on the whole, have been quite good on the 7,000 and 1,400 KC of late, and much DX has been done. The best work being with K1AF, XW7EFF (Siam), AP9FRG, several ZS and VK stations, U.S.A. 6th District, and Canadian 4th District. A schedule is kept every Sunday with W2JN on 28 M.C. at 14.00 G.M.T., using the crystal-controlled transmitter. Conditions have been very erratic on 28 M.C., but so far my signals have been logged in U.S.A. every Sunday since November.

DISTRICT No. 6.

Representative: G. W. THOMAS (G5YK), 169, Hills Road, Cambridge.

Conditions during this month have looked up considerably and there has been much activity on the 7,000 k.c. band with the Asiatic stations, though this district does not appear to have specialised in such work. Canadian stations have been audible in this band in the early evenings. The 14,000 k.c. band appears to have gone on in its own little way, while the 28,000 k.c. band appears to have improved somewhat as we passed from December to January.

Essex is certainly our largest county, and G2ABK has offered to do the work of collecting reports from Essex. I have accepted his offer, as he is on the spot and apparently knows most of the active Essex amateurs. Further, it will relieve me of a lot of work, and my time is rather crowded as it is. So in future Essex reports to Mr. R. C. Horsnell, "Hevani," Guernsey Gardens, Wickford, Essex, by the 17th of the month. Reports from the other counties to me, please.

G2XV appears to be spending most of his time working W stations on 14 mc.

G5YK has worked ZS1SR on 14, and, after three months trying, W2JN on 28. Crystal control is used on all frequencies and tests on 28 mc. aeriels will now commence.

G5YX has closed down until Easter, the operator having gone to London, where he is doing station visits.

Much experimenting with few contacts is the order of the day at G6CR.

G2HJ has done a little on frequency measurement during the vacation, but is now hard at work again.

G2AAK is fixing himself up in a radio den. He wants to know if a mains eliminator can really be used with a S/W receiver, as he suffers from a hum which is tunable, being worst on about 7,000 k.c. He listened for G6NK's skip tests, but didn't hear a whisper.

G6DG, also operator at G2MV, has succeeded in getting a very successful 5 watt C.C. set to work and has done really good work with it on 7 mc. He has got all over Europe and to North Africa, Georgia and U.S.A. He has closed down until April.

BRS144 has built a new receiver (O-V-2) and finds the C.B. audibility chart very useful. He is in a very isolated position and would welcome any transmitters or other BRS men who find themselves in his locality.

G2ABK is now living with BRS191. They have built a new 30 mc. receiver, from which much is hoped.

DISTRICT No. 7.

Representative: H. C. PAGE (G6PA), Newgardens Farm, Teynham, Kent.

I must express my regret at the poor show this area made last month. The only notes received were those collected by G2BUW.

Now, you fellows, this really won't do. No. 7 District has got to be the best of all the districts, and it's up to you to make it so. Therefore let's have a line from each of you every month. You can send them direct to me or else to G2BUW or to G5UY, according to your county.

What about a conventionette? Anyone got any ideas? If so, shoot them along.

Now for the reports.

G5UY has been trying the effect of coupling the coils of his T.P.T.G. transmitter, which is crystal controlled. He finds the crystal controls best with the coils at right angles. DX, however, seemed better with the coils coupled, as he worked a "W." Best DX with the other arrangement, Finland. He wonders if this was a coincidence.

G6PA has little to report. Rebuilding is still going on here. Best DX here, fone to F.M. on 14 mc. Aerial here is a "Zepp" fed Hertz. The transmitter is an Ultra Audion, using a LS5D and 360 volts of D.B.'s. Conditions have been hopeless here after dark for weeks.

28 mc. will be tried here soon. Has worked India on 7 mc. input 10 watts.

SURREY REPORTS.

By G2BUW.

G6LK is still doing fone on 7 mc. He works CTICK on sked every Sunday and Friday at 2350 G.M.T. CTICK is very anxious to work "G" fone stations on 7 mc. He finds conditions very poor on both 7 and 14 mc. for working "W." He is very busy trying out different aerial systems. H.T. is derived from dry batteries, which he finds give a good note, but burn a hole in his pocket.

G6GS is using a QST 1929 transmitter on 14 mc. He finds conditions very poor, but has worked a few "local Yanks."

G5WP is active on 14 mc., using a Hartley Push Pull when not troubled by one of the numerous forms of QRM experienced at his QRA. Has also been QSO a few "local Yanks." This station also works on 28 mc. with an Ultraaudion using an A.T. 40 and a vertical half wave aerial.

G2BUW is now waiting for his two letter call sign and hopes to be working on 7 mc. by the time this is in print.

SUSSEX.

G2AGC is busy improving his Morse as he goes for his test in a few days' time. By the time this is in print the ordeal will be over. We wish him the best of luck.

DISTRICT No. 9.

Area Representative: G. COURTENAY PRICE (G2OP), 2, St. Annes Villas, Hewlett Road, Cheltenham.

I expect some of you wondered why no district notes appeared last month. Did you send in your report? No, and that is why.

This is the first time I have written under the new district scheme. Rumour has it that I am of the medical profession. I agree that the new number of the district would be most appropriate to one of that profession, and I have heard it stated that this particular number took quite a responsible part in the Great War, but, no, OM's, I am not a doctor.

G2OZ wants information on vertical aeriels, the gale having put paid to his copper pipe. Offers in exchange a suitable hairpin now lying on the ground.

G6XB still busy solving the mysteries of crystals. Best DX Moscow R6 CC on 4 watts. Hopes to be on 14,000 K.C. soon.

G2YX is now on 1,750 K.C. and is building a new crystal outfit for 7,000 K.C. Has had aerial systems down for overhaul and cleaning.

G6RB on QRP. QSO's W.AG.AU. on 5 watts. 28,000 K.C. transmitter working fairly well using LS5 bottle.

G2OP is on 1,750 K.C. and 7,000 K.C. Still very busy, but will shortly be on 14,000 K.C.

BRS212 the only one to report last month. Had a good log of W stations on 28,000 K.C. during November. On December 1 logged signals from every continent. Now a complete rebuild is being carried out. Reports visits G2AWV and G6XN.

No. 10 DISTRICT.

Representative: J. CLARRICOATS (G6CL), "Ciel," Hartland Road, Friern Barnet, N.11.

With the exception of a letter from Mr. Vickery (G5VY) and Mr. Hudson (G5GU) I have received no response to my request that the active North London stations tell us what they are doing. From now on, therefore, I do not propose publishing any reports from stations who do not give me their "dope" direct. Nearly all last year I had to make up a "story," and I do not intend to keep this up for ever.

If only you fellows would write and say that those reports are useless we should know a little better what to do, but the apathy of the majority does not prevent us pleasing the minority so far; but unless these notes become more interesting I assure you that I shall do my best to have them dispensed with and give the space over to more worthy interests—C.B., for instance.

G6UN has been more active on 7 m.c., and has had fair European success using 6 watts input. He is trying for his first W.

G5QF has now increased his input to about 8 watts from Pertrix batteries and has had several good European QSO's. His receiver is being described in the BULLETIN. An interesting calibration was made at 6CL recently with this receiver. Harmonics of a crystal supplied by The Oscillating Xtal Company were checked down to 8 metres. The crystal resonator described by 2NH is being found invaluable at 6CL.

G6CL has been working on 7 and 14 m.c. On the latter wave Europe has at last been worked, SP, OH, OZ and EC being the countries concerned. For Sunday work—when conditions are good—this band is recommended for low-power stations. All QSO's made so far have been perfect in every way.

The heavy W interference on 7 m.c. one night lately has prevented any serious work, but during odd periods a fair number of DX Europeans were worked. A series of most interesting tests with a Cossor Stentor 2 as oscillator have been made, and practically the whole month's work was conducted with this valve. A voltage of 250 at 25 to 30 ma.'s was used for all contacts over 1,000 miles.

5VY has been extensively rebuilding and now has mains installed. He assures us that very soon he will be disturbing the ether at his new permanent address.

6PP has given up hopes of again working W with 5 watts on 7 m.c., but we suggested that an attempt be made on 14 m.c. His best QSO was EU9, but his signals were but R2.

5HJ has been rather inactive, but has been in touch with OGRP off Finisterre.

5HS has been on 28 m.c., but has no DX, only locals, whether these are local G stations or local W's we are left to surmise.

5GU has been rebuilding extensively and will very soon be on 28 m.c. with a specially designed transmitter. His new receiver goes down to 3.5 metres.

DISTRICT No. 11.

Representative: L. H. THOMAS (G6QB), "Conway," 66, Ingram Road, Thornton Heath, Surrey.

If the reports received by me on the 21st of the month are any criterion, this area consists of three active stations and the area representative. Perhaps the recent changes in representative may account for the absence of reports, but I asked G6PG to forward to me anything received, and this he nobly did, the contents of his letter being his own short note to me and nothing else.

He wants to apologise to the gang for the non-insertion of last month's notes on account of extreme pressure of work. I am sure they all appreciate the work he has done for the time he has been Area Manager, and I can sympathise with him on having to give up the job because of lack of time!

G2CX reports nothing much doing on the air, but a difficult and exciting time getting a decent output on 7 mc. from his new C.C. outfit. He is trying to get the old aerial to work on the new bands by lopping off chunks on the "hit and miss" principle.

G6HP has had a good month, although he thinks conditions have been bad! The bag includes KIAF (Philippines), VSICB (Hong Kong), and XW7EFF at Singapore, all on 7 mc., several Yanks on 14 mc., and W2JN on 28 mc. Very bad conditions, OM, by the look of it.

G6WY has been experimenting with H.F. chokes and with a QRP transmitter on 7 mc. He reports nothing much on the air, but a few "W's" on 7 mc. and 14 mc.

G6QB has not been on a great deal, owing to much rebuilding of receiver and transmitter. Best work was KIAF on 7 mc., and PK4AZ (Sumatra), FO1SR and FOA3A on 14 mc. 28 mc. still "in the air"!

Please let's have those reports next month, OM's.

No. 12 DISTRICT.

Representative: L. J. FULLER (G6LB), 13, Seagry Road, E.11.

G6UT is the star station for the Division this month, having at last secured W.A.C. by working Asia, his missing link for the honour.

G6LL has worked U.S.A. on fone on 14 m.c. and has also burnt out all his valves, including his S.W. D.E.T.I.

G6FY and G6LB have received their permits for the 3,500 k.c. band, and will be conducting organised work with the other C.B. stations in this group.

G6FY now has his receiver working on 28 mc.

G6LB is having great trouble with his new receiver owing to induction from car magnetos, and would welcome suggestions for curing same.

DISTRICT No. 13.

Representative: H. V. WILKINS (G6WN), 81, Studland Road, W.7.

Well, OM's, another month and yet in spite of my request last month for better co-operation to help swell these area notes, very few have reached me. Look to it, OM's!

It has been suggested by one of the amateurs in this area that we start a club on the lines of the "QRP Society"—what about it! All those interested please write me and I will endeavour to arrange something. I should like to hear from you as soon as these notes appear.

Now for the notes from those who seem to be the only ones who show an interest.

G6CO has little to report. Has ground a crystal to 3,500 kc. band, got it to work on harmonic in 7,000 kc. band, but finds it increases plate current and as this comes from dry batteries he has to be careful.

G6JY found conditions on 7,000 kc. bad, but had good contacts with CT and EAR, also worked FM with 5.5 watts from hand generator. U.S.A. stations came in well several times, but did not hear any work a G.

G2XO rebuilding his 7,000 kc. transmitter—only finds time for this week-ends every two or three weeks.

G6VP reports 49 trans-oceanic contacts, including W1, 2, 3, 4, 8, XENOCR off Mombassa, OGRA off Alexandria. On 14,000 kc. worked U.S.A. every night except one; finds conditions improving on this wave. Has got his 28,000 kc. ticket and had reports from one G and one W—good, OM! Is using indoor $\frac{1}{2}$ X Zepp actually below ground level. Arranging sked with W2JN on this latter wave.

G6WN has got C.C. going on 7,000 kc., 14,000 kc., and 28,000 kc. Reports on the two former but so far not on the latter. Several European stations have been worked on 7,000 kc. and Egypt has also worked on this wave. On 7,000 kc., VK, K, ZS, W and FQ have been heard during the evening hours.

G2ARV spent most of the month with valve and chemical rectifiers, also harmonic control with quartz lenses on 7,000 kc. band found encouraging. A CO FD PA set will soon appear here. An article for "BULL." on zincite oscillating crystals promised.

BRS15, just got going after his return from Canada six months ago. Has heard VS6AB and wants full QRA—try G6PP, OM! Finds 7,000 kc. band dud, but 14,000 kc. and 28,000 kc. very good. Heard 6th district U.S.A. on the latter band.

No. 14 DISTRICT.

Representative: J. WYLLIE (G5YG), 31, Lubnag Road, Newlands, Glasgow, S.3.

At the start permit me to apologise for the cancelling in December of the arrangement by which transmitters of as many districts as possible meet at my house on the last Wednesday of each month. Serious illness in my home brought about the necessity, but I am glad to say that once again all is OK, and by the time this reaches the publisher I trust we will have got together once more.

During December I was visited by 5ST, Mr. and Mrs. 5GK, 2MA, 2WL and 6WZ, and while I trust they will pardon me for, in the circumstances, a necessary lack of hospitality, I was, nevertheless, very glad to see them.

In 21A we have now Britain's second YL station, and I am sure we wish her every success.

I am not, in the circumstances, able to say much about radio conditions during the period under review, but I understand that in Scotland there has been considerable improvement on the 7 mc. band. The 14 mc. band has been very "patchy," and the 28 mc. band not nearly so good as in the previous month.

I am pleased to note signs of recrudescence of life in "B" District.

Along with 6NX and 2MA, I had the pleasure of paying a visit to 6WL at Dalry, where we spent a most interesting afternoon and evening.

I was also pleased to be able to visit 2MA's station, and have to congratulate him on the way he has made best use of the small space he has available for radio work.

"A" DISTRICT.

Representative: A. T. WILSON (G2WL), 206, Newlands Road, Cathcart, Glasgow.

2MA is at present the most hard-working station in the district, and has been very successful in the 7 mc. band. During the month he has had an R6 report from Mespot with an input to his TX of barely 7 watts. A chemical rectifier (bridge) is in use at the station, and is giving fair satisfaction, although the losses are heavy.

2FV is still very QRL business, but is using what spare time he can get to build up a CCTX.

21A, Miss A. J. Burns, Alhambra, Carlisle, Lanarkshire, has just received her permit from the P.M.G., and will be on the air before this reaches print.

2WL has not yet been able to do much owing to pressure of business.

5XQ is devoting his time temporarily to broadcast reception work in connection with moving coil loud speakers and push-pull amplification.

5YG, as indicated above, has been more or less out of the game owing to family illness.

5YQ, owing to his awkward location, is at present unable to take up transmission, and is devoting his time to the construction of a receiver for S/W, which incorporates H.F. amplification.

5ST, after a long absence from the "air," hopes to get going again soon.

6NX has been having a good deal of trouble with his aerial, which is not radiating so well as its predecessor. He is carrying on with it for a little while yet.

6WL has not reported, but is frequently heard testing with his CC TX.

6WZ is in the same position as 2WL at present, but hopes to get a move on when things quieten down a bit.

" B " DISTRICT.

Representative: E. G. INGRAM (G6IZ), 20, Cairnfield Place, Aberdeen.

2AP has not reported, but is thought to be QRW professionally.

5JK has completed a Quartz controlled wavemeter, and awaits the arrival of a new generator, when he is expected to make things hum up Aberdeen way.

6IZ is suffering from a surfeit of broadcast work professionally, and until things quieten down a little from a business point of view he confesses he cannot work up much enthusiasm for S/W work.

6VO has now got going once again with a Quartz controlled TX, and has worked the greater part of Europe with 3 watts input.

" C " DISTRICT.

Representative: J. B. STURROCK (G6KO), Kirkbuddo, Forfarshire.

2SR has now completed a new CC TX for C.W. and fone, also a 28 mc. TX and RX. He is also getting great satisfaction from a new S/W super-het with screened grid, tuned anode coupled I.F.

5GK has been very QRL with broadcast business, but means to get busy on the air when things quieten down a bit.

5NW is in more or less the same position as 5GK.

6KO has just purchased a new crystal, but has not managed to get much done with it yet. He hopes to have a new TX on the air by next month.

" D " DISTRICT.

Representative: J. S. BAMFORD (G5JB), 22, Walker Street, Edinburgh.

5JB presents a nil report for the whole district, and mentions the fact that he has once again been engaged in changing his QRA, and consequently has not been transmitting.

DISTRICT No. 15.

Representative: H. ANDREWS (G5AS), Ystradgynlais, Swansea.

I have very little to report from my district this month and should like to ask all members in my district to get going and send me along their news.

G5PH has reported that he is now using full wave rectified A.C. and has also found a really good crystal. Best work this month was ECI AB R7, input 4 watts.

G5TJ is very busy with the help of 2AWX testing various H.T. supplies. Just tried BTH 60 watts generator driven by $\frac{1}{4}$ h.p. petrol engine. Excellent results, but due to interference from generator receiving is impossible when generator is running. Will anyone send him information to overcome this trouble?

G2AHN has just been called to join his ship.

G5AS hopes to do a little this month. Best work this month 3rd District Canada, input 6 watts, from T.P.T.G. crystal controlled.

No. 16 DISTRICT.

Representative: C. MORTON (GI5MO), "Simla," Glastonbury Avenue, Belfast.

Conditions during the month appear to have been bad on all bands, and nothing of any importance has been done by any of the stations reporting.

GI6MU, who was at home during Christmas, did some general work on 7,000 k.c. He was also working on 28,000 k.c., but had no contacts owing to bad conditions.

GI2CN is occupied with business, and has little time except at week-ends, when he works on 7,000 k.c.

GI5HN has worked a number of Europeans during the month, including Switzerland and an R3 report from Budapest. The hand generator is going well and all reports give pure dc now.

GI6YM is the wireless section of the Y.M.C.A., at present run by GI5HN. He hopes to have the transmitter working very soon on 7,000 k.c., and reports will be welcomed.

GI6HI has been using an ultra audion circuit on 7,000 k.c., and finds it quite efficient. He complains about the interference on 7,000 k.c. band and suggests the band should be "barred" to fone stations.

GI5OT is still working on 7,000 k.c. GI5WD and GI5MO spent a very enjoyable day with him on January 13, and wish to thank him for his hospitality.

GI6WG has now got going on 14,000 k.c. So far he has only been in contact with European countries, and is waiting for the dx when conditions improve.

GI5WD has spent all month on the 28,000 k.c. band, and has nothing to report.

GI5MO has also been on 28,000 k.c. all month, without results in the way of contacts.

GI6YW finds most of his time taken up with C.B. work, and has only done a little 7,000 k.c. work during the month.

GI2TU is the call of the portable set belonging to the Radio Transmitters' Union (N.I.). It is arranged that a series of tests on 28,000 k.c. will be carried out on Saturday afternoon, February

23, using GI6YW as a fixed home station and endeavouring to make contact with GI2TU from various points. Reports from anyone hearing either of these stations will be welcomed and acknowledged by GI5MO.

GI2WK has nothing to report in consequence of a sprained ankle caused by motor bike kick-starter. I am sorry to hear about this and hope he will soon be quite OK again.

Notes and News from British Dominions.

Channel Islands.

Representative: A. M. HOUSTON FERGUS (G2ZC), La Cotte, St. Brelades, Jersey, C.I.

Little actual work has been done in this area during the past month, but signs are not wanting to show that activity is about to take place. G6PU is rebuilding his whole station, and is going over to H.T. accumulator, and has two generators for sale, I believe. He intends using C.C. G6OX, who has just started a wireless business of his own, tells me that he is very busy, but that he has every intention of restarting again with C.C. G6HZ tells me the same story, with the difference that his business has become so large that he has had to move into larger quarters, and when he will get on the air again depends on a lot of things. However, he tells me that he, too, is going to use C.C. This is F.B., as it means that once all our stations get going again, everyone of them will be using C.C. G2ZC has been carrying out tests with Harmonic C.C., and, thanks to the kindness of G5MU and G6PP, has now mastered the initial difficulties. He has one loose-coupled TX running on 7124 Kc., and the D.C. American type TX is ready to run on 7100 Kc. any day now. WX has been, on the whole, good and when snow seemed to be the order of the day in England we could boast several days here with a sun temperature of around 70, but on such days a marked morning blanket or fading effect is to be noticed here, which does not affect other parts.

Irish Free State.

By COL. DENNIS (EI2B).

Things have been fairly quiet over here during the past month, many stations having been busy in perfecting their arrangements for C.C. on the new bands. Permission to use the 28 mc. band has been refused to all stations who applied for it, which is hard on those stations which have done good work on this band before January 1, but we are still living in hope! We are also hoping that it may be found possible for the Society, in conjunction with foreign amateur organisations, to clear the amateur bands of those commercial and official stations which are at present frequently heard on them. We would like to thank the "BULL" for so kindly publishing the list of our new calls in the last issue.

Now for reports.

3B has been off the air for some time, but expects to be active again soon under the new Transmitters' Section of the W.S.I.

5B has just started up again after the Christmas holidays. He reports only European DX.

6B reports working AG7KAD and TPKW, as well as many Europeans on 7 mc.

8B, using 7 watts to MOPA, has worked EU, EH, and AUTRX, the last being in Turkestan, as well as CT2AA and two W stations.

9B writes that he is still alive, but that business has kept him from the key for some time past, though he hopes to be active again very shortly. He has found the mains at his station impossible, and is looking forward to the maturing of the Shannon Scheme, pending which he intends to use H.T. accumulators. He has been experimenting with a totally screened SG receiver on the 28 mc. and higher frequencies, and is so pleased with the results that he is rebuilding it for use on 28 mc.

4C has nothing to report.

5C has got his crystal going satisfactorily on 7 mc. and is getting good reports.

6C has been very little at the key, having been busy testing his new transformer and working at crystals.

7C reports conditions on 14 and 28 mc. as being very poor. His last QSO on the latter band being AQ1LM in December. On 7 mc. he worked the American ship XW7EFF at Singapore in the afternoon, R3 with 6.6 watts input. He has successfully ground a 7 mc. xtal for use in the 14 mc. band.

8C on 7 mc. has worked FM twice. He also is experimenting with C.C.

2D reports only European work on 7 and 14 mc.

4D is rebuilding his TX for C.C. on 7 mc.

2B on 7 mc. worked two W stations 1 and 2 dists., but has nothing else of interest to report. He has just put up the long-deferred Zepp. aerial, but has not yet tried it out. He again thanks 7C for assistance in collecting most of these reports.

Notes and News from Europe.

Belgium.

By PAUL DE LECK.

Work with XEB4WK, our sailing training ship, *l'Avenir*, has proved to be a success. Every day communication has been realised during the 38 days that took the vessel for going from Antwerp to the Martinica, and signals were always of a good strength with a real good crystal-like note.

XEB4WK and EB4FT got not less than 72 communications together, and 4WX, 4BC and 4AR when time permitting, were of the party.

With the new regulations, good contacts are made with W hams, but till January 15 no other communications are available for report. The fact remains that a step forward must be taken to avoid bad QRM between 'phone and key hams on the 40-metres band.

A QSO has been realised for the first time in Belgium between EB4EA of Antwerp and FBHYO of the Isle of La Reunion, East of Madagascar.

We hope to be able to start soon the 28,000 k.c. band, and shall be glad to try contacts on this band with all amateurs in the world who are testing this new very interesting wave.

Denmark.

By OZ7SE (H. PETERSEN).

For the time of year conditions seem to be rather good and in reality a little better than last year at the same time. A lot of amateurs seem to be off wave, at any rate as far as Europe is concerned.

On the 40-metre band practically all Scandinavian and Central European countries may be heard during the day, and QSO's are easily established. Early in the evening this band is very quiet, sometimes some of the nearer Asiatic countries may be heard, and very weak sigs from South Europe. During the course of the evening Southern European signals increase in strength, and about midnight it is easy to obtain QSO's. About midnight W stations commence coming through.

The 32-metre band was formerly very much used by many Continental countries for European connections, but there is not much to be heard now. DX is not good on this band at present—an exception is the Danish Expedition Ship, *Dana*, which is at present situated near New Zealand. Call, OXQ, he may be heard frequently QSA4. QSO has recently been established by a Danish ham using 12 watts input. Reports highly appreciated.

On 20 metres there is little activity. Only on Sundays in the afternoon is activity noted.

Danish amateurs are becoming more and more interested in the 10-metre band, and I learn that some intend to communicate with the Contact Bureau for tests.

Germany.

By E. REIFFEN.

There is, unfortunately, nothing to report concerning 28 M.C. QSO's, but the interest of German amateurs has been aroused, and we hope that the early results will come to hand in a very short time.

DX conditions on 14 M.C. have not improved since last month, but remain fairly constant. On 7 M.C. it has been possible to QSO all Europe in daylight quite easily, and at night remarkable skip-distance effects take place. From 23.00 G.M.T. it is generally easy to work U.S.A., and W's come in well also in the early hours.

D4DBA has had several good 14 M.C. daylight QSO's with U.S.A., using 120 watts input.

D4CB is on the air again with his 200-watter, and is working DX on 14 M.C.

D4ACX has just started up, and is operating on 7 and 14 M.C.

D4BY was the first German station to get into touch with our Dr. Lamm (4CL—4AFA), who was at the key at WSADM. His input was only 8 watts C.C. D4BY has recently been in communication with 6th and 7th districts U.S.A., and also Uruguay.

The D.A.S.D. would be very glad to receive lists of D calls heard abroad, which will be published in "CQ."

Holland.

By J. H. KOEN, M.Sc.

The end of 1928 brought us a little sunbeam peeping through the thick clouds that darkened the Dutch amateur radio sky. At last our Government has finished some suggestions about a transmitting licence, but I think it will not be until March that the new licence law will come into action. During the first three months of the New Year all experiments remain to be carried out under the old piratical conditions. Most of us now use PA as prefix, followed by the old zero-call. This call, which was a reliable mascot in the past years, is understood to be officially adopted in the near future when licences will be real matters in this country. DX conditions

have been very bad, this strange matter since continuing over three months, is worth to be mentioned. Even old timers don't remember this in the long course of their radio experiments, and even very high-powered people have a poor chance to cross the pond. After sunset only a few Russian, Moroccan and Spanish stations were heard this being the only DX for the average amateur.

It is regretted that the second part of Mr. Megaw's article on "The Valve as an Oscillator and Amplifier" had to be omitted from the last issue of THE BULLETIN owing to unforeseen circumstances. It will appear in the next issue.

QSL Section.

By A. HINDERLICH, G2QY.

The amount of work here has been something awful, chiefly due to the new nationality prefixes. My attention has been irresistibly drawn to the high proportion of out-of-date cards passing through. I seem to be the dumping-ground for rubbish six and nine months old.

These new nationality letters have come to stay, and the sooner we change over to them the better. Please note that I have no use whatever for the old "intermediates"—they merely cause a tremendous lot of extra work. Those of you who have not already done so, please make out your cards for the stations you worked last year, and send them along. As for the few foreign stations who have not yet changed over, isn't it about time they were told they are using "pirate" calls?

There should be only one single way of addressing cards. For example OZ7BB. The OZ part means Denmark, so there is no need to write "Denmark" or "Danish." The figure shows that the call is an amateur one, and the rest is up to the foreign QSL section.

Will B.R.S. stations note that we do not, as a general rule, forward cards to any but amateur stations? (See previous paragraph.) A list of "commercial" stations who desire to work amateurs will be found in the call-book—it is extremely unlikely that the others have any QSL cards to send.

QRA Section.

By M. W. PILPEL G6PP.

54, Purley Avenue, London, N.W.2.

Several more countries have changed their call-signs in accordance with the Washington regulations. Polish stations are now using the letters SP, the figure 3, and the last two letters of their old calls, thus old TP3AR now signs SP3AR, etc. South African calls have also been altered, from the familiar FOA3A, etc., to ZS or ZT, one figure and one letter. Contrary to the notes on page 150 of last month's "BULL.," Australian stations have been heard using VK.

As soon as things get settled down, I shall endeavour to prepare a full list of prefixes in use by amateurs, but it would be very difficult to do this at present, when some countries are still using the old I.A.R.U. intermediates and show no signs of relinquishing them. Russia, for example, is apparently sticking to EU, while Frenchmen, particularly the unlicensed crowd, show great reluctance to abandon EF for F. Until cases of this sort are definitely settled, it is useless to compile a list which might easily become obsolete before it gets into print.

QRA'S WANTED.—Has anyone authentic information concerning the following? Published addresses are incorrect: G2CL, G2FH, G2FS, G2HF, G2QT, G2VZ, G6MD, HOP.

Correspondence

SIR.—Now that the use of raw A.C. is expressly forbidden by those countries who are parties to the Washington Conference agreement, so far as amateurs are concerned, is it not time that we amateurs took some steps to discourage the use of R.A.C. amongst those who still persist in using it.

Some time ago it was suggested in the T. & R. BULLETIN that all R.A.C. stations should be boycotted, and while hardly falling in with this suggestion, I would like, however, to point out that the best way would be for us to make a point of not answering R.A.C. replies to our test calls, and not answering R.A.C. CQ's, or of taking every opportunity of pointing out to the stations concerned the jamming they are causing in a band already quite full enough.

If they could only be convinced of the selfishness of using R.A.C., and provided that they were "Hams," the air would soon be free of all band-saw effects.

We amateurs in the Channel Islands, being nearest to the Continent, suffer most from R.A.C.

I refer to the 7 M.C. band, which is our most useful one at the moment, and perhaps C. B. might take up the matter.

Another point. Why is it that when we get a good service of calibration waves sent out, lots of amateurs do not seem to take the trouble to take them, and what is more, spoil the reception of those who take them by transmitting during the time they are being sent. Might I suggest that we amateurs who take them each time they are sent log those stations who jam the service, report same to R.S.G.B., who, if they get confirmation from more than three stations, take steps to write to the station concerned, and point out the complaint. I am sure no "Ham" would willingly jam such a useful service. The last transmission was completely spoiled here by fone and C.W. stations, and I am sorry to add that they were all British.

How about C. B. forming a group to deal with "minor offences" such as "off wave," "jamming calibration," "R.A.C.," etc., who could be entrusted to deal with the offenders in a tactful way, by offering a helping hand rather than of a "telling off"?

If any refused the helping hand, then the G.P.O. would be given the case to deal with, where G stations were concerned, or the authority in the case of foreigners.

A. M. HOUSTON FERGUS (G2ZC).

La Cotte, La Moye, Jersey, C.I.

DEAR SIR.—Just a little information regarding the activity of my station, VK2NO.

The station is in the process of merging with VK2AW at that address, which is c/o Mr. A. W. Dye, 44, Martin Road, Centennial Park, Sydney. Both call signs will be used from four or five standard frequency operating on the new frequencies.

The two main transmitters will use crystal control mostly on 14,000 and 7,000 kc. with an input of 200 watts.

The standbys will be self-excited TPTG with DC supply, also with 200 watts.

A great deal of experimental work will be done in connection with television and the station will, when complete, be one of the largest and most up-to-date experimental stations of the world. For contact with Great Britain, we shall concentrate on 14,000 kc., so any British transmitters hearing and working with VK2AW and VK2NO will know that they are two operators at the same station.

All good wishes to the BULL., and may we enjoy many yarns over the air.—Yours faithfully,

DON B. KNOCK (VK2NO),
Associate Technical Editor,
Wireless Newspapers, Ltd., Sydney.

DEAR SIR.—I should be very pleased if you publish the following notes in the BULLETIN.

Radio CT1BR is working on fone, but has not yet had a QSO with a G station. He asks phone stations to look out for him on the 42-metre band. He uses a modified Meissner transmitter with 50-60 watts input.

QRA is J. Pereira da Silva, R. José Falcao 144, Porto.

Radio EU3AM wishes to exchange station photographs, and says that photos will be printed in the Russian short-wave paper, *Paano Bcem* if two prints are sent.

QRA is W. Nelepez, Sagorodny pr. No. 27 log 13, Leningrad 2, U.S.S.R.

Radio D4SM would like to work with British stations using phone or C.W. on 42-metre band. Reports also would be appreciated, as this station is QRP.

QRA is near Saarbrücken, Germany, and reports should be sent via DFTV or via BRS90.—Yours faithfully,

T. COOKE PLATT (BRS90).

SECURING GLASS RODS TO FEEDER WIRES.

DEAR SIR.—With reference to your editorial note at the foot of page 148 of January BULL., the following method of attaching glass

spreaders to feeder wires was used by me, and will, I think, be found neat and satisfactory. Heat the end of the glass rod in the flame of a spirit lamp, then roll it on the end of a stick of Chatterton's Compound until it is well coated for a length of about one inch, and allow it to get cold. Then take a piece of copper wire about 20 gauge and six inches long, and take one turn tightly round the rod at about a quarter of an inch from the end. Heat a stick of Chatterton and apply it to the end of the rod so as to completely cover the turn of wire, then hold the whole in the spirit flame, turning it, to ensure that the Chatterton runs into a solid mass and allow the Chatterton to become quite hard. The glass rod can then be laid across the feeder wires and five turns of the No. 20 wire wound closely and tightly round the feeder wire at each side of the glass rod, any spare being finally cut off. Incidentally is it advisable, as has sometimes been recommended, to varnish the glass rods? All "shellac" varnish is by no means incapable of absorbing an appreciable quantity of moisture, and even were this not so, a varnished surface is much more likely to collect and retain dirt in exposed situations.

M. J. C. DENNIS (EI2B).

*It is advisable to varnish the glass rods as the surface formed by good shellac is definitely less hygroscopic than that of the glass.—Ed.]

Calls Heard.

By G5WQ, W/T. Op., S.S. *Calchas*, January 5-7. Position of S.C. *Calchas*, January 5, off Cape Bon, Tunisia, bound Port Said. All on 7 mc. band: G—2hp, 5ey, 5da, 5lw, 5ml, 5tz, 5ub, 5cl, 5dg, 5dh, 5fa, 5gc, 5hj, 5hp, 5ia, 5pp, 5rw, 5wn, 5wo, 5wy, 5xb, 5xg, 5yc, 5yl. GI—5hu, 5ui.

EXCHANGE & MART.

Rates 1d. per word, minimum 1s. 6d. Front line in capitals if desired. 2d. per word where all capitals are required. Minimum 3/-.

TANTALUM AND LONIUM.—Make your own Battery Chargers for alternating current. Simple, reliable. Lionium Rectifying Electrodes, 2-4 amps., 10s., 5-10 amps., 15s. Also Transformers, Blue Prints, 1s. each, and complete Chargers.—BLACKWELL'S METALLURGICAL WORKS LD., Liverpool.

FOR SALE.—MARCONI D.C. H.T. GENERATOR, coupled to 1/6 H.P. 200 volt 50-cycle motor; output 550 volts, at 40 milliamps; pure D.C.; offers.—5GQ, 5, Pollards Hill South, Norbury, London.

"ALWAYS" RESISTANCES.

PATENTS obtained, Trade Marks and Designs registered, British and Foreign.—GEE AND CO., Patent and Trade Mark Agents (H. T. P. GEE, Member R.S.G.B., A.M.I.R.E.), 51-52, Chancery Lane, London, W.C.2. Telephone: Holborn 1525.

D.C. H.T. Generators, 600 volts, 80/100 m/a, 48/-; 960 volt ditto, £8; Armatures, 30/-; Fields and poles, 10/-; 2,000 volt, 500 m/a Newton Generator, £25; Newton 1,500 volt, 100 m/a, £15; Osram Valves, 1,200 volts, 40 m/a, 4/6; Cossor Rectifier, 1,000 volts, 4/6; Marconi D.C. 1,000 volt Generator, coupled to 100 volt D.C. motor, output 1,000 volts, at 40 milliamps, pure D.C., £15.—ELECTRADIX, 218, Upper Thames Street.

Q.S.L. Cards, various designs. New Q signs. Send for samples.—G6MN., Worksop.

WANTED.—MICROPHONE AND TRANSFORMER; must be matched and in perfect condition; Sterling preferred.—Send price and particulars to G5VM, 199, Russell Road, Moseley, Birmingham.

THE OSCILLATING XTAL CO.

WE LEAD THE WAY.

OTHERS FOLLOW.

STANDARD CRYSTALS - **20/-**

HEAVY DUTY CRYSTALS - **30/-**

We Welcome Enquiries.

88, DE FREVILLE AVENUE, CAMBRIDGE.

**1250 mfd's in a case
only 5 inches high!**

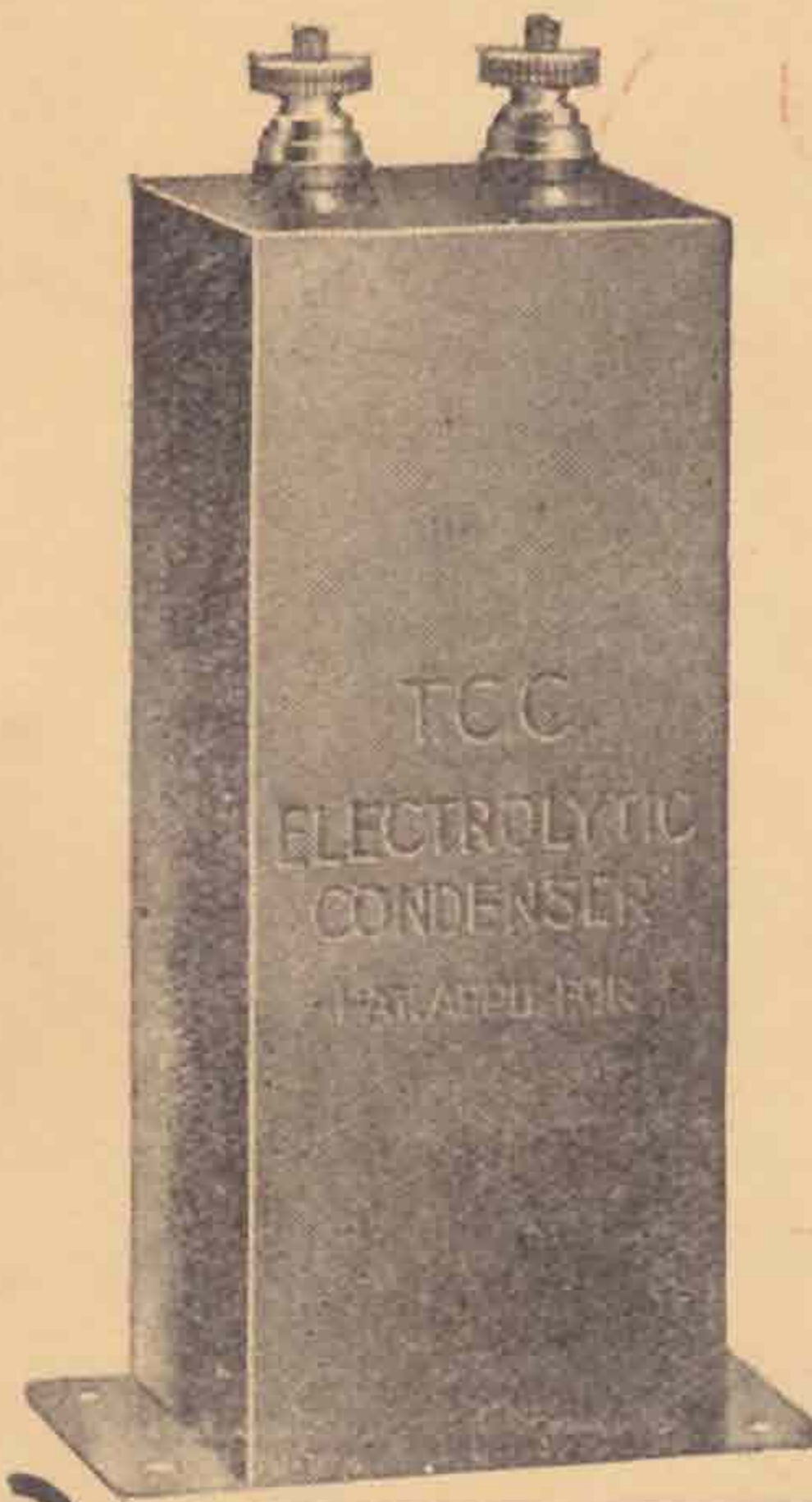

A GAIN T.C.C. leads the way with the first All-British Electrolytic Condenser. If you are building a Low Tension Eliminator you need this wonderful new Condenser. Its enormous capacity of 1250 mfd's smooths out the last trace of ripple and hum from the mains and gives the filaments of your valves that smooth unfluctuating current that ensures perfect reception upon a background of dead silence.

**T. C. C.
ELECTROLYTIC CONDENSERS**

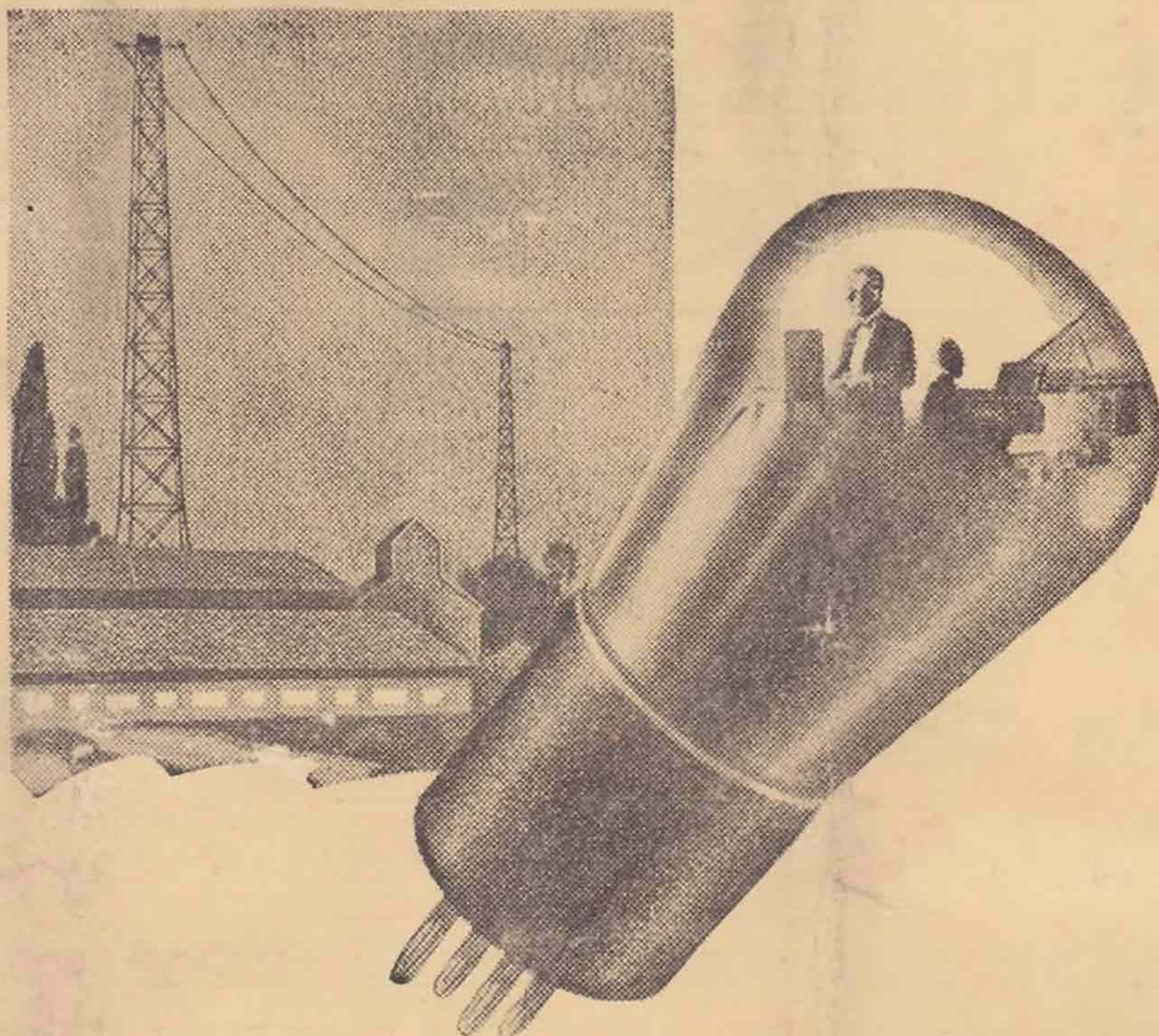

CLARITY

CLEAR, perfectly defined radio; every note, every intonation re-created for you with life-like realism. Between the far distant broadcasting station and your own fireside, Mullard P.M. Valves form the perfect link.

The tone they give you—the volume—their sensitivity to distant stations—Mullard P.M. Valves make an old radio set modern and a modern set perfect.

Your receiver is as good as your valves; your valves are as good as their filaments—and the Mullard P.M. Filament is unique.

Get a set of Mullard P.M. Valves to-day—all radio dealers sell them. Put them in your receiver and enjoy better tone, greater volume and keener sensitivity.

Mullard

THE MASTER VALVE

DVT. THE MULLARD WIRELESS SERVICE CO. LTD. MULLARD HOUSE, DENMARK STREET, LONDON, W. G. 2
Ark