

# T. & R. Bulletin

Incorporating

## The Journal of the Inc. Radio Society of Great Britain

(BRITISH EMPIRE RADIO UNION)



Vol. 3. No. 12. June, 1928 (Copyright)

Price 1/6

### The first essential of any set!

# CYLDON

### VARIABLE AIR SPACED CONDENSERS

They have been rightly described as "A Supreme Example of Scientific Engineering." There is a type for every purpose, each built to the "Cyldon" standard of perfection, each a means of obtaining better results. Make no mistake. "Cyldon" Condensers are an essential to perfect reception. The "Cyldon" Short-Wave Condenser is specified in the Short-Wave Receiver described in this issue.

### "CYLDON" SHORT WAVE CONDENSER

The "Cyldon" range of Short-Wave Condensers is the result of exhaustive research and experiment. The pigtail is air-spaced so that it will not touch its own turns when rotated. The frame is widened out considerably so that the vanes are spaced much further from the end plates than in the ordinary standard condensers.

The "Radion" dielectric is right outside the electrostatic field as in the standard "Cyldon" models. The assembly includes a long bronze bearing with  $\frac{1}{4}$  inch diameter thrust face, precision ground spindle, and thick skeletonised end plates.

### PRICES:

(complete equipment as illustrated)  
.00015, 15s.; .00025, 16s.; .0001,  
14s. 6d.; .0002, 15s. 6d. Price  
includes extension handle, etc.

Extension rod, bracket, panel bush, nut and spindle can be supplied separately at 3s. 6d. per set.

Write for FREE Booklet "Concerning Variable Condensers," and Booklet of 6 selected Circuits, enclosing 3d. in stamps for postage.

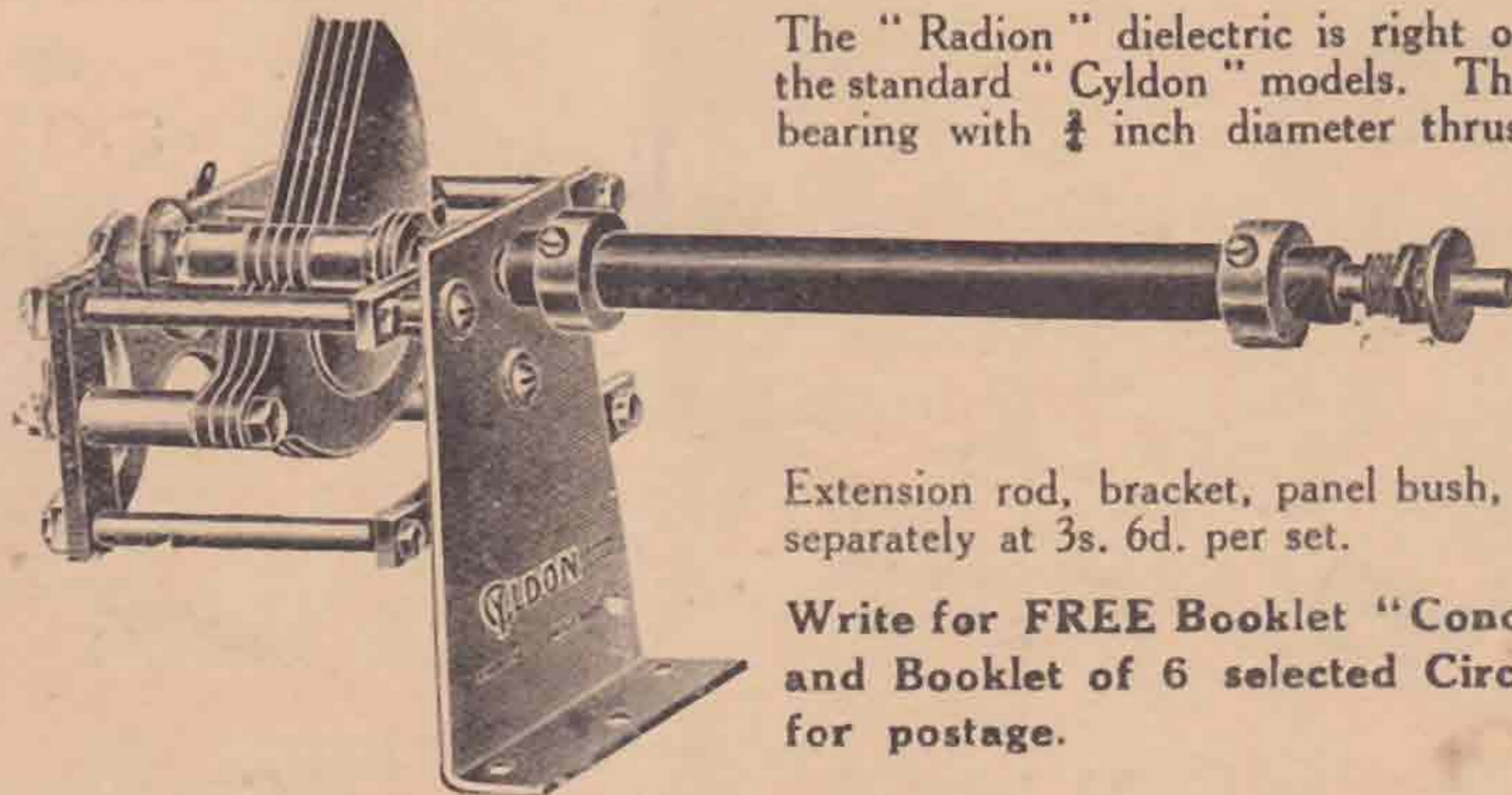

SYDNEY S. BIRD & SONS, Cyldon Works, Sarnesfield Road, ENFIELD TOWN, MIDD.  
Telephones: Enfield 2071-2. 'Grams: "Capacity Enfield."

# FERRANTI TRANSFORMERS

**R**ADIO ENGINEERS—*everywhere*—both professional and amateur, have expressed highest praise of Ferranti Transformers, and use them exclusively. They are by test the World's *best*. No other Wireless Transformers have such high primary impedances. Ferranti have over forty years' experience as designers and builders of all types of transformers. That vast experience coupled with scientific research is applied to Ferranti Wireless Transformers. Every foot of the miles of enamelled wire in each is *tested*. Before a completed Ferranti Transformer is marketed it is submitted to eleven special tests.

## PUSH-PULL TRANSFORMERS

These are similar to our standard A.F. and O.P. types. They are provided on their secondary and primary sides respectively with centre, tapings—and in consequence the

windings of the Push-Pull O.P. Transformer have been suitably increased. Push-Pull Amplification gives loud and pure Speaker tone, devoid of harshness or "blast."

*It's BETTER if made by FERRANTI!*



**PRICE 32/6**

### AUDIO FREQUENCY

AF5c. Ratio 1-3.5

Price

**32/6**

### OUTPUT TYPE

OP3c. Ratio 1-1

Price **23/6**

OP4c. Ratio 25-1

Price **23/6**

*Send for catalogue. Ask your dealer to supply you, or write us.*

**FERRANTI LTD., HOLLINWOOD, LANCs.**

C.F.H.

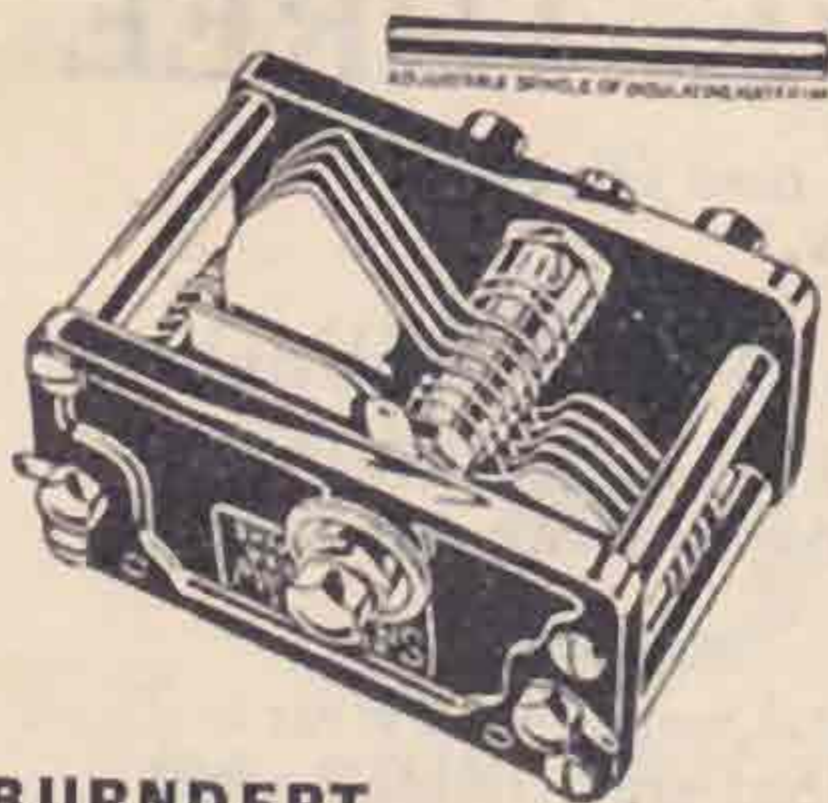

**BURNDEPT  
VARIABLE CONDENSERS.**

These condensers are entirely free from hand-capacity and are safest for "all-mains" receivers, because of the insulated spindle. They give improved signal strength.

PRICES: "Square Law" .0001 and .00007 mfd., 13/6 each.

"Log Law," .0003 and .0005 mfd., 15/- and 15/6 respectively

**For best results in any set you build, select BURNDEPT Components**

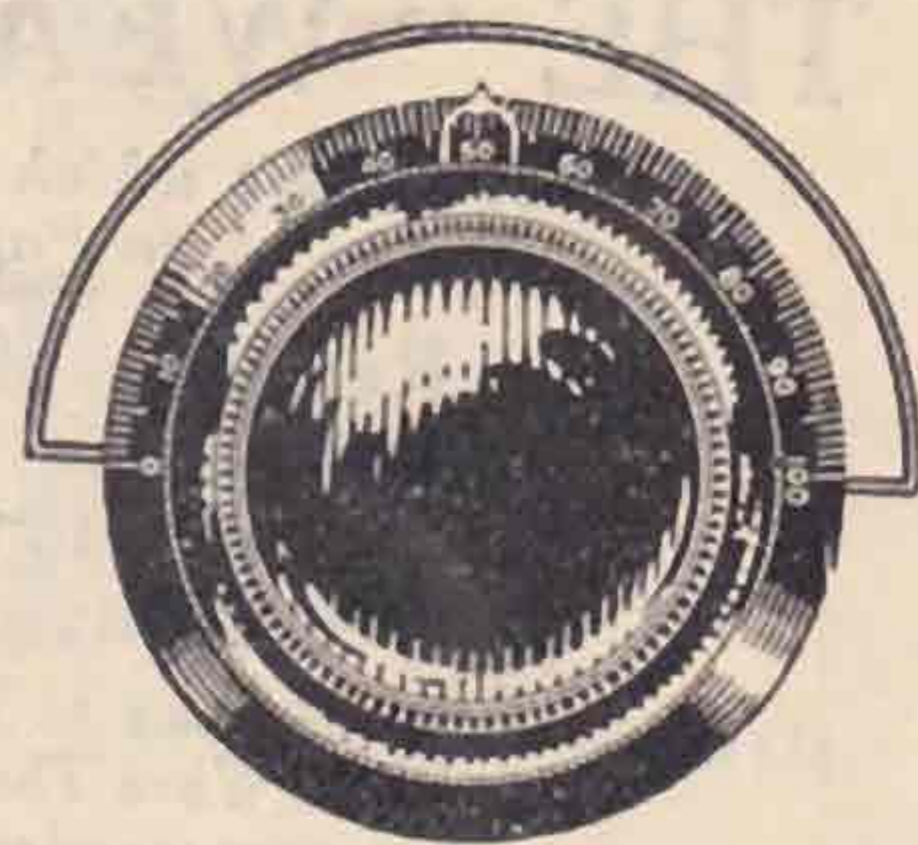

**ETHOVERNIER DIAL**

In any selective set needing fine adjustment the BURNDEPT Ethovernier Dial is an essential component. Fits any condenser. 18-1 reduction Direct drive for rapid searching. *This attractive component is mentioned editorially on page 21 of this issue of the "T. & R. Bulletin."*

PRICE: complete with Etholog and Card Scales ... .. 9/-

Offices:

**BLACKHEATH,  
LONDON, S.E.3.**

**BURNDEPT**

London Showrooms:

**15, Bedford Street,  
Strand, W.C.2.**

A.J.W.

**TANTALUM**

Sheet and Strip for  
**RECTIFIERS**

Immediate Delivery

**LIONIUM**

New Rectifying Alloy  
in rods with terminals.

No. 1. charges 2-4-6 volt acc. at 2-4 amps.

No. 2. charges 6-12 volt acc. at 10 amps.

Safe—Simple—Efficient.  
Practically everlasting.

Blueprints supplied, also transformers and complete chargers.

**Blackwells Metallurgical Works  
Ltd.**

**The Albany, Liverpool,**

**8 to 80 metres**

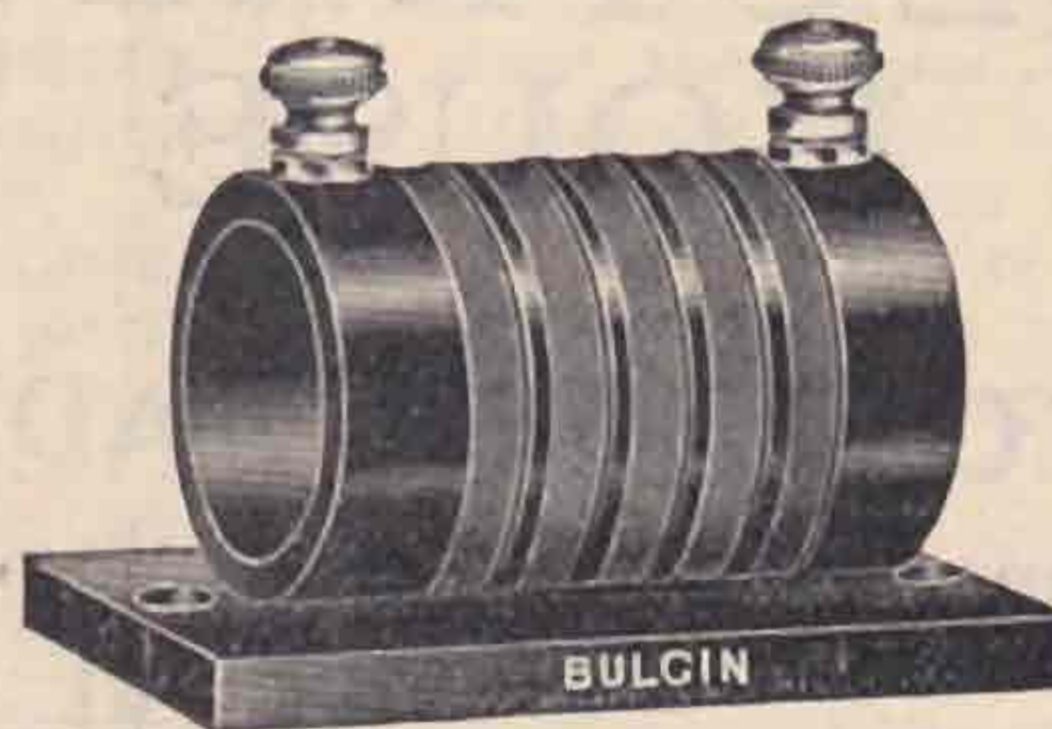

**A SHORT-WAVE CHOKE**

When working at frequencies in the neighbourhood of 37 millions, efficiency counts for everything. This Bulgin Short-Wave Choke is just what you have been wanting. Scientifically designed and sturdily constructed of high-grade materials, this H.F. Choke carries the usual Bulgin guarantee of complete satisfaction.

PRICE **3/-**  
EACH *This choke is only one of over 250 guaranteed Bulgin Products. A post-card to-night will bring you our complete illustrated catalogues free by return.*

**A. F. BULGIN & Co.** 9, 10, 11, CURSITOR ST.,  
CHANCERY LANE, E.C.4

# THE "WEARITE" SHORT WAVE THREE

The circuit which is employed in this receiver is the one described and illustrated on Page 3, MARCH issue, of the "T. & R. BULLETIN."

Readers of the "T. & R. Bulletin" in any part of the World have in this receiver an instrument that will enable them to pick up and report accurately to their overseas friends the quality of transmissions and the results of special tests carried out.

In addition to the interest of "Listening-in" on Amateurs' experimental work the "Wearite" Short Wave Three will give you the full pleasures of the general broadcast entertainments sent out over wavelengths between 20 and 1,800 metres.

This great variation in range is obtained primarily through the efficient, low-loss plug in system employed, which includes the use of a standard "Wearite" H.F. Choke.

Running costs are low, the set is moderately priced and is of sound design. One stage of H.F. amplification is used, followed by a Detector (with reaction) and one stage of L.F. amplification. The reception on both broadcast bands is all that one can desire, and the sensitivity combined with selectivity is most marked.

**PRICE £16 16s. 0d.**

(Royalties extra.)

The set is contained in a well constructed Oak cabinet.

Price does not include coils or valves.

Sole Manufacturers:—

**WRIGHT & WEAIRE LIMITED,**  
740, HIGH ROAD, TOTTENHAM, LONDON, N.17, ENGLAND.

Telephone: Tottenham 3132.

Telegrams: (Inland) "Writewea, Tottlane, London." (For ign) "Writewea, Londor."

Write for  
Illustrated and  
fully descrip-  
tive "Leaflet  
S/W3."

Come to

## ELECTRADIX HOUSE

for everything.

### ELECTRADIX RADIOS

218 Upper Thames St., London, E.C.4

Telephone: City 0191

### "T. & R. Bulletin."

#### ADVERTISEMENT RATES.

| Per insertion. |        | Per insertion. |         |
|----------------|--------|----------------|---------|
| Full Page ..   | £5 0 0 | Half Page..    | £2 10 0 |
| Quarter Page   | 1 5 0  | Eighth Page    | 0 12 6  |

Series Discounts—5% for 6 or 10% for 12 consecutive insertions.

Advertisements specified for *Facing Matter Positions* are not subject to series discounts.

The T. & R. BULLETIN is published on the 14th of each month. Orders, Copy and Blocks should be received by us on the 25th of each month preceding month of issue.

All applications for space or specimen copies should, please, be sent to Advertisement Manager,

**PARRS ADVERTISING, LTD.,**

Craven House, Kingsway, W.C.2.

Telephone: Holborn 2494.

## ANNUAL LOG BOOK, 1928

### NOW READY

Complete List of Amateur Call Signs.

Price: MEMBERS, 3/- NON-MEMBERS, 4/-

THE INCORPORATED RADIO SOCIETY OF GREAT BRITAIN,  
53, Victoria Street, London, S.W.1.

# TRAR

## BULLETIN.

*The only British Wireless Journal Published by Amateur Radio Experimenters*

**Officers and Council for year 1928.**

*President* : CAPTAIN IAN FRASER, M.P., C.B.E.

*Acting Vice-President* : GERALD MARCUSE (2NM).

*Hon. Treasurer* : E. J. SIMMONDS, Member I.R.E.,  
F.R.S.A. (2OD).

*Hon. Secretary & Editor (pro tem.)* : H. BEVAN  
SWIFT, A.M.I.E.E. (2TI)

**COUNCIL :**

O. F. BROWN, M.A., B.Sc.; G. F. GREGORY,  
A.M.I.E.E., A.M.I.M.E. (5PZ); A. HAMBLING,  
Associate I.R.E. (2MK); J. F. STANLEY, B.Sc.,  
A.C.G.I.; Flight-Lieutenant DURRANT, R.A.F.;  
K. ALFORD (2DX); E. DAWSON OSTERMEYER  
(5AR); Captain K. HARTRIDGE; R. F. HIBBERD,  
Member I.R.E., F.R.S.A.

JUNE, 1928.

Vol. 3. No. 12.

## SOCIETY NOTES

Our principal feature this month is our own Annual, which has at last materialised and is now in many of my readers' hands. Many are the praises we have received from every quarter, commenting upon its usefulness and the fact that as soon as copies are delivered from the binders, they drift out to fill various orders. That the work is appreciated is perhaps best shown by the fact that orders have been executed for certain classes of customers who you would hardly credit would apply for an amateur-produced work. It is perhaps the most ambitious issue the Society has ever issued and reflects great credit on those responsible for its compilation. One or two errors have been already pointed out to us, but of course such matters are unavoidable. They will stand together with all additions for insertion in our first supplement sheet.

\* \* \*

Again we must remind our members that if they have not already obtained their copy, they should do so without delay or they may be disappointed in finding the issue sold out. We are unable to make any guarantee of a further reprint beyond the present edition, so if you wish to have a copy before all are gone, please send your order at once.

\* \* \*

We have received many comments upon our campaign, initiated last month, to ban unrectified alternating current for transmission purposes. The vast majority cordially agree with us and endorse every sentence of 5IS's article and our own editorial note. The few dissenters who have written are

obviously those whom the matter hits, more or less. Their arguments, however, are so weak that we still maintain our first opinion, that Raw A.C. must go. It is hopeless to expect to work upon the new limited bands if a few are going to monopolise the whole region. We almost wonder whether our correspondents have given the matter their unbiased consideration. It almost makes us wish at times that QSL cards had never been invented. Anything to get them, no matter whether anybody wishing to do experimental work can carry out his tests or not. Still, collecting things appears to be one of the heritages of humanity, from the schoolboy who collects numbers of locomotives and tramcars, to the antiquarian. So I suppose the collection of QSL cards must go on, but Raw A.C. must stop, and our recommendations upon this point, endorsed by the special sub-committee dealing with the subject, have already gone forward to the authorities.

\* \* \*

One of our best-known transmitters had the shock of his life the other day. He substituted his bank of grid bias accumulators for his H.T. generator and found he could work more stations and get R7 replies where he could only raise R3 before. Nuff sed!! No, we are not going to mention any names.

\* \* \*

Once again we must express our opinion upon the quality of certain components now being offered to the public for the making up of broadcast receiv-

ing sets. Hardly a week passes by but we are asked to look at some set which either will not work or produces indifferent results. It has become quite our practice to condemn certain of the components straight away, and when these are replaced by others of good make, the sets generally work without further trouble. How people expect to obtain articles of any value at about one quarter the cost charged by reputable firms, we cannot understand. In one set recently inspected, the smoothing condenser across the high tension battery had a dead short circuit in it. One valve holder had the connection missing between the grid terminal and the socket, and so on! No doubt the great demand for cheap radio parts is the cause of all this trouble, for there will always be unscrupulous dealers ready to cater for the public desire.

\* \* \*

We take this opportunity of congratulating Mr. Allen on the success of Contact Bureau. His report this month shows us clearly that such an organisation was very badly needed and we look forward to the time when every active transmitter and receiving enthusiast will be a member. The "Budget" idea, which is credited to Mr. Dedman (2NH), is worthy of our special notice and we hope that these most interesting dossiers will be carefully preserved, so that when their useful life is ended they may be kept as historical mementos of our most illustrious art.

\* \* \*

To Mr. Courtenay Price, the South-Western area manager, we offer our congratulations on the success of the first Conventionette to be held in his area. We understand that another is contemplated before the year is passed.

\* \* \*

The many friends of our vice-president, Mr. J. H. Reeves, will be pleased to know that he has made a fine recovery from the serious illness and operations which he underwent last winter. He was able to be present at the Bristol Convention.

\* \* \*

Our hearty congratulations are extended to Captain G. Courtenay Price and the men of the South-West for their first Convention. Although we were prevented from attending personally, yet we were ably represented by our acting vice-president, Mr. Marcuse, together with 5AD and 2QY, and from their lips we have had glowing accounts of the proceedings. It would appear that the Bristol Society acted as hosts and laid themselves out proud to show what could be done in the way of hospitality. The day seems to have been a great one, and included a visit to the Post Office Station, GKU, six or seven miles outside Bristol. A procession of overflowing charabancs and private cars composed the transport. A meeting followed on the return to Bristol, while the day's proceedings wound up with dinner. We have been blaming ourselves ever since for not having been able to go and enjoy the good fare which the Bristol Society provided.

\* \* \*

The Northern, East Mid-Britain and S.W. Britain Sections have all had their Conventionettes, and we

are pleased to note that the West Mid-Britain area are considering holding one. But what about the other areas? We all know how Irishmen are experts in the organisation of all kinds of social gatherings, while what place could be more attractive during the summer months than "Edinboro's fair city" for the rendezvous of the "Hieland Hams"? We can assure those who have already tried it that Conventionettes are just the thing to stabilise and put life into a flagging set of radio men. They are brought together and get to know each other in a manner never gained by simple key work. May we commend the suggestion to their notice as an excellent idea?

## A Visit to Bristol.

By 5AD.

Upon the 19th of May, in company with our worthy Vice-president, 2NM and 2QY we journeyed to Bristol and were met by a contingent of the Bristol gang, who took us in cars to the first meeting place, where we found 6BR, 6ZR, 2OP, the Area Manager, 6WQ, and a host of cheery people. They packed most of us into charabancs which were filled to overflowing to such a degree that I escaped and found a more comfortable corner in 6UG's car. We all then went off for a glorious ride of 6 or 7 miles to GKU, the Post Office station, where we were all welcomed by the C.O. (HI), and were shown over the station, the hams casting envious eyes at nice 250-watters all nicely stowed in racks.

The Post Office Station, GKU, which practically faces the Atlantic, has three aerials supported upon steel lattice masts 250 feet high. The station is under remote control from Burnham, twenty miles away, and operates upon 2,000 metres. The power of each transmitter can be varied between four to twenty kilowatts and they are driven by tuning fork control.

Note.—Big pockets were barred.

Leaving GKU we returned to Bristol for tea, and then a meeting where a lecture on "Sound Waves" was well attended (and illustrated).

To finish the day a dinner was given at St. Stephen's Restaurant, where we met some more of our radio freinds and wound up a most interesting day.

May I add that all the arrangements were made and expenses borne by the "Bristol Radio Society," and to them I extend my congratulations and thanks for the hospitality they afforded us.

5AD.

## Forthcoming Events.

JUNE 20. Lecture I.E.E., 6 p.m.  
J. A. J. COOPER. "Radio Telephony."

JULY 17. London Hamfest, 6.30.  
Pinolis Restaurant, Wardour Street,  
5/-.

SEPT. 28-29. Annual Convention.

# The R.S.G.B. Amateur Band Receiver.

By R. L. ROYLE (2WJ).

(Continued from May Issue, Page 4.)

The aims and objects of the receiver having been outlined in the previous issue, we now turn to the constructional details.

### METAL CONTAINER.

As previously stated, the whole receiver, including batteries, is contained in a metal box. The object being, of course, to provide complete screening from all extraneous influences, as well as to obviate any chance of body effect. The construction of the box is quite a simple matter. The metal chosen for the purpose is aluminium, mainly on account of its lower cost and weight. Other metals, such as copper or brass, can, of course, be used if preferred, although of course the cost will be greater. Using the aluminium, the following will be required:—

Two pieces of hard rolled aluminium 1/16th inch thick, 21in. by 10in.

Two pieces of hard rolled aluminium 1/16th inch thick, 14½in. by 10in.

One piece of hard rolled aluminium 1/16th inch thick, 14½in. by 9in.

One piece of hard rolled aluminium 1/16th inch thick, 15in. by 21½in.

Four pieces of right-angle aluminium 1in. each side, 10in. long.

Two pieces of right-angle aluminium 1in. each side, 9in. long.

The whole of the above can be obtained from the British Aluminium Co., 34, Banner Street, E.C.1, who will on request carefully cut all the pieces to the exact size required. Owing to the thickness of metal used and the fact that it is hard rolled, it is almost impossible to cut it nicely with ordinary shears, and constructors are well advised to obtain the material cut to size on a guillotine. The base of the set consists of a piece of oak or other hard wood ¾in. thick, 21in. by 14½in. This is faced with thin sheet copper, the edges being neatly bent over the sides of the wood.

The two pieces 21in. by 10in. form the back and front and the two 14½in. by 10in. form the ends. The piece 14½in. by 9in. is the division from front to back. The piece 15½in. by 21½in. forms the top. The latter is secured in position by four studs rising from the base in the corners. Four corresponding holes are made in the lid and nuts (preferably of the wing type) used for fixing. All the necessary holes, including those for the condensers, jack, aerial and earth terminals are drilled before assembly. The aluminium sheets are fixed to the baseboard by wood screws, the angle pieces being bolted to the corners outside with 5BA brass screws and nuts. Finally, the centre shield is fixed in position by the same means.

### COIL CONSTRUCTION.

Fig. 1 shows the construction of the coils which are wound upon Becol formers 3in. in diameter and 6in. long. These must be carefully grooved six to the inch and to a sufficient depth to securely hold the No. 18 gauge wire in place. It will be noticed that the coils are of the plug-in type. The ebonite pieces forming the bases of the coils to hold the pins and the socket bed should be drilled together through a steel plate jig which will ensure uniformity and render it possible for further coils to be constructed at any future time for other wavebands. It is also essential to hold the drill perfectly vertical when drilling the holes. To get the coils to slip into position easily so that all six pins make good contact requires a little careful workmanship, and it is well not to hurry over this part of the work. If one of the sockets and pins do not coincide, it will be impossible to insert the coil in place without damage. The pins and sockets are of the ordinary type now easily purchasable for plug-in coils.

### DATA FOR WINDING COILS.

| Kilocycles  | Metres      | Aerial L1 | Grid E2 | Reaction L3 |
|-------------|-------------|-----------|---------|-------------|
| 7000—7300   | 41.07—32.83 | 3         | 18      | 7 turns     |
| 14000—14400 | 20.82—21.43 | 3         | 7       | 3 "         |

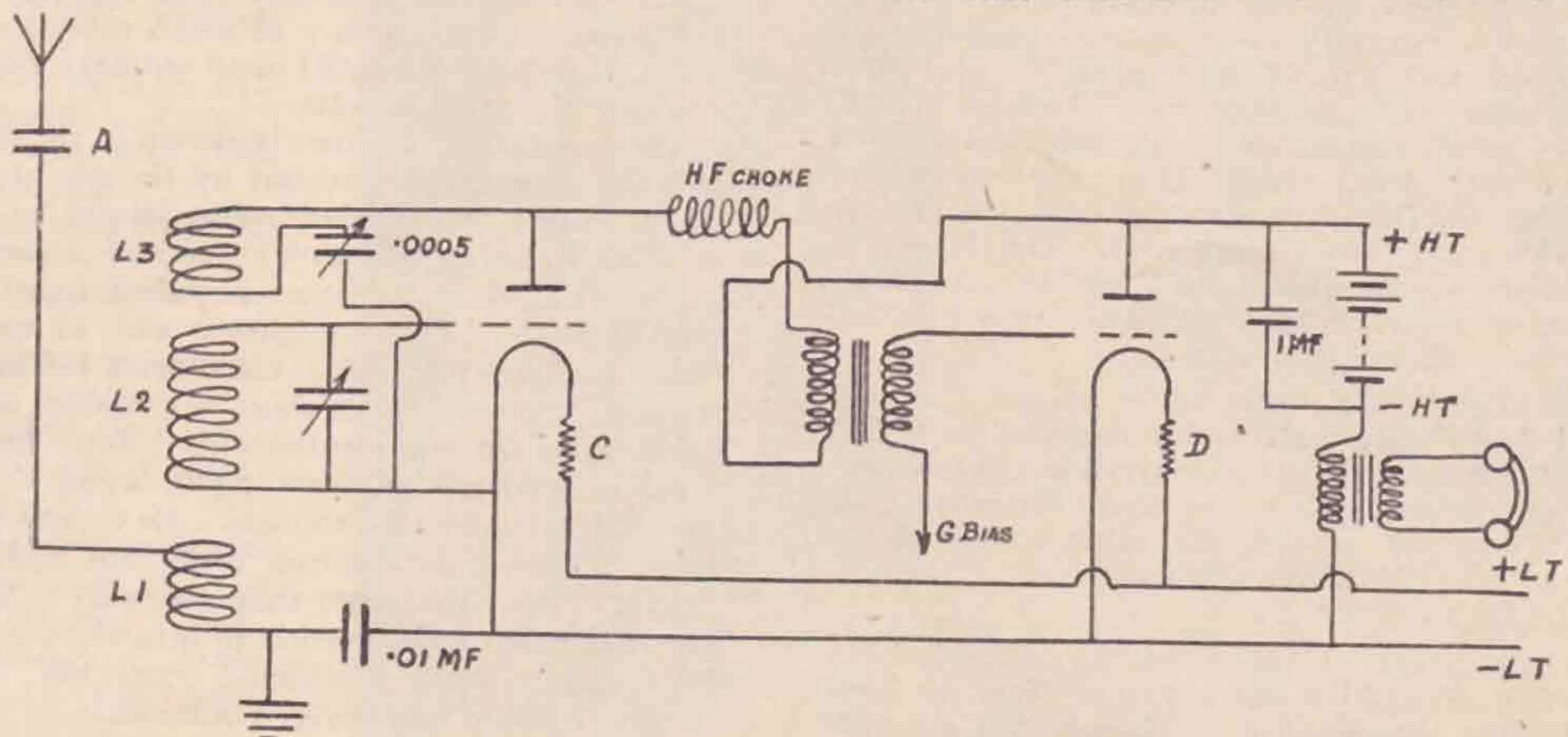

Using the above number of turns on Becol formers with the single-plate condenser to be described, the required wavebands are nicely covered with a small overlap at each end of the scale.

#### AERIAL COUPLING.

The aerial terminal is mounted on a small ebonite plate which is fixed by 5BA screws and nuts over a 1-in. hole cut in the side aluminium panel. The coupling condenser which is connected to the aerial coil has been kept small in order to avoid frequency change due to body capacity to the aerial lead. It would, however, be possible to use a larger condenser, or even dispense with one altogether, and much stronger signals will be obtained by so doing, but this will be at the expense of stability.

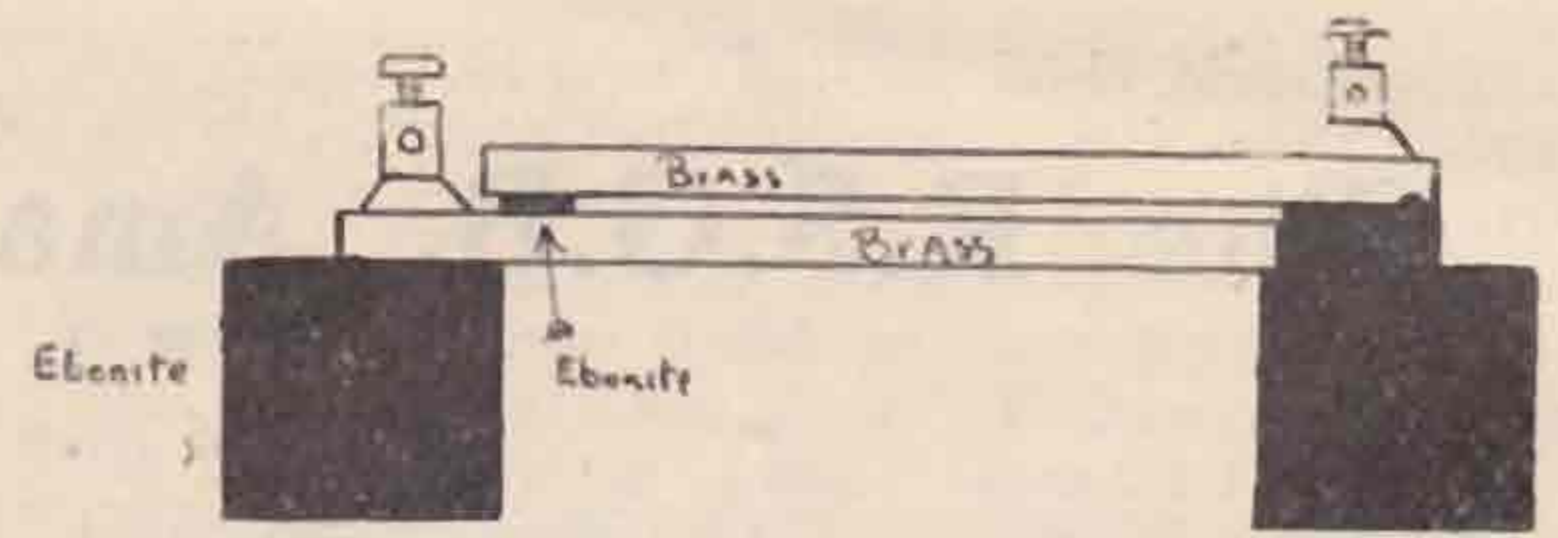

compartment, together with the batteries, and follows standard practice, except that the primary and the telephone transformer used is connected in the lead from the negative side of the H.T. battery (see Fig. 2 diagram of connections). A further point is that the headbands of the phones are earthed to the aluminium box by a length of single flexible cord bound in with the ordinary cords. This is a most important point to observe for avoidance of body capacity.

#### GENERAL NOTES.

"Amperites" are used in place of the usual filament resistances. In ordering these care must be taken to see that those obtained are suitable for the valves used.

It will be noticed that anode bend rectification is used for the detector, although grid condenser and leak can be used if preferred. This latter will give a slight increase in signal strength, but the anode bend system, together with a Cosmos blue spot (type 55) valve, has been chosen on account of the silent background obtained by this method

and to avoid the risk of possible noise due to a defective grid leak. Again, the deletion of the grid leak and condenser will avoid a capacity to earth which alters the L.C. value of the coil.

The detector valve socket is of the rigid type, but mounted upon a disc of sorbo rubber sponge. The L.F. valve is mounted in an ordinary Benjamin holder with spring sockets.

The connections are clearly shown in the diagram and the wiring is carried out by the use of No. 12 gauge tinned copper wire. This should be cut off in a length about 6ft. long; one end is then fixed in the vice while the other is pulled tight with a pair of pliers. This straightens and, at the same time, hardens the wire. Care must be taken to make all connections as short as possible, avoiding all unnecessary bends in the wire. The connections must be soldered at every point, using the small tinned lugs under all terminals. Be careful to use a clean tinned soldering iron really hot and not to hold it to the joint longer than necessary. Remember that much deterioration to insulation is caused by trying to make a soldered connection with an iron only warm and covered with scale.

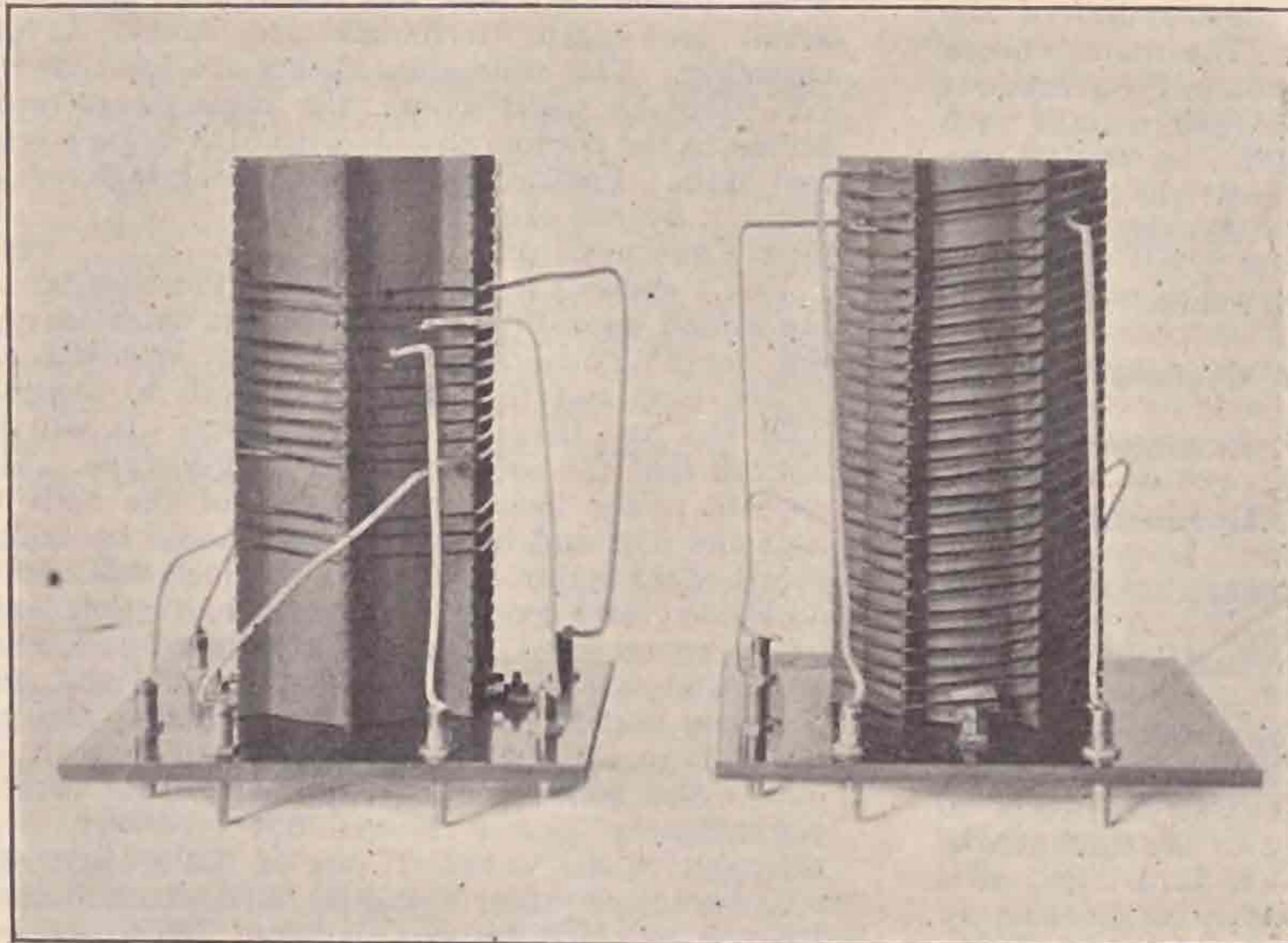

#### VARIABLE CONDENSERS.

The two condensers used are of the Cyldon make. That used for the control of reaction is of .0005 M.F. capacity. The grid tuning condenser was originally .00025 M.F. capacity, but this was found to be of too great a capacity, and it was consequently dismantled and rebuilt to consist of only one moving plate and one fixed one. This, of course, does not mean one moving plate interposing itself between two fixed ones. Both condensers are controlled by Burndept Etholog dials which give both slow and direct movement. The fitting of these dials is somewhat tricky, but the directions enclosed in the carton should be carefully followed when the work will be easy.

#### HIGH FREQUENCY CHOKE.

This is of Bulgin make and is mounted some 3in. above the base. An old wire spool is a convenient form of packing pillar to mount it upon. Be careful, however, to only use brass screws in the fixing of both the choke and spool.

#### LOW FREQUENCY SIDE.

The one stage of low frequency amplification, consisting of a DE5 valve and a Marconi Ideal transformer ratio 6 to 1, is housed in a separate



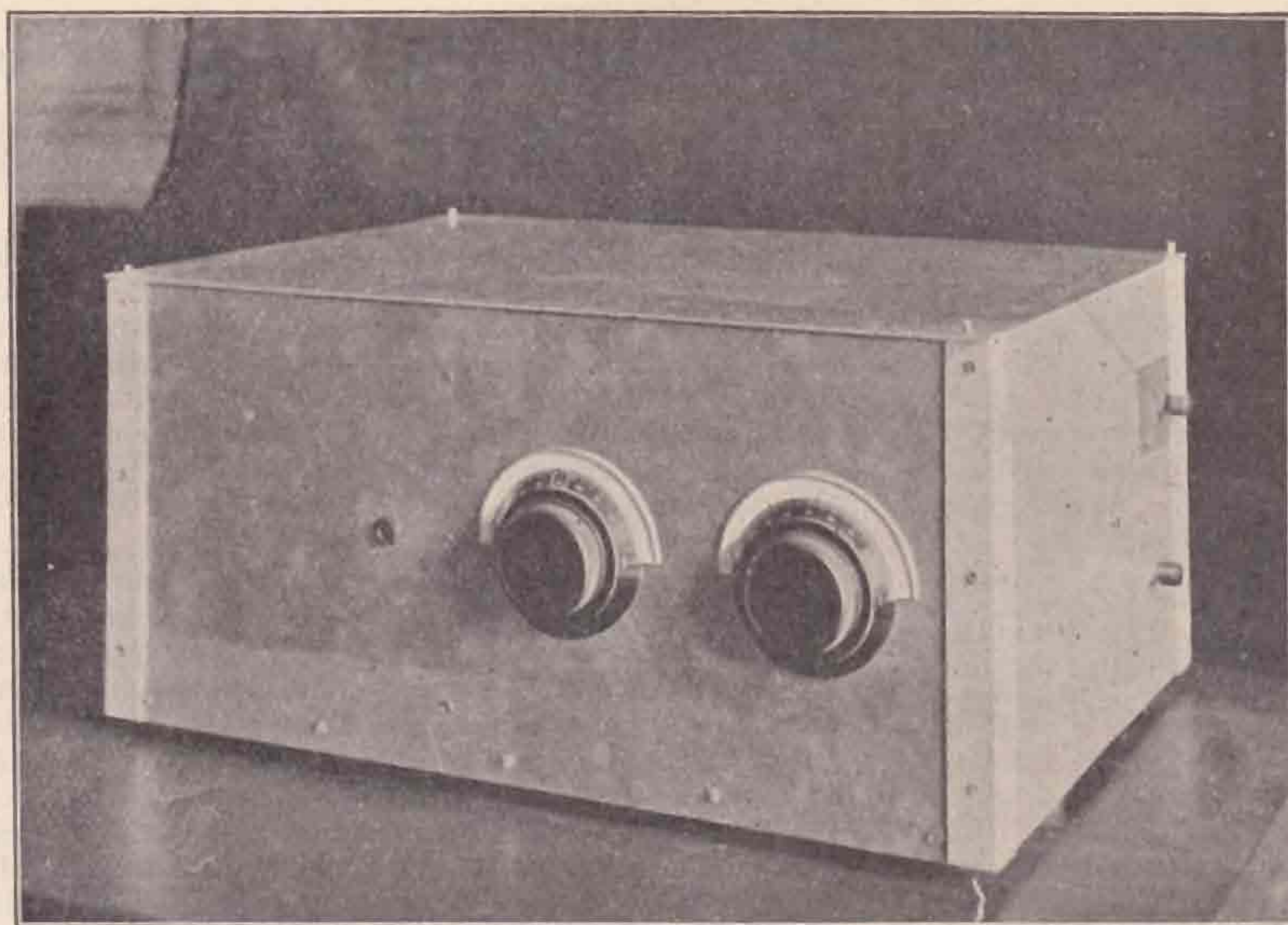

The photographs show the set from different angles and will be a guide to the constructor.

The complete case is mounted on four lumps of sorbo rubber sponges.

As stated in the opening article, this set is not designed for loud signals but rather for the obtaining of clear readable signals without any background of noise. If further strength is required, it is easy to add a further stage of low-frequency amplification. This is to be preferred to closer aerial coupling or the use of leaky grid rectification.

In our previous issue, we gave a list of the components required. The following is a more complete list of the various parts:—

One oak or hardwood baseboard, 21in. by 14½in., ¾in. thick.

One piece of soft sheet copper, about No. 24 gauge, 22½in. by 16in.

The necessary pieces of aluminium, as previously listed.

Three 2-volt Oldham accumulators.

One 60-volt H.T. battery (Ripault).

One 9-volt grid bias battery (Ripault).

One blue spot (type 55) valve Cosmos.

One Marconi Osram DE5 valve.

One .0005 M.F. variable condenser (Cylton).

One .00025 M.F. variable condenser (Cylton), (to be cut down).

One inter-valve transformer, ratio 6 to 1 (or 8 to 1) (Marconi Ideal).

One telephone transformer (Electradix Radios).

Two formers, 3in. by 6in. (Becol).

Four pieces of ebonite, 5in. by 5in., for coil mounts.

One fixed condenser, 1 M.F. (T.C.C.).

One fixed condenser, .01 M.F. (T.C.C.).

One valve holder (Benjamin).

One valve holder, fixed type.

One Amperite type 150.

One Amperite type 1A.

One H.F. choke (Bulgin).

One telephone jack with filament contact (Igranic).

Twelve pins and sockets for coil pins.

Sundries: Wander plugs, spade terminals, tinned lugs (Lectro-Linx), No. 12 tinned copper wire, aerial and earth

terminals (Lectro-Linx).

It must of course be remembered that the headphones used with this set must be of suitable resistance for the secondary winding of the telephone transformer, *i.e.*, 120 ohms.

## Calibration Waves.

Calibration waves will be transmitted from 5YK on June 24 as follows:—

13.00 G.M.T., 46 metres (nominal).

13.05 G.M.T., 45 metres (nominal).

13.10 G.M.T., 44 metres (nominal).

A similar schedule will be transmitted on July 8 at 09.00 G.M.T. The call is R.S.G.B. DE 5YK, and the exact wave-length announced at each change.

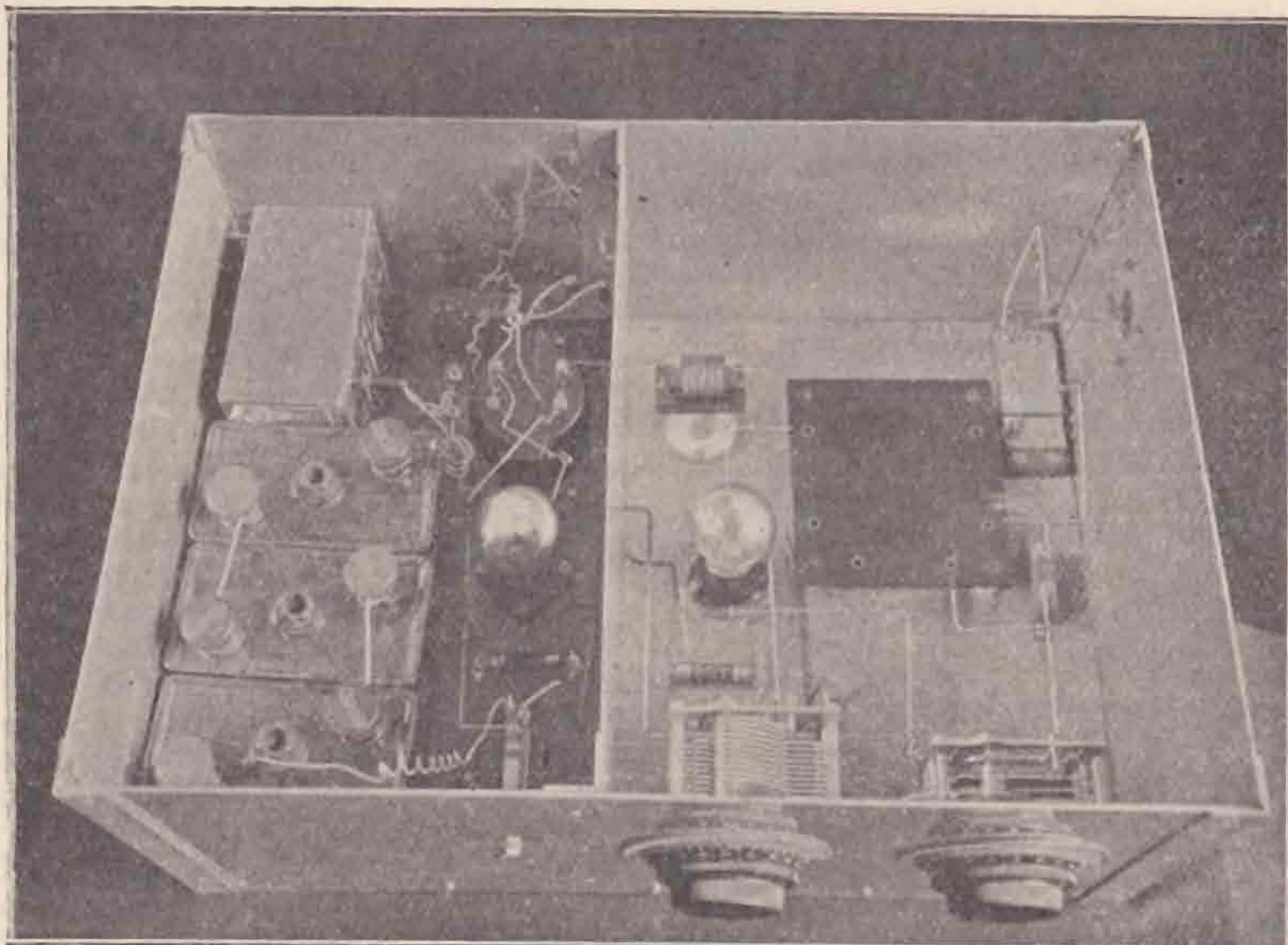

## Essay Competition.

The closing date for this competition is July 1, 1928. Prizes and diplomas will be awarded to members sending in short essays on any of the following subjects:—

- (1) Fundamental Circuits. Transmitting and Receiving.
- (2) Hertzian Systems.
- (3) Quartz Oscillators.
- (4) Station Lay-out.
- (5) High-tension Supplies.

Essays should not exceed 1,000 words.

## Cooper Testimonial.

As announced in our last issue, the subscription list to the above was closed upon May 20. The sum realised was £6 12s. 6d., and a cheque for this amount was handed to Mr. Cooper at the May meeting.

## Strays.

EG5YX makes it a rule always to be fully dressed when QSO Brenda of OZ4AA, even though it may be 5 a.m.

It is interesting to note that the Grenfell Association in Labrador are in constant communication with Radio G2XY through the medium of Mullard valves. They are using Mullard P.M. receiving valves and the Mullard S.W.50 (a special short-wave transmitter), whilst Radio G2XY uses a Mullard VO/250 transmitting valve.

## Radio for the Million.

The sixth issue of this very interesting publication is announced by The Mullard Wireless Service Co., Ltd.

Items dealt with in this issue are:—

- “RECEIVING AMERICA ON THE ‘MULLARD MASTER THREE.’”
- “HOW TO BUILD THE ‘MULLARD ‘MIKADO’ RECEIVER.”
- “NOTES ON THE ‘RALEIGH P.M.’ AND ‘NELSON P.M. DE LUXE.’”

A free blue print is supplied for the “Mikado” receiver, a 2-valve set embodying the Mullard “Permaçore” Transformer and the latest valve addition to the P.M. series, the P.M. 4D.

Copies may be obtained, post free, from the Editor, Radio for the Million, 63, Lincoln's Inn Fields, London, W.C.2, when the application is accompanied by a coupon taken from a Mullard advertisement, or by mentioning this paper. We recommend immediate application.

## SAVE TIME AND POSTAGE

Just send us a list of all the names of advertisers in this issue whose products interest you. We will see that you receive further particulars without delay

Address: T. & R. Catalogue Dept.,

**PARRS ADVERTISING LIMITED,**  
Craven House, Kingsway, London, W.C.2.

## Radio and the Weather or the Weather and Radio.

By W. F. FLOYD, 5WF.

AMONGST the “populi vulgi” one very often meets nowadays with the very firm and sweeping assertion that “We shan't have no more fine weather now that wireless business has come to stay!” The writer has had this and like statements made to him many times, and often by people who ought to have known better. We have only to make a survey of the other electro-magnetic vibrations which exist, and have existed since the world began to see, and satisfy ourselves to the full, I hope, that the few extra vibrations liberated on the ether by amateurs and commercials and broadcasters alike will have only an infinitesimal effect—if any—on the weather conditions which are now prevailing in this country.

General observation seems to indicate that it is the weather which affects radio and not the reverse. We all know that signal strength is frequently greater on a cold, crisp wintry night, than during those hot sultry weeks of summer. The writer's observations have gone further, and the results of the notes made over a period of several months are expressed in the form of graphs.

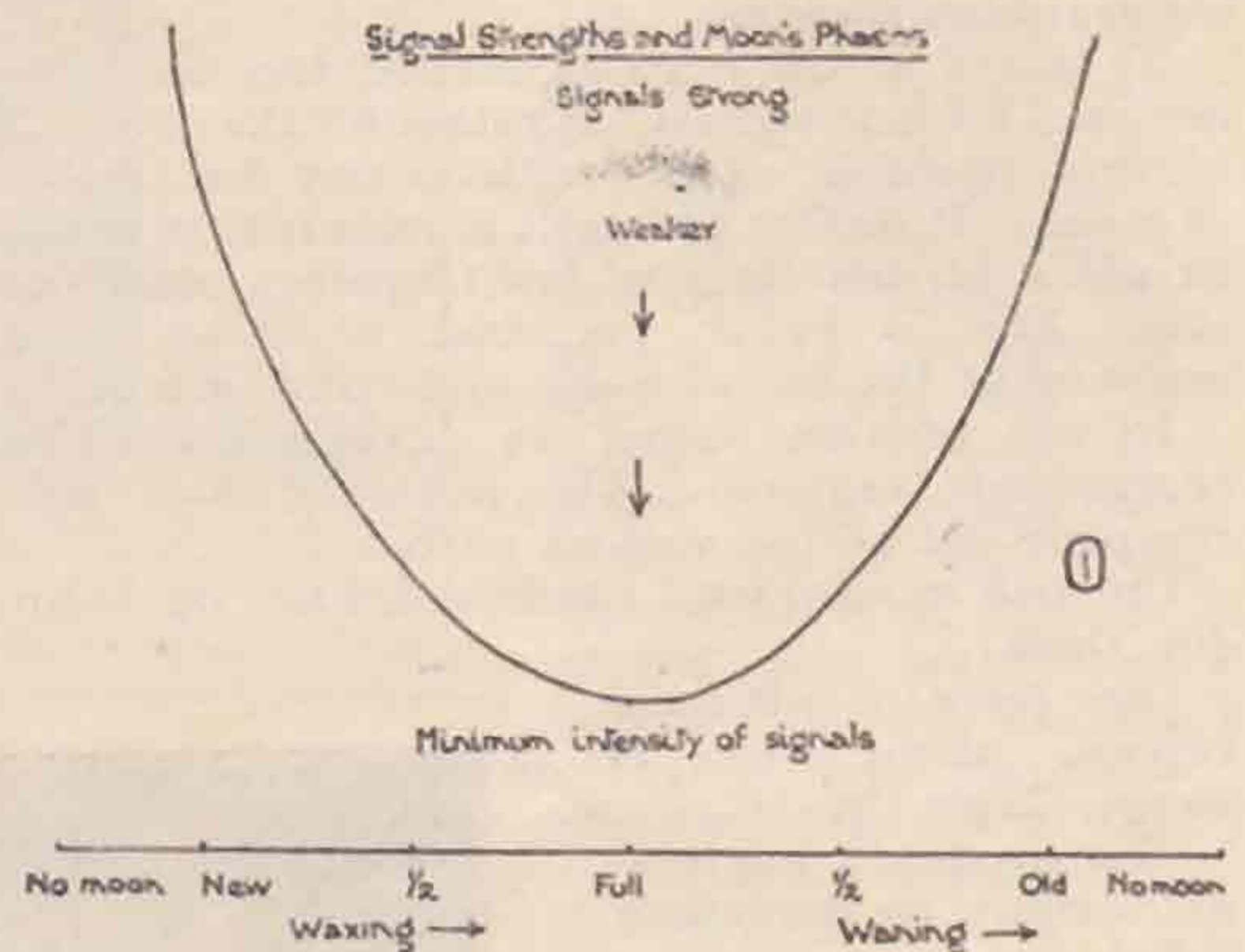

Two ranges of wave-lengths have been considered. Those of from about ten metres to twenty five, and from twenty-five to about sixty-five metres. As will be evident from the graphs, the signal strength has been plotted against the phases of the moon, and static intensity against both the phases of the moon and the barometric readings as supplied in the *Daily Telegraph*. Fading is shown in comparison with the barometer also.

Referring to the first, we see that the form of the curve is very roughly that of a parabola having a minimum value when the moon is full. No actual direct measurements of signal strength were made for the drawing of this curve as so many other factors have to be considered that the usual way of measuring signal strength had to be discounted. These particular readings were taken by the writer for about five months and previously by 5QB (Mr. E. J. Reid) for about two years. This long period thus made it possible to observe the rise and fall effect with only the ear as a means of comparison.

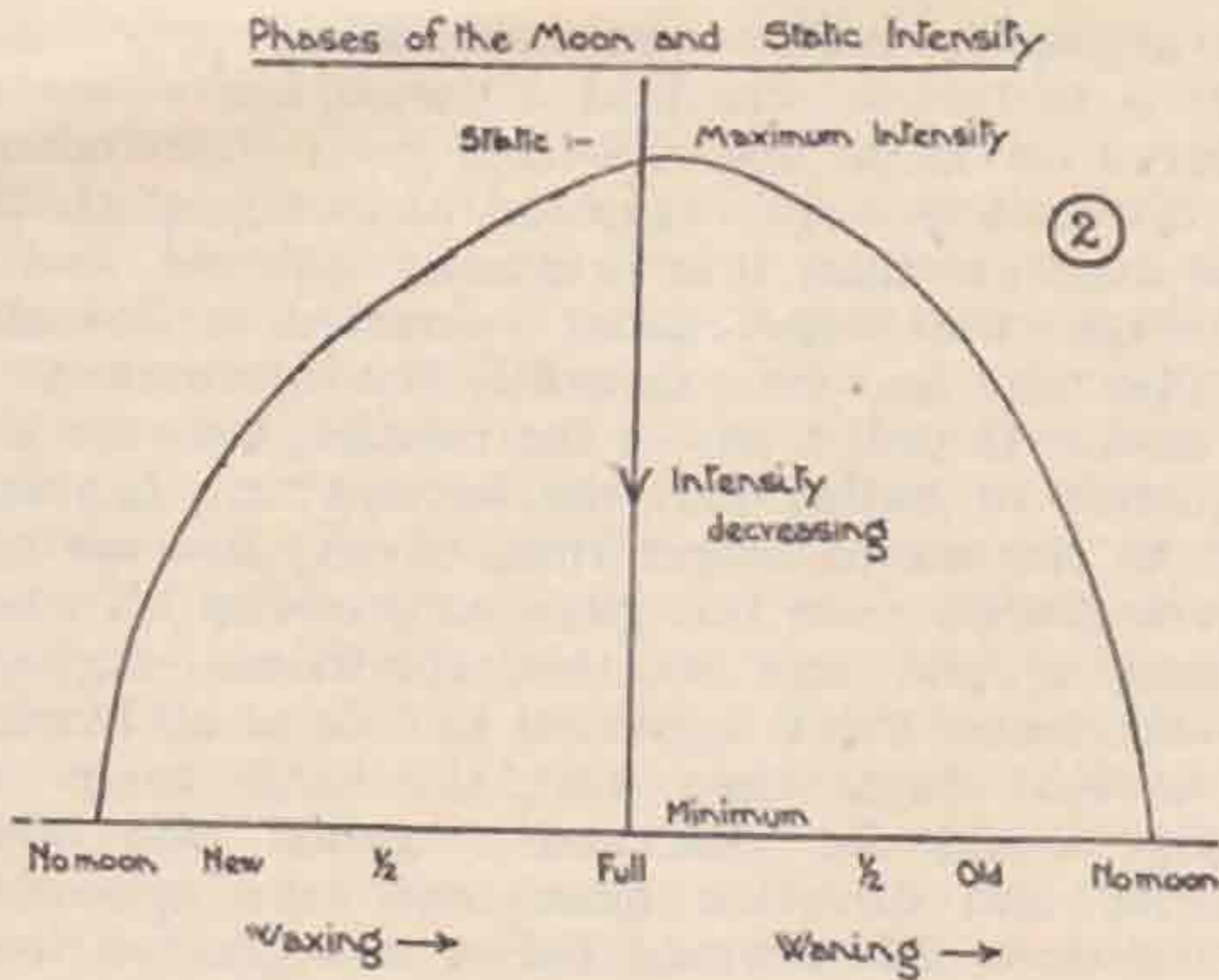

Having got so far one is extremely curious to investigate further and say, "Why is this so?" The only difference between the full-moon and the no-moon periods viewed from the earth is that during the full-moon periods the part of the moon which is constantly illuminated by the sun's rays is turned towards the earth. This leads to the query, "Is it that the moon has some power of reflecting and/or intensifying those radiations from the sun which cause the ionisation of our atmosphere, or does the moon, so illuminated, emit radiations peculiar to itself which affect our radio frequencies?" As to the former the writer has had no experience of nor has any information available on this. The latter property has not yet been discovered. This does not mean that it cannot exist, only that it now remains for some brain to show the existence of one of these possibilities or prove the existence of another.

In conjunction with the remarks of the previous paragraph one has to consider the information furnished by the second curve. Here the static intensity is seen to grow with the moon until just after the full-moon period, then the intensity died until the no-moon period is reached again. Once more the readings were taken over a very extended period of time, viz., five months by myself and two years by Mr. Reid. It is not intended to convey by the graph that when there is no moon there is no static. Far from it, in fact, as a subsequent graph will show. All that is meant by the rise and fall is that when static is recorded its intensity is greatest when the moon is just passed its full state, and least when there is no moon, other conditions being

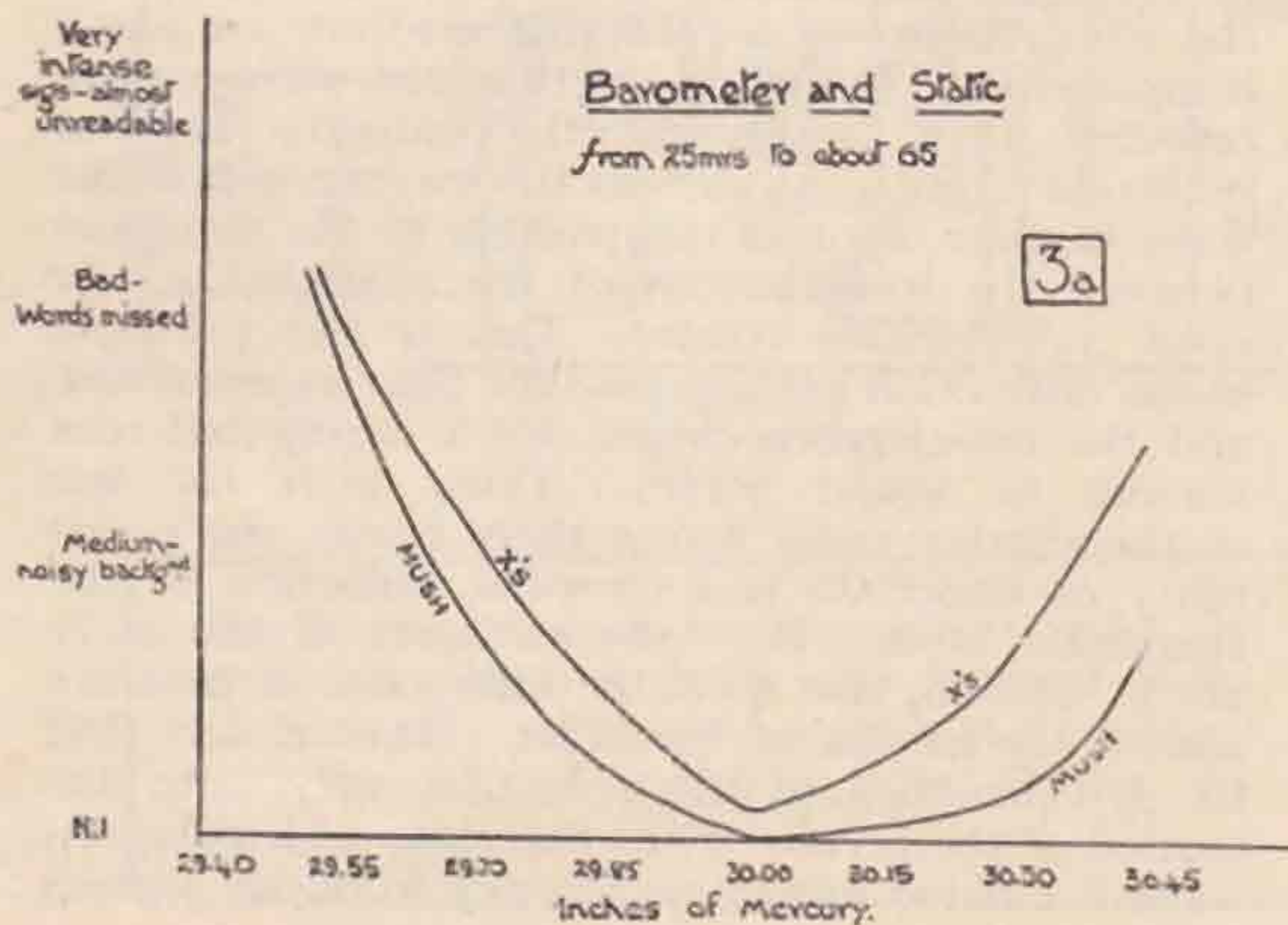

equal. The cause of this is more obscure to the writer than the cause of the previous effect, and it is very difficult to conceive any reason which can be offered in explanation.

These two effects are noticeable only on the waveband of twenty-five to sixty metres—or thereabouts—and have never been persistently present below the twenty-five metres mark, and, moreover, the lack of signal strength at the period of the full moon is most marked on wave-lengths around thirty metres.

The third curve shows static intensity in comparison with the barometric condition of the atmosphere, and is, perhaps, the most interesting of all the graphs which have been drawn from the collected data. Graph 3a refers to the waveband of twenty-five metres to about sixty-five metres, and 3b to the waves below the twenty-five metres mark. In all cases mush, as distinct from X's, is seen to be of less intensity than the X's. Here, again, the general form of the curves is that of a parabola with a minimum value. The exception seems to be the curve for the waves shorter than twenty-five metres.

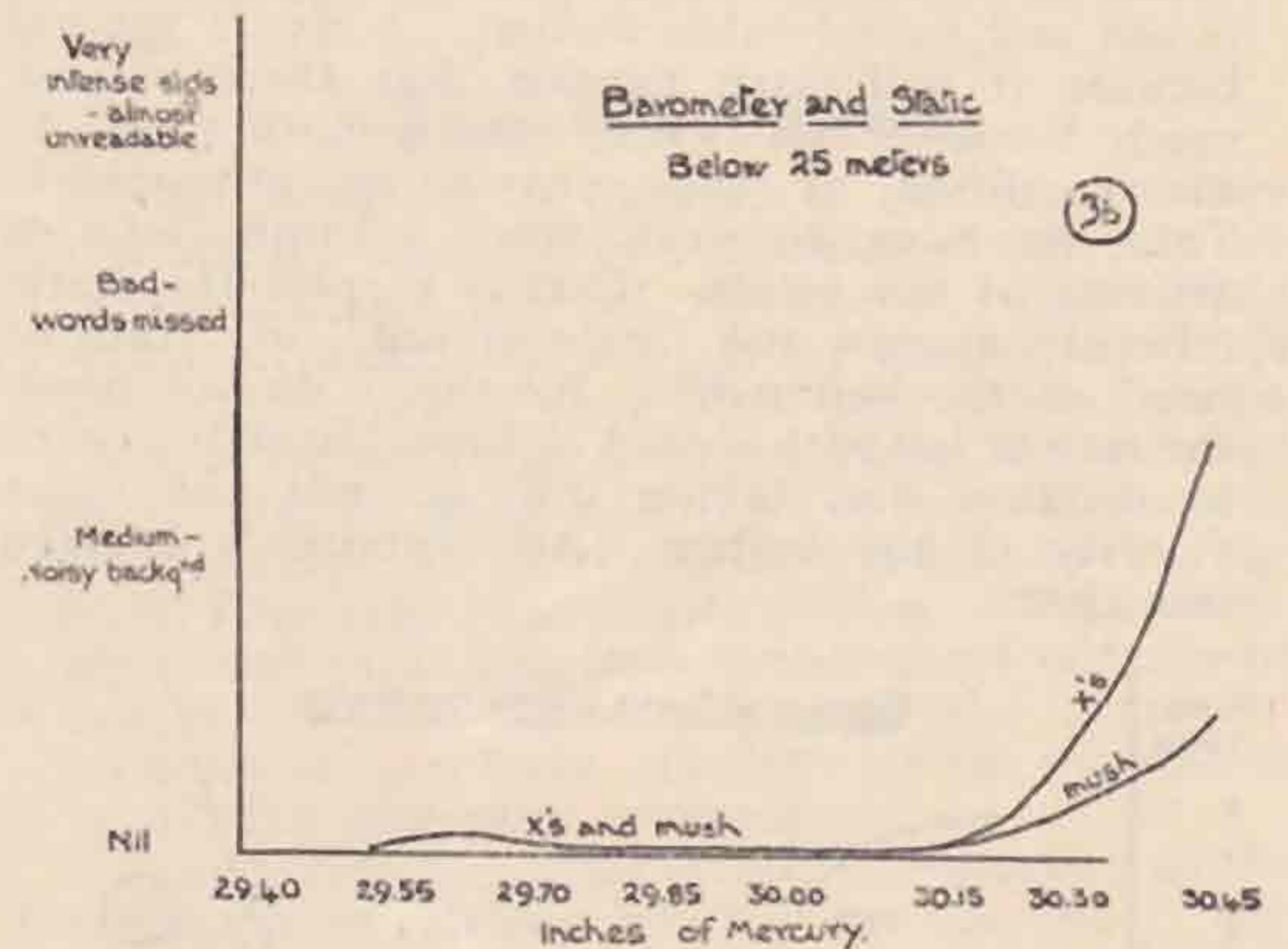

In general we see that, other conditions being equal, the optimum time for reception is when the barometer stands around 30 inches of mercury. One great difficulty stood in the way of the accurate recording of data. That was the personal equation of the writer. On some days body fatigue would seem to make static more troublesome than on others. There was no other direct method of measuring the amount of charge liberated by each stray that struck the aerial, so the human ear had, once more, to be relied upon. The set was not expected to give extra trouble by inconsistency. It never had, and it kept up its reputation. The worst kind of static was to be "Very intense signals almost unreadable," and it was never experienced below one hundred and fifty metres. The intensity was graded down from this to "medium, noisy background," and, least of all, "nil."

Some critics may say that there is too much possibility of recording the wrong data because of the apparent crudity of the method of taking the readings, but the practice of the last few weeks has shown that the graphs represent to a very fine degree the true connection between the barometer and static conditions. Having made enough readings to get a regular smooth curve of

the shape shown, no further co-ordinates were marked on the graph. Instead, either the barometer was consulted and conditions computed from the curve, or conditions were noted and the barometric height read off. Both ways gave answers approximating very nearly to the true state.

The fact that the best reception conditions, so far as static is concerned, occur when the barometer stands at 30 inches must in no way be connected with the physical and chemical normal pressure, which, in England, is about 762 millimetres or just 30 inches. That "normal pressure" is only an arbitrarily selected unit, just as is the millibar, chosen because it so chanced that that was the average height of a column of mercury supported by our atmosphere. It has no claim to importance, as has the absolute zero of the scale of temperature. It would seem that the reason for the effect is still not far to seek. We know that atmospheric electricity has its origin partly in the motion of clouds which are at different temperatures. The more accelerated the motion the greater the charge, and the greater the resultant difference of potential. When the barometer is at normal, in general there is not any considerable motion. I say in general because it will often happen that there will be much tendency to a very strong motion due to the condition of the surrounding atmosphere. Thus we have an even more accurate way of arriving at our result. That is to plot the static intensity against the "rate of fall" or "rate of rise" of the barometer. By this I do not mean the rate of fall with regard to time, but with regard to distance and taking into account the mean velocity of the system. An example will make this clear.

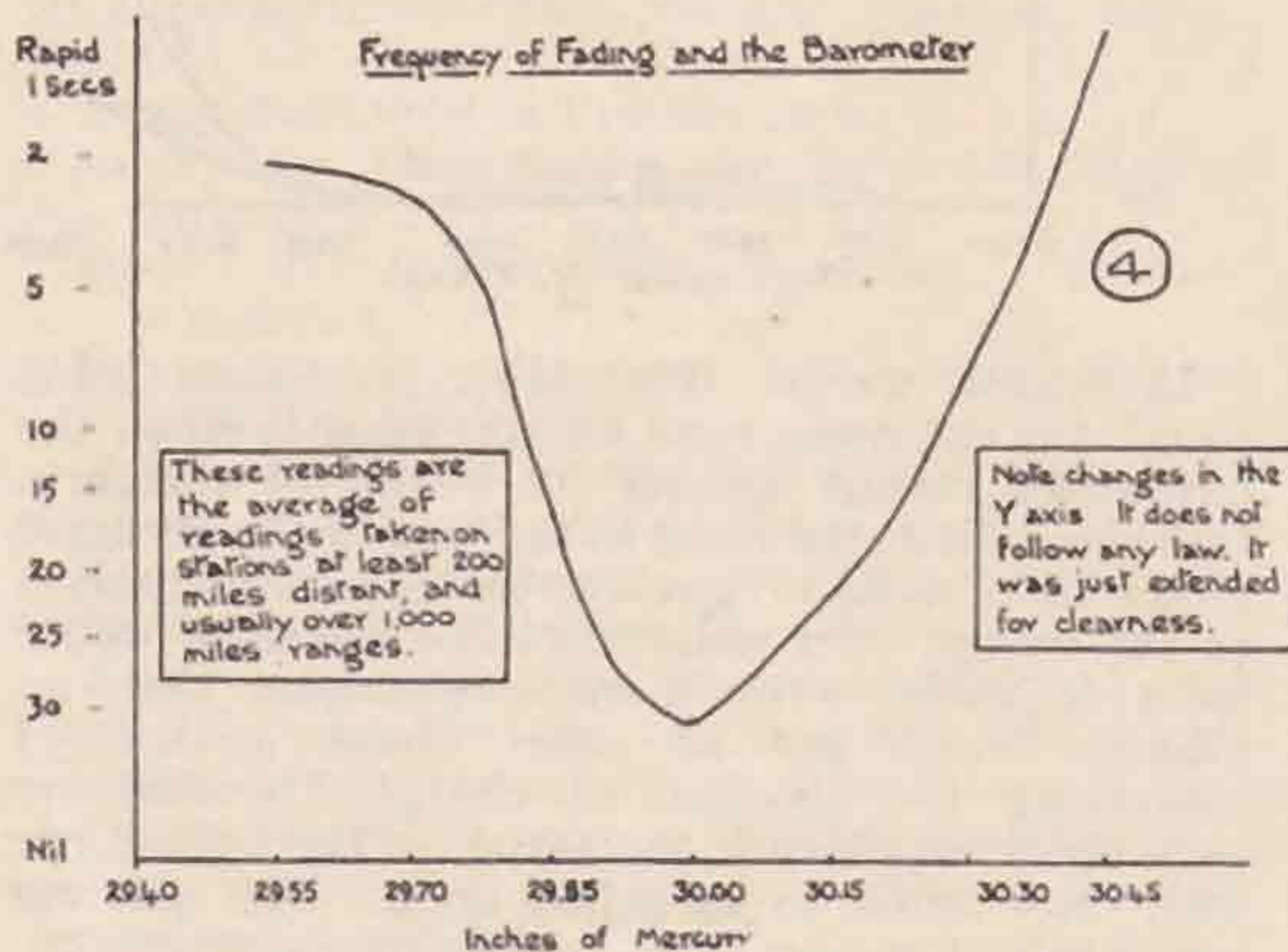

We will suppose that the barometer registers 30 inches at our place of observation, and that one hundred miles away in the direction from which the system is approaching the height is 30.15, and two hundred miles in the same direction it is 30.20, also that the mean velocity of the system is 20 m.p.h. Now, for every series of readings we shall plot we must always decide at what distance we shall measure the variation in the barometer. If we decide to take a hundred miles, then the rate at which the barometer is rising is .03 inches per hour. If we had taken two hundred miles, then it would have been .02 inches per hour. There is quite a considerable difference between these

two answers, and so we must decide previously what is to be our standard distance for reference. A curve on these lines has not been constructed. The method is only suggested as being, perhaps, more accurate than that originally adopted, and it is thought that some reader interested in this side of radio may find time to utilise the information.

The fourth graph shows the relation between the frequency of fading and the barometer. It refers only to the waves longer than twenty-five metres. Waves shorter than this gave no result at all when plotted against any weather condition. Against the barometer the Y appeared to fade at all heights for several days, then over the same range no fading would be observed. Against the wind velocity and direction anomalies were appearing all the time, and nothing better was gleaned from the curve showing temperature. The normal pressure again indicates the prevalence of the best conditions for reception so far as fading is concerned. Before we ask why this is so let us consider the conditions which cause fading. Their absence would mean the absence of fading. Signals fade because either (1) the wave-length changes or (2) the angle of polarisation alters, that is, the plane of polarisation is so twisted during its journey towards the receiving aerial that the component of the wave causing the voltage in the receiving aerial varies. A change of wave-length is not a very easily understandable thing when we are told that the conditions at the transmitting end remain dead steady over a long period of time. The writer has no suggestion to offer in explanation of this type of fading. With reference to the second cause, the plane of polarisation is twisted under several circumstances. A mass of clouds will cause such a twist. It is a well-known fact that clouds, under certain conditions, will polarise light. In the same way a polarised radio wave will be twisted so that on emerging from the clouds it is in a different plane from that in which it entered. Since the clouds are constantly moving, if they are causing a great amount of twist to the plane of polarisation, the twist will be steadily altering with the movement of the clouds. Thus, if reception is carried out on, say, an entirely vertical aerial, the signals will appear to fade because the vertical component of the wave is constantly altering with the plane of polarisation.

Another reason for such irregularities in the plane of polarisation is probably the unevenness of the layer of ionised atmosphere above the earth. If the irregularities of a reflecting medium are small compared with the wave-length of the wave motion reflected, then, in general, the ordinary laws of reflection apply. As soon as the wave-length of the wave motion becomes comparable to the distances between the irregularities of the medium, or *vice versa*, interference results. This is the principle of the diffraction grating used for light experiments, and the interference caused by a corrugated iron fencing to sound waves. Thus, with the use of the shorter radio waves there comes the possibility of uncertain and irregular reflection at the Heaviside layer. Now the elements of the layer are in motion, due to both differences in pressure and to the inertia of the layer. That means that the irregularities of the reflection vary with the motion of the layer. Thus the plane of a polarised wave is twisted during its journey from one station

to another. The absence of the particular type of cloud that causes a large twist to the plane of polarisation, or the absence of greatly varying irregularities in the heaviside layer would thus seem to accompany steady signals. The graph drawn in connection with fading only deals with the weather at the receiving end. A consideration of the foregoing would indicate that it is necessary to examine the weather conditions at some place in between the transmitter and receiver, probably at the place where the waves are experiencing reflection and refraction by the upper atmosphere. Such examination requires careful measurements of the angle of the downcoming wave-front, and extensive trigonometric calculations. These experiments are now being carried out by the writer, and he hopes to be able to write the results in the form of another article for the BULLETIN.

### Another S.W. Receiver with a Stage of R.F. Amplification.

The attention which has been directed to the above in your March issue prompts me to give an alternative diagram for those who do not want to use the screen-grid valve, but merely the common or garden variety, and yet attain complete success, as I have done, with the same finding as EG6NR, namely, that "the strength of the signal is raised above the 'noise.'" It will be noticed that I have employed the double RFC stunt of EG6CJ and found it most satisfactory in keeping RF out of the audio end of the receiver, and I hereby acknowledge his suggestion with mni tnx.

The oscillation control in the plate of the RF valve is of the variable resistor-condenser type, and the RF and detector valves are Red Band Cossors, and do their job thoroughly. I have not shown the audio amplifier, as I leave this to be designed according to different tastes, but enormous volume can be obtained by using push-pull and high anode volts with the right type of valves.

Needless to say, when constructing the receiver, the usual care should be exercised in keeping the plate and RFC leads away from the grid leak and condenser; my values for the latter are, respectively, 10 megomhs and .00015 mfd.

E. T. SOMERSET (BRS125).

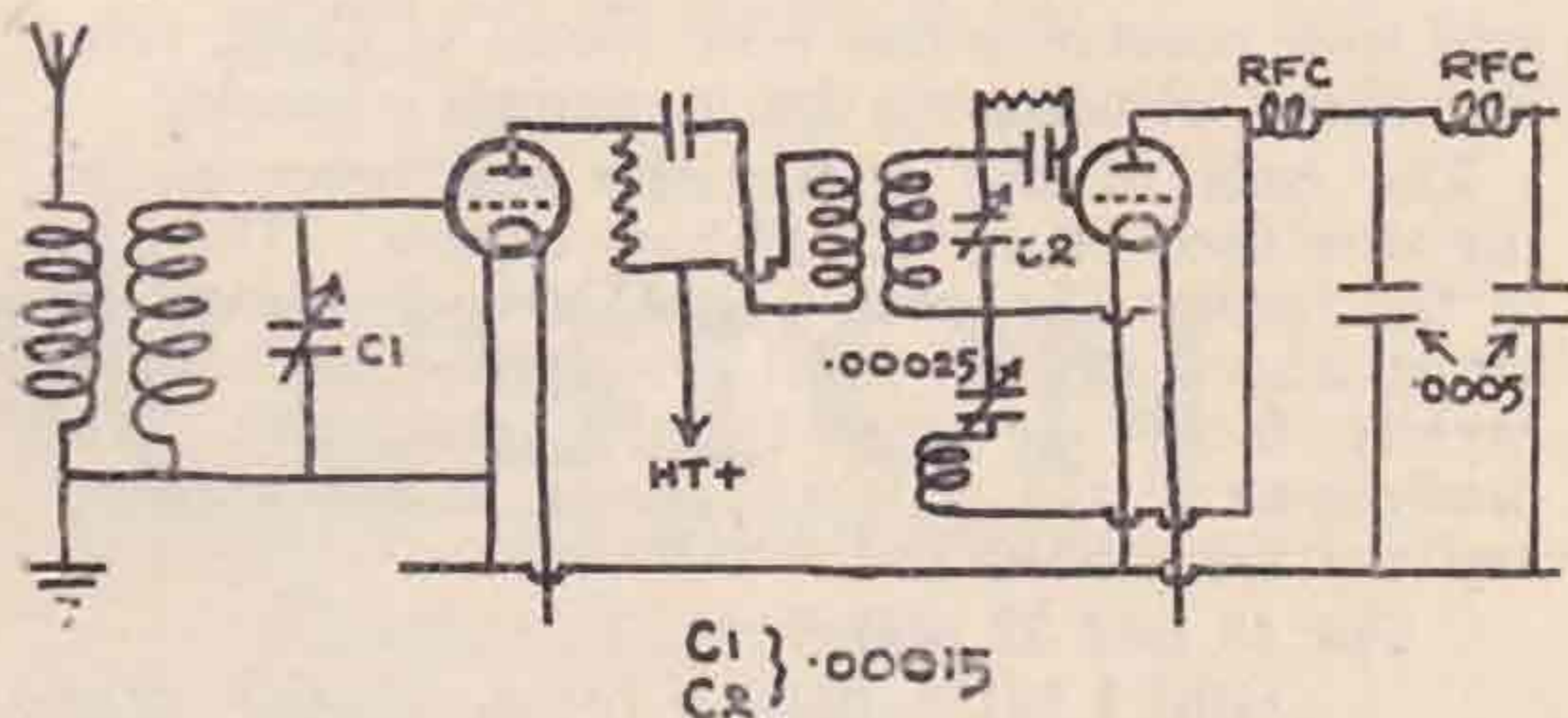

We have pleasure in announcing that as and from May 1, 1928, the Mullard P.M. H.T. supply unit (for use with A.C. mains) will be reduced in price from £7 10s. to £6 10s.

### Wolverhampton Radio Society.

On Wednesday, March 28, Mr. Valentine, of Messrs. Mullard Wireless Service Co., Ltd., gave a lecture to the Wolverhampton and District Transmitters' Society.

A short introduction on the history of the thermionic valve was followed by a description of Mullard large type receiving valves of the D.F.A. series, low, medium and high-power transmitting and rectifying valves, and silica and metal-glass transmitting valves.

Later a description of British 2NM (Caterham) Station was given, illustrated by a selection of lantern slides, showing the circuits used, including the studio and control rooms, with their respective amplifiers and transmitting apparatus and special crystal-drive circuits.

Mr. Gerald Marcuse was present at the lecture, and after talking about amateur transmission in the early days, replied to various questions on his station, 2NM.

There was an attendance of about 50, all of whom were amateur transmitters or enthusiasts living 0im-8 tiwhinanl e radius fo Wolverhampton.

### The Wavemeter.

This paragraph is inserted to remind members that the wavemeter is now available at any time for calibrating *any type* of wavemeter. Heterodyne wavemeters are attended to by the writer at his home QRA, while absorption wavemeters can be done in the same way (calibrated from the standard wavemeter by using a short-wave receiver), or will be calibrated for North London members by Mr. H. C. Page (6PA) at his own station. 6PA's wavemeter was calibrated from the standard instrument and is checked periodically, and the degree of accuracy is more than sufficient for the purpose of calibrating absorption wavemeters.

The charges made by the Society (payable to the Secretary at Headquarters!) are 2s. 6d. "per sweep" on the standard wavemeter and 1s. 6d. on 6PA's instrument.

A short list of commercials and their measured wave-lengths at 6QB during April and May is given below. Of course, some of them shift about from time to time, but each one listed has been heard at least three times on exactly the same wave-length and, therefore, appears to be fixed.

FW3, 14.33 metres; SPP, 14.53 metres; IR2, 14.72 metres; APV, 15.73 metres; PCLL, 17.90 metres; ANF, 20.15 metres; WIK, 21.35 metres; GLL, 21.85 metres; WIZ, 43.05 metres; CF, 43.80 metres.

L. H. THOMAS (6QB).

We have received from the Assistant Secretary of the Golders Green and Hendon Radio Society an invitation for our members to co-operate in a direction finding field day to be held on Sunday, June 17th. The invitation (received just as we go to press) comes too late for us to include conditions of the test, but these can be seen at H. Q. by anyone interested, while details of assembly etc., can be obtained from the Secretary, The Club House, Golders Green and Hendon Radio Society, Willifield Way, N.W.11.

## Station 5NJ.

By F. R. NEILL.

It is hoped that the following description of 5NJ may be of some little interest to other experimenters in short wave wireless communication, and while nothing new is claimed in the way of design, yet there may be one or two points which may be useful to those about to alter or modify their stations.

The complete station is situated in a small hut at the back of the house, and the aerial is supported at one end by a 52 foot mast, and at the other by a pole, made fast to a chimney of the house. The "roof" of the aerial has an average height of 48 feet, and the hut containing the apparatus is situated roughly half-way between the masts. The aerial "lead in" is *via* a heavy glass tube 2 feet long, and insulation has been very carefully attended to at all points where leakage might occur.

Coming now to the inside of the hut, the general lay-out of the short wave apparatus may be seen from the photograph (Fig. I.). In Fig. II. is

### GENERAL LAY-OUT OF STATION

shown the super-heterodyne receiver, which at one time was used continually for short wave reception. The broadcast receivers are not shown,

as they are situated at the opposite end of the hut.

Referring to Fig. I., the o-v-i receiver is shown at the extreme left, on the bench. Above this, on the wall, may be seen the crystal oscillator, while to its right is the crystal amplifier and frequency doubler. The change over switch is seen about the centre of the photograph, while above it, to the right, is the transmitter panel. The latter contains the grid tuning condenser, the grid stopping condenser, grid leak, and plate stopping condenser, the leads from which are all brought out to terminals. Almost any circuit may therefore be "hooked up" at a minute's notice.

On the left and right of the transmitter panel are the grid and plate coils respectively, while below the plate coil is the aerial coil. The condensers tuning the latter coils are on the right of the photograph.

On the bench, behind the telephones, is the modulation panel, containing microphone trans-

former, the necessary resistances, and the modulator valve which is used when absorption modulation is employed.

As regards the components used, all the variable condensers in the transmitter are standard Igranic receiving condensers of .0003 mfd. each, and although the plates are somewhat close together for any high voltage work, yet these condensers have been found to stand up very satisfactorily to the power used. The stopping condensers are Dubilier, tested to 2,000 volts, and of .002 mfd. each. The grid leak has a maximum value of 25,000 ohms, and is wound in sections on very thin bakelite, as shown in Fig. III. The wire used is No. 42 Eureka, and each section, of which there are ten, has a resistance of 2,500 ohms. The tappings are brought out to a stud switch, giving a range of from 2,500 to 25,000 ohms. This variation of the

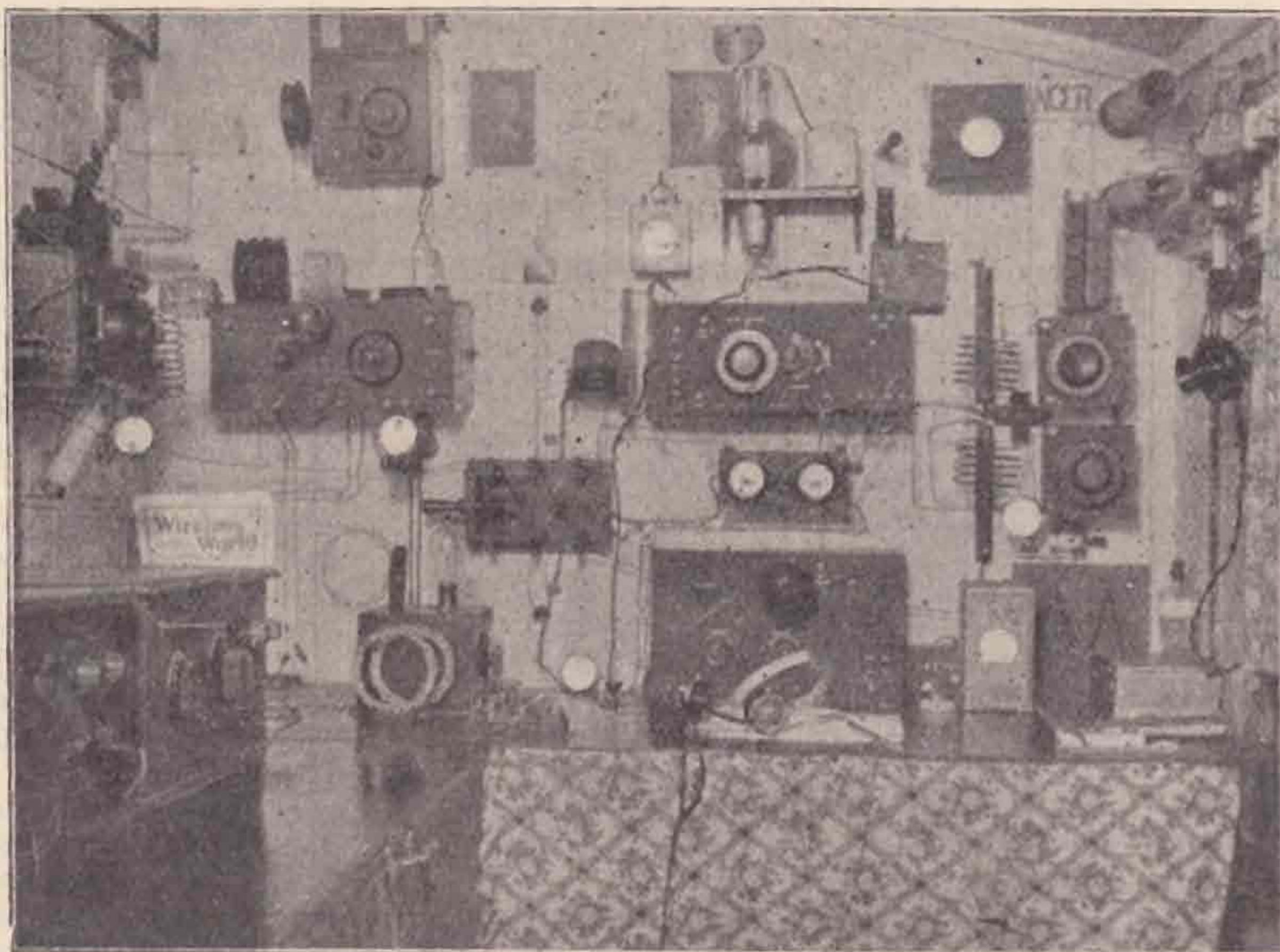

grid leak resistance has been found of great value in making adjustments for maximum efficiency.

The coils of the transmitter are home made, the wire used being No. 12 bare copper. The idea of the coils is shown in Fig. IV., and as they are interchangeable, they form a ready way of changing rapidly from one wave-length to another. The dimensions of the coils are shown in the drawing, and the turns used are as follows:—

*For 45 and 32 metres :*

Grid 4 turns, plate 6 turns, aerial 5 turns.

*For 23 metres :*

Grid 2 turns, plate 5 turns, aerial 3 turns.

The high frequency choke for the transmitter consists of 3 inches of No. 42 s.w.g. wound on a  $\frac{1}{2}$  inch glass former, and this appears quite satisfactory on all the various wavebands.

The circuit diagram of the transmitter is shown in Fig. V. and will be seen to be quite standard.



# RADIO CONTROL BOOKLET - Free!

Every radio amateur requires an authoritative guide to the correct electrical operation of his receiver. Here you have the opportunity of obtaining such a booklet entirely free. Just fill in and send the coupon below and a copy will be sent to you by return.

"Radio Control" has been prepared by the Weston Electrical Instrument Co., Ltd., who, for the past 30 years, have been universally acknowledged as the leading manufacturers of accurate electrical measuring instruments. Since the inception of radio the Weston Company have examined carefully every phase in its development and with each succeeding stage of progress have designed and produced appropriate instruments to assist the efforts of radio engineers.

Now the result of many years' radio experience is placed at your disposal. "Radio Control" will show you definitely how appreciable economies may be effected in the operation of radio receivers and how improved reception may be obtained at the same time.

To-day is not too soon—cut out and post the coupon now.

# WESTON

STANDARD THE WORLD OVER

*Pioneers since 1888*

WESTON ELECTRICAL INSTRUMENT CO., Ltd.

15, GT. SAFFRON HILL, E.C.1.

Application for free copy of booklet "Radio Control" from

NAME.....  
ADDRESS.....

T. & R

# QUARTZ and Rochelle Salt

QUARTZ OSCILLATORS LTD.,  
1, LECHMERE ROAD,  
LONDON, N.W.2.  
ENGLAND.

Distinctive

## Q. S. L. CARDS

(as supplied to G.6. BT.)

A Style to Suit Every Taste.

SAMPLES FREE ON REQUEST.

100 .. 5/6      500 .. 15/6

250 .. 9/6      1000 .. 19/6

Let us quote for your Private Note Paper, Business Letter Headings, etc. We are Specialists in all classes of Radio Printing.

TERMS: Cash with Order.

## PAUL & MATHEW

11, Butter Market, Bury St. Edmunds, Suffolk

## AT LAST.

A really reliable Electric Soldering Iron.

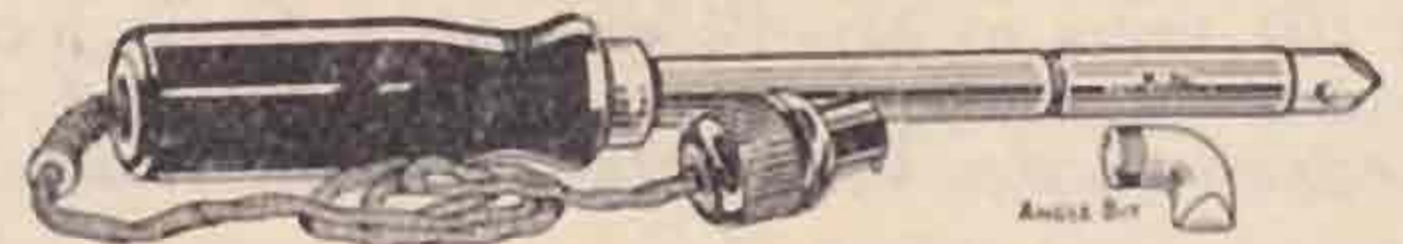

Light and well balanced in weight, beautifully finished. Complete with two 1/4" bits, straight and angle. Will effectively handle the large as well as the small jobs. Draws 75 watts, and supplied for voltages of 100-110, 200, 220-250. When ordering state voltage.

GUARANTEED FOR ONE YEAR.

Price 12/6, post free, from

J. E. SINGLETON. WELLINGTON PLACE, PENN FIELDS, WOLVERHAMPTON

## URIAH BEATON'S Wire Bargains.

| S.W.G. |        | Paraf.               |  | Price. |
|--------|--------|----------------------|--|--------|
| 44     | D.W.S. | 4 oz. reel           |  | 2/6    |
| 40     | D.W.S. | " 4 " "              |  | 1/6    |
| 40     | D.W.S. | " approx. 1 lb. reel |  | 5/6    |
| 39     | S.S.C. | " 4 oz. reel         |  | 1/2    |
| 34     | D.W.S. | " 8 " "              |  | 2/3    |
| 33     | D.W.S. | " 8 " "              |  | 2/-    |
| 32     | S.S.C. | " 4 " "              |  | 9d.    |
| 32     | S.S.C. | " 8 " "              |  | 1/4    |
| 27     | S.S.C. | " 8 " "              |  | 1/-    |
| 20     | S.S.C. | " 4 lb. "            |  | 6/-    |

All orders to—

Reels charged 2d. each.

45, Chalk Farm Road, London, N.W.1

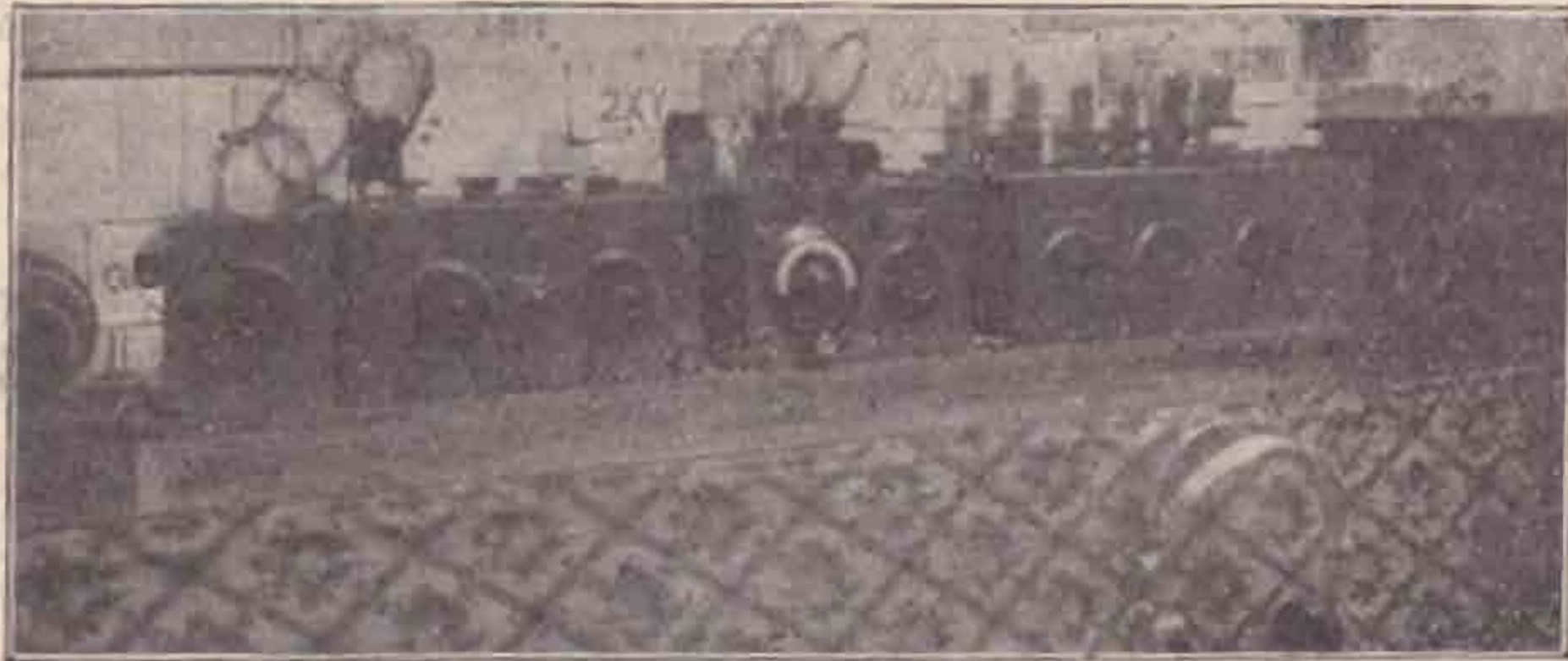

In connection with the o-v-i receiver, the circuit is shown in Fig. VI. The most important part of a receiver of this type is the coil used, and in the writer's case, coils manufactured by Collinson's Precision Screw Co., Ltd., of London, are employed. These coils are really efficient, and quite the best the writer has seen. They cover a range of from 9 to 70 metres and are used at 5NJ with an Osram DEQ valve as detector, and a PM4 valve as amplifier.

Coming now to the power supply, this consists of a Mortley Sprague type CF/147 generator, driven by a 1/4 h.p. Hicks D.C. motor. The motor in turn runs off the 220 volt town mains, and is direct coupled to the generator. The output of the latter is 1,100 volts at 80 milliamperes and the speed is 3,500 r.p.m. The whole of the generating gear is housed in an outhouse about 20 feet distant from the hut containing the apparatus, and overhead leads carry the power to the transmitter. To prevent ripple, it was found very necessary to insert high frequency choke coils in both the input leads to the motor, and the output leads from the generator, and these chokes are inserted both at the point where the leads leave the outhouse, and where they enter the hut. The chokes consist of 100 turns of No. 22 wire on a 2-inch former. Additional smoothing is provided by a 4 mfd. condenser across the generator output terminals.

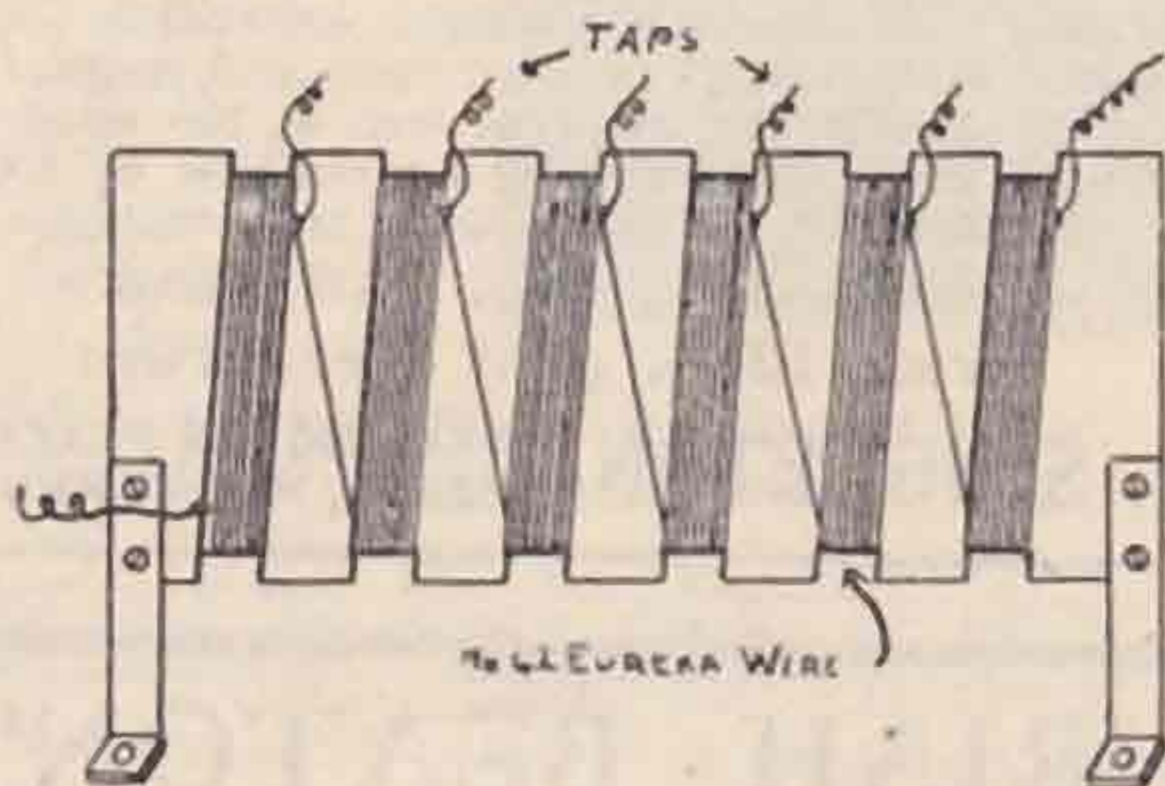

FIG. 3 GRIDLEAK

As regards the aerial used, many types have been tried over fairly long periods, and after buying many yards of wire and going to great trouble trying aerial after aerial, it must be admitted that no great difference has been found between any of the types used. I am inclined to agree with my friend Kenyon Secretan, who remarked to me some years ago that, provided each type was properly adjusted, he found very little difference in the results obtained. This has been the experience

at 5NJ, but the important thing is to get the type decided upon properly adjusted—which may entail lots of trouble, but is usually worth it in the end. At the time of writing, the aerial used for all waves is the "6JV aerial," particulars of which have already appeared in these columns. This aerial is a delight to use, and has given great satisfaction on all wave-bands. The aerial and counterpoise are each 75 feet long, which is a convenient length for many stations.

Having now described briefly the short-wave gear, a word may be said about the broadcast receiver. Unlike some other so-called "DX experimenters," the writer does not despise broadcast

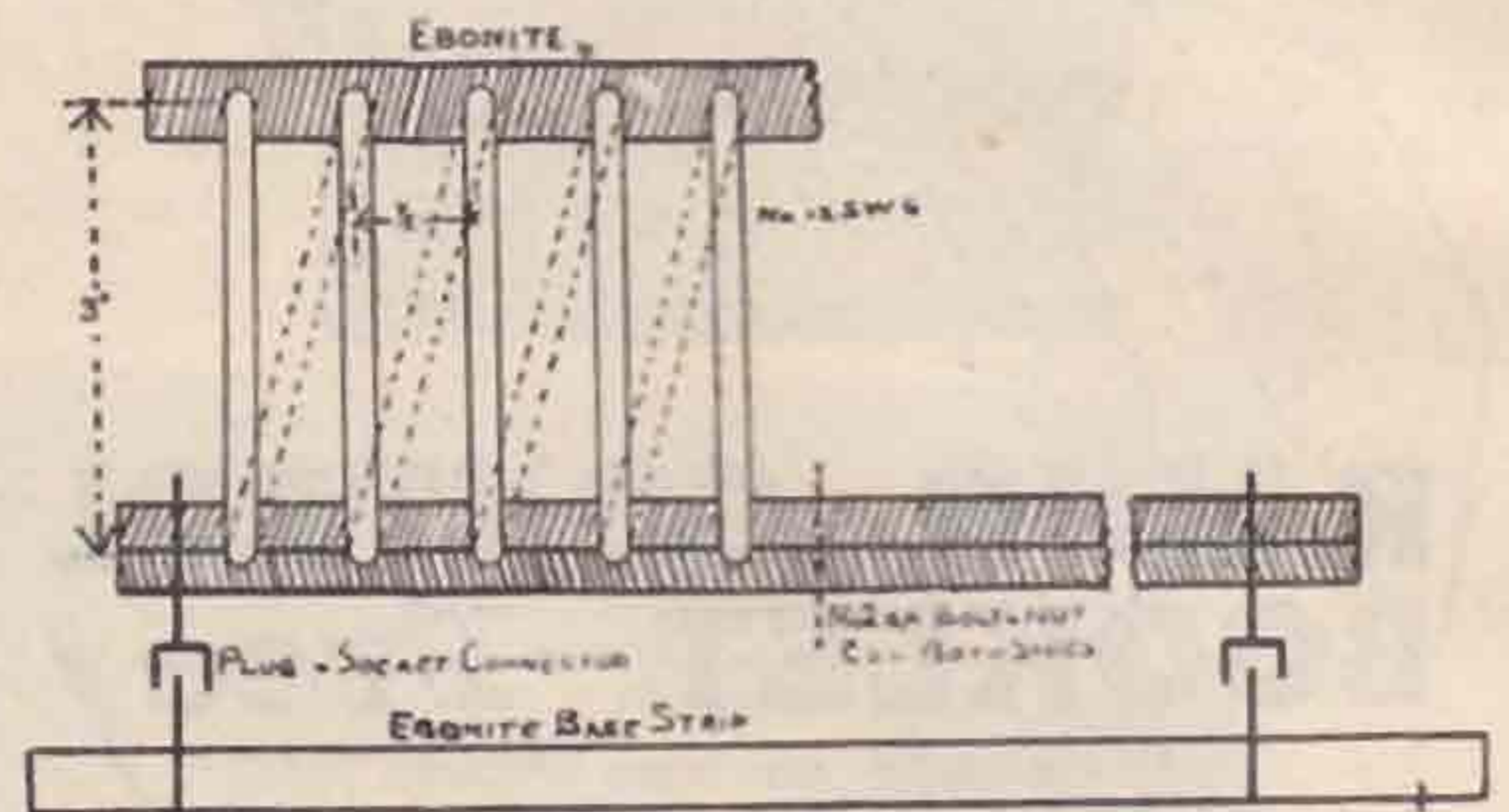
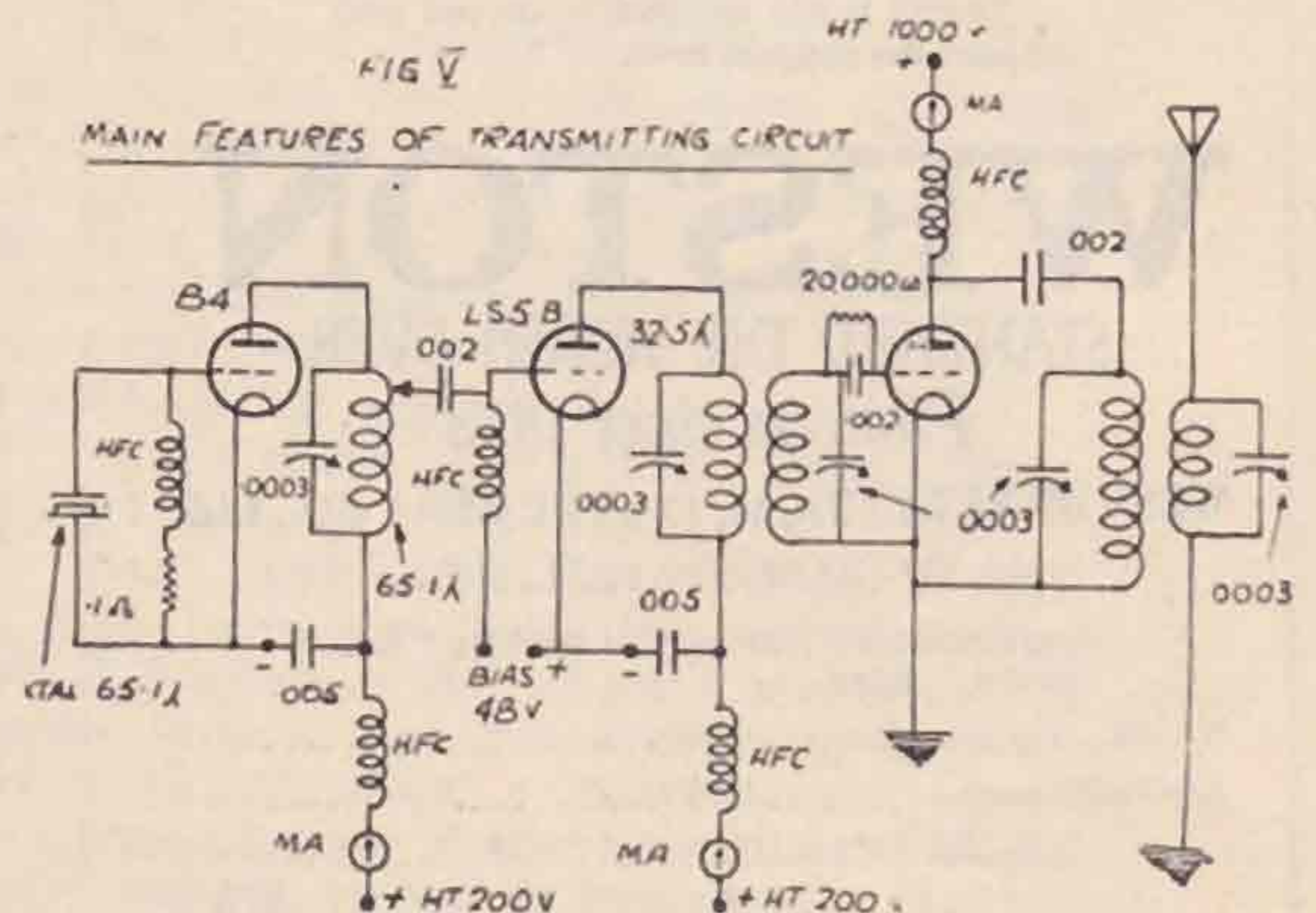

FIG. 4  
DETAILS OF COILS

reception, and is in fact intensely interested in high quality reproduction. Being situated some 15 miles from a main B.B.C. station, the receiver used is the "Special Demonstration Receiver," particulars of which will be found in the "Wireless World" of February 16, 1927. This receiver may be heartily recommended, and used with a moving coil loud speaker, the reproduction obtained is delightful and it would be difficult to distinguish it from the original in the studio. In any receiver intended to give large output, the last stage is the important part, and at 5NJ two LS5A's valves are used in a push pull circuit, with 350 volts on the anodes, made up by the 220 volt mains plus high tension accumulators. The M/C speaker was made in accordance with directions given in the "Wireless World" of September 28, 1927, and this speaker has been found very satisfactory.





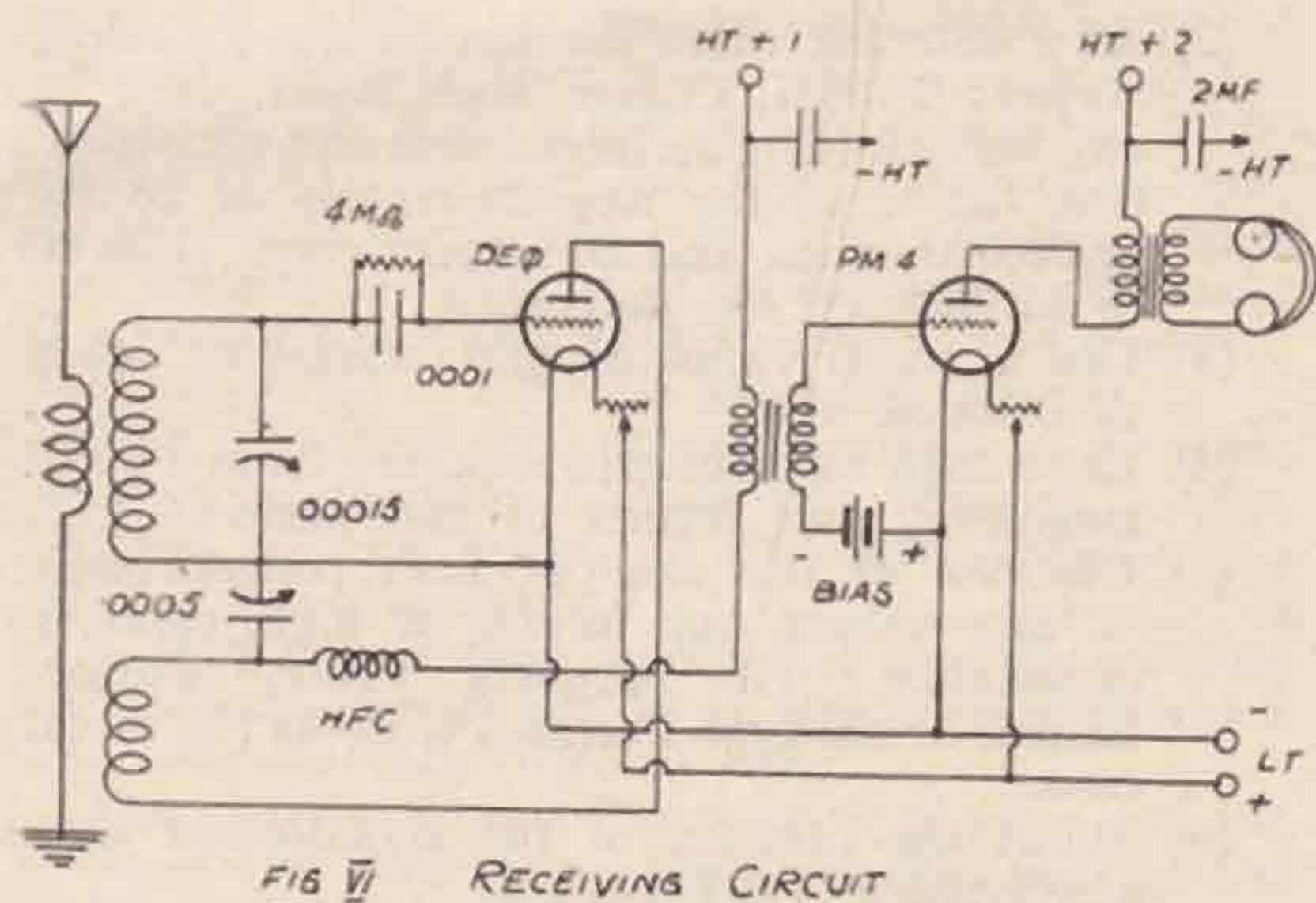

FIG. V. RECEIVING CIRCUIT

This completes the brief description of the main part of the apparatus at 5NJ. There are, of course, other units, such as two wavemeters, an oscillator, charging board, and various measuring devices, but it is thought that details of these would not be of general interest, as they are used for specific purposes only. Before concluding, the writer may perhaps be permitted to give some of his own experiences in short-wave work generally.

Considering receivers first, the writer is of the opinion that the best short-wave receiver is the super-heterodyne. It is, however, expensive to run and difficult to design, but no other receiver compares with it for sensitivity. At the same time, the o-v-i appears quite good enough for C.W. work, but it has been found of little use on long distance telephony, especially when any amplification of the received speech is to be undertaken. The addition of a high frequency stage before the o-v-i, as done in the Igranic short wave kit, marks a big step forward, and may be recommended once one has become familiar with "searching."

As regards crystal control, the circuit and power ratios shown in the diagram and used at 5NJ, are not recommended unless the transmitter is neutralised, because of the fact that, without neutralisation, the output from the crystal (using the power ratios shown) is just sufficient to hold the oscillator down and nothing more. With the aerial system at present in use, a very loose coupling is employed, and this results in a fairly large feed back to the grid coil of the oscillator. Undoubtedly the crystal would have more control if a tightly coupled aerial were employed, but as shown, it fulfils its purpose. The point is, however, that very careful adjustment is necessary, with nothing to spare, to get the crystal to take command, and therefore the power ratios shown are not recommended for general use. They are used at 5NJ because, firstly, it is not desired to neutralise the transmitter, and secondly, they fulfil the purpose for the particular work at present being done. At the time of writing, crystal control is only used on 32.55 metres.

Little need be said about the transmitter proper. It will be seen from the photograph that it has been carefully laid out, some attention being given also to its appearance. The "Heath Robinson" arrangements are all very well in their way, but the writer has always found that well-made and carefully designed apparatus is a great advantage when any regular work is to be undertaken.

In conclusion, it is desired to put on record the many delightful friendships which have been formed owing entirely to a common interest in amateur radio, and to say that 5NJ is open to report on the tests of anyone doing experimental work at any time. It is also desired to thank my many friends in and around London for their assistance and advice at various times, and particularly Mr. Gerald Marcuse, of 2NM.

## Contact Bureau Notes.

By 6YW.

There has been considerable activity during the last month, and I am glad to be able to report that the CB has had a goodly number of fresh applications and is now a strong and healthy branch of the Society. I welcome especially 2OD, whose experimental work is so well known, and the German and Austrian experimenters whose names are listed in the new members at the end of these notes.

I shall be glad to receive applications from experimenters in other countries, and membership of this Society is not necessary for membership of the C.B.

The first "Group" was formed a few days after publication of the April issue, and 2NH has the honour of being the first "Group Centre," and I thank him for his assistance and wish the Group every success. The subject upon which the Group is concentrating is 8 and 10 metre transmission and reception, and it is hoped that someone will offer to start a second Group on the same subject, as I feel that great developments will be made on this wave, and EG must not be behind.

As far as the subject permits I shall endeavour to have at least two BRS members in each Group.

Shortly after this Group was formed, a second, on the subject of skip distances, was formed under the "Group Centre" 6LN, and to them I also wish every success.

I appeal again for offers to undertake Group Centre work from members who have a problem at heart and who are willing to concentrate on the one phase of our experimental work. I think also that they should be men who have already been experimenting on the subject they choose and have a good knowledge of the theoretical side of the question as well. Please don't think that you must be an "expert" on the subject, but it is obvious that if you are to be a Centre you must be able to assist all the members in your Group and direct the work along suitable lines.

I could mention a score of suitable men at the moment, and I hope that they will not be backward in coming forward!

The Wireless Society of Ireland has joined up in respect of their station 12B, and I have arranged to co-operate with them in the exchange of news with regard to tests and other such matters; they have also offered to bring this Bureau to the notice of all GW stations.

EK-4QM, a new member, is experimenting on the propagation of waves from 20 to 3 metres, using a frame for transmitting purposes, and desires schedules with EG experimenters for this work.

During the summer he transmits from 04.00 G.M.T. each morning. Please write via DFTV or to me, as he is working "under cover."

6TW sends me some information about his aerial experiments and a sketch of his aeriels, three in number; he calls the arrangement "The Pigeon Trap," and includes a counterpoise!

There is a 40-ft. high cage aerial, a 53-ft. high single wire aerial, and a 7-ft. high cpse, and in amongst these he has put up a  $\frac{1}{2}$ -wave Hertz.

I think something is wrong with his description, as he is using a "Zepp" feeder tapped to apparently one-third of the length, and he says: "The span tunes to  $\frac{1}{2}$  wave, and the feeders and coupling coil to one-third the fundamental, but a great benefit of this type is that one can handle the feeders and condensers in operation with 17 watts and the strength is only reduced by a third when in communication." Although the height is only 28 ft., he says that it is much more efficient than any other he has tried.

I, personally, think that a Zepp connected to the third of the length will not really be acting as a Zepp efficiently, and I think he has not conveyed what he means by the feeders tuning to

- (2) As a detector valve use one of the following types: PM5X, Cossor Red Band, etc., or any valve having an impedance and amplification factor in the neighbourhood of 20,000 or 30,000 ohms and 20 respectively. Use 60 to 80 volts on the detector.
- (3) Use a small value of grid condenser, such as 0.00005 mfd.
- (4) Use a high value of grid leak, say from 5 to 10 megohms, and return to the positive L.T.
- (5) Use one of the cheaper L.F. transformers, or any others not having a high primary impedance. He suggests Croix, Formo, Lissen, or old type Ferranti without the metal case.
- (6) Shunt the primary of the transformer with a resistance of 0.5 megohm.
- (7) Use a reliable 2 mfd condenser across each tapping of the H.T.

2NH concludes by saying that all these precautions may not be necessary in one case, but if they are attended to there will be no Threshold Howl.

Gi-6WG sends me the circuit of his receiver, and I think it should interest readers as being something

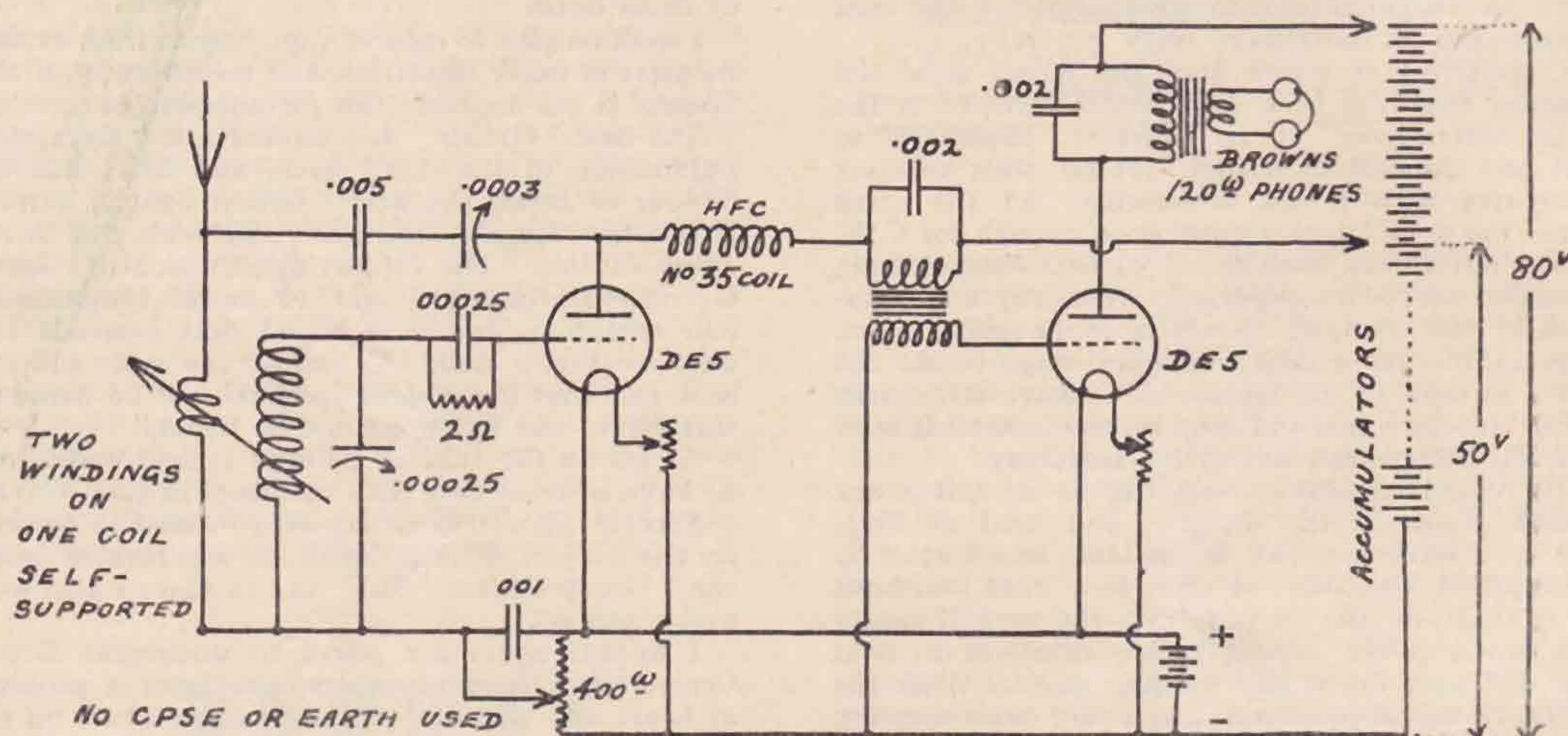

### RECEIVER AT Gi-6WG

one-third the fundamental; if so, they would have a different frequency to the aerial and could not feed it. Now then, 6MU and 6JV, comments, please.

2NH sends me some good reading on "Threshold Howl," and seems to have had great success in the elimination of it. He says that there are two types of howl in S.W. receivers, and the reason for different remedies being suggested by members is due to the fact that they are experiencing different forms of this trouble. 2NH puts the difference thus: (a) Detector portion of the circuit, (b) the L.F. transformer. He has tried the following remedies in 12 cases with complete success:—

- (1) Modify your circuit to the Schnell, as this is singularly free from this trouble.

rather out of the ordinary run of S.W. receivers. He has no trouble with howl, and I can speak for its sensitivity and flexibility at my last visit to his station.

Gc-5YG not only joins this month, but supplies me with some very interesting matter on the subject of insulators for a Zepp feeder. At 5YG ebonite was used for spacing feeders and despite the fact that it was good quality ebonite, it was found to be quite useless for this purpose except during a long spell of dry weather, and even then it was ineffective in the early morning dew.

Some experiments were carried out with this ebonite; a piece was carefully dried in an oven, weighed, and inserted at the high voltage point where the feeder connects to the aerial. Result,

very FB, lamps burning brightly and heaps of "juice." It was then taken out and soaked in water for an hour, after which it was carefully dried both inside and out with a dry cloth, and re-inserted in the original position. Result, visual and sentient indications of its decreased efficiency. It was taken out and weighed and it was found to have absorbed nearly one gramme of water.

This prompted 5YG to have a look at it under a powerful microscope, and this revealed a vast number of tiny pores, all of which appeared to be in a moist condition!

A further test was made, this time by making short pieces of wire fast to an ebonite spacer which had been carefully dried by hand.

The affair was placed on a sheet of glass and the ends of the wire were applied to the ends of the anode coil of the transmitter. The lamps in the feeders immediately dimmed, and the milli-ammeter flickered badly.

A portion of glass rod was now substituted for the ebonite and applied in a similar way, but no change was noticed in the normal condition of lamps and milli-ammeter.

5YG thinks, therefore, that the use of ebonite for out-of-doors work is not at all to be recommended, and he now uses Marconi 14 in. by 1 in. highly glazed porcelain straining insulators and has no trouble in the worst weather.

I thank the members who supplied these notes, this month, and I hope that I shall continue to receive items such as you have just read; it is not reports of long research alone that are welcome, but any unique facts which arise in general practice and which would be of interest and of service to the membership.

The list of new members this month is as follows: G6TW, G2OD, G2OP, BRS93, G5MA, BRS90, G2BBX, G6WY, BRS137, G6PP, EK-4QM, EK-4DK, EA-PY, G6OH, G2AAK, GW-12B, Gc-5YG, G5KL.

#### LATER NOTES.

EG.6YQ informs me that NU6UF and NU6DBO will call him or "Test EG" on 10.5 metres between 18.00 and 18.15 G.M.T. every Sunday throughout the summer, and they request reports by card sent directly, and also a report to EG6YQ, who will be able to QSR by radio. The same post brought the first letter "Budget" from the 10 metre Group, which consists of 2NH, 5KL, 6QT, 2BRJ, BRS107 and BRS26. This budget consists of the first letters on the subject sent to the Group Centre and then neatly bound in a folder and circulated in the Group, and each member will make his observations on the other letters and also a report of further work the basis of his next letter to the Centre, who will then circulate the six letters as the next budget. All the present news of known stations and best times for listening on 10 metres, which is in possession of the Centre, has been neatly duplicated and the duplicates included in the folder. As each member passes it on to the next on the list he retains one of the duplicate news sheets. The budget was first sent to me by the Centre 2NH, and I have added any additional information which has come to hand at CB. This is a very fine scheme, and 2NH is to be congratulated on the whole organisation.

This is going to be SOME Group, and this first budget is almost a text-book on 10 metre work,

and is an excellent production, full of keenness and very practical "dope."

Now, it is too bad to let these people have the whole field to themselves, and I am anxious to get another Group started on the same subject. There are names on the files here, but I want some more, and a good man to act as Group Centre for the second Group.

### Membership.

K. C. WILKINSON (5WK), 113, Half Moon Lane, Herne Hill, S.E.24.

W. G. K. KILBOURN, 341, Middlewood Road, Sheffield.

R. P. COLE (6RC), 55, Park Road, Chiswick, W.4.

R. E. SUMMERFIELD (6RK), 1, Newhall Street, Birmingham.

C. J. REED (2AWV), 184, Henleage Road, Bristol.

C. J. W. SCHIERENBECK, Bremen, Cellerstrasse 57.

E. P. OSCROFT (Associate Grade), Attenborough, Notts.

R. LENG, 16, Great Cumberland Place, W.1.

SERGT. J. PETERS, B Corps Signals, Rawalpindi, India.

A. POWYS-LYBBE, Rectory Farm, Streatley, Berks.

#### RESIGNATIONS.

C. L. FRY, Vale Lodge, Norman Road, Hove.

#### B.R.S. NUMBERS ISSUED.

166.—G. SAVILLE, 1, Solent Road, West Hampstead.

167.—W. G. K. KILBOURN, 341, Middlewood Road, Sheffield.

168.—A. POWYS-LYBBE, Rectory Farm, Streatley, Berks.

#### B.R.S. NUMBERS RELINQUISHED.

B.R.S. 37.—C. L. FRY, Vale Lodge, Norman Road, Hove.

## Notes and News from the British Isles.

### NOTICE TO AREA MANAGERS.

*Commencing immediately reports revert to the old style. Area Managers are asked to use their discretion when sending in reports, and are asked to draw them up on the lines adopted in this issue.*

*Area Managers may appoint an independent representative in the London Area to attend meetings of the Committee and to vote on their behalf. A letter appointing a member to the purpose mentioned shall be addressed to the Hon. Secretary informing him of the appointment.*

*Members appointed by Area Managers for this purpose shall not already be serving on the Committee as Representative Members.*

The Editor regrets that, with the exception of the Northern Division Notes, the London Area Notes had not been received at the time of going to press.

## LONDON AREA. Northern Division.

By 6CL.

The same few regulars again this month. Oh! where are you other North London fellows? I know you have been active, crowds of you, but no report. We are all interested in your work; why not let us tell the world!

6PA has sent no report, but he has visited us, and we feel that congratulations should be offered on his remarkable sequence of DX. He has only recently been licensed, but in his first few weeks on 23 has surpassed many of us. Using a bare five watts, he has worked NU 1, 2, 3, 5, 8 and 9 districts and NC 1 and 3.

6PP receives our congratulations on his appointment as QRA manager. He reports that 45 is "dead" now for QRP work, but has, in spite of this, found yet a new country in Europe to QSO. This was Estonia (ET8CX). Is this the first EG contact with Estonia?

6SC has experimented with different types of modulation and is now rebuilding to choke control. "Break in" is in operation here. Wave-length 162 metres. He has joined the 90 metre party and hopes to be on C.C. very soon.

5GU reports from Shanklin (I. of W.). He is still testing aerials. A half wave is now being tried, using 2VJ's modified Marconi system. We hear via 5GU that Jumbo (5TZ) has now acquired an OW. Good luck, OM, to you both from the North London Area.

5CD has done some work on 45 with indoor aerials, using 9 watts EC was best DX. (Don't forget the QRP indoor aerial tests, OM.—6CL.)

5UM has tested the efficiency of various oscillators in the series fed Hartley, but seems to have spent a lot of his time visiting 5AA, 6SC, 6FI, 6KW, and BRS61, all having been entertained at his QRA, whilst 6SC, 6FI, 6DP, 5TT, and BRS61 have all been visited.

5QF has succeeded in QSOing NU with QRP (4 watts) on 45, but has no DX otherwise, except that all distant Europeans have been worked, including Perm, East Russia.

2AX has had a successful month on 23, about 30 NU's having been worked, and also SC3AC. Conditions after May 9 very poor on 23.

6UN has a nil report owing to business engagements, but says that replies are coming in as a result of his questionnaire on Hertz aerials.

5AD and 5KU are now definitely B.C.L.!

5HS.—No report, but still working local OA's and OZ's!

BRS92 has a nil report, but says PCJJ is breaking all records for clarity and absence of QSS. He has applied for an artificial licence.

6CL has not been very active on the key, but is kept out of mischief most days answering letters and doing odd jobs at headquarters.

23 has been made to function and several Yanks raised, but no other QSO's on this wave. Conditions faded out immediately we got going on this wave! A few Yanks on 45 complete the DX here, but a fair amount of time has been spent in testing couplings.

Igranic short-wave coils are now being tested; results excellent. These coils are very suitable for portable transmitters or receivers.

## Northern Area.

Manager: S. R. WRIGHT, 2DR.

It would appear that the period of light nights and tennis has descended upon us with a rush, for reports are akin to the proverbial needle in the haystack. I would not mind it, you fellows, if you would only send a P.C. with "QRW tennis" on it, for that would show you were still alive. As it is, I am always uncertain as to my duty regarding obituary notices, fearing to cause pain to your relatives and all that!

Supposing, for instance, on opening the BULLETIN, you found a blank space for a few months in the place where "Northern Notes" are usually found, and you had all sent your reports in. I shudder to contemplate the hot air which my postman would usher in through my letter-box! The next Northern Area Conventionette would be a riot which even Mr. Bevan Swift could not control. What about it, you brasspounders?

Yorkshire, even though it is the county of broad acres, is evidently incapable of growing "reporters," judging by the display below. Lancashire is even worse, while 2AIZ with his four counties can only produce two staunch reporters, even after two or three attempts to circularise his sub-area. This is a sad tale of woe to be sure, but, unfortunately, it is the truth. Anyone short of a supply of postcards can have a packet on application to me!

### Yorkshire.

(By 2DR.)

6WD finds that the size of the aluminium electrodes in chemical rectifiers plays a large part in their efficiency. Europe has been covered on 45 metres with a measured input of 5 watts, while NU was worked on 23 metres R6 with the same input.

6DR reports 12NU, 1NC, 1SB, 1AQ on 23 metres and 18NU on 45 metres. He has now qualified for his W.A.C. with an input of under 10 watts. Congratulations, OM; you deserve it.

6OO registers 54 QSO's, notably R5 with SB1AH and NC3BK. This has been done on 23 metres and 8 watts. He reports reception conditions very good, and by his report it would appear so, too! 6OO wants the QRA's of AM1AB, AM3AB, ASRAO3. Will someone oblige?

BRS26 has been carrying out tests on 90 metres with 6FY and 2HH. 2NH has collected a band of 8-10 metre enthusiasts by means of the contact bureau, and BRS26 has joined it.

6IG has been pushing his 3 watt signals into NU as usual, but

has nothing of note to report. A BCL aerial, distant 3 yards from 6IG, has reduced working hours at this station considerably.

BRS107 is again rebuilding for 8-80 metres. It would appear that he has been troubled with threshold oscillation. Hopes to be on the air before these notes are in print.

5SZ has banged the key down again, this time on a Hartley circuit in place of the T.P.T.G. He will have more to report next month. A few NU's have been worked.

2DR anticipates a change of QRA in the near future and is re-organising gear. Fading experiments and signal strength measurements continue.

2YU is reported to be about to make a come-back. It will be a pleasure to hear from you, OM.

6BY carefully melted both rectifier plates and is rebuilding with T.P.T.G. and V.F. Hertz. DX 23 NU's, 1, 2, 3 and 8, and 1NC 1st district.

2BPH is rebuilding throughout and has nothing to report.

Failed to report: 5KZ, 6XL, 6TY, 5JA, 5CX, 2XY, 5US, 6BR, 6YR, 2YU.

### Lancashire and Isle of Man.

(By 5XY.)

2AUH is rebuilding his S.W. set for the tests and sends in a good report of reception.

5XY reports nothing doing. I fear a new Sunbeam and the light nights have something to do with this!

Failed to report: The rest of Lancashire and the Isle of Man!

### Northumberland, Durham, Cumberland and Westmorland.

(By 2AIZ.)

6GC is now working on 170 metres, but will be working on 8 metres as well shortly. Best QSO on 170 is 300 miles R6.

6QT reports a QSO with SC3AC on 7 watts; 8 metre work is also being attempted here.

Failed to report: All the others!

### Notts, Derby and Lincs.

(By 6MN.)

BRS103 is trying the super-heterodyne circuit as given in the BULLETIN and will report later.

BRS137 would very much like to fix schedules with transmitters using fone. Not afraid of a daily one!

2ACC finds the selection of the correct coupling coil for his T.P.T.G. set with artificial aerial a matter of difficulty. Has been QRW during the last month.

2BOW is hard at Morse practice and experimenting with coupling coils.

5BD has had considerable trouble with his generator almost all month. An 11½ metre Zepp aerial seems O.K. on 45 metres, NU and Russia having been worked, while NU has at last been raised on 23 metres.

6UO is out of action owing to changing his QRA. He has gone down to 23 metres.

6LN has done little DX this month, but has been keeping schedules with BRS98 and BRS72 on nightfall fading. The directional effect of the aerial system has also received attention, and useful data collected.

6MN seems to have had trouble with a Levy aerial on 23 metres. A change to an end-fed Hertz produced immediate results in both NU and NC. After months of work on 45 metres trying to effect this, 6MN wishes he had tried 23 metres earlier!

### Cheshire and N. Wales.

(By 6TW.)

Some replies have been received about the Cheshire Conventionette, and for their information it is hoped this will be arranged to take place in July. Will all Cheshire and N. Wales members who are not in touch with 6TW please forward their names and addresses?

2SO.—A little work is being done in the late evening on 45 metres on QRP. Poland and Latvia have been worked and confirmations of working NU4DU and Florida 4BL have been received.

BRS90 visited 6BY with 2AUH, but QRW exams.

BRS98.—Almost QRT, with exception of a schedule with 6LN. 5BR has had a very excellent month. On 23 metres 27NU, NC, OA, AI, NP, OIB have been worked, on 45 metres 2 NU's and on 90 metres EF and EN. Late news, reports QSO with NU6JN and OA5WH. Considering the input is 9 watts to a B4 valve, these results are worthy congratulations, OM.

BRS152 is in the middle of building a super-heterodyne and is also swatting Morse. This station is standing by with an O-V-2. For schedules write: 85, Hale Road, Hale, Cheshire.

6TW has carried out his usual 45 metre working, but is busy getting ready for a change over to A.C. mains. A 1,000 volt transformer is being constructed here.

## Mid-Britain (East).

Manager: H. J. B. HAMPSON (6JV).

The outcome of a very welcome visit from 2XV during the month was an effort to arrange a summer meeting at a suitable place of interest during August. Up to the time of writing, however, the necessary permission to view the places of interest selected has not been forthcoming, and it is possible that we shall have to content ourselves with a less ambitious meeting at a place and date to be announced in the July BULLETIN. Despite this disappoint-

ment, our warmest thanks are due to 2XV for his kind offer to organise the meeting, and it is hoped that, with his assistance, an enjoyable day may still be arranged and details announced next time. Here, then, is what 2XV has to say about his proposed arrangements and it is hoped that members will respond in accordance with his suggestions.

#### Cambridge.

By 2XV.

The first thing to mention this month should be a foreword regarding the Eastern Counties Conventionette, which we hope will be equally successful as last year, even if the area is now smaller—to make up for this a welcome is extended to any hams and friends, YL's, OW's, etc., from any other area. The venue is not yet fixed, but provisional applications are solicited, together with votes as to the most suitable date out of the following: Sunday, 19th, Saturday 25th, Sunday 26th of August—please let me have your votes with provisional application on a postcard, the date getting most votes will be selected and published in next "BULL.," all voting cards *must* be in my possession on or before July 5, and the *latest date* for applications will be August 10, *not later*. The cost will be approximately as last year, viz., 5s. per head, and it is hoped to make the money just as well spent.

Now, please, oh! please, don't leave it until the last minute before you make application like last year, as it complicates the organisation of the affair and doubles the work entailed—it is much easier to cancel an arrangement and return the money than it is to make extra hurried arrangements at the last minute.

Now, then, just a postcard to vote your most suitable date, then, when you see the ultimate decision published in the "BULL." later, fire off your money, stating how many tickets wanted, *absolutely at once*: No. 2XV, G. A. Jeapes, 117, Victoria Road, Cambridge.

Now for the month's reports:—

5JO reports a shock upon receiving a card from EJ7XX for a QSO ten months ago!!! He has worked five districts U.S.A., also fone to EC1RO at Prague (R7) and Rome (R5). He is now rebuilding for 23-metre work.

2DB now spring-cleaning his outfit and started on a new transmitter for 23. He will be on the air before this is in print. Gud luk, OM!

5YX is very pleased with an H.F. stage added to his receiver, and is now QRT until June, when a new C.C. transmitter and vertical aerial will make its debut.

BRS161 is welcomed to the area, and his QRA is P. L. Waters, "Jepshome," Green End Road, Old Chesterton, Cambridge. He is ready to report on any telephony work between 15-200 metres, and will shortly be QRV on 8 metres. Here's luck No. w OM!

6CR has really settled down to the job now, and is regularly QSO U.S.A. on 9-10 watts, and is building a C.C. outfit for use on the same wave, viz., 23 metres. He is also experimenting with H.F. amplifiers on receiver with quite satisfactory results.

2XV has now increased power to 60-75 watts and during the month of April has confined activities to the 23-metre band, with excellent results, all districts U.S.A. are being regularly worked, also Australian stations. Early mornings (5 a.m.-7.30 a.m. B.S.T.) has been found best for QSO 6th and 7th Districts, U.S.A., and Antipodes, but late evenings seems better for the Eastern States of U.S.A. The aerial here will shortly be raised, as it is at present only about 8 ft. clear of the roof.

2HK and 5YK have made no report this month.

#### Huntingdon.

By 2XV.

Mr. Maddox has completed the short-wave receiver and interesting results are being obtained. A wavemeter has been made and calibrated. Transmitting activities will undoubtedly follow shortly. We need a pioneer in ham radio in the county, OM, and wish you speedy success with P.M.G.

#### Norfolk.

By 2BWB

Owing to heavy QRW, 6ZJ has been unable to collect and forward reports for this county recently. 2BWB has kindly promised to take over these duties from him. Will members residing in Norfolk kindly note this, also Mr. Blake's QRA above? Judging from his first effort, 2BWB is going to "deliver the goods" in fine style. Even the dignity of an Area Manager's hind leg being inadequate to preserve its owner from a gentle "tweak"! F.B. OM, and carry on—but mind it isn't a wooden one or a "wouf-hong"!—6JV.

6JV last seen QRW with plastering. Believed to be also studying copper losses in a geyser.

2AAK is investigating the mysteries of 8 metres with a Mesny, using D.E.R.'s. Is puzzled to know why a "hay-wire" outfit "perked" nicely, while the finished article, as usual, won't!

2BWB has tried and abandoned Gi6MU's small field receiver coils owing to the necessity for capacity aerial coupling, which he finds far more effected by aerial swing than auto-coupling. Is still investigating "threshold howl" with a transformer specially wound to avoid it (which doesn't!). After laboriously winding 2,750 turns (by hand) for weak signals, as recommended by 2ZC, was unable to get a "perk" of any kind; so is still outside that happy circle who can receive  $\frac{1}{4}$ -watt Aussies at R9 on a picture wire! Has not been stung by a bee, nor inundated with T. & R. orders!

6ZJ reports heavy QRM. Has dismantled his 50-watter, but

hopes to be on the air very shortly on 23 and 45 metres with 200 volts of batteries to an LS5.

2AAS has been QRW and has only done a little reception.

5UF reports that he has not been on the air much this month. Has been making comparisons between DE5 and LS5 valves, with inputs up to 5 watts. Will shortly be testing  $\frac{1}{4}$ -wave aerial on 45 metres.

## Mid-Britain (West).

Area Manager: D. P. BAKER (2OQ).

The reports from Warwickshire show a considerable increase for this month; for this I am pleased, but Staffordshire, I am afraid, has been somewhat lax.

For this month I think we must all take our hats off to 5UW for working AC2AL; this, I think, is very creditable to the area, and shows what we can do.

Now what about a conventionette in this area? Will all members interested write to me personally about this; the time is getting short, and as I have not all your addresses, I cannot write to you.

I should propose Wolverhampton as a centre, but would like your opinions.

### STAFFORDSHIRE.

Reports to 5UW.

Reports this month are conspicuous for their absence, which fact simply will not do, OM's. I know that quite a number of Staffordshire men are busy, and their stations in fairly consistent operation, so why not let the rest of the world know about it, OM's. Send along the report for next month by the 10th, please.

2WN has rebuilt H.T. side, and changed over from chemical to valve rectification, and is pleased with the result.

6UZ does not have much time at his disposal these days for DX, but some fone work has been undertaken with varying results during the past month.

6OH reports a fine total of DX stations worked, including several 6th and 7th districts U.S.A., and 4th district NC. Has not managed to raise a South American yet to complete WAC. Unfortunately the week-ends only are available for radio at 6OH.

5UW has eased up somewhat, owing to the recent spell of fine weather, but has found conditions remarkably good during the early part of May on 20 metres. Has done some work on 10 metres, but has not yet heard a DX station down there. QSO's have been made with OA, OZ, many NU, NC, and what is believed to be the first EG-AC QSO with AC2AL of Peking, China. At 6AT's request, 5UW has been testing capacity coupling with Levy aerial, results are very interesting, and will be made known later.

2OQ has been very QRW lately, and has not had much time for experimenting, but has a new fitter under test and hopes for a better QSB.

6SO has been QSO with nearly all Europe with input of 4 watts, and would welcome schedules for observation of conditions.

### WARWICKSHIRE.

Reports to 6CC.

Please let me have all reports by 10th of the month.

5QP has been working 25 watts, and keeping schedule with Holland, reports of R7-4 on 45 metres. A report from Wilno (Poland) gives DC fb es by gtdi R4 on one valve. (Good bis on one valve with 230 mains input OM.)

6CC has been very busy only QSO this time with EF, 8YO, QRM very bad sig. R4.3. Steel mast under suspicion.

There are no reports from Coventry this month.

STATION VISITS.—BRS7 to 6CC. 6CC to 5QP, to BRS7.

5ML experiments with various types of Hertz aerials on 23 metres using T.P.T.G. Results: workings with all continents "regular service." N.R, NP, 567, NC345, AI, AM, AQ, FO, OA.

6CL.—Aerial test still proceeding as last month, OA5HG worked again, also SC-3AC, condition since beginning of May are excellent for South American DX, while Yanks have not been coming in well in the evenings.

2YX has been testing ship distances with 2OP, at a distance of 60 miles on 45m. No very interesting results obtained. Details to be given at a later date.

STATION VISIT.—6RB and 5FS.

### WORCESTERSHIRE.

Reports to 6AT.

6AT has been QRT for some time now, but some of his work may be found in other parts of the "BULL."

List of British stations logged by EP3MK during first half of May, 1928:

G—6ig, 2kf, 5ml, 5jw, 2bm, 5br, 5vl, 5kg, 5kl, 5jo, 6by, 2xy, 6so, 5cx, 6qt, 6qc, 5sh, 6co, 6bp, 6pa, 5ph, 6oq, 5td, 2rk, 6as, 6lr, 5uf, 6rm (first G station to QSO Azores); G1—6wg, 2it, 6mu, ;GW—16c, 17c, 18c.

## South-Western Area.

Manager: G. COURTENAY PRICE, 2OP.

The Conventionette concluded to-day and was a very great success. My most sincere thanks to the Bristol and District Radio Society for their great hospitality and enthusiasm. A full report of the proceedings will appear in the next issue.

2BI has deserted 45 metres and is now c.c. on 90 metres and descending to 23 metres for DX.

2GW has been carrying out schedule of duplex with 6LM on low power.

2YX has been full of good intentions, but too QRW to carry them out.

5FS seems to have spent much time cutting bits off his aerial and arranging the Conventionette. The efficiency of both 100 per cent.

5VL.—Still working a Hartley on 23 metres. Closed for two weeks. Minor experiments with feed methods only. QSO NU6, NC5, AI, FO, SB during month.

6JK, usual QSO's with NU on 45 and 23 metres, is conducting feed experiments with interesting results.

6RB reports success on 23 metres, having raised Australia. QSO OA5HG, strength R5. Worked usual bag of NU on 23 metres and 45 metres. Reports visits from 5LS and 6JK.

6UG all out on tube base receiver. Reports excellent results.

6ZR.—QSO all England on indoor aerial with input 2 watts. Hopes to be on 90 metre band soon.

2BFA, hon. secretary of Dorset Wireless and Television Club, experimenting with gram. amplifier and coil drive L.S.

BRS80 hopes to become a transmitter ere long.

BRS132 now 2ACG. Experiments on C.C. will begin shortly.

## Southern Area

By 2ABK.

I have pleasure in receiving this month three new station reports and will start the notes with them.

6XH, of Andover, is busy on 180, 90, 45 and 23 metres, and has worked NU on 23. He will be glad of schedules on any above waves after the end of June.

5LU, Basingstoke, having got a "lump" of quartz, has decided not to remain QRT any longer. Power, 10 watts.

2BRJ, of Clacton, sends a list of countries heard. He listens daily at 1500 B.S.T. on 10 m. Has heard NUSALY at R6, and EU15RA also many 20 metre harmonics.

5UY has been on 23 most of the month, and has had only one QSO, EP1BL.

5QV listens on 10 metres each week-end, but so far ND. Arranging aerial tests on 23 metres, has put phone to Montreal. Has sked with NC 4th dist. The gang there look for E.G. sigs. at 0630 G.M.T.

6FT is QRW tennis, but has experimented with valve grid leaks on 45 and 23. Had visit from 5QV.

6NZ has been on 9 watts chemically rectified RAC and worked States consistently on 45 metres, also Europe. On 23 worked Denmark only!! (Sorry missed you out last month om. I mislaid it.—2ABK.)

BRS91 has been busy with experiments with pick-ups and threshold howling. Also has made up some 6MU coils on valve bases.

2HJ has not punched the key, but has managed to hear all districts of U.S.A. on 40 metres within 30 minutes. He wants DX reports for QST the I.A.R.U. section.

2LZ has been on 180 metres only, but has been on 32 trying a drive circuit.

5QK (operated by 2ABK) has been active on 172 metres, and has been QSO 2AI of Plumstead, also several other London hams. Best report was from Felixstowe. All tests on fone.

Suffered QRM from 2LZ on 180 metres 100 yds. away!!

I'm glad to have a few more reports, but there's still room for more—buck up oms and send them to me, 2ABK, 2, The Broadway, Wickford.

## Scottish Area.

Manager: J. WYLLIE (5YG).

District managers' reports are due on the 10th of each month.

There seems to be little to record of importance regarding April, apart from the fact that DX conditions on 23 metres were exceptionally good. Eastern stations came in well from 16.00 G.M.T. and faded out in the region of 19.00 G.M.T., at which time western stations began to strengthen up, reaching their maximum about 01.00 G.M.T. 45 metres seems to suffer more than ever from appalling QRM, and as I heard an American express it the other night, "The 40 band is all gummed up." Terse, but true!

I have pleasure in intimating that Dr. R. R. Morrison (5ST) has agreed to represent the Scottish Area at Committee meetings in London, and act there on my behalf. I hope by this means to keep the area more closely in touch with H.Q. Dr. Morrison is an old hand at the radio game, and in his new capacity will, I am sure, prove a valuable asset to the Area.

I am pleased to say that ere this issue of the BULLETIN goes to press, No. 3 District is likely to be augmented by a very lively amateur in the person of Flight-Sergeant McLaren, R.A.F., lately AQ1HF. Sergeant McLaren's Iraq call-sign is well known to most of us, and he will be a decided acquisition to the Area.

### No. 1 District.

By 2WL.

2FV has been doing a little on 45 metres, using about 4½ watts. He finds, however, that his signals are badly screened and absorbed by a large cage aerial belonging to the radio installation of the Wireless College in the same building, and is at present altering this cage aerial to a single wire in order to try to improve matters.

2MG not transmitting at present.

2WL has not been regularly on the air for several months, as

most of his time has been taken up with experiments in connection with gramophone pick-ups and coil-driven loud speakers.

2BQK has changed his QRA from Aberdeen to Glasgow, is applying for his radiating permit, and hopes to be on the air soon. He recently had a very pleasant evening at 5YG and had the pleasure of meeting NC2CG there.

5XQ will be closed down for a few months owing to pressure of business.

5YG is still running regular NU, NC and G schedules on 23 and 45 metres. Considerable work has been done with respect to removing key-thump QRM from the broadcast bands, this incidentally involving a decided improvement in the note of the TX.

6MS duly got back from Mexico, but was only home for a few days prior to setting out for parts unknown.

6NX has practically abandoned 45 metres in favour of 23, and is "raising" many trans-Atlantic stations. He states he finds relief on that band from the horrible 45-metre QRM.

6WL is carrying out some interesting aerial work, and hopes to make a report on the subject soon. He has worked NU 2nd District and has been reported R4 there when only using 130 volts on the anode of his valve.

### No. 2 District.

By 6IZ.

2AP has gone back temporarily to 200 metres, but does not mean to stay there for good, and will eventually return to 45 metres. He is on holiday at present.

6IZ.—The QRA of this station is now 20, Cairnfield Place, Aberdeen. A good deal of work was done on 23 metres, which included QSO with all NU districts except the 6th. The Pacific Coast was reached however, in course of a QSO with NU7MO (Portland, Oregon). A visit has been received from AI2BG, who looks forward to some DX from 6IZ while he is in Aberdeen.

### No. 3 District.

By 6KO.

2SR continues his work with 23-metre telephony. Reports indicate satisfactory modulation. An attempt is presently being made to eliminate generator hum.

6KO.—Still convalescent and not yet fit for much radio work. The old hand-generator has been abandoned in favour of a small M.G. and great things are expected of it.

### No. 4 District.

By 2TF.

5JB has got a start made at last at his new QRA, which is 9, Grange Road, Edinburgh. He is getting out well on 45 metres with about 2 to 3½ watts input from H.T. accumulators. The TX is T.P.T.G. and the aerial system a half-wave voltage fed Hertz. Many QSO have been made, and he is forging ahead.

6UU, a new station which has appeared in No. 4 District. QRA 60, High Street, Bonnyrigg, Midlothian. He transmits on Sundays from 11 to 12 o'clock B.S.T., on 200 metres.

BRS62 has now got the TX "itch," and will shortly put forward his application for radiating gear.

## Northern Ireland Area.

Manager: E. MEGAW (GI-6MU).

We were very pleased to see G6WD over here a few weeks ago. Several of the GI's had the pleasure of meeting him, and we hope he enjoyed his visit as much as we did. If any other members are thinking of visiting Northern Ireland during the coming summer, I would be very glad if they would let me know, if convenient, beforehand. As it is expected that quite a number of amateurs whose activities also extend to the petrol world will come over for the road race, which is to take place in August, the R.T.U. are considering making special arrangements in connection with this event. Any suggestions or information from possible visitors should be forwarded to GI-6TB or myself.

I feel that it is high time we all began to consider very seriously the new conditions under which we will be working before very long. It is gratifying to see that definite steps are being taken in this direction in some quarters, but in the end the matter really rests with the individual station. While I think the standard of transmitter notes in this area is a fairly high one, I also think that there are very few GI's who could set and maintain the frequency of their transmissions at a given figure with a degree of accuracy even approaching that which will be essential next year; this, I may admit, includes the present transmitter at 6MU. I hope, therefore, that all concerned will turn their attention during the period of relative inactivity which usually occurs in amateur radio work about this time of year to the redesigning and reconstruction of their stations. The first essential is obviously an accurate and permanent frequency meter. The use of some form of master oscillator transmitter will be practically a *sine qua non*, but the idea that a low-power M.O.P.A. involves great difficulty or expense is entirely erroneous. I will be glad to do anything I can to assist GI's in this period of upheaval.

The station reports this month are neither numerous nor lengthy.

5MO still on 20 metres: NU-1, 2 and 3 worked during the month.

6YW on 45, 32 and 23 metres: NU-1, 2 and 3 worked and reports from NU 8 and 9. NC-3CS worked three times.

5WD not on much: a few G QSO's on 45 metres.

6WG not very active, but a few NU's usually worked at the week-ends.

## Notes and News from British Dominions.

### India.

By F. RODMAN (AI2KT).

Our old friend the "hot weather" is with us once more and with it QRN ad lib. During most of March it was almost heart-breaking to read signals on the 30 and 45-metre bands; on occasions R8 was uncopiable. As a result, the Ai transmitters have been comparatively dormant on the 30-metre band, once or twice conditions have improved and the active Ai's made hay whilst the "sun shone," or in this case whilst QRN-less. The 20-metre band has proved the most interesting and fruitful.

2KX (Rawal Pindi) reports bad conditions generally, but an improvement in the Ai-EG conditions on the 30-metre band between 15.00 and 18.30 G.M.T. QRM and QRN bad on the 45-band and no stations audible before 17.30 G.M.T. EG's 2VQ, 5JW and 6OH heard regularly on the 23-band, but this band not very good. Very successful schedule with Gi6MU at 20 whm continued.

2KX has now closed down and on his way to England; he will probably reopen in India in December.

2KW (Karachi) complains of QRN and bad conditions, not as active as usual. Successful work has been done on 21 metres during week-ends, but no details to hand.

2KT (Jubbulpore) actually worked to Western Europe (EG, EK, EB, EF) on the 30-metre band. FO and OA schedules maintained, but other countries were irregular and uncertain on the 30 band. QRN the dizzy limit. The 32 and 45-metre EG's very scarce and weak, EG's 5YX and 6YV on 32 metres reported f.b. by OA stations. The 20-metre band excellent after the 11th, most of Western Europe SB, FO and OA being worked every week-end. QSO with Europe possible from 16.30 G.M.T. up to 20.30 G.M.T. (2 a.m. here, and as we rise at 5.30 a.m. on Monday morning no later information available). Full daylight schedule with FOA3Z in its 6th month. 2KT will be closing down early in May in preparation for a visit to England.

The remainder of the Ai's inactive.

### Ceylon.

By G. H. JOLLIFFE.

I am leaving for England in June for about eight or nine months and hope to see some of my radio friends in the flesh.

For the past three weeks I have been most unfortunate, not getting any QSO; it appears to be a bad time of the year for Ceylon on 32.5 metres. I have heard no FO stations, very few OA, and occasionally OZ. Three AZ, but generally speaking very disappointing. I forgot to mention that I have heard no AI stations as well.

We are in the change of the monsoon, after having experienced a very hot and dry period; we are now having bad thunderstorms practically every night; atmospheric are very bad now.

TELEPHONY.—The Jave telephony stations are still to be heard here very well on a loud speaker with three valves. PCJJ is still very disappointing and not nearly as good as the old station. 5SW and 2NM can be sometimes heard, but very poor in strength. PCJJ are in the key thump of KZET, which is annoying.

### Irish Free State.

Manager: COLONEL DENNIS (GW11B).

Reports are again disappointing this month, although a number of stations are active. Quite a number are now down to 23 metres, only occasionally working on 45 metres. These include 11B, 12B, 18B, 14C, 17C, 11D and 13D. Of these, 18B and 17C have been doing especially good work, and the hopes for SB QSO's expressed in my April notes have been realised in several instances.

Now for reports.

12B has been too busy to be much on the air and only reports two NU QSO's at the end of April.

18B using MO transmitter, CF Hertz and hand generator with a maximum input of 10 watts, reports the following QSO's between April 11 and May 6: 25 NU's, 4 NC's, 3 OA's and 2 SB's: a great record.

14C, using TP-TG with half-wave C.F. Hertz on 45 metres and full-wave C.F. Hertz on 23 metres, reports QSO's with two NU's, R6, and one SB, R3, as well as some European DX.

17C, on 45 and 90 metres C.C., has done little beyond schedule work. On 23 metres he reports the following QSO's: 42 NU's, 1, 2, 3, 4, 7, 8 and 9 Districts, with input from 3.6 to 10 watts, as well as two NU's when using only 80 volts H.T.; 5 S.B's, 1 and 2 Districts, with 3.6 watts and 10 watts input; and 4 OA's, 2 and 4 Districts, average R4. Not a bad performance for QRP!

13D is mainly testing with 'phone on 45 metres and would be glad of reports.

11B went down to 23 metres TP-TG at the beginning of May, but has been too busy to be on the air except on a very few occasions. Using a V.F. Hertz with inputs of from 6 to 10 watts, he has had three NU, one FM, two SM and one ED QSO's. Would be glad of reports on 23 metres.

## Social Notes.

Except for the South-Western Area Conventionette no news of interest can be reported this month. We were very pleased to hear of the success of Capt. Courteney Price's first "get together" and hope it is the forerunner of many.

\* \* \*

For the information of the 450 odd members in the London Area we have to advise the receipt of a postcard from one member in favour of a field day. Sorry, 5BQ, OM—you and I would feel lost! Now, you fellows, don't grumble after this and say the social side is neglected.

\* \* \*

Convention is within a few weeks of us; not a single member from the provinces has written for accommodation, and not a London man has offered. This is a serious situation, as it would appear that the Convention will be an entirely London affair—this will not suit us at all—the whole aim of the Convention is to provide a means whereby we in London can entertain our provincial friends, at the same time giving them and us an opportunity to talk over in Convention the various business affairs of the Society.

No very definite plans are yet formulated, but it is intended to follow the lines of previous Conventions except that the Saturday sessions will be changed somewhat.

In previous years the main business has taken place during the morning, but at this time many of the London members have been unable to attend. In order to overcome this we intend to make the afternoon gathering the main business session.

As in 1927 a Hamfest will be held on the Saturday evening, when it is hoped every member of the Convention will be present.

\* \* \*

Those of us who visited the R.S.G.B. stand at Olympia last year were very interested in the fine collections of station photographs. Can we not improve on last year's showing and fill the walls with these interesting snaps? Photos can be sent to either Mr. King (5AD) or to myself. Thank you, OM, if you can oblige.

J. CLARRICATS (6CL),  
Chairman Social Committee.

### Strays.

Dr. Wortley Talbot, Broadsands House, Churston Ferrers, South Devon (6WT), will be pleased to co-operate with amateur stations working on 8 metres.

EG6TR has been using the 45-metre band for a year, has been QSO 150 Europeans, but has never received a single card from a German DE station. He claims this as a record.

### NOTICE.

ANNUAL LOG BOOK—We much regret that, owing to an error in setting up the illustrations of the Celestion Loud Speakers, Models C.10 and C.14 got reversed. We wish to tender our apologies to the Celestion Radio Co. for the mistake and hope our readers will take due notice of the fact.

## The Voice of Holland.

Every Wednesday at 13.40 G.M.T. the wireless transmitter PCLL (Kootwijk, Holland) speaks in Dutch, English, French and German to the Dutchmen abroad and to all those whom the Kingdom of the Netherlands interests.

Transmitting station: Kootwijk, Holland (5° 49' 30" and 52° 10' 24" N), Q.R.H. 16.600 kilocycles; power, 32 k.w. beam aerial; direction, Holland-Java.

Listen yourself and let your friends listen.

Transmit the reports to the press, which may publish same free of charge.

## Correspondence.

To the Editor of THE T. & R. BULLETIN.

SIR,—It gives me great pleasure in stating how well the British Experimental Station 5SW is now being received in Ceylon. Every night, 11.30 p.m. local time, Big Ben booms out 7 o'clock, followed by the London programme.

Whether it is due to atmospheric conditions or not, some nights it is practically impossible to keep 5SW tuned in, while other nights there is no difficulty.

To receive 5SW it is necessary to get one's set near the oscillating point; this is difficult to do straight away, with the result that we often miss the joyful sound of Big Ben. Would it not be possible to put on a record (musical item) say at 6.55 p.m., followed by your announcement; then change over. The present method of tuning note does not appear quite long enough.

Another important thing now it is summer time and we are now receiving you at 11.30 p.m., which is quite late enough—when England goes back to ordinary time, will you be able to alter your transmitting hour?

I consider 5SW clarity and modulation the best ever received in Ceylon, far in advance of PCJJ.

Java ANE on 15.93 metres, and ANH on 17 metres are to be heard most nights. Generally ANE is louder, but the hum of his dynamo very pronounced. Their best transmission appears to be when they are talking to Holland.

Station 7VX has stopped work, as I am going to England for a holiday, but shall be pleased to correspond with any member in connection with future transmission lists if you will write me c/o this paper.

I have heard station S.B. IBO about 0030 G.M.T. coming through very well.

G. H. JOLLIFFE.

Frocester, Govinna, Ceylon.

To the Editor of THE T. & R. BULLETIN.

DEAR SIR,—We herewith have to inform you that on the 29th inst., we begin the picture-transmission from our short-wave station 7RL. The wave-length is 42.12 m., or 84.25 m.

During the days Tuesday, June 5 and Friday, June 8, 42.12 m.; Tuesday, June 12 and Friday, June 15, 84.25 m., we hold a Scandinavian short-wave competition, and there will at the stated hours and wave-lengths be transmitted telephony with a fixed programme, which is to be the listeners to receive and report to our address: Postbox 340, Copenhagen, Denmark.

We beg all the listeners outside Scandinavia, even if they don't take part in the competition, to send us a report of how our transmission has been heard on the two wave-lengths.

7RL, Copenhagen.

To the Editor of T. & R. BULLETIN.

DEAR SIR,—Whilst I was QSO OA5BW recently, he asked me why it was that the majority of British amateur stations who were working on the 23-metre band used spacing waves. He mentioned certain stations whose spacers were quite as loud as their marking wave, some of them being up to R7. He also said that he considered that many lost QSO's must occur through the use of spacers, and that he thought it reflected badly on the abilities of the operators of such stations. He was not, of course, complaining about crystal controlled stations, whose spacer was on the same wave as the true wave.

May I ask the stations (I need not mention their calls, but they were nearly all QRO chaps) to please find some method of keying which will eliminate those vile spacers? Surely one wave is enough; and will they please remember that every station using two waves like that is doing some other ham out of a place on the band?

The excuse may be made that the spacing method of keying is used to eliminate QRM to local receivers, but this cannot apply at 5 a.m. G.M.T.

Yours sincerely,

E. MENZIES,  
G5MQ.

To the Editor of T. & R. BULLETIN.

DEAR SIR,—I should like to make a suggestion, which, to my knowledge, has not been made before, i.e.:

That after a station has finished calling another station, it should sign off as usual and then add R5 or whatever the QRK is. Also "QRM," if any.

This, I think, would facilitate unnecessary repeating when the signals are QSA and when QRZ would give the station being called the chance of knowing that he was being received with difficulty.

I should be glad to see opinions upon this suggestion in the BULL., and think it would be a help.—Yours faithfully,

GEORGE A. WOODS.

"THE TEST-HOUND."

To the Editor of T. & R. BULLETIN.

DEAR SIR,—Judging from opinions expressed by those who have heard what I have to say on the above subject, some who read this will doubtless think I have a bee in my bonnet. Carry on, OM's! I don't mind a bit, if this has any sort of effect.

I do think, though, from much listening, particularly on the 45-metre band, that we are becoming as bad as the Yanks with their "CQ-Hound" pest. Last Sunday morning there were about ten British stations who all came on and called test together. They all finished nearly together and the ether was bare for a while as they were all listening. Then the whole lot came on and called some more "test."

Personally, I always look upon a man who is always heard calling "test" as the owner of a punk receiver. There is nearly always someone calling "test" or CQ, and you can raise such a man by calling him, instead of adding another "test" to the mush that is already there. I have nothing to say against short and snappy "test" calls, but when people blather away solid for three to ten-minute periods I think it is deliberately adding to the QRM that we already have to put up with.

Why not try "test" three times, sign three times, and repeat the lot three times, sending slowly and not using some vile key and falling all over yourself all the time? It would produce more replies, and people would look upon you as a better operator than they do now. Why not give it a try, at least, OM's?

I know it is a tendency, if one listens round the dial and hears no one about, to change over and call "test" on chance. Personally, I generally switch off and get on with something else for ten minutes or so if I don't hear a likely station first time. To my mind, however, hams who do this are not in quite such a bad class as those who switch on the transmitter and call "test" before even picking up the headphones and switching on the receiver. Unfortunately there are many of them!

Of course, I know that there must be someone calling test or CQ if we are to QSO at all, but there are always quite enough of these to go round, in my experience, without our adding to their number.

What we want over here is a good old Wouffhong!

Yours with all sorts of apologies,

L. H. THOMAS, 6QB.

To the Editor of T. & R. BULLETIN.

SIR,—It is with sincere regret that it becomes our sad duty to chronicle the death, on May 17, of a personal friend and fellow amateur in the person of Mr. J. Geary, G5GZ, of Swansea, South Wales.

Although of latter days circumstances prevented his taking an active interest in radio, we knew him in the past to be an able and untiring worker in the cause, and, above all, a real "ham." May we thus pay small tribute to A Silent Key, for Amateur Radio will be the poorer for his passing.

Yours, etc.,

Geo. A. MASSEY, G6YQ.  
B. F. PHILLIPS, G5PH.

To the Editor of T. & R. BULLETIN.

DEAR OM,—I notice a letter in the May BULLETIN from 5GW, stating that there is no such thing as GCT.

While I am not personally in a position to discuss this matter with any authority, I would like to refer him to an editorial on page 8 of the March, 1927, QST, where this time is defined as that which commences at 00.00 midnight and goes on to 24.00 midnight following, whereas G.M.T. (Greenwich Meridian Time) runs from midday to midday, being used for astronomical purposes only. In this editorial it is stated that "navigators have been using G.C.T. instead of G.M.T. since the 1st of 1925."

Very 73,

K. E. BRIAN JAY, eg2HJ.

To the Editor of T. & R. BULLETIN.

SIR,—Commencing May 6, stations NU6UF and 6DBO will make test transmissions on or about a wave-length of 10.5 metres every Sunday from 18.00-18.15 G.C.T. A code word will be repeated several times during the course of each transmission. Reports, giving all possible details, will be appreciated by the above stations, who also request that duplicate reports be forwarded to EG6YQ for direct QSR on schedule.

Thanking you on behalf of 6UF and 6DBO.

Yours faithfully,

Geo. A. MASSEY, eg6YQ.



To the Editor of T. & R. BULLETIN.

DEAR SIR,—I have recently received a letter from Radio AC2CK China, and he is very anxious for an English QSO. I am enclosing particulars of some special tests to be carried out by 2CK in June. Can you please bring them to other English amateurs' notice through the T. & R. BULLETIN?

Thanking you, Yours truly,  
H. E. COOK.

#### SPECIAL TRANSMISSIONS FROM RADIO AC2CK, JUNE 16-30

Starting on Saturday, June 16, and each day until June 30, at 21.00-24.00 C.M.T., 2CK will call G stations on 32.5 metres also.

On Saturdays, June 16, 23 and 30, 2CK will call G stations at 04.00-06.00 G.M.T. on 32.5 metres.

Will any English amateurs hearing these signals please give AC2CK a call?

Thanking them in anticipation,  
Radio AC2CK, China.

To the Editor of T. & R. BULLETIN.

DEAR SIR,—Here is a little suggestion that may be of use to a number of amateurs, in particular the QRP people.

Most amateurs build their transmitters on a base board, which is usually of good wood.

Many also use the Dubilier Type 577 condenser, especially as a "by pass" condenser in such circuits as parallel-feed. Hartley, Tune-plate-Tuned grid, etc.

The conditions in such a position demand that a really good condenser be used, as a very heavy "Radio-Frequency" current has to be "by-passed," and it has also to stand, with a conservative "safety factor," its high tension voltage of the system.

The 577 condenser is made in a nickel-plated metal case, with two convenient screw-holes at the base, by which more amateurs screw the condenser to the afore-mentioned base board.

Around the condenser there will be a very strong Radio Frequency field, and if any amateur, with an efficiently working transmitter, cares to touch the metal casing, he will get a nasty shock and burn; at least, I did.

It struck me, not the condenser or the wall, but the idea that this could be the seat of very heavy losses, so I investigated, and here are the actual figures in my case.

Testing on the 90-metre band with 20 m/a at 400 volts I had a radiation of .175 amp.

This with the condenser screwed down to the base board, which is well seasoned wood, well varnished.

The condenser was then unscrewed and allowed to be held "in the air" by the wiring well away from the base board, etc.

Result: 17.5 m/a radiation up to .2 amp. So saving one watt and getting extra radiation was well worth it.

MORAL.—Paying attention to small things is FB, OM's.

Yours faithfully,  
HAROLD HARDING, G-2HH.

To the Editor of T. & R. BULLETIN.

DEAR SIR,—For some little time past there have been several amateurs somewhat annoyed at having their card lost in the QSL bureau, and they have been inclined to attribute it to carelessness at the QSL section. Perhaps a few remarks may be of interest by one who is in no way connected with the QSL bureau, but who has been up there when 5AD has been sorting out and dispatching cards.

Firstly, some are to blame for sending envelopes that are inadequate. Some envelopes are too small, of too thin paper, and have very weak gum, etc., and it takes 5AD an unnecessarily long time to get the cards into some envelopes, and an even longer time trying to make the envelope stay "licked up." Messrs. Woolworth can supply an excellent envelope, 7 in. by 4 in., of thick paper, and with a flap at the end, not on top, with an adequate amount of gum.

Secondly, about 50 per cent. of the cards handled are reports, which, so far as I am concerned, and most other transmitters will agree, I think, are useless. To take two examples: One, a card to one of our 100-watt 23-metre members from a B.R.S. living in the next road reporting signals R6; 2, a pile of cards nearly an inch thick from a B.R.S. addressed to Yanks, the greater number of which are in communication with Europe nightly. Apart from the uselessness of these reports, they waste time and cause trouble, and the twopence charged for QSR may cover the cost of postage, but it does certainly not cover the time and trouble involved.

Any B.R.S. can buy a list of Yank QRA's from Headquarters, and if they only thought for a moment, does this fellow want a report, and then sent the card *direct* if the QRA was known, or *direct* to the distributing agency the other end, they would receive some very enthusiastic replies, and 5AD would be relieved of a lot of unnecessary trouble.

Yours faithfully,  
N. C. SMITH.

## Q.R.A. Section.

Manager: M. W. PILPEL (6PP), 54, Purley Avenue, N.W.2.

First of all let me express my appreciation of having been elected Manager of this Section. I trust that I shall succeed in carrying on the good work of Mr. Jamblin in this capacity. Anyway, I have the satisfaction of knowing that I will be ably backed up by the members of the QRA sub-committee who have kindly promised to do all they can to help with supplies of new QRAs. Firstly, Miss Dunn (6YL), whose splendid work in the past is well known to all members, Mr. Denny (6NK) and Mr. Browne (2AUH), in conjunction with BRS90, have all assured me of their intention of doing their bit, and I am sure I shall not be let down by these, but I also look to every member to help by letting me know at once about any new QRAs or changes of old ones which come to their notice. Set to it, fellows, and let us make the British QRA list the most complete and up-to-date one in the world. You can be sure that I'll do my share, and I want you to do yours.

## Trade Notices.

Last month we had pleasure in noticing the excellent wander plugs for batteries made by Messrs. Lectro-Linx, Ltd., of Vauxhall Bridge Road, under the name of Clix-Lox. This month we have received from the same firm a sample of the Clix accumulator terminal. This embodies a novel form of connection for the wire leading to the accumulator. Instead of binding round under a milled nut, where it promptly proceeds to corrode and cause endless trouble, the wire is terminated in a Clix plug and introduced into the side of an ebonite-headed nut which is first screwed on the terminal stem. It is thus out of the way of acid and enclosed in a dry, acid-proof enclosure. This will be a boon to those who have suffered from the usual accumulator terminal trouble.

From Messrs. Stratton, & Co. Ltd., Bromsgroves Street, Birmingham, we have received particulars of their short-wave inductances and other features. The desire of the average broadcast listener to delve into the short-wave region, has had a beneficial effect for the amateur in the production of commercial short-wave apparatus. Messrs. Stratton, whose material is sold under the name of Eddystone, show some very efficient and nicely spaced short-wave coils and inductance units. There are also some H.F. chokes and short-wave variable condensers. This firm evidently caters for the ham who finds difficulty in constructing his own gear, and it is worth while to write for their catalogue.

The Burndept Ethovernier dials are known by most amateurs for their smooth action and suitability for short-wave work. We have had one on the Editorial short-wave set for over a year now, and would not be without it. The mechanism is most ingenious and consists of friction rollers operating upon the epicycloidal principle. There is no back-lash whatever and the dial turns smoothly round, enabling the most fleeting signal to be captured and held. We have adopted these dials upon the R.S.G.B. short-wave set, knowing their high efficiency. A useful accessory to this dial is a segmental card which fits between the dial and the panel, so that special spots may be charted with ease. We also notice that Messrs. Burndept have introduced some well-made variable condensers and also holders for screened grid valves. We know that these accessories will uphold the traditions of this old-established firm.

When we decided to use Cyldon condensers for the R.S.G.B. short-wave set, we knew that we would be safe on the grounds of efficiency, but when we approached Messrs. Sydney Bird & Sons, Ltd., their well-known makers, we did not know that they had such a vast range of variable condensers for different purposes. From the small neutralising condensers up to the triple gang with thumb control, all needs can be met. The workmanship throughout is excellent and we could not help comparing them with the condensers of not so long ago, when to get one which did not short at some part of the scale was indeed a rarity. The large gang condensers with thumb control tuning are fitted with shields and ought to be just the thing for the multivalve H.F. amateur. Messrs. Bird have taken elaborate tests and produced frequency curves of all their condensers and this matter in printed form is at the disposal of clients.

### Book Review.

A POPULAR GUIDE TO RADIO. By B. Francis Dashiell. (Bailliere, Tindall & Cox.)

The title of this work well describes it. Although it hails from America it can be read with the greatest of interest by British readers. The only apparent difference is that most of the apparatus described and illustrated is American and the word "tube" has to be read as "valve" throughout the pages. These small features can hardly be considered, however, and they do not detract from the value of the work. It is a comprehensive survey of all radio work from the early crystal to the latest up-to-date receiver and transmitter. Every possible circuit ever thought of is thoroughly described and the result is perhaps the most up-to-date description we have yet read. The book is essentially one for the beginner, for it takes him by easy stages through the whole realm of radio work. The author has avoided throughout the use of mathematics to explain his points; instead, he describes in word the function of each part and the method in which it acts. The opening chapters deal with the fundamental features of electrical knowledge which every radio worker must know. The principles of the production of high frequency radiations are next explained in simple language which anyone can understand. Simple and complex transmitting circuits are described and the work closes with a chapter giving some interesting information upon atmospheric conditions and static. The work is well illustrated and can be confidently recommended to anyone who wishes to obtain an all-round knowledge of radio work.

### EXCHANGE & MART.

Rates  $\frac{1}{2}$ d. per word, minimum charge 1s. 6d.

FOR SALE.—Rotary Converter, 220 volts D.C. to 3 phase, 300 cycles, 500 watt, with new Zenith transformer to 2,500 volts, three rectifier and one oscillator filament windings.—2SH.

TANTALUM AND LONIUM.—Make your own battery chargers for alternating current. Simple, reliable. Lionium Rectifying Electrodes, 2-4 amps., 12s.; 6-10 amps., 16s. Also Transformers, Blue Prints and complete chargers.—BLACKWELL'S METALLURGICAL WORKS, LTD.—Liverpool.

ZENITH AIR-COOLED TANK TRANSFORMER.—Primary 210-240 v., 50 v. Secondary, No. 1-3,000-2,000-1,000-0-1,000-2,000-3,000, 300 M.A. Secondary, No. 2, 12-0-12 v., 12 amps. Specially made for short-wave transmission requirements, and used 12 hours only. Cost, £17. Offers? Owner R.A.F. officer ordered abroad. Also Mullard S.W.2 Transmitting Valve. Brand new and never used. Rating 250 watts. Anode volts 2,000-3,500. Fil. volts, 10.9. Amps., 9.7.—H. F. G. SOUTHEY, School of Naval Co-operation, Lee-on-the-Solent.

WANTED.—WESTON (or similar) MILLIAMMETER, 0-1.5. Accurate voltmeter, about 0-15. Sifam Milli-Ammeters, 0-100 and 0-200, respectively. Cheap central-zero Ammeter for battery charging. Two accurate wire-wound Resistances of 100,000 ohms and one of 1,000,000 ohms. Two Zenith (or similar) 100-ohm Rheostats for about 2 and 3 amps., respectively.—6MU, Fortwilliam Drive, Belfast.

FOR SALE.—Limited supply of genuine Quartz Lenses, as used at 6VJ for CC; 1s. each and postage.—Apply 6VJ, 337, Anlaby Road, Hull.

PATENTS obtained, Trade Marks and Designs registered, British and Foreign.—GEE AND CO., Patent and Trade Mark Agents (H. T. P. GEE, Member R.S.G.B., A.M.I.R.E.), 51-52, Chancery Lane, London, W.C.2. Telephone: Holborn 1525.

TRANSMITTERS please note.—We are making a Rectifying Valve to cost you 15s. Specifications: Fil. volts  $5\frac{1}{2}$ , plate volts 1,000 with an output of 50 m.a. Guaranteed.—Send for price lists of new valves and repairs to NORTH LONDON VALVE CO., LTD., 22 $\frac{1}{2}$ , Cazenove Road, Stoke Newington, N.16.

POWER TRANSFORMERS.—A Limited Number only. Owing to a change in the design of our Main Receivers we have for disposal a limited number of Power Transformers with H.T. and L.T. Tappings. Primary: 200/240 v. or 100/120 v. 1st Secondary: 6 volts, 2 amps.; centre tapped. 2nd Secondary: 340 v. 60 milliamps; centre tapped. These Transformers are built to a most generous specification and have a very large factor of safety. Your opportunity of obtaining a power transformer of the highest class now occurs and because of the limited number available it is advisable to apply at once. Price 27s. 6d. post paid. Orders and remittances should be sent direct to our works—GAMBRELL BROS., LTD., Merton Road, London, S.W.18.

"ALWAYS" RESISTANCES.

POTENTIAL DIVIDER for H.T. Eliminators, all values, price 2s. These are very efficient when used as Grid Leaks for Transmission. R.C. Units, Resistances and Condenser interchangeable, 6s.; Grid Leaks, glass enclosed, 1,000 ohms to 30 megohms, 1s. 9d.—ABINGDON WIRELESS SUPPLIES, 45, Stert Street, Abingdon.

# Special Offer to T & R Readers



## The Dubilier Wavemeter

**A**N accurate wavemeter is essential to every experimenter.

This Dubilier Wavemeter is fitted with a special buzzer which retains its adjustment and gives a high clear note making sharp tuning an easy matter. The self-contained dry battery is controlled by an on-off switch and the case is of polished mahogany.

Readers of the T. & R. Bulletin are invited to write to us at once and avail themselves of this special offer, while it lasts.



Advt. of the Dubilier Condenser Co. (1925), Ltd.,  
Ducon Works, Victoria Road, North Acton, W.3.

Price

**45/-**

Complete with  
Calibration Chart  
and Broadcast  
Range Coil.

POST 1/6.

# The Filament

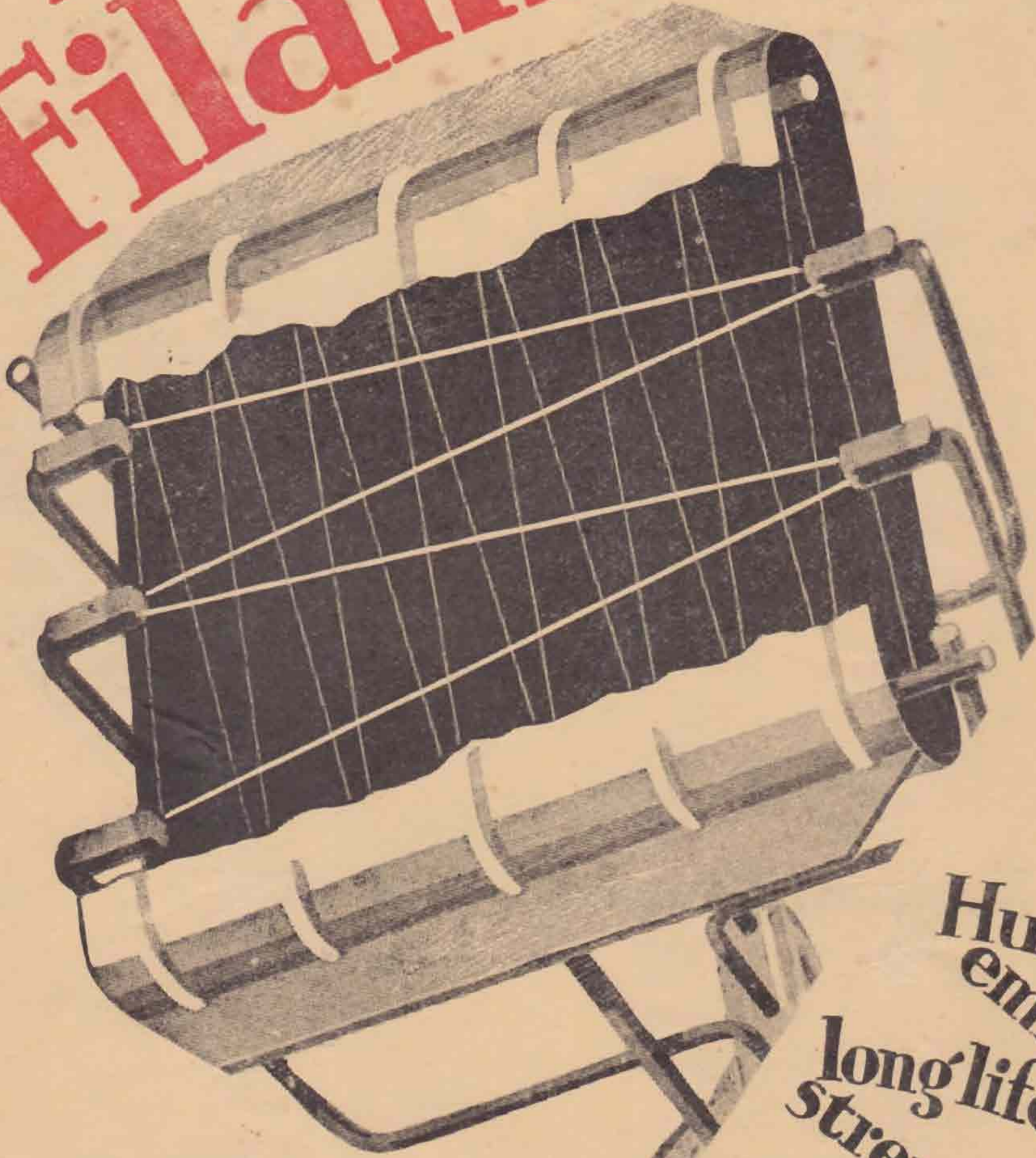

The Filament that cannot be broken except by the very roughest handling . . . a powerful filament . . . British made, found only in Mullard P.M. Valves.

Huge  
emission  
long life  
strength &  
improved  
results

# Mullard

**THE · MASTER · VALVE**  
with the wonderful P.M. Filament

