

short wave magazine

SEPTEMBER 1998 £2.75

BRITAIN'S BEST RADIO MAGAZINE

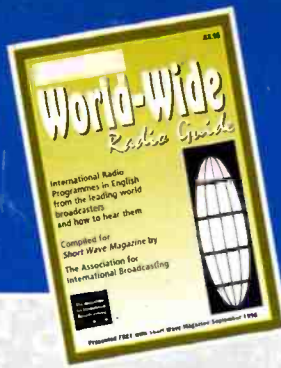

short wave magazine

WORLD-WIDE RADIO GUIDE FREE 16-PAGE BOOKLET WITH THIS ISSUE

DECODE SPECIAL

- **Wavecom W41PC Decoder - Reviewed**
- **The Data Mode Low-Down**
- **Lots Of Complex Data Mode Frequencies Listed**



- **How Does The Icom IC-R8500 Fair On Long Term Test? - Find Out Inside**



all your
Favourites
inside

- **JW Looks At A Bargain Ex-Commercial Gem - Racal's RA1792**



Bearcat BEST VALUE!

UBC 120XLT

Perfect for long distance reception of Aircraft, Public Services, Land Mobile and much more! Outstanding value for money!

- 66 - 512 MHz (with Gaps)
- AM/FM/WFM
- 100 memory channels
- TURBO SCAN 100 Channel/Second
- TURBO SEARCH 300 St/Second
- Data Skip facility
- 10 Priority Channels
- Programmable Search
- Channel Lockout Key

£129.95



UBC 220XLT

Uniden has built its reputation on reliability, ease of use and quality of reception with its most popular model, the 220XLT. Ideal for Aircraft, Public Service & UHF Communications.

- 66 - 956 MHz (with gaps)
- AM/FM/WFM
- 200 memories
- TURBO SCAN 100 Ch/Second
- TURBO SEARCH 300 St/Second
- Data Skip facility
- 10 Priority Channels
- Memory Backup
- Supplied complete with earphone, case, belt clip, charger and rubber duck antenna

£149.95



UBC 3000XLT

Uniden's top of the range scanner has 400 channel near continuous channel coverage from 25 to 1300MHz. New TWIN TURBO search and scan allow high speed scanning or searching to give lightning quick results. The set is packed with new features:

- 25 - 550, 760 - 1300 MHz
- AM/FM/WFM
- 400 memory channels
- TURBO SCAN 100 Ch/Second
- TURBO SEARCH 300 St/Second
- Automatic Frequency Storage
- Selectable Attenuator
- Automatic Frequency Sorting
- Data Skip
- Delay Key
- Channel Count Key
- Supplied complete with earphone, case, belt clip, charger and rubber duck antenna

£189.00



£249.00

UBC 9000XLT

High performance, virtually continuous coverage scanner with a large, clear display and easy to use controls. The set is packed with features - ideal for the serious enthusiast. It may be used at home or mobile. For unattended operation the 9000XLT has an automatic tape recorder ON/OFF and tape output feature.

- 25 - 1300 MHz (with Gaps)
- 500 memory channels
- VFO Control
- Selectable Attenuator
- Selectable Delay
- Selectable Mode AM/WFM/NFM
- TURBO SCAN 100 Ch/Sec
- TURBO SEARCH 300 St/Second
- Alpha Numeric Display
- Automatic Store
- Frequency Transfer
- Auto Tape Record
- Data Skip facility
- Programmable Search

UBC 60XLT-1

A brand new low cost scanner that covers MARINE, POLICE, LAND MOBILE and more!

- 66 - 512 MHz (with gaps)
- 30 memories
- Channel or Frequency display
- Priority Channel
- Channel Lockout
- Scan Delay
- Supplied complete with NiCads and Charger

£79.95

new from
Bearcat



UBC 860XLT

AIRBAND BASE SCANNER
A stylish low profile base scanner with TURBO SCAN and TURBO SEARCH facility. Covers CIVIL AIRBAND, MARINE, POLICE, CELLULAR and more!

- 66 - 956 MHz (with gaps)
- 100 memories
- Auto Squelch
- Priority Channel
- Unique Data Skip
- Scan Delay

£129.95



YUPITERU *probably the* WORLD'S BEST SCANNER RANGE

YUPITERU MVT 3300EU

An exciting new handheld packed with features - but at a price you can afford! The receiver has "breathtaking performance" ensuring this set is destined to be a number one seller

- **FREQUENCY:** 66 - 88MHz 300 - 470MHz 108 - 170MHz 806 - 1000MHz
- **MODES:** AM/NFM
- **STEPS:** 5, 6.25, 10, 12.5, 25kHz
- **MEMORIES:** 200
- **BAND MEMORIES:** 10 (user re-programmable)
- **PRIORITY CHANNELS:** 10
- **SCAN/SEARCH SPEED:** 30 per sec
- **POWER:** Requires 4 x AA batteries
- **SUPPLIED WITH:** Antenna, Earpiece, Carrying Strap and built-in Desk Stand

£149.95



YUPITERU MVT 7100 EU

Probably the most popular high end Scanner. It's easy to use and can receive just about anything going!

- 530kHz-1650MHz
- AM/FM/WFM/SSB/CW
- 1000 Memories
- C/W NiCads & charger

£249.00



YUPITERU MVT 9000 EU

Yupiteru's flagship model, with a range exceeding 2000MHz, a real time bandscope, twin VFO receiver, and a host of other features. EU version is especially designated by Yupiteru for the UK and Europe.

£369.00



We are proud to be
authorised by **YUPITERU Japan**
TO DISTRIBUTE THEIR SCANNERS IN THE UNITED KINGDOM
NEW LOWER PRICES on all YUPITERU models!

NEVADA[®]

Order Line 01705 662145 Fax 01705 690626

• 189 London Road • North End • Portsmouth • PO2 9AE

• E-MAIL info@nevada.co.uk • <http://www.nevada.co.uk>

Release

**Scanners
-we've got them all!**

NEW!
LARGE STOCKS
available
NOW!

AR 8200

- 530kHz - 2040MHz
- ALL MODE RECEPTION
- STEPS FROM 50Hz UPWARD INCLUDING 8.33kHz
- PRESELECTED FRONT END
- 1000 MEMORIES
- PLUS LOTS MORE!

**EXPORT &
PRICE MATCH
available**

£379.00



AOR AR8000 STILL the No 1 seller!

- All mode FM, WFM, SSB, CW, AM
- 500kHz-1900MHz
- Computer control
- Data clone
- 1000 Memories
- C/w NiCads & charger

£269.00

PRICE MATCH

NEW! ALINCO DJ-X10E *top of the range scanner*

- RECEIVES 100kHz - 2000MHz
- MULTI MODE RECEPTION
- 1200 MEMORY CHANNELS
- CHANNEL SCOPE SPECTRUM ANALYSER
- CHANNEL SCOPE PEAK SEARCH
- ADVANCED SCANNING FEATURES
- USER FRIENDLY FEATURES
- LARGE CLEAR ILLUMINATED DISPLAY
- TIMER FUNCTIONS
- BATTERY SAVE FACILITY
- SQUELCH CONTROL
- STYLISH CABINET WITH LARGE SPEAKER
- A SUPER SENSITIVE RECEIVER
- DUAL VFOs
- FACILITIES FOR CLONING ANOTHER SET
- BUILT IN 24 HOUR CLOCK
- DISPLAY - CONTRAST - CONTROL
- LOW BATTERY ALARM
- SWITCHABLE ATTENUATOR
- SELECTABLE CONTROL BEEP TONE
- KEYPAD LOCK CONTROL

includes
FREE

- MAINS DROP IN CHARGER For easy and convenient use
- NICAD BATTERY PACK 4.8V DC 700mAh NiCad bat pack
- BELT CLIP
- CARRYING STRAP
- FLEXIBLE LOW PROFILE ANTENNA

£295.00



We are one of Europe's largest Scanner Specialists
• Friendly expert advice • Large Stocks • Same Day Despatch

DEALERS!
for further details contact
Phil Jeffery
in our TRADE DEPARTMENT
Phone: Intl (0044) 1705 698113
Fax: Intl (0044) 1705 690626

Opto Hits The Spot



SCOUT

- 10MHz - 1.4GHz
- Stores 400 frequencies in memory
- Reaction Tune the ICOM R7000, R7100, R8500, R9000, R10, AOR 8000, AOR 8200, and Opto R11
- 10 digit LCD with signal strength bargraph
- Vibrator and beeper alert mode

DB32 Antenna Sold Separately



R11

- 30MHz - 2GHz wide band receiver
- Built-in speaker for instant audio demodulation
- LED frequency range indication display
- Reaction Tune with Scout
- Capture 5 watt UHF signal from 500 feet
- 1000 frequency lockout

TA100S Antenna Included



XPLORER

- 30MHz - 2GHz
- Two line LCD frequency display
- Decode CTCSS, DCS, LTR, and DTMF
- 500 memories
- 1000 frequency lockout
- Built-in PC interface
- Capture 5 watt UHF signal from 800 feet

TA100S Antenna Included

In The Spotlight



OPTOCOM

- High speed triple conversion GRE receiver
- Track Motorola 400, 500, 800, and 900MHz systems
- Decode CTCSS, DCS, LTR, DTMF, and Motorola talk group IDs
- Scan trunked and conventional frequencies simultaneously
- Reaction Tune with Scout Frequency Recorder
- Software Controlled volume & squelch for remote control operation

Computer Not Included

- Store & Scan, download up to 28 different frequencies or one talk group ID for scanning without computer control
- Supplied with the all new Trakkstar software
- Trunk Track LTR systems
- Scans conventional frequencies from 25-1300MHz

OPTOTRAKKER

- Decodes CTCSS, DCS, LTR, 5 tone (ZVEI) Motorola Type I and II, and DTMF
- Scan multiple trunked systems at the same time under computer control
- All trunked frequency bands supported, including 400MHz, 500MHz, 800MHz and 900MHz
- Built-in Data Slicer Circuit
- Pass through technology requires only one com port

Receivers supported under computer control:
Icom R7000, R7100, R8500, R9000 and R10, AOR AR8000, AR3000A, AR5000, and Pro 2005/6 with OS456/OSLite, Pro 2035/42 with OS535

MINI-SCOUT

- Reaction Tunes AR8200, AR8000, ICOM R7000, R7100, R8500, R9000, R10, and Optoelectronics OptoCom
- Locks on to signal in less than 1 second and automatically tunes radio to frequency
- 10MHz - 1.4GHz operation
- Lock on to 5 watt UHF signal from 250 feet
- Patented Digital Auto Filter
- Super Sensitivity: <math><3\text{mV}</math> @ 150MHz
- 16 segment bargraph for signal strength reading
- PC interface for datalogging using optional Optolinx interface
- NICads and charger included



COUNTERS

Handheld frequency counters, all incorporating patented Digital Filter and Digital Auto Capture. All counters come with initial accuracy of +/- 1ppm. High impedance amplifiers standard on M1 and 3000APlus. Call for additional features on all three counters.

Antennas Sold Separately

M1

3000A+

Micro Counter

Micro DTMF



Micro RF Detector

TECHTOYZ

Micro Test equipment in pager style cases featuring a 2000 character DTMF decoder, a Frequency Counter with three memory hold, and an RF Detector with settable threshold alarm.

TMC100 Antenna Sold Separately

Made in the
U.S.A.

www.optoelectronics.com

OPTOELECTRONICS®

5821 NE 14th Avenue, Ft. Lauderdale, FL 33334 U.S.A

HAYDON COMMUNICATIONS

132 High Street • Middlesex • HA8 7EL
Telephone: 0181•951•5781 Fax: 0181•951•5782

NEVADA COMMUNICATIONS

189 London Road • Portsmouth • PO2 9AE
Telephone: (01705) 662154 Fax: (01705) 690626

WATERS & STANTON ELECTRONICS

22 Main Road • Hockley • Essex • SS5 4QS
Telephone: (01702) 206835 Fax: (01702) 205843

short wave magazine

September 1998 Issue

BROADCAST

- 10 Bandscan Australia
11 LM&S

FREE THIS MONTH

In the centre of this month's issue you will find the **SWM World-Wide Radio Guide 16-page pull-out publication, bringing you a wealth of information, in booklet form.**



DECODE SPECIAL

- 23 Data Modes - The Low Down
Mike Richards G4WNC
- 44 Decode - The Column
Mike Richards G4WNC
- 46 Bits, Bauds & Bandwidth
Phil Cadman G4JCP
- 52 Commercially Speaking
John Wilson G3PCY
- 58 Wavcom W41PC Decoder Review
Dave Gentile



52



58

COVER SUBJECT

An ideal solution for any data enthusiast, a Racal RA1792 receiver and Wavcom's W41PC decoder.

features

- 17 A Delightful Year -
With An R8500
Peter Bond



17

regular columns

Airband	75	Next Month	56
Amateur Bands Round-up	70	Order Form	91
Bandscan Australia	10	Propagation Extra	73
Book Profiles	64	Propagation Forecast	72
Book Reviews	33 & 48	QSL	9
Book Store	88	Rallies	5
Communiqué	4	Satellite TV News	78
Decode	44	ShackWare	84
DXTV	85	SSB Utilities	69
Editorial	8	Subscription Offer	63
Info in Orbit	80	Trading Post	90
LM&S	11	What's in PW	92
MilAir	77		

Vol. 56 Issue 9 September 1998

ISSN 0037-4261

ON SALE AUGUST 27

Next issue on sale September 24

EDITOR:

Kevin Nice, G7TZC, BR95787

NEWS AND PRODUCTION EDITOR:

Zoë Crabb

EDITORIAL ASSISTANT:

Jo Williams

ART EDITOR:

Steve Hunt

ASSISTANT ART EDITOR:

John Kitching

EDITORIAL ADDRESS:

Arrowsmith Court, Station Approach,

Broadstone,

Dorset BH18 8PW

Telephone: (01202) 659910

Facsimile: (01202) 659950

If you wish to send E-mail to anyone at SWM then our Internet domain name is:

pwpublishing.ltd.uk

Simply add the forename of the person you wish to contact.

For example:

kevin@pwpublishing.ltd.uk

BOOKS, BACK ISSUES

& SUBSCRIPTIONS

(ALL ORDERS)

Michael Hurst:

(01202) 659930

(Out-of-hours service by answering machine)

ADVERTISEMENT DEPARTMENT

(Broadstone)

ADVERTISING SALES:

Chris Steadman MBIM

ADVERTISEMENT PRODUCTION:

Carol Trevarton

ADVERTISEMENT TYPESETTING:

Peter Eldrett

Telephone: (01202) 659920

Facsimile: (01202) 659950

ADVERTISEMENT MANAGER:

Roger Hall G4TNT

PD Box 948, London SW6 2DS

Telephone: 0171-731 6222

Facsimile: 0171-384 1031

Mobile: (0585) 851385

© PW PUBLISHING LTD. 1998.

Copyright in all drawings, photographs and articles published in *Short Wave Magazine* is fully protected and reproduction or imitation in whole or in part is expressly forbidden. All reasonable precautions are taken by *Short Wave Magazine* to ensure that the advice and data given to our readers is reliable. We cannot, however, guarantee it and we cannot accept legal responsibility for it. Prices are those current as we go to press. *Short Wave Magazine*, USPS No. 006996, is published monthly for £30 (UK) per year by PW Publishing Ltd., Arrowsmith Court, Station Approach, Broadstone, Dorset BH18 8PW. Second Class Postage paid at South Hackensack. Postmaster: Send USA address changes to Royal Mail International, c/o Yellowstone International, 2375 Pratt Boulevard, Elk Grove Village, IL 60007-5937.

DISCLAIMER. *Short Wave Magazine* wishes in no way to either condone, or encourage, listeners to monitor frequencies and services which are prohibited by law. We respectfully refer you all to both the Wireless Telegraphy Act 1949, and the Interception of Communications Act 1985. Some of the products offered for sale in advertisements in this magazine may have been obtained from abroad or from unauthorised sources. *Short Wave Magazine* advises readers contemplating mail order to enquire whether the products are suitable for use in the UK and have full after-sales back-up available. The Publishers of *Short Wave Magazine* wish to point out that it is the responsibility of readers to ascertain the legality or otherwise of items offered for sale by advertisers in this magazine.



HAYDON EXPAND INTO EUROPE!

Haydon Communications have recently returned from exhibiting at what must be the largest



Ham Radio Show for them to date. Over 35 000 people graced the Friedrichshafen three-day radio show and sales of Haydon's Q-TEK range of antennas were 'amazing' according to Mike Haydon.



Customers from all over Europe visited Haydon's stand and much interest was shown in the 6m Yagi antenna, as this band will be available in Germany



later this year due to the closure of TV services in this part of the spectrum. All in all Haydon Communications report that it was a superb show and definitely one they would recommend visiting next year!

LEICESTER AMATEUR RADIO SHOW

The **27th Leicester Amateur Radio Show** will be held at the Donington International Exhibition Centre at the Donington Park Grand Prix Motor Racing Circuit, Castle Donington in north west Leicestershire on the **25th and 26th September 1998** from 0930 till 1700 each day. Admission for one day is £3, £2.50 for OAPs and children under 16.

A new feature this year is a two day ticket for £5. Parties of 12 or more can get a further discount by booking in advance (£2 each).

The show is easy to get to by air, rail and road. It is five minutes from junction 23A of the M1 motorway close to where the A42 and A50 join the M1. It is three minutes from the East Midlands Airport.

A free shuttle bus service will run from the airport to the exhibition. The nearest railway stations are Derby and Loughborough on the Midland Mainline. However, there is a direct nonstop bus service from the station to the East Midlands Airport costing only £1.

A bus service also runs from Derby passing the railway station and stops immediately outside the entrance to Donington Park. A shuttle bus will run from the entrance to the Exhibition Hall.

There will be 150 stands with all the major traders and amateur magazines attending as well as national clubs and societies. In addition to these there are many component stalls and computer stands, which will be of interest to all electronics enthusiasts.

The venue is all on one level and access for disabled visitors is very easy. There is also parking right outside the main entrance.

The hall itself is purpose built and has a floor area approximately **one third larger** than the previous venue at Granby Halls! Also, the car parking is vast and **free!**

Catering is much improved over the previous venue as there is a cafeteria, snack bar and a licensed bar. There are also many new features including camping and caravanning on site, a meeting room for clubs and societies and a flea market.

There will be all the usual features such as Morse tests on demand and a Bring & Buy stand as well as prize draws and raffles. A number of events are also planned for this weekend, including the RSGB Centenary of Radio Dinner.

For those interested, a discount admission has been arranged to the Donington Collection Motor Museum, which is the world's largest collection of Formula One cars and to the British Superbike Championship.

The latest information can be found on line at

CLASSIC CLANGERS!

The **British Wireless for the Blind Fund** has launched a CD of classic radio clangers from around the world as a fundraising venture for its 70th anniversary. The Golden Goofs have been compiled and are to be presented by broadcaster Jonathan Hewat, who is a member of the BWBF Executive Council.

Bloopers Gold was on sale from the end of July, priced at £8.99 and all net profits will be going directly to the British Wireless for the Blind Fund to provide audio equipment for Registered Blind people in the UK. The momentous moments when broadcasters found their world crashing about their ears have been collected by Jonathan Hewat since 1979, although some of the classic in his collection date back as far as 1934!

"It really is the pick of the collection" says Jonathan, who taught broadcasting and journalism for many years at the University of The West of England in Bristol. According to him, 'The Gold Collection' comes from live broadcasts all over the world, including Africa, South America, Australia and the USA, as well as the UK and Europe.

The CD includes people forgetting their own name, some uncontrollable giggles - live, and possibly the world's longest ever question! Jonathan says "We used to put out cassettes of Bloopers (one each year) for several years, but the joy of the CD format is that you can find a particular blooper quickly and easily". All the clips have been digitally re-mastered and if you have a CD player in the car it can make long journeys a real pleasure and the accompanied booklet itemises all the tracks and each glorious clanger.

To order *Bloopers Gold*, send a cheque or Postal Order payable to '**46 Design**' for £8.99 and post to: **Gabriel House, 34 New Road, Chatham, Kent ME4 4QR**. Please allow 21 days for delivery.



<http://www.lars.org.uk> For stand and table bookings contact **John G4MTP** on (combined telephone and FAX number) **(01604) 790966**, E-mail: g4mtp@mail.com All other enquiries to **Geoff G4AFJ** on **(01455) 823344**, FAX: **(01455) 828273**, E-mail: g4afj@argonet.co.uk

NOW ON WEB

The **International Short Wave League** now has a web page run by Headquarters, the URL is as follows:

<http://website.lineone.net/~john.g0bwg/index.htm>

OOPS!

We have an apology to make to **Twrog Press**. In the August 1998 'Communiqué' pages we incorrectly printed their address and also some incorrect text. *Recent Rigs & Receivers*, the new publication from Twrog Press is actually edited by **Dave Morgan GW4KYZ**. Copies are available from Twrog Press at: **Penybont, Gellilydan, Blaenau Ffestiniog, Gwynedd LL41 4EP** or telephone **(01766) 590341**.

NEW WATSON RANGE

To replace the highly successful Watson range of base power supplies, **Waters & Stanton PLC** have informed us of five brand new models. The new power supplies have been completely redesigned with distinctive and clearly marked front panels and cover most customers' requirements up to 30A output.

The new range fully complies with all CE and LVD legislation and have highly competitive specifications. The new models are as follows: The **W-3A** 3A continuous, 5A peak, fixed voltage power supply; the **W-5A** 5A continuous, 7A peak, fixed voltage power supply; the **W-10AM** 10A continuous, 12A variable power supply with V/A meter; the **W-25AM** 25A continuous, 30A variable power supply with meters and finally the **W-30AM** 30A continuous, 35A variable power supply with meters. The price of these p.s.u.s range from **£22.95** up to **£119.95** inc. VAT.

To find out more, you're invited to contact Waters & Stanton PLC, at **22 Main Road, Hockley, Essex SS5 4QS**. Tel: **(01702) 206835**, FAX: **(01702) 205843**.

A SINGLE PACKAGE

A new product for use in the precision timing and frequency industry has been launched by Motorola. The Oncore

Remote GPS Precision Timing combines a complete GPS receiver and antenna in a single package. Intended for use in harsh environments, it outputs a serial data stream and a highly accurate one pulse per second signal.

By combining the receiver and antenna in a single weatherproof housing, the remote GPS receiver eliminates r.f. signal loss problems and the need for expensive coaxial cable. Instead, a low cost, twisted pair data cable connected the GPS timing device to its host system. The Remote GPS receiver uses RS-422/485 compatible transceivers to provide for remote commands, timing status and the one pulse per second signal interface.

The combination of Motorola's UT Oncore GPS receiver technology and rugged packaging provide an easy to install and cost effective GPS solution for precision timing and frequency

devices used in telecommunications infrastructure, computer networking and other timing applications. The Oncore Remote GPS Precision Timing Receiver, together with optional hardware mounting kits and cables for easy mounting and installation, are now available.

All Motorola GPS receivers are available through Motorola's international network of distributors, which provide sales support and application information. For a full list of European Distributors, contact **Tina Connolly** at **Motorola's Automotive, Components, Computer & Energy Sector, 27 Market Street, Maidenhead, Berkshire**, Tel: **(01628) 763260**, FAX: **(01628) 637059**.

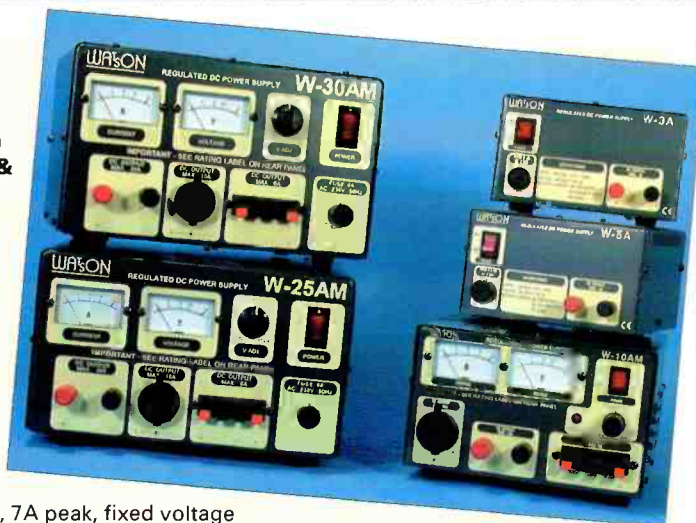

Dick Ganderton G8V FH is shown here attending **Friedrichshafen**, his last exhibition, on behalf of **Short Wave Magazine** and **Practical Wireless** with **Joerg**

Klingenfuss, the compiler and publisher of the famous **Klingenfuss** range of frequency publications. (Photo courtesy of **Waters & Stanton PLC**).

A general view of the main exhibition hall at **Friedrichshafen**, held back on **Thursday 25, Friday 26 and Saturday 27th June** at the large exhibition site beside **Lake Constance in Germany**, near the site of the original **Zeppelin Airship Works**. (Photo courtesy of **Waters & Stanton PLC**).

Jeff Stanton G6XYU with the first production model available in Europe of the new **AOR AR8200** hand scanner with the overseas Sales Director of **AOR**, **Mr Oshima JAIXM**. (Photo courtesy of **Waters & Stanton PLC**).



rallies

August 30: The Galashiels and DARS are holding their Open Day and Rally in the Volunteer Hall, St Johns Street, Galashiels, Scottish Borders from 1100 to 1600. There will be traders, refreshments, Bring & Buy, etc. **Jim GM7LUN** on **(01896) 850245** or packet @ **GB7JED**.

August 31: The Huntingdonshire Amateur Radio Rally, Annual Bank Holiday Monday Rally is to be held at Ernulf Community School, St Neots, Cambridgeshire (near Tesco Superstore on A428). Doors open 1000 to 1400 and admission is £1. There will be hot and cold refreshments available and a hall and car boot sale on handstanding. Talk-in on **S22**. **David Leech G7DIU** on **(01480) 431333** (between 0900 and 2100).

September 6: The Bristol Computer & Radio Rally will be held at the Brunel Centre, Temple Meads Station, Bristol. Doors open 1030 until 1600 (from 1015 for disabled visitors). Admission is £1, accompanied children under 12 go in for free. There will be a large Bring & Buy, under £30 Bring & Buy, refreshments, 150+ tables, table hire at £15 each and parking opposite in the NCP for £1. **Muriel Baker, 62 Court Farm Road, Whitchurch, Bristol BS14 0EG**, or telephone on **(01275) 834282** (24 hour answerphone).

September 6: The Coleraine & District Amateur Radio Society will be holding their annual Radio Rally at the new venue of the Bohill Hotel & Country Club, located a short distance outside Coleraine on the main road to Bushmills and the Giants Causeway. Doors open at 1200 and admission is £1.50. Further information from **John M10AAZ** on **(01265) 54930** or by E-mail **john@mi0aaz.force9.co.uk**

September 6: The Annual Wight Wireless & Computer Rally will be held at the National Wireless Museum, Arreton Manor, Newport, Isle of Wight. Admission is free and so is the parking. **Douglas G3KPO** on **(01983) 567665**.

September 6: The Bury Radio Society's 14th Annual Rally will be held at the Castle Armoury (TA Centre), Castle St., Bury. Doors open 1030 (1000 for disabled visitors). Talk-in on **S22**, Morse tests, Bring & Buy and all the usual traders. Further information and booking forms from **Alan G0RFE** on **(01706) 621263** or via E-mail: **g0rfe@zen.co.uk**

September 12: Reddish Rally is to be held at St Mary's Parish Hall, Reddish, Stockport. More information from **John G4ILA** on **0161-477 6702**.

September 12: The 4th Northampton Radio & Computer Rally is to be held at the heart of the Shires Shopping Village Showground on the A5, just two miles north of Weedon, with easy access. Rally opens at 0900. There will be a Bring & Buy, organised by the Northampton Radio Club. Bring the family as they can spend the day in the 'ole worlde' village. Refreshments and toilets are on site. Admission is only £1. Contact **Steve M0ARZ** or **Paul G0HWC** on **(01604) 632478**.

September 13: The 1998 BARTG Rally will be held at Sandown Exhibition Centre, Esher, Surrey. Doors open 1030. Attractions include free parking, Bring & Buy, many trade stands, a licensed bar and catering. **DataStream 98** forms an integral part of this Rally. **DataStream 98** will consist of a series of lectures looking at various aspects of amateur radio data comms. More info. from **Alan Hobbs G8GQJ**, 83 St Peters Street, South Croydon, Surrey CR2 7DG, **0181-688 2564** (evenings) or **http://www.bartg.demon.co.uk/rally.htm** or E-mail: **rally@bartg.demon.co.uk**

Send your news to Zoë Crabb at the Editorial Offices

Maplin Joins National Society

Maplin has become a member of the Radio Society of Great Britain (RSGB). This further underlines the chain's commitment to the amateur radio and hobbyist electronic markets.

Representing UK radio amateurs at national and international level, the RSGB was formed in 1913. With 30 000 members world-wide, the society negotiates on behalf of UK radio amateurs with the DTI's Radiocommunications Agency to protect UK amateur radio bands from commercial pressure and works to improve licence facilities.

Marcia Brimson, the RSGB's Marketing & Sales Manager commented "We are very pleased to be working with Maplin. Their membership of the society will allow closer links to be forged.

At the moment there are many radio enthusiasts listening to world radio transmissions who don't know how easy it is to get involved in amateur radio and learn how to transmit themselves. The RSGB and Maplin will be working together to provide more information to customers about amateur radio and the equipment needed, with the aim of broadening the hobby".

Customers can pick up free, specially prepared RSGB information packs at one of the 48 Maplin stores nationwide. The packs include information on the society and how to get involved in amateur radio, together with membership details.

For further information and store locations, contact (01702) 554002.

RAE/MORSE COURSES

The **Sandwell Amateur Radio Club** are running RAE examination classes (both full and Novice) in September 1998. Enrolment is on Thursday September 3rd 1998 and classes commence on Thursday September 10th 1998. Classes take place at the club premises, The Broadway, Warley, Oldbury, West Midlands. More information on 0121-552 4902, 0121-429 6061 or 0121-532 7039.

The **Widnes & Runcorn Amateur Radio Club** will be running an RAE and Novice RAE course at The Beacons, Simmons Lane, Frodsham, Cheshire. Enrolment takes place on Friday 4th September 1998 from 1930. Further details from course tutors **Dave Bibby G1PIX** on (01928) 591401 and **Dave Wilson G7OBW** on (01270) 761608.

The **Bradford & Ilkley Community College**, Bradford, West Yorkshire, are running an RAE course in the dept. of engineering. Enrolment is the first week in September and classes are on Tuesdays, 1800-2100. The course tutor is **Ralph Turner G3VRX**. Call (01274) 753371 for more information.

The **Glenrothes & DARC** will be offering classes for preparation for the RAE and Morse tests beginning late September 1998. RAE classes will be on Monday evenings at 1930 at Balwearie High School, Kirkcaldy. Morse classes will be held on Tuesday evenings at 1900, also at Balwearie High School, and the course is designed for both beginners and advanced. Enrolment will be Monday 28 September 1998, 1900-2000. More information for both courses can be obtained from **Ken Horne GM3YBQ** on (01592) 265789 (evenings, after 1900).

An RAE course is to be held at **Newstead Woods School**, Avebury Road, Orpington, Kent on Monday evenings at 1930-2130, commencing 14 September. The course leads to the May 1999 exam, which will be held at the school. For information regarding enrolment, post to: **Bromley Adult Education College, Church Lane, Prince's Plain, Bromley BR2 8LD, Tel: 0181-462 9184**. Course tutor will

be **A.E. Betts** and he can be contacted on (01689) 831123.

Ray Oliver G3NDS is again running RAE courses at **The Newbury Technical College** commencing Thursday 10 September 1998, 1900-2100 (course no: 99018A). A Morse code for amateurs (RSGB 12w.p.m.) starts Tuesday 5 January 1999, 1900-2030 (course no: 99208B). Telephone (01635) 35353 for more information. An RAE course is also being run at the **Swindon Technical College**, commencing Monday 21 September 1998, 1900-2100 (course no: UFF30S). Telephone (01793) 498300. In addition, Ray is also organising two practical electronics courses at Newbury College that might be of interest to those wishing to gain skills in constructing and testing their own equipment.

Practical Electronics: (course no: 99032A) starts 16 September 1998, 1900-2100, basic electronic theory with practical emphasis on components, circuit construction and testing.

Electronic Construction for Radio Amateurs: (course no: 99571C) starts 13 May 1999. This is a short course specifically for radio amateurs/s.w.l.s to assist those in wishing to construct and test their own radio projects. Contact the Newbury College on the number above or call Ray G3NDS on (01672) 870892.

The **North Cheshire Radio Club** will be taking enrolments and starting both their RAE and NRAE course on Sunday evening, 13th September 1998 at 1900. These will take place every Sunday thereafter at their HQ, the Morley Club, Moberley Road, Morley Green, Wilmslow, Cheshire. Further details from the Education Officer **Gordon L. Adams G3LEQ** on (01565) 652652 or FAX: (01565) 634560.

The **Warrington Collegiate Institute** will be taking enrolments on the 3rd, 4th and 5th September and thereafter, and the RAE lectures start at 7pm on Thursday 17th September 1998 and every Thursday thereafter at the Winwick Road Campus, Warrington, Cheshire. Further details from the Institute on (01925) 494494 or from **Gordon L. Adams G3LEQ** (Lecturer) on (01565) 652652.

HIGH PERFORMANCE RANGE

Mitsubishi Electric announce the introduction of its high performance range of internally matched GaAs f.e.t.s designed specifically for L and S-bands. The complete f.e.t. range comes in high reliability sealed metal ceramic packaging and generates high output power making the devices ideal for digital radio links, base stations and wireless local loop applications.

Four Class A operation devices comprise the range. MGFL45V1920 provides 30W output power with a high power gain of typically 13dB for 1.9-2.0GHz applications. MGFS45V2123 for 2.1-2.3GHz, MGFS45V2325 for 2.3-2.5GHz and MGFS45V2527 for 2.5-2.7GHz. All provide 30W output power with a high power gain of typically 12dB.

All devices are internally matched to 50Ω and boast an extremely high power added efficiency of 45% over their respective wavebands and low distortion figures of typically 45dBc at output powers of 34.5dBm. Typical electrical characteristics of the devices



Mitsubishi launches high output power internally matched GaAs f.e.t. L&S band amplifiers for digital radio applications.

include a saturated drain current rating of -5V maximum and 45dBm output power at 1dB gain compressions. Third order intermodulation distortion is typically -45dBc and thermal resistance is 1.7°C/W.

More information from **Mitsubishi Electric Europe BV, Semiconductors, Travellers Lane, Hatfield, Herts AL10 8XB, Tel: (01707) 276100, FAX: (01707) 278997, Web: <http://www.mitsubishichips.com>**

CONTACT POINT

Feba's latest video, **Point of Contact**, is now on release. The video visits Feba's Seychelles station to look at how it all happens, then moves to the reception areas to see what is being achieved.

Producer Geoff Martin says, "Feba ministry is exciting and we were determined to reflect that in what we filmed. That meant hiring top mission video cameraman Crawford Telfer, and

using a helicopter for aerial shots in Seychelles.

We asked ex-ITV producer Tim Dehn (now with Feba Zimbabwe) to do a 'listener safari' in Zimbabwe and Ed Larby of Feba's Middle East team to activate his TV contacts there. It's taken a lot of time and effort to pull it all together but it's nice to view the finished video and truly we feel we couldn't have done any better".

As a result, video viewers meet Feba listeners,



Video cameraman Crawford Telfer gets set for some aerial filming over Feba Radio's offshore installations in Seychelles.

producers, engineers and programming strategists. They hear something of how today's electronic developments and the advent of Internet communications are bringing change, diversity and new challenges to the way Feba broadcasters approach their task.

Feba have also produced a short version of **Point of Contact**, intended for use in church services, group meetings and on any occasion when time is short. This appears on the same videotape, straight after the main 19 minute video. **Point of Contact** can be borrowed (or purchased at £9.75 inc. UK P&P & VAT) from **Jennie Ring** at **Feba Radio, FREEPOST, Worthing West Sussex BN14 7BR.**

HEADPHONE ADAPTOR

Isoplethics IHA1-1 headphone adaptor has been developed to allow modern 32Ω stereo headphones to be used in high impedance applications. Using the IHA1-1, an impedance of around 8kΩ is obtained, with a sensitivity approaching that of 1950s Brown Type F 4kΩ headphones. (Modern stereo headphones vary considerably in sensitivity. This performance is obtained on examples having a sensitivity exceeding 100dBm.

By careful transformer design, the peaky response of metal-diaphragm headphones has been simulated to give good c.w. and communications-grade telephony performance. Additional internal filtering limits h.f. response to around 3kHz to reduce noise levels. Internal clipping limits noise spikes to a safe level. This filtering has been achieved without sacrificing sensitivity. The input is shunted to eliminate 'threshold howl' in regenerative detectors.

The IHA1-1 is ideal for use with simple receivers, especially valve t.r.f.s and crystal sets and gives good results with older valve receivers and test equipment such as the BC221 frequency meter. The IHA1-1 is housed in a custom, black, isophthalic resin-moulded box of traditional design, output is via a 6.35mm (1/4in) standard stereo socket and the input is a 300mm flying lead terminated in a mono 6.35mm jack. IHA1-1 headphone adaptors, together with a comprehensive data sheet are available ex-stock direct from **Isoplethics, 13 Greenway Close, North Walsham, Norfolk NR28 0DE**, priced at £14.90 each, inclusive of VAT and P&P within the EU.

The new Isoplethics IHA1-1 headphone adaptor.



40TH ANNIVERSARY CONFERENCE

The Brunel Manor Christian Conference Centre, near Torquay in Devon, is the setting for the 40th Anniversary Conference of the **World Association of Christian Radio Amateurs and Listeners (WACRAL)**. The event is to be held over the weekend of **2/4th October 1998** and is open to all Christian enthusiasts who are invited to join members for a full and varied programme of radio related events, lectures, services and general fellowship.

A special presentation and demonstration will be made by **David Palmer G4PFX** and **John Corbett G3TWS** entitled 'Satellite Communications in the Congo'.

David Wiltshire of the charitable organisation 'HoverAid', a Christian concern dedicated to overcoming communication and transportation problems in developing areas by the use of specialised hovercraft, will guide the Conference - 'In the Footsteps of Livingstone'.

Parallel tuition sessions will offer Novice Instruction and DXing for absolute beginners, a simple construction competition and a private visit to the Brixham lifeboat and coastguard station are just a few of the attractions lined up to complement the WACRAL AGM and Services of worship.

If you would like to find out more, contact **Geoff Peterson G4EZU** at **124 Darnley Road, Gravesend, Kent DA11 0SN**, Tel: **(01474) 533686** or E-mail: **geoff.peterson@zetnet.co.uk**

rallies

September 13: The Milton Keynes & District Amateur Radio Society are holding their Annual Rally and Boot Sale in Bletchley Park. More information from **Dave White G3ZPA** on (01908) 501390.

***September 13:** The 13th Lincoln Hamfest will be held on the Lincolnshire Showground. This is on the A15 just five miles North of the City. Talk-in on 70cm. There is extensive parking available on the day and overnight on the 11/12th for caravans and tents. There will be many trade stands, a Bring & Buy, Flea Market and Car Boot Sales. More tests will be available by arrangement, there is also catering and a licensed bar. Admission is £2, (free for those 14 and under). **John & Sue** on (01522) 525760 or John (mobile) on (0385) 738976.

September 20: The Cambridge & District Amateur Radio Club are holding their Car Boot Sale in the Reindeer Pub grounds, Saxon Street, Near Newmarket. Open from 1100 till 1500, entrance fee is 50p, pitches are from £5, depending on vehicle size. More information from **Michael Adlessee**, Public Relations Officer, on (01223) 872258, or visit the web site, which contains a current club programme, <http://peach.cam-ori.co.uk/cdarweb/>

September 20: The Mansfield Amateur Radio Society's first Radio, Computer and Electronics Car Boot Sale is to be held at Debdale Lane Sports & Social Club, Debdale Lane, Mansfield Woodhouse, from 1000 to 1600. Talk-in on S22, ample parking. **Angela G1DZH** on (01623) 429218.

September 20: Their will be an Electro-Jumble Sale (4th) to be held at The South Yorkshire Aircraft Museum. The organisers planned the event for constructors, restorers and collectors of electrical radio and radar equipment up to the 1950s and 1960s (both commercial and military), to buy, sell or swap pieces of kit, transmitters, receivers, components, connectors, cables, handbooks, test gear, etc. and those odds and ends you've had for years but cannot use and do not know what they are for! Starting time is 1000, setting up from 0800. Admission is free and so is the parking. More information from **Mike Diprose** on (01433) 631296 or **Mike Green** on (01253) 347176.

***September 25/26:** Leicester Amateur Radio Show will this year be held at the Donington International Exhibition Centre at Donington Park, Castle Donington, Leicestershire. Many traders have already reserved space at what will be the biggest UK Amateur Radio event this year. The hall itself is purpose built and features a floor area approximately one third larger than the two Granby Halls combined and the car parking is unlimited and free. There will be 150 stands and many new features such as camping and caravanning on site, a meeting room for clubs and societies and a convention. **Geoff G4AFJ** on (01455) 823344, FAX: (01455) 828273.

If you're travelling a long distance to a rally, it could be worth phoning the contact number to check all is well, before setting off.

The Editorial Staff of **SWM** cannot be held responsible for information on Rallies, as this is supplied by the organisers and is published in good faith as a service to readers.

If you have any queries about a particular event, please contact the organisers direct.

Editor

Send your news to Zoë Crabb at the Editorial Offices

ed's comments



t's summer at last and my timing seems, for once, to be spot on. As I type these words, I am actually on holiday, with Zoë and Jo 'holding the fort'. Due to the communication facilities available to me, seconds after I finish keyboard bashing, this collection of Editorial thoughts will be winging its way to the SWM offices.

Mariners around the world have, for seventy five years, enjoyed 'being in touch' too. Portishead Radio, the BT coastal station based on the Severn estuary coast in Somerset, last year celebrated its three quarter century anniversary. In the first quarter of 1999, the station is to close. A service that will be sadly missed by many users and listeners alike. Me for one.

I recently was fortunate enough to have a guided tour of the Portishead facilities at Highbridge. The main 'ops' room is a shadow of its former self. The heydays in the mid seventies saw hundreds of operators working the world. Now at the end of the century barely a handful visibly 'work out their time'.

I understand that things could have been very different for Portishead, as they were approached by the ever expanding Globe Wireless. I am uncertain of the details so I can't be specific, but it seems a tragedy that

this is the last complete year that Portishead will provide that important link between the traveller and home.

Speaking of closures, another loss to the radio community is the GCHQ outpost at Culmhead. After a period of 42 years distinguished service the station will also close next year. Yet another casualty of the cessation of the 'cold war'.

More Freebies

If you are a broadcast listener, and I know that a high proportion of you are, then I'm sure that you will enjoy the *World-Wide Radio Guide* pull-out booklet in this issue of *SWM*. This guide was

brought to you with the help of the AIB - Association of International Broadcasters.

I have recently had a letter from one reader who, in his enthusiasm for broadcast related topics, seems to have missed the point of this magazine. He wants me, it would seem, to turn your magazine, the one that covers a broad spectrum (literally) of topics for your reading pleasure, into a kind of international *Radio Times*.

Well, this is not what *Short Wave Magazine* is about, is it? We try to provide a wide coverage of a diverse section of the monitoring hobby.

Though I guess a few people take our historic title a little too literally. We strive to cover more than just short waves.

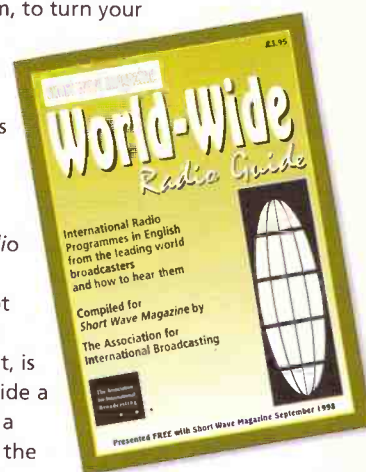

Reader Survey

I have had a few disgruntled readers contact me who are somewhat unhappy that last month's reader survey contained questions other than those related directly to *SWM* topics.

Since we are published by a small independent publisher, resources are rather limited. Tasks such as analysing thousands of survey forms is a task that we cannot undertake in-house. We just don't have the time to turn it around **quickly**. As a result of this, we have taken the approach that most other magazines take. We used an outside specialist company to run the questionnaire on our behalf. We supplied the *SWM* related questions and they do everything else, up to supplying the results. So the final questionnaire takes the form of that vast majority of other surveys you are likely to encounter.

You don't have to answer it, but I'd appreciate it if you did.

...now, where did I put that sun tan lotion and who's got my headphones?

Happy listening!

Kevin Nice

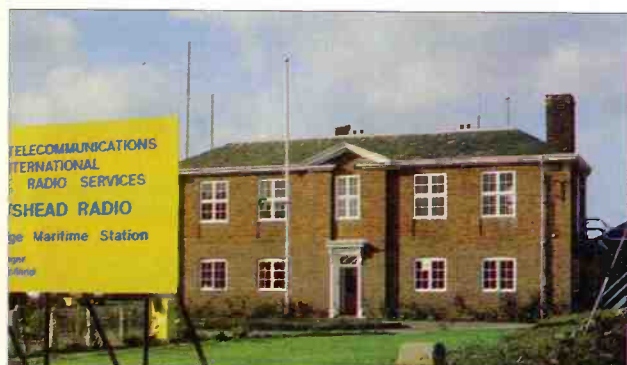

Just a reminder to one and all that **Badger Boards** can be contacted at: **12 Hazelhurst Road, Castle Bromwich, Birmingham B36 0BH, Tel: 0121-681 4168.**

A small catalogue containing a range of components, projects and p.c.b.s is available, free, to anyone sending **Roy or Sue Martin** an s.s.a.e.

Dear Sir

It gives me great pleasure to write this letter to you. I have been a regular reader of *Short Wave Magazine* since its re-launch in April 1987 and in that time I have purchased several books from the SWM Book Store.

On the 13th May 1998 I ordered a copy of the *Global Radio Guide 1998*. This I received, by return, with the date: January 1998 on the front cover. You can imagine my dismay when, on looking inside the guide, I saw an order form for the next issue, which was dated April 1998, thus making the copy I received this morning obsolete.

I sent a FAX to the Book Store explaining my problem and within fifteen minutes a gentleman from the Book Store 'phoned back with a full and satisfactory explanation, indeed I was so taken back with this prompt reply that I did not quite catch his name so could you say thank you once again to him for me.

I would just like to say how much I have enjoyed SWM over the years, while I concentrate almost wholly on the broadcast side, I have had no difficulty in the many other aspects on s.w.ling which, of necessity, a magazine like SWM must cover. I am particularly pleased with 'LM&S' now being at the front of the magazine.

Strangely, over the last couple of months, I have read more of the new broadcast side in SWM than I normally do.

To end this letter I have recently been given, as a present, a Realistic DX-394. At £99.99, it must be the buy of the year!

**Michael J. Astley
Crewe**

The very helpful gentleman to whom you refer, is none other than Michael, who, together with Shelagh, is responsible for the excellent service enjoyed by our Book Store customers. - Ed.

Dear Sir

I have been a s.w.l. for some 18 years, I have a variety of h.f./v.h.f./u.h.f. equipment, namely PRO-2005, PRO-2036, PRO-30, PRO-50, PRO-27, DX-394 and Yaesu FR-50B. As you can see, I tend to stick with equipment, if it works I keep it!

The point of my letter is over the years it has come to my attention that in the hobby of radio, things change so quickly. The 'black box of today' is the discarded box of tomorrow.

In my view, new is not necessarily better. I think that I am like most in our hobby. I have not the income to chop and change. Let's try and keep a happy medium in the pages of SWM.

Sure, show the latest and greatest but don't forget the large percentage of readers who are looking for something (maybe second-hand) at a lower price. No gripes about the magazine, but more radio and less computer. Keep *Short Wave Britain's* best Radio Magazine.

**J. Hepburn.
Northumberland**

We try! - Ed.

Dear Sir

I have a Lowe HF-150, an excellent receiver. Yes, the broadband front-end does allow in some unwelcome visitors from time to time, but that's not a problem unless it is a weak signal. So it was with great interest that I read in March SWM the review about the HF-150 Europa.

My interest increased to delight when, in the reviewer's summary, I read that an upgrade was possible to existing receivers for £200. I decided to do it - but needed to save cash. I checked with Matlock who said, "Just send the radio with the fee and it will be slotted into the production line".

So by July, just four months later, I had enough

Dear Sir

I must say how much I enjoyed 'A Unique Event', the article by Roy Clayton G4SSH about GB stations. I can personally vouch for the Scarborough Special Events Group's high standard of operating and a superb attitude to s.w.l. reports.

When I heard GB8SF in 1996, the huge pile-ups were expertly managed with lists being taken of calls with number 9, 8, 7, 6, 5, 4, 3, 2, 1, 0 and non-UK and non-European stations. Such was the efficiency of the process that stations who missed out on a list did not have to wait long for an opportunity to come around again.

After listening to GB8SF, I was perplexed whenever I heard a Special Event Station just taking one call at a time from a pile-up!

I sent my standard ISWL club card (I now have my own card) via the bureau. In return I got one of their highly attractive, limited edition, full colour QSL cards. What's more, it was sent to my address direct! They said that my comprehensive report, listing about 20 QSOs deserved a direct reply!

Yes, Scarborough Special Events Group Stations are indeed a joy to listen to for hours on end, and the more GB, DX or unusual call stations that adopt their good practice, the better!

**Tom Read G20843
Macclesfield**

TOP
QSL

money and rang Matlock to confirm the returns procedure, only to be flatly told: "Sorry, we have stopped making them here and we cannot do it."

However, I was given the 'phone number of SMC, where the new production line will be, who have said they may be able to help but in a few months time.

Short wave radio and amateur radio is a small, close knit interest group and people talk. Reputations are made and lost by service and attitude as well as the quality of products. I am disappointed that such an acknowledged popular offer was apparently such a short-lived one, and no published warning was given about its time limitations, and yes, I am sorry that an era has ended at Matlock.

**Geoff Crawford
Nottingham**

I'm sure there are a great many of our readers that will agree about the sad end of an era. It is seldom the case,

however, that commercial activities, such as the sale of brands is made public knowledge before the transfer has taken place. I Hope you can hang-on until SMC are able to perform the modifications - Ed.

Dear Sir

With respect to my article entitled 'A Unique Event' which you published in the August edition of SWM. Firstly, may I congratulate you on the presentation of the article, which was first class. Secondly, I am sure that you will be interested in the response - I have already received ten telephone calls from readers (my telephone number is printed in the *RSGB Callbook*) all expressing admiration for the full-colour impact of the article and thanking me for putting into words their own feelings with regard to Amateur Radio Special Event Stations and the listener.

It certainly appears to have been a popular subject, which has been very well received by the readers.

**Roy Clayton G4SSH
Scarborough**

Who said SWM has nothing to do with amateur radio? - Ed.

Dear Sir

After buying your magazine now for several years, I am sad to see that four pages are taken up with a Questionnaire, of which many of the questions have nothing to do with s.w.l. radio.

In a recent TV programme they showed how some firms sold the information they received and made big gains. I wonder if the information received from the *Short Wave Magazine* questionnaire is sold on, and if so, perhaps some of the profit could reduce the cost of the magazine.

There seems to be far too many adverts these days and far less information. Perhaps it would be a good idea to put all the information to the front of the magazine and all the adverts at the rear, then it would be so simple to read.

At the end of the day, *Short Wave Magazine* is still a good magazine.

**D. Price
Wellington**

I think that you'll find that the method we have chosen for collecting your's and our other readers' feedback, typical of the magazine industry as a whole. Please bear in mind there is nothing compelling you to provide information against your will. - KN.

Dear Sir

Being an older DXer, I started DXing in 1952 in New Zealand, I had been used to goods brought from UK suppliers taking up to three months to arrive by surface mail. It has been refreshing, since I've been in the UK, to be able to get first class service. But last week, I was even more surprised to receive what I would class as exceptional service from the 'Lynch Mob'.

After poking around their stand at Picketts Lock, I was impressed with the Icom IC-PCR1000 and had decided that when I needed a new receiver, I would get one.

Well, last week I rang Martin Lynch & Son to be told that it was on special. So, on the next Thursday, I posted off a bank cheque for the full price quoted to me. On Monday morning at 8.30am, I received the full package.

I was up and going by 11.30am. I had one small question and was given good advice on the 'phone, the staff also recommended a local shop in Northfield Avenue, who sent me an additional piece of equipment over night.

Great service all round!
**Dallas McKenzie
West Sussex**

■ Greg Baker, PO Box 3307, Manuka, ACT 2603, Australia

■ E-MAIL: greg@pcug.org.au

Bandscan Australia

Other News

The government has launched what it calls a Community Access Network to link 135 community radio stations and six community television stations across Australia. This package includes a network production fund to assist in the creation of on-line content and a community broadcasting database.

Funding at less than \$A1.5 million (£570,000) over three years seem meagre. To remove an anomaly, the government has changed the law to allow free to air broadcasters to demand a fee for the re-transmission of their signals. Until this change, pay television operators could re-transmit without payment.

Changes have been made to antennae on Canberra's Black Mountain tower to allow digital television trials to begin.

Technical people are keen to see whether existing infrastructure can be used successfully for simultaneous analogue and digital transmissions.

The government has formed a high-level group to co-ordinate the introduction of digital television in Australia. The group includes representatives from peak representative bodies in free to air and pay television, manufacturers and consumers.

In another related move, the Australian Broadcasting Authority (ABA), the planning authority for the transition to digital television, has signalled that it expects industry to bear the cost of ABA planning processes. In addition, the government has backed down in the face of opposition pressure and agreed to reduce the number of years that existing television stations would be protected from competition in the new digital era from eight to six.

I welcome any news and comments. In particular I am interested in any s.w.l. information on Australian stations heard by SWM readers so I can chase up more details and interesting snippets from this end. My address is PO Box 3307, Manuka, ACT 2603, Australia. For personal replies please send two IRCs. Those with an Internet connection can get me at greg@pcug.org.au.

This time I have news of **Radio Australia (RA) and telecommunications, which have been in the news a lot in the last few months. In addition I have some RA reception reports and a range of other news.**

Radio Australia

During, and after, the Indonesian crisis which led to the demise of President Soeharto, the government has come under heavy fire for its decision leading to the closure of the Cox Peninsula transmission facility near Darwin. The decision means that most of Indonesia is unable to receive the Indonesian language service through normal short wave channels.

The government has claimed that the signals are available via other means. Other means appear to be the weak signal from the Shepparton transmitters, the RA satellite signal or the recently introduced audio facilities in the Indonesian language on the Internet.

Unfortunately, very few Indonesians have access to satellite facilities and the reported 25000 hits per day on the RA Indonesian page <http://www.abc.net.au/ra/indon/indhome.htm> is tiny compared with the likely short wave audience. Many foreign affairs commentators are amazed that the government would choose to compromise Australia's national interest by enforcing the closure during turbulent times in Indonesia.

On the same topic, a report handed down by the Parliament's Joint Committee on Foreign Affairs, Defence and Trade said that the Cox Peninsula should be re-opened. It claimed that the saving of \$A1.6 million (approximately £610000) was small in comparison to the \$A13.5 million (£5 million) invested in the site in the last six years.

In addition, an internal ABC document leaked to the press here says that it would be cheaper to operate even a minimal service into Indonesia from the Cox Peninsula than to pay for the site to be kept mothballed.

RA QSL Information

Radio Australia can be QSLed to **Radio Australia Transmission Management Unit, GPO Box 428J, Melbourne 30001, Victoria, Australia.** If your establishment extends to a FAX the RA QSL FAX number is +61 3 9626 1878. RA also accepts reports by E-mail to ratx@radioaus.abc.net.au

To receive a QSL card of course you will need to include your postal address as QSLs are only sent by mail. Currently, QSLs should take from six to eight weeks. RA, on receipt of reception reports either by post, FAX or E-mail, filters them for those needing personal and individualised replies then bulks them up on a monthly basis for handling and answering by the ARDXC radio club.

The club verifies all reports and prepares QSL cards on a co-operative basis with RA, a

process that is particularly necessary now that RA funds have been slashed by the government. The ARDXC processing takes a couple of days and the cards are sent airmail from Australia or parcelled up in bulk for North America and the UK for local postage in those places. This latter process reduces overhead costs of the QSL process for RA.

Telecommunications

As noted here some time ago, the national telecommunications carrier Telstra has now passed from total public ownership and is one third privatised. The current government is keen to sell the remaining two thirds of Telstra, it says to retire government debt. However, the sale of Telstra appears unpopular within the community according to opinion polls.

In addition, in the lead up to the first tranche of privatisation, rural and remote Telstra services suffered. As a consequence, rural and remote users of telephones are concerned that a fully privatised Telstra will mean inadequate services in the bush.

The government - a coalition of two parties including the National Party, a rural based party - is treating this very seriously indeed, particularly in light of the emergence of a new party, One Nation, which has been very successful in National Party territory in Queensland state elections. The government has been offering some sweeteners - called the 'social bonus', in the hope of gaining its privatisation objective and of retaining the rural vote.

These sweeteners include the promise of untimed local calls for some sections of the bush, a part of Telstra long taken for granted in the city. The government says that 37000 households will benefit from this initiative which is expected to cost \$A150 million (£57 million).

Another sweetener that the government is taking credit for but for which Telstra itself has been working for some time, is the integration of analogue and digital mobile telephone networks. Telstra has invested \$A400 million (£152 million) in a new Code Division Multiple Access (CDMA) system which allows multiple telephone calls to be carried on a single frequency using encryption techniques. The new CDMA network will replace the 420 station analogue system to provide rural analogue users with a network which will enable them to benefit from the extended coverage in the bush now available to analogue mobile telephone users.

In addition, the new system will allow rural mobile users to use their handsets in the cities when the analogue system is phased out there. The downside for these users perhaps is the need to purchase new mobile telephone handsets.

Despite all these sweeteners, however, enough Senators remained unconvinced of government promises and voted down the bill intended to pave the way for full Telstra

privatisation. The government says that it will push ahead with its plans which it intends to put to the people at the next Federal election due before May 1999.

Radio

There has been some disquiet at the level of foreign ownership of Australia's radio stations according to a report in Australia's Age newspaper. The paper, reporting studies by Australia's Communications Law Centre, says that the largest regional network is foreign owned as is 50% of the second largest metropolitan network. The UK publisher and broadcaster, Daily Mail and General Trust, owns 53 stations across Australia including the largest rural radio network developed here by Rural Press.

Commercial radio stations are upset at the government's plans for the introduction of digital broadcasting. Commercial television interests will be protected from new competitors for six years after the introduction of digital television - see 'Bandscan Australia' June 1998 - while commercial radio interests will face competition from the start of the digital radio broadcasting era.

Spectrum Auction

The government has sold off more spectrum space in the 800 and 1800MHz bands making around \$A350 million (£133 million) in the process. The main player was Telstra purchasing around \$A177 million (£67 million) worth of spectrum. Mobile carriers Optus and Vodaphone bought spectrum to expand their digital networks, and new players AAPT, Hutchinson and OzPhone bought parts of the 800MHz spectrum, it is thought, to allow for them to set up a fourth mobile telephone network.

Radio Australia Reception

Martyn Gardiner from **Portsmouth** has been onto Radio Australia again but with mixed success. He has managed to bring in RA clearly on 9.500MHz in the evenings from 2130UTC until shutdown. Although he can make out this transmission before 2100UTC by using one sideband, he says that there is strong interference from another station.

Martyn has tried 15.415MHz and 17.750MHz in the mornings but with no success and the 11.660MHz signal in the afternoons is satisfactory from 1430-1500UTC but after that, another station interferes.

James Duckworth from **Herts** has got RA on 15.510, 15.415, 11.880, 17.750 and 9.710MHz all at around 0825UTC on 19 April. At other times he has pulled in RA on 15.415 and 15.510MHz at around 0635UTC and 21.725MHz at 0600UTC. James operates from home which he says is on the top of a 150m hill. His equipment includes an Eddystone 830/9 and a Grundig Satellite 700 run from a 11m longwire trailed around his attic.

■ BRIAN ODDY G3FEX, THREE CORNERS, MERRYFIELD WAY, STORRINGTON, WEST SUSSEX RH20 4NS

LM&S

Getting away from it all may have more than one meaning for the listeners who reside in a city or town because a high level of electrical noise is always present in such places, which can make radio reception quite difficult. A holiday in a remote location may well provide them with an opportunity to search the bands in an 'electrically quiet' environment.

The details of your reception in the broadcast band during a recent holiday would be very welcome here for inclusion in this column. Please send them to me at the above address.

Long Wave Reports

Note: l.w. & m.w. frequencies in kHz; s.w. in MHz; Time in UTC (=GMT).

Unless otherwise stated, all logs were compiled during June.

Most of the channels in this band are shared by several stations. During daylight the ground waves from one or more of them may reach a point of reception but after dark the sky waves from some of the other occupants may arrive and it is that factor which makes monitoring each channel worthwhile.

David Stevenson has been doing just that in Swansea and at 0437UTC on June 11 he picked up a weak broadcast in Turkish under the Polish Raszyn Reserve transmission on **225kHz**. It probably came from the co-channel TRT 600kW outlet at Van, Turkey, but no ident was heard.

One of the most interesting channels is **189kHz**, which is shared by Tbilisi, Georgia (500kW) and Caltanissetta, Italy (10kW); also Gufuskalar, W.Iceland (300kW), which is a recent addition. Quite often **Brian Keyte** (Gt.Bookham) has received Gufuskalar after midnight - on June 23 he rated the transmission SINPO 34443 at 0030UTC. During some evenings the sky waves from Caltanissetta reach the UK. They were received between 2040 & 2100UTC on June 30 by **Fred Pallant** in Storrington. He clearly heard music and song followed by a conversation in Italian.

Medium Wave Reports

There was no indication in the reports that any of the broadcasts from m.w. stations in E.Canada and E.USA reached the UK at night during June. In contrast, the sky waves from some of the m.w. stations in the Middle East, N.Africa, Europe and Scandinavia did reach the UK at night - see chart. Nevertheless the conditions were noted by **Eddie McKeown** (Newry) and others as poorer than expected.

Good reception of BBC R.Gloucestershire via the new 500W outlet at Stow on the Wold on **1413kHz** was noted during daylight by **John Court** in Birmingham. Following a report to the station he received a letter of confirmation in early June. Reports from other areas would be welcomed by the station engineer. Send them to **Mr Roy Preece, BBC Radio Gloucestershire, London Road, Gloucester GL1 1SW**.

Short Wave Reports

Much to the disappointment of some listeners the **25MHz (11m)** band remained unused during June.

In contrast, the **21MHz (13m)** band was a hive of activity during daylight. The occupants therein include DW via **21.680** (Eng to Africa 0600?-0650?) rated 43343 at 0616 by **Chris Shorten** in Norwich; **UAER, Dubai 21.605** (Ar to Eur 0615-1030) 44444 at 0936 by **David Hall** in Morpeth; **UAER, Dubai 21.605** (Eng to Eur 1030-1100) 25343 at 1038 by **Tony**

Hall in Freshwater Bay; R.Portugal Int via Sines **21.720** (Port to Africa 0900-1100) 55555 at 1040 by **Sheila Hughes** in Morden; **RAI Rome 21.520** (It to Africa 0600-1300) 23222 at 1207

Thomas Williams in Truro; Vatican R, Italy **21.850** (It to S.America 1200-1230) **23343** at 1220 by **Robert Hughes** in Liverpool; R.Prague via Rimavska Sobota **21.745** (Eng to E.Africa, M.East 1300-1330) 43323 at 1300 by **Bernard Curtis** in Stalbridge; BBC via Ascension Is **21.660** (Eng to Africa 1100-1700) 33333 at 1305 by **Robert Connolly** in Kilkeel; DW via Wertachtal **21.705** (Ar to M.East 1300-1559) 54454 at 1309 in Newry; RFI via Issoudun? **21.580** (Fr to S.Africa 0900-1600) 43444 at 1319 by **John Eaton** in Woking; BBC via Cyprus **21.470** (Eng to E.Africa 1400-1700) 35434 at 1440 by **Simon Hockenhill** in E.Bristol; R.Portugal Int via Sines **21.655** (Port to Brazil 0800-2100) SIO433 at 1455 by **Philip Rambaut** in Macclesfield; **RAI Rome 21.535** (Tt [Football]) to Lat Amer, Africa 1330-1700, Sun only) 44444 at 1539 by **Rhoderick Illman** in Oxted; WYFR via Okeechobee, USA **21.525** (Eng, Fr, Port to Eur, Africa 1600-2000) 34433 at 1609 by **Darren Beasley** in Bridgwater; DW via Kigali, Rwanda **21.560** (Ger to M.East 1400-1755) 45333 at 1630 by **Ernest Wiles** in NE.Bedford; **UAER, Dubai 21.605** (Eng to Eur 1600-1640) 54444 at 1635 by **Stan Evans** in Herstmonceux; **HCBJ Quito, Ecuador 21.455** (Eng [u.s.b. + p.c.] to Eur 1900-2200) 22222 at 2043 by **Richard Reynolds** in Guildford.

The new **18MHz (15m)** band is being used by Christian Science BC to reach listeners in C.Africa. Their transmission via WSHB Cypress Creek, USA on **18.930** (Eng 1700-1800 Tues, Thur, Sat) was rated 44344 at 1745 by **Vera Brindley** in Woodhall Spa.

Noted in the **17MHz (16m)** band during the morning were R.Australia via Shepparton **17.750** (Eng to Asia 0600-0900), rated 25532 at 0730 by **David Edwardson** in Wallsend; DW via Rwanda? **17.800** (Eng to Africa 0900-0950) 44333 at 0904 in Oxted; R.Austria Int via Moosbrunn **17.870** (Eng, Ger to Australasia 0930-1030) 44434 at 0930 in Truro; **AIR via Bangalore 17.387** (Eng to Pacific areas 1000-1100) 33222 at 1010 in Morden; R.Pakistan, Islamabad **17.835** (Eng to Eur 1100-1120) 44343 at 1104 in Freshwater Bay, IoW; R.Sweden, Stockholm **17.870** (Eng to USA 1130-1200) 45544 at 1145 in Bridgwater; R.Bulgaria, Sofia **17.585** (Eng to Eur 1100-1200) 44444 at 1155 in Herstmonceux.

During the afternoon R.Romania Int **17.770** (Eng to Eur? 1300-1356) was 43232 at 1307 in Newry; DW via Wertachtal **17.845** (Ger to S/SE.Asia 0600-1355) 33233 at 1315 in Liverpool; REE via Noblejas? **17.755//17.715** (Sp to S.America 0900-1900) 45444 at 1320 in Woking; Channel Africa via Meyerton **17.675** (Eng to W.Africa 1300-1455 Sat/Sun) 44444 at 1410 by **Bill Griffith** in W.London; BBC via Ascension Is **17.830** (Eng to W/C.Africa 0730-2100) 33553 at 1430 by **John Parry** in Larnaca, Cyprus; RCI via Sackville, Canada **17.820** (Eng, Fr to Eur, Africa 1330-1500 Mon-Sat) SIO333 at 1500 in Macclesfield; Africa No.1, Gabon **17.630** (Fr to W.Africa 0700-1100, 1200-1600) 55544 at 1504 by **Martin Goodey** in St.Mary's, Isles of Scilly.

Later, VOA via Morocco **17.895** (Eng to Africa 1600-1900) was 43545 at 1800 in NE.Bedford; Israel R, Jerusalem **17.545**

LONG WAVE CHART

Freq (kHz)	Station	Country	Power (kW)	Listener
153	Bechar	Algeria	1000	I*
153	Donebach DLF	Germany	500	A,B,D*,E,F,G,H*,I,J
162	Allouis	France	2000	A,B,D*,E,F,G,H*,I,J
171	Nador Medi-1	Morocco	2000	A,F
171	B'shakovo etc	Russia	1200	A*,D*,E,F,G*,J
171	Lvov	Ukraine	500	B*,G*
177	Oranienburg	Germany	750	A,B,D*,E,F,G,I,J
183	SaarLouis	Germany	2000	A,B,D*,E,F,G,H*,I,J
189	Gufuskalar	W.Iceland	150	C*
189	Caltanissetta	Italy	10	F
198	Droitwich BBC	UK	500	A,B,D*,E,G,H*,I,J
207	Munich DLF	Germany	500	A,D*,E,F,G,I*,J
207	Azilal	Morocco	800	F
216	Roumoules RMC	S.France	1400	A,D*,E,F,G,H*,I,J
225	Raszyn Resv	Poland	?	A,B*,E*,F,G*,H*,I*
225	Van TRT-1	Turkey	600	I*
234	Beidweiler	Luxembourg	2000	A,B*,D*,E,F,G,H*,I,J
243	Kalundborg	Denmark	300	A,D*,E,F,G,I,J
252	Tipaza	Algeria	1500	E*,B*,I*
252	Atlantic 252	S.Ireland	500	A,B*,D*,E,F,G,H*,I,J
261	Burg(R.Ropa)	Germany	200	A,B*,E,G*,I*,J
270	Topolna	Czech Rep.	1500	A,B*,D*,E,F,G,H*,J
279	Sasnovy	Belarus	500	B*,E,G*

Note: Entries marked * were logged during darkness. All other entries were logged during daylight or at dawn/dusk.

Listeners:-

- (A) John Eaton, Woking.
- (B) Sheila Hughes, Morden.
- (C) Brian Keyte, Gt.Bookham.
- (D) Eddie McKeown, Newry.
- (E) George Millmore, Wootton, IoW.
- (F) Fred Pallant, Storrington.
- (G) Harry Richards, Barton-on-Humber.
- (H) Tom Smyth, Co.Fermanagh.
- (I) David Stevenson, Swansea.
- (J) Phil Townsend, E.London.

ACCESSORIES

A full range of accessories for all main equipment is always in stock or on order with the manufacturer. You can include a selection of filters, a power supply or Tuner in the new finance deal.

WIDEST CHOICE

As the official U.K.'s largest dealer of Yaesu, Icom, Standard & Kenwood products, you'll find everything you could ever dream of under one roof. Our friendly (and non pushy) sales team will be delighted to show you around and supply you with as much coffee as you can drink.

SELLING

We're always short of good quality used gear and currently have £150,000 to spend on increasing our used stock. So if you're wanting to sell your current receiver (or accessory) for cash we would be pleased to hear from you.

FIVE YEAR EXTENDED WARRANTY

ML&S was the first company to introduce a meaningful 5 Year cover plan for your equipment. Don't let high servicing costs put you off!

£25 DEPOSIT

Most of the products advertised by ML&S are available from a small £25 deposit and if you choose to pay more you can enjoy a reduced monthly payment.

DELIVERY TO YOUR DOOR

Our next day couriers are waiting to safely deliver your new purchase direct to your door, anywhere in the U.K. or most overseas locations.

FLEXIBLE FINANCE

Let our professional sales team tailor a finance package to suit your individual requirements. Our super new Budget Plan makes paying for your new purchase so much easier.

PART EXCHANGE

We desperately need your part exchange right now - top prices paid. Don't let it depreciate over another twelve months, we'll take your current transceiver now at an agreed CASH price and still have your new rig on finance if you wish!

CASH-IN

If the value of your part exchange is greater than the value (or deposit) of the new purchase, we'll give you back the difference! Turn the value of your old gear into cash for the start of the year.

DIAL-A-DEAL

Call any of our sales hot lines now - we're eagerly awaiting your call - everything sorted over the phone, model, trade-in, collection, delivery and finance! Even if you do not live locally you can still have the peace of mind feeling when dealing with ML&S!

OPENING TIMES

Open 6 days a week - 9:30 6.00



MARTIN LYNCH
140-142 NORTHFIELD
LONDON W13 9SL

ONE ONLY

As new ICOM ICR-9000 Receiver

Retail £4,995

Chance of a Lifetime £2495
finance available: Call for details

CALL TODAY FOR THE LARGEST SELECTION OF NEW & USED EQUIPMENT

PCR-1000DSP

It seems difficult to imagine that this PC controlled receiver has only been on the market for less than a year. Tens of thousand's have been sold (literally) world-wide and its little wonder. The specification reads like a £2000 receiver of years ago and now that we have REDUCED the price AND are fitting the DSP module as a package deal it seems your credit card can wait no longer



Just connect to your Windows 95 PC via a serial port, plug in an aerial and go! Full 100kHz-1.3GHz.

RRP £349 + £79.95 for the DSP UT-106.

ML&S Price: £299.95 for both
Or £18.44 deposit & 11 x £28 p/m

Icom ICR-10E

The ICR-10E is still selling well and after almost a year in the market place it has proven to be a good, reliable and sturdy scanner to use. All mode, all band and PC controllable. What are you waiting for?
500kHz-1300MHz, all mode.



ML&S Price £259

including FREE Air band scanner guide and postage



Icom ICR-8500

The granddaddy of them all. Not because it's old but because this is the one scanner that all the rest look up too.



100kHz-2GHz, no gaps, all mode. Now with a FREE AX-400mkII scanner when ordered on our budget plan

RRP £1699

ML&S Price £1549

or £34.85 deposit & 57 x £40 p/m with a FREE AX-400mkII



Yaesu FP-1030A

Still running your 12 Volt equipment off cheapo branded power supplies? Do yourself justice (and your kit!) And introduce a proper, regulated R.F. immune FP-1030A to their lives.

- * 13.8 Volts DC at up to 25 Amps continuous Duty
- * OverLoad Protection.
- * High RFI Immunity, including extensive internal filtering
- * Multiple DC Outlets including Cigar Socket for Handies
- * Metres for Volts & Amps
- * Only 250Wx150Hx240Dmm (9.8"x5.9"x9.5")



RRP £229

ML&S Price £149.00

NEW! AOR AR-8200

The latest in AOR's range of benchmark scanners. The new AR-8200 has arrived! Tak from AOR U.K. wandered in to our London showroom the other day with what looked like yet another scanner. Were we in for a surprise! The first comment from all of us was how solid the unit felt and excellent the audio was. In fact the audio was amongst the best we have heard from a handheld receiver.

Features include 530kHz-2040MHz coverage, Band Scope and 1000 "dynamic" memories, 40 programmable search banks, AM, Narrow AM, USB/LSB, WFM/NBFM. Tuning steps are from 50Hz and include the new 8.33kHz for AM Airband.

Better still, there is FREE FINANCE on this product

Only £39 deposit
and 12 payments of £30 - ZERO APR



TEL: 0181 - 566 1120

FAX: 0181 - 566 1207

CUSTOMER CARE: 0181 - 566 0 566

Web site: MLandS.co.uk

e-mail: sales@

& SONS
ELD AVENUE, EALING,

EQUIPMENT IN EUROPE

ML&S

ALL ITEMS ARE AVAILABLE ON THE ML&S BUDGET PLAN

JRC NRD 545

DSP Receiver

PLUS FREE AX-400mkII Handie Scanner!

If you actually take a look around at the receiver market and compare with fifteen years ago I'm sure you will notice there isn't quite the choice of equipment available today. Never mind. With startling performers like the new NRD-545 who cares? A summary? John Wilson paid the ultimate tribute, saying:

'The NRD-545 would be welcome in any listener's station. It is a sheer delight to use, well proportioned and with very pleasing styling and appearance.'

Nuff said then. I appreciate that £1595 is a lot of money but then the best never come cheap. This month we're offering a brand new NRD-545 on our budget plan and I will throw in a FREE AX-400mkII RRP £249.95, scanner FREE!



RRP £1795

ML&S Price £1595

or £47.94 deposit & 59 x £40 p/m with a **FREE AX-400mkII**



Standard AX-700mkII

50MHz-905MHz, nbfm, wbfm and am with built in panoramic display.



AOR AR-3000A

Been around since the early nineties, the AR-3000A has found its way into many thousands of hobby and commercial applications. 100kHz-2GHz, all mode and nice and compact.

£?? Call it's so low you'll order one!! (And we can offer it on Budget Plan payment)!

The final few and offered at an unrepeatable price of only £349.95

MVT-7100

Been around so long its growing a beard!

530kHz-1650MHz, all mode. **Only £229.95**

MVT-9000

When this first came over to the U.K. we thought EEEK!! They've left the PC interface off!! Hasn't made a blind bit of difference though. You might not be able to control this scanner from a PC (who bloomin' well cares) but it shows the others where to get off when it comes to performance. And build quality. And ease of use. And... and! Just ask Graeme or Jez our TWO resident Scanner junkies!



Yaesu FRG-100

Right back in stock after months of sell out, the FRG-100 really is an ideal receiver for those who want to start in short-wave listening but don't want to throw your money away on something cheap and nasty. (Believe me, there are plenty of cheap and nasty receivers advertised!)

30kHz-30MHz, SSB/CW and AM. FM mode receive an option.



£419.95

or £29.18 deposit and 18 x £25 p/m

Only £339

or £34.15 deposit and 12 x £28 p/m

AOR 5000

The AR-5000 is the alternative to the Icom ICR-8500. Similar in specification but presented in a smaller neater package. Covering 10kHz-2600MHz with all mode capability. Apparently won the German best wide band receiver award. So there. Also available as an '+3' version with AFC, Sync AM and noise blanker.

AR-5000 Only £1295

or £30.40 deposit and 53 x £35 p/m

AR-5000+3 Only £1495

or £32.13 deposit and 54 x £40 p/m

PRICE SMASH

AX-400MkII

Special offer on this fabulous mini scanner
 RRP £249.95

ML&S Price £149.95

PRICE SMASH



A SHORT WAVE RADIO BUDGET PLAN - THAT WORKS!!!

The Martin Lynch & Sons SWL "Budget Plan"

A simple solution to spreading the cost of buying equipment without huge deposits and massive monthly payments. We can even buy your part exchange for CASH and you can still walk out with a new NRD545 for under £50! (Actually £47.94!)

Take a closer look at the ML&S A.R. Budget Plan - many of you already have. Call the sales desk today for any product listed in this magazine. If its available and approved by my buyers the Sales team will quote you a monthly repayment package suited to you.

DON'T FORGET!!

You can pay off the loan much quicker if you like and even send a lump sum one month if you wish. Trade-in your old gear or add to the minimum deposit, reducing the amount of monthly repayments. You tell us what you can afford per month and we'll tell you the deposit you require.

Just call for an instant quotation!*

* Budget Plan requirements: Full time employment (or disabled/retired), over 18 and below 71, Current bank account (or building society). For instant finance please ensure you have UK driving licence and cheque guarantee/credit card or Electricity/Gas/BT bill with your current name and address. Finance subject to status. **APR 19.9%.**

FINANCE EXAMPLE

All examples do not include P&P.

Cash Price	10% Deposit	36 Months@	Total Credit	APR
£289.00	£29.00	£9.44	£368.84	19.9%

Written quotations available on request

(Heb [Home Sce rly] to W.Eur, N.America 0500-1855) 44444 at 1815 by **Vic Prier** in Colyton; WHRI South Bend, USA **17.655** (Eng to E.U.S.A, Eur 1500-2300) 23333 at 1900 by **Gerald Guest** in Dudley; HCJB Quito, Ecuador **17.735** (Eng to Eur? 1900-2300?) 44344 at 2000 by **Clare Pinder** in Appleby; R.Nederlands via Bonaire, Ned Antilles **17.605** (Eng to Africa 1830-2025) 25333 at 2005 in Storrington; RCI via Sackville **17.870** (Eng to Eur, M.East, Africa 2000-2100) 54444 at 2010 by **Tom Winzor** in Plymouth; WYFR via Okeechobee, USA **17.555** (Ger, Eng to Eur, Africa 1900-2200) 34433 at 2012 in Morpeth; VOA via Greenville, USA **17.725** (Eng to Africa 2000-2200) 33333 at 2055 in Stalbridge; R.New Zealand Int **17.675** (Eng to Pacific areas? 2052 [2107 Fri/Sat] -0457) 35333 at 2104 in Guildford; R.Taipei Int via WYFR **17.750** (Eng to Eur 2200-2300) 55545 at 2246 by **Martin Cowin** in Kirkby Stephen; RFI via Allouis? **17.620** (Sp to C.America 2300-0000?) 22322 at 2325 in Kilkeel.

In the **15MHz (19m)** band the BBC via Masirah Is, Oman **15.310** (Eng to S.Asia 0300-0915, 1000-1400) was 34533 at 0400 in Wallsend; BBC via Seychelles **15.420** (Eng to E.Africa 0400-0630 Mon-Fri, 0400-0700 Sat, Sun) 24552 at 0540 in Larnaca, Cyprus; Voice of Malaysia, Kajang **15.295** (Eng to Asia 0455?-0825?) 34433 at 0610 in Guildford; Voice of Nigeria via Ikorodu **15.120** (Eng 0500-0700) SIO444 at 0630 by **Tom Smyth** in Co.Fermanagh; Christian Science SWB via KHBI N.Mariana Isles **15.665** (Eng to Eur 0800-0900) 35433 at 0830 in Bridgwater; R.Pakistan, Islamabad **15.530** (Eng to Eur 1100-1120) 54444 at 1103 in Norwich; R.Oman via Thumrait **15.140** (Ar to M.East 0800-1600) 32232 at 1151 in Newry; BBC via Cyprus **15.575** (Eng to M.East, E.Eur 0400-1500) 44433 at 1200 in Herstonmouceux.

During the afternoon WEWN via Vandiver, USA **15.745** (Eng to Eur 1000-2200) was rated 44444 at 1258 by **Martin Dale** in Stockport; RCI via Sines, Portugal **15.325** (Eng to Eur, M.East, Africa 1330-1400) 44444 at 1330 in Truro; UAER, Dubai **15.395** (Eng to Eur 1330-1355) 54544 at 1330 in W.London; R.Romania Int **15.390** (Eng to Eur 1300-1356) 54444 at 1342 in Freshwater Bay, IoW; WINB Red Lion, USA **15.715** (Eng to Eur, N.Africa 1500-1900?) 21111 at 1515 in Liverpool; VOIRI Tehran, Iran **15.084** (Home Sce relay) 44334 at 1700 in Colyton; R.Norway Int, Oslo **15.220** (Norw to C/S.Africa 1700-1730) SIO555 at 1729 in Macclesfield; R.Sweden via Horby **15.735** (Eng to Eur? 1730-1758) 44344 at 1737 in Woodhall Spa.

Later, Channel Africa via Meyerton **15.240** (Eng to W.Africa 1800-1830) was 23223 at 1800 in Dudley; R.Nederlands via Bonaire, Ned.Antilles **15.315** (Eng to Africa 1830-2025) 22243 at 1838 by Michael Casey in Manchester; VOA via Morocco **15.410** (Eng to Africa 1600-2000) 35454 at 1839 in Storrington; R.Algiers Int, via Bouchaoui **15.160** (Eng,Sp to Eur, M.East, N.Africa 1600-2000?) 44444 at 2000 by Peter Pollard in Rugby; Voice of Russia **15.485** (Eng [WS]) 45445 at 2000 in E.Bristol; Voice of Indonesia, Jakarta **15.150** (Eng to Eur, Africa 2000-2100) 44444 at 2015 by **Adam Farnsworth** in Bridgnorth; WWCR Nashville, USA **15.685** (Eng to N.America, Eur 1100-2200) 44333 at 2024 in Woking; VOA via Botswana? **15.445** (Eng to Africa 1900-2200) 54444 at 2032 in Plymouth; R.Cairo, Egypt **15.375** (Eng to W.Africa 2030-2200) 33343 at 2045 in Oxted; RCI via Sackville **15.325** (Eng to Eur, Africa 2000-2129) 55555 at 2058 in St.Mary's, IoS; Christian Science SWB via WSHB **15.665** (Eng to Eur 2100-2200) 43333 at 2115 in Stalbridge; AWR-Asia via KSDA Guam **15.310** (Eng to NE.Asia 2130-2200) 22212 at 2130 in Morden; R.Taipei Int via WYFR **15.600** (Eng to Eur 2200-2300) 44444 at 2200 in NE.Bedford; RAE Buenos Aires, Argentina **15.345** (Sp to S.America 0000?-0100?) 34443 at 0045 in Kilkeel.

R.Australia has been reaching the UK well in the **13MHz (22m)** band during the early morning. Their broadcast to Pacific areas on **13.605** (Eng 0000-0800) was rated SIO444 at 0517 by Francis Hearne in E.Bristol. Also mentioned in the reports were Vatican R, Italy **13.765** (Eng to Africa 0630-0700) rated 35354 at 0630 in Manchester; R.Austria Int via Moosbrunn **13.730** (Eng to Eur 0730-0800) 55454 at 0745 in Herstonmouceux; UAER, Dubai **13.675** (Ar to Eur 0615-1030) 55534 at 0835 in St.Mary's, IoS; SRI via Sottens? **13.685** (Eng,

LOCAL RADIO CHART

Freq (kHz)	Station	ILR BBC	e.m.r.p (kW)	Listener	Freq (kHz)	Station	ILR BBC	e.m.r.p (kW)	Listener
558	Spectrum, London	I	0.80	B,C,G,H,J	1260	Brunel CG, Bristol	I	1.60	J
585	R.Solway	B	2.00	A	1260	R.York	B	0.50	A
603	Cheltenham R.	I	0.10	A,G,H,J	1296	Radio XL,Birmingham	I	5.00	A,G,H,J*,K
603	Capital G,Litt'brne	I	0.10	C,G,H,K	1305	Magic AM,Barnsley	I	0.15	A
630	R.Bedfordshire(3CR)	B	0.20	B,C,F,G,H,K	1305	Premier via ?	I	0.50	C,G,H,J*
630	R.Cornwall	B	2.00	A,H,J	1305	Touch AM, Newport	I	0.20	H,J
657	R.Ciwyd	B	2.00	A,G,H,J,K	1323	Capital G,Southwick	I	0.50	C,G,H,K
657	R.Cornwall	B	0.50	A,B,H,J	1323	SomersetSnd,Bristol	B	0.63	A,J
666	Gemini AM, Exeter	I	0.34	A,G,H,J	1332	Premier, Battersea	I	1.00	C,G,H,J*
666	R.York	B	0.80	A,G,K	1332	CI.Gold 1332,Pt'bo	I	0.60	A
729	BBC Essex	B	0.20	C,E,G,H,K	1332	Wiltshire Sound	B	0.30	H
738	Hereford/Worcester	B	0.037	A,B,D,E,G,H,J*,K	1359	The Breeze,Chelms'd	I	0.28	G
756	R.Cumbria	B	1.00	A	1359	CI.Gold C9,C'try	I	0.27	G
756	R.Maldwyn, Powys	I	0.63	G,H,J	1359	R.Solent	B	0.85	C*,H
765	BBC Essex	B	0.50	C,E,G,H	1359	Touch AM, Cardiff	I	0.20	J
774	R.Ken.	B	0.70	C,G,H,K	1368	Southern Counties R	B	0.50	B,C*,G,H,J*,K
774	R.Leeds	B	0.50	A,G	1368	Wiltshire Sound	B	0.10	H
774	CI.Gold 774, Glos	I	0.14	A,G,H,J	1413	R.Gloucester via ?	B	0.50	B
792	CI.Gold 792, Bedford	I	0.27	C,E,G,K	1413	Premier via ?	I	0.50	C*,G,H,J*
792	R.Foyle	B	1.00	A,I	1413	Yks Dales R,Skipton	I	0.10	A
801	R.Devon & Dorset	B	2.00	A,D,G,H,J,K	1431	The Breeze,Southend	I	0.35	C,G,K
828	CI.Gold 828, Luton	I	0.20	C,G,K	1431	CI.Gold, Reading	I	0.14	G,H
828	ZCR CG, Bournemouth	I	0.27	H,J	1449	R.Peterboro/Cambs	B	0.15	A,G,H
828	Townland R, Ulster	I	0.80	A	1458	R.Cumbria	B	0.50	A
837	R.Cumbria/Furness	B	1.50	A	1458	R.Devon & Dorset	B	2.00	A,H,J
837	Asian Netwk Leics	B	0.45	A,C,G,H,K	1458	Sunrise, London	I	50.00	C*,G,H,J*
855	R.Devon & Dorset	B	1.00	C,H,J	1458	Asian Netwk Langley	B	5.00	C
855	R.Lancashire	B	1.50	A	1476	CountySnd,Guildford	I	0.50	A,B*,C*,F*,G,H,J*,K
855	R.Norfolk, Postwick	B	1.50	C,G,K	1485	CI.Gold, Newbury	I	1.00	G
855	Sunshine 855,Ludlow	I	0.15	B,G,J	1485	R.Merseyside	B	1.20	A,H,I
873	R.Norfolk, W.Lynn	B	0.30	C,G,H,K	1485	Southern Counties R	B	1.00	B,C,G,H,K
936	Brunel CG, W.Wilts	I	0.18	C,G,H,J*	1503	R.Stoke-on-Trent	B	1.00	A,C*,F*,G,H
936	Yks Dales R, Howes	I	1.00	A	1521	Heartbeat 1521,AM,NI	I	0.50	A,I
945	CI.Gold GEM, Derby	I	0.20	A,B	1521	Fame 1521, Reigate	I	0.64	C,G,H,K
945	Capital G, Bexhill	I	0.75	C,G,H,K	1530	R.Essex	B	0.15	C,E,G,H,K
954	Gemini AM, Torquay	I	0.32	G,H,J	1530	CI.Gold W.Yorks	I	0.74	A,G
954	CI.Gold 954, H'ford	I	0.16	C*,G	1530	CI.Gold Worcester	I	0.52	A,G,H
963	Asian Sd,Manchester	I	0.80	A	1548	R.Bristol	B	5.00	H,J
963	Liberty R, Hackney	I	1.00	A,C,G,H	1548	Capital G, London	I	97.50	C*,G,H
972	Liberty R, Southall	I	1.00	C,G	1548	Magic AM,Merseyside I	I	4.40	A
990	R.Devon & Dorset	B	1.00	A,G,H,J	1548	Forth AM, Edinburgh	B	2.20	B
990	CI.G.WABC,Wolv'ton	I	0.09	B,G	1557	R.Lancashire	B	0.25	A
999	C.Gold GEM Nott'ham	I	0.25	G	1557	Mellow, Clacton	I	0.125	G
999	Red Rose 9-99 P'stn	I	0.80	A	1557	CI.Gold 1557,N.hant	I	0.76	G,K
999	R.Solent	B	1.00	C,E*,G,H,K	1557	Capital G, So'ton	I	0.50	C*,G,H
999	Valleys R, Aberdare	I	0.50	J*	1584	KCBC, Kettering	I	0.04	B,E*
1017	CI.G.WABC,Shrewsb'y	I	0.70	A,G,J*,K	1584	London Turkish R	I	0.20	C,G
1026	R.Cambridgeshire	B	0.50	B,C,G,K	1584	R.Nottingham	B	1.00	E*,G
1026	Downtown, Belfast	I	1.70	A,I	1584	R.Shropshire	B	0.50	A,G
1026	R.Jersey	B	1.00	G,H,J	1602	R.Kent	B	0.25	B,C,E*,G,H,K
1035	RTL Country 1035	I	1.00	B,C,G,H,J*					
1035	R.Sheffield	B	1.00	A					
1035	N.Sound 2, Aberdeen	I	0.78	A,G*					
1116	R.Derby	B	1.20	A,B,G					
1116	R.Guernsey	B	0.50	C,G,H,J					
1116	Valleys R,Ebbw Vale	I	0.50	J*					
1152	LBC 1152 AM	I	23.50	C,G,H					
1152	Pic'ly 1152,Manch'r	I	1.50	A					
1161	R.Bedfordshire(3CR)	B	0.10	C,G,K					
1161	Brunel CG, Swindon	I	0.16	A,G					
1161	Magic AM,Humberside	I	0.35	A					
1161	Southern Counties R	B	1.00	C,G,H					
1170	GNR, Stockton	I	0.32	A					
1170	Capital G,Portsm'th	I	0.50	G,H					
1170	Swansea Snd,Swansea	I	0.58	A,J					
1170	1170AM,High Wycombe	I	0.25	C,G,K					
1242	Capital G,Maldstone	I	0.32	G,K					
1242	IoW Radio, Wootton	I	0.50	D,H					
1251	C.G.Amber,Bury St'ed	I	0.76	G,K					

Note: Entries marked * were logged during darkness. All other entries were logged during daylight or at dawn/dusk.

Listeners:-

- (A) Robert Connolly, Kilkeel.
- (B) John Court, Birmingham.
- (C) John Eaton, Woking.
- (D) Simon Hockenbult, E.Bristol.
- (E) Sheila Hughes, Morden.
- (F) Rhoderick Illman, Dxted.
- (G) Brian Keyte, Gt.Bookham.
- (H) George Millmore, Wootton, IoW.
- (I) Tom Smyth, Co.Fermanagh.
- (J) David Stevenson, Swansea.
- (K) Phil Townsend, E.London.

It, Ger, Fr to Australasia 0830-1030) 34553 at 0847 in Larnaca, Cyprus.

After mid-day R.Sweden via Horby **13.740** (Eng to Asia, Pacific 1330-1400) was 43433 at 1335 in Freshwater Bay, IoW; Vatican R, Italy **13.765** (Eng to Asia 1540?-1610) 55545 at 1600 in NE.Bedford; DW via Nauen **13.610** (Fr to Africa 1700-1800) 54555 at 1715 in Liverpool; Vatican R, Italy **13.765** (Eng to Africa 1730-1800) 44444 at 1734 in Woodhall Spa; R.Ukraine Int, Kiev **13.590** (Ger to Eur 1700-1800) 44334 at 1740 in Colyton; WHRI via Noblesville, USA **13.760** (Eng to E.U.S.A, Eur 1500-2100) 44444 at 2007 in Morpeth; Christian Science SWB via WSHB Cyprus Creek, USA **13.770** (Eng to Eur 2000-2100 Wed & Sun) 33333 at 2012 in Plymouth; R.Havana Cuba **13.715** (Eng to Eur 2030-2130) 32222 at 2030 in Appleby; R.Havana Cuba **13.605** (Eng [u.s.b.] to Eur 2030-2130) SIO343 at 2034 in Woking; R.Austria Int via Moosbrunn **13.730** (Sp to Africa 2030-2100) 44233 at 2040 in Rugby; RCI via Sackville **13.650** (Eng, Fr to Eur, Africa 2000-2200) 44444 at 2101 in Oxted; WINB Red Lion, USA **13.790** (Eng to Eur, Africa 1700-2200) 32222 at 2123 in Stockport; RCI via Sackville **13.670** (Eng to Eur, Africa 2000-2130) 24232 at 2126 in Newry; R.Damascus, Syria **13.610** (Eng to America, Pacific 2105-2205) 44544 at 2147 in Bridgwater; R.Nederlands via Flevo **13.700** (Du to Africa 2130-2225) 44444 at 2157 in Truro; WEWN Birmingham, USA **13.615** (Eng to N.America 2130-

2300) 2322 at 2250 in Kilkeel; Christian Science BC via WSHB Cyprus Creek, USA **13.770** (Eng to S.Eur, W.Africa 2300-0000 Wed & Sun) 43333 at 2300 in Stalbridge.

R.New Zealand has been reaching the UK in the **11MHz (25m)** band. Their broadcast to Pacific areas on **11.905** (Eng 0459-0800) was rated 23312 at 0615 in Newry. Also noted during the morning were the Voice of Greece, Athens **11.645** (Gr, Eng to Eur, Australia 0600-0800), rated SIO3333 at 0650 in Woking; HCJB Quito **11.960** (Eng to Eur 0700-0900) 45554 at 0805 in Wallsend; R.Prague, Czech Rep **11.600** (Sp, Fr, Cz to Eur 0730-0857) 55555 at 0814 in Plymouth; R.Korea Int via Sackville, Canada **11.715** (Eng to S.America 1030-1100) 34334 at 1043 in St.Mary's, IoS.

During the afternoon R.Finland via Pori **11.900** (Eng to W.Eur, USA 1230-1255 Mon-Sat) was 33333 at 1235 in Truro; ERT Tunisia **11.730** (Nat prog 0600-1710) 43333 at 1320 in Stalbridge; R.Japan via Sri Lanka **11.880** (Eng to Asia 1400-

1500) 22322 at 1400 in Dudley; R.Jordan via Al Karanah **11.690** (Eng to W.Eur, E.USA 1000-1630) 33333 at 1430 in W.London; R.Cairo, Egypt **12.050** (Ar [Home Sce relay] to Eur, N.America) SIO222 at 1515 in Macclesfield; R.Australia via Shepparton **11.660** (Eng to Asia 1330-1700) 43444 at 1620 in Freshwater Bay, IoW; BBC via Skelton & Woofferton, UK **12.095** (Eng to Eur, N/W.Africa 0400-2000) SIO444 at 1700 in Co.Fermanagh; WWCR Nashville, USA **12.160** (Eng to N.America, Eur 1400-2200) 44344 at 1715 in Liverpool.

Later, R.Pakistan, Islamabad **11.570** (Ur to Eur 1700-1900) was 44344 at 1825 in Colyton; R.Australia via Shepparton **11.880** (Eng to Pacific areas 1700-2130) 23443 at 1854 in Storrington; China Nat.R, Taiwan **11.100** (Ch) 33343 at 1856 by **Robert Shacklock** in Westwood, Notts; Voice of Vietnam, Hanoi **12.020** (Eng to Eur 1900-1930) 24333 at 1904 in Manchester; Voice of the Mediterranean, Malta via Russia **12.060** (Eng to Eur 1900-2000 [Not Fridays]) 43543 at 1905 in

MEDIUM WAVE CHART

Freq (kHz)	Station	Country	Power (kW)	Listener	Freq (kHz)	Station	Country	Power (kW)	Listener
819	Warsaw	Poland	300	F*	1251	Huisberg	Netherlands	10	E*,I*
819	S.Sebastian(EI)	Spain	5	F*	1250	SER via ?	Spain	?	F*
820	Rotterdam	Holland	20	A*,E*,J	1250	Guldford (V)	UK	0.5	A,J
828	Barcelona(SER)	Spain	50	I*	1269	Neumunster(DLF)	Germany	600	E*,F*
831	Nancy	France	200	H*,I*	1269	COPE via ?	Spain	?	I*
837	COPE via ?	Spain	?	A*,E*,F*,I*	1278	Dublin/Cork(RTE2)	Ireland (S)	10	D,E*,H,I
846	Rome	Italy	540	A*,C*,F*	1287	RFE via ?	Czech Rep.	400	E*,F*
855	Berlin	Germany	100	E*,I	1287	Lerida(SER)	Spain	10	A
855	RNE1 via ?	Spain	?	A*,E*,F*,I*	1296	Valencia(COPE)	Spain	10	A*
864	Santah	Egypt	500	A*,F*	1296	Orfordness(BBC)	UK	500	D,H
864	Paris	France	300	A,F*,J	1305	Rzeszow	Poland	100	E*
864	Socuellamos(RNE1)	Spain	2	F*	1305	RNE5 via ?	Spain	?	I*
873	Zaragoza(SER)	Spain	20	E*,F*,I*	1314	Kvitsov	Norway	1200	A*,E*,F*,G,I*
873	Enniskillen(R.U.I)	UK	1	E*	1323	W'brunn (V.Russia)	Germany	1000/150	E
882	COPE via ?	Spain	?	A*,E*,F*	1332	Rome	Italy	300	A*,E*,F*
882	Washford(BBCWales)	UK	100	A,B,D,F,H,I,J	1341	Lisnagarvey(BBC)	Ireland (N)	100	D,F*,H,I
891	Algiers	Algeria	600/300	A*,B*,E*,F*	1341	Tarrasa(SER)	Spain	2	A*,E*
900	Brno(CRo2)	Czech Rep.	25	A*,E*,F*	1350	Nancy/Nice	France	100	A*
900	Milan	Italy	600	A*,E*	1350	Cesvaine/Kuldiga	Latvia	50	A*,F*
900	COPE via ?	Spain	?	F*,I*	1359	Madrid(RNE)	Spain	600	E*,F*
909	B'mans Pk(BBC5)	UK	140	A,F,H,I	1368	Foxdale(Manx R)	IoM	20	D*,E*,G,H,I
918	Domzale	Slovenia	600/100	A*,F*	1377	Lille	France	300	A,F,I,J
918	Madrid(R.Int)	Spain	20	A*,F*,I*	1386	Bolshakovo	Russia	2500	E*,F*
927	Volvertem	Belgium	300	A*,E*,F,I,J	1395	TWR via Filake	Albania	500	E*,F*
936	Bremen	Germany	100	E*,F*	1395	Lopic	Netherlands	120/40	E*,F*,J
936	L'ov	Ukraine	500	I*	1404	Brest	France	20	E*,F*
954	Brno (CRo2)	Czech Rep.	200	F*	1413	RNE5 via ?	Spain	?	E*,F*,I*
954	Madrid(CI)	Spain	20	F*	1422	Heusweiler(DLF)	Germany	1200/600	A*,E*,F*
963	Pori	Finland	600	E*,F*,I*	1431	Kopani	Ukraine	500	E*
963	Tir Chonail	Ireland (S)	10	H*,I*	1440	Marnach(RTL)	Luxembourg	1200	E*,E*,H,I,J
972	Hamburg(NDR)	Germany	300	E*,F*,I*	1440	Damman	Saudi Arabia	1600	B*,C*
981	Alger	Algeria	600/300	B*,E*	1449	Squinzano (RAI)	Italy	50	A*
990	Berlin	Germany	300	B*,F*	1449	Monchegorsk	Russia	42	I*
990	R.Bilbao(SER)	Spain	10	F*	1449	Redmoss(BBC)	UK	2	E*
990	Redmoss(BBC)	UK	1	E*	1467	Monte Carlo(TWR)	Monaco	1000/400	A*,C*,E*,F*,J*
990	Twynn(BBC)	UK	1	D,I*	1476	Wien-Bismar	Austria	600	I*
999	Schwerin (RIAS)	Germany	20	E*	1485	SER via ?	Spain	?	I*
999	Madrid(COPE)	Spain	50	I*	1494	Clermont-Ferrand	France	20	A*
1008	Flevo(Hilv-5)	Holland	400	A*,E*,F,I,J	1494	St.Petersburg	Russia	1000	F*
1017	Rheinsender(SWF)	Germany	600	E*,F*	1503	Stargard	Poland	300	A*
1017	RNE5 via ?	Spain	?	I*	1503	Jarragon(SER5)	Spain	5	I*
1026	SER via ?	Spain	?	I*	1512	Wolvertem	Belgium	300	A*,B*,E*,F*,I
1035	Lisbon(Prog3)	Portugal	120	E*	1521	Kosice(Cizatice)	Slovakia	600	F*
1044	Dresden(MDR)	Germany	20	F*	1521	Duba	Saudi Arabia	2000	A*,F*
1044	Sebbae-Aioun	Morocco	300	F*	1530	Vatican R	Italy	150/450	A*,E*,F*
1044	S.Sebastian(SER)	Spain	10	F*	1539	Mainflingen(ERF)	Germany	350/700	E*,F*
1053	Zaragoza(COPE)	Spain	10	E*	1539	SER via ?	Spain	?	A*,C*
1053	Talk R.UK via ?	UK	?	A,F,H,I,J	1557	Nice	France	300	H,I
1062	Kalundborg	Denmark	250	E*,F*	1566	Samen	Switzerland	300	F*
1062	R.Uno via ?	Italy	?	F*	1575	Genova	Italy	50	A*
1071	R.France via ?	France	?	F*	1575	SER via ?	Spain	5	C*,F*,I*
1071	Brest	France	20	F*	1584	SER via ?	Spain	2	A*,I*
1071	Bilbao(EI)	Spain	5	F*	1593	Holzkirchen(VOA)	Germany	150	E*,F*
1071	Talk Radio UK via ?	UK	?	A*	1602	SER via ?	Spain	?	A*,F*,I*
1080	Katowice	Poland	1500	E*	1602	Vitoria(EI)	Spain	10	F*,I*
1080	SER via ?	Spain	?	E*,F*,I*	1602	R.Beograd	Yugoslavia	1	I*
1089	Talk Radio UK via ?	UK	?	A,F,I	1611	Vatican R	Italy	15	I*
1098	Nitra(Larok)	Slovakia	1500	E*,F*					
1107	AFN via ?	Germany	10	E*,I*					
1107	Talk R.UK via ?	UK	?	A,F,I					
1116	Bari	Italy	150	I*					
1125	La Louviere	Belgium	20	F*					
1125	RNE5 via ?	Spain	?	E*					
1125	Llandrindod Wells	UK	1	D,I					
1134	Muransk & Saransk	Russia	75 & 30	I*					
1134	COPE via ?	Spain	?	F*					
1134	Zadar(Croatian R)	Yugoslavia	600/1200	E*,F*					
1143	AFN via ?	Germany	1	A*					
1143	Stuttgart(AMN)	Germany	10	E*					
1143	COPE via ?	Spain	2	A*,F*,I*					
1152	RNE5 via ?	Spain	10	I*					
1161	Ain-Salah	Algeria	5	F*					
1179	Solvesborg	Sweden	600	A,E*,F*					
1188	Kuurne	Belgium	5	A,E*,J					
1188	Szolnok	Hungary	135	F*					
1197	Munich(VOA)	Germany	300	E*					
1197	Virgin via ?	UK	?	A,F,H,I,J					
1215	Virgin via ?	UK	?	A,F,H,I					
1224	Lelystad	Holland	50	A,E*					
1224	COPE via ?	Spain	?	I*					
1233	Liege	Belgium	5	E*					
1233	Virgin via ?	UK	?	I*					
1242	Marseille	France	150	I*					
1251	Marcali	Hungary	500	F*					

Note: Entries marked * were logged during darkness. All other entries were logged during daylight or at dawn/dusk.

Listeners:-

- (A) John Eaton, Woking.
- (B) Sheila Hughes, Morden.
- (C) Rhoderick Illman, Oxted.
- (D) Brian Keyte, Gt.Bootham.
- (E) Eddie McKeown, Newry.
- (F) George Millmore, Wootton IoW.
- (G) Clare Pinder, while in Appleby.
- (H) Tom Smyth, Co.Fermanagh.
- (I) David Stevenson, Swansea.
- (J) Phil Townsend, E.London.
- (K) Thomas Williams, Truro.
- (L) Tom Winzor, Plymouth.

TROPICAL BANDS CHART

Freq (MHz)	Station	Country	UTC	DXer	Freq (MHz)	Station	Country	UTC	DXer
3.255	BBC via Meyerton	S.Africa	2022	B,I,J,K,N,O,P	5.025	R.Rebelle, Habana	Cuba	1938	F
3.270	SWABC 1, Namibia	S.W.Africa	2021	B,K,N,O	5.025	R.Uganda, Kampala	Uganda	1943	F,J,K
3.290	Nambian BC, Windhoek	S.W.Africa	2021	B,K,N,O	5.030	AWR Latin America	Costa Rica	0200	A,B
3.306	ZBC Prog 2	Zimbabwe	1947	B,K,N	5.030	RTM Kuching	Sarawak	2308	C
3.316	SBS Goderich	Sierra Leone	2021	B,K,O	5.035	R.Bangui	C.Africa	2034	J,K,O
3.320	SABC (RSG) Meyerton	S.Africa	1927	B,K,O	5.047	R.Togo, Lome	Togo	1946	B,G,I,J,K,O
3.335	CBS Taipei	Taiwan	2019	C,K	5.050	R.Tanzania	Tanzania	1945	E,H,K
3.365	R.Cult. Araraquara	Brazil	2329	C	5.055	RFO Cayenne(Matoury)	French Guiana	0005	B
3.365	GBC R-2	Ghana	2121	B,C,G,K,N,O	5.075	Caracol Bogota	Colombia	0005	B,O
3.380	NBC Blantyre	Malawi	1844	B,K	5.100	R.Liberia, Totota	Liberia	2145	H,I,M
3.915	BBC via Kranji	Singapore	2124	B,C,I,J,M,N,O,P,Q					
3.955	BBC via Skelton	England	0400	A,J,R					
3.955	Nexus, Milan	Italy	2130	M					
3.970	R.Korea via Skelton	England	2100	A,J,J,L,P					
3.975	R.Budapest	Hungary	1900	F,I,J,L					
3.980	Nexus, Milan	Italy	1903	J					
3.985	Nexus, Milan	Italy	2117	I,M,N					
3.985	China R.Int via SRI	Switzerland	2100	A,B,J,L,P,Q					
3.995	DW via Julich	Germany	2116	B,C,I,J					
3.995	DW via Meyerton	S.Africa	2133	P					
4.005	Vatican R.	Italy	2140	B,I,J,M,N					
4.735	Xinjiang, Urumqi	China	2258	C					
4.755	R.Educ CP Grande	Brazil	0335	J					
4.765	R.Rural, Santarem	Brazil	0015	B					
4.770	FRCN Kaduna	Nigeria	2100	B,C,E,F,G,I,J,K,N,O,P					
4.777	R.Gabon, Libreville	Gabon	2046	G					
4.783	RTM Bamako	Mali	2100	B,C,F,G,H,I,J,K,M,N,O,P					
4.785	Caiari Porto Velho	Brazil	2303	C					
4.800	LNBS Maseru	Lesotho	2135	B,F,J					
4.815	R.diff.TV Burkina	Ouagadougou	2029	B,C,J,K,N,O,P					
4.820	R.Botswana, Gaborone	Botswana	2040	F,H,I,J,O					
4.822	R.Mauritania	Mauritania	2130	O					
4.825	R.Educadora,Braganca	Brazil	2202	C					
4.828	ZBC R-4	Zimbabwe	2000	B,K					
4.830	R.Tachira	Venezuela	0339	B,J					
4.835	RTM Bamako	Mali	2125	B,C,J,K,O					
4.845	ORTM Nouakchott	Mauritania	2140	B,K					
4.850	R.Younde	Cameroon	2229	B,C,I,J,K,O					
4.860	AIR Delhi	India	1858	C					
4.865	R.Alvorada, Londrina	Brazil	2215	C					
4.865	PBS Lanzhou	China	2205	H					
4.870	R.Cotonou	Benin	2244	B,C,G,K,O,P					
4.885	R.Clube do Para	Brazil	2220	O					
4.885	R.Difusora Acreana	Brazil	2355	B					
4.890	RFI Paris	via Gabon	0357	J					
4.890	R.Port Moresby	New Guinea	1943	K					
4.905	R.Nat.N'djamena	Chad	2057	J					
4.910	R.Zambia, Lusaka	Zambia	2155	B					
4.915	R.Anhanguera	Brazil	0040	B,O					
4.915	GBC-1, Accra	Ghana	2000	A,B,F,H,I,J,K,O,P					
4.915	KBC Cent Sce Nairobi	Kenya	1950	K					
4.915	R.Cora de Peru, Lima	Peru	0400	A,F					
4.920	R.Quito, Quito	Ecuador	0410	A,D					
4.927	RRI Jambi	Indonesia	2224	C,O					
4.935	KBC Gen Sce Nairobi	Kenya	2055	F,O					
4.950	VOA via Sao Tome	Sao Tome	1930	E,F,G,H,I,K,L,O,P					
4.955	R.Nac. de Colombia	Colombia	0415	B,D					
4.960	VOA via Sao Tome	Sao Tome	0320	J					
4.965	Christian Voice	Zambia	1945	B,K					
4.975	R.Uganda, Kampala	Uganda	1940	E,F,H,I,J,K,P,Q					
4.980	Ecos del Torbes	Venezuela	0015	B,C,H,J					
4.985	R.Brazil Central	Brazil	0010	A,B,O					
4.990	R.Animas, Chocaya	Bolivia	0437	A					
5.009	R.TV Malagasy	Madagascar	1841	K					
5.010	R.Garoua	Cameroon	1917	K					
5.020	La V du Sahel, Niamey	Niger	2139	B,I,J,K,O					
5.025	R.Parakou	Benin	2151	B,I,K					

DXers:-

- (A) Michael Casey, Manchester.
- (B) Robert Connolly, Killeel.
- (C) John Eaton, Woking.
- (D) David Edwardson, Wallsend.
- (E) Bill Griffith, SW London.
- (F) David Hall, Morpeth.
- (G) Simon Hockenhill, E.Bristol.
- (H) Sheila Hughes, Morden.
- (I) Rhoderick Illman, Oxted.
- (J) Eddie McKeown, Newry.
- (K) Fred Pallant, Storrington.
- (L) Clare Pinder, while in Appleby.
- (M) Peter Pollard, Rugby.
- (N) Vic Prier, Colyton.
- (O) Richard Reynolds, Guildford.
- (P) Robert Shacklock, Westwood.
- (Q) Tom Smyth, Co.Fermanagh.
- (R) Ernest Wiles, NE.Bedford.

Bridgwater; Voice of Hope via Georgia **12.125** (Eng to Eur 1900-2000) 34333 at 1915 in Morden; China R.Int via ? **11.840** (Eng to Eur 1900-1955) 43444 at 1919 in Woodhall Spa; REE via Noblejas? **11.830** (Eng to Eur, Africa 2000-2055) 33433 at 2000 by **Ross Lockley** in Galashiels; BBC via Ascension Is **11.835** (Eng to W.Africa 1930-2300) 44444 at 2018 in Morpeth; R.Kuwait via Kabd **11.990** (Eng to Eur, N.America 1800-2100) 33333 at 2050 in Stockport; RCI via Sackville **11.690** (Eng to Eur, Africa 2000-2130) 42342 at 2102 in Oxted; R.Budapest, Hungary **11.700** (Eng to Eur 2100-2130) 44333 at 2100 in Appleby; R.Bulgaria, Sofia **11.720** (Eng to Eur 2100-2200) 54444 at 2150 in Norwich; BBC via Ascension Is **12.095** (Eng to S.America 2000-0200) 55455 at 2200 in Kirkby Stephen; R.Bulgaria, Sofia **11.720** (Eng to N.America 2300-0000) SIO444 at 2346 in N.Bristol.

Some of the broadcasts in the **9MHz (31m)** band are intended for European listeners. Those noted came from Christian Science BC via WSHB Cypress Creek, USA **9.835** (Eng 0800-1000) rated SIO433 at 0922 in Macclesfield; R.Nederlands via Wertachtal, Germany **9.860** (Eng 1030-1225) 55555 at 1040 in Herstmonceux; R.Vlaanderen Int, Belgium **9.925** (Eng 1030-1055, also to M.East) 55555 at 1045 in Norwich; RFI via Allouis? **9.805** (Fr, Eng 0600-1400, also to M.East, N.Africa) 55444 at 1245 in Kirkby Stephen; R.Norway Int, Oslo **9.590** (Norw [Eng Sun] 1300-1330) 33333 at 1300 in Truro; Israel R, Jerusalem **9.435** (Eng 1545-1600, also to USA) 44444 at 1545 in NE.Bedford; R.Bulgaria, Sofia **9.700** (Eng 1900-2000) 44444 at 1915 in Woodhall Spa; RAI Rome **9.670** (Eng 1935-1955) 42432 at 1935 in Galashiels; Voice of Turkey, Ankara **9.460** (Tur 0800-2200, also to USA) 55534 at 1954 in E.Bristol; China R.Int, Beijing **9.920** (Eng 2000-2157) 43334 at 2000 in Dudley; Voice of Russia **9.710** (Eng [WS]) 55555 at 2010 in Bridgnorth; R.Thailand, Udon Thani **9.680** (Eng 2030-2100?) 32433 at 2035 in Rugby; R.Bulgaria, Sofia **9.700** (Eng 2100-2200) 44444 at 2108 in Stockport.

Whilst beaming to other areas ORTM Bamako, Mali **9.635** (Fr, Ar? to W.Africa 0758-1757) was 24542 at 0820 in Wallsend; HCJB Quito, Ecuador **9.640** (Eng to S.Pacific 0700-1100) 32233 at 0824 in Morpeth; R.Yugoslavia **9.720** (Eng to E.Africa 1830-1900) 34253 at 1850 in Manchester; DW via Sines **9.640** (Eng to W.Africa 1900-1950) SIO444 at 1900 in Co.Fermanagh; R.Australia via Shepparton **9.500** (Eng to Asia, Pacific 1430-2200) 43433 at 2159 in Oxted; RCI via Sackville **9.755** (Eng [CBC prog] to USA, Caribbean 2200-0300) 33333 at 2200 in Morden.

Many of the broadcasts in the **7MHz (41m)** band are also to Europe. Some come from VOA via Woofferton, UK **7.170** (Eng 0400-0700, also to N.Africa) rated SIO222 at 0600 in

Co.Fermanagh; R.Japan via Woofferton, UK **7.230** (Jap, Eng 0500-0700) 44444 at 0613 in Newry; WYFR via Okeechobee **7.355** (Eng 0600-0800, also to Africa) 33333 at 0640 in Stalbridge; Christian Science BC via WSHB **7.535** (Various 0400-0958) 44444 at 0652 in Plymouth; Sudwestfunk via Rohrdorf 7.265 (Ger 24hrs) 44444 at 0744 in Oxted; AWR via Forli, Italy **7.230** (Eng 0900-1000) 35433 at 0951 in Bridgwater; R.Prague, Czech Rep **7.345** (Eng 1030-1057) 23322 at 1030 in Dudley; AWR via Forli, Italy **7.230** (Eng 1200-1300) 33333 at 1245 in W.London; R.Norway Int, Oslo **7.485** (Norw [Eng Sun] 1800-1830) 55555 at 1830 in St.Mary's, IoS; Voice of Greece, Athens **7.515** (Eng 1900-1910) 44333 at 1900 in Morden; R.Thailand via Udon Thani **7.210** (Eng 1900-1958) 53422 at 1900 in Galashiels; RAI Rome **7.145** (Eng 1935-1955) 33433 at 1940 in E.Bristol; Vatican R, Italy **7.250** (Eng 1950-2010) 44444 at 1950 in Bridgnorth; Polish R, Warsaw **7.285** (Eng 1930-2025) 53433 at 1950 in Herstmonceux; VOIRI Tehran **7.260** (Eng 1930-2028) 45444 at 1953 in Woking; R.Minsk, Belarus **7.210** (Various [Eng Tues 1930 & 2030, Thurs 2030] 1900-2100, 0400-0600) 53554 at 2030 in Manchester; RCI via Skelton, UK **7.235** (Eng 2000-2130, also to Africa) 43333 at 2030 in Appleby; BBC via Skelton **7.325** (Eng 2000-2230) 55444 at 2037 in Kirkby Stephen.

Logged in the **6MHz (49m)** band during the early morning were WEWN Birmingham, USA **5.825** (Eng to USA, Eur 0000-1000), rated 22222 at 0600 in NE.Bedford; R.Japan via Skelton, UK **5.975** (Eng to Eur 0600-0700) 54454 at 0612 in Newry; WWCR Nashville, USA **5.935** (Eng to USA 0100-1400) 22232 at 0730 in Colyton; SRI via Lenk? **6.165** (Eng, Fr, Ger, It to Eur 0400-1930) 54444 at 1017 in Norwich.

Later, Suddeutscher Rundfunk, Muhlacker **6.030** (Ger to Eur) was 54554 at 1700 in W.London; Polish R, Warsaw **6.095** (Eng to Eur 1700-1800) 43333 at 1730 in Morden; R.Yugoslavia **6.100** (Eng to E.Africa 1830-1900) 42343 at 1830 in Manchester; Polish R, Warsaw **6.095** (Eng to Eur 1930-2030) 44544 at 1944 in E.Bristol; RCI via Skelton, UK **5.995** (Fr, Eng to Eur, M.East, N.Africa 1900-2100) 44444 at 2000 in Woodhall Spa; R.Finland via Pori **6.135** (Eng to Eur 2000-2030) 55555 at 2000 in Bridgnorth; BBC via Cyprus **6.180** (Eng to Eur 1700-2200) 55555 at 2045 in Liverpool; R.Austria Int via Moosbrunn **6.155** (Eng to Eur 2130-2200) 44444 at 2130 in Appleby; R.Ukraine Int **6.020** (Eng to Eur 2100-2200) 44344 at 2200 in Rugby; R.Cultura, Sao Paulo, Brazil **6.170** (Port 0800-0400) 24433 at 2212 in Guildford; R.Nederlands via Flevo **6.020** (Eng to N.America 2330-0125) rated SIO444 at 0036 in N.Bristol; WHRI South Bend, USA **5.745** (Eng to E.USA, Eur 2200-0400) 54455 at 0300 in Morpeth.

A Delightful Year

SCANNING



Peter Bond, our MilAir man, reports in with his personal findings, resulting from his 'Long Term Test' of his very own IC-R8500. After a year's use, here are his findings.

Ever since John Wilson's comprehensive report on the Icom IC-R8500 appeared in *SWM* in September 1996, I have been in the fortunate position to have had, 'Hands on' experience with this extraordinary radio. John's review covered primarily the facilities and specifications and reference to the review should be made for more detailed information on these aspects. This long-term look is a supplementary review seen more from the user's viewpoint.

Over the past few years several manufacturers have produced radios which have covered both the h.f. and v.h.f./u.h.f. spectrums. (I exclude from these comments the Icom IC-R9000 as it is quite simply beyond the means of most of us mere mortals!). Receivers such as the AOR AR3000A have been very competent v.h.f./u.h.f. scanners with the addition of modest performance on h.f., but could never be described as dedicated h.f. radios. I owned an Icom IC-R7100 which again was an excellent performer on v.h.f. and u.h.f. but had an h.f. conversion which could only be regarded as adequate - not an Icom conversion I might add. Consequently, the field was open for someone to produce a wide-band radio that gave well above average performance on both the h.f. and v.h.f./u.h.f. bands - Enter the IC-R8500.

Memory Mania

To kick-off, I would like to make some comments regarding the memory facilities of the R8500, and dare I say it, I am also compelled to make one memory related complaint. The initial thing that I was pleased to see was that Icom have followed the path of using more banks with less channels. Some of the other receiver manufacturers continue to use fixed banks of 100 channels, and for the large percentage of users I have discussed this subject with, this is far too many - 30, 40 or even 50 channels is a much more manageable size - However, Icom have come up with the perfect solution to bank sizes.

The new 'cut and paste' aspect of the memory channels, is a unique feature that I am surprised no one has thought of before. Instead of having 800 channels

which are fixed into 20 banks of 40 channels, the R8500 gives you the flexibility to expand or contract the banks to suit your own needs. For example, if you listen to the military airbands and wished to store all the London Military frequencies in one bank, (currently about 62 frequencies), you can easily expand a bank from 40 to 65 memories. This is achieved by first deleting selected memories from other banks to the **free** bank, (used for storing spare memories), and then allocating them to the bank of your choice. This all adds to great flexibility, the only restrictions are that each bank must retain at least one memory, and the total number of memories available to the 20 primary banks is 800. If you so wish you can expand the 800 memories by using some of the 200 available to the SKIP and AUTO banks, although you would be wise not to reduce these banks too far as you would degrade their ability to work efficiently when running searches or operating in auto - memory write mode.

Now for the moan - The R8500 can only scan one bank at a time, or all the banks together, there is no facility to link and scan selected banks. Considering, even some of the most modest hand-held radios have this facility, it seems a rather glaring omission for a radio of this sophistication. Unfortunately, Icom have compounded this matter by removing one of the facilities included with the previous model, the IC-R7100. This allowed 10 user definable groups of memories to be selected throughout any of the banks by the allocation of a unique number between 0 and 9 to selected memories. Just one user defined scan is available on the R8500, which I personally feel is a step backwards. This is achieved by deselecting the 'BANK' command, and then adding the 'SELECT - CHANNEL' command to the memories of your choice, Having said that, I think that my complaint is





Lowe Electronics Ltd



GRAND OPEN DAY



**SATURDAY
5TH
SEPTEMBER
10:00am - 4:00pm**

NOT TO BE MISSED!
KENWOOD ICOM YAESU
in attendance
LOTS OF BARGAINS

*** During Open Day ***

Come and try our Scanner Test Range

This will allow you to compare all airband receivers against each other

Low Electronics Catalogue

Order your **FREE** catalogue now. Full of interesting products with comprehensive descriptions.

- Communications
- Amateur Radio
- GPS Navigation
- Short Wave Listening
- Airband Radio
- Scanners
- Weather Monitoring

Just send four first class stamps to receive your own catalogue!

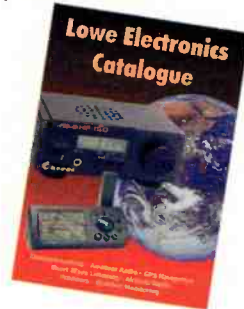

Low Electronics Ltd

Chesterfield Road, Matlock
Derbyshire, DE4 5LE
Telephone (General Enquiries) 01629 580800,
Fax 01629 580020

Orders **FREephone 0800 174749**

Email: info@lowe.co.uk
URL: <http://www.lowe.co.uk>

Showroom opening hours are 9.30am to 5pm Mon-Fri and 10am to 4pm on Sat, but check with our local branches as times may vary

Branches

Bristol & Wales, 79 Gloucester Road, Patchway, Bristol BS12 5QJ,
Tel 0117 931 5263 Fax 0117 931 5270

North East, Unit 18B, Airport Industrial Estate, Newcastle, NE3 2EF,
Tel 0191 214 5424, Fax 0191 214 0761, Email info@lowenewc.demon.co.uk

South West, 117 Beaumont Road, St Judes, Plymouth PL4 9EF
Tel 01752 257224 Fax 01752 257225

The Premier Airband Centre



**£399.00
AR8200**



**£139.00
MVT3300**



**£369.00
MVT9000**



**£249.00
MVT7100**



**£99.00
PSR244**



**£249.00
PCR-1000**



**£1495.00
ICR-8500**



**£699.00
AR3000A**

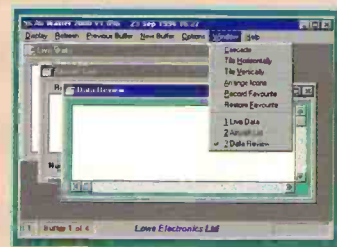

AIRMASTER 2000

Software decoder for ACARS

AIRMASTER 2000 is Lowe's ACARS Windows based decoding system. Hardware and software is supplied consisting of a small demodulator built into a 25 way D-type plug and the decoding software. The plug connects and derives its power from a COM port on the PC. The software is installed on the PC hard disk drive. The receiver or scanner is connected to the other demodulator connection.

Low Price £89.95

Upgrade from earlier DOS version £29.95



NOW IN STOCK

JRC NRD545



The latest model in the JRC range, the new NRD 545, which is their first receiver using DSP (Digital Signal Processing) from the IF stages onwards.

The DSP enables a wide choice of digitally implemented filters to be provided, together with IF shift and continuously variable passband width. The combination of these facilities gives the NRD 545 a level of performance than has previously been unheard of in a receiver costing less than £10,000.

Every equipment reviewer that has had the opportunity to try the NRD 545 to date has been amazed at the performance that JRC engineers have managed to cram into this small box.

Low Price £1595.00 Carriage £10.00

ALSO IN STOCK

NVA 319 SPEAKERS £199.00

CHE199 WIDE BAND CONVERTER £299.00

JRC NRD345G



JRC need no introduction to most SWL's but their mini receiver does! An all-mode receiver, the NRD345 includes synchronous detection as standard, offering low signal distortion and clear sound. Direct Digital Synthesis is employed in a phase locked loop circuit to enhance the carrier to sideband noise ratio. The RF amplifier and the first mixer in the front end stage incorporate 4 low-noise junction-type FETs with excellent cross modulation characteristics respectively to ensure high sensitivity with wide dynamic range. Other features include a variable level noise blanker, clock and timer functions and a built-in RS232 interface for computer control.

Low Price £649.00

RF SYSTEMS PRICES DOWN

Magnetic Long Wire Balun

The original model that started it all - not to be confused with cheap copies. Uses special military grade ferrite to ensure optimum magnetic transfer of signals over a wide frequency range.

Price now only £33.00

MLB isolator

A matching transformer based on MLB technology that fits in the coax downlead at the rear of your receiver to remove mains borne noise components. When used in conjunction with an MLB, this gives the lowest noise antenna system that money can buy. Really!

Price now £22.00

DX One Professional Active Antenna

A Beverage on your balcony?

The ultimate in SW active antennas. We have supplied dozens of these for critical high performance applications such as military and Government monitoring and hotel radio distribution systems. Covers 10kHz to 85Mhz with exceptional active amplifier specifications.

Price now only £295.00

AA150 active antenna

Originally designed to match our own HF150 receiver, this high performance small active antenna is only the size of a mobile whip, yet gives excellent results for those without long back gardens in which to put up a wire. Comes complete with a mains power unit and DC splitter box to enable it to be used with any make of receiver.

Price now £148.00

DX10 Active Antenna

An economy active antenna for HF using a specially designed amplifier whose gain increases with frequency, thus giving excellent results with older receivers. Only 90 cm long and complete with mains power unit.

Price now £125.00

ACCESSORY BARGAINS

JX1 Mini Speaker £7.00

LA801 Wideband Scanner Aerial £12.95

LA881 High Gain Wide Band Scanner £19.95

(Extends range to 2GHz)

LAC1 Window Clip for Scanner Aerials £14.95

BOOK BARGAINS

POOLEY'S 1997 FLIGHT GUIDE

Details on all UK Airfields and Airspace
Bargain at £5.00

p&p £2.00



A Delightful Year

Peter Bond reports on using the IC-R8500



Competition

Some of you reading this article may have wondered why I have not made the most obvious comparison and that is with AOR's AR5000 - The answer is, I did. However, I did not want my comments to become a direct head to head between the two receivers. All I will say is this. For four complete days I ran both sets side by side on the same antennas an all bands and formed my own opinions. As I type the final words of this long term test, I am still sitting here with my '8500 ticking away in front of me. Whilst the AR5000 is an excellent radio, I for one have no intention of replacing my R8500 with one - personal choice!

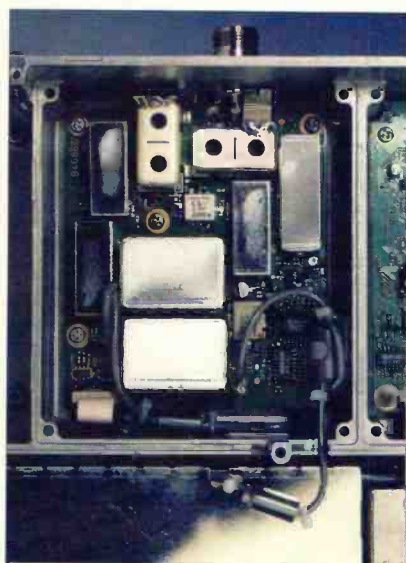

tempered slightly by the addition of the excellent 'cut and paste' facility.

Antennas

Now on to R8500 in everyday use. To ensure that this review was representative of the facilities used by many readers, the following antenna set-up was used. For h.f. listening, two antennas were used. (1) A simple 20m multi-strand copper, longwire was connected directly to the 500Ω socket using a phono plug. (2) A 30m multi-strand copper longwire was connected via a balun (UNUN) and a 50Ω coaxial feeder cable to the 50Ω socket. The longwires were about 8m above the ground, an r.f. earth was connected and an antenna tuner was used intermittently.

For v.h.f./u.h.f. listening, a roof mounted, stainless steel, wide-band discone was used with a good quality low loss cable with N-type connectors to the radio. Plus, a dedicated stainless steel v.h.f./u.h.f. airband antenna was also used, but to be honest the extra gain achieved by this antenna does not make that much improvement over a good discone. Although my comments cover reception on many bands, I make no apology for using the various airbands for some of my main comments and comparisons. This is simply because it is the subject I know best, and am consequently therefore better qualified to comment.

Hands On - VHF & UHF

My home in the South of England is located on the side of a Northwest facing hill about 67m above sea-level. This raised location admittedly does help with v.h.f./u.h.f. reception, but you still need a good radio to get the results. Quite simply the v.h.f./u.h.f. performance of the R8500 is outstanding.

On the airbands the '8500 'pulls in' signals that others radios on the same antenna will not even break the squelch, it is one of the few radios that could out-perform the venerable Signal R-535. I can clearly hear aircraft in Upper airspace, working London Military East frequencies with no problem. Aircraft descending into Mildenhall can be heard down to around 15000 feet, the ground controller at Yeovilton Radar can be heard over 112km away and on occasion when the conditions are right I can hear the weather on the ATIS at Lyneham, well over a 160km away! As I type this, I have just heard 'Archer formation' leave London Military North on 254.275, they then called Shawbury Approach on 362.475 at Flight Level 210 descending to 5000 feet. Shawbury must be at least 380km in a straight line - need I say anymore.

On v.h.f., aircraft at even greater distances can be heard. Aircraft in the North of England working the Wirral Sector can be clearly heard, as can aircraft working Shannon Control and occasionally the southern sectors of Scottish Control.

On other bands the reception is equally as good. I have heard two-way transmissions, base to p.m.r. from traffic

police attending an accident on the M5 by Junction 3 just south of Bristol. Once again this is at least 112km away. Radio amateurs using hand-held radios have been heard at substantial distances considering their low output power. On the Marine Bands, ships well over the horizon have been heard and stations on the north coast of France such as 'Cherbourg Radio', are often heard. (Good old marine ducting - Ed.)

I could go on, but by now you will have gathered that I am more than impressed with the v.h.f./u.h.f. performance of the '8500.

Hands On - HF

Whilst the R8500 is in a different league and price-bracket to some of the other sets that have had coverage of both h.f. and v.h.f./u.h.f., I was still dubious as to whether it could perform on short wave bands as well as a dedicated h.f. set. I set-up the R8500 alongside my NRD-525 with a splitter and combiner system, so that both antennas were available to either receiver.

As a consequence of house decorating, the radio set-up was placed away from my normal listening station. After the move the best part of the first hour was spent tracing sources of interference that sent the 'S' meter hovering around the S7 to S8 mark - Not the best arrangement for reception of strong signals, let alone those that need to be coaxed from the atmosphere. To cut a short story long, the moral is if you use a D2-MAC decoder with a satellite system or alternatively an amplifier to boost a signal to a remote TV, keep them well away from h.f. receivers and their antennas - So endeth the lesson. (Yes I know it all seems obvious now!). Anyway - back to the plot.

Over the weeks, I have roamed around the h.f. bands and have become more and more impressed with the R8500. My main interest is the utility stations especially those that

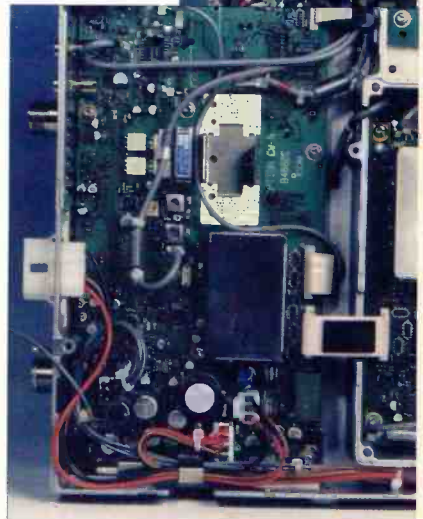
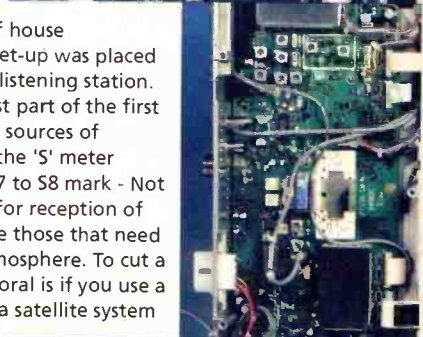
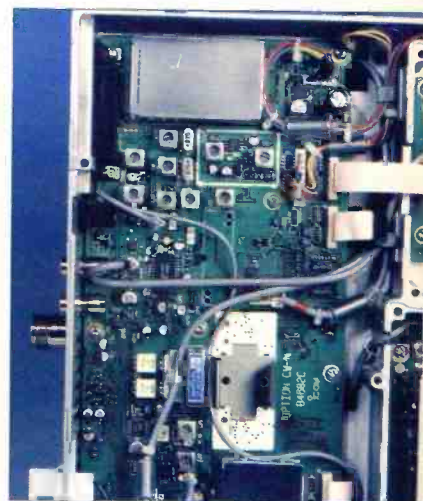

are aviation related. During the past 18 months, I noted numerous stations the most interesting being calls to distant US Global stations such as Hickham (Hawaii), and Yokota (Japan). Aircraft working the major world air routes were heard working some of the more distant areas such as Southeast Asia (SEA-1 and 2), and South Pacific (SP), with calls to Honolulu and Auckland being noted during periods of high atmospheric pressure.

Reception on the Broadcast bands was excellent and many distant stations were received, not least of which was a rather eccentric religious evangelist in Tennessee! Radio amateurs were heard from a wide range of countries, the list of which would have been greatly increased if I could understand a few more languages.

Linked up to an ageing PK-232, the R8500 produced a good stable signal to enable decoding of FAXes, Morse, SITOR and other modes.

I cannot say whether the '8500 can compete on h.f. with the latest d.s.p. sets such as the NRD-545, as I have not yet had the chance to make a comparison. What I do know, is that it more than

equalled the performance of my NRD-525, so much so that after running the two side by side for seven months, I reluctantly sold my long serving NRD-525. I was so impressed with the h.f. performance of the R8500.

HF Mobile

To side-track slightly, and to expand on my comments regarding electrical interference above. If you ever want to really see how much spurious electrical emissions come from the average home, try going mobile as I do occasionally and place your radio in an almost sterile environment - r.f. wise. Several years ago I bought a small 12V, 8AH battery from an electrical wholesale outlet, they are quite easy to find and cost about £15 - 18. With a suitable power lead made up with spade connectors and a 10m longwire antenna you have a very simple h.f. mobile system. The battery can be recharged by a household car battery charger and fully charged it will give you between four and five hours

The Bottom Line

During the past 15 months, my R8500 has been evaluated alongside the following receivers: AR2002, AR3000, AR3000A Plus, Signal R-535, Icom IC-R7100, NRD-525 and a Kenwood R-5000. I realise that direct comparisons between radios are not ideal due to a variety of reasons. Not least of which is price differential and consequently, the target market at which they are aimed. The R8500 comes in at the top of the price range, before you head off into the 'lottery winners' class of professional receivers. It therefore, would logically be expected to out-perform cheaper radios. Having said that, in my experience price has not always been the performance indicator. In this instance it most certainly is.

The past decade has seen many new wide-band radios enter the market place. I have been in the fortunate position to have had the opportunity to have had 'hands-on' with a fair proportion of them. With each new arrival, new facilities, and in some cases new gimmicks, have been included in the specifications. It the end it doesn't matter how many knobs and buttons a radio has, to my mind the most important thing is the performance. What use is the ability to change numerous parameters on a radio if the sensitivity, selectivity and strong signal handling characteristics are not up to scratch.

As technology advanced, with each new radio I had the chance to operate, I expected find an increase in performance to complement all the new facilities. To be honest, in most cases little changed. Occasionally I was surprised and on more than a few occasions I was badly disappointed! With the IC-R8500, it was the first occasion for some time where I was actually stunned at its performance. On v.h.f. and u.h.f. the performance was noticeably better than its predecessor the IC-R7100, but it was on h.f. that it really performed above expectations. In my opinion, the IC-R8500 became the first radio available to the UK market, (below £2000), which could deliver the goods on h.f., v.h.f. and u.h.f. At around £1500 new, it is not cheap but taken into context it does effectively replace two receivers. If you want the best of all worlds then this will be the radio for you.

listening with the R8500's current drain of around 2A. One point of note, don't power the R8500 from your car except for short periods, it can flatten an average car battery quite quickly, especially if it is not in a fully charged state! A radio such as the AR3000A with a lower current drain will run for about 10 hours on this battery. A variety of higher capacity batteries are available but they become rather unwieldy for mobile use.

I live near the sea and consequently in the summer I regularly take my mobile R8500 set-up to the local cliff tops for a picnic and a serious search around the h.f. bands. The spot I choose is about 500 yards walk from the car park, it is about 76m above the sea with spectacular views and is at least a mile from any form of electrical emission. The results with the R8500 are spectacular, (as they would be with any other h.f. radio in this noise-free situation). With the 12V d.c. power source and all background noise removed the R8500 could clearly pick-up faint signals that were almost inaudible at home. This remote location really shows up the amazing h.f. performance of the '8500. I realise that it can be a bit cumbersome to carry a radio this size, a battery and leads, etc, to a remote location, but if you get the chance try it, you will not be disappointed with the results!

Problems!

I have to admit that my time with the '8500 has not been problem free. After about four months in use an intermittent problem arose which progressively became worse. After power-up, the whole of the digital display would flash for a few seconds before allowing normal control. During this period none of the controls would work. After about a week the whole system locked up and the display flashed continuously. The set went back to Icom who repaired it quickly and I had it back in eight days.

Unfortunately, the problem re-occurred after about eight weeks and the receiver, once again, went back to Icom. The problem was diagnosed as a faulty capacitor array which was replaced and since then the set has performed perfectly. One thing I did notice was that when the set was returned the second time there appeared to be a very slight but noticeable increase in the sensitivity. Whether it had been tweaked by Icom or it was just my imagination, I am not quite sure, but one thing's for certain, I am not complaining!

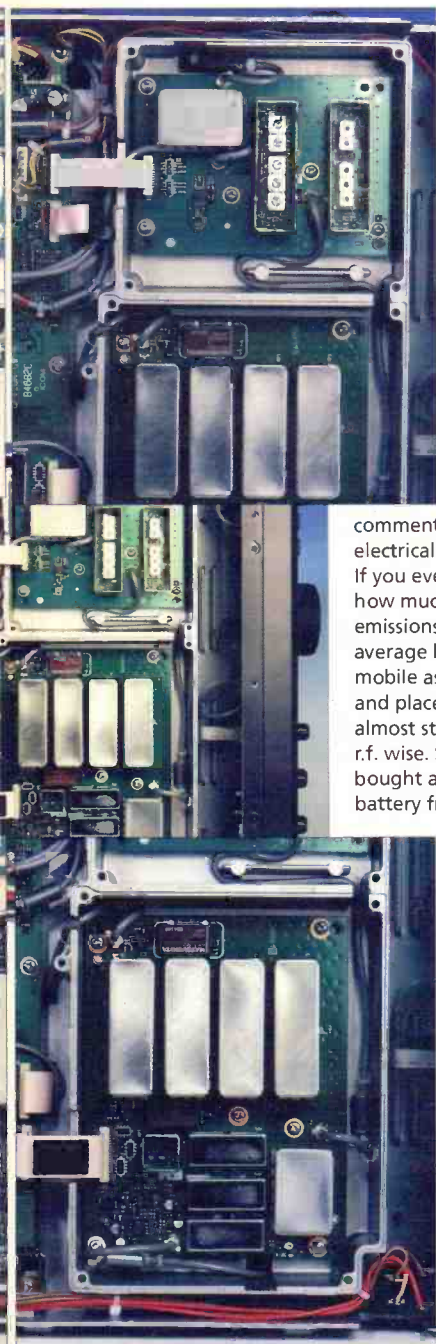

"If you ever want to really see how much spurious electrical emissions come from the average home, try going mobile as I do occasionally"



ASK ELECTRONICS LTD

248/250 TOTTENHAM COURT ROAD, LONDON, W1P 9AD • Tel: 0171-637 0353/0590 • Fax: 0171-637 2690



SONY RADIOS ARE ON SPECIAL OFFER

YOUR SONY SPECIALIST

All products covered by a total manufacturers guarantee

NEW FROM SONY

- ICF-SW1000T RRP £449 ASK price £360.00
As reviewed in Short Wave Magazine April '96 issue
- ICF-SW77150-29995kHz, usb/lwb cw, 160 memories & labelling facility, 5 event timer, world timer RRP £429.95 ASK price £350.00
- ICF-SW55 RRP £299.95 ASK price £250.00
- ICF-SW100E RRP £219.95 ASK price £149.95
- ICF-SW100S KIT inc active antenna RRP £299.95 ASK price £235.95
- ICF-SW7600G RRP £199.95 ASK price £120.00
- ICF-SW30 RRP £79.95 ASK price £69.95
- ICF-SW10 RRP £49.95 ASK price £39.95
- ICF-SW12 RRP £85.00 ASK price £55.00
- ICF-SW40 RRP £119.95 ASK price £84.95
- AN1 Active SW antenna RRP £74.95 ASK price £59.95
- AN-71 Wire antenna £4.99
- AN-100 Active antenna for ICF-SW100 or ICF-SW7600G £49.95
- AN-102 Compact active antenna £59.95

ROBERTS ASK price

- RC-828 RRP £219.95 **£180.00**
- R-827 RRP £179.95 **£135.00**
- R-861 RRP £199.95 **£165.00**
- R-809 RRP £119.95 **£89.95**
- R-617 RRP £129.95 **£115.00**
- R-876 RRP £129.95 **£120.00**



SW Receivers

- HF-150 **£369.95**
- KEY PAD **£39.95**
- PR-150 **£205.00**
- IF-150 interface **£39.95**
- HF-250 **£700.00**

GARMIN GPS SYSTEM

- GPS 35 PC 12 channel engine & antenna with serial port connection & cigarette lighter adaptor, so that it can be connected to a lap top PC or Psion directly (null modify lead/adaptor required for Psion) **£209.95**
- GPS 12 Hand-held portable systems includes: 12 parallel channel receiver, built-in antenna, lanyard. No external antenna option **£115.00**
- GPS 12XL Europe Hand-held portable system includes: Europe City Point Database, 12 parallel channel receiver, built-in antenna, carrying case & lanyard **£205.00**
- GPS II Plus Europe Hand-held portable system includes: Europe City Point Database, 12 parallel channel receiver, portable antenna, velcro & lanyard **£205.00**
- GPS 48 Europe Hand-held portable system includes: Europe Marine Database, 12 parallel channel receiver, a built-in point database including major cities, buoys and lights, portable antenna, carrying case & lanyard **£240.00**
- GPS 3 Hand-held mapping portable system includes: 12 parallel channel receiver, a built-in international basemap including major cities, roads, lakes and rivers, portable antenna, velcro mount & lanyard **£Phone**

Frequency Guides and Books

- UK Scanning Directory 5th edition **£12.00**
- UK Scanning Directory 6th edition **£18.00**
- Scanners 3 **£9.95**
- UHF/VHF Frequency Guide **£12.95**
- Passport to World Band Radio 1998 **£14.95**
- World Radio TV Hand Book 1998 **£18.95**
- Global Radio Guide **£3.95**
- The Worldwide Aeronautical HF Radio Handbook **£6.95**
- International Airband Radio Hand Book **£9.95**
- How to Interpret Facsimile Weather Maps & Charts **£8.95**
- The Worldwide Aeronautical Communication Frequency Directory **£19.95**
- Weather Reports from Radio Sources **£6.95**
- Simple GPS Navigation (Land, sea & air) **£9.95**
- Air Band Radio Hand Book 6th Edition **£9.95**
- Klingenfuss the super freq list CD ROM **£29.95**
- Shortwave International Freq Handbook **£12.95**
- Ferrells Confidential Frequency List 10th ed **£19.95**
- Radio Listeners Guide **£4.95**
- Scanner Busters 2 **£6.00**

MAIL ORDERS WELCOME ON THE ABOVE PHONE NUMBERS. FAST-EFFICIENT-CONVENIENT TO YOUR DOOR STEP!!

GPS ACCESSORIES

- Swivel mounting bracket for GPS 48 **£20.00**
- Swivel mounting bracket for GPS 2/3 **£20.00**
- Bicycle mount kit for GPS 2/3 **£13.00**
- Bicycle mount kit for GPS 12/12XL/48/45 **£15.00**
- PC cable **£26.00**
- PC cable with cigar lighter adaptor for GPS 2/3/48/12XL **£30.00**
- PC cable with cigar lighter adaptor for GPS 12 **£30.00**
- PC software & cable kit **£69.95**
- Personal navigator prof. CD ROM for use with PC & GPS **£19.95**
- Car cigar lighter adaptor for GPS 2/3/48 **£19.95**
- Car cigar lighter adaptor for GPS 12/12XL **£25.00**

GPS ANTENNAS

- GA26 Low profile antenna for GPS 2/3/48 **£64.95**
- GA27 Low profile antenna for GPS 12XL **£64.95**
- MCX to BNC adaptor for GPS 12XL **£15.00**
- Watson GPS 150 low profile antenna for GPS 2/3/48 **£39.95**
- Case for GPS 2/3/48/12/12XL **£10.00**

AOR

- AR7030 Voted best table top HF rcvr available at the best price ~~£799.00~~ **£675.00**
- AR3030 Another high quality HF rcvr by AOR 30kHz-30MHz ~~£499.00~~ **£440.00**
- AR-5000 High performance wide band base rcvr 10kHz-2600MHz ~~£1495.00~~ **£1175.00**
- AR5000 +3 As above but with noise blanker, syncr AM & AFC ~~£1749.00~~ **£1375.00**
- AR3000 all mode base rcvr 100kHz-2056MHz no gaps RS232 port fitted ~~£799.00~~ **£615.00**
- AR3000 plus As above but with narrow AM & SAT filter, tape relay SDU ready ~~£899.00~~ **£670.00**
- AR8000 Still the best h/h rcvr available. All mode 500kHz-1900MHz ~~£349.00~~ **£260.00**
- SA7000 Ultra wide passive ant 30kHz-2600MHz ~~£139.00~~ **£115.00**
- SA08000 Link between AR8000 & Opto Scout. No mod req **£24.95**
- CU8232 Computer control/clone interface for AR8000 **£79.95**
- PC Manager PC based DOS management software for AR8000 **£49.00**
- PC Manager WIN As above Windows based for AR2700 & AR8000 **£49.00**
- Opto Scout Freq counter 400 mem 10MHz-2GHz ~~£399.95~~ **£319.95**
- Xplorer Freq ctr recorder, decoder, deviation mtr, GPS interface ~~£899.95~~ **£699.95**
- AR8000 + Scout Package AR8000 + Scout + SAC8000 ~~£775.00~~ **£615.00**
- AR7030 3rd anniversary new limited edition ~~£899.00~~ **£879.00**

SCANNERS

- YUPITERU
- VT-125II Civil air band ~~£179.95~~ **£159.95**
- VT-225 Civil and military air band ~~£239.95~~ **£209.95**
- VT-150 Marine band ~~£179.95~~ **£159.95**
- MVT-3300 New budget priced rcvr ~~£229.95~~ **£169.95**
- MVT-7000 200kHz-1300MHz h/h rcvr WFM, NFM, AM 200ch ~~£249.95~~ **£215.95**
- MVT-7100EX 100kHz-1650MHz h/h rcvr all mode 1000ch ~~£289.95~~ **£195.00**
- MVT-7200EX As above with narrow AM ~~£369.95~~ **£299.95**
- MVT-9000 500kHz-2039MHz h/h rcvr, all mode, 1000ch ~~£489.95~~ **£330.00**
- MVT-8000 Base/mobile rcvr, 200kHz-1300MHz, 200ch ~~£329.95~~ **£295.00**
- UNIDEN
- UBC-65XLT 65-512MHz, 10ch mem with gaps ~~£99.95~~ **£55.00**
- UBC-80XLT PMR/marine/VHF & UHF ham ~~£129.95~~ **£99.95**
- UBC-220XLT As above also with air band ~~£229.95~~ **£135.00**
- UBC-3000XLT 25-1300MHz + gaps 400ch ~~£299.95~~ **£199.95**
- UBC-9000XLT Base rcvr 25-550 & 760-1300MHz 500ch ~~£299.95~~ **£250.00**



- IC-R10 500KHZ-1300MHZ all mode receiver ~~£379.95~~ **£260.00**
- ICPCR-1000 **£PHONE**
- IC-R8500 pro base rcvr ~~£1695.00~~ **£1450.00**
- REALISTIC
- DX-394 HF receiver ~~£349.95~~ **£149.95**
- PRO-26 Wide band receiver ~~£299.95~~ **£199.95**
- PRO-2042 Wide band receiver home base ~~£429.95~~ **£309.95**
- WELZ
- WS-2000 As above with 800ch mem ~~£299.95~~ **£209.95**
- CNB-401 Nicad pack **£11.95**
- CSA-401 AC charger **£35.00**
- WSC-1000 Soft case **£15.00**
- AX-400 **£199.95**
- YAESU
- FRG-100 As reviewed in SWM Nov 97. Still the finest SW rcvr in its class ~~£499.95~~ **£435.00**
- FRG-9600 Wide band base rcvr 60-905MHz ~~£549.95~~ **£459.95**

PLEASE MAKE ALL CHEQUES PAYABLE TO: ASK ELECTRONICS AT 248-250 TOTTENHAM COURT ROAD, LONDON W1P 9AD

For the best prices give us a call on: 0171-637 0353

All products are subject to a posting & packaging charge



Waters & Stanton PLC

22, Main Road, Hockley, Essex. SS5 4QS

Open Monday - Saturday 9.00am to 5.30pm

Free-Phone Order Line
0500 73 73 88

E-mail: sales@wspc.demon.co.uk

Web: http://www.waters-and-stanton.co.uk



Not just a catalogue!

" - - the definitive colour guide to everything to do with Ham Radio"

176 pages crammed with products, some you have never before see advertised. **£2.95 plus £1 postage.**
Pay by credit card or cheque

Orders: 0500 737388
01702 206835
Enquiries 01702 206835
01702 204965
FAX 01702 205843
E-mail sales@wspc.demon.co.uk

Open Mon-Sat 9.00AM - 5.30PM

MVT-7000 Scanner Special



Save £70!

Was £249.95

Now **£179.95**

- * 100kHz - 1300MHz
- * WFM, NFM, AM
- * 200 Memories in 10 banks
- * 20 channels per second speed
- * Programmable Steps
- * Illuminated Display
- * Audio and Carrier Search
- * Signal Strength meter
- * RF attenuator switch
- * Ni-cads and AC charger

Your chance to purchase this popular Yupiteru scanner at a very special price. Full UK warranty included.

Limited Stock!

Universal Power Supplies

All are regulated and have switched outputs. Don't pay silly money for power supplies - these are really great value.

WPS-240

AC240v @ 1 Amp
DC 3, 6, 9, 12V

£16.95



WPS-312

Cigar 13.8V input
DC out 1.5, 3, 4.5,
6, 7.5, 9, 12V

£9.95



W-10AM

24V AC Input
10 Amps Continuous
Variable 3 - 15 Volts

£59.95



New AR-8200 Scanner



Read AOR's Advert

Then Check OUR PRICE!

~~£399~~

Phone

- * 100kHz - 2040MHz
- * Includes 8.33kHz steps
- * 7 modes inc. FM AM SSB
- * Super Narrow FM for 12.5kHz
- * 1000 Memories
- * Auto "birdie" cancellation
- * Optional Plug-in Memory cards
- * Preselector VHF Front-end
- * Improved short wave reception
- * Pug-in MW Bar Antenna
- * Scan rate 37ch per second.

Great Value

MVT-7200EX

New Low Price

£299 100kHz - 1650MHz



- SSB FM AM Excellent Filters
- 11 Freq. Steps Clear Display
- 1000 Memories 4 x AA Nicads
- 30 Ch. Per Sec. AC Charge!
- Very Sensitive Cigar Lead

One of The Best Scanners Ever produced

AR-7030 PLUS Anniversary Edition

Whilst Stock Lasts!

Includes:
Noise Blanker
Notch Filter
Whip Antenna



£899.95

* 0 - 32MHz * SSB CW AM FM Data * AM Synchronous * 100 Memories * 4 filters fitted * Switched Pre-amp * Passband tuning * Enhanced AGC * Noise spike compression * Six level attenuator * Bar S-meter * AC adaptor included

AR-7030 Standard model £694.95

WPR-2 Transforms your scanner's Short Wave performance

WATSON £39.95

- * 500kHz - 30MHz
- * 6 Bands
- * SO-239 input/output
- * Size 84 x 55 x 60mm



No scanner works well on short wave when you simply connect a long wire to the antenna socket. All you hear is mush and a few of the very strong signals. Connect this unit between your antenna wire and your scanner. Then adjust it for best response and hear signals you never new existed!! Full money-back warranty

MVT-3300EU £159.95
New Low Price



- 66 - 88MHz
- 108 - 170MHz
- 300 - 470MHz
- 806 - 1000MHz
- Excellent Sensitivity
- 200 Memories
- 5kHz - 25kHz Steps
- 100 Search Pass
- 10 Priority Channels
- 30 Ch. Per Second
- Requires 4 x AA batts.

Upgraded Fairhaven RD-500VX
20kHz - 1.75GHz **£899.95**



The new upgraded Fairhaven RD-500VX, now with extended memories, offers you wide band coverage on all modes SSB - CW - FM AM. The enormous memory capacity and alphanumeric display enables you to build up a very comprehensive data base of stations.

ICOM ICR-8500 £1549



- * 100kHz - 2GHz
- * SSB CW FM WFM AM
- * 1000 Memories
- * 4 IF Bandwidths
- * Alphanumeric display
- * Analogue S-meter
- * RS-232 interface
- * IF shift & Audio filter
- * Keypad entry option
- * Min tuning step 10Hz
- * 12v DC supply
- * Windows software £49.95

VHF/UHF Frequency Guide

The VHF - UHF Scanning Frequency Guide



Great Value £12.95

£1.50 postage

The Most Complete Guide Available

* Ring bound in easy flat format style

WAT-2 Short Wave ATU

£49.95 500kHz to 30MHz

- * 500kHz - 30MHz
- * 6 Band Positions
- * "Q" Control
- * Long wire systems
- * Coax feed systems
- * SO-239 output
- * Size 84x55x60mm



NEW

£329.95



Garmin GPS-III

With complete moving map of the UK & Europe

The new GPS-III is loaded with a moving map covering millions of miles of motorways, ordinary roads, railways, rivers and shorelines. 12 channel receiver means fast positioning from switch-on, and the display width can be zoomed to cover from 500ft to 5,000 miles. Sit the GPS-III on the dashboard and watch your progress as you travel. Display rotates vertical or horizontal. We have the latest UK version in stock now.

We can supply any ham radio item - phone for deal

New Icom Scanner

IC-R2



£119.95

- 500kHz - 1310MHz
- FM - WFM - AM
- 400 Memories
- 25 Scan Pairs
- 10 dB Attenuator
- Cloning software option
- SMA Antenn connector
- Requires 2 x AA cells
- Size 58 x 86 x 27mm

This is Icom's latest scanner offering a host of features in a very small package at a very small price. Just the tuning to take with you for the weekend! It features advanced circuitry with a highly sensitive front-end and ample volume from the built-in speaker. Able to operate from a very low voltage, it is very economical on batteries. If you want to know the full details, send for a brochure. As usual, Watees & Stanton PLC will offer you the best deal around.

New Opto Mini Scout

10MHz - 1.4GHz £199.95



Hunts Signal & Auto Tunes Receiver*

Just connect up with suitable Icom or AOR receiver. As soon as the Mini Scout locks onto an unknown signal, the receiver is auto tuned.

*Phone for list of receivers that operate with the Mini Scout

New Sun Visor Speaker



SP-2000 £19.95

What better place to put a speaker. Clips easily onto any sun visor. Robust built-in aircraft-style speaker with panel volume control. Supplies with 5m cable fitted 3.5mm plug.

Save £££s.. on Batteries



£13.99

- Rechargeable Alkaline
- 1.5V cells
- No memory effects
- Charging mid cycle is OK
- 5 year charge shelf life
- 3 times capacity of ni-cads
- Very low cost

Price Down

This is a brand new technology which has major advantages over ni-cads. Now you get a 1.5v cell that will hold its charge for up to 5 years and has 3 times the current capacity of normal ni-cads. We are offering these at a very special price direct from Canada. In stock. Starter Kit comprising 4 x AA and AC charger £13.99
4 x AA cells - fully charged £5.95
8 x AA cells - fully charged £10.99
4 x AAA cells - fully charged £6.25

MVT-7100
100kHz - 1650MHz

£249.95

PRICE MATCH

- 100kHz - 1650MHz
- NFM, WFM, SSB, AM
- 1000 Memories
- Signal Strength Meter
- Illuminated keypad - display
- 500 Ch. pass memories
- 30 Ch. per second speed
- Unique mode scan
- Ni-cads & AC Charger



Yupiteru MVT-9000

Buy from us and be confident - of legal UK stock!! Plus our back-up service

- 530kHz to 2039MHz
- 1000 Alphanumeric Memories
- Duplex monitoring & tracking
- USB LSB CW AM FM
- Channel spectrum scope
- Blistering scanning speed
- Good performer on the SW bands
- Totally programmable
- Multiple tuning steps
- Extremely sensitive front-end
- Good strong signal performance
- Includes AC charger and Ni-cads

24 Hour Digital WallClock £34.95

+ Temperature & Date

- 265mm diameter
- 24/12 hours LCD
- 55mm digits
- date - day - month
- Celsius / Fahrenheit
- 2 x AAA cells

In Stock NOW!



WATSON

FC-130 Counter

1MHz - 2.8GHz £79.95



This new model has a wide frequency range and is powered by internal ni-cads. External BNC socket with aerial makes it very sensitive. Supplied with AC charger, it is very well built. Don't be fooled by the price!

QS-400 £9.95
Mobile Mount

- Mounts handy or GPS on dash grill
- The safe way to go mobile
- Quick release feature.
- Doesn't use nasty adhesive!

NEW

ICOM PCR-1000

+ FREE ACARS Software!



NEW DSP Module £59.95

10kHz to 1300MHz SSB FM AM computer receiver. The remote black box plugs directly into your PC. Because it can be positioned remotely from the PC, there is no problem with interference. This is the next generation of receivers - here now! Its performance knocked our socks off.

NEW DSP version £369.95
Offer ends 6th April, 1998

WATSON Hunter Counter

NEW

£59.95



Range up to 150ft

Displays the frequency of nearby radio transmissions in an instant. Ideal for use with scanners

- 10MHz-3GHz
- 8 Digit Display
- Battery Save
- Hold button
- 6hr batt. life
- Ni-cads
- Charger
- Antenna

Yaesu FRG-100

Plus FREE Power Supply

£429.95



Probably one of the most underrated receivers on the market. It covers the complete short wave spectrum and performs better than anything else in this price bracket. With our 10-day approval you can't go wrong! Runs from 12V. Suitable matching power supply £44.95.

Radio Controlled Clock

RM-913

£19.95



- Locked to Rugby Ideal shack clock
- Time Day & Date
- Second time Zone
- 2 Alarm times
- 2-minute crescendo alarm
- Low battery indicator
- Requires 2 x AAA cells
- Size 110 x 86 x 42mm

Offered at an amazing price, this radio controlled clock will always be right! It automatically locks to the Rugby standard time signal. Ideal for radio rooms.

WATSON

WMM-1 Multimode Modem

- Packet, AMTOR, CW
- SSTV, Fax, RTTY
- NAVTEX, SYNOP
- Transmit and receive
- Needs PC 286 or better
- Includes software
- No external power required
- Connects to RS-232

£69.95



Decoding Systems

Over the years a vast array of decoding systems have been produced and in this section I'll attempt to give you enough information to guide you through the maze. To help with this I have divided these decoding systems into three broad areas - Computer based, Data Controllers and Stand Alone Systems.

Computer Based Decoding: If you already have a computer at your disposal, particularly a PC compatible, then a computer based decoding system is likely to be the cheapest option for you. This is because the processing power of your computer can be harnessed to do most of the hard work. However, you do need to be aware of the limitations of computer based systems as many of the older models can only be used to decode simple RTTY and c.w. signals. By far the best supported computer is the IBM PC and compatibles, but even with the PC you need to be sure you have a processor fast enough to handle your requirements. The most demanding application for a PC is the direct decoding and display of FAX images using a program like *JVFAX 7.0*. When receiving this mode the processor not only has to process the incoming audio signal, but also has to decode the data and update the screen. All this demands a lot of processor time and you may find that computers with a 80286 or earlier processor struggle to keep up. The problem can be overcome by using an external interface between the receiver and the computer, but this will typically cost £100 plus and doesn't offer a complete solution. The market leaders in this area are *JVFAX 7.1* for FAX and amateur Slow Scan TV. *Hamcomm 3.0* for RTTY, c.w. and ARQ systems. The newest program is Francois Guillot's *RadioRaft* which offers an extremely wide range of receive modes in a very well priced package. If you look around the second-hand ads you may well find software from many other suppliers such as ICS Electronics and Lowe Electronics.

At the very top end of the computer based decoding systems are the hardware cards that can be fitted to your PC. The market leaders in this area appear to be Wavecom with the excellently specified W41PC DSP Data Decoder Card. For other computer systems check out the adverts in this issue.

Data Controllers: These devices have been developed primarily for the amateur radio market, but can be used very successfully by short wave listeners. In most cases these systems take the audio signal from your receiver, process it and present the decoded output as a serial data signal. All the hard work is done by a dedicated processor built-in to the Data Controller. As a result all the computer has to do is display the decoded output. This very modest requirement means that the Data Controller can be connected to virtually any computer system or a even a dumb terminal.

In addition to carrying the decoded output, the serial connection is also used to carry keyboard commands to configure the Data Controller. One advantage of the Data Controller over a simple PC based system is the inclusion of well controlled audio filtering that can provide much improved performance when operating under poor conditions. Perhaps the most famous data controller is the AEA PK-232 and its derivatives, but this is balanced by very capable products from MFJ and Kantronics.

Stand Alone Decoders: These systems are usually the

preferred choice for newcomers with no computing experience. This is because they offer by far the simplest solution to decoding h.f. data signals. The disadvantage being cost as these systems require their own built-in micro-processor and display systems. In addition to being simple to use, stand alone units generally offer much lower interference levels than computer based systems. For many this is a major advantage in itself and is particularly important if you are unable to erect an effective antenna. Popular examples are the Momentum MCL1100 for simple modes or the Wavecom 4010 and Universal range for the more complex modes.

Receivers

For utility listening a receiver needs to have some features that are perhaps not required for many other aspects of the hobby. The first requirement is that of a single sideband (s.s.b.) receive mode. In most cases this will be selectable between upper and lower side band. If you are considering one of the older receivers such as an RA-17 you will find that s.s.b. reception is achieved using a b.f.o. and side band selection depend on the b.f.o. frequency. You will also find that with this type of receiver you get better results if you turn the volume to maximum and use the r.f. gain control to set the sound level.

One of the next most important aspects of a utility receiver is that of frequency stability. Whilst RTTY reception is bearable on drifting receiver, FAX is just about impossible. This is because a typical FAX chart can take around fifteen minutes to receive. Stability is also very important when receiving some of the more advanced narrow-band modes. In these cases you may well have to leave your station monitoring for considerable periods to receive any interesting messages. This is normally done by leaving the receiver tuned to the chosen frequency and letting your computer store any received text to a disk file. At the end of the monitoring session you can then just quickly review the text file to see what's been going on. This operation is completely impractical if you have to chase signals up and down the band as your receiver drifts!

If you already have an older receiver that suffers drift problems you can take a few steps to minimise the problems. The first point to note is that frequency drift is almost always temperature dependant, so give your receiver plenty of time to warm-up before you start listening. You can also help by ensuring the receiver is kept in a dry environment with as constant a temperature as possible and well clear of any draughts.

Another important point for utility receivers is the minimum tuning steps. A step size of around 10 or 20Hz is ideal, but you can get away with much coarser steps with some decoding systems. If you're using a modern decoding package with an auto tune feature, the program can overcome quite coarse tuning steps at the expense of slightly slower set-up time. If your decoder cannot alter its centre frequency, then you really need to stick with 10 or 20Hz frequency steps. Just to illustrate the point, if you're trying to receive maritime SITOR stations, you will find that the signal has a shift of just 170Hz. If your receiver can only tune in 100Hz steps you can see that you will never achieve accurate tuning as your receiver will always be significantly off-set one way or another. The problem is magnified when you come to receiving those weak DX signals.



JVFAX Main Screen.



JVFAX Configuration screen.



HAMCOMM Receiving Weather Data.

the default shift setting. Just press Alt K, move the highlight bar to 425Hz and press ENTER.

Now we will set the baud rate to 50 baud by pressing Alt S and moving the highlight bar to 50 baud. All that remains now is to set the receive mode to Baudot. To do this type ALT M and move the highlight bar to BAUDOT and press ENTER.

Having completed the software you now need to move on to the interface.

Interface Connection

All you have to do here is plug the 3.5mm jack plug from your interface into the tape out or external speaker socket of your receiver. Next plug the D-type connector into your serial port. If you have a 25-way D-type connector and a 9-pin socket on your computer, don't worry, you can pick-up an adapter from your local electronic or computer store. Make sure you take the interface lead with you and also make a note of whether your computer has a male or female socket. If you have to use the external speaker socket of your receiver you will have discovered that this action cuts out the internal speaker making tuning somewhat difficult!! The solution is to visit your local Tandy, Maplin or similar and buy a 'Y-adapter' and an external speaker. This lets you listen to your receiver through the external speaker and run your decoder from the spare socket. If you have a choice of using the external speaker or 'tape/line' output, always choose the 'tape/line' first. Not only does this overcome the problem of cutting-out the speaker, but it provides a constant level output for the decoder.

Receiver Set-up

This is the final part of the process which should see your first signal decoded. The signal I'm going to start with is not that interesting, but has been chosen because it's very reliable. Turn on your receiver, set the mode to s.s.b. (upper sideband) and tune to 7.646MHz you should hear a strong warbling signal - this is the Hamburg Meteo coded weather station. Depending on the accuracy of your receiver's tuning, you should find this station somewhere between 7.642 and 7.650MHz. You will probably find that all sorts of rubbish is being printed on the screen - don't worry about this for now.

The next stage is to adjust the receiver's tuning so you are in perfect alignment with the signal. Fortunately, *HAMCOMM* has some excellent tools to make this very easy.

On your computer you need to type ALT M followed by P on its own. This should take you to the spectrum analyser display. You should see a pair of fixed vertical lines with some moving lines close by as shown in **Fig. 1**.

HAMCOMM Tuning Display

The object is to adjust the receiver's tuning so that the signal aligns as closely as possible with the two fixed lines. Once you've done this you are correctly tuned to your station.

You now need to press ALT M then highlight Baudot and press ENTER. If you're lucky you should now find groups of five numbers being printed out on the screen. If not then press ALT K and try selecting NORMAL and then REVERSE. If you still don't have any luck run through this procedure:

1. Check the tuning by pressing ALT M then P.
2. Check the main settings e.g. Speed = 50 baud: Keying = 425Hz and Mode = Baudot.

3. Is the signal interference free? If not try again at a different time of day.

I know that receiving a string a five digit groups is hardly exciting, but you can spice this up a bit by pressing ALT T and selecting SYNOP. *HAMCOMM* will then attempt to decode the messages into plain text.

Now that you have had your first success try tuning to 7.658MHz where you will find the TANJUG news agency in Belgrade.

JVFAX

JVFAX version 7.1 is a sophisticated FAX and SSTV decoding and encoding system that can be used by amateurs and short wave listeners alike. One of the important points to note about this program is the interfacing requirements. If, like most, you are using the simple comparator interface you will find that *JVFAX* demands a lot of processor time and may even crash when using older 8088 or 80286 based computers.

Software Installation

As with *HAMCOMM* software installation rather depends on where the program came from. If you've just downloaded the basic compressed program file (normally called *INSJV71.EXE*) you can follow these steps to get it installed on the hard drive.

First of all put *INSJV71.EXE* into the root directory of your C drive and type *INSJV71.EXE*. The self extracting program will then run and install all the program and support files in the appropriate directories on your hard drive. Once its completed you can then delete the main *INSJV71.EXE* archive file from the root directory.

Hardware Installation

This is exactly the same as for *HAMCOMM* so refer back to that section for guidance. The only point to note here is that although the latest design of comparator interface will work with

both *JVFAX* and *HAMCOMM* this is not the case with some of the very earlier designs. The older interfaces used a different method to extract the local power for the interface.

Software Configuration

We can now move on to configure *JVFAX* to work with your computer system. To do this change to the *JVFAX* sub-directory by typing *cd\jvfax71* from the C:> prompt. Now type *JVFAX* to start the program. If this is the first time you've run the program you will be taken straight to the configuration screen which can be somewhat daunting. Don't worry, there are very few items you have to alter to get started. Just to help you through this stage **Fig. 2** shows a sample screen with the important boxes identified.

As you can see, there are just four sections that need to

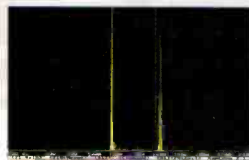

HAMCOMM's Spectrum Tuning Display.



HAMCOMM Port Selection Menu.



RadioRaft Manual Mode Selection.

Continued on page 34...

SRP TRADING

1686 Bristol Road South
Rednal
Birmingham B45 9TZ

Telephone: 0121-457 7788

0121-460 1581

Fax: 0121-457 9009

COMMTEL



Commtel 214

C/W NiCad Pack & PSU

£129.99 + £5 p&p

Commtel 214 spec'

100 channel scanner
Jetscan at 100 channels per second
10 priority channels
Search speed up to 300 steps per second
Band search
Data skip
Memory back-up
Includes rechargeable batteries and charger
Frequency coverage:
66-88 Mhz
108-174Mhz
406-512Mhz
806-956Mhz



AOR AR8200
RING FOR
SPECIAL
OFFER

Full spec sheet available.



Radio shack DX-394 communications receiver

- 150kHz to 30MHz base station
AM, CW, USB, LSB
communications receiver. Features include clock and timer, signal meter, 100+ memories, RF gain control and direct frequency entry. A steal at **£149.95** + £7 P&P.



Yupiteru MVT-3300 -

Latest Yupiteru scanner
AM/FM switchable. Limited stock at **£149.95** + £5 P&P.

Yupiteru MVT-7100 - All mode switchable handheld HF/VHF/UHF scanning receiver. Covers 0.5-1650MHz. Features 1000 memories, over 500 pass memories, 10 limit search banks, 12 step sizes. Comes complete with earpiece, belt clip, wrist strap, rechargeable batteries, PSU, in-car adaptor and telescopic antenna.

RING FOR THIS MONTH'S SPECIAL OFFER



Super Syncro 1300 - 1100mAh Nickel Metal Hydride (NiMH) AA size rechargeable cells. No memory effect. Twice the capacity of NiCds. **£3.00** inc P&P.



Skyscan Desktop Antenna Model Desk 1300 disconn

Built and designed for use with scanners. Coverage: 25 to 1300MHz. Total height 36" and 18" wide at widest point. Comes complete with 4m of RG58 coax cable and BNC connector. High performance antenna, ideal indoor or as a car antenna when vehicle is stationary. **£49.00** + £3 P&P.



Skyscan DX-V1300 base disconn

Most disconnes only have horizontal elements and this is the reason that they are not ideal for use with a scanner. Most of the transmissions that you are likely to receive on your scanner are transmitted from vertically mounted antennas. The DX-V1300 has both vertical and horizontal elements for maximum reception. Constructed from best quality stainless steel and aluminium and comes complete with mounting pole. **£49.95** + £3 P&P.



Airband mini-mag antenna - Civil (108-137MHz) and military (225-400MHz) dual band receive antenna featuring super strong miniature magnet and coax cable terminated in BNC connector.

£24.95 + £3 P&P



Wideband mini-mag antenna

- Wideband (25-1300MHz) receive antenna featuring super strong miniature magnet and coax cable terminated in BNC connector. **£29.95** + £3 P&P.

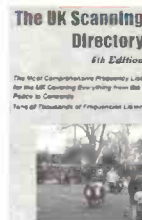

NEW 6th edition
UK Scanning
Directory

£18.50

+ £1.50 P&P

WE ALSO HOLD A LARGE RANGE OF SECOND USERS SHORTWAVE AND SCANNING RECEIVERS. PLEASE CALL WITH YOUR REQUIREMENTS

NEVADA SHORTWAVE & SCANNING SPECIALISTS

ACTIVE ANTENNA MATCHER

Palstar **COMBINED AM30 3-IN-1 UNIT**

- * ACTIVE ANTENNA MATCHER
- * SHORTWAVE PRE-AMPLIFIER
- * ACTIVE ANTENNA

£69.95

£6 p&p



SCANMASTER NOTCH FILTER SNF170

If your scanner is suffering from overloading, blocking or breakthrough then the SNF-170 could help. Its a tunable notch filter from 85-175MHz that will eliminate broadcast or public service breakthrough. Notch approx 30dB plus 70dB rejection below 1.7MHz.

Price £27.95 £2.75 P&P

* ACTIVE ANTENNA MATCHER

Active electronics allow almost loss-less matching of your antenna to the receiver.

* SHORTWAVE PRE-AMPLIFIER

A variable gain and peak tune control it is possible to achieve best possible weak signal reception.

* ACTIVE ANTENNA

Using the Telescopic whip provided this unit will act as a stand alone active antenna ideal for use in flats, bedsits and situations where an outside antenna is impossible.

- Freq: 100kHz-30MHz
- Power: 12V DC/battery (supplied)
- Antenna: Telescopic whip included for use as an active antenna if required.

NEW LOW PRICE SP55 PRE-AMP

Improve the reception of your scanner with this Japanese made low noise pre-amp. A fully adjustable gain control -6dB to +20dB ensures best possible performance. 3 band pass filters reduce out of band interference.

- 24 - 1500MHz
- Variable gain (-3dB to +20)
- 3 bandpass filters
- Battery or 12V operation

£59.95

£4.75 P&P

ICOM PCR 1000 ICOM'S NEW COMPUTER RADIO SYSTEM

- 100kHz - 1300MHz ● ALL MODE RECEPTION
- Plus Lots More!

NEW PCR OPTION DSP UNIT

UT 106 £59.95 £2.75 p&p

NEW LOW PRICE! £249 while stocks last



BEST PRICES ON GPS PRODUCTS

GPS 12XL

- 12 Channel Receive
- Moving Map Graphics
- NEW! Database with City Locations
- Simple One Hand Operation

£262 **£209.95** £6 P&P



£339.00

£6 p&p

PRICE MATCH

ACCESSORIES

- GPS III.....Mounting Bracket.....£23.50
- GPS II,12, 45.....Power, Data Cable.....£22.33
- GPS 40.....Cigar Adaptor Power Cable.....£29.38
- GPS 45, II, 12XL.....Cigar Adaptor Power Cable.....£7
- GPS 38.....Data Cable.....£18.80
- GPS 38, II.....Carrying Case.....£11.75
- PC Interface Cable.....£29.55
- PC Software and Cable Kit.....£99.00
- GPS III.....Swivel Mounting Bracket.....£17.62

The latest handheld GPS that is pre-loaded with a map of Europe.

- Ability to zoom in & out ● Weighs 255g
 - can be dash mounted for use in a vehicle or boat. This unit will tell you:-
 - Where you are ● Where you've been
 - Where you're going
- Includes:- LAT/LONG, UTM, Ordnance Survey, Swiss, Swedish, German & Maidenhead grids.

GPS 48

£319

£6 p&p

- 12 Channel Receive
- Database for Marine, Nautical, Navaid's, Cities, Radio Beacons, Buys, etc
- Moving Map ● Compass



PERSONAL NAVIGATOR

An electric road atlas of Great Britain combined with a host of databases, it provides:-

SPECIAL PRICE! £119.00 £99.00

- Satellite navigation (with use of GPS)
- Full colour digital maps
- The Good Pub Guide
- The Good Guide to Britain
- Egon Ranoy Guide
- Gazetteer Database
- Route Planning
- Postcode Database
- Petrol Stations

SYNOPSIS WEATHER PLOTTING

Receive and decode RTTY signals on shortwave to produce live on screen weather pictures. **NEW LOW PRICE £99** £4.75 P&P

AEA FAX III

A SOFTWARE PACKAGE THAT ALLOWS RECEPTION OF WEATHERFAX, NAVTEX, RTTY AND MORSE CODE

ALL YOU NEED is an SSB receiver & a PC.

- Fax database included
 - Receives while you're away
 - On screen tuning
 - Manipulate images after they are received
 - No Amateur Licence or TNC needed!
- £99** £4.75 P&P

SCANMASTER

SCANMASTER DISCONE

A quality wideband stainless steel discone with frequency range of 25-1300MHz. Fitted with low loss 'N' type connector. Able to transmit on 2M & 70cms. **£49.95** £6.00 P&P



SCANMASTER ACTIVE DISCONE

As above but with 20dB pre-amp. **£69.95** £6.00 P&P

NOMAD PORTABLE RECEIVING ANTENNA

- Fully portable flexible wire scanning receiving antenna covering both VHF & UHF.
- Length (approx) 1.5mtrs
- Optimised for airband
- 4mtr coaxial cable
- Fitted BNC

£17.95 £4.75 P&P



SCANMASTER DOUBLE DISCONE

A high performance wideband antenna, offering gain over a conventional discone. Stainless steel construction with standard PL259 connector, mounting pole plus brackets. Superior performance on Air, Marine and PMR bands.



- 25-1300MHz
- Ultra wideband TX capability

£59.95 £6.00 P&P

SCANMASTER ACTIVE DOUBLE DISCONE

As above but with 20dB pre-amp **£79.95** £6.00 P&P

SKYSCAN DESKTOP

A complete desktop antenna covering 25-1300 Mhz, just 36" high with 4 metres of cable, fitted BNC plug with a magnetic base.

£49.95 P&P £8

LP 1300

Log Periodic WideBand Beam Antenna

Covers 105-1300MHz with over 8dB of gain at all frequencies!

- 16 elements (longest length being 1.4m)
- Fitted "N" type 50Ω socket
- Power rating: 500W transmit
- Gain 11-13 dBi F/B 15dB

Special £99.00 P&P £8

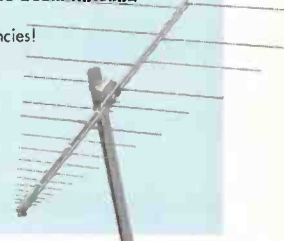

USED EQUIPMENT

ALL SAFETY TESTED & GUARANTEED FOR 3 MONTHS

SHORTWAVE RECEIVERS

AKD TARGET HF-3.....HF Receiver	125.00	LOWE HF 225.....* Extras	395.00
AOR AR7030.....HF Receiver	569.00	MATSUI 4099.....Shortwave Receiver	85.00
DRAKE RBE.....Communications RX	599.00	NR 55 VFL.....Shortwave Receiver	49.00
DRAKE R8A.....Communications Receiver + VHF Converter	699.00	REALISTIC DX394.....HF Receiver	99.00
DRAKE SWB.....HF Receiver	399.00	ROBERTS RC-828.....Including case	129.00
ICOM R72.....* Batt pack & Filters	599.00	SAISHO SW-5000.....Portable SW	69.00
JRC NR0 525.....HF Receiver	599.00	SANGHAN ATS 803A.....Portable SW	99.00
KENWOOD R-2000.....* VHF Converter	395.00	SANGHAN ATS 818.....Portable SW	105.00
KENWOOD R-2000.....HF Receiver	229.00	SONY SW1.....Portable	75.00
		SONY SW 7600G.....Portable	95.00

SCANNING RECEIVERS

ALINCO DJ-XI.....Handheld (100kHz - 1200MHz) 100 Channels	145.00
AOR AR 800E.....Handheld (75 - 950MHz)	99.00
AOR AR 900 (UK).....Handheld (108 - 950MHz) 100 Channels	99.00
AOR AR 2000.....Handheld Scanner (500kHz - 1300MHz) 1000 Memory Channels	149.00
AOR AR 8000.....Handheld Scanner (500kHz - 1900MHz) 1000 Memory Channels	225.00
BEARCAT UBC 2000LT.....Handheld (66 - 950MHz) with gaps	125.00
FAIRMATE HP-200.....Handheld Scanner (500kHz - 600MHz) 1000 Memory Channels	125.00
NETSET PRO 2029.....Base (68 - 512MHz) 60 Channels	99.00
NETSET PRO 46.....Handheld (66 - 965MHz) 100 Channels	89.00
NEVADA MS 1000.....Base (500kHz - 1300MHz) 1000 Channels	180.00
REALISTIC PRO 2039.....Base (68 - 960MHz) with gaps 200 Channels	165.00
REALISTIC PRO 38.....Handheld (66 - 512MHz) with gaps 10 Channels	45.00
REALISTIC PRO 2006.....Base (125 - 1300MHz) with gaps 400 Channels	175.00
REALISTIC PRO 9200.....Base (66 - 512MHz) 16 Channels	85.00
TRIDENT TR 2000.....Handheld (100kHz - 1300MHz) 500 Channels	129.00
TRIDENT TR 2200.....Handheld (100kHz - 2059MHz) 500 Channels	149.00
TRIDENT TR 4000.....Handheld (100kHz - 2059MHz) 1000 Channels	199.00
WIN 108.....Handheld Airband Scanner	95.00

NEW ITEMS ARRIVING EVERY DAY - PLEASE CALL!

tel: 01705 662145 fax: 01705 690626

• 189 London Rd • North End • Portsmouth • Hants • PO2 9AE

FAST



- ✓ **LOWEST PRICES**
- ✓ **FRIENDLY ADVICE**
- ✓ **FAST DELIVERY**
- ✓ **SERVICE BACK UP**

USE YOUR CREDIT CARD FOR SAME DAY DESPATCH!

SANGEAN-ATS818



- 150kHz - 29.99MHz
- 87.5MHz - 108MHz
- 54 memories
- AM/FM/SSB
- AM Wide/Narrow filter
- RF gain control

£139.95
£8 p&p

If you are looking for a really good no nonsense portable SW receiver that covers SSB - this set represents unbeatable value for money!

ICOM R8500



YES, we've got them IN STOCK!
This receiver is everything we hoped it would be, covering 100kHz - 2GHz and lots of features including computer control.
PAY BY 3 POST DATED CHEQUES! £516 each
Our Price ~~£1649.00~~ **£1548.00**

AOR SDU 5000



SPECIAL
£699
£8 p&p

PRICE
WALK

Get the most out of your AOR and Icom receiver. Supports AR 3000A, Icom R-8500, R-7100, R-7000, R-9000.

- Wideband Spectrum Monitor
- Displays Average, Peak, Max Levels
- Download to computer (with Hawk 5000 Software - not supplied)
- Can be used with any (wide) 10.7MHz IF. output receiver
- Supplied c/w 12V DC Supply, RS232 Lead, BNC Patch Lead, Op Manual

YAESU FRG 100



£429
£8 p&p

This receiver provides solid coverage from 50kHz to 30MHz with all mode reception of AM, SSB and CW. 50 fully tunable memory channels store frequency, mode and filter selections. The FRG-100 has twin 12 hour and 24 hour programmable clocks with on timer and sleep timer. The set requires 12V DC.

FM option available - add £33

JRC NRD 345



A cracking new receiver aimed at the Broadcast and Shortwave listener. JRC build some of the World's finest receivers and this is no exception. Designed to give clarity and interference free reception.

- AM synchronous detector
- Low noise PLL chip
- Noise blanker
- Wide dynamic range
- Sensitive receiver
- RS232 computer I/F
- 100 memories
- Clock/Timer functions
- Supplied c/w AC mains adaptor

£699
£8 p&p

ROBERTS R861



£169.95
£8 p&p

SYNTHESISED RECEIVER FM STEREO/MW/LW/SW PLL

- 307 memories (261 in SW, 18 each in MW/FM, 9 in LW + priority station)
- ATS auto scan & preset in priority pf signal strength in FM/MW/LW bands
- E2 PROM for memory
- FM stereo via earphones
- 29 pages SW stations memory, 9 memories in every page
- 8 characters for editing station name
- Built-in 42 world cities time+DST device
- Battery & signal strength indicator

SONY ICF-SW7600G



SPECIAL PURCHASE!

~~£179.99~~
£125.00
£8 p&p

PORTABLE SW RADIO

- Covers 153kHz - 30MHz
- AM/SSB/CW & 87.6 - 108MHz FM
- FM stereo via earphones
- 10 key Direct Access Tuning
- 22 Station presets
- LCD display
- Tone control
- External antenna & record jacks
- Clock/Timer-sleep & standby functions
- Includes compact reel antenna & carrying case

OPTOELECTRONICS

MINI SCOUT JUST RELEASED!

- Reaction Tunes AR8000, AR8000, ICOM R7000, R7100, R8500, R10
- Locks on to signal in less than 1 second & automatically tunes radio to frequency
- 10MHz - 1.4GHz operation
- Lock on to 5W UHF signal from 250 ft
- 16 Bargraph for signal strength reading
- NiCads, Antenna, Charger included

OPTOTRAKKER



£299.00
£8 p&p

- Decodes 5 tone (ZVEI), CTCSS, DCS, DTMF, LTR & Motorola Trunking
- Motorola decode with Trakstar software
- Scan multiple Motorola trunked systems simultaneously
- PC interface for data download
- All software and cables included

R-10 FM

- 30MHz-2GHz cont cover
- Nearfield Test Receiver
- Dual 10 segment bargraphs provide deviation & relative signal level indication
- Earphone supplied
- Excellent for bug detection
- Pocket sized
- Self tuning to strongest nearfield signal
- c/w antenna, NiCads & Charger

£299.95
£8 p&p

OPTO CUB



£119.95
£8 p&p

Handheld Frequency Counter

- 1MHz - 2.8GHz
- Auto Capture
- 9 digit display

MICRO DTMF DECODER

Decodes DTMF tones on 12 digit display and stores in 2000 character memory

TMC 100

Rubber Duck Antenna
Designed specifically for the Micro Counter & RF Detectors **£8.95** £9 P&P

R-11 NEARFIELD FM TEST RECEIVER

Sweeps 30MHz to 2GHz in less than one second. Can lock onto a 5W UHF signal at 500ft. Listen to the signal on the built in speaker & display the general band and transmit frequency.

£369.95
£8 p&p

TARGET HF-3 A NEW BUDGET PRICED COMMUNICATIONS RECEIVER



An British made shortwave receiver
● 30kHz-30MHz ● All Modes ● S Meter
£159.95 £8 P&P

TARGET HF-3M A special version of the HF3 with weatherproof interface, PC Cable & software. **£209.95** £8 P&P

SHORTWAVE ANTENNAS

EFW - Shortwave Antenna
20 meter s/w receive end fed wire antenna. Balun fed, uses high quality "Flex Weave" copper wire. 1-30MHz. **£59.95**

DLB - Shortwave Balun
Matches end fed long wires to 50Ω coax, helps on rec. to reduce noise & interference. Transmits up to 100W. Fully moulded for full weather protection. **£39.95**

VR-60 PORTABLE DIGITAL RECORDER

- 60 mins record
- VOX Control
- Store 128 memories
- Link to your radio with adaptor lead (not supplied)

SPECIAL PRICE
£49.95
£8 p&p

LIMITED AT THIS PRICE!

email us on
info@nevada.co.uk

CHECK OUT OUR WEBSITE
<http://www.nevada.co.uk>



IT'S EASY TO PAY!
- by three post dated cheques
(on any NEW item over £100)
• Simply divide the price into 3 equal payments.
• Write 3 cheques dated in consecutive months starting with today's date.
• Write your telephone number, cheque card No & expiry date on the back of each cheque.
• Post them to us, enclosing your name & address & we will (subject to status) send your goods immediately.

Listen to the World!

Call SMC now on 01703 246222 for friendly impartial advice

Receivers

YAESU FRG-100 HF Receiver



One of our best selling HF Receivers

50kHz - 30 MHz,
USB/LSB/CW/AM/FM*, 10Hz/100Hz
(CW, SSB) 100Hz/1kHz (AM,FM)
Tuning steps. 50 Memory Channels,
CAT Compatible,

*Optional FM Unit available.

OUR PRICE £425.00
Including AC Adaptor

AOR AR8000 Scanner

The AR8000 offers the benefits of short wave & professional wide band VHF/UHF receiver.

500kHz - 1900MHz
AM/NFM/WFM/USB/LSB/CW
1,000 nameable memories
Internal Nicads, 12V DC and
240AC mains (PSU included)

NOW ONLY £275.00
INC. FREE CARRY CASE

COMING SOON

THE NEW AR8200 SCANNER
ONLY £369.00

Low Receivers

SMC are proud to announce that we have now acquired the manufacturing and marketing rights for the Lowe receivers.

Our HF150 has been one of the World's best selling Short Wave receivers over the last 6 years, with over 10,000 units sold. Now we are pleased to announce the new enhanced version with even better performance - the HF150 europa.

This is innovation at its very best. The HF-150 europa is designed to be a survivor. With solid hard alloy casings, metal panels, and machined parts. The level of mechanical strength ensures excellent stability and shock proofing.



Tuning range is from 30kHz to 30MHz with a variable tuning rate according to the speed of rotation of the main tuning knob. For large frequency shifts, a single press on the Fast button gives tuning in 100kHz steps; a second press returning you to ultra-fine tuning rate.

In the dual conversion design there are two carefully chosen IF bandwidths of 2.6kHz and 6.5kHz, selectable at will by the user to suit reception conditions, whilst the use of quartz crystal master

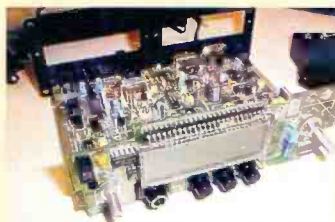

oscillators ensures long term frequency accuracy. Tuning frequency is displayed on a clear 5 digit liquid crystal display which is also used to show all other important operating functions.

60 memory channels are provided, each storing frequency and mode. Memory access is easy and unambiguous, as are all the operating features of the HF150 europa. The whole concept of the HF150 europa is to provide every desirable feature for the listener whilst keeping operation as simple as possible.

Call us for more information

Worldband Radios

NEW SANGEAN ATS 909



SSB (USB + LSB), 40Hz Step Fine Tuning. Auto scan and preset in priority of signal strength in FM/MW/LW bands. 306 Memories. RDS (Radio Data System) on PI, PS and CT for station time and clock. 42 world times built in.

ONLY £139.00
Including AC Adaptor

SANGEAN ATS 818



After popular demand we now have the 818 back in stock.

Five tuning methods, direct frequency, auto scan, manual scan, memory recall and rotary tuning.

45 memory presets 9 on each of FM, LW, MW and 18 presets on SW • AM Wide/Narrow filter • Full coverage of the SW meter band 120m to 11m • Standby function • Adjustable RF Gain • BFO Control • Dual conversion design.

STILL ONLY £99.00
Including AC Adaptor

Data Products

SMC Multidata Interface
Manufactured exclusively
for SMC by SMC.

Our entry level offering into the exciting world of data over radio.

DOS based multimode RS232 Receive Interface Module. Supports Colour

SSTV, FAX (inc WEFAX), CW, RTTY and AMTOR.

Minimum requirement - 286 PC with VGA screen.

ONLY £29.95 - Plug and Play (CE Approved unlike some competitors products).

NOW INCLUDES WINDOWS 3.1/95 SOFTWARE

ONLY £29.95 Plug and Play
Minimum req. - 286 PC with VGA screen

GPS Systems



GPS-III

The ultimate Global Positioning System with in built maps

The GPS III features an excellent on screen map resolvable down to 500 feet with up to 500 user definable way points. The map has details of millions of motorways, railways, rivers and shorelines.

The GPS III fits comfortably in your hand or on your dashboard.

GPS-12

An affordable alternative to the GPS III

The GPS 12 has a rocker keypad design that provides true one-handed user friendly operation. It also features 500 available waypoints, 1024 track log points and nine proximity waypoints. With a host of other features including a moving map plotter displaying waypoint names and symbols plus average and maximum speed

The Garmin 12 parallel channel receiver will find your position fast and keep your position even in dense foliage.

CALL FOR OUR BEST PRICES

SOUTH MIDLANDS COMMUNICATIONS LTD



South Midlands Communications Ltd HQ, SM House, School Close, Chandlers Ford Industrial Estate, Eastleigh, Hampshire SO53 4BY. Tel: (01703) 246222 Fax: (01703) 246206. Open 9-5.15pm Monday-Friday, 9-1pm Saturday. E:mail: amateur@smc-comms.com Web: <http://www.smc-comms.com>

Reg Ward & Co, 1 Westminster House, West Street, Axminster, Devon EX13 5NX.
Tel: (01297) 34918 Fax: (01297) 34949. Open 9-5.30pm Tuesday-Saturday. E:mail: regward@smc-comms.com

Book Review

DAVENTRY CALLING THE WORLD BY NORMAN TOMALIN

PUBLISHED BY CAEDMON OF WHITBY. £7.50

To anyone with even the slightest interest in broadcasting history this privately published, 95-page good quality and well illustrated booklet will provide fascinating reading. I say this because I think there must be many other people who like me, have passed many times up and down the old A5 and the nearby M1 admiring the extensive, and very famous 'aerial farm' that comprised the old Daventry transmitter site.

And again like myself I've no doubt that they also wish they'd been able to visit the station 'as it was' before the multitude of h.f. masts disappeared forever...particularly the most fascinating structure - the giant 'anti-fading' medium wave radiator used for the original 'Third Programme' on medium waves. This incredible mast dominated the Northamptonshire countryside and like the author - I too witnessed it engulfed in a thunderstorm while in the area. Something to remember!

If you've not been fortunate enough to read *BBC Engineering History 1922-1972* by E. Pawley (long out of print but still on some public library shelves) this book provides a superb, personal, detailed and warmly written tribute to a pioneering broadcasting station which during its long service transmitted on long, medium and short waves and provided 'special services' including the famous 49 Metre band radar experiment. But even if you have read Pawley's massive tome (I recommended it) Norman Tomalin's account provides a very 'personal' account by someone who worked there.

Highly readable from the foreword (written I believe by the genuine 'Professor' Stanley Unwin - the originator of the comical 'techno-speak' who entertained us for many years on radio and TV and who also started as a BBC Engineer) right through to the end pages I thoroughly recommend this book. A first class, fascinating read which conveys technical information, life on duty at the station and an inkling of what it was like to work perched up on the top of the famous Borough Hill. **Very highly recommended.**

Daventry calling the World is available from the publishers, post free. Contact: **Caedmon of Whitby, Headlands, 128 Uppang Lane, Whitby, North Yorkshire YO21 3JJ. Tel: (01947) 604646. Price is £7.50.** **Rob Mannion G3XFD**

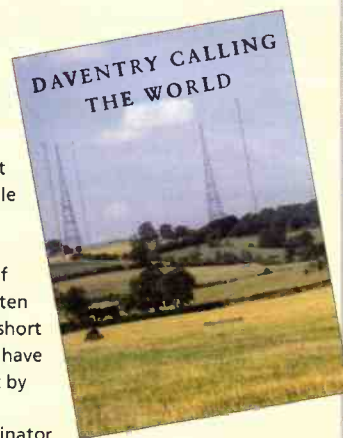

The Association
for International
Broadcasting

A World of Radio

The Association for International Broadcasting brings you a whole world of radio.

For the complete tuning information source, choose the *Global Radio Guide*. Published twice a year, the *Global Radio Guide* is the comprehensive directory of all the world's English-language radio stations.

With complete and detailed frequency information, the *Global Radio Guide* allows you to tune to stations right across the world. Combine the *Global Radio Guide* with *The Channel*, the Association for International Broadcasting's regular magazine, and you can keep up to date with the latest developments in the rapidly changing international electronic media scene, world-wide.

To order the *Global Radio Guide*, send a cheque or postal order for £4.25 to the Association for International Broadcasting, PO Box 4440, Walton, C014 8BX.

Or fax your Visa or Mastercard number and expiry to: 01255 676996.

The Association for International Broadcasting is a non-profit making organisation

be adjusted and we will cover these in order here.

Section 1 - This where new users often slip-up. Because the simple comparator interface connects to the serial port they often mistakenly assume that this setting should be serial - wrong! If you are using the simple comparator the settings shown in the diagram are correct, e.g. 8 bits on COMPARATOR.

Section 2 - This is potentially more troublesome but the vast majority of users should be able to use one of two possible settings. To know which settings to use, you really need to know which COM port your interface is connected to. For most users this will be either COM 1 or COM 2. If you have a serial mouse, this is usually connected to COM 1 so, by default, you must be connected to COM 2. The following table shows the standard settings assigned to each COM port:

COM Port	Address	IRQ
COM 1	03F8	4
COM 2	02F8	3

Section 3 - This section is specific to your computer and printer but it's worth using some simple, less demanding, settings to start with. I recommend leaving the Graphics and T-C graph setting at the standard VGA setting unless you're sure you have 600 x 800 pixel capability. Although this may not fully exploit your display system, it can make for a simpler start. For the printer settings, you need to step through the various options until you see your own printer name or a printer type that your printer can emulate. If in doubt you will need to refer to your printer manual. However, Epson 9-pin is usually a safe starting point.

Section 4 - You will only need to adjust the interrupt frequency if you are using a slow PC. By lowering this value from the pre-set 7500 you progressively reduce the demand on the processor. The disadvantage is a reduction in image resolution.

When you've finished changing the settings in the Configuration screen, press Ctrl Enter to return to the main menu.

First FAX Picture

You're now ready to attempt your first FAX picture. For this exercise I'll take you through the steps required to receive weather charts from the Met Office at Bracknell.

1. Tune your receiver to around 4.610 or 8.040MHz u.s.b. where you should either hear a steady carrier or a cyclic grating sound. The carrier shows that the station is at rest, whilst the grating sound means a FAX image is currently being sent.
2. Select FAX option from the JVFX main menu.
3. Press M and select mode 1 WEFAX 576 from the menu.
4. Now press D until the number 400 is displayed. This sets JVFX for the standard h.f. shift of ± 400 Hz.
5. Press T to start the auto-tune function.
6. Next press F2 to enable quick save.
7. If you're happy that the previous steps went OK you can now press 'A' to start the picture capture. If all is OK you should see the picture start to build-up on the screen.

When you have a basic picture, you can carefully alter the receiver tuning to give the best picture. You only need to make

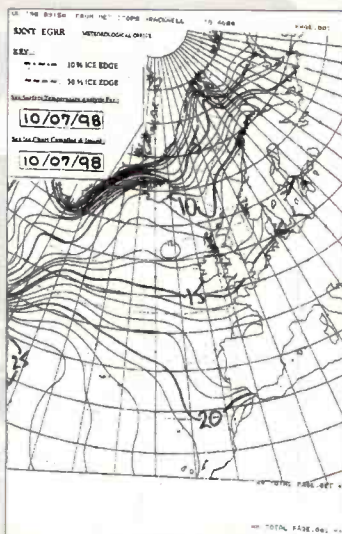

**Hamburg Chart Received Using JVFX.
This is all you need for the Data modes.**

very small adjustments and make sure you leave time for the result of each move to show through into the displayed image.

Once you've cracked your first image you can go back to the configuration screen and try optimising the settings for your set-up.

RadioRaft

This program is comparatively new to the radio scene, but offers the listener access to a wide range of data modes. Perhaps the most

attractive feature of the program, is its ability to automatically analyse data signals, establish the mode and data speed then start decoding the message. This is truly remarkable for a package in this price range and makes it very popular with new listeners. As well as offering excellent facilities *RadioRaft* is also one of the easier programs to set up. Installation of the software is simply a question of following the instructions in the README file and the interface required is the same as that for *HAMCOMM* and *JVFX*.

Configuring the program for your system is simply a question of selecting the appropriate COM port and setting the appropriate interface. This latter setting has caused some confusion in the past but if you're using a *HAMCOMM* type interface you need to select 'AF Interface' from the SETTINGS menu.

One other tip concerns the tuning indicator. Rather than operating as a conventional frequency meter *RadioRaft's* tuning indicator has different functions for each side of the indicator. The indicator sits in the top right-hand corner of the screen and looks like this:

—————<SIGNAL>—————

The hyphens on the left-hand side are used to indicate the error rate of the signal whilst the right-hand side shows the degree of synchronisation. You don't need to get too bothered about this as you just need to make sure you get as many lines as possible for the best reception.

Getting The Software

There are lots of ways to get your hands on these software packages and the associated interfaces. You will find them on sale at just about every radio rally and many of the Internet software archives have ham radio sections with this software. You will also find plenty of adverts for data products in this issue. To help you get started with Internet sources, here are a few sites worth a visit:

www.btinternet.com/~mikespage
[ftp.funet.fi/pub/ham](ftp://funet.fi/pub/ham)
www.pervisell.com
<http://www.gem.net/~berri/wun>
ourworld.compuserve.com/homepages/F6FLT
ourworld.compuserve.com/homepages/klingsenfuss/homepage.htm

I should also make mention of **Pervisell Ltd.** who have provided excellent service to 'Decode' readers for many years now. They can supply registered versions of all the programs mentioned here and also supply a particularly good range of interfaces at very reasonable prices. Pervisell can be found at: **Pervisell Ltd., 8 Temple End, High Wycombe, Bucks HP13 5DR. Tel: (01494) 443033.**



AR8200 *The Superior Concept*

The AR8200 is the 'first' and 'only' (so far) receiver to correctly implement the new 8.33 kHz airband channel step enabling spot on reception with correct tuning and searching. If your main interest is listening to airband it's worth considering the AR8200 as a safe investment beyond 1999.

8.33 kHz tuning step: International governing bodies have recently redefined the VHF airband tuning step to provide additional frequencies, **ultimately many older receivers will not be able to correctly receive these new channels.** Latest information suggests that the new allocation will come into effect on 01.01.1999 for parts of Europe (although this will probably be pushed back another year) and one year later in the UK. Being at 'the cutting edge' the AR8200 supports **8.33 kHz** correctly implemented as eight-and-one-third kHz. This means that the AR8200 will tune the VHF airband displaying the following steps 118.0083(3), 118.0166(6), 118.0250(0) MHz, the end numbers are correctly forced to **33** then **66** then **00**. Most other receivers would incorrectly display **33** then **66** then **99** as the last digits so would quickly drop out of channel synchronisation, further tuning of other receivers would result in the end digits displaying 32, 65, 98 then 31, 64, 97 then 30, 64, 96 etc. If your radio cannot tune in 8.33 kHz steps, you cannot correctly search the new allocation, although tuning within 1 kHz (or tuning in 1 kHz steps) will enable you to hear the traffic, you will not be able to search.

Selectivity is not a problem with the AR8200 as a narrow AM bandwidth is also supported (although undoubtedly the geographical allocation of tightly allocated channels will be taken into consideration by the governing bodies?). The AR8200 channel steps may also be programmed in multiples of 50 Hz in any mode. Extensive step-adjust and frequency offset facilities are also provided to ensure accurate tracking of the most obscure band plans. A wide frequency coverage is available from 530 kHz to 2040 MHz with no gaps.

A.F.C.: Automatic Frequency Control is included for spot on tuning ensuring that nothing is missed, this is especially useful for monitoring offset transmissions of London ATC etc without the need to retune.

Alpha text: A larger than average back lit LCD with contrast control provides operational data. Alphanumeric text comments of up to 12 characters may be added to memory channels, memory banks and search banks (for example **MANCHEST APP**) for easy identification reducing the need for a complex list or data base.

A text search feature simplifies recall of stored information.

Band scope: A high resolution signal meter and **multi-function band scope** is provided, this enables you to visually interrogate up to 10 MHz bandwidth at a time for activity, peak hold assists location of unusual or sporadic transmissions. **Flexible dynamic memory bank layout** is provided (memory banks may be varied in size between 10 and 90 channels each i.e. bank 'A' 80 channels / bank 'a' 20 channels with bank 'B' 40 channels / bank 'b' 60 channels etc). 1,000 memories, 20 memory banks, 40 search banks, select scan list, priority and lockout facilities are included. It is also possible to edit and delete individual memories, swap, copy, move and delete whole banks including dumping all data.

Computer control is available via a metallic side mounted robust connector and optional lead, an extensive RS232 command list is supported. A software package is under development which will be made available as an internet **free** download over the coming months. This connector also supports clone of data between two AR8200 along with tape output, detector output, mute and AGC. Optional **internal SLOT CARDS** (which fit into the AR8200 base) extend the AR8200 capability even further: **Memory slot card** (increase storage to 4,000 memories, 160 search banks). **CTCSS slot card** squelch & search. **Record chip slot card** (records up to 20 seconds of audio). **Tone eliminator slot card**, **Voice inverter slot card**. The **side keypad** provides four arrow keys presented as a single 'rocker' resulting in more natural and intuitive navigation through the on-screen menus. Tuning is accomplished via a variety of controls including a side panel indented main tuning dial, arrow keys and keypad. The scratch resistant "military green" cabinet has a quality feel.

Supplied with: NiCads, charger, cigar lead, whip aerial, MW bar, belt hook & screws, strap, operating manual

£399.00

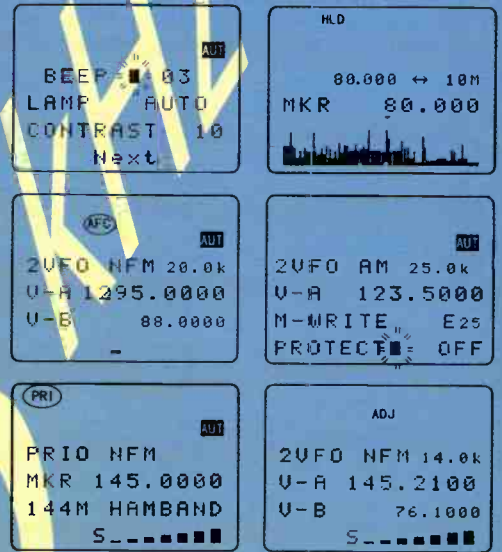

Contact your dealer for full details & reserve your stock today!!!



AOR (UK) LTD

4E East Mill, Bridgefoot, Belper, Derbyshire, DE56 2UA England

Tel: 01773 880788 Fax: 01773 880780

info@aor.co.uk www.demon.co.uk/aor **E&OE**

Spectrum monitoring for AOR ICOM and KENWOOD receivers...

It is not a common sight to see an ICOM receiver featured in an AOR advertisement, this is a special occasion demonstrating the COMPATIBILITY between the AOR SDU5000 Spectrum Display Unit with both AOR and ICOM receivers (AOR AR5000, AR3000A, ICOM R8500, R7100, R7000, R9000).



The SDU5000 Spectrum Display Unit adds a variety of features to extend your receiver's capabilities, such as visually identifying new active frequencies and taking measurements. The SDU5000 may be used with a number of receivers (which have a 10.7 MHz I.F. output) and provides a bandwidth up to ± 5 MHz in 1 kHz increments with a resolution of 5 kHz or 30 kHz. When using selected AOR and ICOM receivers, the frequency, mode (& attenuator with some sets) may be controlled from the SDU5000 so that a displayed frequency may be easily monitored and the cursor frequency of the SDU5000 is equal to the receive frequency of the radio. Of course the SDU5000 also makes an excellent band scope so that adjacent channel activity may be constantly monitored, this is particularly popular with frequency management organisations. The SDU5000 may also be connected to a PC where all controls are accessible and display data can be downloaded for record and later analysis, you may measure the frequency and signal strength of historical events!

AOR products are sold by many dealers large and small. Below is a sample of the most "active" dealers in the UK who procure stock and have the full after-sales support of AOR (UK) LTD. All main equipment supplied by AOR (UK) LTD carries a silver label on the carton stating that distribution has been via AOR (UK), this is your assurance of after-sales service. The list appears in no particular order.... It is advisable to contact dealers prior to travelling to check availability of products.

- **Waters & Stanton**
Essex Tel: 01702 206835
- **ASK Electronics Ltd**
London Tel: 0171 637 0353
- **Martin Lynch & Son**
London Tel: 0181 566 1120
- **Haydon Communications**
London 0181 951 5781
West Mids Tel: 01384 481681
- **Nevada Communications**
Portsmouth Tel: 01705 662145
- **South Midland Comm. Ltd**
Eastleigh Tel: 01703 255111
- **Reg Ward & Co**
Devon Tel: 01297 34918
- **ARC - Amateur Radio Comms**
Merseyside Tel: 01925 229881
- **Lowe Electronics**
Matlock Tel: 01629 580800
Newcastle Tel: 0191 214 5424
Bristol Tel: 0117 931 5263
Plymouth Tel: 01752 257224
- **S.R.P. Trading**
Worcestershire Tel: 01562 730672
Birmingham Tel: 0121 460 1581
- **Photo Acoustic Ltd**
Bucks. Tel: 01908 610625
- **Javiation**
West Yorkshire Tel: 01274 732146
- **Northern Shortwave Centre**
Cumbria Tel: 01228 590011
- **Jaycee Electronics Ltd**
Fife Tel: 01592 756962
- **The Shortwave Shop**
Dorset Tel: 01202 490099
- **Air Supply**
Leeds Tel: 0113 250 9581
- **RAS**
Nottingham Tel: 0115 928 0267
- **CB37 Communications**
Cheshire Tel: 01270 588440
- **Link Electronics**
Peterborough Tel: 01733 345731
- **QSL Communications**
Weston Super Mare Tel: 01934 512 757
- **EARS**
Essex Tel: 01268 752522
- **Micron Services**
Belfast Tel: 01232 438610
- **Radio & Electronics Services**
Guernsey Tel: 01481 728837
- **Belgar Ltd**
Jersey Tel: 01534 877067
- **Long Communications**
Co. Donegal Tel: 00 353 733 7323
- **Waterford Communications Centre**
Waterford Tel: 00 353 88 532656

Of course the SDU5000 also makes an excellent band scope so that adjacent channel activity may be constantly monitored, this is particularly popular with frequency management organisations. The SDU5000 may also be connected to a PC where all controls are accessible and display data can be downloaded for record and later analysis, you may measure the frequency and signal strength of historical events!

Other receivers. It is also possible to connect the SDU5000 to other receivers which provide a suitable (wide) I.F. output at 10.7 MHz (or in the range of 5.7 to 15.6 MHz) such as the **KENWOOD TS870S**.



You can reprogramme the SDU5000 centre frequency (front panel) when using other receivers which use different IF frequencies (Kenwood, Yaesu etc). In the case of the **Kenwood TS870S** the I.F. frequency is set to 8.83 MHz and results are good over a 50dB range. See the note at the end of the specification section of the revised sales leaflet for more examples... in practical terms the IF should be between 8.2 - 13.2 MHz for a 5 MHz span. **SDU5000 £699**

HAWK5000 is an optional **Windows PC software package** designed specifically for the SDU5000. **£49**

For further details please contact your dealer.
Dealers currently participating in a SDU5000 promotion are identified by a star *

AR5000 True high performance, voted best wide band receiver by readers of the German "funk" magazine in 1997. **£1345**

The enhanced **AR5000+3** includes AFC, Synchronous AM and noise blanker, voted best wide band receiver by readers of the German "funk" magazine in 1998. **£1574**



AR7030 High dynamic range, short wave receiver, awarded table-top receiver of the year 1996/97 by WRTH and 5-star editor's choice by Passport to World Band Radio 1997 & 98. Supplied with mains power unit, infrared hand control & comprehensive operating manual. **£799**

AR7030 PLUS Enhanced version, fitted with narrow AM filter, optical encoder, features CPU with 400 memory channels with alpha-tag, optimised components for highest performance. **£949**

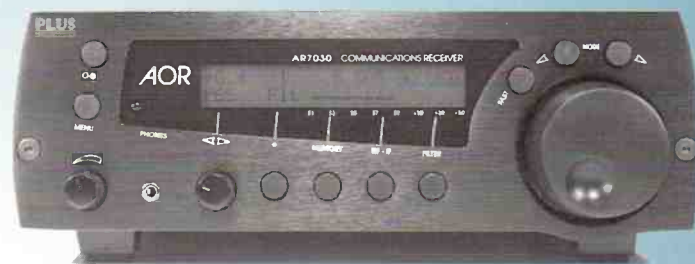

AR3000A Evolution at its very best. Wide band all mode receiver, high performance, respected best seller. **£699**

Although the AR8200 has arrived, the AR8000 is still in production and in great demand, a testimony to its carefully thought-out design concept. This unit provides a cost effective answer to those seeking wide frequency coverage, all mode reception and computer control features in a hand-held package. Frequency coverage is 500kHz to 1900MHz with no gaps, AM, NFM, WFM, USB, LSB, CW. Computer port and Opto Scout compatibility (optional leads & interface required). **£299**



ARD-2 ACARS & NAVTEX decoder and display unit. Very simple to use, only one audio connection is required from a suitable receiver. Can be used portable from internal batteries or external 12V. A computer port is provided for enhancement but is not required for operation.

FREE display software is available from the AOR web site **£295**



DECODE SPECIAL...DECODE SPECIAL...DECODE SPECIAL...DECODE SPECIAL...DECODE SPECIAL...

COQ-8

Freq	Callsign	Station	ITU	Mode	Settings
6.7213		Unidentified		COQ-8	26.7
6.8113		Algerian Customs		COQ-8	26
9.1186		Algerian Embassy Rabat		COQ-8	26.6
10.4673		Algerian MOI Net		COQ-8	26.6
13.4284		MFA Algiers		COQ-8	26.6
16.2786		Unidentified		COQ-8	26.6
16.2813		MFA Algiers		COQ-8	26.6
16.3412		MFA Algiers		COQ-8	26.6
16.3413		Unidentified		COQ-8	26.6
18.1834		MFA Algiers		COQ-8	26.6
18.2025		MFA Algiers		COQ-8	26.7
18.5294		Algerian Embassy Geneva		COQ-8	26.6
19.0336		Algerian Embassy Accra		COQ-8	26.6
19.0364		MFA Algiers		COQ-8	26.7
19.0564		Algerian Embassy Yaounde		COQ-8	26.67
		Unidentified		COQ-8	26

CW

Freq	Callsign	Station	ITU	Mode	Settings
2.5795	9VG	Singapore Radio	SWG	CW	
4.213	VIP	Perth Radio	AUS	CW	
4.2285	VIM	Melbourne Radio	AUS	CW	
4.2325	VRX8	Hong Kong Radio	CHN	CW	
4.245	VIS	Sydney Radio	AUS	CW	
4.2633	ZLO	Waiouru Radio	NZL	CW	
4.274	GKB4	Portishead Radio	G	CW	
4.274	KFS	Palo Alto Radio	USA	CW	
4.275	HPP	Panama Radio	PNR	CW	
4.276	JNA	JMSA Tokyo Radio	J	CW	
4.3055	JNA	JMSA Tokyo Radio	J	CW	
4.340	XSQ	Guangzhou Radio	CHN	CW	
5.2375	FDI22	AF Narbonne	F	CW	
5.270	FDG	AF Bordeaux	F	CW	
5.342	FDV	AF Orleans	F	CW	
5.880	RMP	RUS by Katinograd	KAL	CW	
6.330	XSG	Shanghai Radio	CHN	CW	
6.3855	ZS13	Ny Capetown	AFS	CW	
6.389	CTP	Ny Oeiras	POR	CW	
6.470	SXA34	Ny Spata Attikis	GRC	CW	
6.4845	W5C	Tuckerton Radio	USA	CW	
6.4915	JOS	Nagasaki Radio	J	CW	
7.335	FDG	AF Metz	F	CW	
7.3355	FDG	AF Metz	F	CW	
7.4705	FDG	AF Metz	F	CW	
7.4725	FDG	AF Bordeaux	F	CW	
7.668	88Y	INTEL	F	CW	
8.4175	XSV	Tianjin Radio	CHN	CW	
8.420	KHF	Agana Radio	GUM	CW	
8.4215	VRX	Hong Kong Radio	CHN	CW	
8.422	NRV	USCG Guam	GUM	CW	
8.423	UFL	Vladivostok Radio	RUS	CW	
8.4265	9VG	Singapore Radio	SWG	CW	
8.427	KPH	San Francisco Radio	USA	CW	
8.4295	NMO	USCG Honolulu	HHI	CW	
8.430	XSG	Shanghai Radio	CHN	CW	
8.4305	WLO	Mobile Radio	USA	CW	
8.435	XSQ	Guangzhou Radio	CHN	CW	
8.437	4XZ	Ny Haifa	ISR	CW	
8.4406	UAT	Moskva Radio	URS	CW	
8.4445	KFS	Palo Alto Radio	USA	CW	
8.448	A9M	Bahrain Radio	BHR	CW	
8.450	RUF	Sevastopol Radio	UKR	CW	
8.450	SAA	Karlskrona Radio	S	CW	
8.457	OFJ	Helsinki Radio	FINL	CW	
8.457	PKP	Dumai Radio	INS	CW	
8.473	PKE	Amboina Radio	INS	CW	
8.4735	A7D	Doha Radio	QAT	CW	
8.484	HLF	Seoul Radio	KOR	CW	
8.487	XSG	Shanghai Radio	CHN	CW	
8.491	AQP5	Ny Karachi	PAK	CW	
8.502	XSG	Shanghai Radio	CHN	CW	
8.505	UFZ	Vladivostok Radio	RUS	CW	
8.510	UBB4	Kaliningrad Radio	KAL	CW	
8.511	XSW2	Tai-chung Radio	TWN	CW	
8.514	XSQ	Guangzhou Radio	CHN	CW	
8.515	SAT	Tripoli Radio	LYB	CW	
8.521	VIP	Perth Radio	AUS	CW	
8.522	9HW20	Kuching Radio	MLE	CW	
8.532	LZW40	Varna Radio	BUL	CW	
8.540	USU	Mariupol Radio	UKR	CW	
8.542	PKQ2	Jakarta Radio	INS	CW	
8.5515	CTP	Ny Oeiras	POR	CW	
8.555	TBB7	Ny Ankara	TUR	CW	
8.5595	GK84	Portishead Radio	G	CW	
8.565	D3E51	Luanda Radio	AGL	CW	
8.566	ZS14	Ny Capetown	AFS	CW	
8.570	WNU53	Slidell Radio	USA	CW	
8.571	JNA	JMSA Tokyo Radio	J	CW	
8.573	CLA21	Havana Radio	CUB	CW	
8.577	HLO	Seoul Radio	KOR	CW	
8.584	VRX	Hong Kong Radio	CHN	CW	
8.586	WCC	Chatham Radio	USA	CW	
8.589	HPP	Panama Radio	PNR	CW	
8.593	UII	Odessa Radio	UKR	CW	
8.605	UIW	Kaliningrad Radio	KAL	CW	
8.6165	URK9	Kertch Radio	UKR	CW	
8.618	KPH	San Francisco Radio	USA	CW	
8.624	1150	Guangzhou Radio	CHN	CW	
8.632	XSW	Kaoshiung Radio	TWN	CW	
8.634	PPR	Rio Radio	B	CW	
8.634	VTG6	Ny Bombay	IND	CW	
8.6365	HLW	Seoul Radio	KOR	CW	
8.650	SPB43	Szczecin Radio	POL	CW	
8.658	ASK	Karachi Radio	PAK	CW	
8.661	XSQ	Guangzhou Radio	CHN	CW	
8.6642		unknown		CW	
8.665	XSG	Shanghai Radio	CHN	CW	
8.6885	ZSC6	Capetown Radio	AFS	CW	
8.691	XST	Qingdao Radio	CHN	CW	
8.698	7TF6	Boufarik Radio	ALG	CW	

8.700	9AR	Rijeka Radio	HRV	CW	
8.7054	PKN	Balikpapan Radio	INS	CW	
12.662	7TF8	Boufarik Radio	ALG	CW	
12.675	SAA	Karlskrona Radio	S	CW	
12.678	9MG	Penang Radio	MLA	CW	
12.6825	PKE	Amboina Radio	INS	CW	
12.687	OFJ32	Helsinki Radio	FINL	CW	
12.6938	ZRQ5	Ny Capetown	AFS	CW	
12.697	USU	Mariupol Radio	UKR	CW	
12.700	XSQ4	Guangzhou Radio	CHN	CW	
12.709	A9M	Bahrain Radio	BHR	CW	
12.712	HLW	Seoul Radio	KOR	CW	
12.721	SPH51	Gdynia Radio	POL	CW	
12.725	UG1	Rogaland Radio	NOR	CW	
12.735	URL	Sevastopol Radio	UKR	CW	
12.7385	PPR	Rio Radio	B	CW	
12.748	IRM	Roma Medici Radio	I	CW	
12.765	UCW4	St. Petersburg Radio	RUS	CW	
12.771	LHP5	St. Petersburg Radio	RUS	CW	
12.780	D3E61	Luanda Radio	AGL	CW	
12.7803	9AR	Rijeka Radio	HRV	CW	
12.7995	PCH51	Scheveningen Radio	HOL	CW	
12.801	TAH	Istanbul Radio	TUR	CW	
12.8085	VTG7	Ny Bombay	IND	CW	
12.8235	CTP	Ny Oeiras	POR	CW	
12.8354	GKB5	Portishead Radio	G	CW	
12.838	URK9	Kertch Radio	UKR	CW	
12.843	HLO	Seoul Radio	KOR	CW	
12.849	ZS15	Ny Capetown	AFS	CW	
12.856	XSG	Shanghai Radio	CHN	CW	
12.864	XSW	Kaoshiung Radio	TWN	CW	
12.8875	EAD44	Madrid Radio	E	CW	
12.891	UFN	Novorossiisk Radio	RUS	CW	
12.910	UAT	Moskva Radio	RUS	CW	
12.9165	QXZ6	Lyngby Radio	DNK	CW	
12.923	HLW2	Seoul Radio	KOR	CW	
12.935	HLG	Seoul Radio	KOR	CW	
12.939	SP61	Szczecin Radio	POL	CW	
12.940	LZW51	Varna Radio	BUL	CW	
12.9525	VIP	Perth Radio	AUS	CW	
12.965	USO5	Ismail Radio	UKR	CW	
12.973	UIW	Kaliningrad Radio	KAL	CW	
12.9885	LPD88	General Pacheco Radio	ARG	CW	
13.012	AQP6	Ny Karachi	PAK	CW	
13.0155	IAR3	Roma Radio	I	CW	
13.0245	ASK	Karachi Radio	PAK	CW	
13.029	SVB5	Athen Radio	GRC	CW	
13.050	UDK2	Murmansk Radio	RUS	CW	
13.062	CLA32	Havana Radio	CUB	CW	
13.0695	JOS	Nagasaki Radio	J	CW	
13.5279	S	Ny Arkhangelsk	RUS	CW	
13.528	C	Ny Moscow	RUS	CW	
16.807	9VG	Singapore Radio	SWG	CW	
16.8075	GKE6	Portishead Radio	G	CW	
16.8075	ZLA	Awanui Radio	NZL	CW	
16.8095	EAD	Madrid Radio	E	CW	
16.8095	VIP	Perth Radio	AUS	CW	
16.8115	A9M	Bahrain Radio	BHR	CW	
16.8125	NRV	USCG Agana	GUM	CW	
16.813	UAT	Moskva Radio	RUS	CW	
16.8185	9VG	Singapore Radio	SWG	CW	
16.821	VRX	Hong Kong Radio	CHN	CW	
16.8225	9VG	Singapore Radio	SWG	CW	
16.880	XSQ	Guangzhou Radio	CHN	CW	
16.892	XSG	Shanghai Radio	CHN	CW	
16.910	HLW	Seoul Radio	KOR	CW	
16.9112	JNA	JMSA Tokio	J	CW	
16.9155	CBV	Playa Ancha Radio	CHL	CW	
16.932	7TF10	Boufarik Radio	ALG	CW	
16.9332	JOS	Nagasaki Radio	J	CW	
16.940	XSW	Kaoshiung Radio	TWN	CW	
16.9426	9AR	Rijeka Radio	HRV	CW	
16.966	SVB6	Athen Radio	GRC	CW	
16.974	SPE	Szczecin Radio	POL	CW	
16.986	CTP	Ny Oeiras	POR	CW	
16.987	VRX81	Hong Kong Radio	CHN	CW	
16.9928	UAT	Moskva Radio	RUS	CW	
17.011	TBO3	Ny Izmir	TUR	CW	
17.011	XSX	Keelung Radio	TWN	CW	
17.013	5BA	Cyprus Radio	CYP	CW	
17.0216	TAH	Istanbul Radio	TUR	CW	
17.0456	LPD46	General Pacheco Radio	ARG	CW	
17.0503	4XZ	Ny Haifa	ISR	CW	
17.0504	ASK	Karachi Radio	PAK	CW	
17.053	XSX	Keelung Radio	TWN	CW	
17.0648	EDZ6	Madrid Radio	E	CW	
17.0742	LGX	Rogaland Radio	NOR	CW	
17.0948	SVA6	Athens Radio	GRC	CW	
17.103	XSG	Shanghai Radio	CHN	CW	
17.105	IRM	Roma Medico Radio	I	CW	
17.113	GKB6	Portishead Radio	G	CW	
17.1416	USU	Mariupol Radio	UKR	CW	
17.145	LZW72	Varna Radio	BUL	CW	
17.147	URL	Sevastopol Radio	UKR	CW	
17.1724	9MG	Penang Radio	MLA	CW	
17.1752	A9M	Bahrain Radio	BHR	CW	
17.177	URK9	Kertch Radio	UKR	CW	
17.1848	KFS	Palo Alto Radio	USA	CW	
17.1989	PCH	Scheveningen Radio	HOL	CW	
17.206	IAR	Rome Radio	I	CW	
17.2387	PKX	Jakarta Radio	INS	CW	
22.459	XSX	Keelung Radio	TWN	CW	
22.512	UAT	Moskva Radio	RUS	CW	
22.5637	9AR9	Rijeka Radio	HRV	CW	
22.5755	PKX	Jakarta Radio	INS	CW	
22.5765	JNA	JMSA Tokyo Radio	J	CW	

CW + SITOR

Freq	Callsign	Station	ITU	Mode	Settings
8.467	LF	Rogaland Radio	NOR	CW + SITOR	
8.417	GKE4	Portishead Radio	G	CW + SITOR	
8.418	IAR	Rome Radio	I	CW + SITOR	
8.4185	LGB2	Rogaland Radio	NOR	CW + SITOR	

DECODE SPECIAL...DECODE SPECIAL...DECODE SPECIAL...DECODE SPECIAL...DECODE SPECIAL...

DECODE SPECIAL...DECODE SPECIAL...DECODE SPECIAL...DECODE SPECIAL...DECODE SPECIAL...

8.419	VIP33	Perth Radio	AUS	CW + SITOR	5.2850	RPN 75	Kyjev Meteo	UKR	FAX	90/576
8.4195	PPR	Rio Radio	B	CW + SITOR	5.3025		Centro Met Ed Frei	ATA	FAX	120/576
8.4205	9VG78	Singapore Radio	SNG	CW + SITOR	5.3360	RBW 41	Murmansk Meteo	RUS	FAX	120/576
8.4205	HEC18	Bern Radio	SUI	CW + SITOR	5.3470	RSW 71	Arkhangelsk Meteo	RUS	FAX	60/576
8.421	OXZ	Lyngby Radio	DNK	CW + SITOR	5.4050	JM1 2	Tokyo Meteo 1	J	FAX	120/576
8.4215	9AR	Rijeka Radio	HRV	CW + SITOR	5.5264	BAF 6	Beijing Meteo	CHN	FAX	120/576
8.422	ESA	Tallinn Radio	EST	CW + SITOR	5.7050	LOR	Puerto Belgrano	ARG	FAX	120/576
8.4225	USU	Mariupol Radio	UKR	CW + SITOR	5.7550	AXI 32	Darwin Meteo	AUS	FAX	120/576
8.4255	HEC28	Bern Radio	SUI	CW + SITOR	5.807	ZKLF	Wellington Meteo	NZL	FAX	120/576
8.4265	WCC	Chatham Radio	USA	CW + SITOR	5.8071	ZKLF	Auckland Meteo	NZL	FAX	120/576
8.427	OXZ	Lyngby Radio	DNK	CW + SITOR	5.8502	OXT	Copenhagen Meteo	DNK	FAX	120/576
8.4275	A9M	Bahrain Radio	BHR	CW + SITOR	5.8577	HLL B	Seoul Meteo	KOR	FAX	120/576
8.4275	5PA46	Gdynia Radio	POL	CW + SITOR	5.8695	RBV 78	Tashkent Meteo 2	UZB	FAX	90/576
8.428	NMN	USCG Camslant	USA	CW + SITOR	5.9080	AF5	USAF AWS Elk Horn	USA	FAX	120/576
8.4285	PCH46	Scheveningen Radio	HOL	CW + SITOR	6.3405	NMF	USCG Boston	USA	FAX	120/576
8.429	EAD	Madrid Radio	E	CW + SITOR	6.4451		Murmansk Meteo	RUS	FAX	120/576
8.431	TAH	Istanbul Radio	TUR	CW + SITOR	6.4525	GYA	RN London	G	FAX	120/576
8.4315	LIAT	Moskau Radio	RUS	CW + SITOR	6.4530	NPG	USN San Francisco	USA	FAX	120/576
8.433	8PO	Barbados Radio	BRB	CW + SITOR	6.4560	CKN	CF Vancouver	CAN	FAX	120/576
8.4345	LPD	General Pacheco Radio	ARG	CW + SITOR	6.4964	CFH	CF Halifax	CAN	FAX	120/576
8.435	VCT	Tors Cove Radio	CAN	CW + SITOR	6.7200	RPN 71	Kyjev Meteo	UKR	FAX	90/576
8.459	LSD836	Argentina Radio	ARG	CW + SITOR	6.7900	YMA 20	Ankara Meteo	TUR	FAX	90/576
8.541	A9M	Bahrain Radio	BHR	CW + SITOR	6.9060	AFS	USAF AWS Elk Horn	USA	FAX	120/576
12.678	LFI	Rogaland Radio	NOR	CW + SITOR	6.9151	XL1763	Charlottetown Radio	CAN	FAX	120/576
12.7565	A9M	Bahrain Radio	BHR	CW + SITOR	6.9170	CZW	Maritim Air Group	CAN	FAX	120/576
16.8145	CBV	Playa Ancha Radio	CHL	CW + SITOR	6.9500	RJK 78	Kyjev Meteo	UKR	FAX	90/576
16.8155	9VG	Singapore Radio	SNG	CW + SITOR	7.3050	JMH 2	Tokyo Meteo 2	J	FAX	120/576
16.8155	OXZ	Lyngby Radio	DNK	CW + SITOR	7.3950	HSW 64	Bangkok Meteo	THA	FAX	120/576
16.8195	NMN	USCG Camslant	USA	CW + SITOR	7.3980		USAF AWS Roosevelt	PTR	FAX	120/576
16.825	WCC	Chatham Radio	USA	CW + SITOR	7.4050	ATP 57	Delhi Meteo	IND	FAX	120/576
16.826	ESA	Tallinn Radio	EST	CW + SITOR	7.4200	BDF	Shanghai Meteo	CHN	FAX	120/576
16.8265	PCH65	Scheveningen Radio	HOL	CW + SITOR	7.4335	HLL 5	Seoul Meteo	KOR	FAX	120/576
16.8385	BAR	Rijeka Radio	HRV	CW + SITOR	7.4650	SYE	Nairobi Meteo	KEN	FAX	120/576
16.8415	BPO	Barbados Radio	BRB	CW + SITOR	7.4700	VLM	Casey Meteo (summer)	ATA	FAX	120/576
16.868	9VG48	Singapore Radio	SNG	CW + SITOR	7.4950	RDK 23	Tbilisi Meteo	GEO	FAX	90/576
16.869	KHF	Guam Radio	GUM	CW + SITOR	7.5080	ZRO 2	Pretoria Meteo	AFS	FAX	120/576
16.879	LZV67	Varna Radio	BUL	CW + SITOR	7.5350	AXI 33	Darwin Meteo	AUS	FAX	120/576
16.886	TAH	Istanbul Radio	TUR	CW + SITOR	7.5700	RBX 72	Tashkent Meteo 2	UZB	FAX	90/576
16.893	USU	Mariupol Radio	UKR	CW + SITOR	7.5820	NKW	USN Diego Garcia	DGA	FAX	120/576
16.8985	LIAT	Moscow Radio	RUS	CW + SITOR	7.5950	AOK	USN Rota	E	FAX	120/576
16.976	LSD836	Argentina Radio	ARG	CW + SITOR	7.6300	RNR 78	Rostov na Donu	RUS	FAX	90/576
17.0665	A9M	Bahrain Radio	BHR	CW + SITOR	7.6700		Moscow Meteo	RUS	FAX	120/576
19.685	WLO	Mobile Radio	USA	CW + SITOR	7.6850		Moscow Meteo	RUS	FAX	120/576
19.692.5	ZSC	Capetown Radio	AFS	CW + SITOR	7.7020	RTP 72	Irkutsk Meteo	RUS	FAX	90/576
19.697	SVN63	Athens Radio	GRC	CW + SITOR	7.7100	VFR	CCG Resolute	CAN	FAX	120/576
19.726	A9M	Bahrain Radio	BHR	CW + SITOR	7.7620	RGH 77	Arkhangelsk Meteo	RUS	FAX	60/576
					7.8450		Khabarovsk Met	FAX	90/576	
					7.8700		USAF AWS Roosevelt	PTR	FAX	120/576
					7.8800	DDK 3	Hamburg Meteo	D	FAX	120/576
					7.9088		Murmansk Meteo	RUS	FAX	120/576
					7.9680	RFU 7	Rostov na Donu	RUS	FAX	90/576
					8.0400	GFA 23	Bracknell Meteo	G	FAX	120/576
					8.0800	NVA	USN Cuttler	USA	FAX	120/576
					8.0830	RJ1 75	Tashkent Meteo 1	UZB	FAX	90/576
					8.1039	SVA 4	Athens Radio	GRC	FAX	120/576
					8.1220	BAF 36	Beijing Meteo	CHN	FAX	120/576
					8.1400	BMB	Tai-pei Meteo	TAI	FAX	120/576
					8.1466	IMB 55	Rome Meteo	I	FAX	120/576
					8.1760	FZR 81	Saint Denis Meteo	REU	FAX	120/576
					8.3022		Beijing Meteo	CHN	FAX	120/576
					8.3315	GYA	RN London	G	FAX	120/576
					8.4440		Murmansk Meteo	RUS	FAX	120/576
					8.459	NOJ	Kodiak Meteo stn	ALS	FAX	120/576
					8.4675	JJC	Tokyo Radio	J	FAX	120/576
					8.4940	NUD	USN Adak	ALS	FAX	120/576
					8.5039	NMG	USCG New Orleans	USA	FAX	120/576
					8.6772	CBV	Valparaiso Radio	CHL	FAX	120/576
					8.682	NMC	USCG San Francisco	USA	FAX	120/576
					9.0445	AOK	USN Rota	E	FAX	120/576
					9.0450	SYE	Nairobi Meteo	KEN	FAX	120/576
					9.0502	AOK	USN Rota	E	FAX	120/576
					9.0500	NPG	USN San Francisco	USA	FAX	120/576
					9.1000	ROO 72	Rostov na Donu	RUS	FAX	90/576
					9.1100	NMF	USCG Boston	USA	FAX	120/576
					9.1500	RCH 73	Tashkent Meteo 1	UZB	FAX	90/576
					9.1650		Seoul Meteo	KOR	FAX	120/576
					9.3180	NRK	USN Keflavik	ISL	FAX	120/576
					9.340	RCH72	Tashkent Meteo	RUS	FAX	120/576
					9.3600	OXT	Copenhagen Meteo	DNK	FAX	120/576
					9.4300	3MA 34	CNA Tai-pei	TAI	FAX	120/576
					9.4380	JM1 3	Tokyo Meteo 1	J	FAX	120/576
					9.4586	ZKLF	Auckland Meteo	NZL	FAX	120/576
					9.9510	LSB	Centro Mt. Marambio	ATA	FAX	120/576
					9.9700	JMH 3	Tokyo Meteo 2	J	FAX	120/576
					9.9825	KVM 70	Honolulu Meteo	HWA	FAX	120/576
					10.1070	ATE 60	Delhi Meteo	IND	FAX	120/576
					10.1170	BAF 4	Beijing Meteo	CHN	FAX	120/576
					10.1210	SUU 2	Cairo Meteo	EGY	FAX	120/576
					10.1300	RBW 48	Murmansk Meteo	RUS	FAX	120/576
					10.2070	RTP 78	Irkutsk Meteo	RUS	FAX	90/576
					10.2423	LOR	Puerto Belgrano	ARG	FAX	120/576
					10.2533	NPN	USN Apra Harbour 1	GUM	FAX	120/576
					10.2567	NPN	USN Apra Harbour 2	GUM	FAX	120/576
					10.5380	CFH	CF Halifax	CAN	FAX	120/576
					10.5420	AOK	USN Rota	E	FAX	120/576
					10.555	ZKLF	Wellington Meteo	NZL	FAX	120/576
					10.5550	AXI 34	Darwin Meteo	AUS	FAX	120/576
					10.8650	NAA	USN Cuttler	USA	FAX	120/576
					10.9800		Moscow Meteo	RUS	FAX	120/576
					11.0300	AXM 34	Melbourne Meteo	AUS	FAX	120/576
					11.0900	XVM 70	Honolulu Meteo	HWA	FAX	120/576
					11.1220	AFS	USAF AWS Elk Horn	USA	FAX	120/576
					11.4200	BDF	Shanghai Meteo	CHN	FAX	120/576
					11.455.0	VLM	Casey Meteo (summer)	ATA	FAX	120/576
					11.4757	HMF 52	KNCA Pyongyang	KRE	FAX	60/352
					11.6179		Moscow Meteo	RUS	FAX	90/576
					11.6220		USAF AWS Roosevelt	PTR	FAX	120/576
					11.6625		Centro Met Ed Frei	ATA	FAX	120/576
					12.3168	SYE	Nairobi Meteo	KEN	FAX	120/576
					12.6620	PIWZ	Rio de Janeiro	B	FAX	120/576
					12.7300	NMC	USCG San Francisco	USA	FAX	120/576
					12.7455	JIC	Tokyo Radio	J	FAX	120/576
					12.7500	NMF	USCG Boston	USA	FAX	120/576
					12.7530	CKN	CF Vancouver	CAN	FAX	120/576

DSC

Freq	Callsign	Station	ITU	Mode	Settings
2.1875		GMDSS Alert Chan		DSC	100/170
6.3120		GMDSS Alert Chan		DSC	100/170
8.4145		GMDSS Alert Chan		DSC	100/170

FAX

Freq	Callsign	Station	ITU	Mode	Settings
0.1225	CFH	CF Halifax	CAN	FAX	120/576
2.0520	NOJ	USCG Kodiak	ALS	FAX	120/576
2.3420	DHJ 51	Grenfell Meteo	D	FAX	120/576
2.4010	LSB	Centro Mt. Marambio	ATA	FAX	120/576
2.6185	GFE 25	Bracknell Meteo	G	FAX	120/576
2.6280	AXM 31	Melbourne Meteo	AUS	FAX	120/576
2.7545	CKN	CF Vancouver	CAN	FAX	120/576
3.2315	DHJ 51	Grenfell Meteo	D	FAX	120/576
3.2320	AFS	USAF AWS Elk Horn	USA	FAX	120/576
3.2530	VFF	CCG Iqaluit	CAN	FAX	120/576
3.2530	VFR	CCG Resolute	CAN	FAX	120/576
3.2800	RBX 70	Tashkent Meteo 1	UZB	FAX	90/576
3.3570	NAA	USN Cuttler	USA	FAX	120/576
3.3600	RPN 71	Kyjev Meteo	UKR	FAX	90/576
3.3650	JM1	Tokyo Meteo 1	J	FAX	120/576
3.3774	YMA 20	Ankara Meteo	TUR	FAX	90/576
3.6100	ROO 70	Rostov na Donu	RUS	FAX	90/576
3.6225	JMH	Tokyo Meteo 2	J	FAX	120/576
3.6520	GYA	RN London	G	FAX	120/576
3.6570	RVZ 73	Arkhangelsk Meteo	RUS	FAX	60/576
3.6800	RBV 70	Tashkent Meteo 1	UZB	FAX	90/576
3.7450	RIS 70	Tbilisi Meteo	GEO	FAX	90/576
3.8205	NRK	USN Keflavik	ISL	FAX	120/576
3.8550	DDH 3	Hamburg Meteo	D	FAX	120/576
3.8630		Moscow Meteo	RUS	FAX	120/576
4.0140	ZRO	Pretoria Meteo	AFS	FAX	120/576
4.2280	CBV	Valparaiso Radio	CHL	FAX	120/576
4.2680	CKN	CF Vancouver	CAN	FAX	120/576
4.2710	CFH	CF Halifax	CAN	FAX	120/576
4.2980	NOJ	USCG Kodiak	ALS	FAX	120/576
4.3070	GYA				

HAYDON COMMUNICATIONS

MAIL ORDER: 0181-951 5781/2

(NEXT DAY DELIVERY £10 TO MOST AREAS)

London showroom & Mail Order
132 High St. Edgware, Middx HA8 7EL.
Tel: 0181-951 5781/2. Fax: 0181-951 5782
Open Mon-Fri 9.30-5.30pm. Sat 9.30-2pm
(or easy to remember number:- "07000 HAYDON")

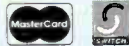

W. Midlands showroom
Unit 1, Canal View Ind. Est., Brierley Hill, W. Mids.
Showroom now quadrupled in size.
Open Mon-Fri 9.30-5pm. Sat 9.30-2pm
ALL ENQUIRIES BY PHONE TO 0181-951-5782



RECOMMENDATION AND PRICE ARE TWO GOOD REASONS WHY YOU SHOULD BUY FROM US!

COMMUNICATION RECEIVERS

NEW LOW PRICE
AR-5000
The AR-5000 advances the frontiers of performance providing excellent strong signal handling, high sensitivity and wide band coverage. Covers 10kHz-2600MHz.
ONLY £1189.00

ICOM IC-8500
"Next generation" technology brings you super wide band, all mode coverage from 0.1-2GHz. It's a professional quality communications receiver with versatile features from high speed scanning to computer control.

£UKs LOWEST PRICE

NEW LOW PRICE
AR-3000A
This highly acclaimed receiver has set its own place in today's demanding market. Your listening horizons are truly extended by its Rx range of 100kHz to over 2GHz and high level performance is achieved by its electronically switched 15 band pass filter system.
ONLY £649.95

AOR ARD-2
ACARS Navtex Decoder **£269.95**

BEARCAT
UBC-9000XLT
An amazing receiver with coverage from 25-1300MHz. 500 memories give ample storage along with auto store, selectable mode, turbo scan (100 channels per sec) alpha numeric facility and much more.
ONLY £249.00

SCANNERS

AOR AR8200
The latest all mode innovation in handies. There's too many features to list.
PHONE FOR LOWEST PRICE

New - includes 0.33KHz
ABF-125 Airband filter £29.00
SC-8200 Soft case for AR-8200 £17.95

AOR AR8000
Wideband scanning receiver covers 5-1900MHz (all mode).
STILL A TOP SELLER
£269.00
SC-8000 Soft case for AR-8000 £17.95

UK MODEL
MVT-7100EU
Wideband handheld scanner covers 500kHz-1650MHz. (All mode).
SALE PRICE
£199.00
Soft case for 7100EU £19.99

MVT-9000
The ultimate handheld scanner on the market. Covers 530kHz-2039MHz (all mode). Outperforms any other handheld on the market.
ONLY
£319.95
Soft case for MVT-9000 £19.99
Icom IC-R10 our price £259.00
Standard AX-400 our price £189.00
Alinco X-10 our price £249.00

SW RECEIVERS

ANNIVERSARY SPECIAL
AOR AR7030 PLUS
Third anniversary special edition. Buy one this month and get a UPNB7030 notch filter & noise blanker & telescopic antenna free of charge.
ONLY £879.00 WHILE STOCK LAST
AR7030 award winning comms receiver £679.00

FREE PSU worth £45
YAESU
FRG-100
Brilliant short wave receiver. Outperforms any other receiver in its price bracket.
ONLY £429.00
with FREE Yaesu PSU worth £45

FAIRHAVEN
RD-500V
Wideband communications receiver covers 0-1750MHz (all mode).
ONLY £759.00

TARGET
HF-3M
Budget communications receiver.
With built-in weather fax decoder.
ONLY £199.95

LOW RATE FINANCE AVAILABLE ONLY 19.9% APR

Data Interface for receiving CW/Baudot/ASCII/Amtor/ARQ/FEC/Sitor A/B/Navtex, Weather Fax, and Slowscan TV.
£39.95
P+P £2.
Including: interface and software connects to RS-232/3.5mm lead connects to receiver (no external power needed).

ICOM PCR-1000

~~£349.00~~ **ONLY £249.00**

ICOM UT-106
DSP digital filter for PCR-1000. Just plug into the PCR-1000 and away you go.
ONLY £59.95 POST £3
(ONCE FITTED YOU'LL NOTICE THE DIFFERENCE)

THE SHORT WAVE SPECIALIST

UK VERSION
SONY SW-100E
Award winning miniature portable SW receiver. Its performance is brilliant for its size. The best short wave receiver for under £250.
RRP £220.
SALE PRICE £149.95
AN-100 Active aerial/100E.....£54.95

UK VERSION
SONY SW-55E
Superb quality portable SW receiver with 125 presets. 100Hz step tuning for shortwave. Includes compact antenna, stereo headphones and carry case. RRP £299.95.
SALE PRICE £235.00

UK VERSION
ROBERTS R-861
Portable SW receiver with SSB and RDS. RRP £199.95.
OUR PRICE £169.00

HAYDON COMMUNICATIONS

MAIL ORDER: 0181-951 5781/2

London showroom & Mail Order
132 High St. Edgware, Middx HA8 7EL.

Tel: 0181-951 5781/2. Fax: 0181-951 5782

Open Mon-Fri 9.30-5.30pm. Sat 9.30-2pm

(or easy to remember number:- "07000 HAYDON")

(NEXT DAY DELIVERY £10 TO MOST AREAS)

W. Midlands showroom

Unit 1, Canal View Ind. Est., Brierley Hill, W. Mids.

Showroom now quadrupled in size.

Open Mon-Fri 9.30-5pm. Sat 9.30-2pm

ALL ENQUIRIES BY PHONE TO 0181-951-5782



SCANNING ANTENNAS

Q-TEK APOLLO 2000MKII

A brilliant new compact indoor antenna that covers 0-1650MHz and is just 20" tall (collapsed). Supplied with coax and BNC plug fitted.

ONLY **£49.95** P&P £5

Comments from John Griffiths

I have to say that I'm not a fan of indoor antennas like this as earlier desk mounted antennas tended to look like

a mad scientist invention. However, I was surprised by the quality of construction of this piece of equipment and it appears to be up to the job it is designed to do. Without getting technical, the Apollo 2000 claims to be able to cover 0-1650MHz. I used it between 108-400MHz: approx and was surprised by what it was able to do. It produced clean copy and there was good reproduction with very little breakthrough.

NEW Q-TEK D.C. 2000

A high performance wideband antenna offering superb performance from 25-2000MHz. Transmit range:- 6m, 2m, 70cm, 32cm & 23cm (power handling 200W). Fitted with low loss 'N' type connector. Supplied with mounting brackets.

OUR PRICE **£49.95** P&P £8.50

Comments from John Griffiths

Putting the DC-2000 up gave me a tremendous boost to all signals with the ancient AR-2000 coming alive! Signals were well received and I found that I wandered out of airband - my usual haunt - into all manner of areas that previously have been less than good here due to my location!

Q-TEK HYPER SCAN

Receive 25-2000MHz. A high performance wideband antenna with PL-259 fitting. Complete with mounting brackets.

OUR PRICE **£39.95** P&P £8.50

AIR-44

Prof quality base antenna for AIR. (Civil & military). Due to popular demand we have now introduced a SO-239 version of the highly popular AIR-44N (1.7m long).

£69.95 P&P £8.50

AIR-33 (As above) 1m long.....**£44.95** P&P £5

DB-32

A miniature wideband antenna. Receives 30 - 1200MHz. BNC fitting only 1.5" long. It's superb (for its size).

RRP **£29.95** P & P £1.

TSA-6671 BNC magmount**£22.95**

HAND-HELD ANTENNAS

REGULAR-GAINER RH-770

21cm flexible whip that is ideal as replacement

OUR PRICE **£12.99** P&P £1

SUPER-GAINER RH-9000

40cm flexible model for the ultimate in gain.

OUR PRICE **£16.99** P&P £1

SCANNING ACCESSORIES

Q-TEK HF INDUCTIVE INTERFACE

Allows the connection of any HF antenna to any scanner that has a BNC connector. Simply connect the long wire antenna to the push terminal on the top of the interface and attach to your scanner in place of your existing antenna.

ONLY **£12.95** P&P £1

Comments from John Griffiths

I mounted this on my AR-2000 and was well pleased with the results on HF. Verdict? A clear winner and well worth the reasonable outlay.

SCANMASTER SP-55

Boost reception of your scanner with this pre-amp. 25-1500MHz, variable gain, band pass filters.

RRP **£59.95** P&P £3.50

NEW Q-TEK HF MINITUNE

Superb quality short wave ATU. Ideal for scanners. Out performs any other tuner of its size. 100kHz-30MHz. BNC input/output. Connect to a long wire and you'll notice the difference.

ONLY **£49.95** P&P £3.50

Comments from John Griffiths

Results were able to be looked at in terms of a cheap, low cost ATU and I can report that it is certainly good! At under £50, it must be the cheapest on the market and would suit an enthusiast looking at putting an ATU on a capable scanner.

POLICE STYLE HOLSTER "HHC-2"

Matches all handhelds can be worn on the belt or attached to the quick release body holster.

£19.95 P&P £1

EP-300

Deluxe over the ear earpiece.

£9.95 + P&P £1

MA-339

Mobile holder for handhelds

£9.99 + P&P £2

QS-200..... Air vent holder**£9.99** P&P £2

QS-300

A fully adjustable desk top stand for use with all handhelds. Fitted coaxial fly (FAI) with BNC & SO239 connectors

OUR PRICE **£19.95** P&P £2

SCANNING ACCESSORIES

THE Q-TEK INTRUDER MODEL QT-2000

Superb quality wideband receiving antenna. Covers 100kHz-2GHz (all mode). ★ Size only 290 wide x 430 high x 45mm deep. ★ Can be mounted like a picture frame on a wall ★ Can be

loft mounted ★ Mounted externally like an alarm box ★ 2 x SO239 sockets.

For HF:- this unit utilises 6 independent HF "inductively" shortened verticals and has a separate wire connection for using the internal MLB (Magnetic Balun).

For VHF/UHF:- that's a semi-secret, although a clever mixture of fan dipole arrays and inductively fed elements help maximise its performance:- It's the most compact all round aerial that works very well!

Ideal indoor or out.

£99.95 + £6 P&P.

Comments from John Griffiths

In rounding up, the intruder performed better than I expected and with little fuss in mounting and connecting up. It appears rugged enough to live out of doors and will also fit nicely on the wall - perhaps an outside wall being the ideal though I have to admit having no problems with my inside one. I found it a pleasing addition to my set-up - with cable correctly mounted and run - it should look professional and very much a part of the kit in the shack. I would suggest that this is the antenna many of us have long been looking for and therefore have no hesitation at all in saying it is definitely the business.



UK Scanning Directory

6th Edition
New UK Scanning Directory
(6th edition). 25-1.8GHz.

£18.50 (P&P £2.50).

GARMIN PRODUCTS

GARMIN GPS-III

The latest hand-held GPS with a pre-loaded map of Europe.

SALE **£319.95**



NEW

GPS-12 NAVIGATOR

(now with 24 hour battery life)

12 channel receiver. Includes:- UTM, ordnance survey, waterproof to IPX-7 standard).

SALE PRICE **£129.95**

GPS-12XL (Includes Europe C.P.D.)**£209.95**

GPS-II New version.....**£245.00**

Cigar power lead.....**£20.00**

Optional active magmount antenna**£39.95**

The secret of our success lies in our massive buying power which has given us the best possible deals from the manufacturers. These we then pass on to you, the customer. Even though we have two shops we have always kept our overheads to the minimum enabling us to give our customers the lowest UK price. We pride ourselves on our first class advice, sales and service. If you are one of the hundreds of existing customers that already deal with us then you'll already know this. If you are not, then why not give us a call and find out for yourself.

RECOMMENDATION AND PRICE ARE TWO GOOD REASONS WHY YOU SHOULD BUY FROM US!

HF ACCESSORIES

Q-TEK HF-30

An amazing new design concept in compact HF antennas. Thanks to its six-stage multi resonant coil system stacked vertically utilising a magnetic balun at the base you can obtain better results than ever experienced from a compact-vertical HF antenna. (S0-239 fitting, 4' high - clamps to any mast up to 2" dia). 0-30MHz.



ONLY **£79.95** (DEL £8.50)
SUPERB HF SHORTWAVE ANTENNA
Send SAE for review

NEW SP-1 SPYWIRE

Ideal for any receiver. Receives all short wave bands. All mode, no ATU required. Built in balun. SO239 connection.

£24.95 + £3 P&P



Vectronics AT100

Active SW antenna Covers 0.3-30MHz with adjustable sensitivity. Simply connect to a

receiver and away you go. **£69.95** P&P £4 (includes pre-selector)
New low price

NEW Q-TEK BALUN

Short wave magnetic long wire adaptor for any short wave receiver. Simply screw onto receiver & connect the wire via supplied screw terminal. (It's brilliant).

PL-259 ONLY **£19.95** P&P £1



GLOBAL AT2000

Deluxe SW ATU 0-30MHz. SO239 fittings.

ONLY **£85.00** P&P £4
(Probably the best ATU around)

HOWES CT-U9 SW ATU with built-in

balun. SO239 fittings. ONLY **£69.95** P&P £4
CT-U8 SW ATU **£49.95** P&P £4

AN-71 PORTABLE ANTENNA

1.8-30MHz unwinds to 28ft. Supplied with clip adaptor. Winds back in seconds. Great for portable use, indoors etc. Connects to any receiver.

OUR PRICE **£9.95** P&P £1

FREQUENCY COUNTERS

OPTO ELECTRONICS

New: **OPTO MINI SCOUT**

10MHz-1.4GHz with bargraph & "Reaction Tune".

£199.00 (Incls nicad & charger).

Opto Scout MkII (as above + 400mems) **£349.00**

OPTO CUB

Miniature frequency finder covers 10MHz-2.8GHz. Includes nicads, charger & antenna. Beware of cheap look-alikes. This is the only counter below £100 with digital capture.

RRP ~~£139~~. SALE PRICE **£99.95**

- Techtoyz Micro Counter **£79.95**
- Techtoyz DTMF Decoder **£89.95**
- Optional Antenna Counter **£8.99**
- R-11 nearfield rcvr (30MHz-2GHz) **£299.00**
- Xplorer (30MHz-2GHz) **£799.00**
- Opto Lynx PC Interface Scout etc **£129.00**

OPTOTRAKKER

A decoder that when interfaced to a PC will turn a receiver into "Trunked Radio" tracking receiver. (Will support many

AOR & Icom receivers). **£299.00**

REACTION TUNE COMBOS

Mini Scout + AR8200

Complete with lead ALL FOR

£549.00

Mini Scout + AR8000 (all leads/mods included) **£449.00**

Scout MkII + AR8200

Full Scout with reaction lead

£679.00

Scout MkII + AR8000 (lead modification included) **£599.00**

LOW PRICED COUNTER. HUNTER

(10MHz-3GHz) includes nicads/charger and antenna.

£59.95

NEW PRODUCTS

Q-TEK "WSK-100"

Weather station picture & fax reception kit includes:

- a) A 2 element crossed dipole for receiving weather satellite pictures live from orbit
- b) A long wire HF antenna for receiving weather fax pictures
- c) Free software for your PC. No interface needed (uses your PC's sound card)
- d) Requires scanner or receiver

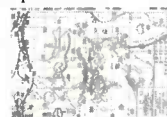

INTRO PRICE **£39.95**
Del £8.50

QTEK SKY SPY

A new high performance (extremely directional) Log Periodic for the real scanner enthusiast.

100-1650MHz (11-15dB gain). 15 elements and superb construction (fits 2" boom) N-type fitting.

£89.95 Del £8.50

DIY CORNER

DELUXE G5RV

Multi-stranded plastic coated heavy duty antenna wire. All parts reusable. Stainless steel and galvanised fittings. Full size - 102ft.

ONLY **£39.95**

Half size 51ft. ONLY **£34.95** Carriage £6.00.

STANDARD G5RV

- Full size 102ft **£24.00** P&P £6
- Half size 51ft **£21.00** P&P £6

COPPER ANTENNA WIRE (All 50mtr rolls)

- Enamelled (50 mtrs) **£11.00** P&P £5
- Hard drawn (50 mtrs) **£12.00** P&P £5
- Multi-Stranded (Grey PVC) (50 mtrs) **£8.95** P&P £5
- Extra H/duty (Clear coated) (50 mtrs) **£22.00** P&P £5
- Flexweave (H/duty) (50 mtrs) **£30.00** P&P £5
- Flexweave H/duty (20 mtrs) **£13.00** P&P £5
- Flexweave (PVC coated 20 mtrs) **£16.00** P&P £5

BITS & PIECES

- Nylon dog bone insulators **£1.00** ea P&P £1
- 30m pack nylon guy rope **£10.00** P&P £2

SECTIONAL MASTS Carriage £8.50

4 x 5 foot aluminium sections each swaged at one end.

- 1 1/4" dia **£19.95**
- 1 1/2" dia **£29.95**
- 1 3/4" dia **£36.95**
- 2" dia **£45.95**

WALL BRACKETS + MAST BASE PLATES

- 2" Mast base plate **£12.00** P&P £5
- 6" Stand off **£6.95** P&P £5
- 9" Stand off **£8.95** P&P £5
- 12" T&K Brackets **£12.00** P&P £8
- 18" T&K Brackets **£18.00** P&P £8
- 24" T&K Brackets **£20.00** P&P £8



■ MIKE RICHARDS G4WNC, PO BOX 1863, RINGWOOD, HANTS BH24 3XD

■ E-MAIL: decode@pwpublishing.ltd.uk ■ Web: <http://www.btinternet.com/~mikespage>

Decode

Joerg Klingenfuss has just sent me the brand new sixteenth edition of his *Radio Data Code Manual*, this excellent reference manual for data enthusiasts includes some major changes that have taken the page count from the present 600 up to a whopping 784 pages for the new edition, so I was keen to see what caused the changes.

For those of you who never encountered this book, let's start with a look at what it covers and why it's so useful. The book actually started life as two separate publications the first was called the *Air and Meteo Code Manual* and was a comprehensive reference on the various message coding systems used in aeronautical and meteorological transmissions. This coding systems fall into the family known as off-line coding because the coding is carried-out before the message gets to the radio system.

The second book was the *Radioteletype Code Manual*. This was a comprehensive reference containing technical details of the various transmission systems that can be heard around the bands. Here the coding is on-line which means that the coding system is an integral part of the radio link.

Anyway, enough of the technicalities. As both of these books dealt with codes and transmission systems, it made sense to bring them together in one reference publication - hence the *Radio Data Code Manual*. Let's take a look at why you might want a publication such as this.

To understand this you need to appreciate what it is that attracts listeners to the more complex transmission mode. After all, there are very few messages that can be resolved.

In my experience, the common factor is the thrill of the hunt! A bit grand perhaps but what I really mean is that most enthusiasts enjoy the detective process of identifying a station and its transmission type rather than deciphering the message itself. This is a good job really because the traffic on most of the more sophisticated modes is encrypted anyway!

In order to make a reasonable shot at identifying a new station you need access to some form of reference data so that you can compare the characteristics of the new station with other known signal types. This is where the *Radio Data Code Manual* really comes into its own as

error rates and protection systems.

There is also a very handy baud rate look-up system. This is a simple cross reference where you look-up the baud rate of the signal you're tracing and you can then see the range of modes that commonly use that baud rate. Whilst in some cases there may be six modes that use that speed some are very specific, a good example being 125 baud synchronous. If you come across one of these it will almost certainly be a DUP-ARQ signal.

This introductory section concludes with a useful review of some of the current decoding systems with lots of screen shots of an assortment of data modes received using Wavecom's impressive W41PC decoder card.

Moving on to the mode descriptions, each topic starts with an excellent introduction that provides an overview of the mode's characteristics. This is then followed by a detailed description of how the mode operates including all the vital timing detail. This is exactly what you need to help identify new signals.

To make this potentially very heavy material as user friendly as possible the technical descriptions are supplemented by timing charts and screen shots. In addition to the detailed mode descriptions, the Manual includes a comprehensive analysis of the various alphabets that are used in teleprinter and Morse systems. These alphabets are really just look-up tables that convert a conventional text character into one of the codes that are accepted by the mode in question.

The simplest example I can think of is in Morse code. Whereas 'dot-dash' is normally used for the letter A, if you were communicating in Cyrillic, Greek, Hebrew or Japanese the translation would have to be different. It is because of this that you will occasionally need this reference data.

This same problem exists in teleprinter or computer based communication links. One of the better solutions comes in the form of the Unicode system. This has been developed to meet the huge demand for international information exchange.

The system is very comprehensive and includes support for the full range of Asian languages. Moving back to the early sections of the manual you will find very comprehensive details of most of the off-line coding systems that are used extensively for meteorological and Aircraft communications.

The Met section is particularly comprehensive with details of the World Meteorological Organisation and its comprehensive communications network. This is followed by detailed breakdowns of the various codes and message systems.

The Aeronautical section follows similar lines with lots of useful information. Overall, the *Radio Data Code Manual* is an excellent reference source of hard-to-find technical data on the data modes - every serious listener should have a copy. Copies are available from the SWM Book Store price £30.00.

New JV FAX!

Yes, at long last Eberhard has developed a Windows version of his famous JV FAX decoding program. The new program is still in development phase and the example tested here was at version 0.95.

The name has changed to *JVcomm32* to better describe its role as a true 32 bit application designed to run in Windows '95 or later. Let's start with a quick look at what you need to run the program.

First of all you need a PC with at least a 486DX66 processor and 16Mb of RAM. You will also need a high or true colour graphics system with at least 800 x 600 video resolution. The operating system needs to be

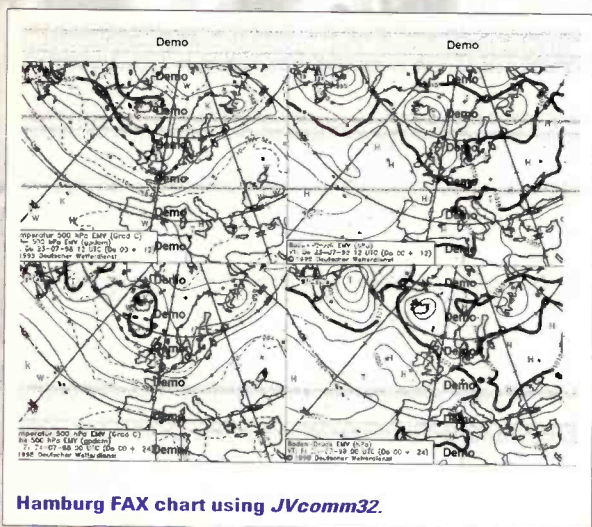

Hamburg FAX chart using JVcomm32.

it's packed with technical data on a very wide range of data modes.

Rather than just comprising the pure technical data, the Manual includes a good introduction to the technicalities with some very clear explanations on the characteristics of different groups of signals. These explanations include short wave propagation,

Bits, Bauds & Bandwidth

Phil Cadman G4JCP clarifies some complicated areas of data communications by illustrating the differences between 'bit rate' and 'baud' with the toss of a coin.

I was prompted to write this feature by the apparent confusion between the terms 'bits per second' and 'baud rate'. However, rather than simply defining the two terms, I thought a more in-depth look at data transmission may be useful.

The Bit

Let's clear one thing up straight away, the bit, short for binary digit, is actually a measure of information. For example, a message telling of the outcome of a flipping of a coin has an information content of one bit.

This is for two reasons: either the message will always be just one of two possibilities - either heads or tails; or there is an equal probability of a heads or tails result. (Unless, of course, you have a dodgy coin).

That last remark is not as flippant as it sounds. In order for the message's information content to equal exactly one bit, a heads result must be equally as probable as a tails result. Put another way, if a message tells of one of two, equally probable, events the information content of that message is equal to one bit.

A formula exists for determining the information content of a message which tells of events that have more than two possible outcomes and when the probabilities of each outcome are not the same. The example above is simply a special case of the general situation.

Binary digits are usually denoted by the numbers '1' and '0'. '1' is usually regarded as 'true' and '0' as 'false'. To communicate the result of one throw of a coin we can ask the question "was it heads?". If the answer is 'yes', then that answer can be represented by the symbol '1', meaning true. An answer of 'no' can be represented by a '0', meaning false. This also demonstrates one other vitally important thing about encoding: both sender and recipient have to agree on the meaning of each symbol beforehand.

Imagine the coin is flipped ten times per second. In order to communicate the results, a channel that can pass information (data) at a rate of ten bits per second is required.

Baud Rate

Before defining baud rate, let's look at the characteristics of a real channel. By channel, I mean a telephone line, a radio link, a fibre optic link, even two empty baked bean cans connected by a piece of string. Any channel over which information can flow.

In order for the symbols '1' and '0' (representing heads or tails) to be passed over a real channel they also have to be represented by a physical quantity. That quantity may be voltage, current, tones of different frequencies, for instance. I'll choose a voltage of +12V to represent a '1' and a voltage of 0V to represent a '0'.

To communicate ten throws per second these symbols have to be sent at a rate of ten per second, as shown in **Fig. 1**. If, by chance, alternate throws give an alternating heads-tails-heads-tails pattern, then the voltage will change ten times per second. In fact, it will look just like a square-wave, as the last few throws in **Fig. 1** demonstrate.

Now is the time to tell you that baud rate is simply the number of symbols communicated per second. In this example, ten symbols are sent every second. That makes the symbol rate equal to ten baud. We don't say ten bauds per second because the term baud already includes the 'per second' qualification.

Because each symbol represents one bit (a binary signal) the data rate is also equal to ten bits per second. This point is most important - it is only over a binary channel that the baud rate is numerically equal to the bit rate.

Bandwidth & Baud Rate

Take a rather idealised telephone channel as an example. It possesses two very important parameters: its bandwidth (b.w.) and its signal to noise ratio (s.n.r.).

This telephone channel will easily pass symbols at a rate of 10 baud and the far-end voltage waveform will look very sharp, as in **Fig. 1**. Telephone-types please note, I'm assuming, for arguments sake, that the frequency response of this telephone connection extends down to d.c.

If the symbol rate is increased sufficiently then the time taken for the voltage to change from one level to another will become significant compared with the symbol time. The reason the voltage cannot change instantaneously is because the channel has a finite bandwidth.

Things could get mathematical now but instead, imagine sending the symbols at 6000 baud. At the transmitter, the signal will look all nice and sharp, as in **Fig. 2a**. All that's changed from **Fig. 1** is the symbol time - from 1/10th of a second down to 1/6000th of a second.

In the worse case, 6000 baud can give rise to 6000 changes in voltage per second. That's equivalent to a frequency of half that, 3000 cycles per second or 3000Hz.

Assuming the telephone channel has a bandwidth of 3000Hz, the signal will look rather like that shown in **Fig. 2b**

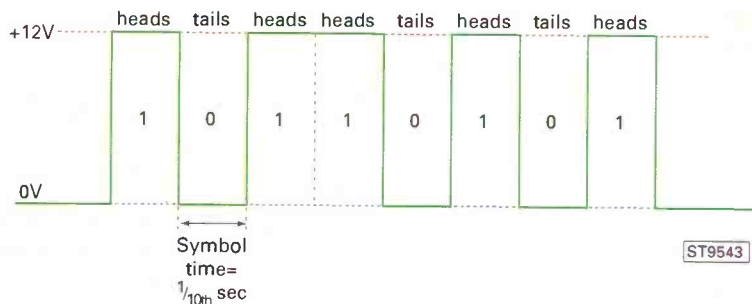

Fig. 1: Our coin throwing waveform, at 10 baud.

once it has passed over the channel. It now resembles a 3000Hz sine-wave. That's understandable because the telephone channel is going to behave like a 3000Hz low-pass filter.

If you are familiar with Fourier analysis then you'll know that a 3000Hz square-wave consists of a 3000Hz sine-wave plus a series of odd-order harmonics. If passed through a 3000Hz low-pass filter all the harmonics will be filtered off leaving just the fundamental sine-wave.

If the symbol rate is increased beyond 6000 baud then the channel will begin to attenuate the fundamental signal as well as all the harmonics. Depending on the rate of attenuation beyond 3000Hz, the signal will eventually be attenuated so much so that the symbols will be detected incorrectly.

Varying a voltage to represent the symbols '0' and '1' is called amplitude shift keying (a.s.k.). I could have chosen to vary the frequency of a tone. That's called frequency shift keying (f.s.k.). Finally, there's phase shift keying (p.s.k.) when it's the phase of a tone which represents the symbols.

For example, using f.s.k., a tone of 1200Hz could represent a '0' and a tone of 2400Hz could represent a '1'. Even so, the theoretical maximum symbol rate would still be 6000 baud - twice the channel bandwidth.

Multi-level Signalling

If the symbol rate over a telephone channel is limited to the relatively low figure of 6000 baud, how do modems manage 28800 bits per second and above? The answer to that is for each symbol to have more than two possibilities. I'll use the coin throwing analogy to illustrate the point.

Instead of asking just one question - is it heads? - the results of two successive throws are used to answer a multi-part question. The table in Fig. 3 shows all the possible results of two consecutive throws. Each individual throw still gives a 0 or 1 result but this time four symbols, the letters a, b, c and d, represent the four possible outcomes of any pair of throws.

Each symbol now represents two bits of information. If a varying voltage is again used to represent these new symbols then four voltage levels, as shown in Fig. 4, are needed.

Fig. 4 also shows how voltage transitions only occur, at most, every two throws. Keeping the symbol rate at 6000 baud the results of 12000 throws, or bits per second, can now be communicated.

Just as in the binary case, different tones could be used to represent the four symbols. For example,
symbol a - 600Hz
symbol b - 1200Hz
symbol c - 1800Hz
symbol d - 2400Hz

Here, twice as many bits per second could be communicated in the same bandwidth.

Going one step further, we could send the results of three consecutive throws at a time. If so, eight symbols will be needed to represent the outcome of the three throws. The combinations are shown in the table in Fig. 5. The data rate is now up to 18000 bits per second whilst the symbol rate is still 6000 baud.

You should have guessed by now that the data rate is equal to the number of bits of information that are encoded into each symbol multiplied by the number of symbols communicated every second. In this last case three throws are encoded into each symbol - three bits per symbol - and the symbol rate is 6000 baud. Multiplying 3 by 6000 gives 18000 bits per second. Encoding four throws (four bits) per symbol (needing 16 different symbols) would give a data rate of 24000 bits per second and so on.

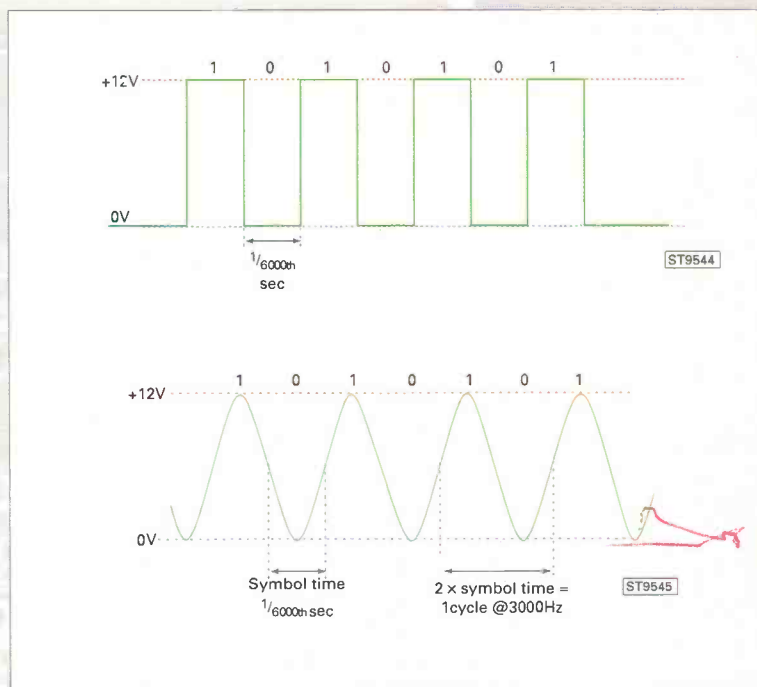

Fig. 2:
a) Now we've speeded up to 6000 baud.

b) The 'real-world' signal via a 'phone line.'

Signal To Noise Ratio

If all this seems too good to be true then you'd be right. In the table in Fig. 5, the last column shows the voltage levels that could be used to represent each of the eight symbols. Compare those eight voltages with just the two required to communicate the result of one throw at a time.

In the latter case only a simple comparator is required to differentiate between a '0' and a '1'. Just set the comparator to compare the input voltage to a fixed +6V reference. If the voltage is lower than +6V then take it as a '0' (0V) and if it's above +6V then take it as a '1' (+12V). Even if the channel were noisy it would take a noise spike of 6V or more to move the 0V level up above +6V or the +12V level down below +6V.

When there are eight voltage levels, seven comparators

Second Throw	First Throw	Binary Representation	Symbol	Voltage (v)
tails	tails	00	a	0
tails	heads	01	b	+4
heads	tails	10	c	+8
heads	heads	11	d	+12

Fig. 3: Encoding to improve the amount of data that can be transmitted in the same bandwidth.

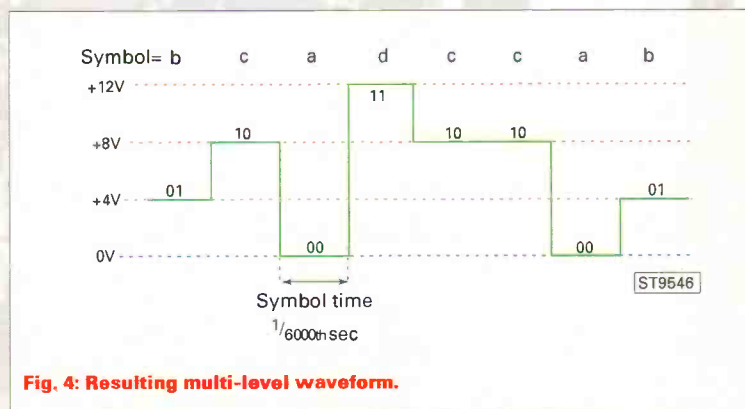

Fig. 4: Resulting multi-level waveform.

Third Throw	Second Throw	First Throw	Binary Representation	Symbol	Voltage (V)
tails	tails	tails	000	a	0
tails	tails	heads	001	b	+1.71
tails	heads	tails	010	c	+3.43
tails	heads	heads	011	d	+5.14
heads	tails	tails	100	e	+6.86
heads	tails	heads	101	f	+8.57
heads	heads	tails	110	g	+10.29
heads	heads	heads	111	h	+12

ST9548

Fig. 5:
Higher level
of encoding,
3-level.

are needed (and a bit of logic) to identify the transmitted voltage level. Actually, the number of comparators and the associated logic is no great hardship. The real problem is the small difference in voltage levels. It now only requires a noise spike of about 0.85V (half the step size) to cause an error. That's only a seventh of the 6V required to produce an error in the binary case.

While the data rate has gone up by a factor of three the noise immunity has gone down by a factor of seven. This loss of noise immunity happens regardless of how the symbols are physically encoded; voltage, frequency, phase or whatever. The more levels a multi-level system uses then the higher the channel's signal to noise ratio has to be for (essentially) error-free communication.

Hybrid Systems

Rather than varying just one physical quantity in order to represent the symbols in a multi-level system there

is nothing to stop there being two (or more) varying quantities. For example, instead of having eight voltage levels, I could pick a series of four tones, each of which could have two voltage levels. This is an extension of the 4-level f.s.k. case above. The combinations could be as shown in Fig. 6.

Symbol.	Freq. (Hz).	Amplitude (V).
a	600	12
b	1200	12
c	1800	12
d	2400	12
e	600	6
f	1200	6
g	1800	6
h	2400	6

Fig. 6: A 4-level example.

Of course, the receiver is more complicated because this time it has to detect both the frequency and the amplitude of each tone.

Real Modems

I've used simple examples, yet similar methods involving frequency shift keying were commonly used until very recently. Indeed, 1200 bits per second over a telephone line was considered fast just a few years ago. Since then, most telephone exchanges have been upgraded to fully digital operation so giving better, more consistent, connections. The incorporation of inexpensive digital signal processing (d.s.p.) within the modems have done the rest.

SWM

Book Review

THE COMPLETE SHORT WAVE LISTENER'S HANDBOOK

NEW 5TH EDITION

Short wave radio may be the most fun you can have sitting down and this A-Z guide for everyone from absolute beginners to advanced hobbyists is your all-in-one partner in listening. It gives you complete, up-to-date information on equipment, world-wide

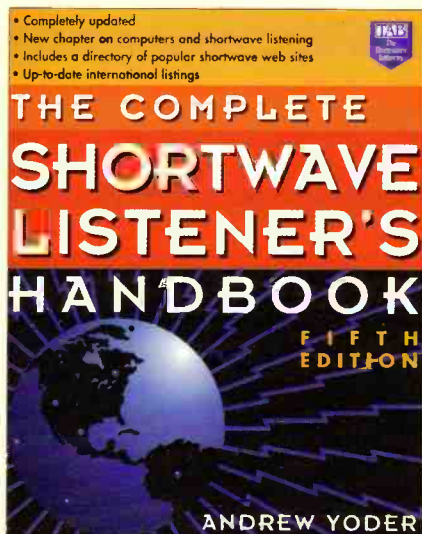

stations, clubs, satellites, computers and much, much more!

This book, now fully updated with a new chapter on computers and short wave listening, will help you choose and use equipment, from the simplest to the most sophisticated, it will give you guidance on finding hot, newsworthy stations, espionage broadcasts and pirate and illegal frequencies, you'll find up-to-date listings of stations and frequencies for all inhabited portions of the globe, information on web sites with shareware for translating audio Morse code to text, simple cheap ways to improve reception and much, much more!

Order your copy of *The Complete Short Wave Listener's Handbook* before 31st October 1998 for the **SPECIAL PRICE** of **£18.95** (£1 P&P UK, £2 P&P Overseas). Order after 31st October and the price will be

£20.95!

SPECIAL LAUNCH

DEMODULATORS FOR JVFX HAMCOMM SKYSPY RADIORAFT DL4SAW & POCSAG

THE ORIGINAL RECEIVE ONLY with 25 way 'D' type £16.99
POCSAG RECEIVE version (as above, with variable hysteresis) £19.99
TRANSMIT version (Pocsag Rx + Fax/SSTV/HamComm Tx) £24.99
 25 to 9 way **Adaptor** £3.00. **Shareware** on 3.5" HD disks
JVFX7 + HamComm 3.1 + Pktnon12 + Pocsag (PD2.04) + Wxgraph £2.50
RADIORAFT Version 2.13 £2.50 **DL4SAW SSTV (V1.2)** £2.50

REGISTERED VERSIONS OF SOFTWARE INCLUDING SKYSPY for ACARS™ (Win95)

NEW DL4SAW/GSHPC SSTV (V2.3) £34.99 **HamComm3.1** £19.99
SkySpy V1.1 £24.99 **Pocsag (PD2.04)** £19.99 **RadioRaft V2.13** £19.99
 All prices UK/Eire inc VAT + P&P. For non-EU deduct 17.5% VAT
 All products (except software) carry a full money back guarantee.
 Minimum credit card order £15.00. Outside British Isles add £2.00

Pervisell Ltd, 8 Temple End, High Wycombe Bucks HP13 5DR
 Tel: (01494) 443033 Fax: (01494) 448236
 www.pervisell.com e-mail: ham@pervisell.com

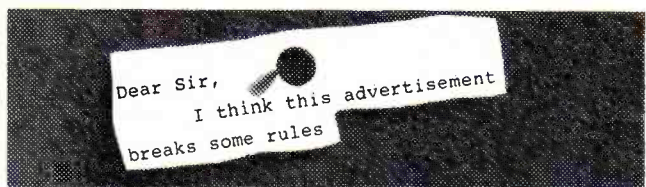

Advertisements are expected to conform to rules and standards laid down by the Advertising Standards Authority. Most do. The few that don't we'd like you to write in about. And if you'd like a copy of these rules for press, poster and cinema advertisements, please send for our booklet. It's free.

The Advertising Standards Authority.
We're here to put it right. ✓
 ASA Ltd., 2 Torrington Place, London WC1E 7HW

1998/1999 GUIDE TO WORLDWIDE WEATHER SERVICES

Internet · Navtex · Radiofax · Radiotelex!

420 pages · £ 21 or DM 60 (worldwide postage included)

While many radiofax and radiotelex services continue to transmit on shortwave, today's primary source for global weather information is the fantastic Internet. This comprehensive reference guide lists meteorological information sources from all over the world. The cheapest and most up-to-date handbook on the very latest worldwide meteo data. Includes hundreds of sample charts, diagrams, graphics, and images!

RADIO DATA CODE MANUAL

state-of-the-art digital data analyzing and decoding!

788 pages · £ 29 or DM 80 (worldwide postage included)

The most up-to-date and comprehensive reference book available today! Covers aeronautical and meteorological codes and telecommunications, modulation types, teleprinter alphabets, modern digital data transmission systems, cryptography, intelligence and secret services, and the great new Unicode global standard for all exotic scripts worldwide. This unique book includes many fascinating Internet websites and dozens of superb screenshots taken with equipment on the cutting edge of technology!

SHORTWAVE COMMUNICATION RECEIVERS 1945-1997

more than 770 SW receivers - past and present!

500 pages · £ 35 or DM 100 (worldwide postage included)

Dramatically improved coverage of European radio manufacturers! With this massive volume in large A4 size, expert author Fred Osterman, Manager of Universal Radio from America, covers virtually everything - from Allied to Yaesu - that has ever been, or currently is, on the worldwide market, with many interesting exotic models and hundreds of variants being included as well. Complete with pictures, this book provides the radio hobbyist with precise information on the features, performance, prices, and specifications of current and former table-top receivers. Brandnew third edition - published May 98!

Plus: 1998 Guide to Utility Radio Stations = £ 29. 1998 Shortwave Frequency Guide = £ 18. 1998 Super Frequency List on CD-ROM = £ 21. Double CD Recording of Modulation Types = £ 36 (cassette £ 21). **Package deals available!** Sample pages and colour screenshots can be viewed on our extensive Internet homepage (see below). We have published our international radio books for 29 years. Payment can be made by cheque or credit card - we accept American Express, Eurocard, Mastercard and Visa. Dealer discount rates available on request. Please ask for our free catalogue with recommendations from all over the world! ©

Klingenfuss Publications · Hagenloher Str. 14 · D-72070 Tuebingen · Germany
 Fax 0049 7071 600849 · Phone 0049 7071 62830 · E-Mail klingenfuss@compuserve.com
 Internet <http://ourworld.compuserve.com/homepages/Klingenfuss/>

MOONRAKER

SUPER DISCONE
 25-2000 MHz with Centre Radiator.
£39.95 ADD £6.00 P&P.

SWP HF30 FREQ. 0.05 - 2000 MHz.
 SPECIALLY DESIGNED FOR HF USE Length 770mm. Comes complete with 4 mts. of quality coax and BNC connector.
£39.95 ADD £6.00 P&P.

SWP 2000 FREQ. 25 - 2000 MHz.(MULTIBAND)
 Length 515mm. Comes complete with 4 mts. of quality coax and BNC connector. **£29.95** ADD £6.00 P&P.

SWP 100 FREQ. 100 - 150MHz.
 (AIRBAND) Length 395mm. Comes complete with 4 mts. of quality coax and BNC connector. **£26.95** ADD £6.00 P&P.

SWP 150 FREQ. 150 - 160MHz.
 (MARINEBAND) Length 395mm. Comes complete with 4 mts. of quality coax and BNC connector. **£26.95** ADD £6.00 P&P.

DISCONE This is designed for external mounting it is an excellent all rounder with receiving Freq. from 70-700 MHz. HEIGHT 920 mm.
£24.95 ADD £6.00 P&P.

H.F.DISCONE
 0.05-2000 MHz. Designed at 1.6 MHz With Centre Radiator
£69.95 ADD £6.00 P&P.

SUPER SCAN STICK BASE
 0-2000 MHz. This is designed for external mounting on a pole, it will receive all Freq. at all levels unlike an omni antenna. It has 4 capacitor loaded coils inside the vertical receiver to give maximum sensitivity to even the weakest of signals.
 HEIGHT 900 mm.
£29.95 ADD £6.00 P&P.

MOONRAKER (UK) LTD. UNIT 12, CRANFIELD ROAD UNITS, CRANFIELD ROAD, WOBURN SANDS, BUCKS MK17 8UR.
 TEL: (01908) 281705. FAX: (01908) 281706.

LEICESTER AMATEUR RADIO SHOW COMMITTEE PRESENT THE

27th LEICESTER AMATEUR RADIO SHOW

at a new venue

CASTLE DONINGTON INTERNATIONAL EXHIBITION CENTRE
 near junction 23A M1 motorway & East Midlands International Airport

on

Friday 25th & Saturday 26th SEPTEMBER, 1998

Direct bus services from Barnsley, Bradford, Leeds, Leicester, Sheffield, Loughborough, Milton Keynes, Nottingham and Wakefield to East Midlands Airport. Free shuttle bus from airport to exhibition hall.

Nearest railway stations: Derby and Loughborough on Midland Mainline from Leeds, Sheffield, Wakefield, Kettering, Wellingborough, Luton, Bedford, London (St. Pancras) and the continent. Central trains from Birmingham and the South-West serve Derby also. Central trains from Cambridge and the East serve Leicester. Air flights from the UK and the World via the British Midland Airways link from Schipol Airport, Amsterdam, Holland.

ALL THE USUAL FEATURES BUT EVEN BIGGER THAN EVER. 150 STANDS, A CONVENTION AND FLEA MARKET.

For stand and table bookings contact John Theodorson, G4MTP.
 Tel/Fax: **(01604) 790966** E-mail: G4MTP@lars.org.uk
 For further details contact Geoff Dover, G4AFJ.
 Tel: **(01455) 823344** or Fax: **(01455) 828273**

or see our internet site <http://www.lars.org.uk> with maps and all sorts of information on how to reach the show and all its features.

MULTICOMM 2000

WORLD WIDE MAIL ORDER LARGE SHOWROOM
FINANCING AVAILABLE

10% DEPOSIT
NEW OR USED
EQUIPMENT

★ ★ ★ **RECEIVERS** ★ ★ ★

LOMBARD
CHARGE CARDS
ACCEPTED



YAESU FT-847

This is the most remarkable set available today. Full DSP, all mode, 100kHz-460MHz. Tx disabled.
OUR PRICE £1599.00
or 36 mths @ £52.22

JRC NRD-545

This receiver is set to take the market by storm. Rave reviews. DSP as standard. 1000 memories, all mode, high sensitivity and wide dynamic range.
OUR PRICE £1549.00
or 36 mths @ £50.59



KENWOOD TS-570D

This set started life as a transceiver. We disabled the transmit so that it would be legal for use as a short wave receiver. Full DSP technology, all mode. GREAT VALUE!
OUR PRICE £999.00
or 36 mths @ £32.63

JRC NRD-345

This smart little set is JRC's entry point into the receiver market. It features synchronous detection as well as all mode.
OUR PRICE £669.00
or 36 mths @ £21.85



REALISTIC DX-394

Excellent value for money. Covers 150kHz-30MHz. AM CW & SSB.
SPECIAL PRICE £145.00

AOR AR7030

The receiver you LIKE or DISLIKE. We don't consider this to be a beginner's receiver.
OUR PRICE £679.00
or 36 mths @ £22.18



YAESU FRG-100

GREAT beginner's receiver. Easy to operate. GREAT VALUE for money. 50 memories. 50kHz-30MHz. 2 year guarantee with PSU.
OUR PRICE £425.00
or 36 mths @ £13.88

DRAKE SW-2

LOW COST American made short wave receiver. Synchronous detection. 100 memories. 100kHz-30MHz easy tuning.
OUR PRICE £459.00
or 36 mths @ £14.99



DRAKE R8-B

Drake's latest flagship, all mode. 100kHz-30MHz. 1000 memories, notch filter. Great performer.
OUR PRICE £969.00
or 36 mths @ £31.65

ROBERTS R-861

All mode, short wave plus VHF portable receiver. RDS. AM narrow filter, stereo.
OUR PRICE £165.00



FINANCE
ARRANGED

FINANCE
ARRANGED

APR
19.9%

FINANCE
ARRANGED

FINANCE
ARRANGED

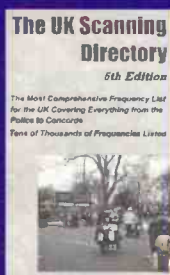

6th UK
Scanning
Directory

£18.50



Ferrells
Confidential
Frequency
List

10th edition
£19.95

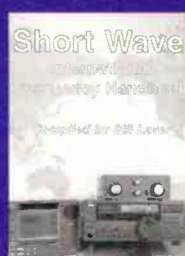

Short Wave
International
Frequency
Guide

£12.95

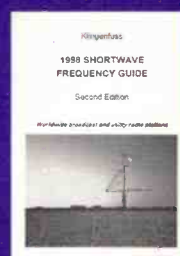

1998
Frequency
Guide

£23.00

SALES HOTLINE

01480 406770

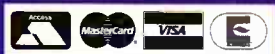

★ ★ ★ SCANNERS ★ ★ ★



ICOM IC-R8500
100kHz-2GHz continuous. All mode. No gaps. 1000 memories. 4 IF band widths. Alpha numeric display. Probably the best all round set in its class. Direct PC interface. Keypad entry.

OUR SPECIAL PRICE
£1399.00

or 36 mths @ £45.69

AOR AR5000
10kHz-2GHz. All mode. 1000 memories DTMF decoder. Direct PC connection. 45 channel per sec scan speed. This receiver has it all in one.

OUR SPECIAL PRICE
£1189.00

or 36 mths @ £38.83



BEARCAT 9000XLT

An amazing receiver at an amazing price. 25-1300MHz. 500 memories. Alpha numeric display. 100 channels per sec scan speed. Auto store AM/FM selectable.

OUR SPECIAL PRICE
£229.00

or 36 mths @ £7.48

AOR AR3000A
A great value for money receiver covering 100kHz-2036MHz. 400 memory channels. Multimode. Direct PC connection. The full frequency spectrum coverage.

FOR ONLY £645.00

or 36 mths @ £21.07



**ALL UNITS
"CE"
APPROVED**



ICOM PCR-1000

For something a little bit different, this PC controlled multimode super-wideband receiver offers incredible value for money. Now available with DSP.

OUR SPECIAL PRICE £325.00

or 36 mths @ £10.61

**ONE STOP
SPECIALIST
SHOP**

★ ★ ★ HAND-HELDS ★ ★ ★



YUPITERU MVT-9000EU

The best full range all mode hand-held scanner ever produced.

OUR PRICE
£319.00

or 36 mths @ £10.42



AOR AR8000

Popular 1000 channel scanner. (Not for the beginner).

OUR PRICE
£269.00

or 36 mths @ £8.79



ALINCO DJ-X10

Our favourite. All mode full frequency coverage scanner. 100kHz-2000MHz.

OUR PRICE
£259.00

or 36 mths @ £8.46



YAESU VX-1R

Amazing miniature set
TX disabled by us.
76-999MHz

OUR PRICE
£235.00



YUPITERU MVT-7100

The greatest value for money scanner ever produced.

OUR PRICE
£199.00



AOR AR8200

Latest release from AOR. ORDER YOURS NOW!

OUR PRICE
£345.00

or 36 mths @ £11.27

**USED EQUIPMENT ALWAYS
WANTED!**

**PRICES DO NOT INCLUDE P&P BUT
THEY DO INCLUDE VAT**

UNIT 5-7, 86 CAMBRIDGE STREET, ST. NEOTS, CAMBS PE19 1PJ
FAX: 01480 356192 SALES HOTLINE 01480 406770
EMAIL: Sales@multicomm2000.com WEBSITE: www.multicomm2000.com

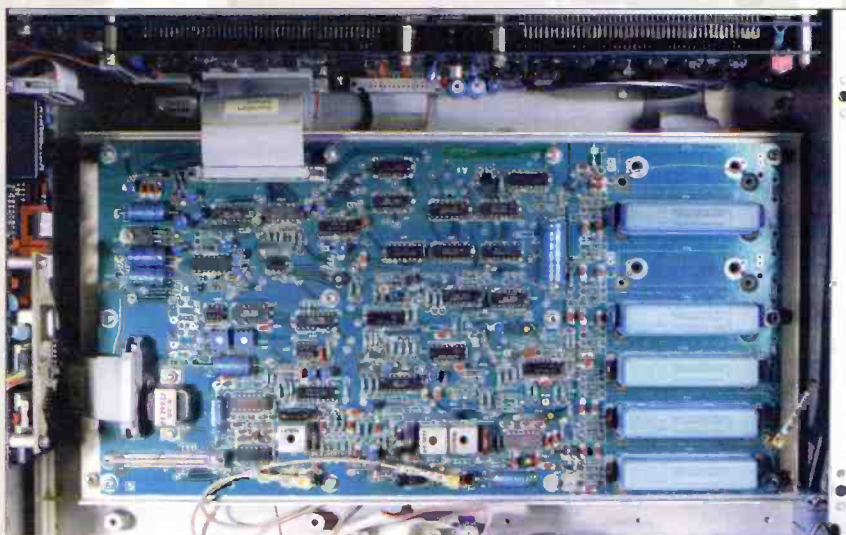
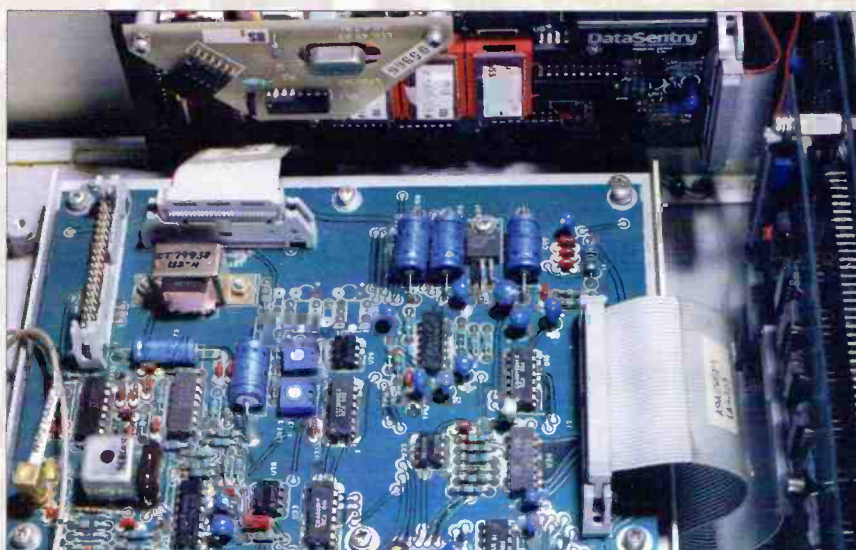

the mode parameters, a board mounted d.i.l. switch S1a located on the front panel memory board must be temporarily set to the CLOSED position. If this switch is permanently left in the CLOSED position, then the pre-set mode parameter facility is inhibited.'

All well and good, but in order to find S1a you have to remove the receiver from its cabinet or rack mount, take off the top cover, find the DIL switch which is not one switch but a bank of three, and then discover by casting the runes that you do not move one of the three switches but two - and which two? after which you can set the mode parameters to your choice and reset the switches, restore the top cover to the receiver, the receiver to its cabinet, and resume listening.

No it's not ideal, but this is after all a professional receiver and I'm testing it in a hobby environment.

Perfect Filters

I imagine that the RA1792 can appear with different i.f. filtering depending on its original application, but the sample I had contained what for me was a perfect set of filters, 300Hz, 1kHz, 3kHz, 6kHz and 16kHz. When I had the lid off locating the mysterious S1a I noticed with approval that the i.f. filters were all top specification Collins mechanical types, so it did not surprise me to find that the receiver performed

superbly under real listening conditions.

Do I prefer this traditional approach to Digital Signal Processing (DSP)? You bet your life I do, the receiver was a joy to listen to whatever the mode and whatever the band conditions, and the recovered audio was smooth and sweet in all modes, helped by the excellent a.g.c. system which is a proper 'hang' type where the a.g.c. 'hangs' to the end of a predetermined period before restoring full receiver gain.

For listening to nets on 80m or air traffic on s.s.b. the long time constant is perfect because it effectively removes the background noise between transmissions, whilst the intermediate and short time constants fit well with other modes. Single sideband also sounds excellent because the u.s.b. and l.s.b. filters are fitted as a matched pair, as is common practice in this class of receiver, and the filter shapes are not symmetrical, falling from -6dB to -60dB in 650Hz on the carrier side of the filters but falling in 1.1kHz on the other slope of the passband.

This has the effect of improving rejection of residual incoming carrier and better low frequency audio recovery, and is largely a requirement brought about by the need for professional receivers to operate in ISB (independent sideband) mode in which the upper and lower sidebands of a common suppressed or reduced carrier are actually carrying different audio information.

The presence of these filters in the RA1792 make ECSS listening to a.m. signals very pleasant indeed because of the better low frequency response obtained and the fact that switching between sidebands on the same signal is perfectly balanced. If you happen to have the optional ISB unit fitted then the situation is even better, but I didn't have this so can't comment further.

Bandwidth selection is available at the touch of a key on the keypad, and in s.s.b. modes you have an i.f. shift facility which works well but sadly not in other modes. Now to r.f. performance. I approached the RA1792 with some awe because of its renowned superiority, and soon realised that this was a remarkable performer. Figures are as follows, and I have normalised the intermodulation measurements for direct comparison with all my previous reviews.

Sensitivity measurements were taken at 14.200MHz, and 3rd order intermodulation measured at 20kHz signal spacing 14.038MHz and 14.058MHz. FM sensitivity was measured with 3kHz deviation at 1kHz modulation

frequency whilst a.m. sensitivity was measured with 60% modulation at 1kHz.

Sensitivity Measurements

See tables (right).

Third order intercept point was +37dBm after normalisation, and 2nd order intercept point using my standard frequencies of 6.5MHz and 7MHz, resolving the intermodulation product at 13.5MHz was +74dBm.

Phase noise performance measured using a wanted signal giving 12dB SINAD and introducing an unwanted signal at a level which degraded the wanted by 3dB. 3kHz bandwidth in u.s.b. mode.

What does all this jargon tell you? It shows that the RA1792 is a terrific h.f. performer, as one would expect considering its pedigree. The 3rd order intercept is way above anything on the current hobby market, with only the AOR AR7030 coming close, whilst the 2nd order intercept shows the effects of a non preselection front-end, but with a modest tuned preselector ahead of it the RA1792 would be very good indeed.

The reciprocal mixing performance which shows the cleanliness of the synthesiser was bettered by the dear old R-820, but the R-820 benefited from being a limited coverage receiver with a PLL for each band, whereas the RA1792 is a wide range general coverage design, so no black marks need be given.

Monkey Chatter

What about the 'monkey chatter'? I obviously had to take a listen to the BBC on 909kHz and compare audible results with those obtained using other receivers, and my feeling is that the conventional filtering of the RA1792 produces cleaner audio with less of the off-carrier chatter, but it isn't outstandingly different.

Two things spring to mind, firstly that the ultimate stop band rejection of the mechanical filter is probably better than that of a d.s.p. system - look at typical d.s.p. responses in works such as Ulrich Rohde's book on receiver design.

Secondly, and this may explain why the RA1792 didn't seem overwhelmingly better, all JRC receivers pre NRD-545 used a homodyne type of a.m. detector in which the incoming a.m. signal was passed through a limiting amplifier to effectively strip off the modulation component and the resultant carrier then used in an s.s.b. detector to demodulate the non-limited a.m. signal.

Because the 'carrier' used in the demodulator is the actual incoming carrier, no heterodyne beats are produced, so most operators never realise that an s.s.b. demodulator is being used. It was interesting to find that Racal have used a homodyne detector in the RA1792, and if by chance the JRC a.m. decoding algorithm in the NRD-545 is intended to reproduce the effect of a homodyne detector so as to maintain JRC previous practice, could it be that the common denominator in all this 'monkey chatter' is the use of a homodyne?

A further thought (and I'm simply thinking aloud) is that I don't know how a homodyne detector behaves when a) the receiver is off-tuned from the carrier, and b) the depth of amplitude modulation is as high as that produced by the 'Optimod' type of processor used in broadcast transmissions, bearing in mind that Optimod can achieve greater than 100% modulation on positive modulation peaks. Please discuss, and have your reports on my desk by next month!

Satisfying To Use

But back to the RA1792. What more can I say? This is a receiver which is incredibly satisfying to use, even

though some of the operational facilities are clearly designed for professional, probably unattended use, and yet it performs with such easy grace that it is a delight.

At its original price on the market it was good value for money, but with its current price at around £1000 it is a bargain. And yet - there has to be a caveat.

There are specimens of the RA1792 around which are not all that they seem, and it is good advice to check very carefully before parting with money to ensure that all the necessary filters are fitted, that the i.c.d. display units are working on all segments, and that the receiver is in every way complete and original.

Many years ago RCA produced a receiver designated the AR-8516L, and in the middle of production something happened which resulted in the receivers being sold out on to the disposal market. If you managed to get hold of a complete example you had a good receiver, but oh dear, there were many incomplete units around which were cobbled together into 'working order' by unskilled technicians, and these were simply awful. Similarly, a release of Collins R-390s on to the surplus market resulted in many stories of heartbreak when it was discovered by unfortunate owners that the i.f. strips had been 'decommissioned' by the US Government by driving sharp instruments into the i.f. sections and wrecking the unobtainable i.f. transformers.

Fault Indicator

Earlier on I mentioned the 'fault' indicator and remarked that it was a good thing it never appeared during my brief operating sessions. Assuming that you are fortunate enough to obtain a working sample of a receiver like the RA1792, you must seriously consider what you will do should it go faulty and require service or spare parts.

If, like me, you are skilled and experienced enough to carry out repairs to a reasonable standard, fine, otherwise be careful. When you enter the world of professional service and spares you are potentially stepping into a very expensive environment, and you must be prepared for some lip-licking prices.

The silver lining to the cloud is that receivers in this category are designed to work without failure for a very long time, but they are coming up for 20 years old, so don't say I didn't warn you.

The bottom line is this: I want an RA1792 for myself, but the owner of this immaculate specimen won't sell it to me. What's even worse is that he also owns the receiver which will be the subject of a future review which promises to be even more impressive - and he won't dispose of that one either. Mind you, I could always refuse to let them go...

Anyone want an immaculate Collins 515-1?

Happy listening!

Sensitivity Measurements

Mode	dBm for 12dB SINAD	Filter Bandwidth (Hz)
SSB	-123	3000
AM	-114	6000
	-117	3000
CW	-126	1000
	-132	300
FM	-120	6000
	-118	16000

Phase Noise Performance

Spacing from wanted signal		Reciprocal mixing ratio dBc/Hz
(kHz)	(dB)	
+5	70	104
+10	84	118
+20	95	129
+50	103	137
+100	108	142

"When you enter the world of professional service and spares you are potentially stepping into a very expensive environment"

SWM

short wave magazine

all the
Regulars

On sale 24th September

* contents subject to change

BROADCAST

Coming in October SWM

Next Month is our
Broadcast Special...

Toroids, Binoculars, Rods & Beads -

More on Ferrites in Part 2 by Joe Carr.

In Part 2 of Commercially Speaking, John Wilson reviews the
Plessey PRS 2280 h.f. receiver.

Receiving Loop Antennas.

Commtel COM214 Reviewed.

Build a Loop Antenna for the h.f. bands.

and much, much more.

...Miss it, Miss out!

Amateur **ARC** Radio Communications **ARC** Ltd

TUE TO SAT
10AM-5PM

Our shelves are bulging with good quality secondhand scanners and receivers, all checked out before being offered for sale. Phone now for details!

Tel: 01925 229881
Fax: 01925 229882



ICOM PCR-1000

Icom's new computer RADIO SYSTEM will turn your PC into a wide band receiver.

Now in stock! £349.00 TEL FOR ARC PRICE



AOR 3000A

Now down in price

100MHz-2035MHz plus lots of extras including an RS-232 interface for computer control. Remember the saying 'all good things come in small packages', well, the AOR 3000A proves it's true.

Now at the new RRP £699.00

PHONE NOW FOR OUR SPECIAL PRICE!



BEARCAT UBC-220XLT

- ★ 66-956MHz (with gaps)
- ★ 200 memories
- ★ Supplied with nicads & charger. £189.95 RRP

**SPECIAL ARC
PRICE £159.00**

YUPITERU MVT-7100

This handheld not only covers up to 1650MHz but the complete short wave band and the medium wave band as well. Plus SSB feature. Now you get all modes and all bands. £249.00 RRP

TEL FOR ARC PRICE

BEARCAT UBC-9000XLT

Excellent value for money base stations scanner. Coverage 25-1300MHz, 500 memories, auto store, selectable mode, turbo scan, alpha numerical facility. £325.00 RRP.

ARC PRICE £249.00

NOW IN STOCK THE NEW

AOR £200

- ★ 530kHz-2040MHz
- ★ All mode reception
- ★ Steps from 50Hz upward including 8.3kHz
- ★ Pre-selected front end
- ★ 1000 memories
- ★ Plus lots more

PHONE FOR ARC PRICE

TARGET HF3



- ★ Coverage 30kHz-30MHz
- ★ 1kHz steps with clarity
- ★ Audio output 2 watts

- ★ Fully synthesised employing a phase lock loop VCO to ensure stable and accurate signal reception
- ★ Headphone socket

£159.00 RRP

S.R.B.R.

We also carry the complete range of short range business radios (SRBR) - Icom, Kenwood, Motorola. Ideal for small businesses who require communications up to 1 mile radius.

From £169.00 + VAT. Phone now for details!

UK Scanning Directory	£18.50 + £2.00 P&P
Howes CTU-8 Antenna tuning unit.....	£49.90
Watson QS-400 Adjustable holder.....	£9.95
Watson WSM-1900 Antenna & magmount.....	£29.95
Ferrells Confidential Frequency List.....	£19.99
Scanmaster Base antenna.....	£39.95
Scanmaster Discone.....	£49.95

INSTANT FINANCE AVAILABLE at low **APR** rates

ACCESS ★ VISA ★ SWITCH - ALWAYS WELCOME FREE PARKING AVAILABLE

**38 Bridge Street, Earlestown,
Newton-le-Willows,
Merseyside WA12 9BA**

RIGS OF DISTINCTION

~~Credit Cards~~ G3RCQ & SON ~~Finance~~

WE BUY AND SELL HAM GEAR

We don't give interest free credit, we don't take credit cards. We do, however, **SELL GOOD GEAR AT REASONABLE PRICES.**

40 years of buying and selling gives G3RCQ a wealth of knowledge. If you are selling a TCS12 or a BC348 to the latest state of the art gear think G3RCQ.

Having won the lottery several times over funds are unlimited - CASH is always available for your gear WORKING, BROKEN, OLD or NEW. It makes sense to phone Dave, Maree or Michael, the family team, for the best deal in the universe. OK, OK, I know it's corny but you're reading this and more importantly I want you to remember G3RCQ is the GENTLEMAN DEALER of the amateur radio world.

CALL DAVE G3RCQ ON:

Showroom (01708) 374043

Mobile (0956) 854947

Pager (01523) 133511

E-mail: radiog3rcq@compuserve.com

New Radio Books



The UK Scanning Directory

This new 6th edition covering 26MHz to 1.8GHz and continues to amaze everybody. The tens of thousands of frequencies include Civil and Military Aviation, Army, Navy, the largest Police list ever published, D55 Snoopers, GCHQ, Eye-in-the-Sky Links, Bailiffs, Prisons, Motor Racing, Universities, Railways, Couriers and many more we dare not mention. Separate parts cover the Civil Aviation Band and European frequencies for Dxers. This book remains Britain's largest and best selling scanning directory, the undisputed leader in the field. No other book dares to list so many frequencies and in such great detail.

Price: **£18.50** + £1 UK post. For Europe add £3.25, elsewhere £7.50.



North Atlantic Flight Communications

Plot trans-Atlantic flights with your HF radio and computer. Enter the flight details and watch in real time as the program plots the flight's progress across the North Atlantic on high resolution charts. The accompanying large book clearly explains all the procedures from filing the flight plan right through to landing at the destination and describes the radio communications system in depth. Software requires IBM/PC. Please state if you require to run it on Windows95 or 3.1.

Price: **£15.00** + £1.25 UK post. Postage for Europe add £2.25 or £5 airmail to other destinations.

Scanner Busters 2	£5.00
Scanning The Maritime Bands	£9.50
UK Scanning Chart	£3.00
Shortwave Maritime Communications	£15.50
100 Years of Maritime Radio	£41.50
Shortwave Receivers Past & Present - New 3rd edition	£18.95
Audio Guide to the Sounds of Shortwave	£4.95
Shortwave Eavesdropper CD ROM	£16.50
Fax, Satellite and RTTY Weather Reports	£11.50
Weather Reports from Radio Sources	£7.50
Mobile Phones - The Tricks of the Trade	£18.75

The above books include UK postage



Ask for free catalogue. Allow 14 days delivery



INTERPRODUCTS (SW98)
8 Abbot Street, Perth PH2 0EB, Scotland

Tel & Fax: (01738) 441199

E-mail: interproducts@netmatters.co.uk

Wavecom W41PC Review

Dave Gentile has been a W41PC owner for the past three months. Here he shares his thoughts on the decoder.

Fig. 1: A Russian QPSK on 7832.08kHz. Notice the 'smooth' spectral appearance, this is the result of a 'randomiser' being added to the bit stream.

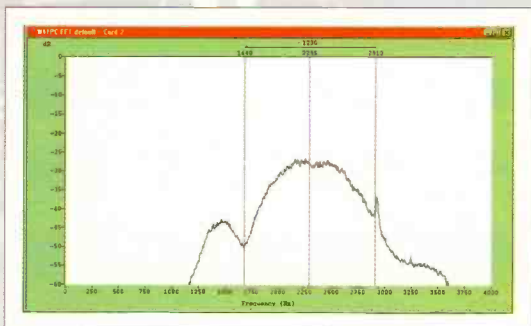

The W41PC is an Analogue-to-Digital (A/D) converter that will allow users to decode a majority of the signals currently found in the h.f./v.h.f./u.h.f. spectrum (mostly h.f., and all non-encrypted).

How Does It Work?

The W41PC has three inputs: a.f., h.f. and i.f. (all BNC). The a.f. (Audio Frequency) input takes the 4kHz output from a receiver's phono or DB-9 "mini" jack. The h.f. (High Frequency) input takes the 455kHz output from a receiver. This output is only available on certain receiver models.

The i.f. (Intermediate Frequency) input takes the 10.7MHz output from a receiver. This output is only available on certain receiver models (normally v.h.f./u.h.f. receivers and scanners).

Whatever the input, the incoming signal is "sampled" at 48kHz, which allows for a maximum Fast Fourier Transformation (FFT) bandwidth of 24kHz without signal degradation. This sampling process takes the analogue signal and turns it into a digital (1 or 0) signal. Wavecom engineers state that the decoder can sample at a rate of 96kHz, but that rate has not yet been implemented in the software.

The now digital signal (constantly being sampled from the analogue input) is scanned for purposes of analysis and decoding.

First Impressions

When I first looked at the decoder board, I was quite impressed with it. A very professional looking product indeed. I was equally impressed with the user manual. It was very well organised and packed with tons of useful information (each signal had at least a page dedicated to it).

I quickly installed the board and powered up my 200MHz Pentium PRO4. I inserted BNC to RCA type plugs onto the three W41PC inputs and hooked the appropriate cables to my h.f. (Kenwood R-5000) and v.h.f./u.h.f. (Icom IC-R7000) receivers. I then started installing the software (from two 3.5in 1.44Mb disks).

The software is Win-95 Graphical User Interface (GUI) based and installed using the standard installation 'wizard'. The installation instructions in the user manual were spot-on and I had absolutely no problems with setting up the W41PC card.

After you have successfully installed the software, the interface is "downloaded" (this takes about 15 seconds). I was now looking at the main operation screen of the W41PC software. The interface is uncluttered and very

easy to understand if you are already used to using Win-95.

I first had to select a valid W41PC card before I could actually begin doing anything. This was easily done and I was now ready to go.

The first thing I did was check each of the three inputs (a.f./h.f./i.f.) to ensure that they were working properly. I powered up my R-5000 and tuned up a signal. I then started the 'FFT mode' (this was done by simply clicking the FFT button). I clicked the demodulator button (a sub-function of the FFT Mode) and chose 'AF'. I was greeted by a 4kHz wide screen that displayed the incoming signal.

I was able to quickly get the idea of what functions were available to me, and I chose an average of '20' to slow down the FFT display. This allowed me to clearly see the frequency components of the signal. I will go into further detail of the FFT screen later.

I next went to the 'Signal Analysis mode'. This mode actually does three things:

1) It shows the detected baudrate of the signal (note: when using this function on asynchronous teleprinter systems with 7.5 bits, the actual baudrate will be one-half of the indicated baudrate). This function is similar to the Code-3/30's shift-speed measurement module. You can select an 'average' or 'peak' display and you can zoom 1000 or 500 baud (for precision measurements).

2) It displays a 4kHz spectrum (basically the FFT mode again, but now the signal is sampled for several seconds providing for a 'snapshot' of the signal's frequency components). You can select an 'average' or 'peak' display and you can also zoom in 1000Hz and 500Hz (for precision measurements).

3) Alongside the baudrate and spectrum displays, are 'waterfall' displays. These are zoomed when you zoom the adjacent baudrate/spectral display. You can also select several colour schemes (like 'HOT', 'COLD', 'COPPER' and 'RGB').

I was initially impressed with these two analysis modes.

Lastly, I went to the "Code analysis" screen. This mode takes the parameters that were determined in previous modes and performs a correlation bit analysis against it (basically it checks the cycle length of the signal against a table set into the software - it then selects the most likely candidates).

Again, asynchronous systems threw this mode off, you must know to choose the correct baudspeed. It is with this mode that I have a few complaints:

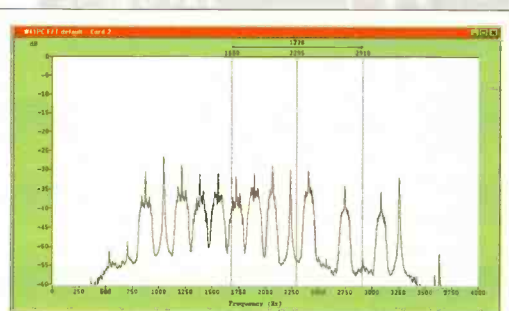

Fig. 2: Here is a nice shot of a multi-channel VFT system. You can easily see the number of channels present.

1) If you find a new signal, you **cannot** find out what the cycle length is because no such analysis function is built into the software (at least not yet).

2) The code analysis function only works with about 90% of the h.f. modes that the W41PC can decode and none of the v.h.f./u.h.f. systems.

Because the signal I was monitoring was asynchronous, I had to manually select the 'baudot' module (if you change the baudspeed to its asynchronous rate, then the W41PC will 'figure out' that the signal is indeed RTTY). This brought up the actual decoding screen (if the W41PC determines the mode, then it will automatically jump to the proper decode module).

Assuming you follow the steps I outlined above, (FFT mode, Signal Analysis mode, Code Analysis mode) you should not have any problems with decoding the monitored signal (all the optimum decoding parameters are auto-selected by the W41PC). If you jump directly to the decode screen, by-passing the FFT and signal/code analysis modules, then you must manually set all of the various demodulator options (shift/centre/demod, etc.).

I would like to point out **one very big advantage** to the W41PC's decode modules - a **Timestamp** feature! This is very well implemented, and really gives the user unprecedented analysis opportunities. Just make sure your system time is correct. Otherwise that guy who you thought started sending at 12:00:00pm might be stamped 06:15:17!

I now began testing the h.f. and i.f. inputs. Although I do not have a 455kHz output on any of my receivers, I was able to take my R-5000's a.f. output into the W41PC's h.f. input.

I saw a display similar to the a.f. display, but it was weaker and did not properly drive the board. I would recommend that you do not use the h.f. input unless your receiver specifically outputs at 455kHz.

On testing the i.f. input, I had quite a bit of a problem! Although my Icom IC-R7000 had a 10.7MHz output, it hardly drove the card at all! Luckily I was able to find another user who gave me some instructions that allowed me to cut the 12V wire that was being fed to the 10.7MHz output. (Thanks Fabrizio!). This modification allowed me to use my R-7000 with the W41PC card well enough to get the modes associated with the i.f. input to work.

Simply put, my first impression was a good one.

1) Nyquist rule - sampling must be at 2x the highest modulated frequency.

2) A higher sampling rate will allow for a larger FFT bandwidth.

3) The board fits into a free 16-bit ISA slot. Depending on your computer's casing, you may have to make some adjustment to get the BNC outputs to fit comfortably against the frame. I actually had to 'cut' the back of my casing so I had a snug fit. Others filled down their casing.

4) Note: A 100MHz (or higher) Pentium processor is the suggested minimum processor for using a W41PC card.

5) The software is capable of controlling up to 8 W41PC cards (it is strongly suggested that if you actually have more than four cards installed, that you use *Windows NT 4.0* as your operating system).

6) Only works on h.f./f.s.k. based systems. On v.h.f./u.h.f. systems you have to guess what system is being used.

7) The 12V voltage on the i.f. output is used to supply power to the external TV adapter. If you don't own it, then you can safely cut this wire without degrading the receiver's performance.

8) Owners of the Icom IC-R7000 will need to build a small general purpose amplifier and connect it to the 10.7MHz output to properly drive the W41PC card.

After several weeks of 'testing' the W41PC, I had a pretty good feel for the software interface. Here are some of my observations.

The FFT Mode

I was originally pretty dismayed with this mode - it appeared that it was simply a 4kHz spectrum without a whole heck of a lot of uses outside of tuning. I was wrong!

One of the first things that you need to do, before you begin logging anything, is to discover your receiver's centre freq. The reason for this is one-fold: you simply will not know if your signal is properly tuned to its true frequency without doing this!

You do not actually have to have your signal tuned at all, because the W41PC **automatically** senses where the signal is, and properly adjusts all of the main parameters for optimum decoding, **but** your signal will be off-tuned.

So what you do is tune up to a known frequency and then move the 'tuning cursors' until they give you the measured centre frequency. This centre frequency is the centre frequency of your receiver's filter.

For example, I tuned up to 252kHz, which is an a.m. station here in the UK, and selected the 'FSK' filter on my receiver. This gave me a nice steady tone (the a.m. carrier) with which I could use to find my FSK filter's centre frequency (each of your receiver's filters must be separately tested to find their centre frequencies).

I adjusted my tuning cursors until they were centred over this tone. When I read the centre frequency it stated 2290Hz. Now when I tune up a signal to 2290Hz in the FFT mode, I know that it is properly tuned to its true frequency.

So what else does the FFT mode do? For VFTs it is a dream come true! You can easily centre the entire signal into the FFT's window. Select the bandwidth you want: 0.5, 1, 4 or 24kHz and tune from there. I selected the 4kHz bandwidth and centred the VFT in the middle of the window.

I set my averaging factor to 60. You can set it anywhere from 1 (the screen is constantly refreshed) to 64 (the screen is refreshed as an average factor of 64). I now selected the type of 'window' I wanted. You can choose 'rectangle', 'hamming', 'hanning' and 'blackman'.

For simplicities sake, I will not go into what each window type actually does (the real tech heads reading this will probably be salivating over this info). I choose the 'rectangle' option. I could now very clearly see the seven active channels and the pilot tone.

Using the tuning cursors, I could easily measure the entire bandwidth of the signal (2.4kHz - accurate to ± 8 Hz in a 4kHz spectrum), the location of the pilot tone (3310Hz), and the number of channels present (7). I now tuned in the first channel and I moved the cursors (using the mouse) so that they were spaced evenly on either side of the channel and then I zoomed to a 500Hz spectrum (you must input the centre frequency of the channel you are interested in before you zoom, otherwise the W41PC zooms to the last input centre frequency).

I could take a very

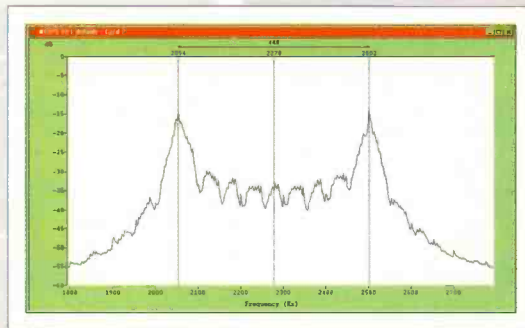

Fig. 3: A close-up of a 50 Baud, 450Hz shift, teleprinter. Measurements of ± 1 Hz can be taken using the Real-Time FFT Analysis module.

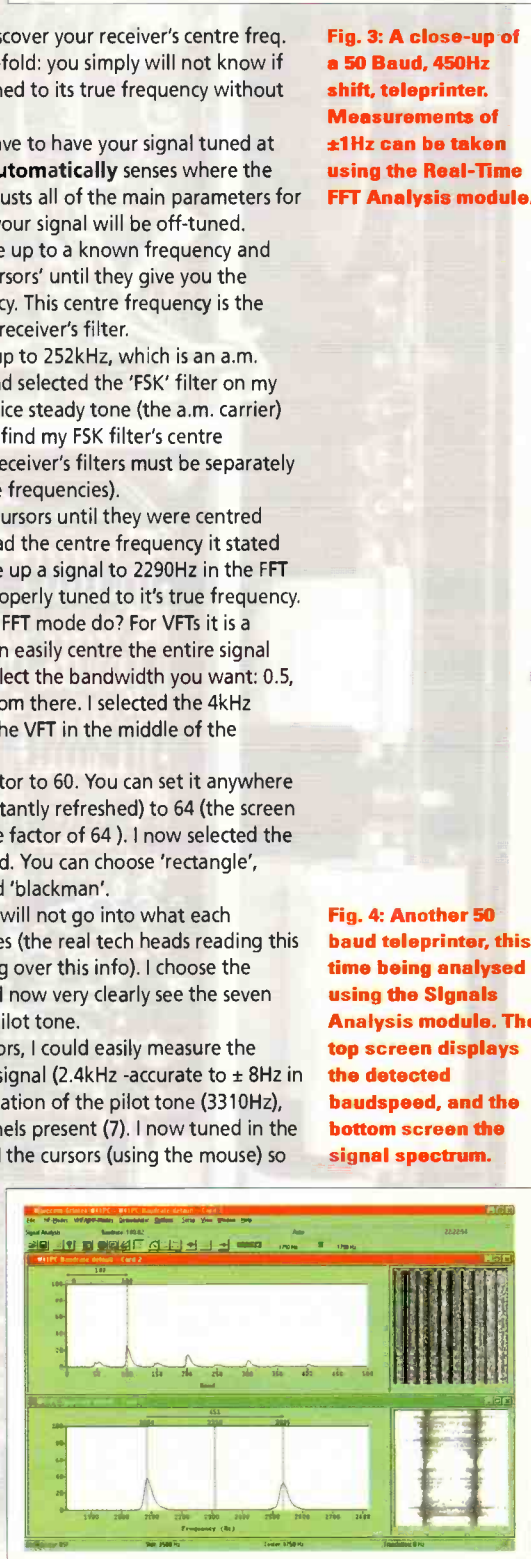

Fig. 4: Another 50 baud teleprinter, this time being analysed using the Signals Analysis module. The top screen displays the detected baudspeed, and the bottom screen the signal spectrum.

In the end, the W41PC is a double edged sword: it is expensive but it has potential. At \$4000 USD it is \$1500 more than a Hoka Code-30 and much much more expensive than anything less. On the other hand, it is relatively inexpensive compared to 'professional grade' products such as the 'ELVIRA' system from Applied Signal Technology (\$10000+ USD).

So what makes a very happy Code-30 user buy a WAVECOM W41PC (besides the fact that I did not need another Code-30)? Potential! The W41PC board is cutting edge technology.

It certainly has the potential to become the successor to the Code-30 within the next two years. That coupled with the capability to control up to 8 W41PC cards in one Win-NT Pentium computer gives users an unprecedented flexibility. The designers at WAVECOM have some really **big** ideas for this, their mainstream flagship product.

The following modes will be added as soon as possible: FELDHHELL, SSTV and BULG-ASCII (this would be cool!!!)

Modes that are being discussed: PACTOR-II, HF-ACARS, ALIS-II, CIS-36, FLEX, FAX G2/G3 (HRPT signal, 2048 pixels/line), CALSEL, CODAN and TETRA.

It is planned to add following analysis tools for the h.f. modes: 3D-Waterfall, Oscilloscope, Autocorrelation, FSK Signal Analysis, MFSK Signal Analysis, Bit Analysis, Bit Analysis F7B, Bit Length and Raw FSK Data.

And following tools for the v.h.f./u.h.f. modes: 3D-Waterfall, Oscilloscope, Autocorrelation, FSK Signal Analysis direct, FSK Signal Analysis indirect, Code Analysis direct, Code Analysis indirect, Bit Analysis and SELCAL Analysis.

Another analysis tool planned: Eye diagram (vector-scope).

Planned Miscellaneous features: Remote control for shoc's RadioManager, Alphabets such as Cyrillic (TASS, ITA-2 3rd Shift), Greek, Arabic, (ATU-80), and Hebrew, The online help is nearly ready, Export option to give customers the ability to edit stored data.

As you can see by this list, WAVECOM has a lot planned for this decoder. Readers of this article should understand that the above bulleted items **are not available** at this time! Some of these are going to be released in a new software build this spring, others may never see the light of day.

I hope this article has been informative, and I would like to hear from readers out there on it's contents.

New items for Version 4.10 of the W41PC software

July saw the first new release of the W41PC software in seven months, here's what is new:

Alarm Monitor

Most hobbyists that have used a decoder have wanted the capability to monitor incoming text for items of interest, be that a string of RY's or a keyword. This capability is now available for the W41PC through the implementation of an 'Alarm Monitor'.

The Alarm Monitor allows you to input up to TEN 'alarm strings' such as 'ZCZC' or 'cq cq cq'. When the string is "seen" in the text of the decode output, an alarm pops-up alerting you to it (along with all text on that line of the output). You can also tell the Alarm Monitor to play a favourite .WAV file whenever the text string alarms.

The alarms, or the entire decode session, can be saved to a text file for later viewing. The Alarm Monitor also works with the Server Control feature, from any other card connected to the 'network' (network being all those cards connected to any computers on your LAN).

Server Control

The Server Control application monitors all W41PC connections to the computer that houses the card(s). This computer is known as 'the server'.

The server manages the W41PC cards, and all connections made to those card(s). The server control application must be started before any W41PC card can be used on the server.

As far as I could tell, this application is intended for use by those individuals that own two or more W41PC cards installed in the same computer (obviously, most amateurs will not have more than one card, so I don't quite understand its inclusion in this software build).

New 'Alphabets'

The following 'alphabets' are now available:

ITA-1 Latin	3rd-Shift Cyrillic
ITA-2 Latin	3rd-Shift Greek
ITA-2 Transparent	Arabic-Baghdad-70
ITA-3 Latin	Arabic-Baghdad-80 (ATU-80)
TASS Cyrillic	Hebrew
ITA-2 Cyrillic	

The last item included with the new software was a standard Win-95 help file for the W41PC hardware/software. This file was quite in-depth, and contained almost all of the information that was contained in the previous version of the hard-copy W41PC manual.

You can visit the Wavecom site at:

<http://www.wavecom.ch/>

You will find tech specs and other W41PC info at their site.

Or, try the Klingenfuss Publications site:

<http://ourworld.compuserve.com/homepages/klingenfuss/wavecom.htm>

Lastly let me say that these observations are strictly **mine!** All of them or none of them may be accurate. The above article is for informational purposes only and if you are seriously considering purchasing the W41PC, you should chat with other users and the folks at WAVECOM for more information. Have a spin and remember to keep your grin!



JOIN THE RSGB - Your National Society and we'll show you how to make a 12-month year grow!

When it comes to amateur radio we have a wealth of experience, plus background advisers to help you enjoy your hobby to the full - but YOU are the most important ingredient in the formula - without you there is no amateur radio. Together we are a winning combination and will ensure that amateur radio continues to thrive and grow into the next millennium.

We put you, the radio amateur and short wave listener first - help us to fight your cause, protect your amateur radio bands, and keep this hobby alive.

Sign up for Direct Debit, and we will give you an extra three months' membership completely **FREE!**

That's how we make a 12-month year grow!

SEE US AT THE
**LEICESTER
SHOW**

To: Radio Society of Great Britain, Lambda House, Cranborne Road, Potters Bar, Herts EN6 3JE. Tel: 01707 659015, Fax: 01707 645105. Web: www.rsgb.org. E-mail: Sales@rsgb.org

I would like to join the RSGB. My payment for £36 is enclosed with this form (Over 65 years of age - £27).

Name Callsign (if licensed)

Address

Post/Zip Code:

Credit card number:

Expiry date: Switch Issue No: Start date:

Please send Direct Debit form for my 3 **FREE** months

Signed: Date:

PW9/98

MONITORING TIMES

For the true state-side perspective on the world of radio monitoring, **Monitoring Times** is must for your shack with its variety of topical articles, news, views and extensive English language short wave broadcast guide. Published monthly.



SATELLITE TIMES

Satellite Times is the only magazine to explore all aspects of satellite communications and covers commercial, military, broadcasting, scientific, broadcast, personal communications and private satellite systems. If it's in orbit, it's in **Satellite Times!** Published monthly.



Sub Rates (1 year):
£38UK

£43Europe
(Airmail)

£49Rest Of World
(Airmail)

**What are you waiting for?
Subscribe NOW!**

**PW Publishing Ltd., Arrowsmith Court, Station Approach
Broadstone, Dorset BH18 8PW**

Tel: (01202) 659930. Fax: (01202) 659950. E-mail: bookstore@pwpublishing.ltd.uk

SHORT WAVE COMMUNICATIONS

by Peter Rouse GU1DKD

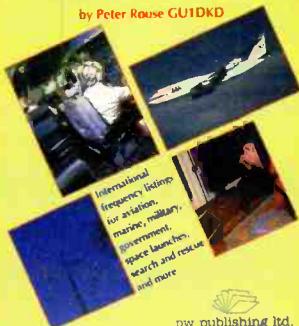

Short Wave Communications is a compact self covered book containing international frequency listings for aviation, marine, military, government, space launches, search and rescue and much, much more. So what are you waiting for? Order your subscription today, that way you won't miss out on this offer of a **free** book.

Subscription Offer

Order a one year subscription to *Short Wave Magazine* now and get a **FREE** copy of *Short Wave Communications* by Peter Rouse GU1DKD.

By subscribing to SWM, you also get the extra benefits of:

- Checking out the 'Trading Post' bargains first.
- Having SWM delivered direct to your door every month.
- Getting your copy before SWM goes on general sale.
- Avoiding cover price rises during the period of your subscription.
- And what's more, when you subscribe this month, you'll get a **free** copy of *Short Wave Communications*.

Offer open until 30th September 1998.

Subscription Rates (1 Year)

UK	£30
Europe Airmail	£35
Rest Of World Airsaver	£38
Rest Of World Airmail	£45

You can now order on-line.

See www.pwpublishing.ltd.uk/books/ for more information

TELEPHONE ORDERS TAKEN ON

(01202) 659930 between the hours of

9.00am - 5.00pm. Outside these hours your order will be recorded on an answerphone

FAX ORDERS TAKEN ON (01202) 659950

Or please fill in the details ticking the relevant boxes, a photocopy will be acceptable to save you cutting your treasured copy!

To: PW Publishing Ltd., FREEPOST, Arrowsmith Court, Station Approach, Broadstone, Dorset BH18 8PW.

TO TAKE ADVANTAGE OF THIS OFFER, FILL IN THE ORDER FORM OR CALL THE CREDIT CARD HOTLINE ON (01202) 659930 QUOTING SUBS 9.

PAYMENT DETAILS

Name

Address

.....Postcode

Telephone No.

Please start my subscription with theissue.

I enclose cheque/PO (Payable to PW Publishing Ltd.) £

Or
Charge to my MasterCard/Visa/Switch/AMEX Card the amount of £

Card No.



Valid fromto.....

Signature Tel:.....

Issue No:

Orders are normally despatched by return of post but please allow 28 days for delivery. Prices correct at time of going to press. **Please note:** all payments must be made in Sterling. Cash not accepted.

**TELEPHONE ORDERS TAKEN ON (01202) 659930
FAX ORDERS TAKEN ON (01202) 659950**

Book Profiles

See pages 88 & 89 in this issue or visit

www.pwpublishing.ltd.uk/books/

for lots more information on radio-related books.

Internet users can order on-line.

The **SWM Book Store** carries a huge range of stock and delivery is usually very quick. Order your books now by 'phone, FAX, E-mail or by post.

E-mail on the Internet

E-mail on the Internet has been written to help you get to grips with both E-mail and the Internet. These days you can't read a paper, listen to the radio or watch television very long before you hear or see mention of E-mails or of the Internet.

An attempt has been made not to use too much computer 'jargon' in this book, but with this subject, some is inevitable, so a glossary of terms is included, which should be used with the text where necessary. Covering everything from the history of E-mail and the Internet to downloading and installing programs, this book is a definite must for all Internet enthusiasts and potential users. **£6.99.**



Discover DXing!

Using equipment you already own, this book will help you learn the secrets to hearing more a.m., f.m. and TV stations. Chapters include propagation, seasonal conditions, equipment, antennas and reference materials. Read the 'best bets' for hearing all fifty states and ten countries on a.m. Other topics include obtaining QSLs, keeping a log and radio clubs. There is also a list of a.m. clear channel stations and a list of v.h.f. TV stations.

So, if you would like to learn new techniques to get more from your a.m. and f.m. radio, discover DXing! **£7.50.**

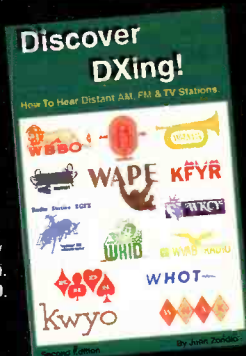

Guide To Satellite TV - Fourth Edition

Guide To Satellite TV is a practical guide, without excessive theory or mathematics, to the installation and servicing of satellite TV receiving equipment for those professionally employed in the antenna rigging and TV trades. This fourth edition continues to meet the practical need between theoretical text book and simple installation guide.

Now fully updated, the fourth edition includes topics such as digital TV, including MPEG-2, reception requirements, LNB requirements, digital link budget extensions, a new section on squinting antennas and much more. Order your copy now for only **£18.95.**

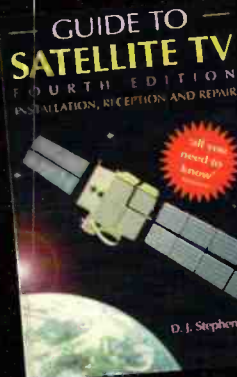

Building and Using Baluns and Ununs

As the title suggests this book is aimed at providing a practical approach to making and using your own balanced-to-unbalanced (baluns) transformers and unbalanced-to-unbalanced (ununs) transformers. This is not primarily a 'theoretical' book (although of

course theory is covered) but can be considered as a well illustrated (primarily by photographs) guide to making successful baluns and ununs.

Chapters include: an introduction, when to use them, history and design, Amateur Radio use, baluns for antenna tuners, using with the G5RV antenna, the unun, introduction, use, dual ratio types, multismatch and ununs for Beverage antennas, short ground-mounted verticals and loading coils. Altogether an interesting read which also conveys the complex nature of the devices in an effective way. Packed with ideas and practical projects. Order your copy now for **£18.95.**

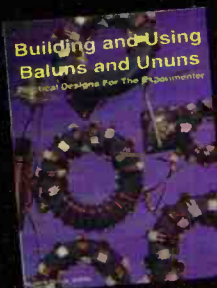

RSGB IOTA Directory & Yearbook 1998/99

If you are new to IOTA and have little idea of what it's all about, turn straight to the Directory section starting on page 43 of this book. It will give you an insight into the Programme and answer any initial questions. By the time you have read this book from cover to cover, you will have sensed some of the mystique of islands.

Just a few of the chapters include: IOTA On The Internet, RSGB IOTA Honour Roll & Annual Listing, DXpedition Roundup, Meet The IOTA Committee and so much more that you'll just have to order the book for **£8.95** and see for yourself!



Now You're Talking! All You Need To Get Your Ham Radio Technician License

This third edition of Amateur Radio's most popular study guide, published by the ARRL, contains everything you need to earn your US Technician licence. *Now You're Talking!* will help you select and set up radios, accessories and antennas for your amateur radio station. It will also guide you through your first contacts on all the popular operating modes, including f.m. repeaters and packet radio.

Now You're Talking! is very informative and very well put together. It's all you need to get your US licence, get on the air and get in on the fun! **£15.50.**

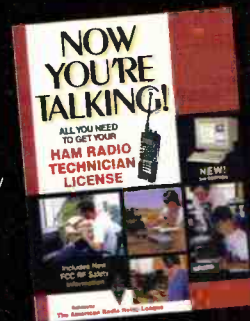

Book Profiles

C.M.HOWES COMMUNICATIONS

www.howes-comms.demon.co.uk

Mail Order to: Eydon, Daventry,
Northants. NN11 3PT
☎ 01327 260178



DC2000 built in
HA22R hardware option

Amateur Radio SSB/CW Receiver Kit - £41.80

This great little receiver makes an excellent project for the novice constructor and experienced operator alike! The plug-in band system gives a wide frequency range. Choose from 160, 80, 40, 30, 20, 15 or 10M amateur bands. Also suitable for BM11 and BM54 HF air-band modules. One band kit included, extra band kits £7.90 each. Can be expanded into an amateur transceiver with add-on kits! Great for holiday and portable use, as well as the home station! DC2000 Electronic kit: £22.90 (inc. one band module). HA22R Hardware: £18.90.



SSB & CW Filter - £29.80!

Clean up your reception!

- Reduce noise and interference! • Sharp SSB/ Speech filter with faster roll-off than IF crystal filters!
- 300Hz bandwidth CW filter • Printed and punched front panel • All aluminium case • Simply connects between radio and external 'speaker or 'phones
- Suits all general coverage receivers & transceivers
- ASL5 Kit plus HA50R hardware: £29.80

Receiver Accessory Kits

ASUB	Antenna Selector & 25dB, 5dB step attenuator (inc. hardware)	£27.90
CSL4	SSB & CW Audio Filter for internal fitment	£10.50
DCS2	"S Meter" for signal indication on direct conversion receivers	£10.90
RA30	HF RX Rotary Attenuator 0/15/30dB for internal fitment	£3.90
SPA4	Scanner Preamp. 4 to 1300MHz wideband for discones etc.	£15.90

Frequency Measurement/ Display

CBA2	Counter Buffer (fits in DXR20 or DC2000 to feed DFD5)	£5.90
DFD4	Add-on Digital Readout for superhet receivers / transceivers	£49.90
PMB4	Adds 5 extra frequency offsets to DFD4	£9.90
DFD5	Digital Frequency Counter / Readout with 5 digits	£54.90
XM1	Crystal Frequency Marker - provides accurate calibration signals	£16.90

Enjoy the fun of home built equipment with HOWES KITS!



Multiband SSB/CW Rx Kit - £79.70

The DXR20 covers 20, 40 & 80M bands as standard. You can add any other SW band with optional plug-in band modules (same type as DC2000). Versatile and popular!

DXR20 Kit, £39.90 + DCS2 "S meter" Kit + HA20R hardware pack = £79.70

The famous HOWES Active Antenna Kits

AA2.	Covers 150kHz to 30MHz. The neat compact answer for those with limited space.	Kit: £8.90	Assembled PCB module: £14.90
AA4.	Covers 25 to 1300MHz. Broad-band performance in a neat, compact package.	Kit: £19.90	Assembled PCB modules: £28.90
AB118.	Optimised for long distance reception on 118 to 137MHz air-band.	Kit: £18.80	Assembled PCB modules: £27.90
MB156.	156 to 162MHz marine band active antenna system (the brother of AB118!)	Kit: £18.50	Assembled PCB modules: £27.60



Antenna Tuning Units for use with HF receivers

CTU8. Covers 500kHz to 30MHz. Matches antenna impedance and helps reduce spurious signals and interference with extra front-end filtering for the receiver. SO239 sockets. Factory Built: £49.90. Kit (including case and all hardware): £29.90.

CTU9. As CTU8 plus balun, bypass switch and terminal posts. The fully featured Rx ATU! Factory Built: £69.90. CTU9 Kit (including case and all hardware): £39.90.

Please add £4.00 P&P, or £1.50 P&P for electronics kits without hardware.

HOWES KITS contain good quality printed circuit boards with screen printed parts locations, full, clear instructions and all board mounted components. Sales, constructional and technical advice are available by phone during office hours. Please send an SAE for our free catalogue and specific product data sheets. Delivery is normally within seven days.

73 from Dave G4KQH, Technical Manager.

JAVIATION

Carlton Works, Carlton Street, Bradford BD7 1DA
Telephone: (01274) 732146

Computer Interfaces for AOR equipment

We now produce several interfaces for the AOR range of scanners. The JAV-232 opposite remains the most versatile option available offering compatibility with various receivers. However, for those looking for basic computer control without some of the features found on the JAV-232 we now offer the following:-

RS-8200

Basic computer interface for the new AR8200 housed in a DB-25 socket. Direct connection to AR8200 via the remote socket. £39.99.

RS-8000

Basic computer interface for AR8000 housed in a DB-25 socket. Direct connection to AR8000 via the FFC socket. Supplied with two (1 spare) FFC's. £29.99.

RS-2700

Basic computer interface for AR2700 housed in a DB-25 socket. Direct connection to AR2700 via the FFC socket. Supplied with two (1 spare) FFC's. £29.99.

New 1998 VHF/UHF Airband Frequency Guide with Callsigns

Our 1998 VHF/UHF Airband Guide is now available. Published in July the new edition has been expanded to over 300 pages and contains invaluable information for the airband listener including over 9000 military callsigns. Ring bound for easy reference. £12.50 including P&P.

NEW JAV-232 Computer Interface

While the AR8000 was the main reason for us producing the JAV-232 it is now compatible with the new AR8200 together with AR2700. Icom equipment, Alinco DJ-X10, Optoelectronics Scout and any other receiver requiring a TTL interface.

Main features

- Full compatible with many receivers
- Original Sumitomo Flat Flexible Cable (FFC) supplied for use with AR8000
- Robust, compact metal die cast case
- 1.0m high quality multicore cable
- Well produced instruction manual
- 6-pin Din outputs provides audio and squelch activated remote tape recording for AR8000 & AR8200
- Discriminator output when used with AR8200
- Demonstration version of various software packages included

£69.99 including VAT and delivery
OS-8200 connecting lead (£12.95) required for use with AR8200

If you would like further information please feel free to telephone, write or E-mail, it would be nice to speak with you. If you would like a catalogue would you please send a large SAE (31p). Thanks.
You can E-mail via info@javiation.co.uk or visit our web pages <http://www.javiation.co.uk/> for further information

MULTICOMM 2000

★ ★ ★ ACCESSORIES ★ ★ ★

ALL "MFJ" PRODUCTS ARE NEW AND HAVE OUR 12 MONTH WARRANTY



MFJ 784-B

Great multi-purpose DSP filter. Works with any receiver to 16 pre-set positions. Plugs directly into the recorder out socket.

OUR SPECIAL PRICE £189.00



MFJ 781

Basic DSP filter. Multimode. Suitable for all receivers or scanners. 10 presets.

OUR SPECIAL PRICE £119.00



TIMEWAVE DSP-599 ZX

The "Rolls Royce" of all DSP filters. Hyper speed DSP processor. Alpha numeric display. Enhances voice data and CW.

OUR SPECIAL PRICE £299.00



MFJ 959-B

Provides proper impedance matching between your receiver and antenna. 20dB pre-amp. 20dB attenuator. 2 antenna and 2 receiver input.

OUR SPECIAL PRICE £79.00



MFJ 1020-B

Tuned indoor active antenna. Plus pre-selector. Can be used with an external antenna. Compatible with short wave receivers and scanners alike.

OUR SPECIAL PRICE £69.00



MFJ 1022

All band active antenna for short wave receivers and scanners. Covering 300kHz-100MHz. Fabulous performance at an affordable price.

OUR SPECIAL PRICE £36.00



MFJ 1040-B

All band pre-selector. Rejects out of band signals 1.8-54MHz. Up to 20dB gain. Connect 2 antennas plus 2 receivers.

OUR SPECIAL PRICE £89.00



MFJ 956

Short wave, medium wave and long wave pre-selector tuner. Boost stations that are weak while rejecting images, intermod, etc. Frequency coverage 15-30MHz.

OUR SPECIAL PRICE £32.00



MFJ 1026

Eliminate interference. Exposes hidden stations. All mode operation. More effective than a noise blander. 60dB null wipes out interference and noise. Unbelievable performance.

OUR SPECIAL PRICE £125.00



Balun Magnetic
£19.00



MFJ 112
clock
£22.00



MFJ
2-way switch £25.00
4-way switch £45.00



QEP 400
£10.00



Deskstand
£17.95



Kenwood HS-5
£59.00



GPS-III System
£345.00



Vectronics AT-100
Active antenna
£65.00



Palstar AM-30
Active antenna
£65.00



Techtoyz counter
£78.00



Scanmaster SP-55
£59.00



SGC power clear
DSP + speaker
£259.00

Scanmaster Stainless Discone
£41.00



MFJ 462-B
Multimode short wave decoder. So simple to use at a push of a button. 2 line, 16 channel display.
OUR SPECIAL PRICE
£159.00

NEW PRODUCT

MFJ 1214-PC
Wefax, RTTY, CW, ASCII interface. Full colour/16-grey level fax. Software included.
OUR SPECIAL PRICE £139.00

SALES HOTLINE

01480 406770

★ ★ ★ USED EQUIPMENT ★ ★ ★



Lowe HF-225
Several to choose from.
£250.00
or 36 months @ £8.17



JRC NRD-525
Wonderful SW receiver.
From **£599.00**
or 36 months @ £19.56



Icom IC-R7000
Great condition.
£610.00
or 36 months @ £19.92



Kenwood R-5000
Plus VHF.
From **£599.00**
or 36 months @ £19.56



Yaesu FRG-8800
Plus VHF.
£369.00
or 36 months @ £12.05



Lowe HF-150
Lowe's entry point receiver.
£225.00
or 36 months @ £7.35



Yaesu FRG-100
As new. 3 to choose from.
£369.00
or 36 months @ £12.05



AOR AR7030
Short wave receiver.
£599.00
or 36 months @ £19.56

12 MONTH WARRANTY ON MOST OF OUR USED EQUIPMENT

****WE NEED YOUR USED EQUIPMENT**
TOP PRICES PAID...GUARANTEED!!!**

LET US SELL YOUR EQUIPMENT FOR YOU

SHORTWAVE RECEIVERS

AOR AR-7030	As new	£550
CODAR CR-70A	Mint.....	£99
ICOM ICR-70E	As new.....	£289
ICOM ICR-71E	Plus extras	£499
JRC NRD-525	Great condition	£599
KENWOOD R-2000	+VHF	£325
KENWOOD R-5000	+ VHF	£599
KENWOOD R-600	Mint.....	£190
LOWE HF-150Several from	£220
LOWE HF-225Several from	£269
LOWE SX-30	Great value.....	£49
REALISTIC DX-200	Digital.....	£149
REALISTIC DX-394	As new.....	£99
ROBERTS ATS-817	Portable.....	£139
SANGEAN ATS-318	£89
SONY AIR-7	Good condition.....	£69
SONY SW-100	Ex demo.....	£139
YAESU FRG-8800	£289

SCANNERS

AOR AR2002	Several from	£129
AOR AR2800	Plus SSB.....	£225
AOR AR3000	Several from	£369

AOR AR3000A	As new.....	£525
ICOM IC-R7000	Late model.....	£599
ICOM IC-R1000	As new.....	£399
JIM SX-400	Great value	£119
REALISTIC PRO-2006	8 from.....	£139
REALISTIC PRO02025	Mobile	£50
REALISTIC PRO-2026	Base	£149
STANDARD AX-700 MkII.....		£325
WELZ WS-1000	Mini hand-held	£135
YUPITERU MVT-9000	£229

ACCESSORIES

DATONG FL-3	Filter.....	£65
DAVIS PERCEPTION II		£110
HOKA CODE 3	Decoder	from £299
JPS NTR-1	DSP	£110
OPTO-SCOUT	Several from	£199
YAESU FRT-V 7700	£50

FINANCE EXAMPLE

Cash Price	Less 10% deposit	Balance for finance	12 months @	Total finance price
£289.00	£29.00	£260.00	£23.87	£315.44

OPENING HOURS

Monday - Friday 9.00-5.00pm.
Saturday 9.00-2.00pm.
Closed Sundays.

WORLD-WIDE DELIVERY

Our efficient couriers ensure a guaranteed next day delivery in the UK and a 48-hour worldwide service if required.

PART EXCHANGE

We urgently require your treasured set. We buy outright for cash. Alternatively, use your old equipment as a deposit on finance for a new or used set.

FINANCE

We now can offer you a competitive finance package with only 10% deposit. Multicomm 2000 is a licensed credit broker. Written quotations are available upon request.

ACCESSORIES

Here at Multicomm 2000 we also have a large selection of books, antennas, linears, etc. If we don't have it in stock we can order it!

USED EQUIPMENT

We probably have the largest range of used equipment in the country. Most of our used equipment carries a full 12-month warranty and can be purchased on finance (if required).

LARGE SHOWROOM

We have a large, modern, showroom crammed full of new and used equipment. All are available for demonstration. Callers are welcome anytime!

PRICING POLICY

We source many products direct and usually offer an unmatched price on all of our products.

UNIT 5-7, 86 CAMBRIDGE STREET, ST. NEOTS, CAMBS PE19 1PJ
FAX: 01480 356192 SALES HOTLINE 01480 406770
EMAIL: Sales@multicomm2000.com WEBSITE: www.multicomm2000.com

ESSEX SHORTWAVE SERVICES

8AM TELEPHONE NUMBER: 8PM
01268 475614

VISITS BY APPOINTMENT ONLY

AOR AR2000.....	£125.00	LOWE HF-150.....	£250.00
AOR AR3000A (New).....	£685.00	LOWE PR-150.....	£125.00
AOR AR5000 (New).....	£1155.00	NRD 535.....	£899.00
AOR AR5000+3 (New).....	£1375.00	NRD 545.....	£1599.00
AOR AR7030 (New).....	£675.00	REALISTIC PRO-2006.....	£150.00
AOR AR8000.....	£225.00	REALISTIC PRO-2035.....	£140.00
AOR AR8200 (New).....	£365.00	SONY ICF-SWE1.....	£65.00
FAIRMATE HP-2000.....	£125.00	TARGET HF-3.....	£99.00
ICOM IC-R10.....	£195.00	WELZ WS1000E.....	£150.00
ICOM IC-R72.....	£495.00	YAESU FRG-7.....	£150.00
ICOM IC-R72 (New).....	£595.00	YAESU FRG-100.....	£350.00
ICOM IC-R8500.....	£1450.00	YAESU FRG-8800.....	£265.00
ICOM PC-R1000.....	£299.00	YUPITERU MVT-7100.....	£165.00
ICOM PC-R1000 with DSP...£360.00		YUPITERU MVT-7200.....	£195.00
KENWOOD R-5000.....	£550.00	YUPITERU MVT-9000.....	£265.00
LOWE HF-125.....	£250.00		

**RING 01268 475614
FOR YOUR SPECIAL DEAL**

RECEIVERS AND SCANNERS WANTED.

Best prices.
Personal
service.

TOP PRICES PAID.

Sales
Repairs
Accessories

SSE
Solid State Electronics (UK)

HIGH QUALITY ACCESSORIES
FOR SCANNING, MONITOR RECEIVERS, CB, AMATEUR RADIO

- JIM PSU-101A Mk5.** UK manufactured regulated 230V AC power supply with ADJUSTABLE radio base holder, combined. For use with most pocket scanners. (Please state radio type). 2 DC output sockets, one for radio the other for accessories. 12 volt DC output. A 9 volt output version for Tandy, Comtel, Netset etc available. (PSU - 101ATA). PRICE £34.95. CE Approved
- JIM PSU-101AC Mk5.** As above but includes 12" fitted 50ohm coaxial cable assembly with BNC plug and socket for base antenna connection. PRICE £36.95.
- JIM BH-A3A.** Universal base holder. With ADJUSTABLE radio base holder, combined. Convenient, safe support of radio. Adjustable front stop. Heavy duty chromed base. TWO models "If you don't need the cable why pay for it". PRICE ONLY £13.95.
- JIM BH-A3AC.** As above includes 12" fitted 50ohm coaxial cable assembly with professional BNC plugs and sockets for base antenna connection TNC type plug available on request. Ideal RX and TX up to 4GHz. PRICE ONLY £17.95.



Payment by postal order or cheque. Price includes postage (UK). Other high quality products available: Car Holder, S Meter, Notch Filter, Flexi Antenna & Wire Antenna. For further information on SSE products, send A4 SAE to:

Solid State Electronics (UK)
6 The Orchard, Bassett Green Village,
Southampton SO16 3NA
Tel: (01703) 769598

The **Jim** logo is a registered trade mark of **SSE** (UK)

ALA 1530

ACTIVE LOOP ANTENNAS

See 1998 WRTH review

- Broadband 150kHz-30MHz, excellent sensitivity, no tuning or ATU necessary
 - Provides far lower noise reception than active whip/dipole and passive wire antennas
 - Rejects locally radiated and mains borne noise, 30dB nulls to reduced interference
 - Ideal for small gardens, indoors and directional reception using antenna rotator
 - Rugged 1m dia. Aluminium Loop, supplied with Interface Unit and PSU.....£99.95 incl. postage
- ALA 2000. Indoor version. Supplied complete with a 12 volt Power Supply£69.95 incl. postage

UMB 130 9:1 Balun. For directional LW/MW Loop, 20dB front to back ratio.....£18.95 P&P £2
Also for low noise Longwire. Balun has isolated feeder winding to reduce mains borne noise

T2TD Balun with 500 ohm termination resistor. Supplied with erection details.....£27.95 incl postage

WELLBROOK COMMUNICATIONS

Wellbrook House, Brookside Road, Bransgore, Christchurch BH23 8NA ☎ (01425) 674174 Write or ☎ for details

IS NOISE A PROBLEM?

NRF-2 NOISE REDUCTION FILTER

Simply plug it in with your headphones or L.S. No batteries required.
Cuts down hum, hiss and sideband splatter.....£16.50 + £1.00 postage.

CT400 LONG-WIRE COUPLING TRANSFORMER

(Sometimes known as a "Magnetic Balun").
Use your wire antenna with a screened down lead.....£6.75 + £1.00 postage.

TU3 ANTENNA TUNING UNIT

A very versatile ATU with a special mode switch.
With quality aluminium case.....£54.00 + £4.00 postage.
Low frequency version (below 500kHz).....£68.00 + £4.00 postage.

LAKE ELECTRONICS, DEPT SW, 7 Middleton Close, Nuthall, Nottingham NG16 1BX (Callers by appointment only)

Phone: 0115 - 938 2509 E-mail: radkit@compuserve.com

SEND SAAE FOR A BROCHURE OF OUR COMPLETE RANGE

VISA

MasterCard

■ GRAHAM TANNER, 64 ATTLEE ROAD, HAYES, MIDDLESEX UB4 9JE

■ E-MAIL: ssb.utils@pwpublishing.ltd.uk

SSB Utilities

Terry Collins from Merseyside writes with a photocopy of an article from the 1998 *Royal Air Force Yearbook*. The article is titled 'Aeronautical Rescue Co-ordination Centre' (ARCC) and it contains some interesting information regarding UK search and rescue operations and the set-up at the ARCC at RAF Kinloss in Scotland. Terry suggests that it may be of interest to the large number of readers who listen to the RAF, RN and HMCG flights on 5.680MHz.

The article explains how their h.f. radio operation has a separate room with separate operators and how h.f. is considered to be a mysterious science. It also mentions that they are hoping to change to satellite communications in the future, which will allow the ARCC to send text messages to the SAR forces, and to receive near real-time position reports direct from the GPS equipment in the helicopters and other aircraft.

Personally, I think that they will never be able to do away with h.f. completely as there are times when satellite communications are not available. The article contains some impressive photographs of the equipment used on SAR missions and also some photographs of the ARCC office. If search and rescue is your thing, then I would recommend that you get a copy of this magazine from your main newsagent.

DX-394

In recent months there has been a lot of discussion and interest in the Realistic DX-394 h.f. receiver available from Tandy shops in the UK. This is a desk-top receiver with 'proper' connections for coaxial cable and twin-feeder antennas. It also features a proper tuning-knob, covers 150kHz to 30MHz, has a useful 160 memories, and a full digital display. For a more detailed explanation of the DX-394, see p26 of April *SWM*.

What makes the receiver so interesting is its low price of just £99, making it the cheapest desk-top receiver on the market-place by far. A number of people were tempted by this low price, Tandy shops up and down the country appear to have been selling-out quickly and then building up waiting-lists.

There were some thoughts that at such a low price, the receiver might be a bit deaf, or even reduced in price due to a replacement about to be announced. This was certainly not the case, as tests showed that it was at least as sensitive as receivers costing three times as much.

The technical specifications for the receiver state that it tunes in 100Hz steps, but after some serious testing it was found that the tuning step was an amazing 50Hz! Even better than some Sony models which some people considered to be the ultimate in design - at a price - and the benchmark against which other radios in this price bracket are compared.

It came to light that the UK shops had over-stocked on the DX-394, and they needed to sell lots of receivers to get their stock-levels back to a more normal level. Unfortunately, all good things must come to an end. By the time you read these words, the price will have returned to its original price, £199. If you were lucky enough to get one at the cheaper price, then you have an absolute bargain.

As a measure of how successful this receiver has become, there are now a few mods starting to appear on the Internet, and I understand that somebody is producing a web-page devoted to this receiver. All this prompted me to see what I could find on the Internet relating to this receiver.

I found a number of web-pages, but two of them seem to be the most suitable in my opinion:

<http://www.rnw.nl/realradio/dx394.html> contains some

technical specifications and a review of the receiver; http://support.tandy.com/support_electronics/19323.htm is an official Tandy/Realistic page containing lots of technical information: details of how to use the receiver; assembly diagrams; and a series of simple instructions explaining how to get the best from your DX-394.

Letters

Alan Burnett-Provan from the West Midlands writes in response to the frequency questions of Mr Sillifant a few months back. Alan says that he can confirm hearing Bombay ATC - or rather Mumbai ATC, as Bombay was renamed a few years ago - on 5.652MHz operating in the AFI-3 network.

However, since Mr Sillifant reported hearing Bombay on 5.648MHz either the mystery remains, or Mr Sillifant's receiver was off-frequency. The only way to find out for sure is to spend more time listening to this frequency until you hear stations and can positively identify them.

M. Brown from Jarrow points out that Bombay is very active on 5.658MHz, and that it is most unlikely for 5.648MHz to be used for ATC purposes as it is so close to 5.649MHz in the NAT network. Our very own **Godfrey Manning** points out that 5.648MHz is not an aeronautical channel, and that it is probably a mis-print (or even a mis-logging) of 5.658MHz. I must admit that I am inclined to go with Godfrey on this one. I have heard Bombay/Mumbai many times on 5.658MHz, and I could understand if they were to make a brief transmission on the wrong frequency, but I would not expect them to control air traffic while they were off frequency.

Staying with M. Brown's letter, he says that the JGO callsign heard by **Kevin Wright** is a C-130 Hercules based at RAF Mildenhall. He says that he got his information from *Callsign 98*. Well, all that I can really comment is that I don't believe the book!

I don't want to criticise *Callsign 98* as it is very valuable, but it should not be considered the final word on the subject. *Callsign* books are extremely useful for giving a general idea of what has been heard, but they should not be taken as gospel. I can only suggest that you read the Introduction to *Callsign 98*.

Without knowing a lot more about the actual flight heard by Kevin Wright, it is very difficult to give an exact answer as to what was heard. However, I have personally heard many different types of aircraft flying to and from various airfields around Europe, all using different JGO callsigns, and the only common factor is that it was an American aircraft - that's what the O part of the callsign signifies. I have seen and heard Air Force, Army and Navy aircraft using JGO callsigns, and it is also used by cargo aircraft, VIP aircraft and helicopters. I would treat this entry in *Callsign 98* with a pinch of salt.

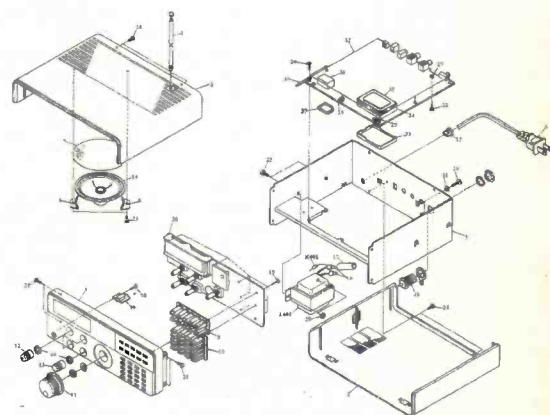

The DX-394 assembly drawing from the Tandy site.

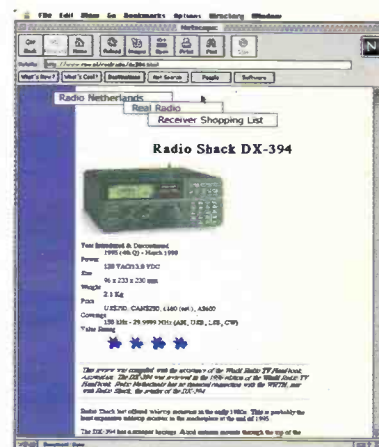

Screen Grabs of DX-394 URLs.

■ PAUL ESSERY GW3KFE, NEWTOWN, POWYS SY16 1ZZ

■ E-MAIL: gw3kfe@pwpublishing.ltd.uk

Amateur Bands

Strange how one's attitude towards one's hobbies change with illness. During the past month Yours Truly collided with a 'bug' and the bug won the first few rounds. 'Horizontal Polarisation' included loss of interest in the shack, and even a state of total non-interest in a newly offered book of *Daily Telegraph* cryptic crosswords!

However, all's well that ends well and the keyboard is active - later than usual for me, but still in time - just - to meet the Gaffer's deadline.

Conditions

The way the Solar Flux has been creeping up since the Sunspot Minimum is of course encouraging and at times visible on the bands - occasional openings to DX on 50MHz for example. On the other hand, if you plot Flux against time as predicted back at the minimum, and then plot over that the figures as given every Sunday on most versions of the GB2RS news, then you have to wonder - are we going to have the predicted Big Peak or are we climbing a Little Hill and a Low Peak?

Nobody, of course, knows in advance, but it does look a bit as though this Cycle will not match the best of the post WW2 ones. This is one time, though when I hope I'm wrong!!

Equipment

The most important part is the 'nut between the ears' though advertisers seek to kid us otherwise. But it does bring up an important point. Don't be afraid to lash out on - and use! - a comfortable pair of headphones. If you've never used 'cans' before you will almost certainly find a place or two where they can be customised with some extra padding, but you will also be surprised how much easier it becomes to winkle out that weak and watery DX under the pile-up.

The reason seems to be that it shuts in all the noises we want and shuts out all the noises we live with, which act as un-noticed QRM. For example, as I wrote that last sentence an electric lawnmower popped up, a 'Sprinter' passed on the railway nearby, and a diesel car has parked. And I live in a quiet place!

Hi-Fi 'phones are probably the best choice nowadays though they are always of relatively low impedance. If your receiver instruction book says the headphone output is at high-impedance and you only have low-impedance cans, the first move is to try 'em anyway! Nine times out of ten the receiver and the 'phones will live happily.

For the tenth case, you need a matching transformer - and there are plenty of those around, though not labelled as such! The one I use is ex-junk sale. It originally came in a little black box labelled 240V in and 9V out. I cut off the mains plug first in favour of a telephone plug to fit the receiver and the 9V connector I replaced by a telephone free socket into which I plug the 'phones.

I finished off by adding a sticky label over the original so no-one can make safety mistakes. Construction time, from concept to first trial - under ten minutes! Perfect it ain't, but it does the job.

Letters

Firstly, an E-mail from Alan which really demanded a personal reply - but alas the 'sender' line got lost - seemingly eaten by the electronics, so I hope Alan can identify himself and accept our apologies.

Basically, Alan is starting out in an amateur radio and he asks which receiver would be best from this lot: AR5000+3, Icom ICR-8500, JRC NRD-535, or JRC NRD-545. My personal suggestion is 'none of these' at this stage.

For one thing amateurs use transceivers rather than separate receiver and transmitter. Perhaps more important, everyone I've

known as correspondents to the column has shown a marked change in their amateur radio in their first year. I'd look for something cheap and cheerful in the way of a transceiver with general coverage receive, and stay with it for at least six months after first licence. Then - sit back and think what you want to do now you've tried it all!

Paul Goodhall's life in Oxford is steadily returning to normal now his **XYL Allison** is progressing well after surgery. Paul's first comment is to remark on how patchy the bands have been. As for monitoring conditions, Paul notes that local G8PX has regular weekday skeds with K1UQV, both running the same power and beams, so by listening and logging signals, Paul gets a very good idea of what things are like over this path.

Paul has a full-size G5RV and finds it a couple of 'S'-points down as compared with the report G8PX dishes out. Now, there are other factors to consider here: a) How high is G8PX's antenna, b) How high is the G5RV and c) is the G5RV's favoured direction, after allowing for the inevitable distortions caused by local buildings and terrain, looking at K1UQV?

Also of course, owning a commercial beam means keeping it up, which in turn implies planning permission for what has become a 'permanent' structure. On the other hand, a wire antenna can be allowed to fall down regularly to reinforce the 'temporary' idea!

Of course there are wire beams, such as the VK2ABQ which can be home-brewed at small cost, work well and can be 'allowed' to fall down now and then! Commercial beams have lossy traps, don't usually benefit from falling down and new parts cost money!

Next we come to the *Just Listening* magazine from the **International Listeners Association, 1 Jersey Street, Hafod, Swansea**. The ILA is not only for amateur band listeners of course - it covers the interests of anyone who uses a receiver for hobby purposes. Well worth a membership I think.

In Barnsley lives **Colin Dean**, and I'm always thankful to open his letters, because although handwritten I can always read them! Colin stuck to sideband, which netted him, on 7MHz: AP2KSD, A45ZN, BV2RS, EX8MLE, FM5GU, RA0WBF, TT8ZB, VK1MJ, VK4MZ, YB2PBX, YC6HDF, ZL2JR, 4L/ON4CFI, 4S7BRG and 9G1MR.

At 14MHz the scalps included BA1DU, G3KLY/MM, (the QE2 near CU2), DS5USH, DU100SAN, HL0K, HS1NGR, HS0/G4JMB, JW7VK, JW0M, S0IHA, ZD7DP, Z21CS, 3V8BB, 4K80ADR, 4S7SA, 9G1NS, 9M6AAT, 9M8HI and 9V1BG.

Another step up in frequency to 17MHz where Colin caught AP2AGJ, A61AB, BV5BG, BV7GA, CT3BM, CX3AL, DS5USH, DU5GD, FR5DX, HZ1AB, JA1-2-6-7, KP4K, TA3BN, TF/DL2NWK, TK5BF, TT8ZB, TU2WK, T77M, ZD8T, 3V8BB, 5N3BAF, 5X1T, 5Z4LL, 6W8RE, 7Q7JL, 9G1YR, 9K2HAN and 9K2ZZ. Finally 21MHz for B14Q, HB0/DL1FDH, YB0DX, ZD7VC, 5N1SYT, 7Q7DC, 7Q7JL, 7Q7RM and 9G1BJ.

Oddments

Hrane YT1AD, has now made some 75000 contacts from 3V8BB in three years. QSLs to his home call. **FR5ZU** can't activate Tromelin until at least the end of the year. The Malpelo (HK0) DX-peditions is to run from September to November; on the other hand, the CY9AA operation which should have been on as I write, was cancelled.

As for the Yemen **HA5PP** was not QRV during his recent visit but did have some hopefully fruitful talks which could lead to licences. On Mauritius, we hear that **Jacky 3B8CF** is hoping to be operational on Top Band from September-ish.

That's it again. I've pruned lists drastically to get everyone a mention - sorry! As usual, letters to reach me by the first of the month, to **Box 4 Newtown SY16 1ZZ** or the E-mail address above. Thanks!

Listener Reports Wanted

GW0GHF is in Llandough, Penarth, and Brian is experimenting with 50MHz home-brew antennas. Brian is to be found on 51.510MHz most afternoons between 1400 and 1700, plus Sunday and some weekday evenings between 2030 and 2130, and he needs reports from listeners all of which will be acknowledged and QSLed.

An amateur needs a report that tells him something he wouldn't otherwise have known. In Brian's case enough reports will enable him to build up a picture of the gain and polar pattern of his new design.

A listener report to me which came from abroad, covered something like twelve hours of listening to my signals over a period of several days. Signal strength was graphed, there was a statement of how my signal compared with other UK ones, plus a nice letter and a photograph of the antenna and shack he was using. That netted him a return card by air-mail.

A few days later in came the other sort from an address within a mile: 'You were 59+ at time X Can I see your station?' - band unspecified, frequency unspecified. That went straight in the WPB!

Space Closes In!

Karl Drage E-mailed me on his birthday and commented that conditions have been very unsettled, apart from the odd short-skip 28/24MHz logging and Sporadic-E on 50MHz. Karl's E-mail set off on June 26, and he noted the Aurora event on 24th.

Just to mention Six Metres, Karl logged 9A, 9H, CT, DL, EA, ES, EW, G, GD0TEP/P, I, IF9I2ADN, IS, IT9, LY, LZ, OE, OH, OH0JLO, OH0KCE, OK, OM, OY9JD, S5, SM, SP, SP1MVA/MM in KQ08CD square, T72B/A, YL, YO, YU and Z3.

■ BRIAN ODDY G3FEX, THREE CORNERS, MERRYFIELD WAY, STORRINGTON, WEST SUSSEX RH20 4NS

Maritime Beacons

LONG WAVE MARITIME RADIOBEACON CHART

Freq (kHz)	C/S	Station Name	Location	DXer
279.0	SI	Simiutaq	Greenland	L*
284.5	LZ	Lizard Lt	S.Cornwall	B,C,E,F,G,H,I*,K,L*,M,PRS,T
284.5	MA	Cabo Machichaco	NE.Spain	B,F,K*,L*,M,R
284.5	PR	Porkkala	Finland	F*,L*,Q*,R*
285.0	NP	Nieuport W.Pier	Belgium	E,F,L*,PR
286.0	TR	Tuskar Rock Lt	Co.Wexford	A,B,E,F,G,H,K,L*,M,N,PRS
286.5	FI	Cala Figuera	Majorca	B*,F*,K*,L*,R
286.5	FT	Cap Ferrat Lt	SW.France	B,F,K*,L*,M,R*,S*
286.5	NK	Inchkeith Lt	F of Forth	A
287.3	IB	I.Berenga	Portugal	L*
287.5	DO	Rosedo Lt	France	B*,L*
287.5	FR	Faerder Lt	Norway	B*,K*,L*
287.5	IB	I.Berenga	Portugal	B*
287.5	MD	Cabo Mondego	Portugal	B,L*
288.0	HH	Hoek van Holland	Holland	FL*,P
288.0	KL	Skinna Lt	Norway	B*,F*,K*,L*
288.0	OH	Old Hd of Kinsale	Co.Cork	B*,H,K,M
288.5	CT	Pt de Combril Lt	France	L*
288.5	FI	Cabo Finisterre Lt	N.W.Spain	B,L*,M
288.5	UD	Cabo Salou	S.Spain	L*
288.5	YM	Ijmuiden Lt	Holland	B,E,F,K,L*,P,Q,R
289.0	BY	Baily Lt	Co.Dublin	A,B,H,K,L*,M,N
289.5	KY	Oksøy Lt	Norway	FL*
289.5	NP	Punta Carena	Italy	F*
289.5	SN	Ile de Sein NW Lt	France	B*,F,K,L*,PR
290.0	AV	Aveiro	Portugal	L*
290.0	FD	Fidra Lt	F of Forth	A,B*,K,M
290.5	DY	Duncansby Hd Lt	NE.Scotland	A,B
290.5	SB	S.Bishop Lt	Pembroke	A,B,E,F,G,H,J,K,L*,M,PRS,T
290.5	VI	Cabo Villano Lt	N.Spain	B*,F*,L*,M,Q*,R*
290.5	VY	Visby	Sweden	K*,L*
291.0	SM	Pt. St.Mathieu	France	B,D,E,F,G,H*,K,L*,PR,T
291.0	SN	Cabo San Sebastian	S.Spain	B*
291.5	SU	South Rock LV	Co.Down	A,B,E,F,H,J,K,L*,M,N,PR
291.9	IT	La Isleta	Canaries	B*
291.9	NA	Punta Lantaila	Canaries	B*
292.0	LK	Pt de la Coubre Lt	France	L*
292.0	MH	Mahon, Minorca	Balearic Is	B*,F*
292.0	SJ	Souter Lt	Sunderland	A,F,H,K,L*,M,PR
292.0	TO	Torungen Lt	Norway	L*
293.0	CP	St Catherine's Is	I.O.W.	B,C,D,E,F,G,H,J*,L*,P,Q,R,S,T
293.0	RN	Rhinnis of Islay Lt	Is of Islay	A,B,H,K,M,N
293.0	SY	Svinoy Lt	Norway	B*,L*
293.5	RO	Cabo Silleiro Lt	N.Spain	B*,K*,R*
294.0	KU	Kullen High Lt	Sweden	B*,L*
294.0	PH	Cap d'Alprech	France	B,D,E,F,G,H,J*,J,K,L*,P,Q,R,T
294.5	KC	Old Hd of Kinsale	Co.Cork	B*
294.5	PS	#Pt.Lynas Lt	Anglesey	B,K*
295.0	SN	Sletnes Lt	Norway	B*,L*
295.5	CB	La Corbiere Lt	Jersey C.I.	B,E,F,H,J*,K,L*,PR,T
295.5	CR	Cap Couronne	France	L*
295.5	JA	Jaroslawiec	Poland	B*,F*,K*,D
296.5	RE	La Rochelle	France	B,L*
296.0	GR	Goeree Lt	Holland	E,F,K,L*,PR
296.0	KN	Knrova Lt	Norway	B*,K*
297.0	FG	Pt de Barfleurt Lt	France	B*,C,D,E,F,G,H,J*,J,K,L*,P,Q,R,S,T
297.5	MA	Mantyluoto	Finland	B*,L*
297.5	PS	Cabo Penas Lt	N.Spain	B*,K*,L*,R
298.0	EL	Eltz Lt F	Germany	D
298.0	GX	Ile de Groix	France	B*,F,K*,L*,PR,T
298.0	TA	Cabo Gata	S.Spain	B*,L*
298.5	RR	Round Is Lt	Is Scilly	A,B,D,E,F,G,H,J,K,L*,M,N,PRS,T
299.0	AD	Ameland Lt	Holland	B,L*
299.0	BN	Les Baleines	W.France	B*,L*
299.0	O	Tarifa	S.Spain	B*
299.5	NP	Nash Pt Lt	S.Wales	B,E,F,G,H,J*,J,K,L*,PR,S,T
299.5	SK	Skornvaer Lt, Rost	Norway	B*
299.5	VR	Urvaer Lt	Norway	A,K*,L*
299.5	VS	Vieste Lt	Italy	B*
300.0	CL	Cloch Pt Lt	W.Scotland	B*
300.0	MZ	Mizen Head	Co.Cork	B,C,F,H,K,L*,M,N*,RS
300.0	TI	Cap d'Antifer Lt	N.France	G,L*
300.5	KS	M.Kanin	Arctic Russ	B*
300.5	KV	Nordvalen	Sweden	L*
300.5	LA	Lista	Norway	A,B*,E,F,G,H,K*,L*,Q*,R
301.0	CA	Pt de Creach	France	B,F,G,H,I*,K,N*,PR,S,T
301.0	ER	Eierland Lt	Holland	B,L*
301.5	DU	Dungeness Lt	Kent	C,E,F,G,H,J*,J,K,L*,P,Q,R,S,T
301.5	KD	Kinnards Hd Lt	NE.Scotland	A,B*
301.5	L	Torre de Hercules	N.Spain	B*,K*,L*,M
302.0	RB	Cherbourg Ft W Lt	France	B,C,E,F,G,H,J*,K,L*,P,Q,R,S,T
303.0	BB	Bjuröklubb Main Lt	Sweden	L*
303.0	D	Rota	SW.Spain	B*,L*
303.0	FB	Flamborough Hd Lt	Yorkshire	A,B,E,F,H,J*,J,K,M,N,P,Q,R,S,T
303.0	MY	Cabo Mayor Lt	N.Spain	B*,F,K,R,T
303.0	YE	Ile d'Yeu Main Lt	W.France	B*,G*,L*,M
303.4	VC	Cape St.Vincent	Portugal	L*
303.5	BJ	Bjornund Lt	Norway	A,B,F*,K*,Q*,R
303.5	FN	Feistein Lt	Norway	A,FL*,R
303.5	IA	Llanes Lt	N.Spain	B*
303.5	OR	Punta de Llobregat	S.Spain	B*,F*,R*
303.5	VL	Vlieland Lt	Holland	L*

Freq (kHz)	C/S	Station Name	Location	DXer
304.0	BR	Cap Bear	France	B*
304.0	SB	Sumburgh Hd Lt	Shetland Is	A,B*,C,E,F,K,R
304.5	GY	Castle Breakwater	Guemsey	C
304.5	PS	Pt Lynas Lt	Anglesey	A,B,E,F,H,J,K,L*,M,N,PR
305.0	FP	Fife Ness Lt	SE.Scotland	A,B*,E,H,K,M,R
305.5	AL	Pt d'Ailly Lt	France	B,C,F,G,H,K,L*,P,Q,R,S,T
305.7	DA	Dalatangi Lt	Iceland	K*
306.0	FN	Walney Is Lt	Off Lancs	B,E,F,H,J,K,L*,M,N,PR
306.5	H	Het Lt	Poland	B*,F*
306.5	KL	Kolkasrags	Latvia	K*
306.5	UT	Utsira	Norway	A,B*,E,F,H,K,L*,M,PR
306.5	VD	Vardo	Norway	L*
307.0	GL	Eagle Is Lt	Co.Mayo	A,B,H,K,L*,M
307.0	LE	Letta Rear	Poland	B*,O
307.5	RS	Ristna	Estonia	B*,F*,K*,Q*,R
308.0	AK	Table O'Okacha	Morocco	B*
308.0	RC	Cabo Roca	Portugal	B*,L*,M
308.0	RD	Roches Douvres Lt	France	B,L*
308.5	NZ	St Nazaire	France	B*,FL*,PR*
309.5	AL	Algiers	Algeria	B*
309.5	BA	Punta Estaca Bares	N.Spain	B*,F*,K*,L*,M,Q*
309.5	FH	Fruholmen Lt	Norway	B*
309.5	MA	Marstein Lt	Norway	B*,F*,K,L*
309.5	PB	Portland Bill Lt	Dorset	B*,E,F,G,H,I*,K,L*,P,Q,R,S,T
310.0	ER	Pt de Ver Lt	N.France	B*,F,G,I*,L*,PR,S,T
310.0	IP	Capo Sandalo Lt	Sardinia	F*
310.0	KL	Kiel Lt	Germany	O
310.5	AS	Castellon	Spain	B*
310.5	GV	Genova	Italy	B*
310.5	RO	Rozewie	Poland	B*
311.0	GD	Girdle Ness Lt	NE.Scotland	A,B,K,M
311.0	NF	N.Foreland Lt	Kent	B*,E,F,G,H,J*,J,K,L*,P,Q,R,S,T
311.5	LP	Loop Hd Lt	Co.Clare	B,H,K,M
312.0	OE	Oostende	Belgium	B*,E,F,K,L*,P,Q,R,T
312.0	SP	Cap Spatel	Morocco	B*,L*
312.0	UH	Eckmuhl Lt	France	B*
312.5	AK	Akmenrags	Latvia	B*,K*
312.5	BK	Baltiysk	Russia	B*,K*,R*
312.5	BT	Mys Taran Lt	Latvia	B*,K*,R*
312.5	CS	Calais Main Lt	France	B,F,L*,P,Q,R,T
312.5	DB	Dobbsky	Ukraine	B*
312.5	KA	Klaipeda Rear Lt	Lithuania	B*,R*
312.5	LB	Liepaja	Latvia	B*,K*,R*
312.5	VS	Cabo Estay Lt	N.Spain	J,K,L*
312.6	KB	Krautsand	Germany	B*
313.0	HA	Haltten Lt	Norway	B*,L*
313.0	PA	Cabo de Palos Lt	S.Spain	B*,F*,L*,T*
313.0	TY	Tory Is Lt	Co.Donegal	A,B,H,K,M
313.5	BR	Cap Bear Lt	S.France	L*
314.0	HK	Hekkingen Lt	Norway	L*
314.0	PQ	Porquerolles	S.France	B*,K*,L*
314.0	VG	Ile Verte Lt	France	B,C,E,F,G,H,I*,K,L*,M,PR,T
314.0	WU	Wustrow Lt	NE.Germany	B*
314.5	CM	Cromer Lt	Norfolk	B*,C,E,F,H,J,K,L*,P,Q,R,T
314.5	TL	Punta D.Penna	Italy	B*
315.5	ND	Nidden	Lithuania	B*
316.0	IN	Ingolshofdhi Lt	Iceland	L*
337.0	MY	Myggenaes	Faeroe Is	B*,F*,K,L*,R*
352.0	RBA	Rabat Sale	Morocco	L*
372.0	DZN	Prins Chms's Sund	Greenland	B*,K*,L*,R*
381.0	AB	Akraberg	Faeroe Is	B*,F*,K,L*,R*
404.0	NL	Nolso	Faeroe Is	B*,F*,K,L*,Q*,R*

DXers:-

- (A) Kenneth Buck, Edinburgh.
 (B) Robert Connolly, Kilkeel.
 (C) John Eaton, Woking.
 (D) Geoff Halligey, Bridgend.
 (E) Brian Heath, Stapleton.
 (F) Brian Keyte, Gt.Bookham.
 (G) George Millmore, Wootton, IoW.
 (H) Albert Moore, Douglas, IoM.
 (I) Fred Pallant, Storrington.
 (J) Peter Pollard, Rugby.
 (K) Victor Robb, Belfast.
 (L) Peter Rycraft, Wickham Market.
 (M) John Stevens, Largs.
 (N) Kelvin Sutherland, Anglesey.
 (O) Andrew Tett, while near Hamburg, Germany.
 (P) Philip Townsend, E.London.
 (Q) Eric Tubman, Whitstable.
 (R) Fred Wilmshurst, Northampton.
 (S) John Woodcock, Basingstoke.
 (T) Ross Workman, Shoreham-by-Sea.

Note:

Entries marked # are calibration stations.
 Entries marked * were logged during darkness.
 All other entries were logged during daylight or at dawn/dusk.

A number of alterations to the beacon service were observed by some of the listeners who searched the band during April, May and June. They found the Dungeness beacon (DU) on 301.5kHz instead of 300.5; Pt.Lynas (PS) on 304.5 (not 304.0); Cromer (CM) on 314.5 (not 313.5).

No trace of the Pt.Lynas calibration transmission on 294.5 was found by Albert Moore (Douglas, IoM) and Robert Connolly (Kilkeel) mentioned that he has not heard it since early April. Since the frequency of the Pt.Lynas beacon (PS) was changed the reception of Sumburgh Head (SB) on 304.0 has improved in some areas. In Edinburgh, Kenneth Buck noted it as 'a very clear signal' and it was logged for the first time by Brian Heath (Stapleton) and Brian Keyte (Gt.Bookham).

The Danish beacons at Hammerodde (MN) on 289.5; Blavandshuk (BH) 296.0; also Gedser (GR) 303.5 were reported as 'unusually absent' by Brian Keyte and Kenneth Buck was unable to find a single beacon in Sweden or Denmark during his search but he did pick up strong signals from a number of Norwegian beacons which appeared to be functioning normally.

In Rugby Peter Pollard found the longer twilight period around 2000-2100 less favourable for DXing but the sky waves from some quite distant beacons were received later by other listeners. Several DXers heard beacons they had not received before; 284.5 PR, 290.5 VI, 310.0 IP by Brian Keyte; 288.5 YM, 296.0 GR, 304.0 SB, 304.5 MY by Victor Robb (Belfast); 279.0 SI, 292.0 TO, 300.5 KV, 303.0 BB, 306.5 VD, 312.0 SP by Peter Rycraft (Wickham Market); 284.5 PR, 293.5 RO, 308.5 NZ, 312.5 BK, BT & LB by Fred Wilmshurst (Northampton) - refer to chart for more details.

In some locations the more distant beacons were masked by local electrical interference. A buzzing noise at 33kHz intervals across the band plagued Keith Seddon in Chapel en le Frith. He traced it to an Osram EL long life lamp.

The interference started at 160kHz, peaked between 290 and 295kHz and was still audible well into the medium wave band! Despite the high level of electrical noise at his new location Kelvin Sutherland (Llangefni, Anglesey) found that he could receive some beacons - see chart. He is now giving some thought to the most suitable antenna.

The fourth edition of the LW Marine and Aero radiobeacon guide by Robert Connolly is still available. If you would like an information sheet about it write to Robert via me, enclosing an s.a.e.

Propagation Forecasts

How to use the Propagation Charts.

The charts contain three plots. The lower dashed line represents the lowest usable frequency (LUF), or ALF (Absorption Limiting Frequency). The chances of success below this frequency are very slim.

The middle line indicates the optimum working frequency (OWF) with a 90% probability of success for the particular path and time.

Lastly, the upper dashed line, represents the maximum usable frequency (MUF) a 50%

probability of success for the path and time.

To make use of the charts you must select the chart most closely located to the region containing the station that you wish to hear. By selecting the time chosen for listening on the horizontal axis, the best frequencies for listening can be determined by the values of the intersections of the plots against frequency.

Good luck and happy listening.

September 1998
Circuits to London

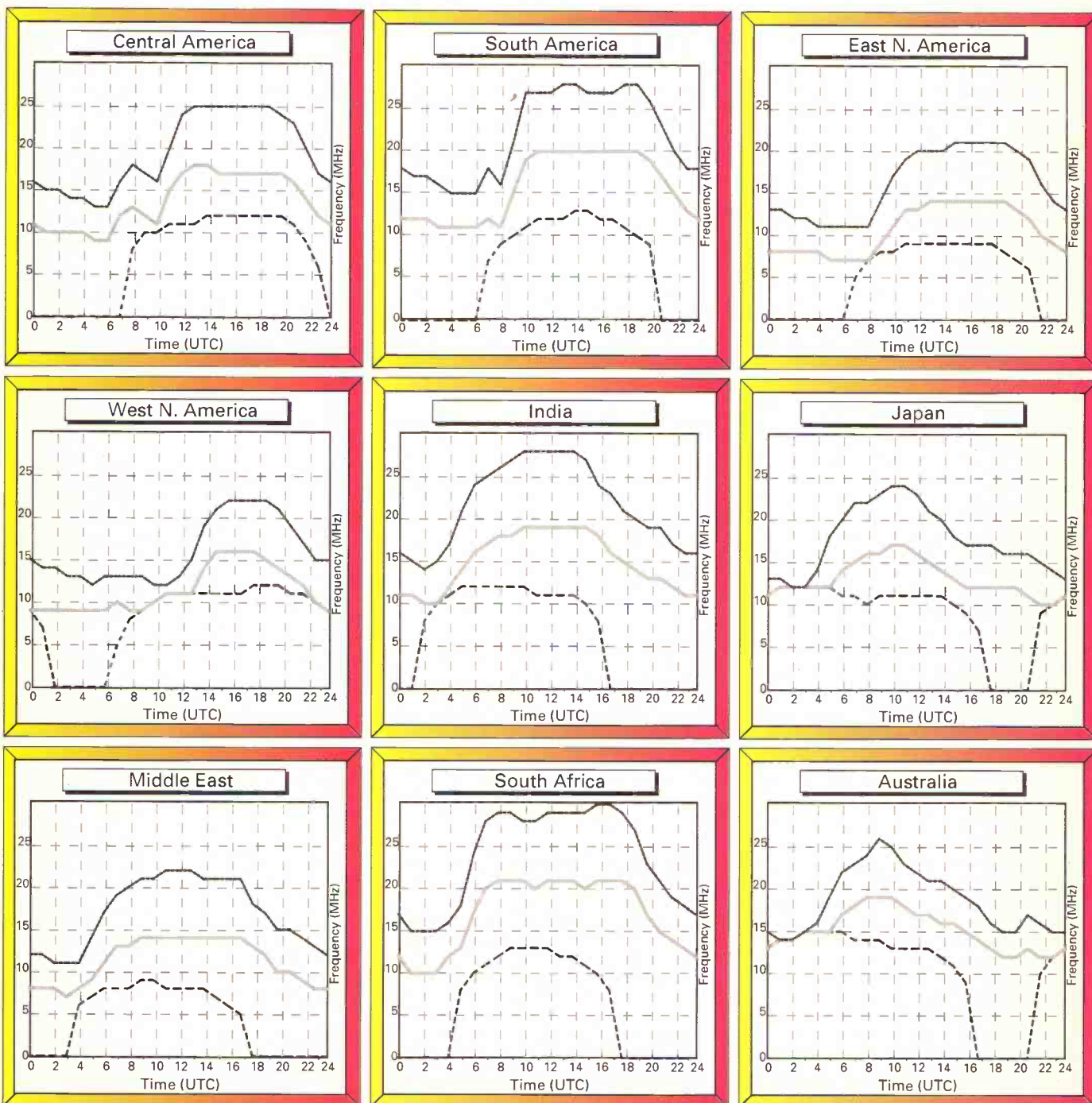

Propagation Extra

Ron Ham's barometric pressure chart, taken at Storrington, W. Sussex, July 1998.

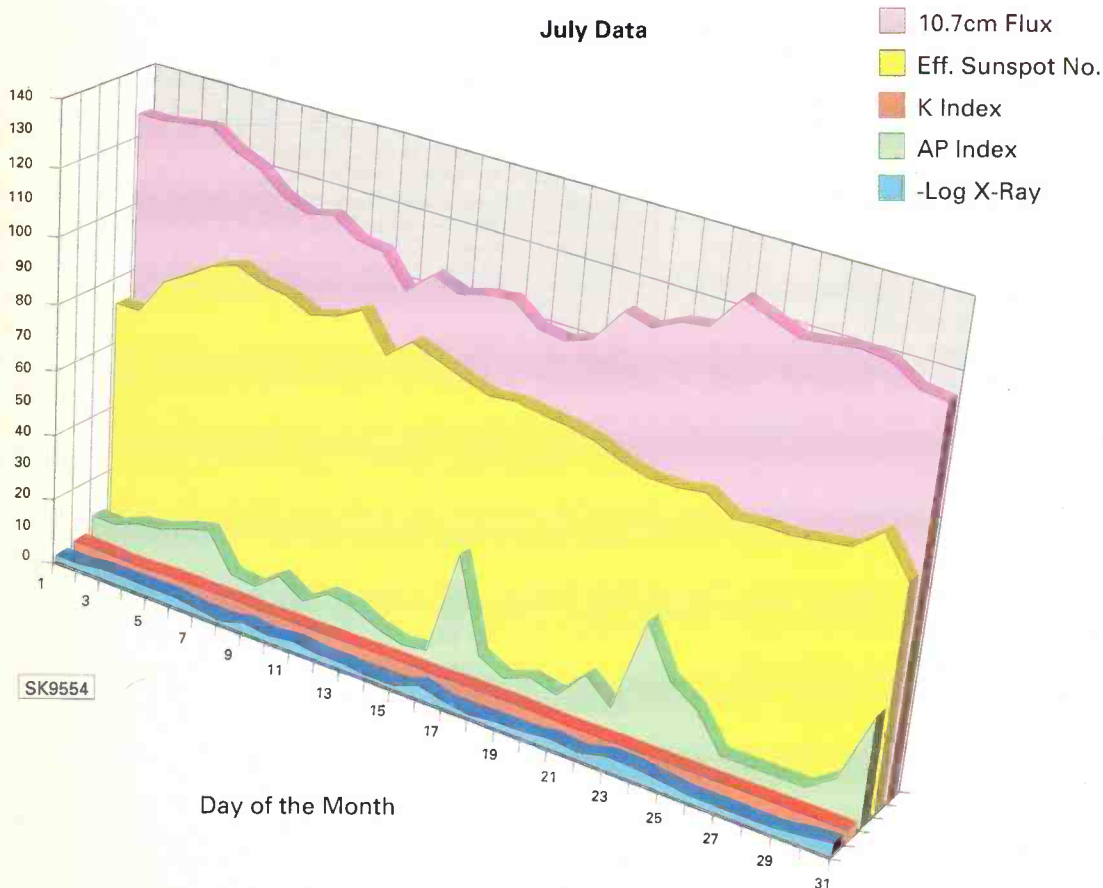
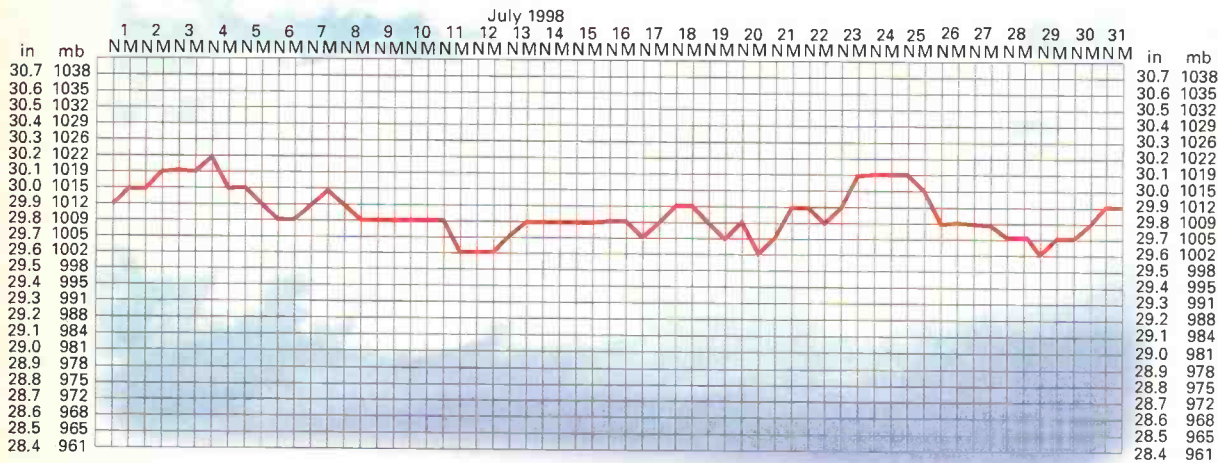

guide to the chart

The 10.7cm solar radio flux is used as an indicator of the general level of solar activity.

The K and AP indices are measures of geomagnetic activity.

The K index ranges from zero (very quiet) to nine (severely disturbed).

K values of five or greater correspond to geomagnetic storm conditions that can relate to poor propagation conditions.

The AP index ranges from 0 to 400. An AP of 30 is the threshold for geomagnetic storm conditions.

THE AVIATION HOBBY CENTRE

VISITOR CENTRE
MAIN TERMINAL
BIRMINGHAM
INTERNATIONAL
AIRPORT B26 3QJ

TEL: 0121-782 2112

FAX: 0121-782 6423

E-mail:
aviation.hobbycentre@zetnet.co.uk
Website:
www.users.zetnet.co.uk/hobbyctr

'REACH' FOR THE SUMMIT

(The G8 Fly In At BHX)

In May 1998 Birmingham hosted one of the world's most important conferences - the G8 Summit. All the major world leaders attended and this video features the aircraft as they arrived and departed, as well as the aircraft that bought in the necessary cars, personnel and equipment, the biggest of which being the Galaxy - call sign 'Reach' See Airforce One, IL76s, IL96s, IL62s Japanese Government B747s Italian AF DC9 plus lots more. Duration: 2 hours.

A unique video for a unique event £17.99 + £1 p&p

THE FLORIDA TAPES

Mention Florida to most people and they immediately think of Miami and Orlando. There are dozens of smaller but still very busy GA airfields, so the Fort Lauderdale and West Palm Beach tapes have 'no frills and no commentary' just quick fire aircraft action - they feature a good selection of airline traffic and corporate air transport in the form of biz jets and biz props.

Test your recognition skills to the limit ... £12.99 each + £1 p&p

Vol 1: Fort Lauderdale - Best of two days movements in a one

hour tape
Vol 2: West Palm Beach - Best of two days movements in a one hour tape

Vol 3: North Perry to Bimini in the Bahamas Returning via Fort Lauderdale North Perry to Marathon in the Keys up North to Naples on the West Coast back across to North Perry via Alligator Alley All in a Cessna 172RG
£12.99 + £1 p&p (1 hour)

Vol 4: North Perry upto Sebring - a visit to the Jack Brown Seaplane Base - Aerial views of Disney World - plus footage of some very sad looking aircraft damaged by the February tornados.

£12.99 + £1 p&p (1 hour)

WHY NOT RING/SEND FOR OUR FREE MAIL ORDER CATALOGUE FULL OF AVIATION BOOKS, VIDEOS, SCANNERS, ANTENNAS, MAPS AND CHARTS.

UK Pocket Frequency Guide Issue 6
VHF/UHF Frequencies listed in numerical and airfield/airport order - plus a lot more useful info £3.95 + 50p p&p.

The Airband Jargon Book
Explains what exactly is being said and the instructions being given over your airband radio between ATC and the aircraft £6.95 post free.

Aviation Videos - always available - full details in catalogue

Hong Kong '96
£16.99 + £1 p&p (2 hours)

Plane Football Crazy
£16.99 + £1 p&p (2 hours)

Five Days in May
£14.99 + £1 p&p (2 hours)

On The Flightdeck
Volume One - £14.95 + £1 p&p (2 hours)

We accept Visa, Access, Switch, Visa Delta, Cheques, Postal Orders and Cash of course! And we are open 7 days a week 8am - 7pm. LOOK FORWARD TO HEARING FROM YOU.



FLIGHTDECK

The Airband Shop

MANCHESTER'S PREMIER AVIATION STORE
We stock all the enthusiast needs

Scanners, Books, Models, Videos, Charts, Apparel, Software and more.

Send £1.00 (no coins please) for our illustrated catalogue or visit our web site at:
www.flightdeck.co.uk

Flightdeck, Dept SW, 192 Wilmslow Road
Heald Green, Cheadle, Cheshire SK8 3BH
Tel: 0161-499 9350. Fax: 0161-499 9349
E-mail: FlightDek@aol.com

PDSL

The Public Domain Software Library
PO Box 131, Crowborough
East Sussex TN6 1WS, UK
Tel: (01892) 663298. Fax: (01892) 667473

PDSL RF, ANTENNAS & HAM RADIO CDROM	£15.00
Over 620Mb of amateur radio software for DOS, Windows 3.1x and Windows95 (as reviewed by Mike Richards).	+ £2.00 P&P
QRZ v11 CDROM by Walnut Creek	£19.00
All the latest software (1400 titles) plus Callsign Database with over 1 million entries.	+ £2.00 P&P
PDSL ENCYCLOPEDIA OF SHAREWARE	£2.50
Latest (June '98) on-disk listing of 9500 programs (includes voucher worth £2 off any purchase).	P&P included

All prices quoted include VAT.
Mastercard/Visa/Switch/Connect accepted.
Orders received before 12.30pm sent same day.

PHOTAVIA PRESS

AIRWAVES 98 !!NEW!!

THE FIFTH EDITION OF THE UK'S MOST COMPREHENSIVE AND UP TO DATE HF/VHF/UHF AVIATION FREQUENCY DIRECTORY
PUBLISHED APR 98 - TEXT & MAPS HAVE BEEN FULLY UPDATED AND EXPANDED HUNDREDS OF ADDITIONS AND AMENDMENTS - ALL THE LATEST AIRBAND INFO INCLUDES ALL THE PAST YEARS UHF CHANGES TO AIRFIELDS AND UKADGE/ADR TOWER - APPROACH - RADAR - GROUND - AIR TO AIR - RANGES - STUDS - ATIS - GCI SQUADRON OPS - AIR REFUELLING - VOLMET - AIRLINE OPS - AFIS - AWACS AIR DEFENCE RADAR (UK/EUROPE) - GROUND OPS - AEROBATIC TEAMS - SAR UK/EUROPEAN CIVIL & MILITARY AREA RADAR - AIRFIELD STUDS (MUCH EXPANDED) SSR SQUAWK CODES - FOUR LETTER AIRFIELD CODES - UK BASED MILITARY UNITS
MAPS OF - UK TRANSMITTER SITES AND FREQUENCIES - MILITARY TACAN ROUTES LOW ALTITUDE & AIR REFUELLING AREAS - UK RADAR SECTORS AND FREQUENCIES UK PRIMARY AIRWAYS AND REPORTING POINTS - UK OCEANIC ROUTES AND FREQUENCIES - SUPERSONIC ROUTES - MAJOR WORLD AIR ROUTE HF AREAS - ETC
MILITARY AND CIVIL HF DIRECTORY - INCLUDES MANY DISCRETE FREQUENCIES AND CHANNEL DESIGNATORS - RAF/ROYAL NAVY - WORLDWIDE/NATO MILITARY AIR-ARMS UN - US MILITARY GLOBAL HF NET - MYSTIC STAR - US NAVY - US COAST GUARD HURRICANE HUNTERS - VOLMET - SEARCH & RESCUE - SPACE SHUTTLE - MAJOR WORLD AIR ROUTES - AIRLINE OPS - LONG DISTANCE OPERATIONS CONTROL - DOMESTIC CIVIL HF
UK PRICE £8.95/EIRE & EEC £9.95 INCLUDING P&P

CALLSIGN 98

THE FOURTH EDITION OF OUR
CIVIL AND MILITARY
AVIATION CALLSIGN DIRECTORY

!! NEW !!
PUBLISHED MAR 1998
FULLY UPDATED WITH OVER 3050 ADDITIONS & CHANGES
162 PAGES - A5 SIZE
WIRE SPIRAL BOUND
OVER 8600 CIVIL & MILITARY AVIATIONS CALLSIGNS

MILITARY DIRECTORY - CALLSIGNS ARE LISTED ALPHABETICALLY AND ALSO BY AIRARM & SQUADRON - INFORMATION INCLUDES: CALLSIGN - AIRCRAFT TYPE - CODE - OPERATOR/SQUADRON - HOME BASE - REMARKS
CIVIL DIRECTORY - CIVIL CALLSIGNS FROM OVER 180 COUNTRIES ARE LISTED ALPHABETICALLY AND ALSO BY THREE LETTER AIR TRAFFIC PREFIX
INFORMATION INCLUDES: CALLSIGN - THREE LETTER ATC PREFIX AIRLINE OR OPERATOR - COUNTRY OF ORIGIN - REGISTRATION PREFIX
UK PRICE £8.95/EIRE & EEC £9.95 INCLUDING P&P

(SORRY - NO CREDIT CARDS) CHEQUES/EUROCHEQUES/POSTAL ORDERS/PAYABLE TO:
**PHOTAVIA PRESS/DEPT SW - SUNRISE BREAK
CHISELDON FARM - SOUTHDOWN HILL - BRIXHAM
DEVON TQ5 OAE - UK Tel: 01803 855599**

■ GODFREY MANNING G4GLM, C/O THE GODFREY MANNING AIRCRAFT MUSEUM, 63 THE DRIVE, EDGWARE, MIDDLESEX HA8 8PS

Airband

Britain's newest international airport is Sheffield (I say without risk of contradiction, I hope!). Plenty of news from here is sent by Leslie Griffiths who lives under one of the flight-paths, aircraft passing so close overhead that he can read their registrations! Once established in the circuit at 1500ft height, though, I'd expect typical light aircraft registrations to be just on the point of having become too far away to read.

If Leslie is in (or bordering) the town of Sheffield itself then I'd expect the airport to be to his east. Further east still is the M1 motorway. So, arrivals on runway 10 or departures on 28 will come overhead (unless they turn when very close to the airport).

I'm not sure what the unpublished frequency 455.225MHz is but I suspect that allocations in this part of the spectrum are for ground operations vehicles.

Likewise, 150.225MHz is outside the airband. A strange effect occurs at certain frequencies. Most radio receivers convert the incoming signal to a fixed frequency. This is known as the intermediate frequency (i.f.) and is internal to the radio set.

Usually, the listener wouldn't have to know about it. Under some conditions in which a strong signal reaches a set with poor selectivity, the signal appears at two different frequencies on the radio. It's only really transmitted on one frequency but the radio seems to receive it on a second frequency, also.

This second (non-existent) transmission is called the image, the ability of the set to avoid this effect is called image rejection. The more image rejection (specified in dB) the better. The image will always be twice the i.f. away from the real signal.

Here's an example. Sheffield is on 128.525MHz. If a radio's i.f. were 10.85MHz, then adding two times 10.85 to 128.525 would give a potential image on 150.225MHz.

When instrument approaches are being checked, a suitably-equipped calibration aircraft flies by instruments whilst its flight path is monitored from the ground. I believe this work has been put out to private contract but I imagine the state-owned HS.748s were 'donated' to the contractor as part of the deal.

I'm a tax payer, I reckon it's mine, they should have given me first refusal! Anyway, I'm not sure what the Shackleton-like aircraft was that Leslie saw as only one Lancaster now flies and I don't think any Shackletons are airworthy at present.

ACARS

Aircraft Communications Addressing and Reporting System. This is a means of sending bursts of data over v.h.f. radio, whenever the need arises. Range is an extended 'line of sight'. Often mentioned in this column, the aircraft can automatically report its take-off time (for example) to company operations departments. Likewise, operations can send last-minute flight plan changes to the crew.

Another means of data communication, mentioned by Leslie, is secondary surveillance radar Mode S. This is in the u.h.f. spectrum. A radar pulse from the ground triggers a brief data transmission from the aircraft. Currently, Mode 3 provides a four-digit 'squawk' number and, additionally, flight level can be added in Mode 3/C.

Now, Mode S is an extension of this basic system that has not been widely adopted at ground radar installations. Far more data can be sent and potentially appear on the radar screen. However, this is unsuitable for communication with company operations as transmission is dependent on interrogation by a radar

head in the first place. Upgoing data from a company is therefore not possible.

Follow-Ups & Foul-Ups

I hope you found my article 'The Long & The Lat Of It' (July issue page 39) useful. To clear up any misunderstandings, there were three errors in the final edition. On page 42, **Fig. 1**, the North pole wasn't marked - but you probably guessed that it was at the top of the diagram, on the broken line, at the end opposite to the South pole.

Again, page 42, 'Longitude' second paragraph, it says: "This time, I've drawn OUT a radius..." when it means "...I've drawn NOT a radius..." Then, page 43, second column, third line, gives an example "...with decimal minutes instead of seconds..." and the accompanying value should be E030°9.05' (the minutes symbol was missing).

Q-Codes

Back to June's 'Airband,' where I mentioned various Q-codes that designate altimeter settings. **Frank Le Blancq** (Jersey) provides a fuller definition of QFF.

This is, as mentioned, the QNH value corrected for temperature. As far as aviators are concerned, the error is only important in exceptionally cold conditions. For meteorological purposes, though, precision demands that this value is always the one chosen by weather forecasters. It's actually the value you see on weather chart isobars.

As far as the comparison with QNH goes, Frank explains that there is little difference at sea level. Go 4000ft up a mountain and the difference could be as much as 11hPa. Thanks for the professional meteorologist's view on this, Frank.

Quite a lot of the information in 'Airband' is not so much over-simplified as distilled. I feel that the experts among you will happily consult a reference book when wanting the fine details.

The purpose of 'Airband' is to introduce and explain technical concepts to everyone else. For example, I referred to the confusing change from mB to hPa as being a more scientific way of expressing the same thing. I didn't go into the fundamentals of SI units, although that's really what it's all about.

So, readers, are you satisfied with learning about technicalities at this level - or would you rather that 'Airband' became more akin to a textbook that appears in monthly instalments? I am always interested in your opinions, so please write in if you have any feelings on the matter. Otherwise, I'll assume I'm giving you what you want and will dish up more of the same!

More reminiscences of aircraft types that are now historic from **Arthur Oglesby** (Harrogate). The Swallow required full rudder on take-off to counter propeller torque. Crosswinds wouldn't have been a problem in those days as an airfield was exactly that. You could take-off in any direction you liked on the big grass field, so putting the wind on the nose would have been easily possible.

Arthur often visits Alaska (where I suppose the fishing's good). Modern British parents are often asked by their teenage children, "May I have the car tonight?" but in Alaska (where distances are greater) the kids borrow their parents' aeroplanes!



Abbreviations

AIPA	Aeronautical Information Publication
CAA	Civil Aviation Authority
CD-ROM	Compact Disc - Read Only Memory
dB	decibels
E	east
ft	feet
hPa	hectopascals
HS.	Hawker-Siddeley
kHz	kilohertz
mB	millibars
MHz	megahertz
PC	Personal Computer
QNH	altimeter pressure setting, reads height above sea level
SI	Système Internationale d'Unités
u.h.f.	ultra high frequency
v.h.f.	very high frequency

Mooney at Quiberon.
Christine Mlynek.



Receiver Hardware

It is understandable that **Kevin Hughes** (Tamworth) would worry over future receivers. The present civil v.h.f. communications airband is spaced at 25kHz intervals but plans are imminent for reducing this to 8.33kHz. I suspect that the authorities would find this cost-effective as only certain ground equipment would need to change. Unfortunately, other purchasers (including the airlines) don't agree as they need full airborne capability.

In fact, only certain airways (*en-route*) frequencies will be affected, there does not appear to be any plan to put local aerodromes on the newly-created channels. The final decision does not yet appear to have been made, but the authorities rarely change their minds!

Software Review

NavBox *QuickPlan* will prepare professional-looking flight plans on a reasonably fast PC compatible machine. On the screen is displayed a map of your chosen part of Europe with various scales selectable. Coastlines, international airspace boundaries and latitude/longitude lines are shown.

Your position is a mouse-controlled cursor. In addition, a menu chooses whether or not you show beacons, airports, etc. Reporting points only appear at airway intersections but you can define your own and even name them. Disappointingly, the name of your own point will not display on the map.

Having read my article on lat/long (as mentioned above) you'll now find it easy to navigate round the map. If you position the cursor over, say, an aerodrome, it tells you - and even the frequencies are listed.

It prints a detailed flight plan but the map has first to be transferred to the *Paint* package (part of

Windows95) before printing is possible.

On a reasonable system, it didn't take too long to draw the map on-screen and with a 233MHz processor it's obviously quite fast. A proprietary package did not report any virus on the single CD-ROM on which the software is supplied. Two floppies are apparently offered as an alternative.

Special offer copies at an air rally cost £10 but I suggest you write for the latest price (including postage) to: **NavBox, 133 Lovibonds Avenue, Locksbottom, Kent BR6 8EN.**

Frequency & Operational News

From **Martin Sutton** (CAA) come the *AIP* amendments.

Aerodromes first. Manchester Radar 118.575MHz is not really new, it's the old Arrivals frequency upgraded to a radar service.

Airways next. London Airways 129.6 is replaced by 127.825MHz, affecting a number of lower, upper and conditional routes. More details will be printed if anyone insists. UR123 from abeam Lambourne to Clacton is on 133.45 and UR126 is on 118.475MHz.

Reporting points. West of Orkney, helicopter routes X and Y lose ANTON and TIGGY, replaced by nearby SODKI and MADOX respectively. Follow UR23 well to the east of Edinburgh, out into the North Sea, where you will find points CUTEI and GIRDO; now FILET has been inserted between them.

All letters received up to July 8 have been answered. The next two deadlines (for topical information) are September 7 and October 5. Replies always appear in this column and it is regretted that no direct correspondence is possible.



DHC-1 Chipmunk.
Christine Mlynek.

SPECIAL SUMMER OFFER



HF3S SHORT WAVE RECEIVER
SUPER PACKAGE
SUPER PRICE
SUMMER SPECIAL



£159.95
+£6 P&P

Receive:
SLOW SCAN TV
WEATHERFAX
SYNOPTIC RTTY
etc. etc

using

JVFAX 7.1
Freeware

&

HamComm 3.1
Shareware

which is included
in the package



System req: 386 SX25 min,
with 2.5Mb hard disc space
VGA, 4Mb mem, serial port

Included in the **HF3S** package:

- ★ The popular HF3 short wave receiver with **NEW 10** memory facility
- ★ Data output on the receiver and data lead for connection to your computer
- ★ UK power supply & long wire aerial
- ★ 2 year guarantee

Web site:

<http://www.kbnet.co.uk/akd>

E-mail: akd@kbnet.co.uk

Telephone:
(01438) 351710



AKD

Unit 5, Parsons Green Estate
Boulton Road, Stevenage
Herts SG1 4QG



MilAir

Two letters arrived within a couple of days of each other regarding two flights of four aircraft seen and heard on June 5th. Martin in Norwich and Adrian from Woodstock near Oxford, both noted these aircraft and have both asked me to check with our readers to see if anyone can supply any further information.

Mystery Flight?

The two flights entered UK airspace via reporting point MC6 in the North Sea and then followed Military Tacan Route 1, (TR1), across the UK via reporting points, Coltishall, Mildenhall, Brize Norton, Yeovilton and Lands End. The callsigns were **PROTON 11 to 14** and **PROTON 21 to 24**. Both of my correspondents concluded that the first flight had an American pilot but the second flight was lead by a pilot with a European accent possibly German or from one of the former eastern block countries?

The aircraft were at Flight Level 330 until just before Yeovilton, they then descended to FL250 to meet up with a tanker in Air Refuelling Area 7, (AARA7). They used standard London Military frequencies across the country and were on **262.975** when they descended at Yeovilton, they then made one check in call on 240.4, (which is a known Air Refuelling frequency), and then the lead aircraft said, "Go refuelling channel 2".

Adrian, who was at Brize Norton at the time, says he scanned through all of the well-known air refuelling frequencies for some time but heard no further calls and did not hear any call whatsoever from the tanker. After about twenty minutes the aircraft returned to 262.975 and continued their journey out past Lands End. They then went onto h.f. with Shanwick Control, but Adrian could not follow them any further as he did not have an h.f. capable radio with him.

The most interesting piece of information came from Adrian's letter, he missed the first flight because of cloud but he got a good look at the second flight of four aircraft. To use his own words, "I have been an enthusiast for thirteen years and I like to think that my aircraft recognition is quite good, consequently I am confident that the second flight were Mig 29s, they were light in colour, possibly white rather than grey". If this ties in with the pilots accent perhaps they could be Czech or Slovak Air Force? The first flight with the US pilot remain unidentified - Any ideas anyone?

Fairford B-1B Deployment

An E-mail from **Steve** gives details of the B-1B deployment to RAF Fairford. Six aircraft from the 7th Bomb Wing have been operating from the Gloucestershire airfield during June, callsigns noted have been **DARK** and **BONE**. A 7th BW operations frequency, callsign 'Bone Ops' has been noted on **282.85**. A second anonymous correspondent also noted a second operations frequency of **337.25**, can anyone else confirm this?

Mildenhall Air Fete

Rarely does a month go by without some information arriving appertaining to Mildenhall, this month was no exception with six separate letters and E-mails. I missed the show this year for the first time since the mid seventies, but judging by your comments I may not have missed too much. The overall tone of the letters I have received was that apart from a couple of star items most of you were rather disappointed with the show compared to previous years. It seems that

even some of the more interesting aircraft were left on the South side of the airfield when there was plenty of room to put them in the static on the North side! The United States Air Force were noticeable by their absence, who would have dreamt of a Mildenhall show without a KC-10A or a B-52H?

A few callsigns of interest that were noted: VMFA-321 FA-18A **COMBAT 31 & 32**, 81st FS A-10A **ATILLA 01**, 4th SOS AC-130U **SPOOK**, 53rd WRS WC-130H **TEAL**, 412th TW NC-141A **ARRIS** and R. Netherlands Air Force 298 Sqn CH-47D **OMEGA**.

One new frequency was noted, with some visiting aircraft calling SCORPION OPS on 362.55 with maintenance reports. Is this a new frequency for Mildenhall or as a friend has suggested that it was in temporary use during a recent exercise?

Military Antennas (New)

In response to a request from a reader for sources of military airband antennas, I am in debt to Rob Smith who is the Sales Manager of **Racal Antennas**. Rob has kindly sent me details of their current range of antennas, which includes two specifically designed for military v.h.f. and u.h.f. airband use. Racal originally produced a combined v.h.f./u.h.f. discone, but about five years ago to give better water-proofing, less corrosion and fewer electrical faults they produced two new antennas dedicated to each of the v.h.f. and u.h.f. airbands.

Racal RA957: The v.h.f. antenna, the RA957 is a folded monopole, Omni-directional antenna with $3\lambda/4$ radial elements and a frequency range of 115 - 150MHz. It uses an N-Type connector and is 950mm tall by 500mm wide, the weight is 3.5kg.

Racal RA978: The u.h.f. antenna, the RA978 is also a folded monopole, vertically polarised Omni-directional antenna, which has a frequency range of 220 - 400MHz. It is 600mm tall by 600mm wide and weighs 4kg.

These antennas are available new from Racal Antennas, but as with any quality item they are not cheap. The v.h.f. antenna - RA957 is £410.50 and the u.h.f. antenna - RA978 is £357.20, both prices include VAT. These prices may seem high but it should be remembered that these antennas are both built to very high military specifications and are designed to withstand just about anything the elements can throw at them.

As each year passes by, we seem to be having more and more violent storms in the UK with the inevitable damage to roof-top equipment. These Racal antennas will by far exceed the life span of the average £60 aluminium discone. As a consequence, the dedicated airband listener should seriously consider the long-term financial outlay for such a robust antenna.

For further information, any reader with a **serious interest** in these two antennas should contact Racal at the following address:

Mr. R. Smith, Sales Manager, Racal Antennas Ltd., First Avenue, Millbrook Trading Estate, Southampton, Hants SO15 0LJ. Tel: (01703) 705705. Thanks again for the information Rob.

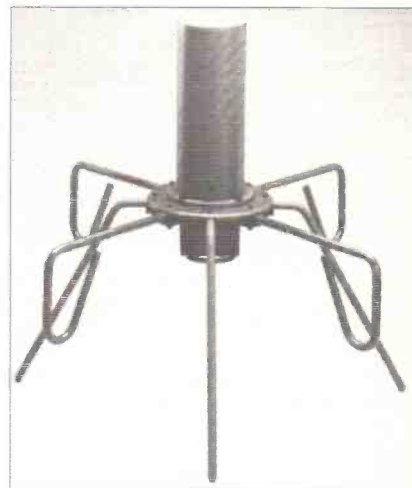

The u.h.f. RA978 antenna



The RA957 v.h.f. antenna

Military Antennas (Used)

Staying with the subject - a reader from Sheffield recently visited the Elveston Castle Rally where he bought an ex-MOD antenna which was described as having a range of 25 - 1200MHz. It came complete with brackets and fittings and he describes it as "a collinear antenna about one metre in length" - The cost was £10. He reports that it works well on the airbands, so much so that it outperformed his discone. Unfortunately, he does not know the name of the company he bought it from. Can anyone who helped organise or visited this rally, identify the company in question who sells this ex-MOD equipment?

Satellite TV News

Satellite zapping football fans have experienced the year of their lives with World Cup football across the satellite belt, both analogue and digital continuing on from through June into July - perhaps diluting the usual June offerings of Wimbledon tennis and providing for many, signals from the new *Intelsat 801* @ 31.5°W.

If you're not a sports fan then there's been plenty to check out though, for example the Rolling Stones 1st stop on their 'Bridges to Babylon' European tour at the Zeppelin Field, Nuremberg, Germany, evening of June 13th. *Intelsat K* carried an evening live broadcast from the concert venue showing the final preparations and promotional recordings taking place. The latter recordings were played out into a live 45 minute programme that detailed the backgrounds to the group, the European tour and included two live numbers from the concert.

Unusual that the *Intelsat K* feed carried details that the concert offering would be distributed across Europe via *Eutelsat II F2* @ 10°E - 11.633GHz horizontal, audio 6.6/7.2MHz. An interesting programme and of course in traditional analogue!

And another concert venue but less than wonderful weatherwise was Glastonbury and Monday morning 29th June found the UKI-149 SNG GMTV SNG unit offering a live report on *Intelsat K* from the Somerset festival site, shots of muddy tents, muddy event goers and more mud. The presenter commented

that June '98 wasn't the wettest June (yet!) on record as only 4in had fallen up to the 29th - June '97 held a 100 year record for precipitation.

GMTV is usually found on *Intelsat K* in the early UK mornings with live feeds back to the breakfast show studio, July 6/7th and our stalwart crew aboard UKI-76 are found on the roadside at Drumcree, NI, caught up in the Orangemens' march confusion, the 7th and the SNG truck was trapped within the immediate area as the deadlock resulted in local road blocks.

Backtracking to World Cup football, the USA outgoing feed June 27th via 21.5°W found the ABC-ESPN engineer clapping his hands with an overlaid caption 'Lip Sync Test'. Problems obviously that day *en-route*, to minimise vision/picture sync disturbance or loss the video path usually passes through frame stores at various points back to the distant studio centre.

Each frame store 'loses' a picture frame which on a complicated circuit might have three or four frame stores. This results in the sound arriving early, i.e. before the picture - to re-sync the base band components it's necessary to insert audio delay to match up the picture and sound once more.

Digital delays are small rack mounting units with easily adjustable time delay constants. That's what the ESPN lip sync test was about.

More sabre rattling in the Yugoslavian region once more with conflict along the Albanian border, sufficient to engineer warning flights by NATO jets over the nearby towns to show their commitment to use force to prevent further Albanian intrusion, pictures of the jets over-flying a local town were carried - once more on *Intelsat K* - June 15 from the Athens, Greece bureau of Reuters.

Roy Carman (Sandown, I°W) and others watched Sky News and the BBC in action June 16/17/18th ex Boston, USA and then back in the UK when Louise Woodward was released and departed the 'States for home. Sky made extensive use of *PAS-3R* @ 43°W for much of the evening and the following morning with live reports on the hour, the return found the BBC using *Telecom 2D* @ 5°W (11.606GHzV) for the Louise UK return coverage.

An interesting feed (*PAS-3R*, June 9, 12.705GHz H via New England Satellite) was seen prior to the Woodward return in which a US lawyer commented on perceived irregularities with the Woodward fighting fund, a received but forged invoice, personal use of the UK fighting fund money, etc. This was aired apparently via *Sky News*.

Bradford, and *SWM* reader **John Womersley** says that following a mention on the free-to-air horse racing for Scandinavia via *Sirius 5°E* bird the pictures were lost in encryption and now a CAM is required to resolve the digital signals (CAM = Conditional Access Module). John also answered a query 'where is the Sainsbury supermarket stores video feed carried', it's now digital on *Eutelsat II F3* @ 16°E but encrypted (more CAMS needed) at 11.128GHz horizontal.

And a tip for digital box user/readers - Associated Press TV on 13°E digital can be resolved now that PIDS are required... 12.549GHz Hor/5632/3/4/ (v512/a650/f8190).

Sports - tennis, football, gold, motorsport and for **Dean Rogers**, an exciting month in Abbeywood, SE2! There was life other than football - including live golf - Womens European Tour, Evian Masters ex France carried on *Telecom 2C*, 3°E for Canal+ and Eurosport, golf too from the UK with the live British Amateur Championships from Muirfield carried again on *Telecom 2C* for the BBC for motorsport the FIA World Rally Championships live from Greece in clear PAL via *Eutelsat II F4* @ 7°E - but it was mainly World Cup football that dominated the sporting sky...

Both **John Locker** (Wirral) and Roy Carman (I°W) commented on the fantastic pictures from space with a recent *MIR/Challenger* docking mission. John accessed the weak direct feed ex *MIR* to *Altair-2* @ 16°E - 10.1830GHz which was cross strapped onto *Intelsat 705* @ 18°W in C-Band (4GHz) for onwards transmission West to NASA. Meanwhile Roy picked up the return feed ex NASA Eastbound via *Intelsat K*.

In last month's column I reported on sightings of the new Nilesat bird @ 7°W. John caught a sight of the new *THOR-3* satellite coming up from the West and on test transmissions at 11.800GHz vertical June 18th and 11.727GHz vert. By now the satellite will have located at 1°W for service into Scandinavia.

I've no idea how the Worldnet feed of the VOA-TV was received by the target audience evening of June 26th, both the Serbian offering at 2100 and the 2130hrs Bosnian programmes were of the most appalling quality, severe signal fluctuation and the picture quality itself was over-exposed, audio too was absent.

The signal was carried via *Eutelsat II F2* @ 10°E, 11.153GHz horizontal - unless the dreadful technical standards



Fig. 1: The UK SISLINK company offer OB uplinking from any remote site in Europe. Seen on *Intelsat K* @ 21.5°W.



Fig. 2: Ident caption for the American ESPN sporting network on *Intelsat K*.

were a less than subtle form of encryption...(?). Overall a busy month for traditional analogue TV by satellite.

Orbital News

December 25th last and *AsiaSat-3* was an insurance loss when the Russian *Proton* rocket failed to orbit the *HS 601HP* bird correctly and it settled into a highly elliptical orbit. Hughes the manufacturers agreed with the insurers to attempt re-orbiting/correction for the now named *HGS-1*.

May 13th and an initial trans lunar orbit was made by firing the craft's motors which put the bird on return into a satisfactory position sufficient to attempt a 2nd lunar trip and June 18th saw a final burn on its latest return and putting *HGS-1* into a useable geostationary slot over the mid Pacific - though suffering a little N/S inclined orbital drift. It's capacity is now available for lease, the revenue shared between Hughes and the insurers.

The new *AsiaSat-4* satellite launch is being delayed anything up to year 2000 due to the unhappy state in the Asian economy, the company reckon to maintain their operations with the existing satellites plus the replacement *AsiaSat-3R*.

Successful Canal+ is planning a SE Asian trip with a co-operative venture on a Taiwanese digital platform Winter '99 - Carnival Star. About 50 international and regional channels will be on offer plus the usual radio and multi-media peripherals. Mediaguard encryption will be used and at least 20 Asian companies will be making the decoder boxes.

A new animation channel 'Animax' will be launched in Japan by Sony Pictures on the SkyPerecTV digital platform. This is the largest digital TV service with nearly 700 000

subscribers and 170 TV channels. Their rival - DirecTV - has 110 000 subscribers viewing up to 130 channels.

The Antena 3 group are to offer ten TV channels and sell to any/all of the digital platforms now covering France. Digital satellite TV in France has proved popular with nearly three million subscribers signed up for either CanalSatellite, AB Sat or Television par Satellite - more than subscribe to cable. Over one million customers signed up for a single digital platform in 1997 with total revenue earned currently \$US250m in that same period.

Not so happy news with the

Indovision Pay-TV operation with a fall-off in subscription levels to only 600 monthly. Total customer base to date is around 37,000 and at least 450,000 are thought to be necessary for financial stability. When the service dropped B-MAC in favour of digital some 7000 didn't make the move into digitland. The UK lost its CMT service end March but our loss is another's gain, CMT (Country Music Television) have opened a 'customised' service across the Asia/Pacific basin region.

Reuter have announced an expansion of their news services following their unsuccessful buyout of the APTV service - which WTN bought in June. Reuters are leasing AsiaSat capacity from this Autumn to bring a higher profile into the Asia/Australasian regions.

The Reuters Thursday only media entertainment bulletin will be increased to a daily offering, free to broadcasters until October. Also just appeared across SE Asia is the the Discovery/BBC 24 hour 'Animal Planet' channel, preceeding by a few days launch of the NBC-National Geographic Channel! 'Animal Planet' will expand covered into India early in '99.

Intelsat news releases - their 805 bird launched successfully on June 18 and slotted 55.5°W and offer 'high quality multimedia services to the Americas and Europe'. A 4GHz C-Band bird it can provided EIRPs up to 40dBW allowing use of dishes down to 1.8m. The Islands of Comoros became the 143rd member of Intelsat, this is a small group in the North Mozambique Channel, a French possession with 630 000 population.

Eutelsat have detailed their new satellite SKYPLEX system of on-board multiplexing of incoming uplinked signals. This system allows up to six individual uplink signals of 6.3Mbps to be combined on board to provide a downlink of 38Mbps.

It allows direct uplinking from small sites rather than terrestrial combination of the six sources and then uplinking the total mixed signal package. Eventually bit rates down to 350Kbps will be 'Skyplexed' when *Hot Bird 5* flies to 13°E this Summer.

Finally, bad news for sat-zappers even when digital reception has been sorted, Sony have introduced their twice data speed package type DSM-T1 for the uplink transmission and the DSM-R1 demodulator at the downlink receiver allowing double speed transmission/reception of data/picture and saving transponder rental charges.



Fig. 3: Local station KAMU-TV gets involved with a corporate TV operating in Texas.



Fig. 4: Many foreign broadcasters took their own equipment into France for the World Cup to complete picture editing, etc.

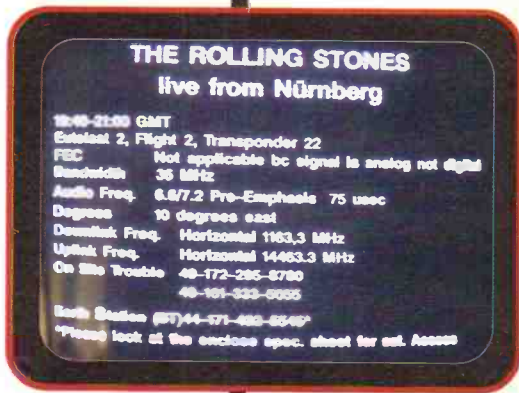

Fig. 5: The Rolling Stones 'Bridges to Babylon' tour hits the road in Germany.



Fig. 6.



Fig. 7.



Fig. 8.



Fig. 9.

Fig. 6: Renewed interest in Woodward Case took SNGS back to Elton.

Fig. 7: CNN Berlin links into CNNI each morning.

Fig. 8: Word Cup edit suite for US TV on 21°W.

Fig. 9: World Cup English Hotel.

■ LAWRENCE HARRIS, 5 BURNHAM PARK ROAD, PEVERELL, PLYMOUTH, DEVON PL3 5QB

■ E-MAIL: info.orbit@pwpublishing.ltd.uk ■ WEB SITE: http://www.peverell.demon.co.uk

Info in Orbit

It seems to have been 'all change' with the WXSATS during July. NOAA-15 unexpectedly started transmitting high quality a.p.t. (low resolution) imagery, METEOR 2-21 failed, METEOR 3-5 resumed transmissions and GOES-9 (an American WXSAT) showed symptoms of imminent failure. METEOSAT-5 started unexpected WEFAX transmissions, and add the possibility of images from a new Russian RESURS satellite and we have an interesting scene!

Current WXSAT Operations

As briefly mentioned last month, the v.h.f. antenna on NOAA-15 suddenly 'clicked' into its correct place during the early hours of 17 June, resulting in the immediate improvement of a.p.t. images. There had been some prior indications to the operations staff - who monitor the 'house-keeping' telemetry - that the antenna boom was slowly deploying. 'House-keeping' data refers to the onboard electronics and routine physical measurements of temperature. This data is incorporated into some of the telemetry.

An early start on the morning of 17th June let me receive the first NOAA-15 pass of the morning - and left me wondering why the signal was not fading. After ten minutes it was obvious that something dramatic had happened overnight - the data was continuous and the image perfect. Subsequent passes - see Fig. 1 - indicate the 'fix' seems permanent.

As is the case with the earlier NOAAs, NOAA-15's orbit is sun-synchronous, but the orbital plane is several degrees away from NOAA-12 so images are received in conditions of different illumination. Visible-light images from the morning passes are brighter than those from evening passes. Instances of sun glint are frequently seen in NOAA-15's images, though not so clearly in this cloud-covered example!

With three operating NOAA WXSATs, METEOR transmissions during June seemed somewhat sparse. The ageing METEOR 2-21 failed around 24 June, after which only a token, non-a.p.t. signal could sometimes be detected as it passed over. My main WXSAT scanner ignored the non-a.p.t. METEOR 2-21 signal - which is exactly what it is designed to do - but the general purpose scanner continued to lock on the r.f. carrier.

When possible, I operate two independent scanners, the WXSAT receiver, and one capable of tuning to a wide variety of frequencies - just for the interest of hearing satellites and their different tones.

Despite the various formal messages that are regularly issued on the Internet about METEOR operations, METEOR 3-5 unexpectedly resumed transmissions on 10 July.

I logged a low elevation easterly transmission at 1308UTC, followed by later passes. Figure 2 was received using 'software synchronisation' in which the software looks for the black-white bars

to form an edge of the image.

By early July, METEOR 3-5's orbital plane had moved away from the 'twilight zone' (sunrise-sunset line) and is now in full solar illumination - except when it passes into night. By mid-September it will have precessed towards the following terminator so we might then see the next 'switch-off'. It is possible that the WXSAT might have failed before that.

New RESURS Satellite

A new RESURS satellite has been launched. Signals can be heard on 137.25MHz but so far they are not a.p.t.

GOES-8 live images in Plymouth (and elsewhere!). I have mentioned the possibility of reception of GOES-8 telemetry from the western side of Britain. This WXSAT is positioned over the east coast of America as their 'GOES-east' satellite where - from Plymouth - it is about three degrees above the western horizon.

By carefully pointing a 45-element Yagi westwards, and then experimenting with different locations within the yard, I found a position where a fair, though noisy signal could be obtained. For this operation I had to remove the pre-amp from my METEOSAT dish for connection to the Yagi. The Yagi was then carefully rotated to maximise the signal.

A succession of GOES-8 images were received. Like METEOSAT-7, GOES-8 not only transmits images from its own radiometer but also those originating from GOES-9 (imminently GOES-10 that is positioned further west) and several composites from the NOAA polar orbiting WXSATs.

Consequently, GOES-8 images are very informative. They had a small amount of noise remaining - not unexpected because of the bushes through which the signal is being received - so a smoothing process has been used to improve image clarity.

In this GOES-8 USIR format (infra-red) image, a storm can be seen in the northern region of Oklahoma. Such severe weather frequently prompts the authorities to put the satellite into a 'super rapid scan operations' mode, in which more frequent scans of the storm region are made and quickly passed to the weather agencies and local authorities.

In this image - as with all those shown here in colour - the original scanned image is black-and-white. Colour is added by using an overlay mask and replacing the grey-scale with a colour shade, according to a pre-defined table. The result



Fig. 1: NOAA-15 image received at 0818UTC on 25 June.



Fig. 2: METEOR 3-5 1642UTC 10 July (small section of the pass).

Timestep

PROsat II is used by most leading Weather Satellite enthusiasts. They have come to rely on the vastly superior features of **PROsat II**. Features such as 1,000 frame full screen full colour animate, 3D, direct temperature readout, latitude-longitude overlays and country outlines from NOAA, and Windows export make Timestep products preferred by most serious users. All satellites are catered for including the awkward Japanese GMS and the very infrequent Soviet Okean series. All current SVGA cards are supported. NOAA images contain full resolution visible and infrared data in a stunning 2.4Mb file!

If you really are serious about Weather Satellites, phone or write us now for a colour catalogue and find out why the world's experts including Arthur C. Clarke use and recommend our equipment.



Advanced Weather Satellite users will by now have read about our new **TRACK II** prediction software. Full screen colour graphics and 6 simultaneous satellites are just some of the amazing features. For the ultimate in detail we offer **HRPT** digital systems with five 1.1km ground sensors, towns and rivers are clearly visible. For everyday use we also have the **PDUS** digital Meteorosat system that takes 2.5km data every 30 minutes. Timestep **PDUS** colour animate is used several times a day by Anglia Television because of its very high resolution combined with spectacular colour. Forecasters will appreciate temperature calibrated 30 minute interval images.

A full range of separate Antennas, Preamplifiers, Cables, Receivers and accessories are held in stock.

Timestep PO Box 2001 Newmarket CB8 8QA England
Tel: 01440 820040 Fax: 01440 820281

SPECTRUM COMMUNICATIONS

Unit 6B, Poundbury West Estate, Dorchester, Dorset DT1 2PG
 Opening times: 9.00am - 1.00pm, 2.00pm - 5.00pm Tue-Fri, 9.00am - 1.00pm Sat. Closed Sun & Mon

WEATHER SATELLITE SYSTEM

WEATHER SATELLITE RECEIVER, 5 channel crystal controlled receiver with scan facility and effective S meter. Good immunity to adjacent channel paging interference. Monitor loudspeaker and remote switching facility. Type WSR. Boxed kit £127.40. Boxed built £184.75. Insured post £5.00.

SATELLITE ANTENNA, 2 element crossed Yagi phased for circular polarisation and beamed skywards. Ready to assemble £35.00. Postage £5.00.

COMPUTER INTERFACE Universal receive interface that works really well with all popular software for weather pictures. Type UNIFACE 1000. Boxed kit £30.00. Ready built £45.00. Postage £2.50.

SYSTEM CABLES DIN to phono for UNIFACE to receiver. DIN to 9 or 25 pin D for UNIFACE to computer. State type required when ordering. Parts £5.50. Made-up £10.00. Including postage.

JVFAX SOFTWARE A copy of the popular shareware version 7.0 or 7.1a on a 3.5" floppy disk. £2.50. Postage 50p.

COMPLETE SYSTEM as described above and including complimentary JVFX version 7.0 or 7.1a software but not including antenna download, in kit form £202.90 including carriage. Ready built £285.00 including carriage.

SEND SAE FOR CATALOGUE

TELEPHONE AND FAX (01305) 262250



THE VINTAGE WIRELESS LISTING

Published regularly containing 100s of out of print and collectable wireless books and magazines. Vintage and valve communications receivers, valves and components for the short wave enthusiast and amateur. Send six first class stamps for next listing or £4 for next four listings or £10 for next four catalogues and eight issues of "The Vintage Wireless Trader" containing our latest acquisitions and subscribers wants and sales. Published at approx six week intervals.

NEW BOOKS

Eddystone Communications Receiver Data 1950-1970. A facsimile reprint of the circuit diagrams, general description and some service notes for sets from 1950-1970. 50 pages £9.75 incl P&P.

Admiralty B40 Receiver. Contains detailed description, circuits, operating instructions, illustrations, etc. Approx 48 large format pages. Facsimile reprint. £13.50 incl postage.

R.1155 Receiver Data. Contains circuits and technical notes. 47 large format pages, facsimile reprint. £11.75 incl P&P.

T1154 Series Transmitter Manual. Contains circuits, technical notes and photos. 54 large format pages. Facsimile copy. £14.75 incl P&P.

HRO Communications Receiver Data. A facsimile reprint of circuits and data for models HRO, HRO-5, HRO-5T, HRO-5R, HRO-M, HRO-MX, HRO-M-RR, HRO-TM, HR-SR. 35 pages. Large format £9.25 incl P&P.

Valve Communication Receiver Handbook. Contains circuits and technical information for valve communication receivers both commercial and of military origin. 1940s to 1960s. Incorporates a surplus/commercial cross referenced valve guide. Large format approx 100 pages. Facsimile copy. £16.50 P&P £2.50.

Wireless Set (Canadian) No 19 MkIII Technical Manual. Facsimile copy, contains detailed description, layouts, circuits, operating instructions, etc. 62 pages. Large format. £12.50 incl P&P.

The Ultra-Magic Deals by B F Smith. A well researched book on Ultra codebreaking operations providing a fascinating study of the technologies, personalities and politics of Britain and America's most mysterious secret - the pooling of their cryptological intelligence against Germany and Japan. Includes recently released details of Bletchley Park operations and is one of the few books published on cryptanalytic operations. 276 pages. Published at £17.95. Our price £11.50 P&P £2.50.

Callers welcome to our vintage wireless shop by prior arrangement. Lots of interesting items but please telephone before visiting.

Vintage components in stock, also government surplus and valved communications receivers.

(Dept SW) CHEVET SUPPLIES LTD.

157 Dickson Road, BLACKPOOL FY1 2EU

Tel: (01253) 751858. Fax: (01253) 302979.

Telephone orders accepted.



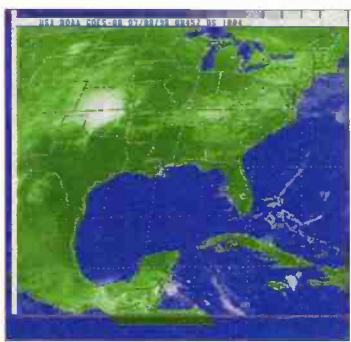

Fig. 3: GOES-8 infra-red image 8 July at 0845UTC direct from GOES-8.

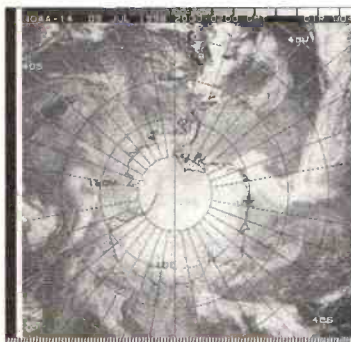

Fig. 4: GOES-8 N14-south-pole on 9 July - composite image.

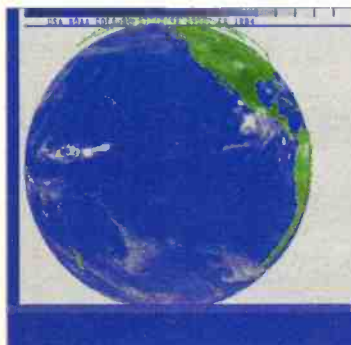

Fig. 5: GOES-9 0900UTC 10 July.

Fig. 6: METEOSAT-5 PDUS image 9 June from Arne van Belle.



is probably closer to the view that would be seen by an orbiting astronaut.

The infra-red image of the south-pole dated 9 July is a composite from a sequence of NOAA-14 passes over that region between 2000 and 0200UTC, re-transmitted from GOES-8 - see Fig. 4. The format is labelled W044 and is transmitted at 0926UTC daily. Think of the potential in building a collection of these images!

I am planning on mounting the Yagi outside permanently so that I can include some GOES-8 (and associated) images in this column occasionally.

GOES-9 Failure

In geostationary orbit above America, three WXSATs - GOES-8, 9 and 10 have been operating (or available). GOES-8 is in the GOES-east position at longitude 74°, and GOES-9 is in the GOES-west position at longitude 134°.

GOES-10 was launched last year and, after checking out, has been kept as an 'in-orbit' spare, in case of failure of either GOES-8 or 9. Well, it happened! On 9 July, the US Department of Commerce's National Oceanic and Atmospheric Administration announced that the GOES-9's attitude control system was near failure, and that GOES-10 was being readied for seamless transfer of operations.

GOES-9 is nearly at the end of its design life. GOES-8 was launched over four years ago and continues to function as the GOES-east WXSAT, with no significant changes in the past 18 months.

Following the announcement of the changeover, GOES-10 imagery is to replace that from GOES-9. I obtained one of the last GOES-9 images - see Fig. 5 - on 10 July within hours of the transfer. As mentioned before, it was obtained from GOES-8 - not the Internet!

METEOSAT-5 WEFAX!

As part of the Indoex (Indian Ocean Experiment), the earlier METEOSAT-5 WXSAT was moved from its former position near longitude 0° (where it was once the prime METEOSAT), to 63° east, over the Indian Ocean. Following several weeks of slow

manoeuvring, it finally arrived in position on 18 May for a series of officially scheduled Primary Data (User) Transmissions (PDUS).

Its main goals are to assess the significance of atmospheric aerosols for global radiative studies, and to assess the

Fig. 7: M5 Indoex 8 July 2100UTC IR1.

magnitude of solar absorption at the surface and in the troposphere, including certain cloud systems. Figure 6 is a METEOSAT-5 Primary Data image received by Arne van Belle of Holland. Arne is the Co-ordinator of Radio Observers for the Werkgroep Kunstmanen organisation, and has recently moved house.

Because of this move, and inclement weather, Arne has only been able to install a 1.2m dish for the Primary Data - hence the noise bursts seen in the image. The picture is a visible-light, maximum resolution image from 1124UTC (slot 22) and shows a storm over eastern India.

The official line on transmissions from METEOSAT-5 is published on the EUMETSAT web site: "Images taken by *Meteosat-5* are disseminated directly from *Meteosat-5* on channel A2 as digital formats only, according to the dissemination schedule S9807101. 1998 onwards."

Until 6 July this 'PDUS-only' policy was evidently in force. Meanwhile, reports from people monitoring WEFAX transmissions in this region had reported that GOMS had apparently ceased regular WEFAX transmissions (on 1691.0MHz) - see GOMS section.

On 8 July Arne van Belle also received a WEFAX transmission - see Fig. 7 - from METEOSAT-5 labelled IR1. The land near the top left side is Madagascar.

My thanks to Arne for sending these images for inclusion here.

GOMS Operations

Those monitoring the GOMS images from METEOSAT-7 will be aware that an image dated 22 May has been transmitted on every GOMS slot for some weeks. Being unable to receive GOMS telemetry from the western UK, I enquired and received confirmation that GOMS WEFAX has not been regularly transmitted by the satellite (also known as ELECTRO) for some time.

Checking the GOMS web site revealed that higher resolution data is still being regularly obtained - see Fig. 8 - so I asked the EUMETSAT METEOSAT operations team for comment. They kindly replied, advising me that although the present GOMS format could not be transferred, they were investigating the situation to try to resolve the problems. "In the meantime it is our policy to disseminate the most recent transferred GOMS formats and plans to disseminate an admin message in their place has been considered not to be a viable option". My thanks to Nicholas Coyne for responding.

Other examples of GOMS near-real-time images can be found at the web site:

<http://smis.iki.rssi.ru/data/goms/archive/>

High Resolution Picture Telemetry

A number of 'Info' correspondents have acquired h.r.p.t. systems, and I am always pleased to hear about their experiences of operating such



precision equipment, and see their resulting images. **Roger Ray** is now running such a system from the German company SSB Electronic and sent me a selection of images - see **Fig. 9**.

To receive h.r.p.t. images, you require a tracking antenna for the 1700MHz band telemetry that has to be driven to follow the satellite across the sky, and a complete signal receiving and processing system. Roger's equipment includes a 650m dish with an active feed, driven by a KR 5600 rotator.

The only problem Roger has not yet solved is how to raise the dish on its tracking bracket - above its

current 1m height. Despite this limitation, Roger sent me half-a-dozen h.r.p.t. images, some others of which may appear in later editions of 'Info'.

Forthcoming 'WXSAT Special'

A 'WXSAT Special' is under preparation for the November edition of *Short Wave Magazine*. Currently scheduled features include reviews of both the RIG (Remote Imaging Group) receiver, and the PROscan receiver from Timestep. Other features should include a look at the next generation LRIT transmissions and h.r.p.t. systems.

Shuttle Launch Schedule

Due to the delay in the availability of the first parts of the modules for the *International Space Station*, there is a pause of a few months before the next Shuttle mission. Currently, STS-95 (*Discovery*) is expected to be launched on 29 October with the Space Hab Single Module and Spartan payloads, and STS-88 (*Endeavour*) is due up on 3 December for the first *ISS-1* (Node-1) flight.

Meanwhile, I am expanding the *Shuttle Pack* to include information on the ISS, which I know is of great interest to many 'Info' readers.

Kepler Elements - MIR and Shuttle

For a print-out of the latest WXSAT elements, *MIR*, and the Shuttle (if in orbit), send a stamped addressed envelope and secured 20p

coin or separate, extra stamp. Transmission frequencies are given for operating satellites. This data originates from NASA. During Shuttle operations I send Kepler elements by return-of-post.

I also send monthly Kepler print-outs to many people. To join the list please send a 'subscription' of £1 (secured, plus four self-addressed, stamped envelopes) for four editions.

You can have the data as a computer disk file containing recent elements for the WXSATs, and a large file holding elements for thousands of satellites. A print-out is included, identifying NASA catalogue numbers (for the WXSATs, Amateur Radio satellites, and others of general interest), ideal for automatic updating of your tracking software. Please enclose 50p with your PC-formatted disk and stamped envelope.

Frequencies

NOAA-14 transmits a.p.t. on 137.62MHz.
NOAA-12 (and/or *NOAA-15*) transmits a.p.t. on 137.50MHz.
NOAAs transmit beacon data on 137.77 or 136.77MHz.

METEOR 3-5 uses 137.85MHz during sunlight only.

RESURS signal on 137.23MHz to be clarified.
OKEAN-4 and *SICH-1* use 137.40MHz for short transmissions.

METEOSAT-7 (geostationary) uses 1691 and 1694.5MHz for WEFAX.

GOES-8 (where low on western horizon) uses 1691MHz for WEFAX.

SRC PLANETA GOMS-1 IR WA
11 JUL 1998 03:05 UT

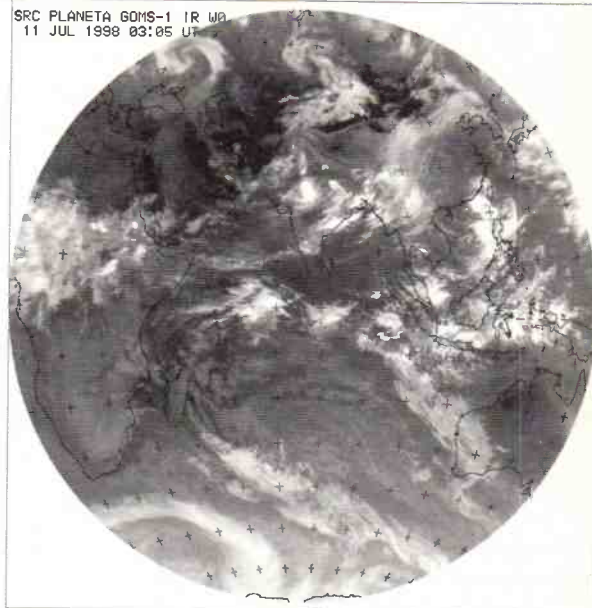

Fig. 8: GOMS high resolution image from 11 July 0305UTC courtesy SRC Planet-A.



Fig. 9: Sweden, NOAA-15 h.r.p.t. on 15 June from Roger Ray.

Stop Press

The new *RESURS-0 1-4* satellite transmitted some a.p.t. images on Monday 13 July, of which **Fig. 10** was actually received by the *RESURS* team themselves. **Olga Tarakanova** of the R&D Centre ScanEx kindly sent this image from the visible-light unit on the satellite. There should be full details of the satellite available for the next issue of *SWM*.



Shackware

Hello and welcome to another instalment of 'ShackWare', the column that details computers (and especially the older boot-sale finds) in the shack. There's lots to cram in this time so without further ado, it's straight on to a bit of useful information to all those who previously, had no good reason to own a palmtop.

Sussex Show Time

I'm putting the finishing touches to this column having only an hour or so ago returned from the Sussex Amateur Radio and Computer show, billed as one of the largest events in the radio calendar. It certainly was well attended - the stalls were four or five deep in bodies and the aisles were full of rain-sodden enthusiasts jostling for bargains, and bargains there were by the bucketful!

Computer equipment at outrageously cheap prices (such as 486DX33 base units for just £25), receivers of all kinds from battered 2m hand-helds at under a tenner to full-blown wide-band base station sets for hundreds of pounds. A stunning bargain on the computer front was a very nice Atari ST in the Bring & Buy hall for just £7 - a shack workhorse at a remarkable price.

All in all then, another good show - though after visiting all those stalls at least twice, can you believe I wasn't able to find a cheap RTTY terminal unit such as an old Maplin TU1000 or some such - anyone able to help?

Hands On

Never mind the Morse 'fist', here's some software that will put c.w. translation right in the palm of your hand (tenuous link). *PalmMorse* is a simple but useful WinCE program which takes words and sentences in standard English or dots and dashes in standard Morse with a translation either way.

There's no transmission option (though that's promised for the future) but nevertheless *PalmMorse* is a very handy pocket translator for those of us whose skill with the dots and dashes is virtually non-existent and yet who have a need to know what it is they're listening to.

Previously, for example, when scouring the long wave section of my HF-225 for maritime beacons, each find would be followed up with some frantic scribbling and searching through tables before I could verify that what I'd found was what I thought I'd found. Now, it's a simple matter of tapping at the keyboard while I listen, then clicking on the translate button.

This is useful even for the relatively simple two-letter callsigns of the beacons, but it really comes into it's own when there's a 'sentence' or more. I'm afraid I have no author information for *PalmMorse* but you'll find a download link for it at **Craig Peacock's Windows CE** web pages (among others) www.craigtech.co.uk

Mail Bag

First on the mat this month is **G D Wilson** of New Basford, Nottingham who writes "I've been given an Atari 520STFM with a colour monitor and second drive. Having to take early retirement on the grounds of ill health, I would like to expand my listening and learn more about decoding. I have a DX-394 with long wire and a.t.u."

The ST is a nice computer. It's easy to use, there's plenty of soft and hardware around at bargain prices

and, while I'd always recommend a PC for those new to computers who haven't yet made a purchase (on the grounds of sheer software numbers), the soon-to-be-launched *FaxCode* from **Dave Miller** is a prime example of quality code for the data modes.

Competently written and at a more than affordable shareware price, *FaxCode* makes use of a simple comparator-like interface (details supplied with the software) which is a suitable build project for anyone with a soldering iron and an hour or two to spare.

Dave E-mailed me recently to say that his software is almost ready to be launched - all that has to be added is the shareware password protection. I'll publicise its arrival as soon as I'm able - which ought to make **Brian Lumsden, L Warren, Peter Clifford** and many other correspondents very happy men!

Another excellent source of ST software is the Walnut Creek CD-ROM available from good PD libraries (including PDSL, a regular *SWM* advertiser). The ROM offers almost 3000 Atari-oriented programs and you don't need a CD drive connected to the ST either. If you have access to a PC with a CD drive (is there a PC without a CD nowadays?), you can browse the ROM and off-load the files you want onto 720K 3.5in disks for use on the ST.

Next out of the hat is this exceedingly interesting letter from **Tony Ward** of Bridgwater, Somerset. Tony was prompted to write following the mention of **David Cripps G7IDB** and his natty pencil-box decode station.

Tony writes that "...mine isn't as small, but it is cheaper! I have a 286 Minisport laptop computer and a Baycom TU both of which cost £30. I use these together with an old CEPT FM Harrier 40-channel CB", and it's with this equipment Tony pursues an interesting (possibly unique, though no doubt someone out there will write and tell me differently) niche in this great s.w.l. hobby of ours. Take it away, Tony...

"The frequencies I listen to are the European packet CB frequencies located on 27.235, 27.245, 27.325 and 27.345MHz, all on f.m. and running at 1200 baud. I have monitored packet beacons containing IDs of the stations and PO box numbers and sometimes even web site addresses and BBS telephone numbers. I have QSLed a lot of these stations mainly from Germany, Denmark and Holland, but I have also monitored packets from as far afield as Switzerland and Greece too. As the sun spot cycle increases over the coming months, I'm sure to get a good collection of QSLs and I must say, the quality of the cards is very good."

Tony believes many of the stations are using Baycom modems with *Graphic Packet* software, vertical antennas and just 4W "...which makes it very QRP in s.w.l. terms". Tony ends "I think I've found quite a niche hobby which is very cheap to do and, as the computer software can be set to monitor with time stamps, is almost 90 per cent automatic. Hope this is interesting to your readers".

Interesting? I'm hooked! I suspect, though, that it isn't especially widespread given the hefty control of data transmissions on 11m and the reduced 'reach' of four watts, though of course some of our European neighbours are a little less concerned than our own authorities.

Interestingly, and after digging a bit deeper on the 'net', it seems that any poll carried out by UK regulating authorities on the matter, found that most CBers don't want data modes on their band. Remarkable! But perhaps it's that very lack of anything technical which attracts enthusiasts away from amateur radio and into CB in the first place?

Return To Lilliput

Sorry! But the mention of portable decoding elsewhere on this page brings me neatly on to a recent acquisition in the field of pencil box stations. The greatest problem has been finding a pocket computer capable of running the necessary software.

Over the years I've experimented with whatever has been available - everything from the Tandy TRS80 shirt pocket computer (essentially a calculator) to the Atari Portfolio, Poqet PC, Psion Series 3 and a HP320LX WinCE machine. None, however, has been a perfect solution. David Cripps mentioned his HP200LX and this, I believed, was probably the best of the palmtops - until now.

On a recent trip to London, I melted my plastic purchasing on what has got to be the most remarkable 'pocket' machine ever. Toshiba's Libretto 50CT set me back around £600 (I know!) but it offers a truly competent spec.

The machine has a Pentium 75MHz processor, 32Mb of RAM and an 810Mb hard drive, a 16-bit fully SoundBlaster compatible sound card, a truly usable keyboard, full compliment of standard I/O ports and, perhaps best of all, a really amazing SVGA screen, all in a package about the size of a VHS video tape.

A downside of all this power is, of course, battery life, which averages around 1.5 hours, but there's an a.c. adapter shipped with the Libretto, little bigger than a box of Swan Vestas, and an optional cigarette lighter adapter for in-car use.

Just drive to the top of your nearest hill with a Sony SW100 receiver, a 12V 137MHz set and fold-down crossed dipole, and the world (and upper atmosphere), shrinks before you! I'm still exploring, but there'll be updates in forthcoming instalments of 'ShackWare'. In the meantime if you happen to bump into my wife, *don't* tell her 'cos she hasn't seen the bill yet! Until next time, good listening...

DX Television

The lengthy reception log for June reflects the vast amount of Sporadic-E activity present every day, perhaps making it something of a record month. Many openings were established as early as 0500UTC with lengthy openings from Italy and the Iberian Peninsula.

There were noticeably fewer signals from Scandinavia, with no reports of Finland. There were many all-day openings similar to the ones which established DXers will remember from the Seventies. **Roger Bunney** (Romsey) recalls such an event when Spanish signals were pounding in.

Arabic Reception

The second-network Syrian Channel E2 transmitter has been logged several times in the United Kingdom during June. **Ian Milton** (Tyne and Wear) and **Paul Logan** (Northern Ireland) have both successfully received the station using a notch filter to remove the spread-over of signals from baby alarms and other r.f. junk operating around Channel R1. On June 2nd, Iranian TV was identified on Channels E2 and E4 in the Netherlands.

On the 3rd, between 1540 and 1620, a mystery signal was located on E2 with French sound and Arabic subtitles followed by *The American Business Programme* at 1650 in English. At 1620, a panel-game show with Arabic subtitles appeared which faded completely by 1632.

Checking out E2 at 1334 on the 19th revealed a strong Arabic caption which lasted for ten minutes before fading. Again, there was no logo but Syria is the prime suspect. It is interesting to note that the L-shape logo in the lower left of the Syrian picture is only present at certain times of the day, notably during the morning, although on the 7th it was present during the afternoon.

Mystery Stations

A second sighting of a mystery station with an oval logo in the top-left of the screen occurred on the 13th at 0820. It was first seen in May carrying Arabic programmes and is possibly the TV6 relay in Turkey. In both cases, the station was co-channelling with Serbia.

We also have an unconfirmed report of this mystery station on E4 with French sound. Talking of which, a Channel E3 station with French audio was logged in Derby at 1052 on June 6th. Could this have been short-skip Sporadic-E from RTBF-1 Liège in Belgium perhaps?

Italian Stations

The private station 'Radio Video' (VIDEO) transmitting

just below E2 seems to come in at the drop of a hat this season, appearing with monotonous regularity in nearly every log! The Italian private station TV Napoli (M NAPOLI) on Channel A has also been a regular visitor this season sporting a distinctive large letter 'M' usually in the top-right of the picture.

On the 25th at 1921, **Peter Barber** (Coventry) noticed colour bars hastily replaced by a 'NAPOLI' caption which was manoeuvred jerkily into place as if using a home slide projector. A brand-new private station on Channel A is thought to be operating but without a logo.

TVA, another private station, which in the past transmitted slightly higher in frequency than Channel A, seems to have disappeared, although this may have merged with, or changed its name to TV Napoli. During some of the openings, **Tim Bucknall** (Congleton) has noted several transmitter offsets, none of which are listed.

Reception Reports

The 18th was the most productive day with an opening into Italy, Corsica and Spain by 0600. By late morning, the Spanish signals receded and stations in Central and south-east Europe began to emerge.

Vince Richardson (Conwy) queried an SF-1 logo on E2 which we can confirm as originating in Switzerland from the 100kW Bantiger outlet a few kilometres east of Bern. Portugal, Germany, Czech Republic, Slovenia, Hungary (RTL KLUB) and Croatia had all been received at some stage by mid afternoon. By 1850, strong signals from Eastern Europe filled the band.

Barry Bowman (Manchester) noticed a football match with France versus Saudi Arabia on R2. A stylised logo in the top-right of the picture resembling a large figure '4' turned out to be Estonian TV from Tallinn. Lithuania (LTV) and the Ukrainian 1st network, both sharing R2, were also showing the same match while over on R1, the 2nd network was presenting the news.

An increase in m.u.f. (maximum usable frequency) brought in TVM Moldova on R3 at 1950. **Simon Hockenull** (Bristol) logged Rumania on this frequency at 2100.

Lithuania has been well received this season, easily identified by the large interlocked LTV logo in the top-left of the picture. **John Woodcock** (Basingstoke) spotted this station broadcasting a gymnastics display on the 23rd.

Peter Barber (Coventry) comments that instead of the normal text pages on the 29th, RUV-Iceland were showing stills of part of a football stadium and scoreboard complete with animated spectators.

Peter Barclay (Sunderland) has spotted a large slanting C-shape logo on E3 during various openings. This sounds very much like Serbia, the C-shaped is actually a satellite dish. Peter says the audio channel

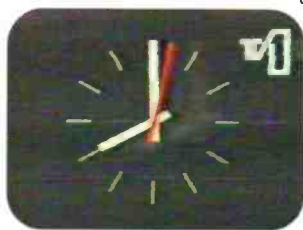

Fig. 1: The Turkish TV-1 clock caption.

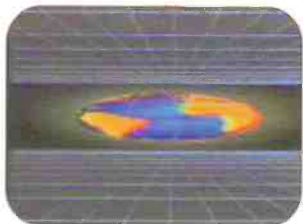

Fig. 2: The Egyptian News opening sequence used by ERTU-2.

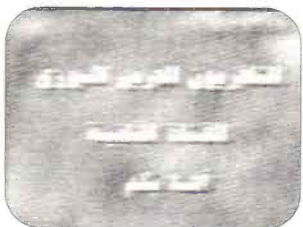

Fig. 3: Unidentified Arabic station received on E2 in Derby on June 9th, 1998.



Fig. 4: Programme caption received from Serbia on Channel E3.



Fig. 5: Unidentified News programme on R1 with identification in the top-left of the screen.

sounds Eastern European and this tends to confirm that the country is indeed Serbia.

Exotics

According to **Pertti Salonen** (Finland), a Finnish DXer identified Kazakhstan TV on Channel R2 during June 8th. The HZ-22 (Aramco TV) E3 outlet at Dhahran, Saudi Arabia, has also been received.

We've also had an unconfirmed report of TVGE Equatorial Guinea being received on E2 in Jersey last April. This was identified at 48.2504MHz using a scanner. The 1kW transmitter sits atop a volcano south of Malabo town.

FM DX

High m.u.f.s provided plenty of f.m. DXing opportunities on at least 13 days. On the 17th, **Mike Gaskin** (Cornwall) reports a possible Canary Islands station (R. Minuto) on 101.40MHz. The m.u.f. rose into the Marine band (156-162MHz) on the 18th and 19th.

Ben Clare (Cleveland) heard a traffic report in Italian from RAI-1 on 94.7MHz from Monte Caccia on his car radio during a recent opening.

The 11th was particularly active between 1800 and 2100UTC with wall-to-wall reception from Spain, Portugal, Italy and Morocco. Many UK stations were wiped off the band!

Service Information

Gösta van der Linden (Rotterdam, Netherlands) has sent the following updates:-

Syria: The 2nd network Channel E2 transmitter at Homs located in the north-west of the country has an e.r.p. of 80kW.

Lebanon: All the 1kW E2 relays have closed. However, there is an E3 transmitter located at Merga Yum beaming towards Beirut. Its e.r.p. is not known.

Romania: A new TVR-1 transmitter is operating on Channel R2.

June DXTV Log

The collective reception log for June has been supplied by Peter Barber (Coventry), Vince Richardson (Dolgarrog, Conwy); Peter Barclay (Sunderland); Simon Hockenhull (Bristol); John Woodcock (Basingstoke) and **Martin Dale** (Stockport). Times are in UTC.

Day	Log
1	Syria (SYR-1) E2 from 0650; Spain (TVE-1) E2 and E3 from 2050; Portugal E2 and E3 from 2055.
2	Italy (RAI UNO) B at 1144; Belarus R2 with G-204 test pattern at 1145; Spain E2, E3 and E4 at 1305, also from 2200; Ukraine (YT-1) with striped '1' logo top-right at 1420.
3	Italy (RAI UNO) A and B; private station (VIDEO) E2 from 0725; Ukraine YT-1 R2 and YT-2 R2 and R3; Norway (NRK-1) from 0922; Lithuania (LTV) R2; Swden (SVT-1) tennis at 0925; Czech Republic (NOVA) R2 at 1050; Hungary (RTL KLUB) R2 at 1330; Serbia (RTS-1) at 1515; Croatia (HRT-1) E4; Unidentified Arabic signals on E2 from 1540; Hungary (RTL KLUB) R2; Estonia (EESTI TV) R2; Rumania (TVR-1) R2; Moldova (TVM) R2; Portugal (RTP-1) E3; Russia (ORT-1) R2.
4	Spain E2, E3 and E4 for most of the day; Portugal E3; France (Canal Plus) L3; Italy (RAI UNO) A; Italy (VIDEO) E2.
5	Spain E2, E3 and E4 for most of the day; Italy (RAI UNO) A; Italy (VIDEO) E2; Portugal E3.
6	Germany (ARD-1) E2; Italy (RAI UNO) A; Italy (VIDEO) E2; Italy (M NAPOLI) A; Unid E3 transmitter with French sound at 1052.
7	Italy (RAI UNO) A; Italy (VIDEO) E2; Czech Republic (NOVA) R1; Russia (RTV) R2; Spain E3; Syria (SYR-2) E2 from 1252 until 1452.
9	Italy (RAI UNO) A and B; Italy (VIDEO) E2; Norway (NRK-1) E2; Slovenia (SLO-1) E3; Hungary (RTL KLUB) R2.
10	Italy (RAI UNO) A; Italy (VIDEO) E2; Hungary (RTL KLUB) R2; Serbia E3.
11	Spain E2, E3 and E4 from 1745; Portugal E3 and E4 (35W relay at Valenca do Duro); f.m. band active until 2100 with Spain, Morocco, Italy and Portugal.
12	Italy (RAI UNO) A and B; Italy (VIDEO) E2; Unidentified private station on Channel A; Corsica (Canal Plus) L2 and L4.
13	Corsica (HRT-1) E4; Turkey (possibly TV6) wit oval logo top-left from the SE at 0820; Serbia (RTS-1) E3; Slovenia (SLO-1) E3; Italy (VIDEO) E2; Italy (RAI UNO) A and B; Also unidentified private station on Channel A.
14	Spain E2 and E4; Portugal E3.
15	Italy (M NAPOLI) A; Spain E2; Norway E2; Lithuania R2.
16	Spain E2, E3 and E4; Portugal E3; Norway E4; Italy (RAI UNO) A and B; Italy (VIDEO) E2.
17	Italy (RAI UNO) A and B; Italy (VIDEO) E2; Italy (M NAPOLI) A; Corsica (Canal Plus) L2.
18	Italy (RAI UNO) A and B; Italy (VIDEO) E2; Italy (M NAPOLI) A; Corsica (Canal Plus) L2; Spain E2 and E3; Portugal E3; Czech Republic (NOVA) R1; Germany E2; Switzerland (SF-1) E2; Hungary (RTL KLUB) R2; Slovenia E3; Croatia E4; Portugal E3 and E4; Estonia (EESTI TV) R2; Serbia E3; Moldova (TVM) R2 and R3; Ukraine (YT-1) R1, YT-2 R1; Lithuania (LTV) R2; Sweden E2.
19	Italy (RAI UNO) A and B; Italy (VIDEO) E2; Italy (M NAPOLI) A; Slovenia E3; Serbia E3; Corsica L2 and L4; Hungary (RTL KLUB) R2; Moldova (TVM) R2; Rumania (TVR-1) R2; Unidentified Arabic caption until 1335; Spain E2; Ukraine (YT- 2) R2.
20	Italy (RAI UNO) A and B; Spain E2 and E3; Portugal E2; Estonia R2.
21	Italy (RAI UNO) A and B; Italy (VIDEO) E2; Italy (M NAPOLI) A; Corsica L2; Spain E2, E3 and E4; Portugal (RTP-1) E3 and E4; Portugal (RTP-2) E2.
22	Italy (RAI UNO) A; Italy (VIDEO) E2; Serbia E3; Spain E2, E3 and E4; Portugal E3.
23	Italy (RAI UNO) A and B; Italy (VIDEO) E2; Italy (M NAPOLI) A; Moldova R2; Serbia E3; Hungary (RTL KLUB) R2; Lithuania R2; Ukraine (YT-1) R1 and R2; Slovenia E3; Switzerland E2; Russia ORT-1) R3.
24	Spain E3; Italy (RAI UNO) A and B; Italy (VIDEO) E2.
25	Italy (RAI UNO) A and B; Italy (VIDEO) E2; Italy (M NAPOLI) A.
26	Italy (RAI UNO) A and B; Italy (VIDEO) E2; Italy (M NAPOLI) A; Spain E2 and E4; Hungary (RTL KLUB) R2; Slovenia E3; Germany E2; Austria (ORF-1) E4; Czech Republic (NOVA) R1 and R2; Portugal E3; Serbia E3. Lithuania R2; Denmark (DR-TV) E3; Spain E2 and E4; Portugal E3; Belarus R2.
27	Italy (RAI UNO) A; Spain E3; Hungary (MTV-1) R1; Hungary (RTL KLUB) R2; Czech Republic (NOVA) R2.
28	Italy (RAI UNO) A; Spain E3; Hungary (MTV-1) R1; Hungary (RTL KLUB) R2; Czech Republic (NOVA) R2.
29	Iceland (RUV) E4.
30	Spain E2, E3 and E4.



Italy: Private stations 'Radio Video' (VIDEO) and 'TV Napoli' (M NAPOLI) both transmit from Monte Faito.

TV Up For Grabs

Ernie Strong (Cambridgeshire) has a Saisho CT141X portable colour receiver for disposal, free of charge but collection preferred. It is in reasonable working order but it is possibly u.h.f. only. If anyone is interested please act now, otherwise Ernie will throw it out! Enquiries should be made via the address at the end of the column, please enclose a stamp so that your letter can be forwarded to Ernie.

Keep On Writing!

Please send your DXTV and f.m. reception reports, off-screen photos, news and information to arrive by the first of the month to:- **Garry Smith, 17 Collingham Gardens, Derby DE22 4FS.**

Fig. 6: This month's 'Down Memory Lane' feature. The ETP-1 test card used in the early Eighties by Channel 4.

Aerial Techniques

UNIVERSAL DIGITAL VIDEO SYSTEMS CONVERTERS

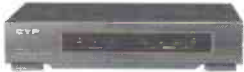

CDM-820 broadcast-class converter
8M bit memory, two sets of S-VHS inputs & outputs, NTSC to PAL and PAL to NTSC, 500 lines dynamic & static resolution, full line & frame conversion, time base correction **£649.00**



CDM 800
4M bit memory, two inputs & outputs, NTSC to PAL and PAL to NTSC also SECAM, 500 lines static resolution, dynamic 300 lines, full line & frame conversion, time base correction, AC operation **£449.00**



CDM 600
2M bit memory, single input & output, NTSC to PAL and PAL to NTSC also SECAM, 420 lines static resolution, dynamic 250 lines, full line & frame conversion, time base correction, AC operation **£299.00**

THOMSON MULTI-SYSTEM NICAM VCR



Multi-system compatibility. Covers VHF, UHF and cable channels. Records, receives and plays back: PAL system I (for UK); PAL system B/G (for Europe); SECAM system L (for France), SECAM system B/G (for Middle East), SECAM system D/K (Eastern Bloc); NTSC 3.58 (via scart) **£499.00**

THOMSON 14" MULTI-SYSTEM TV

Covers VHF/UHF PAL/SECAM L for use in UK France & Europe.

- 14" screen multi-standard
- PAL/SECAM (NTSC via scart)
- VHF-UHF hyperband tuner
- 59-channel memory
- Fasttext teletext
- S-VHS (via scart)
- 240V AC operation

£269.00



FULL CATALOGUE Features Satellite, Multi-system TVs + VCR's, Converters, Decoders, Amplifiers and Aerials for domestic and TV-Dxing. AVAILABLE BY RETURN OF POST FOR ONLY £1, or ring with your credit card.

11 Kent Road, Parkstone, Poole, Dorset BH12 2EH

Tel: 01202-738232 Fax: 01202-716951 E-mail: atech@dircon.co.uk

(All prices are inclusive of VAT, delivery by courier £10.00)

The SHORTWAVE Shop

18 FAIRMILE ROAD, CHRISTCHURCH, DORSET BH23 2LJ

Phone/Fax 01202 490099 SHORTWAVE HOTLINE: 07000 CQDXCQ (273927)

THE SCANNER AND RECEIVER SPECIALISTS

Scanners and Receivers from £75 - £5999.

Call & discuss which part of the Radio Spectrum you wish to monitor & we will advise you on the most cost effective way of doing it.

- Full range of new & secondhand equipment available.
- We stock all famous brands:-

AOR, YUPIITERU, BEARCAT, SCANMASTER

+ ALL THE ACCESSORIES

Visit our web site:
<http://www.shortwave.co.uk>

AMATEUR RADIO

We stock one of the best selections of used equipment on the South Coast!

SAME DAY DESPATCH on all postal sales quoting your Visa/Access number.



Visit our **SHORTWAVE CENTRE**

We've one of the **LARGEST** selections of shortwave equipment on the **SOUTH COAST!**

We stock ● Icom ● Yaesu ● Kenwood ● Alinco

AND WE GIVE FRIENDLY ADVICE

CB - Amateur - SWL - Novice - Airband - Marine

4 MILES FROM BOURNEMOUTH INTERNATIONAL AIRPORT ON B3073

300 YARDS FROM CHRISTCHURCH RAILWAY STATION. FORECOURT PARKING FOR DISABLED

FOZTECH DATA COMMUNICATIONS

Radio and computer specialists

117 Beaumont Rd, Plymouth PL4 9EF. Tel: (01752) 257224

Approved dealer for Icom, Kenwood, Yaesu, AOR, Yupiteru and many others. Shortwave, marine, amateur, PMR, Garmin. Suppliers of Intel, Microsoft, Creative, gigabyte motherboards and memory.

We are open Mon to Sat 9am-5.30pm. Mail order (01752) 268899.

Visit our web site for more info at: <http://www.foztech.demon.co.uk>

Hear VLF "Natural Radio" Emissions!

Hear lightning storm atmospherics, whistlers, auroral and dawn "chorus", tweaks and other natural electromagnetic emissions from high in the Earth's magnetosphere with the WR-3E receiver.

WR-3E receiver just **£95.00** + £2.50 P&P (UK) or £5 P&P (airmail).

Includes receiver with telescopic whip, 90-minute demonstration cassette, manual and tips sheet. Size just 11.5 x 6.5 x 3.7cm (excluding whip). Full specs. available.

For details send an A5 sized SAE to **Simon Collings, Radio Communications Consultant** 46 St. Michaels Road, Cheltenham, Gloucestershire GL51 5RR. Tel/Fax: (01242) 514429.

E-mail: simon.collings@cablenet.co.uk Website: <http://wksveb4.cablenet.co.uk/simon.collings>

VISA, MASTERCARD, EUROCARD AND DELTA CARDS ACCEPTED.

JAYCEE ELECTRONICS LTD

20 Woodside Way, Glenrothes, Fife, Scotland KY7 5DF

Tel: 01592 756962 • Fax No. (01592) 610451

Opening hours: Tues-Fri 9am to 5pm. Sat 9am to 4pm. Closed Sun & Mon.

KENWOOD, YAESU & ICOM APPROVED DEALERS

A good stock of new and secondhand equipment always in stock

THE INTERNATIONAL GROUP FOR WEATHER SATELLITE ENTHUSIASTS

RIG - THE REMOTE IMAGING GROUP

RIG publishes a quarterly journal containing: Many images from space, some in colour. Orbital elements and satellite predictions. Articles about the interpretation of weather images, equipment construction and software. Helplines to advise beginners. All the news about weather satellites.

RIG supplies (to members only): receivers and hardware at a discount, shareware of relevant programs, images on disk and CD-ROM.

Send for free information pack (UK readers SAE please) to:-
RIG-S5B, 34 Ellerton Road, SURBITON, Surrey KT6 7TX, UK

RADIO REVIEW

The in-depth 24 page magazine covering Radio Caroline, UK radio, Dutch radio, satellite radio, D.A.B., Irish radio, short wave pirate stations and more!!

For a trial six issue subscription, send **£10** (all cheques payable to G. J. Baldwin). Payment by bank notes or blank uncrossed postal orders is acceptable.

Send your details and payment to P. O. Box 46, Romford RM7 8AY

LAR COMMUNICATION CENTRE

ESTABLISHED 21 YEARS

12 Station Road, Crossgates, Leeds LS15 7JX

Tel: 0113-232 8400 Fax: 0113-232 8401

Approved dealers for Kenwood, AOR, Icom, Yaesu and many others. We sell amateur radio equipment, scanners, shortwave receivers, antennas and over 800 accessories. Books, *PW* and *SWM*. Our after sales service is second to none.

We are open Mon to Sat 9am to 5pm We have private customer parking.

NORTHERN SHORTWAVE CENTRE

BLACKDYKE RD, KINGSTOWN IND EST., CARLISLE, CUMBRIA CA3 0PJ

Phone/Fax: 01228 590011

David Brown G4KFN

New and used short wave receivers, scanning radios, amateur radio equipment and accessories plus books and magazines.

The books listed have been selected as being of special interest to our readers. They are supplied direct to your door. Many titles are overseas in origin.

Book Store

FREE POST & PACKING ON BOOKS MARKED *

LISTENING GUIDES

Airband

ABC CIVIL AIRCRAFT MARKINGS 1998. Alan J. Wright	336 pages	£6.99
ABC MILITARY AIRCRAFT MARKINGS 1998. Alan J. Wright	192 pages	£6.99
AIR BAND RADIO HANDBOOK 6th Edition. David J. Smith	192 pages	£9.99
AIRBAND RADIO GUIDE 3rd Edition. Graham Duke	96 pages	£6.99
AIRCRAFT RADIO FREQUENCIES & GUIDE BOOK 2nd Edition	96 pages	£5.99
AIR TRAFFIC CONTROL 7th Edition. Graham Duke	112 pages	£8.99
AIRWAVES 98	134 pages	£8.95
CALLSIGN 98	156 pages	£8.95
FLIGHT ROUTINGS 1998. Williams	160 pages	£6.95
INTERNATIONAL AIR BAND RADIO HANDBOOK. David J. Smith	192 pages	£9.99
UNDERSTANDING ACARS		
3rd Edition. Aircraft Communications Addressing and Reporting System. Ed Flynn	80 pages	£9.95
VHF/UHF AIRBAND FREQUENCY GUIDE & CALLSIGN GUIDE	280 pages	£12.50
WORLDWIDE AERONAUTICAL COMMUNICATIONS FREQUENCY DIRECTORY		
2nd Edition. Robert E. Evans	260 pages	£19.95

Datamodes

FAX & RTTY WEATHER REPORTS. Philip Mitchell	88 pages	£11.50
GUIDE TO UTILITY STATIONS. 16th Edition. Joerg Klingenfuss	588 pages	£30.00
GUIDE TO WORLDWIDE WEATHERFAX SERVICES. 18th Edition		
Joerg Klingenfuss	436 pages	£23.00
WEATHER REPORTS FROM RADIO SOURCES. Philip Mitchell	32 pages	£7.50
RADIO DATA CODE MANUAL. 16th Edition. Joerg Klingenfuss	788 pages	£30.00

DXTV

DXTV FOR BEGINNERS. Simon Hamer	31 pages	£3.95
GUIDE TO DX-TV. Keith Hamer & Garry Smith	36 pages	£3.95
GUIDE TO WORLDWIDE TV TEST CARDS	60 pages	£4.95
THIS IS BBC TV - FIRST 30YRS OF TV GRAPHICS. Keith Hamer & Garry Smith	38 pages	£4.95
THE FIRST 30 YEARS OF BBC-2. Keith Hamer & Garry Smith	60 pages	£4.95
THE STORY OF BBC COLOUR TELEVISION	36 pages	£5.95

Frequency Guides

1998 SHORTWAVE FREQUENCY GUIDE. Joerg Klingenfuss	584 pages	£23.00
1998 SUPER FREQUENCY LIST CD-ROM. Joerg Klingenfuss		£25.00
* NEW - ORDER NOW. FERRELL'S CONFIDENTIAL FREQUENCY LIST 11th Edition	450 pages	£19.95
PASSPORT TO WORLD BAND RADIO 1998	528 pages	£15.50
RSGB IOTA DIRECTORY & YEARBOOK 1998/9 (A4 size)	112 pages	£8.95
SHORTWAVE INTERNATIONAL FREQUENCY GUIDE	176 pages	£12.95
VHF-UHF SCANNING FREQUENCY GUIDE. Bill Laver	192 pages	£12.95
WORLD RADIO TV HANDBOOK 1998	608 pages	£18.95

General

BUYING A USED SHORT WAVE RECEIVER 3rd Edition (Booklet). F. Osterman	23 pages	£2.95
FROM INTERNATIONAL WATERS. Mike Leonard	570 pages	£20.95
GETTING ON TRACK WITH APRS. Stan Horzepa WA1LOU	165 pages	£11.50
POP WENT THE PIRATES. Keith Skues	568 pages	£15.95
*SHORT WAVE COMMUNICATIONS. Peter Rouse GU1DKD	187 pages	£4.50
SHORT WAVE RADIO LISTENING FOR BEGINNERS	174 pages	£13.95
SHORTWAVE RECEIVERS PAST & PRESENT (NEW 3rd Edition)	450 pages	£25.95
SHORTWAVE LISTENER'S GUIDE. Ian Poole	192 pages	£14.99
THE COMPLETE SHORT WAVE LISTENER'S HANDBOOK New 5th Edition		
Andrew Yoder	410 pages	£19.95

Marine

DIARY OF A MARITIME RADIO OFFICER. Ross Bradshaw	230 pages	£12.95
GMDSS EDITIONS MARINE SSB OPERATION. Michael Gale	96 pages	£11.95
GMDSS EDITIONS MARINE VHF OPERATION. Michael Gale	48 pages	£7.95
GMDSS FOR SMALL CRAFT. Alan Clemmetsen	94 pages	£11.95
SCANNING THE MARINE BANDS. F.F. O'Brian	152 pages	£ 9.50
SHORTWAVE MARITIME COMMUNICATIONS. B. E. Richardson	195 pages	£16.50
SHIP TO SHORE RADIO FREQUENCIES. Ken Davies	95 pages	£5.99
SIMPLE GPS NAVIGATION. Mik Chinery	96 pages	£10.95

Satellite

AN INTRODUCTION TO SATELLITE COMMUNICATIONS BP326.F. A. Wilson	230 pages	£5.95
ARRL SATELLITE ANTHOLOGY 4th Edition	150 pages	£9.50
NEWNES GUIDE TO SATELLITE TV. Derek Stephenson	371 pages	£18.95
NEWNES SATELLITE COMMUNICATIONS POCKET BOOK. James Wood	220 pages	£12.99
SATELLITE HANDBOOK (ARRL) New Edition		
Martin Davidoff K2UBC	370 pages	£15.50
SATELLITE PROJECTS HANDBOOK. Lawrence Harris	174 pages	£14.99
* SATELLITE TELEVISION. A layman's guide. Peter Pearson	73 pages	£1.00
SATELLITE TELEVISION INSTALLATION GUIDE. 5th Edition. John Breeds	76 pages	£15.00
WEATHER SATELLITE HANDBOOK. 5th Edition. Dr Ralph E. Taggart W8BDQT	192 pages	£15.50

Scanning

AN INTRODUCTION TO SCANNERS AND SCANNING BP311. I. D. Poole	152 pages	£4.99
SCAN 98 (PWP)	48 pages	£3.95

SCANNER BUSTERS 2. D.C. Poole	100 pages	£6.00
SCANNERS 2 INTERNATIONAL. Peter Rouse GU1DKD	261 pages	£10.95
SCANNERS 3 PUTTING SCANNERS INTO PRACTICE		
4th Revision. Peter Rouse	271 pages	£10.95
SCANNING SECRETS. Mark Francis	280 pages	£16.95
UK SCANNING DIRECTORY. NEW 6th Edition	540 pages	£18.50

AMATEUR RADIO

Amateur Television

AN INTRODUCTION TO AMATEUR TELEVISION		
Mike Wooding G6IQM & Trevor Brown G8CJS	156 pages	£5.00
SLOW SCAN TELEVISION EXPLAINED. Mike Wooding G6IQM	156 pages	£5.00
THE AMATEUR TV COMPENDIUM. Mike Wooding G6IQM	104 pages	£3.50

Antennas & Transmission Lines

25 SIMPLE AMATEUR BAND AERIALS BP125. E.M. Noll	63 pages	£1.95
25 SIMPLE INDOOR AND WINDOW AERIALS BP136. E.M. Noll	50 pages	£1.75
25 SIMPLE SHORT WAVE BROADCAST BAND AERIALS BP132. E.M. Noll	63 pages	£1.95
25 SIMPLE TROPICAL AND MW BAND AERIALS BP145. E.M. Noll	54 pages	£1.75
ALL ABOUT VERTICAL ANTENNAS. W.I. Orr W6SAI & S.D. Cowan W2LX	192 pages	£8.95
ANTENNA EXPERIMENTERS GUIDE (RSGB). Peter Dodd G3LDO	160 pages	£15.00
ANTENNA IMPEDANCE MATCHING (ARRL). Wilfred N. Caron	195 pages	£15.50
ANTENNAS FOR VHF AND UHF BP301. I.D. Poole	104 pages	£4.95
ANTENNAS & TECHNIQUES FOR LOW BAND DXING (ARRL)	394 pages	£15.50
ARRL ANTENNA BOOK 18th Edition	732 pages	£24.00
ARRL ANTENNA COMPENDIUM Volume One	175 pages	£10.50
ARRL ANTENNA COMPENDIUM Volume Two	208 pages	£10.50
ARRL ANTENNA COMPENDIUM Volume Three. Edited by Jerry Hall K1TD	236 pages	£11.50
ARRL ANTENNA COMPENDIUM Volume Four	204 pages	£16.50
ARRL ANTENNA COMPENDIUM Volume Five	200 pages	£16.50
BEAM ANTENNA HANDBOOK. W.I. Orr W6SAI & S.D. Cowan W2LX	268 pages	£8.95
BUILDING & USING BALUNS. Jerry Sevick	125 pages	£18.95
CUBICAL QUAD ANTENNAS 3rd Edition. William Orr W6SAI and Stuart Cowan W2LX	110 pages	£8.95
EXPERIMENTAL ANTENNA TOPICS BP278. H.C. Wright	70 pages	£3.50
G-ORP CLUB ANTENNA HANDBOOK		
Compiled and edited by P. Linsley G3PDL & T. Nicholson KA9WRI/GW0LNQ	155 pages	£7.25
HF ANTENNA COLLECTION (RSGB). Edited by Erwin David G4LOI	233 pages	£10.99
HF ANTENNAS FOR ALL LOCATIONS (RSGB). Les Moxon G6XN	322 pages	£14.65
* MORE OUT OF THIN AIR (PWP)	112 pages	£6.95
PRACTICAL ANTENNAS FOR NOVICES. John Heys G3BDQ	52 pages	£6.30
PRACTICAL ANTENNA HANDBOOK 2nd Edition. Joseph J. Carr	437 pages	£29.95
PRACTICAL WIRE ANTENNAS RSGB. John Heys G3BDQ	100 pages	£8.95
RADIO AMATEUR ANTENNA HANDBOOK. W.I. Orr W6SAI & S.D. Cowan W2LX	188 pages	£8.50
RECEIVING ANTENNA HANDBOOK. Joe Carr	189 pages	£17.50
SIMPLE, LOW-COST WIRE ANTENNAS FOR RADIO AMATEURS		
W.I. Orr W6SAI & S.D. Cowan W2LX	188 pages	£8.95
W1FB'S ANTENNA NOTEBOOK (ARRL). Doug DeMaw W1FB	123 pages	£8.00

Beginners (inc RAE)

AMATEUR RADIO FOR BEGINNERS (RSGB). Victor Brand G3JNB	65 pages	£3.50
AN INTRODUCTION TO AMATEUR RADIO - New Edition. Ian Poole G3YWX	150 pages	£4.99
BASIC RADIO PRINCIPLES & TECHNOLOGY. Ian Poole G3YWX	262 pages	£14.99
BASIC RADIO & ELECTRONIC CALCULATIONS. Ray Petri G0OAT	160 pages	£13.95
AN RAE STUDENTS NOTEBOOK. Bob Griffiths G7NHB	76 pages	£6.95
HOW TO PASS THE RADIO AMATEURS' EXAMINATION (RSGB)		
Clive Smith G4FZH and George Benbow G3HB	88 pages	£8.75
NOW WE'RE TALKING (ARRL)	144 pages	£15.50
PRACTICAL RECEIVERS FOR BEGINNERS (RSGB). John Case GW4HWR	165 pages	£12.50
THE NOVICE RADIO AMATEURS EXAMINATION HANDBOOK (BP375)		
Ian Poole G3YWX	150 pages	£4.95
THE RADIO AMATEURS' QUESTION & ANSWER REFERENCE MANUAL		
Fifth Edition. Ray Petri G0OAT	208 pages	£13.95
RADIO AMATEURS EXAMINATION/END OF COURSE TEST PAPERS. Ray Petri G0OAT	104 pages	£13.95
RAE MANUAL (RSGB). G.L. Benbow G3HB	127 pages	£8.75
RAE REVISION NOTES (RSGB). G.L. Benbow G3HB	92 pages	£5.25
THE NOVICE LICENCE STUDENT'S NOTEBOOK. John Case GW4HWR	124 pages	£5.00
SHORTWAVE RADIO LISTENING FOR BEGINNERS. Anita Louise McCormick KA8KGI	176 pages	£13.95
TRAINING FOR THE NOVICE LICENCE A MANUAL FOR THE INSTRUCTOR (RSGB)		
John Case GW4HWR	101 pages	£6.75
W1FB'S HELP FOR NEW HAMS (ARRL). Doug DeMaw W1FB	155 pages	£8.95
YOUR FIRST AMATEUR STATION. (RSGB) Colin Redwood G6MXL	120 pages	£5.75

Callbooks

JOINT INT/N.AMERICAN CALLBOOK CD-ROM		£40.00
RSGB YEARBOOK 1998 EDITION. Edited by Brett Rider G4FLQ	512 pages	£13.50

Computing

ELECTRONIC PROJECTS FOR YOUR PC BP320. R.A. Penfold	102 pages	£3.99
E-MAIL ON THE INTERNET. BP420	156 pages	£6.99
GETTING THE MOST FROM YOUR PC HARD DISK BP280	90 pages	£3.95
HOW TO EXPAND, MODERNISE AND REPAIR PCs AND COMPATIBLES BP271		
R. A. Penfold	166 pages	£ 5.99
INTERFACING PCs AND COMPATIBLES BP272. R. A. Penfold	86 pages	£4.99

MS-OFFICE ONE STEP AT A TIME (BP402).....	77 pages	£5.95
MS WORKS FOR WINDOWS 95 EXPLAINED BP405.....	175 pages	£5.95
NEWNES COMPUTER ENGINEER'S POCKET BOOK Third Edition. Michael Tooley.....	256 pages	£12.95
PERSONAL COMPUTERS IN THE HAM SHACK (ARRL).....	284 pages	£11.50
THE INTERNET AND WORLD WIDE WEB EXPLAINED. J. Shelley.....	130 pages	£5.95
WINDOWS 95 EXPLAINED (BP400).....	175 pages	£5.95

EMC

INTERFERENCE HANDBOOK. William R. Nelson WA6FQG.....	250 pages	£9.50
THE RADIO AMATEUR'S GUIDE TO EMC (RSGB). Robin Page-Jones G3JWL.....	117 pages	£8.95

Historical

1934 OFFICIAL SHORT WAVE RADIO MANUAL. Edited by Hugo Gernsback.....	260 pages	£11.85
OLD TIME RADIOS - RESTORATION & REPAIR. J. Carr.....	256 pages	£19.95
COMMUNICATIONS RECEIVERS - THE VACUUM TUBE ERA. R.S. Moore.....	141 pages	£17.95
CRYSTAL SET BUILDING & MORE (Inc Newsletters Vol 6 & 7 of Xtal Set Society).....		£10.50
CRYSTAL SET PROJECTS. Phil Anderson.....	160 pages	£9.50
EXPERIMENTAL TELEVISION (1932).....	312 pages	£11.75
HEATHKIT - A GUIDE TO AMATEUR RADIO PROJECTS. C. Penson.....	248 pages	£21.95
HENLEYS 222 RADIO CIRCUIT DIAGRAMS (1924).....	271 pages	£9.45
HOW TO BUILD YOUR RADIO RECEIVER (A4) (Popular Radio Handbook No. 1).....	100 pages	£6.95
SECRETS OF HOMEBUILT REGENERATIVE RECEIVERS (Rockey).....	127 pages	£7.95
* SEEING BY WIRELESS - THE STORY OF BAIRD TELEVISION. Ray Herbert.....	27 pages	£4.95
THE XTAL SET SOCIETY NEWSLETTER. Volume 1 & 2 Combined. Phil Anderson W0X196 pages		£13.00
THE CRYSTAL SET HANDBOOK & VOL. 3 XTAL NEWSLETTER. Phil Anderson W0X1.....	130 pages	£7.00
THE XTAL SET SOCIETY NEWSLETTER. Volume 4. Phil Anderson W0X1.....	88 pages	£6.50
THE CRYSTAL SET HANDBOOK & VOL. 5 XTAL NEWSLETTER. Phil Anderson W0X1.....	88 pages	£6.50
CRYSTAL RADIO HISTORY, FUNDAMENTALS AND DESIGN. P.A. Kinzie.....	122 pages	£7.50
THOSE GREAT OLD HANDBOOK RECEIVERS (1929 + 1934).....	94 pages	£6.95
VISION BY RADIO (1925) (Jenkin).....	140 pages	£7.85
WIRELESS FOR THE WARRIOR VOL. 1 (Wireless Sets 1-88).....	204 pages	£27.50
WIRELESS FOR THE WARRIOR VOL. 2 (Hardback - Standard Sets of World War II).....	430 pages	£36.00

Maps & Log Books

AMATEUR RADIO LOGBOOK (RSGB).....	50 pages	£3.75
AMATEUR RADIO WORLD ATLAS (A4 SIZE).....	20 pages	£8.00
NORTH ATLANTIC ROUTE CHART.....	740 x 520mm	£8.50
QTH LOCATOR MAP OF EUROPE. New Edition.....	1080 x 680mm	£7.00
RADIO AMATEURS MAP OF THE WORLD. New Edition.....	980 x 680mm	£7.00
RECEIVING STATION LOG BOOK (RSGB).....	60 pages	£3.75
RSGB PREFIX GUIDE.....	32 pages	£5.75

Morse

MORSE CODE FOR RADIO AMATEURS (RSGB).....	28 pages	£4.25
SECRETS OF LEARNING MORSE CODE Mark Francis.....	84 pages	£6.95

Microwaves

AN INTRODUCTION TO MICROWAVES (BP312). F.A. Wilson.....	134 pages	£3.95
ARRL UHF/MICROWAVE EXPERIMENTER'S MANUAL. Various Authors.....	446 pages	£15.50
ARRL UHF/MICROWAVES PROJECT MANUAL (ARRL).....	400 pages	£15.50
MICROWAVE HANDBOOK - COMPONENTS & OPERATING VOL 1 (RSGB).....	110 pages	£10.50
MICROWAVE HANDBOOK - CONSTRUCTION & TESTING VOL 2 (RSGB).....	120 pages	£15.75
MICROWAVE HANDBOOK - BANDS & EQUIPMENT VOL 3 (RSGB).....	140 pages	£15.75
OR BUY ALL 3 FOR.....		£34.00

Operating & Handbooks

ALL ABOUT HAM RADIO. Harry Helms.....	290 pages	£16.50
AMATEUR RADIO OPERATING MANUAL (RSGB). Ray Eckersley G4FTJ.....	249 pages	£12.23
ARRL HANDBOOK 1998 75th Edition.....	360 pages	£24.00
ARRL HANDBOOK 1998 ON CD-ROM.....		£30.00
ARRL OPERATING MANUAL NEW EDITION.....	420 pages	£18.50
COMPLETE DX'ER. Bob Locher.....	204 pages	£9.50
DISCOVERING DXING (2nd Edition). John Zondlo.....	90 pages	£7.50
HAM RADIO MADE EASY (ARRL). Steve Ford.....	204 pages	£11.50
HINTS AND KINKS FOR THE RADIO AMATEUR. Edited by Charles L. Hutchinson and David Newkirk.....	129 pages	£9.50
LOW PROFILE AMATEUR RADIO (ARRL). Jim Kearman KR1S.....	124 pages	£7.50
SETTING UP AN AMATEUR RADIO STATION BP300. I.D. Poole.....	81 pages	£3.95
TRANSMITTER HUNTING - RADIO DIRECTION FINDING SIMPLIFIED. Joseph D. Moell & Thomas N. Curlee.....	325 pages	£23.95

Packet

NOS INTRO: TCP/IP OVER PACKET RADIO. Ian Wade G3NRW.....	356 pages	£11.50
PACKET RADIO PRIMER (RSGB). Dave Comber G8UYZ & Martyn Corft G8NZU.....	266 pages	£9.95
PACKET, SPEED & MORE SPEED APPLICATIONS (ARRL).....	148 pages	£10.50
YOUR PACKET COMPANION. Steve Ford WB8IMY.....	170 pages	£7.50

Propagation

AN INTRODUCTION TO RADIO WAVE PROPAGATION BP293. J.G. Lee.....	116 pages	£3.95
--	-----------	-------

QRP

G-QRP CLUB CIRCUIT HANDBOOK. Edited by Rev. G. Dobbs G3RJV.....	96 pages	£9.00
INTRODUCING QRP. Dick Pascoe G0BPS.....	48 pages	£6.95
QRP POWER (ARRL).....		£9.50
W1FB's QRP NOTEBOOK (ARRL). 2nd Edition. Doug DeMaw W1FB.....	175 pages	£8.00

Test Equipment

GETTING THE MOST FROM YOUR MULTIMETER BP239. R.A. Penfold.....	102 pages	£2.95
HANDS-ON GUIDE TO OSCILLOSCOPES. Barry Ross.....	228 pages	£19.95
HOW TO USE OSCILLOSCOPES & OTHER TEST EQUIPMENT BP267. R.A. Penfold.....	104 pages	£3.50
MORE ADVANCED TEST EQUIPMENT CONSTRUCTION BP249. R.A. Penfold.....	102 pages	£3.50
MORE ADVANCED USES OF THE MULTIMETER BP265. R.A. Penfold.....	96 pages	£2.95
AN INTRODUCTION TO THE ELECTROMAGNETIC WAVE BP315. F.A. Wilson.....	122 pages	£4.95

PRACTICAL TRANSMITTERS FOR NOVICES. John Case GW4HWR.....	126 pages	£10.00
TEST EQUIPMENT FOR THE RADIO AMATEUR. Clive Smith G4FZH.....	170 pages	£10.95

VHF

ALL ABOUT VHF AMATEUR RADIO. W. I. Orr W6SAI.....	163 pages	£8.85
VHF/UHF HANDBOOK (RSGB). Dick Biddulph G8PDS.....	180 pages	£18.75

ELECTRONICS

A REFERENCE GUIDE TO PRACTICAL ELECTRONICS TERMS BP287. F.A. Wilson.....	431 pages	£5.95
BEGINNERS GUIDE TO MODERN ELECTRONIC COMPONENTS BP285.....	166 pages	£4.99
CIRCUIT SOURCE BOOK 1 - BP321. R.A. Penfold.....	182 pages	£4.95
CIRCUIT SOURCE BOOK 2 - BP322. R.A. Penfold.....	214 pages	£4.95
FAULT FINDING ELECTRONIC PROJECTS BP391.....	133 pages	£4.99
GETTING STARTED IN PRACTICAL ELECTRONICS BP345. Owen Bishop.....	198 pages	£4.95
HOW TO TEST ALMOST EVERYTHING ELECTRONIC.....	326 pages	£15.95
NEWNES AUDIO AND HI-FI ENGINEER'S POCKET BOOK Third Edition. Vivian Capel.....	210 pages	£12.95
NEWNES ELECTRONICS ENGINEER'S POCKET BOOK. Keith Brindley.....	306 pages	£12.95
POWER SUPPLY PROJECTS BP76. R.A. Penfold.....	89 pages	£3.99
PREAMPLIFIER & FILTER CIRCUITS BP309. R.A. Penfold.....	92 pages	£3.95
PRACTICAL ELECTRONIC FILTERS BP299. Owen Bishop.....	89 pages	£4.95
PRACTICAL ELECTRONICS HANDBOOK. Ian Sinclair.....	439 pages	£13.95
PRACTICAL OSCILLATOR CIRCUITS BP393. A. Flind.....	136 pages	£4.99
RADIO ENGINEERS FACTFINDER FOR WINDOWS (Floppy Disk) John Davies.....		£18.00
TEST EQUIPMENT CONSTRUCTION BP248. R.A. Penfold.....	104 pages	£3.00
*THE ART OF SOLDERING BP324. R. Brewster.....	84 pages	£3.99
UNDERSTANDING BASIC ELECTRONICS (ARRL).....	314 pages	£15.50
VALVE AMPLIFIERS. Morgan Jones.....	374 pages	£25.00
VALVE & TRANSISTOR AUDIO AMPLIFIERS. John Lindsay Hood.....	310 pages	19.95
W1FB's DESIGN NOTEBOOK (ARRL). Doug DeMAW W1FB.....	195 pages	£8.00

Data

ARRL ELECTRONICS DATA BOOK. Doug DeMaw W1FB.....	260 pages	£8.95
ELECTRONIC HOBBYIST DATA BOOK BP396. R.A. Penfold.....	242 pages	£5.95
PRACTICAL ELECTRONICS CALCULATIONS AND FORMULAE BP53. F.A. Wilson.....	249 pages	£3.95
PRACTICAL ELECTRONIC DESIGN DATA BP316. Owen Bishop.....	327 pages	£5.99
PRACTICAL RF HANDBOOK (2nd Edition). Ian Hickman.....	302 pages	£18.95
SECRETS OF RF CIRCUIT DESIGN. Joseph Carr.....	405 pages	£23.95
SOLID STATE DESIGN FOR THE RADIO AMATEUR (ARRL) Les Hayward W7ZOI & Ooug DeMaw W1FB.....	256 pages	£11.50
SPREAD SPECTRUM SOURCE BOOK.....	320 pages	£15.50
TOWERS INTERNATIONAL MOSPOWER & OTHER FET SELECTOR.....	140 pages	£19.95
TOWERS INTERNATIONAL TRANSISTOR SELECTOR - UPDATE 5.....	476 pages	£24.95
TRANSISTOR DATA TABLES (BP401).....	178 pages	£5.95

Projects

BUILD YOUR OWN INTELLIGENT AMATEUR RADIO TRANSCEIVER. Randy L. Henderson.....	350 pages	£24.95
COIL DESIGN & CONSTRUCTION MANUAL BP160. B.B. Babani.....	106 pages	£3.95
HOW TO DESIGN & MAKE YOUR OWN PCBs BP121. R.A. Penfold.....	66 pages	£2.50
MORE ADVANCED POWER SUPPLY PROJECTS BP192. R.A. Penfold.....	92 pages	£2.95
PRACTICAL RF HANDBOOK (2nd Edition). Ian Hickman.....	300 pages	£19.95
PROJECTS FOR RADIO AMATEURS & SWLs BP304. R.A. Penfold.....	92 pages	£3.95
RADIO RECEIVER PROJECTS YOU CAN BUILD.....	312 pages	£19.95
SIMPLE SHORT WAVE RECEIVER CONSTRUCTION BP275. R.A. Penfold.....	88 pages	£3.95

Valves/Tubes

ELECTRON TUBE LOCATOR. George H. Fathauer.....	350 pages	£21.95
ESSENTIAL CHARACTERISTICS (TUBES & TRANSISTORS) (Original publishers General Electric Re-published by Antique Electronic Supply (Arizona).....	475 pages	£10.50
HANDBOOK OF RADIO, TV, INDUSTRIAL & TRANSMITTING TUBE & VALVE EQUIVALENTS.....	60 pages	£2.95
RADIO VALVE GUIDE BOOK VOL 1.....	54 pages	£2.95
RADIO VALVE GUIDE BOOK VOL 2.....	42 pages	£2.95
RADIO VALVE GUIDE BOOK VOL 3.....	40 pages	£2.95
RADIO VALVE GUIDE BOOK VOL 4.....	48 pages	£2.95
RADIO VALVE GUIDE BOOK VOL 5.....	44 pages	£2.95
RCA RECEIVING TUBE MANUAL (Original Publishers Radio Corporation Of America). Re-published by Antique Electronic Supply (Arizona).....	384 pages	£10.50
RCA TRANSMITTING TUBES (Original Publisher Radio Corporation of America) Re-published by Antique Electronic Supply (Arizona).....	318 pages	£10.50
TUBE SUBSTITUTION HANDBOOK.....	150 pages	£15.50

Telephone
(01202) 659930

OR USE THE ORDER FORM ON PAGE 91
Please note: Cash not accepted with mail orders.



SUBSCRIPTION RATES

Please enquire for airmail rates

SHORT WAVE MAGAZINE - 6 MONTHS

£16.50 (UK)

SHORT WAVE MAGAZINE - 1 YEAR

£30.00 (UK) £35.00 (Europe)

£38.00 (Rest of World Airsaver) £45.00 (Rest of World Airmail)

Please Send me my FREE copy of Short Wave Communications.

SPECIAL JOINT SUBSCRIPTION WITH PRACTICAL WIRELESS (1 YEAR)

£50.00 (UK) £59.00 (Europe Airmail)

£63.00 (Rest of World Airsaver)

£74.00 (Rest of World Airmail)

Please start my subscription with the.....issue.

MONITORING TIMES - 1 Year (12 issues)

£38 (UK) £43 (Europe Airmail)

£49 (Rest of World Airmail)

SATELLITE TIMES - 1 Year (12 issues)

£38 (UK) £43 (Europe Airmail)

£49 (Rest of World Airmail)

BINDERS

Please send meSWM Binders at **£6.50**£

Postal charges: £1 for one, £2 for two or more (overseas surface)

FREE P&P if you order two or more (UK only)£

Please send me the following books

.....£

.....£

.....£

.....£

.....£

Postal charges.

UK: £1 for one, £2 for two or more.....£

Overseas:

£2.00 per item.....£

NEW FASTER NEXT DAY SERVICE (UK)

(For orders received before noon) £4.50.....£

GRAND TOTAL£

Order Form

FOR ALL MAIL ORDER PURCHASES IN *SHORT WAVE MAGAZINE*

You can now order on-line.

See www.pwpublishing.ltd.uk/books/ for more information

TELEPHONE ORDERS TAKEN ON (01202) 659930

between the hours of 9.00am - 5.00pm. Outside these hours your order will be recorded on an answerphone

FAX ORDERS TAKEN ON (01202) 659950

Or please fill in the details ticking the relevant boxes, a photocopy will be acceptable to save you cutting your treasured copy!

To: PW Publishing Ltd., FREEPOST, Arrowsmith Court, Station Approach, Broadstone, Dorset BH18 8PW.

PAYMENT DETAILS

Name

Address

.....Postcode

Telephone No.

I enclose cheque/PO (Payable to PW Publishing Ltd.) £

Or

Charge to my MasterCard/Visa/Switch/AMEX Card the amount of £

Card No.



Valid fromto.....

SignatureTel:.....

Issue No:

Orders are normally despatched by return of post but please allow 28 days for delivery. Prices correct at time of going to press. **Please note:** all payments must be made in Sterling. Cash not accepted.

TELEPHONE ORDERS TAKEN ON (01202) 659930

FAX ORDERS TAKEN ON (01202) 659950

STAR BUY

This month we're giving you the chance to buy a copy of **Klingenfuss 1997/1998 Guide To World-Wide Weather Services - 17th Edition** for the special price of £12.50 inc. P&P (was £25).

This most comprehensive, reliable and up-to-date manual includes information of Internet locations, NAVTEX stations, Radiofax stations, Radiotelex stations, Meteorological data, Satellite images, Weather charts and hundreds of sample charts, images and web pages. Why not order your copy now?

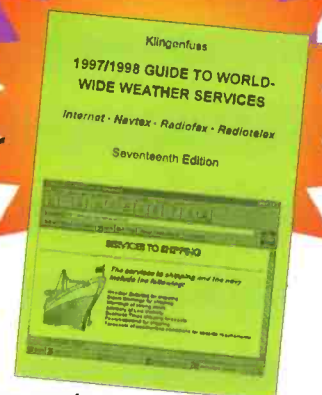

TO ORDER THIS BOOK, USE THE ORDER FORM ABOVE OR CALL THE CREDIT CARD & ORDER HOTLINE ON (01202) 659930 AND QUOTE SWM9.

ADVERTISERS INDEX

Aerial Techniques	87
AKD	76
AOR	36/37
ARC	57
ASK Electronics	22
Chevet Supplies	81
Essex Shortwave Services	68
Flightdeck	74
Foztech Communications	87
G Baldwin	87
G3RCQ	57
Haydon Communications	41, 42/43
Howes CM	65
Icom UK	IBC
International Association of Broadcasters	33
Interproducts	57
Javiation	65
Jaycee Electronics	87
Klingenfuss Publications	49
Lake Electronics	68
LAR Communications Centre	87
Leicester Show	49
Lowe Electronics	18/19, OBC
Martin Lynch & Son	12/13
Monitoring Times	62
Moonraker	49
Multicomm 2000	50/51, 66/67
Nevada Communications	IFC/1, 30/31
Northern Shortwave Centre	87
Optoelectronics	2
PDSL	74
Pervisell	49
Photavia Press	74
Remote Imaging Group	87
RSGB	62
Simon Collings	87
SMC	32
Solid State Electronics	68
Spectrum Communications	81
SRP Trading	29
The Aviation Hobby Centre	74
The Shortwave Shop	87
Timestep Weather Systems	81
Waters & Stanton	24/25
Wellbrook Communications	68

PUBLISHED on the fourth Thursday of each month by PW Publishing Ltd., Arrowsmith Court, Station Approach, Broadstone, Dorset BH18 8PW. Printed in England by Southernprint (Web Offset), Factory Road, Upton Industrial Estate, Poole, Dorset BH16 5SN. Tel: (01202) 622226. Distributed by Seymour, 86 Newman Street, London W1P 3LD. Tel: 0171-396 8000, Fax: 0171-396 8002, Web: <http://www.seymour.co.uk>. Sole Agents for Australia and New Zealand - Gordon and Gotch (Asia) Ltd.; South Africa - Central News Agency Ltd. Subscriptions INLAND £30, EUROPE £35, REST OF WORLD (Airsaver) £38, REST OF WORLD (Airmail) £45 payable to SHORT WAVE MAGAZINE, Subscription Department, PW Publishing Ltd., Arrowsmith Court, Station Approach, Broadstone, Dorset BH18 8PW. SHORT WAVE MAGAZINE is sold subject to the following conditions, namely that it shall not without the written consent of the publishers first having been given, be lent, re-sold, hired out or otherwise disposed of by way of trade at more than the recommended selling price shown on the cover and that it shall not be lent, re-sold, hired out or otherwise disposed of in a mutilated condition or in any unauthorised cover by way of Trade, or affixed to or as part of any publication or advertising, literary or pictorial matter whatsoever.

Next Month in Practical Wireless, the magazine that brings you Amateur Radio & So Much More

Coming Next Month in

PRACTICAL WIRELESS

THE UK'S BEST SELLING INDEPENDENT AMATEUR RADIO MAGAZINE

Next Month in *Practical Wireless*, the magazine that brings you Amateur Radio & So Much More

LEICESTER SHOW SPECIAL!

The 27th Leicester Show takes place not only a month earlier but also at a new venue - we bring you details of all you need to know.

REVIEWED!

PW's very own antenna enthusiast Tex Swann G1TEX puts the MFJ-259B Antenna Analyser to the test.

Rob Mannion G3XFD has been out and about with the Pro-Am MM3401 triple mag-mount antenna in his quest to find himself a suitable portable/mobile system.

ELECTRONICS IN ACTION!

More electronics related hints, tips, news and mini reviews.

BUILD!

David McBright shares his idea for a Morse practice oscillator.

Plus all your regular favourites including

Bargain Basement
Carrying on the Practical Way
Keylines
News
Radio Scene
Valve & Vintage

and much, much more!

* Contents subject to change

PW

CAN YOU AFFORD TO MISS IT? - OCTOBER ISSUE ON SALE 10 SEPTEMBER 1998 PLACE YOUR ORDER TODAY!

IC-PCR1000

DON'T MISS THIS CHANCE TO SAVE £100!!!

GREAT NEWS... YOU CAN NOW PICK UP THE FANTASTIC ICOM PCR1000 FOR JUST £249 INC. VAT. A MASSIVE SAVING OF £100!!! HURRY - THE OFFER MUST END 30TH SEPTEMBER 1998.

The explosive growth of the Internet in recent years has brought a wealth of information to PC users the world over. However, long before the Internet even existed, the airwaves have been filled with communications of all kinds - broadcast radio and television, Ham, special services and aviation to name just a few. The IC-PCR1000 is a versatile, new radio interface that lets you listen to this exciting world from your computer.

- An exciting new radio receiving idea!
- For today's listener who doesn't want to miss a thing!
- Not a knob in sight, use your keypad 'n' mouse instead.
- **3 Interface screens to choose from -**
 1. Display screen showing all you need, as on a real receiver.
 2. Component screen for tuning and mode choice etc.
 3. Radio screen shows presets for stations and frequencies etc.
- External connection for your PC or laptop.
- Real-time bandscope function for easy location of the busiest frequencies.
- All-mode Rx - 100kHz~1300MHz.

SEE YOU AT THE LEICESTER SHOW

SAVE £100!!!

- **NEW!!!** UT-106 DSP Digital Filter Unit for Automatic Notch Filtering and Improved Noise Reduction.



Icom (UK) Ltd. Sea Street Herne Bay Kent CT6 8LD. Telephone: 01227 741741. Fax: 01227 741742. internet: <http://www.icomuk.co.uk> E-mail: info@icomuk.co.uk

Count on us!



1..2..3...

GO FOR THE NEW

LOWE CATALOGUE

COMMUNICATIONS

AMATEUR RADIO

GPS NAVIGATION

SHORT WAVE LISTENING

AIRBAND RADIO

SCANNERS

WEATHER MONITORING

Over the last 20 years we have built a solid reputation with our customers for providing exciting and innovative products, backed up by the finest service and support expertise available anywhere in the UK. We have specialised in the sale of everything for the airband radio enthusiast, ranging from simple VHF only receivers to multiband scanners covering all civil, military and HF communications channels. We manufacture some of the best short wave receivers in the world, and also supply radio decoding software, ham radio equipment, weather monitoring station equipment and much, much more. We have just produced our first ever 80 page full colour mail order catalogue, and you now have the chance to receive this ABSOLUTELY FREE. With no obligation to purchase at all, we are confident that you will find one of the most comprehensive product offerings in this area of technology available anywhere in the world. We are also confident that you will find something there to interest

you. Just send four first class stamps to cover the postage to Lowe Electronics, and we will send our bumper colour catalogue by return.

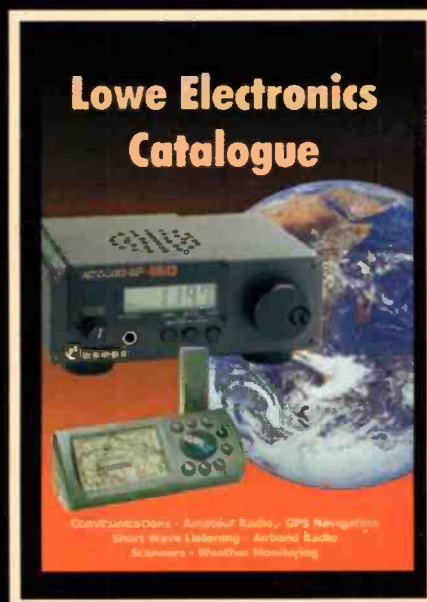

LOWE ELECTRONICS LTD

Chesterfield Road
Matlock
Derbyshire DE4 5LE
Telephone 01629 580800
Fax 01629 580020
Email: info@lowe.co.uk
URL: <http://www.lowe.co.uk>

short wave magazine

£3.95

World-Wide Radio Guide

International Radio
Programmes in English
from the leading world
broadcasters
and how to hear them

Compiled for
Short Wave Magazine by

The Association for
International Broadcasting

The Association
for International
Broadcasting

• • •



Presented FREE with Short Wave Magazine September 1998

ICOM

**I
C
W
3
2
E**



NIGHT VISION
from **£179.99**

USR PALM PILOTS
from **£149.99**

DIGITAL CAMERAS
from **£199.99**

LASER POINTERS
from **£29.99**

**MAGELLAN
GPS**

**Color
T
R
A
K**



WORLDWIDE

SUNRISE

IMPORT AND EXPORT
EST 1985



MAIL ORDER HOTLINE

0171-637 3727

Fax: 0171-637 3728 E-mail: sales@sun-rise.co.uk

229 Tottenham Court Road, London W1

All prices include VAT. Next day delivery available

TRANSCEIVERS

Alinco DJ-190.....	£149.99
Alinco DJ-S41.....	£99.99
Icom ICT-7E.....	£279.99
Kenwood TH-22E.....	£209.99
Alinco DJ-G5.....	£269.99
Yaesu FT-50.....	£Call
Yaesu FT-11.....	£Call
Alinco DR-140.....	£219.99
Alinco DR-430.....	£259.99
Yaesu FT-8100R.....	£Call
Yaesu FT-3000M.....	£Call
Icom IC-207H.....	£439.99
Icom IC-2710H.....	£494.99
Icom IC-W32E.....	£349.99
Icom IC-T8.....	£Call

**GARMIN
GPS III**



GPS 12.....	£129.99
GPS II+.....	£209.99
GPS 12XL.....	£204.99
GPS 48.....	£229.99
GPS MAP130.....	£434.99
GPS MAP135.....	£Call
GPS MAP175.....	£Call
GPS MAP230.....	£Call
GPS MAP220.....	£Call
GPS III new.....	£Call

GPS Pioneer.....	£89.99
GPS 2000XL.....	£139.99
GPS Tracker.....	£219.99
Color Trak.....	£279.99
GSC 100.....	£1349.99
NAV 1200.....	£229.99
NAV 6000.....	£569.99
NAV 6500.....	£739.99

YUPITERU

**M
V
T
7
1
0
0**



SCANNERS

Welz WS-1000.....	£209.99
Icom IC-R10.....	£259.99
Uniden 220XLT.....	£169.99
Uniden 60XLT.....	£49.99
Yupiteru MVT-9000.....	£319.99
Yupiteru MVT-7100.....	£199.99
Uniden BC-80XLT.....	£89.99
AOR AR8000.....	£289.99
Alinco DJX-10.....	£289.99
Yupiteru MVT-3300.....	£154.99
AOR AR3000.....	£Call
Icom ICR-8500.....	£1199.00
Yaesu FRG-100.....	£489.99
Icom PCR-1000.....	£Call

WELCOME

to the WORLD-WIDE RADIO GUIDE



Suddenly, it's all happened. With the rush to market on the Internet, hundreds of radio stations have found that they can get themselves heard all over the world, just for the cost of an Internet site, and a little bit of software.

So what does 'international radio' mean now? One way of cutting the cake is in two slices:

- The classic international radio station, broadcasting about its own country to all the other countries of the world. Its programmes are designed for an overseas audience, and targeted abroad.
- Stations with programmes designed for audiences in their own countries, but which can now be heard abroad. Many keen radio enthusiasts have made it their business to track down these stations on radio in the past. Now, more and more domestic stations have put themselves on the Internet and on satellite, and can be heard world-wide.

The magic of making your way across the world by short wave radio is still very potent, but the scene has changed. Not only have many international broadcasters set up web sites and provided audio on the Internet, many of them make the audio available 'on-demand', giving you the sound when you want it, not when the broadcasters say you have to listen.

Programmes are often available on satellite, too,

with listeners picking up the signals direct, or hearing them relayed via cable systems or local radio stations.

In the *World-Wide Radio Guide*, we have broken new ground by including not only the familiar short, medium and long wave frequencies, we have given satellite and Internet details, and contact information - telephone, FAX, E-mail and web site.

But what is really different about this Guide is that we have included something which is very rare - information about the programmes. The broadcasters want you to listen to what they have to say. It is hard enough to track down the transmissions, because of the complicated technical schedules. As for knowing what's going to be on the air - where do you find it?

The answer is here in the *World-Wide Radio Guide*, where for some of the major broadcasters, we have included programme schedules alongside the technical information. This is a step in the right direction, and we hope that you will find this new approach useful.

Tom Walters

Association for International Broadcasting

© 1998, PW Publishing Ltd.

Pull-out booklet supplied free with *Short Wave Magazine*, September 1998 issue.

HOW TO USE THE WORLD-WIDE RADIO GUIDE

All times are given in UTC, which is the same, for practical purposes, as GMT. The areas to which it is expected programmes will reach are sometimes abbreviated for reasons of space, as are programme titles.

Radio

All frequencies in this *World-Wide Radio Guide*, are in kilohertz. The experienced listener will of course know that if you need the frequency in megahertz, you pop in a decimal point, three figures from the right. So 12095kHz is 12.095MHz.

Many radios still group the frequencies in metre bands, which is likely to give beginners a headache, because as frequency increases, the wavelength (in metres) goes down. Here are two quick reference guides:

metre band	49	41	31	25	21	19	16	13
kilohertz	6000	7100	9500	11600	13600	15100	17500	21700
megahertz	6	7	9	11	13	15	17	21

The International Frequency Spectrum

	Usual abbreviation	Approximate frequency range (kHz)	Distance covered (km)
Long wave	l.w.	150-250	up to 5000
Medium wave	m.w./a.m.	500-1500	200-5000
Short wave	s.w.	3000-30000	world-wide
FM/VHF	f.m./v.h.f.	90-100	up to 50

Where frequencies are in the medium or long wave bands, we show ^{mw} or ^{lw} immediately after the kilohertz figure e.g. 1413^{mw} is a medium wave frequency, and 198^{lw} is a long wave frequency.

For beginners, the a.m. band is another name for the medium wave band. As the more knowledgeable will point out, broadcasts in all three main bands - short, medium and long are in fact all the a.m. type of transmission, but the medium wave band has got stuck with the a.m. label.

Transmission on short wave is almost as much an art as a science. Engineers can only hope that their predictions will work out, because sometimes after very careful calculation, a frequency will fail altogether to reach a target area, while a frequency will get there which was meant for another area altogether. In addition, a frequency engineer's hair is likely to turn prematurely white because the effectiveness of all frequencies varies on a day-to-day basis.

We have given all the frequencies that are 'on' at each given time. Try all the frequencies to find which work best, and also try frequencies intended for other areas. Remember that over weeks and months, the patterns which worked for you at first may need revising as atmospheric conditions (and stations' schedules) change.

Satellite & Internet

If you have satellite equipment, we have included tuning information for those stations where we have given programme content. If you have a multimedia computer, and you were not already aware of the Internet radio explosion, then you are in for a real white-knuckle ride as you go surfing the hundreds of radio sites. We have given you just an inkling here. For a real humdinger of a radio roller coaster Internet trip, go to:

- World Radio Network on www.wrn.org WRN is a pioneer distributor of international radio by satellite and Internet. The station is a gateway to a huge range of world-wide listening.
- The AIB on www.aibcast.demon.co.uk The AIB is a co-operative forum for everyone engaged in international broadcasting, and leads you to many stations and organisations that can expand your listening experience.

We hope that the detailed information in *World-Wide Radio Guide* will be easy to follow, and that it will help you to get more successful international listening, with a wider choice and awareness of the hundreds of programmes that are there for the finding.

Tom Walters AIB

AUSTRIA: RADIO AUSTRIA INTERNATIONAL

Radio Austria International, A-1136, Vienna, Austria

Telephone: +43 1 87878 3636

FAX: +43 1 87878 4404

E-mail: roi@orf.at

Internet: www.orf.at/roi/UK_home.htm



Frequencies:

0030-0100	Americas	9655
0230-0300	Americas	9655, 9870, 13730
0430-0500	Eur	6155, 13730
0530-0600	Americas	6015
0730-0800	Eur, ME	6155, 13730, 15410, 17870
0930-1000	As, Australia	15455, 17870
1230-1300	Eur, Americas	6155, 13730
1630-1700	Eur, Af, As	6155, 11855, 13710, 13730
2130-2200	Eur, Af	1476 ^{mW} , 5945, 6155, 13730

The Austrian Broadcasting Corporation Centre.



Areas:

Af	Africa
As	Asia
Eur	Europe
ME	Middle East



Station Director, Prof. Paul Lendvai.

The steerable curtain antenna at Moosbruun.



AUSTRALIA: RADIO AUSTRALIA

Radio Australia, GPO Box 428G, Melbourne 3001, Victoria, Australia

Telephone: +61 3 9626 1800

FAX: +61 3 9629 1899

E-mail: ruast3@ozemail.com.au

Internet: www.abc.net.au/ra



Frequencies:

Time	Frequencies	Time	Frequencies
0000-0500	17750	1400-1800	5995
0000-0800	15240	1430-1700	11660
0900-1200	6080	1430-2130	9500
0100-0500	15415	1700-2200	11880
0200-0900	21820	1800-2000	6080, 7240
0200-0900	15510	1800-2000	7240
0600-0900	15415	1800-2100	9660
0600-1100	17750	2000-2200	12080
0800-0900	5995, 9710	2100-0200	21740
0800-1200	9770	2100-0800	17715
0800-1200	9770	2100-0800	17715
0900-1100	11880	2100-2200	7240, 9660
0900-1200	6080	2100-2200	7240
1200-1400	5995, 6020	2200-0200	17795
1200-1400	6020	2300-0800	9660
1200-1800	6080	2300-0900	12080
1200-2100	9580		

BELGIUM: RADIO VLAANDEREN INTERNATIONAL

Radio Vlaanderen International, PO Box 26, B-1000 Brussels, Belgium

Telephone: +32 2 741 3807

FAX: +32 2 741 3807

E-mail: rvi@vrt.be

Internet: www.brtn.be/rvi/

Programmes on short and medium wave:

Time	Area	Mon	Tue	Wed	Thu
0730-0800	Europe, Australia	PR, B, T, AT	PR, BT, FE, S	PR, BT, A, AT	PR, BT, A, AT
1030-1100	Europe	PR, B, T, AT	PR, BT, FE, S	PR, BT, A, AT	PR, BT, A, AT
1230-1300	North America	PR, B, T, AT	PR, BT, FE, S	PR, BT, A, AT	PR, BT, A, AT
1630-1700	Europe	PR, BT, FE, S	PR, BT, RS, GS	PR, BT, A, AT	PR, BT, E, IR
1730-1800	Africa	PR, BT, FE, S	PR, BT, RS, GS	PR, BT, A, AT	PR, BT, E, IR
2000-2030	Europe	PR, BT, FE, S	PR, BT, RS, GS	PR, BT, A, AT	PR, BT, E, IR

Every programme segment includes News.

CANADA: RADIO CANADA INTERNATIONAL

Radio Canada International, PO Box 6000, Montreal HC3 3A8, Canada

Telephone: +1 514 597 7555

FAX: +1 514 284 0891

E-mail: rci@montreal.src.ca

Internet: www.rcinet.ca



Programmes on short wave:

Time	Area	Mon	Tue	Wed	Thu
0100-0200	Am	AC, M	S	S	S
0200-0230 (to 0300 Sunday-Manday)	Am	T	S	S	S
0400-0430	ME	M	S	S	S
0500-0600(Tue) (to 0530 Wed-Sat)	Eur, ME, Af	-	VC	S	S
1200-1230	Asia	S	S	S	S
1200-1300 (to 1400 Mon-Fri)	Am	TM	TM	TM	TM
1300-1600 (Sun only)	Am	-	-	-	-
1330-1400	Eur, Af, ME, Asia	S	S	S	S
1630-1700	As	S	S	S	S
2000-2130	Eur, ME, Af	S	S	S	S
2100-2130	ME	W6	W6	W6	W6
2200-2230	Am, As	W6	W6	W6	W6
2230-0000	USA, Caribbean	-	-	-	-
2300-2330	Latin America	W6	W6	W6	W6
2300-0000	Latin America	-	-	-	-
2230-2300	Americas	AH C	AH	-	AH

All programmes begin with News.

Areas:

Af Africa
As Asia
Am Americas

Satellite:

Many of Radio Canada International's programmes can be heard on: *Hot Bird* Eutelsat II -F6 at 13°E, 11.265GHz (Channel 3) Horizontal, audio 7.56MHz. Regions: Europe, Middle East, Northern Africa.

Internet:

Several programmes can be heard directly from Canada (www.rcinet.ca), and some RCI programmes are available via World Radio Network (www.wrn.org)

Programme Key:

A	The Arts
AT	Around Town
BT	Belgium Today
E	Economics
FE	Focus on Europe
GS	Green Society
IR	International Report

MF	Music from Flanders
P	PO Box 26
PR	Press Review
RS	Rockspot
RW	Radio World
S	Sports
T	Tourism



Satellite:

Astra 1D 19.2°E, Channel 58 (BSkyB) 10.847GHz vertical, audio 7.74MHz
Also on World Radio Network

Internet:

Radio Vlaanderen International is available on the Internet via World Radio Network (www.wrn.org)

Fri	Sat	Sun	Frequencies
PR, BT, E, IR	PR, MF	RW, PO	7290, 9940
PR, BT, E, IR	PR, MF	RW, PO	9925, 15535
PR, BT, E, IR	PR, MF	RW, PO	15545
PR, BT, A, T	-	-	5910, 7290
PR, BT, A, T	-	-	17655, 11810
PR, BT, A, T	-	-	1512 ^{mw}



RCI's transmitter site at Sackville, New Brunswick, in the Atlantic Provinces.

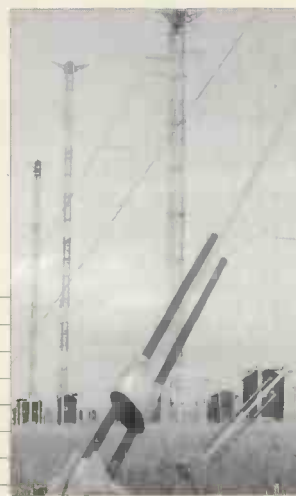

RCI



RADIO CANADA INTERNATIONAL

Fri	Sat	Sun	Frequencies
S	S	S, VC, EW	5960, 9535, 9755, 11715, 13670
S	S	V, SC, S	9635, 9755, 11715, 13670
S	S	VC	9715, 11835, 11975
S	S	S	7295, 9595, 11835, 15430
S	EW	AC	9660, 15195
TM	TH	CQ	9640, 11855, 13650
-	-	TM, SM	11855, 13650
S	VC	M	9535, 11935, 11795, 15325, 17820
S	VC	M	6140, 7150
S	VC EW	AC M	5995, 7325, 11690, 13650, 13670, 15150, 15325, 17820, 17870
W6	SCS	IT	7325, 11690, 11890, 13650, 13670, 15150, 15325, 17820
W6	WW	WW	5960, 9755, 13670, 15305
-	MP	AH, C	5960, 9755, 13670
W6	-	-	11895, 15305
-	CQ	SA	5960, 9755, 11895, 13670, 15305
-	MP	SA	5960, 9755, 13670, 15305

Programme Key:

AC	The Arts in Canada
AH	As It Happens
C	Connections
CQ	Classic Quirks
EW	Earth Watch
IT	The Inside Track

M	The Mailbag
MP	The Mystery Project
S	Spectrum
SA	Sound Advice
SCS	A Summer Comedy Summary
SM	Some of the Best Minds of Our Times
T	Tapestry
TB	Talking Books

TH	The House
TM	This Morning
V	The Vestibules
VC	Venture Canada
VC	Vinyl Café
W6	The World at Six
WW	The World This Weekend

FINLAND: YLE RADIO FINLAND

YLE Radio Finland, Box 78, 00024 Helsinki, Finland

Telephone: +358 9 1480 4333

FAX: +358 9 148 1169

E-mail: rfinland@yle.fi

Internet: www.yle.fi/rfinland



Frequencies:

Time	Area	Frequencies
0200-0230	Europe, America	558 ^{mw} , 9780, 11900
0630-0700	Europe, Asia, Australia	558 ^{mw} , 11945, 17830
2000-2030	Europe, Africa	558 ^{mw} , 963 ^{mw} , 6135

GERMANY: DEUTSCHE WELLE

Deutsche Welle, PO Box 100 444, D-50968, Cologne, Germany

Telephone: +49 221 3890

FAX: +49 221 389 4155

E-mail: online@dwelle.de

Internet: www.dwelle.de/english



Programmes on short and medium wave:

Time	Area	Mon	Tue	Wed	Thu	Fri	Sat
0100-0150	North America	MB, AA	ME	IN	LG	SP	GR
0200-0250	South Asia	SU, MM	ME	IN	LG	SP	GR
0300-0500	North America	RS, AA	ME	IN	LG	SP	GR
0400-0450	Africa, Middle East	SU, MM	GMA	GMA	GMA	GMA	GR
0500-0550	North America	MB, C	ME	IN	LG	SP	GR
0600-0650	West Africa	SU, MM	GMA	GMA	GMA	GMA	GR
0900-0950	Africa, Middle East	DF	ME	IN	LG	SP	TP, AFK
0900-0950	Asia, Pacific,	APR	APR	APR	APR	APR	TP, MM
1100-1150	West Africa	AFR	AFR	AFR	AFR	AFR	TP, AFK
1600-1650	Africa, Middle East	AFR	AFR	AFR	AFR	AFR	TP, S
1600-1650	South Asia	APD	APR	APR	APR	APR	TP, S
1900-1950	West Africa	AFR	AFR	AFR	AFR	AFR	TP, S
2000-2050	Europe	GR, F	ME, F	IN F	LG F	SP, F	SA, AA, F
2100-2150	Asia, Pacific, West Africa	DF	ME	IN	LG	SP	SA, MB
2300-2350	East Asia	DF	ME	IN	LG	SP	SA, MB

Deutsche Welle carries News in each segment, and in most segments it also carries *Newslink*. Fre

Travel the World

by Radio by Satellite by Internet

The World-Wide Radio Guide gets you on your way to a whole new World of Listening.

FRANCE: RADIO FRANCE INTERNATIONALE

Radio France Internationale, BP 9516, F-75016 Paris, France

Telephone: +33 1 42 30 30 62

FAX: +33 1 42 3 0 26 74

E-mail: english.service@rfi.fr

Internet: www.rfi.fr

Frequencies:

Areas:

Af Africa
As Asia
Eur Europe
ME Middle East

Time	Areas	Frequencies
1200-1300	All areas	9805, 11600, 15155, 15195, 15530, 15540, 17575
1400-1500	ME, Af, As, Australia	11910, 15405, 17560
1600-1700	Eur, ME, Af	11615, 11705, 12015, 15210, 15640, 17850

Programme Key:

AFK	African Kaleidoscope	GMA	Good Morning Africa	S	Spectrum
AA	Arts on the Air	GR	German by Radio	SA	Saturday Review
APD	Asia Pacific Report Development	IE	Inside Europe	SP	Spotlight on Sport
APR	Asia Pacific Report	IN	Insight	SU	Sunday Review
AFR	Africa Report	LG	Living in Germany	TP	Talking Point
C	Cool	MB	Mailbag	WK	Weekend
DF	Development Forum	ME	Man and Environment		
F	Frequencies	MM	Marks and Markets		
		RS	Religion and Society		

Sun	Frequencies
SA, IE	6040, 6085, 6145, 11810
SA, MB	1548 ^{MW} , 7285, 9615, 9690, 11945, 11965, 12045
SA, S	6085, 6145, 6185, 9535, 9640
SA, IE	5990, 6015, 7225, 9565, 11765
SA, MM	6045, 6185, 9615, 11810
SA, IE	11915, 13790, 15185, 17820, 17860, 21680
RS, C	9565, 15205, 15410, 17800, 21600
RS, C	6160, 12055, 17560, 21680
RS, C	15370, 15410, 17765, 17800
RS, AA	7130, 9735, 11810, 21695
RS, C	1548 ^{MW} , 6170, 7225, 9875, 15415
RS, AA	9640, 9670, 11785, 11810, 13790, 15245, 15390
SU, AA, F	9615
SU, AA	7115, 9670, 9735, 9765, 11785, 11865, 15135
SA, AA	5975, 6090, 7325, 9815

Internet:
Many of Deutsche Welle's programmes can be heard on the Internet. Go to:
www.dwelle.de/english/audio.html

ency information is given in every segment.

Short Wave Magazine
catering for all your listening needs.

JAPAN: NHK WORLD RADIO JAPAN

Radio Japan, NHK World, 2-2-1 Jinnan, Shibuya-ku, Tokyo 150-01, Japan

Telephone: +81 3 3465 1111

FAX: +81 3 3481 1350

E-mail: info@intl.nhk.or.jp

Internet: www.nhk.or.jp/rjnet/



Programmes on short wave:

Time	Area	Mon	Tue	Wed	Thu	Fri	Sat
0000	Eur, Afr, SEAs, NAm	44	44	44	44	44	AW
0100	ME, As, SAs, SE As, Oc, H, SAm	44	44	44	44	44	W
0300	SE As, Oc, CAm	AT, MR	AT, E	AT, MR	AT, MJ	AT, MB	W
0500	Eur, As, SEAs, Oc, Nam, H	44	44	44	44	44	H
0600	Eur, As, SEAs, Oc	AT, MR	AT, E	AT, MR	AT, MJ	AT, MB	AW
1000	As, SEAs	44	44	44	44	44	H
1100	As, SEAs, Oc, NAm	AT, MR	AT, E	AT, MR	AT, MJ	AT, MB	AW
1400	SAs, ME, Nam	44	44	44	44	44	W
1500	As, SAs, SEAs, NA	AT, MR	AT, E	AT, MR	AT, MJ	AT, MB	AW
1700	Eur, Afr, As, SEAs, Nam	44	44	44	44	44	H
2100	Eur, Oc	AT, MR	AT, E	AT, MR	AT, MJ	AT, MB	H

NETHERLANDS: RADIO NETHERLANDS

Radio Netherlands, PO Box 222, 1200 Hilversum, Netherlands

Telephone: +31 35 672 4211

FAX: +31 35 672 4207

E-mail: letters@rnw.nl

Internet: www.rnw.nl/rnw



Programmes on short and medium wave radio, and on satellite:

Time	Area (Radio)	Satellite No	Area (Satellite)	Mon	Tue	Wed	Thu
0030	NAm	1	Eur, ME	SY, SI	RF	M5	DO
0030	SAs	1,2,6,8	Eur, ME, Afr, As, Pac	SY, SI, FM	RF, PI	M5, PI	DO, PI
0130	SAs	2,6,8	Eur, Afr, AS, Pac	WA, SS, FM	AT, PI	GL, PI	SI, PI
0230	SAs	2,6,8	Eur, Afr, AS, Pac	SY, SI	RF	M5	DO
0430	NAm	1,2,6,8	Eur, ME, Afr, As, Pac	SY, SI	RF	M5	DO
0730	Pac	2	Eur	RF, IN	M5, IN	DO, IN	MN, IN
0830	Pac	2	Eur	AT	GL	SI	RF
0930	FE, SEAs	-	-	RF, PR	M5, PR	DO, PR	MN, PR
1030	FE, SEAs	2	Eur	AT	GL	SI	RF
1030	Eur	2	Eur	AT, PR	GL, PR	SI, PR	RF, PR
1130	Eur	2	Eur	RF	M5	DO	MN
1330	SAs	-	-	RF, PR	M5, PR	DO, PR	MN, PR
1430	SAs	2 (not Sun)	Eur	AT	GL	SI	RF
1730	Af	-	-	RF, PR	M5, PR	DO, PR	MN, PR
1830	Af	1,2,6,8	Eur, ME, Afr, As, Pac	AT, PR	GL, PR	SI, PR	RF, PR
1930	Af	1,2,6,8	Eur, ME, Afr, As, Pac	RF	M5	DO	MN
2030	Eur	2	Eur	RF, PR	GL, PR	DO, PR	MN, PR
2130	Eur	2	Eur	AT	M5	SI	RF
2330	Nam	1	Eur, ME	AT, PR	GL, PR	SI, PR	RF, PR

Areas:	FE	Far East	SAs	South Asia	
Af	Africa	ME	Middle East	SEAs	South-East Asia
As	Asia	NAm	North America		
Eur	Europe	Pac	Pacific		

All programme segments are of 55 minutes duration: all begin with News, and most include Newslite

Programme Key:

44	44 Minutes
AT	Asian Top News
AW	Asian Weekly
E	Enjoy Japanese
H	Hella from Tokyo

MB

MJ

MR

W

Music Beat

My Japan Diary

Music Reflections

Weekend Break

Sun	Frequencies
H	6155, 6180, 9665, 11705, 11815 (to 0015), 13650 (to 0015)
H	6150, 11860, 11880, 15570, 15590, 17810, 17835, 21610, 21670
H	17685, 17825, 17885
W	6110, 7230, 9835, 11760, 11715, 11840, 11850, 15230, 17810
H	5975, 7230, 11740, 11840, 11850, 17810
W	9695, 11730
H	9505, 9695, 11730, 11850
AW	9505, 11730, 11880
H	7200, 9505, 9750, 11730
W	6090, 7110, 9535, 9825, 15355
AW	6035, 9725, 11850

Areas:

Afr	Africa
As	Asia
CAM	Central America
Eur	Europe
H	Hawaii
ME	Middle East
NAM	North America
Oc	Oceania
SAM	South America
SAs	South Asia
SEAs	South East Asia

Radio Japan carries
News on the hour.

Satellite:

RNW has a complicated satellite schedule. Contact the station via Internet, or other means for full information. Here are some details:

Mono service to Europe is on *Hot Bird* Eutelsat II F6, 13°E, transponder 11.431GHz horizontal polarisation (POLSAT), audio 7.56MHz

Digital service is an *Astra 1G* 19°E, transponder 109 horizontal polarisation, choose from audio channels RNW-1 and RNW-2

Internet:

RNW can be heard on World Radio Network (www.wrn.org)

Fri	Sat	Sun	Frequencies
MN	OL	WE	6020, 6165, 9845
MN, PI	GL, PR	WE, IN	9855, 11655, 12090
RF, PI	DO, PR	RS, IN	9855, 11655, 12090
MN	GL	WE, FM	9855, 11655
MN	OL	WE	6165, 9590
GL, IN	WE, IN	SY, SI, FM	9720, 9820
DO	RS	WA, SS	9720, 9820
GL, PR	WE, IN	SY, SI, FM	12065, 13710
DO	RS	WA, SS	12065, 13710
DO, PR	RS, IN	WA, SS, FM	6045, 9860
GL	WE	SY, SI	6045, 9860
GL, PR	WE, IN	SY, SI, FM	9890, 15585
DO	RS	WA, SS	9890, 15885
GL, PR	WE, IN	SY, SI, FM	6020, 7120, 11655
DO, PR	RS, IN	WA, SS, FM	6020, 7120, 9895, 11655, 15315, 17605
GL	WE	SY, SI	6020, 7120, 9895, 11655, 15315, 17605
RS, PR	WE, IN	SY, SI, FM	1512 ^{mw}
DO	RS	WA, SS	1512 ^{mw}
DO, PR	RS, IN	WA, SS, M	6020, 6165, 9845

Programme Key:

AT	Aural Tapestry
DO	Documentary
FM	Four Minutes
IF	Info
IN	Insight
M5	Music 52/15
MN	Media Network
PI	Programme Info
PR	Press Review
RF	Research File
RS	Roughly Speaking
SI	Sounds Interesting
SS	Siren Song
SY	Sincerely Yours
WA	Wide Angle
WE	Weekend

RUSSIA: THE VOICE OF RUSSIA

The Voice of Russia, Pyatnitskaya 25, Moscow 113326, Russia

Telephone: +7 095 950 5801/6631

FAX: +7 095 230 2828

E-mail: letters@vor.ru

Internet: www.vor.ru



РАДИО ГОЛОС РОССИИ
RADIO VOICE OF RUSSIA

Programmes on short and medium wave:

Time	Area	Mon	Tue	Wed	Thu	Fri	Sat	Sun
0100	Americas	MMU	UPFB	UPJS	UPYFA	UPMYR	UPMYT	MMU
			FB	JS	YFA	YR	YT	
0200	Americas	MMB	SE	NM	MMB	SE	NM	MMB
0230	Americas	TL	KL	TR	MYT	RR	ABC	TW
0300	Americas	SE	NV	NV	NV	NV	NV	NV
0330	Americas	ABC	AP	AP	AP	AP	AP	CMM
0400	Americas	PA	MMB	SE	NM	MMB	SE	PA
0430	Americas	JS	YFA	MYR	FB	TR	TL	MYT
0500	Europe, Asia	MMB	FAP	FAP	FAP	FAP	FAP	SE
	Australasia							
0530	Europe, Asia	TR	MYR	RR	MYT	TR	CMM	ABC
	Australasia							
0600	Europe, Asia	SE	MMB	NM	MMB	SE	NM	MMB
	Australasia							
0630	Europe, Asia	RR	KL	MYT	ABC	KL	TR	RR
	Australasia							
0700	Europe, Asia,	MMU	UP	SE	UP	MMB	UP	PA
	Australasia							
0730	Europe, Asia	MMU	FB	ABC	TR	MYT	KL	TW
0800	Europe, Asia	SE	FA	UP	NM	UP	MMB	MMU
0830	Europe, Asia	MYT	MMB	TR	FB	JS	CMM	MMU
1400	Asia	NV	NV	NV	NV	NV	NV	SP
1430	Asia	FB	MYR	JS	YFA	MYT	TL	KL
1500	Middle East	FAP	FAP	FAP	FAP	FAP	NM	PA
1530	Middle East	TR	MYT	ABC	FB	TW	KL	RR
1600	Middle East	NM	SE	MMB	NM	MMB	MM	SE TL
1630	Middle East	AP	AP	AP	AP	AP	MM	SE TL
1700	Europe, Africa	NV	NV	NV	NV	NV	NV	SP
1730	Europe, Africa	KL	YFA	MYT	MYR	FB	TW	TR
1800	Europe, Africa	UP	UP	UP	UP	UP	PA	PA
1830	Europe, Africa	AP	AP	AP	AP	AP	TR	CMM
1900	Europe, Africa	MMB	NM	SE	MMB	NM	SE	MM
1930	Europe, Africa	MYT	TR	KL	ABC	RR	CMM	MM
2000	Europe, Africa	SE	MMB	NM	SE	MMB	NM	SP
2030	Europe, Africa	TW	YFA	MYR	FB	JS	RR	TL

News is broadcast on the hour, with *News in Brief* on the half-hour. All programme segments are 3

Programme key:

ABC	Audio Book Club	MM	Music and Musicians	TW	Your Top Tune/You Write to Moscow
AP	Alternative Programmes	MYR	Music at Your Request	UP	Update
CMM	Christian Message from Moscow	MYT	Moscow Yesterday and Today	YFA	Yours for the Asking
FA	Focus on Asia	NV	News and Views		
FAP	Focus on Asia and the Pacific	NW	Newmarket		
FB	Folk Box	PA	Programme Announcements		
JS	Jazz Show	RR	Russian by Radio		
KL	Kaleidoscope	SE	Science and Engineering		
MMB	Moscow Mailbag	SP	Sunday Panorama		
		TL	Timelines		
		TR	This is Russia		

Satellite:

Horizont 40°E, 3.675GHz circular polarisation right-hand, audio 7.92MHz. Carries English throughout the 24 hours, except 0100-0200, and 1700-1800, which are in Russian.

Internet:

VOR can be heard on World Radio Network (www.wrn.org)

Frequencies

9615, 9665, 12050, 15520

9615, 9665, 12050, 15520

9615, 9665, 12050, 15520

7125, 9615, 9665, 11980, 12000, 12050, 13640, 13665, 15180, 15455

7125, 9615, 9665, 11980, 12000, 12050, 13640, 13665, 15180, 15455

7125, 9615, 9665, 11980, 12000, 12050, 13645, 13665, 15180, 15455, 15595

7125, 9615, 9665, 11980, 12000, 12050, 13645, 13665, 15180, 15455, 15595

1323^{mw}, 1386^{mw}, 9450, 17495, 17615, 17665,

17715, 21760, 21790

1323^{mw}, 1386^{mw}, 9450, 17495, 17530, 17615,

17635, 17665, 17715, 21760, 21790

1323^{mw}, 9450, 15470, 15490, 17495, 17530,

17615, 17635, 17665, 17715, 21760, 21790

1323^{mw}, 9450, 15470, 15490, 17495, 17530, 17615,

17665, 21760, 21790

1323^{mw}, 9450, 15470, 15490, 17495, 17530,

17615, 17635, 17665, 17715, 21760, 21790

1323^{mw}, 9450, 15470, 15490, 17495, 17530, 17615, 17635, 17665, 17715, 21760, 21790

1323^{mw}, 9450, 15470, 15490, 17495, 17530, 17615, 17665, 17715, 21760, 21790

1323^{mw}, 9450, 15470, 15490, 17495, 17530, 17615, 17665, 17715, 21760, 21790

1125^{mw}, 4730, 4940, 4975, 7510, 11655, 12025, 15510, 17570

1125^{mw}, 4730, 4940, 4975, 7510, 11655, 12025, 15510, 17570

693^{mw}, 1215^{mw}, 1323^{mw}, 7330, 9450, 9710, 9765, 11980, 12020, 12030, 12070, 15485

693^{mw}, 1215^{mw}, 1323^{mw}, 7330, 9450, 9710, 9765, 11980, 12020, 12030, 12070, 15485

11775, 11850, 11930, 15490, 15515, 17570

11775, 11850, 11930, 15490, 15515, 17570

9765, 9775, 11655, 11775, 12070, 15350, 17570

9765, 9775, 11655, 11775, 12070, 15350, 17570

1143^{mw}, 1494^{mw}, 7290, 9765, 9775, 9820, 11655, 11675, 11775, 12045, 12070, 15350

1143^{mw}, 1494^{mw}, 7290, 9765, 9775, 9820, 11655, 11675, 11775, 12045, 12070, 15350

1494^{mw}, 7290, 7425, 7445, 9440, 9450, 9765, 9775, 9820, 11630, 11655, 11675, 11775, 11850, 12045, 12070, 15350

1494^{mw}, 7290, 7425, 7445, 9440, 9450, 9765, 9775, 9820, 11630, 11655, 11675, 11775, 11850, 12045, 12070, 15350

1323^{mw}, 1494^{mw}, 7425, 9440, 9470, 9710, 9765, 9775, 9820, 11675, 11850

1323^{mw}, 1494^{mw}, 7425, 9440, 9470, 9710, 9765, 9775, 9820, 11675, 11850

minutes long.

SWEDEN: RADIO SWEDEN

Radio Sweden, S-105 10, Stockholm, Sweden

Telephone: +46 8 784 7281

FAX: +46 8 660 2990

E-mail: info@rs.sr.seInternet: www.sr.se/rs/

Time	Area	Frequencies
0130-0200	Asia, Americas	9435, 11985
0230-0300	Americas	7135, 9495
0330-0400	Americas	9475, 11665
1130-1200	Americas	15235, 15240, 17870
1230-1300	Asia	13740, 15240
1330-1400	Asia, Americas	13740, 15240, 17515
1730-1800	Europe	1179 ^{mw} , 6065, 13855 (Sunday only), 15735
1930-2000	Europe	1179 ^{mw} , 6065
2030-2100	Europe	1179 ^{mw} , 6065, 13830 (Saturday and Sunday only)
2130-2200	Europe	1179 ^{mw} , 6065, 9430

UNITED KINGDOM: BBC WORLD SERVICE

BBC World Service, Bush House, London WC2B 4PH, United Kingdom

Telephone: +44 (0)171 240 3456

FAX: +44 (0)171 257 8258

E-mail: worldservice.letters@bbc.co.ukInternet: www.bbc.co.uk**Satellite:**

In Europe: Astra 1B 19.2°E, transponder 23 (UK Gold TV) 11.552 horizontal polarisation, audio 7.38MHz. In North America: Satcom C3 131°W, transponder 3.840GHz, vertical polarisation, audio 5.40MHz.

Internet:www.bbc.co.uk/worldservice**Programmes for Europe on short, medium and long wave:**

Time	Frequencies
0000-0200	198 ^{lw} , 648 ^{mw}
0200-0300	198 ^{lw} , 648 ^{mw} , 9410
0300-0400	198 ^{lw} , 648 ^{mw} , 1323 ^{mw} , 5875(to 0330), 6180, 6195, 9410
0400-0500	198 ^{lw} (to 0415), 648 ^{mw} , 1323 ^{mw} , 3955, 6180, 6195, 7325(from 0430), 9410, 12095
0500-0600	648 ^{mw} , 1323 ^{mw} , 3955, 6180, 6195, 9410, 12095
0600-0715	648 ^{mw} , 1323 ^{mw} , 6180 (to 0630), 6195, 7325, 9410, 12095, 15565(from 0700)
0715-0800	648 ^{mw} , 1323 ^{mw} (Sat & Sun), 6195(to 0730), 7325, 9410, 12095, 15565
0800-0900	648 ^{mw} (Mon-Fri from 0815), 1323 ^{mw} (Sat & Sun), 7325(to 0815), 9410, 12095, 15576, 17640
0900-1500	648 ^{mw} , 1323 ^{mw} , 9410, 12095, 15565, 17640
1500-1600	648 ^{mw} (to 1515), 1323 ^{mw} , 9410, 12095, 15575
1600-1700	648 ^{mw} , 1323 ^{mw} , 9410, 12095, 15575
1700-1900	648 ^{mw} (not Mon-Fri 1730-1830), 1323 ^{mw} , 6180, 6195, 9410, 12095, 15575
1900-2000	648 ^{mw} , 1323 ^{mw} , 6180, 6195, 9410, 12095
2000-2230	648 ^{mw} , 1323 ^{mw} , 6180, 6195, 7325, 9410, 12095
2230-0000	648 ^{mw} , 1323 ^{mw} (to 2330)

The BBC World Service has a very complex programme schedule. There is News of various sorts on every hour, ranging from full-scale programmes such as *Newshour*, *Newsdesk* and *Newsday*, through 'running news' such as *The World Today*, to 15, 10 and 5 minute bulletins and one minute summaries. Off the hour, the BBC covers the whole range of radio subjects, including documentaries, Science, Music, Drama, Sport, Religion etc. There is variation from month to month and week to week,

making it impossible to list everything in such a limited space. Contact the BBC for details of their programme magazine *On Air*, and see their web site (www.bbc.co.uk/worldservice).

The above frequency schedule is for Europe only. To include the whole frequency schedule would also take too much space. Full frequency listings for the five other regions of the world can be found in the AIB's *Global Radio Guide*.

SWITZERLAND: SWISS RADIO INTERNATIONAL

Swiss Radio International, Giacomettistrasse 1, 3000 Berne 15, Switzerland

Telephone: +41 31 350 9790

FAX: +41 31 350 9580

E-mail: english@sri.srg-ssr.ch

Internet: www.srg-ssr.ch/sri/

Time	Target	Frequencies
0100-0130	Americas	9885, 9905
0400-0430	Europe	5840, 6165
0400-0500	Americas	9885, 9905
0530-0600	Europe	5840, 6165
0730-0800	Africa	9885, 11860, 13635
0615-0630	Europe	6165, 9535
0830-0900	Australasia	9885, 13685
1000-1030	Europe	6165, 9535
1100-1130	Asia	9810, 17515

Time	Target	Frequencies
1200-1230	Europe	6165, 9535
1200-1300	Europe	6165, 9535
1300-1400	Asia	7230, 7480
1400-1500	Asia	9575, 15265
1600-1615	Asia	9675, 15265
1700-1730	Europe	9905
1900-1930	Europe	6165, 9885
2000-2030	Africa, Middle East	9840, 9885, 9905, 11725
2100-2130	Europe	9905

UNITED KINGDOM: WORLD RADIO NETWORK

PO Box 1212, London SW8 2ZF, United Kingdom

Listener answer-line: +44 (0)171 896 9010

FAX: +44 (0)171 897 9007

E-mail: online@wrn.org

Internet: www.wrn.org

Satellite:

Europe: Astra 1B 19°E, transponder 22 (VH-1) 11.538GHz, audio 7.38MHz

Internet:

www.wrn.org

This London-based broadcaster is a distributor of international radio services on satellite and the Internet. The programmes, in English and other languages, can be heard world-wide. The basic streams available are WRN1 (English), WRN2 (multilingual) and WRN3 (German).

WRN1 is available in several regional streams. The audio can be heard live, according to the schedule below, or on-demand. Extensive details are available from the WRN web site, or by E-mail, post, or ring their answerline. Alternatively you can FAX them for more details.

WRN1 programmes to Europe, on satellite and on the Internet:

0025	Earth & Sky	1200	NPR Morning Edition (Mon-Fri); NPR Weekend Edition (Sat & Sun)
0030	Radio Sweden	1300	Radio France International
0100	NPR All Things Considered (Tue-Sat) (rpt), NPR Weekend Edition (Sun & Mon)	1400	Voice of Russia (Mon-Fri); Radio New Zealand (Sat); VOA Communications World (Sun)
0200	CBC As It Happens (Tue-Sat); RCI News & Features (Sun); RCI News & Features (Mon)	1430	Adventist World Radio
0300	Polish Radio Warsaw	1500	ABC Radio Australia
0330	Radio Budapest (Mon-Fri); Glenn Hauser's World of Radio (Sat); UN Radio from New York (Sun)	1600	CANA - News from the Caribbean (Mon-Fri); Vatican Radio World News (Mon-Fri); Glenn Hauser's World of Radio (Sat); Copenhagen Calling (Sun)
0400	PRI Market Place (Tue-Sat); SABC Network Africa (Sun); Copenhagen Calling (Mon)	1630	ORF Radio Austria International
0430	ORF Radio Austria International	1700	Channel Africa (Mon-Sat); Norden This Week & Health Watch (Sun)
0500	Swiss Radio International	1730	RTE Dublin
0600	NPR All Things Considered (Tue-Sat) (rpt); NPR Weekend All Things Considered (Sun & Mon)	1800	Radio Vlaanderen International
0700	ABC Radio Australia	1830	Radio Netherlands
0800	Radio Budapest Hungary (Mon-Fri); Radio New Zealand (Sat); Adventist World Radio (Sun)	1925	Earth & Sky
0830	Radio Canada International (Mon-Fri); UN Radio from New York (Sat); VOA Communications World (Sun)	1930	Radio Sweden
0900	Radio Prague	2000	YLE Radio Finland
0930	SABC Channel Africa (Mon-Sat); Glenn Hauser's World of Radio (Sun)	2030	Polish Radio Warsaw
1000	ABC Radio Australia (Mon-Fri) (rpt); NPR Car Talk (Sat); PRI Prairie Home Companion (Sun)	2100	VOA World Report (Mon-Fri); VOA (Sat & Sun)
1100	NPR Morning Edition (Mon-Fri); NPR Fresh Air (Sat); PRI Prairie Home Companion (Sun)	2200	PRI The World (Mon-Fri); NPR All Things Considered (Sat & Sun)
		2300	Radio Budapest Hungary
		2330	Radio Netherlands

UNITED STATES OF AMERICA: THE VOICE OF AMERICA

The Voice of America, 330 Independence Avenue, Washington DC 20547, USA

Telephone: +1 202 619 2538

FAX: +1 202 619 1241

E-mail: -

Web: www.voa.gov

VOICE OF AMERICA



Frequencies for Europe and North Africa:

Programmes to Africa

Time	Frequencies
0300-0330	909 ^{mw} , 1530 ^{mw} , 4960, 6080, 7280, 7290, 7340, 9575
0330-0400	909 ^{mw} , 1530 ^{mw} , 6080, 6115, 7280, 7105, 7290, 9575, 9885
0400-0430	909 ^{mw} , 1530 ^{mw} , 6080, 6115, 7105, 7265, 7280, 7290, 9575, 9885
0430-0500	909 ^{mw} , 7265, 6080, 7280, 7290, 9575
0500-0600	909 ^{mw} , 5970, 6035, 6080, 7195, 9630, 12080
0600-0630	909 ^{mw} , 1530 ^{mw} , 5970, 6035, 6080, 7195, 9630, 11995, 12080
0630-0700	909 ^{mw} , 1530 ^{mw} , 5970, 6035, 6080, 7195, 9630, 11995, 12080
1600-1700	909 ^{mw} , 1530 ^{mw} , 6035, 13600, 13710, 15225, 15410, 15445, 17895
1700-1730	909 ^{mw} , 1530 ^{mw} , 15410, 15445, 17895
1730-1800	909 ^{mw} , 15410, 15445, 17895
1800-1830	909 ^{mw} , 6035, 7415, 11975, 15410, 15580, 17895
1830-1900	909 ^{mw} , 6035, 7415, 11975, 15410, 15580, 17985
1900-1930	909 ^{mw} , 4950, 6035, 7375, 7415, 11975, 15410, 15445, 15580
1930-2000	909 ^{mw} , 4950, 6035, 7375, 7415, 11975, 15410, 15445, 15580
2000-2030	909 ^{mw} , 1530 ^{mw} , 4950, 6035, 7375, 7415, 11855, 11975, 15445, 17725, 17755
2030-2100	909 ^{mw} , 1530 ^{mw} , 6035, 7375, 7415, 11975, 15445, 17725, 17755
2100-2130	909 ^{mw} , 1530 ^{mw} , 6035, 7375, 7415, 11975, 15410, 15445, 15580, 17725
2130-2200	909 ^{mw} , 1530 ^{mw} , 6035, 7375, 7415, 11975, 15410, 15445, 15580, 17725
2200-2230	909 ^{mw} , 1530 ^{mw} , 6035, 7340, 7375, 7415, 11975

Programmes to Europe and North Africa

Time	Frequencies
0000-0300	1197 ^{mw}
0400-0430	792 ^{mw} , 7170, 11965, 15205
0430-0500	7170, 11965, 15205
0500-0515	792 ^{mw} , 1197 ^{mw} , 7170, 11965, 15205
0515-0530	792 ^{mw} , 1197 ^{mw} , 7170, 11965, 15205
0530-0600	792 ^{mw} , 1197 ^{mw} , 7170, 11965, 15205
0600-0700	792 ^{mw} , 1197 ^{mw} , 7170, 9680, 11805, 11965, 15205
1130-1200	11680
1200-1400	1197 ^{mw}
1400-1500	15255
1500-1530	5205, 15255
1530-1600	1197 ^{mw} , 15205, 15255
1600-1630	15205, 15255
1630-1700	15205, 15255
1700-1800	9760, 15135, 15255
1800-1900	1197 ^{mw} , 9760
1900-1930	9760, 9770
1930-2000	9760, 9770
2000-2100	9760, 9770, 15410, 15580
2100-2200	9535, 9760
2300-2400	1197 ^{mw}

For the world's major
international
broadcasters:

Frequencies

Satellite information

Internet sites

How to contact stations

What's in the programmes

When to listen

Short Wave Magazine,
in partnership with the Association
for International Broadcasting,
widens your listening horizons.

Short Wave Magazine
catering for all your
listening needs.