

FOR THE  
RADIO LISTENER

# shortwave magazine

September 1993 £1.90 ISSN 0037 - 4261



## RADIO STATIONS SPECIAL

**Cuban Clandestines**  
**Swiss Radio International**  
**EDXC '93**

**SINPO Explained** Plus Regular Features Covering

Airband, Scanning, Junior Listeners, SSB Utility Listening, Propagation, Amateur Bands, Long, Medium & Short Waves, Satellite TV Reports, Weather Satellites ... and more.

**UNIVERSAL M-8000**  
**DECODER REVIEW**

**ROBERTS R101**  
**PORTABLE 9-BAND**  
**RADIO REVIEWED**

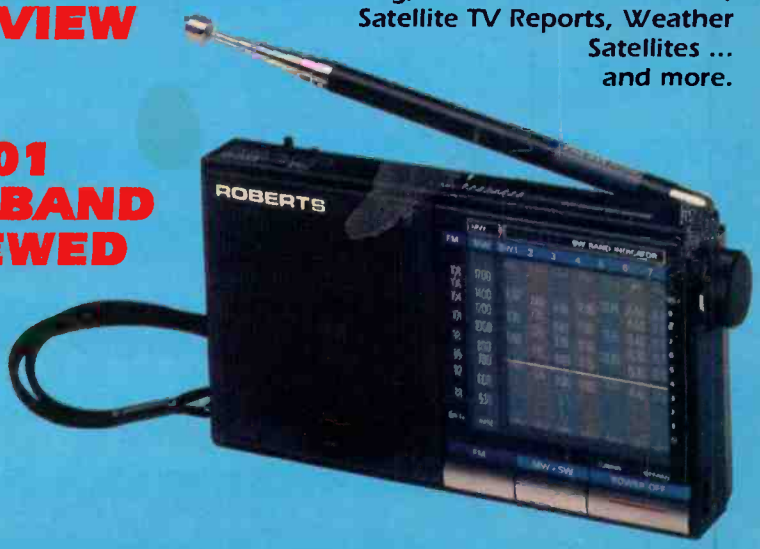



# YUPITERU MVT-7100

*A Handheld Sensation!*

- ▲ Continuous Coverage 100KHz - 1650MHz
- ▲ 1000 Memory Channels
- ▲ All Mode Reception (including SSB & CW)
- ▲ High Scan Speed

The MVT-7100 is a new handheld sensation with the widest ever frequency coverage! It's sensitive receiver provides effortless reception of SSB and CW using true carrier injection with 50Hz resolution. It can even be hooked up for fax and data reception (with accessories).

The MVT-7100 is a complete communications package in the palm of your hand.

Accessories supplied:-  
Telescopic Antenna, NiCad Batteries, Car Connector, UK Charger, Carrying Strap, Earphone, English Manual

**Price £449**



Available from your local dealer or direct from U.K. Distributors

**NEVADA COMMUNICATIONS**

189 London Road, North End, Portsmouth, Hants PO2 9AE. Tel: (0705) 662145 Fax: (0705) 690626

# short wave magazine

VOL. 51 ISSUE 9 SEPTEMBER 1993

ON SALE AUGUST 26  
(Next issue on sale September 23)

EDITOR: Dick Ganderton, C. Eng., MIEE, G8VFH  
ART EDITOR: Steve Hunt. Layouts: Richard Gale  
NEWS & FEATURES: Elaine Richards G4LFM

EDITORIAL

Arrowsmith Court, Station Approach,  
Broadstone, Dorset BH18 8PW  
Tel: (0202) 659910  
FAX: (0202) 659950

BOOK SERVICE, SUBSCRIPTIONS, BACK ISSUES ETC:  
CREDIT CARD ORDERS: (0202) 659930  
(Out of hours service by answering machine)

ADVERTISEMENT DEPARTMENT  
ADVERTISEMENT MANAGER

Roger Hall G4TNT  
TEL: 071-731 6222 Cellphone: (0850) 382666  
FAX: 071-384 1031

ADVERTISEMENT PRODUCTION (Broadstone)  
Lynn Smith (Sales) Ailsa Turbett (Production)  
TEL: (0202) 659920  
FAX: (0202) 659950

© PW PUBLISHING LTD. 1993.

Copyright in all drawings, photographs and articles published in Short Wave Magazine is fully protected and reproduction or imitation in whole or in part is expressly forbidden. All reasonable precautions are taken by Short Wave Magazine to ensure that the advice and data given to our readers is reliable. We cannot however guarantee it and we cannot accept legal responsibility for it. Prices are those current as we go to press. Short Wave Magazine is published monthly for £21(UK) or \$45 (USA) per year by PW Publishing Ltd., Arrowsmith Court, Station Approach, Broadstone, Dorset BH18 8PW. Second class postage paid at Middlesex, NJ. Postmaster. Send USA address changes to Short Wave Magazine, c/o Permit to post at Hackensack pending. The USPS (United States Postal Service) number for Short Wave Magazine is: 006696.

pw publishing ltd.

**Cover:**  
Our theme this month is radio stations. Many broadcast stations are located in exotic places - here the Andean volcanoes act as a backdrop to HCJB's antennas at Quito, Ecuador.



**DISCLAIMER.** Some of the products offered for sale in advertisements in this magazine may have been obtained from abroad or from unauthorised sources. Short Wave Magazine advises readers contemplating mail order to enquire whether the products are suitable for use in the UK and have full after-sales back-up available. The Publishers of Short Wave Magazine wish to point out that it is the responsibility of readers to ascertain the legality or otherwise of items offered for sale by advertisers in this magazine.

## features

- 10** Roberts R101 9-Band Portable Radio  
*Lawrence Harris*
- 13** Weighing Your Catch - SINPO  
*Don Phillips*
- 18** Crisis & Credibility at Radio Moscow  
*G. D. Rawnsley BA.*
- 22** EDXC 93 Vive Las Palmas!  
*George Wood*
- 25** A Visit to Swiss Radio International  
*Derek Jasnoch*
- 28** Short Wave Target: 23°N, 82°W  
*Gerry L. Dexter*
- 35** Universal M-8000 Decoder Review  
*Mike Richards*
- 41** Optoelectronics Interceptor Review
- 41** Errata. The Super-Regenerative Receiver. July 1993
- 42** Do-it-yourself Chart Recorder Part 4  
*Richard Noble*
- 45** The International Red Cross Broadcasting Service  
*Dick Moon*

## regulars

- |                           |                          |
|---------------------------|--------------------------|
| 59 Airband                | 70 Long, Medium & Short  |
| 57 Amateur Bands Round-up | 6 News                   |
| 54 Bandscan Australia     | 49 PCB Service           |
| 80 Book Service           | 48 Propagation           |
| 68 Decode                 | 4 Rallies                |
| 51 DXTV Round-up          | 50 Satellite TV News     |
| 4 Grassroots              | 61 Scanning              |
| 65 Info in Orbit          | 2 Services               |
| 84 Index to Advertisers   | 56 SSB Utility Listening |
| 5 Junior Listener         | 83 SWM Subscribers' Club |
| 2 Letters                 | 76 Trading Post          |
| 16 Listen With Grandad    | 75 Maritime Beacons      |

## good listening

TRADING POST  
SEPTEMBER 1993

# letters

IF YOU HAVE ANY POINTS OF VIEW THAT YOU WANT TO AIR PLEASE WRITE TO THE EDITOR. IF YOUR LETTER IS PUBLISHED YOU WILL RECEIVE A £5 VOUCHER TO SPEND ON ANY SWM SERVICE

## SWM SERVICES

### Subscriptions

Subscriptions are available at £22 per annum to UK addresses, £25 in Europe and £27 overseas. Subscription copies are despatched by Accelerated Surface Post outside Europe. Airmail rates for overseas subscriptions can be quoted on request. Joint subscriptions to both *Short Wave Magazine* and *Practical Wireless* are available at £38 (UK) £42 (Europe) and £45 (rest of world).

### Components for SWM Projects

In general all components used in constructing SWM projects are available from a variety of component suppliers. Where special, or difficult to obtain, components are specified, a supplier will be quoted in the article.

The printed circuit boards for SWM projects are available from the SWM PCB Service, Badger Boards, 87 Blackberry Lane, Four Oaks, Sutton Coldfield B74 4JF. Tel: 021-353 9326.

### Back Numbers and Binders

Limited stocks of most issues of SWM for the past five years are available at £2.00 each including P&P to addresses at home and overseas (by surface mail).

Binders, each taking one volume are available for £5.50 plus £1 P&P for one binder, £2 P&P for two or more, UK or overseas. Please state the year and volume number for which the binder is required. Prices include VAT where appropriate.

Orders for back numbers, binders and items from our Book Service should be sent to: **PW Publishing Ltd., FREEPOST, Post Sales Department, Arrowsmith Court, Station Approach, Broadstone Dorset BH18 8PW**, with details of your credit card or a cheque or postal order payable to PW Publishing Ltd. Cheques with overseas orders must be drawn on a London Clearing Bank and in Sterling.

Credit card orders (Access, Mastercard, Eurocard or Visa) are also welcome by telephone to Broadstone (0202) 659930. An answering machine will accept your order out of office hours and during busy periods in the office. You can also FAX an order, giving full details to Poole (0202) 659950.

The Editor reserves the right to shorten any letters for publication but will try not to alter their sense. Letters must be original and not have been submitted to any other magazines. The views expressed in letters published in this magazine are not necessarily those of *Short Wave Magazine*.

## Airband Radio

Dear Sir

I have been a keen airline enthusiast for a while and each night for about an hour I scan the different ATC stations on my AOR AR-1500EX, with an indoor desk-top scanner antenna. The problem is I'm not allowed to have an outdoor antenna, but that does not stop me.

My hobby involves me scanning a different station each night for a month and logging down the airlines plus all the usual information. At the end of the month I calculate the number of airlines received, plus how many times I have received the same airline.

For example, for the month of June, the Top Ten airlines reported were:

1: British Airways	132
2: British Midland	61
3: UK Air	32
4: Britannia Airways	31
5: Air France	28
6: Air 2000	21
7: Aer Lingus	17
8: Lufthansa	14
9: Shuttle	13
10: SAS	12

The number of planes that I logged was 608, and a total of 67 different airlines.

**Paul M Fineman  
Kent**

Dear Sir

I was very interested to read the letter from Mike Wynn in the July SWM, concerning the Future Air Navigation System and possible demise of the h.f. airband.

FANS was the subject of an excellent article by Charles Tyler in the March issue of *Geographical* magazine, which indeed states that h.f. is to be completely phased out from aircraft communications. Not only that, but the use of Automatic Dependant Surveillance is intended to reduce the need for pilots to communicate directly with ground stations, since virtually all navigational information will be processed automatically. I, for one, feel that even if equipment to monitor such traffic became available, not being able to actually 'listen' to aircraft going oceanic would be a very poor substitute for the present situation.

However, I feel that h.f. may yet belie the obituaries being written for it. On a recent visit to RAF Marham, I had the opportunity to discuss satellite versus h.f. with a communications technician, who informed me that the RAFs experience in the Gulf was that satellite proved very vulnerable to sunspot activity, while h.f. was much more reliable. It is my feeling that while satellite may be effective for navigation, retaining h.f. as a communications back-up would be eminently sensible - it is, after all, proven technology.

On a final note, it is worth remembering that the US military pioneered the Global Positioning System, but the Global High Frequency System remains as active as ever, proving that satellite and h.f. are complementary, not exclusive. Short wave is too useful to be discarded!

**Roderick McKenzie  
King's Lynn**

## Mystery Station

Dear Sir

In response to C. Prior's letter, the station he heard was Radio Aum Shinrikyo, 381-1, Hitoana, Fujinomiya, Shizuoka, 418-01, Japan. They have a relay via Radio Moscow and broadcast at 0530-0600 and 2130-2200 on numerous frequencies. I have heard them clearly on 11.630 and 11.800MHz between 2130 and 2200.

**J. Pattison  
Bath**

Dear Sir

The unidentified Japanese station is almost certainly Radio Aum Shinrikyo, a religious station broadcasting on some of the transmitters of Radio Moscow. I am currently logging it on 15.220MHz from 0430-0500 and 2130-2200UTC (English language). At the end of each transmission a Radio Moscow announcement is made and English language broadcasts of Radio Moscow resume.

I, too, find the voice of the female announcer difficult to understand.

**Gerry Haynes  
Bushey Heath**

## Callsigns

Dear Sir

May I thank you for the timely delivery of your excellent magazine, which arrived this morning. On turning to the Letters page, I could not believe what I was reading from your contributor W.E. Moore, West Yorks.

What a lot of irrelevant waffle! It surely did not merit inclusion. Radio stations can call themselves what they want in this country, so long as the title is decent and the Radio Authority does not object.

Obviously two stations in the United States could not be licensed with the same call letters, there could not be two WACSS. The USA is administered by the FCC. This country (the UK) is administered by the Radio Authority and they would not licence a station that used an illegal name.

Any station in this country would, granted, be foolish to use a name already being used by another,

In most cases the station titles are simply abbreviations of a longer title, enabling shorter 'catchier' jingles and easier listener recognition. Here are a few examples:

CWR - Coventry & Warwickshire Radio  
GWR - Great Western (or Wiltshire) Radio  
BRMB - BiRminghaM Broadcasting company  
KLFM - Kings Lynn FM  
KCBC - Kettering & Corby Broadcasting Company

In any case, none of these examples are actually callsigns, such as 5XX or 2MT, etc., simply names with no copyright.

**Michael J Smith  
Warwickshire**

## US Callsigns

Dear Sir

I was interested to read W.E. Moore's letter in your August edition. He is quite correct in making a complaint about the disturbing trend towards using American-style callsigns by British commercial radio stations. But this is nothing new. The first example of this was Two Counties Radio, based not a million miles away from SWM. They came on air using the callsign 2CR, surely an Australian callsign. In Gloucestershire we have the Severn Sound medium wave outlet calling itself '3CR'. Confusion reigns supreme!

But I must correct Mr Moore on his suggestion that this practice is illegal. It is not. All the callsigns he mentions in his letter, KFM, WNK, CNFM, etc., have all been approved by both the Radio Authority and the DTI. So perhaps he should address his comments to those bodies. In any case v.h.f./f.m. stations are unlikely to become long distance DX catches, but the problem in relation to medium wave a.m. outlets is an interesting one.

Second, I should like to correct the piece of information in the August 'Junior Listener' page, in an item headed Sunshine 855. The Orban Optimod processor is not normally used to limit audio bandwidth. This function is usually performed by high and low pass filters built into the transmitter installation. What the Optimod is used for is to increase audio quality to the listener. It does this by a complex combination of both level compression and frequency equalisation. It is, in effect, a sophisticated 'loudness button'. Most a.m. outlets use this type of processing in their output.

FM stereo transmissions are also processed using either the f.m. version of Optimod or a similar system called Innovonics. The latter is generally thought to have a less crude sound than the Orban unit that, which if not very carefully set-up can have a rather 'ghetto blaster' type sound. To hear what I mean, take a listen to Radio 1 FM that uses Optimod, or Classic FM, which is an Innovonics user.

**Mike Ganley**  
Gloucestershire

## Peter Rouse GU1DKD

Dear Sir

Even though it was not unexpected, the death of Peter Rouse - GU1DKD shook me badly. I first met Peter on the Ham Radio Stand at the Leicester show some years ago, when we both got fairly blitzed on Chris Lorek's freebie wine. Sharing the same publishing company, writing similar material to each other, even suffering the same medical complaint (although mine being a different type) we immediately struck up a friendship. His laconic and 'dry' sense of humour closely matched that of my own. And we both had this burning desire to pass-on information winkled-out from a surprising variety of sources, most of them emanating from the States, where 'Freedom of Information' is a way of life, and not a daily struggle!

Peter was generous to me with his information sources, and, as I had just started with the same publishing company, gave me much valuable information about the company itself. Information which was to stand me in good stead over the years. I meet an enormous number of people every year as I wander around the world collecting little nuggets of information, to be filed away until a need arises. Yet, very few of these people stand out in my memory. Peter was so different. He was a charismatic man, whose ability to communicate was (in my opinion, certainly not Peter's!) only second to my own. He stands out in my mind as one of the very few giants of intellectual ability able to talk on equal terms with just about anyone he met.

And behind the brain, ready to pounce at a second's notice, was his incredible sense of fun. Witness when I asked him about his 'day-job' was, somewhat shocked, Peter told me that he was an Announcer for Channel TV. I explained that Channel TV was particularly difficult to receive in the depths of Sherwood Forest, to which we both fell about in complete hysterics - no doubt aided by the wine!

Peter will be a hard, if not impossible act to follow. I

# letters

## Good Service

Dear Sir

I know you get many letters on this theme, but I had cause to be impressed with the efficient service of SRP Trading. A telephone call on June 30 and the sending of a cheque was all it took, the unit arrived on July 2!

**H. Richards**  
South Humberside

As I would not hesitate to complain if I were to receive poor service from an advert in your magazine, I should give mention to the fabulous service I received at Haydon Communications of Edgware.

Mike Haydon was very helpful and patient. I got a very fair trade-in price for my old receiver and the Lowe HF-150 that I purchased is every bit as good as the reports I've heard, and **NO** I don't have shares in the shop!

**Stephen J Sadler**  
Middlesex

I would like to thank Waters & Stanton Electronics for the excellent service I have received. The staff were very courteous and helpful at all times.

**Les Borthwick**  
Roxburgshire

I would like to express my thanks to AOR at Wirksworth for the help and assistance they gave me over a few problems I had with some equipment I had from them. I am an avid short wave listener, being disabled I can't do much else. Just a few kind words to those radio amateurs out there, it is nice to hear you say, "and to all our short wave listeners out there", it really makes listening well worth while.

**Ken Hornby**  
Derby

"Service' today is hard to come by in a spontaneous manner. I sent \$83 in US funds to J&J Enterprises after a 'phone call that was highly informative in regards to mating their Scancat to an Icom IC/R5000 via an CT-17 interface. They also gave me a home 'phone number for help. Unfortunately, six weeks later, the product had still not arrived. I 'phoned again, using the home 'phone number, and within hours was telephoned back and asked to describe my plight. Taking me at my word, J&J Enterprises despatched a repeat order to me that same day. This is not a letter cautioning the sending of money through the post. It's just a commendation to J&J Enterprises for accepting my word and expressing professional concern.

**Neville L.H. Cresdee**  
Gosport

certainly don't envy the pretender to his crown. He helped me personally when I was a very 'green' and naive beginner. I shall miss you greatly Peter. When I join you in that Great Publishing Company in the skies, we can finally settle just who is the best writer! My love to a great

man, and my deepest sympathy to his family, to whom I am offer the following thought.

You're only dead when the last person on Earth can no longer remember your name.

Farewell Peter

**K. M. Fox**  
Sheffield

# grassroots

## Club Secretaries:

Send all details of your club's up-and-coming events to: Lorna Mower, Short Wave Magazine, Arrowsmith Court, Station Approach, Broadstone, Dorset BH18 8PW. Please tell us your County and keep the details as brief as possible.

\* Short Wave Magazine & Practical Wireless in attendance

## rallies

**September 5:** The Telford Rally will be held at the Telford Exhibition Centre, Telford. Bob G7BWQ. Tel: (0952) 770922.

\***September 5:** The Bristol Radio Rally will be held in The Great Train Shed, Temple Meads Railway Station, Bristol. **Muriel Baker G4YZR.** Tel: (0275) 834282.

**September 5:** The Vange ARS Annual Rally will be held at The Laindon Community Centre, Laindon High Road/Aston Road, Laindon, Basildon. Doors open from 10.30am. Admission 75p. There will be trade stands, a Bring & Buy, raffle, refreshments, good car parking, talk-in on S22. **Mike Musgrove G4NVT.** Tel: (0268) 543025.

\***September 11:** Scottish AR Convention 93 is being held at Cardonald College, Glasgow. The usual Convention events, together with all the usual traders. **Tom Hughes GM3EDZ.** Tel: 041-882 5753.

\***September 12:** Lincoln Hamfest, organised by Lincoln Short wave Club, will be held as usual in the Exhibition Centre, Lincolnshire Showground from 10.00am for the disabled, 10.30am to 17.30 for the general public. Trade stands together with the usual attractions for the family.

**September 12:** The BARTG Rally will be held at Sandown Exhibition Centre, Esher, Surrey. Attractions include Bring & Buy, on-site catering, special interest groups and car parking. Doors open from 10.30am to 5pm. Admission £1.50 for adults, OAPs £1. **Peter Nicol.** Tel: 021-453 2676.

**September 19:** The East of England Rally will be held at the East of England Showground, Oundle Road, Peterborough. Entrance fee £1, accompanied children free. **Mike GOCVZ.** Tel: (0733) 222588.

**September 26:** Three Counties Radio Rally will be held at the Three Counties Show Ground, Malvern. All trade stands are in one hall with the catering facilities. **E. Cotton.** Tel: (0905) 773181.

\***September 25:** Lowe's Open Day. Matlock. Visit the famous Matlock Emporium on Chesterfield Road, browse and perhaps purchase from the vast stocks. The workshops will be open as well.

\***October 3:** The Great Lumley Amateur Radio & Electronics Society will take place in the Community Centre. Doors open 10.30am for the disabled and 11am for others. There will be trade stands, Bring & Buy and refreshments available. Talk-in on S22. Admission £1. **Barry G1JDP.** Tel: 091-388 5936.

## AVON

**RSGB City of Bristol Group:** last Mondays, 7pm. The Small Lecture Theatre, Queens Building, University of Bristol, University Walk, Bristol. September 27 - History & Use of Oscilloscopes by G8KGH. Dave. (0272) 672124.

**South Bristol ARC:** Wednesdays. Whitchurch Folkhouse Assoc, Bridge Farm House, East Dundry Rd, Whitchurch. September 1 - Preparation for the Bristol Rally, 8th - Review of the Bristol Rally, 15th - Talking Brick, Bring & Buy, 22nd - Airband Monitoring, the Facts by Ron, 29th - 144MHz Band All Bristol Activity Evening. For more information ring (0275) 832222 on a Wednesday evening.

## BUCKINGHAMSHIRE

**Atari RUG:** G. Rayer, 38 Brockhurst Road, Chesham HP5 3JE.

## CHESHIRE

**Stockport RS:** 34 Ladythorn Road, Bramhall, Stockport, Cheshire. September 8 - Pulsars, Time Keepers of the Universe by G0DMU, 22nd - Surplus Equipment Sale. J. France 061-439 4952.

## CORNWALL

**Cornish RAC:** 7.30pm. The Village Hall, Perranwell Station, Perranwell, Nr Truro, Cornwall. September 2 - More on Antennas by G3NPB, 13th - Re-writable CD ROMs by Peter. Geoff. (0209) 820836.

## DERBYSHIRE

**Derby & DARS.** Wednesdays, 7.30pm. 119 Green Lane, Derby. September 1 - Junk Sale, 22nd - Video Surveillance Equipment Demo by G3XER. Mrs Hayley Winfield, 2 Hiltz Cottages, Crich, Matlock, Derbyshire DE4 5DD. (0773) 856904.

## DEVON

**Torbay ARS:** Fridays, 7.30pm. ECC Social Club, Highweek, Newton Abbot. September 17 - CQWW Video by GW6ZUQ. Peter G4VTD. (0803) 864528.

## DORSET

**Dorset Police ARS:** 1st Thursdays & 3rd Tuesdays at Head Quarters, in the Bar & Social Club. September 2 - BBQ and Evening on the Air, 21st - Introduction to Constructional Competition. PC915 Richard Newton. (0202) 229351 or PC828 Bob Knight. (0202) 552099 ext 2031.

## EAST SUSSEX

**Southdown ARS:** 8pm Chasely Home for Disabled Ex-Servicemen, Southcliff, Bolsover Road, Eastbourne, East Sussex. September 4/5 - Exchange Weekend with Radio Club de Normandy, 6th - AMTOR & RTTY. Jan G4XNL (0323) 412699.

## ESSEX

**Vange ARS:** Thursdays 8pm, Barnstable Community Centre, Long Riding, Basildon, Essex. September 2 - Junk Sale, 9th - Rally Review, 16th - Weather Satellites by G1UB0, 23rd - Photography, 30th - Talk by G3JWI. Doris. (0268) 552606.

## FIFE

**Dundee ARC:** Tuesdays, 7pm. College of Further Education, Graham Street, Dundee. September 7 - Enrolment for the new session, 14th - Lecture by Morse Enthusiasts Group Scotland, 21st - Construction Evening, 28th - AGM. GM4FSB, 30 Albert Crescent, Newport on Tay, Fife DD6 8DT

## GREATER LONDON

**Acton, Brentford & Chiswick RC:** 3rd Tuesdays, 7.30pm. Chiswick Town Hall, Heathfield Terrace, Chiswick, W4. September 21 - The Poor Man's Rig Discussion. Colm. 081-749 9972.

**Wimbledon & DARS:** 2nd & last Fridays, 7.30pm. St Andrews Church Hall, Herbert Road, SW19. September 10 - Surplus Equipment Sale, 24th - Civil Aviation Safety Videos. 081-397 0427.

## HAMPSHIRE

**Horndean & DARC:** 1st Thursdays, 7.30pm. Horndean Community School, Barton Cross, Horndean. September 2 - RAYNET by G0MNL S. Swain (0705) 472846.

## HEREFORD & WORCESTER

**Bromsgrove ARS:** 2nd & 4th Tuesdays. Lickey End Social Club, Alcester Road, Burcot, Bromsgrove. September 14 - Technical Topics, 28th - Night on the Air (RTTY). Barry Taylor. (0527) 542266.

**Bromsgrove & DARC:** Fridays: Avoncroft Arts Centre, South Bromsgrove, Worcester. Joe Poole. (0562) 710010.

## HERTFORDSHIRE

**Dacorum AR & TS:** 1st (informal) & 3rd (formal) Tuesdays, 8pm. The Heath Park, Cotterells, Hemel Hempstead. September 21 - Talk by G3WGV. Dennis Boast. 8 Juniper Green, Warners End, Hemel Hempstead, Herts HP1 2NQ.

**Hoddesdon RC:** Alternate Thursdays, 8pm. Conservative Club, Rye Road, Hoddesdon. September 2 - Pre-Field Day Briefing, 16th - Emergency First Aid by Nurse Jane Churchill, 30th - The Training of a Guide Dog by G8PPZ. Roy G4UNL 081-804-5643.

## KENT

**Bromley & DARS:** 3rd Tuesdays, 7.30pm. The Victory Social Club, Kechill Gardens, Hayes. September 21 - Introduction to

Electronics by Graham Chamberlain. A.G. Messenger. 081-777 0420.

**Medway AR&TS:** Fridays, 7.30pm. Tunbury Hall Catkin Close, Tunbury Avenue, Walderslade, Chatham. September 10 - Video Evening, 17th - Novice Evening with G3UXH. Gloria. (0634) 710023.

**Sevenoaks & DARS:** Sevenoaks DC, Council Offices, Argyle Road, Sevenoaks. September 20 - RADAR by G7IET.

## LANCASHIRE

**Rochdale & DARS:** Mondays, 8pm. Cemetery Hotel, 470 Bury Road, Rochdale. September 20 - Construction Competition, Judgement Day! G0PUD. (0706) 32502.

## NORFOLK

**Norfolk ARC:** Wednesdays, 7.30pm. The Norfolk Dumpling, The Livestock Market, Harford, Norfolk. September 15 - Refrigeration by G4ILR, 29th - Pre-historic Elephant of West Runton by Dr Stewart. Sheila Snelling G0KPW. (0603) 618810.

## NOTTINGHAMSHIRE

**Mansfield ARS:** 2nd Mondays, 7.30pm. The Polish Catholic Club, off Windmill Lane, Woodhouse Road, Mansfield. September 13 - Evening on the Air. Mary G0NZA. (0623) 755288.

**South Notts ARC:** Fridays, 7pm. Highbank Community Centre or Fairham Community College, Farnborough Road, Clifton Estate, Nottingham. September 10 - Talk on SNARC Supported Novice, Amateur Radio & Morse Courses Available, 17th - Construction at Fairham College, 24th - On the Air at Fairham. Julie Brown G0SOU. (0602) 211069.

## OXFORDSHIRE

**Oxford & DARS:** 2nd & 4th Wednesday's, 7.45pm. Littlemore Hospital Social Club Terry Hastings. (0865) 863526.

## SURREY

**Sutton & Cheam RS:** 1st & 3rd Thursdays, 8pm. Sutton United Football Club, The Borough Sports Ground, Gander Green Lane, Sutton, Surrey. September 2 - Natter Night, 19th - 70MHz Trophy Contest. Tel: 081-655 9945.

## WARWICKSHIRE

**Mid Warwickshire ARS:** 2nd & 4th Tuesdays. September 14 - Visit to CWR. Don Darkes. (0926) 424465.

## WILTSHIRE

**Trowbridge & DARC:** 3rd Wednesday. The Southwick Village Hall, Southwick, Trowbridge. September 1 - RAYNET by G4TIX, 15th - Natter Nite. Ian G0GRI. (0225) 864698.

Jon Jones  
PO Box 59  
Fishponds  
Bristol BS16 4LH

# junior listener

## Listeners Awards

A recent letter from Chris Carrington, the International Short Wave League's Publicity Officer, reminded me of the ISWL's range of awards. With the summer drawing to a close (what summer!) it's a good time to start preparing for those winter projects. The ISWL offers a range of nine awards that may well appeal to junior listeners. As well as providing interesting certificates to decorate the shack, working for awards helps you learn more about the hobby as you strive to improve your results to get that last DX station. Let's just briefly run through the various awards.

**Century Club:** This is given for those that have verifications from a hundred countries or more. This is certainly a stiff test and I'm sure there aren't too many of these about.

**Commonwealth Award:** This is for the amateur loggings of 50 countries or 30 broadcast countries.

**Continental Award:** For this you will need verification reports from ten stations in each of the six continents.

**European Award:** This requires 50 (30 for broadcast) countries within Europe.

**Zone Award:** For the reception of 25, 50 or 75 ITU Zones as defined on an ITU Zone map.

**5 Band Century Award:** This is a tough amateur award and requires QSL cards for 100 countries on each of the 3.5, 7.0, 14.0, 21 and 28MHz amateur bands.

**Pacific Ocean Award:** A total of 45 (30 broadcast) countries that border the Pacific Ocean.

**States Award:** Requires verified reception of 50 US states.

**Short Wave Broadcast Bands DX Award:** This is a specialist award for broadcast enthusiasts and requires verified reception of stations in all eight continents. This award is also split into four classes as shown below.

	Europe	Africa	Asia	N.America	S.America	Oceania
Class 1	35	40	35	12	10	8
Class 2	30	30	27	10	7	6
Class 3	25	22	18	7	5	3
Class 4	17	15	10	4	3	1

This gives a total country score of 140 (class 1), 110 (Class 2), 80 (Class 3) and 50 (Class 4)

All of these awards are open to non-members and further details, along with claim forms, can be obtained from the **Awards Manager, Herbert Yeldham, Deal Hall Farm, Burnham Marshes, Burnham-on-Crouch, Essex CM0 8NQ**. As this is a largely voluntary organisation, please remember to include a large s.a.e. with your enquiry.

## Space Odysseys The TV Heroes

A World Of Toys, Dorset's first Musical Box Toy Museum at the village of Arne, near Wareham, Dorset is currently holding an exhibition entitled Space Odysseys The TV Heroes.

The exhibition has models on display including Thunderbirds', Fireball XL5 and Stingray all of which have been recreated by Wareham based professional model maker Martin J.

Bower, who has worked for the TV and film industry for the last 25 years. Martin, a Thunderbirds fan himself became involved in recreating these models after the launch of the Thunderbirds comic. As all the original models from the 1960s were destroyed, when the comic was launched decent stills were needed for photographs. This led to Martin recreating the entire Thunderbirds fleet, along with other popular models, at exactly the same size as the originals with particular attention being paid to detail.

**Top: Thunderbird 4 in the Repair Bay.**

**Centre: Martin Bower's interpretation of War Of The Worlds as created for the Bournemouth Science Fiction & Fantasy Society.**

**Bottom: The Stingray**

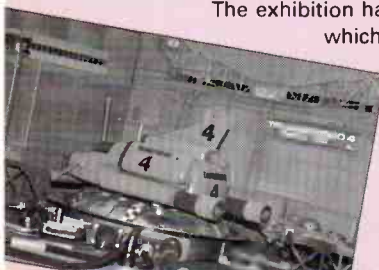

## Science Museum

I've recently received a very interesting information pack from the Science Museum. Included within this was their museum guide that, I thought, was very well set out with clear layouts and excellent photographs. Having been around the Science Museum many times in the past, I recommend spending some time looking at the guide to make sure you see all the things that interest you. Short Wave listeners may be particularly interested to see the demonstration radio station GB2SM. In addition to running amateur equipment for all the bands from 1.8MHz through to 430MHz, this station features television and satellite systems. Included in the satellite systems are both television and meteorological reception.

If you want to see the station running, there are normally demonstrations on Sunday, Monday, Tuesday and Thursdays. For detailed times you will need to contact the information desk on 071-938 8000.

## Helpline

Judging from my mailbag, and that of the editor, there are lots of readers out there that need a wide range of basic problems answered. As a fair number seem to come my way, I thought it was about time I offered the service through the column. So, if you have any radio related questions from satellites to Radio 1, drop a line to the address at the head of the column. I will do my best to answer promptly and there may even be a prize or two for the star questions!!

Martin has also worked on several highly regarded cult films and shows such as Alien, Blake 7, Space 1999 as well as being involved with Dr Who for five years.

The highlight of a visit to this museum must be the chance to see an original Parker puppet, one of only three still in existence, owned by Martin himself. If you remember the original, or are an avid fan of Thunderbirds and the other Gerry Anderson cult series a visit to the museum is a must.

The Museum run by Brian and Iris Etches is staging this exhibition in aid of The Joseph Weld Hospice Appeal (Dorchester) until September 17 1993. Admission charges have been increased to £2.25 for Adults, £1.95 for OAPs and £1.10 for children so that 50p per visitor can be donated to the appeal.

For more information contact **A World Of Toys, The Purbeck Toy & Musical Box Museum, Arne House, Arne, Nr., Wareham, Dorset BH20 5BT. Tel: (0929) 552018.**

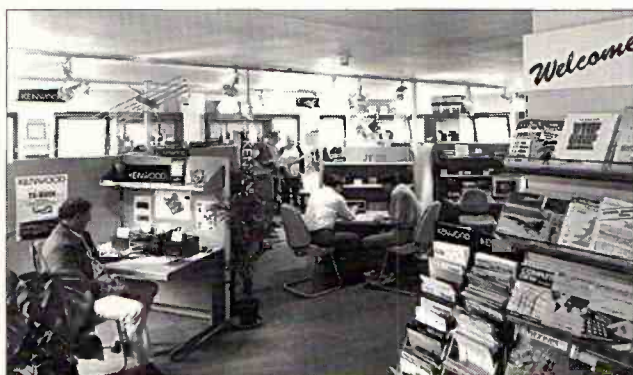

## Lowes 1993 Open Day

Lowes Electronics Ltd., are to hold another of their popular open days on Saturday September 25 1993. This year's attractions will include special demonstrations covering a wide range of equipment and accessories, Packet radio techniques, free Car Boot space to sell your own gear and a bargain basement of odds and ends. *SWM* Editor Dick Ganderton and Peggy will also be there with a stand offering *SWM* back numbers and a selection of books.

The Lowe workshop will be open for visitors to meet their team of engineers and discuss technical problems with them. New for this year is the short wave room containing receivers and the now famous Modemaster decoding software, plus Multiscan control programs, a full range of antennas, headphones and other accessories.

Special concessionary tickets will be available on the day for some of the local attractions making this ideal for a family day out.

If you can't make it to Matlock, all Lowe branches throughout the country will be taking part by running some special offers, so contact them to find out what's on offer.

For more information contact **Lowes Electronics Ltd., Chesterfield Road, Matlock, Derbyshire DE4 5LE. Tel: (0629) 580800.**

## Calling All Owners Of MVT-7100 Yupiteru Receivers

Waters & Stanton Electronics are anxious to contact owners of MVT-7100 Yupiteru Receivers with the following serial numbers in the following ranges: 30201181 to 30201190 and 30201231 to 30201240. There could be a problem with these receivers so if you own one of these models you are advised to contact **Waters & Stanton Electronics, 22 Main Road, Hockley, Essex SS5 4QS, Tel: (0702) 205843** immediately so that they can arrange a replacement if necessary.

## New Showroom Opens

On 10 July 1993 Welland Communications opened their new showroom in Bedford. This opening saw an expansion into Amateur radio, CB and short wave listening after four years of successful trading in business communications.

Visitors to the new showroom will benefit from useful and helpful advice as well as being able to try out transceivers and receivers on the customised antenna system. There is a wide range of equipment available.

Welland have introduced a club purchase scheme to enable groups to get a discount. Any groups interested should contact them for a discount certificate.

For further information on the services available contact **Welland Communications, 33 High Street, Bedford MK40 1RY. Tel: (0234) 364004.**

## Radio & TVDX News

Below is some important data for new Australian TV channels which will be adopted in the future.

Channel	Video (MHz)	Audio (MHz)	Notes
9A	203.25	208.75	new channel
10	210.25	215.75	shifted up 1MHz
11	217.25	222.75	shifted up 1MHz
12	224.25	229.75	new channel

Cellular-Vision NZ (Auckland) is proposing a microwave distribution service (MMDS) in the major cities around New Zealand and hopes to provide an eventual maximum 49 channels.

German broadcasting network ARD has delayed the start of digital audio broadcasting (DAB), intended for 1995, and the earliest date for commencement is now 1997. ARD are strapped for cash and to re-engineer Band 3 ch.E12 for DAB will cost over 30 million DM and will involve moving nearly 300 ch.E12 relay transmitters up to u.h.f. The government have indicated that the ch.E12 spectrum will be used for DAB!

Meanwhile, down Mexico way the government is to sell off the former state-run (but now closed) chs. 7 and 13 Imevision network to private operators, presenting commercial giant Televisa with serious competition. Already six consortia have bid for the old Imevision facilities.

There's a 'pirate' ship operational in the Adriatic transmitting to the embattled Balkans - though it is funded by the EEC and run by a French political group! Radio Brod operates a 50kW, 720kHz transmitter and broadcasts in Croatian, Muslim and Bosnian dialects. The French ship is tendered from Bali in SE Italy.

Less radio and TV activity in Turkey, as from April 1st the government closed down all private land based stations which - the government claim - were operating in breach of the law. The broadcasting explosion lead to nearly 700 radio and 100 TV stations nationwide and now the only private stations operating are those transmitting in from offshore, nearby islands or from distant studios linking programmes by satellite - London has several!

Indian TV is to improve with greater regional linking via satellites INSAT 1 and 2. Doordershan will link 48 stations in the North East across Assam, Meghalaya, Nagaland, Arunachal Pradesh, Tripura, Miroram and Manipur via 2A. Nearly 4000 community TV receivers are being installed in villages across the seven North East states. Other regions to be covered in regional operations are Pradesh, Jammu, Kashmir, Rajasthan, Madhya and the Punjab. Regional radio networking will also be improved.

After changes in private broadcasting in Turkey, Italy is also pushing for change. The Fininvest group may lose one of their three TV networks as indeed may RAI, the state broadcaster. Five year franchises will be awarded to new applicants, this intended to break the duopoly that Fininvest and RAI enjoy. The Fininvest group is run by Italian magnate Silvio Berlusconi. Ch. 31 Bucharest now radiates the CNNI programme for 23 hours daily.

On April 22nd last the Telshan network opened in Sri Lanka. Telshan Network (PVT) Ltd provides countrywide transmissions of local and foreign programmes on four channels.

Programme hours are 1600-2300 weekdays and 1600-2300 weekends. The Daily News, Sri Lanka report that TNL is introducing stereo (or dual language programming) on the service and additionally the TV sound is broadcast in the f.m. radio band at 101.70MHz. TNL transmits on chs. E3 and E4 Band 1 and at chs.E21, 26 u.h.f. And news that 'East West TV' (ETV) is likely to be on air shortly in Sri Lanka and will transmit the Hutchvision (Star TV) programme from AsiaSat 1, Prime Sports and the BBC Asia TV service. Transmissions will be at u.h.f. chs.E31, 32, 33 and 56.

Roger Bunney





## Bunfight at the Hendon Hamstore

Saturday 22 July saw the official opening of the Icom Hamstore in Hendon. Located at 11 Watford Way, Hendon, London NW4 3JL, the store was overflowing with people, searching for (and finding) bargains, throughout the day. As usual in London, parking is not the easiest, but Hendon Central underground station is a very short distance away.

Doug G0LUH, and Paul G7MNI, were helped out on the day by Matthew 2E1AWE from Icom, Mark Jarvis and Dennis Goodwin G4SOT. Reinforcements were there in the guise of Steve Devine G0TKD from Lowes and David Wilkins from Kenwood, while Sally Coning masterminded the refreshments. Judging by the number of trips Doug made to re-stock the drinks cabinet, the day was a remarkable success.

## MAN-93 Convention

Flightdeck - The Airband Shop, Cheadle, Cheshire have announced that they are holding this year's MAN-93 Convention at Terminal 1, Manchester Airport on October 17 between 10am and 5pm.

The Manchester Convention is a well established aviation enthusiasts' meeting joining the ranks of prestigious venues such as Paris, Zurich, Frankfurt, Los Angeles, Miami and London-Gatwick. This event presents the opportunity for aviation 'buffs' to get together to buy, sell and trade anything to do with 'planes including postcards, slides, photos, models, kits, timetables, books, etc.

The ever increasing public fascination with watching aircraft, along with the growing demand for table space has prompted the move to Manchester Airport's Gordon Thomas Suite for Man '93. Previous conventions have attracted visitors from the West and East coasts of America, Canada, France, Holland, Germany, Ireland, Switzerland and all over the British Isles.

For further information and details of how to book table space contact **Sue Fairbotham, Flightdeck - The Airband Shop, 192 Wilmslow Road, Heald Green, Cheadle, Cheshire SK8 3BH. Tel: 061-499 9350.**

## New From Uniden

Nevada have introduced two new Uniden Scanners to their range.

The first of these, the Bearcat 2500XLT Scanner features continuous band coverage, 400 channels, 20 banks, 10 priority channels, v.f.o. control, weather search and rechargeable battery pack to name a few. The 2500XLT, is available from Nevada for £365. The second is the Bearcat 890XLT Scanner. This is a 200 channel continuous band scanner with features such as 10 banks, 10 priority channels, weather alert, auxiliary tape output and an optional CTCSS key. Both of the latter are the first additions to the Uniden Bearcat range for many years and have been developed after painstaking research.

The 200XLT costs £365 and the 890XLT £299; both are available from **Nevada, 189 London Road, North End, Portsmouth, Hants PO2 9AE. Tel: (0705) 662145.** Both prices include either UK charger or mains adapter.



## RAE Courses

**Hull College** are to begin running a selection of radio courses, starting on Monday September 13 with the Global Maritime Distress & Safety System (GMDSS) course, leading to the new GMDSS Certificate of Competence necessary to operate Marine Radiotelephony equipment. Also starting on the 13th is the Yacht & Small Boat Owners, VHF Radiotelephony course, leading to the Certificate of Competence necessary to operate Marine VHF radio equipment. Both of these will only run if there is sufficient demand.

The College will also be running a City & Guilds London Institute 765 Radio Amateurs Examination Course starting on Tuesday 14 September and a Learning

Morse Code Course commencing on Wednesday 15 September.

Enrolment for all of the above is September 1 1993. For details of prices and availability contact **Hull College, Queen's Gardens, Hull HU1 3DG. Tel: (0482) 29943.**

**Reddish Vale Evening Centre, Reddish Vale Road, Reddish, Stockport SK5 7HD.** A full RAE course of 25 sessions, commences Monday September 27. The classes will run on Mondays, 7 to 9pm. Facilities will be available for students so who register for the course to sit the examination in December 1993. It is available either for those wishing to obtain the licence quickly, or for students needing to resit one or more components. The examinations will be held at

the centre.

They will also be running a Morse course of 25 sessions, up to 20w.p.m. The sessions will run on Thursdays, 7 to 9pm, commencing Thursday September 30. Enrolment for both courses will be on September 13, 14 & 16 between 7 & 8pm. Further details from course tutor **Dave Wood on 061-430 6246.**

**North Trafford College, Talbot Road, Stretford, Manchester M32 0XH. Tel: 061-872 3731** are offering another RAE course this year, starting in September. The course tutor will be J. T. Beaumont G3NGD. Theory will be on Monday evenings or Wednesday mornings, Morse on Tuesday evening or Wednesday afternoons,

Amateur Television on Wednesday mornings and An Advanced Radio Course Tuesday afternoons.

The all day course (Wednesdays) should appeal to retired or unemployed people, as a successful student could apply for an A licence at the end of the first year.

Enrolment dates are September 1, 2 & 3. For further details on the course contact the college at the above address.

**Sawston Village College** are to begin running an RAE class in September. The course tutor will be P. B. Buchan G3INR. For more details contact **SNR Community Tutor, Mr D. W. Cupit BA, Sawston Village College, Cambridge. Tel: (0223) 834492.**

---

# LOWE ELECTRONICS

---



**Y**ES, the original "open day" is back! Make a note in your diaries, PIMs, Filofaxes, Psion Organisers, scraps of paper or the back of an envelope! Wherever you keep important information, don't forget 25th September. Yes, it is a Saturday!

As well as all the usual attractions, we'll have lots more going on for those less radio orientated so why not bring the whole family out for the day. They can indulge you for couple of hours and you can spend the rest of the day sight-seeing in and around Matlock. We'll have some special concessionary tickets on the day for some of the local attractions.

**Right! That's the carrot for the family — now we've got a few for you!**

- 1** We'll be catering for every aspect of the radio hobby, with special demonstrations covering a huge range of equipment and accessories.
- 2** Packet radio techniques run by DANPAC, our local Packet group.
- 3** Talk-in on S21 and SU21 with G4LOW run by our local radio club.
- 4** Free car boot sale space to sell your own gear.
- 5** Bargain basement full of odds and ends.
- 6** Super special prices on all mainline equipment, including HF rigs, mobiles, handies, antennas, PSUs, TNCs. Terrific trade-ins too!



## Check our workshop

Even the workshop will be open so there's no better time to meet the biggest and best team of engineers in the country and maybe discuss some of your more technical problems with them.

We'll also be showing off our new R&D department where you might just get a glimpse of Project N and for the first time, you'll be able to visit our new receiver production unit at Cromford in the original workshop of Arkwright's Mill.

## Live 'short-wave' room

Something else new for this year is the short-wave room with the world's finest receivers complete with our now famous Modemaster decoding software and Multiscan control programmes on continuous live demonstration, together with a full range of antennas, headphones and other accessories.

---

**LOWE ELECTRONICS LTD**  
Chesterfield Road, Matlock, Derbyshire DE4 5LE  
Tel. 0629 580800 Fax. 0629 580020

---

# ... HQ OPEN DAY '93



**It's  
a  
great  
day  
out!**



**Run the  
rigs...  
Work the  
Dx...  
Bag the  
bargains!**



**Books...  
Boot sale...  
and  
Beautiful bargains!**



*And don't forget our branches*

*There's a Lowe shop near you at...*

Maidstone 0622 692773

Leeds 0532 452657

Bristol 0272 315263

Plymouth 0752 607384

Cumbernauld 0236 721004

London-Heathrow 0753 545255

Bournemouth 0202 577760

Cambridge 0223 311230

Newcastle 0661 860418

# THE ROBERTS R101 9-BAND PORTABLE RADIO

*The new 9-band receiver from Roberts, the R101, is small and light enough to slip into a shirt, or blouse, pocket. Lawrence Harris has been looking at this very portable receiver.*

With any new radio I always find something unexpected - this time it was the use of a manual rotary tuning knob. Many radios are now fitted with electronic, digital push-buttons and it is common to include storage capability for selected frequencies. However, the proof of the pudding?

First a look at the buttons and switches. The front face incorporates the 50mm speaker, together with three keys labelled FM, MW-SW and POWER OFF. The radio is switched on using either the FM or MW-SW button, according to choice. Choosing between medium wave m.w. (often referred to as amplitude modulation - or a.m.) and short wave, is made using a slider control located on the top right-hand section of the radio. This moves between m.w. and each s.w. band, numbered sequentially from one to seven. This choice is also indicated on the front face by an orange number showing the selected band. I tested the rotary tuner very carefully and could not feel any backlash whatsoever. Tuning was easy and could be done accurately. There is also a SAFETY lock switch on the right hand side. Pushing it up prevents the receiver being accidentally switched on or off, so is particularly useful for travelling. On the left side the rotary volume control can deliver as much power as you could want, though remember that excessive volume drains batteries disproportionately quickly. The receiver uses either two AA batteries, or 3V from a mains converter. Power consumption is a miserly 100mA at 3V, demonstrating the efficient receiver design used by the circuitry. Incidentally, this features

four integrated circuits, five transistors and one f.e.t.; well, I was interested to know that! The MONO-STEREO switch allows f.m. stereo decoding to be disabled, a useful facility when you are trying to listen to a weak f.m. station. Most local stations around Britain now broadcast in stereo, and on certain occasions, particularly during periods of enhanced solar activity, one can pick up more distant stations. The use of this switch can improve reception for weak signals, otherwise, in STEREO mode the decoder will try to extract the two components, producing a rather noisy result. It worked well, particularly while using the earphones. There are also two sockets, one for the stereo earphones, the other for the optional mains/d.c. supply. There are tiny TUNING and STEREO

i.e.d.s situated just above the POWER OFF switch. The TUNING i.e.d. lights when any station is accurately tuned and reasonably strong. It worked well on each band, including s.w. though sometimes there was a short delay before it lit. The STEREO i.e.d. indicates that a stereo f.m. broadcast is being received. This will only be heard properly using the earphones, as the speaker is then automatically disconnected.

## Antennas

The telescopic antenna is a neat job that slots into a clip on the top of the radio when not in use. It expands to nearly 600mm, and can be swivelled but not rotated. When expanded, it is used for f.m. and all s.w. bands. An internal ferrite rod is used for m.w. (a.m.) reception.

## Results

I spent some pleasant afternoons and evenings listening to the various bands to get a feel for the reception capabilities of this model. It came up against some stiff competition when comparing its performance with radios collected over many years. In each case I used a comparable antenna and location. One Sunday afternoon I methodically tuned into every receivable station on each band and logged the numbers found. The f.m. band picked up all local stations perfectly. I tried it next to the computer while writing this review. There was considerable noise between stations, resulting in a mix of high pitched tones (a polite way of describing an awful racket!), but the tuning circuits correctly extracted the f.m. broadcasts from the computer mush and the result was good. Under such challenging conditions the antenna must be adjusted for best reception.

In the

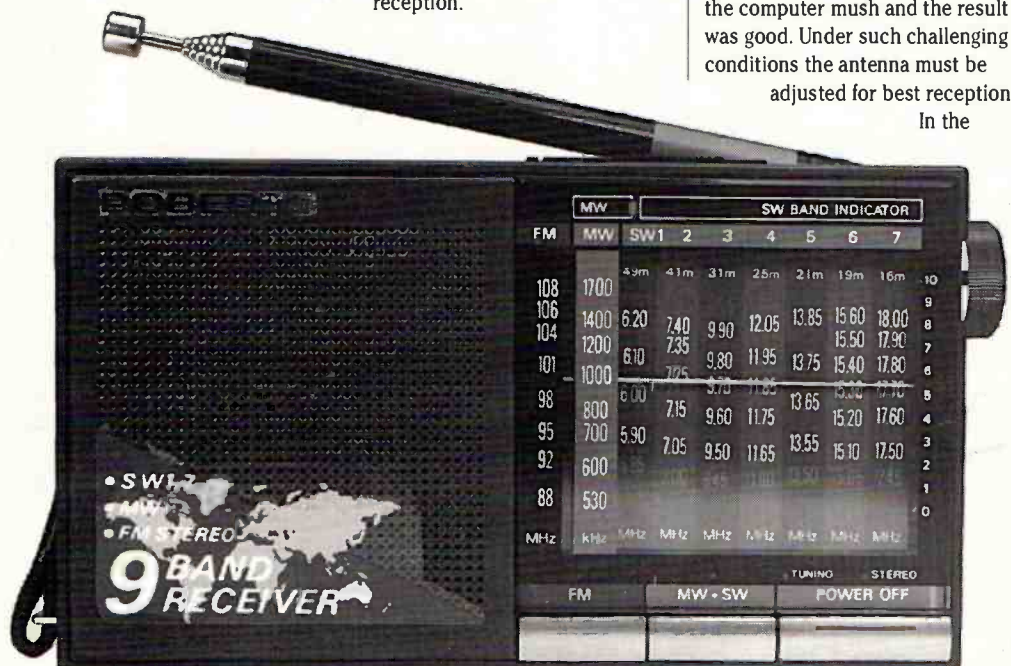

# Radio Stations Special



living room, reception was easier, as expected. Medium wave was, as usual, filled with stations, so I did not do a census! SW-1 is the 49m band and I logged three foreign language stations and one English, while SW-2 (41m) also included three foreign stations plus two utility broadcasts. I didn't try to decode these but the signals were loud and clear. SW-3 (31m) seemed packed - 14 foreign stations and three English language programmes were heard. Some of the broadcasts were obviously one station using several frequencies. SW-4 (25m) was similarly crowded. I remember listening to this band every weekend as a student, as it included a number of stations broadcasting English pop records at a time when there was no such service in Britain - just before the 'pirates' arrived. SW-5 (21m) had

four foreign stations; SW-6 (19m) had an assortment of utility broadcasts, French, English, and 16 other foreign stations. Finally, SW-7 (16m) was also nearly full, with Russian, English, French and ten other stations. You can never feel lonely with so many different programmes available 24 hours every day!

A radio like the R101 must be a boon to students of foreign languages. I puzzle over the market for foreign language study records when so many clearly spoken broadcasts are available. This type of radio would surely make the perfect introduction to short wave listening for the youngster, rather than throwing mindless video games at them? Some parental help in exploring the world of short wave broadcasting can open up such fascinating horizons.



Short Wave Magazine, September 1993

## Specifications

Power 3V via 2xAA batteries, preferably alkaline. or using a 3V d.c. output mains converter; uses 100mA.

Battery life: approx. 20 hours is claimed, using normal volume and alkaline cells.

Aerials:

FM Telescopic  
MW built-in Ferrite rod  
SW Telescopic

Loudspeaker 8Ω 50mm; 3.5mm stereo earphones provided

Frequency coverage:

FM	87.5 - 108MHz
MW	530 - 1605kHz
SW1 49m	5.90 - 6.20MHz
SW2 41m	7.05 - 7.40MHz
SW3 31m	9.50 - 9.90MHz
SW4 25m	11.65 - 12.05MHz
SW5 21m	13.55 - 13.85MHz
SW6 19m	15.10 - 15.60MHz
SW7 16m	17.50 - 17.90MHz

Price: £49.99

*My thanks to Roberts Radio for the loan of the radio.*

## Sound quality

No matter how new, how old, how many facilities, or how easy to use, in my view, the main test of a radio must always be sound quality. With a 50mm speaker we are away from the tinny reproduction offered by some miniature speakers. I was happy with the sound from this radio - and I consider my hearing to be unusually critical. I used the earphones for several broadcasts. The sound quality was adequate and there was plenty of volume available, but I would have liked a headband to have been provided because the phones tended to slip.

## Publications

Two small booklets are included with the radio - a manual and a *Wave Handbook*. The manual describes the correct operation of the radio, including standard warnings about avoiding exposure to the elements. The *Wave Handbook* contains a listing, arranged in alphabetical order by country name, of the various short wave transmissions to be found while tuning around the various bands.

When using this, or any other frequency listing, it is important to remember that not all listed transmissions will be heard. I did hear most of the English language broadcasts that were listed for the BBC, but could not identify Radio Australia even though I heard transmissions on the listed frequencies for the correct time of day. Experience comes with tuning in regularly to these bands, and cannot be obtained just by reading, essential though that is. To me, one of the most fascinating things about s.w. radio, has always been actually monitoring a broadcast until the station finally identifies itself. That way I eventually logged many countries and got to hear about events going on all over the world that no-one else seemed to know about! That has always been the way with short wave. ■

# NEW IMAGE SMC

We aim to give the best prices on all major brands and we will endeavour to match any competitors genuine offer on Icom, Kenwood, AOR & Yaesu receivers.

**This month's special: 10% OFF all list prices on Icom, Kenwood, AOR & Yaesu receivers.**

## FRG-8800 - OFFER EXTENDED DUE TO OVERWHELMING DEMAND



- ★ Built in power unit
- ★ Direct entry keypad
- ★ Built in automatic timer
- ★ All mode AM, FM, SSB, CW
- ★ 12 channel memory
- ★ Optional VHF converter

~~£659~~  
**NOW ONLY**  
**£559**  
carriage D

	List	Specials	Carriage
ICR1 hand-held scanner	£395	£355	B
ICR100 wide-band receiver	£629	£566	D
ICR72E general coverage receiver	£859	£773	D
ICR7100 25-2000MHz receiver	£1395	£1255	D
ICR9000 100kHz-2GHz receiver	£4950	£4455	E
R5000 Kenwood communications RX	£999	£899	D
FRG100 Yaesu's latest winner	£599	£539	D



*Offers subject to availability*



## AOR: THE ROLLS ROYCE OF SCANNING RECEIVERS.

	List	Specials	Carriage
AR3000A	£949	£854	C
AR2000	£309	£278	B
AR2800	£449	£404	C
AR1500EX	£349	£314	B

## Selection of used & ex demo equipment

RX & SCANNERS		£ inc. Vat				
AX MX7000	Regency	£229	RX ICF-80	Sony	Receiver with Airband	£220
AX FRG7000	Yaesu	£250	RX AR2001	AOR	Wideband Scanner	£194.99
AX ICR7100	Icom	£1000	RX AR900	AOR	Handheld Scanner	£145
AX FRG9600M	Yaesu	£299	RX AIR7	Sony	Airband Receiver	£140
AX ICR1/SSB	Icom	£329	RX ICF2001D	Sony	Receiver	£225
AX ICF2001D	Sony	£169	RX DRB600	Panasonic	HF Receiver	£185
AX R2000	Kenwood	£389	RX R2000	Trio	HF Receiver	£495
AX FRG7	Yaesu	£179	RX FRG9600M	Yaesu	VHF/HF Receiver	£440
AX ICR7000HF	Icom	£825	RX RS3000	Revco	Wideband Scanner	£135
AX R532	Signal	£125	RX SRG8600DX	Sumerkamp	Wideband Receiver	£350
AX 800XLT	Bearcat	£169	RX ICF5W55	Sony	Receiver	£225
AX R2000	Trio	£369	RX FRG7700	Yaesu	HF Receiver	£295
AX HP200E	Fairmate	£199	CX FRG9600	Yaesu	Scanner	£325
AX AR2002	AOR	£225	PX AIR7 (x2)	Sony	Airband Scanner	£169
AX ICF7600	Sony	£110	PX AR3000 (x2)	AOR	Scanner	£598.99
AX ICR71E	Icom	£639	PX FRG9600	Yaesu	Scanning RX	£439
AX MVT5000	Yupiteru	£179	PX ICF2001D	Sony	Portable Receiver	£245
AX FRG7	Yaesu	£179	PX PR080	Sony	Sony	£219
LX IC-R100	Icom	£380	PX PR09200	Realistic	Scanner	£109
LX AR1500E	AOR	£259	RX R-5000	Kenwood	HF Receiver	£690
			RX FRG-8800	Yaesu	HF Receiver	£495

KEY  
 PX SMC SOUTHAMPTON TEL: 0703 251549/255111 BX SMC BIRMINGHAM TEL: 021 327 1497/6313 CX SMC CHESTERFIELD TEL: 0246 453340  
 LX SMC LEEDS TEL: 0532 350606 AX ARE LONDON TEL: 081-997 4476 RX REG WARD AXMINSTER TEL: 0297 34918

\*Please phone to confirm availability. Carriage B=£5.00 C=£7.50 D=£12.50 E=£16.50

South Midlands Communications Ltd, S.M. House, School Close, Chandlers Ford Ind. Est., Eastleigh, Hants SO5 3BY



Showroom hotline 0703 251549 HQ showroom hours 9.30-5 weekdays 9-1pm Saturday



**HQ & Mail Order Southampton (0703) 255111 Leeds (0532) 350606**  
**Birmingham 021-327 1497 Axminster (0297) 34918 Chesterfield (0246) 453340**

# WEIGHING YOUR CATCH

## SINPO - What Does It Really Tell Us?

*The SINPO code is the most generally used way of telling others how well a broadcast signal is being received. Don Phillips tries his best to use the SINPO code to report his reception details and wonders just how helpful it really is.*

Let me suggest that I have tuned in my receiver and am in the process of logging a station. I am concerned about reading the exact frequency, I have struggled to get a clear identification and need also to record some details of the programme. I have logged the ITU code, the station name, and have checked the transmitter site with the *World Radio TV Handbook*. I can record the time and date by checking wrist-watch and calendar. The only bit left is the little box in my logging book which says 'SINPO'. What should I write in here?

The station I am listening to is moderately weak, there is some interference by other stations, but it is quite possible to understand the broadcast. I am keen to move down the band to look for some other DX. Shall I unthinkingly record SINPO = 33333 to give the general picture, or shall I take the coding seriously and think about each digit I record? I feel in a pedantic mood and decide upon the latter course.

In this article I have set out what really amounts to a list of questions that the curious DXer might, at times, ask when using the SINPO system of coding broadcast listening.

### Signal Strength

The first SINPO parameter is signal strength. On the face of it, this is the easiest of the five parameters to record. I can read it from the signal strength meter on my receiver. But the signal is fluctuating. Should I note the average? S-meters are notoriously inaccurate? Is my receiver accurately calibrated? There is some atmospheric noise present adding to the signal reading. Should I try to allow for this? My antenna runs in the wrong direction. Will this affect the reading? My antenna tuning unit also modifies the strength of signal to reach my

receiver. Should I ignore this? If I were listening to an s.s.b. signal, I would have to wait for full modulation to get a useful S-meter reading. How would I know when it was a maximum?

I will record a signal strength of 3 to be on the safe side.

### Interference

The second SINPO parameter might be easier - interference is obvious. But is it? I am still listening to the same station. On broad-band a.m. there is a lot of interference - I can hardly hear the programme. I switch to upper sideband. There is a loud teleprinter. I cannot hear the station at all. I switch to lower sideband. The station is perfectly clear except for a loud whistle. I can remove this with my notch filter. The station is very clear now. Listening is luxurious. But how must I record the interference using the SINPO code? At the a.m.-wide filter setting? At l.s.b. setting? With or without my notch filter present? How can I remind myself in future that I had to do all these things to get good reception?

To be on the safe side I will record an interference level of 3.

### Noise

Noise is the third SINPO parameter. There is a little bit of hiss in the background of my signal. I presume this is noise. Is it generated by my receiver or by atmospherics? My receiver, like most modern receivers, has a powerful automatic gain control. There is always some noise when I am not tuned to a powerful station. So apparent noise is really a function of signal strength. But sometimes there is more noise with this station than other times - it would be nice to be able to measure this. But I do not really know how. I know that noise is a function of bandwidth. Should I record apparent noise at wide or narrow filter settings? At the most narrow setting there does not seem to be much noise at all.

As an average of these possibilities I will record a noise level of 3.

### Propagation

The fourth SINPO parameter is propagation. By propagation I understand this number really represents apparent fading. Good or bad propagation conditions should

generally show themselves in the signal strength and noise readings. I notice that my receiver's S-meter is pulsing up and down in response to what I presume are rapid fades. But reception remains generally good as the automatic gain control is coping well with this. Should I try to estimate this fading or report that propagation is good? When listening to a single sideband of an a.m. signal such as this, I usually switch in the beat frequency oscillator, treating the signal in effect as an s.s.b. transmission. When I do this the effects of fading are greatly reduced. How shall I allow for this in my logging?

To be safe, I shall record the number 3.

### Overall Merit

The fifth SINPO parameter - overall merit - must be the easiest parameter to record. Surely at least here, I am allowed to be subjective. But I want my logging to be helpful as I intend to send it to my DX Club. Reception, now that I have made the various adjustments, is undoubtedly good, so I should really record '4'. But won't that be misleading? A club member with domestic receiver would never hear it like that. Should I switch the receiver to 'a.m.-wide' and the notch filter off? That is surely more honest isn't it? But then the signal is 'unusable'! No, I will call overall merit 'good'. But I am listening to a really good catch - a low power station from another continent. Considering that, my impressions of overall merit is 'excellent'. But that is too subjective, even a little boastful.

To be fair to everyone, I will record the reception as 'fair' represented by the number 3.

### How Can I Tell Them?

How do DXers talk about their catches, and - more importantly - how do I interpret what they are telling me? One well-known DXer speaks of his best loggings in terms like 'it came in like a local station' or 'it came in so well that you do not need a receiver to hear it'. But I know he lives in a rural area, has extensive antennas and uses his modern receivers with great skill and understanding. When he tells me of an easy triumph, I know I might just be able to receive the station at my own home.

I have never heard DXers exchange

a string of SINPO figures in conversation - they know of their shortcomings. What they use is a single adjective. If I want to know more about the logging a DXer is talking about I find out more about the person as a DXer, the receiver and the location.

That gives us a clue perhaps about how reception could be recorded. We should comment on the process of reception, not the outcome.

Let's make the assumption that with a theoretically perfect receiver and antennas, all loggings could be recorded as perfect - SINPO 55555. Then perhaps we should simply try to estimate, from our understanding of actual reception conditions and knowledge of our receiver and antenna, how difficult this would be to achieve. A local medium wave station can be received excellently on Junior's 'transistor six portable'. A communications receiver can produce excellent results from a signal which has some obvious imperfections. Some signals are too poor to ever be satisfactorily 'cleaned up'.

### A Simpler System

But from the standpoint of trying to estimate how much you have to do to a signal to make it useable, I would suggest that there is, perhaps, the beginnings of a useful way of talking about a particular logging that will be of value to everybody.

**Excellent:** Easy to receive - a simple receiver would be adequate.

**Average:** Good reception possible by skilfully using the facilities of a communications receiver.

**Poor:** Even with skilful adjustment of a good receiver it is still not possible to receive this station well.

This system is, unashamedly, very simple and makes great approximations. But listeners and broadcasters alike use words like 'excellent', 'average' and 'poor', don't they?

### Abbreviations:

a.m.	amplitude modulation
DX	Long distance
DXer	Someone who listens to DX
ITU	International Telecommunications Union
l.s.b.	lower sideband
s.s.b.	single sideband

# Lynch's Third Year At

To celebrate the third year at our Northfields showroom, we're having the biggest sale ever offered by a Radio Retailer. Very **LOW DEPOSITS ON INTEREST FREE**, (isn't it funny how everyone seems to have caught on to this one!), or **CASH purchase**, (TRADE-INS still welcome), the savings on all **NEW & USED SHORT WAVE RADIO EQUIPMENT** will be offered during **SEPTEMBER ONLY** and will not be available at these prices again.

Thanks to all my loyal U.K. and Overseas customers, **MARTIN LYNCH** has had another successful year. Over **TEN THOUSAND** customers have poured through the front door or telephoned to place an order. Even more important is that you keep coming back to support your "Independent Retailer", realising that we really can offer objective and unbiased advice, giving you the very best in customer care.

More recently, you may have had a call from Brian, G3THO. He's the latest member to join my sales team, his role being somewhat unusual. His job isn't to make sales, (albeit I'm the last to stop him!), it's actually to liaise with you **AFTER** the sale is made. Without landing you in it with the other half, Brian's role is to make sure you're satisfied with the purchase and ensures that nothing is left out of the transaction. In other words, if you're delighted with the service you've received from **MARTIN LYNCH**, then he is satisfied. So am I. How many other retailers contacted you - after the sale?

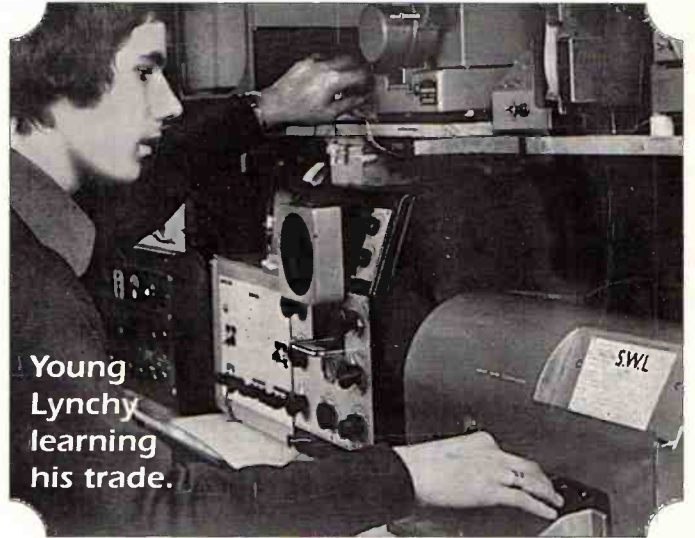

Young Lynchy learning his trade.

# Massive Celebration

## SHORTWAVE BIRTHDAY BARGAINS

YAESU FRG8800



**SALE PRICE**

Many "AS NEW" examples available from stock from £499.00 including FREE Shortwave Antenna.

YAESU FRG100

The latest receiver from Yaesu. Small, Compact & very high performance. Only £599.95 including a MyDEL ATU-1 antenna tuner & Shortwave antenna.

**SALE PRICE**

LOWE HF150



**SALE PRICE**

Short & Dumpy, but looks aren't everything! (Are they Tom?). The "QUAD" Electronics equivalent of Radio Manufacturers. It works well. Only £379.00 including FREE NICADS & Telescopic Whip.

KENWOOD R5000



**SALE PRICE**

The best KENWOOD receiver money can buy. Only £999 including MyDEL ATU-1 antenna tuner and Shortwave antenna.

ICOM ICR71E

Still ICOM's ultimate Shortwave Receiver. Discounted to £999 including FREE MyDEL ATU-1 & Shortwave Antenna.

**SALE PRICE**

DRAKE R8E

Quaky looks, but a quacking good radiol! Only £995 including FREE R8 software for IBM computer Control, OR MyDEL ATU-1 and Shortwave Antenna.

**SALE PRICE**

ICOM ICR-72E



**SALE PRICE**

This alternative to the Big Brother, the ICR-71. Discounted to only £799 including a FREE Shortwave Antenna.

**ALL THESE BIRTHDAY BARGAINS AVAILABLE DURING SEPTEMBER ONLY!!**

**A MASSIVE RANGE OF USED RECEIVERS AND SCANNERS ALWAYS AVAILABLE. FREE FINANCE OVER NINE OR TWELVE MONTHS ALWAYS AVAILABLE AT NORMAL LIST PRICES - THIS INCLUDES SECOND HAND! PHONE FOR YOUR FREE LISTS.**

**D i a l 0 8 1 5 6 6 1 1 2 0 N O W**

**286 NORTHFIELD AVENUE, EALING, LONDON W5 4UB**



# Northfields

**MARTIN LYNCH**  
G4HKS  
**THE AMATEUR RADIO EXCHANGE CENTRE**

## The Universal Range of Decoders Direct From The USA

### M-400

As featured in August Short Wave Magazine, the NEW UNIVERSAL M-400 decoder is a must for those who want a serious RTTY, SITOR, FEC, WEATHER FAX plus much more CODE CONVERTOR at a sensible price. Available from stock.

**£379.95 incl. VAT**  
PSU extra at **£19.95.**



### M-900



Similar in features to the M-400, the M-900 has a powerful FAX-to-SCREEN processor built in, enabling weather and other 'picture' transmissions to be viewed by a simple video monitor, before dumping to printer.

**£499.95 incl. VAT**

### M-1000



Got a PC and want a powerful decoder using your own computer as part of the system? The UNIVERSAL M-1000 is a complete CODE CONVERTOR on a single card, ready to slot into an IBM compatible PC. Full colour on screen graphics are at your disposal. This one IS fully recommended - our Chief Engineer uses one!

**£379.95 incl. VAT**

## M-8000 - SEE THE REVIEW IN THIS ISSUE!!!!

The ultimate in all mode code converters. Mainly used by commercial organisations throughout the world, UNIVERSAL have managed to engineer the package at a price within reach of the true hobbyist. A true colour VGA output is given to enhance the incredible definition obtainable in all modes by this advanced piece of hardware. It's easier to use than you think - a few hours will soon bring decoded data to your own screen from around the world. Open your eyes to a new world just waiting for you to explore. Put your NRD535 or R5000 or Drake R8E to real use today!

**& 1199.95 incl. VAT. A 10" VGA HIGH RES COLOUR Monitor is available for only £179.95**



# MyDEL

## IS HERE

### MyDEL TPA Tunable PreAmp Antenna

Housed in one neat unit, the MyDEL TPA is the latest innovation from the USA. Ever wished you could increase the input signal just a little bit when the going gets tough? MyDEL thought so, and for the first time, the TPA offers an effective ATU for short random wires together with a pre-amp, and as an alternative a telescopic whip for the occasional indoor short wave listening. Powered by one 9V PP3 type battery, it could be the answer to your tuner problems! Ideal for listeners who only have limited space for antenna systems.

**£69.95 incl. VAT.**  
(9V battery not supplied)

### MyDEL ATU-1

A more conventional approach to resonating that length of wire or centre fed dipole for an antenna system is the NEW MyDEL ATU-1. Built in the U.K. to our own specification, the ATU-1 is housed in a strong metal case and employs two good quality tuning capacitors with a tapped coil in the standard "Pi" configuration. Almost identical to a similar Japanese model costing nearly 40% more, isn't it time you bought British?

**£59.95 incl. VAT and patch lead to your radio.**

**Attention all Yupiteru MVT7100 & 7000 owners!**

### The new MyDEL SCAN-2513

**Wide band scanner antenna**  
Ideal as a direct replacement to the telescopic antenna offered with the Yupiteru models, the NEW MyDEL SCAN-2513 flexi antenna covers 25 - 1300MHz. It's a far more convenient than the standard unit and a lot safer! Will suit any hand-held scanner.

**£19.95 incl. VAT, plus £2.00 p&p.**

# Attention Sale!!!

## SCANNER BIRTHDAY BARGAINS



**YUPITERU MVT7100**  
The LEADER in Scanners!

Only £449.95 with FREE Desk top power supply/charger & MyDEL SCAN 2513 Flexi Antenna.

**SALE PRICE**



**VT-225**

Nothing to beat the Civil Air & Military coverage VT-225. Only £269 with FREE AIR BAND FREQUENCY GUIDE!

**SALE PRICE**

**AOR AR2000**

Still the best value scanner money can buy. Reduced to £299.95 with free UK Scanning Directory.

**SALE PRICE**

**IC-R1E**

After three years, it's still the smallest scanner on the market. Only £395 with FREE UK Scanning Directory.

**SALE PRICE**



**AOR 1500EX**

The best value ALL-MODE scanner available. Reduced to only £339 with FREE copy of the UK SCANNERS DIRECTORY.

**SALE PRICE**

**ICOM ICR7100 HF mkII**

Nobody does it better! 50kHz to 2000MHz! ONLY from MARTIN LYNCH. ONLY £1395 with FREE HF fitted and UK Scanning Directory!

**SALE PRICE**

**AOR 3000A**

The ultimate BASE/MOBILE all mode all frequency SCANNER! Heavily reduced to £849.00!!

**SALE PRICE**



**MVT7000**

A MVT7100, without SSB, excellent performance. Only £349, with FREE spare set of NICADS & UK SCANNING DIRECTORY.

**SALE PRICE**

**VT-125 mkII**

The smallest & lightest Civil Air band monitor available. Reduced to only £179.95, including free spare nicads.

**SALE PRICE**

**D i a l 0 8 1 5 6 6 1 1 2 0 N O W**

**Tel: 081 566 1120 FAX: 081 566 1207**



**The Practical Wireless Dayton HamVention Holiday 1994**, promises to be an even bigger success than last year's trip! Organised in conjunction with **RCT International: Bristol**, participants are guaranteed a first class service throughout the week.

On Monday April 25, the group, led by the Editor of *Practical Wireless* **Rob Mannion G3XFD**, departs from Gatwick on a scheduled flight to Cincinnati, followed by direct coach transfer to The Engelwood Holiday Inn, Dayton, Ohio, home town of pioneer aviators Wilbur and Orville Wright. No visit to Dayton would be complete without a tour of **USAF Dayton**, which houses the worlds' largest flight museum. *Practical Wireless* have arranged a private coach trip to the museum on Tuesday, April 26, which will not only allow a chance to see exhibits such as Flyer III, but will also include a visit to the world renowned IMAX Three Dimensional Cinema. This is a visit that everyone on the trip will enjoy, even if you think you're not interested in aircraft, but please don't forget the comfy shoes.



Wednesday's free day allows time to explore downtown Dayton. Doubtless some will home in on **Mendelsons**, the worlds' largest electronic surplus store, to stock up on goodies! Or else you could head for the shopping malls - ladies please note this is well worth doing. Those who went on the '93 trip really enjoyed the different shops and came home laden with many bargains.

Thursdays' schedule will include a Day Excursion by private coach and two radio orientated special visits.

Friday 29 sees the start of the HamVention itself. Doors open at 12 noon, though it might be worth asking Room Service for an early call since the Giant Fleamarket opens at around 6am! For

those who overestimate their flight bag capacity over the weekend, Delta Airlines will thankfully be operating their excellent and reasonably priced 'Pack and Despatch Service' at the HamVention itself. Admission fees and courtesy buses for the weekend are included in the package. But if you're not interested in amateur radio, don't think there's nothing at the HamVention for you. There are three days of 'alternate activities' planned. All kinds of craft, cookery and other social events are laid on for those with little or no interest in the radio side of things. The 1993 programme had things like 'Stained Glass in a Frame', 'Victorian Bear', 'Christmas Door Swag' and 'Silk Screen Stationary' on the agenda - although these are only a few examples.

After the bustle of the

convention, *The Practical Wireless Dinner*, to be held on Sunday evening at one of Dayton's excellent restaraunts, promises the opportunity to meet up again with friends made at the 1993 HamVention, and perhaps make a few more.

Departing from Dayton on Monday afternoon, there will probably be just enough time to spend a few hours in Cincinnati City prior to boarding the overnight flight home.

The tour price of just £630 per person is inclusive of scheduled return flights from Gatwick to Cincinnati, seven night's accomodation, all coach transfers, two day excursions by private bus, and, of course, admission to the HamVention itself. Single rooms are available at an additional £205 per person, and travel insurance is optional at £40.

Only a limited number of places are available. Full booking information and a detailed itinerary are available from **Annette Oxley at RCT International, Practical Wireless 1994 HamVention Holiday**, 44 College Green, Bristol BS1 5SH. Tel: (0272) 230933; Fax: (0272) 22691.

## *Listen With Grandad* by Leon Balen & David Leverett



*My Grandad can't come to the 'phone at the moment, I'm afraid he's rather tied up....*

## RC818 (SSP £199.99)

### Multi-band Digital Preset Stereo World Radio with Cassette Recorder

This flagship model demonstrates the leading edge of Roberts technology. With a clear LCD display of all functions, it has 5 tuning methods, 45 preset stations, dual-time display, standby and clock/alarm plus a cassette section for timed recordings from the radio. Provision is made for single side-band and CW transmissions as well as stereo FM on headphones and stereo record/playback of cassettes.

Comes complete with a mains adaptor.

- 5 Tuning methods – direct frequency keying, auto-scan, manual scan, memory recall and rotary
- 45 memory presets
- SW metre bands from 120m to 11m
- BFO control for reception of CW and SSB
- FM stereo on headphones
- AM wide/narrow filter
- Waveband coverage: LW 150-519 kHz; MW 520-1620 kHz; SW 1.621-29.999 MHz; FM 87.5-108 MHz
- Radio standby function



- Pre-programmable radio to tape recording
- LCD display
- Signal strength and battery condition indicator
- Sleep timer
- Safety lock switches
- Adjustable RF gain
- 700 mW Power output

## R817 (SSP £169.99)

### Multi-band Digital Preset Stereo World Radio

Offers all the outstanding features of the RC818, minus the cassette section.

An unequalled combination of value, quality, technology and choice....in short....

# ROBERTS

## R808 (SSP £119.99)

### Multi-band Digital Preset Stereo World Radio

The R808 has all the advanced features of the R817 with the exception of BFO (Beat Frequency Oscillator) but in a more compact case specially designed for the regular traveller.

## R621 (SSP £59.99)

### 10-Band Compact Stereo World Radio (FM/MW/SW1-8)

All the functions of a much larger model are combined in this compact radio with clock/alarm. Easy SW bandspread tuning with LCD tuning/stereo indicator and FM stereo on ear or headphones. The clock/alarm shows dual time on a backlit display with up to 60 min sleep timer and snooze with wake to radio or buzzer. Comes complete with soft carrying pouch and stereo earpieces.



## R101 (SSP £49.99)

### 9-Band Miniature World Radio (FM/MW/SW1-7)

Exceptional sound quality and facilities in a truly pocket-sized, ultra-light receiver. Easy to tune with featherlight touch-band switches. LED tuning/stereo and waveband indicators. Wide SW bandspread tuning with stereo FM via ear or headphones. Complete with soft carrying pouch and stereo earpieces.



For your nearest stockist contact:

**ROBERTS RADIO CO. LTD**

127 Molesey Avenue, West Molesey, Surrey KT8 2RL  
Tel: 081 979 7474 Fax: 081 979 9995

# CRISIS AND CREDIBILITY AT RADIO MOSCOW

By G D Rawnsley B.A.

Since it began broadcasting in 1978, the World Service of Radio Moscow has achieved a level of notoriety amongst its listeners. Employing a dozen frequencies at any one time, for up to twenty four hours a day, the station is expert in the propaganda techniques of saturation broadcasting. Regular listeners are familiar with its style and content, which have changed little over the years, despite the introduction Perestroika. Since the onset of Glasnost and the period of reform, however, the political diatribe and rhetoric have been tempered, and a certain informality has crept in to its programming which is pleasing to any ear that remembers Radio Moscow in the pre-Gorbachev era. On Monday, 19 August, 1991 all that changed. The West awoke to learn that Mikhail Gorbachev had been replaced as President of the Soviet Union for unexplained 'health reasons'. For the Western media the explanation was obvious: Gorbachev had been the victim of a hard line *coup d'etat*. How did the post - Glasnost Russian broadcasting service react to the situation?

## Day One

The programme schedule of Radio Moscow was changed accordingly, most of the early broadcasts being taken up with stirring classical music which, in any other circumstances, would have suggested the death of a major political figure. At 0756UTC, Radio Moscow broadcast a statement issued by the 'new' Soviet leadership; a masterpiece of political rhetoric which attempted to justify the coup as a constitutional act, carried out, it was claimed: "in order to overcome the deep crisis in all fields...chaos

and anarchy threatening the life and safety of Soviet citizens...(in order to safeguard) territorial integrity, freedom and independence of the country, proceeding from the results of a national referendum to retain the Union of Soviet Socialist Republics...a State of Emergency is introduced for six months..."

This statement was followed on the hour (0800UTC) by a news flash. This was perhaps the most surprising change to the schedule that day. Regular listeners to Radio Moscow World Service know that the news, traditionally extremely long and often tedious given its narrow focus, is usually the most dominant feature of the schedule. However, this edition consisted of five minutes resume of the statement just broadcast (repeated yet again in full only five minutes later), and a summary of an address by the new State Emergency Committee, which equalled its previous statement in propaganda content, bandering such words as 'democratic', promising the continuation of 'reform', and perhaps most importantly given that this was being broadcast to a global audience, guaranteeing to abide by all treaties and international obligations.

By this time, the Western media had started to report extensively on events as they occurred - that President Gorbachev was under house arrest; that Boris Yeltsin was urging the Soviet people to strike and take part in civil disturbances to defeat the coup; that there was a large army present in the centre of Moscow, and that the coup was a KGB/military/ right wing conspiracy. Not surprisingly none of this was broadcast by Radio Moscow World Service, usually so

vociferous about events happening within the Soviet Union that they take priority over major world stories. It seemed obvious to all listening that the Soviet media, Radio Moscow included, was now under the control of the conspirators. This was apparently confirmed by a new statement issued by the Committee and first broadcast at 1000UTC, which detailed the emergency measures to be implemented; curfew, the possibility of stop and search; the prohibition of strikes and demonstrations; the banning of opposition parties and demonstrations, and so on: most importantly for the media, the creation of a new central body to control it. The end of the coup just two days later, facilitated by the masses defiance of these decrees, indicated the futility of the statement, and the bungled nature of the coup itself. Had its managers been competent, (and who would have thought, with the KGB behind them, they were anything but), the threats made in such statements would have been carried through, and order imposed almost immediately. The failure to do this sealed the fate of the coup. Listeners of Radio Moscow World Service have become adept at 'reading between the lines' and realise that what is not broadcast is often more important than what is. The fact that such a statement was issued was indicative at the precise moment of the disorder threatening to break out on the streets, even though no such news was being broadcast at the time.

It is possible to interpret even the music being broadcast at this time as a secret reaction by the staff of Radio Moscow World Service to the events that engulfed them. It is interesting that the

station should choose to play Beethoven's *5th Symphony* after some of its news programmes that day. As any regular listener will be aware, it is rare for Radio Moscow to play the work of non-Russian composers: can the fact that the first notes of the symphony are famous as the Morse signal for 'V' really have been pure coincidence? The *5th Symphony* was used in this very context during World War Two by the BBC in its European broadcasts, and was later employed by the German occupation forces in France for the same propaganda ends: the 'V' representing the word 'victory'. Perhaps Radio Moscow's use of this piece of music indicates the fact that the station knew its broadcasts would be monitored in the West. Given the control it was supposedly subject to at the time, perhaps it could not openly broadcast news of the resistance to the coup, but used the *5th Symphony* as a message to indicate that they were broadcasting under the control of hostile forces, but that resistance had begun.

By 1000UTC on August 19, the 'News Flash' format had been abandoned, and for the first time that morning there was a full bulletin of world news, including yet again the statement of the new Soviet leadership. There was news of Yugoslavia; King Hussein's visit to Syria; reports of Arab deaths in the Occupied Territories; the UN Secretary General's decision to send a UN mission to Cambodia; terrorism in Spain; South African programmes against poverty; and a report on the success of the Russian chess players at a tournament in Brussels. But still no news of events within the Soviet Union itself.

Needless to say the normal

schedule of programmes, usually strictly adhered to and guaranteed except under the most precarious of situations was abandoned in favour of music and obviously non-political programmes. Thus listeners were not able to hear *News and Views*, *Inside Report* or *Update*, but were allowed to continue attempting *Russian by Radio*, and hear of the latest developments in *Science and Engineering*, both of which sounded quite banal on a day of such historic proportions.

The news had changed yet again by 1700UTC, following a news conference given by the acting President Gennady Yanaev, in which he reported Gorbachev to be 'resting', and expressed the hope that he would be able to resume his duties as President when he was well enough! For the first time we learnt via Radio Moscow World Service of disturbances against the coup and its condemnation as 'illegitimate' by Boris Yeltsin, as well as his call for a national strike to begin. At the end of the news, the announcer revealed what could be interpreted either as a glimmer of optimism, a simple case of impromptu irony, or perhaps, another coded message in the phrase:

'And that is the end of The News from the World Service of Radio Moscow on this beautiful summer evening! The usually strict and formal style of news presentation had momentarily lapsed, but why, at such an apparently critical juncture in the nation's history?

## Day Two

By the end of the second day of the coup, August 20, Radio Moscow World Service had managed to restore a level of balance in its broadcasts. 'The News' was just that, news of events going on in the Soviet Union, instead of the simple repetition of government decrees. Indeed, it could be said that Radio Moscow was revealing its own blatantly anti-coup line via its broadcasts, which is surprising, given that the fact that the emergency decrees had supposedly placed the media under the control of an especially created central body, and, as one knows, the first rule of ensuring a successful coup is seal the communications network. Yet Radio Moscow was allowed to broadcast news of the armed troops on the streets of

Moscow, (describing the atmosphere as 'calm but tense'), and of the makeshift barricades around the Russian Parliament. They also included Yeltsin's call for strikes, and his demand that both he and World Health Organisation doctors be allowed to verify the health of President Gorbachev, who we now know, was able to monitor news of his own detention in the Crimea via the BBC World Service! The news was also interesting for a number of other reasons, not least of which was its inclusion of a statement by the Patriarch of All Russia. A religious figurehead commenting on the political situation was an occasion to be looked upon as the embodiment of Glasnost, and would have been unthinkable in the years prior to Gorbachev. Radio Moscow also broadcast the reaction of various world leaders; the marked ambivalence of the United Nations General Secretary to the events; the hesitation of the French to 'assess the implications before we understand all the circumstances of what has happened', and the insistence of the Chinese, the USSR's traditional enemies, not to become involved in their internal affairs. These contrasted sharply with the vociferous condemnations of the coup made by President Bush and Prime Minister John Major and carried by Radio Moscow. By now it should have been obvious to all listeners that the coup was on its' last legs, were now merely smouldering, but we had to wait until the next day to witness its final death throes.

## Day Three

On August 21, at an extraordinary meeting of the Russian Parliament, Boris Yeltsin told the world that he was in control of the Republic's armed forces, that the army was hastily retreating from the streets of Moscow after a night of violence in which three people were killed by troops, and that the leaders of the coup had fled to the airport in disarray. He declared that he was determined they would stand trial, and to show his resolve, he blocked their flight and enacted a purge of all local officials who had supported them.

Thus the three day coup was over. After listening to recordings made of Radio Moscow during that time, it seems clear that the station and the Soviet media was never

actually under the control of the State Emergency Committee. Not only did we hear comments on the weather and Beethoven's *5th Symphony*, as mentioned above, but throughout the drama the announcers continued to refer to Mikhail Gorbachev as 'President'. Thus despite the claims by its leaders that the takeover was constitutional, it was never really recognised as such. This was one of the main failures of the coup, but there were others. Throughout these three days, but particularly on the second and third, as Radio Moscow World Service began to restore a degree of balance, the words that Gennady Yannaev had spoken at the news conference on the 18th were broadcast, and they sounded pitiful. The committee were justifying the coup and were seeking a popular support that would never be forthcoming. This is not how coups succeed. Coups are based on naked power, and the creation of a fear of that power amongst the restless masses, not on a promised crime. That Radio Moscow World Service was allowed to continue broadcasting, and tell the world of the resistance to the coup leaders, despite so-called central control of the media is indicative of the botched nature of the whole event. Lenin once said that he who controls communications controls the world. The hardliners would have done well to heed their mentor, for in the event they controlled neither.

## Postscript

Just when it seemed safe to go back to the radio receiver after the blanket coverage of the historic events in the Soviet Union, on the afternoon of Saturday August 24, the story continued to unfold and heighten in drama. Western media reported that Interfax - an independent news agency with close government ties - had claimed that President Gorbachev was considering resigning as General Secretary of the Communist Party. Simultaneously, Radio Moscow was broadcasting a news bulletin which, as well as reporting on the funeral procession for those killed in the coup (or as the station put it, 'who had given their lives for freedom and democracy'), also included various Interfax reports. These included, amongst other things, the sealing of Communist Party Headquarters in Leningrad, but

made no mention of the report the West had obviously got over the wires. If Radio Moscow World Service was prepared to broadcast Interfax reports, the agency was obviously regarded as a credible source by the station: what did this indicate about the validity of its reports of Gorbachev's impending resignation? Obviously, once again, what was omitted from the broadcasts was just as important as what was transmitted.

By 1900UTC the media in the West was reporting Gorbachev had stepped down, after making a statement on Soviet television in which he said it was 'not possible to fulfill my duties as General Secretary'. He had appointed the Russian Prime Minister, Ivan Silayev to head the new Soviet Government, and had subsequently ordered the confiscation of party property. Communism in the Soviet Union was nearing its end. The news on Radio Moscow World Service, broadcast at 1900UTC included none of this, but did mention (albeit not as priority news) an unclarified report of this by Interfax - which refused to name its source, but which had been made and accepted by the West. It was a full hour later, at 2000UTC before the 'fact' of Gorbachev's resignation was reported as a top priority news story, without the Interfax tag, but with the President's full statement.

## Credibility

What this reveals about Radio Moscow World Service is not clear. It is determined to be seen as a station manned, first and foremost, by professional journalists, and one which therefore insists that all facts and sources are checked and verified before broadcasting. If this is its claim, how does it justify itself in light of the fact that the BBC World Service, famous across the globe for its journalistic credibility, carried the story at 1900UTC, a full one hour before Moscow? Perhaps Radio Moscow simply did not want to believe such news? The true answer may be less cynical; Radio Moscow World Service must be applauded for its resilience through what were obviously difficult times for the Soviet media. It has steadily gained journalistic credibility since these events, but still has some way to go if its international reputation for journalistic integrity is to improve. ■

# NEVADA EVERYT

## YUPITERU

### THE NEW MVT 7100

Set to be THE handheld scanner of 1993 this radio has to be heard to be believed! Now with SSB reception here are some of the many features:-

- ★ Covers 530kHz-1650MHz
  - ★ Modes NFM/WFM/AM/LSB/USB
  - ★ Memories 1,000 channels
  - ★ Freq steps 0.05/0.1/1/5/6.25/9 12.5/20/25/50/100 KHz selectable
  - ★ Scan Speed 30 Ch. per second
- The set is supplied with a full compliment of accessories ..... **NOW IN STOCK!**



### MVT 7000 HANDHELD

- ★ Receives 8 to 1300 MHz 100kHz-1300MHz (at reduced sensitivity)
  - ★ 200 Memory channels
  - ★ AM/FM/NFM
  - ★ Rotary or keypad freq control
  - ★ Large display with signal strength meter EACH SET IS SUPPLIED COMPLETE WITH:-
- Full set of high power NiCads, AC charger, DC power lead and carry strap .... **NOW IN STOCK!**



## YUPITERU

Original Leatherette soft carrying cases for MVT-7100 or MVT-7000  
**£15.95 plus £1.25 p&p**  
 State which model when ordering

### MVT 8000 MOBILE/BASE

This new model is the mobile version of the popular MVT 7000 Handheld above.

- ★ Receives 8 to 1300MHz, 100kHz to 1300MHz (at reduced sensitivity)

THIS RADIO IS ESPECIALLY SENSITIVE AT UHF FREQS. Set is supplied with mains power unit. .... **NOW IN STOCK!**



### AIRBAND RADIOS VT-225 CIVIL/MILITARY AIRBAND

A powerful pocket scanner that leaves the competition standing. - A super sensitive set designed for optimum performance on the Civil/MilitaryAirbands.

- ★ Receives 108-142 MHz Civil Airband 222-391MHz Military Airband 149.5-160MHz Marine Band
- ★ 100 Memory channels
- ★ AM/FM on VHF
- ★ Priority channel function



**£269**

### VT-125 UK CIVIL AIRBAND RECEIVER

Using the same technology as the VT-225, this set covers the full Civil Airband - hearing distant signals that are inaudible on some other scanners.

- ★ Covers 108-142MHz
- ★ 30 Direct entry memories
- ★ Search steps 25, 50, 100kHz SUPPLIED COMPLETE WITH NICADS AND UK CHARGER ..... **£189**

## FAIRMATE HP2000

STILL ONE OF THE MOST POPULAR HANDHELD SCANNERS ON THE MARKET. Over the last year the HP2000 has outsold almost all other models.

- ★ Continuous coverage from 500kHz to 1300MHz
- ★ 1000 channels of memory
- ★ Keypad or rotary control
- ★ AM, FM and WIDE FM modes
- ★ Search steps from 5 to 995kHz



Supplied with full set of accessories/charger ..... **£299.99**

## NEVADA

### MS1000 BASE/MOBILE SCANNER

MOBILE VERSION OF THE HP2000 HANDHELD BUT WITH SEVERAL ADDITIONS:-

- ★ Switchable audio squelch
- ★ Tape recorder output socket
- ★ Automatic - signal operated tape recorder switching
- ★ Metal case for improved EMC compatibility
- ★ Receives:- 500kHz - 600MHz, 805 - 1300MHz. Supplied with mains power supply ..... **£299**



## AOR SCANNERS

### NOW IN STOCK THE NEW AR1500 EX

ENHANCED MODEL FOR THE UK. With a new circuit board and many improvements this set is better than ever. Covers 500kHz to 1300MHz receiving NFM, WFM, AM, and SSB. Supplied with a large selection of accessories including:-

- ★ Charger
  - ★ Soft case
  - ★ Ear piece
  - ★ Dry cell battery case
  - ★ 5 mtr LW antenna
- NOW IN STOCK ..... £349**



### AR3000A MULTIMODE SCANNER

- ★ Receives 100kHz - 2036MHz.
- Modes:- USB, LSB, CW, AM, FM, WFM ..... **£899**



### AR3000 COMPUTER CONTROL

With SCS Software from the USA, give comprehensive logging system, large frequency data base and runs on IBM PC ..... **£59.95**  
 Send £1.00 p&p for your free 5.25/3.5 demo disk.

### JAPANESE LOW LOSS COAX

Super low loss coax - essential for optimum performance with wideband UHF scanners and receivers. This cable is good for frequencies up to 3GHz.  
 Model 5D (8.1mm) ..... **75p** per metre  
 Model 8D (11.1mm) ..... **£1.79** per metre  
 Model 10D (13.1mm) ..... **£2.75** per metre  
 We stock a range of PL259, BNC & 'N' type connectors for the above cable ..... **£ CALL**

## BLACK JAGUAR BJ200 MKIV

A new and completely re-vamped version of this popular scanner. Now using surface mount technology performance is better than ever.

- ★ 50-88, 26-30, 115-178, 200-280, 360-520 MHz
- ★ Selectable AM/FM
- ★ 16 memories

IDEAL FOR: Civil/Military Airbands ..... **£239**



## NEW COMMTEL SCANNERS

We are pleased to introduce a new range of scanners under the Commtel brand. Although a new name to the UK, Commtel scanners are made by one of Japan's largest and most respected manufacturers. They have been building high quality products for the American and European markets for many years.

We have tried and tested the first samples and can thoroughly recommend these scanners. They are reliable and easy to use.

### COMMTEL 102

A 3-band 10-channel scanner.  
 ★ Frequency coverage: 66-88MHz, 138-174MHz, 380-512MHz ..... **£99.95**

### COMMTEL 203

Easy to programme, covering all the popular bands up to 960MHz. Its double conversion receiver provides excellent reception.  
 ★ 200 channels ★ Frequency coverage: 68-88MHz, 118-174MHz, 380-512MHz, 806-960MHz  
 ★ Scan delay ★ Lock out ..... **£199.00**

### COMMTEL 204

Top of the range with a triple conversion receiver. Selectable AM/FM.  
 ★ 200 channels mem. ★ Frequency coverage: 68-88MHz, 118-174MHz, 220-512MHz, 806-999.99MHz  
 ★ Selectable AM/FM ★ Scan delay  
 ★ Search function ..... **£249.95**

### COMMTEL 205

A superb base/mobile scanner with easy-to-read front panel display/control button.  
 ★ 400 channel mem. ★ Frequency coverage: 25-512MHz, 760-1300MHz ★ Direct access up to 207,002 frequencies ★ Modes - AM, NFM, WFM ★ Audio squelch ★ Scan delay ★ Plus many other features ..... **£344.00**

## SONY

As a Sony Shortwave Centre we stock the complete range of Sony Shortwave products - here is a selection of the popular models.

### SW33

JUST RELEASED, this new model covers 13 bands  
 ★ 76-108MHz  
 ★ All major SW broadcast bands  
 ★ World time clock, adjustable by city name  
 ★ 17 memories  
 Supplied c/w Compact Antenna, Carrying Case, Short Wave Guide Book  
 ..... **RING FOR DETAILS**

### SW77

The SW77 covers 150kHz to 30MHz plus 76-108MHz. With a rotary tuning dial, 125 scan memories, reception of AM, FM, USB, LSB, CW, tape record facility, this is a superb all rounder ..... **£399.99**

### SW1E

Pocket shortwave plus VHF radio supplied with headphones, case and shortwave guide. This model won't hurt your pocket! ..... **£179.99**

### SW7600

One of Sony's most popular VHF and Shortwave radios, 76-108MHz FM, 150kHz - 30MHz Shortwave receives AM, FM, SSB ..... Well Rated! ..... **£179.99**

### SONY SW55

A new multiband radio from Sony with dual conversion receiver that gives outstanding results.  
 ★ 150kHz-30MHz, 76-108MHz  
 ★ All modes including SSB  
 ★ 125 multi-function memories  
 Plus lots more facilities ..... **£279.99**

### AN1

An external active antenna with built-in pre-amp, covers 150kHz - 30MHz. Fully portable with easy to mount fixing brackets. .... **£58**

### AN3

Active antenna for Aircraft and VHF reception, suitable for Sony Air 7 and others. .... **£58**

## NEW SONY "PYXIS" GLOBAL POSITIONING RECEIVER

A portable satellite receiver that gives  
 ★ Position in Lat./Long. and altitude accurate to 30-100 metres  
 ★ Distance and direction to destination  
 ★ Current speed and heading  
 ★ Time incl. estimated time of arrival



**NEW LOW PRICE £599.00**

## THIS MONTH'S BEST BUY

### NRD-525 HF GENERAL COVERAGE RECEIVER

Considered to be one of the finest receivers ever made! We've managed to locate a limited quantity at a very special price. Now's your chance to own one of the thoroughbreds amongst receivers.

- ★ Receives 90kHz to 34 MHz
- ★ 200 channels of memory
- ★ RTTY, CW, SSB, AM, FM, FAX
- ★ Programmable memory scan
- ★ Fully solid state modular design



- ★ Pass band tuning
  - ★ Microprocessor controlled, electronic tuning
  - ★ Wide dynamic range
  - ★ Built in Clock/Timer circuits
- LIMITED QUANTITY AT £795**

**THE FASTEST MAIL ORDER COMPANY**



USE YOUR CREDIT CARDS FOR SAME DAY DESPATCH

# THING FOR THE RADIO ENTHUSIAST

**HUGE STOCKS - FAST DELIVERY - PERSONAL SERVICE**

**TELEPHONE HOTLINE: (0705) 662145 FAX: (0705) 690626**

## ACCESSORIES

### WIDEBAND PRE-AMPLIFIERS

These low noise pre-amplifiers are a must for the scanner enthusiast and will improve reception on many brands of base/handheld radio.

#### SCANMASTER GW-2

A low noise GaAs FET pre-amp covering 1-1400MHz with variable gain (-3 to +20dB). Requires PP3 battery. **£59.95**



#### JIM M75

Similar to GW-2 above but with selectable band pass filter for improved performance and (25-2100MHz) freq coverage. **£79.95**

#### JIM PSU101 MK IV

A combined desk stand and power supply/charger for handheld scanners. Suitable for most popular models. Special versions now available please call for more details. **£29.50**



#### JIM PSU101 TA

A new 9V version of the popular desk stand and power supply, suitable for most Tandy and new Comitel scanners. Please advise model when ordering. **£29.50**

## SCANNING ANTENNAS

### SCANMASTER BASE (500 kHz - 1500MHz)

New high quality wide band receiving antenna uses fibre glass/stainless steel, with 4 small radials. 'N' type connector. Length 1.1 metres. **£39.95 + £4.75 P&P**



### SCANMASTER MOBILE (25-1000MHz)

A wideband high quality magnetic mount mobile antenna - wired ready to go with 12ft of low loss coax and BNC connector. Approx. 18" long. **£29.95 + £4.75 P&P**

### SCANMASTER DISCONE (25-1300MHz)

Stainless steel top of the range 'N' type connector. Complete with short mounting pole and clamps "8 elements with vertical whip" - complete with short mounting pole and clamps etc etc. Best value at... **£49.00 + £4.75 P&P**

### SCANMASTER DOUBLE DISCONE (100-1300MHz)

Our very latest antenna - gives outstanding performance. Nearly 2.5dB gain over a standard discone plus transmit on any frequency in its range! We've heard signals on this antenna that were inaudible on many others! **INTRODUCTORY PRICE £59.95**



### SCANMASTER ON GLASS

(25-1300MHz) ideal for mounting on the rear window - discreet but excellent reception. Supplied c/w 15 ft. cable plus BNC connector ready to go. **£29.95**

### DIAMOND D505 (500kHz - 1500MHz)

Mobile version of D707. **£94.95 + £4.75 P&P**

### DIAMOND D707 (500kHz - 1500MHz)

A base ant. with 20dB pre-amp 3.5ft long fibreglass. Requires 12V DC supply. **£125.95 + £4.75 P&P**

## YAESU

### NEW FRG-100 HF RECEIVER

Call us now and be one of the first to own this brand new general coverage receiver. To the first customers we will offer a UK Mains Adaptor free of charge plus a G5RV Antenna. Order Now **£599**

## ICOM

### IC R7100

Covers 25 - 2000MHz. Includes 900 memory channels with all mode capability. Five different scan options and an automatic record facility, what more you ask? Full brochure available. Special offer **£1395**

### IC R72

Covers 100kHz to 30MHz on the HF Bands and offers all mode reception (FM), with the optional board) Easy to use and ideally suited to the new comer. A full 99 memory channels with scan facility and a 10dB preamp fitted as standard. **£895**



### IC R1

Icom's most popular pocket-sized wideband scanner Frequency from 150kHz to 1300MHz with 100 programmable memories. AM, FM and WFM Modes. Sleep timer and clock facility. Optional NiCads, carry cases, and fast chargers are available. **NEW LOW PRICE £395**



### IC R100

Mobile or base extra wideband scanning receiver covering 500kHz to 1.8GHz with 100 memory channels and receives AM, FM & WFM Modes. **£629**

## VIDEOS

Three times Emmy Award winning producer, Richard Mosson NW2L, has pulled out all the stops to create a series of interesting, informative and entertaining VHS videos on Amateur Radio backed by CQ Magazine USA.

- ★ Getting Started in Ham Radio
  - ★ Getting Started in Packet Radio
  - ★ Getting Started in Amateur Satellites
  - ★ Getting Started in DX'ing
- All videos **£19.95** each, plus £2.75 p&p. Running time approx. 50 mins.

## BOOKS...

- VHF/UHF Scanner Frequency Guide New 160 Page guide covers 20MHz to 12GHz **£9.95**
- Shortwave Con Freq List 0-30MHz **£9.99**
- Marine Freq Guide (Near the coast) **£4.95**
- VHF/UHF Airband Guide **£6.95**
- Scanners 2 by Peter Rouse **£10.95**
- Short Wave Communications **£8.95**
- Flight Routings Guide Book (1993 version) **£5.95**

**JUST RELEASED**  
**NEW THIRD EDITION**  
**UK SCANNING DIRECTORY**  
 Now with spiral binder and even more frequencies! This book is the last word for scanner enthusiasts - order yours now.  
**Price: £16.95 plus £2.75 p&p**

## KENWOOD

### R5000 RECEIVER

Based on the receive section of the TS440S HF Transceiver both in look and design this model covers 100kHz to 30MHz all mode, 100 memories and facility for optional filtering. **RECOMMENDED £ CALL**

## MICRO-READER

### ERA Microreader

Data Communications decoder - decodes RTTY, CW, AMTOR (A) & SITOR (B). 16 character LCD display needing only connection to receiver extension speaker socket. Shortly to become available will be the large 4-line LCD display with built-in parallel printer driver port. Variable in-built morse tutor. (Call and reserve your optional display now) **£169.00**



## RECEIVERS

### LOWE HF-225

Receiver (30kHz - 30MHz) Optional extras inc FM/AM detector, Ni-cads, Speaker, Case & Active Ant. Long standing favourite. Quality filtering included. **£479.00**

### LOWE HF-150

Receiver Economy model but with an excellent set of 'EARS'. LCD display. Portable or Mains Power **£359.00**

## DRAKE



**Drake R8E** - To own one of these receivers is a dream in itself - everything you could ever want in facilities and performance is in the R8E. Drake are no newcomers to radio - they have been No. 1 in the USA since 1943! Unlike other expensive receivers the Drake has all its filters fitted as standard, therefore, there are no hidden extra costs. Its performance is truly staggering! With an excellent dynamic range coupled with superb filtering it takes a lot of beating! Multiple scan facilities, easy use 100ch. memory, all mode coverage and synchronous detector for improved AM reception are just a few of its extensive range of facilities.

- ★ Twin VFO's
  - ★ Selectable AGC
  - ★ Passband Tuning
  - ★ Timer Function
  - ★ RS232 Interface
  - ★ Built-in Pre-Amp
  - ★ Dual Noise Blanker
  - ★ Non-Volatile Memory
  - ★ 100kHz - 30MHz Wide Coverage
- Options**
- Matching Speaker **£49.95**
  - PC Drive Software **£59.95**
  - Full VV/Stop Manual **£29.95**
  - VHF Converter (Internal) **£225.00**



## SANGEAN ATS803A

Full coverage shortwave receiver with AM/FM and SSB reception, with many features and good sensitivity filtering. This has become one of our most popular low cost radios. **SPECIAL OFFER THIS MONTH: Free post and packing £119**



## STEEPLETONE MBR7

Multi-band Radio. This radio will appeal to both Aircraft Enthusiasts and the Marine Monitors. The multi-band "jumbo" radio has almost everything you need to monitor these bands. LW, MW, & SW plus the Marine and Aircraft Bands... **Good Starter! £76.40**



## TRADING POST

As many SWM reader are aware, we are the UK's largest distributor of Scanning Receivers - supplying many of the dealers who advertise in this magazine. As a result, over a period of time, we receive in our bulk shipments from Japan and elsewhere product with marks or slight damage to the outer colour sleeve or carton.

For this month we can offer a limited quantity of fully tested scanners, **BRAND NEW WITH 1 YEARS GUARANTEE**, but with slightly damaged or missing outer packing sleeve, box, etc.

- Yupiteru MVT-7100 **£389.00**
- Yupiteru MVT-7000 **£289.00**
- Fairmate HP2000 **£269.00**
- AOR 2500 **£379.00**

Quantity is strictly limited - sold on a "first come, first served" basis.

## SECONDHAND ITEMS

- Bearcat 800XLT Base Scanner **£99**
- AR3000 Base Scanner **£595**
- Icom R7000 Receiver **£795**
- Yaesu FRG7700 Receiver **£399**
- Kenwood R2000 + VHF **£495**
- Yupiteru MVT-8000 Base Scanner **£225.00**
- Yupiteru MVT-7000 **£245.00**
- Nevada MS1000 **£219.00**
- Fairmate HP2000 **£215.00**
- Sony Pro 80 Handheld **£195.00**
- Icom R71E HF RX **£695.00**
- Sony Air 7 Handheld **£185.00**
- Realistic PRO 34 **£150.00**
- Yupiteru VT125 Airband **£99.00**
- Sony 2001 HF RX **£175.00**
- Regency MX7000 **£199.00**

**Stock of secondhand product changes daily - call for the latest info or P/X quotation**

## PAY BY THREE POST-DATED CHEQUES (INTEREST FREE)

Simply divide the price into 3 equal monthly payments. Write 3 cheques dated in consecutive months starting with today's date and post them to us enclosing your name, address, telephone number and cheque card number. We will (subject to status) send your goods immediately we receive the cheques! **The hardest part is deciding what to buy!**

**SHOWROOMS:- 1A MUNSTER ROAD, PORTSMOUTH PO2 9BS**  
**MAIL ORDER:- 189 LONDON ROAD, PORTSMOUTH PO2 9AE**

# EDXC 93

## Vive Las Palmas!

*Although Whitsun is the traditional time for the annual conference of the European DX Council, 1993 was different. For the first time the EDXC met outside continental Europe. Radio Sweden's George Wood went to Las Palmas in the Canary Islands.*

"Good morning ladies and gentlemen. I'm sure we're going to enjoy our stay here in the Canary Islands. It's very pleasant to come from the United Kingdom and find that sunshine and warm temperatures do exist".

A couple of years ago when EDXC Secretary General Michael Murray told me there were plans to hold a conference in the Canary Islands, my response was basically 'Dream on'. At that point the council was at a real low point, having trouble just finding any venue for the following year. It didn't seem like a local club way out on the southern fringes could actually do all the organising that older and more established clubs in the north were reluctant to do.

Yet, there was Michael Murray standing on the stage at the University of Las Palmas, opening EDXC 93 in the Canary Islands!

The European DX Council brings together the clubs for short wave listeners in Europe. Aside from a newsletter, the major activity of the council in the annual conference, organised by a member club, often in collaboration with a broadcaster. Many representatives from radio stations also take part, making the EDXC meeting a unique opportunity for program makers and programme listeners to meet.

EDXC 93 was held at the University of Las Palmas. The local club, AER Canarias, had such good relations with the university that there is even a course in DXing. Many of the EDXC participants were young graduates of that course, and several of the conference lectures were aimed at them.

For example, industrial engineer Jose Miguel Navarro

Garcia spoke about the propagation of radio waves, the key to understanding how short wave works. Many veteran EDXC attendees had probably already grasped some of these basics, but for the new DXer, this informed and well illustrated discussion on the various layers of the ionosphere was certainly both welcome and informative.

He was followed by local Sony

were fascinated as Senor del Campo Pujada spoke at great length on the virtues of the dipole, the inverted V, multi-band dipoles, vertical antennas and many variations thereof, accompanied by illustrations.

"Sony is best known for its research, do some research yourself", Senor del Camp Pujada exhorted his listeners, "build your own antennas, and I'm sure the

for the Canaries, isolated as they are out in the sea. He spoke of Spain's Hispasat direct broadcasting satellite, intended to provide television programming to both Spain and Latin America, of the NATO communications base just 10km away, which provided military communications across the Atlantic, the trans-oceanic submarine cables that passed close by, and the fibre-optic link to the nearby island of Tenerife, the first of its kind in all of Europe.

He was followed by Doctor of Engineering Juan Domingo Sandoval Gonzalez, who told the conference how Spanish universities have used the Olympus direct broadcast satellite for multi-media interactive education in telecommunications. The programme is intended to reach 12 schools across Spain by next year. (This isn't the kind of thing satellite YV monitors can just tune into on Olympus however. The system is digital, with a 2Mb/s uplink from Madrid, and 64Kb/s uplinks from the other schools. Eventually, it will include a connection to the international Internet network, providing electronic mail and access to databases outside of Spain).

There was also a workshop on Satellite Broadcasting, in which those of us broadcasters who are on satellite, shared our experiences.

But the high point of Satellite Day at EDXC 93 was the trip to the southern shores of the island, not to the tourist beaches at Playa de Ingles, but rather to the nearby Maspalomas satellite station. This is divided into two sections. One part, called North MER (Main Equipment Room), monitors weather satellites such as the



**The local affiliate of Onda Cero in Las Palmas was a sponsor of EDXC '93**

representative Senor Mauricio de Campo Pujadas. After a brief introduction to his firm's products, he surprisingly announced "It's better to have a good antenna and a poor receiver, than a poor antenna and a good receiver".

He then spent about an hour talking about 'Everything You Ever Wanted To Know About Antennas' (and perhaps some things you didn't want to know). Once again, for veteran EDXC-goers this was old stuff, but the young Canarians

result will be far superior to what you might have with an antenna inside your house".

If that day of EDXC 93 was devoted to the basics of short wave listening, another day was an illustration of what is intruding more and more into the hobby every year - satellites.

When Antonio Nunes, the Director of the Escuela Tecnica Superior de Telecomunicaciones, addressed the conference he described how cables and satellites have made a difference



# ASK ELECTRONICS LTD

248 TOTTENHAM COURT ROAD, LONDON, W1P 9AD • Tel: 071-637-0353/0590 • Fax: 071-637-2690

FOR ALL ORDERS  
RING OUR  
EXPERT STAFF  
KUMAR OR MARK



## SONY ICF-2001D FULL KIT INCLUDING: AN1-£275

AWARD WINNERS

071-637-0353/0590

AN AWARD WINNING MASTERPIECE

ICF-2001D Kit ..... £275 ONLY  
Finest all-round pro-receiver in the business.

FW/LW/MW/AIR multi-band reception • 32 station preset memory • Synchronous detector circuit • PLL quartz-locked synthesiser circuit digital/analogue tuning • 2-way scan tuning (memory, broadcast, define) • 2-position tone control • Direct metre band access • 4-event programmable time • AM attenuator SSB reception • External antenna for AM, FM and AIR band • 288x159x52mm (w/h/d) 1.7kg. 2001 DSYSTEM-ICF-2001D with active antenna AN-1 in one complete package.

NEW ICF-SW77 Similar specification to 2001D but with jog-shuttle dial tuning for accuracy ..... £349



- |                      |      |
|----------------------|------|
| Kenwood TH7BE.....   | £449 |
| Fairmate HP2000..... | £269 |
| Nevada MS1000.....   | £269 |
| Alan CT145.....      | £169 |
| Yaesu FT26.....      | £239 |
| Yaesu FT76.....      | £249 |
| Yaesu FT23R.....     | £229 |
| Yaesu FT411.....     | £249 |
| Yaesu FT811.....     | £269 |
| Yaesu FT911.....     | £359 |
| Yaesu FT219.....     | £319 |
| Yaesu FT2400RH.....  | £349 |

The UK Scanning Directory  
3rd Edition..... £16.95  
ICF-SW7600..... £154.95



**HIGH PERFORMANCE PORTABLE RECEIVER WITH PLL SYNTHESIZER CIRCUITRY AND CONTINUOUS AM FREQUENCY COVERAGE**

LW/MW/FM/SW/SSB reception • PLL synthesized circuitry • FM stereo • Continuous AM frequency coverage • 4 way tuning: 10 memory presets, auto scan, manual tuning, 10 key direct tuning • Sleep function • Digital clock • Programmable timer • 2 step tone control • Antenna input socket • Headphone socket • Key protection • LCD display • Dual conversion system • Supplied with compact antenna, stereo earphones and AC power adaptor • Power: 4xAA size battery.  
ICF-AIR7 ..... £249  
ICF-PRO 80 ..... £309  
CR-V21 world band receiver - fax printout, RTTY weather rec ..... £2699

## YOUR SONY SPECIALIST

Full Worldwide Guarantees from SONY!

CALL THE SONY SPECIALISTS  
071-637-0353/0590!!

Mail Orders Welcome.  
071-637-0590/0353

Fast - Efficient - Convenient. To your doorstep!!

- PRO worldband rec incl weather fax ..... £2699.00  
PRO dish antenna..... £1599.00

## SONY

- ICF-SW7600..... £154.95  
ICF-SW1E ..... £154.95



ULTRA-COMPACT SHORTWAVE RADIO WITH PLL SYNTHESIZER CIRCUITRY

FM/LW/MW/SW reception • PLL synthesized circuitry • FM stereo • Continuous AM frequency coverage • 4 way tuning: 10 memory presets, auto scan, manual tuning, 10 key direct tuning • Programmable timer • Sleep function • Digital clock and alarm • LCD display with light function • Dual conversion system • 2 step tone control • Key protection • Record out socket • Supplied with stereo earphones, shortwave guide and compact aerial • Power: 2xAA size battery.

- ICF-SW800 ..... £59.95  
ICF-SW20 ..... £69  
AN-1 ANTENNA..... £54.95  
ICF-7601L ..... £89.95



## SONY ICF-SW55 "SUPERADIO"

- World time zones • SSB
  - Full digital p/sets
  - Multiband
- £249 only**

## SCANNERS AND TRANSCEIVERS

### YUPITERU AIR-POWER AT YOUR FINGERTIPS

- VT-125 II ..... £169.95  
MVT-7000..... £329.95  
VT-225..... £239.95  
MVT-7100..... £399.95

### PANASONIC

- RF-B10 World band receiver - pocket size ..... £69.95  
RF-B65 S/pro multi band digital radio - memories preset ..... £189.95  
RF-B45 Digital m/band radio ..... £129.95  
071-637 0353/0590

### ICOM

#### SCANNERS/TRANSCEIVERS

- IC-R1 15-1300 MHz  
100 memories...Only **£380.00**  
ICP-2ET ..... £310.00  
ICR-7100 ..... £1199  
ICW-2E ..... £429.95

#### FULL RANGE STOCKED

- ICP-2E 144MHz ..... £275  
IC-21E ..... £275  
IC-25 ..... £500  
ICP-2E ..... £279  
ICP-2GE ..... £319  
IC-229E ..... £369  
ICW21E Dual Band ..... £429  
ICW-21ET ..... £459  
ICW-3230H ..... £675

### GRUNDIG

- SATELLIT 700..... £349.00  
YACHT BOY 222..... £52.95  
YACHT BOY 230..... £65.95  
CONCERT BOY 230..... £35.95



### YUPITERU

- VT-150  
142-170MHz  
FM marine monitor ..... £169.95  
MVT-8000 ..... £349.95

### ALINCO

- DJ-180E ..... £189.95  
DJ-51E ..... £214.95  
DJ-F1E ..... £269.00  
DJ-F4E ..... £265.00  
DJ-S80E Dual band ..... £434.95  
DR-S99E Dual band 2m/70cm - 50 watt mobile ..... £679.00  
DR-112E 2m FM 45w mobile transceiver ..... £300.00  
DJ X 11 with free manual & charger ..... £299.95

### AOR

- AOR1500EX ..... £319.00  
AOR2800 ..... £409.00  
AOR2000 ..... £279.95  
AOR3000A ..... £859.95

**YUPITERU  
MVT 7100  
"BEST SELLER"  
£399.95  
ONLY**

**New full range antennas,  
base stations, CB mobiles, etc**

### ROBERTS

- R717 ..... £79.95  
R701 ..... £79.95  
RP-28 ..... £89.95  
R737 ..... £119.95  
RP-15 ..... £21.95  
R101 ..... £44.95  
R621 ..... £54.95  
R817 ..... £139.95  
RC818 ..... £179.95  
R808 ..... £99.95  
R727 5 bands - FM/MW/SW/LW/SW1-4 ..... £79.95  
R747 3 bands ..... £92.95  
RF-M3 Tiny ..... £59.95  
RP-26 FM/MW/LW ..... £81.95  
RC-35 Mono cassette radio ..... £56.95

### PHILIPS

#### D2345

• Portable Radio • LW/MW/FM/2 x SW • Fine Tuning Control • Mains/battery supply ..... £24.95

#### D1875

• Compact 12-band Portable Radio • LW/MW/FM/9 shortwave • Large tuning control • Tuning LED indicator • Telescopic and ferroceptor aerial • DC supply connection • Earphone connection • Wrist strap • Attractive pouch ..... £49.95

PLEASE MAKE ALL CHEQUES PAYABLE TO ASK ELECTRONICS AT 248-250 TOTTENHAM COURT ROAD, LONDON W1P 9AD

For your deal call: **071-637-0353**

GOVT. AND LOCAL AUTHORITY  
ORDERS ARE WELCOME.  
TAX-FREE EXPORT!  
MAIL ORDERS IMMEDIATE DISPATCH



**Stickers and QSL cards are popular items with DXers. The stations represented here were all represented in Las Palmas.**

American NOAA series, and earth resources satellites, like the French-Swedish SPOT, Japan's MOS, and Europe's ERS-1.

This was a treat for amateur WEFAX monitors, who could compare their modest equipment (PCs for orbit prediction and demodulating and small omnidirectional antennas for 137MHz), with the rack of computers used for tracking the 10 metre dish antenna at Maspalomas and the second computer rack for the demodulation of signals in the X (8.6GHz), S (2GHz), and L (1.6GHz) bands.

The other side of the facility, South MER, is a satellite control station, a European Space Agency prototype that can be configured to provide telecommands and monitor telemetry for many kinds of satellites. South MER has a 15 metre dish and uplinks in the S-band and downlinks in both the S and X bands. While we were there, it was being used for the Eureka (European Retrievable Carrier) scientific satellite, which was placed in orbit last year by the American Space Shuttle and was retrieved by the Shuttle a few weeks after EDXC 93.

For those who missed EDXC 93, there's always next year. The 1994 conference will be held in Paris. After the last few years, when it was uncertain where the next conference would be held, the next two years are also booked. EDXC 95 will be in the Danish resort of Rebild, north of Aarhus, and EDXC 96 will be in Florence, Italy (with the organisers promising a visit to Vatican Radio). For more details, write to: EDXC, Box 4, St Ives, Huntingdon PE17 4FE.

There's always some DX news

announced at EDXC meetings. The biggest such news at EDXC 93 was a special broadcast in connection with the conference itself. The Voice of America transmits in sideband on 10.869kHz, including a rare short wave relay of VOA Europe, with the left stereo channel on one sideband, and the right channel on the other. It was probably the first stereo broadcast in the history of short wave, although listeners needed two receivers, one tuned to each sideband, to hear the stereo.

Every year's EDXC meeting also sees the release of some very important publications for short wave listeners from the Danish Short Wave Clubs International. The 30-page *Tropical Band Survey* covers all broadcasters in the frequency range of 2 to 6MHz, most commonly used by Third World stations, and most sought after by many listeners.

The 20-page *Clandestine Stations List* has all known clandestine frequencies, addresses, political affiliations, and QSL



policies. The TBS is available for 7 IRCs, the Clandestine List for 6 IRCs, from DSWCI, DK-2670 Greve, Denmark.

Jeff White from Radio Miami International announced that now that they have a construction permit and call letters (WRMI), along with the old transmitter from Radio Clarin in the Dominican Republic, and a brand new antenna, they are about to begin tests on 9.955MHz. Unfortunately

for Europeans, broadcasts are aimed south towards Latin

America. But, after the recent bad publicity about robberies directed at tourists, Miami is interested in promoting its image, and tourist programs to Europe may be in the offering.

On the satellite from, Deutsche Welle has now absorbed the external services of Deutschlandfunk. DW intends to drop some language services, and station representative Waldemar Kramer indicated that good relations with countries such as the Netherlands, France and Denmark may mean that the services to those countries will be among those discontinued.

Deutsche Welle TV continues to grow. After the recent expansion to North America on the Intelsat-K and Satcom C-4 satellites, Asia is next. Deutsche Welle is to have a transponder on Asiasat-2 when the satellite is launched in 1994.

That may also have something to do with the announcement by Henry Lee of Taiwan's Voice of Free China that they will be coming to Europe by satellite within the next two years, through co-operation with Deutsche Welle.

The other station news was my confirmation that Radio Sweden was dropping its Spanish and French services, due to the Swedish parliament's vote to cut our operating budget by a third. This was probably what prompted the Spanish DXers' Workshop at EDXC 93 to adopt a manifesto calling on international broadcasters not to cut back on services in languages such as Spanish, French and Italian.



# A VISIT TO SWISS RADIO INTERNATIONAL

By Derek Jasnoch

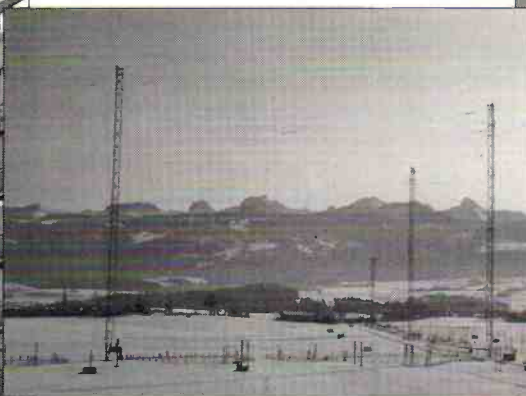

*The Schwarzenburg transmitter site.*

*SRI's studios and offices in Berne.*



## A Brief History

Short wave transmissions from Switzerland started in 1934 with experimental transmissions from Swiss people living abroad. These trials met with such a positive reception that regular transmissions began a year later. The political situation in Europe during the 1930s had created a need for Swiss people living in other continental countries to keep themselves informed of the political position at home via access to news direct from Switzerland. Throughout the war years, Switzerland remained one of the few truly neutral voices to be heard. Because of this, many people, on both sides of the conflict came to rely on Swiss Radio for an objective viewpoint. In the United States, SRI built up a particularly strong audience

since it provided a studio in which American GIs could send messages back home to families and friends.

By the end of the war, SRI was transmitting in German, French, Italian, English, Spanish, and Portuguese. In 1946 Esperanto was added. This was followed by Arabic in 1964, and Rumantsch (Switzerland's fourth language) in 1971. Currently there are plans to drop the Esperanto broadcasts, leaving eight language services broadcast from SRI. From March 1993 two services will be offered on short wave, one for an international audience, and the other for Swiss nationals living abroad. In practice, this will mean that typical transmissions will begin with half an hour of English broadcasts on five or six frequencies, followed by French

for half an hour; the frequencies will then be split. The International service would continue in German or Arabic for example, with programmes geared towards the international listener, while the second service would continue with programmes broadcast in German, Italian and French, serving the ex-patriate Swiss audience.

The long term strategy of the SRI is to become more than just an international short wave station. It sees its future as a multi media information channel, providing news and views from Switzerland. In terms of its radio operations, this will mean using the superior broadcast quality of f.m., with distribution via satellite to Europe, North America and Australia where the signals could either be received by individuals with suitable

equipment, or retransmitted on local f.m. stations. In North America SRI is available on the C-SPAN satellite, and in Europe as of March 1993, it will be available on ASTRA 1A, transponder 9H, at a frequency of 11.332GHz, and a sub carrier of 7.2MHz.

As far as European broadcasting is concerned, Mr Fankhauser, Head of SRI's PR and Marketing Department, believes that short wave has a limited future. With the advent of direct digital audio broadcasting from satellite, any European service must eventually switch over to this medium, which offers far superior sound quality in stereo, and more reliable reception. He does, however see a continuing role for short wave in maintaining a link with peoples in less - developed parts of the world, where short wave is, and



*One of the production studio control rooms at SRI.*

probably will be for some time, their only reliable means of learning what is really happening in the world, and even sometimes in their own country! For the time being, however, SRI remains committed to its short wave service, with the opening of a new 500kW relay station in Montsinery, French Guiana at the end of 1993. This will serve Latin American, North America, Australia and SE Asia, replacing half the transmissions from the Africa Number One transmitter in Moyabi, Gabon, and replacing all the transmissions from the current 250kW transmitter in Brasilia. Relays to the Far East will continue from the 120kW transmitter which is currently leased from Radio Beijing.

There are also five transmitting stations in Switzerland itself, four 250kW transmitters at Schwarzenburg for world broadcasts, and a 500kW transmitter at Soltens. For the omni-directional European service there are two 250kW transmitters at Lenk and one 250kW transmitter at Sarnen. There are also two 250kW transmitters held in reserve at Beromunster. So far plans to site a sixth station in Switzerland have been thwarted due to environmental considerations.

During the last year or so SRI has been experimenting with an RTTY service, and a great deal of interest has been generated by this from news agencies, TV and radio services in other countries, as well as individual listeners. A one hour transmission is sent to various parts of the world. This consists of the news in German,

French and Italian, followed by an English section which provides information on various aspects of Swiss life such as culture, politics and economic matters.

## Swiss Radio International Today

Berne, the capital of Switzerland on a Tuesday morning. The crowds still mill through the covered shopping arcades lining both sides of Marktasse. Others walk on the cobbled main street carefully avoiding the trams which lumber languidly along. So here I am amongst the ancient fountains, the clock towers, and the fourteenth century shopping centre. Swiss time is pressing on, so I hop on a tram and head out to the suburb of Ostring. Soon I am standing in front of a rather utilitarian buildings which houses the studios and offices of Swiss Radio International.

Greeted by SRI's PR and Marketing Head, **Walter Fankhauser**, we walk past the English Language section and settle down in the PR office. The table and desk spaces are piled high with papers, books and brochures, people bustle in and out of the office, and the phone often interrupts our conversation.

My hosts gave me a guided tour around the building, accompanied by **Paul Badertscher**, Head of the Technical Production Department. With his staff of thirty they look after the studio facilities, operate the studio equipment and provide technical



*The announcer's suite.*

support as and when needed. The buildings and maintenance of the transmitting sites is left to the Swiss PTT.

First stop on the tour was one of the three Production Studios. Here programmes are produced not only for the short wave service but also for supply to local a.m. and f.m. stations mainly in the United States. These are largely music programmes which are recorded onto CDs between four or five hundred of these discs are sent out to local stations during a month. The studio itself is very large and is divided into two areas. The Announcers Suite is roomy enough to accommodate about a dozen people. On the other side of the sound-proof glass is the Operating Suite. This contains most up-to-date equipment including a CD recorder, turntables, tape recorders and a mixer. Other equipment included a reference receiver to check the frequency accuracy of the transmitters, a slow speed, multi-track tape recorder to store each and days output onto a single reel of tape for future reference. Most of this is supplied by Swiss manufacturers Studer AG.

It is possible to broadcast direct from these studios, but this is rarely done, with most

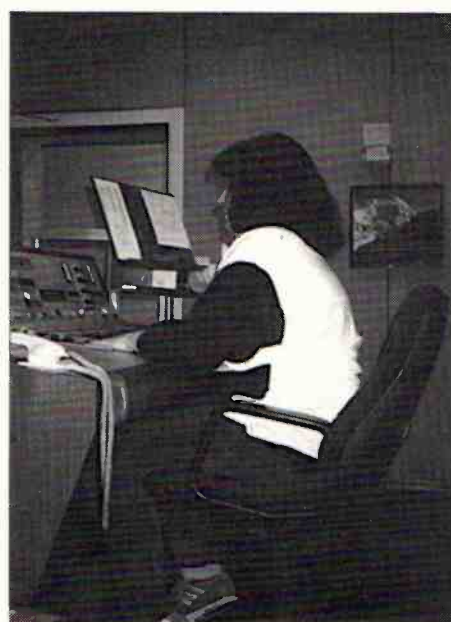

*SRI's continuity studio.*

feature programmes being recorded ahead of airtime. Live broadcasts are usually made from the Continuity Studios. I arrived just in time to hear the English News bulletin being broadcast to the Far East. I watched the announcer deliver a flawless performance, then it was time to cue and play a taped feature programme. There are four Continuity Studios, and these are often in use at the same time. The announcer sits behind the glass while a Continuity Operator controls sound levels, cueing of taped items and jingles etc. Further along in Studio Three, a music programme was being aired on the European service. Meanwhile we disappeared off to the modulation room which houses the switching mechanism for connecting various sources to

# Radio Stations Special

## RTTY TRANSMISSIONS FROM SRI

Time (UTC)	Beamed To Azimuth	Freq (MHz)	
0030 - 0130	South America	10.515	230
0200 - 0300	North America	010.515	295
1700 - 1800	Australia	15.835	50
1830 - 1900	Africa	17.530	17
2000 - 2100	Asia	10.515	50

\* These transmissions may be received in Europe via the sidelobes.

### English Transmissions to Europe via Astra

Time (UTC)	Freq (MHz)
0000 - 0000	
0200 - 0230	
0400 - 0430	3.985, 6.165, 9.535
0600 - 0630	3.985, 6.165, 9.535
0900 - 0900	
1100 - 1130	6.165, 9.535, 12.030
1300 - 1330	
1500 - 1530	
1700 - 1730	
2000 - 2030	

the continuity studios and for connecting the output of the studios to the transmitter sites and the satellite ground station.

Much of the switching at the station is now controlled automatically, including the playing of certain jingles and the

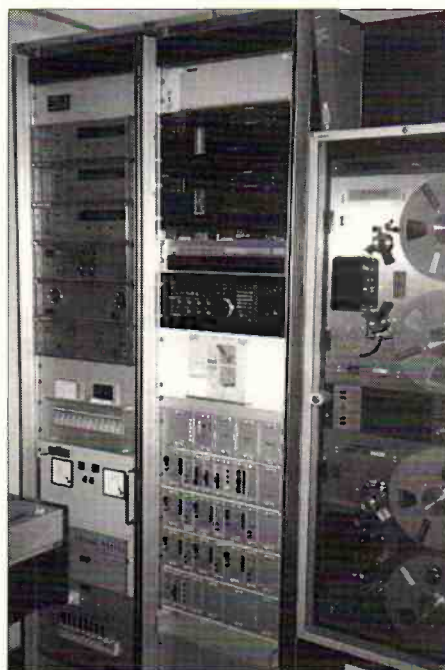

**SRI's Modulation Room. Top left is the accurate time standard. The Broadcast monitor receiver is in the centre with the programme logging recorders on the right.**

switching of lines to the various transmitter sites. All this is synchronised by a very accurate time source which allows

Sufrin, for their help and kindness during my visit.

millisecond accuracy.

The jingles, such as station announcements, and frequency announcements, are not stored on tape, but rather on a hard disk which is controlled by a central processor unit. There are about two hundred announcements stored on the disc, and their access time is about 50 ms. It was amazing to see behind the scenes operations at SRI, and to be given an insight into their views on the future of international broadcasting. I would like to thank all staff at SRI, especially Paul Badertscher, Walter Fankhauser and Paul

## SRI: INTERVIEW WITH THE HEAD OF THE ENGLISH SECTION: PAUL SUFRIN. By Derek Jasnoch

Most articles in magazines about short wave listening offer either technical advice on broadcasting, or provide guides to what is broadcast, but what of the people who work to give us this short wave programming? Derek Jasnoch interviews Paul Sufrin, the 'software behind the hardware' at SRI.

### How did you first get involved in international broadcasting?

*It was by accident. I had journalistic training in Toronto between 1961 and 1964, and after a brief apprenticeship in Canada I decided to try my luck in Europe. Firstly I moved to England and tried for a job at Reuters, but that didn't work. Then I saw an advertisement for newsroom work at SRI, so I went for an interview and was accepted.*

*So began a kind of love/hate relationship. Working in international radio is a challenge; firstly because of the transmission problems involved, and secondly the challenge of presenting a message that is very ephemeral. It has to be clear and simple for the listener.*

### Describe a typical working day

*I start by opening all of the junk mail and follow that up by throwing away all of the junk mail! Check the wire services to see what stories should*

*be followed up. Most of the editorial decisions are left up to the person doing the programmes that week or that day. I may go out reporting and offer this work to the person in charge that day, and it may be accepted or rejected.*

### What do you enjoy most about your job?

*The combination of administration and journalism. As an administrator there is a lot of duty work to do, attending meetings, working out budgets, schedules and rotas. The challenge is to do this and keep a hands-on approach to the programming with presentation, reporting, feature work and so on.*

### What do you most dislike about your job?

*The same thing!*

### 'What has been your most memorable moment in broadcasting?

*A memorable occasion was being on reporting duty for the International Committee of the Red Cross in Thailand, reporting their activities for the radio, and becoming a member of an ICRC delegation for one week, unofficially of course, and going everywhere that delegation went. That was in the early Eighties. It was interesting to be part of a process that one doesn't normally see, and to be*

*able to turn that into a programme.*

### Do you listen to short wave radio at all?

*I'm not a frequent listener - I don't have the time! I try to listen when I have the chance but it's very seldom. If I could, I would listen to the BBC, VOA and Radio Canada, if it existed as such!*

### What do you personally understand to be the role of the SRI?

*To make a listener, anywhere in the world, feel like he is listening to Swiss local radio in English. To bring the listener into Switzerland, by informing him not only about the clique' image of Switzerland, but to let him know what Swiss people think about what is going on in various parts of the world.*

### And the future role of short wave broadcasting?

*As far as I am concerned, it has a good future, certainly in the short term. From the point of view of programming it has got an important role to play. On the basis of the letters that we get, the listeners appreciate what they consider a balanced, objective opinion from Switzerland about current affairs. The value of Swiss short wave is the trust it engenders."*

# SHORT WAVE TARGET: 23° NORTH, 82° WEST

*"Alert, alert! Look well at the rainbow. The fish will rise very soon. The sky is blue. The fish is red..."*  
Gerry L. Dexter takes up the story.

Those words, spoken in Spanish and transmitted from a not-so-secret clandestine radio station, were part of the Central Intelligence Agency's contribution to the Bay of Pigs invasion of Cuba in 1961. The CIA station has been on the air for a year, beaming to Cuba from tiny Swan Island off the coast of Honduras.

Radio Swan - however well known it became - was but one of a long and still growing list of anti-Castro broadcasters, ranging from little known Cuban exile groups to the US government itself, determined to do what they can to agitate and stir up the Cuban populace, further weaken and eventually bring down the Castro government.

The collapse of communism, the disintegration of the USSR, extreme cuts in aid to Cuba from Russia and the Confederation of Independent States, along with Castro's growing isolation in the world has many experts predicting that he's be gone in another year, perhaps even less. There can't be much doubt that Cuban exile groups, sensing that the time may at long last be at hand, are jumping on the airwaves to make their voices heard and have at least some small part in the final victory. There's no question that, at this time anyway, the shortwaves have more voices raised against Castro and his regime than at any time since he came to power.

## Radio Rebelde

The Cuban radio wars date back even before Fidel marched into Havana early in 1959. In fact, Castro himself first brought clandestine radio into the Cuban power game. His forces operated Radio Rebelde, broadcasting against the then dictator Batista, from rebel-held areas within Cuba. Today's Radio Rebelde (3.366 and 5.025MHz) is named after this station.

But once Castro took power, once his real politics became known, and the exile community in and around Miami began to grow, Washington decided it did not like Castro's

government, broadcasts against Castro began, limited initially to the weak and sputtering efforts of one or two exile groups. The number of groups or elements involved in anti-Castro broadcasting has had its ups and downs over the years. These highs and lows have run fairly parallel to such outside factors, as the degree of US irritation with Castro at any one time and how tolerant Washington (and thus the Federal Communications Commission) was with illegal broadcasts to Cuba coming from within US territory.

## Gibraltar Steamship Corporation

The first major character in this multi-decade drama was Radio Swan (later called Radio Americas), an operation of the American Central Intelligence Agency. Run through a front called the Gibraltar Steamship Corporation, based in New York City. GSC, it turned out, owned no steamships. The station was heard throughout the world with its 7.5kW transmitter operating on 6.000MHz, and a 50kW medium wave unit running on 1.160MHz (later 1.157MHz). The station's seven-year run caused no end of speculation within the short wave listening community as to who was running it, and whether it was really on Swan Island. Early programming was done at the Gibraltar offices in New York but this work was soon turned over to a Miami production studio and the tapes flown to Swan twice weekly. Radio Swan became very well known; often as not books which deal with the Bay of Pigs or the CIAS give, at least, brief mentions to this station. One book on US intelligence agencies devoted an entire chapter to it.

## Bay of Pigs

After the Bay of Pigs defeat, Gibraltar moved its offices to Miami and soon disappeared, to be replaced by the Vanguard Service Corporation, another

CIA front. Within weeks Radio Swan changed its name to Radio Americas. Radio Americas continued operating until 15 May, 1968 when it closed down - having announced its coming end some weeks ahead of time.

A contemporary of Radio Swan/Americas was Radio Liberated - La Voz Anti-Comunista de America, whose transmitters it was eventually learned, were near Caracas, Venezuela. It maintained post office boxes there and in Miami and claimed to use a 5kW transmitter. Clandestine broadcasting enthusiasts never learned for certain who was behind this station, though speculation was that it, too, was a CIA operation.

## Sporadic Efforts

The Bay of Pigs disaster was followed by a quiet period which lasted from the late 1960s into the late 1970s. Americas and Liberated were off the air, Washington seemed uninterested and the exile community made only very limited and sporadic efforts at beaming radio broadcasts to the island.

An upswing was underway by around 1978, however, with a series of anti-Castro broadcasters illegally taking to the air off and on over the next several years. Most used converted amateur radio equipment and operated in the area between 7.000 and 7.100MHz

## Faded Away

During those years American clandestine radio enthusiasts picked up signals from such stations as Radio Cuba Libre, operated by the Christian Democratic Movement; Radio Abdala, operated by Agrupacion Abdala Radio Rebelde; Radio Libertad Cubana; La Voz de Alpha 66 (operated by the Alpha 66 group); La Voz de Junta Patriotica Cubana (Junta Patriotica Cubana); Radio Antorcha Martiana (Marti Insurreccional Movement); Radio Trinchera (Radio Foxhole) La Voz de Juventud Progresista Cubana (Voice of the

Progressive Cuban Youth); Radio 1450 (1450 Brigade); a fake Radio Havana Cuba and some others were all on the air at one time or another. In some cases they had life spans of just weeks or even less. Some were located and closed by the FCC, others just faded away.

## Commandante David

One of the more interesting of these stations was Radio Libertad Cubana which featured 'Commandante David', who claimed to be broadcasting from Oriente Province in Cuba. The air name he used was the same one used by Castro in his own rebel broadcasts from radio Rebelde. 'David' claimed to be able to predict the dates and places where sabotage would occur on the island. The station was raided and closed in the summer of 1980 and 'David' was identified as one Jose Gonzales of Hialeah, Florida, a Cuban who had been a US citizen for 30 years. Libertad Cubana and Commandante David re-appeared briefly in mid-1988, although one cannot be certain whether it was the same 'David' at the microphone.

## Cuban Agents

In 1984 a source claimed that Cuban agents operating in Miami worked to locate some of the clandestine transmitters and then turned the information over to the FCC!

La Voz de Alpha 66 station was raided and closed by the FCC. The Alpha 66 group put a second station on the air several years later and maintained a fairly regular three evenings per week schedule on 6.666MHz, but this, too, was eventually closed down.

The station, run since its inception by Dr Diego Medina, was found to be operating from a Ford van. Medina accused the FCC of confiscating about \$30,000 worth of broadcasting equipment. La Voz de Alpha 66 is back on the air now, practising safer methods of broadcasting, as we'll see shortly.



Communications Centre (Photo Acoustics Ltd.)

TWO-WAY RADIO ● AMATEUR RADIO ● AUDIO VISUAL ● SALES & SERVICE  
58 High Street, Newport Pagnell, Bucks MK16 8AQ. Tel: (0908) 610625 FAX: (0908) 216373

# TWELVE MONTHS TO PAY AT ZERO INTEREST

## YUPITERU MVT-7100 Factory Fresh AM-FM-SSB-CW Scanner

Latest European Version  
530kHz-1650MHz!

PHONE FOR  
FULL TECHNICAL  
INFORMATION  
WFM/NFM/AM/LSB/  
USB/CW

Widest Frequency  
Range Ever!  
1000 Memories in 10 Banks  
500 Search-Pass Memories  
Steps from 50Hz to 100kHz  
Proper USB/LSB Switching  
Dial Resolution to 50Hz  
30 steps per sec. scan rate!  
Illuminated Keypad  
20dB Attenuator



**£449**

Supplied with:  
Ni-cads, DC Cigar Lead, Antenna,  
Hand Strap, Belt Clip, Earphone,  
AC Charger, Full Warranty.  
Each one individually tested.  
**YOU'RE SAFE WITH US!**

Deposit  
**£49.00**  
and 6 payments of  
**£66.67**



Deposit **£199.95** 12 monthly payments of **£66.67**

## KENWOOD R5000

Kenwood's only receiver now but still holding its own  
with the competition.



Deposit **£172.00** 12 monthly payments of **£57.25**

## ICOM R72E

Icom's excellent mid-price receiver. Ideal for listeners  
needing "modern" facilities like scanning, loads of  
memories and a clock. Now with battery back-up.



Deposit  
**£395.00**  
12 monthly  
payments of  
**£83.33**

## ICOM R7100E

The ultimate scanner! W-i-d-e  
coverage from 25MHz to  
2000MHz. HF version available  
covering 100kHz to 2000MHz.

HF version  
Deposit  
**£495.00**  
12 monthly  
payments of  
**£83.33**

Deposit  
**£190.00**  
12 monthly payments of  
**£63.25**

## AOR AR3000A

Still one of our more popular scanners 100kHz to 2036MHz,  
all modes, 400 memories.



Deposit **£120.00** 12 monthly payments of **£39.92**

## YAESU FRG100

Yaesu's new compact receiver is the latest in a long and  
successful line. It has one or two excellent features but  
they're not immediately obvious.

### SECOND-HAND LIST

HF 125 .....£225.00  
AOR AR2800 .....£325.00

**AUTHORISED AGENTS FOR KENWOOD, ICOM, YAESU & ALINCO. FULL SERVICE FACILITIES AVAILABLE**

SPEND UP TO £1,200 INSTANTLY WITH A PHOTO ACOUSTICS LTD. CREDIT CHARGE CARD

PART EXCHANGE WELCOME, ASK FOR KERRY G6JZF, ANDY G4YOW OR PAUL SWL.

RETAIL SHOWROOM OPEN MONDAY - FRIDAY 9.30 - 5.30, Saturday 9.30 - 4.30

Goods normally despatched within 24 hours. Please allow 7 banking days for cheque clearance. Prices correct at time of going to press - E&OE



# Waters & Stanton

UK's largest stockist of specialist receivers

## Mail Order Code

- Immediate despatch
- 24 hour delivery on most items
- Full value carriage insurance
- 3 full time service engineers on ham radio
- 10 days to return if not satisfied
- 12 months parts and labour warranty
- Excellent spares stocks
- No grey imports - just honest prices
- Free after sales help

**NOBODY BEATS OUR SERVICE!**



## New items

- HB-100** Quality desk stand for any hand-held. Fully adjustable, amazing little accessory **£27.95**
- AB-88V** Miniature magnetic mount with BNC socket and plug. For instant handy mobile put your helical on the mag. **£29.95**
- EP-300** High quality earclip pieces as supplied to the police. Zero fatigue. **£13.95**
- HX-9000** High gain dual band helical for 2m and 70cms hand-helds 2m - 2dB 70cms - 3.8dB. Total length is 19 inches. Also wideband receiver centred on 150/300/450/900MHz. **£29.95**
- HX-7000** 7" version of above. **£19.95**

## UK SCANNING DIRECTORY

We've got the new 3rd edition in stock. Is it legal or is it not? Get your copy before the whole lot get taken off the market! As a service to our many mail order customers we are offering this post free. **£16.95**

## HB-400 Amazing! £13.95!

P&P £2.00

### Hand-held mount

The easy way to mount your hand-held or scanner in the car. Fits any hand-held using the belt clip. Gives firm mounting for safe driving.



## Airband/Marine/Broadcast Monitor Receiver SAB-9 MkII

Ideal for the beginner and those on a budget. It covers the civil airband, marine, amateur, emergency and FM broadcast bands. One of our most popular "birthday presents" it offers hours of entertainment.

Very popular at air displays and the like, particularly at this price. It is powered by 4 x AA cells and covers LW/MW plus 108 - 176MHz. There is a headphone socket for private listening and a telescopic whip. SAB-9EP - The above radio in presentation box with headphones and book. **£31.95**



## SONY AIRBAND & SHORTWAVE DISCOUNTS

We have a small quantity of both the Sony Air-7 and Sony Pro-80 scanning receivers for disposal in hardly used condition. Each one is checked over and supplied with manual, accessories and a six month warranty. Prices are extremely low so it's first come first served.

- Air-7 LW/MW and FM 76-174MHz AM/FM ..... **£109**  
Pro-80 115kHz-227 MHz AM/FM/SSB ..... **£139**



## On Glass Scanning Aerial

TGSP Scanner Model 30 - 1200MHz



**NEW**

**£32.95 COMPLETE**

Just attach to the glass surface of rear window and line up the internal connector box on the inside of the window. It's as simple as that. 14' of cable is provided with

screw connector to attach to box. If you ever need to remove the aerial we can supply the special kit to carry out this with replacement parts for remounting.

## NEW FOR OLD!

Too good to be true? Well er...yes. But the next best thing is to part exchange your gear. We are always interested in good clean equipment that needs a new home. We have customers waiting for all the popular items so why not give us a call today and see if we can help you buy that new model or even pay you cash. Everything we take in is checked in our own workshops and you get a true 3 months warranty. Stocks at the moment include a lovely old Eddystone EC-10 £95; Icom R-71s from £549; Realistic DX-390 short wave receivers from £119; AOR-2002 £269; IC-R100 £329; R-535 VHF/UHF Airband £199; DJ-X1 £229; Pro-30 and 32s from £119 and lots more. We'll send you the list on request. Plenty of transceivers for HF and VHF also normally in stock. DIAL 0702 206835 for quote or information.

## Great news

### FREE HAM RADIO CATALOGUE

*The best ever produced!*

For the first time ever you can obtain a copy of this catalogue packed with Ham Radio equipment and accessories, some never before advertised. You get the full specification with pictures and accompanying price list. Forty four pages of absorbing reading and it's all FREE! Just call in and collect one from our Hockley or Hornchurch stores. Alternatively send two first class stamps to cover postage.

Frank in control of mail order despatch



AVAILABLE BEGINNING OF SEPTEMBER

## FREE CREDIT

On Most HF Receivers  
12 Months to pay!

### SONY ICF SW7600

**£179**



0.1-30MHz Shortwave Receiver with SSB. Comes with 240V PSU other Sony models in stock.

### KENWOOD RS5000

**£999**

FREE CREDIT



Highest Quality All mode base Station Shortwave Receiver.

### ICOM R729

**£859**

FREE CREDIT



100kHz - 30MHz All mode Base Station Shortwave Receiver.

### YAESU FRG100

**£599**

FREE CREDIT



50kHz - 30MHz All mode 12V Shortwave Receiver with Free Power Supply.

### AOR 3000A

**£949**

FREE CREDIT



100kHz - 2036 MHz ALL MODE BASE/MOBILE SCANNER

### ICOM IC-R7100

**£1395**

FREE CREDIT



25MHz - 2GHz ALL MODE BASE STATION SCANNER

INTEREST FREE CREDIT OVER 6, 9 or 12 MONTHS DEPOSIT TO SUIT YOU. PLEASE PHONE MARK FRANCIS FOR DETAILS

Retail and Mail Order: 22 Main Road, Hockley, Essex SS5 4QS. Tel: (0702) 206835/204965 Fax: (0702) 205843  
Retail Only: 12 North Street, Hornchurch, Essex. Tel: (07084) 44765  
VISA & ACCESS MAIL ORDER. 24 Hour Answerphone. Open 6 Days a Week 9am-5.30pm  
Rail: Liverpool St./Hockley or District Line/Hornchurch



## Alinco Scanner DJ-X1D

AM NFM/WFM 200kHz - 1300MHz

The DJ-X1 is produced by the famous ALINCO Corporation of Japan and is the toughest, smallest and most sensitive scanner we have ever offered. Ideal for both professional and hobby applications it fits snugly in the pocket and has proved a winner with our commercial customers. It is fully programmable and can monitor everything from Military aircraft to broadcast FM. It even has illuminated display and buttons! Superb value!

- ★ No gaps
- ★ 100 memories
- ★ Battery saver
- ★ Ni-cad and AC charger
- ★ Fully programmable
- ★ Helical whip
- ★ Strap and belt clip

Sensitivity 12dB SINAD 0.4uV  
Antenna 50 ohms bnc  
Steps 5 - 100kHz  
Size 110 x 53 x 37mm  
Weight 370g

Send for full colour leaflet

NOW WITH NICADS AND CHARGER

£329



### GLOBAL AT-1000

**Receiver ATU 500kHz - 30MHz**

This receiver ATU has been in production for over ten years and is still the best on the market! Its performance is excellent and is the sure way to improve your aerial matching problems when using random wires, balancing feeders or even coaxial fed systems. No aerial can hope to be a good match over the whole spectrum and you will only get maximum transfer of signal into your receiver when the aerial load presents a 50 Ohm impedance. This is just what the AT-1000 does. It also has provides the added bonus of improving the front end selectivity. An essential item.

**£89.95 carr £4.00**

## Professional Frequency Directories

The VHF/UHF Scanning Frequency Guide      Short Wave International Frequency Handbook

- \* Large A4 format
- \* 26MHz - 12,000MHz
- \* Thousands of frequencies
- \* Full Duplex information
- \* Air, sea and land stations
- \* Military and civil
- \* Government and commercial
- \* Emergency and security
- \* Official band plans
- \* Editorial and review

This is the long awaited replacement for our previous title, "The Complete Guide To VHF/UHF" which was sold to hobbyists and professional bodies. Now it has been completely updated and expanded. It's even better value and you will find it brimming with information. It's beautifully bound and printed and is a must for any VHF/UHF enthusiast's reference library.

**£9.95**      **£9.95**

160 printed pages Carriage £1.50 Phone your Access number NOW!  
192 printed pages Carriage £1.50 Phone your Visa number NOW!

## "It's Fantastic!" Optoelectronics 2300

1MHz - 2.4GHz  
Can read a 2W signal frequency at over 100ft!  
With 25 Watts .. WOW!

Simply switch on and connect an aerial to read

**£169.95** £3 post

frequencies from local transmitters. This is like no other unit you have ever seen. It's absolute magic!

- HIGHLY ACCURATE COUNTER
- BNC AERIAL SOCKET • INTERNAL NI-CADS • AC CHARGER • VARIABLE GATE TIME • HOLD FUNCTION
- AMAZINGLY SENSITIVE!

BACK IN STOCK

### MFJ - 722 Receiver Audio Filter

This filter will radically improve your short wave reception whether it be receiver or transceiver. Simply plug between audio output and speaker or headphones and hear the weak signal DX without the QRM! Uses 71C devices and provides full speaker output when fed with 12V DC. Far cheaper than conventional IF xtal filters and far more flexible. Used by DX'ers throughout the world, the MFJ filter will transform your listening pleasure.

- SSB high pass filters 2.5 - 2.0 - 1.5kHz
- CW band pass filters 180 - 150 - 110 - 80 Hz
- CW centre audio frequency 750Hz
- Notch filter 300Hz - 3kHz variable
- Notch bandwidth adjustable
- Straight Through Position

**£94.95** carr. £4.00

Full 1993 MFJ Catalogue now available. Please send large SAE for copy

## YUPITERU MVT-7000

**£369**

- 100kHz - 1300MHz No Gaps!
- 200 Memories in 10 Banks
- WBFM/NBFM/AM Selectable
- Dual Speed Scanning
- Variable Contrast Display
- Battery Saver
- Programmable Steps
- Signal Strength Bar Meter
- Superb Sensitivity
- 4 x AA Ni-cads Supplied
- AC240 Volts charger
- Cigar 12V Power Lead
- External 12V Socket
- Telescopic Whip
- Illuminated Display

SEND FOR FULL COLOUR YUPITERU LEAFLET

## FREE CREDIT! 20% deposit 12 months to pay. Phone Now!

### MVT-7100

**£449**

- AM, LSB, USB, NBFM, WBFM
- 530KHz - 1650MHz
- 1000 Memories
- 30 CH Per Second Scan
- 500 Search Pass Frequencies
- Signal Strength Meter
- Battery Save Function
- Tuning Dial
- 4 AA Nicads Supplied
- AC PSU Supplied
- Cigar 12V Power Lead
- Telescopic Whip
- Priority Function
- User Friendly
- Keypad Illumination

### VT-225

**£269**

- Military & Civil Airband Monitor
- Civil 108 - 142/149.5-160MHz
- Military 222 - 391MHz
- 100 Memories 10 Bands
- Scanning and Search Modes
- Delay and Lockout
- Priority Channel
- Memory Lockout
- Steps 10 - 25 - 50 - 100kHz
- Superb Weak Signal Reception
- Illuminated Display
- Power from 4 x Ni-cads
- 240V AC psu + 12V cigar lead
- BNC Helical Antenna & Strap
- Size only 127 x 35 x 58mm

### VT-125

**£189**

- Superb Civil Airband Monitor
- 108 - 142MHz
- 30 Memories
- High Quality AM Reception
- Scanning and Search Mode
- Priority Channel
- Memory Lockout
- Steps 25 - 50 - 100kHz
- Superb Weak Signal Reception
- Illuminated Display
- Power from 3 x Ni-cads
- 12V Cigar charger/supply lead
- BNC Helical Antenna & Strap
- Size only 57 x 127 x 35mm

SOFT CASES NOW AVAILABLE FOR ALL MODELS

## YUPITERU NOW AVAILABLE IN ALL MAPLIN STORES!

Birmingham	021 3848411
Brighton	0273 620930
Bristol	0272 232014
Cardiff	0222 464554
Chatham	0634 818588
Coventry	0203 550504
Edinburgh	031 3135551
Edgware	081 9510969
Forest Hill	081 2919192
Gateshead	091 4889555
Glasgow	041 3531838
Hammersmith	081 7480926
Iford	081 5990100
Leeds	0532 449200
Leicester	0533 623288
Manchester	061 2360281
Middlesborough	0642 242900
Nottingham	0602 410242
Portsmouth	0705 654411
Reading	0734 566638
Sheffield	0742 855492
Southampton	0703 225831
Southend	0702 392000

Sorry - Interest Free Credit not available through Maplin Stores

ICOM YAESU KENWOOD ALINCO

RADIO

# HAMSTORES

## SPECIAL EVENT DAY AT 'BIRMINGHAMSTORE'



Last year we claimed to have one of the best Ham Radio Showrooms in the country... this year we know we have. Come and see for yourself between 10am & 4pm on

### Saturday 18th September



Come and see how we have developed and help us celebrate our second year in Birmingham with a glass of Buck's Fizz and some nibbles, you might even get

**your teeth into a NEW RADIO!** There will be some **EXTRA SPECIAL DISCOUNTS ON OFFER PLUS...**

- Selection of second-hand radios
- 2m/70cms transceiver checks
- Video presentations on Amateur Radio
- Advice on the Radio Amateur's exam
- Guidance on the Novice course
- Local Radio Club representation
- Radio Station GB5IT demonstrating modes of operation including RTTY, PACTOR and PACKET
- Shortwave listening & weather chart reception
- Operating desks c/w rigs by all the major manufacturers
- Extensive stocks of new gear
- Scanning radio displays
- Mobile radio aerials and accessories
- Portable radios of all kinds
- Loads of Radio books
- Data sheets to mull over, in fact everything for Radio Hobbyists, be they listeners or transmitters
- ICOM Marine, Avionic and PMR radios will also be on display
- HAMSTORES stock AEA, AKD, Alinco, AOR, Barenco, Comet, Cushcraft, Davis, Dee Comm, Diamond, Icom, JRC, Kenwood, Lowe, Microset, MFJ, RSGB books, Toyo, Yaesu and Yupiteru gear
- Low deposit, interest-free credit is available on most radio purchases
- Gordon, John and Ray are all looking forward to greeting you on the 18th!



**BIRMINGHAM: (STORE IS JUST OFF M5 MOTORWAY AT JUNCTION 2)**

International House, 963 Wolverhampton Rd. Oldbury, West Midlands B69 4RJ.  
Tel: 021 552 0073 Fax: 021 552 0051. Also at...

**LONDON:**

11 Watford Way, Hendon, London NW4 3JL. Tel: 081 202 0073 Fax: 081 202 8873

**HERNE BAY:**

Unit 8, Herne Bay West Industrial Estate, Sea Street, Herne Bay, Kent CT6 8LD.  
Tel: 0227 741555 Fax: 0227 741742. N.B. Herne Bay closed for lunch 1300-1400.

**OPENING TIMES:** Mondays to Fridays: 09:00-17:00 & Saturdays: 09:00-16:00.

# Radio Stations Special

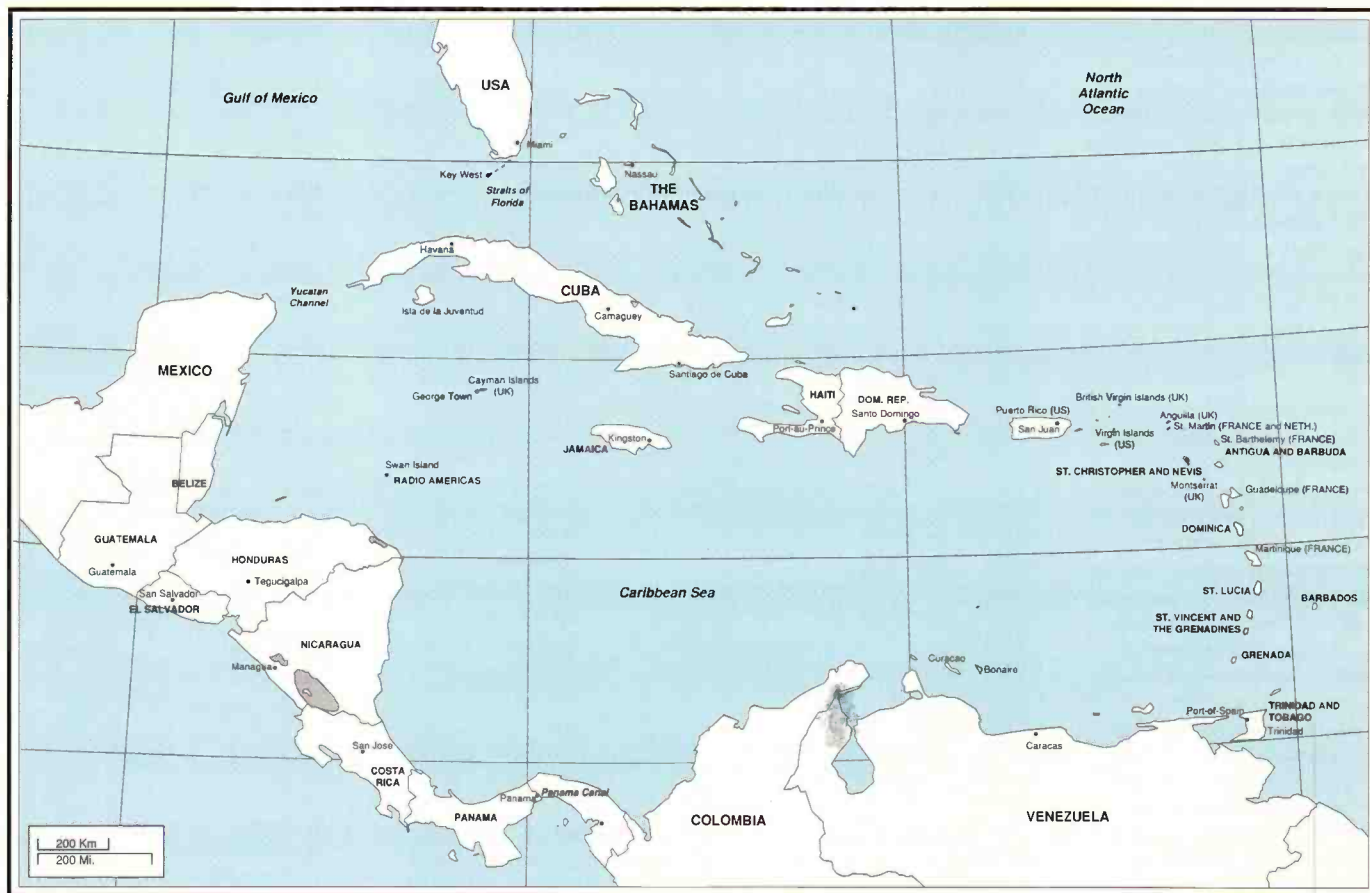

## La Voz del CID

Early 1981 saw the arrival of what was to prove the longest-running anti-Castro broadcaster La Voz de Cuba Independiente y Democratica - La Voz del CID - operated by the organisation Cuba Independence y Democratica. But it, too, heard an FCC knock on its door and was closed down. Its first transmitter was traced to a horse farm near Mirmar, Florida. CID, however, wasn't deterred. It was soon back on the air - this time from sites outside the country and thus out of the FCC's reach. Over the next couple of years CID grew into several separate services aimed at specific parts of the Cuban population - Radio Maximo Gomez was aired via the facilities of Radio Clarin in the Dominican Republic, Radio Ignacio Agramonte was a CID owned transmitter, apparently from Guatemala, operating on 5.106MHz, Radio Antonio Maceo was carried over Venezuelan shortwave station Ecos del Torbes. Other CID programmes and services included Radio Jose Antonio Echevarria, Radio Antonio Guitera, Radio Camilo Cienfuegos and Radio Frank Pais. There were several others, of briefer duration as well. Some were on the air for periods of several hours each day, others for as little as half an hour. All of the services were named

after Cuban heroes, martyrs and former resistance leaders.

Today, however, the station has done away with that rather cumbersome arrangement and uses mostly the Voz del CID identification. Its broadcasts run virtually around the clock and are thought to be from transmitters in Guatemala, running around 10kW. CID says its funding comes from American foundations, Latin American businessmen and other individual contributions. In 1988 CID announced plans to put Tele CID, an anti-Castro TV station on the air, broadcasting from a ship off the Florida coast but this plan never came to fruition. CID is headed by Huber Matos, an early member of the Castro government who later broke with Fidel and then spent 20 years in Cuban jails.

## Controversy

In 1985 the US government got back into the anti-Castro broadcasting game, putting Radio Marti on the air via Voice of America transmitters. Radio Marti is on the air 24 hours per day, programmed from studios in Miami. Castro threatened to retaliate and use his high power, medium wave transmitters to interfere with US clear channel stations and, in fact, did so briefly but did not stay to pursue the threat any further. TV Marti,

broadcasting from a transmitter in a balloon, began test broadcasts in March 1990 and regular operations a couple of months later. It had been plagued with controversy and technical problems.

## Mystery

A few months before Radio Marti began regular broadcasting another clandestine Cuban station came on the air, one which remains a mystery to this day. In the spring of 1985 US short wave DXers spotted a station on 9.920MHz which, night after night, played only music - mostly Latin vocals by a man with a voice which sounded like Nat King Cole, (but wasn't). These strictly music broadcasts went on for several months. Then, in September, after some six months of playing nothing but music the station began to speak. It called itself Radio Caiman (alligator) and signed on and off with the Latin classic *Siboney*. The programming took a soft sell approach and still consists largely of music. Unofficial direction finding placed the transmitters in Guatemala. Radio Caiman continues to broadcast, though not with as long a schedule as it once had. The station's technical aspects, its production, its sound are all highly professional. Eventually a group calling itself 'Pro

Libertad de Cuba' claimed to be operating the station but the group seems not to have a home location or address. And the broadcasts never make any mention of 'Pro Libertad de Cuba' or any other sponsoring organisation, nor is an address or studio or transmitter location announced. So Radio Caiman is almost as much a puzzle today as the day it first began its programmes. It continues to provide strong, regular reception in North America and its widely heard in Europe.

The Cuban American National Foundation began broadcasting a programme called 'La Voz de la Fundacion' in late 1989, carried at first via Radio Clarin in the Dominican Republic on 9.950MHz. It followed that by purchasing air time on missionary station WHRI in Indiana and its broadcasts now amount to six hours per day, fed to the station via telephone link from studios in Miami.

## New Path

CANF's purchase of airtime from a licensed short wave broadcaster lit up a new path, a new way for exile groups and the like to get on the air and do their thing legitimately. They no longer had to hide or operate with erratic schedules or from mobile studios in hopes of out foxing the FCC.

# Radio Stations Special

The first to follow CANF was Alpha 66, which, having been closed down by the FCC on at least two previous occasions, could now broadcast regularly and without worry. Alpha 66's programming is now described as education and news analysis. Programmes are taped and sent to WHRI. A different version is on Tennessee short wave station WWCRC, which is recorded just a few hours before it is broadcast.

## Broker

WWCR, yet another religious broadcaster, soon found that Cuban and other political interest groups were a source of steady income, and added broadcasts by three different Cuban groups in the early part of 1991. Then a third party got into this act and began to actively seek out groups who wanted to broadcast their story to Cuba. Radio Miami International, already had an application for a short wave station on file with the FCC (it has since been granted). RMI began seeking out these exile groups and acting as a broker between the groups and the stations, taking a fee for their services. RMI also places some of the broadcasts on New Orleans short wave station WRNO. At present, Radio Miami International has a healthy list of Cuban groups on one or more stations:

## Special Messages

*Esperanza* is the programme of the Municipalities of Cuba in Exile (Municipios de Cuba en el Exilo) and features world and Cuban news, discussion of news and commentary and a feature which focuses on a different Cuban municipality each day. Also included are special messages for members of the Cuban military urging them to stop supporting Castro.

*Radio Conciencia* is produced and presented live by the Cuban National Commission live and often features interviews with people favouring a change to democracy in Cuba. It also publicises the activities of dissident groups inside Cuba.

*Radio Voluntad Democratica* broadcasts on behalf of the Partido Revolucionario Cubano Autentico (Authentic Cuban Revolutionary Party) which has been active since before Castro came to power. The programme includes a regular segment on human rights violations within Cuba.

*Rubo A La Libertad* is the programme of the 2506 Brigade, the military group which invaded the Bay

## Anti-Castro Broadcasts by Frequency

MHz		Times (UTC)
6.030	Radio Marti	0600-0930
6.070	Radio Marti	0930-1200
6.305	La Voz del CID	0210-0930
7.080	occasional use by Miami based clandestine stations	
7.340	La Voz del CID	2300-1100
7.355	Radio Conciencia (via WRNO)	0100-0200 Tu-Sat
7.355	Rumbo a la Libertad (via WRNO)	0200-0300 Tu-Sat
7.355	La Voz de Alpha 66 (via WRNO)	0300-0359 Tu-Sat
7.355	La Voz de Alpha 66 (via WHRI)	0800-0900 Tu-Sat
7.355	Radio Periodico Panamericano (via WRNO)	0300-0400 Mon
7.355	Un Solo Pueblo (via WRNO)	0400-0459 Mon
7.395	Movimiento 30 de Noviembre (via WRNO)	0400-0430 Tu-Sat
7.435	La Voz de Tribuna Libre (via WWCRC)	0100-0200 Mon
7.435	Radio Voluntad Democratica (via WWCRC)	0200-0259 Mon
9.495	La Voz de Fundacion (via WHRI)	0100-0400 Tu-Sun
9.495	La Voz de Alpha 66 (via WHRI)	2300-0000 Mon-Fri
9.525	Radio Marti	2300-0600
9.590	Radio Marti	1200-1400
9.850	La Voz de Fundacion (via WHRI)	1000-1300 Tu-Sun
9.941	La Voz del CID	0940-0210
9.965	Radio Caiman	1200-1530
9.965	Radio Caiman	2300-0400
11.635	La Voz del CID	1100-2300
11.930	Radio Mari	1400-2300
15.690	Alternativa (via WWCRC)	2315-2330 Sun
15.690	Pueblo Libre (via WWCRC)	2330-0059 Sun

of Pigs. It focuses on news and commentary and interviews with brigade members or other Cuban exiles.

'La Voz del Movimiento 30 de Noviembre' or voice of the 30th of November Movement began a regular programme of WHRI just last December.

*Alternativa* is produced by the Cuban Democratic Revolutionary Movement (Directorio Revolucionario Democratico Cubano) featuring interviews and discussions and analysis of news. Aired live, the show is aimed more at younger Cubans.

*Pueblo Libre* is the voice of the Junta Patriotica Cubana which has operated its own clandestine transmitters in the past. The show centres on the activities of the Junta and its many member groups and has, from time to time, broadcast coded messages to Cuba.

*La Voz de Tribuna Libre* is produced by the Cuban Alliance (Alianza Cubana) and contains news, features, segments, segments for young people and editorials.

*Radio Periodico Panamericano* is a weekly produced by Caribe Infopress, based in Miami, and is closely allied with an umbrella organisation of exile groups under the name Plataforma Democratica Cubana. They urge the creation of a dialogue with Castro, which they hope would eventually

lead to free elections. Among the several weekly features is a report from the Latin American Service of Radio Moscow.

*Un Solo Pueblo* is from the Social Democratic Co-ordinating Committee (Coordinadora Social Democrata) and includes international and Cuban news and news of some of the exile groups. This organisation is a member of the Plataforma Democratica Cubana and thus takes a liberal approach to creating change of island.

If and when Castro's government falls we can expect most of these clandestine stations and programmes from exile groups to disappear from the airwaves. As of early this year experts were using the term 'freefall' to describe the state of the Cuban economy. Castro is reported to be cracking down hard on dissidents, at the same time trying to raise the spectre of a coming invasion by the US.

It isn't hard to imagine that a blow-up is on the way within Cuba, and with it perhaps, the beginning of the end of the Castro era. That makes right now 'prime time' for adding these broadcasters to your reception log and their QSLs to your collection!

The author thanks Mr Jeff White of Radio Miami International for information on the various Cuban exile programmes and groups handled by RMI.

## Addresses

**La Voz de Alpha 66**  
PO Box 420067  
Miami, FL 33142

**La Voz del CID:**  
Cuba Independiente y  
Democratica  
10200 SW 37th Terrace  
Miami FL 33165

or

Apartado 8130  
San Jose 1000  
Costa Rica

**La Voz de Fundacion**  
Cuban American National  
Foundation  
7300 NW Terrace, Suite 104  
Miami, FL 33144

**Radio Marti**  
400 - 6th St. SW  
Washington DC 20547

**Radio Caiman - unknown**

**Esperanza**  
Municipios de Cuba en el Exilio  
c/o Radio Miami International  
8500 SW 8th St., Suite 252  
Miami FL, 33144

**Radio Conciencia**  
Cuban National Commission  
Via Radio Miami International

**Rumbo A La Libertad**  
2506 Brigade  
Via Radio Miami International

**La Voz del Movimiento 30 de Noviembre**  
November 30th Movement  
via Radio Miami International

**Alternativa**  
Cuban Democratic Revolutionary  
Directorate  
via Radio Miami International

**Pueblo Libre**  
Junta Patriotica Gubana  
via Radio Miami International

**Radio Voluntad Democratica**  
Partido Autentico  
via Radio Miami International

**Radio Periodico Panamericano**  
Caribe Infopress  
via Radio Miami International

**Un Sol Pueblo**  
Social democratic Co-ordinating  
Committee  
via Radio Miami International.

# UNIVERSAL M-8000 DECODER

*Top-the-line decoders may be out of the reach of many pockets, but it's great to dream! Mike Richards has a look at the impressive M-8000 from Universal Electronics.*

Anyone who follows my 'Decode' column will know that decoding systems come in all shapes and sizes. They range from a simple Verobox for some of the computer based systems, through to the M-8000, which must be the ultimate in push-button technology! The M-8000 stands at the top of the Universal product range and, as you would expect, carries an impressive price tag of £1199.95. However, it boasts a very wide range of facilities and, will appeal to those who would rather keep away from computers.

So what does it do? In simple terms, it connects to the audio output of your receiver and decodes signals for display on a printer and/or a video monitor. The M-8000 is able to process Morse, RTTY several ARQ modes, FAX, Packet and pager systems.

To help the operator discover the various modes, the M-8000 is supplied with a very comprehensive owner's manual. This spiral bound A4 book comprises 101 well laid-out pages, with a clear index system. The sections dealing with the more complex modes are accompanied by a handy frequency list for each mode. Having tried a few of these they appeared to be reasonably well up-to-date and ideal for the new user.

## Push-Button Mania!

Well, what about that front panel? It's certainly good for impressing your friends, but what do all those buttons and lights do? In practice this very effective design enables the operator to change many of

the M-8000's parameters very rapidly. As you can see from the photograph Fig.1., each of the keys is labelled to indicate its function. Some of the labels are obvious, e.g. SPEED, but others will take a little getting used to. The secret, as with any complex equipment, is to take time to explore all the modes. I found that after only a few hours of use, I had memorised all the important operating controls.

Selection of the required receive mode is done with the MODE key which cycles through the available options. A quicker way to do this is to take advantage of the function buttons and use the mode menu. To select a mode you just enter the appropriate menu number using the number buttons on the right-hand push button set. This is a very quick and easy way to change the operating mode.

Perhaps the most common adjustments required by the utility listener are to the speed and shift settings. The M-8000 handles these with a number of options. The most basic involves toggling through the preset speeds and shifts for the selected mode using the front panel SPEED and SHIFT keys respectively. Closely linked to these, the T/S or Tone Select key enables different tone sets for a given shift.

Although the M-8000's ability to make manual selections of the operating parameters is great for the experienced operator, it does require a certain amount of technical understanding. To counteract this, Universal have included a couple of facilities to make life a little easier. The first of these is the TUNE



Fig.1: Mode Memory Screen

option. Pressing this key on the front panel causes the M-8000 to analyse the signal and automatically tune the decoder to the incoming signal. For this option to work successfully you first have to roughly tune the receiver. I found that the M-8000 is happy providing I was within about 500 or 600Hz of the correct tuning point. The time taken for this operation depended on the quality of the signal and the degree of mistuning, but averaged around ten to fifteen seconds. As an added bonus, the M-8000 reports the revised mark and space frequencies and the shift of the signal.

Closely related to the TUNE function and just as useful, is the SRO or Speed Read Out. This is activated with a single key press and attempts to measure the baud rate of the signal. On pressing TUNE with F2 active, the M-8000 not only matches the filters to the signal but also measures and sets the baud rate. This very powerful and convenient feature will appeal to all users. For those who want total control, both the tones and baud rate may still be manually set.

In addition to the vast array of keys, the front panel includes a number of l.e.d.s providing supplementary information. The main

bargraph display has two switchable functions - 'Tune' and 'Input level'. The tune option operates from the output of the mark/space detectors and so is very dependent on the mark/space ratio of the signal. In practice, it could only really be used as a tuning indicator for signal with an even mark/space ratio such as a RTTY station sending RYs. In its other role as an input level monitor, it shows the level by illuminating l.e.d.s from left to right. This is very effective and the fast response time of the display is particularly good. Perhaps the most useful of the tuning indicators is the pair of mark/space l.e.d.s. These are driven by the mark and space detectors and flicker in sympathy with the incoming signal. Although this may sound rather crude, it's one of the oldest and most effective tuning systems. However, you do have to set the shift to get the best from this system. The remaining l.e.d.s are self explanatory and indicate the status of the received information. The only other control is a single rotary knob sat in the centre of the panel. This is the audio gain control and is particularly useful when receiving level-sensitive a.m. weather pics or the pager modes.

## Interconnections

To support the M-8000's comprehensive range of facilities, there are a number of optional connection points on the rear panel. Perhaps one of the key points to check is the voltage setting for the a.c. mains power supply. The review model is supplied with this set to 115V!

To support the comprehensive display capabilities of the M-8000 a VGA computer monitor is needed. The connection for this is a standard mini 15-pin D connector. To connect the receiver audio, a pair of 6.3mm input jacks are provided. Although either input could be used for the receiver there are some special features associated with input 2 that optimise it for v.h.f. use. This second input uses a stereo jack with the ring fed to a special circuit designed to provide special conditioning for pager signals.

Printer support is through a, now standard, 25-way D connector for parallel printers and a not-so-standard serial port. Printer types supported are Epson compatible 9 and 24-pin dot matrix and HP LaserJet laser printers.

Should a serial printer be required, the connection is via the 15-pin accessory jack. This jack also provides access to a number of other advanced options. Those of you with computer driven shacks can use the auxiliary jack to provide remote control the M-8000. An external X-Y tuning scope, or even an external decoder can also be connected.

## High Resolution Display

One of the main changes over previous decoders is the use of a computer VGA display system. This provides a significant improvement in display features over traditional composite monitors. The M-8000's video output provides 640 x 480 pixel resolution with sixteen colours (Fig.2).

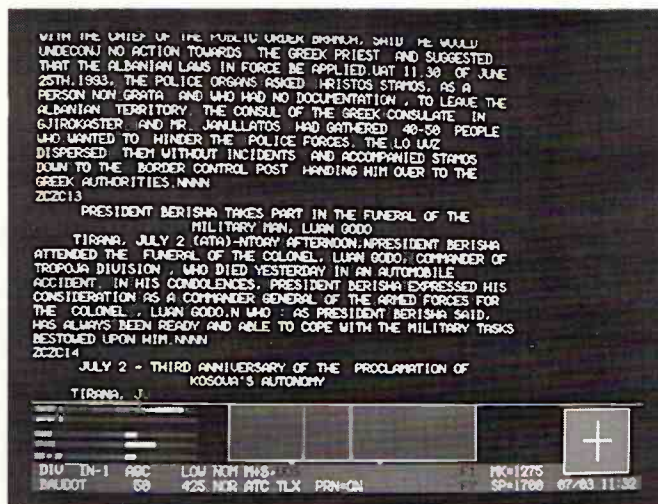

Fig.2: Press RTTY reception using the M-8000.

When decoding RTTY-type signals, the display area is divided into twenty-six rows of text with the rest set aside for graphics tuning and status information. Included within the graphics section is a spectrum analyser style display. This shows a band of audio frequencies with the vertical display showing the duration of the signal, not its amplitude. This display proves particularly useful when using the auto tune facility. I found that as long as the signal is shown on the analyser the auto tune would capture it. For use as a main tuning indicator, however, the response time is rather too slow. Next to the analyser is a simulated X-Y tuning scope. This operates on the decoder output and produces a perfect + when the tuning is correct. As with the analyser, the response time is a little slow, restricting it to fine tuning corrections rather than main tuning.

Also included on the display are a selection of bargraphs operating from the input signal. Two of these show the respective signal levels, whilst another three display mark space combinations. One very simple but useful feature is the inclusion of the current time and date in the bottom right hand corner. This is particularly useful for checking FAX schedules.

The M-8000 also features scroll inhibit and a form of video squelch, both designed to optimise the use of the screen and prevent it becoming cluttered with

rubbish or messages scrolling off the screen.

## User Programming

With so many options available within each operating mode the M-8000 has a programming mode so that your most used settings can be stored. There are a total of nine memories, each of which can store the full operating conditions, including any non-standard settings such as speed or shift.

One other interesting feature of the programming section is its ability to select what Universal call 'Sel-calls' With this system up to three different character strings can be entered to act as a search pattern for the printer output. As an example, if you wanted to print out all the AAXX-prefixed SYNOP reports, you would set the 'Sel-call' to AAXX. The M-8000 then monitors the decoded text, but only sends output to the printer following receipt of the AAXX string. For the system to work properly you also have to set a 'Sel-call' to stop the printing. In this example you would set this to NNNN, the standard code indicating the end of a message. There are, doubtless a thousand-and-one other uses for this interesting extra.

## Common Modes

Let's now take a more detailed look at the main operational features of some of the more common utility modes.

Decoding Morse

transmissions is particularly simple with the M-8000. Once selected, this mode accepts a single tone input that can be set to either 750 or 1000Hz. Correct tuning is shown by the MORSE l.e.d. flashing in synchronisation with the received signal. The only adjustment required on the M-8000 is to ensure that the input level is correctly set. Speed tracking is automatic, with just three pre-set ranges: slow, medium and high. In practice, the medium setting handles all but the very fast or very slow. The decoder locks very quickly and produces well spaced and relatively error free text. For the very best performance it is also worth using a narrow filter in your receiver.

RTTY is probably one of the modes most used by utility listeners. Despite the various spectrum and X-Y tuning aids, I found the quickest method is to use the Mark and Space l.e.d.s on the front panel. The alternative is to roughly tune by ear and use the automatic speed and shift to finish the job. Once tuned-in, the decoder proves very capable, with low error rates even with quite poor signals. There is also the ability to decode from either mark or space only. This could be very helpful when suffering interference from an adjacent station. The M-8000 includes a number of standard features such as Unshift On Space, CASE toggle and a number of alphabets including Cyrillic.

Maritime enthusiasts will be pleased to hear that the M-8000 is well equipped for ARQ reception. There are three modes to support this: ARQ, FEC and AUTOR. Whilst ARQ and FEC provide direct reception of these modes, the AUTOR is likely to be the most used as it provides automatic detection of FEC and ARQ and is very quick and convenient. As with RTTY, the best tuning technique is to use the Mark and Space l.e.d.s. The M-8000 showed a very fast synchronisation time averaging around two seconds.



## MVT 7100

### Specifications

- NFM / WFM / AM / LSB / USB
- 530 KHz – 1650 MHz
- 1000 memory channels
- 500 search pass frequencies
- 10 search bands
- 30 channels per sec. scan speed
- 12v d.c. or 4 x AA power supply
- Back-lit l.c.d. & buttons

**VERY SPECIAL PRICE  
RING FOR QUOTATION**

## SANGEAN Portable SW Antenna ANT 60

- Greatly improve reception power of portable shortwave receiver
- Easy hookup to snap onto telescoping rod antenna or plug into radio's external AM antenna jack extends to 7 metres (23 feet).
- Portable for indoors and outdoors.
- Suitable for all kinds of shortwave radios.



**FREE**  
with every purchase of  
Sangean  
ATS 803A

**£14.99 FREE POST AND PACKING WITH THIS ISSUE ONLY**

## SKY SCAN

### Desk Top Antenna Model Desk 1300

Built and designed for use with scanners. Coverage: 25 to 1300MHz. Total height – 36ins – 9ins at widest point. Comes complete with 4 metres of RG58 coax cable and BNC connector fitted.. Ideal indoor – high performance antenna and can also be used as a car antenna when your car is static. REMEMBER YOUR SCANNER IS ONLY AS GOOD AS YOUR ANTENNA SYSTEM!



**£49.00 + £3.00 p&p**

### SKY SCAN V1300 Antenna

Most discons only have horizontal elements and this is the reason that they are not ideal for use with a scanner. Most of the transmissions that you are likely to receive on your scanner are transmitted from vertically mounted antennas. The Sky Scan V1300 discone has both vertical and horizontal elements for maximum reception. The V1300 is constructed from best quality stainless steel and aluminium and comes complete with mounting pole. Designed and built for use with scanners.



**£49.95 + £3.00 p&p**

### SKY SCAN Magmount MKII

For improved performance, wide band reception, 25 to 1300MHz. Comes complete with protective rubber base, 4m RG.58 coax cable and BNC connector. Built and designed for use with scanners.



**£24.95 + £3.00 p&p**

### NEW 100 Channel Scanner £199.99

Netset PRO-46. Covers 66-88, 108-136.975 (AM), 137-174, 406-512 and 806-956 MHz. LCD display with backlight, search, priority, lockout, scan-delay, memory backup circuit. Belt clip. Requires 4 "AA" batteries or Adaptor. 20-9305



### NEW 50 Channel Scanner £149.99

Netset PRO-44. Covers 66-88, 108-136.975 (AM), 137-174 and 380-512 MHz. LCD display with backlight, search, lockout, scan-delay and keyboard lock. Memory backup circuit for changing batteries. Belt clip. Requires 6 "AA" batteries or AC/DC Adaptor. 20-9304



### NEW 200 Channel Scanner £219.99

Realistic PRO-39. Covers 66-88, 108-136.975 (AM), 137-174, 380-512 and 806-960 MHz. Hyperscan search and scan, 10 channel monitor back, priority, lockout, scan-delay, LCD display with backlight. Memory backup circuit. Belt clip. Requires 6 "AA" batteries or AC/DC Adaptor. 20-9303



Pro 2006 £299

Pro 43 £249

## SCANNERS

**Yupiteru MVT7100**  
SEPT. SPECIAL OFFER PHONE?

**Yupiteru MVT7000**  
SEPT. SPECIAL OFFER PHONE?

**Yupiteru VT225**  
SEPT. SPECIAL OFFER PHONE?

**Yupiteru VT125**  
SEPT. SPECIAL OFFER PHONE?

**Fairmate HP2000**  
SEPT. SPECIAL OFFER PHONE?

**Nevada MS1000**  
SEPT. SPECIAL OFFER PHONE?

**AOR 3000A**  
SEPT. SPECIAL OFFER PHONE?

**AOR 2000**  
SEPT. SPECIAL OFFER PHONE?

**AOR 1500EX**  
SEPT. SPECIAL OFFER PHONE?

### FAIRMATE HP2000

STILL ONE OF THE MOST POPULAR HANDHELD SCANNERS ON THE MARKET. Over the last year the HP2000 has outsold almost all other models.

- ★ Continuous coverage from 500kHz to 1300MHz
- ★ 1000 channels of memory
- ★ Keypad or rotary control
- ★ AM, FM and WIDE FM modes
- ★ Search steps from 5 to 99.5kHz

#### EVERY SET COMES COMPLETE WITH:-

Full set of high power NiCads, 2 antennas, carrying case, earphone, DC cable, belt clip and strap, UK charger

September Special Offer ...£PHONE



### PRO 43 HAND-HELD SCANNER

Frequency coverage:  
68-88MHz (in 5kHz steps) 225.0125-400MHz (in 12.5kHz steps)  
118-136.975MHz (in 25kHz steps) 400.0125-512MHz (in 12.5kHz steps)  
137-174MHz (in 5kHz steps) 806-999.9875MHz (in 12.5kHz steps)  
220-225MHz (in 5kHz steps)

Channels of operation: Any 200 channels in any band combinations (20 channels, 10 banks) and 10 monitor channels.

#### SPECIAL OFFER PRICE

**£229.95 + £5P&P LIMITED STOCK**



### YUPITERU MVT 7000 HANDHELD

PROBABLY THE UK'S MOST POPULAR HANDHELD SCANNER!

- ★ Receives 8 to 1300 MHz 100kHz-1300MHz (at reduced sensitivity)
- ★ 200 Memory channels
- ★ Rotary or keypad freq. control
- ★ AM/FM/NFM
- ★ Large display with signal strength meter

EACH SET IS SUPPLIED COMPLETE WITH:-  
Full set of high power NiCads, AC charger, DC power lead and carry strap.

September Special Offer ...£PHONE



### AOR SCANNERS

#### AR1500 HANDHELD

Covers 500kHz to 1300MHz receiving NFM, WFM, AM, and SSB. Supplied with a large selection of accessories including:-

- ★ Charger
- ★ Dry cell battery case
- ★ 5 mtr LW antenna
- ★ Ear piece
- ★ Soft case

September Special Offer .....£PHONE



Mail Oder: SRP Trading, Unit 20, Nash Works, Forge Lane, Belbroughton,  
Nr. Stourbridge, Worcs. Tel: (0562) 730672. Fax: (0562) 731002

Shop: SRP Radio Centre, 1686 Bristol Road South, Rednall, Birmingham B45 9TZ. Tel: 021 460 1581

# LOWE ELECTRONICS

*Yupiteru Scanner  
Specialists*

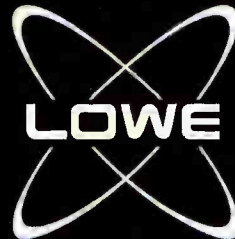

## *The new MVT7100... ...the ultimate scanner!*

**MORE MODES:**  
AM/FM/WFM/USB/LSB

**MORE FREQUENCIES:**  
100kHz to 1650MHz (no gaps!)

**MORE MEMORIES:**  
1000 Channels

Plus:

Delay and skip functions

High speed search

10 search bands

Three-way tuning

Fast scan speed

Ultra-fine tuning

Priority scan

User friendly

Attenuator

**IN STOCK NOW!**

*Complete with:*

- Belt clip
- Earphone
- Wrist strap
- Car cigar lead
- Mains charger
- Nicad batteries
- Telescopic antenna and  
Lowe's famous service  
and back-up!

*Receives: Utilities*

- TV sound
- Marine band
- Civil airband
- Military  
airband
- Broadcast radio
- Emergency services and  
many more local and  
international services

### **SPECIAL OFFER**

1992 Edition of "POOLEYS FLIGHT GUIDE"  
This "Aviator's Bible" contains details of all UK airfields, all ground, tower, approach and radar frequencies, all lower airspace and radar information, airways frequencies, private airstrip locations and much, much more.  
This is last year's edition but almost all data is still correct.

Normal Price £16.50

**OFFER PRICE £4.00**

plus £2.00 Post & Packing (It's heavy with information!)

# LOWE ELECTRONICS LTD

CHESTERFIELD ROAD, MATLOCK, DERBYSHIRE, DE4 5LE

Tel. 0629 580800 Fax. 0629 580020

(HEAD OFFICE, MAIN SHOWROOM & MAIL ORDER DEPARTMENT)

Branches at: Bournemouth - 0202 577780, Bristol - 0272 315263, Cambridge - 0223 311230,

Cumbernauld - 0236 721004, Heathrow - 0763 545265, Leeds - 0532 452657,

Maidstone - 0622 692773, Newcastle - 0661 860418,

NEW BRANCH - Plymouth - 0752 607284



Last of the common modes is Packet data, in which the M-8000 can be set to receive data at either 300 baud for h.f. or 1200 for v.h.f. I must say I found the tuning particularly tricky with this mode. The problems are caused by a combination of the slow response of the tuning displays and the short duration of the packet signal.

However, with a bit of practice, I mastered it.

## Powerful FAX

The M-8000 features a particularly comprehensive FAX reception system. Not only can it accept conventional h.f. images, but it can also receive the a.m. images from orbiting satellites. As with all

### Specification

#### Modes and Speeds

Morse	5 to 120w.p.m. auto ranging
Baudot	45, 50, 57, 75 and 100 baud plus variable
Packet	300 and 1200 baud AX25
SITOR	Mode A and B (FEC collective and selective) 100 baud plus variable
FEC-A	96, 144 and 192 baud plus variable
FEC-S	96, 100, 144, 192 and 200 baud plus variable
ARQ-M2	86, 96 and 100 baud plus variable
ARQ-M4	172, 192 and 200 baud plus variable
ARQ-E	48, 64, 72, 86, 96, 144 and 192 baud plus variable
ARQ-E3	48, 64, 72, 86, 96, 100, 192 and 200 baud plus variable
ARQ-S	86, 96, 100, 172, 192 and 200 baud plus variable and 4, 5, 6 or 7 character groups.
SWED	100 baud plus variable
Databit	Asynchronous and synchronous 4,5,6,7,8, pr 9 bits per character
Bit Inversion	Baudot codes
Three Shift Cyrillic	Baudot and video output only
Literal Display	Baudot and video display only
POCSAG	Digital pager code
GOLAY	Digital pager code
PICCOLO	Multi-tone teleprinter code
FAX	60, 90, 120 and 240 l.p.m. 288, 440 and 576 IOC
Filter Tones	High 2125, Low 1275 fixed shifts 60, 85, 170, 425, 850 and 1200Hz
Variable Shift	60 to 1250Hz in 5Hz steps
Modem Tones	Seven standard modem tone pairs.

#### VFT

Four standard f.d.m. channelisation schemes

#### Inputs

Two channels 4 - 600Ω 250mV p-p plus pager audio

#### Aux

External demodulator

#### Outputs

Video VGA colour, 26 lines of 80 characters excluding status and graphics.

#### Printers

Mil or EIA levels and parallel ASCII with handshaking

#### Power Requirements

115/230V a.c. 50/60Hz 25W max.

#### Size

409 x 88 x 269mm deep

#### Weight

4.1kg approx.

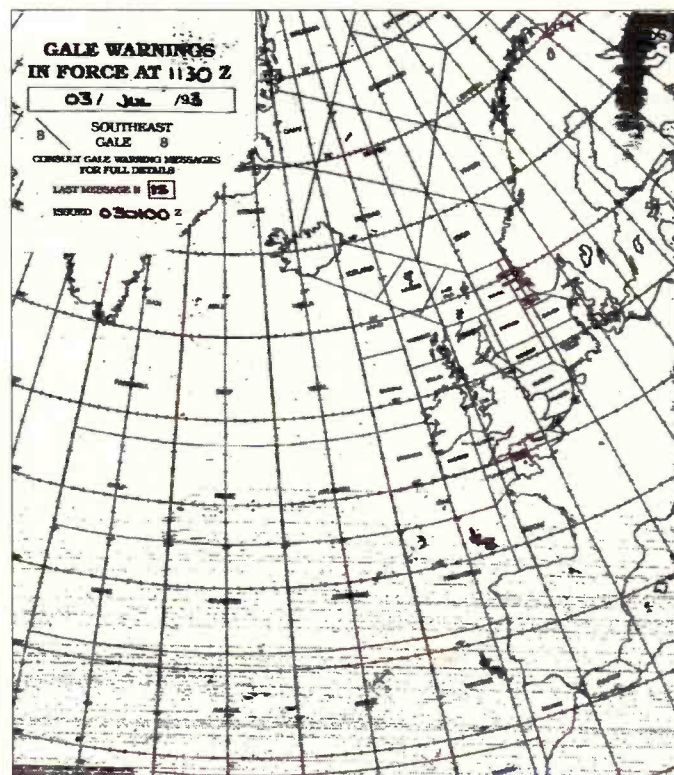

Fig.3: FAX reception. Chart from Northwood.

modern FAX systems automatic picture reception is possible with the IOC set according to the transmission start tone. The only odd point is the way in which the end of a picture is detected. The conventional technique is for the decoder to stop when the 450Hz stop tone is detected. Instead of using the stop tone, the M-8000 stops printing when it detects the ten second idle pause. Although fine for the vast majority of signals, it could occasionally be fooled by some transmissions that include a delay between consecutive charts. This was also a problem when trying to receive l.f. FAX images as these typically use a  $\pm 150$ Hz shift and didn't seem to register strongly enough to keep the auto-stop software at bay. As a result, tuning l.f. signals is very difficult. However, as there is only one station left on l.f. this is not that serious a problem.

During the review, the internal clock remained extremely stable and there is no skewing of the received charts. The techniques for printing FAX images depend on the type of printer used. If you are running with a HP compatible laser printer you can choose to print images

after they had been received using the screen dump option. With dot matrix printers, however, you can only print during reception. Although this is not the most convenient system, the resultant charts are very good quality. In addition to the default monochrome display you can cycle through black and white and a number of colour modes, the later being useful for showing temperature gradients on infra-red satellite images.

Those interested in satellite weather pictures will find the a.m. FAX mode very interesting, being delightfully simple to use and capable of producing excellent images.

## Advanced Modes

No top level decoder would be complete without a selection of the more obscure decoding modes thrown in for good measure. The M-8000 includes most of the well known ARQ modes - ARQ-E, ARQ-E3, SWED-ARQ and the multi-channel ARQ M2 and M4 systems. All of these worked very effectively, thanks to the good internal filtering. One of the problems commonly associated with these modes is difficulty in synchronising.

The M-8000 overcomes this with a manual synchronisation mode that works extremely well. With the two and four-channel t.d.m. systems, channel selection is achieved with a simple key press.

I was particularly impressed by the M-8000's ability to handle v.f.t. signals. This mode is accessed by first selecting RTTY and then pressing the VFT button. It is then possible to cycle through the twelve or twentyfour channels with ease. All the standard channel spacings, e.g. 60, 85, 120 and 180Hz, are supported.

The sophisticated Piccolo multi-tone system is notoriously difficult to tune, but not with the M-8000, since it includes a special tuning mode that provides a five segment tuning display. All you need to do is adjust the receiver's tuning so that the tones align with the display. As the tuning is so critical, there is provision to shift the filter frequencies in 1Hz steps.

As with many of the complex modes, once a signal has been decoded you will often find that the traffic is encoded.

### **Pager Decoding**

Two interesting new modes featured in the M-8000 are the POCSAG and GOLAY radiopaging systems. These are widely used in the v.h.f. bands and carry a wide range of traffic. There are a few problems associated with the low frequency content of pager transmissions., which is where the special input associated with the ring of Input 2 comes into its own. This provides a degree of correction that aids reception. I found that you just need to be careful with the audio levels to secure clean decoding.

### **Analysis**

Just to complete the range of facilities, the M-8000 boasts a couple of analysis modes to

help the more advanced listener. These are based around straightforward bit analysis of the signal. Whilst the system is adequate for basic signal identification, a thorough understanding of data transmission techniques is necessary. As mentioned earlier, one of the most useful analysis modes is the auto-tune speed-shift measurement. Once the speed and shift of a station are known it is relatively easy to narrow down the mode.

### **Summary**

The M-8000 is a comprehensive decoding system with a particularly wide and interesting range of operating modes. Although the front panel appears very complicated, once mastered, it provides very efficient access to the operating parameters. The signal processing abilities of the decoder are also very good and it is able to work successfully, even with quite

poor signals. During the review I found that the performance could be further improved by the addition of external audio filtering such as the FL2/3 from Datong. There are no poor areas, though I would like to see better use made of the front panel bargraph display to aid tuning of packet and ARQ signals. I'm sure that FAX reception could be improved by using the stop tone to end a transmission and maybe adding the facility to print out to a dot matrix printer after reception. These few items would finish off what is already a fine decoder.

The Universal M-8000 costs £1199.95 inc. vat and is available from **Martin Lynch, 286, Northfield Avenue, Ealing, London W5 4UB.** Tel: (081) 5661120. My thanks to Martin Lynch for the loan of the review model.

# ELIMINATES SEARCHING, SCANNING & TUNING INTERCEPTOR

## INTERCEPT, DETECT AND CAPTURE NEAR FIELD TRANSMISSIONS

Follows and locks on to all FM two-way transmissions and even follows when frequency changes.  
Does not have to tune through RF spectrum to find signals.

*FCC classified as Communications  
Test Instrument for:*

- Deviation, WFM, NFM
- Relative signal strength
- Modulation monitor
- Great for testing VHF, UHF and Cellular transmitters

A new dimension in recreational monitoring, also suited to many commercial and security applications

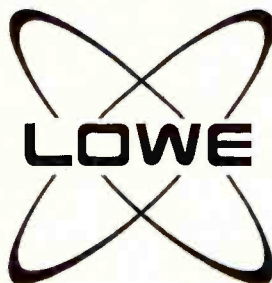

*Available new from  
UK Distributors:*  
**Lowe Electronics Ltd**  
Chesterfield Road  
Matlock  
Derbyshire DE4 5LE  
Tel 0629 580800  
Fax 0629 580020

TRADE & COMMERCIAL ENQUIRIES INVITED

# Optoelectronics R10 FM Communications

*Once in a while an interesting piece of radio equipment turns up for review. The R10 FM Communications Interceptor falls into this category.*

The new R10 FM Communications Interceptor from Optoelectronics is a rugged, hand-held, f.m. only 'receiver' of unconventional concept and design. For a start there is no means of tuning the receiver - in fact the only controls are two edge-knobs - volume/on-off and squelch - and two push buttons, one to change the deviation range and the other to skip a signal. These are mounted on the top panel together with the BNC antenna socket, phone socket and two small l.e.d.s to indicate that power is on and a signal has been locked onto. The front of the set has two bargraph displays. The vertical one shows the deviation of the received signal, while the other, set at 45°, indicates signal level. A 50mm speaker

lurks behind a series of slots in the front panel. Apart from a power socket in the side for the charger plug, that is all. No means of tuning and no indication of the frequency of the signals being received! Power is from built-in, NiCad rechargeable batteries.

The frequency coverage of the Interceptor is quoted as 30MHz to 2GHz. The sensitivity has been purposely set so that it will only detect strong, local signals. This prevents it being paralysed by the vast number of f.m. signals around, particularly in built-up areas.

### Uses

To use the Interceptor just extend the telescopic whip antenna, switch on and listen. The only adjustments that can be made are to volume, squelch threshold and 'full scale' deviation, which can be set to be either 10 or 100kHz full scale

Out in the country the only signals the Interceptor wanted to lock onto were from a local amateur 144MHz packet station about 400m away - not very interesting.

The unit would be of most use as a piece of test gear,

rather than as a scanner. A repeater keeper could use it to monitor the signals from his repeater. It could also be used by amateurs to monitor the output from their v.h.f. or u.h.f. transceivers.

Then there are the 'professional' uses. It could be used to check the operation of all the wireless microphones in use during a production, for instance. A p.m.r. operator with a fleet of vehicles could use one to do rapid spot checks on each vehicle as it leaves base. This type of check would be made quickly and simply with the Interceptor as there is no tuning or channel selection to be made and the low sensitivity means that the receiver is less likely to be overloaded.

The Optoelectronics R10 FM Communications Interceptor is an interesting concept which will cost you £349 inc. VAT (the price includes a mains charger) from **Low Electronics Ltd., Chesterfield Road, Matlock, Derbyshire DE4 5LE. Tel: (0629) 580800** who supplied the unit reviewed.



## ERRATA

### The Super-Regenerative Receiver July 1993

Some errors crept into the section of this article headed Try it! A corrected version of **Fig. 3**, based on a circuit from *Amateur Radio Techniques*, is reproduced here.

The coil details are shown in **Table 1**. The tuning capacitor is a 35pF + 35pF twin variable centre tapped.

The Editorial Staff of *SWM* apologise for any inconvenience that may have been caused by these errors and omissions.

**Table 1**

Coil	Turns	Dia.	Wire	Notes
L	4t	13mm dia.	18s.w.g.	Centre tapped. Feedback taken 1t from 'cold' end.
	2t			Antenna Coupling
RFC	3t		32s.w.g.	Through ferrite bead

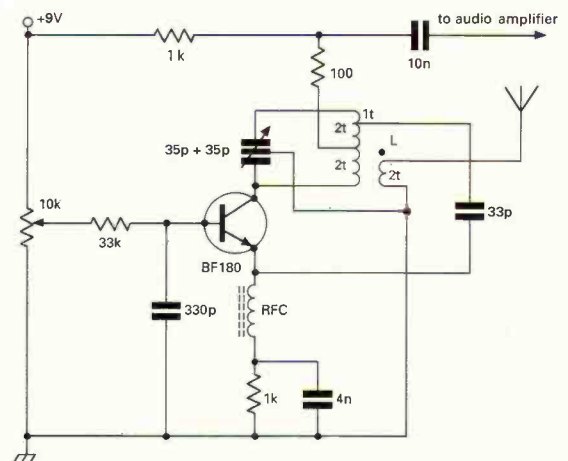

# Do-it-yourself Chart Recorder Part 4

Richard Noble concludes his description of a simple chart recorder.

The electronics for the chart recorder are built on two printed circuit boards. The smaller board holds the stereo slider potentiometer in the correct position behind the pen lever, whilst the other board forms the servo drive amplifier, trace multiplexer and power supply. This should be built into a suitable case that also houses the mains transformer. The power supply is straightforward and is shown in **Fig. 4.1**.

Construction of the two p.c.b.s is straightforward. The component layout and track pattern of the main board is shown in **Fig. 4.2**. If you have bought the author's kit the stereo slider potentiometer is supplied ready fitted to the p.c.b., but not soldered in place. No other electronic components are provided with the kit.

A small modification to the solenoid driver circuit (**Fig.**

**3.2**) has been made. Resistor R33 is now connected to the base of Tr5, not the emitter and its value has been increased to 100k $\Omega$ . The physical layout of the recorder is such that the stereo slider potentiometer must be held in the correct position behind the pen lever and this is achieved by mounting it on a small p.c.b. (**Fig. 4.3**) screwed to the main frame of the recorder.

## Setting Up Procedure

First check the servo drive system by leaving the i.c.s out of the channel sequencer section. Short both channel inputs and point B on the 4016 switch to ground. Connect point A on the 4016 switch to +5V. Set both channel offset potentiometers (R9 & 10) to mid-range.

Applying power to the circuit should make the pen



**Motors, solenoid, pen and paper roll as supplied with the author's kit.**

settle somewhere near the middle of the paper width - if the motor connections are the right way round. If the pen rushes off and jams at either end of the leadscrew, the motor connections need reversing.

Before going any further the two 1k $\Omega$  potentiometers (R24 & 26) at either end of the stereo slider (R25a & b) should be set to maximum resistance. These potentiometers are found on the small p.c.b. in the recorder mechanism, not on the main board.

Once the pen settles properly, adjustment of the channel 1 offset potentiometer R9, should allow the pen to move smoothly from side to side. Connecting point A to ground and point B to +5V should switch to channel 2 and produce the same effect using the channel 2 offset potentiometer, R10.

Next the two 1k $\Omega$  potentiometers (R24 & 26) can be slowly, just a little bit at a

time, reduced in resistance.

This should have the effect of increasing the range by which the pen moves as the offset potentiometers are moved from end to end. This adjustment is a little tricky as there will suddenly come a point where the pen will move rapidly towards the end of its travel and may even try to jam at the end of the leadscrew. This means that the resistance at that end has been reduced too much.

The reason for this is that at the ends of potentiometers there is a short length of conducting metal which the wiper can move over. But while it is doing this there is no corresponding change in resistance and consequently no changing feedback signal telling the motor it is going too far. The travel must therefore be restricted to just not quite reaching the ends of the resistive parts of the track.

The adjustments are also slightly interactive, so a series

**Printed circuit boards, side plates and other mechanical items as supplied with the author's kit of parts.**



**Fig. 4.1: Circuit diagram of a suitable power supply for the chart recorder electronics.**

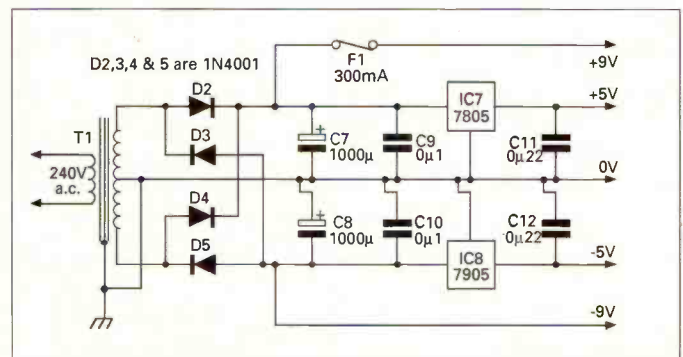

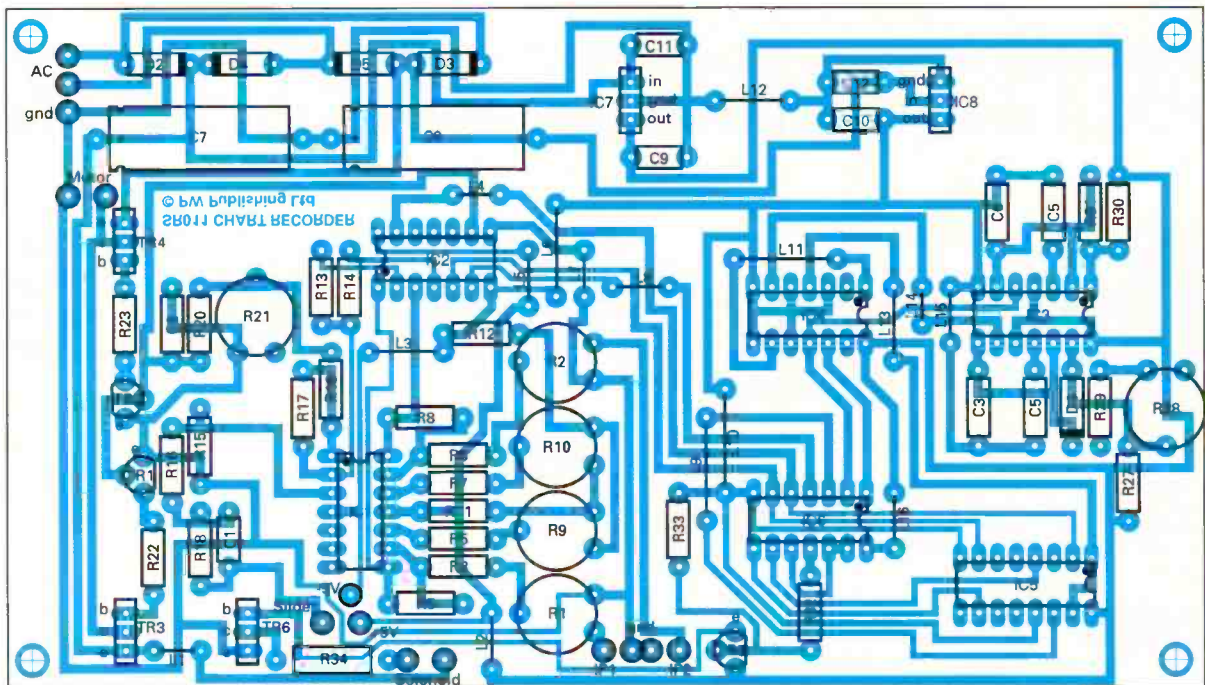
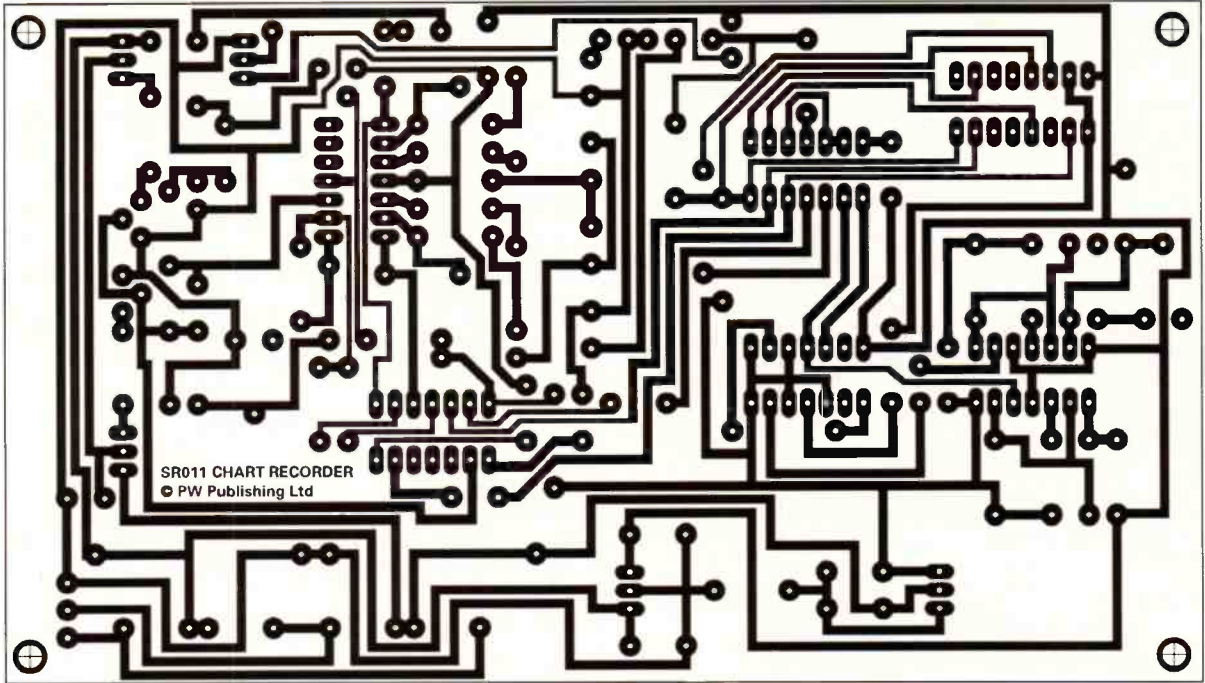

**Fig. 4.2: Full size printed circuit board layout and copper track pattern for the main board.**

**Fig. 4.3: Full size printed circuit board layout and copper track pattern for the p.c.b. carrying the stereo slider potentiometer and trimmer pots.**

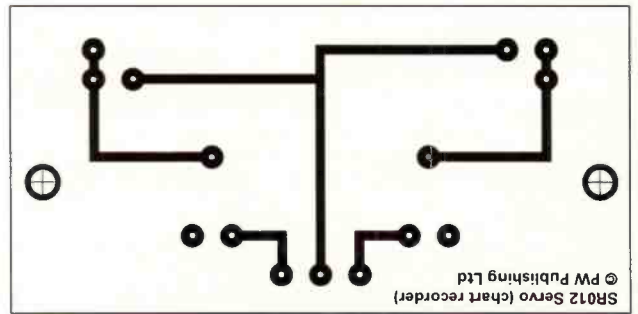
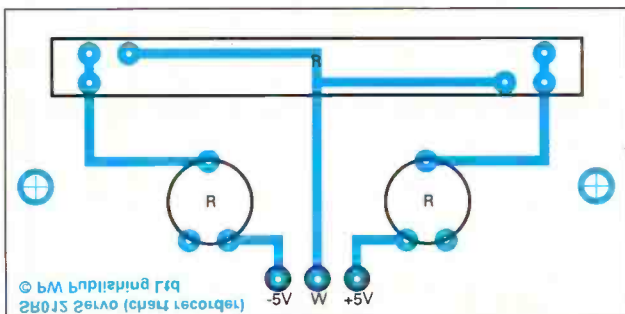

# MOMENTUM COMMUNICATIONS



## MCL 1100 DATA DECODER

The MCL 1100 Easyreader Data Decoder will automatically make sense of some of the strange noises that you can hear on your H.F. Radio Receiver enabling you to make FULL use of your equipment. The MCL-1100 processes data transmissions without the need of a separate computer and displays a full screen of text on your video monitor. Why make-do with one or two lines of information as offered by other manufacturers. And it's designed and manufactured in the U.K.

### STANDARD FEATURES:

- SMARTLOCK system for easy tuning.
- Full screen of readable text with on-screen tuning indication.
- Automatic decoding of RTTY, CW, FEC (NAVTEX) and ARQ.
- Auto or manual selection of transmission speeds.
- Extremely rapid lock onto signal.
- Connection for a parallel type printer.
- Made in the U.K.

PHONE EASYREADER  
HOT-LINE FOR SPECIAL STARTER  
PACK DETAILS

**0384 896879**

EASYREADER STILL ONLY  
**£225.00** inc. VAT + Postage



Authorised Dealers (Martin Lynch) (Lowe Electronics) (ARC)



6 & 7 Clarkson Place, Dudley Road, Lye, West Midlands DY9 8EL

# C.M.HOWES COMMUNICATIONS

Mail Order to: **Eydon, Daventry,  
Northants NN11 6PT**  
Tel: **0327 60178**

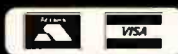

## EASY TO BUILD HOWES KITS!

Building your own equipment is half the fun of amateur radio! Whether you are a novice or an old hand, you should find an interesting project in our range.

**CTU30** Antenna Tuning Unit covering all shortwave bands and 6M. 30W RF rating for reception or QRP transmitting. Suits all antenna types. Top quality performance. **CTU30** kit plus **HA30R** hardware pack: **£57.80**



Antenna Tuner



Crystal Calibrator

**XM1** Crystal Frequency Marker for calibrating receivers and helping to meet amateur licence requirements. Voltage regulator, marker ident facility and harmonic rich output covering LF to UHF. A very handy piece of test equipment. **XM1** kit plus **HA11R** hardware pack: **£28.80**

		Kit	Assembled PCB
<b>AP3</b>	Automatic Speech Processor	£16.80	£24.90
<b>CV100</b>	Adds Medium & Shortwave to VHF scanners	£27.50	£39.90
<b>CM2</b>	Quality Microphone with VOGAD	£13.50	£18.90
<b>DCS2</b>	"S Meter" for our receivers	£10.90	£15.90
<b>DFD4</b>	Add-on Digital Read-out for superhet radios	£49.90	£69.90
<b>DFD5</b>	5 Digit 35MHz Frequency Counter	£54.90	£79.90
<b>ST2</b>	Morse Side-tone/Practice Oscillator	£9.80	£15.90

Optional hardware packs are available for most of the above, please enquire.



ST2 Kit + HA12R  
Hardware

DXR10 + DCS2 Kits  
+ HA10R Hardware



## RECEIVERS

**TRF3** Easy to build TRF receiver with AM, SSB & CW shortwave reception from 5.7 to 12.8MHz in 3 bands Kit: **£15.50** Assembled PCB: **£22.90**

**DcRx** Single Band SSB/CW receiver for 160, 80, 40 or 20M Amateur Bands or 5.45MHz HF Air (air-sea rescue etc.) Kit: **£16.90** Assembled PCB: **£24.90**

**DXR10** Three Amateur Bands, 10, 12 & 15M SSB & CW receiver with excellent sensitivity and dynamic range Kit: **£27.50** Assembled PCB: **£42.50**

Optional hardware packs are available to go with the above receiver electronics kits. The amateur band receivers can all be expanded into transceivers by adding on the relevant transmitting kits.

## TRANSMITTERS

		Kit	Assembled PCB
<b>AT160</b>	80 & 160M Bands AM/DSB/CW 10W PEP adjustable	£39.90	£62.90
<b>CTX</b>	QRP CW Transmitter, 40M or 80M versions	£15.50	£22.90
<b>MTX20</b>	20M 10W (adjustable) CW Transmitter	£29.90	£39.90

All the above transmitters are crystal controlled. Matching VFO kits are available and these enable transceive operation with the relevant receiver kits. There are also kits to build a 10 & 15M SSB transmitter (super Novice rig).

## ACTIVE ANTENNAS AND PRE-AMPS

		Kit	Assembled PCB
<b>AA2</b>	150kHz to 30MHz Active Antenna Amplifier	£8.90	£13.90
<b>AA4</b>	25 to 1300MHz Active Antenna	£19.90	£27.90
<b>AB118</b>	118 to 137MHz Optimised VHF Air-band Antenna	£18.80	£25.90
<b>SPA4</b>	4 to 1300MHz Receiver Pre-amplifier	£15.90	£22.90

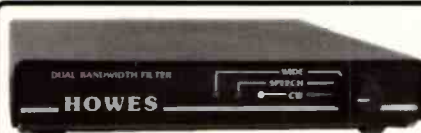

**ADD EXTRA  
SELECTIVITY!**

### DUAL BANDWIDTH AF FILTER: £29.80

• Reduce noise and interference! • Sharp SSB/Speech filter with faster roll-off than IF crystal filters! • 300Hz bandwidth CW filter • Printed and punched front panel • All aluminium case  
• Simply connects between radio and external 'speaker or 'phones • Suits all general coverage receivers and transceivers • Excellent receiver upgrade!

ASL5 Filter Kit (£15.90) + HA50R Hardware (£13.90) = £29.80

PLEASE ADD £1.50 P&P for kits or £4.00 P&P if ordering hardware.

**HOWES KITS** contain good quality printed circuit boards with screen printed parts locations, full, clear instructions and all board mounted components. Sales, constructional and technical advice are available by phone during office hours. Please send an SAE for our free catalogue and specific product data sheets. Delivery is normally within seven days.

73 from Dave G4KQH, Technical Manager.

# THE INTERNATIONAL RED CROSS BROADCASTING SERVICE

By Dick Moon

*The idea began in 1859 in Solferino, Northern Italy during a battle involving French and Italian troops, and the occupying Austrian forces. The medical services of the armies proved totally inadequate in the face of such carnage, and thousands of wounded troops were left to a gruesome fate on the battlefield. This situation so affected a visiting Swiss businessman, one Henry Dunant, that he set about helping the abandoned wounded himself, and persuaded many of the local populace to assist him in his efforts.*

On returning home, he wrote a book entitled 'A Memory of Solferino', and sent a copy to all reigning Monarchs and other influential people in Europe, many of whom were shocked by his harrowing account of the cruelties of warfare. Amongst those who read his book was Gustav Moynier, then President of the Geneva Public Welfare Society, who was so moved by its revelations that he set up a committee to discuss the matter. This ultimately led to an International conference at which the name 'The International Committee for Relief to the Wounded', and the insignia of a red cross on a white background was adopted. Subsequently the title 'International Committee of the Red Cross' (ICRC) was taken as the official title of the organisation, with the 'Red Crescent Society' subsequently enlisted to its ranks.

## Refugees

In 1945, with the Second World War at an end, hundreds of thousands of civilian refugees, and prisoners of war freed from their years of imprisonment,

### RED CROSS BROADCASTING SERVICE: ENGLISH SERVICE

#### To the AMERICAS

TIME (UTC)	FREQUENCY	DATES
0310-0327	6135	Tuesdays: 02.07.91
0310-0327	9885	3.07.91
0319-0327	12035	27.08.91
		Fridays: 05.07.91
		02.08.91
		30.08.91

#### To EUROPE

TIME (UTC)	FREQUENCY	DATES
1100-1130	7210	Sundays: 28.07.91
1700-1730	7210	25.08.91
		29.09.91
		Mondays: 01.07.91
		29.07.91
		26.08.91
		30.09.91

#### To AUSTRALIA

TIME (UTC)	FREQUENCY	DATES
0740-0757	9560	Mondays: 01.07.91
0740-0757	13685	29.07.91
0740-0757	17670	26.08.91
0740-0757	21695	Thursdays: 04.07.91
		01.08.91
		29.08.91

were desperately trying to find their way back to their families. With communications virtually non-existent, radio stations destroyed, telephones out of order, and all forms of transport in a state of chaos, families at home, eager for news of their loved ones, appealed to the only body able to offer any assistance - The ICRC in Switzerland. Reacting to these countless pleas for help, the Swiss Department of Posts, Telegraphs and Communications, who owned the transmitters of Swiss Radio International, granted air time to the Red Cross to enable them to broadcast all available information regarding the location and state of health of released prisoners and displaced persons. Thus was born the International Red Cross Broadcasting Service.

At The World Administrative Radio Conference held in 1948, approval was granted to a Swiss

government request for a permanent frequency allocation for the ICRC. To this day, this body remains the only international organisation in the world to operate on its own radio frequency. It was felt that, in the event of another war, such a service would be of immeasurable value, and with this in mind, the ICRC commenced test programmes in 1951 to evaluate world-wide reception conditions. By 1965, the organisation had been granted air-time for a bi-monthly service, transmitting to Europe, the Middle East and the Americas.

As the organisation grew, more studios were built, and in 1971 the service was extended to include Asia and Africa. In 1978 the service was officially re-named 'The Red Cross Broadcasting Service', and the regular broadcasts were made monthly.

## Budget Restrictions

Decisions over the amount of air-time allocated are still made by the Swiss PTT, and at present, the Red Cross Broadcasting Service is on the air for only 78 hours a year, the time period being determined largely by budget restrictions. Broadcasts go out in English, French, German, Spanish, Portuguese and, appropriately enough in view of the Middle East problems, in Arabic, and considering that the entire staff comprises only one producer, a studio technician and a few part-time journalists, it is quite a remarkable effort. The programmes deal with the work of the Society, whose principal task is to protect and assist victims of conflict. Coverage is also given to National Red Cross groups, with interviews, news reports and answers to listener's queries making up the balance of

the programme.

There are currently two transmitters in operation, one at Scharzenburg which is used for directional broadcasts, and another at Beromunster for non-directional transmissions. The table gives the English language transmission details for Europe and the Americas.

*The International Red Cross Broadcasting Service will QSL your reports, which should be sent (enclosing 1 IRC), to: The Red Cross Broadcasting Service, 19 Avenue de la Paix, CH-1202, Geneva, Switzerland.* ■

# DIY Chart Recorder

CONTINUED FROM PAGE 43

of iterative changes have to be made, first at one end and then the other, until the best setup is obtained.

Applying signals to the inputs instead of the short-circuits should then make the pen follow whichever input is selected by the settings on points A and B of the switch. A convenient way of doing this is with an external potentiometer connected between +5V and -5V. The gain controls of each channel can also be checked at this point.

To check the channel sequencer insert only the 556 timer chip and look at the outputs on pin 9 and pin 5. The changes on these pins are slow enough to be seen easily with a meter. The output on Pin 9 should be set to change once every minute or so using R28 for adjustment, while Pin 5 should change level every 1 - 2 seconds.

Next insert the 4013, 4017 and 4001 chips and check that the level goes high on pins 2,

4, 7 & 10 of the 4017 chip, in that order, every minute or so, depending on how often you have set the pin 9 output of the 556 chip to change. Connect the solenoid and it should operate twice in each triggered cycle.

If all is well so far, insert the remaining 4016 switch chip and watch the pen and solenoid do their ritual dances while plotting your two traces.

*Note: A convenience kit of all mechanical parts, finished and drilled, including both p.c.b.s, motor, solenoid, clock, paper roll, pen, etc., but no electronic components other than the slider potentiometer, is available from the author. SAE for details to: R & W Noble, Penbidwal House, Pandy, Abergavenny, Gwent NP7 8EA.*

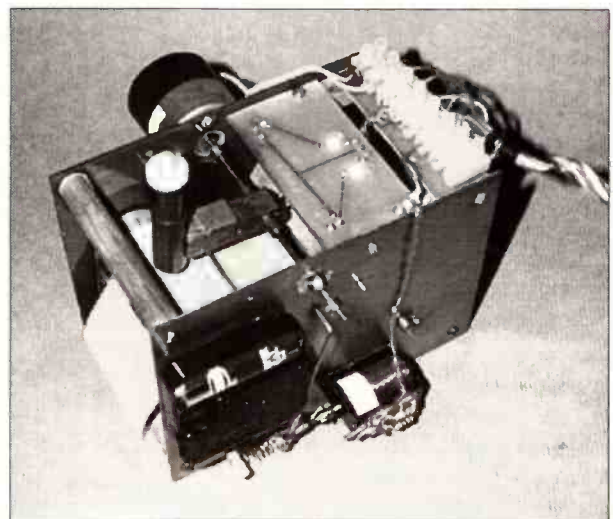
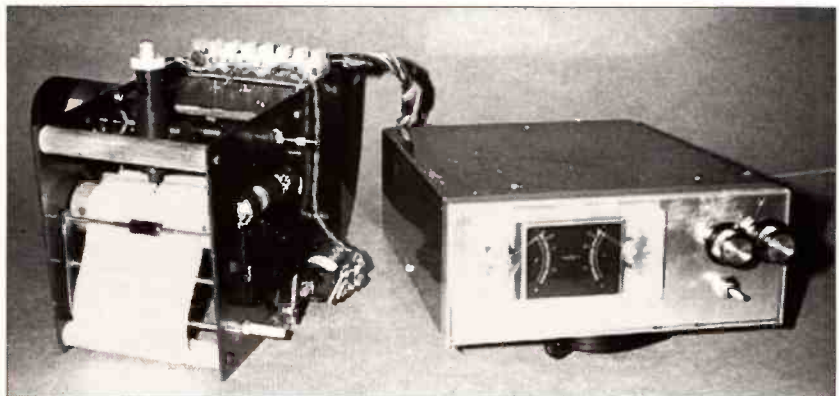





## Toroidal Transformers for 13.8V DC Power Supplies

9T845 16,1 VOLT AT 42 AMPS  
(PW MARCHWOOD PSU)

8C267 18 VOLT AT 27.8 AMPS (500VA)

Complete standard range of 107 types of ILP Toroidal Transformers and the full range of ILP Audio Amplifier Products

## Low Profile Encapsulated Transformers

A range of 30 types from 4VA to 30VA suitable for PCB mounting



Write or phone or fax for free Data Pack

UK DISTRIBUTORS FOR

## Jaytee Electronic Services

143 Reculver Road, Herne Bay, Kent CT6 6PL  
Telephone: (0227) 375254 Fax: 0227 365104

# HAYDON COMMUNICATIONS

## SCANNER SECTION

**MVT-7100**  
The two in one Receiver  
0.1-1650MHz  
(All mode)  
Put one to the test! (It's brilliant)  
**£399**  
INCL'S FREE LONG WIRE

**AR-1500EX**  
Now with enhanced performance  
0.1-1300MHz  
(All modes)  
Incl SSB  
**£315**  
INCL'S FREE LONG WIRE

**HP-2000E**  
0.1-1300MHz  
All modes  
Incl's Nicads/Charger  
**£269**  
Incl's free p&p

**AR-3000A**  
Still the best selling ALL MODE Scanner.  
(0.1-2GHz) Includes PSU + FREE long wire/p&p  
**£849**

**DON'T FORGET THESE** → **- NEW -**  
3rd edition - UK Scanning Directory  
**£16.95 FREE p&p**

**OPT-2300**  
The digital frequency finder!  
0.1-2.3GHz  
Incl's Nicads/Charger  
**£149**  
FREE P&P

## SHORTWAVE CORNER

**Kenwood R-5000**  
0.1-30MHz (All mode)  
(One only-as new)  
**£749**

**FRG-100**  
Award winning HF receiver  
0.1-30MHz (All mode)  
(includes free PSU/Delivery)  
**£549**

**Sony ICF-2001D**  
What a bargain!  
0.1-30MHz all mode + AM airband  
(includes PSU etc.)  
**£339**

**Sangean ATS-803A**  
0.1-30MHz  
+ FM Broadcast (Excellent value)  
**£119.95**  
FREE P&P

**NB:- ALSO AVAILABLE - SW-77/SW-55 - HUGE SAVINGS!!!**

## STOP PRESS:-

Now in stock:- Deecom S.W.L. A.T.U. (0.1-30MHz) **£44.95 p&p £5**

## The perfect companions for S.W.L.!!

**Sony An-1 Active antenna**  
0.1-30MHz (incls cable) Free p&p  
(Indoor/outdoor)  
**£59.95**

**AT-1000 ATU (0.1-30MHz)**  
The best ATU money can buy  
**£89.95**  
FREE P&P

**WHERE TO FIND US**

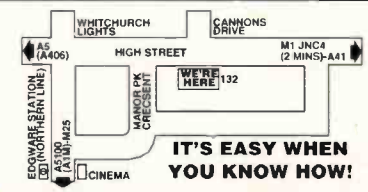

**Due to Autumn re-fit - RE-STOCKING!**  
2nd hand & Ex-demo goodies at bargain prices!  
Guarantee:- 2nd hand - 3 months/Ex-demo - 12 months

SW-1E As new	£89	TS90 SDX As new	£2995
AR-3000A Ex demo	£799	TS-50S Slightly marked	£849
HP-2000 As new	£239	IC-735 As new	£749
MS-1000 As new	£229	FT-767 Gx As new	£1299
DJ-X1 As new	£199	FT-747 GxII As new (incl FM)	£749
PRO-80 As new	£199	HF-225 incl's all options (as new)	£469
WIN-108 Ex demo	£119	Drake R-8E As new	£849
MVT-7100 Ex demo	£369	ICF-2001D Ex demo	£219
TS-850S Ex demo	£1399		

★ 24 hour salesline 0850 586313 ★ Mail Order: Same Day Despatch ★

Sales/service:- (Phone/Fax) - **081-951 5782**  
132 High Street, Edgware, London HA8 7EL  
Close to Edgware underground station (Northern Line). Close to M1, M25, A406.  
★ FREE PARKING ★ OPEN - MON-SAT 10-6PM

## THE KITS WITH ALL THE BITS!

### Guaranteed complete to the last nut!

### COMPACT 80m CW QRP Tx/Rx

DTR3 Kit - £87.50 P&P £3.00 Ready Built - £140.00

- ★ Stable VFO ★ Sidetone ★ Audio Filter
- ★ Requires 12/14 VDC ★ Vary detailed Instructions ★ Black steel case ★ Printed panel

40m & TOP BAND VERSIONS ALSO AVAILABLE

### ANTENNA TUNING UNITS

TU1 Kit - £41.25 Ready Built - £57.50  
TU2 Kit - £51.00 Ready Built - £72.00  
P&P £3.00

- ★ Large dia. coil ★ High grade capacitor ★ Built in balun ★ Circuits to match your antenna ★ Up to 30 Watts of CW ★ TU2 has sensitive QRP/SWR meter ★ TU1 is ideal for SWL

### QRP SWR METER

- ★ Specially designed for QRP ★ HF 1-30MHz
  - ★ Can be set down to 1/2 watt for FSD
  - ★ Ideal for milliwatting ★ Low Insertion loss 0.2dB
- TUA1 Kit - complete with case & meter £18.00 P&P £1.00

### CARLTON (Receiver)

### 80-40-20m Dc Rx

- ★ Receives USB, LSB and CW ★ Very sensitive and selective ★ Simple modular construction
  - ★ 12-14 volt battery operated ★ Printed facia
- Kit complete with case - £69.50 P&P £3.00

### PSU 15 REGULATED POWER SUPPLY

- ★ Ready built ★ Mains input ★ 13.8V @ 1.5A output ★ Ideal for DTR3 & 'Carlton' ★ Fully protected
- Supplied ready built - £52.00 P&P £4.00

Send SAE for brochure or call Alan G4DVW on 0602 382509

## LAKE ELECTRONICS

7 Middleton Close, Nuthall, Nottingham NG16 1BX  
(callers by appointment only)



# Propagation

by Ron Ham

Faraday, Greyfriars, Storrington, West Sussex RH20 4HE

**T**hanks to your letters, we can see how frequent Sporadic-E disturbances have influenced the paths of radio signals throughout the month of June. But first, let's look at the reports from the solar observers.

## Solar

During May, **Ron Livesey** (Edinburgh), using a 2.5in refractor and a 4.0in projection screen, located three active areas on the sun's disc on days 8, 9, 10, 11, 29, 30 & 31. The latter days lead to the drawing of the sun, **Fig. 1**, made by **Patrick Moore** (Selsey) from his projection box at 1335 on June 1.

While using his spectrohelioscope at 0930 on May 29, **Cmdr. Henry Hatfield** (Sevenoaks) located two sunspot groups, 12 filaments and three slightly active plages. In addition to the 2grps and 9fs seen at 0943, on June 4, Henry found an active plage, almost flaring, near a double spot and a medium sized prominence on the south-west limb that 'looks like a lizard'. He logged 3grps and about 12fs early on the 5th and 6th and at 0936 on the 7th, there were 2grps, 15fs, two active plages and the remains of two flares in the SW limb.

**Ted Waring** (Bristol) counted 36 sunspots on June 1 but, only four on the 22nd. **Wallace Shackleton** (Kinross) said that, "the average Relative Sun-spot count for June was 53". This is a bit down on last month's figures. Henry's radio telescopes recorded individual bursts of solar noise on the 3rd and 7th at 136MHz and at 1418 on the 7th he recorded a 10 minute burst, **Fig. 2**, at 1297MHz. In May, **Tony Hopwood** (Upton-on-Severn) noted fading on the h.f. bands on days 6 to 10, 13, 14, 19, 20, 26 & 27.

Fig. 1.

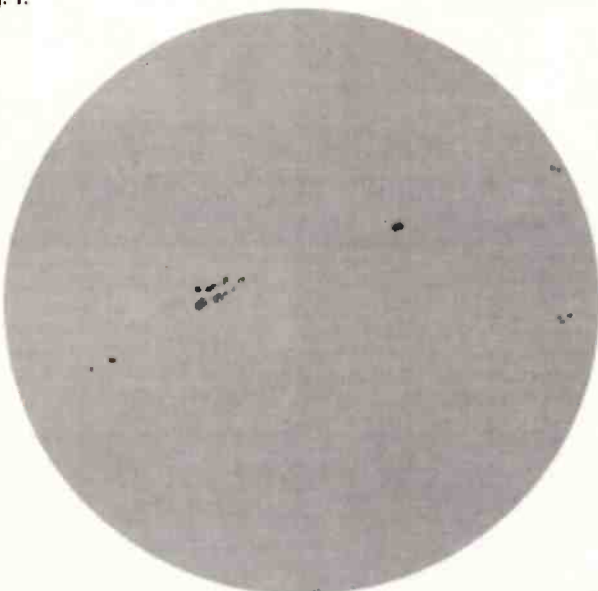

Beacon	May					June																								
	26	27	28	29	30	31	1	2	3	4	5	6	7	8	9	10	11	12	13	14	15	16	17	18	19	20	21	22	23	24
CTOAP0												X	X	X	X	X	X	X	X	X	X	X	X	X	X	X	X	X	X	X
DFOAAB	X	X	X	X	X	X	X				X	X	X	X	X	X	X	X	X	X	X	X	X	X	X	X	X	X	X	X
DF0THD	X			X		X						X	X	X	X	X	X	X	X	X	X	X	X	X	X	X	X	X	X	X
DK0TEN	X			X	X	X					X	X	X	X	X	X	X	X	X	X	X	X	X	X	X	X	X	X	X	X
DL0GI	X	X	X	X	X	X				X	X	X	X	X	X	X	X	X	X	X	X	X	X	X	X	X	X	X	X	X
EA3JA	X			X	X	X																								
HG5GEW	X	X	X	X	X	X					X	X	X	X	X	X	X	X	X	X	X	X	X	X	X	X	X	X	X	X
IK1PCB	X			X	X	X					X	X	X	X	X	X	X	X	X	X	X	X	X	X	X	X	X	X	X	X
IY4M	X	X		X	X	X					X	X	X	X	X	X	X	X	X	X	X	X	X	X	X	X	X	X	X	X
LASTEN	X	X		X	X						X	X	X	X	X	X	X	X	X	X	X	X	X	X	X	X	X	X	X	X
OK0EG	X																													
OH2TEN												X	X	X	X	X	X	X	X	X	X	X	X	X	X	X	X	X	X	X
OH5TEN	X				X	X				X								X	X	X	X	X	X	X	X	X	X	X	X	X
S55ZRS	X	X	X	X	X	X				X	X	X	X	X	X	X	X	X	X	X	X	X	X	X	X	X	X	X	X	X
SK2TEN																		X												
SK5TEN	X	X	X	X	X	X				X	X	X	X	X	X	X	X	X	X	X	X	X	X	X	X	X	X	X	X	X
VK6RWA	X			X																										
W3VD											X																			
ZS1LA	X	X	X	X	X	X				X	X	X	X	X	X	X	X	X	X	X	X	X	X	X	X	X	X	X	X	X
ZS6PW	X	X	X	X	X	X				X	X	X	X	X	X	X	X	X	X	X	X	X	X	X	X	X	X	X	X	X
ZZ1ANB	X	X	X	X	X					X	X	X	X	X	X	X	X	X	X	X	X	X	X	X	X	X	X	X	X	X
4N3ZHK																		X	X	X								X		
5B4CY	X	X	X	X	X	X				X	X	X	X	X	X	X	X	X	X	X	X	X	X	X	X	X	X	X	X	X

Fig. 3.

## Auroral

Ron Livesey, the auroral co-ordinator for the British Astronomical Association, received reports described as 'glow' for the overnight period on May 3/4, 'homogeneous arc' on 18/19, 'active forms pulsating' on 7/8, 9/10, 11/12, 13/14, 19/20 & 27/28 and 'half sky' on 9/10, from observers in North America and Scotland.

## Magnetic

The magnetometers used by, Tony Hopwood, **Karl Lewis** (Saltash) and Ron Livesey between them recorded magnetic disturbances on May 1, 7-10, 13, 14, 16, 18, 19, 21, 26-29 & 30.

## Propagation Beacons

First, my thanks to **Gordon Foote** (Didcot), **Ian McDermid** (Comrie), **Ted Owen** (Maldon), **Ted Waring**, **Ern Warwick** (Plymouth) and **Ford White** (Portland) for their 28MHz beacon logs from which I compiled **Fig. 3**. Between them, they added the beacons CTOAPO (28.200MHz), DF0THD (28.325MHz), IK1PCB (Bordighera) (28.180MHz) and S55ZRS

(28.251MHz) plus the return of old friend 4N3ZHK. Note the regularity of 'local' beacons due to the amount of Sporadic-E.

## Band II

"Fluctuations of signals from nothing to full stereo", remarked **David Edwardson** (Wallsend) when he heard Portuguese and Spanish stations, around 95 and 105MHz, at 1100 on June 10. David uses an elderly Decca music centre with a 4-element beam for Band II DXing. When he checked the band again from 1500 to 2000 he logged Italian and Portuguese stations and lost count of the signals from Spain. All typical Sporadic-E, David.

While another event was in progress between 1650 and 1720 on the 12th, **Ian McDermid** found the bottom end of Band II jammed with signals. "Spanish stations were coming in like locals," said Ian, as he was trying to separate them on his Roberts RC818 receiver with its own rod antenna laying horizontal.

Whilst tuning the h.f. bands around 0900 on the 12th, **S.M. Hockenull** (Bristol) noted that the 21MHz band was full of strong European signals and Radio France International was coming in on 25.820MHz. He rightly assumed that all this activity was due to Sporadic-E, then checked Band II and found two

Italian stations around 88MHz.

## Tropospheric

S.M. Hockenull, received BBC Radio 4, at varying strengths, from the transmitter at North Hessary Tor, on 92.5MHz, from 2310 to 2340 on June 7. "I think this was caused by a ridge of high pressure giving way to a low pressure moving in from the Bay of Biscay," he reported. He added, "This led to the storms that wreaked havoc throughout Wales and the West-Country during the following week." This fall can be seen on the atmospheric pressure chart in my Television column elsewhere in this issue.

While on holiday in the Isle of Arran, on June 15, **George Garden** (Edinburgh) took his Sony portable to the top of Goat Fell, some 880m a.s.l. and logged Manx Radio on 103.7MHz. **Leo Barr** (Sunderland) found it possible to receive distant UK stations in Band II on May 30 and June 12. On those days he heard BBC and IBA stations, fluctuating in strength, from Ashkirk, Blackhill and Holme Moss. Leo logged Minster FM on his car radio, for the first time, on the 30th while driving through intermittent fog and remarked, "every time I drove through a fog-bank, reception conditions for that particular station improved".

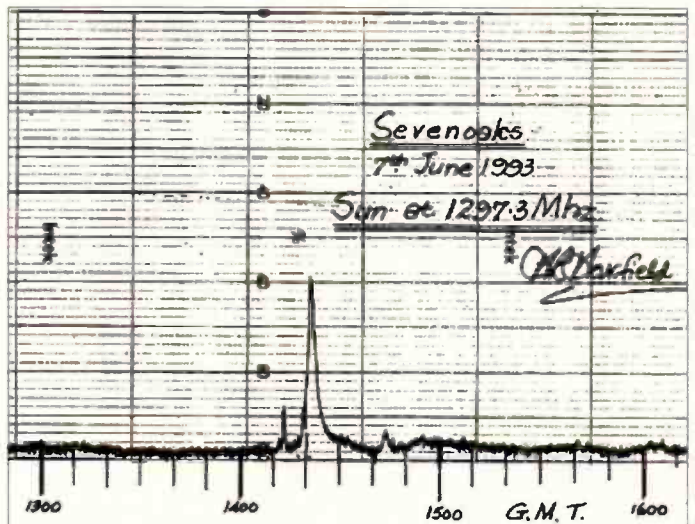

Fig. 2.

# SUMMER 1993 CATALOGUE



## The new enlarged Cirkit Catalogue is out now!

- 32 more pages
- New range of Kenwood 'scopes
- The latest scanning receivers and accessories
- New section of low cost security products
- Extended range of Velleman kits including: 250W 12Vdc to 220Vac inverter, in-car amplifier power supply, 200 and 400W amplifiers, suppressed lamp dimmer, halogen lamp dimmer, day/night thermostat and telephone remote control unit
- New test equipment, includes: 2.3GHz bench frequency counter, EPROM emulator/programmer, portable 'scopes and bench function generators
- Host of new components, including: compression trimmers, variable capacitors, connectors, fuses, and fuseholders, potentiometers, IC s, soldering irons and lead free solder
- Published 27th May 1993
- Available from most large newsagents or directly from Cirkit
- **Send for your copy today!**

**£1.90**  
+ 30p p&p

**Cirkit**



**CIRKIT DISTRIBUTION LTD**

Park Lane · Broxbourne · Hertfordshire · EN10 7NQ  
Telephone (0992) 444111 · Fax (0992) 464457

Short Wave Magazine, September 1993

## SHORT WAVE MAGAZINE PCB SERVICE

Printed circuit boards for SWM/constructional projects are available from the SWM PCB Service. The boards are made in 1.5mm glass-fibre and are fully tinned and drilled. All prices quoted in the table include Post and Packing and VAT for UK orders.

Board	Title of Article	Issue	Price £
SR010	A Green Bandsread Dipper	Jun 93	5.75
SR008	Experimental VHF Receiver	Jun 91	5.81
SR007	VLF Receiver	Dec 90	5.24
SR006	Medium Wave AM Radio	Nov 90	3.34
SR005	R210 Converter	July/August 90	6.87
SR004	PRO-2004 Modifications	Oct 89	6.63
SR003	HF to VHF Converter	Aug 89	5.22
SR002	Weather Satellite Reception	Jun 88	3.88

Orders and remittances should be sent to: **Badger Boards, 87 Blackberry Lane, Four Oaks, Sutton Coldfield B78 4JF. Tel: 021-353 9326**, marking your envelope **SWM PCB Service**. Cheques should be crossed and made payable to **Badger Boards**. When ordering please state the Article Title as well as the Board Number. Please print your name and address clearly in block capitals and do not enclose any other correspondence with your order.

Please allow 28 days for delivery. Only the p.c.b.s listed here are available.

**Badger Boards, 87 Blackberry Lane, Four Oaks,  
Sutton Coldfield B78 4JF.  
Tel: 021-353 9326**

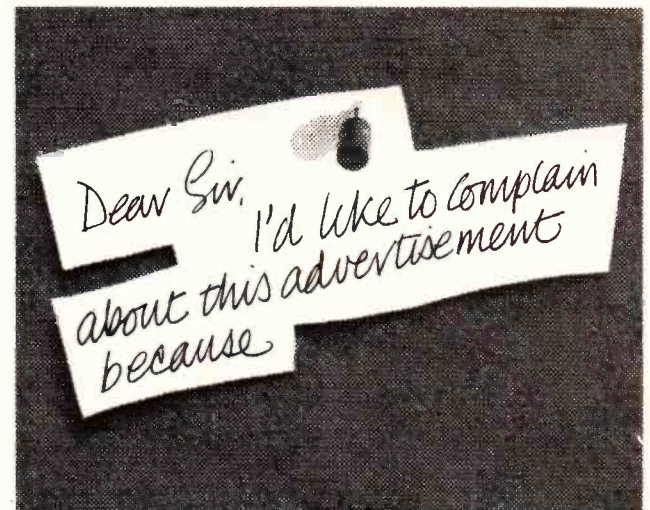

**M**ost advertisements are legal, decent, honest and truthful. A few are not, and, like you, we want them stopped.

If you would like to know more about how to make complaints, please send for our booklet: 'The Do's and Don'ts of Complaining'. It's free.

**The Advertising Standards Authority.**

**We're here to put it right. ✓**

ASA Ltd., Dept. Z, Brook House, Torrington Place, London WC1E 7HN.

This space is donated in the interests of high standards of advertising.

# Satellite TV

Roger Bunney, 33 Cherville Street,  
Romsey, Hants SO51 8FB

It's an unfortunate fact that council planners lack enthusiasm when it comes to DXing. Radio amateurs will be aware of the planning restrictions that relate to high (and often not so high) lattice masts and it will come as no surprise that even satellite dishes sitting in your garden - perhaps no higher than a standard panel fence (2m) - are subject to restriction and regulation. Odd to relate that a large wooden garden shed is permitted development under Town and Country Planning regulations but a patio mount 1m diameter satellite dish, in theory, needs planning approval!

In a non-conservation area you are permitted a single dish within the garden or on the house (preferably rear) provided that a house mounted system does not protrude about the highest point of the roof - the dish not exceeding 700mm in diameter in the South/Central UK or 900mm north of a line approximately between The Wash and Aberystwyth. If you're domiciled in a conservation area, the Norfolk Broads, an area of outstanding beauty or a National Park you will, in theory, need permission for your dish of any size.

Practically, if a dish is carefully positioned, is unseen from the road and the neighbours are happy then I would go ahead with your installation. Common sense obviously prevails - a 5m dish will attract attention, but a dish of 1.2 or 1.5m, if discreetly sited, should cause no anguish. If your conservation area neighbour is the local council planning officer then obviously it's wise to proceed through appropriate channels. There's a free booklet - *A Householders Planning Guide for the Installation of Satellite Dishes* ref: 91 PLAN 0084 issued by the DOE at PO Box 135, Bradford, West Yorkshire BD9 4HU, which is a very useful guide.

If, by local environmental problems, you are restricted to a small dish, satellite reception performance can be improved with the use of a very low noise LNB (low noise block down converter). With improvements in HEMPT technology it is now possible now to obtain Ku-FSS band low noise LNBs commonly down to 0.7dB noise levels at £30 trade + VAT! (Protel Distribution 081-445 4441) and most LNBs considered for 'DXing' should feature under a 1dB noise figure - for a price of just under £200 an LNB with maximum noise figure of 0.5dB is now available! Such low noise figures coupled with high gain should put you up into a higher DXing league -

**Fig. 1: A weak sound in sync test signal prior to a news feed via Eutelsat II F4 out of Budapest. Andrew Sykes uses his Pace receiver with internal sync locking to almost stabilise the picture.**

though a small dish will never perform like its big brother in terms of beamwidth, side lobe radiation pattern, etc., by virtue of the dimensions - small dish = wider beamwidth. Another remedy for sparkly signals is a Threshold Extension Board, a small p.c.b. circuit that fits within the satellite receiver and improves signal threshold performance; typically a receiver threshold of 7-8dB can be improved to 4dB. Chaparral manufacture an outboard threshold extender that fits in the external 70MHz i.f. looping; Echosphere feature internal circuitry and Eurusat have available a 70MHz threshold extension board which can be fitted to many receivers. A u.h.f. i.f. board is now under development. Improvements are dramatic, very weak noisy signals are lifted to virtually noise free clear colour pictures.

The last few weeks have been quiet across the Clarke Belt, but perhaps June 26 was memorable - the day the Americans missed Baghdad. Sky, CNN and the American networks went live with updates though I missed the SNG feeds incoming ex Baghdad via Eutelsat, etc., were seen incoming. There are at least two SNG trucks stationed in Baghdad since this is a news breaking location. The 11.617GHz transponder on 13°E was where the SNG action happened that night with NBC, ABC and WTN feeds. A report via SNG concerning the Baghdad attack was seen over the same transponder at 2330UTC June 29 with a live NTSC (525 lines) insert to the 'States. Interesting to see the presenter struggling with earpiece talk-back levels, in the background were two petal dishes, the larger the uplink to 13°E and the smaller an Immarsat communications link.

Following the attack, President Clinton spoke to 'the Nation' (and indeed the rest of the world), through satellite communications. The west-east circuit into Europe was carried in C Band (4GHz), but trans-European distribution was carried over the Reuters/VisEurope transponder at 12.52GHz 13°E. Rehearsals were also carried of the address on the World feed out of Washington. The same evening the European feed of *Pavarotti in Central Park* was carried via Intelsat K (21°W 11.530GHz vertical) late evening. Very spectacular camera shots were taken, one showing the whole park and the NY skyline, possibly from a tethered blimp.

A letter arrived from a complaining reader concerning his subscription to 'Red Hot Television',

the 'nothing left to the imagination' adult movie channel! The lack of arrival of the Smart Card seems related to the Danish government withdrawing RHT's licence following the lack of payments to Danish Telecom for uplinking services. Certainly in mid-July, the 13°E transponder was lacking any sign of scrambled programming (either SAVE or ENIGMA) from 0015 hours!

With the BT business feeds transferring to Eutelsat II F3 at 16°E from II F1 at 13°E - thus leaving the 13°E bird another hot TV spot in the sky - check out on 16°E trdr 22 - 11.163GHz horizontal that has seen much BT activity this past month. Apart from the Muslim Ahmadiyya TV, various SNG feeds for UK insertion have been noticed.

Our old friend Bindu Padaki in Bangalore writes to update the Ekran u.h.f. satellite transmissions down into India. The 714MHz bird at 99°E still carries the Russian Orbital TV channel but the 754MHz satellite is now transmitting the Asianet Malayalam language TV service, again from 99°E and intended for the Southern Indian state of Kerala using PAL. A press release from Colombo speaks of Asianet increasing its TV services with other Ekran birds at 95, 84, 69, 64 & 48°E. The latter is well above the UK horizon and may well offer TVDXing potential if and when on-stream. Additional channels are planned in English/Hindu, a data channel and an entertainment mix of Star TV/MTV/Prime Sports/BBC WS TV. Signal strengths are from 46-56.5dBW and will provide easily received u.h.f. signals for domestic or cable head end systems.

Alan Smith in Si Racha, Thailand, has upgraded his receiving system with a Monterey 40 + TAD, a new Ku/C Band feed into a Swedish Microwave 0.8dB noise Ku band LNB + a C Band LNB. Nothing has been seen at Ku band, but he hopes for Thaisat reception when it launches this autumn. One new signal received is EMTV Papua New Guinea from Palapa B4 118°E.

## Satellite News

A cutting from the *Saudi Gazette, Jeddah*, suggests that a future Arabsat may transmit in Ku Band rather than the present S and C

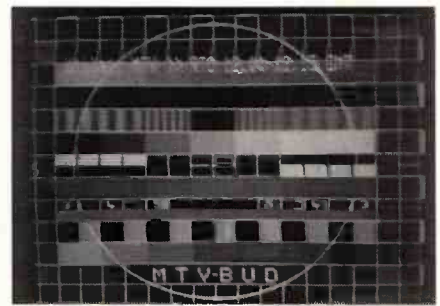

**Fig. 3: John Locker snapped this VTR clock ex BBC Glasgow en route via 13°E to TV Centre, London. This heads the 'A' roll suggesting that there are additional inserts on another tape being called 'B' roll, etc.**

Bands. This will open the market to dramatic expansion with the advent of small dishes of about 1 m diameter. At the present time, dishes in excess of 2m are needed to receive ArabSat, AsiaSat and other transmissions totalling up to 26 channels.

Astra 1D and 1E satellites launching later in 1994 use digital compression, the on-board transponders having 33MHz rather than 26MHz bandwidths. Oddly, Japan reckons not to be digital until well past 2000 and then at the higher 21GHz band using 100MHz transponder bandwidths. Already the BBC WSTV are transmitting digitally compressed TV programming into CBC Canada via Intelsat 513 at 53°W using a 36MHz transponder relaying up to four video and 16 audio channels based on DigiCipher encoding equipment. DigiCipher will be used in SE Asia for the Hong Kong based Star TV service which broadcasts across the region to over 11 million homes.

Satellite delivered BBC WS TV have ousted CNN is becoming the main news source for the terrestrial Channel 2 in Bangladesh. Previously CNN had been active on their Channel 1 but had their hours halved in favour of the BBC.

And finally on the digital compression theme, the Ukraine, Moldavia, Slovenia and Belarus have all recently commissioned 9m satellite earth stations (13m in the Ukraine) for use with the new digital compression services of the European Broadcasting Union (EBU) which start early 1994. Scientific Atlanta won the contracts with financial loans for construction coming from the European Bank for Reconstruction and Development.

# DXTV Round-up

Ron Ham, Faraday, Greyfriars, Storrington,  
West Sussex RH20 4HE

**O**ne of the surviving pre-1939 combined radio and television receivers, **Fig. 1**, is currently on display in the Vintage Wireless building at the Amberley Chalk Pits Museum, Houghton Bridge, near Arundel, West Sussex.

When television programmes began, from Alexandra Palace, on 45MHz, in 1936, some manufacturers decided to add a TV sound band to their standard broadcast receivers. This was a big step forward because it was nearly 20 years previous to a v.h.f. band (88 to 100MHz) being fitted to a domestic set. I was reminded of this by **Tony Hopwood** (Upton-on-Severn) after he found a 1937 Pilot U106 receiver, in a 'junk shop'. "There is a separate ultra short wave band for BBC TV sound reception," said Tony and added, "this allowed radio licence holders to eavesdrop on TV sound that was of much higher quality because of the bandwidth available on Band I."

## VHF Receivers

Other set makers such as Cossor, Marconiphone and Mid-West did the same, which no doubt encouraged more people to buy a televisor. Owing to the outbreak of war, the new television service was closed from September 1939 to June 1946. However, during the war, v.h.f. communications receivers, like the Hallicrafters S27 and S36, were made for the US Navy. Later, in the early 1950s, came the Eddystone 770R and the military R216. Each of these sets can tune through Bands I and II and although they are now between 40 and 50 years old they can still give the DXer a useful service. I have used a wide-band TV pre-amplifier ahead of an S36, 770R

and R216 with pleasing results.

**If you should find such a set please be very careful, because of the high voltages employed around the mains transformer and each of the valve sockets. Make sure they are electrically safe before use.**

## Band 1

The ability to tune through Band I, independently of a television receiver, can greatly assist the TVDXer. Let's suppose you had a Band I TV set and a radio receiver that covered 40-70MHz working side by side and fed by the same antenna through a 'Y' distributor. Now, if, during a Sporadic-E opening, your TV is receiving a picture from Hungary on Ch. R1 (49.75MHz) you should also hear the synchronising pulses from the vision transmitter by tuning your radio to 49.75MHz. Also, by tuning to 56.25MHz you should hear the associated sound. This also applies to the other channels such as:

- E2 (48.25/53.75MHz);
- E3 (55.25/60.75MHz);
- E4 (62.25/67.75MHz);
- Ia (53.75/59.25MHz);
- Ib (62.25/67.75MHz); and
- R2 (59.25/65.75MHz).

Separate antennas are better for a dual arrangement, because one can be rotated whilst the other remains stationary. If the TV set shows heavy patterning on a picture or an obvious signal from another station on the same channel, then, by carefully tuning the radio around the vision frequency and adjusting the antenna direction, it is possible to identify the 'intruder'. Take a look in the TV section of the *World Radio TV Handbook* and see just how many countries actually share the same channel. Under normal

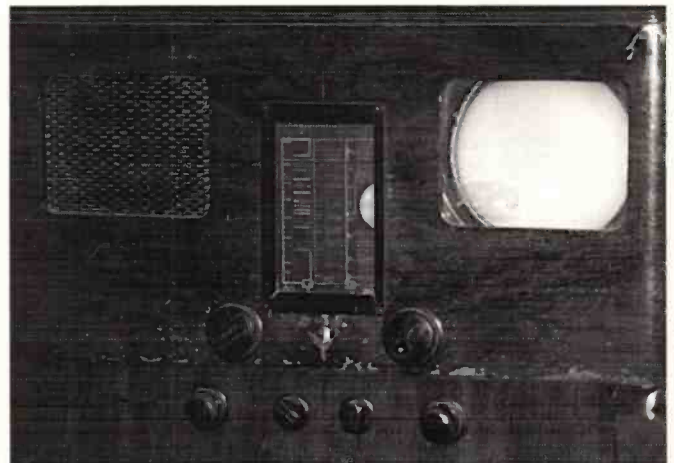
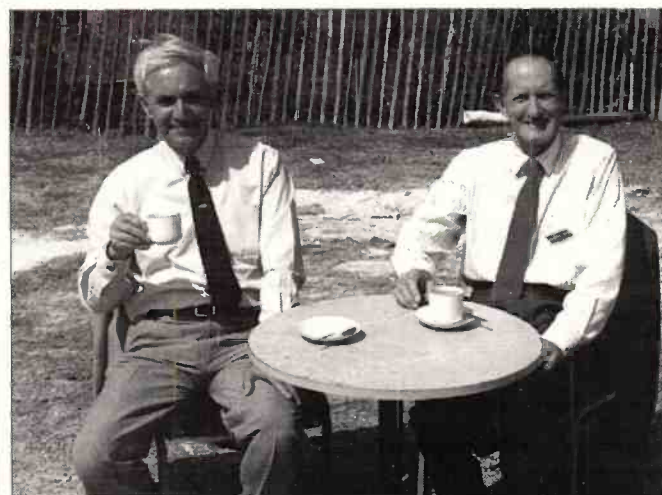

**Fig. 1: Pre-1939 combined radio and television receiver.**



**Fig. 2: Early post-war television receivers.**

**Fig. 3: David Rudram and Ron Weller at Chalk Pits Museum, Amberley.**



atmospheric conditions these stations do not interfere with each other because of the distance between them, but, when Sporadic-E is present, television signals in Band I can increase their range tenfold.

## Special Day

A variety of early post-war television receivers made by Philips, Bush and Pye, left to right in **Fig. 2**, are on display in the Amberley Museum, where a special Vintage Wireless Day has been arranged for September 12. The Hon. Curator of the Wireless section, David Rudram, and radio engineer Ron Weller, left and right respectively in **Fig. 3**, are organising the event. They plan to have 405-line television among the working equipment plus a number of special exhibits by members of the British Vintage Wireless Society. The museum's own extensive wireless collection, a part of which is the subject of **Fig. 4**, plus a few extras, will be on show for all to see. I have been invited to represent my columns in *PW* and *SWM* and, along with Dave and Ron, I look forward to meeting some of you at

Amberley. The museum will be open on the 12th from 1000 to 1700. The adult admission is £4.20 with a range of reductions for the over 60s, students and children.

## Band I Reports

Pictures in Band I from South-East Asian TV were received via Trans-equatorial Propagation (TEP), on Ch. E2, on April 7, 8, 12, 15 & 16, by Lt. **Col. Rana Roy** (Meerut, India). Often these pictures were smeary and fluttering. However, at 1615 on the 15th, he tuned to Ch. A2 and found a rolling 525-line transmission, possibly Vietnam, which he steadied with the vertical hold control. During the Sporadic-E openings on May 7, Rana saw children's programmes, films, football, music and news from Arabic stations on Chs. E2 and E3.

Back in the UK, **Richard Bell** (Melton Mowbray) saw a sports programme from an unidentified source at 1638 on May 31, adverts, a trail for a show called *Martes*, programmes called *Colarin Colorado*, *Magyver*, *Pinnic*, *Telediario*, and a weather forecast from Spain (TVE1) during the evening of June 1, *Disney Club* and *Wheel Of Fortune* from Norway or

# OFFERS FOR THIS MONTH!



Aerial Techniques celebrates its 14th year of successful trading with several special offers to customers' both old and new.

**GRUNDIG P27-549/12** Multisystem 10" Screen tv, covers Bands 1,2 & 3, UHF and cable channels, systems PAL I (for UK); PAL B/G (for Europe); SECAM L (for France); SECAM B/G:D/K etc. NTSC 3.58 & 4.43MHz; 12-24v DC & Mains operation complete with infra-red remote control ..... **£339.95**

**AKAI VS X470E GN** Multisystem VCR, covers Bands 1,3 & UHF. Systems PAL I (for UK); PAL B/G (for Europe); SECAM L (for France); SECAM B/G:D/K etc. NTSC 3.58 & 4.43MHz. DX 4 head; Long Play; Multi-voltage; 8 event-1 year timer ..... **£499.00**

**ECHOSTAR SR-50** manually tuned Satellite receiver with built-in bandwidth filter (reduces to 12MHz) ..... **£149.95**

**ALBA SA20** manual Satellite positioner with 3 digit LED display ..... **£79.95**

**SATELLITE DXERS** motorised package, comprises Echostar SR-50 manually tuned receiver, 90cm spun aluminium Dish, 0.9dB LNB, feedhorn, polariser, actuator and indoor positioner (1.2m Dish option available) ..... **£499.00**

(All prices are inclusive of Vat, Carnage & Insurance delivery £9.00 on larger items)

Serving the TV and Satellite trade, the retail and enthusiast sector, we have been providing an expert and knowledgeable sales with a free consultancy service for over 14 years. We sell both the usual and often requested, together with the unusual and rarely asked for, if we've not got it then it's made we WILL obtain it. Terrestrial of Satellite - we're there.

Our CATALOGUE at £1 samples some but not all that we can supply, send for your copy today. UK & overseas despatch normally ex stock within 24 hours, we'll accept the usual credit cards, cash, cheques, POs - as convenient. Ring daytime with you query or late on our 24 hr phone or send in your fax and we'll get back to you shortly.



**11 Kent Road, Parkstone, Poole, Dorset BH12 2EH**  
Tel: 0202 738232 Fax: 0202 716951

# Aerial Techniques

## SCANNER OWNERS

### TURN YOUR 'SHACK' INTO A MONITORING STATION!

Connect to any receiver with a squelch control and the **AUTO-VOX** will automatically switch your tape recorder on and off as signals are detected. A **must** for all scanner owners. Return to a neatly compressed tape of all the action. Supplied as a kit with full instructions or ready built and tested.

**Kit £12.50 AUTO-VOX Built £25.00**

Send large SAE for details of all our scanner upgrades

Radio Research, SWMS, 3 Pasture Close, Whitmore, Staffs, ST5 5DQ

Please mention

## Short Wave Magazine

when replying to advertisements

## TRANSCAN FOR THE ICOM R7100

- Load 7100 internal memories
- Multi band search with time and date stamp
- Dump 7100 memories to disk
- Selective scanning using flagged data fields
- Create, edit and scan database files
- Variable bandwidth spectrum analyser display

System requirements: PC or compatible, hard disk, vga colour screen, serial port and radio interface

**£60.00** including pp

MIDAC SYSTEMS 33 CANNON LEYS CHELMSFORD CM2 8PB TEL: 0245 474554

## JAYCEE ELECTRONICS LTD

20 Woodside Way, Glenrothes, Fife, Scotland KY7 5DF  
Tel: 0592 756962 (Day or Night) • Fax No. (0592) 610451

Open: Tuesday-Friday 9-5; Saturday 9-4

### KENWOOD, YAESU & ICOM APPROVED DEALERS

A good stock of new and secondhand equipment always in stock

# SOUTH ESSEX COMMUNICATIONS LTD

## New DRESSLER Active Antennas

### ARA 100 HDX

40kHz - 200MHz  
Gain: 9dB to 100 MHz  
8dB to 150 MHz  
7dB to 200 MHz

**£299**

3rd Order IP +48 -50dBm typical N-type between antenna and interface BNC plug to receiver. Length 1250mm. Complete with 15 metres cable, power supply, interface and mounting brackets.

### ARA 2000

50MHz - 2000MHz  
Gain: 19dB to 1000 MHz  
18dB to 1400 MHz  
16dB to 2000 MHz

**£299**

Noise: 1.5 - 2dB to 1000MHz  
1.8 - 2.5dB to 1500MHz  
2.5 - 4dB to 2000MHz  
3rd Order IP +40 -42dBm typical. Complete with 15 metres cable, power supply, interface and mounting brackets.

ARA 60 and ARA 1500 are still current and available at **£169.00** each.

We also are now specialising in TSM range of antenna products.

**This month's special offer: MVT 7100 scanning receiver with ssb £394.95 and the MVT 7000 £324.95**

Prompt mail order service, finance facilities available, interest free credit on selected items.

Prices correct at time of going to press, E&OE



191 Francis Road, Leyton, London, E10 6NQ  
Telephone: 081-558 0854 081-556 1415  
Fax: 081-558 1298 Telex: 8953609 lexton G

## SOLE UK IMPORTERS

### DRESSLER ACTIVE ANTENNAS

**ARA60** Active Antenna  
50kHz-60MHz with limited performance up to 100MHz  
**£169**

**ARA1500** 50MHz-1500MHz

Frequency	Gain
50-1000	11.5dB
100-1500	11.0dB

### WIDE-BAND MAST-HEAD PREAMPLIFIERS ALSO AVAILABLE

50MHz - 950MHz from **£89**.

## OUR LOCAL AGENTS

**DAVE** (Eastcote, Leics)  
0533 608189;  
**STUART** (Bromley, Kent)  
081-313 9186;  
**TERRY** (Biggleswade, Beds)  
0767 316431

TRADE ENQUIRIES WELCOME  
FROM BONE-FIDE DEALERS  
CALL FOR LATEST TRADE PRICE LIST

Opening hours:  
Mon-Fri 9:00am-5:30pm  
Sat 9:30am-4:30pm

Fig.4.

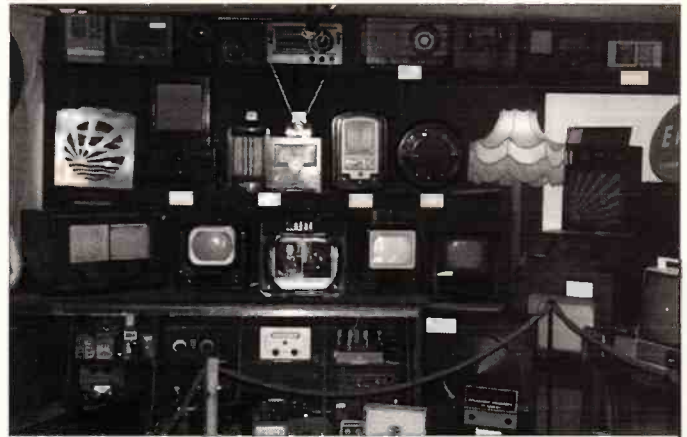

Spain for short periods on the 4th, adverts and cartoons from Spain on the 5th, and *Popeye*, a large analogue clock on the right of the picture from an unidentified station and *Colarin Colorado* and *Magyver* again from Spain on the 7th.

Early on the 12th, **S.M. Hockenhill** (Bristol), using his portable TV with 3m of wire hooked over a curtain rail for antenna, found weak-to-strong pictures between Chs. E2 and E4 and on E4 he saw the Pope conducting a service.

From May 30 to June 22, **Bob Brooks** (Great Sutton) received signals, spread over various days, from stations in the Commonwealth of Independent States (CIS), Czechoslovakia (CST), Finland (YLE TV1), France (Canal+), Germany (ARD Bayern Studio and Grunten,) Hungary (MTV), Italy (RAI), Poland (TVP1), Nigeria (NTA), Norway (NRK and Hemnes), Romania (TVR), Spain (TVE) and Sweden (SVT). Among the programmes he saw were ballet, basket-ball, cartoons, church services, circus, cookery, films, *Murder She Wrote*, news, orchestral, the Pope's visit to Spain, singing, speedway, tennis and weather. In addition to clocks, various logos and test-cards, he saw the news captions HOBCTN (CIS), Telediario (Spain), and the Spanish regionals, Andalucia and Barcelona.

**John Woodcock** (Basingstoke) watched talks about the Spanish elections from TVE1 at 1835 on June 1, pictures from Italy (RAI) at 0658 on the 11th and 1015 on the 12th, a test-card from Sweden (Kanal 1 Sverige) at 1315 on the 16th, cartoons from Spain (TVE1) at 0950. On the 19th, programmes from Norway (NRK) at 1757 on the 21st and a number of unidentified stations from Eastern Europe during the evenings of the 13th and 17th.

In New Radnor, **Simon Hamer** received pictures from Italy (RAI-Uno) and Russia (TSS/OK1) on June 7, Austria (ORF1), Italy and Switzerland (+PTT/SR6) on the 8th, Albania (RTSH), Finland (YLE), France (TDF & Canal+), Iceland

(RUV), Italy, Jordan (JTV), Nigeria (NTA), Portugal (RTP1), Russia, Spain (TVE1), Yugoslavia (JRT/RTB & JRT/HTV) and an unidentified 525-line signal (Ch. A2) on the 9th, Austria, Czechoslovakia (CST), Germany (ARD1) and Poland (TVP) on the 11th, Germany (ARD1 Grunten), Italy, Russia and Switzerland on the 12th and Czechoslovakia, Hungary (MTV1), Poland and Spain (TVE1) on the 16th.

## Weather

"We have had some very unusual weather conditions," wrote **Rana Roy** on May 20 and explained, "It was cool until April 20. It suddenly warmed up from April 21 and became very hot in a few days with temperatures going to 44°C. This unusual heat continued till May 7 when we had thunderstorms almost every evening till the 17th, bringing the temperatures down."

While at the Chelsea Flower Show on May 28, Joan and I visited the stand of **Diplex Ltd** to see their range of weather instruments. In addition to a variety of thermometers (max-min, wet & dry) rain gauges, etc., there was an instrument screen, in kit form and a selection of attractively styled barographs. The screen measures approximately 330 x 230 x 130mm which, to me, looks easy to assemble and sells for £19.50, post free. The barographs range from a miniature (Cat.2020), with brass fittings on a mahogany base, at £175, through a new medium size (Cat.2015), **Fig. 5**, with a brass base and components at £250 to larger versions for home and marine use between £335 and £435. For instance, Cat.2003 which has a mahogany case, gold plated components and 8 vacuum capsules is £420. The price of these instruments includes VAT, carriage and packing, 52 charts and an article entitled 'The Uses Of A Barograph'. The chart drums are driven by a quartz clock with a 1.5V battery (AA) and the stylus is a replaceable red fibre pen. (No more

dirty fingers or forgetting to wind the clock!). Both the battery and the pen last about one year. I found the people on the stand very knowledgeable and only too pleased to help. Readers interested can get more detailed information and advice from this 50 year old firm at PO Box 172, Watford, Herts WD1 1BX.

## Mid-Summer

I recorded 2.59in of rain at my home in Sussex in June compared with 1.38in for the same period in 1992. The largest amounts of 0.90 and 0.81in fell on the 12th and 16th respectively. It was well reported that parts of UK were subjected to severe flooding around the 11th and 12th. While the pressure was falling on the 2nd, I watched black clouds coming in over the South Downs, **Fig. 6**. The daily variations in atmospheric pressure for the period May 26 to June 25, **Fig. 8**, were taken at noon and midnight from the recording chart of my own barograph.

## Tropospheric

In the early mornings of April 18 to 30 and May 3 & 5, **Rana Roy** received pictures in Band III, from Lahore on Channel E5, Amritsa (E7), Marhi (Pakistan TV) (E8), Jalandhar (E9), Sialkot (E10), STN (Pakistan TV) (E11) and Bhatinda (E12). On May 5 he saw Delhi, **Fig. 7**, on Ch. E7 between 0930 and 1005 when the signals faded away.

While on holiday in the Isle of Arran, on June 13 and 15, **George Garden** (Edinburgh), using a JVC 610 portable, received Eireann TV, (RTE1) on Ch. E10, which he identified by confirming the programmes he saw with the list in

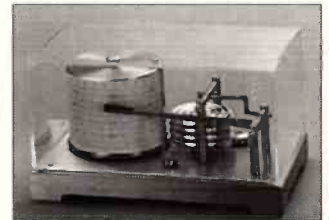

Fig.5.



Fig.6.



Fig.7: Delhi.

the *Daily Telegraph*. On the 26th, **Tim Bucknall** (Congleton) found that the u.h.f. signals from The Wrekin and Winter Hill were subjected to co-channel interference. When tropospheric conditions improved on June 29, **Simon Hamer** received pictures from Denmark (DR) on Ch. E8 and their TV2 in the u.h.f. band, on Chs. E30 and 35.

Fig.8.

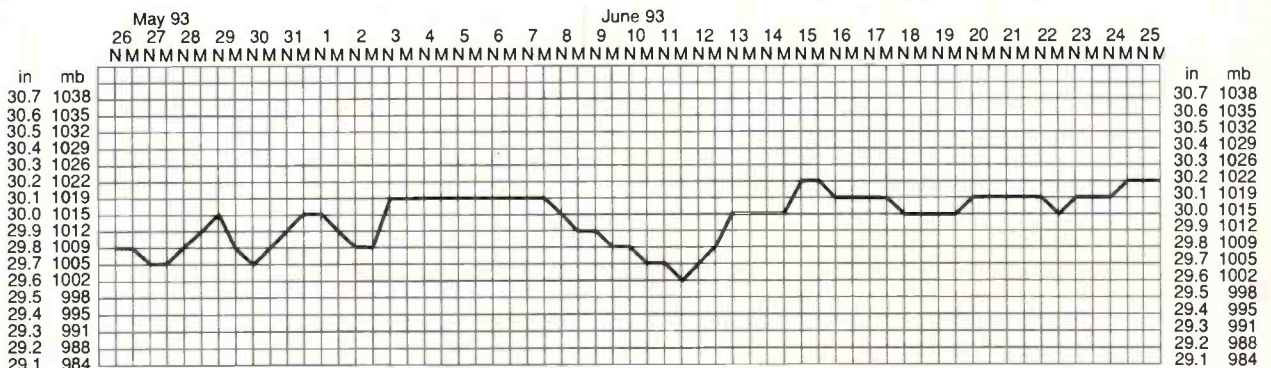

# Bandscan

AUSTRALIA  
By Greg Baker



The age of serial communications has finally hit my place. I had been feeling out of step with the modern world by too often having to confess to not owning a FAX machine and decided to take the plunge. That may seem like an everyday decision but when your house electricity supply is low voltage direct current the number of available FAX machines can be counted on the fingers of one thumb. After a great deal of market research I found an Australian designed and manufactured machine called a Microfax. The Microfax will fit into a shirt pocket and turns my bubble jet printer into a plain paper FAX receiver and my notebook computer into a FAX transmitter. And as a bonus the dear little machine works as a modem as well. Now I'm busy spending time investigating local bulletin boards and what they have to offer. Anyway that's all a little removed from transmissions through the ether, so I will get on with it.

## Pay TV

Readers of this column will be familiar with Australia's pay television saga. I definitely don't use the word 'saga' in the OED sense of 'a story of heroic achievement' here but rather to mean 'a long and complicated series of more or less loosely connected events'.

This story will just not go away no matter how hard the players try. I noted in 'Bandscan Australia' for June 1993 that the tussle between the proponents of pay television by satellite and of pay television by a ground based microwave frequency multi-point distribution system (MDS) was before the courts. That challenge to the government's decision to postpone the introduction of MDS until 1995 is still underway.

During all this the government discovered what it claimed were technical legal flaws in the MDS tendering process and abrogated the whole process. These flaws were tied up with the way frequencies were to be allocated to successful tenderers. This abrogation was in turn subject to another legal challenge. That challenge was eventually withdrawn and the government issued a consultation paper to canvas views on the allocation of

MDS licences. The cynics, of course, would argue that the government was introducing yet another tactic to slow acceptance of MDS in favour of its preferred direct broadcasting by satellite (DBS).

Almost simultaneously with all this the two highest bidders for the two commercially available DBS licences were announced to a fresh uproar. According to most commentators on the matter, the bids were too high for the possible income stream to flow from DBS and questions were raised as to the financial viability of the two previously unknown bidders.

Added to this was a question on deposits made by the tenderers during the bidding process. Reportedly to allow new players to enter the media field the deposit required of tenderers by the Department of Transport and Communication (DoTC) was a mere \$A500 (about £200) rather than the government's preferred 5% non-refundable deposit. The newly re-elected Keating government hit its first parliamentary session knee deep in opposition questions on DBS and MDS. The Minister for Transport and Communications Senator Collins and his House of Representatives colleague managed to fend off the questions by dint of considerable weaving and ducking and the promise to hold a select committee enquiry into the deposit requirements of the tendering process; that committee eventually decided that the Minister was not personally responsible for any oversight during the tendering process.

The question, of course, remains as to why the government is so keen that DBS is the preferred system when its digitally compressed technology is unproven and not in use anywhere in the world, when it is at least two years behind MDS in its potential for being operational and when forcing potential customers to satellite technology opens up the possibility of foreign satellite competition from satellites such as the Pan-am Sat soon to be in orbit over Fiji.

No doubt this story will continue in the months and years ahead as the government works its way through whatever Machiavellian plans it has afoot. Mind you, what may seem to be Machiavellian may

be good old fashioned bungling.

In the meantime Australia's radio amateurs are fearful of losing their status in the 2300 - 2450MHz band even as secondary users and are weighing in on the side of DBS. As it is currently proposed there will be fourteen MDS channels in the frequency range 2302 - 2400MHz and amateurs are worried that future developments will allow MDS into the 2400 - 2450MHz segment as well.

## Flying Doctors

Mike le Ves Conte reported what he thought was the Royal Flying Doctor Service (RFDS) on 11.330MHz in the 'SSB Utility' column in *SWM* for June 1993. While I was musing on checking that one out the latest copy of the Australian magazine *CB Action* presented the following RFDS frequencies: 2.2815, 2.6575, 2.8065, 4.045, 4.3515, 4.6075, 4.8815, 4.9815, 5.0115, 5.110, 5.145, 5.227, 5.230, 5.300, 5.360, 5.370, 5.410, 5.445, 5.731, 5.740, 5.845, 6.825, 6.845, 6.866, 6.880, 6.890, 6.920, 6.945, 6.950, 7.307, 7.392, 7.410, 7.465, 7.475, 7.517 and 7.550MHz. I am still chasing after 11.330MHz.

## Met Satellites

Recent satellite images of New Zealand and the south west Pacific in 'Info in Orbit' in *SWM* have prompted me to check into the satellites accessed by the Australian Bureau of Meteorology. For domestic purposes, the met bureau taps directly into the Japanese Geostationary Meteorological Satellites (GMS) and the USA polar orbiting satellites of the USA's National Oceanic and Atmospheric Administration (NOAA). For international purposes, the met bureau here is one of the three world centres of the World Meteorological Organisation and for these purposes accesses in addition the geostationary GOES weather satellites, the USSR METEOR satellite and the European ERS satellite. It also uses data derived from METEOSAT and INSAT and will use data from the Chinese Feng Yun 2 after it is put into orbit next year. Although pictures of the earth's surface are the most spectacular output from these satellites it is the data stream that holds the main interest for the met

bureau. These data include for example information on surface and upper level winds, on sea surface temperatures, on volcanic ash and on vegetation. Satellites are used too over this area to retransmit information from data collection platforms located on buoys, atolls and islands throughout the oceans surrounding Australia and Antarctica.

## Balloon Crossing of Australia

Prominent Australian millionaire adventurer Dick Smith VK2DIK took his amateur radio equipment aloft for the first successfully completed west to east crossing of the Australian continent by balloon in June. Working via ground based net control special call sign station V12AUS he was able to make many amateur radio contacts world-wide in the 14MHz band. I am in contact with co-ordinator Stephen Pall VK2PS and will report more details in the next 'Bandscan Australia'.

Dick Smith created a furore in the media here over his decision to use a British manufactured balloon for his crossing of the continent rather than a locally made product.

## Radio New Zealand

The Radio New Zealand (RNZ) 6.035MHz transmission reported in *SWM* for June 1993 operates from 1650 - 1850UTC daily except Sunday. It features Pacific regional news at 1700 and 1800UTC and sports news at 1730 and 1830UTC.

Other RNZ frequencies are 11.735MHz daily except Saturday 1850 - 2137 (2158 Friday)UTC, 15.120MHz daily 2137 (Saturday 2155) - 0658 (Sunday 0728)UTC and 9.700MHz daily 0658 (Sunday 0758) - 1206UTC. RNZ is closed each day after 1206UTC. The frequency 9.510MHz is occasionally used in the period 1207 - 1648UTC for national and international sports broadcasts. The RNZ programming guide and frequency schedule can be obtained from Radio New Zealand International, PO Box 2092, Wellington, New Zealand. Letters and reception reports are welcome to the same address. RNZ says that reports must contain detailed programme information for verification and be accompanied by three (3) IRCs for a QSL.

**1053 2CA**  **FOR RAIDERS REVENGE '93**  
GOODTIME OLDIES

CONTINUED ON PAGE 73



# Radio Communication Products from AOR



**AR1500EX** - One of many receivers & products produced by AOR. The very compact AR1500EX hand-held wide range receiver offers all mode reception including SSB as standard. Newly designed printed circuit boards have been incorporated to ensure this new version offers the very best performance. Frequency range is 500 kHz ~ 1300 MHz without gaps, all mode reception AM, FM(N), FM(W) & SSB (USB, LSB & CW - with BFO). The AR1500EX offers full coverage of the VHF, UHF and Shortwave Airbands plus Broadcast, Amateur band, Utility services etc. Many accessories included: NiCad pack, Charger, Dry battery case, DC lead, Soft case, Belt hook, DA900 VHF-UHF aerial, SW-wire aerial, Earphone, Comprehensive Operating manual... **Suggested Retail Price of £349.00 inc VAT.** (UK Carriage free)

**AR2000** - this popular receiver continues and remains a firm favourite with listeners and enthusiasts. Features include coverage from 500 kHz ~ 1300 MHz and reception of AM, FM(N) & FM(W). Many accessories supplied as standard including Charger, NiCads etc. **Suggested Retail Price £309.00 inc VAT.** (UK Carriage free)

With the **AR3000A** (base-mobile receiver) your listening horizons are truly extended providing receive coverage from 100 kHz all the way up to 2036 MHz without any gaps in the range. The AR3000A offers the widest coverage on the market today with a high level of performance and versatility from long wave through shortwave, VHF and onward to the upper limits of UHF and SHF. Not only will the AR3000A cover this extremely wide range it will allow listening on any mode: NFM, WFM, AM, USB, LSB AND CW. The AR3000A also features an RS232C port for computer control. **Suggested Retail Price £949.00 including VAT.** (UK Carriage free)



## AORSC ~ Spectrum Coordinator IBM-PC computer control of the AOR AR3000A, AR3000 & AR2500 receivers

AORSC is a powerful program for the IBM PC (and 100% compatible) computer, which allows you to control an AOR scanning receiver using a serial port (RS-232 interface) of the computer. Many facilities are offered to provide you with a high performance radio monitoring system. It is possible to switch instantaneously between the two VFOs with a single key press. A fixed VFO offset may be entered into the system and the VFOs locked together using the "tracking" facility so that an offset is maintained while tuning across the receiver's spectrum. Three thousand mode sensitive memory channels are provided in each memory file, each with dual VFOs and a 50 character comment. A selection of these memories is displayed on the screen so that you may review memory contents easily. The display of memories may be paged up or down so that it is possible to check on the contents of the entire bank of 3000 channels from the VDU. You may expand the memories by creating new memory files, each with 3000 channel as above. There is no limit to the number of files you can create, unless you run out of disk space. A comprehensive range of scanning facilities is provided with the software. It is possible to scan memories, free scan or perform band limited scans. A descriptive 8 page booklet is available to request. The software is priced at **£75.00 plus £2.00 P&P.** AORSC is supplied on both 3.5 & 5.25 inch media for installation onto a hard drive. **A DEMO disk (without RS232 support) is available on a 3.5 inch disk for installation onto a hard drive, Price is £3.00**

## New ABF~125

VHF Air Band Filter for better strong signal performance...

The ABF125 is a receive bandpass filter especially designed to improve the strong signal handling characteristics of receivers for VHF commercial Airband listening. The ABF125 is suitable for connection to most airband and wide range receivers on the market, it is not designed just for AOR branded products. The addition of this filter to the aerial signal path will provide additional selectivity which will enable the receiver's circuitry to cope much more easily with strong interfering signals such as Band-2 Stereo or Shortwave broadcast transmissions which can be manifest in many ways such as 'hissing', mixing of many signals together, music breakthrough and desensitisation of the receiver.

The ABF125 will provide useful additional selectivity (in many situations) to any receiver's 'front end' by reducing the multitude of unwanted strong signals from reaching and saturating the receiver's first mixer stage... this results in less interference and improved reception.

Of course 'stub filters' can provide a degree of rejection to unwanted signals but tend to be bulky being suitable for base station applications and usually have to be hand-made. The ABF125 on the other hand is ready made and very compact measuring only 73.5mm and weighing a mere 52g yet offers excellent out of band attenuation typically of 25dB from 0.3 ~ 75 MHz and 20dB from 190 ~ 400 MHz. This makes the ABF125 suitable for connection to both external aerials and for connection directly under the whip aerial of a hand-held receiver. A BNC socket (female) is fitted to the top of the ABF125 and a BNC plug (male) to the other making connection to an aerial easy and straight forward.

The ABF125 is not an amplifier so will not 'boost' signals, however the additional selectivity offered can significantly improve reception in many situations by removing unwanted strong signals which may overload the receiver and reduce its effectiveness. When any connection is fitted to the aerial signal path some reduction of signal is resulted (attenuation) however the ABF125 in band attenuation level is very small due to the excellent in band V.S.W.R. of 2:1 resulting in a loss of only about 4dB.

*Note: Remember to remove the ABF125 from the aerial when monitoring signals other than VHF Airband or signal strength will be dramatically reduced.*

**Suggested Retail Price £24.50 inc VAT.** (UK Carriage £1.50)

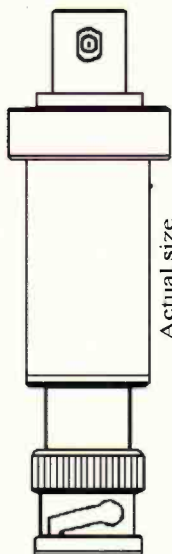

Actual size

## ACEPAC3A ~ IBM-PC control...

For those with a larger budget, ACEPAC3A is also available for the AR3000A & AR3000 receivers. Installation is recommended on a hard drive but can be run from 3.5 or 5.25 inch floppies depending on machine compatibility. Features are similar to AORSC but ACEPAC3A has a more versatile spectrum graph type display. A descriptive leaflet is available to request. **Suggested Retail Price £139.00 plus £2.00 P&P.**

## "Nearly New" stock offers substantial savings

Occasionally we are able to offer "Nearly New" equipment with full 12 months' AOR warranty at attractive prices. There can be many reasons for this stock, but most important for 'you' is that we can offer substantial savings from Suggested Retail Price. All equipment is thoroughly tested before despatch to ensure full conformity to specification. (Carriage £6.00 extra).

MODEL	DESCRIPTION	Suggested Retail Price	"Nearly New" Price	Saving
AR3000A	The ultimate. Unique all mode extremely wide band base-mobile receiver. Coverage is from 100 kHz - 2036 MHz with no gaps.	949.00	799.00	150.00
AR1500e	Compact all mode hand-held receiver. Receive coverage 500 kHz ~ 1300 MHz... AM/NFM/WFM & SSB using BFO. Enhanced model.	Was 299.00	250.00	49.00
AR1500EX	Compact all mode hand-held receiver. Receive coverage 500 kHz ~ 1300 MHz... AM/NFM/WFM & SSB using BFO. Latest model.	349.00	299.00	50.00
AR2000	Hand-held receiver 500 kHz - 1300 MHz without gaps. AM/NFM/WFM.	309.00	270.00	39.00
AR2800	Competitively priced full featured base-mobile scanning receiver. All mode operation AM/NFM/WFM & SSB using a BFO. Coverage is 500 kHz - 600 MHz & 800 - 1300 MHz. Includes internal NiCad battery.	449.00	375.00	74.00

"Nearly New" equipment is truly supplied as-new and is not the result of worn out used equipment through trade-in deals etc. Offer only available directly from AOR UK and is subject to availability. Please phone or send a large S.A.E. for full details of New and "Nearly New" equipment, there are many models in the range.

**Many other receivers and products are available from the AOR range. Please phone or send a large S.A.E. (34p) for full details. Dealers throughout Europe... fast mail order available for direct orders.**



**AOR (UK) Ltd.**

Adam Bede High Tech Centre, Derby Road, Wirksworth, Derbys. DE4 4BG. Tel: 0629 - 825926 Fax: 0629 - 825927

AOR (UK) Ltd is a subsidiary of AOR Ltd Japan. All Trade Marks acknowledged. E&OE.



# SSB Utility Listening

Graham Tanner,  
42 David Close, Harlington, Middlesex UB35EA

**T**his month we take a look at some recently announced changes in the UK Search and Rescue set-up, and take a look at some of your questions from recent letters. I have been asked to explain my policy on personal replies, now that I am compiling this column each month. Unfortunately, due to pressure of work, and the need to produce this column within the magazine deadlines, personal replies cannot be made. I will, however, try to answer as many questions as possible within this column each month. I will combine similar questions together so that the same kind of questions are not mentioned every few months.

## UK SAR

Within the United Kingdom, air-sea rescue cover is provided by the RAF, RN and HM Coastguard. Recently, the MOD announced some changes to the structure of the RAF SAR equipment and bases; some of these have already taken place, and others will happen over the next 3 years. The 'fixed-wing' element of UK SAR cover is provided by Nimrod MR.2s operated from RAF Kinloss in Morayshire. The fleet used to be split between here and RAF St Mawgan in Cornwall, but during late 1992 the aircraft at St Mawgan all moved north to Scotland. During major incidents, one of these aircraft usually flies around co-ordinating the movements of the helicopters; they are frequently heard on h.f. using two-digit 'Rescue' callsigns (e.g., 'Rescue 11', 'Rescue 51').

The helicopter element is provided by 22 Squadron operating a fleet of Wessex HC.2s and 202 Squadron operating Sea King HAR.3s. Each squadron operates from a number of 'flights' around the UK, principally at RAF airfields

near the coast. Each 'flight' usually has two helicopters at any one time although some have more due to their training needs (e.g., RAF Valley has extra helicopters because they train crews in mountain rescue techniques).

The MoD announcement stated that the remaining Wessex HC.2s would be phased-out and replaced by additional Sea King HAR.3 helicopters; this was to be accomplished by 1996. Also, a number of 'flights' would be moved, stood-down or changed from one helicopter type to another; these are listed in the adjacent box. All these helicopters need a lot of maintenance, and the SAR Engineering Wing provides this; they themselves moved from RAF Finningley to RAF St Mawgan during 1992. With all these changes, the h.f. frequencies used by the SAR aircraft and helicopters have not changed. These frequencies are well known, but worth repeating; the most active appears to be 5.680MHz.

SAR h.f. transmissions (all in MHz)	
3.023	primary night
3.085	secondary night
5.680	primary day
5.695	secondary day

One piece of information that I have never seen printed is a list of callsigns used by the RAF SAR helicopters when they are not on a rescue flight. 'Rescue' callsigns are frequently reported by numerous people, but this callsign is only used when the helicopter is on a rescue mission. At other times, they use a standard three-letter prefix to their flight number. These are as follows:

Call Sign	Unit
SRD	22 Squadron
SRG	202 Squadron
SRW	Engineering Wing



A Wessex HC.2 of 22 Squadron, RAF, soon to be replaced by new Sea King HAR.3 helicopters.

One of the best times to hear these callsigns on h.f. is at weekends. The crews need to fly regularly to maintain proficiency; they regularly train at weekends using their 'SRD'/'SRG' callsigns. Typical examples might be 'SRG 191', a Sea King from 202 Squadron 'B' flight at RAF Brawdy, or 'SRD 125', a Wessex from 22 Sqn 'E' flight at RAF Coltishall. This information updates the excellent *Rescue* book by Paul Beaver & Paul Berriff (available from your local library).

## Questions

Ron Galliers writes with some answers to earlier questions. The callsign 'Dusty Dog' was mentioned a few months back; Ron reports that he heard 'Dusty Dog 610' on 11.176MHz make a phone patch to Norfolk NAS in the USA, and then made some morale phone-patches. This would indicate that the callsign 'Dusty Dog' is something to do with the US Navy, and the '610' part would indicate that the callsign was used by a US Navy Sea King helicopter.

Ian Lockwood asks "What are HRs?"; he recently heard a USAF aircraft pass an arrival message to a USAF base in the USA, and said that he had "2 DVs and 0 HRs on board". Any suggestions? Also, in

the July issue Mike le Ves Conte was asking after a logging program for his PC. Jim Dunnet (5 Queen's Rd, Wellington, Somerset. TA21 9AW) writes offering various 'shareware' logging programs. Jim says that he can read/write any size and capacity of disk, and his offer is open to anyone who would like any radio-related software from his collection (please write direct to Jim, not me!).

The subject of the r.f. power used by aircraft and ground stations has been answered by Peter Nicholson. Stations in the North Atlantic network (Shanwick, Gander, Santa Maria, etc.) use 5kW according to their QSL cards, as do Gulf Air ('Falcon Ops') in Bahrain. The RAF Volmet uses 3kW, while Sydney Volmet uses 10kW. The ICAO manual for Aeronautical Telecomms says that h.f. transmissions from aircraft should not exceed 400W p.e.p. Peter asks about the callsigns 'Shark' and 'Skuer' heard on 11.176MHz during the evening. Both made phone patches to Howard AFB (Panama) Command Post. I can answer the 'Shark' question myself, and I assume that the 'Skuer' callsign belongs to the same user. 'Shark' is the callsign used by the 310th MAS (Military Airlift Squadron) based at Howard AFB; they operate a fleet of C-130 Hercules and C-27 (Fiat G.222) aircraft to fly around south and central America. Their callsign used to be 'Omni', but it changed to 'Shark' on 1 June 1992. Peter also asks about the callsign 'Ninja Control', which is probably in Europe somewhere; it is frequently called by Incirlik, and USAF RC-135s (callsigns OLIVE, BAMA and SNOOP) often ask for messages to be passed to 'Ninja'. It is certainly a ground station, but where?

## Next Month

More questions and answers, and a look at some USAF tanker callsigns. ■

### 22 Squadron, Wessex HC.2

A flight	Chivenor, Devon	to get Sea King s by 4.94
B flight	Leuchars, Fife	stood-down 4.93
C flight	Valley, Anglesey	to get Sea King s by mid 1996
E flight	Coltishall, Norfolk	to disband in mid 1994

Also, the HQ Flight moved from RAF Finningley to RAF St.Mawgan during late 1992. 22 Squadron are also responsible for the SAR Training Unit at RAF Valley.

### 202 Squadron, Sea King HAR.3

A flight	Boulmer, Northumberland	
B flight	Brawdy, Dyfed	to close in 4.94
C flight	Manston, Kent	to RAF Wattisham in mid 1994
D flight	Lossiemouth, Morayshire	
E flight	Leconfield, Humberside	

Also, the HQ Flight moved from RAF Finningley to RAF Boulmer during late 1992. 202 Squadron are also responsible for the Sea King Training Unit (SKTU) at RNAS Culdrose in Cornwall.

# Amateur Bands Round-up

Paul Essery GW3KFE, PO Box 4, Newtown, Powys SY16 1ZZ

**E**dward Sheeley in Ely, Cardiff, wrote in asking about amateur radio, having seen a previous column, and we were pleased to pass him on to GW4YKL who runs a class near here.

Westcliff-on-Sea is home to **Robin Guppy**, who wondered what constitutes DX. A very good question! Robin included a short log - short as he had just got married - and on 14MHz found such as KIPS, KF6QL, TI4CF, N2IDM, VK600, VK6AGP, JA9GI, VE2AFU, ZL400, 9A3IJ, WA4AFE, NICZI, S59DKR, 9H1EV, GB2SM (Science Museum), JA1JRK, PY1AQT, LY2JB, 4Z4UR, VE7GQ and VP2APB. On 3.5MHz he hooked GB2PIH, GB5RAF, V01PG, GU4WRO and T7ICE on 7MHz. Finally, to 18MHz where OZ3PZ was booked in.

Next we turn to **H Richards** of Barton-on-Humber who says he is a 'listener' rather than a 'callsign collector'. For example, UB5BBC was heard, seemingly from Berlin, and apparently arranging a sked for 7MHz. In fact, UB5 is the prefix for Ukraine, so UB5BBC was probably talking to a DL station in Berlin. On a different tack readers, Richards asks about nets. A net is a group of stations all on the same frequency (they hope!) and all taking it in turn to have a say. Many local club nets can be heard on, say, Top Band and Eighty; for example Powys ARC members gather around 3.794MHz at 1100 on Sunday mornings, or on 1.934MHz on Tuesday evenings at 1900 clock time. Many other groups form nets, some to work DX, some for a social natter, or in a way of common interest such as satellites or setting up skeds for moonbounce or MS activities.

## Calling Dennis Sheppard!

We have a letter from Mr J. Fletcher, 14 Hawthorn Walk, Eastfield, Scarborough, N. Yorks YO11 3HW in which he says he has a JR310 such as Dennis mentioned he was looking for a couple of months back. Perhaps if Dennis who lives at Earl Shilton cares to get in touch with Mr Fletcher, they might both be pleased!

**Leighton Smart** in Trelewis has been QRT because his youngster has been hospitalised; however, he does mention in his letter that he has a home-brew vertical for 28MHz and around 60 metres of wire end-fed on Top band. Nice to hear the harmonic is fully recovered.

In Iceland's Hafnarfjörður **Geoff Crowley** has observed how the low bands become useless in daylight - which for him comes 24 hours daily in midsummer! Also of course, June and at least the first part of July have been mostly poor in terms of

summer conditions, at least when yours truly has been active. Geoff highlights WA1HMM's English accent, VK6UN, PY1AQT, VE7IM, JA3QWJ, K6PWR, KC5KR, JW6MY, VK6AJ, 9X3XX, PZ1EL at S9 plus a lot, loads of Europeans, and lots of East Coast Ws. On the technical front, Geoff has spent more time playing with his antenna. He often hears CB signals when 28MHz is open. This happens when the m.u.f. on the path is above the CB and but below 28MHz, and at this stage of the cycle it may happen more often.

Oh, those birds and bees!! **Simon Griggs** (Chelmsford) has a new lady friend and this has put a decided crimp in the receiving activity level. However, a listen on Eighty produced VP5JM, while 3.786MHz around 0300 was crawling with East Coast Ws, VO, and CO2PX one night, all calling OM3CBU. As for 7MHz there was the odd W, UA9AAV, VE1BN, 9X5HG around midnight. UTC and VP9NMX around 0100. Unsurprisingly 14MHz was most exercised and we see CU2YA, EA9UK, PZ1BS, YV5ENI, UZ9CXA, T94HI, YV5DPO, 9K2HA, CE3FCF, 9K2GS, 4Z4DX, 4X4JU, KI6CG, RZ0Y/JA0VWW, 9K2HA, RW9C and HH2JO.

It must be said that we are sliding on the downside of the sunspot cycle rather faster than the oft-quoted 11 years might suggest. Whether we crash onto a plateau for a while, or whether this one turns out to be a shortie is anyone's guess - cycles have been known to down to eight years. On the other hand addicts of 50 and 30MHz will remind themselves that this is the time when most Sporadic-E openings occur. Of course, one never knows when the bottom is hit until several months later, but a couple of guides are useful; firstly, sunspot numbers fall below ten, and secondly observers of the sun will notice that not only are there few or no sunspots, but the occasional new one that does appear is much nearer the solar pole. That said DON'T look at the sun direct or through telescope of binoculars, or you will suffer as Galileo probably did (he was blind in his later years). If you want to look at sunspots, then project them onto a white acre screen and thus look at the image indirectly.

## Clubs

Have you ever thought of joining either a local or national club? Listeners to the amateur bands looking for a national club have, in essence, a choice of either ISWL or RSGB. Which to choose? Personally I chose RSGB, though I was for several years in ISWL as well. That

having been said, nowadays I support RSGB because it is my belief that without the RSGB and all other national societies we could well lose our bands to commercial pressures. At a lesser level, the fight against the EE bureaucrat and his wish that all our equipment have his rubber-stamp of approval seems to be - if it goes through - the end of home-brew and the smaller suppliers. RSGB President G3RZP is, as it happens, professionally engaged in this area, and he tells us that at least we have the backing of the British Euro-MPs. You can help by writing to your Euro-MP to say that in your view, the proposed amendments to the Telecommunications Terminal Equipment Directive (91/236/EEC) should NOT cover amateur radio equipment. The name and address of your MEP can be obtained from your local public library.

## Letters

We kick off with **Phil Townsend** from London E17, who wrote that he had got in a tangle with the fitting of an antenna attenuator. The object of the attenuator is to reduce all signals when one big one is overloading the receiver front-end - probably the mixer stage. The big one makes the stage go non-linear, and every signal beats with every other one to create noise. The offender is maybe many tens of kHz away from the signal you want to listen to. Thus, the idea is to reduce the strength of all signals until the cause of the problem is reduced below the overload limit, when the noise level suddenly falls and signals pop up out of the noise. This scheme is particularly useful on the lower bands, notably 3.5 and 7MHz where megawatt broadcasters outside our bands are usually the culprits.

Still with noise, much is picked up on mains leads and coaxial cable screens, and there is a lot to be said for coiling these up wherever possible, both on the station receiver and nearby TV, video and computer devices. The coil should be located as near to the TV, video, computer or communication receiver as possible. It makes the place tidier anyway, and can make a considerable improvement to the rumpus that emanates from, for example, a TV timebase.

Now we come to **Gerlad Bramwell's** gleanings from Swinton. Gerald's enquiries about IARN nets is as yet unanswered, but he has found them on 3.795, 14, 175, 28.475MHz at 1000, 1300, 1700, 2100 and midnight UTC. In addition 3.890 at 2200 UTC and 7.290MHz at 2300 UTC are used but on a.m., these

outside our bands but within the Region 2 allocation. Other signals noted came on 3.5MHz from VK3DZM, CN8LI, VO1FG, V85AA, PY1RR, 9U1XQ and PY1HY. The crop on 7MHz included VE1DGE, TL8NG, PY5OT, ZL2ADX, CR6RP, ZP6UT, 7X2BK, UL7JGJ, D2SA - one wonders a bit about this one - PT7YS, PZ1EL, LU5FCI, VK4MZ, TR8LC, 5NOMVE, EL2PP, TV2JL, UJ8JMM, 9G1MR, UN9LX, CN8MA, Ws and Europeans. A look at 18MHz yielded RTTY sigs from W1AW, c.w. from VS6U, AA2U, N4DU and UD6DKW while on sideband a load of Ws, A92BE, KP4ERJ, HZ1AB, ZLs, 5B4ES, JAs, FG5GI, FG4GA, VP9IN, 5X5A, TU5DX, FR5DX, HKOHEU, J88AQ and all sorts of smaller fry came in. Tuning to 24MHz we see ZD7DP, EA8ZO and a W. Now to 14MHz and quite an enormous list, starting with 16 RTTY DX stations, VA9KLN, and just about all there was to be heard on s.s.b. Giving 21MHz a work-over KP2N came in on RTTY. VA9CQC and W1WA on the key, and shoals of DX stations, among which I single out for notice YI1MH, 3X0HLU, ZS21GO, J37P, HK3MZS and Z21GO - though I ha'e ma doots about the first one mentioned.

**David Forester** next, in Cross Heath, Newcastle, Staffs. David stuck to 3.5MHz sideband and offers VK6ACY, 9V1XR, 3C1TR, EL2PP, ZK4KS, VK2CWG, VK2DZO, PY1RR, VK6LK, JA6BJT, 4X4WB, VK5JP, VK3EW, VK5AFO, VK3DZM, VO1FG, 5A0RR, ZL3LB, ZL1KP, ZL2ADX, VK4CV, VK3PA, 9A1GST, V85AA, 4L2G, 4J4AH who sounds a bit 'iffy', W3YOZ, PY50BA, LU8EEM, K04MZ, PY4BK, N4JJ, PU2OBA, W8NGO, A28FAG(?), ZL4AP, ZP4AP and CE2CC.

Great Harwood next, to **Mark Malone**, who seems to have heard mainly Europeans on his DX302 receiver and random wire antenna. However, we note 9K2JC and V9BWO for Asia, 3C1TR for Africa and shoals of the 'rarer' Europeans. One wonders whether Mark has a skywire which 'looks' in a less than favourable direction, or whether an improvement would be obtained by a change of listening time. For example, there is the morning period; if you can't hear VK and ZL working into UK around 14.150kHz, the band is not too hot or you have a receiver fault! The mornings are in fact also better simply virtue of an absence of European signals to blot out the more distant stuff.

So, there you have it for another month, Letters as always to the address above to arrive at the beginning of the month. Remember for the record that your mention will appear some six weeks after the letter reaches me.



**A.O.R, YUPITERU, ALINCO  
DIAMOND, HUSTLER, & E.R.A.**  
Products from Stock *Plus MANY MORE*  
**Phil - G7 AZK, Syd - G7 BMT**  
**Tel: 0270 - 588440 Fax: 0270 588440**  
15 MIDDLEWICH STREET,  
CREWE CW1 4BS



**ELECTRONICS  
VALVES &  
SEMICONDUCTORS**

Phone for a  
most courteous quotation

**081-743 0899  
Fax: 081-749 3934  
Telex: 917257**

We are one of the largest stockists  
of valves etc, in the U.K.

COLOMOR (ELECTRONICS) LTD.

170 GOLDHAWK ROAD  
LONDON W12 8HJ

**AIR SUPPLY**

83B HIGH STREET, YEADON,  
LEEDS LS19 7TA. Tel: (0532) 509581 Fax: (0532) 500710

Shop just two minutes from Leeds Bradford Airport.  
Shop hours: 1000-1330: 1430-1700 (hours do vary) **CLOSED WEDNESDAY**

**AIR TRAFFIC  
CONTROLLERS**

On hand to help you towards an interesting and  
rewarding pastime. Specialists in **AIR BAND RADIOS  
AND SCANNERS**. Hand held, mobile or base - AOR,  
Signal, Yupiteru, Icom, Uniden, Sony, Nevada: HF  
receivers from Sony, Icom, Lowe.  
**Everything you need - contact us.**

If you would like our info pack send large SAE and stamps to value of 50p.



**FLIGHT DECK**

**The Airband Shop**

THE NORTH'S PREMIER AVIATION STORE

- ☆ ALL types of Airband Radios - Civil, Mil, HF ☆
- ☆ Nav Charts ☆ Aerials ☆ Videos ☆ Books ☆
- ☆ Display Models ☆ Telescopes/Binoculars ☆

For catalogue send 50p or 2 I.R.C. to Dept. SW5  
192 Wilmslow Road., Heald Green, Cheadle,  
Cheshire SK8 3BH, - 3 miles from MAN Airport.  
Telephone: 061-499 9350 Fax: 061-499 9349

**RUN BY ENTHUSIASTS, FOR ENTHUSIASTS**

Open Monday to Saturday, 9:30 am to 5:30 pm Note: Closed Wednesdays

**THE FLYING SHOP**

BIGGIN HILL AIRPORT



**THE NEW!!!  
YUPITERU MVT-7100**

- 1000 Channels
- All Mode AM/FM/  
MW/LSB/USB
- 500kHz-  
1650MHz
- SSB tuning in  
10Hz steps



**YUPITERU MVT-7000**

- 1MHz-1300MHz
- AM-NBFM-WBFM • Multiple steps
- Better than 0.5µV • 200 memories
- Rotary dial • S-meter • Fast scan  
speed • Lockout/priority • Ni-cads
- Charger/AC PSU • 12V lead

The MVT-7000 from Yupiteru provides  
unbroken coverage throughout the spectrum.  
Each one is carefully tested by us and supplied  
with a unique power supply that will not only  
recharge the ni-cads, but also run the set  
directly from the mains. Its beautifully styled  
lines and superb engineering make it the best  
buy for the customer who wants the widest  
frequency range possible. **£315 inc. VAT**

**YUPITERU VT-125 MkII**

- Excellent reception • 108-142MHz
- 30 memory channels
- Illuminated LCD display! 25, 150 or  
100kHz steps • Search, scan or direct  
frequency entry • Keylock • Keyboard  
beep tone • LCD signal meter

**£165 inc. VAT**

Complete with 3 AA size ni-cad batteries,  
240V mains adaptor. 12V d.c. cigar plug &  
carry strap

**YUPITERU VT-225**

**£235 inc. VAT**

The Flying Shop, Biggin Hill Airport, Westerham, Kent TN16 3BN

24 hr delivery £7.50 48 hr delivery £5.00

Prices are subject to change with out prior notification



Tel: (0959) 576370 0900 - 18.00 (Mon-Sun)  
(0959) 572352 0700-0900 & 1800-2000  
Fax: (0959) 576711 24 Hour.



**PC HF FAX 6.0**

RECEIVE and TRANSMIT weather charts,  
rebroadcast satellite pictures, amateur and  
press images.

230 Page manual with worldwide - fax frequency and schedule list, together with  
built in program database. Supports Hercules, CGA, EGA, VGA and SVGA. Printer  
support for 9 pin, 24 pin, inkjet and laserjet printers up to 14 inch carriage. Display  
in grey scale, blue grey and colour. All standard line rates and IOC supported.  
Automatic image capture scheduler with sync and start/stop tone recognition.  
Images may be saved in GIF or PCX format.

Installation is simple, both the demodulator and modulator plug into the serial port  
of the PC and are powered by the computer.

Upgrade for existing PC HF FAX users £43.40 P&P £1.50

**£116.33 inc VAT P&P £3.25**

Optional Transmit Modulator £59.80

**PC SSTV 5.0**

RECEIVE and TRANSMIT Slow Scan TV Images

Images can be received and transmitted in monochrome or colour. Support for  
ROBOT, SCOTTIE, MARTIN and AVT modes. Image resolution in VGA or SVGA up  
to 640x480x256. Received and transmitted images can be converted to .PCX or  
.GIF formats. Tuning oscilloscope, noise smoothing, saving to disk, printing and  
editing are some of its many features.

Upgrade for existing SWL, HF FAX and GOES users £64.92 P&P £1.50

**£99.00 Inc VAT P&P £3.25**

Optional Transmit Modulator £59.80



All items come complete with a comprehensive manual,  
tutorial audio cassette and demodulator. They will work  
on any PC compatible computer from 8088 to 486 and  
notebooks. The demodulator plugs into the serial port of  
the PC and requires audio from a radio receiver. Suitable  
dedicated receivers and aerials are also available.

Call today for full details and brochures

**COMAR ELECTRONICS**  
UNIT 3, MEDINA COURT  
ARCTIC ROAD, COWES,  
ISLE OF WIGHT, PO31 7XD



Tel: 0983 200308 Fax: 0983 280402

**PC GOES/WEFAX**

PC GOES/WEFAX enables you to receiver both  
FAX and SATELLITE images on your PC computer

In FAX mode it will display weather charts, rebroadcast satellite images, press and  
amateur transmissions. In SATELLITE mode it will capture images from both  
METEOSAT and all Polar orbiting satellites. Some of its many advanced features  
are: • Image resolution: 640x800x16 standard, 1280x800x256 with VGA and 1MB  
EMS • Super VGA support • Display in black/white, monochrome grey scale,  
blue/grey • Colour or user programmable colour • supports all known FAX and  
satellite transmission modes • Start, stop, phasing tone recognition and tuning  
oscilloscope • Latitude and longitude gridding on Polar orbiting images • interactive  
thermal infra red analysis • Polar orbiting prediction program • Multiframe  
animation • Image brightness • Contrast • Reversal and rotation control.

Price only **£199 inc VAT p&p £3.25**

**PC SWL 3.0**

PC SWL is a complete package allowing  
decoding of data sent over radio

This new version contains the following facilities:

- RTTY baudot 45, 50, 75 and 100, or user selectable rate • ASCII 75, 110, 150,  
and 300, or user selectable rate • FEC/ARQ including AMTOR/SITOR 75 and 100  
baud • MORSE CODE with automatic or manual speed control • NAVTEX marine  
weather and navigational information • RAW HEX for manual decoding • Improved  
automatic signal analysis • Integrated shortwave station log, to enable search, sort  
and store stations • New drop down menus, integration with PC HF FAX.

Upgrade for existing PC SWL users £43.40 p&p £1.50

**£99 inc VAT p&p £3.25**

Order PC SWL and PC HF FAX together for only £178 p&p £3.25

# Airband

Godfrey Manning G4GLM  
c/o The Godfrey Manning Aircraft Museum,  
65 The Drive, Edgware, Middlesex HA8 8PS

**M**y Museum celebrates its 10th anniversary on March 20 next year. Has anyone a suggestion for a way to mark the occasion on that Sunday?

Talking of history, it's about time I replaced my h.f. receiver with something more up-to-date. I suggest getting rid of my old HRO (mid-war vintage) and replacing it with, say, a Trio 9R-59DS (from perhaps the late 1960s) thus making my station about two decades more modern! General coverage with b.f.o. is required, valves are preferred (to cope with overloading from strong signals) and funds are short. If you can offer a suitable rig, or are interested in the HRO, let me know. The old receiver will be available on generous terms to a deserving cause such as a school, club or poor young novice.

## You Are (Not Necessarily) Clear to Display

During September, the Red Arrows are expected to appear at: Kinloss on September 4, Manston & Shoreham on the 5th, Llandudno on the 9th, Benson & Bristol on the 10th & 11th, Duxford & Southport on the 12th, Guernsey & Jersey on the 16th and Finningley and Leuchars on the 18th. In October, the team heads for the USA and, traditionally, its membership changes as some pilots finish their three year tour at the end of that month.

Then follows intensive training to bring the new recruits up to standard; the leader of the 'synchro pair' is chosen, and he in turn selects his Number 2. Final training takes place on detachment to Cyprus where better weather can be expected more frequently. Then the 1994 display season will be with us before we even know it! No display is guaranteed, so check before setting out by ringing the Red Arrows Hotline (0891 664424) which is presumably charged at a high rate, and also the temporary airspace restrictions recording (0500 354802) which is free.

Although they still have airshows scheduled there, Cranfield can no longer host big rallies. On a recent visit, I noted that new industrial units have been constructed on what was the 08 threshold but leaving 04/22 intact. There are plans for further phases of development. I'm sorry that of all the places available to build these premises, they felt compelled to choose a runway. Why does a centre of technical excellence need the revenue from buildings,

anyway? Is it not worth funding properly as a resource in its own right? The skills training on offer at the Institute is an incalculable investment for the future of our country's prosperity which mere financial accounting fails to reflect.

The last (?) Halton show passed off smoothly, in good weather, but with a sense of a lack of enthusiasm. It is as if everyone knew that this would be the last flying display. Rumours still circulate amongst the locals, of course; some people hope that this won't in fact be the last display! Others suggest that a show will still take place but the only airborne part of it will be a simple flypast. If that is not possible, a ground-based 'fête' style show could still occur to raise money for charity, but I suspect that this would be devoid of aircraft. As usual the kindly controllers made sure that the public were aware of the display frequencies of 129.25 and 255.4MHz. These are not the club's usual spots and I don't know why they change from year to year. The controllers have their own mobile control tower, positioned just on the air side of the crowd fence near the mid-point of the 09/27 active runway.

## A Cry for Help

"How can I suppress vehicle ignition interference when a v.h.f./a.m. receiver is operated from a car?" asks Nigel Tucker (International Short Wave League Z2-20551) in Zimbabwe. For starters, all metal parts of the vehicle are bonded together, which is to say that thick electrically-conductive braid is used to keep all metal panels electrically interconnected. Note that the braid must be thick, well-secured (by more than just a self-tapping screw) and attached to a conductive point with the paint scraped away. Then, to preserve the connection, waterproofing paint or covering (such as Finnigan's Waxoyl or a bitumen-based product) must be applied. Remember that fasteners such as bolts appear on both sides of the panel and both surfaces need protection. The most important panel to bond in this way is the engine compartment lid. The result is an electrically-screened box surrounding the engine.

On its own, this is not enough. The screened box has a hole in it: the power lead to the receiver. This should be filtered in order to keep interference from entering the radio. In-line chokes can be purchased for vehicle use, but make sure that they can handle the current drawn by the



Fig. 1: The Harrier, it hardly needs and introduction! This times it's the AV-8 variant. Christine Mlynek.

set (especially if a transceiver is involved). Where the power leads enter the equipment, they should pass into the radio's metal enclosure via feed-through capacitors. If one power rail of the radio is bonded to the earthy side of the vehicle supply then only the other needs a feed-through, assuming the metal case is not floating (it shouldn't be!). How this is arranged varies from one set to another because drilling holes might invalidate the guarantee and/or maintenance contract.

There are other ways of keeping the noise level down as well. The ignition leads should be a suppressing type, so pure copper out of the question. These latter are fashionable among drivers who think that they improve engine performance. I don't believe in them; the high-voltage, low-current ignition system is inherently high impedance anyway, so copper leads won't confer any benefit. They will, however, cause widespread interference in any neighbourhood through which the vehicle is driven. Likewise, resistive spark plugs are available, their type number often being prefixed by letter R. If not, then resistive suppressors are made which connect between the h.t. lead and the top of the plug. I doubt if a ferrite placed over the h.t. lead will be effective. Remember also that the distributor and coil can be enclosed in a screen. Aircraft h.t. leads are covered in an earthed screening braid and you could try imitating this technique. Finally, have any non-ignition sources of interference, such as an electronic tachometer, been missed?

## Follow-Ups

Shackletons have received numerous recent mentions. Andy Keddie (Lincoln) knows about the two Paphos examples (July). Years ago a Cypriot businessman bought them at auction but his plans for running pleasure flights probably haven't come to fruition. The aircraft are WL 747 and WR 963.

During a visit to the island in April, Fred Wilson (London SE2) observed that they were still there.

## Information Sources

Various airport ground services have short-range communication allocations typically around 456MHz. Some of these frequencies relay Ground or Tower as these two controllers share responsibility for movements of aircraft and vehicles on the ground. This enables service vehicles to coordinate their movements with aircraft whilst traversing the taxiways and apron. The Tower has the special function of safeguarding the runway, and vehicular access might be needed in order to remove debris or scare off birds. R. Keary (Manchester) points out that the third edition of Peter Rouse's *Scanners* (temporarily out of print), details some of these u.h.f. channels. Look out for this, and other books by the same author, from the *SWM Book Service*.

Living in Lincolnshire, Frank Slater has plenty of nearby airfields. Marham, Mildenhall and the others provide Frank with frequent sightings of tankers, Starlifters and so-on. I don't know how the military keep track of their wide range of callsigns, which seem to vary so much! Various specialist hobby-orientated magazines and clubs offer information on such callsigns. As for the frequencies allocated to such aerodromes, the best guide is the *RAF Flight Information Publication*. In your case, Frank, try the *En Route Supplement: British Isles and North Atlantic*, which is sold to the public by mail order from 1 AIDU, RAF Northolt, West End Road, Ruislip, Middlesex HA4 6NG. Telephone (081) - 845 2300 ext 7209. As stated at the end of this column, I regret being unable to send out direct replies to individuals, so watch future issues if you want to

CONTINUED ON PAGE 62



**NEW** **YUPITERU**

**MVT-7100**  
Hand-held.  
Covers 530kHz  
to 1650MHz

**MVT-8000**  
Mobile or base wide band scanner

**YAESU**  
**FRG-1000** **NEW**  
The most promising general coverage  
receiver yet.

**SPECIAL OFFER THIS MONTH ONLY**

**YUPITERU**  
**MVT-7000**  
Hand-held. Probably the  
UK's most popular  
hand-held scanner!  
**£320 incl V.A.T.**

**FAIRMATE**  
**HP-2000**  
One of the most  
popular scanners  
on the market.  
**£260 incl V.A.T.**

**ALINCO**  
**DJX1E**  
Hand-held scanner.  
Covers 500kHz to  
1300MHz,  
receiving AM/FM/  
WFM with 100 memories.

**ICOM** **ICR1**  
Wide band receiver.  
Covers 100kHz to  
1300MHz receiving  
AM/FM with 100  
memories.

**AOR**  
**AR-1500**  
Hand-held. Covers 500kHz to  
1300MHz receiving NFM,  
WFM, AM and SSB.

**AR-3000A**  
Multimode scanner -  
covers  
100kHz-2036MHz.  
Modes: USB, LSB,  
CW, AM, FM, WFM

**AR-2000**  
Hand-held wide band  
scanning receiver 1000  
memories.

**PHONE FOR BEST PRICES ON ALL OTHER ITEMS**

# ALAN HOOKER

42 NETHER HALL ROAD, DONCASTER, SOUTH YORKSHIRE, DN1 2PZ  
TEL/FAX: (0302) 325690 Open: Mon-Sat 10-5pm Closed Thurs



Due to imminent price rises the above prices are held only while stocks last

# ARE

COMMUNICATIONS '92

"The shop with the smile"

6 Royal Parade  
Hanger Lane, Ealing  
London W5A 1ET  
Fax: 081-991 2565

Now in stock  
- UK Scanning  
Directory:  
Revised  
Edition

Part exchange and equipment purchases welcomed! Credit facilities available subject to status. APR from 37.8%. Located next to Hanger Lane Tube Station (Central Line) and on the junction of the A406 & A40.

**PHONE NOW ON - 081-997 4476**

After hours - 0836 550899

73s - Alan and Jez.

A.R.E. modifications still available for Icom receivers

OPEN MONDAY-FRIDAY 9.30-5.30 SATURDAY 9.30-1.00pm EASY PARKING AT THE REAR OF THE SHOP

## FRG-100 SPECIAL OFFER

This month only **£485** (without power supply)

Best Communications  
Receiver 1992  
WRTV Handbook 1993  
Radio Industry  
Awards

or FRG-100 incl. PA11C at **£525**  
plus stock of good 2nd hand receivers & scanners at realistic prices

# Scanning

Alan Gardner  
PO Box 1000, Eastleigh, Hants SO5 5HB

**B**y now most readers will have read about the situation that has arisen in America, where the powerful cellular telephone companies have managed to sneak legislation through the House of Representatives to restrict the importation, sale and design of equipment capable of receiving cellular phone transmissions. In addition, it will no longer be permissible to sell scanners where cellular frequency coverage can be restored by simple hardware or software modifications. A good example of this would be the Tandy PRO-2004/5/6 series where the cellular band is locked out on US versions by the inclusion of an additional programming diode.

Because of the size of the American market for scanning receivers it could mean the end of continuous coverage scanners such as the Icom IC-R1 or AOR 1/2/3000 series as the FCC would no longer be able to certify them.

The way the legislation has been worded it is unlikely to have much impact on cellular monitoring, and is seen by many to be just a cosmetic exercise on the part of cellular companies to make systems appear more secure to their customers.

Let us hope that the imminent arrival of digital cellular systems in this country will forestall any similar laws being considered this side of the Atlantic.

## Intercepting Communications

You may remember in the January column I mentioned a unit becoming available in America that the manufacturers, Optoelectronics, have named the 'R10 FM Communications Interceptor'. This novel device will sweep over a large range of frequencies and lock onto any strong transmissions that may be present. The received signals can then be heard through a built in loudspeaker. This is ideal if you want to quickly check for local activity as the unit can lock on to any signal in the range 30MHz-2GHz in less than two seconds, although it should be noted that only f.m. signals can be demodulated - It seems a pity that a.m. detection is not available, but I am sure that someone will devise a modification to make it possible.

The unit measures 130 x 71 x 150 and is similar in appearance to the Optoelectronics range of hand-held frequency counters. The front panel has two l.e.d. bargraph displays, one indicates the f.m. deviation and the other the

received signal strength, a loudspeaker grill occupies the remainder of the front panel. The top of the unit has controls for volume, squelch, deviation measurement sensitivity, and a button to 'skip' to the next transmission. Sockets are provided for a BNC antenna connector and earphone jack. Power is provided by an internal NiCad battery pack that can be recharged with the supplied mains charger.

The unit can detect signal levels of around 1mV at 100MHz and 10mV at 1GHz that makes it much less sensitive than an average scanning receiver, but it should be remembered that the unit is only designed to receive very local transmissions. As a typical detection range is in the order of 50-150m from a 5W v.h.f. or u.h.f. transmitter, a lot depends on the terrain and the level of other signals (including f.m. and TV broadcast stations) that may be present. The unit is primarily intended for use in semi-professional applications, such as maintenance of radio communications systems or counter-surveillance operations, so the UK price tag of £389.00 may seem a bit steep for the average hobbyist, but I am sure there will be several readers who would like to try one. You can obtain further details from Waters & Stanton Electronics, 22 Main Road, Hockley, Essex. SS5 4QS. Tel: (0702) 20843.

## Reading the Digits

Another new product that may be of particular interest to owners of scanning receivers is the Universal M-400 decoder that was reviewed in the August issue of *SWM*. As far as I am aware this is the only device available to the hobbyist (apart from perhaps a unit made by Scanmaster) that is capable of decoding the POCSAG/GOLAY data format used to send information to message display pagers.

This could be the start of a trend towards add-on decoder boxes for scanners as more and more users change over from voice based communications to digitally transmitted textual information services. Several companies are now operating national mobile data networks including Paknet around 164MHz, Cognito around 178MHz, RAM mobile data in the lower part of the 453MHz band and Hutchinson mobile data in the upper part, a few regional networks also operate around 440MHz. All of these systems use an adaptation of the industry standard X-25 digital

communications protocol and offer very secure communications. Other digital transmissions include signalling systems used to provide control information for trunked networks. Most of these appear in the 200.5 - 207.5MHz band and follow a standard defined by the DTI Radiocommunications Division in publication MPT1327.

It is often not possible to recover data once it has passed through the audio stages of the receiver unless it is specifically designed with data reception in mind. In order to overcome this problem the next generation of data decoders may require the receiver to provide an i.f. output signal. The 'raw' data could then be manipulated by the decoder using Digital Signal Processing (DSP) techniques that are capable of producing results almost independent of receiver performance, which normally tends to be the limiting factor.

## Frequency Counters

A number of readers have written to me asking for advice on the use of frequency counters to determine transmitter frequencies. Often, this is not quite as straightforward as advertisements may suggest. A lot depends upon the location of the transmitter and the frequency it is operating on.

A frequency counter is an essentially a broadband device. It cannot discriminate between multiple signals if they are of comparable signal strengths, so if you are trying to measure a particular transmission in the presence of other signals the chances are that you will be unsuccessful. The majority of radio sites have more than one service operating from them. They may also make use of point to point radio links that can permanently transmit on several different frequencies and all of these transmissions will confuse a frequency counter.

Another factor is the level of transmitter power used, as this may be very low. For example, the power transmitted by office-based control stations operating on community repeaters is restricted so that they do not interfere with other users. Some base stations are remotely sited and controlled over private telephone lines, the antenna on the control centre roof may not be used for transmission purposes and could just feed a monitoring receiver.

Antennas mounted on high structures are not intended to give

strong signal levels at ground level, they are designed to concentrate most of the transmitted power towards the horizon, in order to maximise the communication range. This is particularly true at u.h.f. where high gain directional antennas produce a very concentrated narrow beam.

The bottom line is that unless you can get within the main beam close to the tower you may not be able to intercept a strong enough signal for the counter to operate.

One other factor to be considered is that is that the r.f. field strength tends to diminish as the frequency increases. Antenna gain can usually compensate for this phenomena, so it doesn't help if you only have a 'rubber duck' antenna on the counter.

You can improve your chances by using a tuned antenna with some gain. This will help to reject unwanted signals and maximise the level of the desired transmission. If you have a telescopic antenna try altering its length to be a 1/4 wavelength at the desired frequency, this may marginally improve the performance.

## Tracking Stolen Vehicles

One of the predictions I made in the January column is about to come true. Tracker Network has commenced operations in the UK. This is the British version of a stolen vehicle tracking system that has already been successfully operating in America, where it is



called Lo-Jack. Persons subscribing to the system have a miniature unit hidden inside their vehicle. If it is stolen the owner can notify the police and Tracker Network who will remotely activate the unit. Once this is done the unit transmits a coded radio signal that can be detected by specially designed direction finding equipment. The great advantage of the system is that the thief is not aware that the car is being remotely identified as stolen.

Even if the car has been hidden it will continue to signal its location to the police. This should permit recovery of the vehicle and capture of the thieves without the necessity for dramatic car chases.

The system has had extensive TV and press coverage including plenty of pictures of the direction finding equipment fitted in a police vehicle. The four roof mounted antennas used as part of the d.f. system would seem to be tuned to v.h.f., so my guess is that the signal transmitted to the car mounted unit is activated by means of one of the national radio paging networks.

I would imagine that, initially, the d.f. equipment will only be fitted to selected police vehicles such as motorway traffic cars or at fixed

locations like major motorway intersections or ports. As the system increases in popularity the number of d.f. receivers is likely to be extended.

If you are sceptical about the scheme working, it does seem to have been very successful in America where the relative simplicity of the system has made it popular with police officers. In one instance, a car was recovered within seven minutes of it being reported stolen - not bad going!

The system costs £160.00 plus an annual subscription charge of £61.10, or alternatively you can make a one-off payment of £350. Further information is available from the AA who are distributing the system and you can contact them on (0800) 990099.

## I-Spy Books

Whilst looking through the publications on display at one of this summer's many amateur radio rallies I came across an intriguing title that I am sure will be of interest to many readers. Called *Latest Intelligence* by James E. Tunnell, published by TAB books, ISBN 0-8306-3531-9, the book

(available from the SWM Book Service) is an international directory of codes used by Government, Law Enforcement, Military and Surveillance Agencies. The listings follow an A-Z format with over 290 pages of concise explanations and descriptions. Although the majority of entries are of American origin, many of the terms and abbreviations are used extensively in other countries. If you try to follow the exploits of agencies such as the DEA or American Customs on the short wave bands then this is an ideal book to keep beside your radio.

Whilst we are on the subject of books the third edition of *The UK Scanning Directory* (available from the SWM Book Service) seems to be proving very popular with readers. The content being well ahead of its rivals in terms of quantity and detail. The only small criticism I have heard relates to the number of errors that have inevitably crept in due to the list being compiled from many different sources. Perhaps one way of improving this would be for people submitting contributions to include a date alongside confirmed frequencies in order to give an indication of when the information

was valid. This would help to keep the listing up to date and eliminate some of the very old (and no longer used) frequencies, which always seem to appear in just about every list I have ever seen.

## Peter Rouse

Whilst writing this column I was saddened to hear of the death of fellow SWM columnist Peter Rouse.

I got to know Peter during my earliest involvement with scanning receivers. I can remember our excited telephone conversations when the latest piece of gear became available, the thrill of monitoring the Space Shuttle and the exchange of stories, many of which have since passed into scanning folklore.

Peter, more than anyone, was responsible for promoting 'scanning' in this country. His best selling *Scanners* books were many enthusiasts' introduction to the hobby, as his wit and writing style made complicated subjects easily understood. He will be greatly missed by all his fellow radio enthusiasts.

# Airband

CONTINUED FROM PAGE 59

see the answer to your questions!

Like **Darren Bruton** (Birmingham) I too was keenly interested in flying by the age of 13. I'm sorry that I can't explain much about obscure military callsigns since, as I explained above, they are too local and changeable. Civil callsigns are much better regulated but the ICAO document that lists them (Designators for Aircraft Operating Agencies, Aeronautical Authorities and Services) is expensive. It can be purchased from CAA Printing and Publication Services, Greville House, 37 Gratton Road, Cheltenham, Gloucestershire GL50 2BN. Telephone (0242) 235151.

Got the latest Airband Factsheet yet? A reply-paid, self-addressed envelope sent to the Broadstone editorial office is all you need to receive the single A4 sheet.

## Frequency and Operational News

GASIL 6/93 from the CAA shows that Oxford (Kidlington) has swapped the functions of two frequencies. As a trial, the a.t.i.s. is on 121.75 and Ground is now on 121.95MHz.

Also from the CAA, AIC 82/1993 introduces new danger areas D110A



& D110B at Braunton Burrows with a crossing service from Chivenor on 130.2 or 340.0MHz (information from London 124.75MHz if Chivenor is closed). New Danger Area Activity Information Services are available for D407A Warcop (Pennine Radar 128.675), D701 Hebrides (Scottish Information 127.275) and D708 Rosehearty (Rosehearty Range 122.75MHz) so make use of these if flying through the areas.

AIC 95/1993 explains some of the ATZ/MATZ changes that I mentioned in previous months. Bentwaters and Woodbridge

airfields, ATZ and MATZ have all closed. Wattisham has transferred from RAF to Army Air Corps who fly mainly helicopters and rarely fixed-wing, so ATZ and MATZ remain here; a new ATZ at Elmsett will also be controlled from Wattisham.

Replies always appear in this column and it is regretted that no direct correspondence is possible. All letters to 'Airband,' c/o The Godfrey Manning Aircraft Museum, 63 The Drive, Edgware, Middlesex HA8 8PS. Genuinely urgent information/enquiries: Tel: 081-958 5113

Fig. 2: A Sea King.

Christine Mynek.

## Abbreviations

AIC	Aeronautical Information
a.m.	Circular amplitude modulation
a.t.i.s.	automatic terminal information service
ATZ	Aerodrome Traffic Zone
b.f.o.	beat frequency oscillator
CAA	Civil Aviation Authority
GASIL	General Aviation Safety Information Leaflet
h.f.	high frequency
HRO	Ham Radio Operator (so it is reputed)
h.f.	high tension
ICAO	International Civil Aviation Organisation
MATZ	Military ATZ
MHz	megahertz
u.h.f.	ultra high frequency
v.h.f.	very high frequency



**SSE****HIGH QUALITY ACCESSORIES**

The Original #1 Scanner Specialists

**FOR SCANNING MONITOR RECEIVERS****JIM PSU-101**

1. **JIM PSU-101 MkIV.** A high quality UK manufactured fully regulated 220-240V AC power supply with RADIO BASE HOLDER combined. For use with FAIRMATE HP-100E/200E/2000/1000AB. AOR-1000/1500/2000. YUPITERU MVT-5000/7000/7100/125, VT225. REALISTIC PRO-35/38. ICOM-R1. UNIDEN UBC50XL. BC55XLT. UBC70XLT, ALINCO DJ-X1. UBC100XLT. New unique features include 2 DC output sockets one for radio and the other for accessories. A bracket for BNC socket for antenna connection. Separate DC leads included. 9 volt version for Tandy, etc. available. **PRICE £29.95.**

2. **JIM BH-A3.** Universal base stand for handheld scanners-transceivers etc. convenient, safe support of radio. Adjustable front stop. Heavy duty chromed base. Bracket for BNC socket for base antenna connection. **PRICE £10.95.**



\*3. **JIM BH-A3C.** Now fitted as standard with approx. 30cm (12in.) high quality low loss 50 ohm RG58A/CU cable with professional right angle BNC plug and BNC bulkhead socket. Ideal for RX and TX up to 4GHz (no SO239 socket). **PRICE £13.95.**

4. **JIM CH-A4.** Car mounting holder for handheld scanners- transceivers with BELT CLIP support. Safe and convenient use of scanner etc. in car, truck, boat etc. **PRICE £7.95.**

5. **JIM BC-4H.** Unique FAST Universal 4 hour + 14 hour Ni-cad charger. "auto-switch-off" timer (no more guessing). Ideal Fairmate, AOR, Yupiteru etc. Leads + 4 sizes of AA holders supplied. **PRICE £19.50.**

6. **JIM SM-A1** High quality S meter for scanners CB. **PRICE £26.95.**

Payment by postal order or cheque. Prices include postage

Further information on SSE products, send A4 SAE to:

**SOLID STATE ELECTRONICS (UK)**

6 The Orchard, Bassett Green Village,  
Southampton SO2 3NA  
Tel: (0703) 769598

**NEW  
JIM BH-A3C**

## GOT A SCANNER? NEED A FREQUENCY?

VHF/UHF AIRBAND FREQUENCY GUIDE. UK Military and Civil. Tower/Approach and Talkdown £3.95. VHF/UHF FREQUENCY GUIDE 27 to 1,300 MHz. Services covered include land, sea and space £3.95. LOOSE LEAVES SPOTTERS LOG. Royal Air Force/Navy/Army Operational Aircraft, A4 format £9.50. Other guides available.

SAE for details. All prices including p&p.

DG ANTILL, Dept SWM 1 CHURCH LANE, MUNDESLEY NR11 8AU

**G2VF LOOP ANTENNAS WITH ATU FOR HF HAM BAND TRANSMISSION** (SWR One to One 40, 15 and 10 One Point Five to One 80 and 20) **AND SWLs LONG AND MEDIUM WAVE FOR BCLs.** Loops 21 inches square or triangle. No special skills required. Circuits, Parts Lists sources of supply assembly data. HIGH FREQUENCY LOOP 80 to 10 Metres £5. LONG AND MEDIUM WAVE LOOP FOR BCLs £3. LONG MEDIUM SHORT WAVE LOOP 1500 to 10 METRES FOR BCL SWL £3. SHORT WAVE ATU LOOP OR LONG WIRE £4. PRE AMP LW MW S WAVE £2. MW LOOP WITH PRE AMP ATU £3. PRE AMP FOR G2VF HF LOOP OR ATU £4. SHORT WAVE ATU BUILT-IN PRE AMP FOR LOOP OR LONG WIRE £7. SAE details. All projects. Z Match ATU 80 to 10 metres for Amateur TX £3. **F. G. Rylands, 39 Parkside Avenue, Millbrook, Southampton SO1 9AF. Tel: (0703) 775064.**

## SPECTRUM FAX

### TRANSCIVE OR RECEIVE ONLY

Our FAX programs now cater for the three popular line speeds, 60, 120 and 240 lines per minute. As always, received screens can be saved to tape, and/or sent to your printer.

Everything you need to receive FAX.....£44.00

Complete Transceive System .....£71.50

Please add £4.00 Post & Packing

We offer a generous trade-in allowance to customers wishing to up-grade their systems. Ring or write for details.

Send large SAE (33p stamp) for details of all our products.

**J. & P. ELECTRONICS LTD.**

Unit 45, Meadowmill Estate, Dixon Street,  
Kidderminster DY10 1HH Tel: (0562) 753893



GOLD SEAL  
BP GARAGE

NORTH WALSHAM RD

B1150

EDWARDS RD

SHOP OPEN

MON-SAT 9.30-5.30

# THE SHORT WAVE

CENTRE  
NORWICH



## Do you need a scanner or receiver ? Do you need amateur radio equipment ?

"Kenwood, Icom, Yaesu, Alinco, Yupiter, Aor etc"  
**But most of all do you need equipment serviced?**  
We have up to date test equipment, fully equipped workshop for all types of radio equipment.

Second Hand Equipment Available, Part Exchange Welcome.

**TEL: OR FAX: 0603 788281**

Prop: P. Gunther G4XBT, 95 Colindeep Lane, Sprowston, Norwich, Norfolk NR7 8EQ. VAT No. 595 1239 21

**NEW SHOP OPEN NOW!  
"PHONE  
US NOW FOR  
BEST PRICES"**

# NEW RADIO CONTROLLED CLOCKS + WATCHES FROM AMDAT



The latest digital Radio Controlled clock from the Junghans stable breaks the price barrier for this quality of product. We are offering this amazing new clock at an introductory price of only £32.95 inc pp.

These new products add to our already extensive catalogue of Radio Controlled clocks and watches. Send a large SAE for full details.

The Radio Controlled watches pictured below reduce the price of these amazing products to an affordable level. We are offering this amazing digital watch at an introductory offer of only £139.95 inc pp



**AMDAT** 4 Northville Road  
Northville, Bristol, BS7 0RG  
Tel: 0272 699352  
Fax: 0272 236088



## ENTERPRISE RADIO APPLICATIONS LTD.

TEL (0925) 573118

26 Clarendon Court  
Winwick Quay  
Warrington  
WA2 8QP



### ERA SYNOPTIC DECODER

CONGRATULATIONS TO  
JOHN ROBERTSON  
OF NORTHUMBERLAND –  
WINNER OF ISWL YEAR ROUND RTTY  
CONTEST WON USING A  
MKII MICROREADER



The easy way to translate the five figure codes from the many METEO stations around the world into plain and readable English. No more books or tables, reports from aircraft, ships and land stations appear instantly in full detail. Works with the MKII Microreader or any other decoder with an RS232 output. Display the output on any compatible computer, printer or our own RS232 display unit. (See May '93 decode column)

Price £99.50



MKII  
MICROREADER

A complete self contained decoder that simply plugs into your speaker socket. No computers or programs needed. Decodes C.W. RTTY. AMTOR, SITOR + built in morse tutor and RS232 port backlit LCD display.

Price still **£170.00**

- MKII MICROREADER (Version 4.1) now with backlit LCD still .....£170.00
- RS232 DISPLAY UNITS limited numbers now in stock .....£185.00
- Serial to Parallel PRINTER CONVERTERS .....£38.00
- Convert to Version 4.1 with the UPGRADE KIT .....£20.00
- Computer TERMINAL PROGRAM for RS232 to computer screen .....£10.00

To order or for more information including sample printouts write or call.  
All products are guaranteed for two years.  
Prices include VAT and delivery



# Info in Orbit

Lawrence Harris

5 Burnham Park Road, Peverell, Plymouth, Devon PL3 5QB

**T**his month I am including notes on the new METEOSAT transmissions, particularly for the benefit of beginners and those contemplating purchasing suitable equipment to receive the new images. I continue to receive numbers of high quality photographs from regular readers of this column. Many will appear during future months.

## Current WXSATS

The last few weeks have included at least one unusual occurrence - the CIS WXSAT METEOR 3-3 remained on during its passage through the terminator. All of the METEOR WXSATS are in orbits that slowly precess - that passes over any specific location (such as the UK) gradually move to earlier or later times, during a period of a few weeks. In the case of the series three WXSATS, this means that passes gradually move forwards by between 10 and 20 minutes per day. Being earlier, they are approaching the morning terminator (the night-day boundary), so during following weeks each satellite passes through it and is therefore illuminated rather poorly by the sun.

At such times they are usually switched off, but on this occasion METEOR 3-3 was left transmitting on 137.85MHz, so we saw very contrasty pictures as the WXSAT slowly traversed this region. METEOR 3-4 uses 137.30MHz and has been on and off during recent weeks. In early July it went off but came back on within a few days. I have not received any recent infra-red images from it - merely blank pictures with only the phasing bars. Listening carefully, monitors probably noticed occasional bursts of white, suggesting to me that it was trying to start the infra-red imager but never succeeded. On these occasions 3-4 was usually passing near the command stations so I wondered whether ground controllers were trying to correct the problem as we watched.

## NOAA 13

I must tell of events in early July when the launch of NOAA 13 was imminent. Having visitors staying with us for a few days, my WXSAT monitoring temporarily stopped. Two minutes after my folks had gone I switched everything back on and ran my predictions program. During the same day a caller told me that signals from 'NOAA 13' had been heard, and that same evening I picked up a NOAA transmission not shown on the list. I therefore

assumed it was NOAA 13. Fortunately, I chose to wait for another pass to confirm it. Suspicious of my 'find' I re-ran the predictions. No joy. Then I tried a different predictions program. Voila! I simply had not noticed that my normal program was set to ignore passes having elevations of less than two degrees, hence it had not shown up these NOAA 11 transmissions received on a far west pass from Labrador! Perhaps this illustrates how careful one should be. My stored image from 'NOAA 13' was quickly deleted! Launch date for NOAA 13 was advanced to July 21 after a faulty crystal was identified, so if all goes well it should be operational by the time you read this.

## Future Launches

Launches currently scheduled include a new METEOR (probably 3-6 i.e., series three, number six) for both late July and early September. The long awaited GOMS geostationary WXSAT for the CIS is now scheduled for early August.

## DMSP Satellites

These are satellites in the Defence Meteorological Satellite Program. They are Advanced TIROS-N type satellites, similar to the NOAA WXSATS but have different sensors. They transmit signals not unlike NOAA h.r.p.t. format, and some also have an a.p.t. capability. One carries a low-light visible band sensor which can apparently pick up city lights, aurorae, etc., on the night side of the orbit. Reading some of the documentation and comments coming out of NOAA, I would not be surprised to see one or more of these satellites becoming part of the WXSAT network. Time will tell.

## Listen Out For..

Many non a.p.t. satellites can be heard near the 136MHz band. MOS 1 and 1B can be heard on 136.11MHz; A TRANSIT can be heard on 136.65MHz. PROSPERO (X3) transmits on 137.56MHz, and there is a constellation of navigation and other satellites to be heard between 149.4 and 150.03MHz several times per day.

## METEOSAT

With the introduction of a new transmission schedule that started on July 8, it may be a suitable time to review the pictures that we can now receive from METEOSAT 4. For beginners, it is worth mentioning

**Fig. 1: Visible light image, METEOR 3-3 from Mark Pepper.**



**Fig. 2: Greenland to Britain, METEOR 3-3 from Jim & Hilda Richardson.**

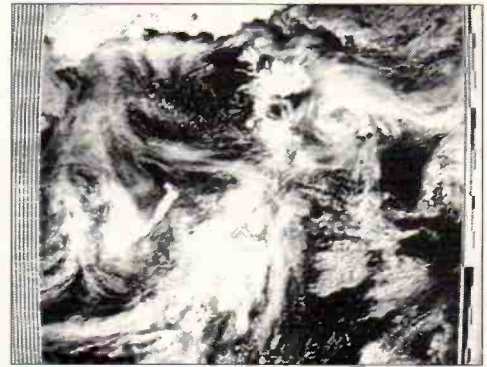

that METEOSAT 4 forms one part of a system of global, geostationary WXSATS, all collecting and disseminating meteorological information, including many virtually live images, to any location suitably equipped to receive and decode the information.

METEOSAT 4 is positioned near longitude 0° and is the European WXSAT. America operates a number of similar WXSATS positioned over its continents but unfortunately most are operating in a greatly reduced capacity due to ageing. This series is called GOES and replacement spacecraft are planned for launching, but are way overdue. Currently, METEOSAT 3, an earlier European WXSAT has been manoeuvred to America to enable them to maintain a reasonable monitoring service. Positioned near METEOSAT 4 is METEOSAT 5 which would now be in service replacing number 4 but for faults affecting its imagery. From time to time METEOSAT 5 is powered up for certain operations, and when this happens some interference with WEFAX reception will be experienced.

I have described some of the WEFAX transmissions from METEOSAT in previous columns; to summarise - it provides almost continuous broadcasts of near realtime pictures as seen in visible, infra-red and water vapour images, of much of the visible side of the hemisphere. The main areas - Britain, Europe, etc., are imaged every 30 minutes. In addition to broadcasting its own pictures, it collects data from the American side of the Atlantic and from Japan.

## METEOSAT 3

This geostationary WXSAT is currently positioned over America near longitude 70° and remains just

detectable from my westerly location in Devon. It replaces a GOES WXSAT that is not yet ready for launch. Images from M3 are included in the METEOSAT 4 schedule, under the titles LY, LR and LZ (for WEFAX transmissions). They are infra-red images of North and South America and visible North America respectively.

## GMS Re-transmissions

The GMS-4 (Geostationary Meteorological Satellite) is positioned over New Guinea, a little north of Australia, near longitude 140° east and is operated by the Japanese. From this position we cannot see it directly from Britain, but from July 8 a regular series of WEFAX images has been included in the schedule broadcast by METEOSAT 4. There are four images, all infra-red, called GMSA, GMSB, GMSC and GMSD, covering the north-west, north-east, south-west and south-east sections of the globe as seen from above New Guinea. Interestingly though, the sections overlap, unlike pictures from either METEOSAT or the GOES group. GMSA includes New Guinea, Japan and right across the Chinese mainland, therefore including Vietnam, an area I have never seen before.

Those readers who remember the GOES transmissions of a few years back will recall that the GOES schedule includes not only the American continent but re-transmitted images from other geostationary satellites. Pictures of these areas are still available to people monitoring FAX broadcasts, but how nice it is to see them now on METEOSAT. I watched (and recorded) the first images from GMS. The first GMSA showed a typhoon approaching Vietnam, with

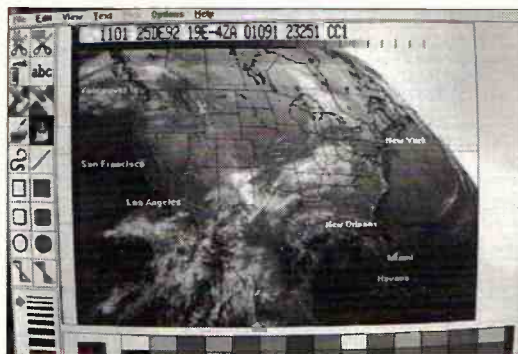

**Fig. 3: A GOES image (after editing), from Jim & Hilda Richardson.**

other vigorous weather systems over both India and China. GMSB overlaps a little with GMSA and shows the globe from New Guinea and Japan, across the Pacific to the east. Many tropical storms were seen, but nothing of great significance. GMSA mainly covers Australia and Indonesia. There was a large, low pressure region over the eastern part of Australia. GMSD, covers the south-east portion, again included Australia looking eastwards into the Pacific, where a tropical storm was in progress.

## Animating GMS

Never having seen this region in such detail, I set up the equipment to animate all of the sections. This can be done with most animating software. The transmission time of every GMS frame was entered into the program, ignoring the fact that they cover different sections of the globe! I left the computer collecting images overnight, then carefully listed each one with its time of storage. By renaming them into separate groups it was easy to make a series of separate animated sequences - I called them GMSA, etc. Running each sequence, which included approximately eight images, the first thing that I noticed was Australia warming up during our night, just like D2 images of Britain when recorded during the day from METEOSAT 4. By 0230UTC it was hot! The weather systems were intense and the typhoon could be seen gathering strength as it headed for Vietnam. My impression of all of the tropical storms in that region was one of vigour - they appeared to develop very quickly.

## Letters

**Mark Pepper** of Camberley has sent me a batch of high quality printouts received by his WXSAT setup. He recently expanded his polar WXSATs system to include METEOSAT, using a TH2 loop Yagi and RIG down-converter to feed the 137.50MHz signal into his Cirkit receiver. METEOSAT 5 was switched on during May, and is positioned very close to METEOSAT 4, so Mark adjusted his Yagi slightly

to confirm that he could resolve both satellites. Other SWM readers reported this interference problem at that time. Mark also collected images from METEORS 3-3 and 3-4 some weeks ago and Fig. 1 shows his 3-3 image including the area from the top of north Africa, right up to Norway. Extensive sea fog covers the North sea.

For beginners, it is worth mentioning that the sensors onboard the METEOR WXSATs differ somewhat in their spectral sensitivity from that of the NOAAs. They respond less to land brightness levels, except for desert regions. Snow and cloud show up very well, so this picture includes detail in the Italian Alps and the snowy peaks in Norway. Mark comments on the 'negative' images received from the METEORS during the night. These are very variable! The American NOAA WXSATs provide us with both visible and infra-red images, but the METEORS behave in an (apparently) unpredictable manner. For many months METEOR 3-3 provided i.r. images during the night-time part of its orbit. These images have better resolution than the NOAAs because the latter include two separate sections transmitted during the same half-second. METEOR i.r. images are transmitted in reverse, with respect to the NOAAs. A NOAA image displays cold clouds as white and warm deserts as dark - the same as the METEOSAT/GOES WXSATs.

Contrastingly, the METEORS show warm water (like the Mediterranean) as white, and cold clouds as dark - essentially a negative image. This is why software often includes a facility to reverse the image grey levels. You can normally identify the type of image (visible or i.r.) by listening carefully. The i.r. image tone is a brief burst, whereas the visible format image includes a tone burst, plus grey scale, plus aperture bars, all of which combine to sound rather like a croaking frog! When you hear this croak you know the METEOR is in daylight. I shall include some more of Mark's pictures in future editions.

**Dave Wilkins G5HY** of Watford is following a common route into



**Fig. 4: A NOAA image from Richard Atkin.**

WXSAT monitoring. He already has a fairly powerful PC system and is running satellite tracking software as (I suspect!) a preliminary to setting up a receiving system. Coincidentally, Dave expressed an interest in obtaining elements from me for the GMS satellite (described earlier in this column), although at the time that Dave wrote, this was of academic interest only!

**Jim and Hilda Richardson** of Strathkinness in Fife have collected and processed some excellent images from METEORS 3-3 and 3-4 recently. They sent me a batch from which came Figs. 3 & 4. Living in Scotland they see more of the area around Greenland than one can from the south. They identified Jan Mayen Island and others, after noting that they appeared static over a few days! They have been delighted about the improvement in their knowledge of geography since taking up WXSAT monitoring. Two mountain peaks on the south-east coast of Greenland, with Britain near the lower right of the picture can be seen in Fig. 2. This is a 3-3 image collected on April 21. Their GOES FAX image being edited can be seen in Fig. 3.

## Pagers

The national problem of paging interference has hit **Julian Woolvin** of Liverpool who has a Maplin receiver fed by a crossed dipole. He is using a 386 PC running the program PC GOES with a demodulator, and wonders whether anyone has any advice about modifications to minimise the paging problems. Pagers are tiny electronic receivers worn by people around the country. They are activated by a transmission from a base and can then use the telephone to contact the original caller. This is a perennial problem experienced all over the country. If anyone knows of any cure I will be happy to publish or pass on the relevant information.

## Receiver IF

From time to time I mention the need for WXSAT receivers to have properly designed circuitry, particularly emphasising the special

i.f. requirements. My main reason is that I do receive many letters from newcomers describing problems with decoding pictures when using general purpose receivers, most of which have unsuitable i.f.s. **Richard Atkin** lives near Holsworth in north Devon and sent me a picture that he actually obtained using his unmodified Icom R7000, which has a bandwidth of about 15kHz - see Fig. 4. Yes, this seems to contradict my comments because it actually shows a fair amount of detail! It is the first picture that I have received (I think) taken under such conditions. What it illustrates is that it can be done, despite the difficulties of persuading the hardware/software to recognise the synchronising tones, which cannot normally be extracted from such narrow bandwidth receivers. Richard has shown the possibilities!

## UTC and BST

Some correspondents run their computer clocks on BST and may forget to set their satellite predictions programs to do the same! One or two people have commented on picking up WXSAT transmissions that don't appear to match known operating satellites. Because of the problems in remembering to adjust all the clocks every few months, I leave my computer clock permanently on UTC. Chatting with SWM Editor Dick Ganderton recently, Dick tells me that he has heard that apparently we are going to switch to double summer time next year! Oh dear!

## Acorn Computers

Although most WXSAT monitors who use computers are using the PC type, I have received a few letters from non-PC users. For readers wanting to find more information about Acorn WXSAT software and hardware contact Spacetech Space Science Resources at 21 West Wools, Portland, Dorset DT5 2EA. Tel: (0305) 822753.

## Kepler Elements

I will send a print-out of the latest elements upon receiving an s.a.e. and extra stamp. All known weather satellites plus MIR can be included, together with their transmission frequencies if operating. This data originates from NASA and is normally accurate but errors do sometimes creep in.

## Frequencies

NOAAs 9, 11 a.p.t. on 137.62MHz; NOAAs 10, 12 on 137.50MHz; NOAA beacons on 136.77 and 137.77MHz; METEOR 3-4 on 137.30MHz; METEOR 3-3 on 137.85MHz.

# Timestep

**PROsat II** is used by most leading Weather Satellite enthusiasts. Lawrence Harris, Roger Ray and Brian Dudman are just a few who have come to rely on the vastly superior features of **PROsat II**. Features such as 1,000 frame full screen full colour animate, 3D, direct temperature readout and Windows export make Timestep products preferred by most users. All satellites are catered for including the awkward Japanese GMS and the very infrequent Soviet Okean series. All current SVGA cards are supported. NOAA images contain full resolution visible and infrared data in a stunning 2.4Mb file!

If you really are serious about Weather Satellites, phone or write us now for a colour catalogue and find out why the world's experts including Arthur C. Clarke use and recommend our equipment.



Advanced Weather Satellite users will by now have read about our new **TRACK II** prediction software. Full screen colour graphics and 6 simultaneous satellites are just some of the amazing features. For the ultimate in detail we offer **HRPT** digital systems with five 1.1km ground sensors, towns and rivers are clearly visible. For everyday use we also have the **PDUS** digital Meteosat system that takes 2.5km data every 30 minutes. Timestep **PDUS** colour animate is used several times a day by Anglia Television because of its very high resolution combined with spectacular colour. Forecasters will appreciate temperature calibrated 30 minute interval images.

A full range of separate Antennas, Preamplifiers, Cables, Receivers and accessories are held in stock.

**Timestep PO Box 2001 Newmarket CB8 8QA England**  
**Tel: 0440 820040 Fax: 0440 820281**

## JAVIATION THE AIRBAND SPECIALISTS

At the time of writing our combined VHF/UHF frequency guide and UHF only supplement are dated mid December however we expect new editions to be available from late February.

IF YOU WOULD LIKE THESE LISTS IN FULL A4 FORMAT JUST LET US KNOW WHEN ORDERING.

**NEW EDITION VHF/UHF LIST: £7.50 including p&p**  
**UHF ONLY LISTING: £4.00 including p&p**

From the comments we receive I would like to think that our guides are the most comprehensive and accurate listings available, if you are not familiar with them then please give them a try, we are sure you will find them both informative & interesting. They include airfield, en-route ATCC centres, Range, Ops, Display and other frequencies whilst also giving Stud/channel tie ups.

### LEATHER CARRY CASES

We have real, yes real leather carry cases available for the Yupiteru VT-225, MVT-5000 and AOR/Fairmate AR1000/2000 series.

**All the same price  
£14.99 each.**

If you don't like the smell of leather please don't buy one as we have had one returned by the purchaser as it smelt too much like leather!!

### COMPUTER SOFTWARE

We now stock a wide range of IBM PC software, mainly aviation related but other 'games' as well. Any radio purchase over £200 entitles you to purchase any PC software within our range for £20. Choose anything from F15 Eagle III to Sub Logic's ATP or if you require something specific just ask!

**Javiation, Carlton Works, Carlton Street,  
BRADFORD, West Yorkshire, BD7 1DA**  
**Telephone: 0274-732146 Facsimile: 0274-722627**

## GUIDE TO FACSIMILE STATIONS

**13<sup>th</sup> edition • 400 pages • £ 22 or DM 50**

The recording of FAX stations on longwave and shortwave and the reception of meteorological satellites are fascinating fields of radio monitoring. Powerful equipment and inexpensive personal computer programs connect a radio receiver directly to a laser or ink-jet printer. Satellite pictures and weather charts can now be recorded automatically in top quality.

The new edition of our FAX GUIDE contains the usual up-to-date frequency lists and precise transmission schedules - to the minute! - of 90 FAX stations and meteo satellites. This includes Bracknell Meteo, Royal Navy London, METEOSAT, and a detailed description of the new Bracknell and Washington meteo telefax polling services! It informs you with full details about new FAX converters and computer programs on the market. The most comprehensive international survey of the "products" of weather satellites and FAX stations from all over the world is included: 337 sample charts and pictures were recorded in 1992 and 1993! Here are that special charts for aeronautical and maritime navigation, the agriculture and the military, barographic soundings, climatological analyses, and long-term forecasts, which are available nowhere else. Additional chapters cover abbreviations, addresses, call sign list, description of geostationary and polar-orbiting meteo satellites, regulations, technique, and test charts.

Further publications available are *Guide to Utility Radio Stations* (11<sup>th</sup> edition), *Radioteletype Code Manual* (12<sup>th</sup> ed.) and *Air and Meteo Code Manual* (13<sup>th</sup> ed.). We have published our international radio books for 24 years. They are in daily use with equipment manufacturers, monitoring services, radio amateurs, SW listeners and telecom administrations worldwide. Please ask for our free catalogue, including recommendations from all over the world. For a recent book review see the *Decode* section in *Shortwave Magazine* 3/93, and RSGB's *RadCom* 6/93. All books are published in the handy 17 x 24 cm format, and of course written in English.

Do you want to get the **total information** immediately? For the special price of £ 110 / DM 250 (you save £ 22 / DM 50) you will receive all our manuals and supplements (altogether more than 1700 pages!) plus our *Cassette Tape Recording of Modulation Types*.

Our prices include airmail postage within Europe and surface mail elsewhere. Payment can be by £ or DM cheque, cash, International Money Order, or postgiro (account Stuttgart 2093 75-709). We accept American Express, Eurocard, Mastercard and Visa credit cards. Dealer inquiries welcome - discount rates on request. Please fax or mail your order to ☺

**Klingenfuss Publications  
Hagenloher Str. 14  
D-72070 Tuebingen  
Germany**

**Fax 01049 7071 600849 • Phone 01049 7071 62830**

# Decode

Mike Richards G4WNC  
200 Christchurch Road, Ringwood, Hants BH24 3AS

**B**ill Clark of Aspatria and E. Mitchell of Manchester have both written with news from Bracknell Met. The station has recently issued a bulletin regarding the future of their RTTY weather broadcasts. Apparently there is currently only one 'official' user of the information, so its future is totally dependent on that user continuing to fund the operation. The bulletin gives no indication who the user might be or a prognosis for the future. However, the rapid spread of satellite communication (see elsewhere in this 'Decode') means that the life of GFE is likely to be somewhat limited.

P.G. Tinkle from Nottingham has written asking for advice about printers. He currently uses an Icom R-70 receiver, Spectrum + computer and an Epson 9-pin printer. He asks if changing to a 24-pin printer would deliver better results. The answer is yes, providing your decoding software supports it. Without knowing the software package that's being operated, it's difficult to give a positive answer, but I know many people are unsure what type of printer to select. Generally speaking, a 9-pin printer gives very good results that will satisfy the requirements of most listeners. But, if higher quality is sought, you should be considering either a 24-pin printer or ultimately a laser printer. With both of these options it's important to make absolutely sure that your decoder includes the appropriate printer drives and can take full advantage of your new (and expensive) printer. I would strongly recommend contacting the decoder manufacturer before splashing out on a new printer.

Day Watson of Clevedon writes reporting the reappearance of the 'lost' PIAB transmissions. The details are:

To Near East  
16.0138MHz (DG21L5), 0730UTC,  
FEC-A 96 baud  
To Middle America  
16.0174 (DG21L1) and  
18.7024MHz (DGS70H3), FEC-A 96  
baud.

Day also reports that Xinhua have a press transmission running 50 baud/400Hz on 17.443MHz.

He has also sent me the latest copy of his Beginners frequency list, which I'll be translating ready for distributing next month.

## HF-150 Computer Control

Lowe's excellent HF-150 receiver has just been supplemented by the release of a new computer

interface. This interface enables many of the HF-150's settings to be controlled by a separate terminal or computer. The interface is supplied as a lead with a 25-way D connector at one end and a 3.5mm jack at the other. The clever bit is contained within the very substantial D connector. A look inside the die cast aluminium connector revealed a mass of surface mount electronics. This provided the conversion from the RS-232 serial signal to that required by the HF-150. The beauty of this system was that it was completely stand alone with no awkward boxes or separate power supplies.

The demands on the computer were very modest requiring a simple serial interface running at 1200 baud, 8 bit, no parity and one or two stop bits. It will also operate with seven data bits and odd or even parity.

For those readers with IBM PCs or compatibles the interface is supplied with a very effective control program. The program has been released as public domain and includes a full source code listing. This unusual step means that the operator with a few Basic programming skills can reconfigure the program for any special requirements. In its supplied form, the program not only enables mode and frequency setting, but can interact with the built-in database. This feature means that you can select a station from the frequency list and transfer that frequency to the HF-150. All you have to do is adjust the volume!

Those without a PC will find the interface very easy to program. As an example, to set the frequency to 4780kHz all you send to the HF-150 is FRQ 4780. The mode can also be set by typing MOD followed by the required mode e.g. LSB = lower sideband. You can also store and recall memories. Perhaps the only weakness in the system is that you cannot read the frequency from the receiver. However, this is only a minor disadvantage. Overall, the new interface brings tremendous flexibility to an already well respected receiver. The HF-150 interface is available from Lowe Electronics priced £39.95. My thanks to Lowe's for the loan of the review model.

## New FAX Decoder

A chance this month for a sneak pre-view of this new release from Lowe Electronics. The Lowe Modemaster is an all new decoding system designed to run on IBM PCs

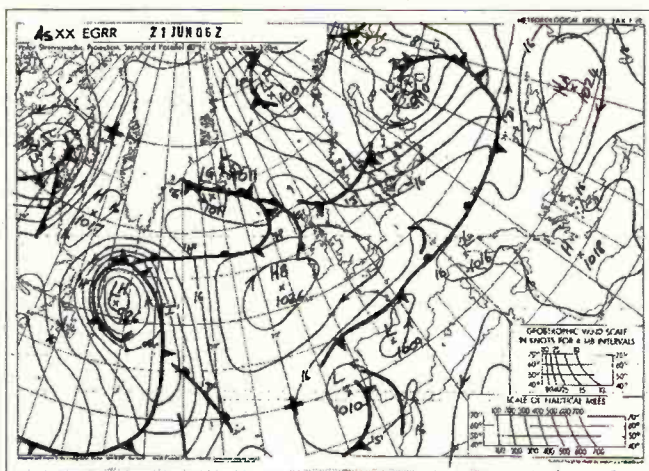

High quality FAX chart received by Bill Clark.

or compatibles. Although it can operate with any good quality h.f. communications receiver, there are some special features available when used with the HF-150. The decoding modes supported are FAX, RTTY, NAVTEX, FEC and Morse.

Modemaster is very professionally presented and includes a comprehensive manual of some eighty-five pages. This covers all aspects of the program and features several tutorials to help the new user better understand the various modes. There were also lots of diagrams and tables to help clarify many of the operations.

Once loaded onto your computer the Modemaster's facilities are accessed via a system of drop down menus. These can either be accessed by key presses or by using the computer's mouse. This system made moving around the program very quick and easy. To save having to keep referring to the manual, the Modemaster included an on-line help facility. This was accessed by pressing the F1 key. Although the help given was not as comprehensive as that in the manual, I found it was usually sufficient to clear-up any operational problems.

Accurate tuning was made very easy by the use of a Miniscope display system. This was used for FAX, RTTY and NAVTEX and gave an oscilloscope like display with two horizontal lines representing the upper and lower limits of the detector system. All you had to do was adjust your receiver so that the signal was centred within these lines. The FAX mode even included a synchronisation facility where the program automatically set the black and white levels to suit the received signal. Once a picture has been received you can perform a wide range of manipulations. Included within this section are zoom and colour palette editing. The resultant picture can then be saved to disk either in standard format or as a .PCX or .GIF file. These latter two options are extremely useful as the picture can then be further

manipulated using one of the many graphics programs that are available.

One of the really powerful options of the Modemaster was its auto reception mode. With this you could set up a number of timed receptions spread over a number of different stations. To take full advantage of this you really need to have an HF-150 receiver with the associated interface as described elsewhere in the column. When setting up this mode you can also review the various frequencies used by station to find the best signal.

Moving on to the other modes, the Modemaster proved to be very comprehensive. The standard RTTY mode featured all the usual extras plus a few that are not so common. So that you don't miss that interesting news item, all the received text is automatically stored in a buffer. This can be reviewed at any time without interrupting the receive process. The Modemaster also has a very effective tuning aid. Whilst you can use the scope type display for RTTY you can also set-up what is called tone tracking. This was an excellent feature where the Modemaster automatically tracks the received signal. This was particularly good when receiving two stations that are not on exactly the same frequency. Modemaster automatically adjusts itself to take account of the difference. There was also a very effective automatic speed setting routine that will prove particularly helpful for the newcomer.

Finally Modemaster features NAVTEX and FEC reception. This was well implemented and included a selection editor where you could choose which stations and message types to receive.

What can I say - if you've got an IBM PC and a Lowe HF-150 you really ought to get yourself a copy of this program. For more details contact any of the Lowe Electronics outlets. My thanks to Lowe for the loan of the review model, an in-depth review should be appearing in *SWM* soon.

Frequency	Mode	Speed	Shift	Callsign	Notes
3.250MHz	RTTY	50	850	-	Shannon
3.7108MHz	RTTY	50	360	-	Conakry Air
4.0147MHz	ARQ E3	48	425	5ST	Asecna Antananar
4.0225MHz	ARQ E3	48	850	3BZ	Plaisance Air
4.1955MHz	RTTY	50	436	TUH	Asecna Abidjan
4.4872MHz	RTTY	50	400	TNL	Asecna Brazzaville
4.7883MHz	RTTY	50	780	TJK	Asecna Douala
5.1172MHz	ARQ-M2	96	425	TYE	Asecna Cotonou
5.1597MHz	RTTY	50	400	5UA	AFTN Niamey
5.2872MHz	RTTY	50	400	FBSK	Gamborone Air
5.474MHz	RTTY	50	850	-	Santa Maria
5.4877MHz	RTTY	50	400	TUH	Asecna Abidjan
5.804MHz	RTTY	50	400	9GC	Accra Air
5.813MHz	RTTY	50	850	-	Shannon
5.8186MHz	RTTY	50	400	9HA	Luqa Air
5.9041MHz	RTTY	50	425	9GC	Accra Air
6.9023MHz	RTTY	75	850	TLO	Asecna Bangui
6.9413MHz	ARQ-M2	96	450	TRK	Asecna Libreville
6.989MHz	RTTY	50	500	8Q9	Male Air
7.3553MHz	RTTY	50	400	TZH	Asecna Bamako
7.626MHz	RTTY	50	400	TZH	Asecna Bamako
7.9908MHz	RTTY	50	850	5HD	Dar-Es-Salaam Air
8.1185MHz	RTTY	50	340	9JZ	Lusaka Air
8.137MHz	RTTY	50	400	-	Larnaca Air
8.145MHz	RTTY	50	850	-	Shannon
8.1615MHz	RTTY	50	300	5YD	AFTN Nairobi
9.154MHz	RTTY	50	850	-	Sal Island
9.994MHz	RTTY	50	850	-	Santa Maria
9.9942MHz	RTTY	50	850	CSY	Santa Maria Air
10.54MHz	RTTY	50	850	-	Santa Maria
11.439MHz	RTTY	50	850	-	Shannon
13.366MHz	RTTY	50	400	-	Nairobi
14.497MHz	RTTY	50	850	-	Santa Maria
14.508MHz	RTTY	50	850	-	Sal Island
18.173MHz	RTTY	50	400	-	Khartoum
18.388MHz	RTTY	50	400	-	Tripoli

## Aeronautical RTTY

Since my request for more information I've received reports, logs and decoding data from many readers. I'll attempt to put it all together here. Let's start by giving a frequency list of active aeronautical stations. Although I've titled this section Aeronautical RTTY, there are a few stations using the more complex ARQ modes. The list uses my normal format of frequency mode speed shift, call and notes.

All of these stations send a mix of information, much of which is weather data. However, **David Murphy** of Sale has a few recommendations that may prove helpful. If you're looking for North Atlantic information, the Shannon - Santa Maria circuits usually contain a high proportion of flight plans. For monitoring African traffic, Nairobi (13.366MHz) provides plenty of flight plans from about 1500UTC into the evening. The best time apparently is the first twenty minutes past each hour. Both Khartoum and Tripoli can be received throughout the day, but the information can be limited. It would appear patience is a virtue for the aeronautical RTTY listener!

## Aeronautical Decoding

Now you know where to find the signals, you will also need to understand format and coding used for these messages. Those with a copy of the *Klingenfuss Air and Meteo Code Manual* should refer to

sections nine and ten. To illustrate how the coding operates, I'll use an example supplied by **Jim G4RGA** of Wellington.

### Message:

- 1) ZCZC VZCZCVLA009
- 2) FF EDDYZU EGGTZI EGGDZG EGGDFLFO EGGHFLFO
- 3) 051513 LOWSZG
- 4) (FPL=FLT205=I
- 5) =BA146=R/R/J
- 6) =LOWS 1712 EDDY 1815 EGTT 1836
- 7) =0420F270 SBG DCT MUN UB1 DKB FFM UG108 SPI UG1 KOK BIG CPT
- 8) =EGGD 1855 EGHH
- 9) =REG/GBPNT)

This apparent gibberish decodes to mean the following:

- 1) ZCZC message start code followed by the message serial number.
- 2) FF is the message precedence code. In this case FF means immediate (flight safety)
- 3) Is the date (5th) and time (1513UTC) of the originating message plus the originating authority LOWSZG (Saltzburg Ops).

4 - 9) These lines contain the text of the message and break down into the following.

- 4) Flight plan for flight FLT205 using I (IFR) rules.
- 5) The aircraft is a BA146 Whisper Jet using RNAV route equipment.
- 6) Departing airfield LOWS (Saltzburg) and time (1712)

intermediate control EDDY (Maastricht), EGTT (London)

- 7) Speed (420 knots) and flight level (FL270, 27000ft) followed by detailed beacons/VORs, etc.
- 8) Destination EGGD (Bristol) arrival time (1855) and alternative destination EGHH (Bournemouth Hurn)
- 9) Additional information - in this case the aircraft registration (G-BPNT)
- 10) The standard end of message code NNNN.

If you're serious about this mode of listening, you really ought to arm yourself with a copy of the *Air and Meteo Code Manual* available from the *SWM* Book Service.

## Satellite Utilities

Regular readers will no doubt have realised by now that there is a general migration of utility transmissions from h.f. to satellite. I'm sure many believe this is the end of the line and there's little we can do - wrong!! Most of the signals that have been lost from h.f. are sitting in amongst the TV stations using the geostationary satellites in the Clarke Belt.

The utility signals are transmitted using what are known as sub-carriers located within the satellite transponder's frequency range. To try and explain this, each satellite carries a number of transponders, each of which can transmit a band of frequencies at least 40MHz wide. Within this band are contained the normal video signal plus the sound channels. However, this does not require the use of the full 40MHz + thats available. The remaining bandwidth can therefore be used to carry other signals. To help visualise how this is done we can treat each satellite transponder like the h.f. bands.

From this you can see that each transponder in each satellite is like a new h.f. band! This gives tremendous potential for introducing new high quality services to customers and explains why the system is so popular. Your next question I'm sure is - how can I receive these. The answer is I'm still working on it, but the basic

requirements are a tunable satellite receiver, steerable dish and an h.f. decoding system. In simple terms you point the dish at a suitable satellite tune the receiver to one of the transponders and connect your h.f. receiver to the i.f. output and see what you can find. Before doing this you need to be sure that your h.f. receiver won't be damaged by the satellite receiver and vice versa, (this is unlikely). The ideal type of satellite receiver for this should be manually tuned and feature as wide a tuning range as possible. An excellent starting point is the Echostar SR-500 receiver that is supplied in modified form by Aerial Techniques of Parkstone (see their regular ad in *SWM* for more details).

Over the next few months I will be gathering information and giving a few suggestions on how to access these signals. The good news is that many of your existing decoding systems may be usable for satellite systems. If you have any ideas or suggestions that may help, I'd be very pleased to hear from you.

## Frequency List

My thanks to all the many readers that responded to my request for logs last month. The response has been very good and, following my summer holiday, I'll be updating my 'Decode' list to include the new logs.

Now for this month's offering which has been selected from logs submitted by **Lee Williams**, **Day Watson**, **Andy Keddie** and **Geoff Crowley**.

If you would like a copy of my Decode, or the Day Watson Beginners list, just send three first or second class stamps to the address at the head of the column (an address label would be appreciated too).

Frequency	Mode	Speed	Shift	Callsign	Time	Notes
4.583MHz	RTTY	50	400	DDK2	1130	Hamburg Met
8.165MHz	RTTY	50	400	5YD	2015	Nairobi
9.318MHz	FAX	120	576	NRK	0820	USN Keflavik
9.34MHz	FAX	60	576	RCH72	2040	Tashkent
11.475MHz	RTTY	50	400	-	1840	KCNA news
12.227MHz	RTTY	50	400	-	1710	Xinhua
12.804MHz	CW	40	-	YQC	1940	Constanza Radio
13.3634MHz	RTTY	50	400	CNM47/X9	-	MAP Spain
13.44MHz	RTTY	50	400	YZJ5	1500	Tanjung News
13.4574MHz	RTTY	50	400	CNM49	-	MAP Spain
13.51MHz	FAX	120	576	CFH	1600	Canadian Forces
13.58MHz	RTTY	50	400	-	1201	Pyongyang
13.8739MHz	RTTY	50	400	CNM58/X9	-	MAP Spain
16.117MHz	RTTY	50	170	6VK317	1420	Dakar News
16.27MHz	FAX	120	576	-	1622	Singapore
16.971MHz	FAX	60	576	JJC	0900	Kyodo News
17.069MHz	FAX	60	576	-	2020	Japanese new
18.441MHz	FAX	120	576	-	1007	Tokyo WX
22.4715MHz	CW	40	-	SV07	2043	Athens Radio

# Long Medium & Short

Brian Oddy G3FEX, Three Corners, Merryfield Way, Storrington, West Sussex RH20 4NS

## Medium Wave Chart

Freq kHz	Station	Country	Power kW	Listener
531	Ain Beida	Algeria	600	B N* U*
531	Leipzig	Germany	100	A* B S* U
531	Oviedo (RNE5)	Spain	20	S* U*
540	Wavre	Belgium	150/50	A F* H* N S* U W
540	Conamara	Ireland (S)	2	P
540	Sidi Bennour	Morocco	600	U*
549	Les Trembles	Algeria	600	N* U*
549	Bayreuth (DLF)	Germany	200	B H* N* S* U* W
558	Tirgu Jiu	Romania	200	U*
558	Valencia (RNE5)	Spain	20	H S* U*
567	Berlin	Germany	100	B S*
567	Tullamore (RTE1)	Ireland (S)	500	A D F G H U W 1
567	Marbella (RNE5)	Spain	10	U*
576	Muhlacker (SDR)	Germany	500	S*
576	Riga	Latvia	500	U*
576	Barcelona (RNE5)	Spain	50	U*
585	Orf Wien	Austria	600	B
585	Paris (FIP)	France	8	B U
585	Madrid (RNE1)	Spain	200	B H S* U* W*
585	Gafsa	Tunisia	350	U*
585	Dumfriess (BBCScot)	UK	2	F
585	Frankfurt	Germany	1000/400	B S* U*
594	Oujda-1	Morocco	100	H U*
603	Sevilla (RNE5)	Spain	50	S* U*
603	Newcastle (BBC4)	UK	2	F O S* Y
612	Athlone (RTE2)	Ireland (S)	100	B F G N* U W 1
612	Lerida	Spain	10	N* U*
621	Wavre	Belgium	80	B U W
621	Barcelona (OCR)	Spain	50	N* S*
630	Vigra	Norway	100	S*
630	Tunis-Djederida	Tunisia	600	U*
639	RNE1 via ?	Spain	?	8
639	La Coruna (RNE1)	Spain	100	A* S* U*
648	Mallorca (RNE1)	Spain	10	S*
648	Orfordness (BBC)	UK	500	F H S* U W
657	Burg	Germany	250	S* U*
657	Madrid (RNE5)	Spain	20	C* S* U*
657	Wrexham	UK	2	F G W
666	Bodensees' drf(SWF)	Germany	300/180	S* 1*
666	Lisboa	Portugal	135	U*
675	Marseille	France	600	S* U*
684	Sevilla (RNE1)	Spain	500	C* N* S* U*
684	Belgrad	Yugoslavia	2000	N* U*
683	Berlin	Germany	250	S*
683	Droitwich (BBC5)	UK	150	G H W 1
693	Stagshaw (BBC5)	UK	50	F
702	Presov (Haniska)	Czech Rep.	400	U*
702	Aachen/Flenburg	Germany	5	B S*
702	Zamora (RNE1)	Spain	10	P* S* T* U*
711	Rennes 1	France	300	B M S* U
711	Laayoune	Morocco	600	U*
711	Murcia (COPE)	Spain	5	U*
720	Holzkirchen (RFE)	Germany	250	T*
720	Langenberg	Germany	200	U*
720	Lisnagarvey (BBC4)	Ireland (N)	10	F
720	Norte	Portugal	100	S*
720	Lots Rd BBC4	UK	0.5	H U 1
729	Leipzig	Germany	5	S*
729	Cork (RTE1)	Ireland (S)	10	S* U W 1
729	Oviedo (RNE1)	Spain	50	C* S* U*
738	Paris	France	4	U
738	Barcelona (RNE1)	Spain	500	A* C* S* U*
747	Flevo (Hilv2)	Holland	400/200	B F H N S* U W*
756	Brunswick	Germany	800/200	B S* U*
756	Lugoj	Romania	400	T*
756	Bilbao (EI)	Spain	5	C* U*
756	Redruth (BBC4)	UK	2	S*
765	Sottens	Switzerland	500	S* U*
774	Enniskillen (BBC4)	Ireland (N)	1	S*
774	RNE1 via ?	Spain	?	N*
774	S. Sebastian (RNE1)	Spain	50	A* S* U*
783	Burg	Germany	1000	B S* U*
783	Miramar (R.Porto)	Portugal	100	S*
783	Dammam	Saudi Arabia	100	U*
792	Limoges	France	300	S* U
792	Lingen	Germany	5	U*
792	Sevilla (SER)	Spain	20	S* U*
792	Londonderry (BBC)	UK	1	F 1
801	Munchen-Ismaning	Germany	300	P* S* U*
801	RNE1 via ?	Spain	?	S*
801	Burgos (RNE1)	Spain	10	U*
810	Madrid (SER)	Spain	20	S* U*
810	Westerglen (BBC)	UK	100	F M* P* S* U* W 1
819	Toulouse	France	50	S*
819	Warsaw	Poland	300	U*
819	S. Sebastian (EI)	Spain	5	U*
828	Barcelona (SER)	Spain	50	S*
837	Nancy	France	200	S* U*
837	Sevilla (COPE)	Spain	10	S* U*
846	Rome	Italy	540	B G* S* U* W* 1
855	Berlin	Germany	100	S* U*
855	RNE1 via ?	Spain	?	N*
855	Murcia (RNE1)	Spain	125	C* S* U*
864	Santah	Egypt	500	S* U*
864	Paris	France	300	B G* U*
864	Socuellamos (RNE1)	Spain	2	S* T*
873	Frankfurt (AFN)	Germany	150	M* S* U*
873	Zaragoza (SER)	Spain	20	S* U*
882	Malaga (COPE)	Spain	5	S* U*
882	Washford (BBC)	UK	100	F S* U W
891	Algiers	Algeria	600/300	B S* U*
891	Huisberg	Netherlands	20	S* U*
900	Milan	Italy	600	S* U*
900	Bilbao (COPE)	Spain	10	S*
909	B'mans Pk (BBC2)	UK	140	W 1
909	M'side Edge (BBC2)	UK	200	F*
918	Madrid (R.int)	Spain	20	C* S* U*
918	R.Ljubljana	Slovenia	600/100	U*
927	Wolvertem	Belgium	300	B N S* U W 1*
927	Evora (RFE)	Portugal	1	T*

Freq kHz	Station	Country	Power kW	Listener
936	Bremen	Germany	100	B S* U*
936	Venezia	Italy	20	S* U*
936	RNE5 via ?	Spain	?	C* U*
945	Toulouse	France	300	G* U* 1
954	Madrid (CI)	Spain	20	S* U*
963	Pori	Finland	600	S* U* W* 3*
963	Tir Chonaill	Ireland (S)	10	B U*
963	Seixal (RRE)	Portugal	10	F*
972	Hamburg	Germany	300	B F* G* S* U* W* 1
981	Alger	Algeria	600/300	B U* W*
990	Berlin	Germany	300	S*
990	Redmoss (BBCScot)	UK	1	8 F S*
999	Hoyerswerda	Germany	20	P* S*
999	Madrid (COPE)	Spain	50	S*
1008	Las Palmas (SER)	Gran Canaria	?	T*
1008	Flevo (Hilv-5)	Holland	400	O F G* N S* U* W T
1008	Aleksinsac/B'grad	Yugoslavia	400/200	T
1017	Rheinsender	Germany	600	B L* S* U* W*
1017	Burgos (RNE5)	Spain	10	S* U*
1026	Graz-Dobl	Austria	100	S* U*
1026	Alicante (SER)	Spain	3	U*
1035	Lisbon (Prog3)	Portugal	120	S*
1035	Tallinn	Estonia	500	U*
1044	Dresden	Germany	250	L* S*
1044	Sebaa-Aiouan	Morocco	300	U*
1044	S. Sebastian (SER)	Spain	10	S*
1053	Droitwich (BBC1)	UK	150	G W 1
1053	Stagshaw (BBC1)	UK	50	F
1062	Kalundborg	Denmark	250	B G* S* U*
1071	Brest	France	20	B U*
1071	Lille	France	40	S* U*
1080	Katowice	Poland	1500	S* U*
1080	Granada (SER)	Spain	5	U*
1089	B'mans Pk (BBC1)	UK	150	W 1
1089	M'side Edge (BBC1)	UK	150	F* G
1098	Nitra (Jarok)	Slovakia	1500	S* U*
1098	RNE5 via ?	Spain	?	S*
1098	Lugo (RNE5)	Spain	10	U*
1107	Munich (AFN)	Germany	40	B M* N* S*
1107	Caceres (RNE5)	Spain	5	U*
1107	Logrono (RNE5)	Spain	25	N*
1107	Wallasey (BBC1)	UK	0.5	G
1116	Pontevedra (SER)	Spain	5	S*
1125	La Louverie	Belgium	20	B S* U
1125	RNE5 via ?	Spain	?	S*
1125	Castellon (RNE5)	Spain	10	U*
1134	Zadar	Yugoslavia	1200	G* S* U* 1
1143	Stuttgart (AFN)	Germany	10	M* S* W*
1143	Messina	Italy	6	S* U*
1143	Kaliningrad	Russia	150	S*
1143	Reus (COPE)	Spain	2	U*
1152	Lerida (RNE5)	Spain	10	S*
1161	Strasbourg (Flint)	France	200	S*
1179	Santiago (SER)	Spain	10	S*
1179	Solvesborg	Sweden	600	G* K* S* U* W* 1*
1188	Kuurne	Belgium	5	B S* U
1188	Szolnok	Hungary	135	B S* U*
1197	Munich (VOA)	Germany	300	S*
1197	Virgin	UK	?	N U*
1197	Chesterton Fen (V)	UK	0.2	D
1197	Fern Barrow (V)	UK	0.5	S
1197	Oxford (V)	UK	0.5	J
1197	Trowell (V)	UK	1	F
1197	Wallasey (V)	UK	2	C X
1206	Bordeaux	France	100	S*
1206	Wroclaw	Poland	200	U*
1215	Virgin via ?	UK	?	G N O R U Z 1 2
1215	Droitwich (V)	UK	105	W X
1215	Hull (V)	UK	0.3	D
1215	Lisnagarvey (V)	UK	16	S
1215	Moorside Ed (V)	UK	250	X
1215	Westerglen (V)	UK	100	E F
1215	Wrekenton (V)	UK	2.2	I
1224	Vidin	Bulgaria	500	S*
1224	S. Sebastian (COPE)	Spain	5	U*
1224	Manningtree (V)	UK	0.5	S*
1233	Liege	Belgium	5	S* U*
1233	Nitra	Slovakia	40	S*
1242	Kiev	Ukraine	150	T*
1242	Marseille	France	150	S*
1242	Stockton (V)	UK	1	F I S*
1251	Marcali	Hungary	500	S* U*
1251	Huisberg	Netherlands	10	U*
1260	Valencia (SER)	Spain	20	G* S* U*
1269	Neumunster	Germany	600	F* G S* U* W*
1278	Strasbourg	France	300	S*
1278	Dublin/Cork (RTE2)	Ireland (S)	10	F G* S* W
1287	Litomysl (RFE)	Czech Rep.	300/200	U*
1287	Melnik (RFE)	Czech Rep.	400	B S*
1287	Lerida (SER)	Spain	10	T*
1296	Valencia (COPE)	Spain	10	S* T* U* 1*
1296	Rebia	Sudan	1500	T*
1296	Orfordness (BBC)	UK	500	F S* U*
1305	Rzeszow	Poland	100	S*
1305	Ornse (RNE5)	Spain	5	U*
1314	Kvitovs	Norway	1200	B F G S* U* W* 1*
1323	Leipzig (RMWS)	Germany	150	S*
1332	Rome	Italy	300	C* S*
1332	Elvas	Portugal	10	H
1341	Lakibegy	Hungary	300	S*
1341	Lisnagarvey (BBC)	Ireland (N)	100	F G* U* W 1
1341	Tarrasa (SER)	Spain	2	U*
1350	Nancy/Nice	France	100	G* H S* U*
1359	Berlin	Germany	250/100	S*
1359	Melilla	Morocco	5	T* U*
1368	Foxdale (Manx R)	IoM	20	F M* N* S* 1*
1377	Lille	France	300	B N S* U
1377	L'ukraine	Ukraine	50	T*
1386	Kaliningrad	Russia	500	C* S* U* 3*
1395	Lushnje (Tirana)	Albania	1000	K* N* S* U*

Freq kHz	Station	Country	Power kW	Listener
1404	Brest	France	20	G* S* U
1404	Dnepropetrovsk	Ukraine	30	T*
1413	RNE5 via ?	Spain	?	S* U*
1422	Heusweiler	Germany	1200/600	B G* S* U* W*
1431	Dresden	Germany	250	S*
1440	Marnach (RTL)	Luxembourg	1200	B H* S* U W 1
1440	Dammam	Saudi Arabia	1600	C* S* T*
1449	Berlin	Germany	5	S* U*
1467	Monte Carlo (TWR)	Monaco	1000/400	H* S* U* W* 1*
1476	Wien-Bisamberg	Austria	600	F* G* S* U*
1485	Bournemouth (BBC1)	UK	2	U
1485	Carlisle (BBC4)	UK	1	F
1494	Clermont-Ferrand	France	20	B G* S* U*
1494	St.Petersburg	Russia	1000	H*
1503	Stargard	Poland	300	F* H* S* U*
1512	Wolvertem	Belgium	600	B F* G* K* N* S* U W 1* 4
1512	Jeddah	Saudi Arabia	1000	T*
1521	Kosice (Gizatic)	Slovakia	600	S* U*
1521	Duba	Saudi Arabia	2000	T*
1521	R.Mansra (SER)	Spain	2	T* U*
1530	Vatican R	Italy	150/450	K* S* U*
1539	Mainflingen	Germany	700	F S* U* W* 1*
1539	Valladolid (SER)	Spain	5	U*
1557	Nice	France	300	S*
1557	Kaunas (Vilnius)	Russia	75	S*
1566	Sarnen	Switzerland	300	H* S*
1566	Sfax	Tunisia	1200	U*
1575	Burg	Germany	250	H* S* U*
1575	Genova	Italy	50	H* U*
1575	Cordoba (SER)	Spain	5	U*
1584	Ornse (SER)	Spain	2	U*
1593	Langenberg	Germany	400/800	U*
1602	Vitoria (EI)	Spain	10	B F G* H* L* S* U* W* 1*

Note: Entries marked \* were logged during darkness. All other entries were logged during daylight or at dawn/dusk.

- Listeners:**  
A: Tim Allison, Middlesborough.  
B: Ted Barty, N.London  
C: Leo Barr, Sunderland.  
D: Vera Brindley, Woodhall Spa.  
E: Kenneth Buck, Eddinburg.  
F: Tim Bucknall, Congleton.  
G: Martin Dale, Stockport.  
H: John Eaton, Woking.  
I: David Edwards, Walsend.  
J: Steve Feringie, Oxford.  
K: Michael Griffin, Ross-on-Wye.  
L: Gerald Herman, Coventry.  
M: Simon Hockenhill, E.Bristol.  
N: Sheila Hughes, Morden.  
O: Rhoderick Illman, Oxted.  
P: Stephen Jones, Oswestry.  
Q: Cyril Kellam, Sheffield.  
R: Ronald Kilgore, Co.Londonderry.  
S: Eddie McKeown, Newry.  
T: Roy Merrall, Dunstable.  
U: George Millmore, Wootton loW.  
V: Ken Milne, Basingstoke.  
W: Sid Morris, Rowley Regis.  
X: Philip Rambaut, Macclesfield.  
Y: Harry Richards, Barton-on-Humber.  
Z: Eric Shaw, Chester.  
1: Tom Smyth, Co.Fermanagh.  
2: George Tobbits, Penmaenmawr.  
3: Michael Williams, Redhill.  
4: Julian Wood, Elgin.

**S**ince the early days of broadcasting many listeners have searched the bands for new stations and those in distant or unusual locations. For years they have experienced a thrill when receiving direct transmissions from stations located many hundreds or even thousands of kilometres away. Such thrills are unlikely when the programme reaches the listener on an audio channel of a TV broadcast satellite. When planning new services, should International Broadcasters bear this in mind?

## Long Wave Reports

Note: l.w. & m.w. frequencies in kHz; s.w. in MHz; Time in UTC (=GMT). Unless stated, all logs compiled during the four week period ending June 30.

The 10kW transmission from Caltanissetta, Italy on 189kHz was logged at 2029UTC on June 1 by Roy Merrall in Dunstable, but reception was very noisy. He also picked them up on June 11 & 14. Whilst checking 189 on June 4 he heard Georgian R-1 at 2238.

Rather unusual conditions were noted on



# Long Medium & Short

## Local Radio Chart

Freq kHz	Station	ILR BBC	e.m.r. (kW)	Listener
558	Spectrum R	I	7.50	A.G.*H.J.L.T.V.3
585	R.Solway	B	2.00	D.G.H.R.V.Z
603	Cheltenham (CD603)	I	?	D.E.G.J.K.S.T.U.V
603	Invicta SG (Coast)	I	0.10	A.H.J.L.S.T.3
630	R.Bedfordshire (3CR)	B	0.20	A.G.H.J.L.T.V.Z.3
630	R.Cornwall	B	2.00	R*.T.3
657	R.Clywd	B	2.00	A.B.D.E.H.J.Q.R* T.V.Z.3
657	R.Cornwall	B	0.50	T
666	DevonAir R	I	0.34	H.J.K.L.R*.T.3
666	R.York	B	0.80	A.D.H.J.R*.T.3
729	BBC Essex	B	0.20	A.H.J.T.Z.3
738	Hereford/Worcester	B	0.037	A.H.J.R*.T.V.Z.3
756	R.Cumbria	B	1.00	A.D.H.P.Q.R
756	R.Maldwyn	I	0.63	D*.G.H.J.N.O S.W.X.Y.3
765	BBC Essex	B	0.50	A.J.L.R*.T.V.Z.3
774	R.Kent	B	0.70	A.J.L.T.3
774	R.Leeds	B	0.50	D.F.H.Z
774	Gloucester (3CSG)	I	0.14	H.T.V
792	Chiltern (S.Gold)	I	0.27	A.G.H.J.M.T.V.Z.3
792	R.Foyle	B	1.00	D.Q
801	R.Devon	B	2.00	A.H.J.K.L.R*.T.V.3
828	Chiltern (S.Gold)	I	0.20	J.M.3
828	R.Aire (Magic828)	I	0.12	D.F.Z
828	2CR (Cl.Gold)	I	0.27	A.T.3
837	R.Cumbria	B	1.50	D
837	R.Furness	B	1.00	D.R*
837	R.Leicester	B	0.45	A.J.T.V.Z.3
855	R.Devon	B	1.00	T
855	R.Lancashire	B	1.50	B.D.F.H.R.Z
855	R.Norfolk	B	1.50	A.B.J.M.Z.3
855	Sunshine R	I	0.15	J.N.V.3
873	R.Norfolk	B	0.30	A.C.H.J.T.V.Z.3
936	Brunel R (Cl.Gold)	I	0.18	A.H.J.L.R*.T.V.3
945	R.Trent (Gem AM)	I	0.20	A.F*.H.J.R* T.V.Z.3
954	DevonAir (Cl.Gld)	I	0.32	L.T.3
954	R.Wyvern (WYVN)	I	0.16	A.H.J.L.V.Z.3
990	WABC (Nice & Easy)	I	0.09	H.V.3
990	R.Aberdeen	B	1.00	D
990	R.Devon	B	1.00	A.J.L.T.3
990	Hallam R. (Gt Yks)	I	0.25	C.H.Z.3
999	R.Solent	B	1.00	A.J.L.T.3
999	R.Trent (Gem AM)	I	0.25	H.J.Z.3
999	Red Rose (Gold)	I	0.80	R*
1017	Beacon R (WABC)	I	0.70	A.H.J.T.V.Z.3
1026	Downtown R	I	1.70	B.D.Q.2
1026	R.Cambridgeshire	B	0.50	A.C.H.J.L.Z.3
1026	R.Jersey	B	1.00	J.L.T.3
1035	NorthSound R	I	0.78	D.Q
1035	R.Kent	B	0.50	A.J.L.T.3
1035	R.Sheffield	B	1.00	H.Z.3
1035	West Sound R	I	0.32	Q.R
1107	Moray Firth R	I	1.50	A.Q.R*
1116	R.Derby	B	1.20	A.H.J.L.R*.V.Z.3
1116	R.Guernsey	B	0.50	J.L.T.3
1152	BRMB (Xtra-AM)	I	3.00	H.R*.V
1152	Great North R (GNR)	I	1.80	D.R*
1152	LBC (Talkback R)	I	23.50	A.J.L*.T.3
1152	Piccadilly R. (Gold)	I	1.50	F
1152	R.Broadland	I	0.83	R*.3
1152	R.Clyde (Clyde 2)	I	3.06	Q
1161	Brunel R (Cl.Gold)	I	0.16	J.L.T.V.3

### Listeners:

A: Ted Barty, N.London.  
 B: Leo Barr, Sunderland.  
 C: Vera Brindley, Woodhall Spa.  
 D: Tim Bucknall, while at Halthwhistle.  
 E: John Coulter, Winchester.  
 F: Martin Dale, Stockport.  
 G: John Eaton, Woking.  
 H: David Forester, Newcastle-under-Lyme.  
 I: Michael Griffin, Ross-on-Wye.  
 J: Gerry Haynes, Bushey Heath.  
 K: Simon Hockenull, E.Bristol.  
 L: Sheila Hughes, Morden.  
 M: Rhoderick Illman, Dxted.  
 N: Stephen Jones, Oswestry.  
 O: Cyril Kellam, Sheffield.  
 P: Ronald Kilgore, Co.Londonderry.  
 Q: Ross Lockley, Stirling.  
 R: Eddie McKeown, Newry.  
 S: Roy Merrall, Dunstable.  
 T: George Millmore, Wootton, IoW.

Note: Entries marked \* were logged during darkness. All other entries were logged during daylight or at dawn/dusk.

## Medium Wave Reports

Very poor conditions for the reception of m.w. transatlantic signals were noted during June by **Ron Damp** in Worthing. Despite frequent checks on 930kHz he heard CJYQ in St.John's, on one night only and then with difficulty. At best their signal rated 12222 at 0043. Ron is about to construct a large loop (2m or more) in readiness for the winter DX season, it will be mounted outside on a flat roof.

Poor conditions were also observed by **Ted Barty** in N.London. Around 0115 on June 2 & 4 he picked up the broadcasts from the Caribbean Beacon, Anguilla on 1610, at best they rated 23332. CJYQ was logged at 0040 on June 3 & 4 as 23232. Slightly better conditions were noted on June 5, when he heard CJYQ at 0159; VQCM St.John's, 590 at 0203; CKPC Brantford, 1380 at 0215; also CHER Sydney, 950 at 0235.

In contrast, **George Millmore** (Wootton, IoW) noted good reception after dark from some stations in N.Africa and the Middle East. He logged Dammam, Saudi Arabia on 783kHz for the first time, rating their signal SIO222 at 2125.

The broadcasts from two new m.w. stations have been attracting the attention of local radio DXers. BBC R.Gloucester closed its outlet on 603kHz to make way for CD603 in

## Long Wave Chart

Freq kHz	Station	Country	Power (kW)	Listener
153	Bechar	Algeria	1000	N*
153	Donebach	Germany	500	ABCEF*G*H*J*LM*ND*PQ
153	Brasov	Romania	1200	J*
162	Allouis	France	2000	ABDEF*G*H*J*LMND*PQ
162	Kaliningrad	Russia	1000	AEG*H*J*LMN*D*
177	Oranienburg	Germany	750	ABCEJ*LM*NO*Q
183	SaarLouis	Germany	2000	CDEF*G*J*LMNO*PQ
189	Caltanissetta	Italy	10	K*
189	Tbilisi	Georgia	500	K*
198	Warsaw 3	Poland	200	F*
198	BBC Droitwich	UK	500	ABCDEGHIJLMND*PQ
198	BBC Westerglen	UK	50	C
207	Munich	Germany	500	AEF*J*LO*PQ
207	Azilah	Morocco	800	N*
216	RMC Roumoules	S.France	1400	ADEHJ*LMND*PQ
216	Dslo	Norway	200	J*
225	Raszyn Resv TX	Poland	?	A.C*E*G*J*M*N*O*
234	Beidweiler	Luxembourg	2000	ADEF*G*H*J*LMN*O*PQ
234	St.Petersburg	Russia	1000	J*D*
243	Kalundborg	Denmark	300	ACEFGH*J*LM*ND*Q
252	Tipaza	Algeria	1500	E*G*O*
252	Atlantic 252	S.Ireland	500	ABCDEFG*H*IJLMND*PQ
261	Burg	Germany	200	EG*LN*Q
261	Taldom (Moscow)	Russia	2000	AEMO*
270	Topolna	Slovak Rep.	1500	AC*EG*J*LMN*D*
279	Ashkhabad	Turkmenistan	150	J*
279	Minsk	Belarus	500	C*J*M*O*

Note: Entries marked \* were logged during darkness. All other entries were logged during daylight or at dawn/dusk.

### Listeners:

A: Ted Barty, N.London.  
 B: Vera Brindley, Woodhall Spa.  
 C: Tim Bucknall, Congleton.  
 D: Martin Dale, Stockport.  
 E: John Eaton, Woking.  
 F: Simon Hockenull, E.Bristol.  
 G: Sheila Hughes, Morden.  
 H: Stephen Jones, Oswestry.  
 I: Ronald Kilgore, Co.Londonderry.  
 J: Eddie McKeown, Newry.  
 K: Roy Merrall, Dunstable.  
 L: George Millmore, Wootton, IoW.  
 M: Sid Morris, Rowley Regis.  
 N: Fred Pallant, Storrington.  
 O: Harry Richards, Barton-on-Humber.  
 P: Tom Smyth, Co.Fermanagh.  
 Q: Phil Townsend, E.London.

Cheltenham. Their broadcasts are being received over a wide area during daylight (see chart). R.Maldwyn has studios in Newtown, Powys. **David Porter** (Ludlow) informs me that a new 61m mast, erected some 2.4km north of the town, radiates their programmes on 756kHz. The e.m.r.p. is about 630W. The ground wave is reaching places well beyond the intended service area! No doubt both stations will welcome reports. Send them to CD603, Churchill Studios, Churchill Road, Cheltenham, Gloucestershire GL53 7EP. Radio Maldwyn, The Studios, Newtown, Powys FY16 2NZ.

## Short Wave Reports

Although the level of solar activity is decreasing, it is still having a marked effect upon propagation in the higher frequency bands. Such effects are most noticeable in the **25MHz (11m)** band, where daily variations in reception have been evident.

Four broadcasters are still using 11m to reach areas outside Europe: UAE R, Abu Dhabi 25.690 (Ar to Far East 0900-1100), 25332 at 1000 by **Simon Hockenull** in E.Bristol; R.Australia via Darwin 25.750 (Eng to NE Africa 0800-0855), 22212 at 0800 by **Chris Shorten** in Norwich; DVV via Julich 25.740 (Ger to E.Asia 1100-1355), 54444 at 1300 by **Robert Connolly** in Kilkeel; also RFI via Issoudun, 25.820 (Fr to Africa 0900-1545), SIO253 at 1100 by **Kenneth Buck** in Edinburgh.

In the **21MHz (13m)** band UK DXers have noted good reception of some of R.Australia's broadcasts: Darwin on 21.525 (Eng to SE.Asia 0200-0800) rated 44334 at 0701 in Barton-on-Humber; 21.745 from Darwin (Eng to Asia 0800-1300) as SIO444 at 0900 by **Cyril Kellam** in Sheffield; 21.595 from Carnarvon (Eng to Pacific areas 0100-0900) as 54444 at 0853 in Worthing; 21.745 (Eng to Asia 0800-1300) as SIO222 at 1030 by **Philip Rambaut** in Macclesfield and 35553 at 1300 by **John Parry** in Northwich.

Also noted in the morning were R.Prague, Czech Rep. 21.705 (Eng to Pacific areas 0730-0800) 54444 at 0730 in Norwich; R.Japan via Moyabi. 21.575 (Eng, Jap to Europe, M East 0700-0900) 24422 at 0737 by **Leo Barr** in Sunderland; R.Finland via Pori 21.550 (Eng to Australia, NZ 0800-0830) 43443 at 0815 in Kilkeel; R.Austria Int via Moosbrunn 21.490 (Eng to Australia 0830-0900) 44444 at 0830 by **Sheila Hughes** in Morden; R.Pakistan, Islamabad 21.520 (Eng to Europe 0800-0845) SIO444 at 0830 in Edinburgh; UAE R.Dubai 21.605 (Eng to Europe 1030-1055) 33122 at 1046 by **Simon Bakewell** in Moldgreen.

# Long Medium & Short

In the afternoon BSKSA Riyadh, Saudi Arabia 21.505 (Ar [Home Service] 1100-1700) was rated 44444 at 1244 by **Zacharias Liangas** in Thessaloniki, Greece and SIO444 at 1320 by **John Coulter** in Winchester; RTV Tunis via Sfax 21.535 (Ar [Home Service] 0700-1800?) SIO333 at 1320 by **Ted Walden-Vincent** in Gt. Yarmouth; UAE R. Dubai 21.605 (Eng to Europe 1330-1400) 33344 at 1335 by **Martin Dale** in Stockport; SRI via Schwarzenburg 21.820 (Ger to S.E. Asia, Far East 1430-1500) 33343 at 1435 by **Peter Pollard** in Rugby; BBC via Ascension I 21.660 (Eng to Africa 0730-1745) 45333 at 1437 by **Ronald Kilgore** in Co Londonderry; R. Portugal Int via Sines 21.515 (Eng to M. East 1430-1500) 22112 at 1449 by **Eddie McKeown** in Newry; R. Japan via Moyabi, 21.700 (Jap to Europe, M. East 1600-1700) 35422 at 1612 in Iceland; WYFR via Okeechobee 21.615 (Eng to Europe, Africa 1600-1700) SIO434 at 1650 by **Sid Morris** in Rowley Regis.

Later, WYFR via Okeechobee 21.500 (Eng to Europe, Africa 1700-1900) SIO444 at 1808 by **Gerry Haynes** in Bushey Heath; R. Portugal Int, Lisbon 21.655 (Port to W. Africa 1800-1900) 44333 at 1826 by **Rhoderick Illman** in Oxted; R. Netherlands via Bonaire, 21.590 (Eng to Africa 1730-2025) 45444 at 1845 in E. Bristol; HCJB Ecuador 21.455 (world-wide u.s.b. + p.c.) 45544 at 1910 by **Ross Lockley** in Stirling; also 21.480 (Eng to Europe 1900-2000) 34533 at 1915 by **David Edwardson** in Wallsend; VOA via Greenville, 21.485 (Eng to Africa 2000-2200) 25443 at 2015 by **Eric Shaw** in Chester; WYFR via Okeechobee 21.525 (Eng to Europe, Africa 2000-2300?) SIO322 at 2025 by **Bill Clark** in Rotherham; VOFC via Okeechobee, USA 21.720 (Eng to Europe 2200-2300) 34433 at 2200 by **John Eaton** in Woking.

Radio Australia has also been reaching the UK in the 17MHz (16m) band. Their transmission to S. Asia via Darwin on 17.695 (Eng 0700-0900) was 33533 at 0705 in Wallsend. Also logged during the morning were FEBA R, Seychelles 17.750 (Eng to M. East 0500-0553, Fri only) rated at 0500 in Morden; Voice of Greece, Athens 17.525 (Gr, Eng to Australia 0800-0950) 34433 at 0920 in Worthing; Israel R, Jerusalem 17.745 (Eng, Fr, Heb to USA, W. Europe 1000-1255) 45444 at 1002 by **Peter Polson** in St. Andrews; HCJB 17.490 (u.s.b. + p.c.) 24422 at 1009 in Sunderland; R. Bulgaria, Sofia 17.830 (Eng to Europe 1030-1200) SIO555 at 1040 in Macclesfield; R. Pakistan, Islamabad 17.900 (Eng to Europe 1100-1120) 33122 at 1116 in Moldgreen and 53554 at 1120 in Hafnarfjörður; KHBI Saipan, N. Mariana I 17.555 (Eng to NE. Asia 0800-1155) 44344 at 1120 in Norwich; DW via Jülich? 17.860 (Eng to W. Africa 1100-1150) SIO443 at 1130 in Rowley Regis.

During the afternoon, AWR via Gabon 17.890 (Eng to W. Africa 1200-1300, Sun only) 23532 at 1200 in Stirling; RTV Tunisia via Sfax 17.500 (Ar [Home Service] 0700-1600) SIO444 at 1330 in Winchester; BBC via Antigua, 17.840 (Eng to S/C. America 1400-1615) 25333 at 1400 in Chester; R. Cairo via Abis 17.595 (Eng, Beng to S. Asia 1215-1430) SIO333 at 1420 in Gt. Yarmouth; Africa No. 1, Gabon 17.630 (Fr, Eng to W. Africa 0700-1600) SIO444 at 1512 in Rotherham; WEWN, Birmingham, 17.510 (Eng to Europe 1400-1555) SIO344 at 1545 in Edinburgh; DW via Trincomalee, 17.810 (Eng to S. Asia 1600-1650) 43333 at 1626 in Barton-on-Humber; BBC via Ascension Island 17.860 (Eng to W/C. Africa 1600-1745) 32222 at 1630 in Oxted; VOA via Tangier,

## Tropical Bands

Freq MHz	Station	Country	UTC	DXer
3.200	TWR Ndebele	Swaziland	0325	L
3.210	Em. Nacional, Maputo	Mozambique	2006	U
3.215	R. Orange	S. Africa	2121	U
3.220	R. Togo, Lome	Togo	2212	J,K,L
3.230	R. Nepal	Kathmandu	2234	G
3.230	ELWA Monrovia	Liberia	0327	L
3.230	R. Sol de Los Andes	Peru	0348	S
3.230	R. Orange	S. Africa	2106	S
3.232	RR1 Bukittinggi	Indonesia	2318	S
3.240	TWR Shona	Swaziland	0325	L
3.245	R. Clube Varginha	Brazil	2140	S
3.255	BBC via Maseru	Lesotho	2155	G,J,K,L
3.265	RTV Brazzaville	Congo	2157	G
3.270	SWABC 1, Namibia	S.W. Africa	2010	R
3.280	R. Beira	Mozambique	2154	K
3.290	SWABC 2, Namibia	S.W. Africa	2046	K
3.300	R. Cultural	Guatemala	0323	J,L
3.316	SLBS Godeich	Sierra Leone	2124	B,J,K,U
3.320	Pyeongyang	N. Korea	2021	L
3.320	R. Orton	S. Africa	1924	J,K,U
3.320	R. Sud Afrika	Nigeria	2125	L,R,S
3.325	FRCN Lagos	Nigeria	2125	E,G,J,K,U
3.330	R. Kigali	Rwanda	2024	K
3.338	R. Maputo	Mozambique	0325	K,L
3.340	R. Altura	Peru	0333	S
3.356	R. Botswana	Gaborone	1923	B,J,K,L,U
3.365	R. Cult. Araraquara	Brazil	0319	L
3.365	GBC R-2	Ghana	2126	B,E,G,H,I,J,K,L,N,R,T,U,X
3.380	R. Malawi	Malawi	2149	K,R
3.395	RR1 Tanjungkarang	Indonesia	2239	R
3.915	BBC Kranji	Singapore	1818	R
3.955	BBC Skelton	England	1925	N,T
3.955	Novostorsk rly A Ata	Kazakhstan	1830	S
3.965	RFI Paris	France	0128	A,O,G,I,L,M,N,R,T,W,Z
3.975	BBC Skelton	England	1750	F
3.980	VOA Munich	Germany	2159	G,L,M,N,O,R,T,W,Z
3.985	China R via SRI	Switzerland	2200	L,M,P
3.985	SRI Beromunster	Switzerland	2200	L,J,R,T,Z
3.990	RFE Munich	Germany	2027	L
3.995	DW via Jülich	Germany	2311	A,E,G,I,L,N,R,T
3.995	Channel Africa, Jo'burg	S. Africa	0316	L
4.000	Bofoussam	Cameroon	2010	K,L,S,U,V
4.500	Xinjiang BS, Urumqi	China	2131	J
4.755	R. Educ. CP Grande	Brazil	0043	R
4.755	Caracol Neiva	Colombia	0015	F
4.765	Brazzaville	P.R. Congo	1927	B,F,K,L,Q,R,U,Z
4.770	FRCN Kaduna	Nigeria	2034	F,G,H,K,O,R,T,U
4.775	R. Gabon, Libreville	Gabon	2235	I,K,Q
4.780	RTD	Djibouti	1955	K
4.783	RTM Bamako	Mali	2100	K,U
4.790	R. Atlantida	Peru	0337	J
4.800	R. Buenas Nuevas	Guatemala	0311	L
4.800	AIR Hyderabad	India	2020	K
4.800	LNBS Lesotho	Maseru	1859	R,U
4.805	R. Naac. Amazonas	Brazil	2345	F,R
4.810	R. San Martin Tara	Peru	0035	S
4.815	R. Ofiusera, Londrina	Brazil	0055	F
4.815	R. diff TV Burkina	Quagadougou	2056	F,G,K,U
4.825	R. Cancaco Nova	Brazil	0327	J
4.830	R. Botswana, Gaborone	Botswana	1959	G,K,L,R,U
4.830	R. Yachira	Venezuela	2300	J,K,L,R,T
4.835	R. Tezulutan, Coban	Guatemala	0315	J,L,R
4.845	ORTM Nouakchott	Mauritania	2105	T,U
4.850	R. Yaounde	Cameroon	2036	B,F,G,J,K,L,N,R,T,U
4.850	AIR Kohima	India	2020	D,U
4.850	Ulan Bator 1	Mongolia	2050	N
4.860	AIR New Delhi	India	1851	J,K
4.865	L.V. del Cimarruco	Colombia	0005	F,J,R
4.870	R. Cotonou	Benin	2037	G,I,J,K,L,Q,R,T,U

17.895 (Eng to N/W. Africa 1600-2100) 34444 at 1706 in Co. Londonderry.

In the evening R. Japan via Ekala 17.775 (Eng to Europe, M. East, N. Africa 1700-1800) SIO343 at 1754 in Bushey Heath; R. Moscow WS 17.760 (Eng 1800-?) 42422 at 1800 in Thessaloniki and SIO443 at 1940 by **Michael Williams** in Redhill; HCJB Quito 17.790 (Eng to Europe 1900-2000) 42343 at 1919 in Newry; R. Netherlands via Bonaire, 17.605 (Eng to W. Africa 1930-2025) 44554 at 1930 in Northwich; R. Algiers Int via Bouchaoui 17.745 (Eng to Europe, E/C. Africa 1900-2000) 44444 at 1950 by **Darren Beasley** in Bridgwater; DW via Antigua, 17.810 (Ger to Africa, Europe 2000-2120) 45434 at 2005 in Woking; RCI via Sackville, 17.875 (Eng to Europe 2030-2130) 54555 at 2055 in Stockport; R. Havana, Cuba 17.760 (Eng to Europe, M. East, Africa 2100-2200) 23332 at 2100 by **Michael Griffin** in Ross-on-Wye.

Later, HCJB Quito 17.790 (Eng to Europe 2130-2200) 43433 at 2130 in Kilkeel; VOA via Tinang 17.735 (Eng to E. Asia, Pacific 2100-0100) 33333 at 2202 by **Robin Harvey** in Bourne; VOFC Taiwan via Okeechobee 17.750 (Eng to Europe 2200-2300) SIO222 at 2204 by **Julian Wood** in Elgin.

Good reception from many areas has been noted in the 15MHz (19m) band. R. New Zealand Int on 15.120 (Eng to Pacific areas 2139-0658) was 43333 at 0601 in Bushey

Freq MHz	Station	Country	UTC	DXer
4.885	R. Clube do Para	Brazil	2345	F
4.885	Voice of Kenya	Kenya	1933	I,K,R,S,U
4.895	R. Bare, Manaus	Brazil	0304	L
4.895	Voz del Rio Arauca	Colombia	0047	F,J,L,R
4.905	R. Nat. N'djamena	Chad	2038	K,L,O,R,U
4.910	AIR Delhi	India	1851	I
4.910	R. Zambia, Lusaka	Zambia	2002	K,S,U
4.915	R. Anhanguera	Brazil	2328	J,R
4.915	R. Naac. Macapa	Brazil	2335	F
4.915	PBS Guangxi, Nanning	China	2202	G
4.915	GBC-1, Accra	Ghana	2041	C,S,I,J,K,L,Q,R,T,U,Y,Z
4.915	Voice of Kenya	Kenya	1935	R,U
4.915	R. Cora, Lima	Peru	0300	L
4.920	ABC Brisbane	Australia	2036	U
4.920	R. Quito	Ecuador	0301	J,L
4.925	Em Merid, Arauca	Colombia	0030	F
4.926	R. Cobria 2000	Peru	0300	L
4.930	RR1 Surakarta, Java	Indonesia	2233	J
4.935	R. Capigaba, Vitoria	Brazil	0255	L
4.935	R. Difusora, Jatai	Brazil	0205	F
4.935	Voice of Kenya	Kenya	2025	K,L,R,U,Y,Z
4.940	R. Abidjan	Ivory Coast	2233	G
4.945	R. RSA, Johannesburg	S. Africa	1752	S
4.970	R. Rumbos, Caracas	Venezuela	0408	J
4.975	R. Uganda, Kampala	Uganda	2053	K,R,U
4.980	Ecos del Torbes	Venezuela	0025	F,J,L
4.985	R. Brazil Central	Brazil	0010	F
4.990	AIR via Madras	India	0005	N,R
4.990	FRCN Lagos	Nigeria	2041	C,E,I,K,L,R,U
4.990	R. Ancash, Huaraz	Peru	2345	F
5.005	R. Nacronal, Bata	Eq. Guinea	2037	K,L,Q,R,U
5.005	R. Nepal, Kathmandu	Nepal	1856	I
5.010	R. Garoua	Cameroon	2118	G,K,R,U
5.010	R. Madagascar	Madagascar	2026	I,L
5.015	R. Brazil Tropical	Brazil	2350	FL
5.020	ORTN Niamey	Niger	1943	K
5.025	R. Parakou	Benin	2016	K
5.025	R. Uganda, Kampala	Uganda	1942	K,U
5.035	R. Aparceida	Brazil	0248	L
5.035	R. Banqui	C. Africa	1945	G,I,K,N,R,U
5.045	R. Cultura do Para	Brazil	2340	F,L,R
5.047	R. Togo, Lome	Togo	2044	F,G,I,J,K,L,O,Q,R,U
5.050	Voz de Yopal, Yopal	Colombia	0245	L
5.050	Em Jesus Gran Poder	Ecuador	0248	L
5.050	SBC Singapore	Singapore	2221	J
5.050	R. Tanzania	Tanzania	2043	K,L,Q,U
5.052	SBC R-1	Singapore	2228	K
5.055	Faro del Caribe	Costa Rica	0241	L
5.055	RFI Cayenne (Matoury)	French Guiana	2330	F,K,R,S
5.075	Caracol Bogota	Colombia	2358	F,Q,R,T
5.320	CPBS 1, Beijing	China	1958	S

## DXers:

A: Tim Allison, Middlesborough.  
 B: Leo Barr, Sunderland.  
 C: Vera Brindley, Woodhall Spa.  
 D: Tim Bucknall, Haltwhistle.  
 E: Bill Clark, Rotherham.  
 F: Robert Connolly, Kilkeel.  
 G: Geoff Crowley, Iceland.  
 H: Ron Damp, Worthing.  
 I: John Eaton, Woking.  
 J: David Edwardson, Wallsend.  
 K: P. Gordon Smith, Kingston, Moray.  
 L: Gerry Haynes, Bushey Heath.  
 M: Simon Hockenhill, E. Bristol.  
 N: Sheila Hughes, Morden.  
 O: Rhoderick Illman, Oxted.  
 P: Cyril Kellam, Sheffield.  
 Q: Ross Lockley, Stirling.  
 R: Eddie McKeown, Newry.  
 S: Roy Merrall, Dunstable.  
 T: Sid Morris, Rowley Regis.  
 U: Fred Pallant, Storrington.  
 V: John Parry, Northwich.  
 W: Peter Pollard, Rugby.  
 X: Eric Shaw, Chester.  
 Y: Oarran Taplin, Brechley.  
 Z: Phil Townsend, E. London.

Heath. R. Australia was noted on several frequencies: 15.575 via Darwin (Chin to Asia 2200-2230) as 33433 at 2200 in Chester; 15.320 via Shepparton (Eng to S. Asia 2200-0730) as 32222 at 0131 in Worthing; 15.240 (Eng to Pacific areas 0030-0830) 32332 at 0800 in Kilkeel; 15.170 via Carnarvon (Eng, Chin, Cant to Asia 0900-1430) as 24432 at 1135 in Wallsend.

During the morning HCJB Quito, Ecuador 15.270 (Eng to Europe 0700-0830) 44333 at 0730 in Ross-on-Wye; R. Austria Int via Moosbrunn 15.450 (Ger, Eng to Australia 0800-1100) 43433 at 0842 in Oxted; DW via Antigua 15.205 (Sp to S/C. America 1100-1150) 44554 at 1127 in Northwich; R. Diff. TV Congolaise via Brazzaville 15.190 (Fr to Africa 1100-1700), ident heard at 1150 in Dunstable.

After mid-day, China R. Int, Beijing 15.165 (Eng to S. Asia 1400-1557) 32322 at 1454 in Newry; BBC via Masirah Is. 15.310 (Eng to M. East, Asia 0900-1700) SIO333 at 1518 in Gt. Yarmouth; SRI via Beromunster? 15.505 (Eng to C/S.E. Asia 1500-1530) SIO544 at 1525 in Rowley Regis; KTWV Agana Guam 15.610 (Eng to S. Asia, India) 23212 at 1530 in Morden; Voice of Greece via Avis 15.630 (Gr, Eng, Sw to N. Europe, USA 1500-1550, also on 15.650) 33233 at 1533 in Moldgreen; WCSN Scotts Corner, USA 15.665 (Eng to Europe 1400-1555) SIO455 at 1550 in Edinburgh; Africa No. 1, Gabon 15.475

(Fr to Africa 1600-2000) 44544 at 1615 in Stirling; Voice of Vietnam, Hanoi 15.009 (Eng to Africa 1600-1630) 44444 at 1626 by **Vera Brindley** in Woodhall Spa; R.Pakistan, Islamabad 15.550 (Eng to Europe 1700-?) 55444 at 1702 in Co.Londonderry.

During the evening RNB Brasilia, Brazil 15.265 (Eng, Ger to Europe 1800-2100) 23333 at 1805 in St.Andrews; R.Vlaanderen Int, Belgium 15.540 (Eng to Africa 1800-1825) 34444 at 1805 by **Ken Milne** in Basingstoke; WWCR Nashville, 15.685 (Russ, Eng to Europe, 1000-0000) 54554 at 1825 in Bridgwater and 35423 at 1859 in Hafnarfjordur; WSHB Cypress Creek, USA 15.665 (Eng to E.USA, Europe 1800-1955) 45444 at 1835 in Woking; WEWN Birmingham, 15.695 (Eng to Europe 1800-2200) SIO232 at 1900 by **Phil Townsend** in E.London; R.Romania Int, Bucharest 15.365 (Eng to Europe? 1900-2000) 55555 at 1917 by **Darran Taplin** in Brenchley; VOIRI Tehran 15.260 (Eng to Europe 1930-2030) SIO322 at 1930 by **Tom Smyth** in Co.Fermanagh; RTL via Junglinster 15.350 (Ger to E.USA 24 hrs) 33223 at 2000 in Barton-on-Humber; RNE via Noblejas, Spain 15.375 (Eng to Africa 1900-2000) 22222 at 2028 in Sunderland; Voice of Vietnam, Hanoi 15.009 (Eng to Europe 2030-2100) SIO433 at 2036 in Redhill; R.Ukraine Int, Kiev 15.195 (Eng to Europe? 2100-2200) SIO433 at 2100 in Sheffield.

Later, VOA via Tangier, Morocco 15.205 (Eng to Europe 1700-2200) was SIO333 at 2145 by **Francis Hearne** in N.Bristol; Israel R, Jerusalem 15.640 (Eng to Europe, USA 2130?-2200?) 34444 at 2150 in Stockport; KTBN Santa Ana, USA 15.590 (Eng to USA 1600-0200) SIO322 at 2204 in Rotherham; R. Bulgaria, Sofia 15.330 (Eng 2145-2315) 54544 at 2205 in Bourne; UAE R, Abu Dhabi 15.305 (Eng to USA 2200-0000) 55555 at 2215 in Norwich; also 15.315 (Eng to USA 2200-0000) 44544 at 2308 by **Tim Allison** in Middlesbrough; BBC via Ascension Is. 15.400 (Eng to Africa

1500-2315) 34444 at 2315 in E.Bristol.

Good reception from many areas has also been evident in the **13MHz (22m)** band. Three of R. Australia's broadcasts have been reaching the UK: 13.605 from Darwin (Chin, Eng to China 1000-1430) 34333 at 1103 in St. Andrews; 13.755 from Carnarvon (Eng to Asia 1430-1800) 43333 at 1500 in Kilkeel; and also 13.605 from Darwin (Chin to China 2200-0000) 33323 at 2214 in Rugby.

Also logged here were DW via Julich? 13.610 (Eng, Fr to W.Africa 0600-0750), 34554 at 0705 in Northwich; SRI via Sottens 13.685 (Eng, Fr to Australia, NZ, S.Pacific 0900-1030) 43333 at 0925 in Worthing; also 13.635 (Eng, Fr to C/ S.E.Asia 1500-1600) 55555 at 1517 in Co.Londonderry; R.Pakistan, Islamabad 13.590 (Eng to M.East 1600-1630) 34433 at 1629 in Brenchley; AWR (KSDA) Agat, Guam 13.720 (Eng to Africa 1700-1900, Sat/Sun only) 33233 at 1820 in Newry; R.Vlaanderen Int, Belgium 13.685 (Eng to Africa? 1800-1830) 33443 at 1808 in Basingstoke; DW via Julich 13.790 (Eng to W.Africa 1900-1950) 24443 at 1915 in Chester; RCI via Sackville 13.670 (Eng to M.East, Africa 2100-2130) SIO444 at 2100 in Sheffield; R.Iraq Int, Baghdad 13.680 (Eng to Europe?) 32432 at 2126 in Middlesbrough; BBC via Rampisham, 13.660 (Eng to Falkland Is 2130-2145) SIO322 at 2130 in Redhill; VOA via Selebi Phikwe, Botswana 13.710 (Eng to Africa 1600-2200) SIO333 at 2140 in Rotherham; R. Netherlands via Flevo 13.700 (Du to S.America 2130-2225) 43433 at 2218 in Bourne; WWCR Nashville, 13.845 (Eng to E.USA 1200-0100) 33223 at 2300 in Barton-on-Humber; R.Vlaanderen Int, Belgium 13.655 (Eng to S.Am 2330-2355) 44444 at 2330 in Morden.

While broadcasting to Europe, R. Austria Int via Moosbrunn 13.730 (Ger, Eng, Fr, Sp 0500?-1900) rated 43344 at 1250 in Stockport; UAE R, Dubai 13.675 (Ar, Eng 0615-2100) 24242 at 1330 in Ross-on-Wye and SIO555 at 1630 in

Edinburgh; R. Prague, Czech Rep. 13.600 (Eng 1500-1527) 43343 at 1512 in Norwich; R.Pyongyang, N.Korea 13.785 (Eng 1500-1550, also to M.East, Africa) 32222 at 1512 in Woodhall Spa; R. Bulgaria via Plovdiv? 13.670 (Eng 1730-1900) 45444 at 1832 in Woking; WHRI South Bend, 13.760 (Eng 1700-0000) 42322 at 1833 in Bushey Heath; Croatian R via Deanovec 13.830 (News in Eng) 45444 at 1900 by **Roy Patrick** in Derby and 45544 at 2108 in Stirling; R.Kuwait via Kbad 13.620 (Eng 1800-2100) 33223 at 2003 in Moldgreen.

Some of the **11MHz (25m)** broadcasts to Europe stem from HCJB Quito, 11.835 (Eng 0700-0830) 44444 at 0800 in Morden; R.Slovakia, Bratislava 11.990 (Eng 0830-0857) SIO333 at 0840 in Rotherham; Polish R, Warsaw 11.815 (Ger, Eng 1130-1255) SIO444 at 1130 in Macclesfield; R. Bulgaria, Sofia 11.720 (Eng 1730-1900) 32222 at 1751 in Woodhall Spa; Israel R, Jerusalem 11.587 (Eng 1900-1930, also to USA) 44444 at 1900 in Brenchley; R.Algiers Int via Bouchaoui 11.715 (Eng to Europe, N.Africa? 1900-2000) SIO211 at 1900 in Co.Fermanagh; AIR via Delhi? 11.620 (Eng, Hi 1745-2230) 32122 at 1912 in Moldgreen; R.Damascus, Syria 12.085 (Eng 2008-2108) 43544 at 2045 in Bridgwater; China R Int, Beijing 11.500 (Eng 2000-2157) 23222 at 2052 in Sunderland; R.Japan via Moyabi, 11.925 (Eng 2100-2200) 43333 at 2131 in Middlesbrough. Although for other areas R.Netherlands via Bonaire, 11.895 (Eng to Pacific areas, F.East 0730-1025) 44444 at 0850 in St.Andrews; R.Australia via Shepparton 11.855 (Eng to SE.Asia 1300-1630) SIO333 at 1510 in Gt.Yarmouth; China R. Int, Beijing 11.445 (Port to Africa 1900-1957) SIO444 at 1900 in Winchester; R.Havana, Cuba 11.760 (Sp to USA 2300-0200) 32222 at 0015 in Kilkeel.

R.New Zealand's **9 MHz (31m)** broadcasts to Pacific areas reached the UK some mornings. Their 100kW signals on 9.700 (Eng 0700-1200) was 25552 at 0701 in Wallsend. It was also

logged in Hafnarfjordur as 14432 at 1102. R.Australia's broadcast to Pacific areas via Shepparton on 9.580 (Eng 0800-2130) was 31321 at 0759 in Bushey Heath. Better reception was noted later from Carnarvon on 9.510 (Eng to S.Asia 1430-1800), 54433 at 1624.

Also noted were WCSN Scotts Corner, 9.840 (Eng to Europe 0600-0800) SIO444 at 0740 in Macclesfield; R.Netherlands via Flevo 9.650 (Eng to Europe 1130-1325), 44444 at 1224 in Basingstoke; Polish R, Warsaw 9.525 (Eng to Europe 1500-1555) SIO433 at 1555 in Rowley Regis; R.Jordan via Al Karanah 9.560 (Eng 1100-1630) SIO332 at 1630 in Dunstable; VOIRI Tehran 9.022 (Eng to Europe 1930-2030) SIO322 at 1933 in Redhill; WSHB Cypress Creek, 9.465 (Eng to USA 2200-2355) SIO444 at 2245 in N.Bristol; WCSN Scotts Corner 9.850 (Eng to Africa 0000-0200) 44444 at 0046 in Barton-on-Humber.

The **7MHz (41m)** logs included WWCR Nashville, 7.435 (Eng to Europe 0000-1000?), rated 44444 at 0400 in Ross-on-Wye; Voice of Nigeria via Ikorodu 7.255 (Eng to W.Africa 0455-0700) 22442 at 0600 in Chester; R.Japan via Skelton, 7.230 (Jap, Eng, Ger to Europe 0700-0830) SIO444 at 0700 in Sheffield; KTBN Santa Ana, 7.510 (Eng to USA 0200-1600) 23432 at 0755 in Stirling; Voice of Greece, Athens 7.430 (Gr, Al, Bul, Ro, Se to Balkans 1600-1710) SIO233 at 1600 in E.London; R.Australia via Carnarvon 7.260 (Eng to N.Asia 1430-1800, to S.Asia 1800-2100) 54434 at 1800 by **George Tebbitts** in Penmaenmawr; AIR via Aligarh 7.412 (Eng, Hi to Europe 1730-2230) 34333 at 1856 in Oxted; R.Ukraine Int, Kiev 7.240 (Eng to Europe 2100-2200) SIO433 at 2145 in N.Bristol; R. Prague, Czech Rep 7.345 (Eng to USA 0000-0027) SIO444 at 0000 in Co.Fermanagh.

In the **6MHz (49m)** band R.Australia via Carnarvon 6.000 (Eng to Asia 1800-2100) 32322 at 1818 in Newry; CKZN St.John's, 6.160 (Eng to E.Canada 0930-0500) 33333 at 2300 in Kilkeel.

## Bandscan

CONTINUED FROM PAGE 54

### Other News

According to *CB Action* there is a new New Zealand short wave pirate station called Radio Kiwi operating between 0630 and 0830 UTC Sundays on 7.445MHz. The station address is announced on air as PO Box 1437, Hastings, New Zealand. The National Transmission Agency (NTA) has launched the ABC's 200th Radio National transmitter at Mount Panorama near Bathurst, New South

Wales. Radio National can now be heard in most parts of Australia; the state of Queensland has 69 RN transmitters. NTA transmitters for ABC Regional Radio and Radio National have grown from 214 to 271 in the period from July 1992 to May 1993; ABC FM from 47 to 54 transmitters; ABC TV from 360 to 375; and Special Broadcasting Services TV from 45 to 49. The NTA now operates and maintains 897 separate transmitters at 565 transmission facilities.

According to statistics released by the Department of Transport and Communication (DoTC) there are currently 18222 amateur licence holders in Australia. Of these 10634 are unrestricted licences, 2633 are novice licences, 1538 are combined licences, 3390 are limited licences and the remaining 27 are for beacons. There are currently 334 amateur repeaters and 427 u.h.f. CB repeaters.

Also from *CB Action*, Qantas is reported on 5.547 and 11.396MHz, the

School of the Air in Port Augusta on 5.845MHz and Antarctic bases on 14.415 and 15.485MHz.

I welcome any news and comments. In particular I am interested in any s.w.l. information on Australian stations heard by *SWM* readers so I can chase up more details and interesting snippets from this end. My address is PO. Box 208, Braidwood, NSW 2622, Australia. For personal replies please send two IRCs.

# B.A.R.T.G. RALLY

SUNDAY 12th SEPTEMBER 1993

SANDOWN EXHIBITION CENTRE, ESHER, SURREY.

EASY ACCESS BY CAR, PLENTY OF FREE PARKING,  
WELL SIGNPOSTED, TALK-IN S22, PLENTY OF TRADER,  
S.I.G. & LOCAL A.R.G. STANDS IN LARGE EXHIBITION HALL

\*\*\*\*\* BRING 'n' BUY \*\*\*\*\*

Admission: Adults £1.50 60+ £1.00  
Children Under 14 FREE (if accompanied by an adult)  
Open: 10.30am to 5.00pm

ON-SITE CATERING: HOT AND COLD MEALS, SNACKS, BEVERAGES AND LICENCED BAR  
Further details from: Peter Nicol, 38 Mitten Avenue, Rubery, Rednal, Birmingham. B45 0JB ☎ 021 453 2676



## Let Your Computer Control Your Radio! . . . with SCANCAT

Once you use the SCANCAT computer program with your radio, you will never operate your radio again without it! SCANCAT Version 4.5 controls the following radios:

- \* AOR 2500, 8000
- \* KENWOOD R-5000, TS-440, TS-450, TS-711, TS-980
- \* DRAKE K-8
- \* YAESU FT-757GX, FRG-9600
- \* ICOM R-71, R-7000, R-9000, R-100
- \* JRC, NRD-525, NRD-595

For other ICOM and Kenwood radios please call.

### UNIVERSAL FEATURES

- \* Create Frequency Databases
- \* Scan between ANY Frequencies
- \* Up to 400 Frequencies/File
- \* Scan by ANY increment and delay
- \* Built in TNC comm program
- \* Share ANY radio's file

AOR-3000, ICOM, NRD-585  
FRG-9600 FEATURES

- \* Auto logging to disk files
- \* Spectrum analysis with spectacular graphics
- \* Auto signal detection/scan stop
- \* Save/Load radio's memories to disk

Optional squelch detect cable - £10.50 + £5 P&P  
\$49.95 US (approx. £35) plus \$7.50 (approx. £4.50) p&p

Charge Cards welcome  
\* Please call

J & J Enterprises  
P.O. Box 18292, Shreveport, LA 71138  
4001 Parkway Drive, Bossier City, LA 71112

Phone. 318-683 2518 (8-5 CST) or FAX 318-686 0449(24 hours)

Windows Compatible



## WEATHER MONITORING

Prices from  
only £199  
WIND SPEED  
& DIRECTION  
only

Features (dependent on model)

- \* WIND SPEED & DIRECTION
- \* ELEGANT MAHOGANY CABINET (choice of light or dark)
- \* BAROMETRIC PRESSURE
- \* HUMIDITY & DEW POINT
- \* RAINFALL
- \* SUNSHINE Hrs.
- \* 12-24V or MAINS
- \* OUTSIDE TEMPERATURE with MIN & MAX - C & F
- \* COMPUTER INTERFACE (soon)

Send for colour  
brochure now to -  
R & D

ELECTRONICS  
Tel. (0843) 866662  
Fax. (0843) 866663

Beaufort House, Percy Ave, Kingsgate Broadstairs, Kent. CT10 3LB



## Quantek Electronics

### YUPITERU MVT7100

- \* 530kHz - 1650MHz
- \* 1000 channels
- \* NFM/WFM/AM/LSB/USB
- \* Supplied with: Ni-cad batteries, UK charger, antenna, DC cigar lead, carrying strap, belt clip and earphone

SPECIAL OFFER.....£399 incl p&p

### AOR 1500EX

- \* 500kHz - 1300MHz
- \* 1000 channels
- \* NFM/WFM/AM/SSB
- \* Supplied with: Ni-cad batteries, UK charger, antenna, LW antenna, dry cell battery case, soft case, earpiece

SPECIAL OFFER.....£339 incl p&p

### OPTO ELECTRONICS 2300

- Frequency counter/finder. An extremely sensitive hand-held frequency counter. It will display the frequency of a 2 watt transmitter at 100ft!
- \* 1MHz - 2.4GHz
- \* Fast/slow gate times
- \* Hold switch
- \* Supplied with Ni-cad batteries, UK charger and antenna

SPECIAL OFFER.....£149 incl p&p

### NEW! - STARTEK ATH-15

- Ultra high sensitivity frequency counter/finder with signal strength bar graph display.
- \* 1MHz - 1.5GHz \* 3 gate times
- \* Sensitivity less than 1mV
- \* 10 segment bar graph display shows signal strength up to 4GHz
- \* Ultra fast response time less than 80 milliseconds \* Auto trigger & hold

\* Supplied with nicads, UK charger and antenna  
SPECIAL OFFER.....£199 incl p&p

### SCANNER AUTO-VOX

Connects to and works with any receiver which has an 'ear' socket and squelch control. Simply plug the AUTO-VOX into the 'ear' socket of the receiver, then plug the output leads from the AUTO-VOX into the microphone and remote sockets of a tape recorder. The AUTO-VOX will then automatically switch the tape recorder on when a signal is received and off when there is no signal present - result a tape full of all the action!

Kit £15.95 assembled £24.95 incl p&p

### SCANNERS

- YUPITERU MVT 7000 .....£329
- YUPITERU MVT 8000 .....£349
- YUPITERU VT125 .....£179
- YUPITERU VT 225 .....£249
- FAIRMATE HP2000 .....£289
- NEVADA MS1000 .....£269
- AOR 3000A .....£899

Please add £5 p&p

Quantek Electronics

3 Houldey Road, Birmingham, B31 3HL

CREDIT CARD ORDERS

OPENING HOURS  
Monday - Friday  
9.00am - 5.30pm

Tel: 021 411 1821 • Fax: 021 411 2355

ALL PRODUCTS  
WARRANTED  
FOR 12 MONTHS

## THE AVIATION HOBBY CENTRE

1st FLOOR, MAIN TERMINAL BUILDING,  
BIRMINGHAM INTERNATIONAL AIRPORT  
BIRMINGHAM B26 3QJ

Telephone: 021 782 2112 or 021 782 6560

OPEN 7 DAYS A WEEK (including bank holidays)

Why not pay us a visit and watch the aeroplanes at the same time. We have two shops, one on the first floor by Mag-Lev (have a free ride to BR station and back) and one in the Airport's Viewing Gallery (Viewing Gallery open everyday - Admission 50p).

Airband Radios from £9.95 and Scanners from £189.00 plus a variable selection of good secondhand and part exchange models usually available.

We stock radios by Fairmate, Jupiter, Icom, Uniden, Steepletone, Texet etc., Models and Prices to suit you.

Come and see the finest range of books on Aircraft and associated subjects there is, by publishers such as Ian Allan, Airlife, Putnam, PSL, Haynes, MCP and many more. Air Maps, Frequency Charts, Books on ATC, even books on how to fly a Cessna or a Jumbo Jet, we stock 'em all. Books for the Student Pilot and PPL, Checklists, Flight Cases, current Topo Charts always in stock, Nav-Flight Computers and much more. We also stock aviation postcards, posters and badges (callers only). Can't visit? Then send £1 for our mail order catalogue or telephone us on:

**021 782 2112 or Fax: 021 782 6423**

We accept all major Credit Cards and Cheques with Bankers Card Number (up to £500 for Personal Callers with I.D.)

**JUST STARTING OUT?** Why Not Try:-  
Our most popular Multi-band Radio with a 'rubber duck' aerial -  
Airband - FM - PSB, batteries included,  
12 months guarantee - **£24.95** POST FREE!

# Maritime Beacons

**Brian Oddy G3FEX, Three Corners,  
Merryfield Way, Storrington, West Sussex, RH20 4NS**

There is a growing interest in this aspect of our hobby and the latest reports indicate that the band is now being checked at all hours of the day and night! An impressive first list was compiled by **Michael Wright** in Hoyland, some 200m a.s.l. in S.Yorkshire. Having studied the quarterly beacon charts in *SWM* he decided to explore the band. Initially he used a 15m random wire antenna with his Kenwood R-5000 receiver, but results were disappointing. A marked improvement was noted when he tried a Datong active antenna erected outdoors. He was surprised to hear some of the beacons along the coast of France and N.Spain during daylight.

Beacons along the coast of Belgium, Holland, France, Jersey, Spain and the Isles of Scilly were logged during daylight by **George Millmore** in Wootton, a vantage point on the Isle of Wight. He also logged some of the more distant beacons. Almost at sea level in Worthing, **Ron Damp** picked up beacons on both sides of the Channel including the Lizard Lt (LZ) on 284.5.

Down in Cornwall **Viv Doide** (Gunnislake) searched the band during daylight and at night. Eighteen of the beacons in his interesting list were logged after dark. His daytime entries include the Eckmuhl beacon (UH) in W.France on 312.0, which he had not heard before. Some of the entries in the impressive log from **Jim Edwards** in Wigan were also noted at night.

An extensive log was compiled in by **Kelvin Sutherland** in Llangefni, Anglesey. He heard for the first time the beacons at Nash Point, SW.Wales (NP) 299.5; Hoburg, Sweden (OB) 301.5; Fife Ness, SE.Scotland (FP) 305.0; Cabo Roca, N.Spain (RC) 308.0; also Cabo Estay, N.Spain (VS) 312.5.

Owing to the long hours of daylight, **John Wells** (E.Grinstead) was unable to receive the distant or low power beacons that he had logged during the winter nights. He says, "Even in the first hours of dusk or darkness, true night-time conditions seem to take a long time to build up, compared with winter."

Up in St.Andrews, **Peter Polson** found the beacon signals were masked by mains-borne electrical interference, so he decided to run his Tatung TMR7602 portable from batteries. It resulted in some improvement and he managed to log seven beacons. Several checks were made in the evenings by **Ross Lockley** in Stirling, but only three beacons were heard. He says the performance of his Realistic DX300 receiver is poor at low frequencies. Perhaps a change of antenna or antenna tuning unit would help.

Seven beacons were logged during daylight by **David Edwardson** in Wallsend. It was the first time he had checked the band since the change

Freq kHz	Call-sign	Station Name	Location	DXer
284.5	LZ	Lizard Lt	S.Cornwall	A,B,G,H,I,M,N,S,U
284.5	MA	Cabo Machichaco	N.Spain	D*,H*,I*,O*,V*
285.0	NO	Cabo de la Nao Lt	S.Spain	D*,H*,V*
285.0	NP	Nieuwpoort W.Pier	Belgium	D*,H*,J,T,U,V
286.0	TR	Tuskar Rock Lt	S.Ireland	A,B,D,H,I,M,N,S,U,V
286.5	AL	Almagrundet Lt	Sweden	O
286.5	BY	#Baily Lt	S.Ireland	D,O,Q,R,V
286.5	FE	Cap Frehel Lt	France	H*,I,O*
286.5	FT	Cap Ferret Lt	W.France	D*,H,I,N*,O*,S,U,V*
286.5	NK	Inchkeith Lt	F.of Forth	B
287.3	IB	I.Berenga	Portugal	D*
287.3	MD	Cabo Mondego	N.Spain	D*
287.5	DO	Rosedo Lt	France	D*,H,I,U
287.5	FR	Faerder Lt	Norway	B,D*,H*,I,S
288.0	HH	Hoek van Holland	Holland	D*,T,U
288.0	KL	Skiinna Lt	Norway	S*
288.0	OH	Old Hd of Kinsale	S.Ireland	B,H,I,N,S
288.5	CT	Pt de Combrit Lt	France	V
288.5	FI	Cabo Finisterre Lt	NW.Spain	D*,H*,I,S,V*
288.5	YM	Ijmuiden Front Lt	Holland	B,D*,T,U,V
289.0	BL	Burt of Lewis Lt	Is of Lewis	B
289.0	BY	Baily Lt	S.Ireland	A,B,D,H*,I,M,N,S,U,V
289.0	MN	Hammerodde	Denmark	B,D*,S*
289.5	LO	Landsort S Lt	Sweden	S*
289.5	SN	Ile de Sein NW Lt	France	D*,H*,I*,N*,S,U
290.0	BS	Port en Bessin Lt	France	U
290.0	FD	Fidra Lt	F.of Forth	B,D*,Q
290.5	DY	Duncansby Hd Lt	NE.Scotland	B
290.5	SB	S Bishop Lt	Pembroke	A,B,D,E,H,M,N,O,S,T,U,V
290.5	VI	Cabo Villano Lt	N.Spain	I*,M,O
291.5	SU	South Rock LV	Co Down	A,B,D,H*,I,N,S,U,V
291.9	LT	La Isleta	Canaries	D*
291.9	MR	Montedor Lt	Portugal	I*,V*
292.0	MH	Mahon, Minorca	Balearic Is	H*
292.0	SJ	Souter Lt	Sunderland	B,D*,I*,J,N*,O,Q,S,U,V
292.0	TO	Torungen Lt	Norway	B
292.5	SM	Pt St.Matthew Lt	France	A,D*,H,I,M,N*,O,S,T,U,V
293.0	CP	St.Catherine's Lt	Irish	A,E,G,H,I,M,O,T,U,V
293.0	RY	Rhinnis of Islay Lt	Is of Islay	B,D,F*,I,L*,R,S
293.0	SN	Svnoy Lt	Norway	B
293.5	RO	Cabo Silleiro Lt	N.Spain	D*,H*
294.0	KU	Kullen High Lt	Sweden	B,D*,I,S
294.0	PH	Cap d'Alprech	France	A,B,D*,E,G,H*,M,N*,O,S,T,U,V
294.5	BA	#Black Hd Lt	N.Ireland	D*,V*
294.5	KG	#Old Hd of Kinsale	S.Ireland	D*
294.5	NG	Pikasaree Ots	Estonia	D*
294.5	PS	#Pt.Lynas Lt	Anglesey	D*,H*,D,S,U
294.5	PT	#Souter Lt	Durham	B,J
294.5	SN	Sietnes Lt	Norway	D*
294.5	UK	Sunk Lt V	Off Essex	D*,H*,J*,N,T,U,V
295.5	CB	La Corbiere Lt	Jersey	A,H,I,M,N,U,V
295.5	RE	La Rochelle	France	D*
296.0	BH	Blavandshuk Lt	Denmark	B,D*,H*,I,S,U
296.0	GR	Gaoree Lt	Holland	I,M,T,U
297.0	FG	Pt de Barfleur Lt	France	A,D*,G,H,I,M,N*,O,S,T,U,V
297.5	PS	Cabo Penas Lt	N.Spain	D*,I*
298.0	GX	Ile de Groix	France	D*,H*,N*,S*,T,U
298.5	RR	Round Is Lt	Is of Scilly	A,B,O,G*,H*,I,M,N,O,S,T,U,V
298.5	SW	Skagen	Denmark	B,D*
299.0	AO	Ameland Lt	Holland	B,D*,I,S,U,V
299.0	BN	Les Baleines	W.France	D*
299.0	O	Tarifa	S.Spain	D*
299.5	BN	Les Baleines	France	H*,I*
299.5	NP	Nash Pt Lt	S.Wales	A,D,E,H*,M,N,O,S,T,U,V
299.5	VR	Urvaer Lt	Norway	B,D*
300.0	MZ	Mizen Head	S.Ireland	A,B,D*,H,I,M,R,S*,U
300.0	TI	Cap d'Antifer Lt	N.France	A,H*,I,M,T,U,V
300.5	DU	Dungeness Lt	Kent	A,E,G,H*,I,M,N,O,T,U,V
300.5	LA	Lista	Norway	B,D*,S
301.0	CA	Pt de Creach	France	A,D,H*,N*,S
301.0	ER	Eierland Lt	Holland	B,D*,I,U,V
301.5	KD	Kinnards Hd Lt	NE.Scotland	B,D*,I,N*,O,Q,U,V
301.5	L	Torre de Hercules	N.Spain	D*
301.5	OB	Hoburg	Sweden	D*,H*,S*
302.0	RB	Cherbourg Ft W Lt	France	A,D,E,G,H*,I,M,N*,O,S,T,U,V

Freq kHz	Call-sign	Station Name	Location	DXer
302.5	FB	Flamborough Hd Lt	Yorkshire	A,B,D,H*,J,M,N,O,Q,S,T,U,V
303.0	D	Rota	SW.Spain	D*
303.0	PV	Falsterborev Lt	Sweden	B,D*,H*
303.0	YE	Ile d'Yeu Main Lt	France	D*,H*,M,N*,S,T,U
303.4	MA	Malarril Lt	Iceland	F*
303.5	BJ	Bjornund Lt	Norway	B,D*
303.5	FN	Feistein Lt	Norway	B,O
303.5	IA	Llanes Lt	N.Spain	D*,H*,U
303.5	VL	Vlieland Lt	Holland	D*,T
304.0	PS	Pt Lynas Lt	Anglesey	B,D,H,N,O*,S,T,U,V
304.0	SB	Sumburgh Hd Lt	Shetland Is	B,I
304.5	GY	Castle Breakwater	Guernsey	C,I,R
304.5	MY	Cabo Mayer Lt	N.Spain	D*,H*,U
305.0	C	Cabo Priorino Lt	N.Spain	D*
305.0	FP	Fife Ness Lt	SE.Scotland	B,I,J,L*,N*,O,Q,S,V
305.5	AL	Pt d'Ailly Lt	France	A,B,D*,E,G*,H,M,N*,O,S,T,U,V
305.7	AK	Table d'Oukacha	NW.Morocco	B,I
306.0	EC	Elizabeth Castle	Jersey	H,M,U
306.0	FN	Walney Is Lt	Off Lancs	B,O,I,N,S,U,V
306.0	TN	Thyboron	Denmark	B
306.5	GJ	Le Grand Jardin Lt	France	H*
306.5	MV	Morzhovskiy	Arctic	U
306.5	UT	Utsira	Norway	B,D*,I,S*,U
307.0	GL	Eagle Is Lt	Ireland	A,B,D,H*,I,N,R,S,V
308.0	RC	Cabo Roca	N.Spain	D*,S*
308.0	RD	Roches Douvres Lt	France	A,D,E,G*,H,M,N*,O,S,T,U,V
308.5	NZ	St Nazaire	France	H*,J
309.0	WW	Ventspils Lt	Latvia	D*
309.5	BA	Punta Estaca Bares	N.Spain	A,D*,G*,H*,O*,S
309.5	FH	Fruholmen Lt	Norway	D*
309.5	MA	Marstein Lt	Norway	B,D*,H*,I,S*,V
310.0	ER	Pt de Ver Lt	N.France	A,D*,H*,I,M,N*,S,T,U
310.5	SG	Sjaellands N Lt	Denmark	B,D*
311.0	GD	Girdle Ness Lt	NE.Scotland	B,I,J,Q,S
311.0	NF	N.Foreland Lt	Kent	A,H*,M,N,O,S,T,U,V
311.5	LP	Loop Hd Lt	S.Ireland	A,D*,H,I,N,S,V
312.0	HO	Tennholmen Lt	Norway	D*,D
312.0	OE	Oostende	Belgium	D*,I,M,O,S,T,U,V
312.0	UH	Eckmuhl Lt	France	D*,H*
312.5	BK	Baltijsk	Latvia	D*
312.5	BT	Mys Taran Lt	Latvia	D*
312.5	CS	Calais Main Lt	France	H*,I,O,S
312.5	LB	Liepaja	Latvia	D*
312.5	VS	Cabo Estay Lt	N.Spain	I,S*
313.0	PB	Portland Bill Lt	Dorset	A,H,I,M,N,O,S,T,U
313.0	TY	Tony Is Lt	N.Ireland	B,O
313.5	CM	Cromer Lt	Norfolk	B,E,H*,N,O,P,S,T,U,V
313.5	OG	Olands Sodra Grund	Sweden	O*,I*
313.5	PQ	Porquerolles	S.France	D*
314.0	HK	Hekkingen Lt	Norway	D*
314.0	PQ	Porquerolles Lt	S.France	H*,J
314.0	VG	Ile Verge Lt	France	A,D,E,H,I,M,N*,O,S*,T,U
315.0	SL	Sletterthage	Denmark	?D*,H*,I,O,R,S*
316.0	IN	Inggolfshofdi	Iceland	O*
319.0	LEC	Stavanger	Norway	A,B,C,D,H*,J,K,L*,M,O,P,Q,S,T,U,V

Notes: Entries marked # are calibration stations. Those marked \* were logged during darkness. All others were logged during daylight.

- DXers:**
- A: Darren Beasley, Bridgewater.
  - B: Kenneth Buck, Edinburgh.
  - C: Tim Bucknall, Congleton.
  - D: Robert Connolly, Kilkree.
  - E: John Coulter, Winchester.
  - F: Geoff Crowley, Hafnarfjordur, Iceland.
  - G: Ron Damp, Worthing.
  - H: Viv Doide, Gunnislake.
  - I: Jim Edwards, Wigan.
  - J: David Edwardson, Wallsend.
  - K: Cyril Kellam, Sheffield.
  - L: Ross Lockley, Stirling.
  - M: George Millmore, Wootton, IOW.
  - N: Sid Morris, Weston-Super-Mare.
  - O: Peter Pollard, Rugby.
  - P: Peter Pollard, while in Horing.
  - Q: Peter Polson, St Andrews.
  - R: Tom Smyth, Co.Fermanagh.
  - S: Kelvin Sutherland, Anglesey.
  - T: Philip Townsend, E.London.
  - U: John Wells, E.Grinstead.
  - V: Michael Wright, Hoyland.

over to the c.w. mode and he was disappointed by these results. He found the 800Hz c.w. off-set of his Trio R600 receiver confusing when searching for beacons on known frequencies, so he used the u.s.b. mode. It soon became apparent that a narrow filter is needed.

Some DXers may be unaware that certain l.w. maritime radiobeacon stations transmit supplementary navigational information using narrow band techniques. Such information is used to improve the accuracy of satellite navigation systems, e.g. Global Positioning System (GPS). The data is transmitted as an additional signal within 500Hz of the beacon frequency by using 'Minimum Shift Keying' (m.s.k.).

An increase in the number of such signals on beacon frequencies has

been noted by **Kenneth Buck** in Edinburgh. He has found that they cause co-channel interference to some of the beacons. The many entries in his log included the beacon at Duncansby Head (DY) on 290.5kHz, which has been 'silent' for several months.

Kenneth advises caution when storing beacon frequencies in the memory bank of a receiver, especially when a very narrow audio filter is employed externally. Although the local oscillator may drift very little after an initial warm up period (e.g. Lowe quote less than  $\pm 30$ Hz for the HF-225), unless the receiver is kept at a constant temperature larger drifts may occur. When using a home - built audio filter (B/W 30Hz) with his HF-225, Kenneth

has found that a drift of only 15Hz will result in a signal decrease of -6dB. Experiments have confirmed that signals retrieved from memory can sometimes be slightly off-tune. To avoid missing a beacon he uses the built-in 200Hz a.f. filter when checking frequencies stored in the memory and the 30Hz filter only for manual tuning.

**Robert Moore** (Holywell) has prepared a useful list of European marine & aeronautical beacons. It is available free. Send an A4 size s.a.e. to him via me.

Over 1000 European maritime and aeronautical l.w. beacons (Iceland to N.Africa) are detailed in a 34-page booklet produced by Robert Connolly in Kilkree. For further details send an s.a.e. to him via me.





## The UK Scanning Directory

**New 3rd Edition - List over 12,000 Spot Frequencies**  
Here is the book that every scanner owner has been waiting for! This new 3rd edition has been completely revised and thoroughly updated, and its comprehensive coverage and detail continues to amaze readers. Listing over 12,000 spot frequencies 25 MHz - 1.215 GHz, remains the biggest and best guide on the market, and covers public utilities, security, telephones and lots more we dare not mention!

Price £16.95 incl. UK post Overseas post add £2 EEC and sea, or £5 airmail.

### New Monitoring the Yugoslav Conflict

Listen into AWACS, the UN boarding ships, aircraft enforcing the Exclusion Zone, diplomatics, press, relief flights and more. Lists over 100 active frequencies and is a must if you want to be in the thick of the action!

Price £4.95 incl. UK post. Airmail Worldwide £1.50.

### Monitoring the Iraq/Kuwait Conflict

Things are hotting up again in Iraq so the radio traffic is increasing again. The disarmament programme and refugee problem will ensure the bands remain active, and it includes an extensive list of US Air Forces flight frequencies.

Price £4.75 incl. UK post. Overseas post add £1 sea or £1.50 airmail.

### New Computerized Radio Monitoring

This book explains how to marry radios to computers for tuning, searching scanning, logging, analyzing, decoding, develop monitoring strategies, plan databases and even remote monitoring, plus reviews software radios and terminal units.

Price £19.50 incl. UK post. Overseas post add £2 sea or £4.50 airmail.

### The International Callsign Directory

Has the most comprehensive list of tactical callsigns and their identifications ever published for the US Air Force, Navy, Customs Marine Corp and foreign military. Also lists worldwide internationally registered callsigns and their users for aviation, NASA, military, Interpol, embassies, maritime and many more.

Price £18.50 incl. UK post. Overseas post add £2.50 or £5.50 airmail.

### INTERPRODUCTS

S93 8 Abbot St., Perth, PH2 0EB, Scotland  
Tel. and Fax 0738-441199



## MICROGATE SERVICES LTD LIQUIDATED UNIDEN SCANNER STOCK



**BC55XLTB**  
Programmable Hand-held. 10 channels, 10 bands track tuning, LCD display, Lockout, Auto-delay, volume squelch, review key, keypad lock, belt clip, AA batteries on Nicads, earpiece socket.

Frequencies: 29-54, 136-174, 406-512MHz  
**£69.99**



**BC70XLTB** One of the smartest scanners available. 20 channels, 10 bands, Nicad rechargeable batteries & charger, keypad lock, illuminated LCD display, delay, full search, volume & squelch

controls, priority, lockout track tuning, carry case, AC/DC operation. Frequencies: 29-54, 136-174, 406-512MHz  
**£89.99**



**BC100XLTB (Airband Scanner)**  
Programmable Hand-held 100 channels + 11 bands, 10 banks of 10 channels. Full aircraft, 10 priority channels, WX search, band search, rechargeable Nicad batteries, illuminated LCD display, lockout, volume + squelch controls, carrying case.

Frequencies: 29-54, 118-174, 406-512MHz  
**£129**



**BC200XLTB (Airband + phone band scanner)**  
Programmable Handheld with 200 channels + 12 bands including 800MHz + aircraft. 10 banks of 20 channels, 10 priority channels, WX search, band search, rechargeable Nicad batteries, illuminated LCD display, lockout, volume + squelch, carrying case. Frequencies: 29-54, 118-174, 406-512, 806-956MHz

**£169**

For a limited period only, Microgate are supplying factory returned, refurbished, liquidated and bankrupt stock at massively discounted prices.

All products carry a full 2 year swap out warranty.

**ALL PRICES INCLUDE VAT. CARRIER £6 ex.**

NEXT DAY SERVICE

Whilst it is not an offence to use a radio scanner use of one on certain frequencies contravenes the Wireless & Telegraph Act 1949

### MICROGATE SERVICES LTD

Metcom House, Bradley Lane, Standish, Wigan WN6 0XQ  
Tel: 0257 472866 Fax: 0257 426577 Mobile: 0831 504379

## HEAR IT ALL AND HEAR IT NOW

### PRO 41 HANDHELD SAVE £20.00!

68-88 137-174 406-512MHz

10 Memories

ONLY £79.95 (WAS £99.95)

PRO 39	66-88	108-174	380-512	806-960	200ch H/H	£219.99
PRO 44	66-88	108-174	380-512	50ch H/H		£149.99
PRO 46	66-88	108-174	406-512	806-956	100ch H/H	£199.99
PRO 43	66-88	108-174	220-512	806-999	AM/FM 200ch	£249.95
AR 1500EX	£349.95	0.5-1300	AM/FM/WFM/SSB	1000ch		£329.95
PRO 2006	£520	& 760-1300	AM/FM	400ch		£299.95

FREE UK Scanning Directory with any scanner over £100 worth £16.95

GOCVZ

All scanners include FREE p&p in the U.K. 12 months warranty

G6YTI

### LINK ELECTRONICS

228 Lincoln Road, Peterborough PE1 2NE Tel: (0733) 345731

Send large S.A.E. for details



## THE VINTAGE WIRELESS BOOK LISTING

Published regularly containing 100s of out-of-print, old and collectable wireless and TV books, amateur radio books and magazines. Send five first class stamps for next issue or £3.50 for next four issues.

### NEW BOOKS

**U.S.A. RADIO SURPLUS CONVERSION HANDBOOK.** Facsimile Reprint includes data, circuits and conversion details for most American receivers, transmitters including the "command" series BC348, BC221 ETC. Now in 3 volume set. 300 pages illus. £17.95 plus £2.05 p+p. (Allow 21 days for despatch as we are reprinting).

**WINNING THE RADAR WAR.** A new book on World War 2 radar. The suspense filled story of the experiments and breakthroughs and electronic eaves dropping including details of German radar. Author was one of the key technicians. 224pp illus. £9.95 + £1.75 p+p.

**SECRET WARFARE. THE BATTLE OF CODES AND CIPHERS** - by B. Norman. A detailed work with emphasis on the development of modern intelligence using codes and ciphers. Throws light on top secret strategies of deciphering including a history of codes and World War 2 employment. Clear concise analysis. Well illustrated with previously unpublished material. Brand new £4.95 incl. p+p.

**WANTED FOR CASH.** Pre 1975 Amateur Radio and Wireless and TV. books, magazines. Also valve communication receivers and domestic sets, working or not. Government surplus items and obsolete test equipment and valves.

(Dept S.) CHEVET BOOKS

157 Dickson Road, BLACKPOOL FY1 2EU

Tel: (0253) 751858 or (0253) 302979.

Credit Card - Telephone orders accepted



## GAREX ELECTRONICS

### GAREX VHF PREAMPLIFIERS

Miniature (only 34x9x15mm), any frequency in the range 40-200MHz, up to 25dB main. £12.21  
Stock versions: 6m, 4m, 2m, 137MHz (W Sat) ..... £12.21  
Airband 118-136MHz (reduced gain due to frequency spread) ..... £14.56  
Other frequencies in the range 40-200MHz to order ..... £14.56  
Any of the above finished in die-cast box with BNC or SO239 connectors (state which) add £12.00 to the above prices. N connectors add £14.00.

### GAREX HPA-2 HIGH PERFORMANCE 144-146MHz PREAMPLIFIER

RF switched (35 watt max. power), 3 band pass stages for improved selectivity 16dB gain, fitted in die-cast box with BNC sockets. £49.95

### GAREX DC/DC INVERTERS

A popular line for many years. Economy package: chassis section cut from commercial R/T gear, rewired & tidied up to make free-standing unit, no expensive cabinet just basic value for money.  
12V DC input, 250V 150mA DC output ..... £11.50  
12V DC input 400V 200mA DC output ..... £12.50  
(24V versions to order)

### 4 METRE RX CONVERTER

High quality PMR front end by famous manufacturer, modified to make a 4m converter: 10-11MHz output. Full data. Requires xtal. approx 15MHz ..... £17.32

### 4 METRE 0.5 WATT FM Tx

Tx low power driver unit matching above Rx, with modulator, ready aligned, with data: ..... £16.30  
Or + xtal for 70.45MHz. £20.35. Suitable PTT fist microphone ..... £4.04

### PYE ANTENNA RELAYS

12V operation, handles 50 watts up to 200MHz ..... £1.99 5+ £1.53 each

### WESTMINSTER FM BANDWIDTH CONVERSION KITS

Converts 50kHz or 12.5kHz FM Westminster (UHF or VHF) to Amateur band 25kHz spec. Comprises 2xIF filters + squelch board ..... £15.28

### 50MHz 10 WATT FM PA

Solid state assembly, 0.25 watt drive, 10-15 watts output ..... £16.95  
Also available: matching driver and modulator assemblies for complete 50MHz Tx.  
REVCO 50MHz mobile antennas available.

### SPECIAL OFFER GAREX VHF FM MONITOR RECEIVERS

Single channel NBFM monitor receiver, any spot frequency from 27-200MHz in neat cabinet 180x140x50mm. Built-in speaker. Requires 12V DC supply. Includes crystal for your choice of frequency (allow 4 weeks delivery).  
Ideal for Packet, RAYNET and other Emergency frequencies. Special price £59.95.  
Many options available, including multi-channel, ask for details.

### SPECIAL OFFER REVCO RADAC DIPOLE NEST WIDEBAND ANTENNA

Receive 25-1300MHz out-performs discons, with guaranteed Tx performance on 144-146MHz and either 50MHz or 70MHz (state which) ..... £59.95  
Upgrade kits available to allow Tx on 27-28MHz also 50MHz and 70MHz.

Write, phone or fax for lists. Regular lines, components and bargains for callers.

Open 10am - 5pm Mon - Fri (occasional Sat).

ALL PRICES INCLUDE UK CARRIAGE AND VAT AT 17.5%



## GAREX ELECTRONICS



STATION YARD, SOUTH BRENT, SOUTH DEVON TQ10 9AL

Phone: (0364) 72770 Fax: (0364) 72007

# RADIO AMATEURS EXAM? PASS FIRST TIME!

**Before you enrol check the benefits of  
RRC'S unique Home Tuition Service**

RRC has helped thousands of students to success in their examinations with this unique system of postal tuition, one which guides you, step-by-step, to qualify in the shortest possible time. Only The Rapid Results College offers you all these advantages:

- |  |   |
|--|---|
| <input checked="" type="checkbox"/> A qualified personal tutor             | <input checked="" type="checkbox"/> Free advice before you enrol                    |
| <input checked="" type="checkbox"/> Study material prepared by specialists | <input checked="" type="checkbox"/> Telephone Helpline                              |
| <input checked="" type="checkbox"/> Completely self-contained courses      | <input checked="" type="checkbox"/> Free 'How to Study' Guide                       |
| <input checked="" type="checkbox"/> Handy pocket-size booklets             | <input checked="" type="checkbox"/> Instalment Plan                                 |
| <input checked="" type="checkbox"/> Personal study programme               | <input checked="" type="checkbox"/> Free Postage on course material                 |
| <input checked="" type="checkbox"/> Regular marked tests                   | <input checked="" type="checkbox"/> Worldwide Airmail Service                       |
| <input checked="" type="checkbox"/> Courses regularly updated              | <input checked="" type="checkbox"/> Extra tuition free if you don't pass first time |
| <input checked="" type="checkbox"/> 48 hour despatch                       |   |

**POST COUPON TODAY FOR FREE  
RADIO AMATEURS PROSPECTUS**  
Please send me my prospectus as quickly as possible.

Mr/Mrs/Miss/Ms \_\_\_\_\_

Address \_\_\_\_\_

Postcode \_\_\_\_\_



**The Rapid Results College**  
Dept. JV138, Tuition House, London SW19 4DS. FREE ADVICE: 081 947 7272 (9am-5pm)  
PROSPECTUS: 081 946 1102 (24 hour Recordcall Service quoting Dept. No. above).



**technical software**  
Fron, Upper Llandwrog, Caernarfon LL54 7RF

**NEW**

## FAX and WEATHER SATELLITES

Full resolution charts and greyscale pictures from any SPECTRUM computer to a dot matrix printer. Basic system £40 plus interface for FAX £40 or WX SATS £59.

## APT-1 WEATHER SATELLITE MODULE

Enables all weather satellite signals to be displayed on any FAX system. Plugs into RX-8 system direct. £59 or £39 if ordered with RX-8.

## RX-8 8-MODE RECEIVE

Every possible feature and performance to receive FAX, HF & VHF PACKET, COLOUR SSTV, RTTY, CW, AMTOR, UoSAT and ASCII on any BBC computer. Reviews Oct. 89 Ham Radio Today and July 91 Rad Comm. Complete system of EPROM, interface, instructions, leads and demo cassette £259.

## RX-4 RTTY CW SSTV AMTOR RECEIVE

Performance, features and ease of use make this still a best seller. Needs TIF1 interface. BBC, CBM64 tape £25, disk £27. VIC20 tape £25. SPECTRUM tape £40, + 3 disk £42 inc adaptor board (needs TIF1 also) or software-only version £25. TIF1 INTERFACE has 4-pole filtering and computer noise isolation for excellent HF and VHF performance. Kit £30, ready-made, boxed with all connections £40. Available only with software.

Also MORSE TUTOR £8, LOGBOOK £8, RAE MATHS £8 for BBC, CBM64, VIC20, SPECTRUM.  
BBC LOCATOR with UK, Europe, World maps £10.  
All available on disc £2 extra.

Full info available on everything. Please ask.

PRICES INCLUDE VAT AND P&P BY RETURN



**Tel: (0286) 881886**

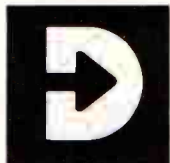

**D A T I N G**  
E L E C T R O N I C S L I M I T E D

Clayton Wood Close  
West Park  
Leeds LS16 6QE  
Tel: 0532 744822  
Fax: 0532 742872



**For products you can rely upon  
to give amazing results**

For information on **Active Antennas, RF Amplifiers, Converters, Audio Filters, the Morse Tutor and Speech Processors** send or telephone for a free catalogue and selective data sheets as required.

All our products are designed and made in Britain.

Orders can be despatched within 48 hours subject to availability.



 — VISA AND ACCESS WELCOME — 





# Trading Post

Continued from page 76

**Realistic DX-302 digital h.f. receiver**, absolutely unmarked, £95. MBR7 all purpose receiver, good condition, £37.50. Eddystone EB35 h.f. receiver, broadcast bands only, £50. Prices include P&P. Tel: (0244) 310271 after 6pm, Chester.

**Sale HROs p.s.u.**, complete O/H coils for 05 - 30Mc/s, price when seen and tested about £150 complete s.w.l. station. Tel: (0204) 695384 6pm view.

**Selling out 81 HRO p.s.u.** 4 coil valves, complete over-hauled, new components. Tel: (0204) 695384 after 6pm.

**Sony 2001D Global AT-1000 a.t.u.**, both excellent condition, boxed with manuals etc., £190. M. J. Millis, 18 Springfield Grove, Southam, Leamington Spa CV33 0ES.

**Sony AIR-7, l.w., m.w., f.m.** broadcast, airband and v.h.f. 144-174MHz n.b.f.m., good condition, £130. Tel: (0525) 240281 Leighton Buzzard.

**Sony AN1 antenna (active)** 15 metres coaxial cable six months old, only, £30 includes postage paid. Tel: Skegness 762359.

**Sony CRF320 digital 32 band receiver**, excellent, £300 o.n.o. Signal 535 airband receiver complete, as new, £230. FAX1 weather map/RTTY, etc., decoder, as new, £200. Ham Major, excellent conversion?, £85 o.n.o. Tel: (0202) 422273 after 6.30pm, Bournemouth.

**Sony ICF SW77** mint condition, boxed with all accessories, nearest offer to, £260. David Marshall. Tel: (0962) 865949 Winchester.

**Sony ICF SW7600** boxed, unused present, as new, u.s.b., l.s.b., all modes with case and accessories, £80. Tel: (0865) 770398.

**Sony ICF-2001** good condition with 110/220V mains adaptor. David. Tel: (0977) 685241.

**Sony ICF-7600 l.w., m.w., s.w., a.m., f.m., s.s.b., a.c.** supply, antennas, case and manual, as new, boxed, cost new, £175. Will accept £100. Would exchange for an ERA MkII decoder. John. Tel: 021-477 8163 any time.

**Sony ICF-7600D**, boxed, power pack, etc. Good condition and working order, £80. Realistic DX-100L b.f.o., etc., ideal first receiver or standby, £45. Prices include P&P. Tel: (0244) 310271 after 6pm, Chester.

**Sony ICF-PRO80** 150kHz to 108MHz plus converter for 115MHz to 223MHz a.m./f.m., wide/narrow s.s.b. with manual, £95 including postage, good condition. Tel: (0533) 891720 Leicester.

**Sony PRO80 scanner**, hardly used, mint condition, £180. Tel: (0877) 611259, Brecon, Powys.

**Sony SW55 portable shortwave receiver**, 150kHz to 30MHz, a.m., s.s.b., 76 to 108MHz, v.h.f., world clock, 125 memory presets, case, p.s.u., excellent condition, 6 months old, cost, £270, accept, £190. Tony. Tel: (0271) 865698 Ilfracombe, North Devon.

**Swinburne DR-600 airband scanner**, five fixed crystals, one tuneable channel, scans on all six, plus spare crystals including NiCad pack and mains charger, £70. Chris Perkins. Tel: (0934) 512054.

**Trio R1000 communications receiver** with Global AT1000 antenna coupler and frequency lists all v.g.c., £190. Tel: (0253) 875127 anytime, Fleetwood.

**Trio TR-2300 hand-held 144MHz transceiver**, f.m., case, NiCads, £150. Eddystone EB34 receiver 500kHz - 21MHz, £65. Solartron CD1400 double beam oscilloscope, v.g.c., £85. RFL 750A gaussmeter with probe, £100. The Warren, Temple Grafton, Alcester, Warks B49 6NZ. Tel: (0789) 772216.

**Trio/Kenwood R2000 h.f. receiver**, manual and original packing, excellent, £320 plus postage, also Sony 7600DSA s.w. receiver, 15 memories, excellent, £85 plus postage. Tel: (0245) 322082 evenings please.

**Uniden 200 channel scanner**. Airband phones up to 956MHz, BC70 scanner part airband up to 550MHz, BC200, £155. BC70, £75. In good condition. Tel: (0257) 472866 or (0831) 504379.

**Yaesu FRG-7 receiver**, a.t.u. digital frequency read-out with handbook, excellent condition and in good working order, £130. Tel: (0603) 501513 Norwich.

**Yaesu FRG-100 receiver**, 2 months old, boxed, f.m. board fitted, £440, good reason for sale. Glenn. Tel: (0639) 888610 anytime, Port Talbot.

**Yaesu FRG-8800 receiver**, with internal v.h.f. converter and FRT-7700 plus manual, g.w.o., not boxed, £300. Also Uniden Bearcat 200XLT with original box, all accessories, no manual, v.g.c., £100. Anthony or John. Tel: (0273) 888488 1-5pm weekdays, Brighton.

**Yaesu FRG-9600 scanning receiver**, 60-950MHz, video unit fitted, a.m./f.m./s.s.b., excellent condition, £320. Mike. Tel: (0480) 470243, St Neotts, or Pager (0426) 930154.

**Yaesu FRG-9600**, 60-905MHz, £300. May consider part exchange for general coverage receiver. Tel: (0734) 751325.

**Yupiteru MVT-7000 scanner** with accessories, mint condition, £240. Tel: (0403) 262882 Horsham.

**Yupiteru MVT-7100 scanner** and soft

case, as new, £375 o.n.o. Toshiba lap-top T-1000SE, some software, £300. Sony Walkman WA55 radio/cassette player/recorder, £40. Walkman WM2091 mini player, £45. Pye TR6108 f.m./a.m. RX, £10. John. Tel: (0379) 652043 Norfolk.

**Yupiteru MVT-7100 scanner** three months old, under guarantee, immaculate condition, £350. No offers. Log periodic antenna CLP-5130-2 ideal for monitoring and transmitting, never used, 105-1300MHz (see Maplin's catalogue), £110. Tel: (0272) 427668 Bristol.

**Yupiteru VT-125 MkII hand-held airband scanner** brand new, hardly used with all accessories including NiCads. Will throw in *UK Airband Guide*. Price includes postage anywhere, £130. Ray. Tel: (0203) 645332 anytime after 6pm.

## EXCHANGE

**Crotech 3133 dual beam 25MHz 'scope** (new) in exchange for small 3in 'scope. Tel: (0304) 822943 Dover.

**Kenwood TS-940S (boxed) base station h.f. general coverage transceiver** with fitted filters in exchange for a Kenwood TS-790E dual-band multi-mode or a TS-711E 144MHz multi-mode and TS-811E 430MHz multi-mode (matching pair). Mr B. Williams. Tel: (0274) 880895.

**Lowe HF-225 receiver**, f.m., keypad. Realistic 2006 scanner. Philips D2935 receiver, b.f.o., digital, manuals, boxed. None over 9 months old, in exchange for AOR AR-3000 scanner, prefer interested party to collect. Tel: (0983) 756533 Isle of Wight

**Oplith Spotterscope 30X75** made in West Germany, cost £500 in exchange for AOR AR-3000 or FRG-9000 or similar. Spotterscope in mint condition complete with leather carrying case. Tel: 061-793 9529.

**Yaesu 9600 with h.f. converter** in exchange for a hand-held receiver or what have you to swap? Tel: (0204) 398844 after 5pm.

**Yaesu FT-411 hand-held complete** with spare NiCads, charger, telescopic antenna, shoulder holster, too many buttons!, also Drake R4-C with MS4, fully Xtals, in exchange for Icom 251, muTek. Bill. Tel: 041 649 4345

## WANTED

**Black Jaguar MkI** or any Realistic hand-held scanner with search mode. Will pay up to £100. Tel: 051-260 5064

**Eddystone receivers any models** considered working or for spares. Also other Eddystone related items, Edometer, Pan adaptor, etc. Collection possible for cash. Lepino. FAX: (0372) 454381 or Tel: (0374) 128170 anytime, Surrey.

**General coverage h.f. communications receiver**. Perhaps 9R-59DS. Prefer valves! Available later: my old, but working, HRO. Godfrey G4GLM. Tel: 081-958 5113 Edgware.

**Grundig short wave stereo radio Satellit model 2400** and Grundig radio cassette model C8800 or model C9000. Must be in mint condition. Hugh McCallion. No. 8 Strathard Close, Coleraine, Co Londonderry, N. Ireland BT51 3ES. Tel: (0265) 43793.

**Hoka Code 3 decoder** with manual, cabling and control software. Will also consider separate purchases of oscilloscope, Piccolo Mk6, ASCII, Coquelet, Special ARQ/FEC and AUTO-classification options. Mick Murphy. Tel: 081-452 7559 NW London.

**Hoka Code 3 decoder**. G. Denman. 24 Ascot Road, Copnor, Portsmouth, Hants PO3 6EY. Tel: (0705) 820315.

**Late model Cobra 148 GTL DX C/B** in good condition and with original specifications. Must be reasonably priced and if possible within 50 mile radius of Cheltenham. Tel: (0684) 295770 anytime.

**OAP wants a good scanner**, age unimportant, but simple plus good condition. Your price for a good RX. Can collect reasonable distance. All replies answered. Cash. C. Yates. 63 Greenfield Road, Colwyn Bay, Clwyd LL29 7PU.

**Realistic Patrolman PRO-2025 16-channel programmable scanner**. Must be in good condition. Peter. Tel: (0624) 623350.

**Realistic PRO-2006** or 2004 considered. Lyndon or Janet. Tel: (0443) 422406 Tonypanydy.

**Sony 320/6800**, Panasonic 8000/9000, Eddystone 940, old wireless sets transistor and large tube used. Advise price to include postage air mail or surface. Sabino FINA, Via Cesinali 83042 - Atripalda (AV), Italy.

**Sony 320/6800/6700**, Panasonic 8000/9000, Eddystone 940/990 R/S, Philips 2999, old Satellit, Bearcat 1000, Soundmaster 75, Explorer Radionette. Advise condition, price to include postage air mail or surface. Sabino FINA, Via Cesinali 83042 - Atripalda (AV), Italy.

**Tandy PRO-2002** working display driver or model to use for spares. Mike. Tel/FAX. Tel: (0333) 310513.

**Top prices paid for your German gear for WWII vintage**. Looking for receivers, transmitters, accessories. Will collect. Lissok, Rue M. Peodts 9, B-1160 Brussels, Belgium. Tel: 010-322-6737115.

**Zenith Trans-Oceanic radio** or Racial 1752 model receiver. Tel: (0462) 441867.

# BOOKS

The books listed have been selected as being of special interest to our readers. They are supplied direct to your door. Some titles are overseas in origin.

## HOW TO ORDER. PLEASE USE THE ORDER FORM ON PAGE 83

**POST AND PACKING;** add £1.00 for one book, £2.00 for two or more books, orders over £40 post and packing free, (overseas readers add £1.75 for one book, £3.50 for two or more for surface mail postage) and send a postal order, cheque or international money with your order to **PW Publishing Ltd, FREEPOST, Arrowsmith Court, Broadstone, Dorset BH18 8PW.** Please make your cheques payable to PW Publishing Ltd. Payment by Access, Mastercard, Eurocard or Visa also accepted on telephone orders to Poole (0202) 659930. Books are normally despatched by return of post but please allow 28 days for delivery. Prices correct at time of going to press. Please note: all payments must be made in Sterling.

### LISTENING GUIDES

#### AIR BAND RADIO HANDBOOK

4th Edition  
David J. Smith  
Extensively revised & updated (October 1992). Air band radio listening enables you to listen-in on the conversations between aircraft and those on the ground who control them, and is an increasingly popular and fascinating hobby. A new chapter on military air band has been added. The author, an air traffic controller, explains more about this listening hobby. 190 pages. £9.99

#### DIAL SEARCH 1992/94

George Wilcox  
The listener's check list and guide to European radio broadcasting. Covers m.w., l.w., v.h.f. & s.w., including two special fold-out maps. Also includes a full list of British stations, a select list of European stations, broadcasts in English and 'Making the Most of Your Portable'. 46 pages. £4.25

#### FLIGHT ROUTINGS 1993

Compiled by T.T. & S.J. Williams  
This guide was produced with the sole aim of assisting airband listeners to quickly find details of a flight, once they have identified an aircraft's callsign. Identifies the flights of airlines, schedule, charter, cargo and mail, and from the UK and Eire and overflights between Europe and America. 122 pages. £5.95

#### FERRILL'S CONFIDENTIAL FREQUENCY LIST 8th Edition

Compiled by Geoff Halfidge  
Spirally bound, this easy-to-use reference book covers 1.6 - 28MHz in great depth, all modes and utility services, with new reverse frequency listing showing every known frequency against each callsign, who's using what frequency and mode, what's that callsign? These are some of the answers this book will help you find. 544 pages. £17.95

#### GUIDE TO FACSIMILE STATIONS

13th Edition  
Joerg Klingenfuss  
The new edition of this super reference book covers the world's facsimile stations, their frequencies and methods of working. There is section covering the equipment needed to receive FAXes over the radio. To give you an idea of what is available there are many pages of off-air received FAX pictures. 392 pages. £18.00

#### GUIDE TO UTILITY STATIONS

11th Edition  
Joerg Klingenfuss  
This book covers the complete short wave range from 3 to 30MHz together with the adjacent frequency bands from 0 to 150kHz and from 1.6 to 3MHz. It includes details on all types of utility stations including FAX and RTTY. There are 19549 entries in the frequency list and 3590 in the alphabetical callsign list plus press services and meteorological stations. Included are RTTY & FAX press and meteo schedules. There are 11800 changes since the 10th edition. 534 pages. £24.00

#### HF OCEANIC AIRBAND COMMUNICATIONS 4th Edition

Bill Laver  
HF aircraft channels by frequency and band, main ground radio stations, European R/T networks and North

Atlantic control frequencies. 31 pages. £3.95

#### INTERNATIONAL RADIO STATIONS

GUIDE BP255  
Peter Shore  
As in 'Broadcast Roundup', his column in *PW*, Peter Shore has laid this book out in world areas, providing the listener with a reference work designed to guide around the ever-more complex radio bands. There are sections covering English language transmissions, programmes for DXers and s.w.l.s. Along with sections on European medium wave and UK f.m. stations. 266 pages. £5.95

#### INTERNATIONAL VHF FM GUIDE

7th Edition.  
Julian Baldwin G3UHK & Kris Partridge G8AUU  
This book gives concise details of repeaters & beacons world-wide plus coverage maps & further information on UK repeaters. 70 pages. £2.85

#### MARINE UK RADIO FREQUENCY GUIDE

Bill Laver  
A complete guide (reprinted January 1993) to the UK s.w. and v.h.f. marine radio networks. Useful information, frequency listings and the World Marine Coastal Phone Stations. 62 pages. £4.95

#### MONITORING THE YUGOSLAV CONFLICT

Langley Pierce  
A guide to monitoring the Yugoslav radio transmissions of the UN, aircraft and shipping engaged in the civil war in the former Yugoslavia. 28 pages. £4.95

#### NEWNES SHORT WAVE LISTENING HANDBOOK

Joe Pritchard G1UQW  
A technical guide for all short wave listeners. Covers construction and use of sets for the s.w.l. who wants to explore the bands up to 30MHz. Also covers the technical side of the hobby from simple electrical principles all the way to simple receivers. 276 pages. £15.95

#### POCKET GUIDE TO RTTY AND FAX STATIONS

Bill Laver  
A handy reference book listing RTTY and FAX stations, together with modes and other essential information. The listing is in ascending frequency order, from 1.6 to 26.8MHz. 57 pages. £3.95

#### RADIO LISTENERS GUIDE 1993

Clive Woodyear  
This is the third edition of this radio listener's guide. Simple-to-use maps and charts show the frequencies for radio stations in the UK. Organised so that the various station types are listed separately, the maps are useful for the travelling listener. Articles included in the guide discuss v.h.f. aeriels, RDS, the Radio Authority and developments from Blaupunkt. 56 pages. £2.95

#### SHORT WAVE INTERNATIONAL FREQUENCY HANDBOOK

Formerly the Confidential Frequency List and re-published in April 93, this book covers 500kHz-30MHz. It contains duplex and channel lists, callsigns, times and modes, broadcast listing and times. 192 pages. £9.95

#### UK SCANNING DIRECTORY

3rd Edition  
This spiral bound book list over 12000

UK spot frequencies from 25MHz to 1.213GHz. Articles on scanning in the UK. 250 pages. £16.95

#### VHF/UHF AIRBAND FREQUENCY GUIDE 4th Edition

A complete guide to civil & military airband frequencies including how to receive the signals, the frequencies and services. VOLMET, receiver requirements, aeriels and much more about the interesting subject of airband radio are included. 123 pages. £6.95

#### VHF/UHF SCANNING FREQUENCY GUIDE

This book gives details of frequencies from 26MHz to 12GHz with no gaps and who uses what. Completely revised and enlarged (February 1993), there are chapters on equipment requirements as well as antennas, the aeronautical bands, as well as the legal aspect of listening using a scanner. 156 pages. £9.95

#### WORLD RADIO TV HANDBOOK 1993

Country-by-country listing of l.w., m.w. & s.w. broadcast and TV stations. Receiver test reports, English language broadcasts. The s.w.l.'s 'bible'. £15.95.

### ANTENNAS (AERIALS)

#### AERIAL PROJECTS BP105

Practical designs including active, loop and ferrite antennas plus accessory units. 96 pages. £2.50

#### ALL ABOUT VERTICAL ANTENNAS

W. I. Orr W6SAI & S. D. Cowan W2LX  
Covers the theory, design and construction operation of vertical antennas. How to use your tower as a vertical antenna and compact vertical designs for restricted locations. All about loading coils and a.t.u.s. 192 pages. £7.50

#### ANTENNA EXPERIMENTER'S GUIDE

Peter Dodd G3LDO  
Although written for radio amateurs, this book will be of interest to anyone who enjoys experimenting with antennas. You only need a very basic knowledge of radio & electronics to get the most from this book. Chapters include details on measuring resonance, impedance, field strength and performance, mats and materials and experimental antennas. 200 pages. £8.90

#### ANTENNA IMPEDANCE MATCHING

Wilfred N. Caron  
Proper impedance matching of an antenna to a transmission line is of concern to antenna engineers and to every radio amateur. A properly matched antenna as the termination for a line minimises feed-line losses. Power can be fed to such a line without the need for a matching network at the line input. There is no mystique involved in designing even the most complex multi-element networks for broadband coverage. 195 pages. £11.95

#### ARRL ANTENNA BOOK

16th Edition  
A station is only as effective as its antenna system. This book covers propagation, practical constructional details of almost every type of antenna, test equipment and formulas and programs for beam heading calculations. 789 pages. £14.50

#### ARRL ANTENNA COMPENDIUM

Volume One  
Fascinating and hitherto unpublished material. Among the topics discussed are quads and loops, log periodic arrays, beam and multi-band antennas, verticals and reduced size antennas. 175 pages. £9.50

#### ARRL ANTENNA COMPENDIUM

Volume Two  
Because antennas are a topic of great interest among radio amateurs, ARRL HQ continues to receive many more papers on the subject than can possibly be published in *QST*. Those papers are collected in this volume. 208 pages. £9.50

#### ARRL ANTENNA COMPENDIUM

Volume Three  
Edited by Jerry Hall K1TD  
As the title suggests, this book is the third in the continuing series on practical antennas, theory and accessories produced by the ARRL. The book reflects the tremendous interest and activity in antenna work, and provides a further selection of antennas and related projects you can build. 236 pages. £9.50

#### BEAM ANTENNA HANDBOOK

W. I. Orr W6SAI & S. D. Cowan W2LX  
Design, construction, adjustment and installation of h.f. beam antennas. The information this book contains has been compiled from the data obtained in experiments conducted by the authors, and from information provided by scientists and engineers working on commercial and military antenna ranges. 268 pages. £7.50

#### G-QRP CLUB ANTENNA HANDBOOK

Compiled and edited by P. Linsley G3PDL & T. Nicholson KA9WRI/GWOLNQ  
This book is a collection of antenna and related circuits taken from *Sprat*, the G-QRP Club's journal. Although most of the circuits are aimed at the low-power fraternity, many of the interesting projects are also useful for general use. Not intended as a text book, but offers practical and proven circuits. 155 pages. £5.00

#### HF ANTENNA COLLECTION (RSGB)

Edited by Erwin David G4LQI  
This book contains a collection of useful, and interesting h.f. antenna articles, first published in the RSGB's *Radio Communication* magazine, between 1968 and 1989, along with other useful information on ancillary topics such as feeders, tuners, baluns, testing and mechanics for the antenna builder. 233 pages. £9.50.

#### INTRODUCTION TO ANTENNA THEORY BP198

H. C. Wright  
This book deals with the basic concepts relevant to receiving and transmitting antennas, with emphasis on the mechanics and minimal use of mathematics. Lots of diagrams help with the understanding of the subjects dealt with. Chapters include information on efficiency, impedance, parasitic elements and a variety of different antennas. 86 pages. £2.95

#### NOVICE ANTENNA NOTEBOOK

Doug DeMaw W1FB  
Another book from the pen of W1FB, this time offering 'new ideas for beginning hams'. All the drawings are large and clear and each chapter ends with a glossary of terms. It is

written in plain language and you don't need to be a mathematician to build and erect the support structures that are presented in this book. 124 pages. £6.95

#### PRACTICAL ANTENNA HANDBOOK

Joseph J. Carr  
As the name suggests, this book offers a practical guide to everything to do with antennas, from h.f. to microwaves. It also has sections on propagation, transmission lines, antenna fundamentals and a helpful introduction to radio broadcasting and communication. The book neatly balances a practical approach with the minimum of mathematics, good diagrams and a lively text. 437 pages. £20.95

#### RADIO AMATEUR ANTENNA HANDBOOK

W. I. Orr W6SAI & S. D. Cowan W2LX  
Yagi, Quad, Quagi and LPY beam antennas as well as vertical, horizontal and sloper antennas are covered in this useful book. How to judge the best location, DX antenna height, ground loss and radials. 188 pages. £7.50

#### SIMPLE, LOW-COST WIRE ANTENNAS FOR RADIO AMATEURS

W. I. Orr W6SAI & S. D. Cowan W2LX  
Efficient antennas for Top Band to 2m, including 'invisible' antennas for difficult station locations. Clear explanations of resonance, radiation resistance, impedance, s.w.r., balanced and unbalanced antennas are also included. 188 pages. £7.50

#### W1FB'S ANTENNA NOTEBOOK

Doug DeMaw W1FB  
This book provides lots of designs, in simple and easy to read terms, for simple wire and tubing antennas. All drawings are large and clear making construction much easier. There is no high-level mathematics in this book, just simple equations only when necessary to calculate the length of an antenna element or its matching section. 123 pages. £6.95

#### WIRES & WAVES

Collected Antenna Articles from PW 1980-1984  
Antenna and propagation theory, including NBS Yagi design data. Practical designs for antennas from medium waves to microwaves, plus accessories such as a.t.u.s, s.w.r. and power meters and a noise bridge. Dealing with TVI is also covered. 160 pages. £3.00

#### YAGI ANTENNA DESIGN

Dr James. L. Lawson W2PV  
This book is a polished and expanded version of a series of articles first published in *Ham Radio* following on from a series of lectures by the author, who was well-known as the expert on Yagi design. Chapters include simple Yagi-antennas, loop antennas, effect of ground, stacking and practical antenna design. 210 pages. £10.95

#### 25 SIMPLE AMATEUR BAND AERIALS BP125

E. M. Noll  
How to build 25 simple and inexpensive amateur band aeriels, from a simple dipole through beam and triangle designs to a mini-rhombic. Dimensions for specific spot frequencies including the WARC bands are also given. 63 pages. £1.95

### 25 SIMPLE INDOOR AND WINDOW AERIALS BP136

E. M. Noll

Designs for people who live in flats or have no gardens, etc., giving surprisingly good results considering their limited dimensions. Information is also given on short wave bands, aerial directivity, time zones and dimensions. 50 pages. £1.75

### 25 SIMPLE SHORT WAVE BROADCAST BAND AERIALS BP132

E. M. Noll

Designs for 25 different short wave broadcast band aerials, from a simple dipole through helical designs to a multi-band umbrella. Information is also given on short wave bands, aerial directivity, time zones and dimension tables that will help spot an aerial on a particular frequency. 63 pages. £1.95

### 25 SIMPLE TROPICAL AND MW BAND AERIALS BP145

E. M. Noll

Simple and inexpensive aerials for the broadcast bands from medium wave to 49m. Information is also given on band details, directivity, time zones and dimensions. 54 pages. £1.75

### INTRODUCING MORSE

Collected Articles from PW 1982-1985  
Ways of learning the Morse Code, followed by constructional details of a variety of keys including Iambic, Triambic and an Electronic Bug with a 520-bit memory as well as a practice oscillator and Morse tutor. 48 pages. £1.25

### SECRET OF LEARNING MORSE CODE

Mark Francis

Updates for the Novice Licence. Designed to make you proficient in Morse code in the shortest possible time, this book points out many of the pitfalls that beset the student. 84 pages. £4.95

### NEWNES GUIDE TO SATELLITE TV

Derek Stephenson

This book, the 2nd edition, is a hard bound volume, printed on high quality paper. The author is a satellite repair and installation engineer and the book covers all information needed by the installation engineer, the hobbyist and the service engineer to understand the theoretical and practical aspects of satellite reception with dish installation and how to trouble-shoot when picture quality is not up to anticipated reception. Mathematics has been kept to a minimum. 284 pages. £17.95

### SATELLITE BOOK - A Complete Guide to Satellite TV Theory and Practice

John Breeds

This book deals almost exclusively with television broadcast satellites and is a comprehensive collection of chapters on topics, each written by an expert in that field. It appears to be aimed at the professional satellite system installer, for whom it is invaluable, but it will be appreciated by a much wider audience - anyone interested in satellite technology. 280 pages. £30.00

### SATELLITE EXPERIMENTER'S HANDBOOK 2nd Edition

Martin Davidoff K2UBC

The book is divided into four main sections - History, Getting Started, Technical Topics and Appendices. It provides information on spacecraft built by, and for, radio amateurs. In addition, it discusses weather, TV-broadcast and other satellites of interest to amateurs. 13 pages. £14.50

### SATELLITE TELEVISION

A layman's guide

Peter Pearson

Pictures from space, that's what satellite television is all about. Orbiting satellites, 35000km high, receive TV signals from stations on

the earth and re-transmit them back again. This book explains all you need to know to set up your own satellite TV terminal at home, dish and accessories, cable and tuner. 73 pages. £1.00

### SATELLITE TELEVISION INSTALLATION GUIDE

2nd Edition

John Breeds

A practical guide to satellite television. Detailed guide-lines on installing and aligning dishes based on practical experience. 56 pages. £13.00

### WEATHER SATELLITE HANDBOOK

4th edition

Dr Ralph E. Taggart VV8DQT

This book explains all about weather satellites, how they work and how you can receive and decode their signals to provide the fascinating pictures of the world's weather. Plenty of circuit diagrams and satellite predicting programs. 192 pages. £14.50

### ALL ABOUT VHF AMATEUR RADIO

W. I. Orr W6SAI

Written in non-technical language, this book provides information covering important aspects of v.h.f. radio and tells you where you can find additional data. If you have a scanner, you'll find a lot of interesting signals in the huge span of frequencies covered, 100-300MHz & 50, 420, 902 & 1250MHz bands. 163 pages. £9.50

### AMATEUR RADIO CALL BOOK (RSGB)

1993 Edition

Over 60000 callsigns are listed including EI stations. Now incorporates a 122-page section of useful information for amateur radio enthusiasts and a new novice callsign section. 444 pages. £9.50

### ARRL HANDBOOK FOR RADIO AMATEURS 1993

This is the 70th edition of this handbook and contains the best information from previous issues. New for this edition is some information on feedback-loop design for power supplies, a new gel-cell charger project, updates on antenna systems and new coverage of baluns, propagation programs are compared and colour SSTV and telephone FAX machines are also covered. Finally there's a new section on 'for the workbench' with new projects for the reader to build. 1214 pages. £18.95

### ARRL OPERATING MANUAL

Another very useful ARRL book. Although written for the American amateur, this book will also be of use and interest to the UK amateur. Topics covered range from short wave listening through operating awards to repeaters, operating and satellites. 684 pages. £12.95

### ARRL SATELLITE ANTHOLOGY

The best from the Amateur Satellite News column and articles out of 31 issues of QST have been gathered together in this book. The latest information on OSCARs 9 through 13 as well as the RS satellites is included. Operation on Phase 3 satellites (OSCAR 10 and 13) is covered in detail. 97 pages. £5.95

### ARRL UHF/MICROWAVE EXPERIMENTER'S MANUAL

Various Authors

A truly excellent manual for the keen microwave enthusiast and for the budding 'microwaver'. With contributions from over 20 specialist authors. Chapters covering techniques, theory, projects, methods and mathematics. 446 pages. £14.50

### COMPLETE DX'ER

Bob Locher

This book covers equipment and operating techniques for the DX chaser, from beginner to advanced. Every significant aspect of DXing is covered, from learning how to really listen, how to snatch the rare ones out of the pile-ups and how to secure that elusive QSL card. 204 pages. £7.95

### HINTS AND KINKS FOR THE RADIO AMATEUR

Edited by Charles L. Hutchinson and David Newkirk

A collection of practical ideas gleaned from the pages of QST magazine. Plenty of projects to build, hints and tips on interference, c.w. and operating and snippets of information from amateurs who've tried and tested the idea. 129 pages. £4.95

### HOW TO PASS THE RADIO AMATEURS' EXAMINATION (RSGB)

Clive Smith G4FZH and George Benbow G3HB

The background to multiple choice exams and how to study for them with sample RAE paper for practice plus maths revision and how to study for the exam. The majority of this book is given to sample examination papers so that candidates can familiarise themselves with the examination and assess their ability. 88 pages. £6.70

### INTRODUCTION TO AMATEUR COMMUNICATIONS SATELLITES

BP290 A. Pickard

This book describes several currently available systems, their connection to an appropriate computer and how they can be operated with suitable software. The results of decoding signals containing such information as telemetry data and weather pictures are demonstrated. 102 pages. £3.95

### INTRODUCTION TO AMATEUR RADIO

BP257

I. D. Poole

This book gives the newcomer a comprehensive and easy to understand guide through amateur radio. Topics include operating procedures, jargon, propagation and setting up a station. 150 pages. £3.50

### INTRODUCTION TO RADIO WAVE PROPAGATION BP293

J.G. Lee

How does the sun and sunspots affect the propagation of the radio waves which are the basis of our hobby? They affect the ionosphere, but differing frequencies are treated differently. Find out how to use charts to predict frequencies that will be the most profitable. What effect will noise have on the signal? Find out with this book. 116 pages. £3.95

### INTRODUCTION TO VHF/UHF FOR RADIO AMATEURS BP281

I.D. Poole

An excellent book to go with the new Novice or full callsign. Nine chapters and an appendix deal with all aspects and frequencies from 50 to 1300MHz. Topics include propagation, descriptions of the bands, antennas, receivers, transmitters and a special chapter on scanners. 102 pages. £3.50

### PASSPORT TO AMATEUR RADIO

Reprinted from PW 1981-1982

The famous series by GW3JGA, used by thousands of successful RAE candidates in their studies. Plus other useful articles for RAE students including emission codes, explanations of diodes, s.s.b. and decibels. 87 pages. £1.50

### PRACTICAL GUIDE TO PACKET OPERATION IN THE UK

Mike Mansfield G6AWD

Introduces the concept of packet radio to the beginner. Problem areas are discussed and suggestions made for solutions to minimise them. Deals with the technical aspects of packet taking the reader through setting up and provides a comprehensive guide to essential reference material. 205 pages. £8.95

### QRP CLASSICS

Edited by Bob Schetgen

Operating QRP is fun. The equipment is generally simple and easy to build, but often performs like more sophisticated commercial equipment. Some QRP Field Day stations operate a full 27 hours on a car battery - it's the perfect equipment for emergency communication when the power fails. Extracts from QST and the ARRL Handbook. 274 pages. £9.95

### RADIO AMATEUR CALLBOOK INTERNATIONAL LISTINGS 1993

71st Edition

The only publication listing licensed radio amateurs throughout the world. Also includes DXCC Countries list, standard time chart, beacon lists and much more. Over 1400 pages. £19.50

### RADIO AMATEUR CALLBOOK NORTH AMERICAN LISTINGS 1993

71st Edition

Listings of US amateurs (including Hawaii). Also contains standard time chart, census of amateur licences of the world, world-wide QSL bureau, etc. Over 1400 pages. £19.50

### RADIO AMATEUR'S QUESTIONS & ANSWER REFERENCE MANUAL

4th Edition.

R. E. G. Petri G8CCJ

This book has been compiled especially for students of the City and Guilds of London Institute RAE. It is structured with carefully selected multiple choice questions, to progress with any recognised course of instruction, although it is not intended as a text book. 280 pages. £7.95

### RAE MANUAL RSGB

G.L. Benbow G3HB

The latest edition of the standard aid to studying for the Radio Amateurs' Examination. Updated to cover the latest revisions to the syllabus. Takes the candidate step-by-step through the course. 127 pages. £6.70

### RAE REVISION NOTES

George Benbow G3HB

If you're studying for the Radio Amateurs' Examination, this book could be useful. It's a summary of the salient points of the Radio Amateurs' Examination Manual, the standard textbook for the exam. It's A5 size and therefore can be carried with you wherever you go. Easy-to-read, it's divided into 13 chapters with topics like receivers, power supplies, measurements, operating procedures, licence conditions and a summary of the formulae all dealt with. 92 pages. £4.00

### VHF/UHF DX BOOK

Edited Ian White G3SEK

An all round source of inspiration for the v.h.f./u.h.f. enthusiast. Written by acknowledged experts this book covers just about everything you need to know about the technicalities of v.h.f./u.h.f. operating. 270 pages. £18.00

### W1FB'S DESIGN NOTEBOOK

Doug DeMaw W1FB

This book is aimed at the non-technical amateur who wants to build simple projects and obtain a basic understanding of amateur electronics. Your workshop does not need to be equipped like an engineering lab to be successful as an experimenter. Don't let a lack of test equipment keep you from enjoying the thrills of experimentation. 195 pages. £8.50

### W1FB'S HELP FOR NEW HAMs

Doug DeMaw W1FB

This book covers everything from getting acquainted with new equipment to constructing antennas, station layout, interference and operating problems to on-the-air conduct and procedures. 155 pages. £6.95

### W1FB'S QRP NOTEBOOK

2nd Edition

Doug DeMaw W1FB

The new improved and updated 2nd edition of this book covers the introduction to QRP, construction methods, receivers and transmitters for QRP. This workshop-notebook style publication, which is packed with new designs for the keen QRP operator, also covers techniques, accessories and has a small technical reference section. 175 pages. 0/5

### YOUR GATEWAY TO PACKET RADIO

Stan Horzepa WA1LOU

What is packet radio good for and what uses does it have for the 'average' amateur? What are protocols? Where, why, when? Lots of the most asked questions are answered in this useful book. It

included details of networking and space communications using packet. 278 pages. £8.95

### ARRL ELECTRONICS DATA BOOK

Doug DeMaw W1FB

Back by popular demand, completely revised and expanded, this is a handy reference book for the r.f. designer, technician, amateur and experimenter. Topics include components and materials, inductors and transformers, networks & filters, digital basics and antennas and transmission lines. 260 pages. £8.95

### AUDIO

Elements of Electronics - Book 6

BP111

F. A. Wilson

This book studies sound and hearing, and examines the operation of microphones, loudspeakers, amplifiers, oscillators, and both disk and magnetic recording. Intended to give the reader a good understanding of the subject without getting involved in the more complicated theory and mathematics. 308 pages. £3.95

### BEGINNERS GUIDE TO MODERN ELECTRONIC COMPONENTS BP285

R.A. Penfold

This book covers a wide range of modern components. The basic functions of the components are described, but this is not a book on electronic theory and does not assume the reader has an in-depth knowledge of electronics. It is concerned with practicalities such as colour codes, deciphering code numbers and suitability. 166 pages. £3.95

### EVERYDAY ELECTRONICS DATA BOOK

Mike Tooley BA

This book is an invaluable source of information of everyday relevance in the world of electronics. It contains not only sections which deal with the essential theory of electronic circuits, but it also deals with a wide range of practical electronic applications. 250 pages. £8.95

### FILTER HANDBOOK

A Practical Design Guide

Stefan Niewiadomski

A practical book, describing the design process as applied to filters of all types. Includes practical examples and BASIC programs. Topics include passive and active filters, worked examples of filter design, switched capacitor and switched resistor filters and includes a comprehensive catalogue of pre-calculated tables. 195 pages. £30.00

### FROM ATOMS TO AMPERES BP254

F.A. Wilson

Explains in simple terms the absolute fundamentals behind electricity and electronics. Topics include the use of SI units, gravity, magnetism, light, the electron, conduction in solids and electrical generators. 244 pages. £3.50

### NEWNES PRACTICAL RF HANDBOOK

Ian Mickman

This book provides an easy-to-read introduction to modern r.f. circuit design. It's aimed at those learning to design r.f. circuitry and users of r.f. equipment such as signal generators and sweepers, spectrum and network analysers. 320 pages. £16.95

### PRACTICAL ELECTRONICS CALCULATIONS AND FORMULAE

BP53. F. A. Wilson

Written as a workshop manual for the electronics enthusiast, there is a strong practical bias and higher mathematics have been avoided where possible. 249 pages. £3.95

### REFLECTIONS

Transmission Lines & Antennas

M. Walter Maxwell W2DU

This will help dispel the half-truths and outright myths that many people believe are true about transmission lines, standing waves, antenna matching, reflected power and antenna tuners. 323 pages. £14.50

# BOOKS

## SOLID STATE DESIGN FOR THE RADIO AMATEUR

Les Hayward W7ZOI & Doug DeMaw W1FB  
Back in print by popular demand! A revised and corrected edition of this useful reference book covering all aspects of solid-state design. Topics include transmitter design, power amplifiers and matching networks, receiver design, test equipment and portable gear. 256 pages. £10.95

## TRANSMISSION LINE TRANSFORMERS

Jerry Sevick W2FMI  
This is the second edition of this book, which covers a most intriguing and confusing area of the hobby. It should enable anyone with a modicum of skill to make a balun, etc. Topics include analysis, characterisation, transformer parameters, baluns, multimatch transformers and simple test equipment. 270 pages. £13.50

## RADIO

### AIR & METEO CODE MANUAL

12th Edition.  
Joerg Klingenfuss  
Detailed descriptions of the World Meteorological Organisation Global Telecommunication System operating FAX and RTTY meteo stations, and its message format with decoding examples. Also detailed description of the Aeronautical Fixed Telecommunication Network amongst others. 358 pages. £18.00

### HIGH POWER WIRELESS EQUIPMENT

Articles from *Practical Electricity* 1910-11  
Edited by Henry Walter Young  
A reprint of interesting practical articles from the very early days of radio, when materials and methods described are from another era. Subjects covered ranges from aerials through detectors to things like Tesla and his wireless age. 99 pages. £7.70

### MARINE SSB OPERATION

J. Michael Gale  
How do you stay in touch when you sail off over the horizon and into the blue? What you need is a single sidband radio, a marine s.s.b. This book explains how the system works, how to choose and install your set and how to get the best out of it. There is also a chapter on amateur radio with the emphasis on the increasingly important maritime mobile nets. 96 pages. £9.95

### MARINE VHF OPERATION

J. Michael Gale  
A v.h.f. radiotelephone is essential equipment for any sea-going boat, but what can you do with it? Who can you call, and how do you make contact? Which channel do you use, and why? What is the procedure for calling another boat, calling the family through the telephone system, or making a distress call? This book will tell you. 47 pages. £6.95.

### PASSPORT TO WORLD BAND RADIO

1993  
This book gives you the information to explore and enjoy the world of broadcast band listening. It includes features on different international radio stations, receiver reviews and advice as well as the hours and language of broadcast stations by frequency. The 'blue pages' provide a channel-to-channel guide to world band schedules. 416 pages. £14.50.

### RADIOTELETYPE CODE MANUAL

12th Edition  
Joerg Klingenfuss  
This book gives detailed descriptions of the characteristics of telegraph transmission on short waves, with all commercial modulation types including voice frequency telegraphy and comprehensive information on all RTTY systems and c.w. alphabets. 96 pages. £11.00

### SCANNERS 2

Peter Rouse GUIDKD  
The companion to *Scanners*, this provides even more information on the use of the v.h.f. and u.h.f. communications band and gives

constructional details for accessories to improve the performance of scanning equipment. 261 pages. £10.95

### SHORT WAVE COMMUNICATIONS

Peter Rouse GUIDKD  
Covers a very wide area and so provides an ideal introduction to the hobby of radio communications. International frequency listings for aviation, marine, military, space launches, search and rescue, etc. Chapters on basic radio propagation, how to work your radio and what the controls do, antennas and band plans. 187 pages. £8.95

### SHORT WAVE RADIO LISTENERS' HANDBOOK

Arthur Miller  
In easy-to-read, non-technical language, the author guides the reader through the mysteries of amateur, broadcast and CB transmissions. Topics cover equipment needed, identification of stations heard & the peculiarities of the various bands. 207 pages. £7.99

### WORLWIDE HF RADIO HANDBOOK

Martyr R. Cooke  
This book lists high frequencies used by aircraft and aeronautical ground stations. Divided into sections, Military, Civil, etc. The book should be easy to use. 124 pages. £6.95

### WRTH EQUIPMENT BUYERS GUIDE

1993 Edition  
Willem Bos & Jonathan Marks  
A complete and objective buyer's guide to the current short wave receiver market. For the novice and the experienced listener, this guide explains how to make sense of the specifications and select the right radio for your listening needs. 270 pages. £15.95

### 1934 OFFICIAL SHORT WAVE RADIO MANUAL

Edited by Hugo Gernsback  
A fascinating reprint from a bygone age with a directory of all the 1934 s.w. receivers, servicing information, constructional projects, circuits and ideas on building vintage radio sets with modern parts. 260 pages. £11.60

## BEGINNERS

### BEGINNER'S GUIDE TO RADIO

9th Edition  
Gordon J. King  
The book takes you in logical steps from the theory of electricity and magnetism to the sound you hear from the loudspeaker. Radio signals, transmitters, receivers, antennas, components, valves & semi-conductors, CB & amateur radio are all dealt with. 266 pages. £14.95

### ELECTRONICS SIMPLIFIED - CRYSTAL SET CONSTRUCTION

BP92  
F. A. Wilson  
Especially written for those who wish to take part in basic radio building. All the sets in the book are old designs updated with modern components. It is designed for all ages upwards from the day when one can read intelligently and handle simple tools. 72 pages. £1.75

## INTERFERENCE

### INTERFERENCE HANDBOOK (USA)

William R. Nelson WA6FGG  
How to locate & cure r.f.i. for radio amateurs, CBers, TV & stereo owners. Types of interference covered are spark discharge, electrostatic, power line many 'cures' are suggested. 250 pages. £9.50

## DATA REFERENCE

### NEWNES AUDIO & HI-FI ENGINEER'S POCKET BOOK

Vivian Capel  
This is a concise collection of practical and relevant data for anyone working on sound systems. The topics covered include microphones, gramophones, CDs to name a few. 190 pages. Hardback £10.95

### NEWNES COMPUTER ENGINEER'S POCKET BOOK

This is an invaluable compendium of facts, figures, circuits and data and is

indispensable to the designer, student, service engineer and all those interested in computer and microprocessor systems. 255 pages. Hardback £12.95

### NEWNES ELECTRONICS POCKET BOOK

5th Edition  
Presenting all aspects of electronics in a readable and largely non-mathematical form for both the enthusiast and the professional engineer. 315 pages. Hardback £12.95

### NEWNES RADIO AND ELECTRONICS ENGINEER'S POCKET BOOK

18th Edition  
Keith Brindley  
Useful data covering math, abbreviations, codes, symbols, frequency bands/allocations, UK broadcasting stations, semi-conductors, components, etc. 325 pages. Hardback. £10.95

### POWER SELECTOR GUIDE BP235

J. C. J. Van de Ven  
This guide has the information on all kinds of power devices in useful categories (other than the usual alpha numeric sort) such as voltage and power properties making selection of replacements easier. 160 pages. £4.95

## FAULT FINDING

### GETTING THE MOST FROM YOUR MULTIMETER BP239

R. A. Penfold  
This book is primarily aimed at beginners. It covers both analogue and digital multi-meters and their respective limitations. All kinds of testing is explained too. No previous knowledge is required or assumed. 102 pages. £2.95

### HOW TO USE OSCILLOSCOPES & OTHER TEST EQUIPMENT BP267

R. A. Penfold  
Hints and ideas on how to use the test equipment you have, to check out, or fault find on electronic circuits. Many diagrams of typical waveforms and circuits, including descriptions of what waveform to expect with particular faults, or distortion in audio amplifiers. 104 pages. £3.50

### MORE ADVANCED TEST EQUIPMENT CONSTRUCTION BP249

R. A. Penfold  
A follow on from *Test Equipment Construction (BP248)* this book looks at digital methods of measuring resistance, voltage, current, capacitance and frequency. Also covered is testing semi-conductors, along with test gear for general radio related topics. 102 pages. £3.50

### MORE ADVANCED USES OF THE MULTIMETER BP265

R. A. Penfold  
This book is primarily intended as a follow-up to BP239, *Getting the most from your Multi-meter*. By using the techniques described in this book you can test and analyse the performance of a range of components with just a multi-meter (plus a very few inexpensive components in some cases). The simple add-ons described extend the capabilities of a multi-meter to make it even more useful. 96 pages. £2.95

### OSCILLOSCOPES, HOW TO USE THEM, HOW THEY WORK

3rd Edition  
Ian Hickman  
This book describes oscilloscopes ranging from basic to advanced models and the accessories to go with them. Oscilloscopes are essential tools for checking circuit operation and diagnosing faults, and an enormous range of models is available. 240 pages. £15.95

### TROUBLESHOOTING WITH YOUR TRIGGERED-SWEEP OSCILLOSCOPE

Robert L. Goodman  
This book steers you through the various features - old and new - that scope technology provides and is an invaluable guide to getting the best out of your scope. An overview of available scopes will help you choose the one that best suits your needs. Areas covered include spectrum analysis, test applications, multiple-

trace displays, waveform analysis, triggering, magnified sweep displays, analogue and digital scopes, etc. 309 pages. £17.50.

## TELEVISION

### ATV COMPENDIUM

Mike Wooding G6IQM  
This book is for those interested in amateur television, particularly the home construction aspect. There isn't a 70cm section as the author felt this was covered in other books. Other fields such as 3cm TV, are covered in depth. A must for the practical ATV enthusiast. 104 pages. £3.00

### GUIDE TO WORLD-WIDE TELEVISION TEST CARDS

Edition 3  
Keith Hamer & Garry Smith  
Completely revised and expanded, this is a very handy and useful reference book for the DXTV enthusiast. Over 200 photographs of Test Cards, logos, etc., world wide. 60 pages. £4.95

## CONSTRUCTION

### COIL DESIGN AND CONSTRUCTION MANUAL BP160

B. B. Babani  
Covering audio to r.f. frequencies, this book has designs for almost everything. Sections cover such topics as mains and audio output transformers, chokes and r.f. coils. What is the required turns ratio? This book will show you how to find out. Text and tables. 106 pages. £2.50

### HOW TO DESIGN AND MAKE YOUR OWN PCBs BP121

R. A. Penfold  
The purpose of this book is to familiarise the reader with both simple and more sophisticated methods of producing p.c.b.s. The emphasis of the book is very much on the practical aspects of p.c.b. design and construction. 66 pages. £2.50

### MORE ADVANCED POWER SUPPLY PROJECTS BP192

R. A. Penfold  
The practical and theoretical aspects of the circuits are covered in some detail. Topics include switched mode power supplies, precision regulators, dual tracking regulators and computer controlled power supplies, etc. 92 pages. £2.95

### POWER SUPPLY PROJECTS BP76

R. A. Penfold  
This book gives a number of power supply designs including simple unregulated types, fixed voltage regulated types and variable voltage stabilised designs. 89 pages. £2.50

### RADIO/TECH MODIFICATIONS NUMBER 3

This book is intended as a reference guide for the experienced radio technician. Produced for the US market it contains modification instructions for a wide variety of scanners, CB rigs and amateur equipment including Alinco, Icom, Kenwood, Yaesu and other makes. 160 pages. £9.95

### SHORT WAVE SUPERHET RECEIVER CONSTRUCTION BP276

R. A. Penfold  
A general purpose receiver to build, from antenna to audio, described in understandable English. 80 pages. £2.95

### TEST EQUIPMENT CONSTRUCTION BP248

R. A. Penfold  
Describes, in detail, how to construct some simple and inexpensive, but extremely useful, pieces of test equipment. Stripboard layouts are provided for all designs, together with wiring diagrams where appropriate, plus notes on their construction and use. 104 pages. £2.95

### 50 (FET) FIELD EFFECT TRANSISTOR PROJECTS BP39

F.G. Rayer  
50 circuits for the s.w.l., radio amateur, experimenter or audio enthusiast using f.e.t.s. Projects include r.f. amplifiers and converters, test equipment and receiver aids, tuners, receivers, mixers and tone controls. 104 pages. £2.95

## COMPUTING

### BASIC PACKET RADIO

Joe Kasser W3/G3CZ  
Joe, who has worked on packet radio for some time, is the author of the excellent Lan-Link computer program. So it comes as no surprise that it features in this book. Well suited to beginners and experts alike this book is a mine of information. 364 pages. £19.95

### INTRODUCTION TO COMPUTER COMMUNICATIONS (AN) BP177

R. A. Penfold  
Details of various types of modem and their applications, plus how to interconnect computers, modems and the telephone system. Also networking systems and RTTY. 72 pages. £2.95

### NEWNES AMATEUR RADIO COMPUTING HAND BOOK

Joe Pritchard G1UQW  
Shows how radio amateurs and listeners can 'listen' to signals by reading text on a computer screen. This book also covers the application of computers to radio 'housekeeping' such as log-keeping, QSL cards, satellite predictions and antenna design as well as showing how to control a radio with a computer. 363 pages. £15.95

### PCs MADE EASY

Second Edition  
James L. Turley  
A friendly, comprehensive introduction to every personal computer - including Macs! This book is packed with valuable tips on every aspect of computer technology available today and will help you to get comfortable with your computer - fast. 438 pages. £14.95

### UPGRADE YOUR IBM COMPATIBLE AND SAVE A BUNDLE

Second Edition  
Aubrey Pilgrim  
Aimed at the owners of the IBM compatible computer, this book provides a very straightforward and easy to read guide on upgrading. The author has adopted a friendly and informative style and the there are many excellent illustrations. Typically American in approach and style, the book provides much information and an excellent read. 245 pages. £16.95

## MAPS

### RADIO AMATEUR'S MAP OF NORTH AMERICA (USA)

Shows radio amateur prefix boundaries, continental boundaries and zone boundaries. 760 x 636mm. £3.50

### RADIO AMATEUR'S PREFIX MAP OF THE WORLD (USA)

Showing prefixes and countries, plus listings by order of country and of prefix. 1014 x 711mm. £3.50

### QTH LOCATOR MAP OF EUROPE

Traxel DK5PZ  
Radio Map Service  
This comprehensive map of the European call sign area has now been updated and enhanced. This well thought out, coloured map covers from N. Africa to Iceland and from Portugal in the west to Iran in the east. Folds to fit into the 145 x 240mm clear envelope. 1080 x 680mm. £5.95

# ORDER

# SUBS CLUB

Be sure of your copy of *Short Wave Magazine* every month and qualify for the Subscribers' Club as well. Special offers and discounts are normally available to all members, including those abroad.



**This month members of the *Short Wave Magazine* Subscribers Club can take advantage of yet another very special offer.**

We are offering readers the chance to buy a Steepletone MBR7 multi-band radio. This general coverage receiver offers wide coverage on l.w., through short wave broadcast to v.h.f. and f.m. bands. The fine and course tuning allows easy resolution on the crowded short wave bands. Other features include telescopic antenna, p.a facility, a.m. direction finder and external mic, antenna and earpiece sockets.

#### Specifications

Frequency Coverage:	
m.w.	535-1630kHz
l.w.	150-315kHz
s.w.1	7-22MHz
s.w.2/MB	Marine Band 2.3-7MHz
f.m.	88-136MHz
Airband	108-136MHz
f.m. Marine	
& p.m.r. band	136-176MHz

**This radio will be of particular interest to airband, marine and short wave broadcast enthusiasts.**

The Steepletone MBR7 normally sells for £76.40 plus £4.75 P&P including VAT, however, we are able to offer it to *SWM* Subscribers' Club members for £65.00 including VAT and P&P (UK), giving a saving of £16.15. Overseas readers please apply for prices.

This offer is open until 24 September 1993 (UK), 28 October 1993 (overseas).

## ORDER FORM FOR ALL MAIL ORDER PURCHASES IN SHORT WAVE MAGAZINE

**CREDIT CARD ORDERS TAKEN ON (0202) 659930  
FAX ORDERS TAKEN ON (0202) 659950**

Or please fill in the details ticking the relevant boxes, a photo copy will be acceptable to save you cutting your beloved copy!

**To: PW Publishing Ltd., FREEPOST, Arrowsmith Court, Station Approach, Broadstone, Dorset BH18 8PW.**

#### SUBSCRIPTIONS

**SHORT WAVE MAGAZINE 6 MONTHS**  £11.00 (UK)  
**SHORT WAVE MAGAZINE 1 YEAR**  £22.00 (UK)  
 \$45\* (USA)  
 £25.00 (Europe)  
 £27.00 (Rest of World)

Please start my subscription with the.....issue.

#### SPECIAL JOINT SUBSCRIPTION WITH PRACTICAL WIRELESS 1 YEAR.

£38.00 (UK)  £42.00 (Europe)  £45.00 (Rest of World)  \$75\* (USA)  
 \* \$ cheques only please.

#### SUBS CLUB OFFER

Please send me .....Steepletone MBR7(s) @ £65.00 inc. VAT and P&P (UK). £  
 (overseas prices on application)

My Subscriber Number is.....

#### BINDERS

Please send me.....PW Binder(s) @ £5.50 each. £  
 Postal charges.  
 £1 for one, £2 for two or more (UK). £  
 £1.75 for one, £3.50 for two or more (overseas). £

#### BOOKS

Please send me the following book/s,  
 ..... £  
 ..... £  
 ..... £  
 ..... £  
 ..... £  
 ..... £  
 Postal charges.  
 £1 for one, £2 for two or more (UK). £  
 £1.75 for one, £3.50 for two or more (overseas). £

**GRAND TOTAL** £

#### PAYMENT DETAILS

Name .....

Address .....

.....Postcode .....

Telephone No. ....

I enclose cheque/PO (Payable to PW Publishing Ltd) £

Or Charge to my Access/Visa Card the amount of £

\$

Card No.

Valid from.....to.....

Signature .....Tel:.....

**FORM** ➔

# ASSISTANT EDITOR

**ARE YOU ORGANISED? CAN YOU COPE IN A CRISIS?**

**Britain's leading monthly magazine for the radio listener, Short Wave Magazine, is looking for an Assistant Editor.**

You will need to work to monthly deadlines that include feature writing, product and news reporting, subbing freelance authors' work, answering readers' letters and generally keeping the magazine on an even keel, as well as organising the Editor!

An enthusiastic knowledge of radio, together with Apple Macintosh experience, would be advantageous.

If you think that this job is for you and can start yesterday, send your CV to

**Dick Ganderton, PW Publishing Ltd., Arrowsmith Court, Station Approach, Broadstone, Dorset BH18 8PW. Tel: (0202) 659910. FAX: (0202) 659950**

PW Publishing Ltd. is an equal opportunities employer.

LICENCED 1962

**G3RCQ** ELECTRONICS

RAOTA

**I BUY AND SELL**

**TOP QUALITY AMATEUR RADIO EQUIPMENT**

Telephone Dave (0708) 374043 (Eves & W/End) or Alan (0268) 752522 (Daytime)

9 Troopers Drive, Harold Hill, Romford, Essex  
Callers by appointment, Part exchange welcomed  
73s de Dove



## ANORAK MAGAZINE

**FOR ALL YOUR RADIO NEWS !!! RADIO CAROLINE, NATIONAL, LOCAL, SATELLITE, SHORT WAVE, IRISH SCENE, DUTCH SCENE, FREE RADIO AND MORE!!! ALL YOU WILL EVER NEED TO KNOW FOR JUST £ 1.00 !!!**

PLEASE SEND £1.00 PLUS SAE OR £5.00 PLUS FIVE SAE'S FOR NEXT FIVE ISSUES.  
OUR PREFERRED METHODS OF PAYMENT ARE A COIN TAPED TO A PIECE OF CARD  
(OR BANK NOTE), STAMPS OR UNCORRECTED POSTAL ORDER.  
CM LEISURE SALES, DEPT. SW, P.O. BOX 46, ROMFORD, RM1 2QE.

# ICS

## ELECTRONIC WEATHER MONITORING

High quality microprocessor controlled weather monitoring systems at affordable prices. Easy to install and use. Computer connectable for graphing long term trends.

From **£149.95** inc VAT



- Inside Temperature
- Outside Temperature
- Wind Speed
- Wind Direction
- Inside Humidity
- Outside Humidity
- Time
- Date
- Barometer
- Wind Chill
- Rainfall etc.

Exact features depend on model chosen.  
Send for free weather station catalogue and price list.

ICS Electronics Ltd. Unit V,  
Rudford Industrial Estate, Ford,  
Arundel, West Sussex BN18 0BD,  
Tel: 0903 731101  
Fax: 0903 731105



## Index to Advertisers

A.O.R.....	55	F G Rylands.....	63	Martyn Lynch.....	14,15
A.O.R.....	55	Flightdeck.....	58	Microgate Services.....	77
Aerial Techniques.....	52	Flying Shop.....	58	Midac Systems.....	52
Air Supply.....	58	G3RCQ.....	84	Momentum Communications.....	44
Alan Hooker.....	60	Garex Electronics.....	77	Nevada Communications.....	.....Cover i,iii,20,21
Amdat.....	64	Haydon Communications.....	47	Photo Acoustics.....	29
ARE Communications.....	60	Howes, C M.....	44	Quantek Electronics.....	74
ASK Electronics.....	23	I C S.....	84	R & D Electronics.....	74
Aviation Hobby Centre.....	74	Icom.....	32	Radio Research.....	52
BARTG.....	74	Interproducts.....	77	Rapid Results College.....	78
C M Leisure.....	84	J & J Enterprises.....	74	Roberts Radio.....	17
CB37.....	58	J & P Electronics.....	63	Short Wave Centre.....	63
Chevet Books.....	77	Javiation.....	67	Solid State Electronics.....	63
Cirkit.....	49	Jaycee Electronics.....	52	South Essex Communications.....	52
Colomor Electronics.....	58	Jaytee Electronics.....	47	South Midlands Communications.....	12
Comar Electronics.....	58	Klingenfuss Publications.....	67	SRP Trading.....	37
Datong.....	78	Lake Electronics.....	47	Technical Software.....	78
D G Anthill.....	63	Link Electronics.....	77	Timestep.....	67
ERA Ltd.....	64	Low Electronics.....	.....Cover iv,8,9,38,46	Waters & Stanton.....	30,31

PUBLISHED on the fourth Thursday of each month by PW Publishing Ltd., Arrowsmith Court, Station Approach, Broadstone, Dorset BH18 8PW. Printed in England by Southernprint (Web Offset), Factory Road, Upton Industrial Estate, Poole, Dorset BH16 5SN. Tel: (0202) 622226. Distributed by Seymour, Windsor House, 1270 London Road, Norbury, London SW16 4DH. Tel: 01-679 1899. Fax: 01-679 8907. Telex: 881245. Sole Agents for Australia and New Zealand - Gordon and Gatch (Asia) Ltd.; South Africa - Central News Agency Ltd. Subscriptions INLAND £21, EUROPE £23, OVERSEAS (by ASP) £25, payable to SHORT WAVE MAGAZINE, Subscription Department, PW Publishing Ltd., Arrowsmith Court, Station Approach, Broadstone, Dorset BH18 8PW. SHORT WAVE MAGAZINE is sold subject to the following conditions, namely that it shall not be lent, re-sold, hired out or otherwise disposed of in a mutilated condition or in any unauthorised cover by way of Trade, or affixed to or as part of any publication or advertising, literary or pictorial matter whatsoever.

# The Ultimate in Mobile Scanners

1,000 Channel Wideband Scanner

Frequency Range: 500kHz – 600MHz  
800 MHz – 1300 MHz

Receiving Modes: AM – FM – Wideband FM

Search Steps 5kHz to 995kHz

Selectable 10dB Attenuator

Tape Recorder Output Socket

Automatic Tape Recorder Switching Circuit

Keypad or Rotary Tune Controls

Switchable Audio Squelch

All Metal Case For Improved EMC Compatibility



AVAILABLE FROM YOUR LOCAL DEALER  
OR DIRECT FROM

**NEVADA COMMUNICATIONS**  
189 LONDON ROAD, NORTH END,  
PORTSMOUTH PO2 9AE

USE YOUR CREDIT CARD FOR SAME  
DAY DESPATCH

**ORDER HOTLINE**  
**(0705) 662145**

**SUPPLIED  
COMPLETE WITH**  
★ 240V mains adaptor  
★ Mobile fixing bracket  
★ Telescopic antenna  
**£299**



— **Wideband Scanning Receiver MS 1000** —

# The Award Winners



**HF-Europa** *"Best DX receiver 1992"*

**HF-150** *"Most Innovative Receiver Design"*

**HF-225** *"Receiver of the Year"*

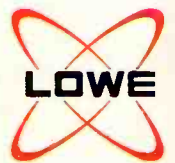

All across the world, users and reviewers are singing the praises of the Lowepro Short Wave receivers. You can join the happy band by calling in at any of our branches to try them out.

Remember - you are buying direct from the manufacturer, and not some importer.

**LOWE ELECTRONICS LTD.** Chesterfield Road, Matlock, Derbyshire DE4 5LE  
Telephone 0629 580800 Fax 0629 580020

London 0753 545255 ♦ Newcastle 0661 860418 ♦ Cumbernauld 0236 721004 ♦ Bristol 0272 315263  
Cambridge 0223 311230 ♦ Bournemouth 0202 577760 ♦ Plymouth 0752 607284 ♦ Leeds 0532 452657