



# ICOM

# Count on us!

## IC-R7000, 25-2000 MHz, Commercial quality scanning receiver



ICOM introduces the IC-R7000, advanced technology, continuous coverage communications receiver. With 99 programmable memories the IC-R7000 covers aircraft, Marine, FM Broadcast, Amateur Radio, television and weather satellite bands. For simplified operation and quick tuning the IC-R7000 features direct keyboard entry. Precise frequencies can be selected by pushing the digit keys in sequence of the frequency or by turning the

main tuning knob. FM wide/FM narrow/AM upper and lower SSB modes with six tuning speeds: 0.1, 1.0, 5, 10, 12.5, 25KHz. The IC-R7000 has 99 memories available to store your favourite frequencies including the operating mode. Memory channels can be called up by pressing the memory switch then rotating the memory channel knob, or by direct keyboard entry. A sophisticated scanning system provides instant access to the most used frequencies. By depressing the Auto-M switch, the IC-R7000 automatically memorises frequencies that are in use whilst it is in the scan mode, this allows you to recall frequencies that were in use. The scanning speed is adjustable and the scanning system includes the memory selected frequency ranges or priority channels. All functions including the memory channel readout are clearly shown on a dual-colour fluorescent display. Other features include dial-lock, noise blanker, attenuator, display dimmer and S-meter and optional RC-12 infra-red remote controller, voice synthesizer and HP 1 headphones.

## IC-R71E, General coverage receiver.

The ICOM IC-R71E 100KHz to 30MHz general coverage receiver features keyboard frequency entry and infra-red remote controller (optional) with 32 programmable memory channels, SSB, AM, RTTY, CW and optional VFO's scanning, selectable AGC, noise blanker, pass band tuning and a deep notch filter.

With a direct entry keyboard frequencies can be selected by pushing the digit keys in sequence of frequency. The frequency is altered without changing the main tuning control. Options include FM, voice synthesizer, RC-11 infra-red remote controller, CK70 DC adaptor for 12 volt operation, mobile mounting bracket, CW filters and a high stability crystal filter.



**Helpline:** Telephone us free-of-charge on 0800 521145, Mon-Fri 09.00-13.00 and 14.00-17.30. This service is strictly for obtaining information about or ordering Icom equipment. We regret this cannot be used by dealers or for repair enquiries and parts orders, thank you.

**Datapost:** Despatch on same day whenever possible.

**Access & Barclaycard:** Telephone orders taken by our mail order dept, instant credit & interest-free H.P.

**Icom (UK) Ltd.**

Dept SW, Sea Street, Herne Bay, Kent CT6 8LD. Tel: 0227 363859. 24 Hour.



|21 to 30| **Weather Satellites**

**Cover** The reception of pictures from weather satellites is becoming very popular with radio enthusiasts. Photograph by courtesy of BTI. Also on the cover is one of HCJB's transmitting antenna sites high up in the Andes near Quito, Ecuador. SWM is organising a DXpedition to Ecuador, details on page 5. Bandscan should be returning next month.

EDITOR Dick Ganderton C Eng., MIERE, G8VFFH  
ART EDITOR Rob Mackie  
FEATURES EDITOR Charles Forsyth  
EDITORIAL ASSISTANT Sharon George  
ADVERTISEMENT PRODUCTION Steve Hunt

**Editorial & Advertising**  
Enefco House, The Quay,  
Poole, Dorset BH15 1PP  
Poole (0202) 678558 (24hrs)  
Prestel MBX 202671191

**ADVERTISEMENT DEPARTMENT**  
ADVERTISEMENT MANAGER  
Roger Hall G4TNT  
(01-731 6222)  
Dave Gadsden G4NXV

© **COPYRIGHT**

PW Publishing Limited 1988. Copyright in all drawings, photographs and articles published in *Short Wave Magazine* is fully protected and reproduction or imitation in whole or in part is expressly forbidden. All reasonable precautions are taken by *Short Wave Magazine* to ensure that the advice and data given to our readers is reliable. We cannot however guarantee it and we cannot accept legal responsibility for it. Prices are those current as we go to press.

# Short Wave Magazine

DXpedition to Ecuador	5	<i>SWM Reader Offer</i>
I Worked for Mr Marconi	9	<i>Joan Ham</i>
Introduction to DX-TV — 7	13	<i>Keith Hamer &amp; Garry Smith</i>
A Chapter of Accidents	17	<i>John Mayall G3VPH</i>
SWM Review WXSAT Weather Satellite Station	21	<i>Mike Richards G4WNC</i>
Crossed Dipoles Antenna	25	<i>Special Offer</i>
Weather Satellites	26	<i>Remote Imaging Group</i>
SWM Review Meteosat Receiving System	27	
Weather Satellite Reception Part 1	28	<i>Peter Rouse GU1DKD</i>
Amateur Radio Ayr	30	<i>Dorothy Dunbar</i>
Visit to Russia	31	<i>Douglas Byrne G3KPO</i>

## REGULARS

First Word	2	<i>Editorial</i>
A Word in Edgeways	2	<i>Your Letters</i>
What's New	3	<i>Latest News &amp; Products</i>
Grassroots	6	<i>Club News</i>
Airband	10	<i>Aeronautical Radio News</i>
Scanning	18	<i>For the Scanning Enthusiast</i>
Starting Out	34	<i>For the Beginner</i>
What Scanner	52	<i>Buyer's Guide to Scanners</i>
Rallies	56	<i>Where to Go</i>
Listen Out For	56	<i>Special Event Stations</i>

## SEEN &amp; HEARD

Amateur Bands Round-Up	37	<i>Justin Cooper</i>
Decode	38	<i>Mike Richards G4WNC</i>
Info in Orbit	41	<i>Pat Gowen G3 IOR</i>
Band II DX	42	<i>Ron Ham</i>
Television	43	<i>Ron Ham</i>
Long Medium & Short	46	<i>Brian Oddy G3 FEX</i>

# FIRST WORD

I trust that you all had a good Christmas and will enjoy a prosperous 1988, full of interesting listening.

Talking of interesting DX, you are invited to join *SWM* on a two-week long DXpedition to Equador in the Spring.

We are organising this all-inclusive holiday in conjunction with HCJB-UK and as well as being able to enjoy two weeks in the Andes you will have the opportunity to visit HCJB's studios, transmitters and other installations as well as some other radio stations. You should also be able to hear many stations that you would not receive here in the UK.

You can find further details of this exciting trip on page 5.



The reception of pictures from the various weather satellites orbiting the earth fascinates many readers. In this issue

we major in on this interesting branch of the listening hobby. Why not put your home computer to use and find out what the weather is like around the world? Apart from the necessary hardware you will need a Letter of Permission from the DTI Radio Regulatory Division, but then you're away. Members of the Remote Imaging Group (RIG) have a blanket permission from the DTI to receive weather satellite pictures, so that in itself is a good enough reason to join RIG.

Antennas are simple and unobtrusive and if you take advantage of our Special Offer you can cut your starting costs dramatically. Full details on page 25.

DICK GANDERTON

## A WORD IN EDGEWAYS

Sir

*Mr. Steele of HCJB-UK misjudges the DX enthusiast. Reception reports are necessary and important. For five years I have monitored the German language service of Deutsche Welle. I do not speak, nor do I understand German, so cannot comment on programme content other than to express appreciation of the performance quality of musical programmes. Deutsche Welle provide monitors with excellently designed report forms and these are mailed, usually monthly on my part, to their Technical Frequency Department. Occasional personal letters of thanks are sent to me regarding my reporting.*

*In the late Thirties I sent my first reception reports to Radio Australia, then making experimental transmissions. I believe the engineers found my reports helpful towards their experiments. Any remarks I could have made about an old 78 recording of "Swan Lake" would neither have been helpful or relevant.*

*Mr. Steele generalises in a way that could discourage DX listeners from sending reception reports to any station of their choice. Over more than fifty years of s.w. radio listening I have never known a station to discourage reception reports, and I have mailed more than I can recall. Most have been friendly and appreciative. Over those years I have listened to HCJB, even sent them reception reports on*

IF YOU HAVE ANY POINTS OF VIEW THAT YOU WANT TO AIR PLEASE WRITE TO THE EDITOR. IF YOUR LETTER IS USED YOU WILL RECEIVE A £5 VOUCHER TO SPEND ON ANY OF *SWM* SERVICES

The Editor reserves the right to shorten any letters for publication but will try not to alter their sense. Letters must be original and not have been submitted to other magazines.

*several occasions. They have an excellent DX feature and I enjoy listening to "Happiness Is"; but we should bear in mind that HCJB is a Christian Missionary station, possibly more interested in converts and donations than reception reports.*

*I recommend Christian charity to Mr. Steele — live and let live. HCJB, being what it is, realises that the Christian religion supports freedom of choice. Mine is to send reception reports. The HCJB letter discourages me not at all.*

ALAN SMITH  
DUSTON  
NORTHAMPTON

Sir

*The letter from Mr. Steele of HCJB-UK, Bradford, in the January issue was interesting. Unfortunately, he does not mention where and when he read Brian Oddy's comments on SINPO reports. Perhaps it was Brian's "Starting Out" article in October 1987 *SWM*. May I make the following comments?*

*Ever since I started s.w.l. and DXing, I have always understood that a SINPO/SIO rating would be imprecise, and would be known to be so by broadcasters. What was*

*important was to make your ratings as impartial — disinterested — as you could and, if possible, identify interfering broadcasts. To attempt a more precise report would be beyond my own knowledge of radio and soundness of judgement and also, I suggest, that of many other s.w.l. and DXers.*  
PHILIP TOWNSEND  
LONDON

Sir

*On behalf of the Houghton-le-Spring Amateur Radio Club (G3NMD) I would like to thank Short Wave Magazine for publicising our Special Event Station GB6HF so well in the weeks leading up to the event. Practical Wireless also played an important role in helping to "pass the word".*

*We operated from the church property of Kepier Hall in Houghton-le-Spring and received 93 contacts during the two weekends of the Feast. You will be interested to know that a number of stations had seen the "Listen Out For" column and had, indeed, done just that. This made our club activity even more enjoyable.*

Once again many thanks.  
F. ANGLES GOABF  
SECRETARY, HOUGHTON-LE-SPRING ARC

Sir

*With reference to Godfrey Manning's "Airband" column in the January 88 issue of *SWM*.*

*If reader Brian Porter really did find a "Eureka" unit, and it wasn't a Christmas try-on, he ought to go back and get it at once so that he can present it to the RAF Museum.*

*Eureka was once widely used by the RAF and Army as a u.h.f. (176-220MHz) homing aid. That's what the vertically polarised two-element Yagis seen on the nose of almost every RAF aircraft in the '40s and '50s were for. The aircraft transmitted pulses which were transponded back by the ground unit so that the aircraft could get range directly, and, by turning the aircraft until the antennas each side of the nose received equally strong signals, bearing as well.*

*Very useful — it saved me from getting lost many times!*

*Obviously it's not in use now — we've had Band III TV on these frequencies, and now p.m.r.*

*On another subject — 243MHz is reserved for emergency use. Here there is a strong pulse signal on that frequency all the time. I haven't been able to d.f. on it yet, but does anyone know what it might be?*

W. BLANCHARD  
DORKING  
SURREY

# WHAT'S NEW

## New Year Present for Poles

The Polish authorities made a magnanimous gesture to their people on New Year's Day when the jamming of the BBC Polish language programmes, as well as those from VOA and Radio Free Europe, ceased.

The h.f. channels of the BBC Polish Service had been jammed by transmitters in the Soviet Union since the imposition of Martial Law in Poland in 1981, although the m.w. outlet on 1.296MHz, which covers some Polish language programming, had been free from deliberate interference.

Jamming of Radio Free Europe Czech and Slovak broadcasts continues and broadcasts in Russian and other regional Soviet languages from Radio Liberty, and the Russian programmes from Deutsche Welle, are also jammed by the Soviet Authorities.

## Young Electronic Designers Awards

The 1988 Young Electronic Designer Awards Scheme was launched with renewed sponsorship from Cirkit Holdings plc and Texas Instruments Ltd.

It offers exciting prospects for young people in the junior (under 15), intermediate (15 - 18) and senior (19 - 25) age groups, who attend educational institutions in the UK.

To enter the scheme, students must produce an electronic device of their own

## Tiger Collinear

Ant Products have introduced a dual band collinear for 145/434 MHz into their range.

It follows the same pattern as the monoband collinear with a similar fully sealed coil base and socket assembly. It is moulded into a solid, fully-machined, aluminium housing and supports a relatively large diameter tubular top section.

Ant Products have tested their antenna and reckon the v.s.w.r. characteristics to be less than 1.25:1 on both bands. The bandwidth on 434MHz is in excess of 20MHz

## AMSAT-UK

This is the Radio Amateur Satellite Organisation of the United Kingdom.

Donations from all members are due on January 1 each year. Prospective members should apply to the Hon. Sec. with an s.a.s.e.

Members may deposit six self-addressed stamped envelopes with the Secretary. These will be used for the "Hot News" service on an *ad hoc* basis. If the s.a.s.e.s are numbered, the lowest number will always be used first.

For more details, contact:

AMSAT-UK  
Ron Broadbent G3AAJ  
94 Herongate Road  
Wanstead Park  
London E12 5EQ

which is original, effective and has a useful application in everyday life. A trophy and cash prizes are presented to the winners in each category, and in the senior age group there are the prospects of a job in electronics and course sponsorship.

For further information, and entry forms contact:

The YEDA Trust  
24 London Road  
Horsham  
West Sussex  
RH12 1AY

too. They mention a gain of 7dB for the 144MHz antenna and 9dB for the 434MHz antenna.

The Tiger Collinear 145/434 comes complete with a full two years written guarantee and full instructions. The cost is £48.50 plus £5.50 post and packing. More details from:

Ant Products  
Foundry Works  
Old Great North Road  
Ferrybridge  
West Yorkshire WF11 8NN

## Dublin Calling

The amateur radio operators of EI are planning great things for 1988. The reason for this is that Baile Atha Cliath, or Dublin as it is better known, is celebrating 1000 years of its foundation as a city.

Dublin is one of Europe's oldest capital cities. To commemorate this Millennium, a group of Dublin-based amateurs are organising some major events throughout the year.

St Patrick's Day, which is on March 17, will be the most ambitious undertaking. They are attempting to make contacts with the many towns and cities called Dublin around the globe. It is estimated that there are over 20. They'll be using not only s.s.b. but also, with the help of pre-arranged skeds, amateur slow-scan TV.

The Lord Mayor of Dublin, The right Honourable Carmencita Hederman, has agreed (if at all possible) to partake in the exchanging of St Patrick's Day greetings with these other Dublins.

The callsign for this station will be very unusual, EI1000. The station will be located in Dublin's main thoroughfare of O'Connell Street.

The other major event will be on July 10, The Millennium birthday. It is hoped they will be able to demonstrate amateur radio in emergency and portable conditions.

The Phoenix park will be the host for the city's birthday celebrations and the special callsign will be in operation for the last time.

A special QSL card will be available via the IRTS bureau, or direct upon receipt of 3IRCS.

For further information, please contact:

Shane Halpin  
DMARC  
25 Knocknashee  
Goatstown  
Dublin 14

## Programme Schedules

### Radio RSA: English Service

Primary Target	Time	Frequency
USA & Canada	0200-0300UTC	11.730MHz
		9.580MHz
		9.615MHz
Africa	0300-0430UTC	11.900MHz
		9.580MHz
		7.295MHz
		4.990MHz
Africa	0630-0730	17.790MHz
		17.825MHz
		15.125MHz
		7.295MHz
Africa	1100-1200UTC	21.590MHz
		15.390MHz
		9.750MHz
Africa	1300-1600UTC	21.590MHz
		17.810MHz
		15.125MHz
		9.750MHz
UK & Irish Republic	2100-2200UTC	11.900MHz
		9.580MHz
		7.295MHz

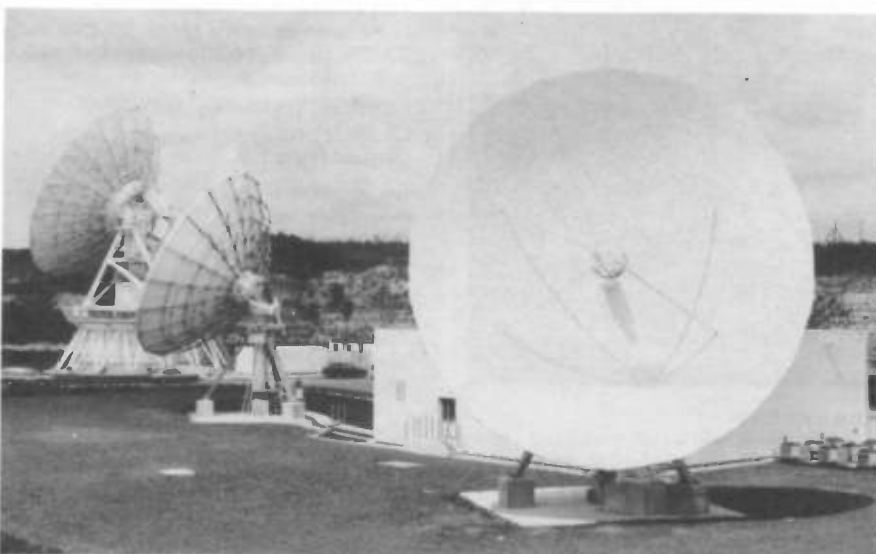

Three terminals at the Mercury Communications satellite communication ground station at Whitehill, Oxfordshire, for which Marconi Communication Systems was the prime contractor. Photo Marconi Company Ltd.

# WHAT'S NEW

## Spanish Relays via Beijing

Test transmissions by Radio Exterior de Espania started on 2nd January 1988 at 1000UTC from the facilities of R. Beijing. These new relays are aimed at Japan and the Phillipines and are in Spanish. The 1000 to 1100 broadcast was received clearly in the UK on 7.165MHz, but the programme scheduled for 1100 on 11.870MHz was not heard as this channel is occupied by a Soviet relay of National Radio of Laos in French.

The test transmissions asked for reports to be sent to REE's usual address at PO Box 156202, Madrid, Spain.

## Technical Software

Methodia Design of Norway have introduced KwikKalk, the latest software in their technical series.

This program is designed to take the hard work out of radio calculations. You just enter the circuit values you already have and it provides the component values you need. The current value of all components is held in the program so that you don't have to keep entering them in every time when performing a series of related calculations.

The program is menu-driven, very easy to use and contains useful explanations and hints for its operation.

There are versions for Spectrum, CBM64 and BBC-B/Master computers costing £12 on tape or £14 on CBM or BBC disk or Spectrum microdrive cartridge. BBC disk users should state 40 or 80 track disks.

### Technical Software

Fron, Upper Llandwrog  
Caernarfon LL54 7RF  
Tel: 0286 881886

## JOTA Contest

This contest is held annually on behalf of the White Fang Fellowship, an association of ex-scouts. The idea is to log as many scout stations as possible during the JOTA weekend. The entry fee of 50p is donated to charity.

The scoring method is quite easy, 10 points for logging GB2WFF, GB2COD and GB2GP. All stations logged outside the contestants own county scores 2 points and all others scores 1 point.

The contest will be held again this year so, if you want to enter, write to:

ILA JOTA Contest  
1 Jersey Street  
Hafod  
Swansea  
SA1 2HF

## CB Info Sheets

The DTI have now produced CB Information sheets B, C and D.

Information Sheet B covers Equipment, C covers Interference and Abuse and D covers Emergency Monitoring and Channel 9. If you would like a copy of these sheets, then send to:

The DTI  
Radiocommunications Division  
CB Licensing Section (RD)  
Room 613  
Waterloo Bridge House  
Waterloo Bridge  
London SE1 8UA

## BAEC

The latest copy of the British Amateur Electronics Club's newsletter has landed in the office.

This issue, number 87, has part 20 of Electronics A-Z, a freezer alarm project, News, Views and Reminders and a cassette recorder problem solved.

If you think you would be interested in joining BAEC, then write to:

Mr C. Bogod  
"Dickens"  
26 Forrest Road  
Penarth  
S. Glamorgan

## FAX not Phone

Unfortunately, the telephone number given in "What's New" last month for Raycomm Ltd was their FAX number. Apologies to any readers who rang this number and heard "demented bumble bees". The correct number is 021-544 6767.

## Dalgety Flier

British Telecom International is helping keep microlight pilot Brian Milton in touch during his historic flight to Australia.

During the 19000km journey from London to Darwin, Mr Milton is relying on BTI's Portishead Radio Station in Somerset to provide a link with home.

BTI radio officers assisted in preparations for the flight by advising on how to make maximum benefit of the extremely lightweight and compact radio equipment fitted into his *Dalgety Flier* microlight aircraft. The h.f. equipment on board is approximately half the size of a typical flight deck h.f. transceiver.

In the past, Portishead's aeronautical service has provided vital communications links for pilots involved in famine relief operations, and the service has handled calls from as far away as the South Pole.

## British DX Club

The December issue of Communication has arrived on the desk this month. It is the journal of the British DX Club, and is full of very interesting information.

Membership to the British DX Club costs £7.50 in the UK, £8.50 overseas surface mail or £11 overseas airmail.

Colin Wright  
Club Secretary  
British DX Club  
54 Birkhall Road  
Catford  
London SE6 1TE

## Apologies

Unfortunately the advertisement that appeared on the back cover of the January *Short Wave Magazine* was the unamended American version. The address for all enquiries regarding Yaesu equipment should be:

South Midlands Communications  
SMC House, School Close  
Chandlers Ford Ind Est  
Eastleigh  
Hants SO5 3BY  
Tel: 0703 255111

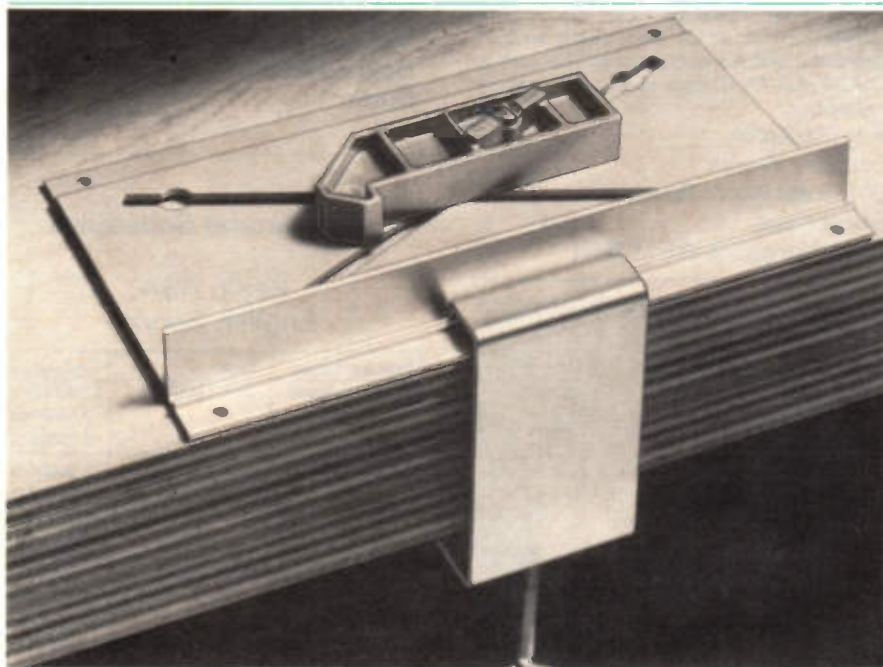

## The Fixer

This is a universal work clamp which is equally suitable for left and right-handed users. It clamps a workpiece up to 500mm firmly into position.

It may be either permanently fixed to a workbench or clamped to any handy surface. Its design allows for work of virtually any length and rapid clamping and removal of the work without screwing and unscrewing the

fixing each time.

The Fixer will hold wood, metal and other objects with equal success. The cost of the Fixer is £6.36 including VAT. For more details, contact:

Fretrade TEP Ltd  
Moor Lane  
Witton  
Birmingham B6 7HH

# DXpedition to Ecuador

Reader Offer from Short Wave Magazine



QUITO

Short Wave Magazine, with HCJB-UK are organising a two week DXpedition to Ecuador. You will have the opportunity to visit HCJB's transmitters, studios and hydro-electric plant as well as some other radio stations in Ecuador. However, the two weeks will not be all radio — you will have plenty of time for sight-seeing and visiting the contrasting sights of Ecuador, making this a holiday that you will not forget in a hurry.

## ITINERARY

Those readers participating in the SWM/HCJB-UK Ecuador DXpedition will fly from London, Heathrow on 27 March 1988 en route for Quito, capital city of Ecuador. The itinerary in Ecuador will include a tour of Quito, trips to the equator and the rain forests of the Amazon, visits to the Otavalo Indian market and the San Antonio wood carvers. HCJB, the Voice of the Andes, has its headquarters in Quito, and we will be visiting the transmitter site, the studios as well as the hydro-electric plant across the Continental Divide. There will also be opportunities to visit other radio stations in Ecuador as well as taking sight-seeing tours and time for shopping.

QUITO

QUAYAQUIL

CUENCA

## ECUADOR

Ecuador is a land of contrast, with lush green jungle and treeless mountain slopes, placid lakes and raging streams, quiet villages and busy cities. It is the home of the Panama Hat and produces bananas, balsa wood, cocoa and oil which it exports worldwide. Quito is only a few minutes drive from the equator and a short distance from the Continental Divide, at an altitude of 2800m, and temperatures range from around 5°C at night to 23°C at midday.



## TOUR INFORMATION

Cost: **£960.00** including Economy Class air fare London to Quito and return by regular scheduled flight, insurance, meals and accommodation in Ecuador and tour-arranged transportation. This price is subject to change due to currency fluctuations or increases in air fares. A deposit of £50.00 per person is required with the booking. This is part of the total cost of the tour, but is non-returnable if cancellation is made after thirty days before the tour starts.

Legal: A valid passport is needed but there are no visa requirements.

Medical: No compulsory injections or vaccinations are required, but you are advised to consult your doctor for recommendations. Remember, Quito is 2800m (9500ft) above sea level.

Clothing: Spring or autumn clothing is the most appropriate together with good walking shoes.

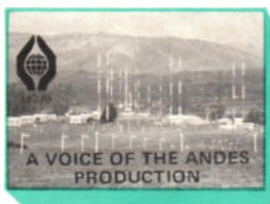

## RESERVE YOUR PLACE NOW

To reserve your place fill in the coupon and post it to **Short Wave Magazine Ecuador DXpedition, FREEPOST, Enefco House, The Quay, Poole, Dorset BH15 1PP** together with a cheque for £50 made payable to Short Wave Magazine. You will be invoiced for the balance of £910 thirty days before the departure date.

To: **SHORT WAVE MAGAZINE, DXpedition FREEPOST, Enefco House, The Quay, Poole Dorset BH15 1PP**

Please reserve ..... place(s) on the SWM DXpedition to Ecuador leaving London on 27 March 1988. I enclose £50 booking fee per place and I agree to pay the balance due when requested.

I enclose P.O./Cheque No. .... Value £ .....

My Credit Card number is

\_\_\_\_\_



Please charge my credit card account with £ .....



Signature .....

Name .....

Address .....

Tel. No. (Home or Work) .....

CUT ROUND DOTTED LINE

**DXPEDITION TO ECUADOR**

# GRASSROOTS

Lorna Mower

I do hope you all received the goodies you were hoping for at Christmas. It's this time of year that programme secretaries are rushing around fixing up the forthcoming events for 1988, so if you think you could give a talk to either your own radio club or another one in the area, go and have a word, you'll be very popular!

Meetings for the **South Bristol ARC** are usually held every Wednesday at the Whitchurch Folk House, Dundry Road, Whitchurch. On February 3 they have a lecture, the 10th is a 10-metre Activity Evening, a VHF Activity Evening follows on the 17th and a Planning Evening for the Bristol Rally on the 24th. Further details from Len Baker G4RZY on Whitchurch 834282.



The **Sutton & Cheam RS** have a Natter Night on February 1, a Committee Meeting at 11 Great Ellshams, Banstead on the 3rd and Commercial Antennas and Feeders by John Tranter on the 19th. They meet every 3rd Friday at 7.30pm in the Downs Lawn Tennis Club, Holland Avenue, Cheam. Natter Nights are the 1st Mondays in the Downs Bar. More from John Puttock GOBWW at 53 Alexandra Avenue, Sutton.

**Coventry ARS** have their Annual Dinner on January 29. They meet every Friday at 8pm in the Baden Powell House, 121 St Nicholas Street, Radford. February 5 is the Indoor Direction Finding Contest (cup qualifier), the 12th is Night on the Air and Morse Tuition, the 19th a talk on Computers by GOAJB and another Night on the Air and Morse Tuition on the 26th. Further information available from Jonathan Ward G4HHT on Coventry 610408.

The **East Kent RS** usually meet every 1st and 3rd Thursday at 7.30pm in the Parkside Lodge (the former Cabin Youth Centre) Kings Road, Herne Bay or, at their Radio Shack, (the former coastguard look-out at Bishopstone). On February 4, Kanga Products introduce their Amateur Radio Kits with Dick Pascoe GOBPS and Ian Keyser G3ROO at the presenters and the 18th is a Natter Night. Brian Didmon G4RIS on Whitstable 262042 can tell you more.

**Vale of Evesham RAC** have Skittles on February 4 and a Ragchew Evening on the 18th. Formal evenings are on the 1st

Thursdays and Informals are the 3rd Thursdays. Both start at 8pm. More details from Mike G4UXC on Evesham 831508.

**St Helens & District ARC** meet every Thursday evening in the Community Resource Centre, Old Central Secondary School, College Street (directly opposite main Police Station), for an 8pm start. Morse tuition is available before the start of the meeting if required. If you would like more details of the club and it's activities then contact Derek Ainscough G1OMY on Marshalls Cross 818455.

A talk by G3WFT on 160m DF Equipment and Contests is scheduled on January 29 for the **South Manchester RC**. A Winter Direction Finding Contest with an 8.15pm start is on February 12. The club meets every Friday at 8pm in the Sale Moor Community Centre, Norris Road, Sale. More details from David Holland G3WFT on Sale 1837.

There is really a full month ahead for those at the **Workop ARS**. February 2 is a Video Night — Electromagnetic Wave, The Electron's Tale and Thin Film Microcircuits, on the 9th they have a Natter Night, Bill Parry (founder member) gives a talk on the History of Amateur Radio on the 16th, and another Natter Night follows on the 23rd. They meet every Tuesday and I'm sure Kevin Fox G4MDQ on Dinnington 566724, will be able to tell you the time and meeting place.



**Wakefield & District RS** meet every Tuesday at 7.45pm in the Community Centre, Prospect Road, Ossett. February 2 is On the Air, the 9th is their Club Project Introduction and Morse Activity follows on the 16th. More from John Bryan G4VRY on Leeds 820198.

**Rhyl & District ARC** meet on the 1st and 3rd Mondays at 7.30pm in The 2nd Rhyl Scout HQ, (behind the Little Theatre) Vale Road, Rhyl.

On February 1 they have The National Grid System — Manweb and the 15th is a Construction Night. For more details contact Mike GWOHWK on Llandegla 621.

A visit by Microwave Modules on February 18 is the main event planned for those at the **Eden Valley RS**. They meet every 3rd Thursday at 7.30pm in the Ullswater Centre, Penrith or The Crown Hotel, Eamont Bridge. For further information ring Martin G4FUI on Penrith 66728.

**South East Kent (YMCA) ARC** meet every Wednesday evening at the Dover YMCA, Godwynhurst, Leyburne Road, Dover. Instruction classes in Morse or Radio Amateur Examination coaching are held at the YMCA on Monday and Tuesday evenings. February 3 is a Natter Night, the 10th a talk by G3JIX, the 17th a Natter Night and Weather Satellite Reception by G4RVB follows on the 24th. More from John Dobson on Dover 211638.

A busy time ahead for all those at the **Bredhurst Receiving and Transmitting Society** who meet every Thursday evening at 8pm in the Parkwood Community Centre, Deanwood Drive, Rainham, Gillingham. January 28 is a Construction/Natter Night, Friday 29th is the Christmas Dinner and Dance at PWCA. How to use the Oscilloscope by GOENN follows on February 4, a Construction/Natter Night on the 11th, the 18th is a talk by G3ZAY on Sunspots and finally the 25th is Rally Briefing by GB4RRR. For more information contact the Chairman Kelvin GOAMZ on Medway 376991.

On January 28, the **Edgware & District RS** have an Informal Evening — Station on the Air. Computer Database & An Application by G4IUZ is planned for February 11 and on the 25th, G3SJE gives a talk on Patents for Everyone. The Society meets on the 2nd and 4th Thursdays at 8pm in the Watling Community Centre, 145 Orange Hill Road, Burnt Oak, Edgware. More details from Ian Cope G4IUZ on Hatfield 65707.

Monday February 8 is an RSGB Film for the **Atherstone ARC** and the 22nd is a Club Night/Night on the Air. The club meets on the 2nd and 4th Mondays at 7.30pm in the Physics Laboratory, Atherstone Upper School, Long Street, Atherstone. For any further details contact John Arrowsmith G4IWA on Atherstone 713670.

**Todmorden and District ARS** meet every 1st and 3rd Monday at 8pm in the Queens Hotel, Todmorden. Monday February 1 is their AGM and the 15th is a Natter Night, G1GZB on Todmorden 7572 can tell you more.



A Quiz — all details and ideas to Peter G8OGE, is being arranged for the **Hastings Electronics & RC** on February 18. The Club meets on the 1st Wednesdays at Ashdown Farm Community Centre for their committee meetings, and the 3rd Wednesdays at West Hill Community Centre for their main meetings. Both start at 7.30pm. Every Friday is their Chat Night at the Ashdown Farm Community Centre. For further information please contact Dave Shirley G4NVQ on Hastings 420608.

**Keighley ARS** have an Informal Evening on February 9 and a talk on 10m by G4YOI on the 23rd. All meetings start at 8pm and you can find out details of their meeting place by contacting Kathy G1GH on Bradford 496222.

On Friday February 5 **Mansfield ARS** have a G1TYU Video Night — an evening of radio video nasties? On Tuesday 16th, G4GYU gives a talk on Mains and Installation Test Gear. The Society meet on the 1st Friday and 3rd Tuesday at 7.30pm in the Victoria Social Club, Mansfield. More from Keith Lawson G4AAH on Mansfield 642719.

**Wimbledon & District ARS** usually meet every 2nd and last Friday at 7.30pm in St Andrews Church Hall, Herbert Road, Wimbledon. January 29 is Practical Soldering by G4XLM, February 12 is a Surplus Equipment Sale and the 26th is Meet the Committee Evening. Any further information available from David Love G4RBQ on Burgh Heath 51559.

**Crystal Palace & District RC** have an AGM and Club Constructional Contest on Saturday February 20. All meetings are on the 3rd Saturday at 8pm in the All Saints Parish Rooms, Beulah Hill, London SE19. More from Geoff Stone G3FZL on Forest Hill 6940.

The **Rippon and District ARS** meet every Thursday at 7.30pm in the Old Air Raid Shelter (behind Ripon Town Hall). A talk by GOCLY is planned for February 25. Further details available from Miss Liz Bulman at The Lodge, Lister House, Sharow, Ripon.

**Rugby ATS** usually meet every Tuesday at 7.30pm in the Cricket Pavilion (outside Rugby Radio Station). February 2 is a Night on the Air and the 9th is Constructors Corner — bring along your project for discussion and technical help.



For more details you can contact Kevin Marriott G8TWH on Rugby 77986.

February 8 is a Social Evening for the Felixstowe and District ARS and on the 22nd they have a Night on the Air. All lecture and social meetings take place at 8pm in the Scout Hut, Bath Road, Felixstowe, unless otherwise specified. Paul Whiting G4YQC on Ipswich 642595 can fill you in on any other details.

The ever popular Junk Sale is planned for the Halifax and District ARS on February 16. They meet on the 1st and 3rd Tuesdays, the 1st Tuesdays being Informal Noggin & Natter Nights at 7.30pm, in the Running Man Public House, Pellon Lane, Halifax. Contact David Moss G0DLM on Halifax 202306 for more details.

Meetings for the Southdown ARS are usually held on the 1st Mondays at 7.30pm, in the Chaseley Home for Disabled Ex-Servicemen, Southcliff, Bolsover Road, Eastbourne. Other meetings are held in the Clubrooms, Hailsham Leisure Centre, Vicarage Road, Hailsham on Tuesdays and Fridays. On Monday February 1 they have The British Engineerium and on Sunday 7th a visit to the British Engineerium. More from C. Evans G4VOS on Heathfield 3168.

Torbay ARS have their weekly meetings every Friday evening at 7.30pm in the English China Clay Social Club, Highweak, near Newton Abbot. On Saturday February 20 they have How It Works by GB3TR. You can get more details from Bob McCreadie G0FGX on Haytor 233.

In February, the Cheshunt and District ARC have three Natter Nights, the 3rd, 17th and 27th. Club meetings are held every Wednesday evening at 8pm in the Church Room, Church Lane, Wormley, near Cheshunt, Herts. Further information available from Peter Davies G1KQA on Lea Valley 764930.

Southgate ARC meet on the 2nd and 4th Thursdays, in the Holy Trinity Church Hall (Upper), Green Lanes, Winchmore Hill, London. An Informal Evening is planned for January 28, a talk on Energy by the Central Electricity Generating Board follows on February 11 and an Informal Evening on the 25th. More from the club's Publicity Officer, D. C. Elson G4YLL on Waltham Cross 30051.

The Crawley ARC meet in the Crawley Leisure Centre, Haslett Avenue, Crawley on the 2nd, 3rd and 4th Wednesdays, starting at 8pm. The 2nd Wednesdays are Informal evenings held at the members' homes and the 3rd Wednesdays are Committee meetings. Club Nets are held

every Friday at 8.30pm. You can contact Dave Hill G4IQM on Crawley 882641 for more details.

Meetings for the Farnborough and District RS are held in the Railway Enthusiasts Club, Hawley Lane, Farnborough at 7.30pm, on the 2nd and 4th Wednesdays. On January 27 they have Construction Contest Winner by G1TTO, February 10 is Packet Radio Talk & Demo by G3RRA and on the 24th, G3HEJ gives a talk on Instrumentation. Any further information available from Tim FitzGerald G4UQE on Camberley 29231.

On January 27, the Nene Valley RC are planning a Three Video Evening from the DTI. They meet every Wednesday, and I'm sure you could get the time and meeting place by ringing M. Byles G6UWS on Wellingborough 71189.

Meetings for the Wirral and District ARC are normally held on the 2nd and 4th Wednesdays at 7.30pm, in the Irby Cricket Club, Mill Hill Road, Irby. On January 26 they have a Surplus Equipment Sale. More from Gerry Scott G8TRY on Wallasey 1939.

Sheffield ARC meet every Monday at 8pm, in the Firth Park Pavilion, Firth Park Road, Sheffield 5. RAE Classes and Morse tuition are held between 7 and 8pm. Alan Pemberton G0ILG on Sheffield 395287 can tell you more.

The Chelmsford ARS usually meet in Marconi College, Arbour Lane, Chelmsford, on the 1st Tuesdays at 7.30pm. On February 2 there is an Interclub Quiz - Chelmsford/Braintree. More details can be obtained by contacting Roy G3MPX or Ela G6HKM on Chelmsford 360545.

Verulam ARC meet on the 2nd and 4th Tuesdays, in the RAF Association HQ, New Kent Road, off Malborough Road, St Albans. For further information contact Hilary G4JKS on St Albans 59318.

Meetings for the Acton, Brentford & Chiswick ARC are usually held in the Chiswick Town Hall, High Road, Chiswick at 7.30pm. On Tuesday February 16 they have a discussion on Youth in Amateur Radio. More from W. G. Dyer G3GEH on Acton 3778.

Loughton & District ARS meet in Room 20 of Loughton Hall at 7.45pm. January 29 is DF Set for Topband - the Club Project, February 12 is an Informal Evening and the 26th a Junk Sale. More details from John Ray G8DZH at 9 Albion Hill, Loughton, Essex IG10 4RA.

Biggin Hill ARC meet at 7.30pm in the Victory Social Club, Kechill Gardens, Hayes. You can get more details from Geoffrey Milne G3UMI on Hayes 2689.

The Cornish RAC have a talk on

Computer Crime by G3VWK on February 8. They meet at 7.30pm in the Church Hall, Treleigh, on the Old Redruth Bypass. More from Norman Pascoe G4USB on Redruth 212314.

Yeovil ARC meet every Thursday at 7.30pm in The Recreation Centre, Chilton Grove, Yeovil. On February 11 G3MYM gives a talk on Moon Bounce, an RSGB video on The World of Amateur Radio follows on the 18th, and a Natter Night on the 25th. Further details from David Bailey G1MNM on Yeovil 79804.

All meetings for the Derby and District ARS are at 119 Green Lane, Derby, starting time 7.30pm. On February 3 they have a Junk Sale, the 10th is a talk by Ian Sneap G3ZYC from Zycrom on Mobile Radio, a Video Show follows on the 17th and the 24th is a visit to the Derbyshire Fire Service HQ. Further information from Jack Anthony G3KQF on Derby 772361.

Wyre ARS meet in the Breck Sports and Social Club, Breck Road, Poulton on the 2nd and 4th Wednesdays at 8pm. Dave Westby G4UHI on Lancashire 854745 can tell you more.

On February 10, Bury RS have a talk on Packet Radio by G4BVE. They meet every 2nd Tuesday for their main meetings in the Mosses Youth & Community Centre, Cecil Street, Bury at 8pm. More from C. J. Ashworth G1PKO on Bury 5018.



The North Wakefield RC meet every Thursday evening at 8pm in The White Horse Public House, Fall Lane, East Ardsley. On January 28 they have their monthly meeting, followed by a Natter Night on February 4, On the Air G4NOK from the new shack on the 11th, a talk by G0COA on Machine Monitoring of Health in the Mining Industry on the 18th and the 25th is their February monthly meeting. More from Steve Thompson G4RCH on Leeds 536633.

Tuesday February 2 is HF Equipment Forum (operating) for all those at the Stevenage & District ARS, and a talk on Planning Permission by a Bor Council Official is planned for the 16th. They meet on the 1st and 3rd Tuesdays at 8pm, in SITEC Ltd, Ridgemoor Park, Telford

Avenue, Stevenage. Peter Daly G0GTE on Stevenage 724991 can tell you more.

Meetings of the Inverness ARC are usually held in the Cameron Youth Club, Planefield Road, Inverness at 7.30pm every Thursday. On February 4 they have First Aid - Demo by the Red Cross. If you would like more details about the club then contact Ronald Macdonell G0CJT on Dingwall 6178.

The Chichester and District ARC meet at 7.30pm, every 1st and 3rd Tuesday, in St. Pancras Hall, St. Pancras, Chichester. For any further details contact C. Bryan G4EHG on Chichester 789587.

**GW4BRS**



**GW3VKL**

The Barry College of Further Education RS meet on Thursday evenings from 7.30pm onwards, in the annex, Barry College of Further Education, along the Barry to Bonvilston Road (A4226), a few hundred yards from the old "Barry Zoo", now the Welsh Hawking Centre. On February 4 they have a Video Film Presentation on "Aerial Construction and Principals" by G6CJ and the 18th is an Amateur Radio Quiz (against local clubs). You can get more details by contacting the club's Publicity Officer, Dr Kevin Johnston GW4BCB at the Barry College of Further Education, Colcot Road, Barry, South Glamorgan CF6 8YJ.

Ealing & District ARS have Morse Training by G3SGT on February 2, an Open Evening on the 9th, the 16th is TVI DFing by G8KLH, and on the 23rd they have Computers and Radio. They meet at 7.30pm on a regular Tuesday evening in The Community Centre, 71a Northcroft Road, Ealing. More from Anton Berg on North Ealing 1416.

Meetings for the Stourbridge ARS are held in the King Edward VI School, Stourbridge. You can find out more by contacting Derek Pearson G3ZOM on Kingswinford 288900.

Sutherland and District ARS meet at 7.30pm on the 1st and 3rd Wednesdays, in the Sutherland Arms Hotel, Golspie. John Cormack G0HBI on Golspie 3197. □

## SHORT WAVE RECEIVERS are our speciality (and all that goes with them)



**HF125**

### Special feature — the HF125

Why did we design and produce the HF125 receiver? Simply to provide the keen short wave listener with a receiver which offered not only all the facilities he or she needed in an HF receiver, but to give at the same time a level of performance which would cope easily with HF conditions likely to be encountered in Europe.

You all know the problems, high power broadcast stations pounding in at night, blotting out the weak signals you wanted to hear — and many of the unwanted signals were generated in your receiver itself. That we succeeded in designing a receiver which could solve the listening difficulties is obvious from comments from reviewers, but we also did it at an attractive price.

The HF125 performance ranks equal to or better than imported receivers at twice its price, and its success stretches around the world.

So what did the reviewers say. I'll give you a few comments, but for the full story why not send a stamped addressed envelope marked "HF125" and we will return a fully descriptive brochure with all the review comments included.



**R2000**

### Quotes

"What is particularly important is the fact that so much attention has been paid to RF and IF performance; areas so lacking in many Japanese sets. Short Wave Listeners will be particularly pleased about the many choices of selectivity on AM." Angus McKenzie.

"I tuned straight to the 40 metre amateur band to see how it stood up to the battering from high powered propaganda broadcasters when attempting to resolve relatively weak amateurs striving to get contacts. The simple answer was, no problem." Chris Lorek.

"After an hour, drift was less than 50Hz in each instance. This is comparable with receivers in much higher price classes." World Radio and TV Handbook.

"I have no doubt that the Lowe HF125 represents extremely good value for money, and the performance far exceeds so much of its competition, including some receivers costing rather more." Angus McKenzie.

"It's refreshing to find a receiver that does exactly what it claims." World Radio and TV Handbook.

The HF125 costs £375 including VAT. Need I say more?



**R5000**

The other receivers shown here represent just part of the range we stock. We can't provide you with reception capabilities from DC to Ultra Violet, but we can come fairly close. A few words on each of the receivers will have to suffice here, but for full details, see the box at the bottom of this ad.

**R2000.** This has to be the most popular receiver ever made. Covering 150kHz to 30 MHz, with an optional internally fitted converter giving 108 to 174 MHz, the R2000 also gives all mode reception, a selection of bandwidths, and a carefully thought out system of memory channels and scanning functions. Operates from ac mains or 12v dc as standard, the R2000 goes anywhere. £637 inc VAT. (Carr. by Securicor £8).

**R5000.** The recently introduced top of the range receiver from Kenwood has brought a new level of performance to the keen listener, and gives this performance in an easy to use package. Truly one of the great receivers, and in use all over the world. £895 inc. VAT. (Carr. as for R2000).



**NRD525**

**NRD525.** Professional monitor receiver from JRC, one of the world's top communication companies. The NRD range of receivers has been recommended by every influential reviewer in the world, and is a byword for performance, features, and reliability. Sooner or later, everyone would like to own a NRD525. Not only do you get top performance but a wide range of options can be incorporated, including RTTY decoding, VHF/UHF converters, and full remote control by computer. Send off for details of this remarkable radio right away. £1195 inc. VAT. (Carr. as for R2000).

**NEWS! NEWS! NEWS!** Kenwood are about to introduce a mobile monitor receiver known as the RZ1. This astonishing unit is intended to form part of an ultimate car audio system but is self contained and is powered from any 12 volt dc supply. What can it do? Well, it's truly surprising, because Kenwood have packed in a coverage from 500kHz to 900 MHz; AM, FM narrow, and FM wide modes; 100 multi function memories with display not only of frequency but station titles as well; direct frequency keyboard entry or tuning with a conventional knob control; a built in stereo FM decoder; and so on and so on. Hard to believe that so much can go into a box the size of a normal car radio, but there it is. Price? Not yet fixed, but clearly it will not be cheap; quality never is. We guess in the £500 region. If you want to know more, give us a call or send for details. The RZ1 is going to add another dimension to monitor receivers.

# FREE

Send 50p to cover the postage and we will send you, by return of post, your **FREE** copy of "THE LISTENER'S GUIDE", a commonsense look at radio listening on the LF, MF and HF bands. Its unique style will, I am sure, result in a "good read" but underneath the humour lies a wealth of experience and expertise. You will also receive detailed leaflets on our range of receivers and a copy of our current price list.

For full details of all our equipment contact any of our branches

Head Office and Showroom

Prices and specifications subject to change without notice

## LOWE ELECTRONICS LIMITED

Chesterfield Road, Matlock, Derbyshire DE4 5LE Telephone 0629 580800 (4 lines) Fax 580020 Telex 377482

Shops in **GLASGOW** Telephone 041-945 2626, **DARLINGTON** Telephone 0325 486121, **CAMBRIDGE** Telephone 0223 311230, **CARDIFF** Telephone 0222 464154, **LONDON** Telephone 01-429 3256, **BOURNEMOUTH** Telephone 0202 577760

# I WORKED FOR MR MARCONI

Joan Ham

We had an exciting day at Chalk Pits on October 3 when **Mrs Edith Trott** visited the museum and saw again a couple of valves designed by Capt. H. J. Round in our valve display. "Again", because the last time Edith saw such valves, she was helping Capt. Round to test them.

Our journey back to the early days began when "torps" (German Zeppelins) were making life dangerous in London and the seventeen-year-old Miss Edith Thompson responded to the call for women to leave domesticity and replace men who had joined the forces, in factories and workshops. A vacancy arose in Marconi House in The Strand and Edith Thompson filled it. She was shown to the top floor and a workshop where Capt. Round taught her to use a lathe and tools and showed her what had to be done. There was a wooden bench with a long steel rod where she learnt to wind coils for his research and experiments.

Edith was the only girl among a group of men. The atmosphere was lively and her memories were full of fun, but "Tommy" as they called her, was treated with respect.

## Perfect Sound

Capt. Round was always in and out giving her different jobs to do, he was working on perfect reproduction of sound; the great development which she remembered was a new moving coil for a microphone. This entailed fixing a hair-fine wire in a spiral on the thinnest paper they could obtain. They searched all over London for it, even rice-paper was found to be too heavy.

Edith thinks that eventually it was specially made in one of the paper mills. Fixing the delicate wire was also difficult and when Capt. Round asked if she had any bright ideas on how it could be done, "... being a woman, I thought of sewing it on." It was tried, but was still too heavy and eventually it was put on "... with some sticky stuff I suppose they made."

On the top floor of Marconi House across the passage from Edith's workroom was another big room hung with rows and rows of canvas to deaden all the sound. One of Edith's jobs was to sit in this room in front of the moving coil microphone and provide a signal for Capt. Round's room for his experiments. I asked her what she said into the microphone. "I read newspapers, magazines, anything I could lay my hands on," she replied. This long spell of reading eventually caused her to lose her voice, so they bought an old gramophone for the tests.

## Caruso

When this, too, broke down they replaced it with a Stentograph, on which they played records of Caruso. This brought a policeman pounding up to the top floor of Marconi House, asking them to stop it!

The Chalk Pits museum is the custodian of an impressive wireless and communications exhibition, and the job of a volunteer steward there, showing our prized exhibits to interested visitors, is a fascinating one. Sometimes, however, we have a rare treat when a representative of living history visits us and we as the spectators are taken on a conducted tour of the past.

The traffic in The Strand was snarled up because people were stopping to listen to Caruso, who could clearly be heard there!

Capt. Round, Edith told me, was responsible for winning the battle of Jutland or Heligoland, where the Germans had been sinking British shipping. He pioneered Radio Direction Finding, which pinpointed the German boats. Another clear memory was of wireless operators from stations abroad, coming in to be kitted with uniforms by another member of staff before returning to duty. Edith remembers the day The Strand suddenly filled with people, all cheering and singing their heads off, and in those pre-broadcasting media days, that was how the news spread that the Armistice had been signed.

Mr Marconi, who often came in to see Capt. Round, was remembered as "very gentlemanly" and his portrait in our wireless building drew the remark, "Yes, just like him — a very handsome-looking man." Mr George Kemp, Marconi's Post Office colleague, was also a frequent visitor to the top of Marconi House, as well as Mr Preece. When I showed her, from

our archives, the commemoration booklet signed by George Kemp to his son, of the Newfoundland experiments, she said, "Oh, I remember that kite!" which they used to raise the long antenna.

There was also Russian and Japanese visitors, eager to see the latest state of the art which Marconi's then represented and which caused Capt. Round great anxiety if he had experimental equipment about. Edith remembered 2LO being broadcast from The Strand and a girl singing there, before the move to Savoy Hill. Edith was given a Marconi crystal junior set by the firm, which she used at home with great enjoyment. I was able to re-introduce her to this little set with its flat coil-packs from our exhibition, and she kindly posed with it for photographs. Her work included "making up bits of equipment from blue-prints" and helping with tests.

## Time to Leave

In 1927 when Edith told Capt. Round that she wanted to leave to get married, he was devastated. "Tommy, you can't leave, there will be no-one to wind my coils!" he told her, but married women in those days did not go out to work, and leave she did. Her last day at Marconi House was memorable because she was kept working very late in order to wind a good stock of coils!

Edith recalled Capt. Round as a very nice man, always with his head in the air (the prototype absent-minded professor?). The Round valves in our display will have special significance, since Mrs Trott brought their inventor to life, but the end of the story for Edith, now Mrs Trott, came many years later. Her daughter was a nurse in a Bognor nursing home and said to her one day, "Mum, you'll never guess who I am looking after? — Capt. Round!" It was in the nursing home that this great pioneer died. □



Mrs Edith Trott at the Chalk Pits Museum recently.

# AIRBAND

Godfrey Manning

**Stan Stewart** (Richmond, Surrey) agrees with the possible reason given in the December column for last-minute changes of landing runway at Heathrow. Stan is a First Officer on Boeing 747s with British Airways and his excellent books were mentioned in a previous "Airband". The change is made at around the outer marker which, relating a 3° glide slope to the distance from threshold, means making a gentle turn on to the alternative i.l.s. when around 1500-1000ft above the aerodrome. The final approach must be established at 800ft so there is no place for a really late decision.

More on this subject comes from Heathrow air-traffic controller **Brendan McCartney G4DYO** (Wokingham) who is better known to many of you as the editor of the RSGB *DX News Sheet*. A last-minute switch would be advised if the previously-landed aircraft is taking time to vacate the runway; if the other runway is clear then this saves having to execute a go-around with consequent advantages to fuel consumption and time.

Brendan also explains that Heathrow changes its runways to try and minimise noise; if the 27 direction is in use then at 15:00hrs the takeoff and landing runways swap over and it is possible that an aircraft near final approach at this time would also need to make a corresponding switch. When 09 is in use, 09R is preferred for departure as it is easier for heavy aircraft. As explained in the Heathrow let-down plates the 27 direction is used up to a worst case of a 5 knot tailwind component, assuming a dry runway surface, and noisy reverse thrust is restricted at night except in emergency.

As a result of the "Heathrow Procedures" piece in December's Airband column further information has come my way. Obviously our readers have the answers to a great many questions, and I hope that you will continue to write to me with information so that I can pass it on.

As far as G-AVXI calibrating the i.l.s. is concerned, Brendan points out that lights on the aircraft interact with the rotating mirror of a teleroscope on the ground. I've never seen one of these so does anybody out there know how it works? Calibration runs have to be squeezed in with the other 1000 or more daily movements that occur at Heathrow during a busy summer. The Shanwick setup is also clarified. Prestwick has the controllers and the computers; Shannon the h.f. equipment and the communicators who actually speak to the pilots. Lastly, Thames and City Radar controllers actually share a space in the Heathrow Approach Control room.

## Altimeters

**Graham Reading G11FH** (Rotherham) would like to put an altimeter in his car to measure his elevation whilst travelling amongst the hills of Derbyshire. It's certainly possible, Graham, as I've already done this in my own car! I was lucky to acquire a very compact, ex-Boeing 707, cabin pressure altimeter with integral

lighting that I've wired to the car's panel lamp circuit through a dropper resistor of adequate power handling ability. The whole is slung under the dashboard in a home-made aluminium bracket where it is easy to glance at without being distractingly obtrusive and is also out of sight of any passing thieves! A vertical speed indicator (v.s.i.) will also work in the car, and I suspect that an inertial-lead or so-called instantaneous type (i.v.s.i.) will be more sensitive just as it would when used in the original aircraft although I haven't personally tried to compare the performance of the two types.

You want an aneroid instrument which has an air pressure connecting tube at the back marked "S" or "Static." As long as you always have a fresh-air vent open then the pressure will equalise between the car's interior and the outside world, eliminating the need to connect anything to this static air inlet. Ensure that it can't get blocked. There may additionally be electrical connections on your altimeter; as well as lighting there could be an altitude encoding output that connects to the secondary surveillance radar transponder.

This transponder shows the air-traffic controller the aircraft height, which is displayed on the radar screen alongside the selected squawk code (or aircraft callsign if code-callsign conversion is available at the controller's end). However, a very few instruments contain their own servo mechanisms and although they too can have a static air inlet they will not work without power. In any case they are not compatible with the d.c. electrical supplies found in a car.

Finally, the all-electric servo altimeter has no pressure connection at all and is also unsuitable for your purpose.

How does it work? To see all of the types of instrument then you might care to visit my personal collection (but please arrange this by 'phoning me on 01-958 5113 first). There's only room for a summary here. Inside the instrument is a metal capsule that is sealed. The air surrounding the aircraft is admitted to the (also sealed) body of the instrument via the static inlet. The capsule expands as the surrounding air pressure falls with increasing altitude, and this movement is coupled to (usually) three pointers which indicate hundreds, thousands and ten-thousands of feet. There is also a barometric pressure subscale.

So, the altimeter is really just a glorified barometer and left in one place will change its reading according to the varying air pressure. The simplest use is to set it for zero feet before leaving home. This will give a relative height above, or below, your starting point. Alternatively you can set the above-sea-level elevation of your home, which can be obtained from the Ordnance Survey map covering your location.



Godfrey sits in the Captain's seat of Super VC-10 G-ASGC at Duxford, Cambs. Opposite, Godfrey and RAF Transport Command VC-10, XV106, "Thomas Mottershead VC" at Brize Norton. Sgt. Thomas Mottershead earned his VC while in the RFC. Under attack, his aircraft caught fire. Mortally wounded, he saved his observer's life by landing behind his own lines. Photos Christine Mlynek.

Not only does air pressure vary as the weather changes but is, simultaneously, different in other parts of the country as a result of the prevailing weather pattern. That's why the country is divided into 21 altimeter setting regions; all aircraft flying below transition altitude in these regions will be advised, by the Flight Information Service, to set the appropriate regional QNH on their altimeters.

Where do you find an altimeter? Try the various air rallies intended for pilots, rather than the air displays that mainly attract spectators. One example is the Popular Flying Association (PFA) rallies, the annual event at Cranfield in Bedfordshire being worth a try.

You want something that works but without going to the expense of being "released" as suitable for actual flight. To test it, first ensure that the knob adjusts the barometric scale and altitude pointers together (warning: some American origin instruments have a tendency towards loose subscales, see Civil Aviation Authority *Aeronautical Information Circular 51/1983*) and that the altitude rises by just over 250 feet for a 10mB increase in pressure setting. Gently suck on the static (try to avoid ingress of moisture) and watch that the altitude reading increases (it helps to look at the instrument face via a mirror); on releasing the suction, the reading should return to its original value.

Lastly, go to an aerodrome and find out the QFE; setting this should give an indication of zero feet. If readers show further interest in descriptions of the workings of the various instruments then I'm more than happy to oblige in this column.

## Frequency Information

The only v.o.r. change (Civil Aviation Authority *General Aviation Safety Information Leaflet 11/87*) since last month is that the London (Heathrow) v.o.r./d.m.e. has temporarily moved from 113.6MHz to 116.95MHz and suffers from some fluctuations.

**Brendan McCartney** points out that airway designators will henceforth be known by the phonetic alphabet rather than their colour, so Amber One become Alpha One, Upper Red One becomes Upper Romeo One, and so-on. Airway colours will now fade into history just like the days that Brendan and I can remember when Heathrow only had Epsom as its southerly holding point; in the north I think they used Brookmans Park from which aircraft flew on to Garston.

## The Space Shuttle

With the report by **Alan Wood** (Ross-on-Wye) about the space shuttle perhaps I should rename this column as "Aero-spaceband!" Alan's trip to the States in

1981 was by Pan Am Boeing 747 (I regret being unable to tie in its name, "*Clipper Polar Express*" with a registration). Due to a head wind, Alan's flight went beyond its fuel estimate and technical stop at Calgary to uplift more fuel was deemed prudent. After landing at Los Angeles Alan hired a car and drove to Edwards Airforce Base in California to watch the first space shuttle (*Columbia*) land. On the big day the massive crowd heard three sonic booms (from *Columbia* and two chase aircraft) at about 09:30 hrs local. The whole event lasted barely ten minutes, at the end of which *Columbia* landed on the runway that was just a set of marks painted on the dry lake bed. All this had to be witnessed from a viewing site several miles away from the actual landing ground. Then came the problem of driving home; with 30000 cars present in the area, the traffic jam was expected to take over a day to clear!

## You Write

**Dave Taskis** (Ilford) has a long-standing affinity for Plymouth airport which started out as a grass strip called Roborough. Brymon's DHC-7 aircraft (as also used on the London (City) 7½° glide slope) are now a regular sight here. Dave has had success with a quarter-wave LAB groundplane in the loft fed by UR67 cable; 3 turns of this below the antenna form an r.f. choke to reduce signals on the braid and a run of 9m brings the far end of the feeder to his Sony Air-7.

"Can you explain weather conditions whiskey, yankee, etc?" asks **Richard Yates** (Birmingham). Major airports transmit a recorded automatic terminal information service (a.t.i.s.) which tells pilots the actual weather and runway in use. The information is updated either at regular intervals or with greater frequency when significant changes occur. The first report will be given letter A (information alpha), then when an update is made this in turn is broadcast as information bravo, and so-on (cycling the letters back to alpha as often as necessary). This saves time on

the approach frequencies as the pilots don't have to receive the weather from the controller on an individual basis; they just call in with something like this; "Birmingham, good afternoon, Short-wave 123 is a Boeing 737 with information delta, over." Details of the weather reports used by a.t.i.s. and VOLMET were given in various previous "Airbands". The Birmingham a.t.i.s. is on 112.9MHz.

## Air-Traffic Services Outside Regulated Airspace

This grand-sounding expression (acronym: a.t.s.o.r.a.) applies to the rest of the airspace that's not controlled in the way described in last month's "Glossary". But that doesn't mean you should go your own way in isolation! You may of course do so (as long as you give way to other aircraft according to the rules of the air) but it's an unnecessary risk. At the very least, there is the flight information service (f.i.s.) to talk to; these helpful people aren't really controllers in the sense that they give instructions, but they can give advice about weather to be avoided, other known nearby traffic, etc.

Then there is the possibility of receiving a procedural service where the controller keeps note of aircrafts' reported positions but does not have radar. Further, it may be possible to call a nearby radar-equipped airfield for a service even whilst flying outside the immediate controlled airspace that the particular a.t.c. unit is responsible for. A radar information service is where the aircraft is given information regarding conflicting traffic; radar advisory service goes one better by issuing instructions in order to resolve the confliction. The pilot is not bound to accept the instructions but in this case neither is the controller obliged to maintain his advisory service. Pilot and controller must therefore "make a contract" and mutually agree the type of service that is in effect.

It's back on the ground for me, until we take to the air again next month. Please keep your letters and reports coming in. □



## DATONG ACCESSORIES FOR BETTER SHORT WAVE LISTENING

Full specifications of these items on request



**VLF £34.90 (carriage £2.00)**  
CONVERTS INCOMING VLF SIGNALS TO FREQUENCIES 20MHz HIGHER, FOR EASY TUNING ON NORMAL COMMUNICATIONS RECEIVERS. SIMPLY CONNECTS IN SERIES WITH THE ANTENNA.



**AD 270/370 £51.75/69.00 (carriage £2.00)**  
ULTRA-COMPACT RECEIVING ANTENNA SYSTEMS GIVING WIDEBAND COVERAGE FROM 200kHz to 30MHz AT HIGH SENSITIVITY. MODELS AD270 AND AD370 GIVE SIMILAR RECEIVE PERFORMANCE TO LARGE CONVENTIONAL ANTENNA SYSTEMS YET ARE ONLY 3 METRES IN OVERALL LENGTH. THE BALANCED DIPOLE CONFIGURATION ALSO GIVES GOOD REJECTION OF LOCAL INTERFERENCE.

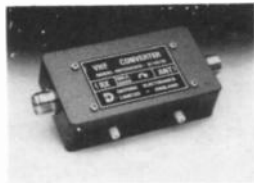

**DC 144/28 £39.67 (carriage £2.00)**  
CONVERTS SIGNALS IN THE 144-146MHz BAND DOWN TO THE RANGE 28-30MHz FOR EASY TUNING ON NORMAL H.F. BANDS RECEIVERS.



**PC1 £137.42 (carriage £2.00)**  
MODEL PC1 CONVERTS ANY GOOD TWO METRE SSB RECEIVER OR TRANSCEIVER INTO A SUPERB GENERAL COVERAGE COMMUNICATIONS RECEIVER. COVERAGE IS 0 TO 30MHz IN THIRTY SYNTHESISED BANDS OF 1MHz AND NO RECEIVER MODIFICATIONS ARE REQUIRED.



**FL3 £129.37 (carriage £2.00)**  
FULLY AUTOMATIC NOTCH FILTER FOR "HANDS-OFF" REMOVAL OF TUNE-UP WHISTLES AND OTHER STEADY TONE INTERFERENCE. INDEPENDENT LOW-PASS AND HIGH-PASS FILTERS WITH VERY STEEP CUT-OFF FOR REMOVING "MONKEY CHATTER" AND OTHER OFF-TUNE INTERFERENCE FROM SSB SIGNALS. BOTH FILTERS TUNE CONTINUOUSLY FROM 200 TO 3500 Hz. SECOND NOTCH FILTER TUNES MANUALLY FROM 200 TO 3500 Hz.



**FL2 £89.70 (carriage £2.00)**  
FEATURES  
TWELVE POLES OF TUNEABLE ACTIVE FILTERING BRING A NEW STANDARD OF PERFORMANCE TO RECEIVER PASS-BAND CONTROL. INDEPENDENT LOW AND HIGH-PASS FILTERS BEAT CRYSTAL FILTER STANDARDS OF SKIRT SELECTIVITY YET CUT-OFF FREQUENCIES ARE CONTINUOUSLY VARIABLE FROM 200 TO 3500 Hz. BUILT IN INDEPENDENT NOTCH FILTER. DESIGNED SPECIFICALLY TO IMPROVE RECEPTION OF SSB, CW, RTTY, AM SIGNALS IN INTERFERENCE CONDITIONS.

Instant credit available  
Mail/Telephone order by cheque or credit card. Cheques cleared before goods despatched. (E&O)



OPEN TUES. SAT. 9.00-5.30  
(CLOSED MONDAYS)

STOCK ITEMS USUALLY  
DESPATCHED WITHIN 48 HRS.

DELIVERY/INSURANCE PRICES  
IN BRACKETS

# STEPHENS-JAMES LTD.

47 WARRINGTON ROAD, LEIGH, LANCS. WN7 3EA  
Telephone (0942) 676790  
Turn at the Greyhound Motel on the A580 (East Lancs. Road).

LANCASHIRE & THE NORTH WEST'S  
LEADING RETAILER IN AMATEUR  
RADIO. 20 YEARS SERVING THE  
AMATEUR: BY AMATEURS  
SPECIALISING ONLY IN AMATEUR  
RADIO EQUIPMENT.  
24 HOUR MAIL ORDER SERVICE

ANTENNA RANGE	
<b>Cushcraft</b>	
A3 3 Element Tribander Beam.....	£262.99
A4 4 Element Tribander Beam.....	£363.35
10-3CD 3 Element 10m Monobander.....	£115.04
15-3CD 3 Element 15m Monobander.....	£139.70
20-3CD 3 Element 20m Monobander.....	£238.21
AP8 8Band Vertical 25ft High.....	£164.35
AP5 5Band Vertical 25ft High.....	£123.36
18Element 2m Boomer Antenna.....	£108.59
15Element 2m Boomer Antenna.....	£85.26
<b>Butternut</b>	
HF6VX 6Band vertical Antenna.....	£159.00
HF2V 80/40 metre Vertical.....	£142.00
A1824HF6V 17/12m Add on kit.....	£30.99
20MRK HF2V 20m Kit.....	£33.39
<b>Hy-Gain</b>	
TH5MK2 5 Element Tribander.....	£592.13
Explorer 4 Element Tribander.....	£468.71
TH2MK3 2 Element Tribander.....	£259.37
18AVT 5 Band Vertical.....	£157.92
<b>Jaybeam</b>	
MM/Minimax Triband Beam.....	£327.00
TB3MK3 3 Element Tribander.....	£316.00
TB2MK3 2 Element Tribander.....	£212.75
TB1MK3 Rotary Triband dipole.....	£106.80
VR3MK3 Triband Vertical.....	£73.80
DB4 4 & 6m Element Beam.....	£117.87
4Y/4m 4m 4 Element Beam.....	£40.53
4Y/6m 6m 4 Element Beam.....	£49.45
LW5/2m 5 element 2m.....	£18.68
LW8/2m 5 element 2m.....	£23.97
PBM14/2m Parabeam.....	£70.15
5XY/2m 5 element Crossed.....	£36.22
8XY/2m 8 element Crossed.....	£46.00

We also stock full range of G Whip mobile range. TONNA and Jaybeam VHF and UHF. Complete range of Aluminum tubing, clamps, lashing kits, rope, insulators.

<b>Kenwood Range</b>	
TS940s HF Transceiver.....	£1995.00
AT940 Automatic Antenna tuner.....	£244.88
SP940 Speaker with filters.....	£87.55
TS930s HF Transceiver.....	£1686.00
AT930 Automatic Antenna tuner.....	£208.00
TS440S HF Transceiver.....	£1138.81
AT440 Automatic Antenna tuner.....	£144.82
PS50 20amp power supply.....	£222.49
TS140S HF transceiver.....	£882.00
PS430 power supply.....	£173.78
SP430 Speaker.....	£40.81
AT250 Automatic Antenna tuning unit.....	£368.00
TS830S HF Transceiver.....	£1098.00
AT230 Antenna tuning Unit.....	£208.67
SP230 Speaker with filters.....	£88.49
TL922 HF Linear amplifier.....	£1496.00
MC50 Base station microphones.....	£46.00
MC60A De Luxe desk microphones.....	£88.22
TR751E 2m Multimode Mobile Transceiver.....	£599.00
TR851E 70cm multimode transceiver.....	£699.00
TM2550E 45 watt 2m Transceiver.....	£466.00
TM221E 45 watt FM Transceiver.....	£317.00
TM421ES 70cm 35 watt Transceiver.....	£372.00
TH21E 2m FM Micro Transceiver.....	£189.00
TH41E 70cm Micro Transceiver.....	£218.00
TH25 2m FM Hand held Transceiver.....	£258.00
TH205E 2m FM Hand held Transceiver.....	£215.28
TH215E 2m Handheld FM Transceiver.....	£262.00
TH405E 70 cm Handheld FM Transceiver.....	£298.00
R5000 General coverage receiver.....	£875.00
VC20VHF Converter 108-174MHz.....	£167.21
R2000 General coverage receiver.....	£595.00
VC10VHF Converter 118-174MHz.....	£161.95
H55 De Luxe headphones.....	£37.54

Full range of accessories stocked microphones. SWR meter, DC Leads, Antennas etc.  
Full size GERV Antenna £16.50. Half size £14.50.  
High Power 7MHz Traps £19.50. Dipole Kits £25.00.  
3.7MHz traps £9.50. 200 watt. 8MHz traps £9.50.

<b>Receivers</b>	
AR2002 Scanning receiver covering 25-55QMHz and 800-1300MHz.....	£487.00
R535 Aircraft Bands receiver covering 108-143 and 220-380MHz.....	£249.00
R537 Handheld Aircraft Band Receiver.....	£89.50
Antennas and accessories for above stocked.	
HF125 General Coverage Receiver.....	£375.00
AR2001 Scanning Receiver.....	£325.00
<b>Datong Range</b>	
AD370 Outdoor Active Antenna.....	£89.00
AD270 Indoor Active antenna.....	£51.75
SRB2 "Woodpecker" Blanker.....	£86.00
D70 Morse Tutor.....	£54.63
<b>MFJ Accessories Range</b>	
MFJ 949C 300 watt Versatuner.....	£157.75
MFJ 1601 Random Wire Tuner.....	£42.02
MFJ 1701 6 way Antenna switch.....	£30.72
MFJ 910 Mobile Matching Unit.....	£20.42
MFJ 300 watt dummy load.....	£28.35
MFJ RF Noise Bridge.....	£63.10
MFJ 815 2kW Cross needle SWR/Power meter.....	£57.32
<b>Rotators</b>	
Kenpro KR400.....	£139.00
Kenpro KR400C.....	£189.00
Kenpro KR600C.....	£219.00
Diawa MR 750C.....	£254.00
CDE AR40.....	£188.72
CD4511R.....	£237.00
<b>Power Supplies</b>	
PS310M Heavy duty 30Amp 22A Cont.....	£198.95
PS120M 3-15V variable 12Amp max.....	£79.50

We are also stockist for Global, Cap Co. and have a full range of publications by RSGB-ARRL and others.

Our secondhand list is updated daily. Please send SAE for this or any information.

Shop Hours 9.30 to 5.00pm Mon. Fri. 4.30pm Sat

# INTRODUCTION TO DX-TV

Keith Hamer and Garry Smith

## Signal Preservation

Careful thought should have gone into the choice and final positioning of the receiving antenna. No matter how efficient the performance of an antenna may be, it can easily be negated by poor installation and an inferior coaxial downlead. The aim is to transfer as much of the signal as possible from the antenna to the receiver via the downlead.

Nowadays most coaxial cable sold is classed as the low-loss variety. It is easily recognisable by its thickness, which is typically 7.5mm. The thinner coaxial cable is rarely obtainable these days. At one time it was widely used in primary service areas in an attempt to save on installation costs. There are still a few points to bear in mind when purchasing cable because its quality and the amount of loss is of the utmost importance when dealing with weak signal situations.

A coaxial cable consists of an inner and an outer conductor separated by a material usually consisting of webbed polythene or a cellular form of polythene foam. This results in a lower dielectric constant than if solid polythene was used. The higher the dielectric constant, the higher the capacitance per given length, resulting in greater signal losses which increase with frequency.

At u.h.f. this becomes an important issue and with some coaxial cables the loss per 100 metres may be higher than 30dB at the top end of Band V, some four times greater than at Band I. The centre conductor is usually made of solid copper and results in greater conductivity than its multi-stranded counterpart often associated with the thinner "standard" loss cable. The thicker the centre conductor, the greater the conductance which means its lower resistance will assist signal transfer.

The construction of the outer conductor or braid will affect the performance of the cable too. Good quality cable usually has a very close woven braid made of copper. Some extremely high quality low-loss coaxial cable has copper tape as well as braid, offering superior screening properties.

Fig. 1: Characteristics of two types of coaxial cable manufactured by Antiference Ltd

Specification	Catalogue Number	
	CCL 400	5540
Inner Conductor	1/1.0mm	1/1.0mm
Dielectric	Quadaire	Quadaire
Outer Conductor	Copper braid	Copper tape and braid
Nominal Impedance	75Ω	75Ω
Capacitance	57.0pF/m	54.0pF/m
<b>Frequency (MHz)</b>	<b>Attenuation (dB/100m)</b>	<b>Attenuation (dB/100m)</b>
50	5.8	3.9
100	8.2	5.5
200	11.8	7.5
400	16.0	11.5
600	20.8	15.0
800	24.7	17.8

In the last article we discussed the pros and cons of the various types of receiving antenna available which are suitable for DX-TV reception at u.h.f. When weaker DX reception is encountered, an amplifier can make all the difference. However, the amplifier with the highest gain doesn't always offer the best end results.

Consequently this will be reflected in the price of the product due to the generous amount of copper used.

Some of the cheaper cable will be very skimpy regarding the density of braid and the minuscule amount will become all too apparent once the cable end is prepared for connecting to the antenna terminals. It is unlikely that the supplier has any performance figures readily available for the cable you intend to purchase but it is hoped that the previous remarks will offer some guidance in what to look for.

## Install with Care

Coaxial cable should be treated with respect when installing. Avoid the temptation to place a drum of coaxial cable on the ground and simply unwinding the cable. This will inevitably lead to coiling and kinking of the cable which can impair its performance. Similarly, care should be taken if the cable is stapled to the wall or window frame. Avoid crushing or piercing the cable in any way.

These points may sound rather obvious, but it is surprising how easily forgotten they are in the eager rush to get the system working. It is vitally important to avoid sharp bends in the coaxial cable. For instance, it is a good idea to loop the cable in order to prevent a sharp bend at the point where it enters the window frame, see Fig. 2. Where the coaxial cable enters the antenna junction box or entry gland on a mast-amplifier, it is advisable to smother the end (and gland) with a generous

application of petroleum jelly. This will protect the coaxial cable from the ingress of water.

The effect of water penetration has to be seen to be believed in some cases. To digress a little, apart from the tell-tale copper braid corrosion at the receiver end of the cable, one of the authors has actually witnessed water leaking from a coaxial plug on a domestic installation! Whilst on the subject of coaxial plugs, don't forget to solder the inner conductor. It is amazing how many people do not bother, including many antenna riggers. Initially, any loss is negligible. That is until the copper tarnishes.

## Amplifiers

If you happen to live at the top of a tower block, you may be able to site the antenna virtually next to the receiver, with a very short connecting cable and therefore negligible cable loss. Not many of us are fortunate in this respect and in practice a typical installation will require some 15 to 20 metres of cable between the antenna and the receiver. Even with the use of best quality coaxial cable, a few dB of signal loss will be inevitable especially throughout the upper part of the u.h.f. spectrum.

Antenna amplifiers are relatively inexpensive and can help compensate for cable losses incurred but experience has shown that unless the amplifier used has a significantly lower noise figure than the tuner in the TV receiver, it is likely to be more effective when situated at the mast-head. Furthermore, the cable itself tends to generate a certain amount of noise and the installation of an amplifier at the mast-head offers an improved signal-to-noise ratio.

The mast-head amplifier should be located at a distance of between 1 and 1.5 metres from the antenna in order to prevent any possible feedback or instability. Where extremely long cable lengths are necessary, a second amplifier in cascade can be used. The recommended minimum distance between the two amplifiers is 10 metres.

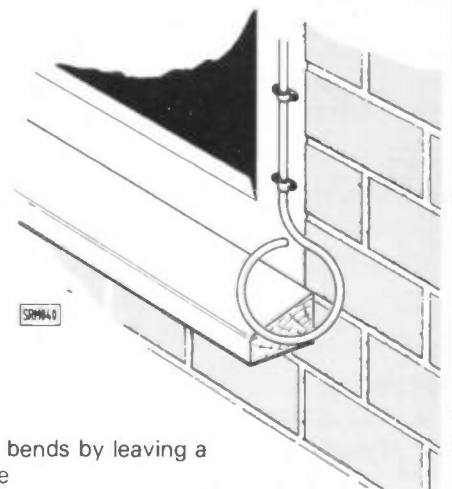

Fig. 2: Avoid sharp bends by leaving a loop of coaxial cable

## Part 7

The manufacturer's installation notes supplied with the mast-head amplifier will often give useful advice regarding additional in-line amplification.

### Low Noise

Nowadays most commercially available pre-amplifiers use broadband techniques which ensures constant gain throughout its intended operating bandwidth. Using modern devices, a high gain combined with a very low noise figure is easily achieved. Currently, commercially produced mast-head amplifiers are available from various manufacturers with a noise figure of less than 2dB. As we mentioned earlier, an amplifier is more effective at the mast-head where a better signal-to-noise ratio is achieved.

Consequently, an amplifier with the lowest noise figure, rather than the highest gain, is considered to be more suitable for DX purposes. Single-stage amplifiers normally have a gain of 10 to 15dB and in most situations this should overcome any cable losses, which increase with frequency.

This approach is best adopted especially if a distribution amplifier is to be used for feeding several receivers. Attention must also be paid to the amount of signal level the amplifier is capable of handling. The general advice is to choose one with the greatest maximum output figure. This is often expressed in mV and several manufacturers produce amplifiers with a figure in the order of 200mV.

### Bandwidth

Wideband coverage u.h.f. amplifiers or those with a limited frequency response designed to match a particular antenna group may be obtained. It is advisable to select an amplifier with a restricted response, i.e. grouped, is used with a wideband antenna system, signals appearing throughout the other groups should not be passed very efficiently. Hopefully the design of the amplifier would be such that its response would be extremely poor outside its intended operating bandwidth.

This brings us to another point. When an amplifier is used with a frequency

Fig. 3: Response curve of the Varicap tuned Schrader RB45 amplifier

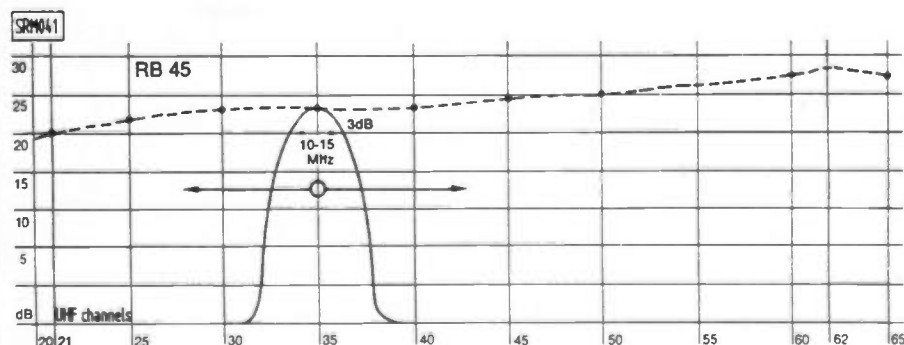

response in excess of that of the antenna, unwanted signals may be passed. If these are sufficiently strong, the amplifier could become overloaded and produce spurious signals or patterning throughout the wanted portion of the spectrum. It is all too easy to assume that the antenna will reject signals outside its designated frequency range. In reality, it will respond to out-of-band signals but less efficiently. For instance a u.h.f. antenna designed for Group A coverage (Channels 21 to 34) will still respond to transmissions in Group C/D (Channels 49 to 68).

However, the antenna may have to be beamed away from the transmitter for maximum signal strength due to its unpredictable polar response outside the range of channels it was designed for. Therefore, if a wideband amplifier was operated in such a situation, strong Group C/D transmissions may introduce overloading causing problems within Group A.

In most DX installations a wideband antenna at u.h.f. will be chosen so naturally an amplifier with similar coverage should be used. Note that two types of amplifier described as "wideband" are available. One covers 470 - 860MHz and this is the type recommended since it covers only the u.h.f. spectrum. Another type covers v.h.f. in addition to u.h.f., and such an example may be recognised by its frequency response of 40 to 860MHz. This type is best avoided because of the problems due to out-of-band signals discussed previously.

A Varicap tuned mast-head amplifier, known as the Schrader RB45, still enjoys popularity among DX enthusiasts on the Continent. The amplifier is tuned by means of a control unit at the receiver end of the cable. With the latest version, the manufacturers claim a high gain figure (in the order of 26dB) with a noise figure of 1.4 to 1.9dB. Note the response curve, Fig. 3, with its very steep cut-off either side of the selected channel. The main drawback with such a system is the limitation imposed by single channel operation - several receivers cannot be used to view DX on other channels simultaneously.

### Excessive Gain

It is naturally tempting to select an amplifier with the highest gain available

but such a choice can often prove disappointing. The use of an amplifier for DX applications is vastly different to the normal situation where one is attempting to secure a viewable picture from the "local" transmitter in an awkward or fringe location. In many cases, the DX enthusiast needs to operate an amplifier in areas of high field strength close to a local transmitter and often finds that the DX channels become swamped with cross-modulation and other spurious effects.

Cross-modulation may take the form of the local broadcasts appearing on channels close to their correct positions, or in severe cases all over the band. Quite often all the four local transmissions can be seen superimposed, accompanied by lines, severe visual distortion and a buzzing on the sound. Sometimes cross-modulation only occurs when the array is beamed at the local transmitter. Unfortunately, Murphy's Law often prevails and the local transmitter is usually directly in line with the Continent!

If cross-modulation effects are apparent, it will not necessarily be due to the mast-head amplifier becoming overloaded with excessively high signals. A similar effect can equally be created within the tuner due to excessive signal strengths being applied to it. Tuners with bipolar front ends tend to be prone to this and some types react more than others.

By attenuating the signal at the input of the tuner, some idea will be established as to where the problem lies. If the cross-modulation disappears, too much signal is being delivered to the tuner. Should the problem remain, although the signal has been weakened, the effect is being created at mast-head.

### Possible Solutions

In the case of the latter, provided that the signal handling capability of the mast-head amplifier is sufficient, it may seem that very little can be done. Filtering is not considered very practical prior to the input of the mast-head amplifier without removing part of the band in which you may wish to DX. Should cross-modulation only occur with the array in certain directions or on some channels, one solution may be to switch the mast-head amplifier in or out depending on how tolerable the effect is before too much degradation of the DX channel occurs.

Low-loss coaxial relays may be used to bypass the mast-head amplifier and such solutions have been used successfully in DX installations in the past. If, for reasons of economy, the existing downlead is used for both modes of operation, both the input and output of the amplifier must be switched accordingly but this could mean a second relay. For convenience, the relay(s) could be supplied from the same source as the mast-head amplifier, provided that the necessary back e.m.f. suppression is incorporated across the



# INTRODUCTION TO DX-TV

relay coil. However, such a decision would obviously depend upon powering requirements.

A check would also have to be made to ensure sufficient voltage was delivered to the mast-head amplifier due to the increased current drawn via the coaxial cable. Whenever possible, the use of a second coaxial download is recommended since it will reduce the number of relay contacts needed for change-over, thus minimising losses even further.

## Filters

If the cause of cross-modulation is due to excessive signals being applied to the tuner input, various filtering techniques may be tried. In some cases, transmissions in a completely different part of the u.h.f. spectrum may be causing the problem. One of the authors found that a single-stage pre-amplifier was acceptable in terms of cross-modulation even with the arrays beamed towards the Waltham transmitter broadcasting in Groups C/D.

Unfortunately as soon as the signal was fed into a high-gain distribution amplifier, no end of problems were encountered! An inexpensive u.h.f. bandfilter/duplexer was acquired which was intended for combining u.h.f. antennas of different groups. By using it as a low-pass filter, the overloading was reduced to an acceptable level by diverting the signal via the Group A/B input prior to feeding the distribution system. The inclusion of a filter after amplification is permissible and in many cases will offer an acceptable reduction in the offending signal.

Group pass filters are commercially available for this application and allow only signals from a specific group of channels through. They can be obtained in the

following groups with through-powering for a mast-head amplifier.

## Group Channels

- A 21 to 34
- B 39 to 53
- C/D 48 to 68

## Distribution Amplifiers

If several receivers are to be employed as DX monitors, a distribution amplifier could be incorporated within the system. Nearly all distribution amplifiers are designed to provide line-powering for a mast-head amplifier. Some have separate inputs for u.h.f. and v.h.f. bands, while others feature only a single input socket. Distribution amplifiers usually provide up to 6 outputs although many provide a further "full" output to feed an extra "T" unit or splitter network. The latter can be either resistive or inductive. Although the inductive type are more expensive, the losses in each spur are lower.

## Power Units

All amplifiers designed for mast-head use are powered via the coaxial cable and generally operate at +12V d.c. Note that many earlier amplifiers required a +24V supply. Power units are normally sold separately and tend to cost more than the amplifier itself!

Commercially-made power units are usually available in two versions: low-current and high current. The former power supply is intended for single stage mast-head amplifiers where the current consumption is typically 8 to 10mA. The high-current type is perhaps more versatile since it will suit two-stage amplifiers and situations where cascaded operation is

necessary. Some power units are now available with an inbuilt splitter designed to feed a couple of receivers. While this may seem more convenient than having to purchase a separate "T" or splitter unit (or distribution amplifier) remember you are limited to two outputs. They also suffer the disadvantage of not having a "full" output available.

A simple power supply is easy to construct and a useful circuit is shown in Fig. 4. Capacitor C1 and r.f. choke RFC1 are necessary to separate the d.c. and r.f. which share the coaxial cable. Capacitor C1 acts as a d.c. block but passes r.f. to the receiver while RFC1 allows d.c. to flow but impedes the passage of r.f. The values are not too critical and may be used for v.h.f. as well as v.h.f. amplifiers. A similar filter arrangement is present on the amplifier output. The choke could be replaced by 2 or 3 turns of 26 s.w.g. enamelled copper wire wound through a small ferrite bead if desired.

The value of "R" will depend upon the current consumption of the amplifier. This is best adjusted on test with the amplifier and appropriate length of cable in situ. Commence with a fairly high value of resistor, say 680Ω. Measure the voltage on the amplifier output terminal and increase the value of "R" until a reading of 12 volts is obtained.

Note that many amplifier designs incorporate a Zener diode across the supply line for protection purposes, so don't choose a value of "R" which is too low otherwise the diode could be damaged through excess current flow. The power supply shown in Fig. 5 is useful where several mast-head amplifiers are in use. To aid heat dissipation, the 7812 regulator i.c. can be fastened to a metal surface such as the p.s.u. casing.

## Hardware Manufacturers

The following manufacturers may be contacted for further information about their product range:

**Filters:** Wolsley Electronics Ltd., Gellihirion Trading Estate, Treforest, Mid Glamorgan CF37 5SX. Tel: 0443 853111.

**Amplifiers & Filters:** Fringe Electronics Ltd. Fringe House, 50 Mansfield Road, Clipstone, Nottinghamshire NG21 9EQ. Tel: 0623 643802.

**Labgear Cablevision Ltd.** PO Box 182, Abbey Walk, Cambridge CB1 2QN. Tel: 0223 66521.

**Antennas, Filters & Amplifiers:** Antiference Ltd. Bicester Road, Aylesbury, Buckinghamshire HP19 3BJ. Tel: 0296 82511.

**Triax Aerial Systems Ltd.** Saxon Way, Back Lane, Melbourn, Nr Royston, Hertfordshire SH8 6DN. Tel: 0763 61755.

**Amplifiers:** Schrader Electronics BV, Lippijnstraat 4 B+C, NL-1055 Amsterdam-W, Netherlands. □

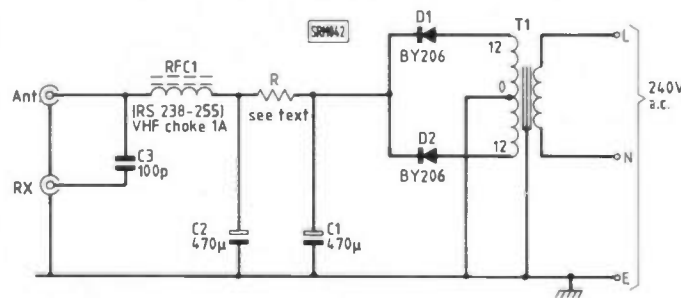
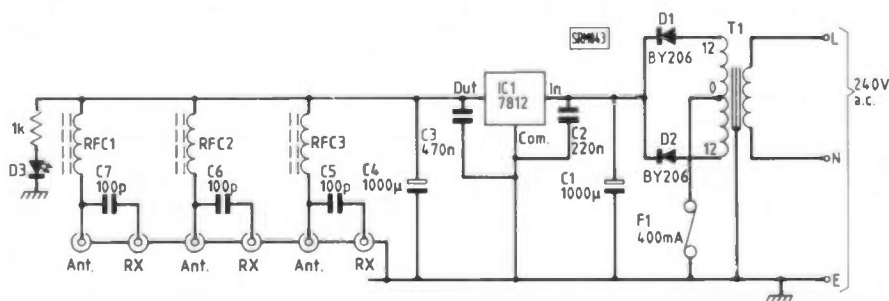

Fig. 4: Simple power supply for feeding a mast-head amplifier

Fig. 5: Power supply suitable for use with a multi-amplifier installation



# Currys

## TUNE INTO THE LATEST WORLD BAND RECEIVER

**EXCLUSIVE  
NEW OFFER**

### CHECK OUT THESE ADVANCED FEATURES

- PLL Synthesized Tuner
- Full AM Frequency Range 150-29999 kHz
- 5 Tuning Functions: Direct Frequency Key-in, Auto Scanning, Manual Scanning, Pre-Set Recall, Manual Rotary Tuning
- Able to pre-set 9 stations for instant recall
- FM Stereo listening through headphones
- 12 separate Shortwave Bands
- Full AM Band for LW/MW/SW
- Sleep Timer with 9 choices - 10 to 90 minutes
- Separate Bass/Treble controls
- Adjustable RF Gain control
- BFO control for SSB and CW
- External Aerial Socket
- Illuminated display for night time use
- 5-dot LED Signal Strength indicators
- LED indicators of Stereo and Power



**MATSUI**

### WORLD BAND RECEIVER WITH QUARTZ ALARM CLOCK TIMER

Powerful enough to pull in broadcasts and transmissions from every corner of the world, this new feature-packed receiver offers unbeatable value to radio enthusiasts. It's manufactured to the very highest specification, and comes complete with full user instructions and a comprehensive worldwide

'Wave Handbook'.  
Exclusive to Currys.  
Model MR 4099.

(Available at larger Currys stores only)

**UNBEATABLE  
VALUE  
AT ONLY**

**£99.99**

OR JUST £5 PER MONTH \*

**TEL: 01-200 0200 FOR YOUR NEAREST CURRYS**



OR TO ORDER  
YOUR RECEIVER  
BY PHONE RING

021-236 7676 (Ask for Audio Department) QUOTING YOUR ACCESS OR VISA CARD NUMBER.  
PLEASE NOTE £10 WILL BE ADDED TO COVER DELIVERY COSTS. DELIVERY WILL BE IN 3 WORKING DAYS.

There's always a better offer at

**Currys**

Offers subject to availability. Terms may vary locally. Instant Credit subject to status - acceptable identity and recognised cheque or credit card. No deposit credit only available to those already holding a BudgetCard. Credit limit 24 x monthly payments. Written details of fixed term credit from Currys Ltd, 46-50 Uxbridge Road, London W5 2SU. Currys are credit brokers.

# A CHAPTER OF ACCIDENTS

John Mayall G3VPH

The first accident happened in the garage. I was doing a boring job on the car so I turned on my cheap little "Radio One type tranny" to cheer me up. When you're lying under a car it's difficult to tune a small plastics dial to Radio Wyvern with only one hand. Somehow I pushed the dial right down to the end of its travel by accident, and there was my wife and her

Although licensed, John has always been a very keen s.w.l. He tells here how there are more things in his Droitwich home town air besides the famous 200kHz transmitter.

hundred and twenty six different telephone conversations! I'm glad to say the scanner then moved into the amateur TV band, but the experience made quite an impression on me.

## How it Happened

Like all radio enthusiasts I had to find out how all these things were happening to me. Here are the answers.

The base unit of legal cordless phones (BT approved) operate on one of eight channels just a little higher in frequency than the 1.6MHz end of the m.w. band. My cheap "tranny", like many others, will tune off m.w. far enough to reach a few of these channels. Our cordless phone is on channel 3 so it could just reach it. Although it only has an a.m. detector it managed to resolve the f.m. by slope detection when it was tuned slightly off channel 3.

## Strange Voices

What about the strange voices on the 1.8MHz amateur band? Illegal cordless phones (BT non-approved) are much more powerful than the approved type and the base units actually inject their r.f. signal into the telephone line. This means they can transmit over relatively long distances, especially if the house is fed by an overhead line which acts like an antenna. They also operate on illegal channels, some of which are to be found in the 1.8MHz amateur band. Ask any s.w.l. or hams who use that band.

## Car Phones

What about the car phones on the scanner? Well, I'm new to scanning and instead of setting the machine to scan up from 1240MHz I somehow got a difference of 305MHz into the onboard computer, with the result that it actually started seaching up from 935MHz, where the 10W cellular radio base transmitters are. As I am a good boy and was most confused and embarrassed by what was happening, I naturally retuned immediately each time it stopped on a phone channel, so I didn't get any verbal indication of distance. However, my radio knowledge leads me to believe that some were every bit of 50km away!

## The Lesson

We all learn from our mistakes. What have I learnt?

1. I must be careful what I say on my legal cordless phone.
2. Naughty people must be even more careful what they say on their illegal cordless phones.
3. People with £1000 car phones should spend a bit more on a scrambler — as soon as it becomes available.



... DIFFICULT TO TUNE ...

friend talking on the radio! It was obviously a telephone conversation on our cordless phone.

So I crawled out from under the car and took the "tranny" for a walk to the bottom of the garden. They were still there. I had to walk about 300m from the house before they began to fade out — and that was with an insensitive bit of medium wave plastic! What range would it have on a decent receiver with a proper antenna? "At least 2km", said an s.w.l. friend who has first hand experience of these things, "eleven or more kilometres if it's an illegal one".

## Second Accident

The second accident happened a few days later. I was chatting on the air to some local friends when I heard other voices close to our frequency. Thinking it might be some more old friends I tuned into them. They were on f.m., which seemed strange for 1.8MHz, and I didn't recognise the voices. They didn't exchange call signs either. Instead, there was the noise of a phone being put down and the frequency went quiet. Some time later I discovered the culprit. It was just like my friend had said. It was an illegal cordless phone and it was every bit of 11km away!

Strange how things happen in threes. I didn't have long to wait for my third accident. I got a wonderful opportunity to test a radio scanner. I've always wanted to

hear amateur TV sound on 1.3GHz so I took the scanner for a drive up a convenient hill, set it up and pushed the search button. However, by accident, I'd started the search well below the band I was after. As a result, and unknown to me at the time, the scanner was searching the cellular car phone band. I was surprised when the first signal it came across was obviously a telephone conversation, so I pushed the "resume search" button. Almost instantly it stopped on another phone, and another, and another ... I started counting and within three minutes I had pushed that button 126 times. One



... PUSHED ... 126 TIMES ...

# SCANNING

Alan Gardener

## New Ambulance Communications

As I have mentioned in previous columns the 1979 World Administrative Radio conference had many effects on the systems used by the emergency services in Britain, besides the obvious ones of having to find new frequencies. All UK Regional Health Authorities use frequencies within the v.h.f. p.m.r. "High Band" between 166.100MHz and 166.6125MHz base TX paired with 170.900MHz to 171.4125MHz base RX. As this allocation is limited in terms of the number of 12.5kHz channels available it is important that the most effective use is made of them.

The impact of modern synthesised transceivers has just begun to surface with the installation of new equipment. One of them is the Marconi RC640, a v.h.f. f.m. mobile transceiver, based on the RC690 v.h.f. a.m. transceiver previously designed by Marconi for the Police and Fire services. This new transceiver has a number of interesting features, the main one being the incorporation of a microprocessor controlled management system. This gives a large amount of flexibility in the use of the equipment, and permits rapid operational changes to be made.

The equipment can be "Loaded" with a new set of channel frequencies, and other data, such as sub-audible tone frequencies, from an external "Fill gun". This dumps the data into the transceiver where it is held in memory which can be accessed by the microprocessor controller. The advantage of this system is that it is possible to reprogram a complete fleet of vehicles in only a few hours, as opposed to several weeks in the case of crystal controlled designs. The other

**This month Alan Gardener covers a wide range of scanning topics, including the new ambulance communications systems, a new log periodic antenna and the phenomenal rate of growth of the cellular telephone system in the UK.**

feature of interest is the "Repeater" mode of operation. Some Ambulance services operate a u.h.f. in-vehicle repeater system which permits hand-held communications with the base station. In such a system two transceivers are connected "back to back" via a control unit. A v.h.f. transceiver receives the signals from the base station and these are re-transmitted locally on u.h.f. by the second transceiver. When the user transmits on his u.h.f. hand-held this is received at the vehicle and is retransmitted back to the base on v.h.f. This system permits a small lightweight u.h.f. hand-held to achieve the same coverage as that of the much larger and higher power vehicle transceiver — providing of course that the hand-held is within range of the vehicle.

The system does have some drawbacks, however — the main one being the need for two separate transceivers and a control box in the vehicle plus the need for additional u.h.f. frequencies to provide the vehicle to hand-held link. The RC640 gets around this problem by being able to scan between frequencies very rapidly. With this type of operation the user has a v.h.f. hand-held receiving the base station directly but transmitting on a separate frequency to that normally used by the base station receiver. This new frequency is received by the vehicle transceiver and retransmitted on the base station receive

frequency, all on v.h.f.

In areas of poor signal strength where the hand-held cannot receive the base station directly, the vehicle transceiver retransmits the signal received from the base station on a further v.h.f. frequency to the hand-held as the vehicle transceiver scans between the two sets of frequencies in use. This reduces the number of separate pieces of equipment that have to be carried in the vehicle, and also means that in strong signal areas it is possible for the user to call the base station directly on v.h.f. using just the hand-held, something which was not practicable before.

## Log Periodic Antenna

My thanks to avid South Wales reader Martin Ehrenfried for a very interesting letter in which he describes what he believes to be the best antenna yet available to scanning enthusiasts. (see Fig. 1). This is a log periodic design made by the Creative Design Co Ltd, and distributed in this country by Waters & Stanton. The antenna itself is fairly unobtrusive with the boom about 1.5m long and the largest element again around 1.5m from tip to tip. The length of the 20 elements tapers to less than 25mm at the other end of the boom where the coaxial feed point is located. The antenna is directional and so requires some means of turning it, but weighing only 3kg practically any cheap rotator should do. The manufacturers claim a frequency range of 105 — 1300MHz with a match to 50 ohms of better than 2:1 and a gain figure of 11 — 13 dBi. This means that the antenna can also be used for transmit if required on the 144, 430 and 1296MHz amateur bands and also the 934MHz C B allocation. Martin has mounted his antenna for vertical polarisation and finds that it out-performs all of the other types of wideband antenna he has tried previously. He does feel that the manufacturers gain

Fig. 1: CLP5130-2 log periodic antenna

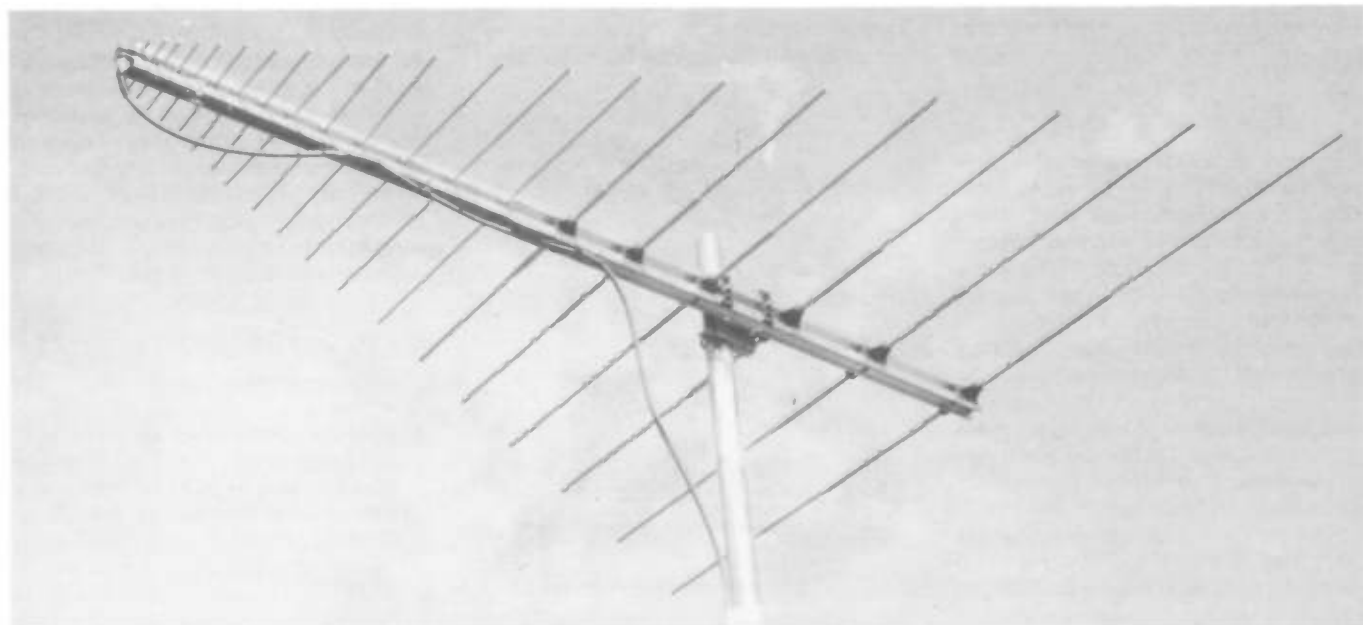

# SCANNING

figure is a little on the high side and after comparisons with dipoles at different spot frequencies he thinks that the figure is closer to 10dBi. This is true over the specified frequency range, however for receive use only the gain falls to that of a dipole at around 80MHz and the antenna is still usable at lower frequencies but with reduced performance. The initial results were so promising he persuaded two more of his friends to buy one! Both of them were pleased with the results — once they had worked out how to assemble the kit of parts that arrived. The approximate current price for the CLP5130-2 from Waters & Stanton is £85.00 but check first before ordering.

As a final note Martin says that another version of the antenna, the CLP5310-1 is available in the US. This covers from 50 to 1300MHz with the same level of performance, and Waters & Stanton may consider importing it if there are enough enquiries. Martin is very keen to get hold of one of these, so how about it scanner fans?

## Oops

Did any of you spot the deliberate mistake in the December column? Just after publication I was informed that the *Handbook for Private Mobile Radio Users* I mentioned was no longer produced by the Home Office. Publication is now by the Electronic Engineering Association, Communications Division, Leicester House, 8, Leicester Street, London, WC2H 7BN. at a cost of £5.00 to non-members plus £1.00 P&P. This new version also contains notes on p.m.r. system operation and is a good general guide to anyone interested in the subject.

## Cellular Expansion

The phenomenal rate of expansion of the cellular telephone system has been one of the major success stories in the communications business over the past year, with coverage now including the Channel Islands. It is quite common to see the more image conscious city folk wandering around the streets of London with warbling pockets, wondering how they are going to pay the next phone bill. To cope with the increased number of users both cellular system operators have been permitted to use extra frequencies in London, giving an extra 200 channels for each service. These are referred to as Extended Total Access (E-TACS) Channels, and are below the current cellular channels on what has until now been an exclusive MOD allocation. (See Fig. 2). This decision means that the frequencies reserved for a future European standard digital service known as Generale Systeme Mobile (GSM) are not affected, much to the relief of the companies involved in the development of the system.

Base RX (MHz)	Base TX (MHz)	Use
872.0	917.0	E-TACS Allocation (London only)
888.0	933.0	
890.0	935.0	TACS Network A
893.5	938.5	
895.5	940.5	Not available until 1989
896.0	941.0	TACS Network A
901.5	946.5	TACS Network B
903.0	948.0	TACS Network A
905.0	950.0	Not available until 1989
915.0	960.0	Reserved for European Cellular system

Fig. 2: UK Cellular radio allocations

As part of their operations both companies are now actively developing voice scrambling systems and have launched cellular data services. Racal in particular have a lot of experience in both these fields as a result of developing military communication systems. They are also offering a new paging system, integrated with the cellular service, using two time slotted 25kHz channels at approx 138MHz being transmitted from an anticipated 300 sites by April 1988. So expect other companies such as Mercury, Air Call and BT to meet the challenge.

## DTI Annual Report

The most important group of people concerned with radio communications in Britain have got to be in the Department of Trade and Industry Radiocommunications Division. This is the government body which sets out the legal requirements for communications equipment and suppliers. Its Annual Report for 1986/87 includes some interesting reading connected with the very many varied aspects of its work — from pure research to enforcement of standards.

Typical of this colourful publication is the section on the Radio Investigation Service (RIS). This is the branch of the Division which is responsible for the monitoring of interference, unlicensed operators, and illegal transmissions. The

main areas of interest over the past year have been the updating of records on existing p.m.r. allocations, an amazing 40 per cent of which did not conform to the licencing conditions. The tracing of pirate radio stations and illegal, long-range, cordless telephones, along with the unlicensed use of v.h.f. marine radiotelephones and CB licence evasion, have accounted for the majority of the workload. There is also the additional problem of interference tracing. Electronic equipment it seems is still being designed without due consideration to electromagnetic compatibility (e.m.c.) although it must be said that the situation is improving, or is it the introduction of the £21 call-out fee that is discouraging people from complaining? Try and get hold of a copy if you can from the DTI, Radiocommunications Division, Waterloo Bridge House, Waterloo Road, London, SE1 8UA.

## Interference

Reading the above publication started me thinking — from the radio listeners' point of view one of the worst devices for creating interference has got to be the microcomputer. Due to the very fast switching of harmonic-rich square waves inherent in the design of such devices, it is not uncommon to detect the "crud" that these beasts produce several miles away. Indeed, Christmas two years ago, at the height of the home computer boom, it was possible to tell which games were being played in many of the homes in the area, and on which machines, particularly the more musical ones. The peak of most noise seems to occur at around 40MHz but strong signals are sometimes detectable at up to 1GHz, making the simultaneous use of both computer and receiver difficult.

One way around this is to keep the antenna as far away as possible from the computer and to use good quality coaxial cable to connect it to the receiver. Try moving the computer leads around to minimise the interference or in really bad cases use filters on all the leads connecting the computer to the outside world. AKD produce a useful clip-on type filter that can be attached to the interconnecting leads of most computers without having to remove any connectors beforehand.

Screening the case of the computer with special metalised paint or stick-on foil can also help with really stubborn problems, although I would advise this only as a last resort and providing that you know what you are doing. I am sure that many of you have come across this problem and I would be interested to hear from you with any tips that I can pass on. As usual all mail to PO Box 1000, Eastleigh, Hants SO5 5HB.

Please send an s.a.e. if you require material returning. Until next month — Good Listening.

# GAREX ELECTRONICS

## WEATHER SATELLITE SYSTEM

This is the genuine MICROWAVE METEOSAT system, 24 hour geostationary (prediction charts not required).

Not to be confused with cheaper, computer add-on devices that normally utilise the VHF Satellites which are only usable for a few minutes at a time.

Our complete plug in and go package requires no computer, no software, and can be up and running, including dish alignment within 10 minutes.

Nothing more to buy: Dish, Microwave Receiver, Frame Store, 12" B/W Monitor AND ALL PLUGS & CABLES **£995.95**  
Expandable to include VHF Satellites and colour. Designed by Timestep Electronics, now supplied by Garex.

## VHF SYSTEMS

VHF Active Antenna + 35m cable **£74.75**  
VHF 10 Channel Receiver **£155.25**  
Colour Frame Store (suits VHF & Microwave) **£454.25**  
SAE for full details and prices of other 'separates'

\*\*\*\*\*

## GAREX VHF RECEIVERS

The celebrated Timothy Edwards designs now owned & manufactured by GAREX.

- ★ A simple but versatile design capable of covering spot frequencies in the range 25-200MHz.
- ★ Excellent sensitivity (typically better than 0.4µV for 12dB SINAD).
- ★ Double superhet (10.7MHz and 455kHz IFs).
- ★ Choice of IF bandwidths from weather satellite to '12.5kHz' PMR standards.
- ★ The basic receiver is single channel crystal controlled. Multichannel options.
- ★ 2 watt audio output stage having a low quiescent current.
- ★ Size: 153 x 33mm Requires 10-14V DC supply.

### PRICES:

Stock Versions: (fully assembled, aligned & tested boards) 6m, 4m, 2m & Weather Sat. **£49.95**

Complete cased versions & special options: details & prices on request. Crystals can be supplied if required; most popular 2 metre frequencies and the currently active Weather satellites are readily available. Crystal prices on request.

Mains power supply module **£15.50**

## THE GAREX VHF PREAMPLIFIER

- ★ Compact size: 34x9x15mm
- ★ Up to 26dB gain
- ★ Can be made for any frequency in the range 40-200MHz
- ★ 3dB bandwidth ±3MHz (at 145MHz)
- ★ Uses BF981 (0.7dB NF at 200MHz)
- ★ Input & output impedance 50 ohms
- ★ 1dB compression: +10dBm
- ★ Saturated output: +15dBm
- ★ Supply voltage 8-17V DC at 5-10mA

Stock Versions: (fully assembled, aligned & tested boards) 6m, 4m, 2m & Weather Sat. **£11.45**

Other versions: prices & details on request.

- ★ **NEW ★ HIGH PERFORMANCE 2 metre PRE-AMPLIFIER**
- ★ 3 Band-pass stages for improved selectivity
- ★ 16dB gain with 1dB NF
- ★ RF switched (fail-safe action): gas-filled relays Assembled, tested (box version on request) **£42.50**

## Main Distributors for REVCO ELECTRONICS LTD.

Ask for details of the latest REVCO "Whippet" and "Kwikfit" antennas and solderless co-axial adaptors (see PW June 87).

Prices include UK P&P and 15% VAT

Ask for details of our Interest Free Credit

## GAREX ELECTRONICS

HARROW HOUSE, AKEMAN STREET, TRING HP23 6AA

TEL: TRING (044282) 8580

and CHEDDINGTON (0296) 686884

Callers by appointment only

## Short Wave Receivers & Scanners



# ELLIOTT ELECTRONICS

Aerial Accessories & Masts

for the Radio Enthusiast



Instant finance available  
Written details on request.



## Books for radio amateurs

FAMOUS "Complete Guide to VHF/UHF Frequencies 26-2250MHz"

## JAYBEAM AMATEUR ANTENNAS

APPOINTED DISTRIBUTOR



OSY OLD MAN TO

Call us on LEIC. 553293  
OR COME AND LOOK AROUND AT

26/28 Braunstone Gate, Leicester.



STD 0272

Radio Communications  
Amateur P.M.R. Marine



# UPPINGTON

Do you need a base station scanner?  
If so the Uniden Bearcat UBC 175XL reviewed Dec. issue Short Wave Magazine could be just what you've been waiting for.

**SUPER WIDEBAND OMNIDIRECTIONAL ANTENNA DISCONE £29.95 + £3 P&P**

A discone is a broadband antenna that is ideal for use with a scanner as it will usually give good reception from 50 to 500MHz.

**£179.00 inc. P.P.**



## Rotators

KR400	139.00
KR500	149.95
KR400RC	168.00
KR600RC	219.00
KC038	17.45



ZL SPECIAL 12 ELE £25.00 P&P £3.50  
2 MTRS 7 ELE £14.50 P&P £3.00  
ANTENNAS 5 ELE £10.50 P&P £2.50

FRG 9600 £469.00

AR2002 £487

**THE G5RV MULTIBAND DIPOLE FULL SIZE 1/2 SIZE 80-10 MTRS 40-10 MTRS**  
£16.25 £14.25  
+ £1.80 P&P + £1.80 P&P

FRG 8800 £599.00



THIS KIT CONTAINS AN ATTRACTIVE END FED LONG WIRE COMPLETE EGG INSULATOR AND ROPE LANYARD PLUS FULL INSTRUCTIONS WITH SO239 CONNECTOR.

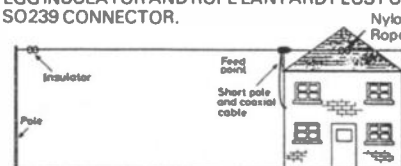

S.W.L. DX RECEIVING ANTENNA

PRICE..... £10.50  
CAR. £1.90

G2BAR

12-14 PENNYWELL ROAD, BRISTOL, BS5 0TJ  
FOR ALL YOUR MAIL ORDER ENQUIRIES CONTACT PETER

GIDFK

**Nationwide Mail Order**

# WXSAT WEATHER SATELLITE STATION REVIEW

Mike Richards G4WNC

The station reviewed here enables the direct reception of the North American NOAA and the Soviet Meteor and Cosmos series of satellites in the 137MHz band. With the addition of a suitable down-converter and antenna, the station can also be used to receive the geostationary weather satellites in the 1690MHz band.

The station comprises four discrete sections namely the antenna, receiver, interface and software. The complete station is available either in kit form or ready-built. For this review I have started from scratch with all items in kit form.

## Antenna

I thought I'd start with the simplest job which appeared to be building the antenna. The constructional details are contained in a three-page, A5 leaflet which contained some useful diagrams along with the simple-to-follow text.

The antenna comprises a pair of crossed dipoles with reflectors and is supplied with all elements cut to length complete with protective plastics end caps fitted to each element.

The first job is to check that you have the correct antenna for the desired frequency band as there are two options of either 137MHz for weather satellites or 145MHz for UOSAT. The antenna frequency was clearly marked on the housing for the driven elements so it was easy to identify.

To obtain the required circular polarisation, the Spacotech antenna uses a  $\lambda/4$  length of 75 $\Omega$  coaxial cable for phasing, followed by a  $\lambda/4$  length of 50 $\Omega$  coaxial cable for matching. The lengths of the phasing and matching sections are critical to the performance of the antenna so great care should be taken during construction. In the review kit the coaxial cable was supplied cut to the correct length, but for those who don't want to take any risks, the antenna kit can be purchased with the phasing and matching harness ready-built.

**Do you have a BBC-B and an interest in weather satellites? If so, this weather satellite station from Spacotech could be just what you've been waiting for.**

The housing for the driven elements comprises a plastics moulding which is a tight push fit on the central aluminium column. The driven elements push into this housing and each element is held in place by a single screw which passes through the element and the housing making a good fastening. This screw fastening also serves to make the electrical connection via a simple solder tag. The main feed and the phasing harness are stowed in the central column which makes for easy weather proofing and keeps the antenna appearance very neat.

The mounting for the four reflectors comprises a very solid aluminium hub, which is itself secured to the central column by a single Allen screw. The reflectors push into this hub and are secured by an individual Allen screw for each reflector. For the antenna to work correctly the reflectors must be directly in-line with the driven elements and this is easily achieved as the reflector mounting hub can be rotated on the central column.

The final operation is to cement the plastics cap on to the driven element housing and spray the whole antenna with a good polyurethane varnish, though this is only really necessary if the antenna is to be mounted externally.

The only slightly odd point about the antenna is that the feeder is 75 $\Omega$  rather than the more usual 50 $\Omega$ , but this should not present a problem as ordinary 75 $\Omega$  TV coaxial cable is perfectly adequate.

## Receiver

The receiver kit supplied is actually produced by Martelec and is known as the MSR-20. The comprehensive 15-page, A5

instruction manual covers the construction from component checking through to the final alignment in logical steps.

The MSR-20 has been purpose designed for satellite reception and as such features an i.f. bandwidth of 50kHz to cope with the signal modulation of  $\pm 17$ kHz and the doppler shift from the satellite. The specification also includes a high sensitivity of 0.15 $\mu$ V for 12dB quieting. Fairly obviously a receiver with a high specification such as this is quite complicated and this is reflected in the degree of skill required to successfully complete the kit. Having said that, Spacotech do offer a fast turn-around service to repair and align any kits supplied by them, so if you have a problem help is at hand.

The circuit is fairly straight forward and operates as follows. The 137MHz signal from the antenna is capacitively coupled to two, low noise, m.o.s.f.e.t. r.f. amplifiers using a BF981 followed by a 3SK88. The amplified r.f. signal is then passed to another 3SK88 which is configured as a mixer. The mixer output is passed to a ceramic filter to produce the required 10.7MHz i.f. which is then coupled to a two-stage bipolar amplifier. This amplified i.f. signal is filtered once more with another ceramic filter before being passed to a SL6601 for conversion to the second i.f. of 300kHz.

The SL6601 also includes a phase locked loop demodulator which is used to produce the required audio signal. One other feature of the SL6601 is the noise mute output, this is used to operate a two stage relay driver with a delayed drop out. The relay contacts are used to mute the audio output in the absence of a signal and also to provide an uncommitted pair of contacts which make when a signal is received. These contacts can be used to automatically start a tape recorder or to stop a scanner when a signal is detected.

The delayed drop out is very useful as the relay remains operated even if the



# WXSAT WEATHER SATELLITE STATION REVIEW

signal should drop below the pre-set threshold for a short period, this quite often occurs at the extremes of a satellite pass.

After detection by the SL6601 the audio signal is fed to both a fixed level output socket and the volume control. The wiper of the volume control is connected to a TBA820M 500mW audio amplifier via the mute relay contacts to provide the audio muting. The final amplified audio output is then connected to a 50mm loudspeaker mounted on the front panel.

The local oscillator signal originates from one of six 14MHz crystals which are selected by diode switches. The third harmonic of the local oscillator is extracted and passed to a bipolar tripler to give the final local oscillator frequency of approx 126MHz.

The power supply is fairly conventional and uses a 1 amp bridge rectifier followed by a 7812 regulator integrated circuit.

The supplied p.c.b. was double sided glass fibre with the top side used as a ground plane. With the exception of the trimmer capacitor holes, all holes were of the correct size and spacing. The trimmer capacitor holes were unfortunately too small and had to be enlarged with a 1.2mm drill. The top-side of the p.c.b. was printed with a component overlay to ease construction, unfortunately the process of continual improvement has resulted in several component positions changing, especially as the review kit was an early one. These changes are detailed in the manual but require careful interpretation, more recent kits have these mods included properly. One very good point regarding the capacitor holes was that in most cases three holes had been drilled to allow the correct mounting of a range of capacitor packages.

The manual covers the receiver construction in 25 well documented steps and it is important to keep to the specified order otherwise you may well find that you cannot gain access to a top-side soldered connection! The first three stages of the

receiver use m.o.s.f.e.t. devices and it is essential that proper electro-static protection is used if the full performance of the receiver is to be realised.

One problem I did encounter concerned the fitting of six r.f. chokes. The manual stated that they should be fitted vertically if the larger bodied type are supplied. My immediate thought was, larger than what? Although the supplied chokes were quite small, when fitted horizontally, they did not leave adequate clearance for the fitting of the adjacent trimmer capacitors. I would recommend that any potential constructors fit these chokes (CH1-6) vertically to avoid this problem.

The receiver kit was very comprehensive and included the case, loudspeaker, sockets, switches, mains lead and mounting hardware there was even a pair of control knobs. I did encounter one problem with the p.c.b. mounting in that the hardware supplied meant that a nut is used to space the p.c.b. above the chassis. Unfortunately this did not give enough spacing to clear the crystal sockets and they shorted to ground disabling the oscillator. The cure is to either use proper spacers or insulate the chassis with some tape.

With the exception of the antenna and power supply, all connections to the p.c.b. were made using plugs and sockets which makes for a very professional finish and easy servicing.

The final operation was the receiver alignment which, although very simple, did require the use of a 137MHz signal generator capable of being frequency modulated by a 1kHz tone with a deviation of  $\pm 17$ kHz at an output level down to 0.2 $\mu$ V. I was fortunate in being able to use the PW/SWM Lab, but this may present a problem to some constructors. If you are stuck then Spaceteck will align completed kits for a very reasonable fee.

## Interface

The interface is a very important part of the

system as it is required to convert the recovered audio from the receiver into a form suitable for presentation to the computer.

It is probably appropriate at this point to briefly describe the format of the satellite signal. The recovered audio comprises a 2400Hz tone which is amplitude modulated by the picture information which can be either visual or infra-red. This audio signal is fed to a LM224 quad op-amp which amplifies and demodulates the picture information. This demodulated signal is then fed to a Ferranti ZN449E analogue to digital converter the output of which is passed to the user port of the computer. The power for the interface was also taken from the user port saving the complications of a separate power supply.

One of the common problems associated with weather satellite reception stems from the fact that the picture information is amplitude modulated on the carrier. This means that the density of the picture is dependant on the signal level. In this interface the problem is handled in two ways. First, a level control is provided to adjust the incoming signal level and secondly a black level control is provided which allows the user to vary the transition point between black and white just prior to the analogue to digital converter.

In order to achieve a properly aligned picture some synchronisation is required. The 2400Hz tone mentioned earlier is used for this synchronisation, by dividing this tone by 600 the required line sync. signal of 4Hz is produced.

The most common and versatile way of receiving satellite pictures is to record the recovered audio on a cassette recorder for demodulation and display later. The reason for this is simply that the satellite pass is short lived and it is much easier to record the signal than to fiddle about trying to obtain a perfect picture during a live pass. One of the problems of satellite reception is the occasional losses of signal at the start or end of a pass or those due to

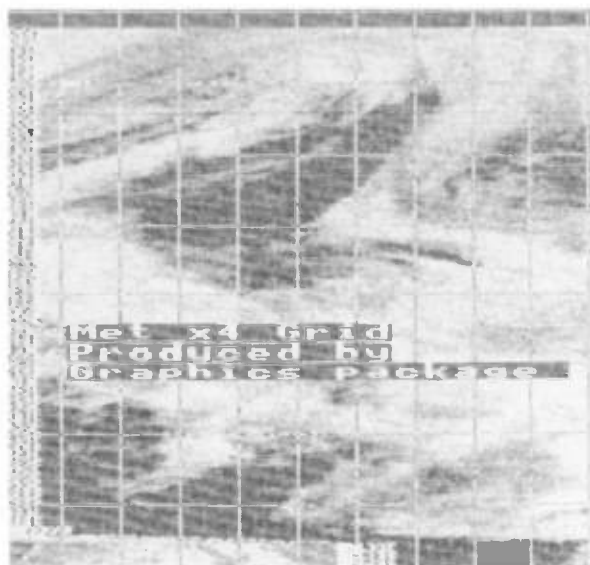



# WXSAT WEATHER SATELLITE STATION REVIEW

nulls in the antenna system. These losses of signal result in picture slip due to the lack of the 2400Hz sync. tone. This problem can be overcome quite simply by recording a good 2400Hz tone on one track of a stereo recorder whilst recording the signal on the other track. During playback the interface tracks the separately recorded 2400Hz tone to maintain synchronisation despite any signal loss. The Spacotech interface includes a separate crystal controlled 2400HZ oscillator to allow this type of recording.

As with the other items in this review the interface was constructed from a kit which was very well presented.

The glass fibre single sided p.c.b. was of good quality and the top side was printed with a clear and accurate component overlay. All components were supplied including the case, switches, sockets and pre-assembled interface leads.

The actual construction of the kit was very simple and presented very few problems. I did find some confusion in the instructions regarding the integrated circuits as the kit was supplied with only one socket whilst the instructions implied that sockets were required for all integrated circuits. I did speak to Spacotech on this point and they recommend that the integrated circuits are soldered directly to the p.c.b. Hopefully this minor problem will be rectified on later instruction sheets. One other point worth noting during construction is that the integrated circuits are not all orientated in the same direction, so be very careful to fit them correctly.

If the interface is connected up as per the supplied diagram, the distribution of signals to and from the tape recorder and receiver are all handled by switches mounted on the front panel making operation simplicity itself.

The testing of the interface was very simple thanks to a pre-recorded cassette containing sample pictures which was supplied with the kit.

## Software

As with most computer driven systems the overall performance is dependant on the quality of the software. The Spacotech system software comprises a 16K EPROM with the main decoding routines and a utilities disk which contains, among other things, a sideways RAM loader for the BBC Master.

The review system was used with a BBC B computer so my comments will refer to this implementation, though the operation on other models is virtually identical.

Although the software is very comprehensive Spacotech have taken great care to keep the operation as simple as possible. The easiest way to start is to install the EPROM (with the computer disconnected from the mains) and type \*DECODE. This enters the decoding routines which are controlled by extensive use of function keys. The default decoding parameters are as follows:

NOAA satellite 120 lines/min.  
South to North pass.  
Visible light greyscale.  
x2 Zoom.  
True colours.

Once the routines have been started the program gathers picture information from the interface via the user port and displays this information on the screen.

As mentioned earlier the decoding is driven by the function keys and the following parameters can be controlled:

Pause decoding.  
Restart decoding after clearing the screen.  
Toggle between visible light and thermal grey scale.  
Toggle between North/South and South/North satellite passes.  
Select 2Hz or 4Hz line rate for NOAA or Meteor.  
Select full frame, 1/2, 1/4 or 1/8 frame.  
True or inverse colours.  
Display or hide the current palette.  
Lighten or darken the whole picture.

Store the A/D gradient.

Draw or erase a plot of the most recent conversion gradient.

Show the status of the current decoding parameters on the top line of the screen.  
Flip from visual to infra-red channel and vice versa.

Tune the A/D conversion.

Load or save a picture on disk.

Load or save a palette on disk.

Fast scroll a picture left, right, up or down.

Invert a picture.

Change any colour in the palette.

Quit and perform a warm start.

Despite the very wide range of options available, Spacotech have done well to provide a very clear printed label which is placed above the function keys. This label makes the decoding routines extremely clear and easy to use. One question you may be asking is how can you control so many options with only ten function keys. The software handles this problem by having two levels of shift on each function key by using the SHIFT key for the first level and the CONTROL key for the second level.

Although operation of the decoding is very simple using the function keys the software is configured to allow other programs to access most of the decoding routines via \* commands. This is a very useful facility for the keen programmer as it will allow specially customised decoding routines to be written.

The supplied utilities disk contains three very useful programs.

The first is an alternative way of using the decoding routines which allows selection of the decoding parameters via menus as opposed to function keys.

The second program is a very comprehensive graphics package which allows stored weather pictures to be enhanced by the addition of text, grids and overlays. Once a picture has been loaded into the graphics package the modified image can be stored on disk or printed on an Epson compatible printer which is a very useful feature.



# WXSAT WEATHER SATELLITE STATION REVIEW

The final program on the utility disk is a routine to take a stored non-weather format image and convert it into a form which can be processed by the graphics package.

## Operation

Spacotech have put a lot of effort into making the system easy to use without sacrificing any useful features. This effort seems to have paid off as I found it very easy to set the parameters for the best picture. The graphics package was particularly useful for annotating pictures with text and overlays to produce a well finished result.

The receiver was very simple to use thanks to the use of crystal control and the measured sensitivity of the review kit was a creditable  $0.2\mu\text{V}$  for 12dB SINAD.

One point to remember is that in order to use all six channels extra crystals will be required which can get quite expensive these days.

The operation of the interface required careful adjustment of the signal and black level controls in order to obtain a properly balanced picture. One software feature which greatly eased this operation was the

tune A/D option. This option displays an indicator in the form of a short vertical line at the top of the screen, the position of which is proportional to the level of the signal being received. The level controls are adjusted so that the indicator gives an even display over the whole width of the screen.

One point I did find a little frustrating was that the interface uses the printer port as well as the user port. This results in having to swap leads when trying to print pictures using the graphics package.

The review kit included a modification to the interface board which added left and right shift buttons to allow the received picture to be centred quickly and easily. The modification was very simple and worthwhile, the only extra components required were a diode and a push-to-make switch.

Overall the whole system worked extremely well throughout the review period and produced some very good images. Most of the limitations were due to the computer screen format rather than the decoding hardware. The most detailed images were obtained by making use of the zoom functions to view fractions of a picture.

The WXSAT system is available from **Spacotech, L. E. Hornby, 21 West Woods, Portland, Dorset, DT5 2EA.**

My thanks to Spacotech for the loan of the review kit.

## Options and Cost

The WXSAT software (p.c.b., ROM, Disk and manual) £38.35.

Software and interface kit (p.c.b., ROM, disk, manual and parts) £59.95.

Cables for User and Printer port £10.00.

Interface hardware kit (port cables, case, feet, pillars and knobs) £14.95.

Interface and software built and cased £75.95 without cables or £85.95 with cables.

MSR-20 receiver kit (p.c.b., parts, connectors and 1 crystal) £54.68.

MSR-20 Hardware kit (Case, transformer, fuseholder, pillars, glands, knobs, switches and p.s.u. components) £14.75.

MSR-20 Receiver (built tested and cased) £94.45.

WX v.h.f. antenna kit £24.95.

WX v.h.f. antenna kit part assembled £26.95.

# TAKE ADVANTAGE OF THIS GREAT SUBSCRIPTION OFFER

Wherever you live, a Postal Subscription will ensure that you receive your copies of **SHORT WAVE MAGAZINE** and/or **PRACTICAL WIRELESS** regularly, through your own letterbox, before it gets onto your newsagent's shelf. Order a Joint Subscription and you will qualify for the Special Discount.

Fill in the Order Form below and post it to: PW Publishing Ltd., FREEPOST, Subscriptions Dept., Enefco House, The Quay, Poole, Dorset BH15 1PP (no stamp required). Credit Card Orders taken on (0202) 678558. Overseas subscriptions outside Europe are now despatched by Accelerated Surface Post for faster delivery.

Please indicate the type of subscription required:

Special Joint Subscription



- £17.00 (UK)     £14.00 (UK)     £27.00  
 £19.00 (Overseas)     £18.50 (Overseas)     £30.00

(Prices correct at January 1988)

To commence with issue dated

To: PW Publishing Ltd., Subscriptions Dept., Enefco House, The Quay, Poole, Dorset BH15 1PP.

Name .....

Address .....

I enclose cheque/PO (Payable to PW Publishing Ltd) £ .....

Charge to my Access/Visa Card the amount of £ .....

Card No.

Valid from  to

Signature .....

# SPECIAL OFFER

**Sandpiper  
Crossed Dipoles Antenna  
for Weather Satellites  
or Airband  
Save £2.95  
on the normal  
price of £14.95**

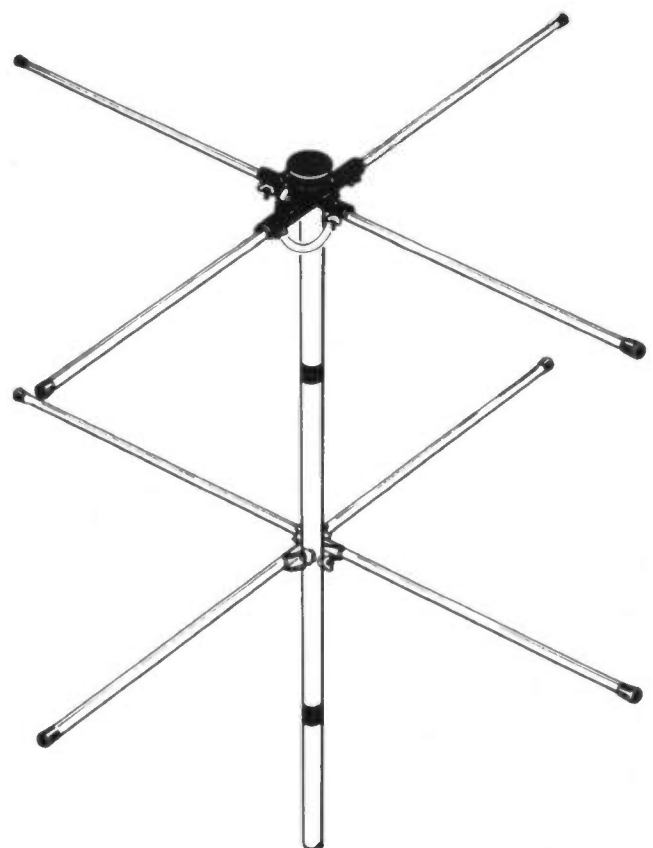

An efficient antenna is vital if you are to get the most out of your receiving station. Sandpiper Communications are noted for their range of soundly designed, high performance antennas and for those readers who are interested in weather satellite monitoring or airband listening their crossed dipoles antenna offers good value for money.

Now you can buy one of these antennas at our special offer price of £12.00 inc. VAT, plus £2.00 post and packing, saving yourself £2.95 over the normal price. The antenna comes in knocked-down form but is very easy to assemble with only a small screwdriver and a pair of pliers being needed. All the elements are pre-drilled and the phasing harness is already prepared. Full instructions are supplied with the package.

For those readers who don't mind drilling a few holes in some aluminium tubing, the antenna is also available in d.i.y. form. All the elements are cut to length, merely requiring you to drill a hole in each one at the appropriate point before you assemble the antenna. The coaxial cable for the phasing harness is supplied and only needs the ends preparing. Otherwise the kit is the same as the ready-made version. The cost of the kit is £9.00 inc. VAT, plus £2.00 P&P.

## HOW TO ORDER

Complete both coupons in ink, giving your name and address clearly in block capitals. Coupon (2) will be used as the address label to despatch your antenna to you.

Send the coupons with your cheque to: Short Wave Magazine Antenna Offer, Freepost, Enefco House, The Quay, Poole, Dorset BH15 1PP. No postage stamp is needed. If you wish to pay by credit card (Access, Mastercard, Eurocard or Visa only), please fill in your card number and sign the coupon where indicated.

Available to readers of *SWM* in England, Scotland, Wales, N. Ireland, the Channel Isles and the Isle of Man. Orders are normally despatched within 28 days, but please allow time for carriage. The closing date for this offer is 30 April 1988.

**(1)**

To:  
Short Wave Magazine Antenna Offer, Freepost, Enefco House,  
The Quay, Poole, Dorset BH15 1PP

Please send me ..... Crossed dipoles antennas @ £14.00 inc. P&P  
..... Crossed dipoles kits @ £11.00 inc. P&P

TOTAL £.....

I enclose P.O./Cheque No ..... Value £.....

My Credit Card number is

--	--	--	--	--	--	--	--	--	--	--	--	--	--	--	--	--	--	--	--



Please charge my credit card account with £.....



Signature.....  
 Name.....  
 Address.....  
 .....

Tel. No. (Home or Work).....

**(2)**

Name.....

Address.....  
 .....  
 .....

Post Code.....

If you do not wish to cut your copy of *SWM* you must send the corner flash with full details and remittance.  
 PW Publishing Ltd., Poole, Dorset (Reg. No. 1980539, England)

# WEATHER SATELLITES

Weather satellites currently come in two types, polar orbiters and geostationary orbiters.

## Polar Orbiters

The polar orbiters are put in what's known as a sun synchronous orbit. This basically means that the satellite will pass overhead at roughly the same time each day. The altitude of such an orbit is about 800km. Because of this low orbit, the picture resolution is very good and it is easy to make out large towns, rivers and forests.

The picture is sent down in a special format, similar to amateur slow scan, but with a very much higher resolution. This format is called APT or automatic picture transmission.

In most cases, two pictures are sent side-by-side, one being a visible light image and the other an infra-red image which shows land, sea and cloud temperatures. The two main makes of polar orbiters are the American NOAA series and the Russian Meteor series. Currently we have NOAAs 6,7 and 9 whizzing around our head and several Russian satellites, so there are plenty to receive pictures from. Both the types use the same APT format with modifications to suit. All these weather satellites transmit in the 136 to 138MHz band.

## Geostationary Orbiters

There are several geostationary weather satellites spaced, approximately, evenly around the world. A geostationary orbit is one in which the satellite takes one day to orbit the earth, thus it appears to be stationary at the same point in the sky at all times. The altitude of this orbit is about 38000km. The satellite which covers our part of the world is called Meteosat II (don't confuse with Meteor) and it sits above the 0 degrees longitude.

From a viewpoint in central England, it sits just east of south and about 30 degrees up. This satellite transmits on 1700MHz, so a small dish is needed to receive it. Although the picture format is similar to the APT of the polar orbiters, Meteosat sends down frames of pictures, so the transmission format has stop and start tones which can be detected to automatically start the receiving and displaying equipment. This kind of APT is called WEFAX (short for WEather FAX).

The satellite's pictures are produced by sending a whole earth disc at high resolution in digital format to the control headquarters in Darmstadt in West Germany where it is processed, cut up, country outlines and titles added and then sent back up to the satellite, which then acts as a repeater, transmitting the pictures to the end users.

Usually, the globe is cut up into nine squares with a naughts and crosses grid. Most of Europe is in the top right hand corner. The infra-red picture of this satellite is sent every half hour so

**The Remote Imaging Group wrote this as an introduction for beginners into the fascinating and informative world of weather satellite watching.**

the updates are quite regular. There are many other types of pictures from Meteosat such as water vapour, visible light images and weather charts, etc.

## Receiving & Displaying the Images

There are two frequency bands which can be received. First to consider is the 136 to 138MHz band. This is the band which the polar orbiters transmit in. The transmission is f.m. with a bandwidth of  $\pm 16$ kHz. Allowing for doppler shift, this means a receiver bandwidth of about 50kHz is needed. This rules out using a converter to amateur frequencies as most amateur receivers have bandwidths of around 5 to 10kHz.

Some scanners, such as the 2001 type have a wide f.m. mode which is for receiving broadcast radio, these can be used although the 150kHz bandwidth is too wide resulting in excess noise on weak signals. The signal is right-hand-circular polarised and only simple antennas, such as crossed dipoles, are needed. All this means that a special receiver is needed for optimum performance. There are plenty of designs and kits available costing from about £30 upwards.

To receive the geostationary weather satellites, we need to be able to listen to the 1700MHz signals. The easiest way to do this is to use a small dish. A 1.2m diameter dish is ample and the most simple type of feed horn is all that is needed. A pre-amplifier is needed for totally noise-free pictures before the 1.7GHz is fed into a down-converter.

There are a few commercially available down-converters, all of which convert the signal down to 137MHz so that existing v.h.f. receivers can be used to demodulate the signal. Meteosat transmits on two channels, 1691 and 1694.5MHz, so it has to be possible to switch between channels. This is done on most converters

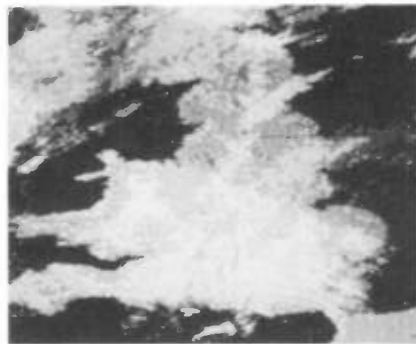

Mark Smith received this picture from NOAA 9.

by switching the local oscillator, but it can be done by switching the receiver up and down 3.5MHz.

In all the previous cases, the end of the v.h.f. receiver there is an audio signal. This signal contains a 2400Hz synchronous sub-carrier which has the information amplitude modulated on it. This can be converted into a picture in several ways.

Computers can be used to display the pictures and act as frame stores. An interface will be needed which decodes the signal and converts it into digital signals which the computer can handle. The advantage of doing this is that it can use existing computer power. The disadvantage is that the picture is limited to the resolution available to the computer. Typically this means only about 100 x 200 pixels for most home computers and worst of all only a few grey levels.

FAX machines are, of course, the traditional way of receiving APT. The FAX machines most commonly used are commercial types, converted to the correct drum and line speed. FAX machines are coming more onto the secondhand market, but require quite some modification before they can be used for APT and they are not the easiest of machines to get on with. However, the best weather satellite pictures are received on FAX machines converted to take photographic paper, which produce full resolution pictures with photo-like quality.

Digital Frame Stores have become the most popular way of displaying weather satellites. These are purely electronic devices which are basically in two parts. First there is an analogue decoder which takes the audio signal, decodes the information on it and puts it into a digital format. This is then taken into the second part of the frame store where it is stored in digital form on a memory array. This memory is then read back through a digital to analogue converter and the picture displayed on a monitor. Nearly all amateur frame stores are 256 x 256 pixel with 64 grey levels producing a good quality picture. Ready-built and kit frame stores are now very popular.

As interest in receiving weather satellites has risen steadily over the past few years, a group was formed in March 1985. This group is called **The Remote Imaging Group**, or RIG. It was formed to promote and further interest in weather satellite watching and become a point of liaison with official bodies such as the European Space Agency, NOAA, AMSAT, RSGB and others. The group now has over 650 members, a good percentage of whom are active watchers. The group publishes a quarterly newsletter which gives satellite predictions, constructional projects, news and views (excuse the pun).

The subscription rates are £4 a year, but if you wish to join, send an s.a.e. to the **RIG Secretary, Phil Seaford G8XTW, 14 Nevis Close, Leighton Buzzard, Beds LU78XA.**

# METEOSAT RECEIVER SYSTEM



Before you set up a weather satellite receiving station it's best to know what you are looking at.

Meteosat 2 was launched in June 1981, it is geostationary and therefore provides nearly 24 hours of pictures each day. Its orbital period is such that, from a point on the surface of the earth, it appears to remain stationary in the sky. From such an orbit it can see a large area of the earth.

The Meteosat satellite was built by ESA (European Space Agency) and launched by an Arian rocket from French Guiana. The Meteosat system comprises of both the satellite and a ground station in Darmstadt, Germany. This ground station receives the data transmitted every 30 minutes and processes it as well as adding land mass outlines to the picture. They are then transmitted back to Meteosat in the correct sequence dictated by the dissemination table. End users receive from Meteosat a series of pictures delayed by about 30 minutes. The image of the whole earth has then been divided into smaller areas.

The system that Peter brought to the office comprised a dish, a receiver, a converter/frame store and a monitor. The instruction manual says that the dish, "must have a clear line of sight view to due south with an elevation of approximately 30°". Well, we've all read instructions like that, and then two hours later have been still fiddling. Not in this case, the dish was placed on a bookcase by the window and swivelled once or twice and straightaway found the satellite.

The converter, which can be up to 10 metres away from the dish, simply plugs into the receiver which can be up to 35 metres from the converter.

The colour frame store represents a radical departure from many other systems currently available. It has a high quality RGB colour synthesiser and 64 grey levels rather than the usual 16. It has full tape recorder switching which eliminates the "spaghetti wiring" and constant lead changes.



SWM



For 24-hour pictures from Meteosat, the frame store will automatically start and stop as well as position the picture centrally on the screen. So you can leave it unattended (as a talking point for friends and visitors perhaps?).

Assembling and connecting up the system is really quite simple. First it is necessary to find a suitable home for the dish antenna, any obstructions will affect the signal. When the dish was brought into the office it was "flat packed", well nearly and you have to move the sliding arm around to make a stand. There's plenty of nuts, bolts and split pins to help with the job.



After connecting the converter, an extension speaker is used to position the dish. Select CH1, s.h.f. and channel 6, you should hear a signal. Now swinging the dish in an arc to find the best position — easy isn't it. Once the dish has been positioned it really should be clamped into position. If the dish is being mounted outside you may need to borrow a friend to get things tuned correctly.

One point Peter made was that it really is a lot easier to line everything up when a signal is being transmitted, so you'll need to consult the Meteosat charts for the times.

The instructions that come with the system, we "borrowed" a copy to read, are very straightforward and easy to understand. If they are followed there should be no problems. Included in the instructions are the dissemination tables for Meteosat. The earth is split up into segments, and the table details which pictures are transmitted at which times, enabling the user to find the most interesting views.

All in all we were quite impressed in the office, and you can see from the photographs the types of views we were able to see. You can see Italy quite clearly in the picture at the top left.

If you would like more details of the Meteosat receiving system, then contact **Garex Electronics, Harrow House, Akeman Street, Tring HP23 6AA**. The system costs £995.95 for a dish, microwave receiver, frame store, 12in b/w monitor and all plugs and cables, the colour frame store costs £454.25. An s.a.e. will bring full details and prices of other "separates". Many thanks to Peter for the demonstration. □

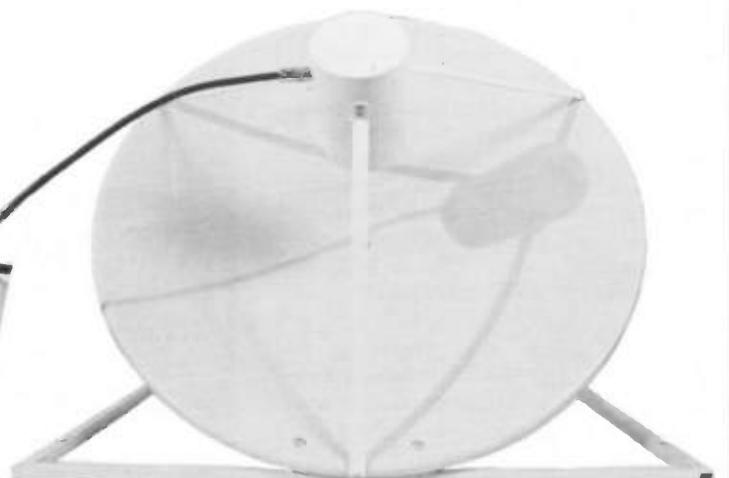
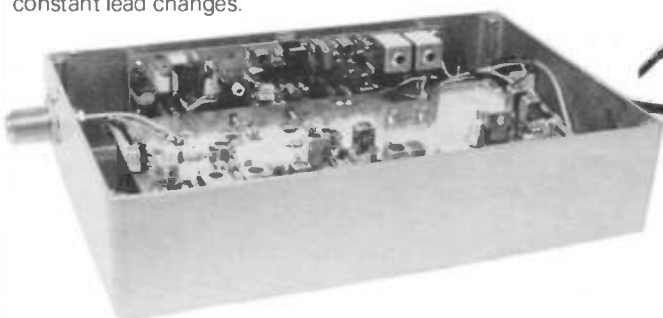

# WEATHER SATELLITE RECEPTION

Peter Rouse GU1DKD

I should explain that I am now something of an expert on getting going on weather satellites. By that I mean that after several months of frustrating trial and error I have finally got there. I am sure that you too have seen articles, seen the advertisements and thought GREAT! Just buy the goodies, twiddle the knobs and *voila!* your own instant round the clock, d.i.y., forecasts whilst sitting in front of the telly flippantly informing Michael Fish that you could have told him that hours ago. It is that easy, isn't it?

You and I both know there has to be a catch. The professionals use equipment that costs an arm and the proverbial leg so don't, for one minute, think you are going to get pictures on a par with the ones they show after the BBC television news.

So, what can we "garden shed boffins" achieve with a budget of about £100? First you must decide how far you are prepared to go with this weather satellite business. Forget the radio side for a moment and let's consider the method of decoding and display. The first and by far the best method is to use a digitiser or analogue/digital converter and store the pictures in a digital frame store. You can buy a ready-made one for hundreds of pounds or you can build the YU3UMY system that is the favourite amongst the more dedicated enthusiasts. If I ever get mine going I'll let you know.

The cheapest, and by far the most popular, option is to use a digitiser with a home computer and suitable software. On top of that you will need a receiver with suitable i.f. bandwidth, an antenna (preferable with pre-amplifier) and a tape recorder. The latter is essential because the computer sprays r.f. all over the place and you will not be able to decode pictures in "real time". The tape recorder is also somewhat critical because strange things happen to the signal if it is even slightly compressed, that is what modern cassette portables, with their automatic level controls, do. More on the equipment later though.

## Where the Birds Sing

Our American cousins call satellites "birds", and there are two species; orbiters and geostationaries. The orbiters are in polar orbit. In other words they just rotate between the North and South Poles. As the earth turns they look down on different sections on each pass (each orbit takes about 101 minutes). The image they scan is in about a 25 degree wide "window" and during the course of a day their "window" will cover the UK twice at least, although some passes may be in darkness.

NOAA 9 image at 4.15pm on 5 September 1987. This 4X zoom picture shown most of England, Wales and Ireland clear of cloud. Note the wide band of cloud sweeping down across the Netherlands and central France.

Much time can be wasted when you first start trying to build up your weather satellite reception station, hopefully after this article more time will be spent receiving pictures than head scratching.

The two current American orbiters are the easiest to keep track of because the various reference figures needed to predict their pass times are published regularly. NOAA 10 makes a pass at around mid-morning and in the evening, NOAA 9 passes overhead around mid-afternoon and during the very early morning, usually in darkness. Morning passes are south-bound, afternoon and evening passes are north-bound.

The Russians have even more satellites in orbit, although some are at the end of their operational life and their performance can be erratic. They can provide excellent pictures on systems that have dozens of grey scales but on simpler computer based systems and just 4 grey scales it is near impossible to differentiate between land and sea.

The geostationaries on the other hand are level with the equator and move in an orbit at the same speed as the earth. In other words, if you were able to sit and look at the satellite during the course of the day, it's position would not move in relation to yourself. There are two other major differences between geostationaries and orbiters. The orbiters "squirt"

their signals down in the 137.5MHz v.h.f. band and send raw data, i.e. the image as they see it together with any distortion that may occur as a result of looking at part of the earth sideways. NOAA 9 also sends a high resolution pictures at u.h.f., but the equipment needed for this is beyond the scope of the beginner.

The geostationaries use the "S" band between 1675 and 1707MHz, and although they too send raw data, they also send enhanced images. This is where the raw data is processed by a ground station and computer enhancement is used to remove distortion, clean up the image and even superimpose a map outline over the land mass even when covered in cloud, (very important when looking for Britain during the summer). The cleaned-up signal is transmitted back to the satellite which then re-broadcasts it. Occasionally a picture of the entire earth is sent, known as the "whole disc", but for the most part the surface visible to the satellite is split up into boxes and a different box is transmitted every 4 minutes. The European satellite is Meteosat and of late it has been re-broadcasting some of the images from GEOS-East, showing the eastern seaboard of America.

## The Hardware

For the purpose of this article, I am going to stick to the v.h.f. satellites, because unless you have an overweight wallet, this is the best place to cut your teeth.

By far the cheapest and easiest antenna to use is a crossed dipole phased for right-hand circular polarisation. Performance is greatly improved if you use a line-

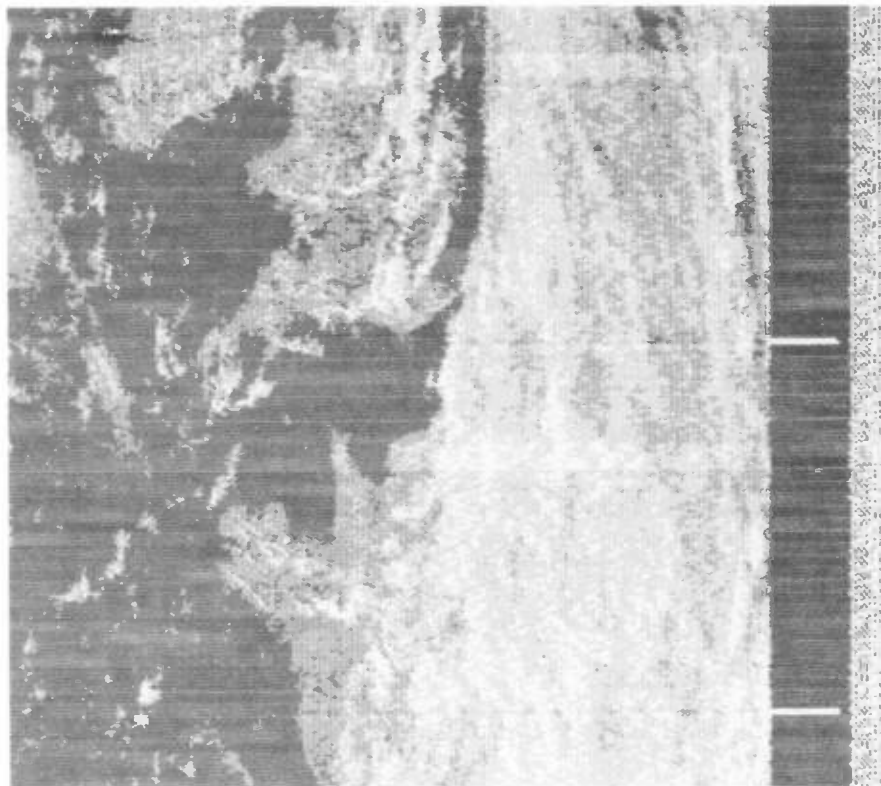

# WEATHER SATELLITE RECEPTION

## Part 1

powered, narrow-band, amplifier because the signals are not very strong unless the satellite is overhead. You can build your own antenna, or buy one ready-made, but one important point which is rarely stressed is that the mounting pole must be non-metallic or the polar pattern will be upset.

Next comes the receiver. The signals from the satellite consists of an f.m. signals with a.m. sub-carrier. It is about 30kHz wide, has no pre-emphasis and the frequency can wander by several kilohertz during a pass because the Doppler shift created by the movement of the satellite. Few v.h.f. scanners can cope with this bandwidth, although sets from AOR, Yaesu and Icom can be used on the stronger part of the pass in wide-band mode. Reception tends to be noisy in w.b.f.m. and a much better solution is to use a receiver designed for the band. Several are available in kit form and use techniques such as a.f.c. to track the doppler shift. Most also incorporate squelch activated switching to control a tape recorder so that the signal can be automatically recorded. If you want to modify an existing receiver, then note that 50kHz bandwidth filters with an i.f. of 10.7MHz are available from Cirkit.

The digitiser you buy will be determined by the computer you own. Unless you have a BBC or Amstrad, then stick to gardening or home wine-making. Amstrad owners are limited to the system supplied by Maplin, but BBC owners have a wider choice with prices starting from under £40 for a no-frills system. Whatever system you buy, the picture you finally get will be limited by the abilities of the

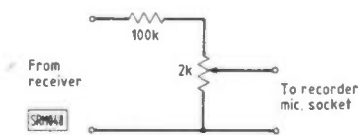
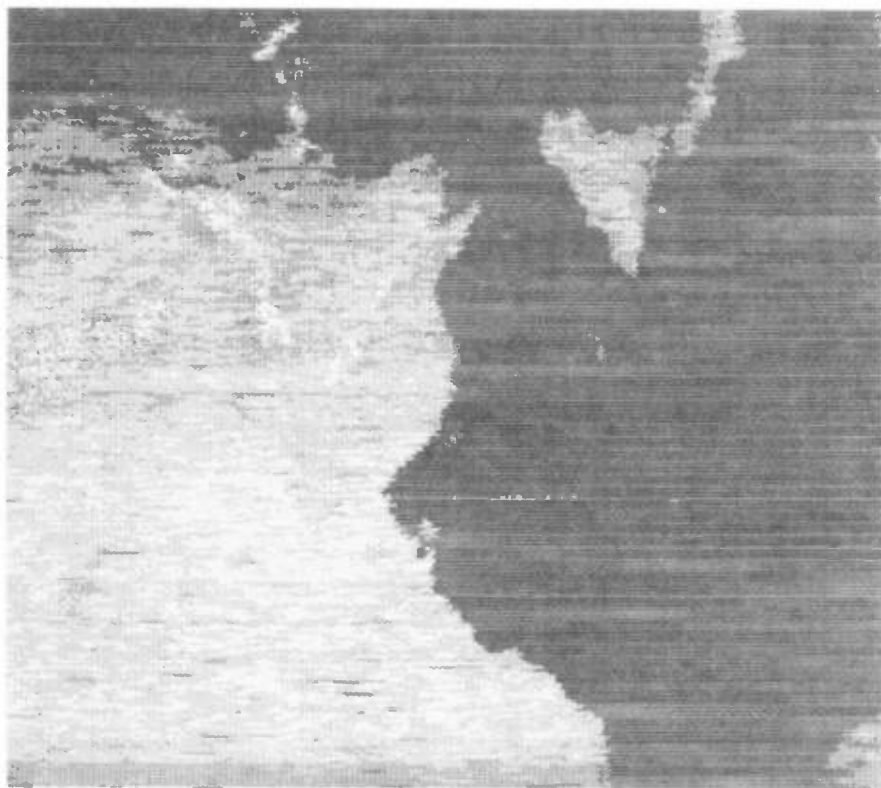

Fig. 1: Variable attenuator suggested by Infotech for use on recorders with a.g.c.

computer. The picture transmitted from the satellite is in black and white and so for instance, on my own BBC system, colours are used to represent just 4 grey levels. Despite that, the contrasts between land and sea is good, particularly in the summer. The software supplied with most digitisers allows a degree of zooming, so that a close up view of the British Isles can be seen. The software will also have options to choose NOAA, Russian and Meteosat, as they all use different formats. The digitiser will also have a switch to select between the automatic picture transmission (APT) of NOAA's and Russians or the "Wefax" system used by Meteosat. The only variation here is the Maplin system which uses plug-in cards to select different systems. Maplin say their digitiser will work with any computer that accepts data in 8-bit format, but for anything other than a BBC or Amstrad you will have to write your own software (good luck). Most digitisers and their software allow images to be stored on disk, but note

**NOAA 9 image of 4X zoom showing the tip of Italy, Sicily and the coast of North Africa including Tunisia and Libya. Even Malta and Gozo can be seen just to the south of Sicily.**



that you won't get many images to a disk because of the amount of memory needed.

Now the tape-recorder and recording technique. This is the biggest stumbling block for the beginner and believe me I have stumbled. As mentioned earlier, the signal does not like being compressed in the slightest. Unless you buy a professional cassette recorder, it is virtually impossible these days to buy a portable one which has manually adjusted recording level. You are left with two options. The first is to use a stereo cassette deck (most have manual adjustment). Even this method can present problems and may need some experimenting. Try recording the signal as two-track mono, or use just one of the stereo tracks (assuming you can keep the input level at zero on the other track to kill circuit noise). If you still cannot get good results, try different recording levels particularly ones that keep the meter needle a fair bit below the 0dB mark.

It is not impossible to use a portable type recorder with automatic level adjustment but two things are essential. It must be good quality, or any "wow and flutter" will cause problems. An external attenuator will have to be used to limit the input signal to the a.g.c. threshold point. Infotech, who supplied my own system, recommend the circuit shown in Fig. 1. With a satellite signal tuned-in, set the potentiometer to maximum and plug earphones or an external speaker into the recorder so that the recorder's level can be heard. Set the recorder going and slowly wind-down the potentiometer. At some point the volume should just start to drop and that is where you should leave it set. If problems are still encountered then use the potentiometer to reduce the input a fraction more. My final tip is this; optimise record for the "mush" produced by the receiver when it is unsquelched and receiving no signal and use that as your record level.

The only final point to mention now is that most low-cost digitisers need careful adjustment of the input level as well to work properly. Start the picture scan by working with the minimum audio level needed to produce a reaction on the screen and increase audio to optimise the "grey scale".

## Problems

As you will have realised by now, there are several areas where problems can arise so let us look at some typical symptoms.

First the receive stage. If all is well you should be able to hold a near noise-free signal for at least 10 minutes (with no zoom, this is the time it will take to fill the screen). If your antenna is a good one and well sited, you may even be able to track the pass for up to 15 minutes or more and even get pictures from non-UK passes covering the Eastern side of the

# WEATHER SATELLITE RECEPTION

Mediterranean. Loss of signal partway through a pass will either be drift due to doppler shift or an antenna problem (usually due to phase matching of the two dipoles as I will be explaining in a future part).

Now picture problems. The easiest way to determine all is well is to select for simultaneous infra-red and visible image on a NOAA pass. Note that with some systems the input volume has to be optimised for one or the other so if this is the case, optimise for visible image as this will be the easiest to recognise. If all is working well, the two pictures should be side-by-side on the screen, the grey scale bars between them should be recognisable and uniform with no jitter on their vertical lines. A bad burst of radio interference can cause synchronisation loss but for the most part, any problems can almost certainly be blamed on the tape recorder or recorded level.

## When all is Well

Using a budget system is fiddly and frustrating at first, but believe it or not you do eventually get the hang of it. There are times when there is so much cloud around that you can hardly recognise any land mass, although you do eventually develop an instinct for knowing what should be where on the screen. Get a good map of Europe to help you recognise the land masses and note the white marker bars to the right of the visible image which mark

every 5 degrees of latitude. The tip of Spain and coast of North Africa are clear on most days and provide a good reference point. Don't be surprised if you suddenly realise that the jumble you have been puzzling over suddenly emerges into a recognisable scene.

Chris Meadows of Infotech tells a wonderful story of a disgruntled customer who wrote a stiff letter claiming he thought their product to be load of old \*\*\*\*. He included disk images to prove his point, and Chris now has a set of some of the finest pictures ever seen on an amateur system!

There is not a lot to see in winter because light levels are so low for most of the day that the lack of a wide range of grey scales on budget systems mean that it becomes difficult to differentiate between land and sea. This symptom also occurs even in the summer when on cheaper systems it is difficult to spot

anything north of Scandinavia even though signals are received. Despite these problems, it is terrific fun looking at the pictures each day and also quite amusing to show off the equipment to friends who invariably treat you either as an amazing genius or a candidate for the funny farm. Do not be surprised if you get hooked, you will not be the first.

## Coming Next

The whole business is very hit or miss, unless you know when the satellites are overhead. In subsequent issues we look at where to get a weekly update on satellite data and a simple program to predict pass times. There will also be details on building an antenna (materials are waiting at your hardware store) and matching pre-amplifier, an audio monitor 'cum level indicator and more on who can supply all the equipment. There'll be a list of national groups who cater for enthusiasts. □

You do not require a licence to receive weather satellite signals, but you do need a Letter of Authorisation. There is no charge and you should send a letter and s.a.e. to **The Department of Trade and Industry, Radio Regulatory Division, Room 309, Waterloo Bridge House, Waterloo Road, London SE1 8JA**. State that you wish to receive NOAA and ESA signals for amateur meteorological purposes and require a letter of authority.

It is also a good idea to join the Remote Imaging Group, RIG. Membership is only a few pounds and the quarterly newsletter is packed with information about equipment, books, software, satellite news and charts showing pass times. Also, all RIG members have blanket permission from the DTI to watch weather satellites for amateur purposes. For details send an s.a.e. to **Phil Seaford, 14 Nevis Close, Leighton Buzzard, Beds LU7 7XD**.

# AMATEUR RADIO AYR

Dorothy Dunbar

There are between thirty and forty members at each meeting, comprising railway workers, business men, agriculturalists, engineers, farmers, miners and of course, disabled people, who find this hobby an ideal one for them. The Ayr club callsign is GM0AYR.

One of their most enthusiastic members is Jack Wilson, a miner. "In those early days", he remembered, "I had a contact on one of the Tonga Islands, but another interesting contact I had was Kurt Karlsen, the captain of the *Flying Enterprise*. We were in contact with each other on the night the ship went down." Jack has always been interested in slow-scan TV. "There are great improvements in it now," he said. "In the old days you received only an outline of your contact, but now the still pictures are in colour."

One of the more professional members is Gary Olesen, an Air Traffic Controller at Prestwick Airport. He is one of the three Morse code examiners belonging to the Ayr club. His callsign is GM3GQO and he has contacts all over the world, and with his family, has visited many of them.

The Ayr club recently won a contest run by the Glasgow Group, and they are hoping to do well in the National Field

Day which is held at the beginning of June.

It was 1947 when a few enthusiastic "hams" in Ayrshire joined the Radio Society of Great Britain. After meeting for years as the Ayrshire Branch of RSGB, the group formed the Ayr Amateur Radio Group.

As well as the club in Ayr, there are two other clubs in Ayrshire, one in Kilmarnock and one in Irvine. Altogether, the county has 130 radio amateurs.

The photograph shows some of the Ayr members at one of their home brew evenings. So enthusiastic are they that there may even be a radio station set up for them in the Leisure Centre in a few years. □

□





# VISIT TO RUSSIA

Douglas Byrne G3KPO

It had been an excellent dinner in this gigantic Russian Hotel. I was slowly sipping my second cup of black coffee when I first noticed the big man enter the room. He really was big, very big, with square shoulders. Stern-faced, with a grim look. As he came through the door, I instinctively knew it was me he was after . . . Slowly, very slowly, he walked down the tables, examining each of the tourists in turn. After what seemed an eternity, he reached my table, stopped, and looked me straight in the eye. "KGB," he said grimly.

Standing up very slowly — "Well, I am British" — I replied "KPO, G3KPO. How do you do," and proffered my hand.

This he immediately grabbed and roared with laughter. "Just my little joke. I was looking for your RSGB badge. Come and meet the boys."

And they were the friendliest crowd of amateurs it had ever been my pleasure to meet, communication being comparatively easy as so many spoke excellent English.

For instance, Leo UA3CR, well-known in AMSAT circles, took the trouble to travel several miles after finishing work one evening, especially to have a chat and present me with a fine Russian cake, topped with Moscow University in icing sugar!

## Electronics Exhibition

Visiting the Electronics Exhibition which takes place every other year in the vast Economics Achievements Park on the outskirts of Moscow, I had no sooner entered the main hall when, once again, my RSGB badge was recognised. I was literally pounced upon by a group of smiling, laughing radio-amateurs, who bore me off to the special demonstration transmitting station U3WRW. Here, they sat me in the operator's chair, and immediately invited me to transmit. The thought crossed my mind that had the boot been on the other foot, and a Russian tourist visited a GB-station in this country, would the British amateurs have felt free to offer him the microphone?

QSL-cards were exchanged, and sincere thanks expressed for the two international callbooks (Foreign and American) donated by *Short Wave Magazine* for the use of the Moscow Radio Club, and which I had carried all the way from the Isle of Wight — they kept growing heavier and heavier en route!

Incidentally, there was no holdup at Moscow Airport as expected, for when I explained to the Customs Officer (a pretty young girl) what they were, she didn't give them a second glance. Was I expected?

As is generally realised, all the amateur-radio equipment in the USSR is home-built, and that shown at the Electronics Exhibition was of a particularly high

**Douglas Byrne G3KPO, curator of the Wireless Museum on the Isle of Wight, made his first visit to the Soviet Union back in 1985. He tells us how he felt about the whole trip and the people he met.**

standard with a really professional finish — quite as good as anything from the Far East. The circuitry was modern, and the specs first-class — as was proudly explained by the amateurs on duty.

The Exhibition ran for a month, all QSOs with U3WRW being logged on a home-built computer constructed by members

of the MSC. This not only kept a complete record of every contact, but also filled in the QSL-cards, signing itself "Amateur Computer-Secretary Delta 80.2". The thought crossed my mind that it was all very well having a computer as secretary, but could it make the tea or sit on the boss' knee?

## Model Moggy

Amongst the several stands of amateur radio equipment were some especially designed to appeal to youngsters, showing simple electronic games they could build on the proverbial "kitchen table".

One particular toy which caused considerable amusement was the wooden model of a cat. When a little carved wood



G3KPO handing over the callbooks donated by *Short Wave Magazine* to members of the Moscow Radio Club. Photo taken at the entrance of the Radio-Electronics Hall at the Economics Achievements Park in Moscow.



The little wooden cat which flashes its eyes and mews when the wooden fish is waved in front of its nose!

fish was waved in front of it's nose, the cat's eyes flashed alternately and it mewed quite realistically. When the fish was taken away, both eyes flashed together and it literally screamed! Murphy's Law also operates in Russia, for when first demonstrated to me, the cats failed to make any response — merely a "dis" on the battery, but cause for a special laugh . . .

## Land of Contrasts

This was my first visit to the USSR, and I found it a land of contrasts. The majority of the old churches have now been turned into museums, although 21 are still active in Leningrad. Their roofs shine brilliantly in the sun, as the slates are of solid gold — and they are full of priceless art treasures. In comparison the giant blocks of apartments sadly need re-decoration. Many of the older ones erected just after the war are now being replaced by new buildings, much higher and of a better standard.

In vain did I search for graffiti or any sign of vandalism, or for that matter, a speck of paper or an empty carton on the streets! It must be said that the rubbish-bins are every hundred yards or so, so there is no excuse to drop garbage — and there is also a policeman the same distance apart . . .

Had I not met the radio-amateurs, who were so smiling, happy and out-going, I would have thought the Russian people were very grim and dour for they walk about the streets in such a quiet, subdued way.

## American Students

A party of young American teenage students staying in our hotel went for a walk in Moscow. They were laughing and chatting together when stopped by a young policeman. At first they thought he was merely trying to chat them up, but soon discovered that was certainly not the case. He pulled down the corners of his mouth with his fingers, and made them understand one did not smile and laugh when walking on the pavement in Russia! Needless to say, they returned to the hotel completely flabbergasted.

## As in 1946

My own general impression was that conditions were very much the same as I remember them to be in England just after the end of the war, with time wasted filling in innumerable forms, all in triplicate, and constant queueing for everything. There was little enough in the shops to be bought, and immediately something did appear, a queue formed — as it did here in '46 and '47. For instance, one queued up at a counter in a shop, then queued at the



U3WRW: This was the special QSL issued for contact with the exhibition station.

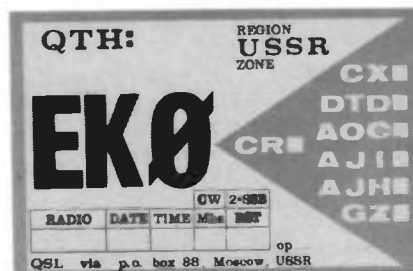

One of the many QSL cards I picked up on my visit.



QSL card celebrating to Polar Expedition.

cash-desk to pay your roubles. Having obtained a receipt, back to the counter to queue, yet again, to obtain the goods — providing they had not been sold in the meantime!

## Other Problems

The other problem was that of simple communication with a people whose language was not only so completely different, but one in which it was impossible to read such simple things as street names.

For instance, on the Metro, the station

names are hidden behind posts, so it was necessary to count the number of stations from where you started to where you wished to go — and keep your fingers crossed.

Everyone looked so very "English" and yet few spoke our language. Enquiring of a crowd, generally someone would say they spoke a little, or even answer in French — about the same standard as mine!

They would then assist as much as possible, and go out of their way to escort me wherever I wanted to go — which was a great help in what I always felt was a "foreign" land.

## Contrary

Contrary to what I had been led to believe, no restrictions were placed on where I went, and as far as I could tell, I was never watched by "Big Brother" — although his presence could be felt all the time! There were police everywhere, so the man-in-the-street did exactly as he was told — especially the foreign tourists!

We filled in forms on entering and leaving the country, showing how much money we had brought in and later took out with us, and had to keep receipts for all purchases. I was approached by a young man wanting to buy my camera, and a few other tourists had offers to buy their clothes. Essentials were cheap, housing, heating and travel — a shilling anywhere on the Metro, — but so-called luxuries prohibitively expensive. Nylons £7 and a cheap-looking raincoat £150.

There were so many police about and no signs of vandalism that I felt perfectly safe on the bus or Metro, or even walking late at night. Perhaps not exactly a relaxing holiday, but certainly an experience not to be missed!

# Automatic Notch Filter

Model ANF stops QSOs being ruined by tune-up whistles. It automatically removes tones within seconds of their arrival on frequency, leaving the QSO in the clear! Classy technology, but simple to use and fit.

**Price: ANF £67.85** Inc. VAT

To order simply dial

**0532 744822**

or write with cheque or postal order to



Dept SW Datong Electronics Ltd., Clayton Wood Close, West Park, Leeds LS16 6QE



Access/Barclaycard welcome — Fast delivery service

Catalogue and data sheets on any product available free on request. Dial 0532 744822

## GUIDE TO UTILITY STATIONS 1988

(6th edition)

including

### GUIDE TO RADIOTELETYPE STATIONS

(14th edition)

480 pages. £21.00 or OM 60.00. ISBN 3-924509-88-3

The fully revised new edition is the first publication in the world giving exact details on teleprinter stations using those new ARQ-E, FEC-A, etc., systems. Hundreds of frequencies of these stations are listed, as well as the results of our 1987 monitoring missions to the Yemen Arab Republic and to Mauritius/Réunion/Rodrigues.

This unique manual covers the complete short wave range from 3 to 30MHz, plus the adjacent frequency bands from 0 to 150kHz and from 1.6 to 3MHz. Contrary to imitative publications it is built on real-time monitoring throughout the year around the clock. It includes details on all types of utility stations including facsimile, Morse, phone and teleprinter stations, the latter covering the entire spectrum from standard RTTY over SITOR to all those fascinating new ARQ, FDM, FEC, TDM and VFT systems.

The numerical frequency list covers 15802 frequencies of stations which have been monitored during 1987, thereof 33% RTTY and 3% FAX. Frequency, call sign, name of the station, ITU country symbol, types of modulation and corresponding return frequency, or times of reception and details, are listed. The alphabetical call sign list covers 3123 call signs, with name of the station, ITU country symbol, and corresponding frequencies.

77 RTTY press services are listed on 502 frequencies not only in the numerical frequency list, but also chronologically for easy access around the clock, and alphabetically in country order.

Additional alphabetical indices cover:

- Schedules of 72 meteorological FAX stations on 287 frequencies.
- 81 meteo RTTY stations on 243 frequencies. 518kHz NAVTEX schedule.
- 952 name and traffic abbreviations and signals. 182 telex service codes.
- 983 utility station addresses in 201 countries.
- Radio Regulations on frequency and call sign allocations.
- Frequency band plans for the Aeronautical and Maritime Mobile Services.
- All Q-code and Z-code groups for civil and military use.
- Emission designations, classes of stations, and various other tables.

Further publications available are Guide to Facsimile Stations, Radioteletype Code Manual, Air and Meteo Code Manual, etc. For further information ask for our catalogue of publications on commercial telecommunication on short wave, including recommendations from all over the world. All manuals are published in the handy 17 x 24cm format, and of course written in English.

The price includes airmail to anywhere in the world. Payment can be by cheque, cash, International Money Order, or post giro (account Stuttgart 2093 75-709). Dealer inquiries welcome — discount rates and pro forma invoices on request. Please mail your order to:

#### KLINGENFUSS PUBLICATIONS

Hagenloher Str. 14, D-7400 Tuebingen, Fed. Rep. Germany. Tel. 01049 7071 62830

## spacetechn



L. E. Hornby, 21 West Woods, Portland, Dorset DT5 2EA. Tel: 0305 822753

OUR RANGE OF SATELLITE PICTURES AND PUBLICATIONS IS STILL EXPANDING. PLEASE ASK FOR OUR LATEST LIST:

- |                                |   |
|--------------------------------|---|
| ★ Remote sensing books         | ★ Superb choice of colour image atlases |
| ★ Guides on how to get started | ★ Photographic prints & slides          |
| ★ Videos . . . sale or hire    | ★ Satellite image posters               |
| ★ Teaching Materials           | ★ Landsat ★ Spot                        |
|                                | ★ Meteosat ★ NOAA                       |



This picture is a screen photo of a NOAA image decoded by our popular WXSAT software and receiving station for the BBC computer:

- ★ RECEIVERS ★ ANTENNAS ★ DECODERS ★ SOFTWARE  
★ PREAMPS ★ ACCESSORIES

Complete starter packs available £139.95  
PLEASE ASK FOR BROCHURE

Take a look at our EVALUATION DISC before spending more money than you need on an inferior system ONLY £3 REFUNDABLE & MAY BE FREELY COPIED.

WEATHER SATELLITE SYSTEMS  
& PUBLICATIONS

# STARTING OUT

Brian Oddy G3FEX

Although the cost usually bears some relationship to the quality and performance of a product, it is advisable to study the design features of each receiver carefully and then arrange for a demonstration of the most likely models before making a final decision. Of course a basic knowledge of superhet principles and the circuit arrangements which are likely to result in good or bad receiver performance would enable the choice to be made more easily, so let us now consider some of them.

By studying, in simple terms, some of the problems associated with the cheaper sets, the need for the more complex circuit arrangements used in the higher priced receivers will then be evident. Furthermore, they will provide an insight into the even more complex circuit configurations used in communications receivers, which set out to achieve the high standards demanded by professionals and some dedicated DXers.

Although many of the cheaper receivers provide coverage of the long, medium and short wave bands, reception is often unsatisfactory, especially on the s.w. bands. In order to cut the manufacturing costs, only the basic superhet building blocks of mixer, local, oscillator, i.f. amplifier, detector and audio output stage are employed in these designs (see last month) and it is important to be aware of their limitations.

One of the most undesirable effects stems from the first stage of these simple receivers, namely the mixer or frequency changer and often results in broadcast and other stations appearing where they are least expected on the dial! In order to understand why this may happen, it is necessary to reconsider the operation of the mixer, whereby an incoming signal ( $f_c$ ) is mixed with a locally generated oscillation ( $f_o$ ) to produce two additional frequencies, namely the sum ( $f_c + f_o$ ) and the difference ( $f_c - f_o$ ), usually called the **intermediate frequency** or i.f.

## Image signals

It is important to realise that the locally generated oscillation ( $f_o$ ) can be placed above or below the incoming signal ( $f_c$ ) to produce the same i.f. It also follows that any signal, spaced above and below the local oscillator by the i.f. will be mixed with the oscillator to produce an i.f. and this is where a serious problem arises, because the selectivity of the tuned circuits associated with the desired incoming signal ( $f_c$ ) at the input of the mixer may allow unwanted signals on the other side of the local oscillator to enter too and be mixed to produce an i.f. When this happens, so called **image signals** appear.

To illustrate the foregoing with a practical example, assume that one of these simple receivers is set to receive 14.200MHz ( $f_c$ ) in the 20m amateur band and that the local oscillator is operating higher than the incoming signal by the

There are so many receivers available these days that anyone intending to make a purchase may find the choice bewildering! This month Brian Oddy looks at some of the more important aspects of receiver specifications to help you to make up your mind.

receiver i.f. of 455kHz — a typical figure. In these circumstances  $f_o$  will be 14.200MHz + 455kHz = 14.655MHz. The receiver is operating normally, but the signal from a broadcast station can be heard on 14.200MHz, so why is that? It will in fact be an unwanted image of the signal from a broadcast station operating in the 19m broadcast band on 15.110MHz, which can also mix with the local oscillator on 14.655MHz and produce an i.f. of 455kHz, consequently it will appear to the listener as though it is actually in the amateur band!

It can be seen from this example that an image signal originates from a spot twice the i.f. away from a wanted signal and on the same side as the local oscillator. If the receiver is retuned to 15.110MHz the real broadcast signal will be found there at greater strength than on 14.200MHz. Note that the local oscillator will then be operating on 15.565MHz and if a strong signal is present on 16.020MHz this too may mix with 15.565MHz to produce an image on 15.110!

## RF Amplifiers

Image signals become a real problem on the higher s.w. ranges of simple receivers because the selectivity of the tuned circuit at the mixer input becomes less as the frequency of the incoming signal  $f_c$  is increased. One way of increasing the selectivity is to add one or more tuned radio frequency amplifier stages ahead of the mixer — see Fig. 1. The tuning of the r.f. stage is kept in step with the mixer and local oscillator by using a "ganged" variable tuning capacitor. Each tuned circuit has to be carefully aligned at the factory by adjusting pre-set trimming capacitors so as to ensure that they remain exactly in step or "track" over the whole length of each band.

## Image ratio

The added selectivity introduced by the tuned circuit of the r.f. amplifier will

considerably improve the ratio of the strength of a wanted signal to that of an unwanted image signal — this is usually referred to as the **image ratio** — the higher this ratio the better the receiver. Most receiver specifications quote the image rejection in terms of decibels, e.g. -50dB. Some of the more expensive receivers also make use of double, or even triple mixing systems to overcome image problems — these will be discussed in a future article in this series.

## Sensitivity

Adding an r.f. stage will also increase the **sensitivity** of the receiver, or its ability to pull in weak but usable signals. Mixers are generally low gain devices and the noise they generate tends to mask weak signals. Although r.f. amplifiers also generate noise they are high gain devices, consequently they can improve the **signal to noise ratio** of a simple receiver.

The sensitivity of a receiver is often quoted in terms of the amount of signal required at the antenna terminals in microvolts to produce a specified amount of audio power at the loudspeaker, however a better expression states the amount of signal required at the antenna terminals in microvolts to give a specific signal output above the inherent noise of the receiver.

The r.f. stage may amplify strong incoming signals to the point where they overload later stages of the receiver, so an **r.f. gain** control is usually provided on the more expensive receivers to allow the amplification to be varied. Sometimes the automatic gain control (a.g.c.) potential is used to control the amplification of the r.f. stage automatically.

## Calibration

Although the main dial of a receiver is intended to indicate the incoming frequency ( $f_c$ ) to which the receiver is tuned, in the cheaper receivers the accuracy of the calibration may be poor and unreliable — consequently it will be difficult to re-locate a station heard previously at a particular point on the dial. Some form of slow-motion drive between the tuning knob and the ganged, variable, tuning capacitors is essential so that precise adjustments can be made — this may consist of a simple system of pulleys and a spring-tensioned nylon cord, an epicyclic drive or, in the case of the more expensive receivers, a gear driven system using spring-loaded gears to avoid **backlash** or slop.

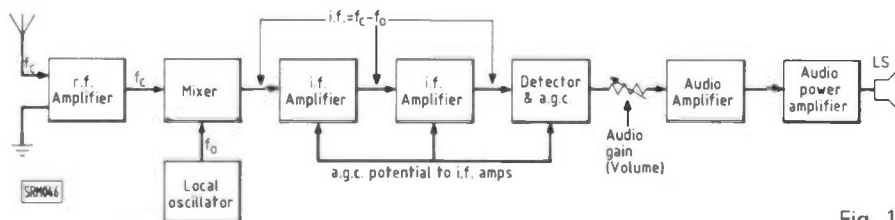

Fig. 1.

# STARTING OUT

The reliability of the calibration is dependent upon the **stability** of the local oscillator. It is very difficult to make a self-excited oscillator stable, especially at the high frequencies needed on the s.w. ranges, because variations in temperature and small mechanical changes affect the frequency of oscillation. The type of circuit employed, the quality of the components used, rigid mechanical construction and regulated supply voltages are all important factors in ensuring good stability.

Instead of using a self-excited oscillator, many of the more expensive receivers use a **frequency synthesiser** to generate the local oscillation required by the mixer — they rely entirely upon the stability of a quartz reference oscillator and their general principles will be discussed later in this series.

Manufacturers often omit to quote the stability ratings of the cheaper sets, but for the more expensive receivers they may detail the frequency change to be expected over a given temperature range e.g.  $\pm 2\text{kHz}$  from 0 - 40 degrees C. The specifications for a communication receiver are much more precise, e.g.  $\pm 300\text{Hz}$  during the first hour,  $\pm 50\text{Hz}$  thereafter.

## IF Amplifiers

Unlike the r.f. amplifier which must tune over a wide frequency range, the intermediate frequency (i.f.) amplifier is only concerned with the output from the mixer — since this is centred around a pre-

determined i.f. frequency the tuning may be pre-set at the factory. The ability of a superhet receiver to reject unwanted signals operating close to a wanted signal is determined mainly by the sharpness of the tuning, or selectivity of the i.f. stages; however the maximum amount of selectivity that can be employed is determined by the bandwidth of the desired incoming signal.

The bandwidth required by an a.m. signal is equal to twice the highest modulating frequency (see page 37, December '87 *SWM*) and so the tuning of the i.f. circuits in an a.m. receiver must allow sufficient bandwidth to accommodate this type of signal without distortion. Only one i.f. stage may be employed in the cheaper receivers, consequently the maximum gain will be limited and the shape of the i.f. response will be too broad across the base for good selectivity — see Fig. 2a.

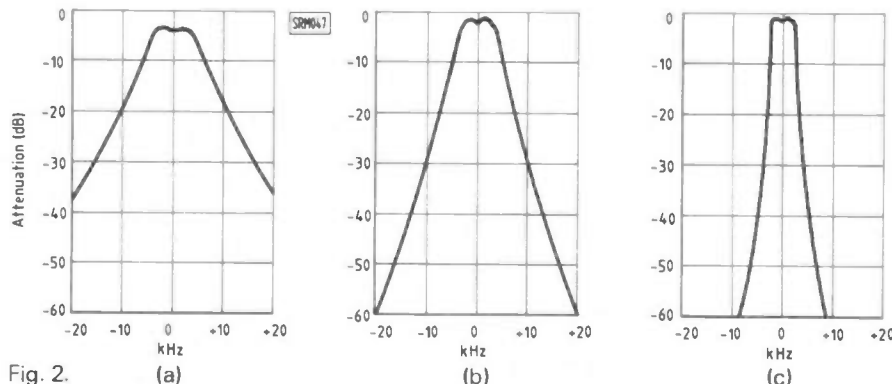

Fig. 2.

The more expensive receivers usually employ several i.f. stages and the gain of each stage is usually controlled by the a.g.c. potential — see Fig. 1. The additional stages not only provide more gain, but allow the associated tuned circuits to be carefully adjusted so as to improve the shape of the i.f. response — see Fig. 2b.

The most expensive receivers employ either a quartz or a mechanical filter to produce the very steep-sided response needed to provide high selectivity — see Fig. 2c. The shape of the i.f. response is usually detailed in the receiver specifications by quoting the bandwidth in kHz at two points along the curve, e.g. 6kHz at  $-6\text{dB}$  and 19kHz at  $-50\text{dB}$ .

No doubt you are beginning to appreciate some of the finer points of receiver designs by now! Some of the more advanced designs will be discussed next month.

# SERVICES

## Subscriptions

Subscriptions are available at £17 per annum to UK addresses and £19.00 overseas by Accelerated Surface Post outside Europe. For further details see the announcement on page 15 of this issue. Airmail rates for overseas subscriptions can be quoted on request. Joint subscriptions to both *Short Wave Magazine* and *Practical Wireless* are available at £27.00 (UK) and £30.00 (overseas).

## Queries

We will always try to help readers having difficulties with a *Short Wave Magazine* project, but please observe the following simple rules:

1. We cannot give advice on modifications to our designs, nor on commercial radio, TV or electronic equipment.
2. We cannot deal with technical queries over the telephone.
3. All letters asking for advice must be accompanied by a stamped, self-addressed envelope (or envelope plus international Reply Coupons for overseas readers).

4. Write to the Editor, "Short Wave Magazine", Enefco House, The Quay, Poole, Dorset BH15 1PP, giving a clear description of your problem.

5. Only one query per letter, please.

## Back Numbers and Binders

Limited stocks of most issues of *SWM* for the past 10 years are available at £1.45 each, including post and packing to addresses at home and overseas (by surface mail).

Binders, each taking one volume of the new style *SWM*, are available price £3.90 to UK addresses, or overseas, including post and packing. Please state the year and volume number for which the binder is required. Prices include VAT where appropriate.

Please note that Volume 45 finished with the December 1987 issue, making nine issues in the volume. In future each volume will run from January to December.

## Ordering

Orders for p.c.b.s., back numbers and binders, *PW* computer program cassettes and items from our Book Service, should be

sent to *PW Publishing Ltd.*, FREE-POST, Post Sales Department, Enefco House, The Quay, Poole, Dorset BH15 1PP, with details of your credit card or a cheque or postal order payable to *PW Publishing Ltd.* Cheques with overseas orders must be drawn on a London Clearing Bank and in sterling.

Credit card orders (Access, Mastercard, Eurocard or Visa) are also welcome by telephone to Poole (0202) 678558. An answering machine will accept your order out of office hours.

## Components for *SWM* Projects

In general all components used in constructing *SWM* projects are available from a variety of component suppliers. Where special, or difficult to obtain, components are specified, a supplier will be quoted in the article.

The printed circuit board for the *SWM* Audio Filter, July 87 issue is available from *Short Wave Magazine*, Enefco House, The Quay, Poole, Dorset BH15 1PP, price £2.00 plus 75p post and packing.

*Practical*  
**Wireless**  
*The Radio Magazine*

FEBRUARY '88 ISSUE

Build the *PW* "Orwell"  
High-performance m.w. receiver

Part 1



PLUS

Directivity Gain in Transmitting antennas

The ICOM IC-761 HF Transceiver Reviewed

Battle of the Beams — Part 2

**ON SALE NOW**

**PRICE £1.20**

# SEEN & HEARD

## AMATEUR BANDS ROUND-UP

Justin Cooper

c/o Short Wave Magazine, Enefco House,  
The Quay, Poole, Dorset BH15 1PP

### All-Time Post War HPX Ladder

Name	Phone Only	Prefixes
B. Hughes (Harvington)		3353
E. M. Gauci (Malta)		3282
E. W. Robinson (Felixstowe)		2653
M. Ribton (Gillingham)		2058
M. Rodgers (Bolton)		1827
R. Shilvock (Halesowen)		1659
N. Henbrey (Northiam)		1610
B. Patchett (Sheffield)		1307
C. R. Eve (Jersey)		1103
A. Woodcock (Denmark)		986
A. P. Lincoln (Aldershot)		888
R. G. Williams (Borehamwood)		874
B. E. Woodcock (Leeds 17)		802
L. Marcquardt (Hereford)		634
D. R. Tanswell (Iver)		621
CW Only		
F. Dunn (Chester)		2035
H. Scott (Rievaulx)		1396
N. Melville (Edmonton)		1226
P. J. Barnes (Blackpool)		533
C. R. Eve (Jersey)		342
M. Rodgers (Bolton)		304
RTTY Only		
W. J. Prior (Lochcarron)		535
C. R. Eve (Jersey)		500
N. Henbrey (Northiam)		334
D. R. Tanswell (Iver)		301
M. Rodgers (Harwood)		270

Starting score, 500 for Phone, 200 for CW or RTTY. Entries in accordance with HPX Rules.

### Annual HPX Ladder Starting date January 1, 1987

Name	Prefixes
P. McAllen (Southampton)	477
J. J. Sales (Lancaster)	450
S. Burgess (Stockport)	427
A. Hall (Lockington)	406
P. McAllen (Southampton)	395
S. Hill (Port Talbot)	339
M. Probert (Basingstoke)	260

200 Prefixes to have been heard for an entry to be made in accordance with HPX Rules. At score 500, transfer to the All-Time list is automatic. Note, the Annual Table is a Phone only listing.

### Most in 1987

E. M. Gauci (Malta)	1009
---------------------	------

Rules as for the Annual Listing. An entry for this listing must be in addition to any claim for the All Time Post War listing.

This is the time, while the world is hibernating its way through winter, to think about the spring alterations to the shack, or the rig, or the vital bit up aloft; or even such Sybaritic thoughts as improvement to the operating chair or the ventilation!

## Skywires

I'm talking in the general sense, to include the indoor arrangements, and the "mobile efforts" as well as the garden variety. The big problem for the s.w.l. is to prove that the thing is working PROPERLY after you have strung it up. In fact, of course, any random length of wire can be forced to take power from any transmitter, at which time it will be doing its best for the receiver — but in the years since WWII, the use of coaxial cable has become an obsession. Now, we are stuck with receivers which want to see a low impedance unbalanced feed, so any other feed impedance offered by the antenna calls into use an a.t.u. — "Transmatch", "Z-Match" or various trade names. The a.t.u. "transforms" whatever impedance the feeder offers into 50 ohms resistive. As you twiddle its knobs into the correct positions, so signals will peak if the band is open, or the "hash" will become louder if the frequency is lacking signals. (Incidentally, this is a good check of a receiver; terminate the antenna terminals in a 50 ohm resistor, and see if you can find the peak of "hash" as you twiddle the PRESELECTOR or TUNE control. It should be noticeable on 28MHz, more so as you try the test on the lower bands. If you can't find the peak on a given band, you have a fault in the receiver on that band.) For most people, an a.t.u. is probably the first accessory to be bought.

However, there is no reason why, with a little care, an antenna for one or more bands shouldn't be one's first home-construction project. Consider the simple dipole; this will be a half wavelength long, and (for preference) a half-wave length high. Hence, we need to have a formula, and the raw materials, for the formula:

$$L = 150/f$$

where f is in Megahertz and L in metres. If covering a band, such as, say, 14MHz, we would use the mid-band frequency, namely 14.175MHz. That gives us 10.58m. Visualise this length as being that of a piece of wire, containing an insulator at each end, where the

wire turns back on itself and is soldered — two loops, then, and a long piece in the middle. L is the length from the end of one loop to the end of the other one. Next, you want a centre insulator. Make one from a scrap of plywood, Perspex or other plastic. Cut out a "T" shape with dimensions about 100mm each way, with the "leg" and both "arms" about 25mm wide. Thickness — what you've got, but if you start with a bit about 8mm thick you're near optimum.

Now get out the old drill, and drill two holes of the size of the wire you've got for the span — say, about 18 s.w.g. or thereabouts, in each of the legs forming the top of the T. Then change to a bit of the

size of the outer diameter of your coaxial cable, and drill a couple of holes in the "foot".

Finally, have a look in your "junk" box for a couple of nuts and bolts — something of the order of 2BA, or its near equivalent in metric or whatever. We can now start assembly. First, strip the pvc outer of the coaxial cable for about 75mm, bunch up the braid by pushing it from the end back towards the pvc; it will increase in diameter. Take a pin and open a hole in the braid, near the pvc; fish the inner conductor through the hole. Now thread the coaxial cable through the two holes you have provided in the foot of the T, and loop it up and over such that when the completed skywire hangs in

the air, the weight of the coaxial cable will cause the open end of the cable to point downwards. This helps keep water out of the works.

Next turn to your wire span as already described. Fold it and cut precisely at the centre. Clean the two ends so obtained free of enamel — I use a flame, followed by a rub of emery-cloth, the flame being obtained from the kitchen stove, cigarette lighter or blowlamp.

The clean bit should be about 25mm or so. Thread one piece of the wire through the two holes provided for it, then the other on the opposite side. Fit the 2BA bolts, plus washers, plus nuts; before tightening, put under the washer on one side of the T the coaxial outer braid plus the wire end; on the other side you will have to put the inner conductor of the coaxial, plus the other piece of the span wire.

To strip the polythene insulation on the inner, you can use the point of the soldering iron and your fingers can slide the unwanted bit of polythene tube away; or you can cut carefully round with a penknife, but avoid cutting any strands of the wire. Wrap the wires round the bolt clockwise, so tightening tends to pull them inwards; if you go the wrong way, the tightening tends to eject the wires. Complete the centre by massaging wire and coaxial to make it lie nicely. Smother the result with Bostik, or Silicone RTV. Insulators will already have been fitted to the ends, or you couldn't have soldered them(!). If you haven't got insulators, use as long a piece of plastics string as possible instead.

Finally, you must connect a suitable coaxial plug to the bottom end of the coaxial cable. If you go straight into the receiver it may require a PL259 type; if you have a home-brew a.t.u. use TV plugs of the Belling-Lee variety, or for purely listening you can get away with phono plugs. Take your new dipole outside and hang it up. For general use, you should aim for the wires to run north-south. To avoid stretching problems it is probably best to support the middle, even if your wire was hard-drawn. As to height, the higher the better. Successful end of first home-brew project!

## Letters

It's always nice to hear again from past contributors. R. Shilvock G1HAL (Halesowen) has an R1000 plus 20m of Windom. The very first trials coincided with the

October 24/25 contest weekend, the end result has been a re-entry in the Ladder at 1589 All-time.

**B. F. Hughes** (Worcester) is the lucky owner of a Drake R4C, and says he has added further crystals to expand his horizons; thus he is now listening to DX on 24MHz with considerable interest.

**P. Barnes** (Blackpool) has been greatly interested by 28 and 21MHz of late, and indeed logged VK on the former; and when things went flat up there, the lower bands enabled him to fill in on the less common European prefixes.

## QRM

**B. Woodcock** (Leeds 17) finds himself driven off the air by the "noises" from assorted thermostats and similar raspberry-noises. The Trio JR-310 has a noise-limiter, and while that is doing its best, would a noise blander do better and is there an outboard unit that would help? Good questions indeed!

Outboard add-ons go back as far as Marconi's time; in Blake's History of Radio Telegraphy and Telephony, 1928, he lists some 17 different approaches to the problem and cross-refers to others! Of the methods surviving to this day, the simple crash-limiter, comprising nothing more than a couple of germanium diodes back-to-back across the headphones is well worth adding to any set-up. A noise-limiter in the i.f. is again not much more than a diode or two so arranged as to "follow" the audio and clip off any large-amplitude "spikes".

Finally, the noise blander in essence uses a separate wide-band receiver, or at least a separate wide i.f. stage to amplify the noise pulse while preserving its shape. The derived pulse is then used to turn off one of the main i.f.

stages — the result is then a "hole of silence" rather than a spike of noise. However, when we come to the thermostat, we are looking at a sustained spark or a series of them whose repetition frequency is within the audio range and whose output is — usually — radiated by the mains wiring acting as an antenna. An accidental spark transmitter in fact! No circuit is known that can cope with this, though at least the crash-limiter and the others can keep the amplitude down enough to save serious ear damage. About all you can do is to connect the receiver to a dummy load right at the antenna terminals. If the noise now disappears, it is antenna-borne. If the noise is still there, then a filter in the mains lead, right where it enters the receiver will improve matters.

I have also heard, though not personally experienced, of a case where screening the mains lead was a help, along with screening of the earth connection to the a.t.u.

You shouldn't forget that a noisy thermostat is potentially a fire hazard, so if there is one in your house, find it and repair or suppress it. Suppression removes the spark which is the potential fire risk — but it can't improve a thermostat which is already bound for the Great Scrap Yard in the Sky.

**P. McAllen** (Southampton) uses a TRS-80 computer, and is interested in getting in touch with S. Hill who recently mentioned a similar interest in this column. If the latter would care to write direct, Peter is at 2 Lynn Close, Chartwell Green, Southampton.

## Prefixes in the USA

**P. McBeath** (Morpeth) notes that during a recent contest he heard various Ws and wonders whether the callsigns he mentions would give information as to where the station actually is. For most of the post-WWII period that was true; a W6 was in California, or if out portable or mobile he would suffix his call with the call area in which he happened to be, for example W6AM/1/M. If he moved his home permanently to another call area, then he would be allocated a new callsign. A few years back, the US authorities decided that a callsign would be allocated and kept permanently, no matter where one moved to after being licensed. Most people affected by this rule do tend to suffix their call with the call area in which they now reside, though not all are so considerate. It is mortifying to work a W6 — DX in any language — and find he is merely a W1 in New England!

Next **T. Woodcock** (Denmark) uses a computer which does a very nice quality print, and he sends the listing in three forms: first a summary of the Prefixes, secondly sorted by prefix showing full details of the QSO, thirdly sorted by time and date with full details of the QSO. He then uses a high-lighter pen to indicate the "specials" in the prefixes-only list.

**R. Shilvock** (Halesowen) found two GV prefixes which I can't count as I believe them to have been probably GB stations.

The long letter from **D. R. Tanswell G6LAU** (Iver) is of interest. Nowadays, an FT101ZD

drives transverters for v.h.f./u.h.f., and in addition is used as a receiver on h.f., inhaling from a G5RV, and feeding a Tono 9000E for RTTY, which is the main h.f. interest. The October 16 gale broke-up the G5RV, so since then till his letter on December 5, he had been listening to just the ribbon feeder alone; and this configuration has been surprisingly successful in hearing all the world.

Another RTTY addict is **Bill Prior** at Lochcarron, he lives in an area where the gentle art of keeping an antenna up in the air is probably the prime skill in listening — but he manages just that, and hears a surprising amount of interesting DX, surrounded by mountains though he is.

**E. W. Robinson** (Felixstowe) heard an unusual one, 3XOA from the Republic of Guinea.

Somehow, we seem to have got the listings wrong for **M. Ribton** (Gillingham), so he has been combing through his old logs so 23 of his 40 new ones are stations he missed out on before. The moral applies to everyone: check the rules carefully, and be sure you claim in accordance with them.

**C. R. Eve** (St. Helier, Jersey) finds that 14MHz is dead by the time he reaches home, so that he has to pray for wet weekends so as to have an excuse for staying at home and short wave listening! Chris has managed the 500 on RTTY, which he found to be much tougher than hearing 1000 prefixes on Phone.

## Finale

The lot for this month, I can always use more letters for this piece, and they should be addressed to Justin Cooper, c/o Short Wave Magazine, Enefco House, The Quay, Poole, Dorset DH15 1PP, by the deadline dates.

Deadlines are February 16,  
March 15 and April 19

## DECODE

Mike Richards G4WNC

200 Christchurch Road, Ringwood, Hants BH24 3AS

## RTTY

This month I have received a good response to my request for details of stations broadcasting weather details in plain language.

**Dave Worthy** has written with details of a whole range of these stations. The first is CFH in Halifax (Canada), which transmits on 122.5kHz, 4.271MHz, 6.33MHz, 10.536MHz and 13.510MHz. The output from CFH is a mixture of coded and plain language RTTY at 75baud interspersed with 120/576 FAX charts. The only schedule I have deals with FAX from this station, but judging by the gaps between charts the best time to

listen for RTTY should be between half past the hour and the following hour. If anyone has access to a full schedule then I would be very pleased to receive a copy.

Another station to watch is CTU/CTV/CTW Lisbon on 4.235MHz, 8526MHz, 13.002MHz and 17.056MHz. The weather reports are sent in Portuguese and English at 0800 and 2000UTC using 50 baud RTTY. I have been unable to confirm the first and last frequency listed for this station so any further information regarding schedules, etc., would be welcome.

Dave also points out that one of

the main sources of up-to-date plain language weather reports and warnings is the NAVTEX system which I have covered in detail elsewhere in this column. I'm sure there are plenty of other plain language RTTY stations so if you know of any please let me know.

**Jack Birse** has written in with a bumper list of RTTY reports which I have included in this month's list. I have also received some interesting reports from Chris Norfolk which again have been included in the list. I'm sure many of you will have noticed that I am tending to include a lot of frequency lists in the column, this is a direct result of

your feedback but if you have any other ideas then drop me a line and I will do my best. So here is this month's list which has been compiled from information received from a number of sources over the past couple of months:

The figures after the mode indicate baud rate/frequency shift, if the shift figure is followed by an R then reverse shift is in use. Any reports without baud rate of shift information are likely to be either 50 or 75 baud and 170Hz, 425Hz or 850Hz shift.

3.667MHz RTTY 50/? UBDD  
4.489MHz RTTY 50/425  
GFL23 Bracknell Meteo



# WORLD RADIO TMR7602

THE BEST GETS BETTER  
AT JOHNSONS

## WHAT A RESPONSE & DEMAND WE'VE HAD FOR THIS RADIO!

UNLIKE THE BIG BOYS  
WE DO NOT PUT A JAP  
NAME ON OUR MODEL  
AND WE ALSO INCLUDE  
A P.S.U. AT OUR CRAZY  
PRICE

- SPECIFICATIONS & FEATURES TATUNG (AMBASSADOR 2020)
- ★ Full AM/FM Frequency Range 150-29999kHz plus FM 87.5-108MHz, Mono/stereo.
  - ★ Five Tuning Functions:
    - Direct Press Button Frequency Input
    - Auto Scanning, Manual Scanning
    - Memory Recall and Manual Tuning Knob
  - ★ Built-in Clock and Alarm. Radio Turns on Automatically at preset time & Frequency.
  - ★ Fourteen Memories
    - Nine Memory Channels For Your Favourite Station Frequencies.
    - Last Setting of Mode & Waveband Stored in 5 Memories.
  - ★ Direct Press-Button Access To All 12 Shortwave Broadcast Bands.
  - ★ Two Power Sources — Battery or AC Mains Adaptor.
  - ★ General Coverage of all AM Bands in LW/MW/SW (Dedicated Broadcast Band Coverage on all Versions) Plus of Course The FM Band for Quality Sound Broadcasts in Headphone Stereo.
  - ★ SLEEP Function Turns the Radio On or Off After an Adjustable Time of 10-90 Minutes.
  - ★ Separate BASS & TREBLE Controls for Maximum Listening Pleasure.
  - ★ External Antenna Jack for Better Reception.
  - ★ Adjustable RF GAIN Control to Prevent Overloading When Listening Close to Other Strong Stations or if There is Interference.
  - ★ BFO Control (Beat Frequency Oscillator) Enables Reception of SSB/USB/LSB (Single Side Band) and CW (Morse Code) Transmissions.
  - ★ Illuminated Display to Facilitate Night-Time Use.
  - ★ Designed for Both Portable and Desk Top Use.
  - ★ Five dot LED Signal Strength Indicator.
  - ★ Dimensions: — 29.2cm x 16.0cm (11.5in. x 6.3in. x 2.36in.)
  - ★ Output: — 1200mW (10% THD).
  - ★ Weight: — 1.7kg. (3.75lbs) Without Batteries.
  - ★ Wide/Narrow Filter Switch.

£ 129.99

+ £8 carriage/handling

Suggested price is  
£ 199.99 but  
anything they can  
do we can do better

OFFICIAL **SONY** DEALER

AN-1 active antenna with FET RF amplifier made for any **SONY** radio ever made plus any other make of receiver. Works on batteries or mains. It simply is the best! £40 + £2.50 p&p. It's the cheapest way round the world.

New **ICF-7600A** and improved **ICF7600DS** in stock. **ICF2001D, PRO80, AIR7**. Plus we stock Sony accessories and their Hi-Fi range.

**DIPLOMAT SG788L** 10 waveband pocket miracle, 13, 16, 19, 25, 31, 41, 49 shortwave bandspread + VHF/FM, long and medium wave and stereo VHF into headphones. £39.95 + £2 p&p for radio, headphones, carry case, 100 page waveguide.

8 band **VEGA 215 MkII SELENA** — mains and battery, true Russian technology and ruggedly made. Complete with long range aerial and earpiece. £42.95 + £3 p&p or add £2 extra for security delivery.

FREE RECENT WRTH HANDBOOK WITH ANY RADIO PURCHASED. YOU JUST PAY £2 HANDLING AND POST.

FULLY ILLUSTRATED CATALOGUE

£1.00.

S.A.E. WITH ALL  
CORRESPONDENCE

**PANASONIC** MULTI-BAND  
PORTABLES

**8600 — RFB20L — RFB60L**  
HIGH TECH AND QUALITY WORLD RADIOS

WE STOCK A RANGE OF AIRBAND RADIOS  
& SCANNERS. TELL US WHAT YOU WANT.

REVIEWED IN WRTH & DATABASE INTERNATIONAL & MADE IN TAIWAN  
TO OUR SPECS BY 'SANGEAN'. (NO SANGEAN IS NOT A SPANISH DRINK).



## JOHNSONS SHORTWAVE RADIO

43 FRIAR ST, WORCESTER WR1 2NA 0905 - 25740

HAPPY NEW YEAR FOR '88. ALL THE ELVES RETURNED TO BASE SAFELY AND ARE READY TO START AGAIN, SO WHY NOT GIVE US A CALL NOW WITH YOUR REQUIREMENTS FOR THE COMING YEAR.



## THE HAMGEAR PMX PRESELECTOR



Our well-known HF band antenna tuning unit and preamplifier combined, made solely with SWL requirements in mind. Covering 1.7 to 34MHz completely, the ATU section allows endless experiments with various lengths and types of antenna and offers correct matching of these to your receiver.

The preamp. section has a gain of 20 DBS which can be controlled down to zero gain, then on down to minus 15 DBS, allowing a boost just where the RX might need it or an attenuation where the band dictates.

This unit peaks only the band required; is not an active antenna. Whether your RX is old or new, the PMX must represent the perfect modern interface between RX and antenna.

Can also be supplied with a 10kHz calibrator. Casework is all metal with brushed aluminium panel.

Prices are:  
Unpowered PMX..... £69.00  
Mains powered PMX..... £78.00  
Mains powered PMX with calibrator..... £97.00

Send for 4-page information on this PMX series.

Introducing our new VFO, ideal to drive that home construction project, whether TX or DC RX. Covering 3.5 to 3.8MHz comprising oscillator, three buffer stages, fully stabilized voltages and provision for RIT and Offset. Completely finished and cased in a cast box.

Priced £31.00. Information sheet available.  
All prices include Postage and Packing.

**HAMGEAR ELECTRONICS**  
125 Wroxham Road, Norwich NR7 8AD.  
Tel: Norwich (0603) 405611.

## RX-4 MULTIMODE RECEIVE RTTY / CW / SSTV / AMTOR

This is the ultimate in software for the SWL. Just one program to receive all four modes, switching from one to the other at a single keypress. Extremely user-friendly, RX-4 has the facilities and performance you need to catch all the action on the bands as soon as you hear it.

When you see the features it's easy to see why RX-4 is today's best-selling receive software.

RTTY and AMTOR tuning scale makes tuning-in very quick and easy. Four RTTY baud rates, any shift, normal or reverse, with selectable unshift-on-space.

CW software filters and controllable autotrack for maximum performance up to 250 wpm! On-screen indicator lets you set the level and tuning with a minimum of fuss.

SSTV has selectable scan rates in both directions and two modes of picture storage for maximum use of memory.

Text and pictures can be stored, recalled to the screen and dumped to a printer as well as being saved to tape or disc.

Please note that the AMTOR section only receives ARQ mode (mode A) but this is the most common mode and covers a lot of commercial TOR stations, also.

Previously, people have paid over £30 for separate RTTY, CW and SSTV programs which do not have the performance, facilities and convenience of RX-4. We are offering this amazing software for the low price of only £25 on tape, £27 on BBC or CBM64 disc.

BBC-B, CBM64 and VIC20 need our TIF1 interface. This has isolation between computer and radio to reduce computer noise and switchable filters, giving much improved copy. Kit £15 (assembled PCB + cables and connectors) or ready-made, boxed with all connections £25. For SPECTRUM we have two versions. One needs no hardware at all, the other uses the TIF1 via an interface adapter board SIA-1 for improved performance. Tape + SIA-1 £40.

Same day dispatch by First Class Post, Airmail Overseas. Prices include p&p and VAT, where applicable.



**technical software** (SWM)  
Fron, Upper Llandwrog, Caernarfon LL54 7RF. Tel. 0286 881886



# SEEN & HEARD

- 4.963MHz RTTY 100/850  
DHN37 Grenchel Meteo
- 5.112MHz RTTY 75/425  
40C3 Belgrade
- 5.168MHz TDM 96/425
- 5.208MHz TDM 96/425
- 5.720MHz RTTY 75/425
- 5.940MHz RTTY 75/850
- 6.835MHz RTTY 50/425  
GFL22 Bracknell Meteo
- 8.048MHz RTTY 50/425  
Iran News
- 8.565MHz ARQ 100/170  
German News
- 8.603MHz RTTY 50/170  
Kalingrad USSR
- 9.353MHz RTTY 50/425R  
Czechoslovakia News
- 10.124MHz RTTY 50/425 Prague
- 10.427MHz RTTY 50?  
YMA7 Turkey Meteo
- 10.475MHz RTTY 50/?R  
Morocco press
- 10.911MHz RTTY Budapest
- 10.916MHz TDM 96/425
- 12.225MHz RTTY 75/425 Tangier
- 12.509MHz ARQ 100/170 USSR
- 12.515MHz USSR Meteo
- 13.510MHz RTTY 75/? Halifax
- 13.563MHz RTTY Taipei Taiwan
- 14.367MHz RTTY 50?  
Beijing China
- 14.510MHz RTTY
- 14.510MHz RTTY 45/170  
AEM1 USA
- 14.576MHz RTTY 50/425  
Morocco News
- 14.623MHz TDM 96/425
- 14.721MHz RTTY  
Brazzaville Meteo
- 16.218MHz TDM 96/850
- 16.347MHz RTTY 50/425  
CLN530 Havana
- 16.683MHz RTTY 50/170R  
USSR
- 17.383MHz TDM 96/170 Moscow
- 18.650MHz RTTY 50/425  
Polish News
- 18.785MHz RTTY 50/425  
French News
- 20.430MHz ARQ 100/170  
Italian News
- 20.560MHz RTTY 50/425  
Tripoli News
- 22.915MHz RTTY 50/425  
France News

## FAX

Amateur FAX seems to be on the increase at last! I have received a letter from Graham GOENF who uses a Telecopier 400 on 144.7MHz from his home QTH in Gloucester. Graham regularly links up with Cliff GOFDD (Lydney), Pat GW1SXU (Chepstow) and Jean

GOAWX (Bristol). If you have the necessary equipment try listening out on 144.7MHz on the first Monday of each month at about 1900UTC as this is the FAX activity night.

Chris Norfolk included an interesting selection of amateur FAX in his letter as shown here: SP8ZBF (Poland), SP3AMZ (Poland), IO1IC (Italy), DL2DO (Germany).

Thanks to Jack Birse and a few others I have been able to prepare the following list of commercial FAX stations heard during the past couple of months. The numbers following the frequency represent the drum speed/index of co-operation.

- 125kHz 90/576 Kristineham Meteo
- 132kHz 120/576 DCF54  
Offenbach
- 2.812MHz 120/576  
GYA1 Northwood Meteo
- 3.290MHz 120/576  
GFA21 Bracknell
- 3.650MHz 120/576 Madrid Meteo
- 3.855MHz 120/576  
DDH3 Hamburg
- 4.205MHz 120/576 Moscow
- 5.150MHz 90/576 Moscow
- 5.355MHz 60/576 Moscow
- 5.784MHz 120/576
- 10.678MHz 60/288  
Buenos Aires Press
- 10.980MHz 60/576 Moscow
- 12.828MHz 60/576 Beijing China
- 13.780MHz 90/576 USSR Arctic
- 16.411MHz 120/576 Meteo
- 17.670MHz 60/576 Press
- 20.735MHz 60/288  
Buenos Aires Press

## NAVTEX

This system is operated by coastal radio stations and provides important navigational information for shipping. The transmission frequency used is 518kHz and the format conforms with CCIR recommendation 540 and can be received by any equipment capable of decoding AMTOR mode A or FEC or SITOR broadcast mode. In order to allow information to be received from a number of stations using the same frequency, a time sharing system is used where each station takes it

in turns to transmit according to a pre-arranged schedule.

In the UK three stations operate the NAVTEX system namely Portpatrick Radio, Cullercoats Radio and Lands End Radio. According to the 1988 Klengenfuss Guide to Utility Stations there are a total of 36 stations throughout the world operating on this frequency. As well as operating to a strict time schedule each station has an identification letter which is sent as the first character of a four character block which heads each transmission. The second character of this header indicates the message category i.e. A = Navigational warning, B = Gale warnings, D = Distress alert, E = Weather bulletin and Z = No message. The final two characters in the header are used as a serial number with 00 representing an urgent message that must be printed.

One of the main advantages of this system is that with some dedicated receiving equipment the mariner can choose the type and source of information to be received. For the s.w.l. 518 kHz can prove quite interesting and DXing becomes a simple matter of tuning to 518kHz and waiting to see what can be heard. A selection of stations and transmission times are shown here. The letter in brackets is the station identification letter.

- Cullercoats (G) 0048, 0448, 0848, 1648, 2048
- Portpatrick (O) 0130, 0530, 0930, 1330, 1730, 2130
- Lands End (S) 0018, 0418, 0818, 1218, 1618, 2018
- Tallinn (U) 0030, 0430, 0830, 1230, 1630, 2030
- Odessa (C) 0018, 0318, 0618, 0918, 1218, 1518, 1818, 2118
- Stockholm (J) 0330, 0730, 1130, 1530, 1930, 2330
- Reykjavik (R) 0318, 0718, 1118, 1518, 1918, 2318
- Boston (F) 0100, 0700, 1300, 1900

## Dragon 32 RS-232 Port

I have just received some good news for Dragon 32 owners who are frustrated by the lack of a RS-232 serial port. Jim Fuller

G4WPI has produced an interface which will allow the use of conventional Packet radio TNCs and a whole range of modems and decoding equipment. The fitting of the interface is fairly complicated so Jim has enlisted the help of his partner Chris Foster(G4USU) to operate the fitting service. One of the notable features of the port is that it is fitted internally so leaving the expansion port free for other things. I have not actually seen or used the interface but it certainly sounds interesting and the price is very attractive. The interface costs £29.98 including fitting but excluding post and packing. For more information contact Chris Foster<sup>(1)</sup> or Jim Fuller<sup>(2)</sup>.

## RTTY on IBM PCs and Clones

J. Moss G4ILO has contacted me with details of a new decoding program for IBM PCs. Having been frustrated by the lack of good quality RTTY decoding software he decided to write his own. This task was simplified somewhat as he is a trained professional programmer! The final program which is to be called RADIOCOM should be made generally available early in 1988. In its initial form it will be able to transmit and receive RTTY, ASCII and CW from 6 to 40 w.p.m.

I don't as yet have details of where to obtain the program but it will be released as a "Shareware" package. For those of you not familiar with "Shareware" this means that the program can be freely tried and copied to other users, if you decide that you want to use it you send a registration fee of £12 to the author and you will receive the latest version. One additional bonus for registered users is that they will be able to receive any future enhancements for the cost of a disk and the return postage. As soon as I have any further details I will include them in this column.

That's all for this month but please keep those reports coming and don't forget you can always contact me via my Prestel Mailbox 425470071.

(1) Chris Foster, 2 The Row, Berwick St James, Nr Salisbury, Wilts. SP3 4TP.

(2) Jim Fuller, 42 Kitchener Road, Amesbury, Nr Salisbury, Wilts. SP4 7AD.

Reports for April '88 issue  
by February 16 please



## INFO IN ORBIT

Pat Gowen G3IOR

17 Heath Crescent, Hellesdon, Norwich, Norfolk NR6 6XD

### Weathersats

Gordon Train of Keswick does work in the field of broadcasting, but claims that he has had no experience whatsoever in the field of amateur radio. He has been into weather satellites for one year now, when he first purchased and built a Cirkit receiver. Although this worked very well, Gordon found that it could be improved considerably by several simple modifications, which we hope to relate for the advantage of all readers in a later column.

After experimenting with various antennas made from wire, aluminium rods, etc. Gordon finally ended up with one employing four telescopic antennas mounted on a plastics tube, which not only performs well, but additionally lends itself to portable monitoring during Gordon's extensive travels.

After many weeks of listening, Gordon managed to make sense of the pass times, and get his first pictures, despite the problems posed by the high mountains and the interference emanating from

other transmitters around Keswick, the latter difficulty being made far worse when a pre-amplifier is added. "Many daytime passes are rendered unusable," writes Gordon, "but I am continuing to experiment with filters and notches to try to prevent the breakthrough".

Gordon records his satellite passes on a cassette, which not only overcomes the r.f.i. from the computer he uses to decode and display the pictures, but also permits archiving and re-runs of the passes to view the different infra-red and visible contents. Additionally, it allows later enlargement of all sections required. To decode the signal he designed and built a circuit incorporating a sync separator, an A to D converter, and a phase locked loop, which provides information to the computer with the synchronisation.

To display, he uses a Computers Lynx 48K computer, which offers good graphics at 256 x 248 with 8 colours, and grey levels in black and white. By writing software, and adding modifications, Gordon

has contributed many additional features to his system. These include variable vertical and horizontal resolutions, variable brightness and contrast, the choice of visible, infra-red or both as well as the facility to save and recall pictures. The latest improvements added resulted from the design of a system that offers the same resolution but with 256 grey levels. In addition, it can also generate graphics using a RGB monitor. The total cost was only some £50.00. and it will interface with most computers, the results of this addition can be seen on some of his pictures reproduced in this issue.

The photograph in Fig. 1 came from NOAA-9 on 29 March 1987, and has a vertical resolution of every fifth vertical line, and a horizontal of every fifth peak (positive or negative) of 2.4kHz carrier. The maximum number of grey levels of 256 was used to produce this excellent frame of the weather system seen over Europe.

The photograph in Fig. 2 is also NOAA-9 of the same date, now

with every second visible line, and every second peak of 2.4kHz carrier, and gives good details of Britain and Ireland. The view in Fig. 3 is the same format, showing the view further south, whilst Fig. 4 uses every visible line vertical and every positive and negative peak of the 2.4kHz carrier.

The photograph in Fig. 5 has the same details basis as Fig. 4, now showing us good definition of Scotland and Northern Ireland, and Fig. 6, also the same selection, shows us detail further south in the UK.

Figs 7 and 8 are in colour and cannot be reproduced to the best value in our column, Fig. 7, from NOAA-9, was taken on Good Friday 1987, using every visible line in vertical resolution, and every positive peak of 2.4kHz carrier in horizontal, with eight colours. The photograph in Fig. 8 is of the same satellite and date and utilised every 5th visible line for vertical resolution and every 3rd positive peak of 2.4kHz carrier for horizontal, also with eight colours.

A good "close up" of southern Italy and Sicily, even showing the

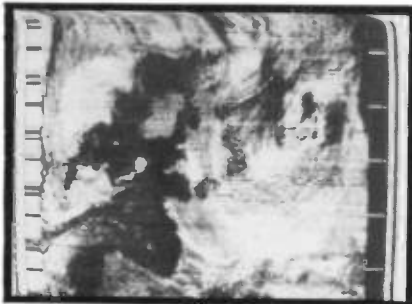

Fig. 1

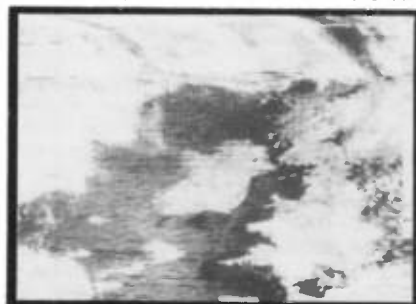

Fig. 2



Fig. 3

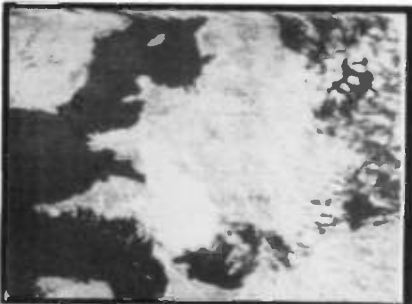

Fig. 4

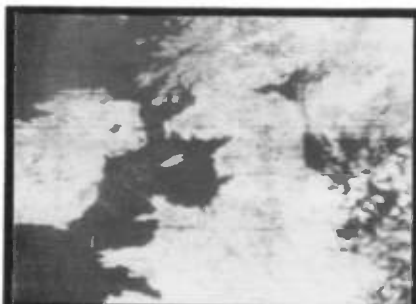

Fig. 5



Fig. 6

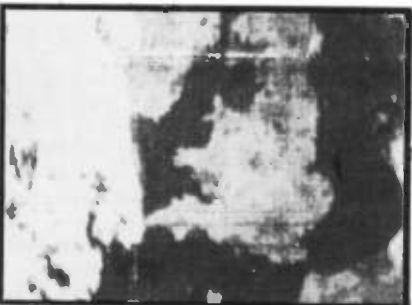

Fig. 7

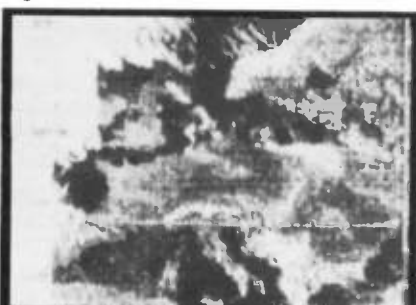

Fig. 8



Fig. 9

small islands of Lipari, Salina and Stromboli by centering at 39 degrees north, 15 degrees east, can be seen in Fig. 9, set for maximum resolution. Our last picture, Fig. 10, with a similar centre, now showing the African coast included with the larger scale, was taken off NOAA-9 at 3.00pm, when Gordon was employing his portable system on location in Devon.

Gordon says that if any of our reader enthusiasts would like copies of the software (or a listing if they do not possess a Lynx computer) or wish to have the details of the decoder or display generator, he would be happy to supply this if they will contact him in the evenings on the telephone number (0596) 73221, or write to him at 52 St. John's Street, Keswick CA12 5AB.

Lawrence Harris, who was a professional satellite controller for many years commanding the UK series and the IRAS satellite, writes from Plymouth, where he now teaches computer literacy. He is an active satellite monitor, and has made a number of discoveries that escaped the attention of many of the more experienced amateurs.

The first of these dates back to November 1986, when Lawrence picked up Meteor 1/30 for the first time, broadcasting its APT on 137.020MHz. Although he was first assured by the "experts" that it was in fact on 137.060MHz, and that he had not measured the frequency accurately, he was absolutely correct, and found that it was drifting lower in frequency all the time. It is currently on 137.010MHz, well on the way to 137.000MHz. Despite the drift, its pictures show very good winter land/sea boundary definition, although archived summer records show little land detail.

Since then, he was amongst the first to discover many of the USSR Meteor series, including Meteor 2/16 last August, and at the same time the first to pick up the re-activated old Meteor 2/3 which was accidentally commanded on whilst Meteor 2/16 was being



Fig. 10

commissioned. (The two satellites were within a few degrees of each other over the USSR at the time).

Lawrence reports the following satellites in current operation:

Meteor 1/30 on 137.010MHz, detectable between 1030 and 1258 UTC time. Passes are some two minutes later each day until the changeover.

Meteor 2/14 and 2/15 are on 137.850MHz, with transmissions receivable whilst the spacecraft is in sunlight only.

Meteor 2/16 is on 137.400MHz, with visibility as above.

NOAA-9 is on 137.620MHz on at all times, normally sending both infra-red and visible pictures. Whilst in eclipse, the satellites visible transmission changes to that of narrow band water vapour.

NOAA-10 is on 137.500MHz, with details as for NOAA-9.

Cosmos-1869 was launched in the summer of 1987, using 137.400MHz, but is only on for limited periods lasting about six minutes. It was last on in September 1987, but tests and operations started again on November 30. As this spacecraft

uses storage facilities, we can look forwards to viewing pictures recorded elsewhere before dumping whilst over the USSR.

Lawrence is also seeing pictures from Cosmos 1766 on 137.400MHz. It is also an occasional broadcaster, but on and active far more frequently than Cosmos 1869.

## Help Line

Leslie Sargent of Runcorn writes in to ask if any reader who has done an i.f. bandwidth conversion can help in his quest to modify his FRG-7700 receiver to the 50kHz bandwidth needed for weather-satellite picture use. He uses this as a general coverage receiver, and adds the FRV-7700 v.h.f. converter to give him coverage from 118 to 150MHz.

"Ideally", says Les, "I would like to have it switchable, so that I can easily return back to the normal narrow bandwidth for general use". If any of our readers feel that they can assist, please drop a line to Les at 2 Bartlegate Close, Brookvale, Phase 2, Runcorn, Cheshire WA7 6BX.

Deadlines are February 16,  
March 15 and April 19

## BAND II DX

Ron Ham

Faraday, Greyfriars, Storrington, West Sussex RH20 4HE

## MIR Misses

John Branegan GM4IHJ, is a regular MIR observer, and has contributed some further good reasons for the reduced use of the voice communications frequency on 143.625MHz. His observations show that there is now a "TDRS" satellite in use taking some of the communications, replacing the earlier "LUCH" satellite that drifted off-station in the February to March time slot. Furthermore, the crew work-schedule has been changed to permit intensive spacecraft manoeuvring to facilitate X-ray observation of the new supernova in the Magellenic cloud, visible only from the southern hemisphere. This means that rest and exercise periods will now be more slotted into the north hemisphere passes, meaning less communications activity. John has been monitoring 166.140MHz for the MIR digital signal, but has yet to hear it, and wonders if any other enthusiasts have spotted it yet.

On 14 November 1987, the day of writing this column, it has just been announced that replacement cosmonauts, accompanied by a medical doctor, will fly by SOYUZ-TM-4 to MIR on Christmas Eve. The current crew will return to earth in the TM-3 on December 31. The 329 days of weightlessness has now had its effect on Yuri Romanenko, who sounds very tired and husky, and has lost 15 per cent of his muscle weight, despite additional exercise and rest periods. The next stay will therefore be cut from the planned 400 down to 200 days duration in MIR.

More details from John on the MIR mission will appear in the Space and Satellites column in the next *Practical Wireless* due out February 11. Our column will include some of the MIR cosmonaut content with a short guide on translating some of the terminology heard in the Russian language, and some more weathersat pictures from David Bird and Mark Smith.

It has been known for several decades that a close relationship exists between the atmospheric pressure, the prevailing weather and the distances travelled by v.h.f. radio signals. The rise or fall in pressure can be seen on a standard household barometer or, better still, recorded on a barograph.

The difference between a baro-

meter and a barograph is that the readings on the former are compared to a user adjustable cursor attached to the viewing glass, the latter traces it's results on a moving calibrated chart. Although a barograph, new or second-hand, is expensive to buy and a years supply of chart is currently around £10, it is a useful instrument to have in your station

especially if you have a particular interest in long-term weather as well as v.h.f. propagation. Among my own records are the weekly pressure charts, produced by the Short and Mason barograph seen in Fig. 1, covering the past 25 years. I have made some interesting comparisons between DX signals in the v.h.f. bands and the movement of weather systems.

On the left of Fig. 1 is the chart secured to the revolving, clock-work driven, drum (winding key in top of drum) and the aneroid pile, which senses the pressure variations and moves the pen arm, is prominent in the centre. The knurled nut at the top of the pile is for setting the instrument to suit the users height above sea level. The recording chart is calibrated

# SEEN & HEARD

horizontally in days (Sunday to Saturday), broken up into hours, and vertically from 28 to 31in. A bottle of ink, stored behind the pen arm, lasts for years because the writing nib only takes a few drops to refill.

## Equipment

Among the selection of receivers used by John Berridge (Cardiff) are such manufacturer's names as Bosch, Bush, Panasonic, Pioneer and Vega. It is worth having more than one receiver in use especially during an opening when many more signals are present at the antenna. This is because, for a variety of reasons, sets do vary in performance.

Some readers have experienced the nuisance of signals appearing in Band II that are nothing to do with the recognised f.m. broadcasting. This may be due to i.f. breakthrough which occurs when strong signals are picked up at the intermediate frequency stages of your set and then processed through to the loud-speaker in the

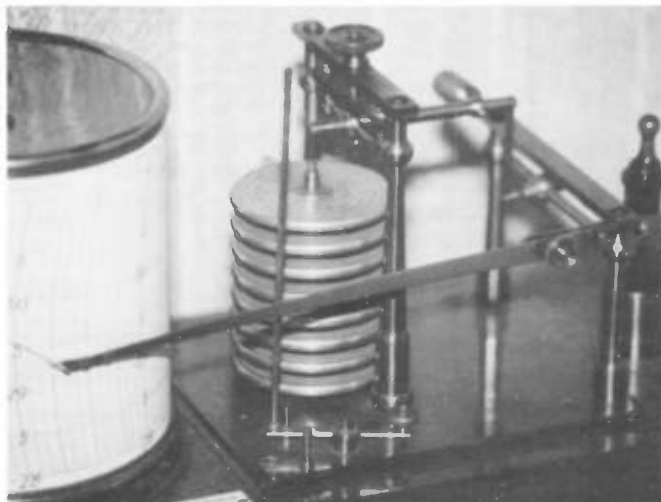

normal way. If you are troubled in this way it is worth getting the alignment of your receiver checked by an engineer and at the same time making sure that all screening cans and plates are

securely in position.

## Reports

"I noticed a slight Band II opening between 0030 and 1400 on

Reports for April '88 issue  
by February 16 please

## TELEVISION

Ron Ham

Faraday, Greyfriars, Storrington, West Sussex RH20 4HE

Newcomers to DXTV often find the combination between bands, channels numbers and frequency a bit confusing so, this time I will try and clarify the situation.

Generally speaking, the world's television programmes are transmitted on internationally agreed channels in the v.h.f. Bands I (45-68MHz) and III (175-230MHz) and the u.h.f. Bands IV (471-607MHz) and V (615-855MHz). However, there are exceptions and reference to the *World Radio TV Handbook* tells me that Australia, China, Japan and the USSR also have allocations in Band II. Readers requiring more detailed information should consult this handbook, which is published annually and obtainable from various suppliers including the *Short Wave Magazine Book Service*. (See Page 00).

The letters "DX", in communications terms, means long distance, therefore the prime object of a Television DXer is to receive pictures from television networks operating mainly in other countries. Such signals are usually logged when their normal range is enhanced by natural disturbances within the "E" region of the ionosphere or in the troposphere. The former, called Sporadic-E, often disrupts Bands I and II for a few hours and the latter, known as a tropospheric opening or "lift", can increase the



Fig. 1

range of signals transmitted in Band III, IV and V for several days.

It is a matter of technical fact that television signals, depending on frequency, have a limited normal range without being specifically designed to cover an even more-limited service area. The UK's original 405-line v.h.f. system ended in recent years therefore the vast majority of receivers currently sold in this country are 625-line and their tuners are restricted to the u.h.f. band.

Among the exceptions to this rule is the Panasonic TR1200 and, like some other multi-band television receivers, it's tuning dial, Fig. 1, is scribed with the channel numbers 2-4 (Band II), 5-12 (Band III) plus 21-69 for Bands IV and V.

Most "DX" in Band I, caused by Sporadic-E, reaches the UK from

countries ranging from Iceland and Scandinavia to the Mediterranean coasts and the USSR. Because this multitude of transmitters share the same or similar frequencies, very often DXers find a variety of pictures fighting for predominance on their screens. For instance, Ch. E2 (48.25MHz) is used in Germany, Norway, Portugal, Spain, Sweden and Switzerland. Signals on Ch. R1 (49.75MHz) are emitted from Czechoslovakia, Hungary, Poland and the USSR.

Note the close proximity of these two vision frequencies, which means that if a set remains tuned around the dial reading 2, pictures from most, if not all, of these countries could appear during an average disturbance. The intensity of a Sporadic-E event will ebb and flow throughout its life cycle, so the DXer's

December 6," wrote Ken Lancaster from Rotherham. He reports that his barometer at that time was reading 1022mb (30.2in) and the weather was very damp. During this period he heard several continental stations between 99 and 106MHz and says that those around 99.5, 100.65 and 105.6MHz were very powerful.

"The most surprising part of the opening was that I usually receive Pennine Radio on 102.5MHz very well here but, for five hours, it was completely blotted out by Radio Broadland on 102.4MHz," remarked Ken. However, he was very pleased to log this Norfolk station for the first time and added. "The Radio 1 relay from London was coming in so strong on 104.MHz it was better here than the medium wave outlet".

Because of strong signals throughout Band II from the numerous BBC, ILR and RTE transmitters, the only mainland station that Bill Kelly can now hear at his QTH in Belfast is BBC Radio Clyde on 102.5MHz.

opinion of "average" develops with experience. Obviously, other such frequency combinations exist in all bands, so it is necessary to tune up and down the scale to see what is about.

Typical examples of this approach came from Lt. Col. Rana Roy who, at his QTH in India, has logged signals from the USSR on Chs. R1 and R2d (59.25MHz), Pakistan (Lahore) on Ch. 5 and India (Jullundur) on Ch. 9, Figs. 2, 3, 4 and 5 respectively.

Dial searching by Len Eastman (Bristol) found pictures from Poland on Ch. R1 Fig. 6, Garry Smith (Derby) found pictures from Tunisia on Ch. E4 Fig. 7, Noel Smythe (Caerphilly) found pictures from Switzerland on Ch 9 Fig. 8 and George Garden (Edinburgh) found pictures from Tyne Tees TV from his portable location at Cairn O' Mounth on Ch. 61.

Engineers at TV stations usually like to have detailed reception reports as Edwina and Tony Mancini (Belper) found out when their letter to Soviet TV was acknowledged by a QSL card from Radio Moscow illustrating Moscow's Byelorussia Railway Terminus Square.

## Band I

During the midday Sporadic-E opening on October 21, John Raleigh (Bedford) logged Finland's

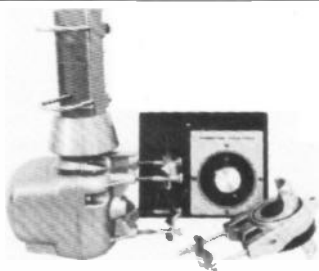

**AUTOMATIC ANTENNA  
ROTATOR**

Special Seasonal Offer — We have recently advertised the above two items separately at special prices. This month we are again breaking our own price barrier — the automatic antenna rotator is now only £38, and the S1814 Band 3 high gain aerial is down to £28. If the two items are purchased together, the total price is only £64 an even further saving.

The rotator is ideal for DXing. Amateur end domestic use to turn your aerial for reception of alternative ITV regions. The system comprises of two major components, the automatic control console and the rotator head unit. The additional support bearing shown, may be fitted if larger multiple aeriels are to be fitted. The attractively styled Control Console features continuous indication of aerial heading, showing the aeriels position at all times. The rotator support mast can be up to 2" in diameter, stub/rotation mast is up to 1½" in diameter.

The Fernseh-Antenna pictured is a 14 element high gain (11.5dB) wideband array covering all VHF channels in Band 3 (175-230MHz). The aerial is gold lacquered for complete protection from corrosion, has a folded dipole for peak efficiency and comes complete with plated mast clamp, which has a 2" grasp capability.

- COLOROTOR Automatic Antenna Rotator and Control Console (uses 3 core control cable) ..... £38.00
- SUPPORT BEARING for heavier load applications ..... £17.00
- FERNSEH-ANTENNA S1814 High Gain 14 element Wideband 3 Aerial ..... £28.00  
(Carriage & insurance on aerial £4.95)

If Rotator and Antenna are purchased together, total price is £64.00 + Carriage.

Aerial techniques is the company that knows the TV-DXing hobby. We carry a large and comprehensive range of aerial equipment for every type of installation, together with a vast range of fitters, amplifiers, cables, rotators, masts and supporting hardware. Send today for a copy of our glossy covered illustrated Catalogue at 75p, in the unlikely event that is doesn't list what you want, we can obtain it quickly.

All prices inclusive of VAT & Carriage.

Delivery normally 7-10 days.

ACCESS & VISA Mail and Telephone orders welcome.



**AERIAL TECHNIQUES (SW)**  
11, Kent Road, Parkstone,  
Poole, Dorset, BH12 2EH. Tel: 0202 738232.



**FERNSEH-ANTENNA  
High Gain Wideband  
VHF Band 3 Aerial  
for TV DXing**

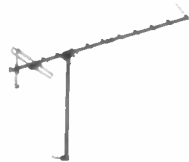

**AIRBAND LISTENERS !**

Our new revised UHF FREQUENCY listing is now available and contains Airfield / ATCC / Range / Ops and Air Refuelling frequencies etc. Priced at ONLY £1.50. It may not be the most "glossy" publication available but its what inside that counts.

We keep in stock a wide range of VHF/UHF airband receivers and accessories from the leading manufacturers along with a wide range of aviation books for the enthusiast.

Some special offers we have at the moment are 5% discount on the SONY AIR-7 and PRO-80 while the UNIDEN BEARCAT 100XL is available at £189.00.

For further information please send a SAE or telephone for details.



**JAVIATION**

Carlton Works, Carlton Street,  
BRADFORD, West Yorkshire, BD7 1DA  
Telephone: 0274-732146  
or 639497 (evenings)



**SHORT WAVE NEWSLETTER**

Our fortnightly report will keep you up to date on the everchanging world of short wave radio. Every issue contains the latest logs from both the official and unofficial broadcasters along with the latest schedules. A feature section is also presented and this may be the latest MW/LW DX tips, a special article or something else. For the latest issue, send 70p, or to get a better idea of SWN, why not try a sample subscription of three issues for £2.10. Please make all cheques payable to P.S. Willsher and write to:

**SWN, 3 GREENWAY, HAROLD PARK,  
ROMFORD, ESSEX, RM3 0HH.**

**ALL  
VALVES  
& TRANSISTORS**

Call or phone for a  
most courteous quotation  
**01-749 3934**

We are one of the largest  
stockists of valves etc. in the U.K.

**COLOMOR ELECTRONICS LTD.**

170 GOLDHAWK ROAD  
LONDON W12

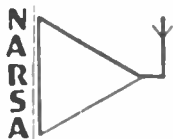

**BELLE VUE / NORBRECK  
RADIO AND ELECTRONICS EXHIBITION**  
by the Northern Amateur Radio Societies Association

at the

**NORBRECK CASTLE HOTEL EXHIBITION CENTRE  
QUEENS PROMENADE, NORTH SHORE, BLACKPOOL**  
(Formerly held at Belle Vue, Manchester)

on **Sunday, January 31st, 1988**

Doors open at 11 am

The North's Premier Amateur Radio & Electronics Event

- ★ Inter-Club Quiz
- ★ Bring & Buy Stall
- ★ R.S.G.B. Book Stall
- ★ R.S.G.B. Morse Tests (Book direct vja R.S.G.B.)
- ★ Overnight Accommodation at reduced rates (contact hotel directly)
- ★ Grand Raffle
- ★ Amateur Computer Stands
- ★ Club Stands
- ★ Restaurant & Bar
- ★ Free car parking
- ★ Attractions for Ladies

★ ALL THE USUAL "BELLE VUE" TRADERS ★

**RADIO TALK-IN ON S22 and SU8**

ADMISSION £1 (OAP's 50p, under 14's free) BY RAFFLE TICKET AND EXHIBITION PLAN

Business Manager: Peter Denton G6CGF 051-630-5790

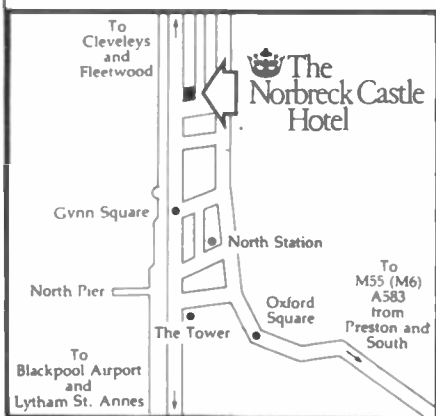

# SEEN & HEARD

(YLE-TV) test-transmissions. He also saw a test-card and news with the "HOBOCTN" and "NORPAMMA" captions, from the USSR. There was a church service from Portugal (RTP) on the 25th.

Although Sporadic-E can be a bit sparse during the winter months, the Mancinis found test cards from Denmark on December 3 and 4, Sweden (STV-Kanal-1) and Switzerland (+PTT NED-1) on Ch. E3 on the 1st and 8th and cartoons from Italy (RAI-1) on Ch. 1b (62.25MHz) on the 4th and 8th.

"My receiving station was behaving like a 'shooting star telescope' on December 7," commented Simon Hamer (New Radnor). This was after seeing brief flashes of test-cards, via meteor trail reflection, from Denmark on Ch. E3, Norway (Greipstad) — Ch. E2, Poland — Ch. R1 and Sweden — Ch. E2 at lunch-time as well as Iceland (RUV-Island) — Ch. E4 at midnight.

## Tropospheric

While the opening was in progress on November 4, John Raleigh watched programmes and test cards in Band III from Belgium (BRT and RTBF-1) on Chs. E8, 10 and 11; France (Canal +) at many

points across the band; Germany (ARD) on Chs. E8 and 10 and Luxembourg on Ch. E7.

On the 6th, Simon Hamer logged ITV stations Border, Grampian and Scottish on the u.h.f. channels 28, and 25 and 23 and 43 respectively plus Television South West (Ch. 23) and Ulster TV (Ch. 24). "All first timers, I now want the Channel Islands," said Simon.

"My best DX occurred on November 6," wrote Garry Smith. This was after logging Czechoslovakia CST-1 on Ch. R10 and CST-2 on Chs. R31, 35 and 38; East Germany DFF-2 on Chs. E22, 29, 33 and 34 and Poland TVP-1 on Chs. R35. "There were countless West Germans in Band III and the u.h.f. band," said Garry. He was "shocked and surprised" to see Czechoslovakia's RS-KH sitting over Sandy Heath on Ch. 31. Who wouldn't be, Garry.

On November 18, Steve Ralph (Sittingbourne) installed JVC C140KM and YOKO F6 receivers for DXTV. On the 28th, using a Band II dipole, he identified pictures from Belgium (BRT-TV1 and RTBF1), France (Canal +) and Holland (PTT-NED-1) in Band III.

However, on the 29th he fitted a 14-element Yagi to his rotator and from then until December 3, he received consistent signals from all 3. Between 0700 and 0730 on the 4th, Steve watched breakfast TV from Luxembourg (RTL) on Ch. E7, at 1900, Germany's ARD-1 was strong on ch. E9. By rotating his antenna on the 5th, he found Belgium on Chs. E8 and 10, France on Ch. L5, Germany on Chs. E9 and 11 and Holland on Chs. E5, 6 and 7. Steve now plans to install a 4-element beam for Band I and a Triax 44 for the u.h.f. band on a 6m high mast.

On December 6, Simon received pictures from Belgium, Denmark (DR) on Chs. E5 and 10, France, East and West Germany (DFF-1, ARD/WDR-1), Holland, Ireland (RTE-1 and 2) and Luxembourg in Band III.

John Raleigh received pictures from Belgium BRT-TV1 on Ch. E10 on November 28, 29, December 4, 6 and 9; RTBF-1 on November 20, 22, 23, 24, 28, 29, 30, December 4, 6, and 9; France Canal + on Ch. L5 on November 29, December 4 and 6, and on Ch. L9 on December 2 and 7; Holland on Ch. E5 on December 5 and 6 and Luxembourg on Ch.

E7 on the 4th. While the atmospheric pressure was falling John received "first-class" pictures from Luxembourg at midday on the 4th and Holland on the 5th.

Between November 26 and December 8, Edwina and Tony received test cards from most of the aforementioned stations and reported seeing *Batman* on Canal Plus, programmes for children, a discussion followed by an interlude and teletext on RTBF-1, current affairs on BRT-TV1 and a logo from ARD.

## SSTV

Allan Sancto DD5FM from Grosskarolinenfeld sent photographs of slow-scan pictures which he received from a DL/EA Fig. 9 and part of a QSO between GW and SM Fig. 10 earlier in 1987.

Although both Ray Gilchrist (Millom) and Les Hobson COCUI found SSTV a bit sparse during the month prior to November 25. Ray copied pictures on 14MHz from East and West Germany, Italy and Switzerland, between days 8 and 15. Les exchanged 8 seconds b/w pictures with Y28WH on 3.5MHz, EA5JY, VE3JDJ, W2WA, W2GQC and W9NTP on 14MHz and KC2Q on 21MHz. This increased his first-timer QSOs to 239.

Deadlines are February 16,  
March 15 and April 19



Fig. 2: USSR Ch. R1



Fig. 3: USSR Ch. R2

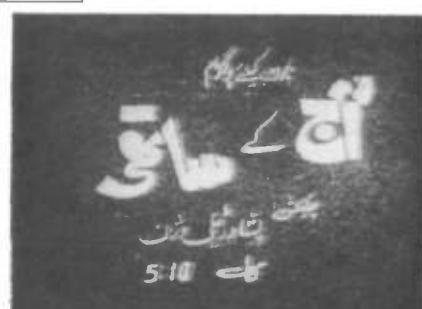

Fig. 4: Lahore TV Ch. 5



Fig. 5: Jullundur TV Ch. 9



Fig. 6: Poland Ch. R1

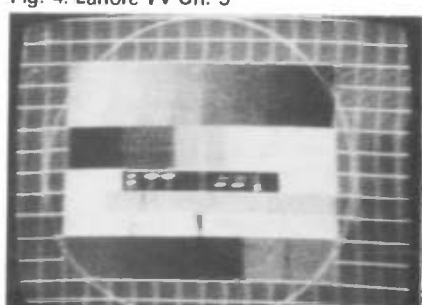

Fig. 7: Tunisia Ch. E4

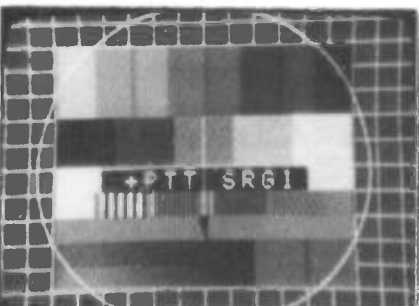

Fig. 8: Switzerland Ch. E9



Fig. 9: SSTV



Fig. 10: Swedish SSTV

# SEEN & HEARD

## LONG MEDIUM & SHORT

Brian Oddy G3FEX  
Three Corners, Merryfield Way, Storrington,  
West Sussex RH20 4NS

Several new agreements have now been reached between some of the major s.w. broadcasters which provide for an increase in the number of relay facilities used on the s.w. bands. Some of them have now been implemented and there can be no doubt that the reception of the programmes from some of the more distant areas of the world has now improved.

The introduction of these new relays may well be a step in the wrong direction as far as the dedicated s.w. listener is concerned, because it is the thrill of being able to tune into a distant broadcast from some distant place that makes s.w. listening such a fascinating hobby!

### DX Report

(Note: l.w. and m.w. frequencies in kHz, s.w. in MHz; Time UTC)

### Long Wave DX

Normally DXer Paul O'Connor is resident in Birmingham, but he recently flew out to Florida, S. Africa to start a visit which he has been planning for some months. One of the more important items in his luggage was his trusty l.w./m.w. car radio and needless to say it was not long after his arrival that he decided to connect it up and explore the bands! The Temperature is around 28°C there just now and it quickly became apparent that the local thunderstorms create a high level of static which makes reception generally very noisy.

A first check of the l.w. band revealed that it is full of aircraft navigational beacons above 200kHz, so the reception of DX broadcast signals in the upper half of the band is likely to be very difficult, if not impossible. Below 200kHz is clearer and there is every chance that some broadcast signals may become audible. Already Paul has picked up three carriers at 1900UTC, they may be from Allouis, France on 162; Medi 1 Nardor, Morocco on 171 and Saarlouis, W. Germany on 183, but so far it has not been possible to obtain any form of positive identification.

Electrical interference of a different kind has been spoiling reception for Phil Townsend in London. He says "the snaps, crackles and pops from the electrified railway (overhead wire supply) at the bottom of the garden are also electrifying when heard through headphones!" He would like to hear of any simple circuit that might help to reduce

the effect — please send along your ideas to him, via me initially. Although Phil compiled most of his list for the chart while using his Blaupunkt Turin car radio with an external wire antenna, he has also been experimenting with his Panasonic RF 1680L portable, making good use of the directional properties of the built in antenna.

Writing from Cardiff, John Berridge says he spent the whole of one day checking the identity of the broadcasts he can hear on the l.w. band. He managed positively to identify all but two, they faded out before getting around to making station announcements! It is a great pity that all l.w. broadcasters do not make more frequent station announcements, perhaps they should be made in several languages and include their operating frequency.

A Vega 206 portable was used by Darren Taplin to compile his list in Tunbridge Wells. At night he rated Allouis 162; Droitwich 200 and Junglinster 236 as SINPO 55555; Donebach at 34533 and Kaliningrad 171 as 25544. Some of the weaker signals noted on certain frequencies after dark have been attracting the attention of Jim Willett. He used a Polish Jubilat domestic receiver to log them in Grimsby.

### MW Transatlantic DX

Writing from Great Missenden, Howard Newell says he decided to try transatlantic DXing for the first time and was very pleased to hear the Carribean Beacon, Anguilla on 1610 at 0134. He was using a Toshiba RP F-11L portable and their religious broadcast rated as SINPO 23311. He had the pleasure of making a second entry in his log at 0230, when he picked-up VOA via Antigua on 1580. Their signal only rated as 11111, but their broadcast in English was clearly identified. The signals from CJYQ in St. John's, Newfoundland on 930 did not become audible until 0335, when they rated as 12111.

Howard says he heard another station just above 1300 which he felt sure was an American, but he could not identify it and decided to switch off as the time was then 0400! Spurred on by his initial success, Howard says he intends to search for more DX quite soon! Not everyone is quite as lucky as that, in fact Daniel Masterson says he has yet to hear his first transatlantic DX signal in Stoke-on-Trent despite repeated attempts, however he has not given up!

A change of listening time may

help, as David Edwardson discovered in Wallsend. He tried monitoring 930 for CJYQ on several occasions between 2200 and 2300 without success, despite the fact that he was using a 1.005m by 0.885m loop and an l.f. converter ahead of his Trio R600 receiver. So he decided to check the band at dawn instead and logged VOXM in St. John's, Newfoundland on 590!

The BBC Newcastle Radio 4 relay transmitter on 603 created a good deal of sideband splatter on 590, so David set the selectivity control on his R600 receiver to the NARROW position (2.7kHz) and was able to rate the signal from VOXM as 33543. He tried checking 930

for CJYQ but it was inaudible and severe interference from the BRT Wolvertem transmitter on 927 made things difficult.

If a receiver capable of s.s.b. reception is being used for DXing, it is perhaps worth remembering that one can largely eliminate sideband splatter from an unwanted station on an adjacent channel by using the "exalted carrier" technique. This simply involves carefully adjusting the tuning of the receiver while in the s.s.b. mode so as to "zero beat" the wanted carrier. Then, by selecting either the upper or lower sideband the unwanted interference may be eliminated!

Using a JRC NRD 525 receiver

Freq MHz	Station	Location	Time (UTC)	DXer
660	WNBC	USA New York, NY	2337	C
710	WOR	New York, NY	2352	C
850	WHDH	Boston, MA	2305	C
1010	WINS	New York, NY	0030	B,D,G,F
1030	WBZ	Boston, MA	0029	B,F
1050	WFAN	New York, NY	0200	B,C,F,G,H
1090	WBAL	Baltimore, MD	0017	B,C
1130	WNEW	New York, NY	0130	B,G,H
1190	WLIB	New York, NY	0330	G
1190	WOWO	Ft. Wayne, IN	0450	D
1210	WCAU	Philadelphia, PA	0008	B,D,F,H
1470	WLAM	Lewiston, MA	0230	H
1500	WTOP	Washington, WA	0200	B,C
1510	WSSH	Boston, MA	0557	D
1540	KXEL	Waterloo, LA	0057	C
1560	WQXR	New York, NY Canada	0220	H
560	CHCM	Marystown, NF	0410	D
590	VOXM	St. John's, NF	0605	A,B,D,F
600	CBNA	St. Anthony, NF	0030	B,C,D
610	CKYQ	Grand Bank, NF	0130	B,C
620	CKCM	Grand Falls, NF	0410	D
710	CKVO	Clarenceville, NF	0130	B
750	CBGY	Bonavista Bay, NF	0100	B
920	CJCH	Halifax, NS	0100	B,F
930	CFBC	St. John, NB	0035	F
930	CJYQ	St. John's, NF	0150	B,D,E, F,H
940	CBM	Montreal	0135	H
1010	CFRB	Toronto	0300	C
1110	CBD	St. John, NB	0210	C,D
1250	CBOF	Ottawa, ON	0250	C
1410	CIGO	Pt. Hawkesbury, NS	0300	H
1570	CKLM	Lavel, PO	0200	B,H
825	R. Paradise	C. America & Caribbean St. Kitts	0200	H
930	R. Antilles	Monseratt	0250	H
1100	ZDK	Antigua	0200	H
1210	R. Caribes	Dominica	0215	H
1555	R. Cayman	Cayman I	0255	H
1570	Atlantic Beacon	Turks & Caicos I	0150	B,D
1580	VOA	Antigua	0230	E,H
1610	Caribbean Beacon	Anguilla	0035	B,E,H
1100	R. Globo	South America Sao Paulo, Brazil	0150	B,D
1220	R. Globo	Rio, Brazil	0025	B,C,D

### DXers

- (A) David Edwardson, Wallsend. (E) Howard Newell, Great Missenden.  
(B) Simon Hamer, New Radnor. (F) Nick Rank, Buxton.  
(C) Davey Hossack, Winchburgh. (G) Tim Shirley, Bristol.  
(D) Bill Kelly, Belfast. (H) Jim Willett, Grimsby.



# SEEN & HEARD

in Belfast, **Bill Kelly** has also been monitoring the signal from VCOM on 590. At 0035 he logged it as S2, but by 0325 it had reached a peak of S4, rapid fading then quickly set in and reception became poor. By 0558 reception had improved to good and the signal was then S3. Some of the interesting sporting events which take place on the other side of the Atlantic have been attracting his attention during the night. For example, he picked WCAU in Philadelphia on 1210 at 0310 and listened to their commentary on an exciting match between the Redsocks and the Dallas Cowboys!

## Other MW DX

Several of the broadcasts from W. Germany were logged by **Tim Shirley** in Bristol during the day, namely Bayerischer Rundfunk via Hof-Saale 520 at 0900; Hessischer Rundfunk via Frankfurt 594 at 1500; Bayerischer Rundfunk via Munchen Ismaning 801 at 2000; Norddeutscher Rundfunk via Hamburg 972 at 1100 and Deutschlandfunk via Neumunster 1269 at 1915. He also logged two stations in Belgium, Wavre-Overijse 621 at 1600 and La Louviere 1125 at 0830.

It seems that the signal from La Louviere on 1125 also reaches Belfast well during daylight. **Bill Kelly** logged it as S3 at 1340. Most of his DXing activity takes place after dark however and he has certainly been hearing some interesting stations — Leningrad, USSR 549 at 0225; Oujda, Morocco 594 at 0305; Batra, Egypt 621 at 0003; Napoli, Italy 657 at 0358; Alger, Algeria 891 at 0025; Nebit Dag, USSR 927 at 2340; Rostov/Don, USSR 945 at 0010; AFN Munchen, W. Germany 1107 at 0225; Kaliningrad, USSR 1116 at 2330; Monte-Carlo, Monaco 1467 at 0550; Sochi, USSR 1512 at 0445; Sfax, Tunisia 1566 at 2320 and Genova, Italy 1575 at 2255.

Listening in Northwich, **John Parry** picked up the signal from the BBC 1kW relay transmitter in Eniskillen, N. Ireland on 873 at 0740. In London, **Phil Townsend** logged BBC Radio Ulster via Lisnagarvey, N. Ireland on 1341 at 1435 and one of the official stations in S. Ireland, namely RTE-2 via Dublin or Cork on 1278. He was using his Panasonic RF 1680L portable indoors with just the built-in antenna. Two more of the official RTE broadcasts were logged by **Martin Lindars** in Crewkerne at 1430, RTE-1 Tullamore on 567 and RTE-2 via Athlone on 612.

Writing from Bungay, **Ron Pearce** says he has now modified his 1 valve (955) s.w. receiver to include the m.w. band. His latest

log, compiled while using this set around 1930, includes AFN via Frankfurt, W. Germany 873; Alger, Algeria 981; Pori Finland 963; AFN via Munchen, W. Germany 1107 and RBl Berlin, GDR 1359 — perhaps these impressive results will encourage others to try building a simple receiver too!

The broadcasts from Radio Finland via their new transmitting installation in Pori on 963, are being well received in the UK. **David Edwardson** rated their signal as SINPO 34443 at 0730 in Wallsend and the report from **Robert Taylor** in Edinburgh detailed their signal at night as SIO 433. In comparison, he logged Radio Sweden, via Solvesborg 1179 as SIO 444.

Using a Matsui MR4099 portable in Brighton, **John Nash** picked-up several of the more distant stations during the evening — Sidi Bennour, Morocco 540; Muge, Portugal 594; Barcelona 738 and Sevilla, Spain 792; Toulouse, France 945; Rome, Italy 1332; Kaunas, USSR 1386; Leningrad, USSR 1494; Duba, S. Arabia 1521 and Vatican Radio, Italy 1530. Another distant station was logged by **Howard Newell** during the evening, namely Radio Tirana via Lushnje, Albania on 1395.

The broadcasts from Radio Prague, Czechoslovakia via Litomysl/Liblice 1287 were mentioned in several of the reports. **Glen Glen-Davison** logged them in Newcastle-upon-Tyne as 55555 at 2100. Their *Sunday Concert* attracted the attention of **Sheila Hughes** in Morden at 2200. Sheila has also been listening to the broadcasts from Warsaw, Poland via Stargard 1503 and from BRT via Wolvertem, Belgium 1512 at 2200. Both signals rated as 43443. Manx Radio, Isle of Man 1368 was noted by several DXers during the evening, **Robert Taylor** rated their signal as SIO 444.

## MW Local Radio DX

It is nice to be able to welcome two more contributors to this section of LMS, namely **E. Walden-Vincent** of Great Yarmouth (his "listening post" is depicted in Fig. 1), and **Ed Wieringa**, of Zandervoort, Holland, (he uses a



Fig. 1

Uniden CR 2021 receiver with a "ferroloop" antenna). Their first logs for the charts certainly make very interesting reading!

During a recent visit to Sidmouth, **Sheila Hughes** used her Vega Sapphire travel portable to explore the local radio scene around noon. She logged ILR Devonair Radio via Exeter 666; BBC R. Devon via Exeter 990 and via Torbay 1458; BBC R. Jersey 1026 and BBC R. Bristol via Mangotsfield 1548, all signals rated SINPO 44444.

Listening in Bristol, **Tim Shirley** says he finds the reception of ILR Red Dragon via Newport on 1305 to be good during daylight, but after dark it is very bad. This effect has also been observed by some of the listeners who live in the Welsh valleys near to the transmitter, more reports from that area would be welcome.

Writing from Manchester, **Michael Hirst** says he was very surprised to hear ILR Capital Radio in London on 1548 at 2200, because he was using his Philips D2935 portable with just the built-in ferrite rod antenna at the time. He is hoping to obtain a loop antenna quite soon, meanwhile he is busy building an a.t.u. so that he can try an external wire antenna.

Using only a 4m length of wire with a Partridge VFA ahead of his Trio R600 receiver, **Martyn Lindars** managed to log the signal from the BBC 2kW Radio Clwyd transmitter in Wrexham! A "Sooper Loop" enabled **Bill Eyre** of Stockport to "null-out" the powerful signal from ILR R. Aire via Morley on 828 and hear for the first time BBC Radio WM via Sedgley also on 828.

Since his last report, **John Nash** has received letters confirming his reception of BBC R. Bedfordshire via Luton 630; BBC R. Northampton on 1107 and BBC R. Guernsey on 1116 and a QSL card from ILR Chiltern Radio to confirm his reception of their broadcasts via their Kempston transmitter on 792.

## Short Wave DX

The 25MHz (11m) band has been attracting the attention of several DXers following last month's report that Radio Norway International, Oslo are now making daily broadcasts to S. Africa on 25.730. The 11m band will offer unrivalled global reception as we climb the upward slope of the present solar sunspot cycle during the next few years. The latest reports from S. Africa on the broadcast from RNI in Oslo suggests that this is already becoming evident!

Writing from Johannesburg, S. Africa **Simon Illingworth** says that during the initial tests the signal from RNI faded in and out at roughly ten minute intervals and there were major fluctuations in

the audio quality too. More recently however, the signal stabilised and reception improved. Reception is now very good and their signal rates as SINPO 4544. He hopes that some of the other broadcasters will now begin to use this band too. Listening in George, S. Africa **Dick Moon** recently logged their signal as SINPO 55555 at 1300!

Several DXers in the UK have been hearing the RNI transmissions too. **Glen Glen-Davison** says he listened to their broadcast from 1155 until 1232 and rated their signal as SINPO 45534. He promptly sent a reception report to them and has now received their QSL card and a copy of their broadcast schedule! Since these broadcasts are not intended for the UK, reception here is likely to be relatively poor in many areas. **Bill Eyre** says he found their broadcast to be fully readable at 1300, but it suffered from fading.

It is unfortunate that many of the receivers on sale just now do not cover the 11m band. **Howard Newell** says he encountered this problem with his Toshiba RP-F11L portable and had to borrow his brother's Uniden CR2021 receiver in order to log their transmission. RNI are anxious to receive reception reports, so if you do hear their broadcast be sure to send along a report.

In the December '87 LMS I mentioned that I had been hearing daily transmissions from Radio Netherlands on 25.970 at 0830. However they ceased before that issue appeared on the bookstalls! Using a Sony ICF 7600DS portable with the built-in whip antenna, **John Dunstall** also logged them on two occasions in Polegate, but at the later time of 1130. John has sent a reception report to Radio Netherlands and is now awaiting their QSL and some information about the transmissions. **Simon Illingworth** says he was also hearing them in Johannesburg and rated their signal as 45544.

The reception conditions prevailing on the 21MHz (13m) band have shown some improvement recently and the transmissions from a southerly direction have been particularly well received in the UK.

The broadcasts from Radio Japan via Moyabi, Gabon 21.695 at 0700 were mentioned in the report from **John Berridge**. He says "They are producing an excellent hour of news and views in English". Some of the other broadcasts which may be heard during the morning were logged by **Robert Taylor**, namely REE via Noblejas, Spain 21.575 — rated as SIO 444 at 1030; UAE Radio Dubai 21.605—444 at 1045 and Vatican Radio, Rome 21.485 — 444 at 1100. The programmes in English from Radio RSA

# SEEN & HEARD

Freq kHz	Station	ILR or BBC	DXer
585	R.Solway	B	C
603	Invicta Sound	I	C,H,J,L*,M,N
630	R. Bedfordshire	B	B,C,D,G,H,I,J,M,N
657	R.Ciwyd	B	B,C,F,H
666	DevonAir R.	I	J
666	R.York	B	B,C,M,N
729	BBC Essex	B	C,G,H,M,N
756	R.Cumbria	B	C
756	R.Shropshire	B	B,C,G,H
765	BBC Essex	B	B,C,H,I,N
774	R.Kent	B	G*,I,M,N
774	R.Leeds	B	A,B,C
774	Severn Sound	I	J
792	Chiltern R.	I	B,G,H,M,N
801	R.Devon	B	B,C
828	R.WM	B	C
828	R.Aire	I	A,B,C
828	Chiltern R.	I	D,G,H,M,N
837	R.Furness	B	C
837	R.Leicester	B	B,C,G,H,M,N
855	R.Norfolk	B	H,K,M,N
855	R.Lancashire	B	B,C
873	R.Norfolk	B	B,C,D,H,M,N
936	GWR	I	C,G,H,J,K
945	R.Trent	I	B,C,G,H,N
954	R.Wyvern	I	B,C
990	Beacon R.	I	B,C
990	Hallam R.	I	C
999	Red Rose R.	I	A,B,C
999	R.Solent	B	H
1026	R.Cambridgeshire	B	B,G,H,M,N
1026	Downtown R.	I	C
1026	R.Jersey	B	G
1035	R.Kent	B	H,M,N
1035	NorthSound R.	I	A,C,M
1035	R.Sheffield	B	B,C
1035	West Sound	I	E
1107	R.Northampton	B	G,H,M,N
1116	R.Derby	B	A,B,C,H,N
1116	R.Guernsey	B	G
1152	R.Broadland	I	K*,M,N
1152	R.Clyde	I	J*
1152	LBC	I	H,J,M
1152	Piccadilly R.	I	B,C
1161	R.Bedfordshire	B	H

Freq kHz	Station	ILR or BBC	DXer
1161	R.Sussex	B	H
1161	R.Tay	I	B,K
1161	Viking R.	I	B,C,H*,M,N
1170	R.Orwell	I	M,N
1170	Signal Radio	I	B,C
1170	Ocean Sound	I	D,H
1242	Invicta Sound	I	C,H,N
1251	Saxon R.	I	B,G,H,M,N
1260	Marcher Sound	I	B,C
1260	Leicester Sound	I	M
1260	R.York	B	N
1278	Pennine R.	I	B,C,K*,N
1305	R.Hallam	I	B,C,N
1305	Red Dragon R.	I	J,N
1323	R.Bristol	B	B,C
1323	Southern Sound	I	B,C,D,N
1332	Hereward R.	I	B,C,M,N
1359	Essex R.	I	H,M,N
1359	Mercia Sound	I	C,H*
1368	R.Lincolnshire	B	B,M,N
1368	R.Sussex	B	D
1431	Essex R	I	N
1431	Radio 210	I	D,G,H
1449	R.Cambridgeshire	B	N
1458	R.London	B	H,I,K*,N
1458	R.Manchester	B	B,C
1458	R.Newcastle	B	E,N
1476	County Sound	I	B,E*,H,N
1485	R.Humberside	B	B,M,N
1485	R.Merseyside	B	B,C
1485	R.Oxford	B	H
1485	R.Sussex	B	H
1503	R.Stoke-on-Trent	B	B,C,N
1521	R.Mercury	I	B,D,H,N
1521	R.Nottingham	B	C,N
1530	R.Essex	B	N
1530	Pennine R.	I	B,C
1530	R.Wyvern	I	H*
1548	Capital R.	I	C*,E*,H,M
1548	R.City	I	C
1548	R.Hallam	I	B,C,H*
1557	Hereward R.	I	C,H*,N
1557	R.Lancashire	B	B,C,N
1557	Northants 96	I	E,H
1584	R.Nottingham	B	B,C,N
1602	R.Kent	B	B,C,H,N

Note:—

Entries marked \* were logged during darkness. All other entries were logged during daylight.

- (A) Alan Curry, Stockton-on-Tees.  
 (B) Bill Eyre, Stockport.  
 (C) Michael Hirst, Manchester  
 (D) Sheila Hughes, Morden

- (E) Bill Kelly, Belfast.  
 (F) Martyn Lindars, Crewkerne  
 (G) John Nash, Brighton.  
 (H) Martin Newell, Great Missenden.

## DXers:—

- (I) Ron Pearce, Bungay.  
 (J) Tim Shirley, Bristol.  
 (K) Robert Taylor, Edinburgh.  
 (L) Phillip Townsend, London.

- (M) E. Walden-Vincent, Great Yarmouth.  
 (N) Ed Wieringa, Zandvoort, Holland.

Johannesburg, S. Africa 21.590 may be heard at 1100 and also from 1300. John Nash rated their signal as 55544 at 1400. At 1208 Howard Newell picked up Radio Nederlands via their relay in Talata Volon, Madagascar on 21.480.

During the afternoon, Neil Dove of Lockerbie logged the BBC World Service via Rampisham, Dorset 21.700 at 1210; Radio Japan via Moyabi Gabon 21.700 — SINPO 34543 at 1515; WYFR via Okeechobee, Florida 21.525 — 45544 at 1620, Radio Free Europe via Gloria, Portugal 21.745 — 55555 at 1627 and VOA via Monrovia, Liberia 21.485 — 35444 at 1630.

John Nash has been checking the performance of his new Matsui MR4099 portable on single sideband (s.s.b.) by listening to the broadcasts from RSI via Varberg, Sweden on 21.5555. Their 100kW u.s.b. transmission commences at

0930 on a Great Circle bearing of 110 degrees centred on Varberg, but at 1200 the bearing is changed to 170 degrees. The broadcast is a relay of the Swedish home service and transmission ends at 1600. John rated their signal as 55353 at 1535. It is possible that transmissions of this type may be used for s.w. broadcasting in the future, so these RSI transmissions offer a good opportunity to assess the performance of the system.

Simon Illingworth also logged the u.s.b. broadcasts from RSI on 21.555 in Johannesburg, rating their signal as SINPO 44444. He says that the reception conditions on 13m have recently improved and the band now stays open until almost nightfall. He uses the BBC World Service broadcast on 21.700 from Rampisham, UK as his reference to conditions and their signal is now excellent! The signal from WCSN in Boston, USA on 21.515 has also improved, it

now rates as SINPO 55445 at 1800.

The reception conditions prevailing on the 17MHz (16m) band have enabled DXers to log a number of interesting stations during the day, but a high level of jamming has been noted too. It is unfortunate for UK DXers that the broadcasts from Radio Australia via Carnarvon to S. Asia on 17.715 are being jammed, because their signal can be a useful pointer to early morning reception conditions. George Hewlett, who monitors this frequency on a daily basis in Torquay on behalf of Telecom Australia, reports that their signal is rarely heard just now.

One of the more distant early morning broadcasts which does reach the UK, stems from FEBA Radio, Seychelles on 17.855. Their programmes in English from 0600 until 0700 are really intended for listeners in the Middle East, but David Edwardson rated

their signal in Wallsend as SINPO 34443 at 0630. An early start is also made by UAE Radio Dubai, they beam programmes in Arabic and English to listeners in Europe on 17.865 from 0615 until 1500.

During the Cricket test matches, the broadcasts from Radio Pakistan, Islamabad 17.660 attract many listeners, their programmes are normally in Urdu with some segments in English and they may be heard from 0715 until 1120. Ian Curry recently picked up their broadcast in Stockton-on-Tees at 1030 and rated their signal as SINPO 54444.

At 1215, Radio Cairo, Egypt broadcasts on 17.675 in English and Bengali. Their programmes are intended for listeners in S.Asia but they often reach the UK well, Neil Dove rated their signal as 44533 at 1230. During the afternoon a variety of interesting programmes may be heard from

# SEEN & HEARD

RCI in Montreal, Canada in eight languages! Their transmitter in Sackville, E. Canada on 17.820 puts a good signal into Europe from 1330.

Some of the broadcasts audible in the UK during the evening include Radio Surinam International via RNB Brazil 17.835 — logged by Edward Broadsmith in Worcester at 1700; Radio HCJB Quito, Ecuador 17.790 — logged by Howard Newell at 1900; RCI Montreal, Canada 17.820 — rated by John Nash as 44444 at 1900 and Radio Netherlands via Bonaire, Ned Antilles 17.605 — rated as 44444 by George Morley in Redhill at 2024.

A high level of jamming has also been noted on the 15MHz (19m) band recently, but it has not prevented UK DXers from logging many interesting stations! Some of the broadcasts noted by DXers during the morning include VOIRI Tehran, Iran 15.084 (Spanish/French to Europe 0530-0730) — logged by Davy Hossack in West Lothian at 0705;

Another religious broadcaster, namely Family Radio WYFR beams programmes in English, German and French towards Europe via Okeechobee, Florida on 15.440 from 1600 until 1900.

During the early evening, Cyril Kellam has been listening to the programmes in English and German beamed towards Europe by RNB Brasilia, Brazil on 15.265 from 1800 until 1950. The programmes from Radio HCJB in Quito, Ecuador 15.270 are very popular with many listeners, John Nash rated their signal as 43233 at 1950. Listening in Florida, S.Africa at 1923, Paul O'Connor logged the VOA broadcast to W.Africa via Greenville, E.USA as 33333. John Nash picked up VOA via Monrovia, Liberia on 15.445, noting 34243 in his log at 2037. Using a Toshiba RP F-11 portable, Howard Newell has been listening to some of the interesting programmes beamed towards Europe by RCI in Montreal, Canada on 15.325 from 1330 until 2200. The programmes in French and English from Africa No.1, Gabon may be heard from 1700. Neil Dove rated their signal as 55433 at 1945.

The 13MHz (22m) band is still dominated by Radio Moscow, but other broadcasters are now moving into the band to take advantage of the good conditions which prevail there. Two new entrants were mentioned last month in LMS, namely WYFR of Oakland, California and WHRI in South Bend, USA and both logged recently. Howard Newell picked up WYFR on 13.695 at 1340 and later, Neil Dove rated their signal as 45544 at 1745. Neil also logged a broadcast in English from WHRI on 13.760 as 35443 at 1925. It may be worth monitoring 13.790 as Radio DW Cologne, W.Germany intend to make test transmissions to Africa and the Far East on that frequency.

The propagation conditions prevailing on the 11MHz (25m) band are fairly reliable just now, so there are many broadcasts to interest the DXer. However if you want to hear the broadcasts from Radio Australia on this band you will have to be up early! Their Shepparton transmitting station in S.E. Australia beams towards the S. Pacific area on 11.910 from 0400 until 0630, using a Great Circle bearing of 118 degrees. When conditions permit, the signals travel on and reach the UK via the "long path". Tim Shirley recently logged them in Bristol at 0600, but George Hewlett says the best time to listen is around 0430 when they often reach a peak of SIO 434.

Listening in Lossiemouth, Bill Stewart picked up RFI via Allouis, France on 11.790, beaming programmes in French to E.Europe from 0600 until 1000. He logged their signal as 43343 at 0755.

Freq kHz	Station	Country	Power (kW)	DXer
153	Brasov	Romania	1200	C*, G*
153	DLF Donebach	W. Germany	500	A, C, E*, F*, G
162	Allouis	France	2000	A, C, E*, F*, G
171	Kaliningrad	USSR	1000	A, C*, D*, E*, F*, G*
171	Medi 1 Nador	Morocco	1200	C*
177	Oranienburg	E. Germany	750	C, G
182	Polati	Turkey	1200	C, G*
183	SaarLouis	W. Germany	2000	A, F*, G
189	Motala	Sweden	300	C*, F*, G
189	Caltanissetta	Italy	?	C*
200	BBC Droitwich	UK	400	A, B*, C, E*, F*
209	DLF Munich	W. Germany	500	C, F*
209	RUV Reykjavik	Iceland	100	D*
209	Azilal	Morocco	800	B*, C*, G*
209	Kiev	Ukraine	500	B*, D*
218	Roumoules	Monaco	1400	C, F*, G
218	Oslo	Norway	200	A, B*, C
218	Baku	USSR	?	G*
227	Konstantinow	Poland	2000	B*, F*, G*
236	Junglinster	Luxembourg	2000	A, B*, C, E*, F*, G
236	Kishinev	USSR	1000	C*, D*
245	Kalundborg	Denmark	300	A, C, G
245	Erzurum	Turkey	200	G*
254	Tipaza	Algeria	1500	A, C, F*, G*
254	Lahti	Finland	200	A, B*, C, D*
263	Burg	E. Germany	200	C, D*, F*
263	Moscow	USSR	2000	G*
272	Topolna	Czechoslovakia	1500	B*, C, D*, F*, G*
281	Minsk	USSR	500	C*, G*

Note:—

Entries marked \* logged during darkness.

All other entries were logged during daylight.

DXers:—

- (A) John Berridge, Cardiff.  
 (B) David Edwardson, Wallsend.  
 (C) Philip Rambaut, Macclesfield.

- (D) Tim Shirley, Bristol.  
 (E) Darran Taplin, Tunbridge Wells.  
 (F) Phil Townsend, London.  
 (G) Jim Willett, Grimsby.

Later he heard a broadcast in English from Vatican Radio, Rome on 11.740 and noted 43343 in his log at 1450. UAE Radio Dubai beam their programmes in English to Europe on 11.730 at 1600. Alan Curry has been listening to them in Stockton-on-Tees and rated their signal as 43323.

Listening during the evening in Corsham, Colin Diffell logged RNB Brasilia, Brazil on 11.765 at 2048, their broadcast in French is intended for listeners in Europe. In Grantham, Leslie Hollis logged Radio Damascus, Syria 11.625 — 45533 at 2040; Radio RSA Johannesburg, S.Africa 11.900 — 44544 at 2100; Radio HCJB Quito, Ecuador 11.790 — 34433 at 2130 and VOFC Taiwan via Okeechobee, Florida USA 11.805 — 34432 at 2200. Using a Vega B212 portable, Sheila Hughes logged RAE Buenos Aires, Argentina on 11.710 at 2245, their signal rated as 33322. Listening in Eyemouth, David Middlemiss logged RCI Montreal, Canada on 11.945 at 2250 (English to Europe 2200-2300) and at 2300 he picked up a news bulletin in English from Radio Japan via Moyabi, Gabon on 11.800.

The 9MHz (31m) band is certainly the one to choose if you intend to listen to the early morning broadcasts from Radio Australia. Their Shepparton transmitter in S.E. Australia beams their programmes to Europe on 9.655 from 0700 until

1030 via the "long path" and reception here is generally good. Shepparton also beam programmes in English to SE. Asia on 9.770 from 1000 until 1100 and these signals often reach the UK via the "short path", so it is possible to compare reception via the two routes at 1000! In his report George Hewlett rates the 9.655 transmission as SIO 322 at 0700, peaking 444 by 0830 and the 9.770 signal as 434 at 1000.

At 1100 their Carnarvon station in W. Australia beams programmes in English to SE. Asia on 9.770 until 1300, they may also be audible in the UK. In fact, Davy Hossack received them from 1200 until 1300 recently. At 1330 their Darwin station in N. Australia takes over 9.770 and beams programmes in Vietnamese to SE. Asia until 1430. These signals also reach the UK via the "short path" and Neil Dove logged them as 55545 at 1345!

Some of the 31m broadcasts logged by DXers during the day stemmed from Vatican Radio, Rome 9.645 at 0730; RFI Berlin, GDR 9.620 at 0745 — both were logged by Francis Hearne in Ilford; AWR via Lisbon, Portugal 9.670 (SINPO 55455 at 0900) — noted by John Nash; RSI Stockholm, Sweden 9.630 (43443 at 0955) — Bill Stewart; Voice of Vietnam, Hanoi 9.840 (44544 at 1305) — Neil Dove; Radio Norway, Oslo 9.590 (54444 at 1320) — Ian Curry; WSCN Boston, USA 9.495



Davy Hossack

Radio Pakistan, Islamabad 15.605 (Urdu/English to Europe 0715-1120) — rated as SINPO 34543 at 0950 by David Edwardson and the Voice of Nigeria, Lagos 15.120, logged by Cyril Kellam in Sheffield at 0915. The broadcasts from Radio Norway International, Oslo 15.235 reach the UK well at 1000. UAE Radio Dubai broadcast a bulletin of news and a local weather report in English on 15.435 at 1030.

At noon, John Nash picked up Vatican Radio, Rome on 15.190, broadcasting in English to S.E. Asia until 1215, their signal rated as SINPO 43344. In Stoke-on-Trent, Daniel Masterson listened to the Voice of Vietnam, Hanoi 15.010 (English/French to Europe 1300-1400), noting SIO 333 in his log at 1340. The broadcasts from Radio RSA Johannesburg, S.Africa on 15.125 often suffer from jamming. John Nash rated their signal as SINPO 33132 at 1455. The programmes in English from the Christian Science Monitor WSCN in Boston on 15.280 have been attracting the attention of Julian Wood in Buckie at 1630.

# SEEN & HEARD

Freq MHz	Station	Country	UTC	DXer
2.380	R.Limeira	Brazil	0110	E
2.420	R.Sao Carlos	Brazil	0150	M
2.490	VOS.1 Fuzhou	China	2210	H
2.495	R.Madagascar	Madagascar	0050	O
3.215	R.Orange	S.Africa	1800	J
3.215	BCC Taipei	Taiwan	0620	O
3.225	R.Occidente	Venezuela	0345	M
3.230	R.RSA	S.Africa	0315	O
3.260	ORTN Niamey	Niger	1845	M
3.270	SWABC 1	Namibia	2200	E,O
3.315	R.Fort de France	Martinique	0520	O
3.320	R.Orion	S.Africa	2230	H
3.320	R.Suid Afrika	S.Africa	1847	E,J
3.335	CBS Taipei	Taiwan	?	M
3.355	R.Botswana	Gabarone	1846	M,O
3.365	GBC Radio 2	Ghana	0605	C
3.380	R.Malawi	Malawi	1845	M,O
3.395	ZBC Gweru	Zimbabwe	2330	O
3.905	AIR Delhi	India	1630	O
3.915	BBC Kranji	Singapore	2210	B,H,K,O
3.925	AIR Delhi	India	2350	O
3.930	R.Capital	Transkei	1932	J,O
3.930	R.Nac.de Cabo	Cape Verde	1937	M
3.955	BBC Daventry	England	2000	A,B,H,K,N
3.955	R.Orion	S.Africa	0030	O
3.965	RFI Paris	France	2000	B,E,K
3.985	R.Beijing, China	via SRI Berne	2230	A,B,D,H,I,N
3.985	SRI Berne	Switzerland	2000	K
3.995	DW Cologne	W.Germany	2000	K,N
4.000	R.Greenland	Greenland	0100	E
4.055	Kalinin	USSR	2025	K
4.060	R.Moscow Kharkov	USSR	2200	I
4.115	R.Sena Madureira	Brazil	0200	M
4.420	R.Reyes	Bolivia	2345	M
4.440	R.Santa Rosa	Bolivia	?	M
4.460	R.Capt.V.Ustariz	Bolivia	?	M
4.500	Xinjiang	China	0020	O
4.680	R.Nac.Espejo	Ecuador	0200	M
4.725	BBS Rangoon	Burma	0630	O
4.735	Xinjiang	China	0010	C,O
4.740	R.Afghanistan	via USSR	0148	D,O
4.755	Sani Radio	Honduras	0130	D
4.760	R.Afghanistan	via USSR	1905	B,E,O
4.760	ELWA Monrovia	Liberia	0628	D
4.760	R.Frontera	Venezuela	0010	E
4.770	FRCN, Kaduna	Nigeria	2030	A,K,O
4.775	AIR Gauhati	India	0045	E
4.780	V.Carabobo	Venezuela	0130	B,C
4.785	R.Baku	USSR	0200	D
4.785	RTM Bamako	Mali	1945	K
4.790	R.Atlantida	Peru	0138	E
4.795	R.Douala	Cameroon	2100	O
4.800	AIR Hyderabad	India	2200	O

Freq MHz	Station	Country	UTC	DXer
4.800	LNBS Lesotho	Maseru	2150	E,J,K
4.810	R.Yerevan	USSR	2130	K
4.815	R.Beijing	China	2234	C,H
4.815	R.diff TV Burkina	Ouagadougou	2130	H,K,O
4.820	E.Prov.Huila	Angola	2220	K
4.820	R.Botswana	Botswana	1940	E,J,O
4.830	Africa No.1	Gabon	2030	G,H,J,K
4.830	R.Relej	Costa Rica	0236	C
4.830	R.Tachira	Venezuela	0140	B,C
4.835	RTM Bamako	Mali	2025	K,O
4.840	AIR Bombay	India	0130	O
4.845	ORTM Nouakchott	Mauritania	2025	B,C,D,K,O
4.850	R.Yaounde	Cameroon	2050	J,K
4.870	R.Cotonou	Benin	2025	F,J,K,O
4.880	SABC Radio 5	S.Africa	2140	J,K
4.890	ORTS, Dakar	Senegal	2250	O
4.895	Ashkhabad	USSR	2200	A,B,G,K
4.905	N'djamena	Chad	2005	J,K,O
4.905	R.Relegio,Rio	Brazil	0215	C
4.915	R.Ghana, Accra	Ghana	2140	C,G,K
4.915	Voice of Kenya	Kenya	2155	O
4.920	R.Quito	Ecuador	0300	B
4.925	R.Nacional, Bata	Eq.Guinea	2150	O
4.930	Ashkhabad	USSR	2235	B
4.930	R.Tbilisi	USSR	0001	D
4.935	SWABC Windhoek	S.W.Africa	0535	F,O
4.940	R.Abidjan	Ivory Coast	0605	C,E,F
4.940	Kiev	USSR	2025	K
4.945	RSA	S.Africa	2000	O
4.970	R.Rumbos	Venezuela	2240	B,C
4.970	R.Yaounde	Cameroon	0030	O
4.975	R.Uganda	Uganda	2025	K
4.980	Azar Kashnir R.	Pakistan	0100	E
4.980	Ecos del Torbes	Venezuela	0200	B,C
4.990	FRCN, Lagos	Nigeria	0525	F,O
4.990	Radio RSA	S.Africa	2000	J
4.990	Yerevan	USSR	0225	C
4.995	R.Andina	Peru	0850	L
5.005	R.Nacional, Bata	Eq.Guinea	2045	K,O
5.010	R.Garoua	Cameroon	2220	B,F,K,O
5.010	R.Pakistan	Pakistan	2315	G
5.015	Arkhangelsk	USSR	0556	F
5.020	ORTN Niamey	Niger	1925	C,F,K,O
5.025	R.Rebelde Habana	Cuba	0200	B
5.035	R.Bangui	C.Africa	2210	K,O
5.040	La Voz del Upano	Ecuador	0005	E
5.045	R.Togo Lome	Togo	2050	B,F,K,O
5.055	Farro del Caribe	Costa Rica	0430	M
5.057	Gjirokaster	Albania	2000	K
5.065	R.Candip	Zaire	0320	O
5.090	R.Beijing T2	China	1652	H
5.095	R.Sutatenza, Bogata	Columbia	0115	B,D
5.290	R.Krasnoyarsk	USSR	2150	D

## DXers

(A) Alan Curry, Stockton-on-Tees.  
 (B) Neil Dove, Lockerbie.  
 (C) David Edwardson, Wallsend.  
 (D) David Glover, Newton-le-Willows.

(E) Davy Hossack, West Lothian.  
 (F) Bill Kelly, Belfast.  
 (G) David Middlemiss, Eyemouth.  
 (H) George Morley, Redhill.

(I) John Nash, Brighton.  
 (J) Paul O'Connor, Florida, S.Africa.  
 (K) Fred Pallant, Storrington.  
 (L) Ron Proudfoot, Newcastle-upon-Tyne.

(M) Tim Shirley, Bristol.  
 (N) Robert Taylor, Edinburgh.  
 (O) Jim Willett, Grimsby.

(45544 at 2020) — Leslie Hollis; Riyadh, Saudi Arabia 9.870 at 2022 — Colin Diffell; AIR New Delhi, India 9.910 (34443 at 2100) — Neil Dove; Radio RSA Johannesburg, S.Africa 9.580 (44434 at 2155) — George Morley; Radio Nat. Paraguay 9.734 (33333 at 2200) — Alan Curry; WRNO New Orleans, USA 9.495 (SIO 222 at 2310) — logged by George Efstratiades in Thessaloniki, Greece; Voice of Turkey, Ankara 9.560 at 2315 — Francis Hearne; Radio Cairo, Egypt 9.670 (44333 at 0230) — Sheila Hughes.

Two broadcasts from the USA were logged on the 7MHz (41m) band during the early morning, WCSN in Boston, Mass on 7.365 at 0727, rated by John Parry as 44554 and WHRI in

South Bend, Indiana on 7.355, logged by Tim Shirley at 0900. Philip Rambaut could still hear WHRI in Macclesfield at 1028 and noted SIO 333 in his log!

On the last Sunday of the month the International Red Cross Radio broadcast to Europe on 7.210 via SRI in Berne, Switzerland, Alan Curry logged their signal as 43443 at 1100. Some of the more distant stations logged by Philip Rambaut during the afternoon were BBC via Kranji, Singapore 7.180 (SIO 222 at 1245); Radio Australia via Darwin 7.120 (Chinese to C.Asia — 433 at 1424); Radio Australia via Shepperton 7.135 (English to S.E.Asia — 333 at 1425); AIR New Delhi, India 7.410 (333 at 1614) and BBC via Kranji, Singapore 7.105 (322 at 1628).

During the evening DXers logged Radio Bangladesh, Dhaka 7.505 (43343 at 1840) — George Morley; Radio Korea, Seoul, S. Korea 7.550 (34344 at 1905) — George Morley; Vatican Radio, Rome 7.250 at 1948 — Colin Diffell; Radio Australia via Carnarvon, W.Australia 7.205 (45434 at 2010) — Neil Dove; AIR New Delhi, India 7.410 at 2042 — Howard Newell; Radio Baghdad, Iraq 7.295 (33433 at 2125) — Darran Taplin; VOFC Taipei relayed via Okeechobee, Florida 7.355 (SIO 434 at 2230) — Robert Taylor.

The 6MHz (49m) band has plenty to interest the DXer too! Bill Stewart picked up Radio HCJB in Quito, Ecuador on 6.205 and rated their signal 34453 at 0755. Bill Kelly logged Vos 2. Fuzhou,

China 6.400 at 1020; Radio Pyongyang, N. Korea 6.576 at 1025; Radio Bangladesh, Dhaka 6.240 at 1405; Radio Pyongyang, N. Korea 6.540 at 1445 and Radio Australia via Carnarvon 6.035 at 1530.

Later, Radio Yugoslavia, Belgrade 6.100 (English to Europe 1900-1925) was logged by Daniel Masterson as SIO 423; Radio Prague, Czechoslovakia 6.055 was heard by Colin Diffell at 1957 and Radio Sophia, Bulgaria 6.070 was rated as 54444 by Darran Taplin at 2130. At 0030, VOFC Taipei was heard via Okeechobee, Florida USA on 5.985 by David Glover in Newton-le-Willows and at 0417 Davy Hossack logged Radio Gazeta, Brazil on 5.955, a rare catch if you can stay awake!

# S.E.M. UNIT C, UNION MILLS, ISLE OF MAN

Tel. Marown (0624) 851277

## S.E.M. VHF CONVERTER

Plugs into any HF receiver aerial socket to give you coverage from 118 to 146MHz. Tune your receiver from 2 to 30MHz. £49.50. Ex-Stock.

## S.E.M. H.F. CONVERTER

Plugs into your scanner aerial socket and converts its range to cover 100kHz to 60MHz. Gives you full LF, MF, HF, VHF, UHF coverage. £49.50 from stock.

## VERY WIDE BAND PRE-AMPS.

3MHz to 500MHz, 9dB gain, 1.5 dB N.F. and unprecedented performance. Basic Pre-Amp £32.00. Switched through when OFF £37 from stock.

## QRM ELIMINATOR

A unique design, which has revolutionised interference suppression. Connects in your aerial lead and stops interference before it gets to your receiver. Any sort of QRM, it can be next to your rx (your computer?) or several miles away, 1.5-30MHz. £69.50.

## AUDIO MULTIFILTER

The most versatile RX Filter with 2 notches, BANDPASS, HI-PASS and LO-PASS. All fully adjustable £75. Ex-Stock.

If you require more information on our products, ring or write. Prices include VAT and delivery.

## BREDHURST ELECTRONICS LTD.

HIGH ST., HANDCROSS, WEST SUSSEX.

TEL: (0444) 400786.



Situated at the Southern end of M23. Easy access to M25 and South London. Open Mon-Fri 9am-5pm except Wed 9am-12.30pm. Sat 10am-4pm.

MAIL ORDER RETAIL

## SPECIAL NOTICE TO READERS

Although the proprietors and staff of *SHORT WAVE MAGAZINE* take reasonable precautions to protect the interests of readers by ensuring as far as practicable that advertisements in *SHORT WAVE MAGAZINE* are *bona fide*, the magazine and its Publishers cannot give any undertakings in respect of claims made by advertisers, whether these advertisements are printed as part of the magazine, or are in the form of inserts.

While the Publishers will give whatever assistance they can to readers having complaints, under no circumstances will the magazine accept liability for non-receipt of goods ordered, or for late delivery, or for faults in manufacture. Legal remedies are available in respect of some of these circumstances, and readers who have complaints should address them to the advertiser or should consult a local Trading Standards Office, or a Citizen's Advice Bureau, or their own solicitor.

G2VF LOOP ANTENNAS COMPLETE WITH ATU FOR HIGH FREQUENCY HAMBAND TRANSMISSION (SWR One to One 40, 15 and 10 and One Point Five to One 80 and 20) AND SWL's AND LONG AND MEDIUM WAVE BANDS FOR BCL's. Loops 21 inches square or triangle. D.I.Y. projects. No special skills required. Circuits, Parts Lists with sources of supply and full assembly data. HIGH FREQUENCY LOOP 80 to 10 Metres £5. LONG AND MEDIUM WAVE LOOP FOR BCL's £3. LONG WAVE MEDIUM WAVE AND SHORT WAVE LOOP 1500 to 10 METRES FOR THE BCL AND SWL £8. SHORT WAVE ATU FOR USE WITH EITHER A LOOP OR LONG WIRE ANTENNA £4. SAE for details. Callers welcome any day any time. F. G. Rylands, 39 Parkside Avenue, Millbrook, Southampton. Tel: (0703) 775064.

## PLESSEY PR155 SERIES HF COMM RECEIVERS

FOR SPARES AND SERVICE

CONTACT

K and M SPECIAL PRODUCTS

8a, ST DAVIDS ROAD, CLANFIELD, HAMPSHIRE

P08 ONL. Tel: 0705 594438

## FLIGHTDECK THE AIRBAND SHOP

NORTH-WEST SPECIALISTS IN AIRBAND AND SHORTWAVE COMMUNICATIONS RECEIVERS.

SETS BY SIGNAL • UNIDEN • SONY • REVCO • LOWE ELECTRONICS • KENWOOD • PHILIPS • GRUNDIG • PANASONIC •

FAIRBOTHAM & CO LTD

58-62 LOWER HILLGATE, STOCKPORT, CHESHIRE SK1 3AN Telephone: 061-480 8080

## Theasby Electronics

"Theasby Electronics can help your DX'ing"

Preselector — cuts interference and amplifies signals — £39 • Aerial Tuner — tunes aerial and reduces interference — £26 • Band pass filter — 8 stages of audio filtering — £29 • Crystal Calibrator — 1kHz to 1MHz output — £19 • All ready built, 12 volt operated, send for free literature Also High pass TVI filter — rejects signals below UHF tv — £3 • Braid Breaker TVI filter — rejects interference picked up on downlead — £3 • Both TVI filters together — £5.50 • PL 259 Fittings, aerial cables, all items post free

THEASBY ELECTRONICS

31, MIDDLETON, COWLING, NORTH YORKSHIRE BD22 0DD Telephone: (0536) 36786



*Component Centre*

## LISTEN INTO THE WORLD

VEGA SELINA 215—5 S/W M/W L/W F/M Mains/Batt.....£36.95  
VEGA 206.—6 S/W M/W L/W.....£24.95  
GOODMANS POCKET RADIO—S/W M/W L/W FM Stereo.....£39.95  
TEC POCKET RADIO—6 S/W M/W L/W FM.....£29.95  
SAB 9 POCKET AIR BAND—M/W L/W F/M.....£21.50  
MBR 7—9 BAND INC S/W Air Marine Mains/Batt.....£59.95  
R5375 TUNABLE AIR BAND—118-136MHz + 2 CRYSTAL CONTROLLED CHAN.....£73.00  
AIR TRAFFIC CONTROL BOOK.....£3.50  
AUDIO TECH AT 9560 ELECTRIC COND LAPEL RADIO MIC 100MT RANGE.....£52.80

DIGITAL MULTIMETERS  
—DC VOLTS 1000V  
—AC VOLTS 750V  
—RES 0-20 MEG  
ALL METERS HAVE ABOVE RANGES +

Model 5500. 20 AMP AC/DC.....£39.95

Model 9000 10 AMP AC/DC Cap and Trans Tester Buzzer.....£59.95

Model 9500 10 AMP AC/DC Cap and Trans Tester Buzzer.....£9.95

PORTASOL GAS IRON 25-60 watt var.....£19.95

ANT ROTATOR with control. Load 5kgs.....£45.00

ALL SETS GUARANTEED. PRICES INCL VAT & P&P



## COMPONENT CENTRE

7 LANGLEY ROAD, WATFORD,

HERTS WD1 3PS

Tel: WATFORD 245335

## ADVERTISERS INDEX

Aerial Techniques.....	44
Bredhurst.....	51
Colomor.....	44
Component Centre.....	51
Currys.....	16
Datong.....	33
Elliott Electronics.....	20
Fairbotham & Co Ltd.....	51
Garex Electronics Ltd.....	20
Hamgear Ltd.....	39
Hornby L E.....	33
ICOM (UK) Ltd.....	Cover ii
Javiation.....	44
Johnsons Shortwave Radio.....	39
Klingenfuss Publications.....	33
K and M Services.....	51
Lowe Electronics Ltd.....	8
NARSA.....	44
Practical Wireless.....	36
Rylands F. G.....	51
SEM.....	51
Short Wave Newsletter.....	44
Stephens James.....	12
South Midlands Communications Ltd.....	Cover iv
Technical Software.....	39
Theasby.....	51
Uppingtons Tele-Radio (Bristol) Ltd.....	20
Reg Ward & Co. Ltd.....	12
Waters & Stanton.....	Cover iii

# WHAT SCANNER

**JIL SX-200N**  
Monitor Scanner



- **COVERAGE:** 26 to 88MHz, 108 to 180MHz, 380 to 514MHz
- **MODES:** a.m., n.b.f.m.
- **SENSITIVITY:** f.m. = >60dB at ±25kHz; a.m. = >60dB at ±10kHz
- **SELECTIVITY:** 26 - 180MHz f.m. = 0.4µV at 12dB s/n; 380 - 514MHz = 1.0µV at 12dB s/n; 26 - 180MHz a.m. = 1.0µV at 10dB s/n; 380 - 514MHz a.m. = 2.0µV
- **RESOLUTION:** 5, 12.5kHz
- **IMAGE REJECTION:**
- **IF STAGE:** 10.7MHz, 455kHz
- **AUDIO OUTPUT:** 2 watts
- **SCAN RATE:** 4 and 8 channels per second
- **SEARCH RATE:** 5 and 10 channels per second
- **MEMORIES:** 16
- **FEATURES:**
- **REVIEWED:** Practical Wireless October 1981
- **PRICE:** £325

**AOR AR2002**  
Monitor Scanner



- **COVERAGE:** 25 to 550MHz, 800 to 1300MHz
- **MODES:** a.m., n.b.f.m., w.b.f.m.
- **SENSITIVITY:** n.b.f.m. = 0.3µV (12dB SINAD); w.b.f.m. = 1.0µV (12dB SINAD); a.m. = 0.5µV (10dB s/n)
- **SELECTIVITY:** n.b.f.m. = ±7.5kHz at 6dB; w.b.f.m. = ±25kHz at 60dB; a.m. = ±10kHz at 70dB
- **RESOLUTION:** 5, 12.5 or 25kHz steps
- **IMAGE REJECTION:** -50dB
- **IF STAGE:** 750MHz, 45.03MHz (w.f.m.), 455kHz (n.f.m./a.m.)
- **AUDIO OUTPUT:** 1W at <10% distortion
- **SCAN RATE:** 5 channels per second
- **SEARCH RATE:** 6 seconds per MHz
- **MEMORIES:** 20
- **FEATURES:** Tuning knob in addition to key pad and computer control facilities
- **REVIEWED:** Practical Wireless December 1985
- **PRICE:** £487

**JIL SX-400**  
Monitor Scanner



- **COVERAGE:** 26 to 520MHz continuous (100kHz to 1.4GHz with converters)
- **MODES:** a.m., n.b.f.m., w.b.f.m.
- **SENSITIVITY:** v.h.f. f.m. = 0.5µV at 12dB s/n; v.h.f. a.m. = 1.0µV at 10dB s/n; u.h.f. f.m. = 0.5µV at 12dB s/n; u.h.f. a.m. = 2.0µV at 10dB s/n
- **SELECTIVITY:** 60dB at ±15kHz (f.m.), 60dB at ±10kHz (a.m.). s/n ratio: 45dB
- **RESOLUTION:** 5, 6.25, 10, 12.5kHz
- **IMAGE REJECTION:** 50dB (v.h.f.)
- **IF STAGE:** 10.7MHz, 455kHz
- **AUDIO OUTPUT:** 2W (4Ω load)
- **SCAN RATE:** 4 and 8 channels per second
- **SEARCH RATE:** 5 and 10 channels per second
- **MEMORIES:** 20
- **FEATURES:**
- **REVIEWED:**
- **PRICE:** £650

**AOR AR2001**  
Communications Scanner



- **COVERAGE:** 25 - 550MHz
- **MODES:** a.m., n.b.f.m., w.b.f.m.
- **SENSITIVITY:** At 70MHz. Input signal for 12dB SINAD n.b.f.m. = 0.3µV; Input signal for 10dB S + N/N a.m. = 1.35µV.
- **SELECTIVITY:** n.b.f.m. = 13kHz @ 6dB, 21kHz @ 70dB; w.b.f.m. = 180kHz @ 6dB, 448kHz @ 70dB; a.m. = 13.5kHz at 6dB.
- **RESOLUTION:** 5, 12.5, 25kHz
- **IMAGE REJECTION:** -50dB
- **IF STAGE:** 750MHz & 455kHz
- **AUDIO OUTPUT:** 1W at 10% distortion
- **SCAN RATE:** 5 channels per second
- **SEARCH RATE:** 6 seconds per MHz
- **MEMORIES:** 20
- **FEATURES:** Good coverage of v.h.f. and u.h.f. airband
- **REVIEWED:** Practical Wireless May 1984
- **PRICE:** Available in limited quantities on special production runs. Apply Lowe Electronics.

**Uniden Bearcat UBC-175XL**  
Base Station Scanner



- **COVERAGE:** 66 - 88, 118 - 174, 406 - 512MHz
- **MODES:** a.m., f.m.
- **SENSITIVITY:** For 12dB SINAD. 29 - 54MHz = 0.3µV; 118 - 136MHz = 0.8µV; 136 - 174MHz = 0.3µV; 406 - 512MHz = 0.5V
- **SELECTIVITY:** -45dB at ±25kHz
- **RESOLUTION:** 5kHz
- **IMAGE REJECTION:** -55dB
- **IF STAGE:** 10.85MHz & 450kHz
- **AUDIO OUTPUT:** 800mW at 10% t.h.d.
- **SCAN RATE:** 5 and 15 channels per second
- **SEARCH RATE:** 5 and 15 channels per second
- **MEMORIES:** 16
- **FEATURES:** Channel lockout, auto squelch, priority channel and short term memory back-up
- **REVIEWED:** Short Wave Magazine December 1987
- **PRICE:** £179.99

**Saiko SC-1600**  
Mobile Monitor Scanner



- **COVERAGE:** 10MHz within 65 to 90MHz, 20MHz within 130 to 175MHz, 30MHz within 390 to 500MHz
- **MODES:** n.b.f.m.
- **SENSITIVITY:** 1.0µV for 10dB s/n
- **SELECTIVITY:** ±15kHz at 50dB, ±7kHz at -6dB
- **RESOLUTION:** 5kHz
- **IMAGE REJECTION:** -40dB
- **IF STAGE:** 10.7MHz, 455kHz
- **AUDIO OUTPUT:** 1.5W at 10% distortion
- **SCAN RATE:**
- **SEARCH RATE:**
- **MEMORIES:** 16
- **FEATURES:** Squelch, delay key, i.c.d. channel display, d.c. power cable and mounting bracket supplied
- **REVIEWED:**
- **PRICE:** £159.95

**Realistic PRO-2004**  
Programmable Scanner



- **COVERAGE:** Continuous 25 to 520MHz, 760 to 1300MHz
- **MODES:** a.m., w.b.f.m., n.b.f.m.
- **SENSITIVITY:** (w.b.f.m. 30dB signal to noise at 22.5kHz dev.) 25 - 520MHz = 3µV; 760 - 1100MHz = 3µV; 1100 - 1300MHz = 1.0µV. (n.b.f.m. 20dB signal to noise at 3kHz dev.) 25 - 520MHz = 0.5µV; 760 - 1100MHz = 0.3µV; 1100 - 1300MHz = 3µV. (a.m. 20dB signal to noise at 60% mod.) 25 - 520MHz = 2µV; 760 - 1100MHz = 2µV; 1100 - 1300MHz = 3µV
- **SELECTIVITY:** (n.b.f.m. & a.m.) ±9kHz @ -6dB, ±15kHz @ -50dB; (w.b.f.m.) ±150kHz @ -6dB, ±300kHz @ -50dB
- **RESOLUTION:** 5, 12.5 or 50kHz
- **IMAGE REJECTION:** -60dB
- **IF STAGE:** 611.5 - 607.505MHz, 48.5MHz, 455kHz (a.m.)
- **AUDIO OUTPUT:** 1.8W @ 3% t.h.d.
- **SCAN RATE:** 8 and 16 steps per second
- **SEARCH RATE:** 8 and 16 steps per second
- **MEMORIES:** 300
- **FEATURES:** Lock-out key, squelch, priority function key and large i.c.d. readout.
- **REVIEWED:** Short Wave Magazine April 1987
- **PRICE:** £329.95

**Revco RS-2000E**  
Monitor Scanner



- **COVERAGE:** 60 to 179MHz, 380 - 520MHz
- **MODES:** a.m., n.b.f.m.
- **SENSITIVITY:** 0.5µV v.h.f. f.m., 1.0µV u.h.f. f.m.
- **SELECTIVITY:** -60dB at ±25kHz
- **RESOLUTION:** 5kHz
- **IMAGE REJECTION:**
- **IF STAGE:**
- **AUDIO OUTPUT:** 2W
- **SCAN RATE:** 5 or 10 channels per second
- **SEARCH RATE:** 5 or 10 channels per second
- **MEMORIES:** 70
- **FEATURES:** Auto search and store.
- **REVIEWED:**
- **PRICE:** £279

**Realistic PRQ-2021**  
Programmable Scanner



- **COVERAGE:** 68 to 88MHz, 108 to 136MHz, 138 to 174MHz, 380 to 512MHz.
- **MODES:** a.m., f.m.
- **SENSITIVITY:** 66 - 88MHz = 1µV; 108 - 136MHz = 2µV; 138 - 174MHz = 1µV; 380 - 512MHz = 1µV
- **SELECTIVITY:** -6dB @ ±9kHz, -50dB @ 15kHz
- **RESOLUTION:** 5, 12.5 and 25kHz
- **IMAGE REJECTION:**
- **IF STAGE:** 10.7MHz, 455kHz
- **AUDIO OUTPUT:** 300mW
- **SCAN RATE:** 4 and 8 channels per second
- **SEARCH RATE:**
- **MEMORIES:** 200
- **FEATURES:** Easy-to-read i.c.d. readout, squelch control, mobile mounting bracket included, sockets for external antenna, speaker and tape recorder
- **REVIEWED:**
- **PRICE:** £219.95

# WHAT SCANNER

## Regency MX7000 Monitor Scanner

- **COVERAGE:** 25 to 550MHz continuous, 800MHz to 1.3GHz
- **MODES:** a.m., n.b.f.m., w.b.f.m.
- **SENSITIVITY:** n.b.f.m. = 0.4 $\mu$ V at 12dB SINAD; w.b.f.m. = 1.0 $\mu$ V at 12dB SINAD; a.m. = 0.8 $\mu$ V at 10dB s/n
- **SELECTIVITY:** n.b.f.m.  $\pm$ 7.5kHz at 6dB; w.b.f.m. =  $\pm$ 50kHz at 6dB; a.m. =  $\pm$ 5kHz at 6dB
- **RESOLUTION:** 5, 12.5 and 25kHz
- **IMAGE REJECTION:** -50dB
- **IF STAGE:** 750 MHz, 45.03MHz, 5.5MHz, 455kHz
- **AUDIO OUTPUT:** 1W at 10% distortion
- **SCAN RATE:** 5 channels per second
- **SEARCH RATE:** 6 seconds per MHz
- **MEMORIES:** 20
- **FEATURES:** Tuning dial as well as keypad, priority channel, mains adaptor and mounting bracket available as extras
- **REVIEWED:**
- **PRICE:** £399

## Signal R528 Scanning Airband Handheld

- **COVERAGE:** 118 to 136MHz
- **MODES:**
- **SENSITIVITY:** >1.0 $\mu$ V for 10dB s + n/n
- **SELECTIVITY:** 20kHz at 6dB
- **RESOLUTION:**
- **IMAGE REJECTION:**
- **IF STAGE:**
- **AUDIO OUTPUT:**
- **SCAN RATE:**
- **SEARCH RATE:**
- **MEMORIES:** 6 xtal controlled within frequency coverage
- **FEATURES:**
- **REVIEWED:**
- **PRICE:** about £125 (xtals extra)

## Bearcat 100FB Handheld Scanner

- **COVERAGE:** 66 - 88MHz, 138 - 174MHz, 406 - 512MHz
- **MODES:**
- **SENSITIVITY:** For 12dB SINAD. 66 - 88MHz = 0.6 $\mu$ V; 138 - 174MHz = 0.6 $\mu$ V; 406 - 512MHz = 1 $\mu$ V
- **SELECTIVITY:** 50dB @  $\pm$ 25kHz
- **RESOLUTION:** 5, 12.5kHz
- **IMAGE REJECTION:**
- **IF STAGE:**
- **AUDIO OUTPUT:** 300mW
- **SCAN RATE:** 15 channels per second
- **SEARCH RATE:** 15 channels per second
- **MEMORIES:** 16
- **FEATURES:**
- **REVIEWED:** Practical Wireless September 1982
- **PRICE:** Available second-hand

## Regency HX850E Handheld Scanner

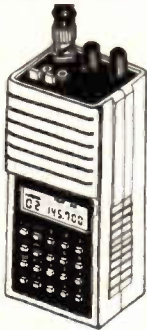

- **COVERAGE:** 75-106MHz or 60-90MHz, 118-136MHz, 136-175MHz, 406-496MHz
- **MODES:** a.m., n.b.f.m.
- **SENSITIVITY:** v.h.f. f.m. = 0.7 $\mu$ V at 12dB SINAD, u.h.f. f.m. = 1.0 $\mu$ V at 12dB SINAD; v.h.f. a.m. = 1.0 $\mu$ V at 10dB s/n
- **SELECTIVITY:** f.m./a.m.  $\pm$ 7.5kHz at 6dB
- **RESOLUTION:** 5, 10 and 12.5kHz
- **IMAGE REJECTION:**
- **IF STAGE:** 21.4MHz, 455kHz
- **AUDIO OUTPUT:** 10mW, 10% or less t.h.d.
- **SCAN RATE:** 12 channels per second
- **SEARCH RATE:** u.h.f. = 7 sec per MHz; v.h.f. 9 seconds per MHz
- **MEMORIES:** 20
- **FEATURES:** NiCads, flexible antennas and 240V charger supplied
- **REVIEWED:**
- **PRICE:** £280

## Realistic PRO-32 Programmable Handheld Scanner



- **COVERAGE:** 68 to 88MHz, 108 to 136MHz (a.m.), 138 to 174MHz, 380 to 512MHz
- **MODES:** a.m., f.m.
- **SENSITIVITY:** (a.m. 20dB signal-to-noise at 60% modulation). 108 - 136MHz = 2 $\mu$ V; (f.m. 20dB signal-to-noise at 3kHz deviation). 68 - 88MHz = 0.6 $\mu$ V; 138 - 174MHz = 1 $\mu$ V; 380 - 512MHz = 1 $\mu$ V
- **SELECTIVITY:** -6dB @  $\pm$ 9kHz, -60dB @  $\pm$ 15MHz
- **RESOLUTION:** 5, 12.5 or 25kHz
- **IMAGE REJECTION:**
- **IF STAGE:** 455kHz, 10.7MHz
- **AUDIO OUTPUT:** 300mW
- **SCAN RATE:** 4 and 8 channels per second
- **SEARCH RATE:** 4 and 8 channels per second
- **MEMORIES:** 200
- **FEATURES:**
- **REVIEWED:** Short Wave Magazine November 1987
- **PRICE:** £239.95

## Realistic PRO-38 Handheld Scanner

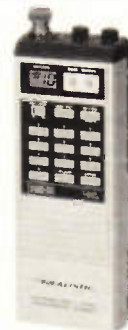

- **COVERAGE:** 68 - 88, 136 - 174, 406 - 512MHz
- **MODES:** f.m.
- **SENSITIVITY:** 68 - 88MHz = 0.5 $\mu$ V normal, 2 $\mu$ V limit; 136 - 174MHz = 0.7 $\mu$ V normal, 3 $\mu$ V limit; 406 - 512MHz = 0.7 $\mu$ V normal, 4 $\mu$ V limit
- **SELECTIVITY:** At 155MHz. -6dB =  $\pm$ 10kHz, -50dB =  $\pm$ 17kHz
- **RESOLUTION:**
- **IMAGE REJECTION:**
- **IF STAGE:**
- **AUDIO OUTPUT:** nominal 260mW
- **SCAN RATE:** 10 channels per second
- **SEARCH RATE:**
- **MEMORIES:** 10
- **FEATURES:** Keyboard lock switch, l.c.d. channel readout, jack for earphone, belt clip and flexible antenna supplied
- **REVIEWED:**
- **PRICE:** £129.95

## Uniden Bearcat 70XL Handheld Scanner



- **COVERAGE:** 29 - 54, 135 - 174, 406 - 512MHz
- **MODES:** f.m.
- **SENSITIVITY:** 29 - 54MHz = 0.4 $\mu$ V, 135 - 174MHz = 0.5 $\mu$ V, 406 - 512MHz = 0.7 $\mu$ V
- **SELECTIVITY:** -55dB @  $\pm$ 25kHz
- **RESOLUTION:** 5kHz
- **IMAGE REJECTION:** -50dB
- **IF STAGE:** 10.8MHz
- **AUDIO OUTPUT:** 140mW at 10% t.h.d. into 8 $\Omega$
- **SCAN RATE:** 15 channels per second
- **SEARCH RATE:** 15 channels per second
- **MEMORIES:** 20
- **FEATURES:**
- **REVIEWED:**
- **PRICE:** £199.99

## Uniden Bearcat 50XL Handheld Scanner



- **COVERAGE:** 29 - 54, 136 - 174, 406 - 512MHz
- **MODES:** a.m., f.m.
- **SENSITIVITY:** For 12dB SINAD. 29 - 54MHz = 0.4 $\mu$ V; 136 - 174MHz = 0.5 $\mu$ V; 406 - 512MHz = 0.7 $\mu$ V
- **SELECTIVITY:** -55dB  $\pm$ 25kHz
- **RESOLUTION:** 5kHz
- **IMAGE REJECTION:** -50dB
- **IF STAGE:** 10.8MHz
- **AUDIO OUTPUT:** 500mW at 10% t.h.d. in 8 $\Omega$
- **SCAN RATE:** 15 channels per second
- **SEARCH RATE:** 15 channels per second
- **MEMORIES:** 10
- **FEATURES:**
- **REVIEWED:**
- **PRICE:** £99.99

## Uniden Bearcat 100XL Handheld Scanner



- **COVERAGE:** 66 - 88, 118 - 174, 406 - 512MHz
- **MODES:** a.m., f.m.
- **SENSITIVITY:** For 12dB SINAD. 30 - 50MHz = 0.3 $\mu$ V; 118 - 136MHz = 0.8 $\mu$ V; 136 - 174MHz = 0.4 $\mu$ V; 406 - 512MHz = 0.5 $\mu$ V
- **SELECTIVITY:** 50dB at  $\pm$ 25kHz
- **RESOLUTION:** 5kHz
- **IMAGE REJECTION:** -50dB
- **IF STAGE:** 10.8MHz
- **AUDIO OUTPUT:** 300mW at 10% t.h.d.
- **SCAN RATE:** 15 channels per second
- **SEARCH RATE:** 25 frequencies per second
- **MEMORIES:** 16
- **FEATURES:** Priority channel, keyboard lock, auto squelch and battery low indicator
- **REVIEWED:**
- **PRICE:** £189.99

# BOOK SERVICE

The books listed have been selected as being of special interest to our readers. They are supplied from our editorial address direct to your door. Some titles are American in origin.

## HOW TO ORDER

Add 75p per order postage (overseas readers add £1.50 for surface mail postage) and send a postal order, cheque or international money order with your order (quoting book titles and quantities) to **PW Publishing Limited, FREEPOST, Enefco House, The Quay, Poole, Dorset BH15 1PP**. Payment by Access, Mastercard, Eurocard or Visa also accepted on telephone orders to Poole (0202) 678558. Books normally despatched by return of post but please allow 28 days for delivery.

★ A recent addition to our Book Service. O/P = Out of print, O/S = Out of stock.

## RADIO

### AN INTRODUCTION TO RADIO DXING (BP91)

**R. A. Penfold**  
How to find a particular station, country or type of broadcast and to receive it as clearly as possible. 112 pages £1.95

### A TV-DXERS HANDBOOK (BP176)

**R. Bunney**  
Information on transmission standards, propagation, receivers including multi-standard, colour, satellites, antennas, photography, station identification, interference, etc. Revised and updated 1986. 87 pages O/P

### BEGINNER'S GUIDE TO RADIO (9th Edition)

**Gordon J. King**  
Radio signals, transmitters, receivers, antennas, components, valves and semiconductors. CB and amateur radio are all dealt with here. 266 pages £6.95

### BETTER RADIO/TV RECEPTION

**A. Nallawalla, A. T. Cushen and B. D. Clark**  
An Australian publication giving guidance and advice both to listeners seeking reliable reception of some distant radio station, and to DX listening hobbyists. 134 pages £9.95

### BETTER SHORTWAVE RECEPTION (USA)

**W. S. Orr W6SAI & S. D. Cowan W2LX**  
Receivers, antennas, propagation, DX listening techniques for the short waves and v.h.f. 158 pages £5.50

### COMMUNICATION (BP89)

(Element of Electronics—Book 5)  
**F. A. Wilson**  
Fundamentals of line, microwave, submarine, satellite, digital multiplex, radio and telegraphy systems are covered, without the more complicated theory or mathematics. 256 pages £2.95

### FOUNDATIONS OF WIRELESS AND ELECTRONICS (10th Edition)

**M. G. Scroggie and S. W. Amos**  
Covering d.c. and a.c. circuits, L, C, tuned circuits and selectivity, valves, semiconductors, transmission lines, antennas, radiation, oscillation, modulation, detection, amplification, superhet receivers, c.r.t.s, waveform generators and switches, computers and power supplies. 551 pages £8.95

### GUIDE TO BROADCASTING STATIONS 19th Edition (1987/88)

**Philip Darrington**  
Frequency and station data, receivers, antennas, Latin American DXing, reporting, computers in radio, etc. 240 pages £6.95

### ★ GUIDE TO FACSIMILE STATIONS 7th Edition

**Joerg Klingenfuss**  
This manual is the basic reference book for everyone interested in FAX. Frequency, callsign, name of the station, ITU country/geographical symbol, technical parameters of the emission are all listed. All frequencies have been measured to the nearest 100Hz. 252 pages £12.00

### ★ GUIDE TO FORMER UTILITY TRANSMISSIONS 3rd Edition

**Joerg Klingenfuss**  
This manual is built on continuous monitoring of the radio spectrum from the sixties until the recent past. It is a useful summary of former activities of utility stations and provides information to the active radio monitor in the classification and identification of radio signals. 126 pages £8.00

### ★ GUIDE TO UTILITY STATIONS 6th Edition

**Joerg Klingenfuss**  
This book covers the complete short wave range from 3 to 30MHz plus the adjacent frequency bands from 0 to 150kHz and from 1.6 to 3MHz. It includes details on all types of utility stations including FAX and RTTY. There are 15802 entries in the frequency list and 3123 in the alphabetical callsign list plus press services and meteorological stations. 494 pages £19.00

### ★ HF OCEANIC AIRBAND COMMUNICATIONS (2nd Edn.)

**Bill Laver**  
Aircraft channels by frequency and band, main ground radio stations, European R/T networks, North Atlantic control frequencies. 24 pages £3.50

### INTERFERENCE HANDBOOK (USA)

**William R. Nelson WA6FQG**  
How to locate and cure r.f.i. for radio amateurs, CBers and TV and stereo owners. 253 pages £6.75

### INTERNATIONAL RADIO STATIONS GUIDE (BP155)

Revised and updated in 1985, this book shows the site, country, frequency/wavelength and power of stations in Europe, the Near East and N. Africa, North and Latin America and the Caribbean, plus short-wave stations worldwide. 128 pages £2.95

### QUESTIONS & ANSWERS RADIO

**Eugene Trundle**  
Basics of electrical theory, radio and semiconductors, receivers, amateur and CB radio, and test equipment. 110 pages £2.95

### RECEIVING STATION LOGBOOK (RSGB)

Standard logbook for the s.w.l. in horizontal A4 format. 32 lines per page. 50 pages O/S

### SATELLITE TELEVISION

**Peter S. Pearson**  
How satellite TV works, setting up your own TVRO terminal, the costs, the programmes available. 72 pages £4.95

### SCANNERS

**Peter Rouse GU1DKD**  
A guide for users of scanning receivers, covering hardware, antennas, accessories, frequency allocations and operating procedure. 177 pages £7.95

### SCANNERS 2

**Peter Rouse GU1DKD**  
The companion to Scanners, this provides even more info on the use of the v.h.f. & u.h.f. communications bands and gives details on how to construct accessories to improve the performance of scanning equipment. 261 pages £9.95

### ★ THE COMPLETE VHF/UHF FREQUENCY GUIDE

Updated this book gives details of frequencies from 26—2250MHz with no gaps and who uses what. There are chapters on equipment requirements as well as antennas, etc. 60 pages £5.95

### UK LISTENERS CONFIDENTIAL FREQUENCY LIST (4th Edn. 1987/88)

**Bill Laver**  
Covering the services and transmission modes that can be heard on the bands between 1.635 and 29.7MHz. 124 pages £5.95

### VHF/UHF AIRBAND FREQUENCY GUIDE

A complete guide to the airband frequencies including how to receive the signals, the frequencies and services, VOLMET and much more about the interesting subject of airband radio. 74 pages £5.95

### WORLD RADIO TV HANDBOOK (1987)

Country-by-country listings of long, medium and short wave broadcasters and TV stations. Receiver test reports. English language broadcasts. The s.w.l.'s "bibble". 576 pages O/S

## DATA & REFERENCE

### DIGITAL IC EQUIVALENTS AND PIN CONNECTIONS (BP140)

**A. Michaels**  
Equivalents and pin connections of a popular selection of European, American and Japanese digital i.c.s. 256 pages £5.95

### ★ GUIDE TO WORLD-WIDE TELEVISION TEST CARDS Edition 2

**Keith Hamer and Garry Smith**  
The main purpose of this book is to assist long distance television enthusiasts (TV DXers) around the world with signal identification. There are 240 test cards, identification slides and clock captions pictured. It is in "semi-alphabetical" order, that is the stations are in alphabetical order in their geographical sections. 52 pages £2.95

### INTERNATIONAL DIODE EQUIVALENTS GUIDE (BP108)

**A. Michaels**  
Possible substitutes for a large selection of many different types of semiconductor diodes. 144 pages £2.25

### INTERNATIONAL TRANSISTOR EQUIVALENTS GUIDE (BP85)

**A. Michaels**  
Possible substitutes for a popular selection of European, American and Japanese transistors. 320 pages £3.50

### LINEAR IC EQUIVALENTS AND PIN CONNECTIONS (BP141)

**A. Michaels**  
Equivalents and pin connections of a popular selection of European, American and Japanese linear i.c.s. 320 pages £5.95

### NEWNES COMPUTER ENGINEER'S POCKET BOOK

This is an invaluable compendium of facts, figures, circuits and data and is indispensable to the designer, student, service engineer and all those interested in computer and microprocessor systems. 203 pages Hardback £8.95

### NEWNES ELECTRONICS POCKET BOOK 5th Edition

Presenting all aspects of electronics in a readable and largely non-mathematical form for both the enthusiast and the professional engineer. 315 pages Hardback £8.95

### ★ NEWNES RADIO AMATEUR AND LISTENER'S POCKET BOOK

**Steve Money G3FZX**  
This book is a collection of useful and intriguing data for the traditional and modern radio amateur as well as the short wave listener. Topics such as AMTOR, packet radio, SSTV, computer communications, airband and maritime communications are all covered. 160 pages £8.95

### NEWNES RADIO AND ELECTRONICS ENGINEER'S POCKET BOOK (17th Edition)

**Keith Brindley**  
Useful data covering maths, abbreviations, codes, symbols, frequency bands/allocations, UK broadcasting stations, semiconductors, components, etc. 201 pages Hardback £6.95

### NEWNES TELEVISION AND VIDEO ENGINEER'S POCKET BOOK

**Eugene Trundle**  
This is a valuable reference source for practitioners in "entertainment" electronic equipment. It covers TV reception from v.h.f. to s.h.f., display tubes, colour camera technology, video recorder and video disc equipment, video text and hi-fi sound. 323 pages £9.95

### OSCILLOSCOPES, HOW TO USE THEM, HOW THEY WORK (Revised 2nd Edition)

**Ian Hickman**  
This book describes oscilloscopes ranging from basic to advanced models and the accessories to go with them. 133 pages £5.95

### POWER SELECTOR GUIDE (BP235)

**J. C. J. Van de Ven**  
This guide has the information on all kinds of power devices in useful categories (other than the usual alpha numeric sort) such as voltage and power properties making selection of replacements easier. 160 pages £4.95

### ★ RADIOTELETYPE CODE MANUAL 10th Edition

**Joerg Klingenfuss**  
This book provides detailed descriptions of the characteristics of telegraph transmission on short waves, with all commercial modulation types including voice frequency telegraphy. It provides comprehensive information on all RTTY systems and c.w. alphabets. 96 pages £8.00



## RSGB RADIO DATA REFERENCE BOOK

**G. R. Jessop G6JP**  
The 5th Edition of an essential book for the radio amateur's or experimenter's workbench. 244 pages  
Hardback £8.56

## SEMICONDUCTOR DATA BOOK

**A. M. Ball**  
Characteristics of about 10 000 transistors, f.e.t.s, u.j.t.s, diodes, rectifiers, triacs and s.c.r.s. 175 pages  
£7.50

## TRANSISTOR SELECTOR GUIDE (BP234)

**J. C. J. Van de Ven**  
This guide has the information on all kinds of transistors in useful categories (other than the usual alpha numeric sort) such as voltage and power properties making selection of replacements easier. 192 pages £4.95

## PROJECT CONSTRUCTION

### HOW TO BUILD ADVANCED SHORT WAVE RECEIVERS (BP226)

**R. A. Penfold**  
Greater satisfaction can be gained from the hobby of shortwave listening when using home constructed equipment. This book gives full practical constructional details of a number of receivers as well as some add-on circuits like S-meters and noise limiters. 118 pages  
£2.95

### HOW TO DESIGN AND MAKE YOUR OWN P.C.B.s (BP121)

**R. A. Penfold**  
Designing or copying printed circuit board designs from magazines, including photographic methods. 80 pages  
£1.95

### INTRODUCING QRP

**Collected Articles from PW 1983-1985**  
An introduction to low-power transmission, including constructional details of designs by Rev. George Dobbs G3RJV for transmitters and transceivers from Top Band to 14MHz, and test equipment by Tony Smith G4FAI. 64 pages  
£1.50

### POWER SUPPLY PROJECTS BP76

**R. A. Penfold**  
This book gives a number of power supply designs including simple unregulated types, fixed voltage regulated types and variable voltage stabilised designs. 97 pages  
£2.50

### PRACTICAL POWER SUPPLIES

**Collected Articles from PW 1978-1985**  
Characteristics of batteries, transformers, rectifiers, fuses and heatsinks, plus designs for a variety of mains-driven power supplies, including the PW "Marchwood" giving a fully stabilised and protected 12V 30A d.c. 48 pages  
£1.25

### SOLID STATE SHORT WAVE RECEIVERS FOR BEGINNERS (BP222)

**R. A. Penfold**  
There is a strange fascination in listening to a broadcast which has been transmitted over many thousands of kilometres. This is even more the case when you've built the receiver yourself. This book contains several designs that will give a fairly high level of performance. 93 pages  
£2.95

## AMATEUR RADIO

### A GUIDE TO AMATEUR RADIO (RSGB)

Amateur Radio—the hobby, the equipment, workshop practice, the licence, the RAE (including sample questions). 154 pages £3.62

### AMATEUR RADIO CALL BOOK (RSGB)

**Winter 87/88 Edition**  
This useful work now incorporates a 48-page reference section of useful information for amateur radio enthusiasts. 310 pages £6.47

### AMATEUR RADIO LOGBOOK

Standard logbook for the transmitting amateur in horizontal A4 format. 25 lines per page. 96 pages £2.30

### AMATEUR RADIO OPERATING MANUAL (RSGB)

A mine of information on just about every aspect of amateur operating, including international callsign series holders, prefix lists, DXCC countries list, etc. 204 pages  
£6.16

### HOW TO PASS THE RADIO AMATEURS' EXAMINATION (RSGB)

**G. L. Benbow G3HB**  
The background to multiple choice exams and how to study for them with nine sample RAE papers for practice, plus maths revision. 91 pages £3.15

### INTRODUCING MORSE

**Collected Articles from PW 1982-1985**  
Ways of learning the Morse Code, followed by constructional details of a variety of keys including lambic, Triambi, and an Electronic Bug with a 528-bit memory. 48 pages £1.25

### PASSPORT TO AMATEUR RADIO

**Reprinted from PW 1981-1982**  
The famous series by GW3JGA, used by thousands of successful RAE candidates as an aid to their studies. Plus other useful articles for students of amateur radio. 96 pages  
£1.50

### PROJECTS IN AMATEUR RADIO AND SHORT WAVE LISTENING

**F. G. Rayer G3OGR**  
Full constructional details are given for all projects, including housing the units in a suitable case. All the projects are either on p.c.b. or matrix board. 90 pages  
£4.96

## QUESTIONS & ANSWERS AMATEUR RADIO

**F. C. Judd G2BCX**  
What is amateur radio? The Radio Amateurs' Exam and Licence. The technology, equipment, antennas, operating procedure and codes used by amateurs. 122 pages  
£2.95

### RADIO AMATEUR'S GUIDE RADIO WAVE PROPAGATION (HF Bands)

**F. C. Judd G2BCX**  
The how and why of the mechanism and variations of propagation in the h.f. bands. 144 pages £8.95

### RADIO AMATEUR'S MAP OF NORTH AMERICA (USA)

Shows radio amateurs prefix boundaries, continental boundaries and zone boundaries. 760 x 636mm £2.25

### ★ THE 1988 ARRL HANDBOOK FOR THE RADIO AMATEUR

This, the sixty-fifth edition is available only in hardback, the first time the ARRL have done this. New construction projects are the theme of this edition, there is a deluxe memory keyer, receiver projects, a linear QSK converter, a low-powered balanced Transmatch and a d.t.m.f. decoder. Updated every year, this provides useful reference material for the radio amateur. It also includes 18 pages of p.c.b. track pattern for you to build your own boards. 1157 pages £19.25 (hardback)

### ★ THE INTERNATIONAL VHF FM GUIDE 7th Edition

**Julian Baldwin G3UHK & Kris Partridge G8AUU**  
The latest edition of this useful book gives concise details of repeaters and beacons worldwide plus coverage maps and further information on UK repeaters. 70 pages  
£2.85

### THE MORSE CODE FOR RADIO AMATEURS (RSGB)

**Margaret Mills G3ACC**  
A guide to learning to send and receive Morse code signals up to the 12 w.p.m. required for the RAE. 19 pages  
£2.88

### THE SATELLITE EXPERIMENTER'S HANDBOOK (USA)

A guide to understanding and using amateur radio, weather and TV broadcast satellites. 207 pages. £9.25

### THE SECRET OF LEARNING MORSE CODE

**Mark Francis**  
Designed to make you proficient in Morse code in the shortest possible time, this book points out many of the pitfalls that beset the student. 87 pages £4.95

### VHF HANDBOOK FOR RADIO AMATEURS (USA)

**H. S. Brier W9EGG & W. I. Orr W6SAI**  
VHF/UHF propagation, including moonbounce and satellites, equipment and antennas. 335 pages £7.95

### VHF/UHF MANUAL (RSGB)

**G. R. Jessop G6JP**  
Theory and practice of amateur radio reception and transmission, between 30MHz and 24GHz. 520 pages  
Hardback £12.92

## ANTENNAS (AERIALS)

### AERIAL PROJECTS (BP105)

**R. A. Penfold**  
Practical designs including active, loop and ferrite aerials plus accessory units. 96 pages £1.95

### ALL ABOUT CUBICAL QUAD ANTENNAS (USA)

**W. I. Orr W6SAI & S. D. Cowan W2LX**  
Theory, design, construction, adjustment and operation of quads. Quads vs. Yagis. Gain figures. 109 pages  
£5.50

### ALL ABOUT VERTICAL ANTENNAS (USA)

**W. I. Orr W6SAI & S. D. Cowan W2LX**  
Theory, design, construction, operation, the secrets of making vertical work. 191 pages £7.50

### AN INTRODUCTION TO ANTENNA THEORY (BP198)

**H. C. Wright**  
This book deals with the basic concepts relevant to receiving and transmitting antennas. Lots of diagrams reduce the amount of mathematics involved. 86 pages  
£2.95

### BEAM ANTENNA HANDBOOK (USA)

**W. I. Orr W6SAI & S. D. Cowan W2LX**  
Design, construction, adjustment and installation of h.f. beam antennas. 198 pages £6.75

### HF ANTENNAS FOR ALL LOCATIONS (RSGB)

**L. A. Moxon G6XN**  
Taking a new look at how h.f. antennas work, and putting theory into practice. 260 pages £6.17

### OUT OF THIN AIR

**Collected Antenna Articles from PW 1977-1980**  
Including such favourites as the ZL Special and "2BCX 16-element beams for 2m, and the famous "Slim Jim" designed by Fred Judd G2BCX. Also features systems for Top Band, medium wave/long wave loop designs and a v.h.f. direction finding loop. Plus items on propagation, accessories and antenna design. 80 pages £1.80

### SIMPLE, LOW-COST WIRE ANTENNAS FOR RADIO AMATEURS (USA)

**W. I. Orr W6SAI & S. D. Cowan W2LX**  
Efficient antennas for Top Band to 2m, including "invisible" antennas for difficult station locations. 197 pages  
£6.75

### SIMPLE, LOW-COST WIRE ANTENNAS FOR RADIO AMATEURS (USA)

**W. I. Orr W6SAI & S. D. Cowan W2LX**  
Efficient antennas for Top Band to 2m, including "invisible" antennas for difficult station locations. 197 pages  
£6.75

## THE ARRL ANTENNA BOOK 14th Edition (USA)

A station is only as effective as its antenna system. This book covers propagation, practical constructional details of almost every type of antenna, test equipment and formulas and programs for beam heading calculations. 327 pages. £9.10

## THE ARRL ANTENNA COMPENDIUM Volume 1 (USA)

This book makes fascinating reading of hitherto unpublished material. Among topics discussed are quads and loops, log periodic arrays, beam and multi-band antennas, verticals and reduced size antennas. 175 pages  
£9.25

## THE RADIO AMATEUR ANTENNA HANDBOOK (USA)

**W. I. Orr W6SAI & S. D. Cowan W2LX**  
Yagi, quad, quagi, l-p, vertical, horizontal and "sloper" antennas. Towers, grounds and rotators. 187 pages  
£6.75

## TWO-METRE ANTENNA HANDBOOK

F.C. Judd wrote this book for radio amateurs new to the 144-146MHz band. The range of antennas described will cater for most situations, particularly those where space is a problem. 157 pages £5.95

## WIRES & WAVES

**Collected Antenna Articles from PW 1980-1984**  
Antenna and propagation theory, including NBS Yagi design data. Practical designs for antennas from medium waves to microwaves, plus accessories such as a.t.u.s, s.w.r. and power meters, and a noise bridge. Dealing with TVI. 160 pages £3.00

## 25 SIMPLE INDOOR AND WINDOW AERIALS (BP136)

**E. M. Noll**  
Designs for people who live in flats or have no gardens, etc., giving surprisingly good results considering their limited dimensions. 64 pages £1.75

## 25 SIMPLE SHORT WAVE BROADCAST BAND AERIALS (BP132)

**E. M. Noll**  
Designs for 25 different aerials, from a simple dipole through helical designs to a multi-band umbrella. 80 pages  
£1.95

## 25 SIMPLE TROPICAL AND MW BAND AERIALS (BP145)

**E. M. Noll**  
Simple and inexpensive aerials for the broadcast bands from medium wave to 49m. 64 pages £1.75

## AUDIO FREQUENCIES

### AUDIO (BP111) (Elements of Electronics—Book 6)

**F. A. Wilson**  
This book studies sound and hearing, and the operation of microphones, loudspeakers, amplifiers, oscillators, and both disc and magnetic recording. 320 pages £3.50

## THEORY & CALCULATIONS

### BEGINNER'S GUIDE TO ELECTRONICS

**Owen Bishop**  
For youngsters thinking of a career in electronics; theory and applications in computers, radio, TV, recording, medical and industrial electronics. 240 pages £4.95

### CARE AND FEEDING OF POWER GRID TUBES (USA)

This handbook analyses the operation of EIMAC power grid valves and provides design and application information to assist the user of these valves. 156 pages £6.75

### PRACTICAL ELECTRONICS CALCULATIONS AND FORMULAE (BP53)

**F. A. Wilson**  
This has been written as a workshop manual for the electronics enthusiast. There is a strong practical bias and higher mathematics have been avoided where possible. 249 pages £3.95

### RADIO FREQUENCY INTERFERENCE (USA)

What causes r.f.i.? Are all r.f.i. problems difficult, expensive and time-consuming to cure? These questions and many more are answered in this book. 84 pages £4.30

### THE SIMPLE ELECTRONIC CIRCUIT AND COMPONENTS Book 1 (BP62)

The aim of this book is to provide an inexpensive but comprehensive introduction to modern electronics. 209 pages  
£3.50

## COMPUTING

### AMATEUR RADIO SOFTWARE (RSGB)

**John Morris GM4ANB**  
Using a computer for c.w., RTTY, data, plus calculations for antennas, distance, bearing, locators, satellites, sun, moon and circuit design. 328 pages Hardback £9.41

### AN INTRODUCTION TO COMPUTER COMMUNICATIONS (BP177)

**R. A. Penfold**  
Details of various types of modem and their applications, plus how to interconnect computers, modems, and the telephone system. Also networking systems and RTTY. 96 pages £2.95

**AN INTRODUCTION TO  
COMPUTER PERIPHERALS (BP170)**

**J. W. Penfold**

Covers monitors, printers, disk drives, cassette recorders, modems, etc., explaining what they are, how to use them and the various types of standards. 80 pages £2.50

**MICROPROCESSING SYSTEMS  
AND CIRCUITS (BP77)**

**(Elements of Electronics—Book 4)**

**F. A. Wilson**

A comprehensive guide to the elements of microprocessing systems, which are becoming ever more involved in radio systems and equipment. 256 pages £2.95

**FAULT-FINDING**

**ARE THE VOLTAGES CORRECT?**

**Reprinted from PW 1982-1983**

How to use a multimeter to fault-find on electronic and radio equipment, from simple resistive dividers through circuits using diodes, transistors, i.c.s and valves. 44 pages £1.50

**PRACTICAL HANDBOOK OF  
VALVE RADIO REPAIR**

**Chas E Miller**

The definitive work on repairing and restoring valved broadcast receivers dating from the 1930s to the 60s. Appendices giving intermediate frequencies, valve characteristic data and base connections. 230 pages Hardback £15.95

**QUESTIONS & ANSWERS  
RADIO REPAIR**

**Les Lawry-Johns**

How to fault-find and repair valved and transistorised receivers, car radios and unit audio equipment. Suggested lists of tools and spare parts. 106 pages £2.95

**SERVICING RADIO,  
HI-FI AND TV EQUIPMENT**

**Gordon J King**

A very practical book looking at semiconductor characteristics, d.c. and signal tests, fault-finding techniques for audio, video, r.f. and oscillator stages and their application to transistor radios and hi-fi. 205 pages £8.95

**TELEVISION INTERFERENCE MANUAL (RSGB)**

**B. Priestley**

TV channels and systems, spurious-radiation TVI, strong-signal TVI, audio breakthrough, transmitter design. 78 pages £2.94

**TEST EQUIPMENT FOR  
THE RADIO AMATEUR (RSGB)**

**M. L. Gibson G2BUP**

Techniques and equipment for tests and measurements on devices, systems and antennas. 142 pages Hardback £7.88

**TRANSISTOR RADIO FAULT FINDING CHART  
(BP70)**

**C. E. Miller**

Used properly, should enable most common faults to be traced reasonably quickly. Selecting the appropriate fault description at the head of the chart, the reader is led through a sequence of suggested checks until the fault is cleared. 635 x 455mm (approx) £0.95

## LISTEN OUT FOR

**GB0BSR:** This callsign will be used on 144MHz, mainly as the talk-in station for the Blue Star Rally, Newcastle on March 5.

**Terry G6VEG**  
091-286 6908

**GB40OR:** The Plymouth Radio Club have obtained this callsign for use during the month of July 1988. July is the celebration of the 400th Anniversary of the routing of the Spanish Armada by Sir Francis Drake. It is being marked, not only in Plymouth in Devon but also in many Plymouths worldwide.

Plymouth Radio Club have organised a massive operation from Plymouth Hoe which will enable radio amateurs to obtain a very rare QSL card in the period July 21 to 28. The station will be on the air every day and probably late into the night.

**Have you Got a  
Special Event Station  
we should know about?  
If so, write and tell us**

**LA1D:** On Saturday May 28, Norsk Radiohistorik Forening (NRHF) will be taking vintage communications sets, including equipment used for clandestine operations during WWII, to an open-air location similar to those used for war-time operations. LA1D will be on 14.080MHz between 0800-0900, 1000-1100 and 1200-1300.

**Tony Smith G4FAI**  
Tel: 01-368 4588

**GB4GOS:** The Sheffield ARC are running this special event station from the Guides' HQ in Trippet Lane, Sheffield. It is to commemorate Guides' Thinking Day. They are hoping to cover as many bands and modes as possible (including TV, Packet, etc.) and to have local media coverage for the event.

**Alan Pemberton G0ILG**  
PO Box 365  
Sheffield  
S1 1BY

**GB2FFR:** The Porthmadog & District ARS will be running this special event station on the weekend of April 30 to May 2. It's to celebrate "125 Years of Steam" and will be operating from The Harbour Railway Station of the Ffestiniog Railway.

## RALLIES

**\*January 31:** The Northern Amateur Radio Societies Association (NARSA) has had to move its rally from Belle Vue. The new venue is the Norbrek Castle Hotel Exhibition Centre, Queens Parade, Blackpool. All the attractions for which "Belle Vue" was well known will be at Blackpool. Bring and Buy, RSGB Morse Tests — pre-booked of course. Traders large and small. Talk-in on S22. Admission is £1 (OAPs 50p under-14 free).  
**Peter Denton G6CGF**  
051 630 5790

**March 5:** The Blue Star Rally will be held at the High Gosforth Park Racecourse, which is 8km north of Newcastle. There will be trade stands, Morse tests, a bring and buy and refreshments. Talk-in will be on S22 under the callsign GB0BSR.

**Terry G6 VEG**  
091-286 6908.

**March 13:** The Bury Radio Society will be holding their 1988 rally at a new venue. The bigger venue is the Castle Leisure Centre, Bolton Street, Bury. There will be the usual large number of stands, a bring and buy and

masses of radio and electronics traders. Talk in will be on S22.

**M. L. Jamil G1VQE**  
29 Harrow Close  
Blackford Bridge, Bury

**March 20:** The Tiverton SW Radio Club are holding The Mid Devon Rally at the Pannier Market, Tiverton. There is easy access from junction 27 of the M5 and excellent parking facilities on site. There will be two halls of trade stands, a bring and buy and a mobile snack bar. Talk-in will be on S22.

**G4TSW**  
Mid Devon Rally  
PO Box 3  
Tiverton

**June 18:** The Royal Air Force Halton Air Show and Amateur Radio Rally will take place at RAF Halton, near Aylesbury, Bucks. The RAFARS Golden Jubilee Rally will be held inside a hangar.

**Terry F. Owen G4PSH**  
0296 85760

**July 15-17:** The RSGB 75th Anniversary National Convention will take place at the National Exhibition Centre, Birmingham. RSGB HQ can give you more details.

**July 28-31:** The AMSAT-UK Colloquium will again be held in the University of Surrey, Guildford.  
**G3AAJ**  
Tel: 01-989 6741

**July 31:** The Scarborough ARS Rally will be held at The Spa, Scarborough. Doors open at 11am. Talk-in will be on S22 and SU8 as well as GB3NY.

**Ian Hunter G4UQP**  
QTHR  
Tel: 0723 376847

**August 14:** The 1988 Derby Mobile Rally will take place at their usual venue of Lower Bemrose School, St Albans Road. Doors open at 11am and more details will be available as the day draws closer.

**G3KQT**  
QTHR

# YOUR ONE STOP LISTENER SERVICE!

Established 1973

**HUGE STOCKS — BEST PRICES — GOOD BACKUP — FREE SECURICOR  
YOU NAME IT — — — WE'VE GOT IT!**

## SONY AIR-7 HAND-HELD AM/FM 108-176MHz + LW/MW/FM UNBEATABLE VALUE

The best VHF monitor there is! That's a fact! 108-176MHz plus LW/MW/FM broadcast. Covers air marine PMR etc. LCD display memories scanning lockout priority etc. Supplies are short but we are the UK's largest stockist so check with us!



£247 FREE SECURICOR

## SONY ICF7600DS PORTABLE COMMUNICATIONS!

Not a toy, but a serious communications receiver. 150KHz-30MHz AM/SSB plus FM 76-108MHz. Digital readout, memories, clock and provision for external antenna. Listen to the DX at work! Mains or battery.

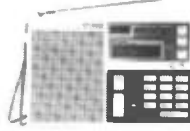

£169 FREE SECURICOR

## NEW SONY PRO-80 RECEIVER AM/FM/SSB 115kHz-223MHz

A major innovation in monitor receivers. Just think, a complete short wave and vhf monitoring system in your pocket! Memories, scanning, etc. Order today!



£329.00 Carriage Free.

## SONY ICF2001D RECEIVER SUPER PORTABLE AM/SSB/CW + AIR BAND COVERAGE

Described as 'the best portable on the market' by a recent reviewer it covers 150KHz-30MHz AM/SSB/CW plus AM VHF air band and FM broadcast. Memories scanning etc. are all included. The SSB performance is superb and can match many base station receivers. 230/110v AC power supply included.

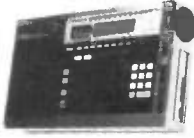

£329 FREE SECURICOR

### Special Offer on above!

Complete ICF 2001D system comprising receiver, AN-1 active aerial with 50' coax, Broadcast station guide, UK Confidential Frequency List of shortwave stations, and VHF/UHF Airband Guide all smartly packed at a price that is unbeatable!

£378.00 inc del.

AN-1 Active aerial separately £49 + £2 carr.

## R537S AIR- BAND MONITOR 118-136MHz

This well known receiver is ideal for the serious air-band enthusiast! superb sensitivity and selectivity, this pocket size monitor is unrivalled in value for money. 2 fixed channels are possible and the squelch control ensures silent background. Complete with battery and whip.



£69 Carr. £2.00

## AOR 2002 SCANNER VHF/UHF MONITOR

From AOR the famous VHF/UHF monitor that covers 26-1300MHz AM/FM. Highly compact, 230V or 12V DC with LCD, memories and scanning. Ideal for the serious user. A wide range of facilities and 230V AC or 12V DC.



£475 FREE SECURICOR

## SCANNING AERIALS



CLP 5130  
105-1300MHz  
13.5dB fwd gain  
15dB F/B ratio  
Length 4.5ft  
Receive & Transmit  
1/2" socket conn  
Vertical or Horizontal  
£82.00 post £3.00

D130N  
26-1300MHz disccone  
Omnidirectional  
Receive & Transmit  
height 6ft approx  
50ft coax supplied  
2" mass fitting  
Corrosion proof  
£82.50 post £3.00

### LATEST PRICE LIST

Our complete price list is available for the cost of a stamp. Over 700 items listed!

## GLOBAL AT1000 AERIAL TUNER

The AT1000 is a receiver aerial tuner designed to give you maximum performance from your receiver. Covering the frequency range 150KHz to 30MHz it matches all the modern receivers produced in recent years. Ideal for matching long wire, dipoles or balanced feeder.

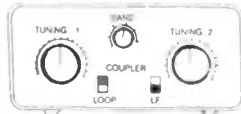

£69.00 POST FREE

JUST  
PUBLISHED

## HF OCEANIC AIRBAND COMMUNICATIONS Second Edition (Dec. 1987) By Bill Laver £3.50 + 80p p&p

This completely revised edition now covers the subject matter in much greater depth. Whether you want to know how the short wave communications system for aircraft works, where to listen or when to listen, you will find the answer in these pages. The book is aimed squarely at the UK listener, all the information is up to date and will provide you with the kind of information that you have always wanted but never knew where to find. The frequency range embraces the aeronautical channels between 2MHz and 23MHz. So now you can sit at home with your receiver and listen to the airliners and military aircraft tracking their way across the world, sit on the world VOLMET weather services. The book also looks at suitable receivers and aerial systems (with dimensions) and lists network frequencies, civil and military VOLMETs, reporting points, telephone networks etc. If you enjoyed our previous issue you will want this new updated issue. Don't be left in the dark, send today and find out where it all happens!

## BOOKS SPECIALLY FOR YOU!

### NEW 1988 EDITION

**COMPLETE  
VHF/UHF  
FREQUENCY GUIDE  
26-2250MHz  
£5.95 + 90p p&p**

THE COMPLETE  
VHF/UHF  
FREQUENCY  
GUIDE



**UK LISTENERS  
CONFIDENTIAL  
FREQUENCY LIST  
1.6-30MHz  
£5.95 + 80p p&p**

FOURTH EDITION



**VHF/UHF AIRBAND  
FREQUENCY GUIDE  
+ FREE UPDATE  
SERVICE  
£5.95 + 80p p&p**

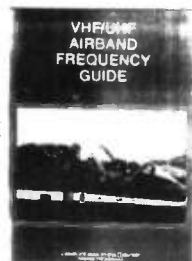

Completely revised and updated, this publication is one that should be an every enthusiast's bookshelf! The previous edition sold 6000 copies in 18 months. This latest issue is 25% larger and has been completely re-written with a new easy-to-read layout. No other publication offers you so much information for such low cost. It provides complete details of all the services in the UK that make use of the VHF/UHF spectrum with listings from 26 to 2250MHz without gaps, and additional listings to 56GHz. Each section begins with full details of the services that use each segment of the spectrum, followed by details of individual services in frequency order. Users covered include the emergency services, marine, aeronautical, and mobile, etc. Many of these services use duplex frequencies and full details of the splits are included for base and mobiles. Although many of the frequencies listed cannot be monitored without a licence, all listeners should find this book a mine of information. Tremendous value!

This famous listing is now in its fourth edition. Completely updated for 1987 and a lot thicker. Yet the price is the same as the 1986 edition! Many additional frequencies have been added and of course some have been deleted where the service is known to no longer exist. Packed full of information on all that happens between 1.6 and 30MHz, you will find this fascinating reading. Covering all aspects of the short wave service, here is just a selection of the listings included: AVIATION BROADCAST, MARINE, EMBASSY, MILITARY, RTTY, FAX, PRESS, and much more. Not only frequencies and stations, but in many cases times of transmissions as well. This is not an American import, but a UK printed manual specially for UK listeners. If you are one of the few people that haven't purchased one of these yet, then you really don't know what you have been missing. If in the other hand you have our previous editions, we know that you will want the latest edition. Available end of March. Order your copy today.

This is the UK's foremost list of military and civil radio frequencies. Nearly three times as large as the 1986 edition and bang up-to-date. Every conceivable airfield is listed from the smallest grass field to the largest of our international airports. We have now included full airways listings plus heliports and off-shore rigs. In addition, there are listings of company frequencies, VOLMETs and miscellaneous air-to-air frequencies. Don't confuse this with other guides you may have seen. This one is REALLY comprehensive and packed with information. For the newcomer there is some interesting editorial plus photographs, and a very useful telephony designation list. Full colour semi-stiff covered in large format style makes this one of the best presented guides yet. Undoubtedly the best manual here is available to the enthusiasts today. There is also a free up-to-date service for purchasers so you will never need to worry about the information becoming out of date. That's real service!

Better Short Wave Reception £6.00 + £0.60 p&p  
Oceanic HF Airband Frequency Guide £2.95 + £0.60 p&p  
World Radio HF Teletype Frequency List £3.95 + £0.60 p&p  
World Radio & TV Handbook (1987) £17.95 + £1.00 p&p

Air Traffic Control by David Adair £6.99 + £1.00 p&p  
Air Traffic Control by Ian Allan £3.50 + £0.70 p&p  
Air Band Radio Handbook £4.99 + £1.00 p&p  
Scanners: A VHF/UHF Listeners Guide £7.95 + £1.00 p&p

RETAIL & MAIL ORDER: 18-20, Main Road, Hockley, Essex SS5 4QS.  
Tel: (0702) 206835, 204965  
RETAIL ONLY: 12, North Street, Hornchurch, Essex RM11 1QX.  
Tel: (04024) 44765  
Visa and Access by telephone. 24hr. Answerphone.

# WATERS & STANTON



# Yaesu has serious listeners for the serious listener

Yaesu's serious about giving you better ways to tune in the world around you.

And whether it's for local action or worldwide DX, you'll find our VHF/UHF receivers are the superior match for all your listening needs.

**The FRG-9600. A premium VHF/UHF scanning communications receiver.** The 9600 is no typical scanner. And it's easy to see why.

You won't miss any local action with continuous coverage from 60 to 905MHz.

You have more operating modes to listen in on: upper or lower sideband, CW, AM wide or narrow, and FM wide or narrow.

You can even watch television programmes by plugging in a video monitor into the optional video output. (NTSC System).

Scan in steps of 5, 10, 12½, 25 and 100kHz. Store any frequency and related operating mode into any of the 99 memories. Scan the

memories. Or in between them. Or simply "dial up" any frequency with the frequency entry pad.

Plus there's more, including a 24-hour clock, multiplexed output, fluorescent readout, signal strength graph, and an optional PA4C, AC power adaptor.

Extend the coverage further with the optional FC965DX 0.15-30MHz and FC1300 800-1300MHz external converters.

**The FRG-8800 HF communications receiver. A better way to listen to the world.** If you want a complete communications package, the FRG-8800 is just right for you.

You get continuous worldwide coverage from 150kHz to 30MHz. And local coverage from 118 to 174MHz with an optional VHF converter.

Listen in on any mode: upper and lower sideband, CW, AM wide or narrow, and FM.

Store frequencies and operating modes into any of the twelve channels for instant recall.

Scan the airwaves with a number of programmable scanning functions.

Plus you get keyboard frequency entry. An LCD display for easy readout. A SINPO signal graph. Computer interface capability for advanced listening functions. Two 24-hour clocks. Recording functions. And much more to make your listening station complete.

**Listen in.** When you want more from your VHF/UHF or HF receivers, just look to Yaesu. We take your listening seriously.

## YAESU

*South Midlands Communications  
S.M. House, School Close,  
Chandlers Ford Industrial Estate,  
Eastleigh, Hants SO5 3BY  
Tel: (0703) 255111  
UK Sole Distributor*



Dealer inquiries invited.

Prices and specifications subject to change without notice.  
FRG-9600 SSB coverage: 60 to 460 MHz.