



# The SHORT WAVE Magazine



July 1985

Volume 43 Number 5

G3ROO adds Top Band to the FT-707

G3XAP bends antennas to fit

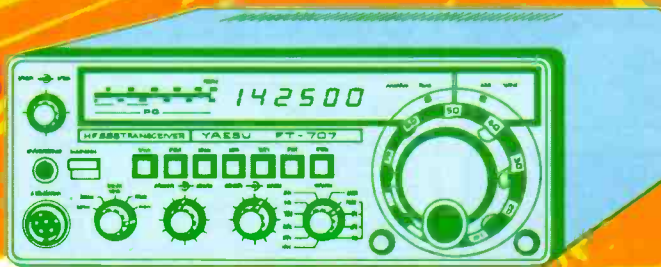

# TOP BANDED!

for the radio amateur and amateur radio

# STEPHENS-JAMES LTD.

47 WARRINGTON ROAD, LEIGH, LANCS. WN7 3EA  
 Telephone (0942) 676790  
 Turn at the Greyhound Motel on the A580 (East Lancs. Road).

LANCASHIRE & THE NORTH WEST'S LEADING RETAILER IN AMATEUR RADIO. 20 YEARS SERVING THE AMATEUR'S BY AMATEURS SPECIALISING ONLY IN AMATEUR RADIO EQUIPMENT.  
 24 HOUR MAIL ORDER SERVICE



The TS930S latest transceiver from Trio Price: £1295.00 inc. VAT



**TRIO TS430's**  
£720.00



**TW4000A**  
£522.00



**TRIO R600 RECEIVER**  
£299.00



**TRIO R2000 RECEIVER**  
£479.00  
**VHF CONVERTER. £128.36**  
 Covers 118-174MHz



**TRIO TS830S**  
**HF SSB TRANSCEIVER**  
 £832.75

- NEW TRIO MODELS**
- TH21E 2M FM Micro Transceiver. . . . . £170.00
  - TR2600E 2M FM Transceiver. . . . . £199.00
  - TS711E 2M Multimode Base Transceiver. . . . . £768.00
  - TS811E 70cm Multimode Transceiver. . . . . £850.00



AR2001 scanning receiver. A glance at the brief specification will tell you why the new AR2001 receiver is going to take the listener by storm.

- ★ Continuous coverage 25-550MHz (no gaps).
  - ★ Receive modes of AM (for VHF/UHF airband), FM narrow (for amateur radio, CB, business radio) and FM wide (for broadcast and TV FM).
  - ★ Digital display of frequency, mode and memory channel.
  - ★ Memory channels which store frequency and mode.
  - ★ Full range of scan facilities.
- The performance of the AR2001 sets new standards. Gone are the complaints of 'deaf' receivers. The AR2001 has typical sensitivity of 0.2 microvolts for 12dB SINAD on FM (N) across the entire 25-550MHz range.
- Finally, the AR2001 is small, light weight, and powered from any 12V dc source, so it can be used at home, in the car, boat or aircraft, and whilst out portable.

Now comes complete with 12V PSU £378.00



**J.R.C. NR515D**

General coverage receiver 100 KHz to 30 MHz fully synthesised. Digital readout PLL synthesiser with rotary type encoder pass band tuning - modular construction. . . . . £965.00

NSD515 TRANSMITTER & AC PSU £1,371.00  
 NEW 96 CHANNEL MEMORY UNIT.

- DATONG PRODUCTS**
- Low Frequency Converter . . . . . £29.90
  - FL1 Frequency Audio Filter. . . . . £79.35
  - FL2 Multi-Mode Audio Filter. . . . . £89.70
  - Automatic FR Speech Clipper . . . . . £82.80
  - D70 Morse Tutor . . . . . £56.35
  - AD370 Active Antenna (outdoor) . . . . . £64.40
  - AD270 Active Antenna (indoor) . . . . . £47.15
  - 2M Converter. . . . . £39.67

- ANTENNA ROTATORS**
- Diawa DR7500R . . . . . £153.67
  - DR7600X . . . . . £189.37
  - DR7600R . . . . . £213.41

- KENPRO**
- Kenpro 250 . . . . . £65.55
  - KR400C . . . . . £132.50
  - KR600RC . . . . . £189.50
  - KR500 Elevation Rotator. . . . . £144.50

- Station Accessories**
- SP400 . . . . . £82.00
  - SP10X . . . . . £28.75
  - SP15M . . . . . £41.00
  - SP45M . . . . . £59.75
  - Weltz AC38 Antenna Tuner . . . . . £73.95
  - Global SWL AT 1000 Tuner. . . . . £52.00
  - SWR25 . . . . . £15.75
  - HK 708 Morse Keys. . . . . £16.30
  - Diawa 2 way Ant. Switch. . . . . £15.88
  - V33 way Ant Switch. . . . . £10.50
  - DL50 Dummy Load. . . . . £7.97
  - DL150 Dummy Load. . . . . £19.95
  - DL600 500hm 600 watt D.Load . . . . . £39.50
  - HP41 high pass filter. . . . . £6.95
  - Trio LF30A low pass filter. . . . . £24.68
  - Diawa CN410M 3.5-150MHz SWR/PWR meter . . . . . £48.00
  - Diawa CN460M 140-150MHz SWR/PWR meter . . . . . £52.00
  - Diawa CN620A 1.8-150MHz SWR/PWR meter . . . . . £66.21
  - Diawa CL690 1.8-30MHz ATU. . . . . £81.50
  - Diawa CN419 1.8-30MHz ATU. . . . . £159.64
  - Diawa PS300 30 amp power supply. . . . . £176.80

- BELCOM**
- LS-202E 2m hand held DM-SSB transceiver. . . . . £225.00
  - belcom LS202E 2M FM hand held transceiver . . . . . £139.00

- YAESU**
- FRG9600 Scanning Receiver. . . . . £475.00
  - FRG880 Gen. Cov. Receiver. . . . . £550.00

Microwave Modules, and other equipment also available, including I.C.S. - Diawa - Telereader - RSGB and ARRL publications - Tau - Yaesu.

- ANTENNAS**
- Hy-Gain
  - 12AVQ 3Band Vertical. . . . . £78.95
  - 14AVQ/WB 4 Band Vertical. . . . . £106.00
  - 18AVT/WB 5 Band Vertical. . . . . £172.00
  - TH2MK3 2EI. Tribander Beam. . . . . £279.00
  - TH3JNR 3EI. Tribander Bea. . . . . 299.00
  - 205BA 5 Element 20m Beam. . . . . £399.00

- Mini Products**
- HQ1 Minibeam 10-15-20m. . . . . £199.00

- T.E.T.**
- HB23SP 2EL Tribander . . . . . £172.50
  - HB23M Triband Minibeam . . . . . £169.50
  - HB33M Triband Minibeam. . . . . £230.00
  - HB33SP 3EL Tribander . . . . . £231.50
  - HB35C 5EL Tribander . . . . . £283.95
  - MV3BH 3Band Vertical . . . . . £45.95
  - MV4BH 4Band Vertical . . . . . £59.95
  - MV5BH 5Band Vertical . . . . . £99.00
  - MV3BH with Radial Kit . . . . . £69.00

- TONNA**
- 4 Element 2m Yagi. . . . . £14.95
  - 9 Element 2m Yagi. . . . . £17.71
  - 17 Element 2m Yagi. . . . . £37.66
  - 19 Element 432MHz Yagi . . . . . £20.70
  - 21 Element 432MHz Yagi. . . . . £29.67

- G-Whip New all band Base Station Antenna  
 Welz Diamond DCP5 10-80 trapped vertical with radial kit . . . . . £149.00

- Hokasin**
- 1/4 wave 2m Whip mobile . . . . . £2.54
  - 5/8 wave 2m Whip mobile . . . . . £11.26
  - 7/8 wave 2m Whip mobile . . . . . £17.06
  - 5/8 wave Base Station antenna . . . . . £42.68
  - GPV-52m Base Station Co-Linear . . . . . £35.27
  - GPV-770cm Base Station Co-Linear . . . . . £35.35
  - GPV 720 144/432MHz dual base station. . . . . £25.00
  - Revcone Discone. . . . . £25.00

- JAYBEAM**
- LW5 5EI 2m Yagi. . . . . £15.33
  - LW8 8EI 2m Yagi. . . . . £19.55
  - LW10 10EI 2m Yagi. . . . . £25.30
  - LW16 16EI 2m Yagi. . . . . £37.95
  - PBM10 10EI Parabeam . . . . . £49.95
  - PBM14 14EI Parabeam. . . . . £60.95
  - C5/2m 2m Co-Linear . . . . . £86.25
  - D5/2m Double 5Element Slot Yagi . . . . . £27.60
  - Q4/2m 4 Element 2m Quad . . . . . £31.63
  - Q6/2m 6Element 2m Quad . . . . . £41.40
  - Q8/2m 8 Element 2m Quad . . . . . £51.75
  - D8/70cm Double 8Slot Yagi. . . . . £28.18
  - PBM 18/70cm 18EI Parabeam . . . . . £34.50
  - PBM 24/70cm 24EI Parabeam . . . . . £46.00
  - LW24 24EI folded dipole . . . . . £31.05
  - MBM28 28EI multibeam . . . . . £23.00
  - MBM48 48EI multibeam . . . . . £37.95
  - MBM88 88EI multibeam . . . . . £51.75
  - 8XY/70 Crossed 8 Yagi . . . . . £44.85
  - 12XY/70 12EI Crossed Yagi . . . . . £55.20
  - 5XY/2m Crossed 8EI Yagi . . . . . £29.90
  - 8XY/2m Crossed 8EI Yagi . . . . . £38.53
  - 10XY/2m Crossed 10EI Yagi . . . . . £48.30
  - TB1 Rotary Dipole. . . . . £77.05
  - TB2 2 Element Tribander. . . . . £143.75
  - TB3 3 Element Tribander. . . . . £212.75

Antenna Tower Range 30ft lattice type and accessories - details on request.

- Full size G5RV antenna. . . . . £14.95
- Half size G5RV antenna . . . . . £12.95
- 80-10 Dipole Kit. . . . . £24.95
- Pair 7-1 MHz Traps. . . . . £9.75

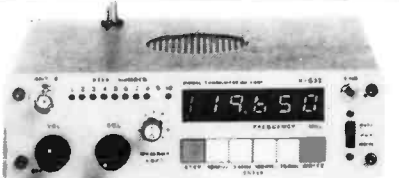

**THE R532**  
**AIRCRAFT BAND RECEIVER**  
 £185.00 inc. VAT

**SPECIFICATION.**  
 Frequency range: 110 to 136MHz, i.e. all NAV/COM channels.  
 Number of channels: 1040 (25KHz steps).  
 Sensitivity: Better than 0.75 microvolts 10dB/SN.  
 Memory channels: 100 (10 banks of 10). Memories can be scanned automatically or selected manually.  
 Power required: 12V dc negative earth 300mA typical. (Display can be switched off to reduce consumption when operating portable). Size: 160 x 45 x 130mm.  
 Weight: approx. 1Kg. (including memory backup batteries).

# SHORT WAVE MAGAZINE

(GB3SWM)

ISSN: 0037-4261

## ADVERTISERS' INDEX

	Page
J. Birkett .....	224
British National Radio and Electronics School.....	227
Colomor Electronics Ltd. ....	226
Datong Electronics Ltd. ....	189
Dewsbury Electronics .....	189
E.M.A.....	224
G2DYM Aerials .....	226
G4TNY Amateur Radio.....	225
Hately Antenna Technology.....	224
D. P. Hobbs Ltd. ....	227
KW Ten-Tec Ltd.....	188
McMichael A. R.S. ....	227
MuTek Ltd. ....	224
P.M. Electronic Services .....	188
Quartslab Marketing Ltd. ....	224
R.A.S. (Nottingham) .....	225
R.M.B. Electronics .....	226
F. G. Rylands .....	227
S.E.M. ....	190
Small Advertisements .....	225, 226, 227
South Midlands Communications Ltd. ....	190
Stephen-James Ltd.....	inside front cover
S.W.M. Publications .....	back cover, inside back cover, 225, 226, 227, 228
Thanet Electronics Ltd. ....	186, 187
Uppington Tele/Radio (Bristol) Ltd. ....	227
Reg. Ward & Co., Ltd. ....	226
Geoff Watts .....	224
Wood & Douglas .....	188

VOL. 43

JULY, 1985

No. 501

## CONTENTS

	Page
<b>Editorial</b> .....	191
<b>VHF Bands</b> , by <i>N. A. S. Fitch, G3FPK</i> .....	192
<b>A Tone Filter for RTTY Transmission</b> , by <i>P. C. Cole, G3JFS</i> .....	196
<b>"Practically Yours"</b> , with <i>Glen Ross, G8MWR</i> .....	198
<b>An Anonymous Communications Receiver</b> , by <i>Chas. E. Miller</i> .....	200
<b>"SWL"</b> , by <i>Justin Cooper</i> .....	202
<b>"Amateur Radio Operating Manual"</b> , third edition — book review. ....	205
<b>160-Metres for the Yaesu FT-707 Transceiver, Part 1</b> , by <i>Ian Keyser, G3ROO</i> .....	206
<b>Communication and DX News</b> , by <i>E. P. Essery, G3KFE</i> .....	211
<b>HF Antennas for Restricted Sites, Part 2</b> , by <i>A. P. Ashton, G3XAP</i> .....	215
<b>"G9BF Calling"</b> .....	219
<b>Clubs Roundup</b> , by <i>"Club Secretary"</i> .....	220

Editor: **PAUL ESSERY, G3KFE/G3SWM**

Advertising: **Charles Forsyth**

Published at 34 High Street, Welwyn, Herts. AL6 9EQ, on the last Friday of the month, dated the month following.  
Telephone: 04-3871 5206 & 5207

Annual Subscription:

Home: £12.00, 12 issues, post paid  
Overseas: £12.00 (\$17.00 U.S.), post paid surface mail

Editorial Address: **Short Wave Magazine**,  
34 High Street, Welwyn, Herts. AL6 9EQ, England.

Prices shown in advertising in this issue do not necessarily constitute a contract and may be subject to change.

## AUTHOR'S MSS

Articles submitted for Editorial consideration must be typed double-spaced with wide margins on one side only of A4 sheets. Photographs should be lightly identified in pencil on the back with details on a separate sheet. All drawings and diagrams should also be shown separately, and tables of values prepared in accordance with our normal setting convention — see any issue. Payment is made at a competitive rate for all material used, and it is a condition of acceptance that full copyright passes to the Short Wave Magazine, Ltd., on publication.

© Short Wave Magazine Ltd.

COVER DESIGN:  
Allan & Co. Ltd., Welwyn

E. & O. E. VAT Reg. No. 239 4864 25





# ICOM

# GREAT SETS..

## IC-735, The Complete HF Radio

This new HF transceiver from ICOM is compact enough to make mobile or portable use a possibility. The IC-735 covers all Amateur frequencies from 1.8MHz to 30MHz including the three new bands 10, 18 and 24MHz. Modes include SSB, CW, AM and FM, all circuits are solid-state and output is approximately 100 watts.

Tuning ranges from 100kHz to 30MHz, made continuous by using a high-side IF and a CPU control system. RTTY operation is also possible. Dynamic range is 105dB with a 70.451 MHz first IF circuit. The direct feed mixer rejects spurious response and gives higher sensitivity and wider dynamic range. Pass-band tuning and a sharp IF notch filter provide clear reception even under duress. Preamp is 10dB and attenuator 20dB.

The new IC-735 from ICOM is easy to operate and versatile, it has various scanning functions, comprehensive LCD and 12 memories. Computer remote control is possible via the RS-232C jack.

Options include: the AT-150 automatic antenna tuner and shown here the PS-55 AC power supply and SM-8 desk mic.

Please contact Thanet Electronics or your local ICOM dealer for even more information on this latest HF transceiver - the IC-735.

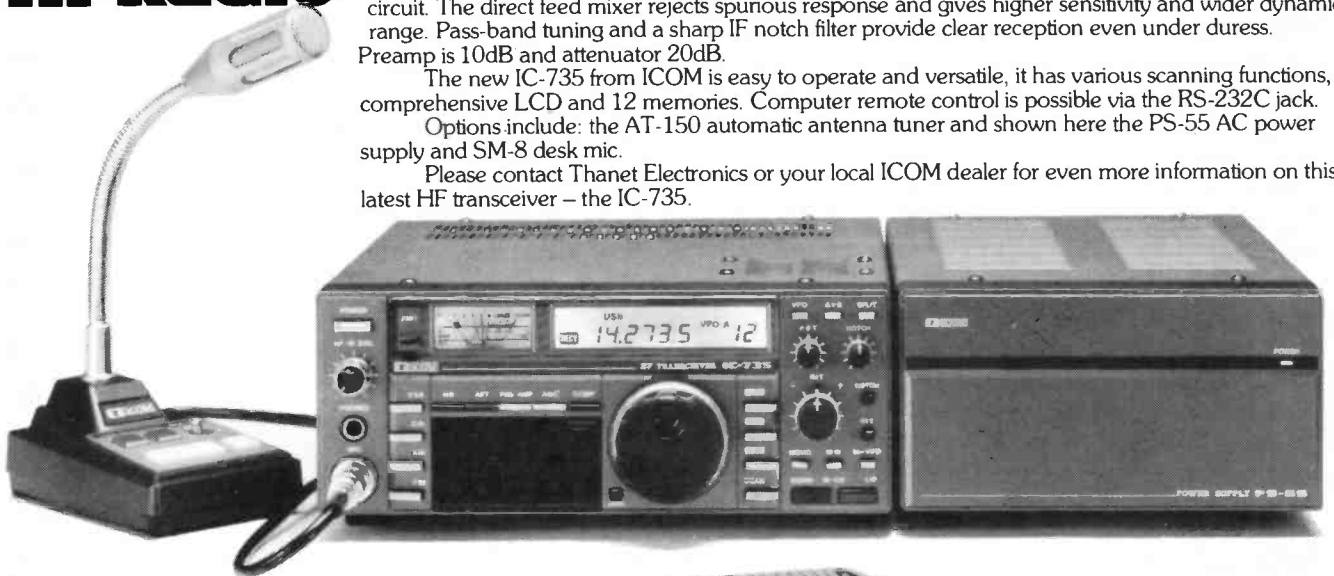

A new exciting set is the ICOM IC-3200E FM Dual-band transceiver (144-430/440 MHz). This is the smallest transceiver available.

The IC-3200E employs a function key for low-priority operations to simplify the front panel. LCD display is easy to read in bright places, showing frequency, VFO A/B, memory channel duplex mode and S/R/F meter information.

Other features include a 10 channel memory able to store operating frequencies, Simplex or Duplex. A memory lock-out function allows the memory scan to skip programmed channels when not required. The IC-3200E has a built-in duplexer and can operate on one antenna for both VHF and UHF. Options include: IC-PS45 DC, power supply, HS-15 mobile mic, SM6 and SM8 desk mics. SP-10 external speaker and UT-23 speech synthesizer. A great future is predicted for the IC-3200E.

## IC-3200E Mobile



Thanet ICOM Thanet ICOM Thanet ICOM Thanet ICOM Thanet ICOM Thanet ICOM Thanet ICOM Thanet ICOM

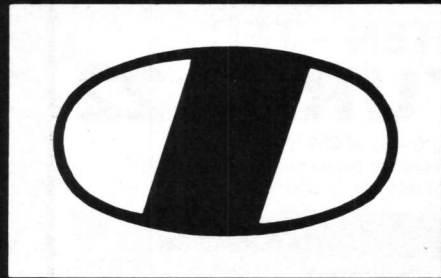

# ICOM

# GREAT VALUE

## IC-02E, IC-04E Handheld

The direct entry microprocessor controlled IC-02E is a 2 meter handheld, features include: scanning, 10 memories, duplex offset storage in memory and odd offsets also stored in memory. Internal Lithium battery backup and repeater tone are included. Keyboard entry is made through the 16 button pad allowing easy access to frequencies, duplex, memories, memory scan and priority.

The IC-02E has an LCD readout indicating frequency, memory channel, signal strength, transmitter output and scanning functions.

HS-10 Headset also available, with earphone and boom microphone, which operates with either of the following:- HS 10-SB Switch box with pre-amplifier giving biased toggle on, off and continuous transmit. HS 10-SA Voice operated switch box, with pre-amplifier, mic gain, vox gain and delay. The IC-2E and 4E continue to be available.



You can get what you want just by picking up the telephone. Our mail-order dept. offers you: free, same-day despatch whenever possible, instant credit, interest-free H.P., telephone Barclaycard and Access facility and a 24 hour answering service.

Please note that we have a retail branch at 95, Mortimer Street, Heme Bay, Kent. Tel: 369464. Give it a visit, BCNU.

### Authorised ICOM dealers in the UK

- Alexian Electronics Ltd. Edinburgh, 031-554 2591.
- Alyntronic, Newcastle, 0632-761002.
- Amateur Radio Exchange, London (Ealing), 01-992 5765.
- Amcomm, London (S. Harrow), 01-422 9585.
- Arrow Electronics Ltd., Chelmsford Essex, 0245-381673/26.
- Beamrite, Cardiff, 0222-486884.
- Booth Holding (Bath) Ltd., Bristol, 02217-2402.
- Bredhurst Electronics Ltd., W. Sussex, 0444-400786.
- Dressler (UK) Ltd., London (S. Harrow), 01-558 0854.
- D.W. Electronics, Widnes Cheshire, 051-420 2559.
- Hobbytronic, Knutsford Cheshire, 0565-4040. Until 10pm daily.
- Photo Acoustics Ltd., Buckinghamshire, 0908-610625.
- Radcomm Electronics, Co. Cork, Ireland, 01035321-632725.
- Radio Shack Ltd., London NW6, 01-624 7174.
- Scotcomms, Edinburgh, 031-657 2430.
- Tyrone Amateur Electronics, Co. Tyrone, N. Ireland, 0662-2043.
- Reg Ward & Co. Ltd., S.W. England, 0297-34918.
- Waters & Stanton Electronics, Hockley Essex, 0702-206835.

Listed here are authorised dealers who can demonstrate ICOM equipment all year round. This list covers most areas of the U.K., but if you have difficulty finding a dealer near you, contact Thanet Electronics and we will be able to help you.

## Cue Dee Antennas Special Offer!

CUE DEE antennas are designed to last for decades – the best possible aluminium alloy for this purpose is used (SIS 4212-06).

The booms are made of 28mm tubing with 1.5mm wall, with colour marks clearly indicating where to fit the elements. By using tubular boom, and a synthetic guy wire on the long yagis, the windload is reduced by a factor 0.66 compared to using square shaped material for boom and guying.

The driver element is made of 12mm tubing and features a PTFE (Teflon) insulated gamma match which is pre-tuned at the factory and made for 50 ohm feeder with a PL 259 type connector. No further adjustments or power consuming balun needed. This matching system ensures a clean radiation pattern and transfers the power without losses.

The parasitic elements are made of 6mm solid rod and mounted to the boom with the aid of a CUE DEE element washer, boom to element part and a screw. This, together with our intelligible assembly manual, makes an extremely easy and solid assembly which assures the long life of a CUE DEE antenna.

- 2 metre Yagis.
- 4144A – 4 element, 8dBd gain £19.00.
- 10144 – 10 element, 11.4dBd gain £37.00.
- 15144 – 15 element, 14dBd gain £49.00.

Order now while stocks last.



**Thanet Electronics**  
Dept SW143 Recliver Road, Heme Bay, Kent.  
Tel: (0227) 363859  
MAKING THE BEST OF THE BEST

# WOOD & DOUGLAS

- ★ NEW CATALOGUE
- ★ NEW PRODUCTS
- ★ NEW PRICES

Package Prices		Kit
1. 500mW TV Transmit	(70FMO5T4 + TVM1 + BPF433)	£40.00
2. 500mW TV Transceiver	(As 1 above plus TVUP2 + PSI 433)	£65.00
3. 10W TV Transmit	(As 1 above plus 70FM10 + BDX35)	£75.00
4. 10W TV Transceiver	(As 2 above plus 70FM10 + BDX35)	£100.00
5. 70cms 500mW FM Transceiver	(70T4 + 70R5 + SSR1 + BPF)	£80.00
6. 70cms 10W FM Transceiver	(As 5 above plus 70FM10)	£115.00
7. 2M Linear/Pre-amp 10W	(144PA4/S + 144LIN106)	£45.00
8. 2M Linear/Pre-amp 25W	(144PA4/S + 144LIN258)	£48.00
9. 2M Linear/Pre-amp 25W	(144PA4/S + 144LIN25C)	£51.00
10. 70cms Synthesised 10W Transceiver	(R5 + SY + AX + MOD + SSR + 70FM10)	£165.00
11. 2M Synthesised 10W Transceiver	(R5 + SY + SYZT + 144FM10A)	£125.00
12. 2M Crystal Controlled 10W Transceiver	(R5 + T3 + BPF + 144FM10 + SSR)	£95.00
13. 70cms Linear/Pre-amp	(70LIN10 + 70PA2/S)	£47.00
14. 24cms FMTV Receive, video out (Kit)	(VIDIF, 1250DC50 Boxed)	£105.00
15. 24cms FMTV Receive, video out (Ass)	(VIDIF, 1250DC50 Boxed)	£120.00
16. 24cms FMTV Receive, Ch 36 out (Kit)	(VIDIF, TVMOD1, 1250DC50 Boxed)	£110.00
17. 24cms FMTV Receive, Ch 36 out (Ass)	(VIDIF, TVMOD1, 1250DC50 Boxed)	£126.00
18. 24cms FMTV Transmit Kit	(UFM01, 70LIN3/LT, 70FM10, WDV400/1200 Boxed)	£140.00
19. 24cms FMTV Transmit (Ass)	(UFM01, 70LIN3/LT, 70FM10, WDV400/1200 Boxed)	£170.00

70cms Transceiver Kits and Accessories	CODE	ASSEMBLED	KIT
FM Transmitter (0.5W)	70FM05T4	£52.25	£33.05
FM Receiver (with PIN RF c/o)	70FM05R5	£68.75	£48.10
Transmitter 6 Channel Adaptor	70MC06T	£21.75	£14.95
Receiver 6 Channel Adaptor	70MC06R	£25.95	£18.80
Synthesiser (2 PCB's)	70SY258	£91.60	£65.35
Synthesiser Transmit Amp	A-X3U-06F	£36.40	£24.30
Synthesiser Modulator	MOD 1	£9.10	£5.75
Bandpass Filter	BPF 433	£6.95	£3.65
PIN RF Switch	PSI 433	£7.90	£5.60
Converter (2M or 10M i.f.)	70RX2/2	£28.40	£21.10
<b>70cms Pre-Amplifiers</b>			
Bipolar Miniature (13dB)	70PA2	£8.95	£6.85
RF Switched (30W)	70PA2/S	£26.30	£16.25
GaAs FET (16dB)	70PAS	£20.95	£13.40

AM TV Products			
Receiver Converter (Ch 36 Output)	TVUP2	£28.75	£23.95
Pattern Generator (Mains PSU)	TVPG1	£48.50	£39.40
TV Modulator (For Transmission)	TVM1	£10.35	£6.05
Ch 36 Modulator (For TV Injection)	TVMOD1	£10.15	£5.75

2M Linears			
1.5W to 10W (SSB/FM) (Auto Changeover)	144LIN108	£42.70	£32.75
2.5W to 25W (SSB/FM) (Auto Changeover)	144LIN258	£44.95	£34.50
1.0W to 25W (SSB/FM) (Auto Changeover)	144LIN25C	£48.20	£37.90
1/3W to 30W (SSB/FM) (Auto Changeover)	144LIN30	T.B.C.	T.B.C.

2M Pre-Amplifiers			
Low Noise, Miniature	144PA3	£9.10	£7.75
Low Noise, Improved Performance	144PA4	£13.45	£8.95
Low Noise, RF Switched, Full Changeover	144PA4/S	£25.95	£16.25

GENERAL ACCESSORIES			
Toneburst	TB2	£7.10	£4.70
Kiptone	PT3	£8.05	£4.90
Kaytone	PTK3	£9.45	£6.65
Regulator Kaytone	PTK4R	£13.40	£9.00
Regulator (12V, low differential)	REC1	£7.25	£4.85
Solid State Supply Switch	SSR1	£6.10	£3.90
Microphone Pre-Amplifier	MPA2	£6.00	£3.85
Reflectometer	SWR1	£6.95	£5.60
CW Filter	CWF1	£8.95	£6.10
TV Filter (Boxed)	HPF1	£5.95	—
Audio Amplifier	AF1	£10.40	£7.25

FM TV MODULES			
50mW 420MHz Source (Video Input)	UFM01	£30.10	£22.75
50MHz i.f. Processor	VIDIF	£58.20	£40.90
Varactor Multiplier (Boxed)	WDV400/1200	£63.95	—
1250MHz Downconverter (50MHz i.f.) (Boxed)	1250DC50	£69.95	—
1250MHz Masthead Pre-amplifier	1250PA2/S		
Transmit Sound Modulated	SCT-2		T.B.C.
Receive Sound De-Modulator	SCR-2		T.B.C.

Details of these and other new products are included in our 1985 catalogue. This will be posted to you on receipt of an A5 stamped self addressed envelope. Kits are usually available by return of post but please allow 28 days for any unforeseen shortages. Place your order by post or by telephone using your credit card. Please include £1.00 to cover order handling and postage.

Our products are kits or assembled kits consisting of circuit board and all components to mount on the board. We do not include external hardware such as boxes, connectors etc.

If your purchase does not work when assembled then apart from being surprised we will offer to service the module for a small charge depending on the complexity of the project. So please remember...

**ANYONE CAN SELL A KIT . . . REPUTATION SELLS OURS**  
 UNIT 13, YOUNGS INDUSTRIAL ESTATE  
 ALDERMASTON, READING RG7 4PQ  
 TEL: (073 56) 71444 TX: 848702

# KW TEN - TEC CENTURY - 22

A 50-watt, 6-Band CW Transceiver that combines excellent performance, Reliability, Simplicity of operation, and low cost.

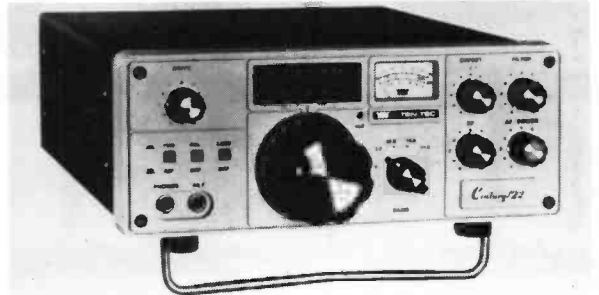

- ★ Full Break-in (QSK)
- ★ Full Band coverage
- ★ Total Solid State
- ★ 50 watts input
- ★ Offset Receiver Tuning
- ★ 6 Pole Variable Audio Filter
- 3.5, 7, 10, 14, 21, 28.0 - 28.5 MHz
- ★ Linear Crystal Mixed VFO
- ★ Receiver sensitivity .5uV, typical
- ★ Receiver sensitivity .5uV, typical
- ★ Operates on 12VDC

For further information on the above together with the famous

## ARGOSY II AND CORSAIR

please contact

# KW TEN - TEC

Vanguard Works, Jenkins Dale, Chatham, Kent, ME4 5RT  
 Telephone. 0634 - 815173.

CREDIT CARD PURCHASE FACILITIES AVAILABLE

# P.M. ELECTRONIC SERVICES

2 ALEXANDER DRIVE, HESWALL, WIRRAL, MERSEYSIDE. L61 6XT  
 Telephone: 051 342 4443 Telex: 627371

## THE QUARTZ CRYSTAL SPECIALIST

AMATEUR RADIO CRYSTALS FROM STOCK

4m, 2m, 7cm and transverter/converter

MICROPROCESSOR *from* MARKER  
 CRYSTALS *stock* CRYSTALS

DOUBLE BALANCED MIXERS M8 and M18

PIN compatible with MD108 and SBL1

but with superior spec available from stock.

WE CAN SUPPLY CRYSTALS TO MOST  
 COMMERCIAL AND PROFESSIONAL  
 SPECIFICATION INCLUDING COLD  
 WELD SPECS.

CRYSTAL SOCKETS for HC6/u, HC13/u  
 and HC25/u

## MADE TO ORDER SERVICE

OVER FREQUENCY RANGE 6KHz to 250MHz with  
 express service if required

For full details of the above services,  
 please send s.a.e.

**DEWSBURY**

**ELECTRONICS**



**NEW FROM DEWSBURY ELECTRONICS**  
 FOLLOWING ON FROM THE  
 SUCCESS OF THE POCOMTOR  
 AFR-2000, DEWSBURY ELECTRONICS



IS PROUD TO ANNOUNCE THE INTRODUCTION OF THE AFR-8000, FEATURING FULLY AUTOMATIC (OR MANUAL) DECODING OF, CW, RTTY (BAUDOT) AND TOR (SITOR, SPECTOR, AMTOR ETC.) THE RECEIVED TEXT IS DISPLAYED ON THE BUILT IN LCD DISPLAY, COMPOSITE VIDEO OUTPUT IS AVAILABLE AS AN OPTION. BOTH SERIAL AND CENTRONICS COMPATIBLE PRINTER INTERFACES ARE FITTED AS STANDARD. FULL DETAILS ON REQUEST FROM DEWSBURY ELECTRONICS.

*STOP PRESS:* CW OPTION AVAILABLE FOR AFR-2000.

VISIT OUR NEWLY OPENED LARGER SHOWROOM SAME ADDRESS SAME PEOPLE.

Dewsbury Electronics offer a full range of Trio Equipment always in stock.

We are also stockists of DAIWA-WELTZ-DAVTREND-TASCO TELEREADERS-MICROWAVE MODULES-ICS AMTOR-AEA PRODUCTS-DRAE-BNOS



**Dewsbury Electronics, 176 Lower High Street, Stourbridge, West Midlands.**  
**Telephone: Stourbridge (0384) 390063/371228. Open Monday thru Saturday.**  
 Instant H.P. subject to status, Access, Barclaycard and real money.



# Automatic Notch Filter

Model ANF stops QSOs being ruined by tune-up whistles. It automatically removes tones within seconds of their arrival on frequency, leaving the QSO in the clear! Classy technology, but simple to use and fit.

**Price: ANF £67.85** Inc. VAT

To order simply dial

**0532 552461**

or write with cheque or postal order to



**Dept SW Datong Electronics Ltd., Spence Mills, Mill Lane, Bramley, Leeds LS13 3HE, England**



Access/Barclaycard welcome — Fast delivery service

Catalogue and data sheets on any product available free on request. **Dial 0532 552461**

# COVER THE SPECTRUM

## FRG 9600

60 - 905 MHz Continuous  
 NBFM, WBFM, AM(W&N) & SSB\*  
 100 Memory Channels  
 7(W) X 3(H) X 8½(D) ins  
 \*SSB up to 460 MHz



IN STOCK NOW



**MS8400A £249.00**  
 68 - 88, 118 - 174, 360 - 512 MHz.  
 5, 10, 12.5, 25 kHz steps.  
 40 memories.  
 AM and FM.



**MX7000 £399.00**  
 25-550, 800-1200 MHz.  
 5, 12.5, 25 KHz steps.  
 20 memories.  
 NBFM, WBFM.



**AR2001 £378.00**  
 25-550MHz.  
 5, 12.5, 25 kHz steps.  
 20 memories.  
 NBFM, WBFM & AM.



**NRD 515 £985.00**  
 General Coverage Receiver  
 0.10 - 30 MHz continuous.

## FRG 8800

0.15 - 30 MHz (118 - 174 MHz)\*  
 AM/W, AM/N, SSB, SW/W, CW/W  
 NBFM Standard (WBFM Option)  
 12 Memory Channels \*Optional Unit

Spin tune VFO, Keyboard Frequency Entry and Computer control optional on these Yaesu Receivers.

SEND LARGE SAE FOR DETAILS

Yearn for a Yaesu? with FREE H.P. and the confidence of  
 2-year S.M.C. guarantee it's never been so easy!



# South Midlands Communications Ltd.



S.M. HOUSE, RUMBRIDGE ST, TOTTON, SOUTHAMPTON SO44DP, ENGLAND. Tel: (0703) 867333.

# COVER THE WORLD...

# S.E.M.

UNION MILLS, ISLE OF MAN

Tel: MAROWN (0624) 851277



**SEMFACT** You may have noticed some adverts getting smaller or disappeared completely. Ours don't.

**S.E.M. TRANZMATCH.** The most versatile AERIAL MATCHING (Tuning) UNIT available. Matches 15 - 5,000ohms BALANCED or UNBALANCED feeders up to 1kw. Air coupled balun (no toroids) means no connection to equipment which can cure TVI both ways. An SO239 and screw terminals for CO-AX, END FED or TWIN FEED. They say "It will match anything". 8½" x 4" x 7½". 3-5-30MHz £89. 1-8-30MHz £99. The highly acclaimed EZITUNE built in (see below) £29.50 extra. All Ex stock.

**SEM WAVEMETER.** Have you read your licence? Have you got a wavemeter? Covers 1.5-30MHz in 3 switched bands with a meter readout. Only £29.50. Selling so quickly. But at last Ex stock.

**S.E.M. EZITUNE NEW CIRCUIT**  
 Gives MORE noise a bomb proof operation. Because no similar unit is made, its usefulness is not appreciated until you have used one. Eliminates need for S.W.R. bridge.

Clean up the bands by tuning up without transmitting. Increase your PA life by many times.

Connects in aerial lead, produces S9 + (1 - 170MHz) noise in receiver. Adjust A.T.U. or aerial for minimum noise. You have now put an exact 50 Ohms into your transceiver. Fully protected, you can transmit through it, save your P.A. and stop QRM SO239s. 3" x 1½" x 2". £34.50 Ex stock. P.c.b. to fit in any A.T.U. £29.50 Ex stock.

**S.E.M. IMABIC KEYS.** No better fully auto keyer anywhere. Uses Curtis chip. R.F. proof. Sidetone etc. £38. A first class twin paddle key £17.50. Ex Stock.

**BRAID BREAKER/HI PASS FILTER.** Put in T.V. ant. lead to cure TVI. £6.50 Ex Stock.

**RF NOISE BRIDGE.** Adjustable 0-1,000ohms, 3" x 1½" x 2" only. SO239s, 1-170MHz. Neat, accurate & economical. £34.50 Ex Stock.

**3WAY ANTENNA SWITCH** 1kw SO239s. Good to 2metres. £17.50 Ex stock. Or 4th position to earth output £19.80 Ex Stock.

**S.E.M. 2 METRE TRANZMATCH.** 5½" x 2", 3" deep. SO239s. £24.90 Ex stock.

## SENTINEL 2M LINEAR POWER/PRE-AMPLIFIERS

Now feature either POWER AMP alone or PRE-AMP alone or both POWER AND PRE-AMP or STRAIGHT THRU when OFF. Plus a gain control on the PRE-AMP from 0 to 20dB. N.F. around 1dB with a neutralised strip line DUAL GATE MOSFET. (BF981).

Ultra LINEAR for all modes and R.F. or P.T.T. switched. 13.8V nominal supply. SO239 sockets.

Three Models:

- 3/36. 12 times power gain. E.g. 3W in 36W out. £70.00.
- 10/50. 10W in 50W out. £86.00.
- 10/100. 10W in 100W out. £135.00.

All Ex stock

**POWER SUPPLIES** for our linears 12 amp £49.00. 6 amp £34.00.

## SENTINEL AUTO 2 METRE or 4 METRE PRE-AMPLIFIER

RF switched, same spec. as in our linears, see above. 400W P.E.P. power rating. Use on any mode. 12V 25mA; £29.50 \* Ex stock.

PA5. Same specification as the Auto including 240V P.S.U. £33.00\* Ex stock

**SENTINEL 2 METRE PRE-AMPLIFIER.** No R.F. switch. £15.00\* Ex stock.

**S.E.M. AUDIO MULTIFILTER** (A very good filter at a very good price). The most versatile filter available. Gives "passband" tuning, "variable selectivity" and one or two notches. Switched Hi-pass, Lo-pass, peak or notch. Selectivity from 2.5KHz to 20Hz. Tunable from 2.5KHz to 250Hz. PLUS another notch available in any of the four switch positions which covers 10KHz to 100Hz. 12V supply. Sizes: 6" x 2½" front panel, 3½" deep, all for only £65.00 Ex stock.

**SENTINEL AUTO H.F. WIDEBAND PRE-AMPLIFIER** 2-40MHz, 15dB gain. Straight through when OFF. 9-12V. 2½" x 1½" x 3". 200W through power. £19.55\* Ex stock.

**SENTINEL STANDARD H.F. PRE-AMPLIFIER.** No R.F. switching. £12.62\* Ex stock.

**12 MONTHS COMPLETE GUARANTEE INCLUDING ALL TRANSISTORS.**

Prices include VAT and delivery. C.W.O. or phone your credit card number for same day service.

\* Means Belling Lee sockets, add £1.90 for SO239s or BNC sockets. Ring or write for more information. Place orders or request information on our Ansaphone at cheap rate times.

Goods normally by return.





# VHF BANDS

NORMAN FITCH, G3FPK

THINGS livened up somewhat in the past month with some welcome tropo, several *sporadic E* openings from north Africa to the Balkans, and a new world record for 2m. *E-M-E*.

## Moonbounce

On May 26, a new world record distance for 144 MHz *E-M-E* was established between Clive Penna, G3POI, (JO0IAH) and ZL2BGJ (RE78IQ). This calculates as 18,821 kms. from centre-to-centre of their respective squares. This is only 1,184 kms. short of the maximum possible distance which could be achieved by someone in Spain. ZL2BGJ is in the North Island so Clive could stretch the DX if he can find another operator in the South Island. Clive uses a 160-ele. colinear array but the New Zealand station was using four *Yagis* and a *Henry 2002* amplifier. Congratulations to both operators.

From Devon, Dave Sellars, G3PBV, has now heard 15 stations off the Moon including eight from the U.S.A.. On May 25, after the thunder and static rain stopped, he logged DL8DAT, F6BSJ, KB8RQ, K0ZK and UA1ZCL. On the evening of the 26th, Dave copied SM2GGF, F6BSJ, F6CJG and UA1ZCL. At 2354 he called K1WHS who was 439 and Dave replied with G3PGB with "O" reports and finally G3PB? At which point K1WHS's signals faded as he called QRZ? again. With his huge array, K1WHS reckons to be able to work single *Yagi* stations running 200-300w, so G3PBV, with four 9-ele. *Yagis* should make it.

## Awards and Tables

The *Ludbreg Radio Club*, YU2EZA, (IG54f) submitted a few more QSLs and were awarded their "225" sticker for 144 MHz QTH Century Club certificate no. 51 on May 13. Over the years, they have used different combinations of equipment and the current station comprises a *Yaesu FT-221R* with *muTek* board, and 3SK97 mast-head preamp. The PA is a pair of 4CX250B valves running 250w output to a single 16-ele. F9FT (*Tonna*) *Yagi* 35m. a.g.l.

Geoff Brown, GJ4ICD, holder of 144 MHz QTHCC award no. 53, has supplied the usual notes about the station. He has been involved in the hobby since 1964 and

was first licensed as GJ8ORH in 1978, the present call being obtained in 1979. He likes to build equipment, main present interest being 23cm., for which he has just put up a 100-ele. *Quad Loop Yagi* array, and 70cms. *E-M-E*. He likes contests and has held the Thorogood VHF Trophy for six consecutive years. Geoff has many "firsts" from Jersey to his credit and his ambition is to work 100 squares on 23cm.

Ted King, G3DCC, from Sidcup in Kent, has become member no. 38 of the 70cm. VHF Century Club and his certificate was issued on June 4. He was first licensed in 1947 and operated on HF and 2m. till 1952. He returned to the fold in 1982 with the call G6KYM and obtained 2m. VHFCC certificate no. 356. He got back his old call after re-taking the Morse test. His station comprises an *Icom IC-490* and 40w amplifier, the antenna being a 48-ele. *Multibeam*. He often goes out -/Portable from high spots. Any reader wanting details of the QTHCC and VHFCC awards should send an *s.a.e.* to the Welwyn QTH.

For the benefit of new readers, some comments about the tables. To enter the Squares table, just state the number of main squares, like ZL, AE, etc. you have worked since 1/1/75; they need not be confirmed. For the Annual VHF/UHF Table, the counties are the 78 *administrative* ones as listed in *RadCom* every January, plus the 26 in the Irish Republic. The countries are the *DXCC* ones plus Shetland (GM) and Sicily (IT9). Both tables are for operation from one fixed station. For the Squares Table, if you move QTH not more than 50 kms. from the location when you started, the scores can be carried on, but if you move from York to London, for example, you must start again.

## Contests

The results of the *Barking R and ES Club's* March 31 144 MHz contest show 13 entries in the high power section and 15 in the low power part. Winner of the former was G4NXO with 9,968 pts. from 173 QSOs, with G4NVA/P second, 9,700/168, and G8SRC/P third, 8,650/177. G8WBO/P, 8,232/160, won the low power section with G6ZZZ/P, 7,440/158, runner-up and G4WET/P third, 6,278/137. 650 different calls appeared in the logs. RF and weather conditions were not good, many folk reporting severe gales.

From GB2RS, some recent contest results beginning with the March 144 and 432 MHz events. 2m. Multi-op;—

1. G4CDA/P 7,105 pts. 847 QSOs
2. G4LIP/P 6,966 ,, 630 ,,
3. G3EFX/P 6,944 ,, 707 ,,

2m. Single-op;—

1. GJ4ICD 4,495 pts. 374 QSOs
2. G4NVA/P 2,962 ,, 370 ,,

70cm. Multi-op;—

1. G4RNL/P 2,962 pts. 370 QSOs
2. G4CLA/P 2,889 ,, 294 ,,
3. GW8TFI/P 2,856 ,, 315 ,,

70cm. Single-op;—

1. G4NVA/P 785 pts. 128 QSOs
2. GJ4ICD 737 ,, 66 ,,

In the two-band Multi-op. section the *Warrington ARC* were first, the *Parallel Lines Contest Group* came second and the *Sheppey Western Contest Group*, third. GJ4ICD was first and G4NVA/P, second, in the two-band Single-op. part. This contest was on the March 2/3 weekend.

The 432 MHz CW event on March 31 was won by the *Wirral & DARC*, GW4MGR/P with 376 pts. from 45 contacts. The *Sheppey Outcasts Contest Group*, G4BVY/P were runners-up, 277/39. There were 19 entries.

"VHF Bands" deadlines for the next three months;—

- August issue — July 3rd  
September issue — August 7th  
October issue — September 4th

Please be sure to note these dates

The next leg of the microwave *Cumulative* contests is on July 14, 0900 to 2000 GMT. 10 GHz is one band but the other remains a mystery due to an error in the April *RadCom* wherein the rules were published. The main event this month is VHF NFD on the 6/7 weekend from 1400-1400 GMT. Full rules appeared in April's *RadCom*. The 432 MHz Low Power contest is on July 27, 1700-2300 and the 144 MHz follow-up is on the 28th, 0900-1700. Both are Fixed, and All-other affairs with radial ring scoring. Exchanges must include the administrative county the final score being "ring" points multiplied by the total of counties and countries worked. Max. Tx output on 432 MHz is 10w and 144 MHz, 25w *p.e.p.*

It has been suggested that details of various European contests are given in VHF. This is a good idea but we must rely on correct information being supplied. It is impractical for our scribe to contact all European societies for such details but if any readers do get authentic information about such events, please pass them on.

## DX Notes

David Hardy, G8ROU, has sent details of the *Derbyshire Hills Contest Group's* proposed *Perseids* expedition which are;— Aug. 3-15, GB4ZAP, North Ronaldsay in the Orkney Is. (YT48f). QRGs;— 70.22, 144.22, 432.22 and 1,296.22 MHz for tropo. 2m. MS QRGs;— 144.144 and 144.444 MHz for CW and SSB respectively. Only a limited number of skeds will be arranged in

advance. For further information contact David at Thorntree House, Wensley, Matlock, Derbys., DE4 2LL. Tel. no. is Matlock (0629) 732620. They will have 50 MHz receive capability for crossband working.

Bryn Llewellyn, G4DEZ, and his group plan operation on HF and VHF from the Inner Hebridean island of Colonsay in WQ square between Aug. 23 and 30. The call will be GB0CIH and 2m. and 70cm. activity is scheduled. Clive O'Hennessey, G4VYX, will be on holiday in XS square (IO78TA) with GW6TGX and they hope to be QRV on 144.333 MHz from the evening of July 14 to the morning of the 28th, using the call GM4VYX/A. The site is north of the village of Lairg about 500ft. a.s.l. and they will be on from 0600 GMT for a few hours and from 1600 to 2400. Instant skeds could be set up on 40m. or 80m. The 2m. station will comprise a 100w to 2 x 13-ele. stacked Yagis at 30ft.

Reg Woolley, GW8VHI, (GNW) advises of XM square operation with the call GB4MS but did not mention dates. He has detailed information about LA6HL's Icelandic trip this summer, so contact Reg who has a telephone number for Johannes in TF. LA6QBA will be at his summer QTH in GV41e from July 8-26. He runs a Yaesu FT-726R and 600w to four 11-ele. Yagis with Gasfet masthead preamp. QRV on MS both SSB and CW up to 1,500 l.p.m. He is often on the 20m. VHF net.

**Satellite News**

According to UoSAT Bulletin no. 128, for the rest of the summer and into the autumn, AO-10 will undergo, "... a major series of eclipses combined with dismal sun angles." Analysts predict cutbacks in operating time and reorientation of the satellite which celebrated its second birthday on June 16. During August and early September, there will be no news broadcasts from AO-10 as the apogee will have moved well into the southern hemisphere reducing access time from the U.K. Martin Lowe, G4YCD, is the only reader reporting activity through AO-10. His best DX were W7TY (Idaho), KA0TLI (Colorado) and KL7ETZ.

The Soviet satellites RS-5, 7 and 8, have been working well recently when they were back in full sunlight, but a new schedule may now be in operation to counter eclipse problems. According to F3HK, it seems unlikely that the French ARSENE satellite will be ready for launch on ARIANE 4, no. 1 next summer, when AMSAT's Phase 3C spacecraft is due for launch. Kick motor problems are responsible for the slippage.

The NASA Space Shuttle Challenger was due for launch on July 15 for a seven day flight with Tony England, WOORE, and John-David Bartoe, W4NTZ, as crew members. The SS/TV and 2m. transceiver used by W5LFL will be taken and the primary downlink QRG is quoted as 145.55 MHz. The SS/TV should send scenes from inside the Challenger, but

**ANNUAL VHF/UHF TABLE**

January to December 1985

Station	FOUR METRES		TWO METRES		70 CENTIMETRES		23 CENTIMETRES		TOTAL Points
	Counties	Countries	Counties	Countries	Counties	Countries	Counties	Countries	
GW4TTU	—	—	83	19	55	8	23	5	193
G4TIF	16	2	60	11	41	12	—	—	142
G1KDF	—	—	71	15	42	7	—	—	135
G4SEU	41	2	52	8	27	4	—	—	134
G1IEZF	—	—	64	19	38	6	—	—	127
G4YCD	—	—	75	15	32	4	—	—	126
G6DER	—	—	57	11	30	5	15	4	122
G6MGL	—	—	43	10	35	7	17	4	116
G4MUT	24	2	46	11	25	6	9	2	114
G6XVV	—	—	64	12	31	4	—	—	111
G6ZPN	—	—	51	10	40	6	—	—	107
G6HKM	—	—	49	12	32	10	—	—	103
G6XLL	—	—	61	13	21	4	—	—	99
G4WXX	—	—	79	15	—	—	—	—	94
G6YIN	—	—	54	9	25	5	—	—	93
G1INK	—	—	32	9	37	8	—	—	86
G3FPK	—	—	69	16	—	—	—	—	85
G4VXE	—	—	47	5	28	3	—	—	83
G6ECM	—	—	68	11	—	—	—	—	79
GW3CBY	16	2	43	7	8	2	4	2	78
G4AR1	16	1	47	7	—	—	—	—	71
GW6OFI	—	—	59	9	—	—	1	1	70
G1EGC	—	—	50	14	—	—	—	—	64
G8RWG	—	—	48	8	5	1	—	—	62
G8VJV	—	—	51	9	—	—	—	—	60
GM4CXP	5	2	34	10	6	2	—	—	59
G8XTJ	—	—	48	10	—	—	—	—	58
GW1JCB	—	—	49	7	—	—	—	—	56
G4YIR	—	—	44	10	—	—	—	—	54
GW6VZW	—	—	45	7	—	—	—	—	52
G4WHZ	—	—	38	7	4	1	—	—	50
G6XSU	—	—	23	8	14	3	—	—	48
G6AJE	—	—	19	3	23	1	—	—	46
G4WJR	—	—	39	7	—	—	—	—	46
G6WZO	—	—	4	1	25	3	8	2	43
G4EZA	—	—	35	5	—	—	—	—	40
GW4VVX	—	—	35	5	—	—	—	—	40
G6XRK	—	—	27	12	—	—	—	—	39
G2DHF	5	1	22	4	2	1	—	—	35
GW4HBK	29	2	—	—	—	—	—	—	31
G4CMZ	18	2	9	1	—	—	—	—	30
G4VKE	—	—	20	6	—	—	—	—	26
G4WND	20	2	—	—	—	—	—	—	22
G1DGO	—	—	15	7	—	—	—	—	22
G6CSY	—	—	9	4	5	1	—	—	19
G8PNN	—	—	—	—	—	—	12	2	14
G1LAS	—	—	12	1	—	—	—	—	13
G6SIS	—	—	4	2	—	—	—	—	6

Three bands only count for points. Non-scoring figures in italics.

little, if any, two-way communication is planned. WOORE may be QRV during 10-12 passes but whether any will be over the U.K. and Europe was undecided at the time of editing.

And now to the band reports and henceforth, the RSGB county abbreviations which appear in each January RadCom will be used, e.g. BDS for Borders, ESX for Essex. Most are fairly obvious, but GNM, GNS and GNW for Mid, South and West Glamorgan respectively might cause a bit of head-scratching.

**The Microwaves**

John Quarmby, G3XDY, (SFK) is now QRV on 13cm. using the G8LMW transverter system at about 300mw. The antenna is a 44-ele. loop Yagi at 46ft. with 20m.; of FHJ-4 cable. In early May he had QSOs with G4BVY (NOR), G3LQR and G8HPU (SFK) and in the May 4/5 contest G3ZQU (SFK) and G4FRE/P and G0ALE/P (KNT). May 30 brought DC4BK (JO43) at 534 kms. and PA0CRA (JO22). Best night was June 1 which brought in SM6ESG (GR72h) at RS57, with John at RST 419, the QRB just over 900 kms.

On June 2 in the morning, G3XDY contacted PA0GUS/P (JO23) and that evening John got PA0FRE (CL03j), DC9XO (JO42) at 515 kms. with RS59 reports exchanged, DC4BK again and PA0JMY (JO22).

On 23cm. John added FC1KAW/P (JO00) for a new square in the May UHF contest. On June 1, he worked G1HGJ (TWR), PA0GUS/P, OZ1QZ (JO56), SM6ESG, LA8AK (DS80b) and SM6HYG (FS58f). The next day, DJ9BV (EN40), PA3BUF (JO23), DC8AH (JO42), DC4BK and DD8BD (DM35d).

Haydn Barker, G6XVV, (YSS) should be QRV on 23cm. about now with a Microwave Modules transverter and home made antenna. John Stow, G4MCU, (ESX) got three new squares on 23cm. thanks to PE1HNR (DM) at 2242 on May 31; SM6HYG (FS) at 2304 on June 1 and DJ9BV (EN) at 2235 on June 2. Ian Morgan, GW6OFI, (GWT) is on 23cm. with borrowed gear, an MM transverter with 700mw at the four 23-ele. Tonna Yagis.

**Seventy Centimetres**

Welcome to first-time reporter Paul Brochett, G1LSB, from Herne Bay in

Kent. His station consists of an *Icom* IC-471H running 90w to a 21-ele. *Tonna Yagi* at 30ft., the QTH being 45m. *a.s.l.* On May 31, he worked OZ5BZ (EP), DC0HW (DN), DD6HK (EN), and PAs in CN, DM and DN. Best DX next day were LA8AK and LA1YCA/P (DS), both using one watt, LA1ZE (CS), LA9DL (FT) and SM6HYG (FS).

David Whitaker, (YSN) heard a lot of Scandinavian DX between June 1 and 3, the first ever OZ being heard at 2049 on the 1st, OZ1KLU (JO46LC). Others in JO45, 46, 56 and 57 were heard. SM6JDO (JO66EW) was copied at 2239. More OZs were heard on the 3rd plus SM6EAN (JO57WQ). Mick Allmark, G1EZF, (YSW) has built the DL7YC PA from the *UHF Compendium* so has 250w available. But his IC-402 is proving a bit deaf so a preamp. is being built.

G3XDY found the band wide open from Newcastle, through LA, SM, OZ, DL and PA on the night of June 1 and John worked several OZs, SM6EAN, LA8AE (JO59) and LA8AK for a new square. On the 3rd, LA and OZ were worked again, LA6VBA (JO48) being another new one. Steve Green, G1INK (HWR) lists D, OZ and SM stations from the home QTH. He was out -/P on June 1 in Lincolnshire and worked LA, OZ and SM with one watt.

Paul Whatton, G4DCV, (KNT) also contacted LA and OZ stations on June 1 and 2. New squares were LA1ZE (JO28), OZ1DVA (JO46) and DJ8PB (JO44). He also lists GM6MGS/P (IO87) on the 2nd, all on SSB. Jerry Russell, G4SEU, (WKS) added 10 more counties during the Monday activity nights in May, with ON and PA new countries over the contest weekend. Martyn Jones, G4TIF, (WKS) concentrated on 70cm. in the June 1-3 tropo. opening and LA8AK (DS) and LA4IW (CS) were new squares bringing his total to 92. On May 12, he caught GD0/DL4VB for a new county and country for 1985. Martyn now has 20 countries all time on the band.

Sue Frost, G4WGY, (LDN) worked her first station on CW on June 2, G0AKQ. G4YCD worked some PAs through the east coast pile-ups at the beginning of June, this being Martin's first taste of DX on 70cm. Ela Martyr, G6HKM, (ESX) was alerted to the tropo. lift the afternoon of June 1 when she heard G1LSB working into LA, but it was not till 2145 when her CQ call was answered by LA8AE (FT). Subsequent QSOs were OZ1QZ (EP) and SM6AFH (GQ). LA8AK provided a new square.

Richard Mason's G6HKS, (NOR) letter missed last month's deadline and dealt with contest activity on May 4/5 which resulted in four new squares. He used a *Yaesu* FT-790R at one watt through LDF4-50 cable to a 21-ele. F9FT *Yagi* at 30ft. G6XVV now has 70w on the band from an IC-402 and amplifier, so Haydn

should do well now that he has finished his A-level exams. Neil Montanana, G8RWG, (SRY) is another reader who has recently got going on the band with 10w and 19-ele. *Tonna Yagi*.

## Two Metres

The most exciting feature this month has been *Sporadic E* and at least seven openings have been reported between May 25 and June 9. The following is a general summary compiled from your letters and QSOs on the band and on 20m. VHF net, starting with May 25, when there was a brief opening from the I3 area to Finland around 1005. At about 1030, the SM4/5/7 stations had QSOs with YUs and there were reports of *FAI* propagation between EA3 and HG. On May 29, at 0918, EA7ERS (WX) worked GW8VHI and was heard by GW6VZW calling "CQ Es."

The first major opening was on June 2. Eddi Ramm, DK3UZ, (EN) worked CT4KQ (WA), EA2LU (ZC) and Fs in BD and CE. Between 1200 and 1600, stations in north Germany worked into EA and IT9. GM4CXM (XP) worked down to IT9, too. David Whitaker (YSN) heard YU7AR but reports earlier paths from his area to EA3, EA6, SV and YO2.

It was utter bedlam in the London area. At G3FPK, I7IWN (JA) was loud for quite a time around 1620. SV1OE (LX) and HG1YI/MM (HD) were also heard. Other stations heard/worked from the southeast were I7QHE, I7HCB, I6CXO and I6MQS (GD), I6IVY and a UB5 or two around 1630. From the southwest, G3PBV records the start around 1500 with IT9 heard briefly. Subsequently, I0FHZ (GC), IW0AKA (GB), IC8EGJ (HA), YU2RJS (ID), YU2FM worked and YU1UN and YU1NDL heard. Between 1800 and 1833, stations further west were heard working HG8CL and YU2EZA.

From the Midlands, G4TIF reports an incomplete QSO with YO5YJ (LH). G8ROU (DYS) worked EA6ET (BZ), later HG8ET and HG8CE (KG), this at 1648. On June 3, between 1646 and 1719, the YU2 area was worked from London but the most interesting contact was made by Ray Baker, G4SFY, (NOR) at 2206 with UA3LBC (SP36c). Remember, Moscow time is three hours ahead of GMT. Ray got 599 and sent 579.

The next major event was on June 5 which seems to have started around 1230 when the GWs were working into I8. Very soon afterwards, stations all over the southeast of England were working from 9H1, through IT9, I0, SV, LZ, YO and YU at least, up to about 1500. SV2JL (LA35b) was one of the more consistent signals around 1300 from London and widely worked. Paul Pasquet, G4RRA, (HPH) made 20 QSOs including SV1OE, SV4LD (LZ), SW2PK (LA) and SV2JL (LA) on SSB. On CW, LZ1KKA and LZ2XU were worked. John Hunter, G3IMV, (BKS)

QTH LOCATOR SQUARES TABLE

Station	23cm.	70cm.	2m.	Total
G3POI	—	—	433	433
G3IMV	—	100	374	474
G4IJE	—	—	333	333
EA3LL	3	32	300	335
G8GXP	—	—	280	280
G4ERG	—	16	261	277
G4DHF	—	—	252	252
G3BW	9	38	250	297
G8VR	2	24	246	272
G4DEZ	—	—	242	242
G4KUX	—	36	240	276
GJ4ICD	41	116	238	395
9H1CG	—	—	225	225
G4DCV	—	67	224	291
GW3NYY	—	48	219	267
GW4EAI	—	—	218	218
GW4TTU	26	74	215	315
GW4LXO	29	69	213	311
G4NQC	61	90	211	362
G3FPK	—	—	208	208
G3UVR	35	92	202	329
G4MCU	25	82	201	308
GJ8KNV	18	79	201	298
GM4IPK	—	—	201	201
G3PBV	41	106	192	339
G4OAE	—	46	190	236
G6ECM	—	—	185	185
GJ8SBT	—	—	182	255
G3BDQ	26	47	177	250
G8LFB	—	—	177	177
GM4CX	—	27	175	202
G8TGM	—	—	175	175
G3JXN	72	110	172	354
G3COJ	42	97	170	309
G8XVJ	—	73	169	242
G6HKS	—	18	169	187
G4TIF	—	92	167	259
G4MEJ	—	—	163	163
G3XDY	61	111	160	332
G4R GK	17	62	160	239
G4BWG	—	68	160	228
G4SFY	—	—	156	156
G4HMF	2	35	152	189
G4IGO	—	—	149	149
G6CMV	18	53	144	215
G6DER	27	72	142	241
G4MJC	—	12	140	152
G8HHI	22	77	135	234
G1EZF	9	50	135	194
G4YUZ	—	—	135	135
G6DDK	3	15	131	149
G4DOL	—	—	131	131
G6MGL	24	55	128	207
G6HKM	—	69	127	196
G8TFI	51	109	126	286
G8PNN	50	83	126	259
G8ULU	35	90	125	250
GW8UCQ	1	70	120	191
G4NRG	5	40	119	164
G4HFO	—	69	118	187
G6JNS	1	48	117	166
G4MUT	6	75	114	195
G4GHA	—	6	112	118
G6DZH	—	61	111	172
GM8YPI	—	43	109	152
G6HCV	—	—	109	109
G8VFC	—	—	108	108
GW3CBY	11	38	106	155
G8WPL	16	70	105	191
G4XEK	—	—	105	105
G8ZDS	—	31	104	135
G8RWG	—	1	103	104
GM8MJV	3	26	101	130
G4TJX	—	59	97	156
G6XLL	—	33	95	128
G4FRX	—	66	92	158
G8ROU	1	43	88	132
G4RSN	2	23	88	113
G6NWF	—	—	86	86
G8XTJ	—	—	84	84
GW8VHI	—	41	83	124
G4ZTR	35	57	82	174
G6AJE	—	21	82	103
G6XRK	—	—	82	82
G4UYL	—	—	81	81
G8FMK	36	70	80	186
G1EGC	—	—	78	78
G6YIN	—	20	77	97
G4LZD	—	—	71	71
G4FRE	42	112	68	222
G4COM	—	52	68	120
G4ROA	25	61	65	151
G6YLO	13	22	59	94
G4MAW	48	105	52	200
G6XVV	1	30	52	83
GW6OFI	1	—	52	53
G1DGO	—	—	50	50
G4WHZ	—	8	49	57
G1LSB	—	35	43	78
G1INK	—	42	42	84
GM8BDX	13	29	41	83
G4WJR	—	—	37	37
G6CSY	15	25	34	74
G6SIS	—	—	30	30
G2DHV	—	3	25	28
G6XSU	—	50	19	69

Starting date January 1, 1975. No satellite or repeater QSOs. "Band of the Month." 2m.



Station	ANNUAL CW LADDER				Points
	4m.	2m.	70cm	$\mu$ Wave	
G4TWD	—	350	—	—	350
G4WHZ	—	246	23	—	269
G3GHY	—	230	11	—	241
G4SFY	—	236	—	—	236
G4UKM	6	189	14	—	209
GW4TTU	—	—	106	29	135
G4VXE	—	127	7	—	134
G4WGY	—	128	1	—	129
G4ARI	7	118	—	—	125
G4ZTR	—	111	—	8	119
GW4VVX	—	96	—	—	96
G4YIR	—	90	—	—	90
G4EZA	—	70	—	—	70
G4CMZ	16	27	—	—	43
GM4CXP	3	38	1	—	42
G2DHV	5	31	1	—	37
GW4HBK	29	—	—	—	29
G8VFX	—	22	—	—	22
G6VMQ	—	18	—	—	18
G4LVE	—	13	—	—	13

No. of different stations worked since Jan. 1.

found 9H1E/A (HW), SV1DH (LY) and LZ2UU (ND) for three new squares.

From Devon, G3PBV records the start around 1218 with I0CUT (GB) and I8TUS (IZ) worked, followed by 5 Is in FC and FD squares. From 1300 to 1343, the *Es* was marginal with Dave with a few YUs and YO2 heard in odd bursts. At G3FPK, there were many MS bursts in this opening.

Now to June 6 when a good, if short, opening to the south occurred from about 1440. GW4LXO reportedly worked an EH9 (YV) and EA7AYD (YX) at 1450. In the London area, CN8EO (IM64PB) was quiet strong but disappeared completely at 1451 when your scribe called him, not to be heard again. The Gibraltar beacon, ZB2VHF, (XW64g) on 144.145 MHz was not heard at G3FPK.

Some late news is that on the 9th, LA1K (FX) worked SV1OE (LX) a QRB of about 3,000 kms. It was mentioned that the LA was also copying SP stations at the same time suggesting double-hop *Es*? Also on the 9th, the I3/4 area stations reportedly worked into UB5, UC2, UD6 and UG6.,

On the tropo. scene, in the May 4/5 contest, G1EZF worked 30 continentals, best DX DJ4GC/P (EL). G4SEU added G1AWP (NLD) and G0/NA5E (YSN) on the 4th. G4SFY found conditions not too good, Ray's best DX being BJ square. Paul Baker, GW6VZW, (GWT) worked Fs in IN78, JN09 and JN19, JO00 and ONs in JO10 and JO11.

The long-awaited tropo. lift began on May 30 and lasted about a week, producing a great deal of activity to Scandinavia and northern Germany, mainly. The continental Field Day over the June 1/2 weekend made the band very busy as well with, "... hordes of PA and ON stations from portable sites..." as described by David Whitaker. On the 30th, Mark Page, G1EGC, (BKS) got six new German squares and the early morning of June 2 brought OZ1CTZ (EP) and SM7AED (GQ). LA3VHF (DS77j) on 144.880 MHz was strong at midnight on the 3rd and still audible at 0500.

Other readers reporting decent DX worked in this period are G1INK; Bob Nixon, G1KDF, (LNH), G1LSB, G4DCV, G4SFY, G4TIF and Jack Charnock, G4WXX (MCH). The more westerly and south westerly stations did not fair so well. G3PBV (DVN) heard weakish Ds in EN on the 30th and Dave wrote that the Scandinavian opening on June 3 did not reach him. G4YCD (AVN) found the east coast pile-ups difficult to penetrate on May 30. On June 3, Mike Morrissey, G6TUH, (LDN) heard three OHs in LV and MV square. Did anyone else copy any?

Our three lady CW operators, Mini Page, G4UKM, (BKS), Sue Frost, G4WGY, (LDN) and June Charles, G4YIR, (ESX) have all written to update their ladder totals. Mini stayed with Sue over the Bank Holiday and both ended up with tongue-ache, it seems. An odd observation now from David Whitaker who, on May 26 at 1532, received GM4LER (ZU65f) at S9+ off the back of his beam, no other GMs being audible. The Angus beacon was only S2. G1EZF complains about telephone and computer QRM which turns Mike off the band except for good openings.

Kev Archer, G4CMZ, (DYS) with his home made half-watt CW rig has now expanded the VXO coverage to 50 kHz. His best DX is 85 miles. G4DCV lists completed MS QSOs with EA2LU on May 10, OH5IY (KP30) on the 12th, and LA8KV (JP52) on the 18th. Paul worked HB9RUO (JN37) on SSB tropo. on the 18th. On June 9 at 2330, G4DHF's "CQ" was answered by GM3JIJ (WS) at RS39+ but *auroral*. LA0DT/MM (BT) was also heard. Best reception was only by beaming at the stations. In the same period, GM3XOQ (SLD) worked UA1ZCL (RC) probably via *auroral Es*, so was Dave getting this too? That evening, 1855-1920, there was *Es* to Finland, too.

G4SFY informs that club station YU2EZA will be QRV daily on the 20m. VHF net till Aug. 15 looking for MS skeds with G stations. Graeme Caselton, G6CSY, (KNT) reckons his home QTH is a cross between a pothole and an RF black hole so spends much time out -/P to good effect, at JO01BH = TQ45 for WAB fans. He has GJ, PA, GD and Anglesey worked from there with QRP.

Ian Parker, G4YUZ, visited I3LGP recently and heard G4IJE's MS signals out of Giuliano's Rx. Since May 15, G6XVV has been using a Trio TS-700 and 100w amplifier and this has boosted his table score a lot. Graham Daubney, G8MBI, (HFD) came across "OY6SS" on May 16

at about 0810 calling "CQ Es" but coming in from the southeast at S3. John Fitzgerald, G8XTJ, (BKS) sent some photos of his antennas which are very low. One is on a balcony, the other over a porch due to planning restrictions. Even so, he does not do too badly but is now plagued by awful computer QRM. He managed to work LA6HL, (CS) in the Scandinavian, monthly contest on June 4, the first Tuesday, some five minutes before a neighbour switched on his computer creating S8 hash.

Ceri Jones, GW1JCB, has supplied station details which are Trio TR-9130 and Jaybeam 10-ele. Yagi. GW6VZW was out -/P in IO72WB on May 31 and Paul worked EI5BUB (Galway) and EI5FK (Cork) for his first ever EIs. GW8VHI worked G4DEZ/A (AL) and G4ANT (AM) on May 19 via aircraft scatter.

### Four Metres

G4SEU (WKS) did not positively identify GM4OBD/P (YR) on May 6 as advertised by "the RSGB news," according to Jerry. He did work G4WND/P (TWR) on May 6, though. On May 30 G0BCT who was running 2w of CW, was worked at 2238 for an all-time new county — Wiltshire. John Jennings, G4VOZ, (LEC) gave G4EPA (NHM) his second QSO on May 1. By the 10th, Crick was running 25w to an outdoor dipole. On May 6, John worked G3TJS (MCH) but could not raise G4WND/P. EI9Q was heard at RST329 on the 23rd. Dave Lewis, GW4HBK, (GWT) heard EI9Q on the 14th and 25th, worked G0BCT on the 26th and G4ISM (NHM) on June 3.

### Six Metres

G3PBV reports ZB2VHF quite strong on May 30 at 2230-2300 and lots of Euro-TV at the end of May, beginning of June period. GW4HBK writes that many stations are monitoring 28.885 MHz looking for crossband QSOs, including CT1WW, DJ2RE, HB9QQ, OZ9QV and SM6PU. A 6/10m. MS QSO with OZ9QV on May 25 was not completed, but 20 mins. later, the OZ was S9 via *E-layer*. Beacons ZB2VHF and 5B4CY (QU14g) were heard on May 25 and June 2 respectively.

### Finale

Yet more 2m. *Es* on June 11 with 9HI and IT9 worked from southeast G around 0930, a couple of UR2s at lunch time, the main opening starting at 1456 to HG, YO, YU, then swinging round to UB5 and SP. That's it for now. All your news, opinions and claims by the dates in the box to;— "VHF Bands," SHORT WAVE MAGAZINE, 34 High Street, WELWYN, Herts., AL6 9EQ. 73 de G3FPK.

#### THIRTEEN CENTIMETRES ALL-TIME TABLE

Station	Countries	Countries	Squares	Total
G8PNN	13	6	18	37
G3XDY	3	4	8	15

# A Tone Filter for RTTY Transmission

*A Simple Circuit to Clean-Up Computer Generated AFSK Tones*

**P. C. COLE, G3JFS**

COMPUTER generated AFSK tones for RTTY use are square wave signals, rich in harmonics, which must be filtered to produce sine waves before they can be applied to the audio circuits of a transmitter. The easiest way to do this is to pass the tones through a suitable low pass filter, and the purpose of this article is to describe a unit which was designed for use with a BBC microcomputer/KW-2000A combination.

## Filter Requirements

Despite the need to produce a reasonably good sine wave from a square wave input the filter specification is not at all severe when it is realised that:

(a) a square wave such as the TTL signal output from the computer consists (in theory anyway) of a fundamental sine wave and odd harmonics only, so that there is no need for very high attenuation at the second harmonic of the tone frequencies;

(b) when using standard 1275/1445 Hz AFSK tones the harmonics from the third upwards will be attenuated in both the audio chain and the sideband filter of a properly designed transmitter.

These considerations reduce the demands on the filter circuit, particularly in regard to the sharpness of cut-off, and bench tests showed that a single *pi*-section *m*-derived filter with its frequency of maximum attenuation centred on the third harmonic of the mark and space tones would give more than enough filtering for this particular application.

Fig. 1 shows the basic circuit and a simplified response curve of the LC filter section used for the initial measurements. This filter had the following characteristics:

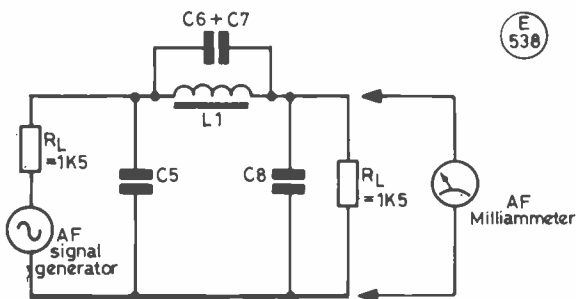

Fig. 1(a) Circuit of the Low Pass filter section used for bench measurements

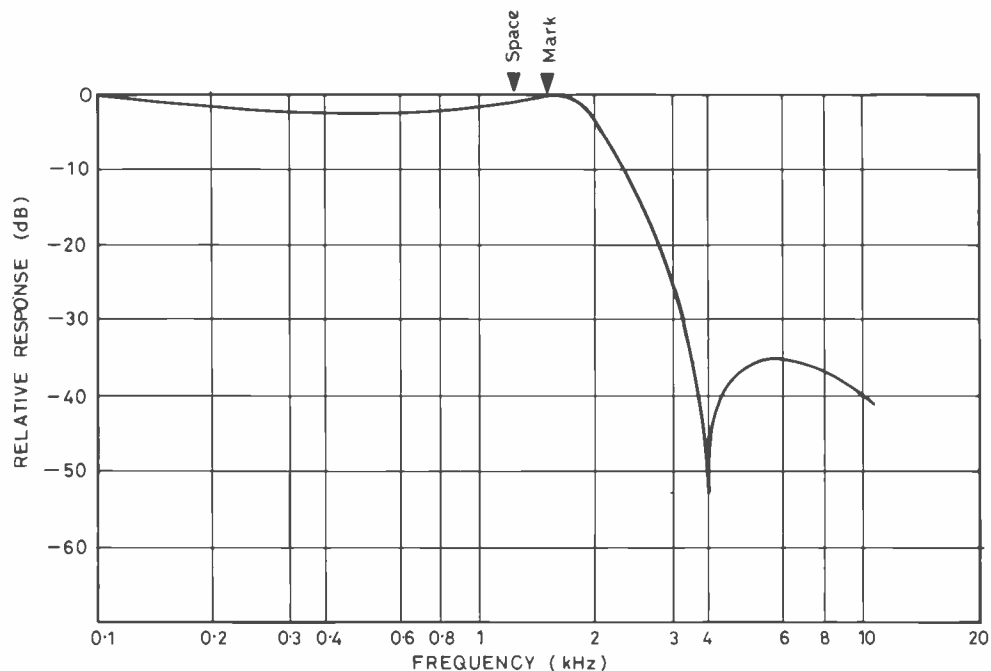

Fig.1(b) Response curve of the LC filter section showing the deep notch centred on the third harmonics of the Mark and Space tone frequencies.

E 536

E 539

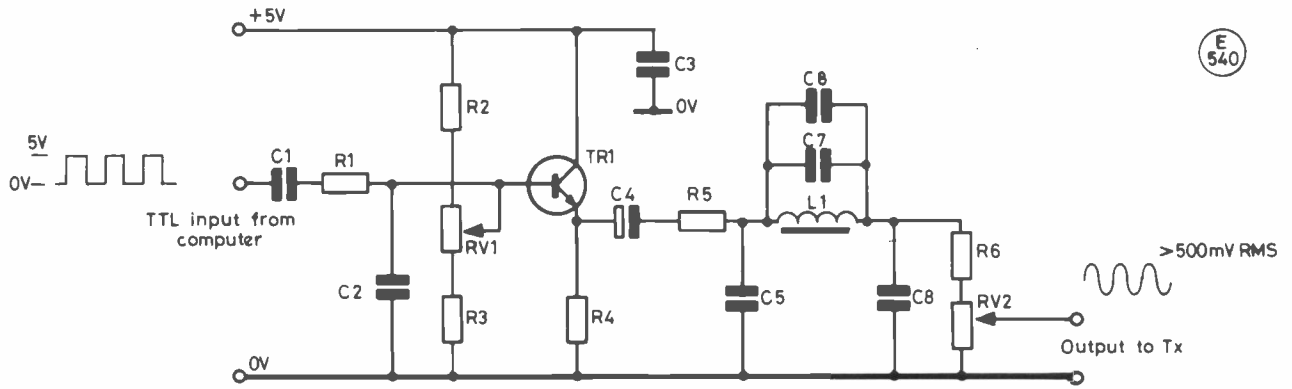

Fig. 2 Circuit diagram of the Tone Filter Unit

- Passband ripple: 1.0dB.
- Cut-off frequency: 1.9kHz.
- Notch frequency: 4.025 kHz.
- Notch depth: >50dB.
- Rejection of second harmonic: 15dB
- Rejection of other harmonics: >35dB.

**The Circuit**

Fig. 2 shows the circuit of the low pass filter unit as built. TTL level signals from the computer user port are fed to the base of TR1, which is a BC108 transistor connected as an emitter follower so as to minimise the loading on the computer output circuits. R1, C2 form a single section RC low pass filter which, although only capable of a 6dB/octave reduction in signal, does give a useful improvement in the stop band attenuation. The +5 volt supply

**Table of Values**

Fig. 2

- R1 = 10K
- R2 = 33K
- R3 = 68K
- R4, R6 = 1K
- R5 = 1K2
- VR1 = 10K preset
- VR2 = 500R preset
- C1, C5, C8 = 0.1 μF, polyester
- C2 = 0.01 μF poly. (but see text)
- C3 = 0.1 μF disc ceramic
- C4 = 2.2 μF tantalum bead
- C6/C7 = C6 + C7 are nominally 0.01 μF total; select values to tune notch frequency
- TR1 = BC108, or similar small signal silicon npn transistor
- L1 = 150mH ferrite pot cored inductor

Note: all resistors are 1/4-watt types

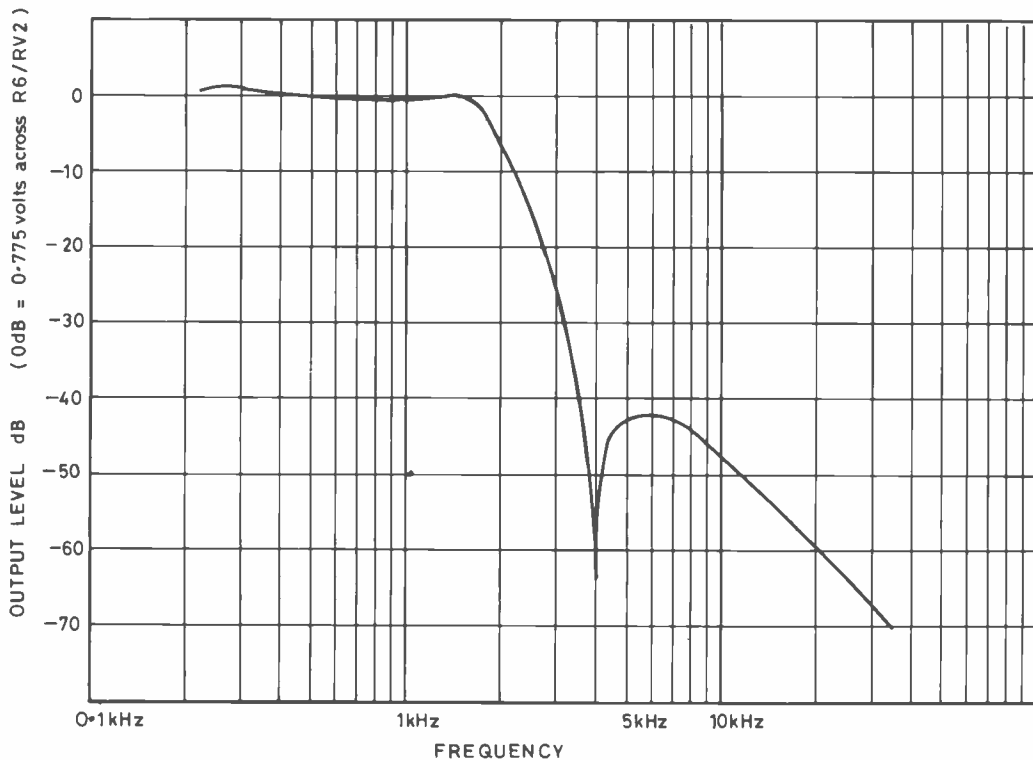

Fig. 3 OVERALL RESPONSE OF THE TONE FILTER UNIT. (With the rejection notch tuned to 4.020 kHz, 3rd harmonic signals are reduced by 50dBs and higher order harmonics by more than 42dBs resulting in a very clean sine wave output.

for TR1 comes from the computer and VR1 serves to set the emitter to half of the supply voltage. Partially filtered signals from the emitter follower then pass through the LC low pass section to VR2 which is used to set the sine wave output level up to a maximum of about 500mV.

The filter design is the result of some calculation and a certain amount of juggling to allow available components to be used. However with such a simple circuit there is considerable latitude in component values so long as L1 and C6 + C7 resonate at the proper frequency for maximum rejection of the third harmonics of the mark and space tones. The other filter components — shunt capacitors and the load resistors — can then be changed if necessary to modify the overall response.

### Construction

Layout is not at all critical and so the components for the prototype were assembled on a piece of matrix board and mounted in a small diecast metal box, which also contained the few additional parts needed to interface the computer and terminal unit. For convenience C2, C6 and C7 are mounted on circuit board pins so that they can be changed easily during the alignment procedure.

The only component likely to be a problem is L1 which in the original was a small ferrite pot cored coil about 3/4-inch diameter by 1/2-inch high of unknown characteristics picked up from a junk stall at some long forgotten rally because "it might come in useful one day"! Several mail order component dealers have ready wound ferrite cored inductors up to about 1 Henry in their lists, or alternatively it is very easy to wind one's own using standard pot cores which are also available from the larger stockists. Although perhaps a bit expensive, adjustable type ferrite pot cores are very convenient and a suitable coil can be made by winding 612 turns of 0.2mm. diameter wire onto an *RS Components* RM4/400 pot

core. This gives an inductance of 150mH with a claimed adjuster range of 20%.

### Test and Alignment

This can be carried out easily by using the following procedure:

(1) apply power to the unit and adjust VR1 to set the BC108 emitter to half of the supply voltage. Because of the wide spread of current gain in the BC108 ( $h_{FE} = 110 - 800$ ), in an extreme case, it might be necessary to change R2 or R3 to get this setting correct.

(2) with a sine wave input do a quick response check to see that the unit is working. Adjust L1 and/or select values of C6 and C7 so that the notch in the frequency response is at about 4020 Hz — choose the notch frequency that gives equal attenuation to the third harmonics of the mark and space tone frequencies (4335/3825 Hz).

(3) check that the output level is the same at the mark and space frequencies. If it is not change the value of C2 until this is achieved. (A 1dB difference, due to the filter passband ripple, was noticeable as a slight flicker on the forward power meter when transmitting RY's. By correct choice of C2 the flicker was completely removed.)

(4) if a scope is available apply square wave signals to the filter input and check that the resultant output waveforms are sinusoidal with no noticeable distortion.

(5) carry out on-the-air tests.

### Results

Fig. 3 is a plot of the overall frequency response of the filter unit, from which it may be seen that all frequencies from the third harmonics upwards are reduced by more than 40dB. The transmitted signal appears clean when monitored on an oscilloscope and there have been no adverse comments from stations asked to give critical reports on the quality of the signals. One cannot ask for more from so simple a circuit.

# • • • "Practically Yours" • • •

with GLEN ROSS, G8MWR

**T**HERE is a generally held idea that amateur radio has become a world of black box operators, and whilst this may be true to certain extent it does not seem to include the readers of this magazine, if the letters that I receive are anything to go by. The number of comments and ideas that I receive is surprising and has resulted in some very lengthy and interesting correspondence. The one thing that stands out in all this is that a major area of interest is in test gear, not so much the all-singing, all-dancing, digital display type of thing but simple straightforward stuff that can be built easily and can be relied upon to do the job. Over the next few months I shall describe a wide range of simple gear that meets these criteria.

### Audio Generator

The first unit in the series is a wide range generator covering from 20 to 20000 Hz in a single range and which provides sine, square and triangle waveforms with adjustable amplitude. These outputs can be switched to a single socket or can be provided on three outputs so that they can be used at the same time if required. The duty cycle can be varied over a wide range and by this means it is possible to generate a sawtooth, ramp or pulse waveform from the basic generator. It is also possible to use the unit over a much greater range if the timing capacitor value is changed, the actual limits being from .001 Hz to 1 MHz. The waveforms produced are



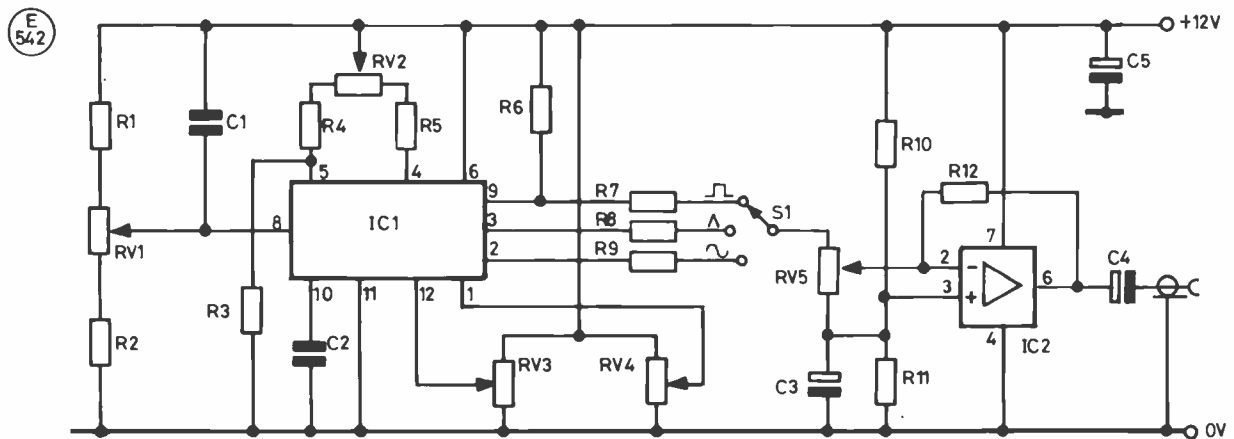

Fig. 1 CIRCUIT DIAGRAM

**Table of Values**

**Fig. 1**

- R1 = 820R
- R2 = 22K
- R3 = 4M7
- R4, R5 = 2K7
- R6, R8 = 12K
- R7, R12 = 47K
- R9, R10, R11 = 10K
- C1 = 0.22  $\mu$ F ceramic
- C2 = 4.7 nF mica
- C3 = 47  $\mu$ F 10V elec.
- C4 = 22  $\mu$ F 50V elec.
- C5 = 220  $\mu$ F 20V elec.
- IC1 = 8038B (RS 305-844)
- IC2 = 741
- S1 = 1-pole, 3-way rotary
- VR1 = 10K lin.
- VR2 = 5K lin.
- VR3, VR4 = 100K lin preset
- VR5 = 50K log.

Note: all resistors are 1/8-watt types.

‘clean’ and the Third Harmonic Distortion (THD) on the sine wave output can be as low as 0.5% over the design range.

**The Circuit**

This is shown in its basic form in Fig. 1, and consists of the oscillator and an output buffer stage. The frequency is set by the value of C2 and the voltage applied to pin 8 from VR1, the lowest end of the range being obtained when the voltage is at its highest value. VR1 should be panel mounted and could, with advantage, be driven *via* a small slow-motion drive of some sort so as to give a more open scale. A ten-turn pot. and a counting dial would be the best arrangement if these can be obtained at reasonable cost. If it is desired to have a choice of ranges then the value of C2 could be switched; as the tuning range of VR1 is 1000 to 1 it would not need more than three switch positions to cover the maximum range that the chip is capable of.

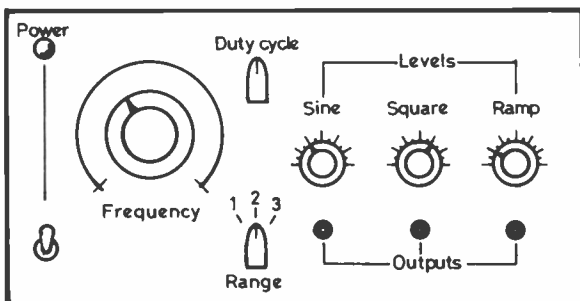

Fig.2 Suggested front panel layout showing all available options

E 543

**Wave Shape**

VR2 controls the duty cycle of the generator and hence the precise shape of the generated signal and this should also be mounted on the front panel. Only when this control has been used will its full potential to generate exactly the required shape be appreciated. VR3 and VR4 are PCB mounted presets and are used to minimise sinewave distortion; ideally they should be set up using a wave analyser, a piece of gear which is not normally available to the average amateur. Excellent results can be obtained by use of an oscilloscope to display the waveform while adjusting the two presets. If neither of these instruments is available then it is best to dispense with the presets, take pin 12 to ground through a 82K resistor and make *no* connection to pin 1. This will usually produce distortion of less than 2% which is adequate for most purposes.

**Output Buffering**

The three outputs are available on pins 2, 3 and 9; these are then set to around the same level by the use of the series resistors and are then switch-selected and fed to the output level control, VR5, and then to a 741 which is used as an output buffer; VR5 is of course panel mounted. If the outputs are required to be separately available then the selector switch is dispensed with and the outputs from the chip are taken to individual level controls, buffers and panel sockets. For the small additional cost this is probably the best arrangement although it must be mentioned here that the duty cycle control will change the shape of all three waveforms.

**Power Requirements**

The unit will operate from a minimum of ten volts to a maximum of thirty at a current consumption of only a few milliamps, the exact amount depending on the configuration you have used. It could be run from an external supply but the cost of low current components is so low that it is probably better to build a supply into the unit.

**Construction**

There is little to comment on as far as construction is concerned. The unit could be built on a PCB but Veroboard is equally convenient. A small metal box could be used to house the completed oscillator, the only important consideration being to give adequate space on the front panel for an uncluttered control layout. The circuit diagram shows a single range, single output unit but the drawing of a completed unit shows all the available options built in.

**Comments**

If you would like to comment on these designs or put forward any ideas for future designs please write to me at 81 Ringwood Highway, Coventry, or contact me *via* Prestel on 203616941.

# An Anonymous Communications Receiver

CHAS. E. MILLER

A rather unusual small communications receiver came into my possession some time ago *via* an auction sale. The front panel measures 12" x 9" and carries a rather plain dial with external slow-motion drive of the Muirhead type. Alongside it is a built-in 5" loudspeaker with extruded metal grill. When I received the set it had but two controls other than tuning — wave band switch and AF gain — others having been crudely removed with wires left dangling. An engraved strip beneath the tuner and LS indicated that two of the missing items were the BFO on/off switch and a socket for "hand-set", but there were two other holes not identified. A discoloured patch at the bottom centre of the panel, flanked by two small tapped holes, suggests that here was once a model identification plate. The panel is finished in the usual Marconi grey (an official description) and the set is generally to that company's pattern. The chassis is rather unusual, being a very thick die-casting measuring again 12" x 9" x 2½" deep. Eight valves are employed, *viz.* KTW61 RF amplifier, X65 frequency changer, two KTW61 IF amplifiers, DH63 detector/AGC/AF amplifier, D63 noise limiter, KT63 AF output and KTW61 BFO. There is no internal power supply, a large 5-pin McMurdo socket being fitted for an input lead. The three wave bands cover 170kHz-460kHz, 460kHz-1.35MHz, and 1.35MHz-3.8MHz, the latter having the greater area of dial space ideally disposed for the 160m. and 80m. ham bands.

A closer inspection of the set, after a large accumulation of dust and deceased fauna had been dispensed with, revealed that much other modification work had been carried out in addition to the butchery on the front panel mentioned above. Immediately noticeable was the fact that the DH63 had been replaced by an EBC33 (similar but not a direct equivalent) with a lead soldered directly to its top cap, which did not bode particularly well for the standard of workmanship. The volume control had been renewed

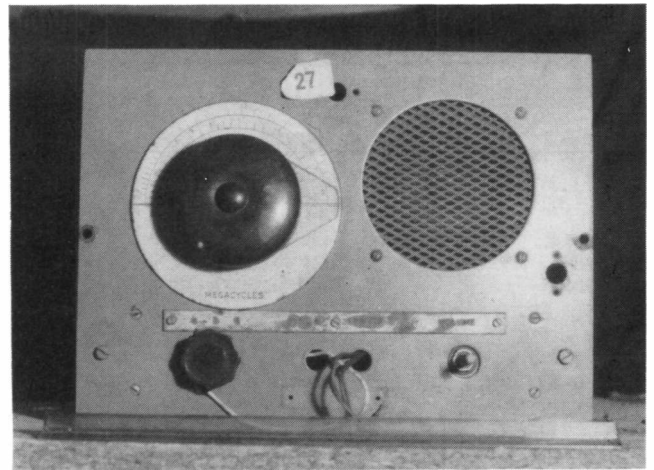

The small, anonymous vintage receiver, as acquired with wires dangling and bearing its 'lot' number.

and left with its spindle uncut to length, and of which more anon. The valve heater wiring had been altered considerably, this probably having been due to an original series/parallel arrangement for 12 or 24V. There had also been some additions to the AGC circuitry near it diode.

For the initial test I disturbed none of the modifications, but merely connected up HT and LT supplies (200V and 6.3V respectively). Not a sound was to be heard, not even when I applied the classic finger-on-AF-amp.-top-cap test. It transpired that during the fitting of the new volume control the lower end

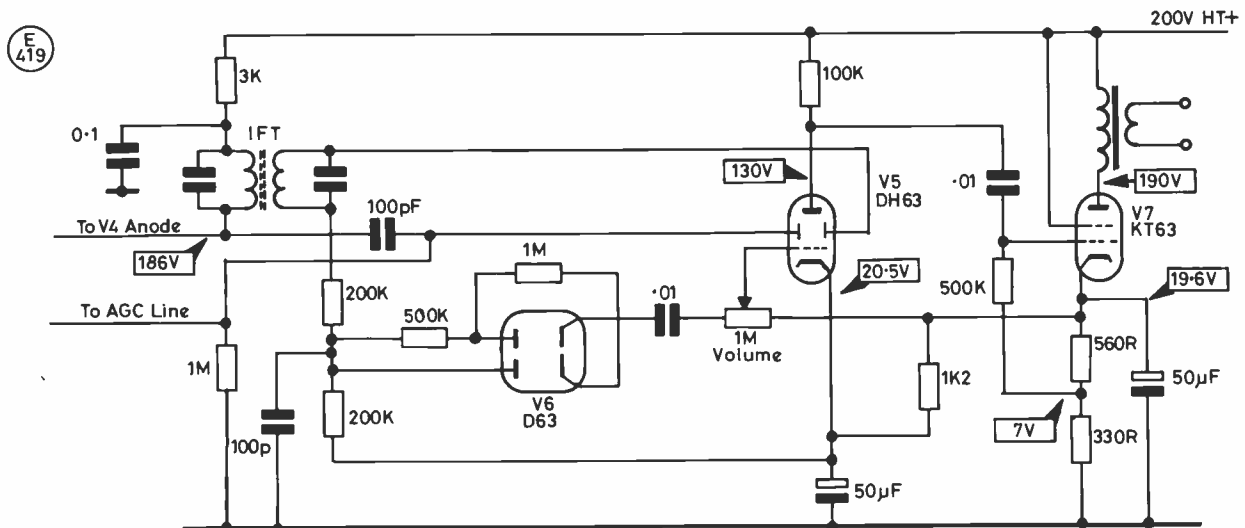

Fig.1 DETECTOR /AGC/NOISE LIMITER /AF AMP/ OUTPUT CIRCUITRY (Note complex cathode biasing of V5 and V7 also the non-standard resistor values).

had been taken directly to earth, resulting in an excessive amount of bias being applied to the grid and cutting it off.

The circuitry around a double-diode-triode valve's cathode is sometimes complex, with, as in this case, more than one bias resistor being employed. (See Fig. 1). The reason for this is the need to apply different levels of bias to the three component sections of the valve. The AGC diode is likely to receive the maximum bias in order to "delay" its action, *i.e.* to ensure that it does not attempt to reduce still further the signals from weak stations. Only when signal strengths greater than the designed level of delay are received does the AGC begin to operate. When the delay voltage is required to be higher than two or three volts it may become inconvenient to obtain it by a straight-forward cathode resistor as this would have to be of a very large value, the current through it being only small. Instead, as in the diagram, it is arranged that the heavier cathode current of the output valve should flow through part of the chain of resistors to bring about a fairly large voltage drop. Now, the triode section of the DDT will not require anything like as much bias as the AGC diode and so it is returned to a point above earth on the cathode resistor chain, restricting the actual grid bias to a low value. In the case of this particular set, it is only 0.9V, although the cathode voltage is 20.5V. The signal diode in any receiver normally requires no bias at all; if any were to be applied it would result in a similar effect as the delay voltage on the AGC diode, *i.e.* only signals strong enough to produce a higher voltage than the bias would be reproduced. The effect may of course be deliberately introduced as "squench" or for "silent tuning". These facilities were in common usage in domestic Rx's as long ago as the early 1930s.

Restoring the lower end of the volume control to its correct place on the bias chain did not, however, improve matters to the extent that was expected, the results still being feeble. This was due to the use of the incorrect EBC33, the triode section of which has different characteristics to that of the DH63. Once the correct valve had been fitted the performance was vastly improved. The (120kHz) IF transformers appeared not to have been interfered with, but the RF and oscillator coils obviously had, and a slight amount of re-alignment was needed to realise the full potential, but this proved to be a simple job. The sensitivity of the 1.35/3.8MHz band was sufficient to pull in a large number of commercial and amateur SSB stations, so restoration of the BFO facility was the next item on the programme.

Of the three wires left hanging through the front panel two were solely concerned with switching the BFO HT supply, and thus were taken to a simple on/off tumbler switch installed in the appropriate hole. The third wire presented a problem. It went to  $G_2$  of the frequency-changer *via* a 20K resistor, and the most

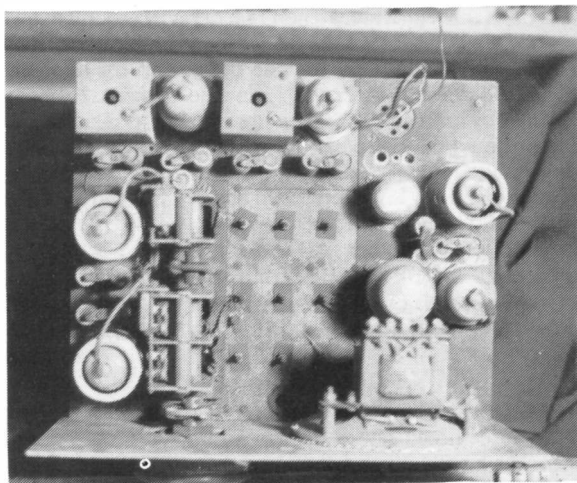

A top view of the un-named receiver

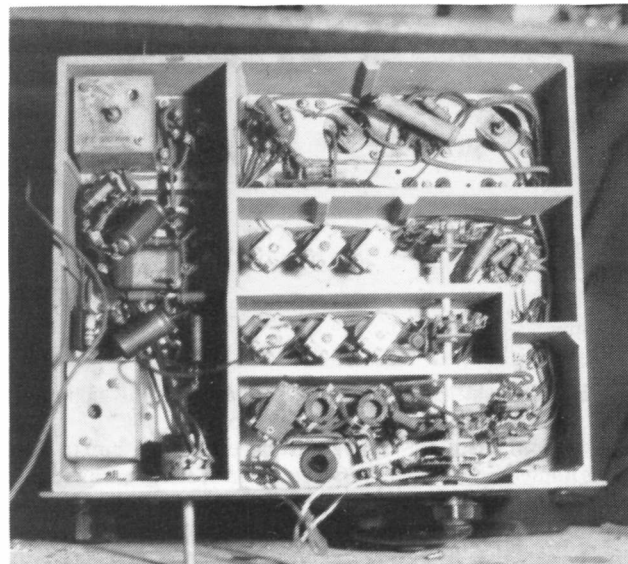

Chassis underside of the small, possibly Marconi-made, receiver

likely reason for its presence appeared to be that it was intended to bleed off some HT onto a manual RF gain control, although none existed. Support for this theory came from a careful examination of the cathode circuitry on the RF and IF amplifier valves; the various bias resistors were not taken to nearby chassis points, but to a common lead which wound around the chassis to a point just by the BFO switch. There it had been earthed to a tag on the middle band oscillator coil — obviously not an original piece of work. The snag was that where one would expect to find the RF gain control was this hole labelled "handset". Had this Rx formed part of a small transmitter/receiver set-up in which depression of a press-to-talk switch also activated a desensitising circuit? This of course, is only speculation as far as I am concerned; I can but hope that someone who reads this may be able to put me wise. In the event I fitted a 2K-ohm pot, in the hole and connected it up as a conventional RF gain control with the 20K resistor feeding its top end. This has given very smooth and effective control over the gain and makes it possible to resolve SSB signals of widely different strengths (*e.g.* whilst listening to an 80m. net) without difficulty. The BFO itself, although preset, also causes no problems. I set it up on a commercial station (Shannon Airadio) after giving the set ample time to warm up, and it has not needed to be touched again as yet.

Sensitivity of this little receiver is good — almost embarrassingly so when compared to larger and more modern sets! For practical comparisons I tend to use MSF Rugby, which apart from its intended function, can be relied upon here to give a constant signal strength. For those who like figures, the lowest inputs which will give good clean output at the loudspeaker are: 190kHz-60 $\mu$ V; 400kHz-60 $\mu$ V; 600kHz-20 $\mu$ V; 1.3MHz-40 $\mu$ V; 1.6MHz-10 $\mu$ V; 3MHz-5 $\mu$ V.

Although the noise limiter is permanently in circuit, it does not appear to introduce any distortion, unlike some examples.

An unassuming Rx of strictly functional appearance, this, but one giving very pleasing results and obviously capable, with its coverage of the standard IF band, of being used in a double superhet role; I hope that I may be able to acquire a suitable vintage pre-selector for this purpose. The alternative, to construct one, appeals to me greatly, but unfortunately the time element is a great deterrent!

As mentioned earlier, should anyone be able to offer any information or advice of any nature regarding this receiver, I shall be most grateful to receive it.



## SHORT WAVE LISTENER FEATURE

By Justin Cooper

**H**ELLO again! This time we have a starter entry which offers an interesting problem for solution. *W. J. Prior (Lochcarron)* has a plot which is just big enough for him to hang up his home-brew five-band trap aerial in an east-west direction, so that it 'fires' north-south. This is hardly the preferred direction; but to make matters worse, a look at the atlas agrees that SWL Prior lives between the Applecross and Torridon mountains; and we are aware by reference to the atlas again that he is based on old rock structure which isn't very conducive to good grounds.

Clearly, then, a vertical aerial will not be at its best as it will be all but impossible to get a decent ground system down. Perhaps the best solution is to build a beam aerial for the 10-15-20 metre bands and put in on the best mast that can be arranged. We would suggest the trial of the VK2ABQ design, which is easily home-brewed and takes up very little space in terms of 'wing-span.' As for the mast, one wouldn't want *too* high a mast, lest the main lobe fail to lift over the mountains. In fact, if one were faced with just one preferred direction for such an aerial, one would choose it to shoot in a westerly direction, for morning VK/ZL/Pacific activity, plus the Ws through the day from about noon onwards. Incidentally, the secret of keeping a VK2ABQ-type beam in the air is to be sure the legs of the thing are guyed to each other all the way round, using pre-stretched Terylene braided line as bought from a boat chandler. The VK2ABQ design *must* be resonated in to the band using a GDO or whatever and one must expect the adjustments on each band to interact; the dimensions will depend on the amount of supporting metalwork. Also, the recommendation to use coat buttons as the end insulators does seem to have some bearing on the success of the beam; it seems to like having the ends of the driven element and parasite within a fraction of each other.

### The Mail

Still with SWL Prior, he uses an FRG-7700/FRT-7700 combination and an MBA decoder hitched to his five-band dipole. Out of his list of callsigns we managed to pick out some 133 prefixes, but to your J. C. the most noticeable thing was just how hard SWL Prior has to work at it from his location. For example, he has no GM signals recorded, and very few G's. A couple of JA and a sprinkling of East Coast U.S.A., nothing from Oceania, one South American and one Asian, out of a total of some 328 RTTY calls logged over a period of eight months. The implication is that a very good aerial system indeed is necessary, or that the activity should be altered to operate portable from the hilltops or the sea coast. Our sympathies!

Next we have a letter from *T. Ross (Edinburgh)* who has a Heath HW-101 plus home-brew ATU, CBM 64 computer with GW3RRI RTTY program, and four aerials, the T2FD as a sloper, an end-fed wire, G5RV of the half-size variety and, finally, a sloper version of the half-wave dipole for 14 MHz; operation is essentially on 3.5 and 14 MHz, but of course the aerials chosen give coverage of all bands 3.5-28 MHz. It is interesting to notice the T2FD reference, as this aerial was first written up properly in this country in *Short Wave Magazine* by, as we recall G2NU, N. P. Spooner, during 1953. It enjoyed a brief spell of popularity and then faded out, chiefly we suspect because few people used it

with understanding. It is *not* a folded dipole in its operation, but should be regarded as more in the nature of a 'rhombic squashed flat into folded dipole shape' — the point being that the dipole family require that standing waves be set up on them (not on the feeder, of course, just on the flat-top), while the rhombic family, being terminated at their far end in a correct match, carry no standing waves on the aerial and rely on the travelling wave going to the far end and being lost on arrival at the termination resistor as heat. In the rhombic, removal of the standing waves removes the backward pattern and the aerial becomes a quite superb unidirectional beam; but we question its use in the T2FD aerial as it isn't directive. The great advantage is the the SWR stays well within bounds even if the thing isn't radiating. Years ago the writer made one up for TV Band 1, and plotted its feedpoint impedance on a Smith chart in the lab, across 3.5 and 7 MHz. It couldn't have radiated significantly, but it had an acceptable SWR! There are so many grey areas in this subject of aerials, as G6XN shows in his valuable book 'HF Antennas for All Locations.' Anyway, Tom enters the lists at 232.

*J. Routledge (Hartlepool)* has been neglecting RTTY in favour of SSB — possibly to tickle the score over the 1000 mark? We certainly wouldn't blame him — that used to be the pinnacle to be reached before "retiring to let the rest have a go" a couple of decades ago.

Our next letter is from *J. Singleton (Withernsea)* who has been an SWL since he received his first receiver as a tenth birthday present; there has almost always been a log about, and for seven years at sea a large chunk of the baggage space was taken up by a receiver. John is at the moment looking for a RTTY tape for the Spectrum — he should be in contact with SARUG by way of G4INP (see our 'Clubs' feature this month). John is still somewhat of an eighty-metre exponent.

*I. Thomson (Rye)* has been 'noticed' by the other two Rye contributors, and by the sound of things Ian would do well to get to know them — they have the answers to the queries on prefixes he has presented already! T77C is pretty well-known but T26FE sounds a little odd; M4DR making a sked with a 4X4 station to try for a contact through a repeater on 144.775 MHz sounds a bit odd too — one would have thought the repeater would have been up at the other end of the band for one thing, and for another the callsign itself doesn't ring true . . . anyone any ideas?

Just nearby in Rye is *N. E. Jennings* who is now mending nicely and has the additional pleasure of having celebrated his 76th birthday and Golden Wedding too just recently — and playing with micros and SWL will keep him amused for years yet! Apart from his list, Norman indicates that he and "SWL" reader Pete Lincoln get lots of enquiries as to where the RTTY is to be found — try around 14080-14100 kHz for a good starter.

*W. G. Shipton* is our third Rye contributor; he has roared up over the 1000 mark, using the Datong AD270 active aerial.

### Conditions

*H. M. Graham (Chesham)* reports that things are still pretty lean. Maurice noted several European openings on Ten, while Fifteen was largely north-south propagation; 14 MHz seems to have been the best with all continents bar Africa. Forty was a 'Nil' but on Eighty some new WAB areas were found; on Top Band the



furthest was Manchester, around noon — there was no late-night listening done. Maurice noted an odd one on April 26, in the shape of LY4L, a prefix that hails from UP-land. The QSL address given was *via* UA4LM, but the station didn't say where it was.

It's a long while since we heard from *A. Vest (Durham)*; but Arthur is now retired and has more spare time. He has started with a CW list — good! — and will be putting in a Phone list in due course. To rake up the 200 from scratch would be, in answer to Arthur's question, the work of a reasonable contest weekend, or a hardworking normal one, given reasonable receiver, aerials, and some previous experience in SWL reception — not to mention a good logging system. And, that refers to *prefixes*, not just lists of stations.

That query from E. M. Gauci last time round brought in a reply from *Stan Herbert, G3ATU (Sunderland)*. Stan says that the G8QVA/5 was in fact "Old Fred, G8QV/EA5", now back at home in Ely.

Lo and behold, our next one is *E. M. Gauci (Sliema, Malta)* with another big list, from which we have deducted 5BA/NF6 — probably a typing error, and ZB3ID which was either piratical or a mis-hearing.

*J. Heath (St. Ives, Hunts)* has at long last been able to get some listening time in, both at HF and on 144 MHz. John has a very questionable one too, his offering rejoicing in "2Q4KS".

## Lightning

For the past few minutes your scribe has been totally stopped from writing the column because of the arrival of a thunderstorm with its attendant problem of one scared dog which insists on sitting on J. C.'s lap as the safest place to be — but at least I've had time to put together a thought or two on lightning protection. Firstly, it should be possible to earth everything down on the aerial side, and that implies an earth connection to the ATU itself. In the second place, the mains plug should be pulled out and placed at least three feet from any known mains wiring of the house. Thirdly, it must be realised that a direct strike is a full-scale disaster; what one is trying to cope with is the close-by bolt, and the tendency for aerials that aren't earthed to pick up static electricity if they haven't a path to get rid of it. Thus, all the low-impedance 'holes' in the J. C. ATU have a 1M resistor permanently wired across them to earth. As the earth radials of the vertical are trenched in the ground the coax outer from this provides the DC ground path for the ATU. The long-wire aerial is permanently connected to earth by the turns of the coil and so can't build up static, while the transmitter cable is pulled out and replaced by a dummy load resistor being plugged into the hole from which the transmitter feeder has just been removed. That takes care of the aerials and involves just one operation of plugging in a dummy load. The transceiver and linear are on a common lead, by way of a distribution board, so one mains plug is pulled out to completely isolate the rig. That's the shack dealt with. For the rest, go round the house and pull out the domestic radio, TV and other stuff from the mains sockets. Unplug the aerial from the TV and radio, as it is likely that both are going to be 'hot'; and finally make sure all items are three feet or more from any known mains wiring. Then sit it out! Now back to business. . . .

## ANNUAL HPX LADDER

Starting date January 1, 1985

SWL	PREFIXES	SWL	PREFIXES
S. Wilson (St. Andrews, Fife)	450	M. Probert (Basingstoke)	288
J. Singleton (Withernsea)	447	D. Pye (London W2)	266
I. Thompson (Rye)	437	T. Ross (Edinburgh)	232

Minimum of 200 Prefixes to have been heard from January 1, 1985 for an entry to be made. At score 500, transfer to the All Time List is automatic. In accordance with HPX Rules, see p. 19 March issue.

## HPX LADDER

(All Time Post War)

SWL	PREFIXES	SWL	PREFIXES
<i>PHONE ONLY</i>			
B. Hughes (Harvington)	2949	J. Heath (St. Ives, Hunts.)	786
Mrs. R. Smith (Nuneaton)	2474	B. Patchett (Sheffield)	782
E. W. Robinson (Felixstowe)	2412	R. Wooden (Staines)	728
E. M. Gauci (Sliema, Malta)	2305	G. Caselton (Orpington)	672
H. M. Graham (Chesham)	1805	A. J. Chapman (Newark)	554
Mrs. T. Parry (Blackpool)	1649	N. Fox (Wakefield)	552
M. Rodgers (Harwood)	1507	C. Burrells (Stevenage)	506
S. Baker (Cwmbran)	1388	Mrs. T. Carmichael (Lincoln)	502
N. E. Jennings (Rye)	1375	<i>CW ONLY</i>	
N. Askew (Coventry)	1362	J. Goodrick (I.o.W.)	1763
P. Oliver (Paisley)	1357	F. Dunn (Chester)	1569
N. Henbrey (Northiam)	1327	R. Fox (Northampton)	463
R. Fox (Northampton)	1305	A. Vest (Durham)	249
P. A. Cardwell (Sheffield)	1238	<i>RTTY ONLY</i>	
F. Dunn (Chester)	1227	N. E. Jennings (Rye)	622
G. A. Carmichael (Lincoln)	1077	P. Lincoln (Aldershot)	494
G. Shipton (Rye)	1021	J. Routledge (Hartlepool)	332
M. Ribton (Gillingham)	985	N. Henbrey (Northiam)	293
J. Routledge (Hartlepool)	950	R. Fox (Northampton)	233
P. Lincoln (Aldershot)	886		

Minimum score for an entry to be made is 500 for Phone, 200 for CW or RTTY. Listings to be in accordance with HPX Rules — see p. 19 March issue.

*C. Burrells (Stevenage)* seems to have regained his activity, at least as far as HPX goes, and he now goes into the All-Time. As he says, up to the time of writing there hasn't been any nicer weather . . . there was, a week or so ago, but J. C. missed it while having a cup of tea!

*R. Fox (Northampton)* has now solved his RTTY problems by obtaining a Tono 9100E at a reasonable price, but this led to others: firstly the monitor developed TVI on transmit, secondly the power supply objected to the increased load, and thirdly the Icom IC-251E PSU also resigned duty; each a separate incident over a period of two weeks — at least it gave some incentive to work on the Morse! Arising from all this, Roy now has a Scarab TU plus interface, plus a program for the 48K Spectrum to go at a reasonable price to a good home. Roy is at 72 Artizan Road, Northampton.

During a recent few days holiday, *G. Caselton (Orpington)* put his entire collection of old logbooks on to the database of his computer, as well as making up an entry for 1985 by a different listing; and, praise be, his dot-matrix printer has been fed recently with a drink of ink! Most of these seem to have a marked shortage of ink, at which moment they can become almost unreadable.

*M. Probert (Basingstoke)* has acquired an old HRO and with it an enthusiasm for Eighty in the night hours between 0200-0630; and it has certainly bumped things up a lot.

We were talking earlier about beams; *F. Dunn (Chester)* was building one at the time of his letter, using ribbon feeder. Not so much for the sake of gain, but more in the hopes of reducing the noise and QRM. This, of course is one area where the SWL and the licensed amateur will always differ. The SWL wants to get the best discrimination between the preferred and all other directions, while the licensed amateur wants maximum forward gain and damn the sidelobes. In the practical, Yagi situation, lab tests confirm the range measurements and say that a Yagi-type aerial optimised for front-to-back ratio will tend to be about 1dB down on the aerial optimised for maximum forward gain. Since you don't ever get something for nothing what's the answer? Imagined in three dimensions the gain pattern of, say, a three-element beam in free space would look very much like a tethered hydrogen balloon of the 'barrage balloon' configuration, with the main lobe being the body of the balloon and the tail fins the minor lobes. Now, tuned for maximum front-to-back the aerial has smallest minor lobes, obviously. However, when you tune it up for maximum gain, the balloon tail fins grow larger, but the body

becomes longer and slimmer, while containing the same quantity of 'gas'.

*P. Oliver (Paisley)* went to the Scottish Convention a week before he wrote on May 13, and seems to have had a great time. Between times, Pete found the time to add 93 more to bring him up to 1357.

Now to *E. W. Robinson (Felixstowe)* who got himself a bumper crop of which the pick was definitely BY1PK, heard twice around lunchtime on 14 MHz, driven by operator Sheng.

*B. Patchell (Sheffield)* wonders whether everyone is as studious as he is about what he records as a hearing in his log; without asking for QSLs, which can take a long time, we couldn't check this one directly. However, we can, from long experience, usually spot the 'wrong' uns' — and, anyway, we have to accept that each SWL has his own ideas on what constitutes a 'hearing.' For example, your J. C. doesn't reckon to log a station until he is (a) sure he listening to the right end of the QSO, and (b) has listened to all the overs of at least one complete contact. If a report is to be sent, then we listen to several contacts, and make comparisons. On a different tack, Brian has discovered the great advantage of a decent filing system in addition to the log itself for keeping down the number of duplicates claimed. This indeed is one place where the Spectrum computer can be very useful indeed.

*N. Askew (Coventry)* comments on the VE3KFI/49X noted by E. M. Gauci, and says the chap was in fact VE3KFE/SU on Golan Heights, and 'scrambling' his SU suffix while handling phone-patches so as to avoid the unwanted attentions of Italian and YU stations calling him.

Now to *Mrs. R. Smith (Nuneaton)*; Ruth notes how much the improvement in one's score can be affected by the time of day one listens, one's position on the Ladder, and above all, how much time one can put in at the rig — she sounds as though all of these factors are annoying!

The letter from *N. Henbrey (Northiam)* indicates that Norman has other things on his mind now that the warmer (?) weather is with us; nowadays he umpires the cricket matches around the area and his wife does the scoring. However, Norman has managed to get a little time in at the receiver as his score indicates on Phone, although the RTTY seems to have been left alone.

### White Rose SWL Contest

*D. Whitaker (Harrogate)* writes in with the results of this shindig, held last January; it was 'blessed' with some atrocious conditions, which ironically enough made a steady improvement after the contest was over. D. Piccirillo, BRS-52868, won the CW section by a handsome margin with a score of 75632 points, more than double that of the runner-up, Alex Elkovavramov, LZ2A-256. On the Phone side, A. Miller came up top with a score of 51168 points, ahead of runner-up Norman Henbrey, BRS28198, who made 24492 points. Congratulations to all; and in particular to D. Piccirillo for being overall winner even though he stuck to CW, and to A. Miller for his persistence. Arthur has always managed to be 'there or thereabouts' meaning in the top three, and this year his first place on Phone was a worthy reward. For myself I would couple with that Norman Henbrey, who has been in the lists with credit for far more years than I like to think about.

On a different line, there were some problems with the Rules, possibly mis-interpreted by foreign journals, so David would appreciate comments from competitors and others as to next year's Rules. Contact him direct: D. A. Whitaker, Hillcourt, 57 Green Lane, Harrogate, N. Yorks, HG2 9LN.

Both *G. Carmichael (Lincoln)*, and *Mrs T. Carmichael* have had a thin time of it in terms of prefixes; Gordon has found the medium wave band in terms of DX so goes up just two in the Ladder, while his wife seems to have been totally QRT visiting a hospitalised relative. We hope all is soon well.

*D. Pye (London W2)* is looking forward to visits from K7RDH and XYL KA7UBC, who first started his interest in amateur radio. On a different tack, Don seems to feel somewhat 'conned' in his purchase of a Commodore Plus 4. The 'built-in' programs all require a disk drive for data storage, and other programs are

distinctly thin on the ground. As Don says, it is not surprising the box was discounted £100! True enough, but that is *always* the penalty of dealing in discounts. It is simple arithmetic that the costs of providing good service are such that to discount successfully you must do as little service as possible. That's fine for a young electronic engineer, but hard luck on a non-technical chap. J. C. *never* goes to a discount house for anything if he can help it, especially for luxury hobby items.

Young *S. Baker (Cwmbran)* bows out with the current list, as there won't be any receiving gear henceforth, says father GW6VZW. We hope to hear again when they have sorted out their receiving station position.

*B. F. Hughes (Harvington)* is finding it hard at the top, but he took note of our detail on the half-size G5RV aerial and intends to put one up before long, plus a better mast too.

The mind of *M. Ribton (Gillingham)* runs on aeriels; and to give point to his question he draws a sketch of his position. The receiver sits in a front bedroom, and an earth connection would have to be on the other side, fully thirty feet away. Mike proposes an alternative, which can be summed up as a 67' top along the back garden to his mast fed from the inner of a piece of coax going through the house; the outer of the coax being taken to another 67' length also run out to the mast. Let's consider this as a 3.5 MHz half-wave dipole — so arranged that it would almost certainly produce near-complete cancellation of pick-up on the wires. On all the higher bands, this problem will to some degree remain, but the 'killer' is to consider the coax cable as a physical capacitor sitting across the receiver input. Say thirty feet of it, at roughly 30pF to the foot, or about 900pF between the aerial and earth terminals of the receiver, to decouple off any signal that might reach there! No, the answer must be in this case to leave up the top section, generate the best possible earth by burying lots of copper, and then either (a) bring the ATU to the lead-in and there connect aerial and earth, feeding back to the shack in coaxial cable, or (b) bring aerial and earth back through the house to an ATU in the shack. Neither is very 'sanitary' but either will give better results than the coax-feed and no ATU proposition. The biggest problem is the amount of electrical noise that can be picked up in the house *en route* to the rig if the ATU is at that end, closely followed by the 'how to' of remote tuning the ATU. Another possible proposition is to use the coax-fed half-G5RV, letting the twin-feeder bit hang straight down, bury the coaxial until you get to the house, and then feed unobtrusively up and in like the TV aerial feeder. A colleague used to do this, but his method was to use 50-ohm *balanced* instead of coaxial, with a balun at the shack ATU end, which for him seemed to work better. Some experimenting seems to be called for.

*P. Lincoln (Aldershot)* has decided with regret that this year he cannot justify the cost of the *U.S. and DX Call Books*, so while he can still look up calls for people they will be from last year's issue. He is on (0252 317870). Peter has a RTTY program for his Sharp computer up and running, to read or send RTTY or ASCII at 45, 50, 75 and 110 baud rates. He also has a machine code program for the HPX List using the same computer. If anyone would like details, contact him direct.

Next we come back to *M. Ribton* and the problem of using the mains earth for RF. The problem has to be that most appliances tend to leak to RF through stray or other capacities. In addition, should an appliance 'go down' to earth, a mighty current could flow if the fuse holds. Now, under these conditions, the worst case would be that of the 'earth' potential *at the shack mains earth point*, roaring instantly up to nearly the voltage of the live wire of the mains. That wouldn't be very nice for Master, and it would probably result in the high voltage eating at least the front-end of the receiver. If you *must* use the mains earth, then don't pick it up on a socket; take a separate, and double-beefy, earth lead to where the mains earth goes to earth, and then make off below (i.e. nearer the ground than the mains earth connection). If anyone has any other views on this or other subjects, Mike would like to receive a letter and will reply — he is at 9 Paget Street, Gillingham, Kent.

Finally, we have *L. H. Marquardt (Hereford)* who uses a vertical dipole almost entirely on 14 MHz, feeding a DX-302; he also has a portable receiver and ¼-wave whip. His latest three letters bring his total up to 160 prefixes and so by next time with any luck he should have his name on the Ladder. We wonder if Luciano is a member of the Hereford club — like most clubs they can always use more members and have chaps there who could probably be a great help to him in progressing along the path to a licence.

## Finis

We seem to have said it all for this time! Somewhat more discursive than usual, but that because of all the interesting questions you throw into the forum. Keep it up, it's fun at this end, and stops the old grey-beard's brain rotting away!

Deadline for next time is **July 18**, latest, to arrive, addressed to your old pal, "SWL", SHORT WAVE MAGAZINE, 34 High Street, Welwyn, Herts. AL6 9EQ.

## BOOK REVIEW

# "AMATEUR RADIO OPERATING MANUAL"

### Third Edition

**T**HE third edition of the *Amateur Radio Operating Manual* has been published and, rather than compare it with its predecessors reviewed in the December, 1979 and April, 1982 issues, this appraisal will start from scratch for the benefit of relative newcomers to the hobby.

The first chapter, *The Amateur Service*, deals with the international and national legal aspects of amateur radio, such as call sign blocks and the designation and classification of emissions. Chapter 2, *Setting Up a Station*, is full of sound advice about the need for, and acquisition and assembly of, equipment, stressing the importance of considering the station as a whole. Since most newcomers do not have a very clear idea of which facets of the hobby they will concentrate upon, a flexible, low cost approach is suggested.

*Operating Practices and Procedures* are covered in the next section which is essential reading for all newly-licensed amateurs, particularly those who have graduated from the CB band. It is all too easy to pick up bad operating habits such as speaking too close to the microphone, incorrectly setting speech processors, using silly phrases like, "That's a Roger," and "Affirmative" when "Yes" would suffice, and the use of the royal "we". This chapter includes extracts from the international Q-code, the RST Code, common CW abbreviations and popular phrases in English, German, French and Spanish.

The fourth chapter has 49 pages and is entitled *DX*. It is a very comprehensive piece including copious information on the characteristics of all bands from 160 metres through 23 centimetres whereon DX can be worked, how to work DX stations, predicting propagation conditions, and awards. The European QTH Locator and Maidenhead World Locator systems are fully explained and all the current band plans and beacons are listed. Several pages are devoted to VHF meteor scatter mode covering the arranging of schedules, operating procedures and a list of thirteen showers.

Whether one loves or loathes them, contests are an established part of the hobby and chapter five is devoted to them. The major, annual HF clashes are tabulated. Most of this section consists of common sense advice on how to do well in contests, covering equipment preparation, maintenance and operation,

organisation and strategy, antennas, log keeping, check sheets and performance analysis. *Mobile, Portable and Repeaters* is the title of the next chapter which includes lists of the U.K. 145, 433 and 1,297 MHz repeaters complete with a map of where they are. Chapter 7, *Amateur Satellites*, covers the remaining Soviet RS orbiters, the two UoSAT ones, UO-9 and UO-11, and the first Phase 3 elliptical orbit spacecraft AO-10. All the information about ground station requirements, tracking, band plans and actual operation are adequately dealt with.

The following two chapters deal briefly with *RTTY* and *SSTV* but neither data systems nor packet radio gets a mention. The final, tenth chapter is entitled *Special Event Stations*, and is a welcome inclusion. These stations are usually the general public's first introduction to amateur radio so first impressions should be favourable. This section offers sensible advice on this public relations aspect of the hobby.

In this edition there are eight appendices the first of which consists of a series of continental and regional maps including a Maidenhead one of Europe, the "CQ" and ITU Zone maps and ones showing all the countries. The second appendix has 28 pages devoted to *International Callsign Series* holders listed alphabetically and supplemented with maps showing the call areas of many countries. The latest U.S.S.R. callsign system occupies two pages. Appendix 3 is a callsign list wherein all the ITU callsign blocks are given, together with the appropriate amateur prefixes, continent, "CQ" and ITU zone numbers and the antenna azimuth from London.

In the fourth appendix, the current A.R.R.L. DXCC countries are listed and there are seven columns for the reader to use to tick off those worked on the bands of his or her choice. Deleted countries are not listed. The next appendix is *Worldwide Legal Time*. No. 6 lists all the amateur frequency allocations in Regions 1, 2 and 3 from 1.8 MHz through 250 GHz. There are two pages of W.A.R.C. 1979 footnotes in minute typeface. *Standard Frequency Stations* in Argentina, Australia, Canada, France, Italy, Japan, the U.K., U.S.A. and U.S.S.R. are listed in Appendix 7 together with their operating schedules. The final appendix gives guidance on phone contacts in French, German, Italian and Spanish and the book is concluded by a short, one-page index.

The *Amateur Radio Operating Manual* is published by the *Radio Society of Great Britain* and edited by R. J. Eckersley, G4FTJ, who lists 43 individual contributors and other groups. The format is 204 pages in soft cover, size 245 x 183mm. This manual remains one of the most informative volumes available, particularly for newcomers to amateur radio, and it is highly recommended. It is in stock at £6.10 and orders should be addressed to "S.W.M." Publications Department at 34 High Street, Welwyn, Herts., AL6 9EQ. The price is inclusive of postage and packing.

N.A.S.F.

# 160-Metres for the Yaesu FT-707 Transceiver, Part 1

*A Conversion Project for both Early and Later Models of this Popular Piece of Equipment*

**IAN KEYSER, G3ROO**

FOR some considerable time I have been considering the possibility of modifying the FT-707 for 160m. operation, but have fought shy due to the lack of space in the rig. Recently, however, interest has been rekindled and a more concerted effort put into finding a solution.

In the past it has always been my intention when modifying a set not to exclude any facility that might be of use and this has been the stumbling block on several occasions. This time a choice had to be made as I wished to include two things, an attenuator for use on 40m. at night and the new pre-mix oscillator needed on 160 metres. The marker circuit, I decided, would have to go — after all it had been used on very few occasions and it was a simple matter to use the redundant components and build it into the ATU; also this gave me a suitable switch on the front panel for the attenuator circuit.

There is another slight drawback that has to be accepted when doing this modification. The variations in gain between bands on the FT-707 is very slight indeed but to carry out this modification we have to make the RF tuned circuits on 28 MHz cover down to 25 MHz, and this has the effect of reducing the overall gain of the front end on the 10 and 12 metre bands. The effect is not as marked in practice as it sounds on paper as it is still possible to hear solar noise on 10m. with only a dipole.

Those of you who have already done my FM modification (*S.W.M.*, April and May, 1984) should have little problem in completing this modification; however I repeat the warning that for those of you who doubt your ability, do not attempt it without the aid of another amateur who has sufficient experience.

## The Attenuator

We will cover this first, but for those who do not wish to remove the 'mark' facility, or those of you with the later RF PCB with insufficient room to include the attenuator, the 160m. oscillator

should be built on a piece of Veroboard and "fiddled" into some convenient corner of the set.

The attenuator is switched using a miniature relay which is obtainable from *MS Components*. Using a small modelmaker's drill and grinding heads, islands can be ground into the unused copper ground plane alongside T1001 and the relay mounted there; it is then a simple matter to add the attenuator circuit (Fig. 1) into the track from J1002 pin 1 and C1005. On my printed circuit the combination of T1001 and C1003 (forming a trap) is not connected as shown in the circuit diagram, but connected to the cathode of D1002. The wire connected to pin 7 of J3003 is removed from the insert. The insert can be removed from plastic case by using a small screwdriver to push down the barb on the insert at the same time pulling on the wire. When the insert is

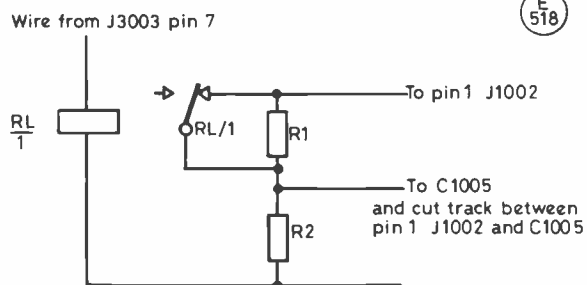

Fig. 1 Input Attenuator circuit

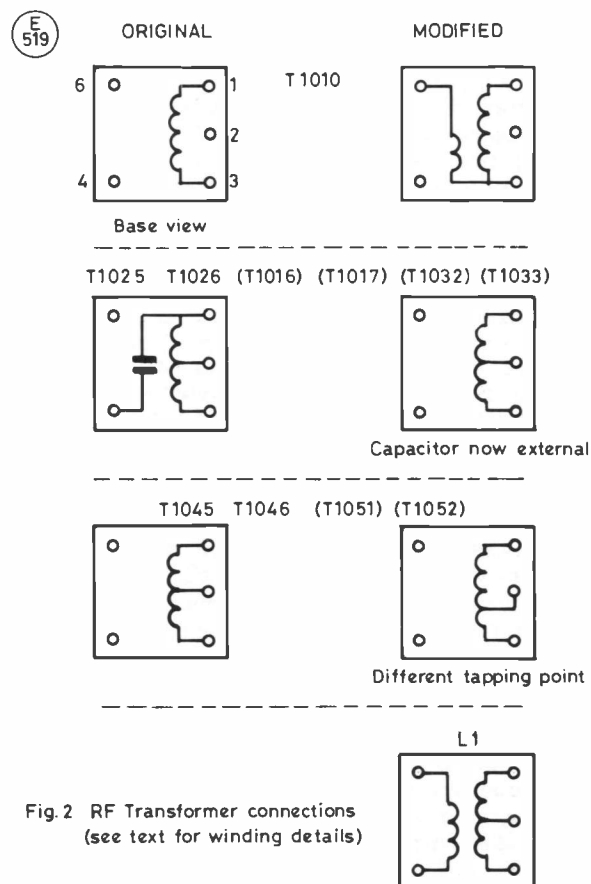

Fig. 2 RF Transformer connections (see text for winding details)



---

The oscillator PCB layout for the 160m. conversion.

---

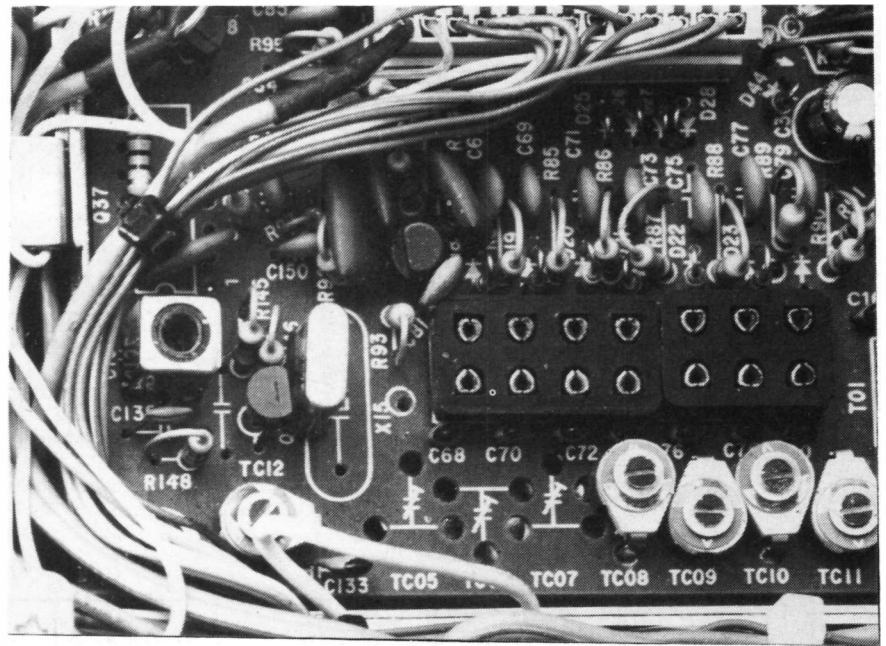

replaced check that the barb has not been pushed flat, otherwise the insert will not catch in the plastic insert and will be lost. This wire is routed back through the cableform until there is sufficient length to reach the relay; when the 'mark' button is depressed supply is available on this wire and is used to energise the relay.

### The 160m. Modification

Having completed the conversion of my FT-707 with the original front end design, it was decided necessary to find someone with a rig with the new style front end and convert that before calling the project complete. Just at that time a call happened to come from Ian, G4MWD, asking about converting his later-version FT-707 to 160m! After a fairly lengthy assessment, the only difference seemed to be that the RF stage input had two tuned circuits and that the high pass filter on the input to the receiver had a slightly higher cut-off frequency than the original on 1.7 MHz.

Addition of the new oscillator would create little problem and could be built on a small PCB if the marker circuit was to be retained. Alteration of the coils would be the next job and as these are all the same units as used in the Rx RF amplifier output on the

original board, conversion of the coils would be carried out in the same manner to be described for T1025 and T1026. The high pass filter on the receiver poses little problem as it will only decrease signals by less than 10dB, and when one considers the sensitivity of the set and the general noise level on the band it is hardly worth worrying about. If you do wish to change the values of the filter these are given in Fig. 14.

With Ian having completed his modification without too many problems I decided that it was only fair that I purchased a later version PCB and did the same to my set. A phone call to *South Midlands Communications Ltd.* and, with the assistance of a very helpful young lady (and *Access*), one was in the post the following day.

To commence the conversion release the front panel by removing the countersunk screws but take care not to release the VFO mounting screws; careful investigation will identify these screws and this unit must come away with the front panel. Ease the panel away from the set a couple of centimetres, that is all that is required, and locate the wavechange switch. Examination will reveal four terminals connected together on the rear wafer and to the left of these a grey/white wire, this is the 12m. RF terminal.

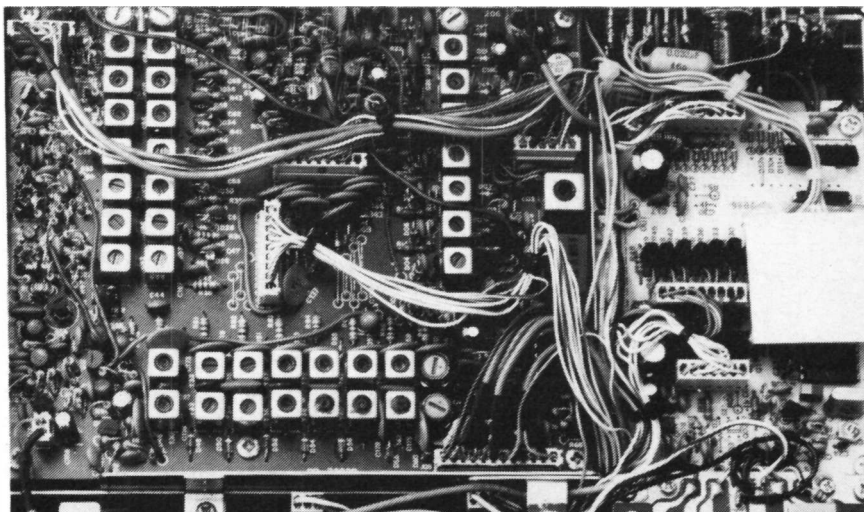

---

The RF PCB, showing the new coils.

---

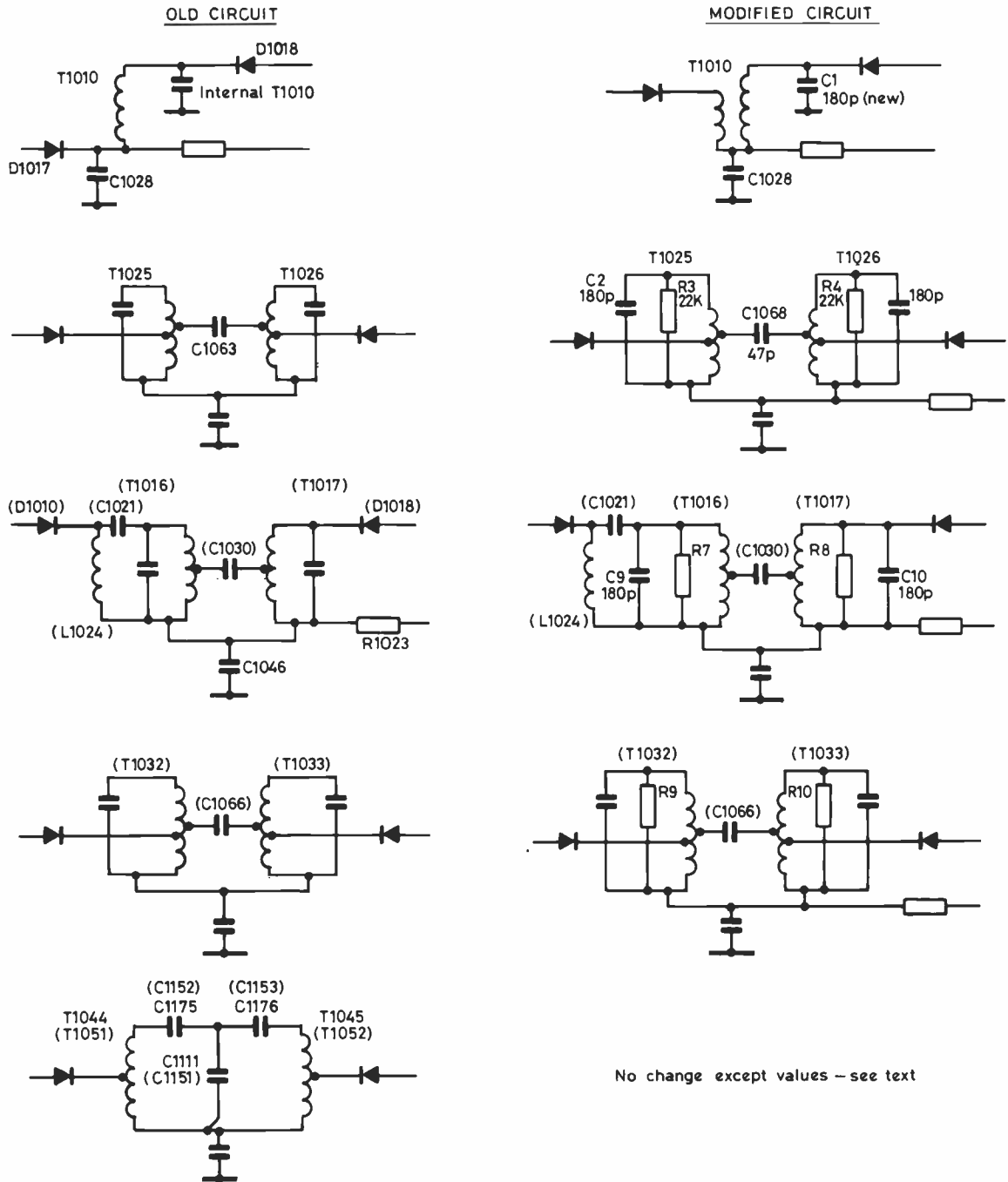

Fig. 3 RF TRANSFORMER CIRCUITS

The corresponding red/white wire on the front wafer is the supply for the 12m. premix oscillator. If the wavechange knob and retaining nut are now removed the switch assembly can be rotated revealing two spare pins, one on each wafer. These pins are the

unused position on the wavechange switch between 10m. and 80m. and is used for 160 metres.

Our first job is to change the switch wiring to enable the 10m. RF and premix filter circuit transformers to be used on 12m. This is done by removing the grey/white wire from the 12m. pin and connecting it to the spare pin on the rear wafer; now, using a short piece of wire, connect the 12m. pin to the four pins that are joined together alongside it. Not only has this changed the coils used on 12m. but has made the old 12m. coils redundant and wired the diode switches onto the 160m. position on the bandswitch. These coils can now be changed for ones suitable for 160 metres.

Next take a 12-inch length of clear plastic covered wire (about the only colour not used in the FT-707) and connect it to the spare terminal on the front wafer of the wavechange switch and then refit the switch taking care not to overtighten the fixing nut. This new wire will be the supply for the new premix oscillator required for 160m. which will be covered later.

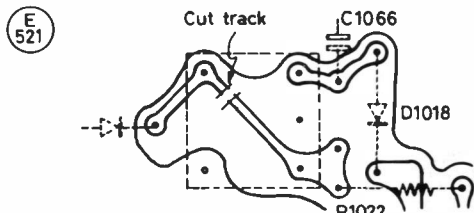
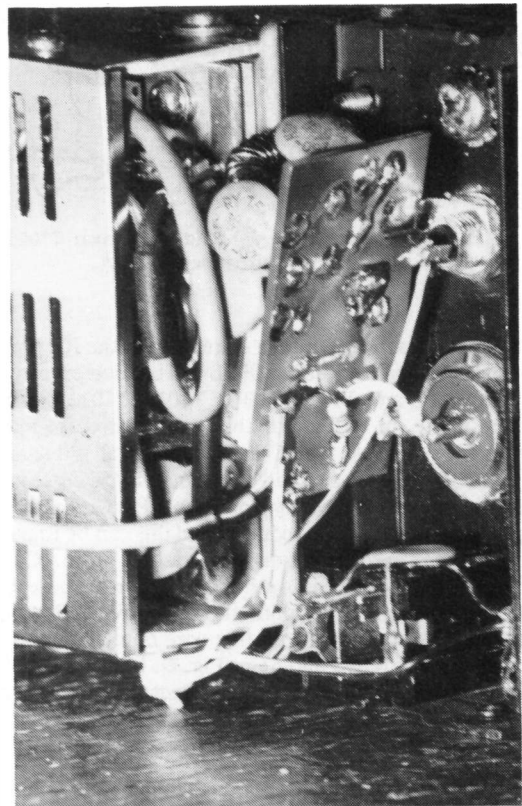

Fig. 4 PCB and component layout (Old style) near T1010 RF input tuned circuit showing cut track in pcb.

**Table of Values**

R1 = 270R	C3135 = 270pF poly or d/c
R2 = 52R	C4807, C4809 = 2000pF d/c
R3, R4, R7, R8,	C4808 = 1000pF d/c
R9, R10 = 22K	L1 = 113KN2K241 (Cirkit)
R5, R11 = 100R	L1024 = 100µH, RFC
R6 = 22R	T1010, T1025, T1026, (T1016),
R3145 = 22K	(T1017), (T1032), (T1033)
R3146 = 10K	= 119ANA5871HM (Cirkit)
R3148 = 1K	T1044, T1045, (T1051), (T1052)
C1, C2, C3, C9	= 119LC30099N (Cirkit)
C10 = 180pF poly	L2, L3 = 26 turns, 22 swg,
C4, C5, C6,	spaced on T68-2 toroid
C7 = 1500pF ceramic	L4801, L4806 = 8.2µH
C8 = 220pF poly	L4803, L4804 = 3.3µH
C1021 = 100pF poly	L4802, L4805 = 10µH
C1028, C1035,	D1 = 1S1555 or similar switching
C3136 = 0.01µF d/c	diode
C1068, (C1066),	Q3034 = BC109 or similar npn
(C1030) = 47pF poly	Xtal (15.9875) = FT-101 spare part
C1111, (C1151) = 1000pF d/c	7180013, HC18/U 210147
C1175, C1176, (C1152),	RL1 = 6V 1-p/2-w min. relay
(C1153) = 68pF poly	RL2 = 2-p/2-w min. relay
C3132 = 0.047µF d/c	

Notes: All resistors are ¼-watt. Capacitors and relays can be obtained from M.S. Components, Zephyr House, Waring Street, West Norwood, London SE27 9LH (tel: 01-670 4466). Cirkit's address is 200 North Service Road, Brentwood, Essex (tel: 0277-211490).



Mounting the 160m. low pass filter.

Having completed that part of the operation it is now desirable to re-assemble the set and test that everything is functioning as expected.

**The New Coils**

Before we start, the component numbers in brackets refer to the new style front end and with two tuned circuits between the aerial input and the RF amplifier, the other numbers refer to the older boards with only one input tuned circuit.

**RF Input, Early Version**

This is the most fiddly part of the operation and one that I was not looking forward to but, in the end, it was quite painless. There are no coils on the market that can be just 'plugged in' without modification but luckily there are a limited number of appropriate transformers and chokes available that are suitable for modification.

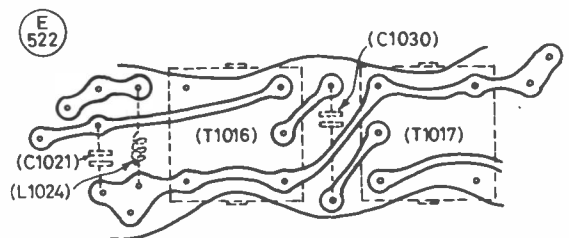
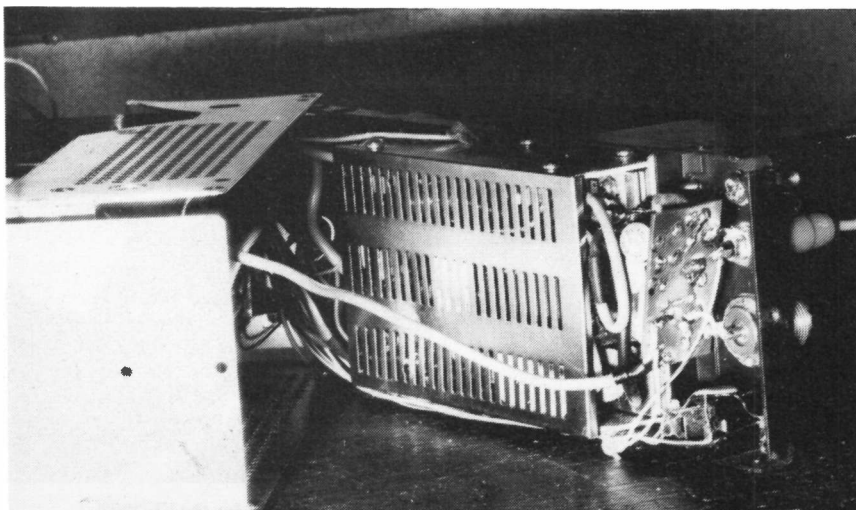

Fig.5 PCB and component layout (New style) near T1016 and T1017 RF input tuned circuits



The FT-707's PA box open, showing the low pass filter for 160 metres.

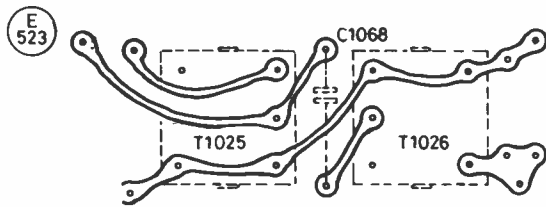

Fig. 6 PC and component layout (Old style) near T1025 and T1026 RF stage output tuned circuits.

We will cover each coil in turn starting with the RF input coil T1010 (the input coils for the new PCB will be covered later). This along with T1025 and T1026 (T1016, T1017, T1032 and T1033) have to resonate on 160m. For this position we use modified 'adjustable RF chokes' which have a nominal inductance of 45μH. For T1010 we have to add a low impedance input winding and for this we need some very fine enamelled wire of about 40 s.w.g.; only a short length is required and this can be found in IF transformers salvaged from an old trannie radio. Carefully remove the outer can by bending the four lugs on the base, the top ferrite cup will come away with the can leaving the exposed bobbin. Wind four turns of the fine wire onto the bobbin and connect the ends to pins 3 and 6 (see Fig. 2). Remove the original T1010 and replace with the new one, connect a 180pF capacitor on the underside of the PCB between pins 1 and 3, change C1028 to 0.01μF, and cut the PCB track between pins 3 and 6 (see Fig. 4).

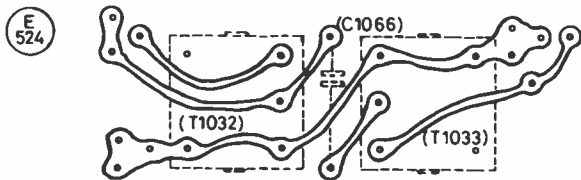

Fig. 7 PC and component layout (New style) (T1032) and (T1033) RF stage output tuned circuits

### RF Input, Later Version, and RF Output Both Models

T1025 and T1026 (T1016, T1017, T1032 and T1033 in the new style PCB) are all modified the same way. Remove the covers and locate pin 3, carefully break the fine wire using a watchmaker's screwdriver. Unwind 26 turns and form a tap onto pin 2; it is not necessary to clean the wire as a hot iron will 'solder through' the insulation. Wind back on 23 turns and finish on pin 3 (ensure that you rewind them in the same direction as they were before they were removed). Check with a meter on the ohms range that the insulation has soldered through. Replace the original T1025 and T1026 (T1032, and T1033) and change C1068 to 47pF. On the new style board replace (T1016) and (T1017) with the two remaining modified coils, change (C1030) and (C1066) to 47pF, (C1021) to 100pF and (L1024) to 100μH. In all cases solder 180pF capacitors between pins 1 and 3.

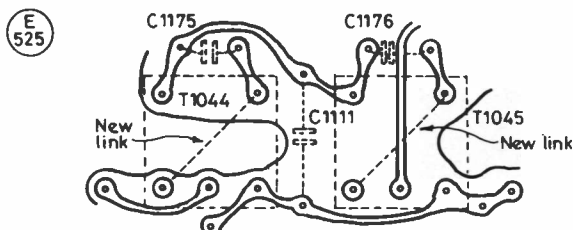

Fig. 8 PC and component layout (Old style) T1044 and T1045 Premix osc. filter showing links.

The next part of the operation is to change the premix tuned circuits to cover the range 10.7875 to 10.9875 MHz; suitable coils for this application are 10.7 MHz IF transformers type 119LC30099N, available from *Cirkit*. Remove the bobbins from the cans and remove the fine wires from pins 4 and 6, this disconnects the secondary winding. Carefully smash the small capacitors in the base of the coils and replace the cans. Use these transformers in place of T1044 (T1051) and T1045 (T1052). Replace C1175 (C1152) and C1176 (C1153) with 68pF and C1111 (C1151) with 1000pF and place links on the PCB between pins 3 and 6 on each coil, taking care that they do not touch the groundplane.

*to be continued*

### ROO-Extra

More pictures of G3ROO's mobile microphones project, which appeared in last month's issue.

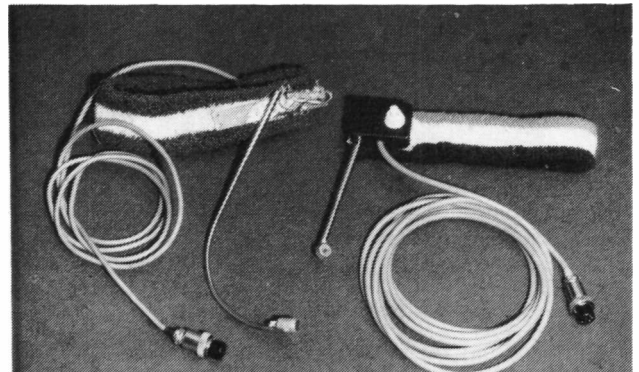

'McEnroe' microphones: for the FT-707 (left) and the FT-290R. Below, microphone head details with, again, FT-707 mic. on the left.

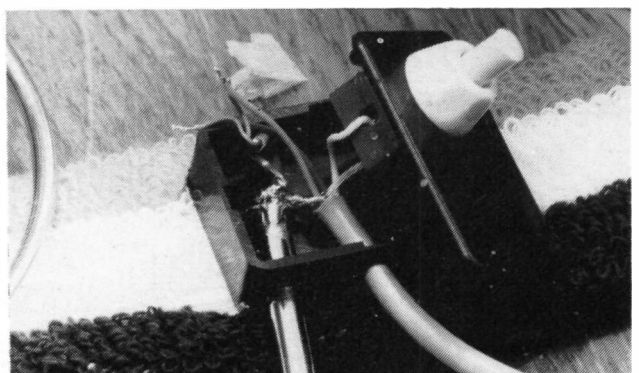
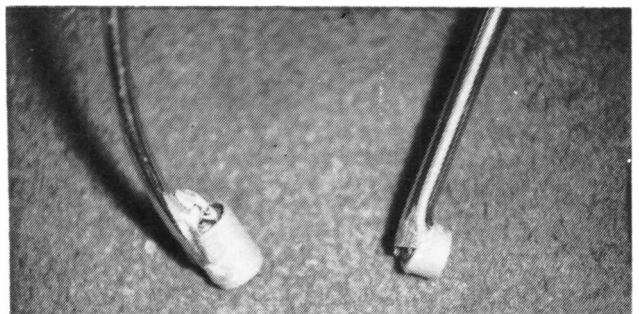

Inside the 'McEnroe' mic. box for the FT-290R.

# COMMUNICATION and DX NEWS

E. P. Essery, G3KFE

## Conditions

**B**Y and large, considering the position we occupy in the solar cycle time scale, not bad at all. Some one-hop and short skip on Ten, and even the odd long-distance contact were reported, implying things were quite tolerable on other bands, with Twenty often open until quite late — well, after this old-timer was safely tucked-up, anyway. So — let's look a little closer.

## Events

Pitcairn Is. are getting positively crowded with ham licensees; first it was VR6TC, then Kari VR6KY, as residents, and now we hear that G3OKQ is there for five months helping with repairs to the jetty and licensed as VR6JR.

Also noted in the *DX News Sheet* is the business of Mt. Athos. Seems that the monks have rebelled a bit — they have written to the civil authority indicating that they will never again permit amateur radio on the Mount.

The station recently around and signing 3A2TO was a very definite dud. Although it sent out some QSLs claiming legality, it gave data which proved otherwise, and the Monaco Amateur Radio Society have raised the matter, we understand, with ARRL.

The G3KQL/TT8 station is raising a few eyebrows. It puts a pretty weak signal into Europe and claims that this is because of beaming to U.S.A. for the 'military transmissions' for which the station is claimed to be licensed. True enough, John Weatherly, G3KQL, is based in the U.S.A. and has been for some years, but we can't help but wonder whether this one is in fact John. If you snag him, WFWL is the motto — work him first, worry later!

For the rest of the year you are liable to trip over Australian signals signing VI — all perfectly legitimate, and celebrating the 75th anniversary of WIA.

The BY stations seem to be getting into the logs of people at a rather quicker rate than of yore, and we notice CE0ZIJ operational from Easter Is.

## Silent Keys

VK3AH wrote to *DXNS* to report the death of PY1SM from a heart attack, less than one month before his 100th birthday. PY1SM was very active right up to the time he was taken ill and must surely have been the oldest active radio amateur in the world.

The other one was YS1UL, Bob, after a short illness. The local DX club are accepting donations in Bob's name for the

local orphanage. Send your bit to: YS DX Club, PO Box 05-43, San Salvador, El Salvador.

Somewhat earlier in time was the death of that well known DX operator, CT1OF. 'Jim' was a regular provider on input to *DXNS*, and we understand that CT1BOF has been asked to convey the sympathies of the DX fraternity to Jim's family.

## Top Band

According to *DXNS* the Americans will, after June 17, be permitted the following modes on Top Band: A1A, A3E, F1B, F3E, G3E, A3C, A3F and F3F.

G2HKU (Sheppey) hasn't been very active, thanks to an outbreak of ground elder in his garden, which positively thrives on weedkiller. Were that not enough the pond pump has been having hysterics and now lies on the bench, just alongside the monitor TV which also has decided to go into a faint! However, on SSB the early Sunday sessions with PA0PN continue, and on CW LG5LG and 7S6SSA were also worked.

G4OBK (Chorley) wrote early, just before NFD, and his reason for absence over the past few months is now clear — Phil's long period of saving-up is over and the garden now sports a tribander at the top of a tower. This is good for Ten of course, and Top Band activity has been lower. Nonetheless, CW accounted for LA7JB and LZ2KZA, while SSB contact was made with OH0MM/OJ0. This last one should be a new one; it is a long time since one recalls Market Reef being on Top Band.

Another early reporter was G3BDQ (Hastings) who was going to be having a holiday in The Smoke at deadline time. John was all-CW, and his contacts were out to AA1K, K1ZM, W2GVX, W2ADH, VE1ZZ, PY1BVY, UP2BP/UF, OL9CQW, UA9CBO, and the Swedish stations 7S3SSA and 7S6SSA.

G4AKY (Newport, Essex) has just returned from a Welsh holiday; in April there was a contact with A92E about which Dave is rather doubtful, plus in May UA9FNR, UJ8JS, GV2DX, GV2WMR, GV2VED, 7S6SSA, UA9CBO, TF3KG and JY9WR (QSL via G4ATS) for a new country. There was also an interesting daylight one with GU2FRO, flying a balloon or kite aerial who was rather surprised to reach out to G4AKY, on SSB. Part of the ragchew was devoted to happy memories of G3APA/GC3APA — Ted it will be recalled used to be on from Sark on Top Band, although the writer's memories

of him go back to thirty years ago when he was in Coventry. An operator to be really missed.

## Ten Metres

First we have a new reporter in GW4ZWO (Abergele) who has fifteen watts of input to a verticle dipole at 10 ft. a.g.l. On SSB there were contacts with OK2BTI, HA2EEO, DL8NAZ, SP6DVP, DK7NL, LA9V, SM6NJK, SM5MGW, DF2UU, SM5POS, DL8SCC, DF3VW, DL3SBI, DF3XZ, Y25XH, and I4OWH; FM gave DL2GBT, and DF9TF, while CW was used to work SP6CDP and a half-contact with DL1RX which sank in the QRM. All this was on May 1, and on 2nd SSB accounted for DK7RT, IK2DRC and I2KAJ; CW was used for DJ1OJ. May 3 saw the band open again, and this time the CW knocked off DF2UU, EA3FDQ, while LZ1BK and YU3UR were heard. On SSB, OK2BTI, DF2UU, EA9NW, EA3EQS, plus some HG stations heard but lost in deep QSB. Just goes to show that there is business to be transacted on the band if you go and look for it!

GW4BLE (Newport, Gwent) reckons the band conditions, considering how far down the side of the cycle we are, were very good indeed, particularly around mid-month. Without his linear, so running barefoot, Steve used his SSB to work CE3AUO, CT1, CT3BM, EA, EA6MR, EA9YV, EL1AH, EL2AK, HA, HG, LU1FOW, LU7DEE, OK, PY5EG, RB7GA, TK/G3KFT, TR8JLD, TR8SA, TZ6FE, UA3, UA4, UA6, UL8AWE, Y39, OE3HGB/YK, ZD8LJ, and 7Q7LW.

Turning now to G6QQ (Hoveton), David wasn't all that active, having not operated on nineteen days of the month. On Ten he offers IV3YRN, YU3CK, UB4DWL, HG8WQ, RP2BDI, UQ2GJN, RQ2GDO, EA3FHT, and EA3BDE.

G4HZW (Knutsford) stuck to Ten and SSB with his TS-820 and Quad; Tony found it a most interesting month, with some Spor-E and some real DX too. On the latter front were such contacts as LZ, YU, HA, OK, I, UB4, UP2, OH, DL, SP, EA, UQ2, UA1, UB5, SM, OZ, LA plus EI2AW in Limerick, and SO1MN; SO is stated to be the prefix for foreigners living in Poland, and SO1MN had retired to live in that country. Turning to the more DX'y signals raised, we note EL2AK, 7Q7LW, OE3HGB/YK, UA6ARE, RA9FCB, UA9CRR, the last two being in Zone 17



which, G4HZW felt, indicated the chance of a Stateside opening later — but this in fact didn't materialise.

G4VFG (Ivybridge, Devon) found the band so interesting that he stuck totally there. Friends had reported the CX, PY, 8P6 stations around, but Peter's own crop was ten EAs, IT9TVF, EL8M, OK2BTI, UP1BXB, IK3FHP, a QRPp I3ZJL on one watt, YU2NA, I1FY on three watts of QRP, EI8EV, DL9HBZ, DF8TK, CT1IR, CN8MC, CT1KN, IM0UXZ (Santa Monica, S.W. of Sardinia) IS0CDS, YU2RMZ, IK0EUP, all on Sideband; CW got out to YU2VC, YU2CAO, HA1VE, UA6LTL, and GM3ZRC. Peter notes how the improved conditions brought out the intruders — mostly Italian and other EU stations, plus of course the increased CW activity involved in trying to shift them.

### Award?

Peter, G4VFG concludes his letter by saying that he is a keen 'squares' hunter on two-metres, and he wonders whether a similar scheme would be of interest on Ten as a way of spreading activity out and around during the next years of sunspotlessness. Any views — from contributors or others — will be welcome on this idea.

However, back to the ten-metre clip. G4ZZG (Warrington) is another new contributor who noted our comments back in April about intruders reading about ten-metre activity or its absence. Charles does not, he says, report any exotic DX, but he has noticed and dealt with the Spor-E and short-skip openings he has come across. The machinery is a TS-120V into an ex-CB vertical minus loading coil, and fitted on the chimney with three radials; this is used with an ATU on 14/21/28 MHz. As there are restrictive covenants in force on the house, a certain amount of care is called for. Operation is mainly CW on 21/14 MHz, but SSB on Ten where the noise is less likely to drown the signal. Now, the interesting thing about this is that although there were days when the beacons were not heard, signals were heard on every day, and worked on all but one, when the EAs were so plentiful they must have swamped him for he couldn't raise even one. On SSB the following were worked: OH5BM, C5AFE (swamped under a pile-up!) SM5FSB, DJ8UI, F6DOV, G4XQA, G3JQ, G4PVI/M, DL2SAD, G4XZX, EA3ATK, G0AXG, EA3FHP, SM4BHF, EA3ELZ, OK3CEG, G4YSN/M, DL2SAV, OK2BHU, OE6UX, EA1AHY, CT1CNP and IK8DOI both calling CQ contest on May 19, DL8MAL, DL8MBN, then the blank day on May 20, IK8EVE, HA0KHK, YU3KK, UQ2GJN, F6IRG, IOJIN, DL1SN, SM5DYC, G4YKR, SM7HGD, SM6NWM, HA4ZZ, LA9TV, EA4CGN, LA0EP, HA5KKN, LA9TV, EA4CFN, lots of EAs on May 29, I6SNP, SK7HW, DK9QD and G4WXO, in date

order through the month. CW accounted for DL1RX, IK5CXL, SP3FDD, F3NB. However, looking at the beacons, G4ZZG would like to know what the 'thing' on 28.2 is that he heard, several times, sending its call as: FUEEEEEKEA? Incidentally, Charles is no newcomer to this game, despite his call — he was trained in the R.A.F., took his C & G certificates in 1944, and worked on X and S band radar to gain exemption from RAE in 1946, but couldn't manage the Morse. When retirement came along, the RAE was passed okay and then seven months work got through the Morse test.

Now we come to the 28 MHz report from G3NOF (Yeovil). Don has been looking at the CB interference on the band in his area, and he says he finds most of it falls into two parts, namely French/Italian stations definitely in the band, and spurious outputs from legal CB FM stations in the band. The EU intruders have been audible between 0800-2300z as have the EU ten-metre signals. Around 1800z the band has often opened to South America, and on one day VU2DVP came through for about thirty minutes. SSB contacts were made with CE4NV, CN2AQ, GM4LER in the Shetlands, LG5LG, OE3HGB/YK, PY5EG, VU2DVP, and 5B4DN.

Full of beans is the verdict of G4OBK. Phil says he found the band full of life with more sporadic-E about than in 1984. So far this year 26 countries have been worked and in the current month the offering is: on SSB EA6MR, HG40Z, IS0XRI, TK/DK9CG, while CW was used for the contacts with C30BBA, PZ1DT, 5B4DN, LZ2HA, CE3DNP, and PU2MIK.

Finally, on CW, G3BDQ worked many NFD stations, and on Phone, IK8EVE, I8LQS/IB0, IK3FXJ, CT1CHV, SP3PPK, TK/DK9CG, YU2CBM — as John says, not really DX, but at least activity.

### New Bands

Let's start with G4UZN (Leeds), who notes that we didn't use his report last time . . . so what's at the top of the left-hand column on p. 149 then — scotch mist? Not very often that one of the gang misses, so Tony quite made my day! Turning to his doings on the air, we see, on 10 MHz, KP4PS, OA4SS, VE7VC, VP2MDY, V2A, W5ZF, in New Mexico, 4X4WF and 5B4OG. It was all heard activity on 18 MHz, with EU of course, plus LU1DOW, LU1DZ, DL2GG/YV5, ZS6BMS, and 9J2BO. As for 24 MHz, it has been the scene of many European openings, plus LU1DOW and 9J2BO. Tony notes that the Ws have this band from June 22 so with any luck there should be a notable rise in activity.

G2HKU found time, in between weeding and mending things to look at 10 MHz and to work G6ZY/EA6, SM5KX and N4SU.

During the Activity Weekend, G4FLK came on and sampled all three bands. On June 1, between 0600-0800z, he had twenty minutes at a time listening on each band with these results: on 10 MHz, he heard DL1MO, DJ6CP, OZ1HRQ, DJ8QR, Y26DM and LA1IE, plus a QSO with DL1NAW/P. 18 MHz yielded lots of G6HL, a thing signing 74BXEN (!), J28EI, VK3XA, HB9QQ and a contact with VK3MR. 24 Mhz was — er, dormant. Next morning the tack was repeated and on 10 MHz contacts were made with OK4HBE/MM, VK3XB and Y22TO, while logging OE9SLH, OZ1KYL, N4FNG, DL6NB, VK2AKE, W7RK, F3NB, G6CJ, and others. 18 MHz produced loggings of ZS6AVM, HB9AMZ, LU1DOW, DL6NB, SM6CYZ, OZ1EUO, DL7UX, in between working Y22TO and J28EI. On 24 MHz things were poor, but Y22TO was worked and G4PGW heard in the morning, while a tea-time session for an hour gave OE6WK, and SM6LQG/MM logged and J28EI worked.

### "CDXN" deadlines for the next three months:

August issue — July 4th  
September issue — August 8th  
October issue — September 5th  
*Be sure to note these dates*

Now we turn to a couple of letters from G3EKP (Blackburn) who used to be active on 70 MHz. Last month he started on the new bands with a dipole for 10 MHz, and worked lots of things, a sample being K3DV, OE3PH, VE3UT, VK5LU, VK2QM, NP2AB (Virgin Is.), VK3BXN, EA3BPQ, HB9CWJ, VK3DQ, three times, LU9CV and lots of Europeans. In the middle of the month an 18 MHz dipole went up, to produce SM6LQG/MM off Newfoundland in a gale, LU6EF/D, DJ2FR, F6CTK, LA5RX, Y26FL, and LU1DOW — so, as G3EKP says, there is activity there. The second letter indicates that G3EKP had next had the idea of feeding his 18 MHz dipole through the station ATU with 24 MHz RF; this turned up contacts with GJ3EML, OZ2RH, Y22TO, I2VUC, DK6BR, IK2EYP, G4UUS, G4UZN, and G4DLE — so Jim says the next move will be a proper aerial for the band once he gets back from holiday.

### Snippets

First the Ipswich Radio Club Golden Jubilee Award; the Award requires you to get 50 points, 25 of these must be for contacts with Suffolk and Ipswich Radio Club. Contacts with a G station count one point, a station in Suffolk counts two

points, a member of Ipswich club counts three, and the club stations G1IRC, G4IRC, and GB2IRC count five — these calls will be on the air in several special-event appearances through the year. Any mode, and band, but no repeater contacts; certificates may be endorsed for a single band or mode. Applications for the award, must be certified by your local club chairman or secretary, or by a representative of RSGB, to be sent (along with six IRCs, £1 or a couple of dollars) to Alan Owen, G4HMF, 102 Constable Road, Ipswich IP42XA, before March 31, 1986; and of course all QSOs to have been in 1985. The certificate you will receive is a quite handsome effort, signed by the club's President and the Mayor of Ipswich, while *Arrow Electronics* are sponsoring the award.

We have a letter from G4HPU of the WAB organisation. At the last AGM (at Drayton Manor Rally) it was stated that £250 had gone to RAIBC and a £100 donation to QTI, and acknowledgements received. Membership in the WAB setup is open to anyone who buys the WAB book, which nowadays cost £4, plus £1 for post and packing, from G4KSQ who is QTHR. Make your cheques to Worked All Britain Awards account.

We have a letter from WIA about their new prefix, to celebrate WIA's 75th anniversary. Aussie radio amateurs may use VI instead of VK, but are being encouraged to only do so if they can send out a VI QSL card. In addition they will have a commemorative station signing VK75A on the air until December 31, which is authorised for use anywhere in Australia, and it will be looking for DX QSOs. QSLs to the VK3 Bureau, or alternatively to VK3WI direct. Additionally there is an Award; to get yours you either (a) work VK75A, or (b) work someone who has already qualified as in (a) and obtain his/her certificate number as part of the QSO; (c) work 75 WIA members, and get their membership number as part of the QSO, no more than 30 of these to be in any one call area. Claim to include a log extract of the contacts, and two dollars to cover the certificate handling and postage costs, and to be sent to: WIA 75 Award Manager, Wireless Institute of Australia, 412 Brunswick Street, Fitzroy 3065, Victoria, Australia.

### Eighty

Turning now to G2NJ (Peterborough), Nick seems to have had his mite of entertainment with the HW-8, despite the summer QSB and the thunderstorm noises. An interesting one was

ON4PAX/P, a club station with a special call from Ypres operated by ON7EW. The station was stated to be 2km from where the first gas attack was made on May 22, 1915. On a different tack there was a contact with G3KSU, who is assistant curator at the Wireless Museum in the Isle of Wight — his two watts was driven with a key dating to 1918. The very next day the curator himself — G3KPO — popped in for a short visit having just returned from his Russian trip, were he received a warm welcome from the local amateurs. On a different tack again, G6IF is playing around with a CO/PA transmitter using an 807, a replica of one he built years ago — it was putting out a fine signal.

GW4BLE reckons the early-morning sessions are out until autumn, unless you are prepared to be a very early bird — like 0430! Bob, ZL2BT, was heard out /M one morning around 0630, so he is obviously out of hospital and on the mend. Another one worked was 3D6AN, thanks to a tip-off over the local two-metre alerting channel.

G4OBK offers CW with UA9SA, UL7CW, 5Z4MX, OH2BCI/OH0, LG5LG, W1KM/HB0, DK111, UP2NK/UF, plus a SSB contact with 7X2LS.

It was CW all the way for G3BDQ, who offers 4N0D, UA9KAA, UA9CBM, UA0BDJ, UL7BX, EO9ACS, EW0CL, and OG3AA.

### Forty

First we have G4FUT (Ryhope) who reckons he has had enough of VHF for the moment; thus he is on 7 MHz with a "dipole so low it gives long-path *via* moonbounce". The knack is clearly there though, as on CW the following are offered: W2BA, LU3ESH, CM5HL, KU1H, PS7OS, VE1BEI, KV8Q, N1DG, VE3OBM, AI5P/TF, PP2WD, PY2MT, UA9FLA, ZS5BH, and WA2SON, plus a collection of small fry.

Another CW man is G2HKU who found KD8QW, UA9XBK, W4ZMQ, G3VTT/W4, TV8QY, and KA8HOK/VP9.

Turning to G3BDQ, John also stuck to the keyer, with a reward by way of contacts with UA9XHT, UA9CI, UA0ABL, OH0MM/OJ0, P29PR who came back to a CQ one evening, VK2APK, VK2PA, JA1AAE, JA5BJC, and ZS6DN.

Yet another all-CW report comes from G4OBK, who found HJ1LR, K1MM, UP3BI/UF, TI0RCT, HB0/DK111, CT3ET, and UL7FEC.

The usual routine for Forty at GW4BLE is to have a session between about

6.45-7.30 local time, and SSB in this time-slot accounted for C6ANU, CE3DPD, CE0ZIJ (Easter Is.) CP6CJS, HK1IOE, HK3IHPN (the four-letter suffix is an indication of novice status), HK5ISX, HC6FS/5, OA4AWS, OA4FT, TI2CF, several VKs, XE1VIC, YV5HAQ, ZL4IG, and 8R1RPN.

### Fifteen

Obviously, if Ten were going to show signs, 21 MHz would do it better! G6QQ stuck to his key, and worked RL8PYL, A92EM, NM5M, 5Z4MX, ZS1CT, NP4CC, J28EI, LU4FDM, LU2DSL, 4Z4NUT, and 4X6NM, all in the WPX contest.

G3NOF next; Don says that in the first half of the month the band was open most afternoons to Africa, but later these openings became fewer. After several weeks of absence a few East Coast Ws were noted in the evenings, also Indians and South Americans. Other than YC5NOF, in the DK9KE net, nothing was heard of Asia, Australasia or the Pacific, until May 28 when Don was called by G3OKQ/MM 700 miles from Pitcairn, at 2158 — and unusual opening. SSB contacts were made with DL7FT/SV9, G3OKQ/MM, G5CW/EA8, G14FUM/ZS1, J28AG, J88AB, JA2DV/MM off Greece, OE1EHB/5B4, PY2CIL, PY7ZZ, S79CW, ST5ALR, TA1A, TI2KD, TL8CK, TR8DR, TR8LD, TR8SA, TU2OK, VP2MDG, VP2MO, W2JT/V2A, XT2BR, YC5NOF, ZD7CW, ZD8JP, ZP5CDB, ZS1SL, ZS3GB, ZS5DT, (ex-9J2DT), ZS6CDZ, 3B8CA, 3B8FP, 5H3YL, 7P8AE, 7P8CM, and 9Y4NW.

GW4BLE found some DX mixed up with the VHF-type propagation, but agrees that the path to the States was absent most of the time. SSB contacts were made with CE2BIC, EC9IR, FM4DN, FT8XB, J28DN, LU5DIT, PY5EG, PZ1DR, S79CW, TL8CK (this one was raised twice, once at 0650z at S9+), TR8DR, TU2OK, TU2LM, WB8YUC/VP5, VE3JGC/VP9, ZD8LJ, ZS3BI, 5Z4RT, and 7P8CM.

On 21 MHz, G4OBK records one SSB contact, with OE1EHB/5B4, plus CW contacts with UA9s, UA0s, UL7CH, UM8MM, UI8BI, PYs, LUs, IS0SZU, NP4CC, HH2WW, CE3DNP, UH8EAA, TR1G, HZ1HZ, 5Z4MX, and OH0MM/OJ0.

A mixed crop at G3BDQ included CW to JA3YBF, 5Z4MX, NP4CC, UH8EAA, EA5YU/EA8, 4X6IF, plus Phone to VQ9YR (Diego Garcia), 7P8CM, and VU2GI.

### Now Twenty

Let G2HKU have first shout this time; Ted used his Morse key to get at VE3NOC, K4KQ, LU9CV, ZP5LOY, PY1QN, K4BAI, VP2E/NL7G, UA0BAJ, FM4CW, G3VTT/W1, G4BUE/W1, G3VTT/W4, and OA4Z.

CW all the way again with G3BDQ, who mentions his contacts with HL1EJ, DV1TV (Manila), V2A, TI2LK, VP2E/NL7G, (Anguilla), JY9WR, FG5XC, AP2AM, TF3XUU/8 on a light-house near Keflavik, VU2RMM, VU2SKP, AI5P/TF, operated by W3HNC, DK6NV/SV9, JE2UYV/MM near Muscat, KL7Y, KL7MF, KH6XX, lots of VE7s, W7s, PYs, lots of JAs, 7S2SSA, 7S5SSA and 7S7SSA, plus OG1AA who turned out to be OH1AA in a disguise. There was one SSB contact, with SP0BEM, an exhibition station.

Sorting through the log from G4OBK, we find Phil using SSB to get out to GU0/ON4TJ, 7S2SSA, A4XRS, EE9UIT, OD5YU, UI8AG, CT3EU, 7X5VBK, UJ8SC, plus CW to UW3HY/1 (Franz Josef Land), HI8DDC,

OH0MM/OJ0, A92EN, TI2LK, all W call areas, NP4CC, PA0JLS/PJ, TR1G, J28EI, HL1CG, LG5LG, 6Y6A, HP1XKR, HH2WW, 8J7ITU, JAs, UI8LB, UA9s and UA0s, HB0/DA1WA, KH6s, VK4XS, FG5DL/FS, VE3DNP, YV5FCK, UH8EAA, 7S3SSA, and V2A.

Twenty was the star turn, avers GW4BLE, with the Pacific over the short path from 0600 onwards on most days — GW4BLE's worst direction, with a barrier of 400 metres of rock a mile away! This is where a linear *does* come in handy! SSB contacts were made with A35TA, A4XRS, AH6FF, AH6FL, AH6FG, BY1QH, EV0AG, FO8LV, FO8MN, JT1KAA, KH6's NH6AT, T32AF, V85GA, VK2, VK3, VK6, VK0DJ and VK0ML (both these two on Mawson Base, Antarctica), YB6NH, YJ8RG, and ZD8LJ. One of the FO8s said he was using a "single element beam" — dipole tied between a couple of palm trees.

Now to G3NOF, who reports short-skip quite noticeable, and only a few weak VK/ZL signals heard on the long path. Don was not on before 0700z but he has

word that there were earlier openings to the Pacific. The band wasn't much good in the day but came back to life in the evenings, the Statesiders peaking around 2300z. Little was heard of Africa or Asia. It added up to Phone contacts with EE9ITU, FM5DD, FW8AF, G3OKQ/MM in the Pacific, HH7PV, HB0/DA1WA, a couple of IB0s, JW0EQ, J6LKZ, KH6SB, KL7LF, KL7TC, KP4BZ, LG5LG, SJ9WL, both Morokulien and operated by G4JBH, UF6FL, UZ9AYA, W2JT/V2A, 4U0ITU, 7S1SSA, 7S3SSA, 7S4SSA, 7S5SSA, and 8P6AW.

Last man in is G6QQ; David used his CW to work W4BW, VE2WQ, UA9OBP, VE1BRP, and JE7JZC, plus Phone to KA9ONO and KE5KK.

### Ending

That's the lot for this time. Deadlines are as shown in the box, and are for the arrival of your letters addressed as always to your conductor, "CDXN", SHORT WAVE MAGAZINE, 34 High Street, Welwyn, Herts. AL6 9EQ. 'By now.

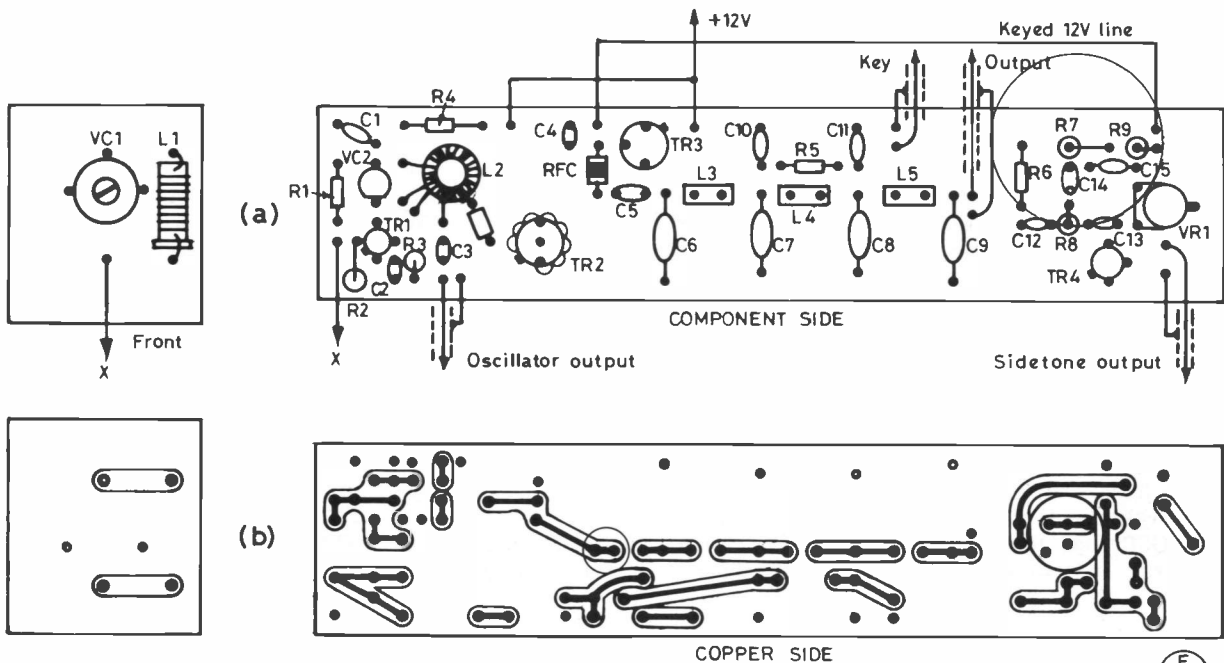

Fig. 2 JLD TRANSMITTER P.C.B LAYOUT (Corrected)



**CORRECTION:** In Part 1 of the "J.L.D." Transceiver (May issue) there were some errors in Fig. 2 on page 120. A corrected transmitter PCB layout is given above, with changes encircled. Also, in Part 2, C8 (Fig. 1, page 161) should be 10nF.

# HF Antennas for Restricted Sites, Part 2

## A Practical Approach to an Everlasting Problem

A. P. ASHTON, G3XAP

IN Part 1 we discussed the method of inductively loading an antenna in order to reduce its physical size yet maintain resonance, and it will have been noted that some care was required in producing suitable loading coils in order to maintain a reasonable level of antenna efficiency. A somewhat simpler method of fitting an antenna into the available space is to 'bend' the device rather than shorten it, and this is a common method.

### Antenna Bending

Where only slight reductions in span are required, the simple approach of erecting an antenna in the 'inverted-V' configuration is a common example of this technique. For example, the W3DZZ type of trapped dipole requires a span of around 110ft. if it is to be erected in a horizontal format, but if we erect it as an inverted-V with its centre at a height of 40ft., and its ends only 5ft. from the ground, the span required is reduced to around 85-90ft. A half-wave dipole for 3.5 MHz, which requires a span of at least 140ft. could be similarly erected in a span of less than 120ft. and either example could make the difference between being able to accommodate the antenna or not. However, most amateurs who have site restrictions are concerned with considerably larger reductions in span than those mentioned, and the bending obviously needs to be more marked.

Before moving on to this more severe bending it is worth going back to 'square one' and consider the current distribution on a half-wave antenna and the significance of the current at a given point. Fig. 1 shows the current and voltage distribution and also indicates the area of maximum radiation, this being the 'business' section of the antenna from which most of the transmitter's energy is radiated during transmission and most signal pick-up occurs during periods of reception. This region of maximum radiation is best left alone since bending in this area will lead to:

- (i) Larger distortions in the radiation pattern,
- (ii) Larger changes in the feed impedance,
- (iii) Larger changes in resonant frequency, and
- (iv) Larger reductions in antenna bandwidth

than will be experienced if we bend the outer sections of the antenna; it is also important that we do not make any bend at an angle greater than 90°.

Having laid down these simple rules, let us take the example of the W3DZZ device mentioned above and consider the ways in which it may be accommodated in restricted sites. Fig. 2 shows various methods of erecting the antenna, 2(a) and 2(b) being the horizontal and inverted-V configurations discussed above. Fig. 2(c) represents an even greater reduction in required span, but it will be noted that the two outer support points will need to be located at least 25ft. from the ground, and preferably 30ft., which

detracts from the inverted-V's advantage of requiring only one high support point. Assuming a centre support point at 40ft. and the two end supports at 25ft., the total span required for the

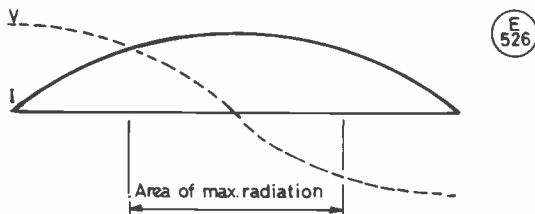
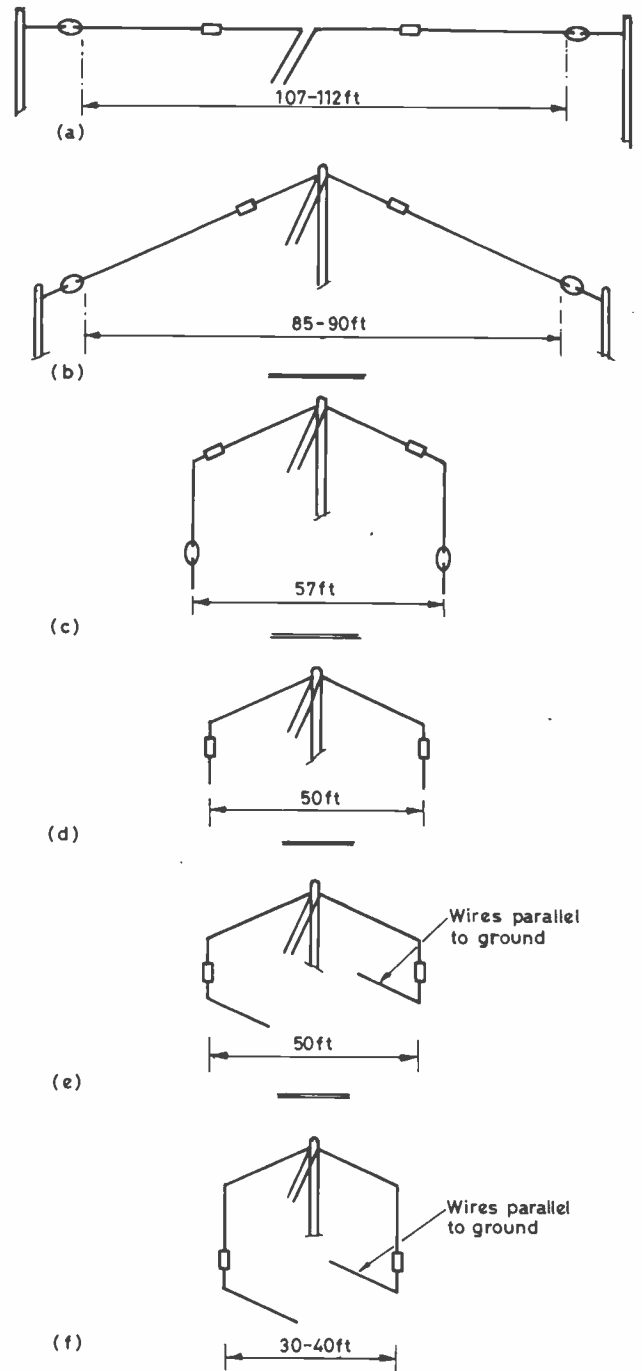

Fig.1 Current and voltage distribution on a half wave antenna

Fig.2 Methods of erecting a W3DZZ trapped dipole. For explanation of spans, see text.

E 526

E 527

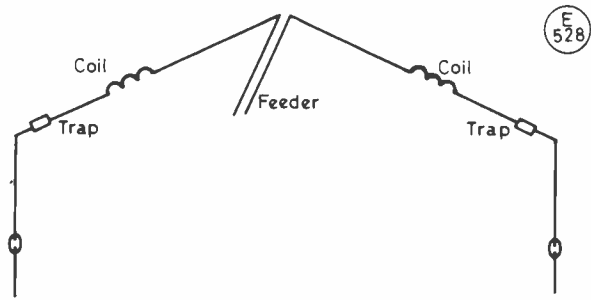

Fig.3 Reducing the span required for a W3DZZ dipole by inductive loading and 'bending'

E 528

W3DZZ will be reduced to around 57ft. Fig. 2(d) is a method of erecting the device without the need to have the end supports elevated, and assuming a centre support of 30ft. high and with the ends 10ft. from the ground, the span is further reduced to around 50ft. Note, however, that when the end supports of a W3DZZ dipole mounted in this manner are as close as 10ft. to the ground, the centre support must be lowered also or the slope of the antenna becomes so steep that performance will be seriously degraded.

It is good practice to ensure that the angle between the two halves of the dipole is never less than 90°, and for the W3DZZ erected as in Fig. 2(b), this means that the difference in height between the centre support and the end supports should not be more than about 38ft. and for one mounted as in Fig. 2(d), the difference should not exceed 23ft. If the dipole is erected as in Fig. 2(d), it will be noted that the device may be seriously detuned and that the feed impedance may be very significantly altered since there is obviously a very high degree of coupling between the sections of the antenna between the traps and the outer sections,

which run directly underneath them. It may also prove impracticable to have these outer sections running across the site in close proximity to the ground and it is suggested that a better alternative may be to run the ends away as depicted in Fig. 2(e).

Even the 50ft. span required for the devices shown in 2(d) and 2(e) may be too much for some sites and a method similar to that in Fig. 2(f) may need to be considered. The actual span required may be reduced to 40ft. or even 30ft., but it must be realised that there is a greater length of wire to be 'folded' into the available area as the span is reduced. The actual layout is open to the ingenuity of the reader, but provided that the guidelines outlined above regarding symmetry and not having angles less than 90° are followed, a surprisingly effective device can result.

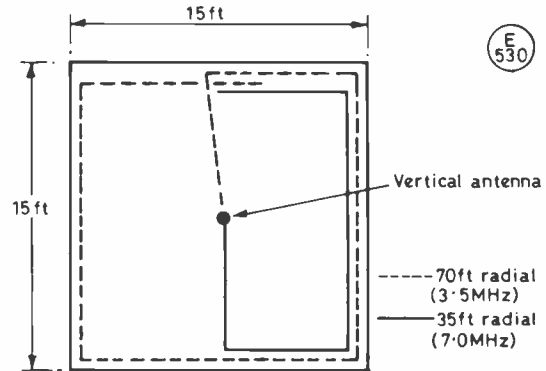

Fig.5 Bending radials to fit into a "restricted" space

E 530

E 529

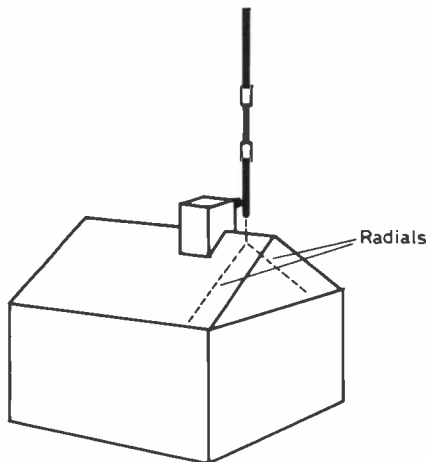

Fig. 4(a) Trapped vertical antenna mounted on chimney stack.

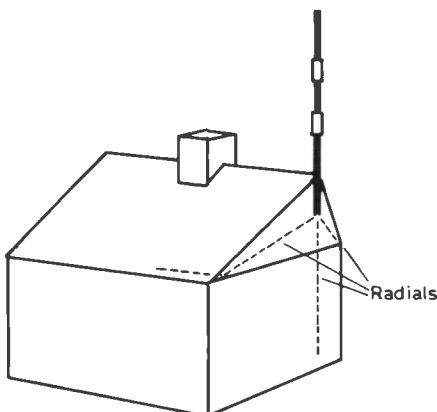

Fig.4(b) Trapped vertical antenna mounted on gable end

At this point it may be worth considering the fact that although we are discussing methods of reducing the area necessary to erect a given antenna under separate headings, there is no reason why two methods should not be used together. The first part of this series discussed inductive loading, and there is no reason why the W3DZZ dipole should not be both individually loaded and bent. Fig. 3 shows one way of combining the two methods, but it must be realised that this will probably convert the antenna into a strictly two band (3.5/7 MHz) device, since the loading effect of the coils when subjected to energy at 14, 21 or 28 MHz will almost certainly move the antenna's resonances away from these frequencies. Since there is an infinite number of inductances and positions in the antenna where they may be inserted, it is possible that a resonance may occur in one or more of these bands, but this will be entirely by accident. In order to maintain the antenna's symmetry, the two loading coils should be as nearly identical as possible, and they must be inserted in identical positions in the two halves of the antenna. A further pair of loading coils could be inserted in the outer sections of the antenna, thus further reducing its overall length, but as the number and size of coils used in an antenna are increased, losses will also increase, whilst the antenna's bandwidth will decrease. However, there is much room here for the reader to experiment and it is hoped that the ideas given will enable an antenna to be fitted into the available area.

Perhaps the most important point to consider when bending an antenna to fit it into a small site is that the high current portion of the device should be in the clear and preferably at the highest point of the antenna. With the dipole type of antenna just discussed this is fairly easy to arrange, but when end-fed wires are used as multi-band antennas, the current antinodes will change position on the wire as we change from one frequency band to another. End fed wires will be discussed in a later part of this series and this aspect will be considered in some detail.

### Vertical Antennas and Inverted-L's

In many cases of restricted area, the restriction applies only in the horizontal plane and it is still possible to think in terms of vertical antennas. However, as the height of a vertical antenna is increased guying becomes necessary and we need to think in terms

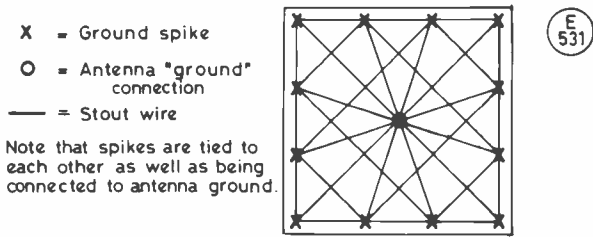

Fig.6 Installation of large numbers of ground spikes on a small plot.

of horizontal space once again. When considering the lower frequency bands (i.e. 3.5 and 7 MHz) we can meet severe problems with verticals which are electrically quarter-wave devices since we will need to provide a radial or ground system against which the antenna can operate. Hence what would appear to be a simple way to overcome our space restrictions becomes less simple as we begin to consider all of the requirements for efficient operation of a vertical antenna.

The author makes no apology for stating yet again that unless we are prepared to provide an effective ground system for a vertical antenna, we will finish up with a device that performs very poorly and will give rise to much frustration and disappointment. It is a fact that the vast majority of cases of ineffective operation of vertical antennas are a direct result of shortcomings in the ground system rather than shortcomings in the vertical antenna itself.

By considering the use of vertical dipole rather than a base fed quarter-wave vertical we can obviate the need for any ground system at all, but this obviously applies more in the case of 14, 21 and 28 MHz, where such a device will be of manageable proportions, than on 3.5 or 7 MHz where vertical dipoles would be respectively 132 and 66ft. in height! However, by applying the principles of inductive loading and bending, such antennas may not be completely out of the question.

Looking firstly at quarter-wave verticals, it is possible to erect them either as single band devices for 14, 21 or 28 MHz, or to construct trapped devices for any two or all three of these bands and yet have a maximum length of about 16ft. This enables them to be erected without guys and they can be fastened to a chimney stack or the gable end of a house and therefore in the clear. They can also be mounted at ground level although, as we are

concerned with restricted sites, it is likely that this method of mounting will lead to severe screening by surrounding structures.

A vertical antenna mounted on a chimney stack can have its radials laid on the roof of the building and will, therefore, slope away from the base of the antenna. This is an advantage in that it has the effect of raising the feed impedance from the 30-ohms or so encountered with radials which are horizontal, to between 40 and 60-ohms, thus providing us with a better match for our 50-ohm coaxial feeder. Fig. 4(a) shows a suggested layout for a three band trapped vertical antenna and uses 4 radials for each band. It has been assumed that the house is semi-detached and that the radials cannot, therefore, be positioned symmetrically around the antenna — the slight distortion to the radiation pattern that will result from this layout should not be significant. Note that some radials may need to be bent and run along the guttering if the distance from the apex of the roof to the eaves is less than about 17ft. — again this practice will not detract seriously from the antenna's performance. Note also that the radials are grouped in 4 'bundles' of three — i.e. one 14 MHz radial, one 21 MHz radial and one 28 MHz radial are taped together to form a single 'bundle' — again this does not appear to affect the performance.

If the antenna is mounted on the gable end as depicted in Fig. 4(b), it is likely that the antenna feedpoint will be well below the apex of the roof and the radials should be run as shown — under no circumstances should any part of any radial be at a height which is above the antenna's feedpoint. Note that Fig. 4(b) shows three sets of radials — this number can be increased if desired.

A trapped vertical dipole could also be mounted as shown in Fig. 4(b) but it must be realised that the ends of the radials in the case of the quarter-wave vertical, and the end of the dipole in the case of the vertical dipole, will have a very high RF potential when operating on 14 MHz and care must be taken to insulate them effectively in order to prevent injury — especially to young children.

Having seen that it is relatively easy to deal with verticals, for 14, 21 and 28 MHz, we must now consider how we can erect efficient vertical antennas for 3.5 and 7 MHz within the confines of a restricted site. The first point to consider is that quarter-wave radials are now becoming rather long and it may prove impossible to accommodate them — especially the 66-plus feet required for 3.5 MHz. Whether our vertical is to be ground mounted or positioned on a building as discussed above, it is recommended that at least one full sized radial should be installed. This radial

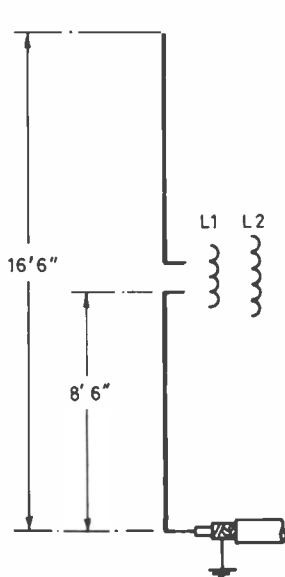

Fig. 7(a) Two band vertical for the 3.5 and 7MHz bands. Coils L1 and L2 'centre-load' the device to resonance.

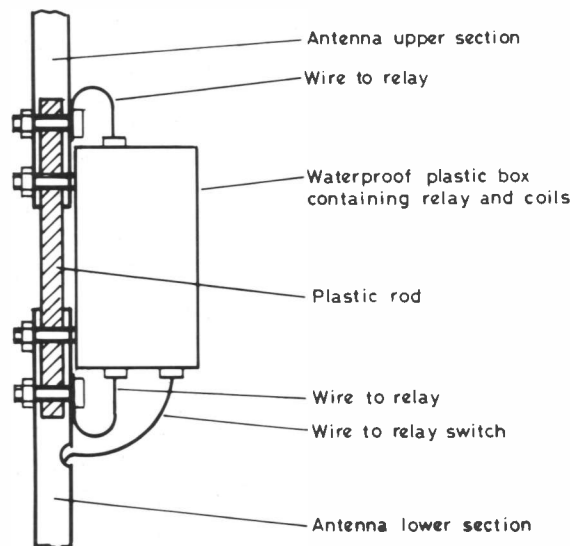

Fig. 7(b) Centre of antenna showing plastic rod insulator and method of securing box containing relay and coils.

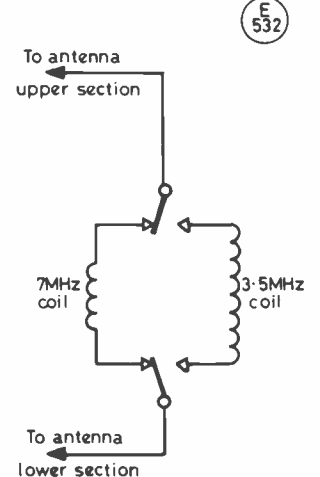

Fig. 7(c) Connections of the coils and relay in waterproof box.



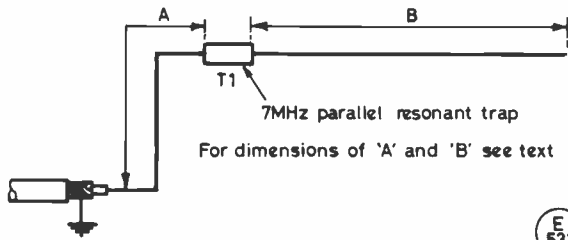

Fig. 8 Multi-band trapped "Inverted L" antenna

will almost certainly need to be bent if the antenna is on a restricted site and it may even have to follow the entire perimeter of the plot and 'overlap' itself at its extreme end.

Fig. 5 shows a two band vertical for 3.5 and 7 MHz in a small plot measuring only 15ft. by 15ft., and it will be seen that the 3.5 MHz radial runs around the entire perimeter and has a few feet of overlap at its very end; it will also be seen that the 7 MHz radial runs alongside the 3.5 MHz radial. This illustration is purely to demonstrate the principle and it is clear that if the 3.5 MHz radial is taken from the antenna directly to one corner of the plot no overlap would, in fact, be required. If the small plot were covered with concrete there is little else that could be done in the way of improving the ground system, except that if a small hole can be made in the concrete at the base of the antenna, a long ground stake could be driven down as deep into the soil as possible in order to establish a "DC" ground, but extreme caution must be exercised on some older properties since it would appear to be easier to hit water supply pipes or drains than it is to miss them! (Murphy's Law). If the plot consists of soil or grass it is recommended that as large a number as possible of ground spikes should be driven in all over the plot, stout wires being run from these to the antenna's radial(s) and to each other — Fig. 6 shows a suggested layout. Such a layout will provide a reasonably low DC resistance and the effort involved will be more than repaid by enhanced antenna performance. The wires can run an inch or so below the ground, being laid in slots cut open with a spade, and after they have been brazed onto the ground spikes, the spikes can be driven down until their tops are also just below the ground, and in this way we finish up with a completely invisible ground system.

If a vertical for 3.5 or 7 MHz (or both) is mounted off the ground, the provision of a ground system is not quite so easy because although one full sized radial can be installed relatively easily by bending it to fit the necessary route, it will not be so easy to provide a series of ground spikes all tied to the antenna's ground terminal. It is suggested that in this situation, as many full sized radials as possible are run across the roof of the house, along guttering, down drain pipes, etc., and that a stout wire be run from the antenna feed point (*i.e.* ground connection) directly down to one earth spike and that other spikes are installed and 'tied together' as in Fig. 6.

Regarding the vertical antenna itself for 3.5 and/or 7 MHz, it is likely that full sized quarter-wave devices will not be possible in a restricted site (partly due to the need for guys) and that some form of bent or loaded device will be necessary. If a centre loaded vertical is decided on, the inductances given in Part 1 of this series will be applicable, and by reducing the antenna to 25% of its full size, we will have a device only 16.5ft. long for 3.5 MHz, this being quite a manageable length even in very restricted locations. By switching inductances in and out of circuit, it is possible to use the same antenna for more than one band, and Fig. 7(a) shows such an antenna for the 3.5 and 7 MHz bands which has been evaluated by the author. Fig. 7(b) shows the detail of how the plastic box containing the coils plus a two-pole change-over relay are fastened to the central area of the antenna, and it will be noted that flying leads from the relay are connected to the upper and lower sections of the antenna — which was constructed from 1¼-inch OD, 18 s.w.g. aluminium tubing. Fig. 7(c) shows how the coils and antenna are connected to the relay, and it is suggested that the coil for the band which is likely to be used most often is the

one which is in circuit when the relay coil is not energised — this will help to prolong the life of the relay and lead to less heat generation. Having trimmed the coils in order to resonate the antenna on 3.5 and 7 MHz, the box is closed and waterproofed. It will be seen from Fig. 7(b) that the wire carrying DC from the shack to the relay coil is passed down the inside of the lower section of the antenna — this is to ensure that it has as little effect on the radiation of the antenna as possible; running the wire alongside and parallel to the antenna is not recommended.

A vertical antenna of this type will not perform as well as a low, horizontal antenna if local and semi-local contacts are required on 3.5 and 7 MHz, but many contacts were made with it and it is considered that in cases where it is impossible to get a decent length of horizontal wire installed, it is well worth a try.

As was discussed with dipoles, an alternative to inductive loading is to bend the antenna into the available area — and this is also possible with vertical antennas, resulting in an 'inverted-L' configuration. Fig. 8 shows a trapped inverted-L, the antenna basically consisting of "one half of a W3DZZ dipole". Length A will be approximately 32ft., and the trap is a 7 MHz parallel resonant device. Length A is adjusted to resonate the antenna on 7 MHz, and then length B is adjusted to resonate the entire antenna on 3.5 MHz and, as with the W3DZZ trapped dipole, resonances will be found in or near to each of the 14, 21 and 28 MHz bands. The vertical section of the antenna can be as long or as short as circumstances permit and it will be found that the antenna will probably outperform the two band inductively loaded 7/3.5 MHz vertical discussed above for local and semi-local contacts on 3.5 and 7 MHz, since the rather short vertical section of the device means that there will be horizontal sections of the antenna carrying a fairly high current and hence radiating horizontally polarised, high angle energy. Like the W3DZZ, it may be found that SWRs get a little high on one or more of the 14, 21 and 28 MHz bands, and some form of antenna matching unit at the transmitter end of the feeder is probably mandatory for these bands. The antenna need not necessarily be in the exact configuration shown in Fig. 8 and can be bent considerably to fit the available area. It is also possible to employ inductive loading in addition to the bending, but, as with the W3DZZ device, this will probably mean the loss of the 14, 21 and 28 MHz bands and be strictly a 3.5/7 MHz two band antenna. Fig. 9 shows such a device on a typical suburban site and suggests a layout that enables the device to be accommodated.

All of the discussion and examples so far have assumed that there is some ground space available, but there are numerous amateurs living in flats or apartments who literally have only the building in which they live on/in which to attach antennas. Indoor antennas and 'invisible' antennas will be discussed later in this series, but it may be desired to attach some form of antenna to the outside of the building. A vertical antenna lends itself to this situation since it can be attached to a building by brackets and lie against the wall as shown in Fig. 10. This presupposes, of course, that it is possible to reach out of the window in order to attach the antenna to the wall, and that there are no objections from the occupiers of the premises immediately above the shack. If a high degree of base loading is used, it should be possible to install an

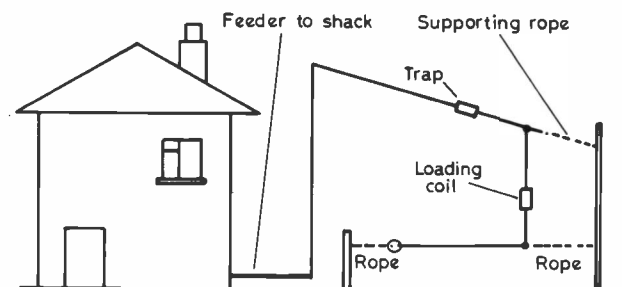

Fig. 9 Loaded trapped "Inverted L" bent into a suburban site

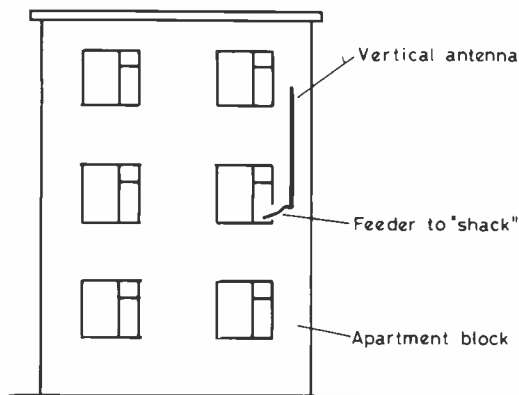

Fig.10(a) Vertical antenna mounted on outside wall of an apartment block.

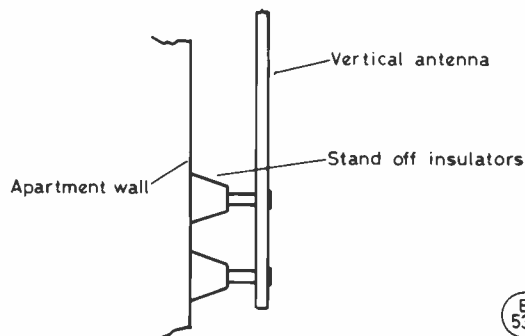

Fig.10(b) Attachment of antenna to apartment wall

efficient device for 14, 21 or 28 MHz without encroaching on other occupant's territory. Radials for such a system will pose difficulties and it is suggested that a single quarter-wave of wire be simply suspended from the base of the antenna — this can be wound up and loosely tied to the antenna when the device is not in use. Such antenna siting is very much of a compromise situation and it can be found that in wet weather its performance may suffer badly since bricks can absorb very large quantities of water, and the whole wall against which the device is mounted will tend to act as a reflector, decreasing the antenna's feed impedance by an alarming amount. Similar effects can be caused by internal wiring or plumbing in the building which can be parallel to, and in close proximity to, the vertical antenna; this can also lead to large amounts of RF getting into the building's wiring — with predictable results!

It is suggested that the flat dweller seeks permission to install his antenna on the roof of the block — it is surprising what can be achieved by asking, so don't automatically assume that permission will be refused. The author knows of one such case where the amateur concerned approached the council who owned the block, asked for permission to install antennas on the roof and *at the time* undertook to take out adequate insurance cover in case of damage or injury. Permission was granted, the only proviso being that the borough engineer's department was required to inspect the installation in order to satisfy the council that the system was secure and posed no threat to anyone's safety. The amateur now has a 5-band trapped vertical on the roof, with radials for each band running across the roof, and the coaxial feeder running down the wall past three flats to his own which is located on the fourth floor from the top. Clips to fasten the coax to the wall were fitted by cooperation from the other flats dwellers who allowed their windows to be used for access for the very few minutes required to fit the clips.

The only warning to be given to any amateur who has received help in this way is not to repay the kindness by causing unnecessary interference to televisions or video recorders! In the case just quoted, severe interference occurs to one video

installation when the 14 MHz band is used, so the amateur concerned does not use 14 MHz at times when the owner of this equipment is likely to be using it — he considers this to be a very small price to pay for what is a superb antenna installation!

*to be continued*

## “G9BF CALLING”

**S**ORRY no recent news from Britain's best genned up station, fans, but G9BF was forced to a -/A location for a year by the rotten D.H.S.S. Some rubbish about not paying out any more dole money and benefits as not enough stamps on card due to long stay in VK. So had to take job to earn bread. The -/A digs useless for serious AR but before QSY did press on with 20m. E-M-E idea.

As reported in Nov. 83 *S.W.M.*, bespoke PL-172 Tx worked FB with dipole antenna but rhombic essential for more gain and big ERP for Moonbounce. Buttonholed local Scout troop leader in pub and he agreed FB idea to use his lot to put up antenna, but what would be in it for them? I said, “What about bob-a-job then?” and he says, “You'll be lucky, mate. It'll be a quid a throw; inflation you see.” After prolonged haggling compromised with G9BF offering to rewire their hut and fix old valve-type record player. This very good deal as all stuff in stock!

Local club owed me a favour so borrowed a few Field Day poles and guys to supplement own ones; not enough trees in the field in the right place. Marked out spots for poles in field with old motor tyres. Next weekend, posse of Cubs and Brownies descended on QTH in a couple of minibuses with two Scouts and a couple of YL Guides. Explained task. Utter chaos ensued, Brownies being right St. Trinians' types. Terrorised innocent little Cubs, chasing them all over the field. Caught some tying the poor things to trees with guy ropes.

Antenna poles and wire eventually erected by OICs and G9BF. Bit of a bodge-up but it pointed more-or-less at the universal window. Realised Cs and Bs nowhere to be seen. Found them in one of the sheds swigging G9BF's special home-brew ale. Head Brownie called Samantha, and a right little horror, said the ginger beer was the best they'd tasted. Thew them some stale sausage rolls and bags of crisps before they piled into their minibuses and departed singing bawdy songs. Really, the youth of today. . . .

Reckoned rhombic legs about 800 feet long so should be bags of gain. Ran open wire feeder to huge ATU made by Dad from bits bought for a song in Lisle Street just after WW2. Used old valve GDO to tune up system then bunged it into the old faithful R-1155 Rx. Terrific sigs. from W and VE, all end-stop with S-meter hard over. Fired up Tx and put out CQ call on the key for a couple of minutes. Bedlam! Great pile-up like I was a VR6. Made a few QSOs with VE4, W5, etc. all reporting “LOUDEST EVER SIG FRM EUROPE OM,” and complaints about bent S-meter needles and de-sensed Rx's.

Next problem to find out when Moon would be on end of rhombic. Enlisted aid of clever-Dick spotty youth in village with old ZX-81 and Moontrack program who came up with dates and times. Trouble was, these were when band was wide open so weak E-M-E sigs would be swamped. Decided test would have to wait till band dead during the small hours but before this, the enforced QSY to the -/A QTH came. Now G9BF QRV again, 20m. open round the clock, so will have to wait. Have had FB QSOs with Ivan the Terrible, UV5AC, and am working on him to put up rhombic for proper E-M-E tests when condx. right.

Just had visit from some twit from local council about G9BF vertical antenna; says it needs planning permission 'cos more than 4m. high or something. Told him to naff off as don't need planning permission to grow big trees so why all the hassle over thin tube? Said I'd grow ivy up it if he didn't like the look of it. Nothing but aggro these days. *73 es CUAGN SN OMs de G9BF.*

# CLUBS ROUNDUP

By "Club Secretary"

**T**O state the obvious, it is absolutely vital that we should have a name and address, plus if possible a telephone number for the Secretaries Panel. That panel is compiled from a data file of names and addresses which is our reference whenever someone writes in and asks about a local club. So — if you want new members, keep the entry on your club up to date!

On phone numbers, it is important to be sure that the telephone number is given in the recommended form of *Exchange Name (STD Code) Number*.

## The Mail

**Abergavenny & Nevill Hall** are first in the pile; find them on Thursdays at 7.30 p.m. at Pen-y-Fal Hospital, Abergavenny, in the room above Male Ward 2.

**Acton, Brentford & Chiswick** have their date on July 16, for a discussion on antennas; as ever at Chiswick Town Hall, High Road, Chiswick, London W4.

## New One

To us, at least. This one is called **Alyn and Deeside** and is to be found at Shotton Social Club, Shotton Lane, Shotton, Deeside, Clwyd, the starting time being at 8 p.m. July 8 is a D/F Hunt and July 22 is a talk on contest arrangements, to be followed by a chat by G3VQT on the uses of computers in amateur radio. To fill up the intervening Monday evenings they have in formals.

Now to **Antrim**; for all the details on this one we must refer you to the Hon. Sec. — see Panel for his details.

Still in GI, and this time **Bangor** where the venue is the Royal Hotel in Bangor, on the first Friday of each month.

**Basingstoke** make special mention of their RAE class, on which full details can be obtained from the Hon. Sec; and he will no doubt have the details on all the club's activities, plus the when-and-where of their venue.

The **Bishops Stortford** crew has its main meeting on the third Monday in the month at the British Legion Club in Windhill — this is the road running from the town centre traffic lights to Much Hadham and Ware. Informals on the first Thursday in the month at the "Nag's Head" on the A120 Dunmow Road in the saloon bar.

The first and third meetings each month at **Bolton** are formals with a speaker or video, or whatever, the others being informals. Find this group any Wednesday evening at the Horwich Leisure Centre.

**B.A.R.T.G.** looks after the interests of all the folk who have an interest in RTTY, packet radio, AMTOR and similar modes of transmission, whether mechanical or electronic. Details from the Hon. Sec. — see Panel.

The **Braintree** arrangements seem to have changed since last we heard; July 3 is the only meeting in the month, for a talk by G4PAY on Egypt. The Hq. is now at St. Peter's Church Hall, St. Peter's Road, off Bocking End, Braintree, starting at 8 p.m.

## Change of Date

The letter from **Brighton** indicates that although they continue to foregather at the Seven Furlong Bar on Brighton Racecourse, they now do so on the first and third Wednesday. More details on 'what gives' from the Hon. Sec. — see Panel.

**Bristol City RSGB** have their place at the Queens Building,

Bristol University, where on July 29 they will have the pleasure of listening to Ron Broadbent, G3AAJ, spelling out in detail about AMSAT and Oscar-10.

Although they get together every Tuesday evening, **Bury** mention July 2 as a surplus equipment sale; normally the 'main' meeting is on the second one of the month. The place is Mosses Community Centre, Cecil Street, Bury.

Next **Cambridgeshire Repeater Group**; they look after the repeaters in the area, and also have some interesting meetings. For details contact the Hon. Sec. — see Panel.

**Cheltenham** comes next, and they are at Charlton Kings Library, in the Stanton Room, on July 19; and in addition they are to man a stand at Bournside School Fete on July 13. More details from the Hon. Sec. — see Panel.

Turning to **Cheshunt** we find they have an RAE course set up once again for East Herts College, Turnford. In addition there will be a Morse class. Find out by going to a meeting — every Wednesday evening at Church Room, Church Lane, Wormley, Herts., except on 24th when they will have their /P evening on Baas Hill Common, Broxbourne.

The **Chester** chaps meet at Chester Rugby Union Football Club, Hare Lane, Vicars Cross, Chester, each Tuesday; the July programme is complicated by the GB4CSB operation, to celebrate 75 years of Scouting in Chester — July 5th to 7th, from Eaton Hall, Chester, the home of His Grace the Duke of Westminster. There will of course be a special QSL. All the details from the Hon. Sec. — see Panel for his statistics.

Special Event stations bulk largely in the **Chichester** thinking too; July 9-13 and 16-20 will be the dates for their GB2CHI from the Chichester 910 festivities, at Guildhall, Priory Park. July 14 is the Sussex Rally, of course at Brighton, so July 2's meeting in the Long Room will be devoted to the details; July 18 is a relaxing evening in the Green Room, and these are at Fernleigh Centre, 40 North Street, Chichester.

## Deadlines for "Clubs" for the next three months—

August issue — June 28th

September issue — July 26th

October issue — August 30th

November issue — September 27th

*Please be sure to note these dates!*

Down to Cornwall, and **Cornish** where they gather on the first Thursday of each month, at the Church Hall, Treleigh, on the Old Redruth By-Pass.

At **Coventry** they are at Baden Powell House, 121 St. Nicholas Street, Radford, Coventry, every Friday evening. July 5 is a treasure hunt followed by a barbecue, and all the remaining sessions are 'open'.

On to **Crawley** where the main thing this time in the newsletter is the tale of G4ZPP's cheap QSL cards — quite hilarious. Try the fourth Wednesday at the United Reformed Church Hall, Ifield, or contact the Hon. Sec. — see Panel.

Turning now to **Crystal Palace** on July 20, you have a good marker to help you find the place — the IBA mast! Hq. is in the All Saints Parish Rooms, Upper Norwood, at the junction of Beulah Hill and Church Road, and opposite the mast. The subject will be op. amps, and the speakers G3OOU and G8OTG.

As far as **Dartford Heath D/F** club's events are concerned we are somewhat confused. The dates are July 2 for an evening hunt, July 28 for the Sunday hunt, and July 23rd for the pre-hunt meeting at the "Horse and Groom," But *where* are the hunts?

We must head north now to **Denby Dale** and the famous Pie — they get together in the Pie Hall. Details from the Hon. Sec. at the address in the Panel.

Now to **Derby** where we still get a feeling of surprise at not seeing G2CVV's name on their letter . . . Find them on any Wednesday evening at 119 Green Lane, Derby, where they have the whole Top Floor.

Every Friday evening the locals at **Devizes** head for the Devizes Football Club Social Club; the first in each month is formal with a speaker, the third is usually some sort of joint social event with other clubs, and the rest are purely social affairs.

At **Droitwich** we have it that the club meets on the second and fourth Monday in each month at the Scout Hq. Union Lane, Droitwich, next to the railway station.

The **East Lancs** business is conducted at the Conservative Club, Cliff Street, Rishton, on the first Tuesday and last Tuesday — the former is a formal and the latter a natter session.

Now **Edgware** and here the venue is 145 Orange Hill Road, Burnt Oak, Edgware, on second and fourth Thursday evenings. On July 11 they have a talk on first aid for electric shock, and July 25 is an informal.

For all the details on the **Exeter** activity at the Community Centre, St. Davids Hill, we must refer you to the Hon. Sec. — see Panel for the needful.

**Fareham** is synonymous with Portchester Community Centre, Westlands Grove. July 3 is a talk on AMTOR, and on the 10th they are on-the-air. On July 17 there is a talk on VHF/UHF Linears, and on 25th the topic will be two-metre rhombic aerials.

July 10 is the date for G5RV to give his talk on HF Aerials to **Farnborough** at 7.30 p.m. in the Railway Enthusiasts Club, Access Road, off Hawley Lane. The other date is July 24 when the subject will be RTTY by G8WMM.

Membership of **Fylde** includes membership of the Kite Club at Blackpool Airport, where they have their meetings. The actual club meetings are on first and third Tuesday evenings; the former is an equipment construction evening and the latter (July 16) is a visit to the control room of Lancashire Police, Hutton Preston, arriving there at 1900. More details from the Hon. Sec. — see Panel.

If you are into low-power amateur radio, or the simple homebrew approach, then you will be hard put to survive if you aren't a member of the **G-QRP Club** — get the details from the Hon. Sec. — see Panel for his details.

July 18 for **Greater Peterborough** is a junk sale, at Southfields Junior School, Stanground, Peterborough.

Hard to know what we should say about **Grimsby** — they forgot to mention where they meet! We suggest you can get all the details from the Hon. Sec. — see Panel for his name and address.

The main meeting of the **Hastings** club is at West Hill Community Centre on the third Wednesday of each month — July 17 is a talk on compact disc. In addition you can find them every Friday evening for a chat night at Ashdown Farm Community Centre, when you can find out all about the other meetings they have!

**Havering** have informals on July 10 and 24. July 3 is the quarterly business meeting, and on 17th they have G3EUR to unravel the mysteries of SWR. July 31st is G4ZTR's talk — subject not named. All are at Fairkytes Arts Centre, we think — they don't say so for sure!

Heading now to **Hereford** we find them at County Control, Civil Defence Hq., Gaol Street, Hereford. July 5 is set aside for a discussion on the club's part in the Droitwich Rally, and July 19 they have an informal.

### Another New One!

This one is known as **Hilderstone**; they are to be found at Hilderstone Adult Education Centre, St. Peter's, Broadstairs, Kent. where they have a booking every Friday evening. More details from the Hon. Sec. — see Panel.

Next **Holyhead** where they foregather on alternate Sunday evenings at 7.30, the venue being the "Foresters Arms", Kingsland Road, Holyhead, Anglesey. More details from the Hon. Sec. (see Panel) or, we understand, from the local papers which carry details a few days before each event.



Reigate Amateur Transmitting Society joined in the recent 'VE' Day commemorations by operating a station under canvas on the coast at Littlehampton, Sussex. Seen here is an Army 62 Set in operation, with a U.S. Patrol Fone resting on an AR88 receiver; Ron Brown, G3JRC, and David Skilton, G1KPU, are in position. *photo: Phil Pardey*

The Hq. of the **Hornsea** club is at Hornsea Mill, Atwick Road, Hornsea. July 3 sees them preparing for VHF NFD, and on July 10 they have a natter session. July 28 is down for them to roar off to the Scarborough Rally.

Now to **Ipswich** and their super newsletter. The front inside cover of this includes a map of the Hq. area, from which we gather that it lies on the junction of Bramford Road and Norwich Road, A45, in the "Rose and Crown", where they have a room with separate access from the bars. Find them on the second and last Wednesday each month. It is understood there is often Morse classes on the other Wednesday evenings, too.

**I.R.T.S.** is of course the national society of Eire, and so can be expected to have knowledge of all that goes on in that country, both nationally and locally.

On the way back we drop in at **Isle of Man** and the local group which foregathers at the Howstrake Hotel, Harbour Road, Onchan. Local groups also have Tuesdays at the Peveril Court Hotel, Ramsey, Tynwald Inn, St. John's on Thursdays, and the Perwich Bay Hotel, Port St. Mary's, on Friday evenings.

Back on the mainland again and we head for **Kidderminster**; this means Aggborough Community Centre, Hoo Road, Kidderminster, on July 9 for G3BA's talk "Radio on the Burma Railway", with July 23 still to be finalised at the time of their letter.

The **Lincoln** Hon. Sec. starts by a mention of the Lincoln Hamfest on September 8th: 10.30-5.30 at the Lincolnshire Show Ground. Normal club meetings are held at the City Engineers Club, Central Depot, Waterside South, Lincoln; July 3 is CW plus RAE plus Hamfest preparation, and on 10th they will put the club on the air. CW and RAE occupy July 17, and July 24 is still to be arranged. That leaves July 31 for another RAE/CW session.

The first Thursday and the third Tuesday it is for the **Maidenhead** club, and the place the Red Cross Hall in The Crescent, Maidenhead.

July 5 is a Treasure Hunt for the **Maltby** crowd, and on July 12 G4BVV will talk about a cheap QRP transceiver. July 19 is another D/F Hunt, and on July 26 G3ZHI will talk about the early days of radio.

For all the current details of the **Maxwelltown** club, based on the "Tam O' Shanter Inn", Dumfries, we must refer you to the Hon. Sec. — see Panel.

The main meeting of the **Midland** club is on July 16; usually the venue is the club's Hq. at 294A Broad Street, Birmingham, but it seems possible they may have moved by the time this is read, so we suggest a contact with the Hon. Sec. — see Panel for his details.

The **Newbury** club normally meets on the second Tuesday of

### Names and Addresses of Club Secretaries reporting in this issue:

*for reasons of space, see last month's issue for those names not appearing here*

ALYN & DEESIDE: G. C. Cook, GW4RXX, 20 Eccleston Road, Kinnerton, Chester CH4 9DY.

BOLTON: P. Ingham, G6HDD, 49 Highfield Road, Farnworth, Bolton BL4 0AH. (*Farnworth (0204) 791918*).

BRAINTREE: D. Willicombe, 355 Cressing Road, Braintree, Essex.

BRIGHTON: P. Turner, G4ILL, Flat 6, 132 Marine Parade, Brighton, Sussex BN2 1DE. (*Brighton 607737*).

BRISTOL CITY RSGB: C. R. Hollister, G4SQQ, 34 Battersby Way, Henbury, Bristol BS10 7SU. (*0272 508451*).

CAMBRIDGE (Rep. Group): C. Lorek, G4HCL, 11 Bevills Close, March, Cambs. PE15 0TT. (*0354 740672*).

CHELTENHAM: T. Kirby, G4VXE, 29 Tivoli Road, Cheltenham, Glos. GL50 2TD. (*0242 36723*).

FAREHAM: B. Davey, G4ITG, 31 Somervell Drive, Fareham, Hants PO16 7QL. (*Fareham 234904*).

HILDERSTON: Ms. A. Penfold, G0BEX, Staple Farmhouse, Staple, Canterbury, Kent CT3 1JX. (*0304 812723*).

HORNSEA: N. A. Bedford, G4NHP, 39 Hamilton Road, Bridlington, Yorkshire YO15 3HP.

KIDDERMINSTER: A. F. Hartland, G8WOX, 22 Granville Crescent, Offmore Farm, Kidderminster. (*Kidderminster 61584*).

NEWBURY: M. J. Fereday, G3VOW, Spindlewood, Stoney Lane, Newbury, Berks. RG16 9HQ.

NORTH WAKEFIELD: S. Thompson, G4RCH, 2 Alden Close, Morley, Leeds. LS27 0SG.

PRESTON: G. Earnshaw, G3ZXG, 12 Withy Parade, Fulwood, Preston.

READING: C. Young, G4CCC, 18 Wincroft Road, Caversham, Reading, Berks. RG4 7HH.

SKELMERSDALE: G. Crowhurst, G4ZPY, 41 Mill Dam Lane, Burscough, Ormskirk, Lancs. L40 7TG. (*0704 894299*).

SOUTH ESSEX: A. Smith, G4FMK, 8 The Parkway, Canvey Island, Essex, SS8 0AA. (*0268 683805*).

WEST KENT: Mrs. J. Green, G4UPI, 13 Culverden Down, Tunbridge Wells, Kent TN14 9SB. (*Tunbridge Wells 28275*).

WILLENHALL: J. Phillips, G4UPF, 16 Burnham Avenue, Oxley, Wolverhampton WV10 6DX. (*0902 782076*).

WIRRAL: C. Cawthorne, G4KPY, 40 Westbourne Road, West Kirby, Wirral L48 4DH.

WORTHING: R. Jones, G4SWH, P.O. Box 599, Worthing, Sussex BN14 7TT. (*Worthing 208752*).

the month at Newbury Technical College. On July 8 they have an illustrated talk "From Berkshire to Box 88" and on August 13 they move to the "Spotted Dog" for an informal gathering.

### Moved

This means **North Wakefield** which now has a place at the "White Horse" pub on Thorpe Lane, off Bradford Road, East Ardsley, which is about a half-mile from their old place. Look for them on any Thursday evening.

Now to **Preston** and hence the Lonsdale Club, Fulwood. On July 4 they have a sort-out for VHF NFD, while on July 18 and August 1 they have informal natters while the majority are on holiday.

**R.A.I.B.C.** is the one to get any invalid or blind amateur or SWL to join — it is their club. Of course, it follows that they need supporters and representatives from the fitter among us. Details from the retiring Hon. Sec. — and will someone QSP the name and address of the new Hon. Sec. which doesn't seem to have reached us yet?

**R.A.O.T.A.** is the Old-Timers club. The qualification is 25 years in the hobby; details from the Hon. Sec. at the address in the Panel.

"The White Horse", Emmer Green, Reading is the home of the **Reading** group. On July 2 they have an extra meeting to finalise the VHF NFD affairs, and on July 9 they have a talk on receiver front-end parameters and their measurement. On July 23 they make final arrangements for the special station they are putting on at the Shire Hall on July 27/28.

July 16 is a night of RSGB slides for **Reigate** at the Constitutional and Conservative Club in Warwick Road, Redhill.

If you have a Sinclair computer, you should be a member of the Sinclair Amateur Radio User Group (SARUG to us!). Details of the club, and its excellent newsletter and offers to members, from the Hon. Sec. — see Panel.

At **Scarborough** the right-thinking people head for the Cricket Club — details on the July programme as far as amateur radio is concerned from the Hon. Sec. — see Panel. (Doubtless he will also have the cricket fixture list!).

Beacon Park Golf Club is the home of the **Skelmersdale** group; the members are to be found there every Thursday evening. We understand that talks and natter nights are alternated in the programme.

At **South Bristol** we can find the locals at the Whitchurch Folk House, East Dundry Road, Whitchurch, Bristol, each week. July 3 is a talk on QRP construction, and July 10 is a "Work a G1 on CW Night" with Sue, G4XED. July 17 is a DX-TV receiver activity evening, and on 24th they have a G1s on HF night, under G0ALG. July 31 is then left, for a talk on amateur television.

**Southdown** are still having their main meeting on the first Monday of each month at Chaseley Home for Disabled Ex-Servicemen, Southcliffe, Eastbourne; but nowadays they also are to be found on Tuesdays and Fridays at the Clubrooms, Wealden District Council Offices, Vicarage Field, Hailsham, every week.

**S.E. Kent (YMCA)** is the formal name for the *Dover* area club, as the base is at the Dover YMCA, Godwynehurst, Leyburne Road, Dover. Meetings appear to be every Wednesday.

The **South Essex** group meet at the Paddocks Community Centre, Canvey Island, every Wednesday evening. All the latest details from the Hon. Sec. — see Panel. On a different tack they have sent us the first notification for their mobile rally on *March 16, 1986*, at the same spot.

Fridays and Mondays are the evenings when the **South Manchester** gang get together, at Sale Moor Community Centre, Norris Road, Sale. More details from the Hon. Sec.

**Stourbridge** meetings are normally on the first and third Monday of each month, at the Robin Woods Centre, School Street, off Enville Street, Stourbridge. Again, the latest details from the Hon. Sec. at the address in the Panel.

The group now known at **Stroud** used to be called 'South Cotswold.' They are now to be found at Nelson School, Stratford Lodge, Stroud, on July 10 and 24; at the time of their letter no programme had been finalised but the matter was in the pipeline.

On we go to **Surrey** where on July 1 they have a talk on amateur television by G8MNY; in fact they have first and third Mondays booked on the first floor mess deck at *TS Terra Nova*, 34 The Waldrons, South Croydon.

**Sutton & Cheam** are to be found at Downs Lawn Tennis Club, Holland Avenue, Cheam; On July 1 they have a natter evening in the Downs club bar, and on July 19 they have G2MI talking about the early days of radio.

The **Thornton Cleveleys** letterhead shows a nice picture of an old windmill, but no other indication of their current Hq. July 1's meeting is deleted, in favour of a visit on July 3 to the local Police Hq. at Hutton. July 8 is an NFD discussion, and on 10th they visit the Red Rose Radio Station, Preston. July 15 is informal with the



Jersey's Liberation Day commemoration station, GJ4HXJ/P, was operated by Jersey Amateur Radio and Electronics Club, and altogether 586 stations were worked on 20m., 80m. and 144 MHz. Left to right, GJ8KNV's YL, GJ8PCY, GJ6SUI, GJ1KCB, GJ8KNV, GJ6TMM, GJ4SZH and GJ4YMX. photo: GJ4ICD

club station on the air, and on 22nd they have a film show; July 29 is down for a clinic on their construction project. For all the details on the venues, contact the Hon. Sec. — see Panel for her details.

Turning now to the **Three Counties** club, we find them at the Railway Hotel, Liphook, Hants. July 10 is down for a talk on aerials, and on July 24 the topic is QRP and home construction.

The **Todmorden** club is based on the Queen Hotel in the town, where they have a booking for the first and third Monday in each month.

At **Torbay** the club now has an Hq. at the ECC Social Club in Ringslade Road, Highweek, Newton Abbot. However, it isn't clear whether they are meeting in July, so we must refer you to the Hon. Sec. — see Panel.

The move to a larger room at Southwick Village Hall, forced on the **Trowbridge** group by the increase in membership, has also forced a change of day; they are now to be found on the *fourth Tuesday*.

A membership drive is on at **Tyne-Wear Repeater Group** so hurry and get all the details from the Hon. Sec. at the address in the Panel.

**Verulam** are being treated to a talk on radio test equipment by Marconi Instruments' staff on July 23. This, as with all the meetings, will be at the R.A.F.A. Hq. New Kent Road, off Marlborough Road, St. Albans, where the gang get together on the second and fourth Tuesday of each month.

Now **WACRAL** which is the world-wide group of committed Christian radio amateurs of all denominations. Details from the Hon. Sec. — see Panel.

**Wakefield** has a place at Ossett Community Centre, Prospect Road, Ossett, on July 9 for an RTTY demonstration, and again on 23rd for a D/F event.

The meeting of the **West Kent** club are now all at the Adult Education Centre, at the Annex in Quarry Road, Tunbridge Wells; they are every Friday evening, with alternate ones set aside for informal natters.

For all the details of the Wednesday evening meetings of the **West Manchester** club we have to refer you to the Hon. Sec. — see Panel. His main object, indeed was to notify us of their two mobile rallies; the first on August 18 at Haydock Park Racecourse, and the second one on November 24 at Pembroke Halls, Walkden, Worsley. Entry by programme only, and details again from the Hon. Sec.

For the details of the **Westmorland** meetings we must refer you to the Hon. Sec; however, we believe they have a booking at the "Strickland Arms", Sizergh, on the second Tuesday each month.

## New Home

This time it is **Willenhall** and they have moved to the "Cross Keys" pub, Prouds Lane, Willenhall, where they are to be found every Wednesday evening.

We have a gentle rhubarb from **Wirral** about a dilatory Club Secretary. But the main thing is that we eventually got the news; they are at Heswall Church Hall, on July 3 for a surplus sale, and 17th for a problem night.

There is another club on the Wirral and this one we call **Wirral (West Kirby)** even though it seems nowadays to live at Irby Cricket Club; here they meet for the formals on the second and fourth Wednesday of each month, with the intervening weeks occupied by informals in different pubs around the area.

**Wolverhampton's** Hq. is at Wolverhampton Electricity Sports and Social Club, Chapel Ash, every Tuesday. July 2 is a visit to Wolverhampton Central Telephone Exchange; July 9 a discussion on CB, chaired by G8YFA. July 16 is a demonstration of RTTY and AMTOR by G1DIL, and on 23rd they have the club on the air. July 30 is a committee meeting to which as usual all members are invited to attend.

Both in formals and club nights nowadays are at the Oddfellows Hall, New Street, for **Worcester**; July 1 for Droitwich Rally planning and July 15 for the informal.

We have a long listing from **Workshop** and from it we see they have meetings on the 9th July for a talk on Converting BC sets to Top Band, and 23rd for a slide show. In between, they have trips to Scarborough Rally and a barbecue in Culumber Park. However, for the club Hq. address we have to refer you to the Hon. Sec. — see Panel.

No mistaking the **Worthing** details; look for them every Wednesday evening at Lancing Parish Hall, South Street, Lancing, West Sussex.

Down to **Yeovil** now, and this means the Recreation Centre, Chilton Grove, Yeovil on Thursdays. July 11 is a visit by the RSGB RR, and on 18th G3MYM talks about 'take-off angles at sunspot minimum'. July 25 is a natter night, and on August 1 G3MYM talks about SSB.

At **York** their GB3YCS station was as ever preceded by the stone-throwing contest ritual for aeralis! Find these cheerful optimists at the United Services Club, 61 Micklegate, York, on any Friday evening.

## Finale

The bottom of the biggest clubs' listing for quite a while at last! Deadlines for the arrival of your letters are in the 'box', addressed as always to your "Club Secretary", **SHORT WAVE MAGAZINE**, 34 High Street, Welwyn, Herts. AL6 9EQ. Keep 'em rolling in — we love reading all about the various things you all get up to. *Cheerio for now!*

## Special Events Stations

From Wivenhoe, near Colchester, **Eddystone Radio Ltd.** will be activating their company callsign, **G6SL**, on **July 7**, using one of the firm's new Orion 5000 transceivers, with operation on 3.655 or 3.720 MHz from 10.00 till 11.00 GMT. A special QSL card will be available to all amateurs who make contact with the **Eddystone** operator.

Pembrokeshire **RAYNET** Group will operate **GB2DFB** on **20-21 July** from Haverfordwest (Withybush) Airfield, during the Dyfed Fire Engine Rally. Operation will be on HF, and contacts with other Fire and emergency services will be particularly welcome. More details from GW4ODN, on 06462-3991.



# All 9 hf Bands from a 2m multimode!

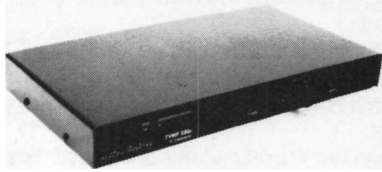

Transverters once had a reputation for being a second best approach to getting on to any band. With careful system design this need not be so. People have favourably compared the receive performance of the TVHF 230c when coupled to a modern vhf transceiver to that of prestige hf transceivers costing well into four figures! Even with a budget 2m rig, the performance will be better in most respects than the sort of hf transceiver available second-hand at the same price! On transmit, the signal generated is very clean, and the 10W pep output is enough to work the world with a decent antenna. Of course, if you want to be a really big signal, then this power is just right for driving a variety of power amplifiers! (If you have a valve vhf amplifier, then an hf linear becomes a very simple thing to build — a pair of 4CX350's will burn as big a hole in 20m as 144MHz!!)

Chris Bartram G4DGU

TVHF 230c  
**£334.90** + £5 p&p  
 inc. 15% VAT



**muTek limited** — the rf technology company



Dept. S.W., Bradworthy, Holsworthy, Devon EX22 7TU (0409 24) 543

## RADIO AMATEUR PREFIX-COUNTRY-ZONE LIST

published by GEOFF WATTS  
 Editor of "DX News-Sheet" 1962-82

The List you have always needed, the list that gives you everything, and all on one line! For each country: —  
 a. its DXCC "status" e. the continent  
 b. the normal prefix f. the "CQ" Zone No.  
 c. the special prefixes g. the ITU Zone No.  
 d. the ITU callsign block allocation  
 Full information on Antarctic stations, USSR Klub-stations, obsolete prefixes used during the past 10 years, and much more.  
 The List can be kept always up-to-date because ample space has been provided for adding every new prefix, each new ITU allocation, etc.  
 Everything arranged alphabetically and numerically in order of prefix. Ideal for Contest operators and SWL's.  
 Tell your Club-members about it. Order an extra copy for that overseas friend. 15 pages. Price £1.00 (UK), overseas (air mail) \$2.00 or 6 IRCs.

**GEOFF WATTS**

62 BELMORE ROAD, NORWICH NR7 0PU, ENGLAND

## J. BIRKETT

13 THE STRAIT, LINCOLN. LN2 1JF. Phone: 20767  
 25 ASSORTED CERAMIC AND PAXOLINE COIL FORMERS for £1.45.  
 1000p.f. 1.2KVW DISCS @ 5p 2500p.f. 3KVW @ 8p.  
 VMOS POWER VN10KM @ 50p, VN90AA @ 80p, WM211 @ 40p.  
 ITT CRYSTAL FILTER Type 014DG 10.7MHz BW 3.75KHz @ £3.95.  
 TRANSISTORS 2N3866 @ 75p, BSX61 @ 50p, MRF511 @ £3.95.  
 STORNO HAND HELD TRANSCEIVERS High Band, No Batteries, Mike, Crystals, Aerial Or details. @ £3.95 p.p. 50p, useful for 2M.  
 NUT FIXING FEED THRU'S 1000p.f. @ 25p each.  
 CRYSTAL FILTERS 10.7MHz, BW 7.5KHz, ex-equipment, @ £2.95.  
 FERRANTI RADIO I.C. ZN414 with details @ 95p.  
 TELEPHONE DIALER CHIP with details @ 85p.  
 FETS J304 @ 6 for £1, E304 @ 7 for £1, J230 @ 5 for 60p.  
 SOLDER-IN FEED THRU'S 5p.f., 27p.f., 300p.f., 1000p.f., all for 20p doz.  
 ERIE DISCS 0.01U.F. 50VW @ 20p doz, small 0.1U.F. 50VW @ 5p each.  
 TRANSISTOR HEAT SINKS TO18 @ 6 for 40p, TO5 @ 6 for 40p.  
 AIRSPACED VARIABLE CAPACITORS 500 + 500p.f. @ £1.60, 250 + 250 + 20 + 20p.f. @ £1.50, 400 + 330p.f. 3mm Spindle @ £1.25, 350 + 180p.f. @ £1.50, 10 + 10 + 20p.f. @ £1.30, 208 + 176p.f. @ £1.50, 125 + 125p.f. @ £1.50, 10p.f. @ £1.50.  
 VOLTAGE REGULATOR I.C.'S 7905 @ 3 for £1.30.  
 VHF TRANSMIT-RECEIVE SWITCHING PIN DIODES 5 for 80p.  
 2 GANG ILLUMINATED EDGEWISE 10 WAY SWITCHES @ £1.15.  
 BF180 TRANSISTORS 8 for 60p, NKT214 @ 8 for 60p.  
 25x25p.f. BUTTERFLY AIRSPACED PRE-SET VARIABLES @ 50p.  
 WOOD AND DOUGLAS KITS AVAILABLE BY POST AND CALLERS.  
 ACCESS AND BARCLAYCARDS ACCEPTED. Post and packing 50p under £5, over free.

WE PROVIDE SOME OF THE WORLD'S  
 PRICELESS POSSESSIONS  
 QUIET BACKGROUND — MINIMAL TVI  
 FREEDOM TO CHANGE BAND QUICKLY  
 ABSENCE OF A. T. U.  
 INCONSPICUOUS APPEARANCE  
 LIGHTWEIGHT AND EFFICIENT  
 FOR THE OWNER OF A

## DIPOLE OF DELIGHT

Send SAE for Technical Data, Stock Position and Prices — the latter will have to rise in September due to the rise in commodity prices.



**HATELY ANTENNA TECHNOLOGY**

1 Kenfield Place, Aberdeen AB1 7UW, Scotland

Proprietor: — Maurice C. Hately, MSc, MIEE, Chartered Electrical Engineer, GM3HAT

## THE UNIDEN CR-201 PORTABLE COMMUNICATION RECEIVER

AM/SSB (USB and LSB)/CW 150KHz to 29999KHz. Triple superhet. Digital tuning, scan and six memories. Also FM 76-108 MHz. LCD frequency display, etc., etc. Supplied with mains power unit. £166.74 inc. VAT and carriage.

## THE BEARCAT DX 1000 COMMUNICATION RECEIVER

AM/SSB (USB and LSB)/CW/FM 10KHz to 30MHz. Micro-processor controlled, digital or manual tuning, 10 channel memory, step facility, 31F bandwidths, LED display, two time zone clock, etc., etc. Supplied with mains power unit. £445.44 inc. VAT and carriage.

FOR FULL ILLUSTRATED TECH. SPEC. ON ABOVE, SAE.

G80OP

G4FLN

G8ADO

## E.M.A.

MUNDAYS LANE, ORFORD WOODBRIDGE, SUFFOLK  
 Tel. 033-45 696

## QUARTZ CRYSTALS

### CRYSTALS FOR 2 METRES

HC25 £2.15 FOR ONE CRYSTAL  
 HC6 £2.15 FOR ONE CRYSTAL  
 TX CRYSTALS  
 HC6/U 4 & 8 MHz 30PF  
 HC25/U 12 MHz 30 & 40PF  
 HC25/U 18 MHz 25 & 30PF  
 HC25

### STOCK CRYSTALS

£1.98 WHEN 2 OR MORE PURCHASED  
 £2.05 WHEN 2 OR MORE PURCHASED  
 CHANNELS IN STOCK  
 R/O TO R7, S11, S20 TO S23  
 R/O TO R7, S8 TO S23 & S32  
 R/O TO R7, S8 TO S23 & S32  
 R/O TO R7, S8 TO S23 & S32

Full list available on request; please send SAE.

### 4 METRE CRYSTALS FOR 70.26 in HC6/U AT £2.40 each

TX B 78250 RX 29-78000  
 700M CRYSTALS £5.00pp or £2.50 each  
 For Pve PF1 PF2 & PF70 series, Wood & Douglas and FDK Multi UII  
 SU8 (433.2) SU20 R80 RB2 RB4 RB6 RB10 RB11 RB13 RB14 RB15.  
 ALSO FOR MULTI UII ONLY SU12 SU16 SU18  
 CONVERTER CRYSTALS IN HC18/U AT £2.80 each  
 22,000 28,695 70,000 95,000 105,695 101,500 116,000

### FREQUENCY STANDARDS £2.75 each

HC6/U 1000kHz 3.50MHz 5.00MHz 10.00MHz 10.700MHz  
 HC18/U 1000kHz 7.00MHz 10.70MHz 48.00MHz 100.00MHz  
 Also HC6/U 455 kHz £3.25 each.1.

### TONEBURST, I.F. & MPU CRYSTALS IN HC18 £2.25 EACH

7.168 MHz (for 1750 Hz Tone), 10.245 MHz (for 10.7 I.F.),  
 3.2765 5.09898 14.3190 15.00000  
 YAESU CRYSTALS for FT101 & FT901 and etc. £4.00 each  
 Many available ex stock. (A list is available on request; please send S.A.E.)

### FUNDAMENTALS

FREQUENCY RANGE	PRICE
5 TO 50kHz	£21.00
50 TO 150kHz	£11.00
150 TO 500kHz	£7.80
160 TO 998kHz	£11.90
1 TO 1.5MHz	£10.75
1.5 TO 2.0MHz	£5.10
2.0 TO 6.0MHz	£4.75
6 TO 21MHz	£4.55
21 TO 25MHz	£6.50

### MADE TO ORDER CRYSTALS

FREQUENCY RANGE	PRICE	DELIVERY
21.00 TO 55.00MHz	£4.55	2.0 TO 175.00MHz 2 TO 3 weeks
50.00 TO 110.00MHz	£5.10	5.0 TO 998.9kHz 6 TO 8 weeks
110.00 TO 125.00MHz	£7.40	1.0 TO 1.498MHz 3 TO 4 weeks
125.00 TO 175.00MHz	£10.00	

Unless otherwise requested fundamentals will be supplied for 30pf load capacitance and overtones for series resonant operation.

HOLDERS: PLEASE SPECIFY WHEN ORDERING — etc HC25/U supplied for XTLS above 3MHz HC13/U 6-200kHz HC6/U & HC33/U 170kHz-175MHz HC 18/U & HC25/U 2-175MHz.

DISCOUNTS: Price on application for 10+ units to same frequency/spec. or bulk purchases of mixed frequencies. We supply FREE xtals for use in U.K. repeaters.

COMMERCIAL CRYSTALS: Available on fast delivery and at competitive prices. Please send for list stating interests.

EMERGENCY SERVICE: for XTALS 1 to 125MHz. Add the surcharge for each XTAL. Days refer to working days. 4 days + £12, 6 days + £7, 8 days + £5, 13 days + £3.

CRYSTAL SOCKETS HC25 £0.20 ea. HC6 £0.25 ea. MINIMUM ORDER CHARGE £1.50 unless ordered with crystals.

TERMS: Cash with order post inc. to U.K. & Ireland. Cheques & P.O.'s to QSL LTD.



**QuartzLab** MARKETING LTD

ALL PRICES ARE EX. VAT. PLEASE ADD 15%  
 Note new Ansafone No.

P.O. Box 19  
 Erith  
 Kent DA8 1LH

A stamped addressed envelope with ALL enquiries please.  
 Telephone: 01-318 4419 2&3; Ansafone: Dartford (0322) 330830  
 Telex: 8813271 GECOMS - G (Attention QUARTSLAB)

**(“SITUATIONS” AND “TRADE”)**

30p per word, minimum charge £3.60. No series discount. All charges payable with order. Insertions of radio interest only accepted. Add 50 per cent for Bold Face (Heavy Type). No responsibility accepted for transcription errors. Box Numbers 80p extra. Send copy, with remittance, to the Classified Dept., Short Wave Magazine Ltd., 34 High Street, Welwyn, Herts. AL6 9EQ. Prices include VAT

Copy must be received by July 11th to be sure of inclusion in the August issue, published on July 26th.

**TRADE**

QSL card specialists. Individual designs at no extra charge. Free samples, please state if SWL. — **Deroga Printing**, Whitwell Road, Sparham, Norwich NR9 5PN.

August issue: due to appear on Friday, July 26th. Single copies at £1.60 post paid will be sent by first-class mail for orders received by Wednesday, July 24th, as available. — **Circulation Dept.**, Short Wave Magazine, 34 High Street, Welwyn, Herts. AL6 9EQ.

**BBC RTTY.** This new programme must be the ultimate for the BBC, includes features not knowingly included on any other RTTY software; tape, £12. Other RTTY programs available on tape for: Spectrum, £10; Vic-20, £10; CBM-64, £11; Atom, £12; Dragon, £12; Tandy Color, £12; Hardware to suit all of the above from **The Computer Teletype Specialists**; please send s.a.e. — **B & J Telecommunications**, 9 Queens Walk, Thornbury, Bristol.

**Course for City & Guilds, Radio Amateur's Examination.** Pass this important examination and obtain your licence, with an RRC Home Study Course. For details of this and other courses (GCE, Career and professional examination, etc.) write or phone: **THE RAPID RESULTS COLLEGE, Dept. JV7, Tuition House, London SW19 4DS.** Tel: 01-947 7272 (9 a.m. to 5 p.m.) or use our 24 hour Recordacall Service, 01-946 1102 quoting Dept. JV7.

**QSL Cards.** Gloss or tinted, send s.a.e. for samples to **Twrog Press**, Dept. S, Penybont, Gellilydan, Blaenau Ffestiniog, Gwynedd.

**Auction Notice, Electronics:** Auctions held every other Friday. Lots include: electronic and electrical equipment, components, test gear, radiotelephones, computers, photographic and video equipment, also manufacturers' plant and general works effects. Catalogues available, subscription £10 per year post paid.—**Anglia Industrial Auctions**, 5 Station Road, Littleport, Cambs. CB6 1QE. (Tel: 0353 - 860185).

**Amidon toroidal cores**, ferrite rings and beads. Send s.a.e. for data and prices. Business hours: 10-5 p.m. Tues.-Fri.; 10-4 p.m. Sat.—**SMC (TMP Electronics)**, Unit 27, Pinfold Workshops, Pinfold Lane, Buckley, Clwyd CH7 3PL.

**D.I.Y. QSL/SWL cards** (state which), 100 mixed designs/colours, £2.50 c.w.o. **Personalised QSLs**, 1000 for £15. Station logs, 10 for £18. — **Currie Cards**, Blackhill, Consett DH8 8LT.

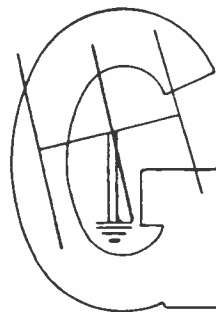

**USED AMATEUR EQUIPMENT**

**Bought, Sold & Exchanged Selling? I pay the Best Prices for your Used Equipment!**

**Buying? I have the best selection of Used Equipment available!**

Phone Dave, G4TNY anytime for the deal you've been looking for on **HORNCHURCH (040 24) 57722** or SAE to:

**G4TNY AMATEUR RADIO**  
132 Albany Road, Hornchurch, Essex RM12 4AQ

**AMATEUR ELECTRONICS UK**

G6XHB



**R.A.S. (Nottingham)**

**Radio Amateur Supplies**

Tel: 0602 280267

G8UUS



**Visit your Local Emporium**

Large Selection of New/Used Equipment on Show

**AGENTS FOR:** F.K.K., AZDEN, ICOM, YAESU, FORTOP ATV  
**ACCESSORIES:** Welz Range, Adonia Mics, Barenco Mast Supports, DRAE PSU and Wave Meters, BNOS PSU and Linear, Microwave Modules, Mutek Pre-Amps

*AERIAL: Tonna, Halbar, New Diamond Range of Mobile Whips*

**PLUS OWN**

'Special' Q.R.P. GW5 HF5 Band Beams **JUST GIVE US A RING**  
Monday: CLOSED. Tuesday - Saturday: 10.00am to 5.00pm

**3 Farndon Green, Wollaton Park, Nottingham**  
Off Ring Rd. between A52 (Derby Rd.) & A809 (Ilkeston Road)

**CALL BOOKS**

**RADIO AMATEUR CALL BOOKS (1985)**  
Foreign ("DX") Listings . . . . . £17.95  
U.S. Listings . . . . . £18.50  
U.K. Callbook, 1985 Edn. (RSGB) . . . . . £6.50

**MAPS**

**"SHORT WAVE MAGAZINE" DX ZONE MAP**  
(GREAT CIRCLE) in colour. *Latest 10th edition* . . . . . £4.35  
**AMATEUR RADIO MAP OF WORLD** Mercator Projection —  
Much DX Information—in colour. *Latest 15th edition* . . . £1.85  
**RADIO AMATEUR MAP OF THE U.S.A. AND NORTH AMERICA** State Boundaries and Prefixes, size 24" x 30", paper. *Latest 7th edition* . . . . . £1.20  
**RADIO AMATEUR'S WORLD ATLAS** In booklet form, Mercator projection, for desk use. Gives Zones and Prefixes. *Latest 12th edition* . . . . . £2.75

**LOG BOOKS**

**Amateur Radio Logbook** . . . . . £2.70  
**Receiving Station Log** . . . . . £2.75  
**Mobile Logbook** . . . . . £1.20

*(The above prices include postage and packing)*

*Available from:*

Publications Dept.

**Short Wave Magazine**

34 High Street, Welwyn, Herts. AL6 9EQ

Tel: Welwyn (043871) 5206/7

(Counter Service, 9.30-5.00 Mon. to Fri.)

(Giro A/c No. 547 6151)

## R.M.B. ELECTRONICS - QSL CARDS FOR THE DISCERNING HAM

Don't you think QSL Cards tend to be boring?

Then try our :-

- Especially commissioned, limited edition, high quality prints depicting the more humorous side of Amateur Radio jargon.
- Cards specifically designed for the S.W.L.
- Cards created to your specifications.

RMB Electronics, FREEPOST, Polesworth, Tamworth, Staffs. B78 3BR  
NO STAMP REQUIRED.

How many Amateurs can you recall by their card  
and not just their callsign?

## REG WARD & CO LTD

The Southwest's largest Amateur Radio Dealer

1 Western Parade,  
Axminster, Devon EX13 5NY  
appointed agent for



- ★ Yaesu, Trio, Icom, FDK ★
- ★ Complete range stocked ★
- ★ Full demonstration facilities ★
- ★ Mail/Phone orders on all items ★
- ★ Barclaycard, Instant Credit, Access ★

ICOM

FDK

Ancillary equipment by Adonis, AKD, AOR, Benchen, BNOS, Datong, Diawa, Drae, Hansen, Himound, JIL, Kenpro, Microwave Modules, Mutek, SEM, Shure, TAU, Tokyo Hypower, Tono, Toyo, Welz, Wood & Douglas

Aerials by: G. Whip, Hygain, Jaybeam, Mini Products, MET, Revco, TET, Tonna  
full range of Wood & Douglas kits:

Opening hours:  
Tues-Sat 9.00-5.30 (lunch 1-2) Closed Mondays

Tel. Axminster  
(0297) 34918

## AERIALS and TRAPS

Date Sheets, Large 24p S.A.E. Aerial Guide £1  
G2DYM, UPLOWMAN, TIVERTON, DEVON  
Callers welcome by appointment ONLY Tel: 03986 215

## ALL VALVES & TRANSISTORS

Call or phone for a  
most courteous quotation  
01-749 3934

We are one of the largest  
stockists of valves etc. in the U.K.

COLOMOR ELECTRONICS LTD. 170 GOLDHAWK ROAD  
LONDON W12

## AMATEUR RADIO

by Gordon Stokes and Peter Bubb

The Lutterworth Press are the publishers of this book, which is intended for those wishing to study for the R.A.E. and comprises nineteen chapters, plus Introduction and Index, covering the basic, technical material the would-be candidate needs to obtain a 'pass'. Copiously illustrated with simple diagrams and excellent plates. Published in hardback.

192 pages

£9.60 inc. p/p

Publications Dept.

SHORT WAVE MAGAZINE LTD.  
34 HIGH STREET, WELWYN,  
HERTS. AL6 9EQ

## READERS ADVERTISEMENTS

10p per word, minimum charge £1.50 payable with order. Add 25 per cent for Bold Face (Heavy Type). Please write clearly, using full punctuation and recognised abbreviations. No responsibility accepted for transcription errors. Box numbers 80p extra. Send copy, with remittance, to the Classified Dept., Short Wave Magazine Ltd., 34 High Street, Welwyn, Herts. AL6 9EQ. Prices include VAT.

Copy must be received by July 11th to be sure of inclusion in the August issue, published on July 26th.

## READERS

**For Sale:** Trio TR-9130 multimode 2m. transceiver, sparingly used and in good condition, £275 or very near offer. — Ring Keith, 01-205 9172.

**Wanted:** AR88, preferably in original and complete condition, can collect within 100 miles of Leicester. Details and price please. — Ring Leicester 864966.

**Sale:** Grundig Satellit 2000, £80 or offer. Tandberg 41 all-wave battery portable, £25. Fidelity Wanderer cordless phone, unused, £80. — Ring Bristol 41800, evenings.

**Wanted:** FRG-7 or FRG-7700 communications receiver, or what have you to offer. — Davey, 31 Gordon Road, Shoreham-by-Sea, Sussex. (Tel: Shoreham 62086).

**For Sale:** "Wireless World" from 1949 to present date. B29 receiver, 15 to 560 kHz, good condition, excellent reception, s.a.e. with enquiries please. — Vest, 45 Edge Court, Durham DH1 2JY.

**Wanted:** DC power supply/speaker for KW-2000A. — Ring Peter, 061-980 5173.

**For Sale:** Redifon R.408 marine communication receiver, frequency coverage 15 kHz to 28 MHz, £200. — Ring Wheeler, 0472-822996.

**Selling:** Trio R-2000 with VHF converter, as new, pristine (cost £607), sensible offers invited. AT-1000 ATU, new (cost £53), boxed, £40. 144 MHz aerial, magnetic base, new, £12. Norcone VHF/UHF aerial, 66-512 MHz, brand new, £20.95; postage £1. — Peckett, 15b Arlow Road, London N21 3JS. (Tel: 01-882 5230).

**August issue: due to appear on Friday, July 26th. Single copies at £1.60 post paid will be sent by first-class mail for orders received by Wednesday, July 24th, as available. — Circulation Dept., Short Wave Magazine, 34 High Street, Welwyn, Herts. AL6 9EQ.**

**Wanted:** "G2DAF" Rx, AR88 Rx or similar. — Ring Campbell, Stevenage 820789.

**Sell or Exchange:** PSU for R.1132, ABK IFF Rx, generator for TR.1133, new APN-1 altimeter, R.3553 A.S.V. indicator Type 6, W.1191A, W.1649 VHF, BC-433F, BC-434F control. *Wanted:* TU-6B, etc., A.1271, WS-18. — Parsonage, 52 Bramble Lane, Mansfield, Notts.

**For Sale:** Telescopic H/D 5-section radio/TV tower, winch to 90 feet, fitted to trailer, with leg supports and cables, under half price, £1,500 or near offer. — Ring 01-888 7839.

**D. P. HOBBS NORWICH LTD.**  
**G3HEO**  
**ELECTRONIC COMPONENT SPECIALISTS**

AGENTS FOR:—  
 FDK — ICOM — YAESU — WELZ — JAYBEAM — DRAE

★ THIS MONTH'S BARGAIN ★

BRIDGE RECTIFIERS 200 volt 25A — £1.85  
 THYRISTORS 400 VOLT 35A — £1.25. Post 25p

**All telephone and mail orders despatched by return**  
**Part exchanges welcome**

Access, Barclaycard + Credit Terms Available

13 ST. BENEDICT'S ST., NORWICH. Tel. 615786

**UPPINGTON**  
**COMMUNICATION ELECTRONICS**

	G2BAR BERT	RS85565 PAUL	G1DFK PETER	
<b>WIRE DIPOLES</b>		<b>MULTI BAND</b>	<b>G5RV TYPE MULTI BAND</b>	
10metres	£4.95	7mhz TRAPS	½ SIZE	£14.25
15metres	£5.50	3.5mhz TRAPS	FULL SIZE	£16.25
20metres	£5.95	3.5 to 30mhz	SLOTTED 300ohm	
40metres	£7.25	TRAPPED DIPOLES	RIBBON	30P/M
80metres	£8.75			

PLEASE ADD £1.50 POSTAGE

12- 14 PENNYWELL ROAD, BRISTOL BS5 0TJ  
 TEL: 557732 — 558578

**BECOME A  
 RADIO AMATEUR**

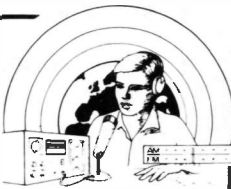

Train now for the Radio Amateur Licence examination. No previous knowledge needed, only a few hours per week of home study for 3 to 6 months. Post coupon now for details or tel. 062 687 2598 (24 hr service)

British National Radio & Electronics School P.O. Box 7, Teignmouth, Devon, TQ14 OHS

FREE brochure without obligation from:—  
**British National Radio & Electronics School**  
 P.O. Box 7, TEIGNMOUTH, DEVON, TQ14 OHS

Name .....

Address .....

BLOCK CAPS PLEASE

**THE SATELLITE  
 EXPERIMENTER'S  
 HANDBOOK**

Recently published by the ARRL, this superb handbook provides all you need to know to communicate through, or pick up the signals from, orbiting satellites — whether your interest is in amateur-radio, weather or TV-broadcast satellites. *Chapter headings include:* — Preliminaries, Early Days, Past/Present/Future, Getting Started, Tracking Basics, Ground Station Antennas, Receiving and Transmitting, Satellite Orbits, and more; plus Tables and Charts.

Whether you are a beginner or an expert, if your interest is satellites, and particularly Amateur Radio "birds", this book is indispensable and un-reservedly recommended.

208 pages £9.15 inc. p/p

Order from: £9.70

**Publications Dept.**  
**SHORT WAVE MAGAZINE LTD.**  
 34 HIGH STREET, WELWYN,  
 HERTS. AL6 9EQ

**McMichael A.R.S. Home Counties**  
**MOBILE RALLY**  
 Sunday, 21st July, at 11 a.m.  
 Sefton Park, Bells Hill, Stoke Poges, Slough  
 Talk-In on S22 & SU8

G2VF inventor and proprietor of Patent for **VARIABLE HIGH FREQUENCY FRAME ANTENNA** offers circuit and full assembly details for the modest sum of £5. A Do-It-Yourself project. Components required to be found in most Hamshacks. Most expensive components, two variable tuning capacitors. Antenna twenty-one inches square, mounts on top of control box, fully rotatable from operating position, tunable all the way 30 to 10 metres there being only one inductance. SWR One to One 40, 15 and 10 and One Point Five to One 30 and 20. RS on CW from JA, W areas O to 9, VE 1 to 6 and all Europe. Ninety awards obtained with frame. Maximum power 100 watts. **NEW EFFICIENT L.W. AND M. WAVE FRAME ANTENNA**. 21 inches square. D.I.Y. project. Circuit, parts list, assembly data £3. Ideal Caravan and flat dwellers.

F. G. Rylands, 39 Parkside Avenue, Millbrook, Southampton SO1 9AF  
 Tel. (0703) 775064 Callers welcome any day any time.

*Please mention*  
**“SHORT WAVE  
 MAGAZINE”**  
*when contacting*  
**Advertisers — it helps you,  
 helps them and helps us.**

# THE ARRL 1985 HANDBOOK for the Radio Amateur

62nd Edition

- ★ 1024 pages
- ★ 376 pages more than last year's edition
- ★ Over 1700 circuit diagrams and illustrations
- ★ 40 chapters
- ★ 17 more chapters than last year's edition

*soft cover, £15.50 inc. p/p*

*hard cover, £21.50 inc. p/p*

Publications Dept.  
SHORT WAVE MAGAZINE LTD  
34 HIGH STREET, WELWYN,  
HERTS. AL6 9EQ

# WORLD RADIO/TV HANDBOOK 1985

*Now in stock!*

The World's only complete reference guide to International Radio & Television Broadcasting Stations. It includes: Frequencies, time schedules, announcements, personnel, slogans, interval signals and much more besides of value to the listener.

Lists all International short-wave stations, including frequencies, for each country; foreign broadcasts, long and medium wave stations (AM broadcast Band), TV stations and domestic programmes. Long recognised as the established authority by broadcasters and listeners. It is the only publication that enables you to identify BC stations quickly and easily. Enables you to fill more pages in your log book on the SW BC bands and helps you add more BC-station QSL cards to your collection.

**£19.15 inc. p/p**

*from*

**SHORT WAVE MAGAZINE**  
34 High Street, Welwyn, Herts. AL6 9EQ

## BEGINNER'S GUIDE TO AMATEUR RADIO

by F. G. Rayer, G30GR

Frank Rayer, well-known to many *Short Wave Magazine* readers, completed this book, published by Newnes, just before he died. It is written especially for those who are interested in learning about radio communication and explains simply many of the aspects of radio that can be baffling to the newcomer. Contains a great deal of information helpful in the preparation for the Radio Amateurs' Examination.

169 pages

£5.45. inc. p/p

Publications Dept.

**Short Wave Magazine Ltd.,**  
34 High Street, Welwyn, Herts. AL6 9EQ.

## "S.W.M." DX ZONE MAP

Latest 10th Edition!

Great Circle Projection on durable, quality, paper for wall mounting, 33½ in. wide by 24½ in. deep. Giving essential DX information — bearing and distance of all parts of the world relative to the U.K., the Zone areas into which the world is divided for Amateur Radio purposes, with major prefixes listed separately. Distance scale in miles and kilometres. Time scale in GMT. Marking of Lat./Long. close enough for accurate plotting. Hundreds of place names, mainly the unusual ones, and most of the rare islands.

Price **£4.35 inc. p/p**

Publications Dept.

**Short Wave Magazine Ltd.,**  
34 High Street, Welwyn, Herts. AL6 9EQ.

## AMATEUR RADIO OPERATING MANUAL

(RSGB)

*Third Edition just published!*

204 pages

Publications Dept.

£6.10 inc. p/p

**Short Wave Magazine Ltd.,**  
34 High Street, Welwyn, Herts. AL6 9EQ

# TELEPRINTER HANDBOOK

2nd Edition

This RSGB book, edited by G8GJ, G3IR and G2UK, is one of the most comprehensive guides available to the theory and practice of amateur RTTY, and is a "must" for anyone seriously interested in this mode. Fully illustrated with line diagrams and close-up photos, it provides descriptions and servicing information for several popular European and American machines as well as other essential RTTY equipment. Plus chapters on setting-up an RTTY station and operating procedures. Published in hardback.

368 pages

£12.70 inc. p/p

Publications Dept.

**Short Wave Magazine Ltd.,**  
34 High Street, Welwyn, Herts. AL6 9EQ.

# 1985 CALL BOOK "DX LISTINGS"

(i.e. all amateur call-signs *outside* the U.S.A. and its Possessions)

*In this issue . . .*

- ★ 447,257 licensed Radio Amateurs
- ★ 46,010 new licences included, issued since the 1984 edition
- ★ 97,904 changes in listings
- ★ QSL managers
- ★ Radio amateur prefixes of the world
- ★ ARRL Countries list
- ★ Standard Time charts
- ★ Census of world Amateur Radio licenses
- ★ Plus much, much more!

**£ 17.95** inc. postage

Publications Dept.  
**SHORT WAVE MAGAZINE LTD.**  
34 HIGH STREET, WELWYN,  
HERTS. AL6 9EQ

# 1985 CALL BOOK "U.S. LISTINGS"

*In this issue . . .*

- ★ 438,007 licensed U.S. Radio Amateurs
- ★ 27,610 new U.S. licenses included, issued since the 1984 edition
- ★ 96,703 changes in listings
- ★ Then & Now — call letter changes
- ★ QSL managers
- ★ ARRL Countries list
- ★ Zip Codes and Licence Class on all listings
- ★ Standard Time charts
- ★ Plus many other features

**£ 18.50** inc. postage

Publications Dept.  
**SHORT WAVE MAGAZINE LTD.**  
34 HIGH STREET, WELWYN,  
HERTS. AL6 9EQ

## SIMPLE, LOW-COST WIRE ANTENNAS

by William Orr, W6SA1

*Latest Edition*

This excellent and thoroughly recommended handbook is *the* publication on the practical approach to building aerials. After starting with aerial fundamentals there are discussions and descriptions of ground-plane, end-fed, DX dipole, vertical and wire beam antennas, plus coverage on a universal HF antenna system and working DX with an "invisible aerial"; the SWR meter and coaxial cable also have chapters to themselves.

The whole book is presented in an authoritative, immensely clear, readable and enjoyable manner with the emphasis on the practical throughout — to the extent that even the chap who can hardly strip a piece of co-ax need not feel at all left out! Just as practical for the SWL, too!

192 pages

**£ 6.20** inc. post.

Order from

Publications Dept.  
**Short Wave Magazine Ltd.**  
34 High Street, Welwyn, Herts. AL6 9EQ

## BETTER SHORT WAVE RECEPTION

by William I. Orr W6SA1 and Stuart D. Cowan W2LX

*Latest 5th Edition*

In the latest edition of this excellent work for all those who own (or intend to own) a radio receiver, these two well-known and respected writers have produced chapters covering: the radio spectrum and what you can actually hear world-wide; the tuning of a shortwave receiver; the business of buying a receiver, both new and secondhand; a description of the SW Rx in non-technical terms, together with receiver adjustment and alignment; DX-ing above 30 MHz; a description of the VHF receiver; building and adjusting efficient aerials; reception techniques.

Thoroughly readable and "digestible", this book is without doubt a very valuable addition to the bookshelf of any SWL.

160 pages

**£ 6.20** inc. post.

Order from:

Publications Dept.  
**Short Wave Magazine Ltd.**  
34 High Street, Welwyn, Herts. AL6 9EQ



# Technical Books and Manuals

(ENGLISH AND AMERICAN)

## AERIAL INFORMATION

Antenna Handbook (Orr and Cowan) .....	£7.75
Beam Antenna Handbook .....	£6.50
Cubical Quad Antennae, 3rd Edition .....	£6.90
Simple Low Cost Wire Antennas, by Orr .....	£6.20
Aerial Projects (Penfold) .....	£2.30
73 Dipole and Long-Wire Antennas (E. M. Noll) .....	O/S
Antenna Book (ARRL) <i>latest 14th Edition</i> .....	£8.00
The (ARRL) Antenna Anthology .....	£4.50
Two-metre Antenna Handbook, F. C. Judd G2BCX .....	£6.35
HF Antennas for All Locations (RSGB) .....	£6.65
25 Simple Shortwave Broadcast Band Aerials (E. M. Noll) .....	£2.25
25 Simple Amateur Band Aerials (E. M. Noll) .....	£2.25
25 Simple Indoor and Window Aerials .....	£2.05

## BOOKS FOR THE BEGINNER

Amateur Radio ( <i>Lutterworth Press</i> ) .....	£9.60
Solid State Short Wave Receivers for Beginners (R. A. Penfold) .....	£2.25
Beginners Guide to Radio (9th Edition) .....	£5.45
Beginners Guide to Electronics, 4th Edition .....	£5.45
Beginners Guide to Amateur Radio (Newnes) .....	£5.45
Beginners Guide to Integrated Circuits, 2nd edn. ...	£5.00
Guide to Amateur Radio, 19th Edition (RSGB) .....	£3.40
Morse Code for the Radio Amateur (RSGB) .....	£1.50
Understanding Amateur Radio (ARRL) .....	£5.45
Radio Amateur's Examination Manual, <i>latest 10th edition</i> (RSGB) .....	£3.60
How to Pass the Radio Amateurs' Examination (RSGB) .....	£3.30

## GENERAL

Weekend Projects for the Radio Amateur (ARRL) ..	£3.05
Projects in Amateur Radio and Short Wave Listening ( <i>Newnes</i> ) .....	£4.20
How to Build your own Solid State Oscilloscope (Rayer) .....	£2.25
How to Design and Make Your Own PCB's .....	£2.25
How to Build Advanced Short Wave Receivers .....	£2.25
Better Short Wave Reception, ( <i>5th Ed</i> ) .....	£6.20
FM & Repeaters for the Radio Amateur (ARRL) .....	£4.35
Easibinder (to hold 12 copies of "Short Wave Magazine" together) .....	O/S
World Radio & TV Handbook 1985 Edition .....	£19.15
The World's Radio Broadcasting Stations and European FM/TV (Newnes) .....	£8.10
Guide to Broadcasting Stations (18th Edition) .....	£5.50
Radio Stations Guide .....	O/S

Long Distance Television Reception (TV-DX) for the Enthusiast ( <i>revised edition</i> ) .....	£2.25
An Introduction to Radio DXing .....	£2.30
Radio Amateurs DX Guide (14th Edition) .....	£2.45
Power Supply Projects (Penfold) .....	£2.05

## HANDBOOKS AND MANUALS

Radio Communication Handbook, Vols. 1 and 2 combined (paperback), RSGB .....	£11.75
Teleprinter Handbook, New 2nd Ed. (RSGB) .....	£12.70
TVI Manual ( <i>2nd Edn.</i> ) (RSGB) .....	£2.20
The ARRL 1985 Handbook for the Radio Amateur, <i>soft cover</i> .....	£15.50
The ARRL 1985 Handbook for the Radio Amateur, <i>hard cover</i> .....	£21.50
Learning to Work with Integrated Circuits (ARRL) ..	£1.70
Weather Satellite Handbook .....	O/S
The Satellite Experimenter's Handbook (ARRL) ..	£9.70
Test Equipment for the Radio Amateur (RSGB) .....	£5.75
Amateur Radio Operating Manual (RSGB) <i>3rd Ed.</i> .....	£6.10
Oscilloscopes — How to Use Them, How They Work (Newnes) .....	£5.40
Practical Handbook of Valve Radio Repair (Newnes) .....	£17.15
Radio Propagation Handbook, by W4LGF (Tab) .....	O/S

## USEFUL REFERENCE BOOKS

Solid State Design for the Radio Amateur (ARRL) ..	£7.60
Foundations of Wireless and Electronics, 10th Edition (Scroggie) .....	£10.05
Amateur Radio Techniques, 7th Edn. (RSGB) .....	O/P
U.K. Call Book 1985 (RSGB) .....	£6.50
Hints and Kinks (ARRL) .....	£4.30
Electronics Data Book (ARRL) .....	£3.15
Radio Frequency Interference (ARRL) .....	£2.40
Amateur Radio Awards, (RSGB) .....	£3.40
Electronics Pocket Book, 4th Edition (Newnes) .....	£6.20

## VALVE AND TRANSISTOR MANUALS

Towers' International Transistor Selector, latest 1985 Edition (Up-Date No. 3) .....	£14.50
Semiconductor Data Book, 11th Edition (Newnes) ..	£8.05
International Transistor Equivalents Guide .....	£3.40
International Diode Equivalents Guide .....	£2.60

## VHF PUBLICATIONS

VHF Handbook, Wm. I. Orr W6SAI <i>new 3rd Edition</i> .....	£9.75
VHF/UHF Manual (RSGB) 4th Edition .....	£10.60
The UHF-Compendium, Parts 1 and 2 .....	O/S

orders despatched by return of post

O/P (Out of print)

THE ABOVE PRICES INCLUDE POSTAGE AND PACKING

O/S (Out of stock)

Many of these titles are American in origin

(Terms C.W.O.)

Prices are subject to alteration without notice.

Available from

SHORT WAVE MAGAZINE

Publications Dept.

34 High Street, Welwyn, Herts. AL6 9EQ — Welwyn (043871) 5206/7

(Counter Service: 9.30 — 5.00 Mon. to Fri.)

(GIRO A/C No. 5476151)