

VOL. XXXII
No. 2

25p

THE
**SHORT
WAVE
MAGAZINE**



WORLD WIDE
COMMUNICATION

For the Radio Amateur and Amateur Radio

Have you done your sums?

Add THE WORLD RECORD ANTENNA
to THE WORLD FAMOUS TRIO
and YOU HAVE A COMPLETE RADIO STATION
equal TO THE BEST FOR ANY LOCATION —

READY TO PLUG TOGETHER IN MINUTES AT A COST LITTLE **MORE** THAN THE COST OF THE TRIO ALONE!!!

F R E E Speaker ; Suitably Terminated Connectors; Handbook; Carriage; Insurance. In addition a JOYSTICK V.F.A.; JOYMATCH A.T.U.; feeder external mounting insulators are supplied FREE or greatly reduced when you buy a PARTRIDGE PACKAGE. A PARTRIDGE PACKAGE constitutes a COMPLETE RADIO STATION—ready to use however confined your domestic space. The World renowned TRIO range of Communications Receivers and Transceivers, the WORLD RECORD, internationally patented JOYSTICK V.F.A. (all band aerial) only 7' 6" long (assembled) and a JOYMATCH aerial tuning unit, internal speaker, plus accessories, go to complete your READY TO USE RADIO STATION at a price that truly represents VALUE FOR MONEY! 24 HOUR DELIVERY (MON.-FRI.) ADD £4.00—OUR RISK!

PARTRIDGE PACKAGE (Write for details of more Partridge Packages).

No. 1 with Gen. Coverage AM/CW/SSB (MW/SW) 9R59DS Receiver (£46.75).

PACKAGE PRICE £64.52 (Save £14.28)

NOTHING MORE TO PAY! OUR RISK Access/Barclaycard orders accepted by 'phone JOYSTICK V.F.A. £13.75; JOYMATCH TX/RX A.T.U. 111A 1.6-32 MHz £13.75; JOYMATCH A.T.U. 111 RX only 500 kHz-32 MHz £13.75; JOYMATCH A.T.U. LO-Z500 TX/RX 500w SSB (PA input), Built-in RF meter £19.91; Communications 8Ω headphones (suitable TRIO, EC10 etc.) £3.14; Matching Speaker (with instructions for internal fitting in 9R59DS £2.00; TRIO: Linear Amplifier TL911 £172.15 PLUS £32.50 worth of Partridge equipment FREE; TRIO TR2200 2m. personal transceiver £87.45 PLUS £17.50 worth of Partridge equipment FREE; TRIO TR7200 2m. car transceiver £142.45 PLUS £28.50 worth of Partridge equipment FREE; 6 spare valves for 9R59DS £2.35; OA2 Mains Stabiliser 74p; 9R59DS £46.75 (VAT incl.) plus FREE Speaker del. OUR RISK.

Amazing "DX-CRYSTAL SET" £2.42 incl. unique aerial. Free with your Partridge Package.

NEW: AMTRON QUALITY KITS—send for brochure and prices.
PARTRIDGE BUDGET LINE

Artificial Earth—solves receive and transmit earth problems (as used on North Sea Rigs!) £5.80; Aerial Bandswitch—tuned aerial for domestic receivers £5.80; A.T.U. KIT—for use with transmitters and Communications Receivers £5.80, (assembled £7.01); Mini SWR Bridge—1.8 to 180 MHz, 2kw P.E.P., 75 or 50Ω SO239 sockets; 1:1 to 1:3 ratio, 80 x 30 x 30mm. £5.60. (All prices quoted INCLUDE V.A.T., CARRIAGE, PACKING, INSURANCE.)

Send 3½p stamp for full illustrated details. Special TRIO brochures (state which) 3½p stamp extra.

NO V.A.T. ON OVERSEAS ORDERS! Carriage and insurance extra overseas orders.

BOX 4

PARTRIDGE
 BROADSTAIRS WENT ENGLAND
ELECTRONIC LTD

G3CED — G3VFA
 FOR EXPERT ADVICE AND INFORMATION
 Telephone: 0843 62535 or 62839
 evenings and weekends



Fine British equipment from

- ★ KW 202 Receiver
- ★ KW 204 Transmitter
- ★ KW 107 Supermatch
- ★ KW 101 SWR Meter
- ★ KW 103 SWR/Power Meter
- ★ KW 100 Linear Amplifier
- ★ KW E-Z Match

KW

- ★ KW Traps (the original and best)
- ★ KW Low Pass Filters
- ★ KW Balun
- ★ KW Antenna Switch
- ★ KW Dummy Load
- ★ KW 108 Monitorscope

The KW 2000 E Transceiver



A COMPLETE RANGE OF EQUIPMENT FOR THE RADIO AMATEUR—SEND FOR CATALOGUE AND ASK FOR DETAILS OF THE NEW KW109 HIGH-POWER SUPERMATCH AND THE NEW KW160 ANTENNA TUNING UNIT

K.W. Electronic Equipment now available exclusively through K.W. Communications Limited.

K.W. Communications Limited has joined the Decca Group, it is company policy to continue manufacturing the finest equipment for the Radio Amateur—British made equipment backed by a servicing facility with available spares—the best in the country.

BY BRITISH—BUY DECCA—KW

THIS COMPANY CONTINUES UNDER THE DIRECTORSHIP OF G8KW

Write or phone for catalogue

K.W. COMMUNICATIONS LTD.

1 Heath Street, Dartford, Kent
Tel.: Dartford 25574/21919

EASY TERMS ON EQUIPMENT AVAILABLE OVER 12, 18 OR 24 MONTHS



Western



We regret that due to cost increases, Yaesu have increased prices and these are now as follows: (Exc. VAT).

YAESU PRICES (inc. free delivery by Securitor):

TRANSCIVERS

*FT-75	£138-00
FT-101	£280-00
FT-101B	£330-00
*FT-200	£170-00
*FT-401	£310-00
*FT-501	£375-00

*Power supply required.

POWER SUPPLIES

FP-75	£32-00
DC-75	£39-00
FP-200	£45-00
FP-501	£53-00

TRANSMITTERS

FL-50B	£70-00
FL-400	£193-00

RECEIVERS

FR-50B	£67-00
FR-400DX	£135-00
FR-400SDX	£210-00

LINEAR AMPLIFIERS

FL-2000B	£195-00
FL-2100	£165-00
FL-2100B	£195-00
FL-2500	£130-00

until stocks exhausted

REMOTE VFO's

FV-50B for FL-50B	£34-00
FV-50C for FT-75	£34-00
FV-101 for FT-101	£42-00
FV-101B for FT-101B	£48-00
FV-200 for FT-200	£48-00

SPEAKERS

SP-101	£11-00
SP-101B	£13-00
SP-101P	£26-00
SP-101PB	£29-00
SP-400/401	£13-00

VHF EQUIPMENT

FT-2 AUTO	£157-00
FT-2FB	£115-00
FP-2AC	£38-00
FP-2AC/B	£71-00
SIGMASIZER 200	£196-00
FT-220	£264-00
FT-620	£170-00

ACCESSORIES

YD-844 Table Mic.	£14-75
YD-846 Hand Mic.	£5-75
Fan, FT-101	£9-00
FP 50DX L.P. Filter	£12-25
Crystals FT2F/B	pr. £3-50

FREQUENCY COUNTERS

YC-355 AC only	£99-00
YC-355 AC/DC	£110-00
YC-355D AC/DC	£127-00

NEW-Coming shortly
YO-100 MONITOR SCOPE

Price £93.00

455 KHz or 9 MHz £2.50 extra

Keep a watchful eye on your transmitter's output or use it to tune-up for maximum p.e.p.!

Can be connected to your receiver also to monitor incoming signals.

BATTERY CLOCK

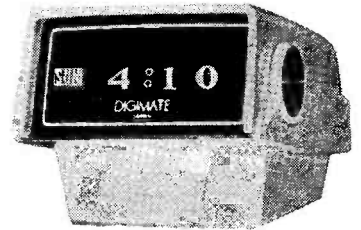

(£6.82 inc. VAT)

This operates for about 6 months on one battery (provided). Available in red, blue, orange, ivory and brown; list your choice in order of preference.

OSKER
POWER METER

(Ex Stock)

Features: Switchable for 52 or 75 ohm systems. Each instrument is individually calibrated. Four ranges: 0-2, 0-20, 0-200 and 0-2 kW, 3-200 MHz. Excellent Styling.

Price: £19.50 VAT extra

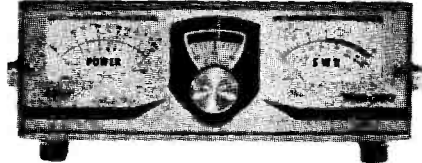

ATTENTION H.F. MOBILE OPERATORS!

Fed-up with having to disconnect resonators/whips before garaging?
Fed-up with having to go slow due to inadequate mounting?
Then here's the answer... the "HUSTLER."

Hustler and only Hustler gives you 12 years of proven performance, mechanically and electrically superior to all others. You get exceptional reports on every band, lowest SWR and broadest bandwidth. Matching devices are not required. Use any convenient length of 52 ohm feed line. Convenience of fold-over mast for rapid band change or easy garaging, optimizes performance on each band and a time proven concept in mobile communications, a concept verified by the overwhelming majority of amateurs, are yours only with the Hustler!

MO2 MAST
FOLDS OVER

Rotates 360° in horizontal plane

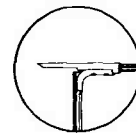

The original hinge and sleeve clutch mechanism.

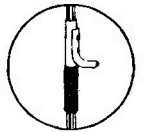

NEWTRONICS HUSTLER MOBILE ANTENNAS. Carr. 75p

BM1 Bumper mount	£5-05	RM10	£5-00	RM20	£6-05
MO2 Mast	£7-50	RM15	£5-55	RM40	£7-50
RM75	£8-00				
Ball Mount	£2-00				
Stainless steel spring	£5-45				
Resonator spring	£2-65				
Carr. 50p.					

VAT extra.

W.E. QUAD 10-20m, "boomless" type. Cast aluminium centre, bamboos, etc. ... £30-00 (Carr. paid)

W.E.J Trapped dipoles for 10-80m. All are fitted with resin encapsulated traps and a high quality commercial grade centre assembly with cable strain relief.

Type S.500 watts, £16. Type HP for 1 kW p.e.p., £17-25. Type P with a special copper/terylene braided element for ease of coiling up. Supplied with winding spools and 70ft. co-ax, £19-50. VAT extra.

PRICE LIST. Our latest (March) list is available f.o.c. upon receipt of a foolscap S.A.E.

CATALOGUE of Tower, Masts, Antennas, Rotors and Communications Equipment is available at 20p. (No S.A.E. required).

All advertised prices exclude VAT and are subject to manufacturers and currency fluctuations.

50p SMALL ORDER SURCHARGE. Due to the increased costs of handling and processing, all orders under £2 will bear this surcharge.

Electronics (UK) Ltd

Punch a hole in the Band! with WILSON QUALITY Mono & Duo-Band Beams

New Reinforced wide spaced 40, 20, 15 and 10 metre beams

All W7GVA beam elements are constructed of the finest aluminium available, 6063T832 and 6061-T6 both top quality alloys.
All Wilson Electronics beams have a 3" O.D. boom made of top grade aluminium 6063-T6.
All our beams come complete with adjustable reactance tuned gamma match network which can handle 4 KW plus on CW and SSB.
Prices include carriage (exclude VAT). All models are ex-stock at the time of going to press and all 20 and 40m. models have reinforcing kits for maximum strength.

WILSON MONO BAND BEAMS VAT extra.

Model No.	Beam	Gain	Price
M340	3 ele. 40 metre beam	8.5 dB	£282
M240	2 ele. 40 metre beam	5.5 dB	£140
M720	7 ele. 20 metre beam	Gain 14 dB	£259
M720	7 ele. 20 metre beam	Gain 14 dB	£259
M620	6 ele. 20 metre beam	Gain 13 dB	£199
M520	5 ele. 20 metre beam	Gain 12 dB	£107
M320	3 ele. 20 metre beam	Gain 8.5 dB	£58
M715	7 ele. 15 metre beam	Gain 14 dB	£99
M615	6 ele. 15 metre beam	Gain 11 dB	£83
M415	4 ele. 15 metre beam	Gain 10 dB	£54
M810	8 ele. 10 metre beam	Gain 14.5 dB	£107
M510	5 ele. 10 metre beam	Gain 12 dB	£54

WILSON DUO BAND BEAM

DB62	6 ELE. 20 and 2 ELE. 40 INTERLACED BEAM	Gain 13 dB—20 5.5 dB 40. Boom length 50ft.
DB52	0 ELE. 20 and 2 ELE. 40 INTERLACED BEAM	Gain 13 dB—20 5.5 dB. Boom length 40ft.
DB54	5 ELE. 20 and 4 ELE. 15 INTERLACED BEAM	Gain 12 dB—20 10 dB—15. Boom length 40ft.
DB43	4 ELE. 20 and 3 ELE. 15 INTERLACED BEAM	Gain 10 dB—20 8.5 dB—15. Boom length 30ft.
DB32	3 ELE. 20 and 2 ELE. 15 INTERLACED BEAM	Gain 8.5 dB—20 6 dB—15. Boom length 20ft.
DB76	7 ELE. 15 and 6 ELE. 10 INTERLACED BEAM	Gain 14 dB—15 13 dB—10. Boom length 40ft.
DB65	6 ELE. 15 and 5 ELE. 10 INTERLACED BEAM	Gain 13 dB—15 12 dB—10. Boom length 32ft.
DB44	4 ELE. 15 and 3 ELE. 10 INTERLACED BEAM	Gain 10 dB—15 8.5 dB—10. Boom length 20ft.
DB67	7 ELE. 20 and 6 ELE. 15 INTERLACED BEAM	Gain 14 dB—20. 13 dB—15.

BANTEX FIBREGLASS MOBILE ANTENNAS (Carr. 75p) VAT extra.

70 1/2 70 MHz, 1/2 wave	£3.00	BGA, 144 MHz, 1/2 wave	£6.15
144 1/2 144 MHz, 1/2 wave	£2.85	BS, 144 MHz, 1/2 wave	£4.45
Magnetic Mount	£6.15	Note—Deduct 50p from price of aerial if base is not required.	

The NEW SILENT CDE ANTENNA ROTORS are ex-stock. These supersede the previous "Clunk-click" models.

CDE ROTOR PRICES:
AR20, £22; AR30, £25; AR40, £30; TR44, £52; HAM-M, £79.
VAT extra.

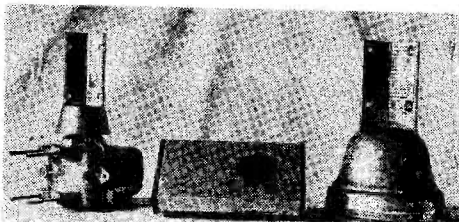

It's Spring time! Antenna time

For the most comprehensive service and advice we hope that you will feel free to consult us for advice upon your requirements.

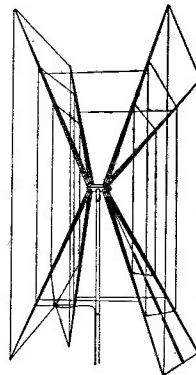

From CANADA

GEM QUAD

£72.00 VAT extra for 10, 15 and 20m.

- * Weighs only 21 lbs.
- * Withstands 100 m.p.h. winds.
- * Forward gain up to 8 dB.
- * Balun included.
- * Converts to 3 or 4 element quad.
- * Fibreglass tri-decticspreaders.
- * Front/back ratio 25 dB.
- * Low angle radiation.

From the U.S.A.

HY-GAIN

Hy-gain 18AVT/WB the great new wide band vertical self supporting for 10-80m. (ex-stock). Take the wide band, omnidirectional performance of Hy-Gain's famous 14AVQ/WB add 80 mtrs. plus extra heavy duty construction and you have the new 18AVT/WB * True 1/2 wave resonance on all bands * 52 I/P * SWR of 2: 1 or less at band edges * 1 kW (AM) * Radiation pattern has an outstandingly low angle * Roof or ground mounting.

Hy-Gain (Carr. Paid)			
Hy-Tower	10-80m.	Vertical self supporting	£132.00
18V	10-80m.	Vertical self supporting	£15.50
12AVQ	10-20m.	Vertical self supporting	£20.00
14AVQ	10-40m.	Vertical self supporting	£29.50
LC-80-Q		Loading coil for AVQ, 80m.	£9.30
18AVT/WB	10-80m.	Vertical self supporting	£42.50
TH6DX	10-20m.	6 element beam	£117.00
TH3 Mk.3	10-20m.	3 element beam	£90.50
TH3 Jr.	10-20m.	3 element 600W., beam	£62.00
TH2 Mk. 3	10-20m.	2 element beam	£62.00
Hy-Quad	10-20m.	2 element quad	£90.00
DB10-15A	10 & 15m.	3 element beam	£69.00
DB 24B		3 element 20m., 2 element 40m.	£129.00
402BA	40m.	2 element	£110.00
261		1/2 Wave 108-470 MHz, co-ax and roof mount	£4.80
262		1/2 wave mag mount, 18ft. co-ax	£10.45
263		1/2 wave 130-174 MHz and Boot lip mount and 16ft. co-ax.	£13.20
265		3 dB Gain 144-174 Stainless steel whip and magnetic mount and 12ft. co-ax	£15.00
204BA	20m.	4 element beam	£96.00
203BA	20m.	3 element beam	£87.00
153BA	15m.	3 element beam	£44.00
103BA	10m.	3 element beam	£25.00
LA-1		Lightning arrester	£17.50
LA-2		Lightning arrester	£3.00
12RMQ		Roof mounting kit	£11.00
14RMQ		Roof mounting kit	£13.00
Type 499		Body mount	£5.80
Type S11		Spring, Heavy duty	£5.80
Type 417		Spring	£4.90
E1		End insulator, per pair	£1.80
400		Rotor	£139.00
EN86		Balun	£9.50

VAT extra



SOUTH MIDLANDS CONSTRUCTION LTD.

INCLUDING WESTERN ELECTRONICS (UK) LTD.

TRADING DIVISION

S.M. HOUSE, OSBORNE ROAD, TOTTEN, SOUTHAMPTON, SO4 4DN

Agents: G3ZUL Droitwich (090 57) 4510
G3PRR Chesham (02405) 4143

Telephone: Totton (04216) 4930 or 2785

Cables: 'Aerial, Southampton'

Hours of business: 9-5.30; 9-12.30 (Saturdays)

Venus Scientific Inc.

The company that put high voltage on the moon,
now brings you expanding amateur radio technology

2nd Generation Slo-Scan

Venus Scientific brings ten years of space-age technology development to the production of the latest breakthrough in HAM Equipment... the SS2 Slo-Scan Monitor. The following unique features of the SS2 have been designed to offer the HAM operator the maximum functional performance in SSTV.

These advances include: **ACCU SYNC**, a diagnostic and tuning aid which converts the SS2 Monitor to an oscilloscope by the flip of a switch that monitors incoming and outgoing video; **LED SWEEP INDICATORS**, go-no-go lights for ease of servicing; **CAMERA ADAPTER** provision to accept Polaroid Color Pack Camera or Polaroid Square Shooter, which enables you to take pictures right off the air; **SIMPLIFIED INDEPENDENT CONTROLS**.
NOTHING COMPLICATED—CONNECTS DIRECTLY TO YOUR LOUDSPEAKER TERMINALS.

PRICE: £249 including V.A.T.

For the full story on how VENUS' SS2 monitor has become the 2nd Generation of Slo-Scan and a list of accessories, write or call today.

U.K. Agents: **LOWE ELECTRONICS RADIO SHACK LTD.**

R. T. & I. ELECTRONICS LTD.

where equipment is fully overhauled

EDDYSTONE EC10	£50.00 (£1.00)
TRIO JR160 2M cal.	£54.00 (£2.00)
HAMMARLUND HG170	£160.00 (£2.00)
KW77	£85.00 (£2.00)
TRIO 9R 59DS	£42.00 (£2.00)
SWAN 500C plus A.C. p.s.u.	£240.00 (£3.00)
KW VICEROY	£80.00 (£2.00)
HEATHKIT DX40 plus VFO	£40.00 (£2.00)
KW YESPA 2 and p.s.u.	£105.00 (£3.00)
HEATHKIT GR 64	£25.00 (£1.00)
LAFAYETTE HA350	£60.00 (£1.50)
HAMMARLUND SP-600-JX6	£135.00 (£2.00)
EDDYSTONE 770U	£160.00 (£2.00)
HEATHKIT DX 100 Transmitter	£45.00 (£3.00)
KW 2000A with A.C. p.s.u.	£180.00 (£3.00)
TRIO JR-500-SE Receiver	£58.00 (£1.50)
RCA AR88D Receiver	£75.00 (£2.00)

WE CAN ALSO SUPPLY ANY MAKE OF NEW EQUIPMENT—and have pleasure in giving a few examples which are normally in stock:—

AVOMETERS, Model 7, Mk. 2, £46.50; Model 8, Mk. 5, £49.80; Model 40, Mk. 2, £46.50; Model 72, £19.12; Multiminor Mk. 4, £16.55; Standard Leather Carrying Case (Models 7, 8, 40), £9.32; Ever Ready ditto, £10.80; Multiminor Leather Case, £4.82; 10K V.D.C. Multiplier for model 8 or 9, £7.50; 30K V.D.C. ditto, £12.50; Pair of Long Reach Safety Clips, £1.75; Model EA113 Electronic Avo, £92.00; Model 272 Electronic Avo, £32.90; Model TT169 Transistor Tester, £19.80. All Above post free in U.K. Trade and Educational enquiries invited. All other AVO and TAYLOR products available, ask for quote.

S. G. BROWN'S HEADPHONES, Type "F" 120 ohm, 2000 ohm, 4000 ohm, £7.00 (30p); Rubber Earpads for same, 50p per pr. (5p); Type 3C/1100 Noise Excluding (with superb fitting) high quality, electro-dynamic, £7.55 (30p); Standard Jack plugs, 24p (4p).

EDDYSTONE EQUIPMENT, Receivers EC10/2, £102.00; EB37, £99.00; 1000, £220.00; 1001, £230.00; 1002, £245.00; 1004, £280.00; 924 A.C. mains p.s.u., £9.00 (50p); Doublet Aerial 731/1, £8.00 (50p); Plinth Speaker 906, £9.00 (50p); General Purpose Speaker 935, £6.90 (40p); Edometer 902 Mk. 2, £29.50 (50p); Telescopic Aerial Type 991, £2.80 (25p); Active Aerial LP3382, £20.50; Diecast Boxes from 51p (10p). Brochure on request.

CODAR EQUIPMENT, PR40, £8.90 (30p); Leaflets on request.

In present conditions we regret that all prices are subject to alteration without notice.

NOTE: 10% VAT must be added to all prices, new and secondhand, inc. carr. and packing.

Carriage for England, Scotland and Wales shown in brackets. Terms: C.W.O., Approved Monthly Accounts, Hire Purchase and Part Exchange. Special facilities for export.

At R.T. & I.

- ★ We have full H.P. facilities.
- ★ Part exchanges are a pleasure.
- ★ We purchase for cash.
- ★ We offer a first-class overhaul service for your electronic equipment, whether you are an amateur or professional user.
- ★ We have EASY Parking facilities.
- ★ We welcome your enquiries for specific items which although not advertised, may very well be in stock.

FREE SHURE MIC. WITH EVERY KW TRANSMITTER or TRANSCEIVER purchased

LAFAYETTE HA800, £57.50 (50p).

PARTRIDGE "JOYSTICKS", "New Lightweight VFA" £12.10 (40p).

"JOYMATCH" 111, Aerial Unit, £12.10 (40p), LO-Z500, £17.60 (40p); ATU kit, £4.50 (30p); ATU assembled, £5.50 (30p); Artificial earth, £4.50 (30p); Aerial Bandswitch, £4.50 (30p). Literature on request.

TRIO EQUIPMENT, Receivers: TR7200, £129.50 (£1.00); TR2200, £79.50 (£1.00); SR59DS, £49.50 (£1.00); JR 310, £75.00 (£1.00); JR 599, £160.00 (£1.50); Transmitter TX-599, £160.00 (3.00); Transceiver TS 515 and PS 515, £210.00 (£3.00); Loudspeaker SP5D, £4.50 (50p); Headphones GS4 (equivalent), £6.00 (20p); Stabiliser, 60p (5p). Leaflets available.

SHURE MICROPHONES, 444T, £15.00 (40p); 444, £13.00 (40p); 401A, £6.50 (30p); 201, £5.40 (30p); 202, £6.00 (30p). Full details on request.

KEYNECTORS, piano key mains connector units, £2.95 (30p).

VALVES, Please state your requirements.

ADVANCE DMM2 DIGITAL MULTIMETER, £104.00 (50p); Alpha, £12.00 (50p), etc., etc.

TMK METERS: TMK500, £10.25 (30p); TW20CB, £13.00 (30p); TP55N, £7.25 (30p); 700, £21.50 (30p); also leather case..

PHILIPS PM2403 ELECTRONIC MULTIMETER, £49.50 (40p), etc., etc. We also supply **PHILIPS and KORTING COLOUR TV TEST EQUIPMENT**, including Colour Bar Generators, Convergators, etc.

KW EQUIPMENT (Don't forget your FREE mic. with every Tx. and Txcr.!). D.C. p.s.u., £48.00 (£1.00); KW 2000B only, £200.00 (£1.50); KW2000E plus A.C. p.s.u., £275.00 (£3.00); KW ATLANTA + A.C. p.s.u., £200.00 (£2.00); Remote V.F.O. for Atlanta, £34.00 (50p); VOX unit for Atlanta, £8.50 (25p); Remote V.F.O. for 2000B, £36.00 (50p); KW1000 Linear amplifier, £150.00 (£2.50); KW202 Receiver with calibrator, £160.00 (£1.50); KW 202 Matching speaker, £8.00 (80p); KW204 Transmitter, £170.00 (£2.00); KW107 combined E-Z Match; VSWR indicator, dummy load, and ant. switch (4 outlets) 52 or 75 ohms, £60.00 (80p); KW103, VSWR and power meter, 52 ohms, £14.00 (60p); KW109, £75.00 (80p); also E-Z match, dummy load, trap dipoles etc., etc. Details on request.

R. T. & I. ELECTRONICS LTD.

Ashville Old Hall, Ashville Road, London, E11 4DX Tel: 01-539 4986

NEAREST STATION: LEYTONSTONE (Central Line)

AMATEUR ELECTRONICS G3FIK



BIRMINGHAM 021-327 1497 021-327 6313

ANNOUNCING A NEW SERVICE!

DUE TO THE FACT THAT WE HAVE THE LARGEST TURNOVER OF QUALITY USED EQUIPMENT IN THE COUNTRY WE ARE CONTINUALLY LOOKING FOR TOP-GRADE GEAR OF EVERY DESCRIPTION. IN OUR EXPERIENCE, HOWEVER, MANY PEOPLE WHO HAVE EQUIPMENT FOR DISPOSAL FIND THE PHYSICAL EFFORT ENTAILED IN EITHER SENDING OR BRINGING EQUIPMENT IS A MAJOR OBSTACLE TO WHAT COULD BE A PROFITABLE TRANSACTION. FOR THIS VERY REASON WE ARE PLEASED TO ANNOUNCE THAT WE ARE NOW ABLE TO ARRANGE COLLECTION FROM YOUR HOME QTH AND THIS SERVICE EXTENDS TO MOST PARTS OF THE UNITED KINGDOM INCLUDING NORTHERN IRELAND. IN THE COMING MONTHS WE SHALL BE ARRANGING REGULAR TOURS FOR THIS PURPOSE AND OUR REPRESENTATIVES WILL BE IN A POSITION TO PAY SPOT CASH FOR ALL FIRST-CLASS GEAR OF COMMERCIAL MANUFACTURE.

IF YOU HAVE EQUIPMENT SURPLUS TO REQUIREMENTS PLEASE WRITE TODAY WITH FULL DETAILS INCLUDING PRICE REQUIRED AND WE SHALL BE PLEASED TO ARRANGE A SPEEDY TRANSACTION. REMEMBER, WE CAN ARRANGE OUR VISIT TO SUIT YOUR CONVENIENCE GENERALLY SPEAKING AND, WITHOUT DOUBT, THIS TAKES ALL THE PROBLEMS OUT OF THE DISPOSAL OF GEAR.

AMATEUR ELECTRONICS FOR NEW GEAR!

- ★ EQUIPMENT BY EVERY MAJOR MANUFACTURER
- ★ SECOND-TO-NONE ATTENTION TO ORDERS AND ENQUIRIES
- ★ CONSCIENTIOUS AFTER-SALES SERVICE
- ★ FIRST-CLASS DEMONSTRATION FACILITIES
- ★ ON-THE-SPOT CREDIT TRANSACTIONS
- ★ FAIR PART EXCHANGE ALLOWANCES ON ALL COMMERCIAL GEAR

JUST TO REMIND YOU! We carry stocks by the following makers

YAESU	Full range including the new FT101B
TRIO	Large stocks of every model
KW	The most comprehensive stock in the country
SOMMERKAMP	Complete range of 2 metre equipment
BELCOM	Excellent stocks of the famous Liner 2
SPACEMARK	The well-known SSM-1 SLOW SCAN MONITOR from stock
SOLID STATE	Every 2 metre item in the range available off the shelf.
FDK	Now en route!—The fabulous Digital Read-out MULTI 2000. This is the ultimate in 2 metre rigs—CW/FM/SSB.

SEND TODAY FOR DETAILS OF ANY OF THE ABOVE—A LARGE S.A.E. PLEASE GENTLEMEN.

AMATEUR ELECTRONICS for USED EQUIPMENT.

WE ARE ACKNOWLEDGED AS THE LARGEST STOCKIST OF QUALITY USED GEAR IN THE COUNTRY. AN S.A.E. WILL BRING YOU OUR LATEST LIST.

RACAL ENTHUSIASTS! We have the largest stocks of RACAL Receivers and equipments in the country. Full details on receipt of your S.A.E.

PLEASE NOTE—We will wish to buy all RACAL Receiver sub-assemblies and particularly hardware (handles, panels etc., etc.). No item is too small and your price paid within reason. Cases are of particular interest to us at the moment.

AN ADEQUATE STAMPED ADDRESSED ENVELOPE WITH ALL ENQUIRIES PLEASE
 REGIONAL REPRESENTATIVES : Northern—John Rowley G3KAE Tel: West Ayton 3039
 Scottish—Ron Turner GM8HXQ Tel: Wishaw 72172

AMATEUR ELECTRONICS

ELECTRON HOUSE, 508-514 ALUM ROCK ROAD, BIRMINGHAM 8

LOWE ELECTRONICS

MAIN DISTRIBUTOR FOR YAESU MUSEN EQUIPMENT

Head Office and Service Department (Bill G3UBO, Alan G3MME and John G3PCY)

119 Cavendish Road, Matlock, Derbyshire, DE4 3HE

Telephone : 9 a.m. - 9 p.m. Matlock 2817 or 2430

Southern Sales (Dave G8FAY)
Goring Road, Steyning, Sussex.
Telephone : Steyning 814466.
Just off the A283 on the Shoreham side of the village.
Halfway down the road on the left—look for the tower.

Midland Sales (Peter G3XWX)
Soho House, 362-364 Soho Road,
Handsworth, Birmingham.
Telephone: 021-554 0708
Just off Exit 1, M5—follow the A41 into town for 1½ miles to the Regal (Bingo Hall) Cinema. We are directly opposite, on the first floor. Within easy reach of the South-West or North-East by Motorway.

NO PROBLEM PARKING AT ANY BRANCH

In addition to the above shops, which are open 9 to 5.30 Tuesday to Saturday, we have part-time Agents who are available evenings and weekends :—

John G3JYG
16 Harvard Road, Ringmer, Lewes,
Sussex.
Telephone Ringmer 812071

Sim GM3SAN
19 Ellismuir Road, Baillieston,
Nr. Glasgow.
Telephone 041-771 0364

Alan GW3YSA
35 Pen Y Waun, Efail Isaf,
Nr. Pontypridd, Glam.
Telephone Newton Llantwit 3809

So, wherever you are, we have a branch or a part-time Agent not too far away. At Matlock, the Branches, or our Agents you will see and can try out the best in both new and second hand, H.F. or V.H.F. along with every conceivable accessory for the complete station.

For some years we have given the Amateur a wide range of the best in equipment, the fastest possible delivery and the best possible after-sales service. We still do and will continue so. Old timers know this, but the newcomer may need to be convinced—if so, all you have to do is to ask any experienced Amateur.

INSTANT H.P. A PLEASURE

PART EXCHANGES WELCOME

Our catalogues are free but we would appreciate postage, etc., so please send 8p in stamps for our VHF catalogue, 8p for our HF catalogue, 3½p for second-hand list, or send us 15p in stamps and we will send the lot.

LOWE ELECTRONICS FOR YAESU

Full range of Yaesu equipment ex stock



LOWE ELECTRONICS FOR 2M SSB

Liner 2, Multi 2000



LOWE ELECTRONICS FOR 2M FM

Yaesu Sigmasizer, FT2FB, FT2AUTO, FDK Multi 7, Multi 8, Multi VFO, Inoue IC210 all ex stock



LOWE ELECTRONICS FOR ACCESSORIES

All accessories for the modern station



LOWE ELECTRONICS FOR ANTENNAS

Wide selection of antennas both H.F. and V.H.F. along with rotators, cable, baluns, etc., etc.



LOWE ELECTRONICS FOR SLOW SCAN

Venus equipment ex stock.



LOWE ELECTRONICS FOR SECOND-HAND

Always a good selection of mint, fully checked equipment, carrying a meaningful guarantee



LOWE ELECTRONICS FOR SERVICE

This is what puts us that little bit ahead—ask anyone

THE AMAZING BARLOW-WADLEY XCR-30 M.K.2 RECEIVER

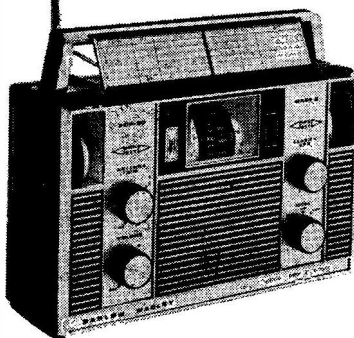

A COMPLETELY NEW CONCEPT IN PORTABLE RADIO DESIGN

1. 0.5 to 30 MHz continuous coverage—direct readout.
2. Antenna tuning for maximum sensitivity.
3. AM, CW, SSB (selectable USB and LSB).
4. Self powered by six SP2 batteries.
5. Power jack for external 6-12v. D.C. supply.
6. Headphone jack.
7. Drift free reception.

At **£99.00.** (Securicor delivery £2.50).

TR801 FM TUNER, **£17.25.** Postage 25p.

All prices include VAT

Sole Distributors:

RADIO SHACK LTD. 188 BROADHURST GARDENS
LONDON, NW6 3AY

Open 5 days 9 until 5 p.m. Sat. 9 until 1 p.m.
Closed for lunch 1 p.m. until 2 p.m.

Just around the corner from West Hampstead Underground Station
Telephone: 01-624 7174 Cables: Radio Shack, London, N.W.6.
Giro Account No.: 588 7151

NOW THE NEW SPACEMARK

SLOW SCAN TV MONITOR SSM-1

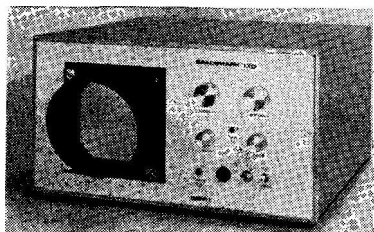

Plug it into your receiver phones jack and watch SSTV pictures on the Monitor screen from DX stations all over the world.

If desired, SSTV pictures can also be recorded on an ordinary tape recorder for viewing again on your Monitor.

- All solid state except 5" CR tube with 7 IC's, 17 transistors.
- Tuning indicator. ● Conforms to international SSTV standards.
- 4 switched inputs. ● Manual. ● Two tone pvc coated cabinet, 13" w. x 7" h. x 13" d. Weight 17 lbs.

SSM-1 MONITOR—£143 (includes V.A.T. and U.K. carr.)
... Why pay double for an imported Monitor?

ALSO AVAILABLE IN KIT FORM. COMPLETE KIT SSM-1K (less case), £82. SET OF PCB's only with full data, £7.50. Special transformer and some other parts available. Kits come with instructions, circuits, layouts, parts lists. SSTV TAPES and CASSETTES with sync. pulses and patterns for setting up Monitors, £1.80. COMING: SSTV Camera and Fast Scan Sampler.

JOIN THE FAST-GROWING SSTV CROWD NOW !!

SPACEMARK LTD.

SOLID-STATE RTTY CONVERTER-KEYER SRD-1

- COPIES 850/400/170 HZ SHIFTS
- BUILT-IN SINGLE AND DOUBLE CURRENT PSU
- F.S. KEYER FOR TX (AND OPTIONAL AFSK)

Complete and ready-to-go for send-receive RTTY with TX, RX and teleprinter.

- Advanced circuitry, 6 ICs, 25 semi-conductors. ● Input matches receiver outputs 3-8 or 500-600 ohms. ● 3-pole Butterworth input bandpass filter. ● Switched 850/400/170 Hz Amateur/Commercial shifts. ● 2-pole low-pass filter. ● Tuning meter.
- Monitor scope outputs. ● Mark Hold and Normal/Reverse shift switch. ● Built-in loop PSU—Instant switch-selection of single- or double-current printers. ● Narrow-shift CW identification. ● F.S. Keyer output for TX. ● Socket and circuitry already fitted for optional plug-in AFSK module, 850/170 Hz. ● Manual.
- Two-tone pvc-coated case, 9" w x 3 3/4" x 14" d. Weight: 7 lbs

SRD-1, £54.45.
(Optional plug-in AFSK module, SRD1-AK, £6.32. SRD-1 complete with SRD1-AK, £60.50).

RTTY CONVERTER-KEYER Model FSD-1, £132. ST-5 PCBs and datasheets, £4.56. ST-6 PCBs and datasheets, £12.92. ST-6 KIT complete less case, with datasheets, £68.75. 88 MH TOROIDS, 38p each plus 10% VAT. **SAMSON ETM-2b, £34.79. ETM-3b, £38.55. JUNKER Precision hand key, £16.59. BAUER keying lever, £5.88. SSB 90° AUDIO PHASE SHIFT NETWORKS, £3.24.**

ALL PRICES INCLUDE V.A.T.
(except Toroids - add VAT please).

All goods post-paid U.K. Send stamp for Catalogue SP5.

**THORNFIELD HOUSE, DELAMER ROAD,
ALTRINCHAM, CHESHIRE.**
(Tel. 061-928 8458)

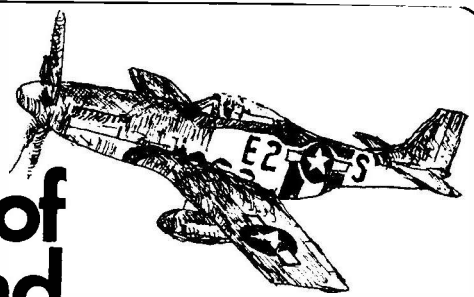
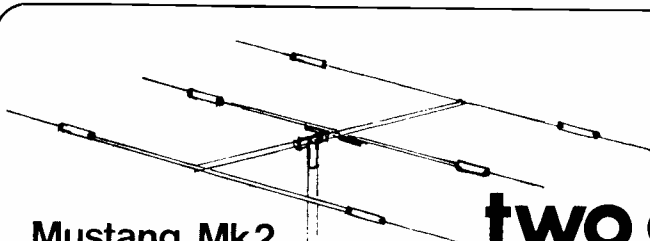

Mustang Mk2

Specifications
 Span 26' 11/2"
 Length 12' 0"
 Weight 26 lbs
 Power Unit: Any Exciter
 up to 2KW SSB
 Armament: High Power Traps
 Price £55+carriage & VAT

two of a kind

SOME ANTENNAS

ATLAS
 Trap Vertical, 10, 15, 20 and 40 metres
£ 25.00
Tri-band
 TA 33jr 3el 10, 15, 20m
£ 39.80

Mustang P51 D

Specifications
 Span 37' Length 32' 3"
 Weight 10,000 lbs
 Power Unit: Rolls Royce
 Armament: 5 Browning MG
 Price \$51,000 (out of production)

Our antennas are built around Stainless Steel hardware and heat treated alloy tubing for highest quality and value.

MOSLEY

Electronics Ltd

Send for **HANDBOOK** containing full details of Antennas and other technical information. 33 pages 20p. Refundable upon purchase of Antenna.

Administrative Address only
 40 Valley Road, New Costessey, Norwich, Norfolk, NOR 26K

AMATEUR RADIO

CHAS. H. YOUNG LTD.
170-172 CORPORATION STREET
BIRMINGHAM B4 6UD 021-236 1635

G3V FV

MICROWAVE MODULES

We now stock the entire range of Microwave Modules. These superbly made units are mounted in small diecast boxes finished in durable black matt stove enamel.

70 MHz	Converters 28 MHz IF	... £16.72
144 MHz	" 2-4 IF	} £16.72
144 MHz	" 4-6 IF	
144 MHz	" 28-30 IF	} £19.91
432 MHz	" 28-30 IF	
432 MHz	" 144-146 IF	} £26.40
1296 MHz	" 28-30 IF	
1296 MHz	" 144-146 IF	
144 MHz	Pre-Amp (2 outputs)	... £9.90
432 MHz	Varactors Triplers	... £19.25
1296 MHz	Varactors Triplers	... £27.90
144 MHz	AM Transmitter (5 watts)	... £35.75

All above post free.

SOLID STATE MODULES

2M Converter 4-6 or 28-30 MHz (22p)	£15.12
70 CM Converter 144/146 MHz (22p)	£15.12
PA3 Pre-Amp for 2M Equipment (10p)	£5.90
2M Pre-Amp in case ... (22p)	£7.15

RECEIVERS

TRIO GR59DS Carr. at cost	£54.45
TRIO JR310	£82.50
Eddystone EC10 K11	£108.90
Yaesu FR50B	£73.70

TRANSMITTER

KW 204	£176.00
------------	-----	---------

TRANSCEIVERS

TRIO TR2200 Portable 2M	...	£87.45
TRIO TR7200 Car 2M	...	£142.45
Yaesu FT101 with 160	£308.00
Standard SRC146A	...	£90.00
5 ch. 2M FM with tone	...	£90.00
Helical whip to fit SRC 146A ... (10p)	...	£2.75

ATU

KW EZ Match (35p)	£18.70
-----------------	-----------	--------

Osker SWR200 SWR/Power Meter 52/75Ω ... (30p)	£20.35
KW107 ATV/SWR ... (40p)	£61.60
KW103 SWR/Power 52 or 75Ω (30p)	£14.30

Comprehensive range of multimeters in stock

Bantex Fibre Glass 2M 1/2 wave ... (25)	£3.14
Bantex Fibre Glass 2M 3/4 wave ... (75p)	£4.90
J Beam Fibre Glass 2M 3/4 wave ... (75p)	£7.70
J Beam Halo 2M head only ... (25p)	£1.87
J Beam Halo 2M with 1/2" pole ... (25p)	£2.20

Full range of J Beam Aerials, Rotators and Accessories.

KW Traps with "AT" ... (25p)	£6.60
Low loss coax 75Ω ... yd. (30p)	14p
Low loss coax 52Ω ... yd. (30p)	33p
Hardrawn 14 SWG Copper Wire 140ft. ... (30p)	£3.05
Hardrawn 14 SWG Copper Wire 70 ft. ... (30p)	£1.05
Soft stranded PVC covered 7/67mm. ... (30p)	£3.50
3" Ribbed insulators ... (6p)	20p
AT Insulator (Centre T) ... (6p)	15p
ML4 4001b ... yd. (25p)	4p

● **Midland Agents**
 for EDDYSTONE, J BEAM,
 JOSTY KITS, AMTRON KITS, TRIO

All prices include VAT
NO C.O.D. PLEASE PRINT YOUR ADDRESS. YOU MAY ORDER GOODS BY PHONE AND PAY BY ACCESS OR BARCLAYCARD. SIMPLY QUOTE YOUR CARD NO. Enquiries S.A.E. please TEL.: 021-236 1635. Prices subject to change without notice.



Out now! Free

the New Heathkit Catalogue

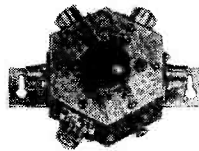
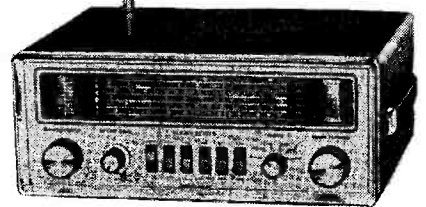
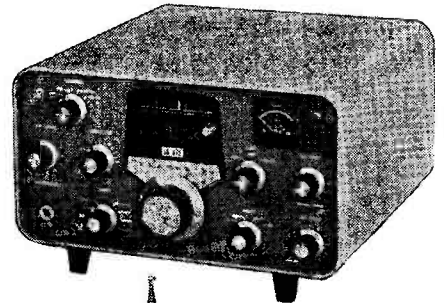
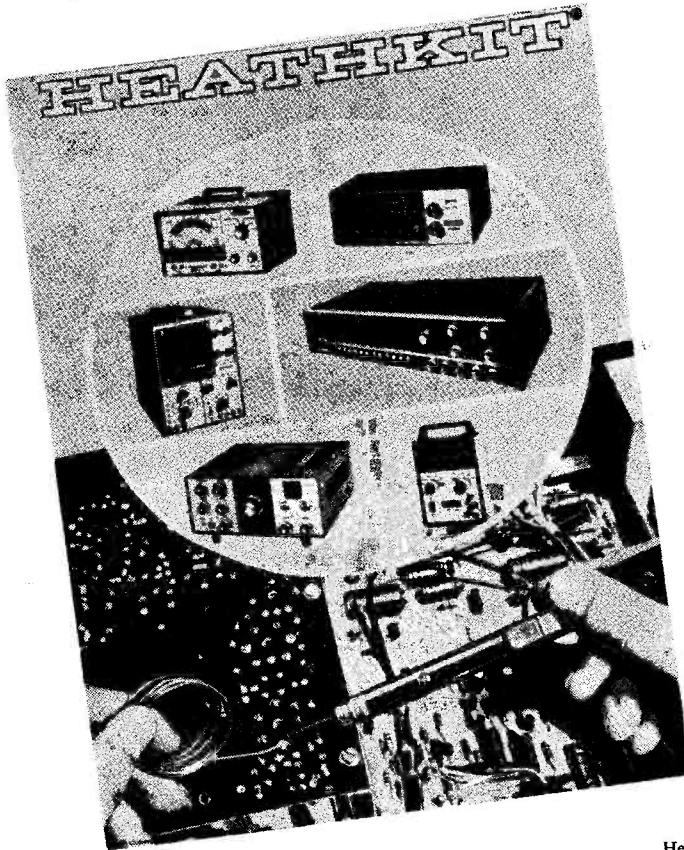

Here's the book of Short Wave Receivers and Amateur Radio gear for you. Handcrafted electronics plus kit form savings. We have hundreds of models to choose from, including: Calculators, Metal Detectors, Burglar Alarm, Battery Charger, Intercoms, Instruments, Hi-Fi etc. All available as kits.

Choose payment by cash or our Monthly Budget Plans—we offer terms to suit your pocket.

Want to know more? Simply post the coupon today for a FREE copy of the Heathkit Catalogue, without obligation.

Electronic kit catalogue

offers something for everyone.
Send for your copy today.

VISIT THE HEATHKIT CENTRES

LONDON

233 Tottenham Court Road.

GLOUCESTER (Factory & Showroom)
Bristol Road, Gloucester.

Free

Please send me the FREE Heathkit Catalogue & details of Monthly budget plans.

NAME _____

ADDRESS _____

HEATH
Schlumberger

HEATH (GLOS.) LTD. DEPT SW/4/74
Bristol Road,
Gloucester GL2-6EE

SPECIAL TRIO OFFERS

9R59DS RECEIVER

Four bands covering 550 kHz to 30 MHz continuous and electrical band-spread on 10, 15, 20, 40 and 80 metres. 8 valve plus 7 diode circuit. 4 to 8 ohm output and phone jack. SSB-CW, ANL, variable BFO. S Meter and separate band spread dial. IF frequency 445 kHz, audio output 1½ watt. Variable RF and AF gain controls. 115/250v. AC.

£42.50 Plus £4.25
VAT
Carriage paid

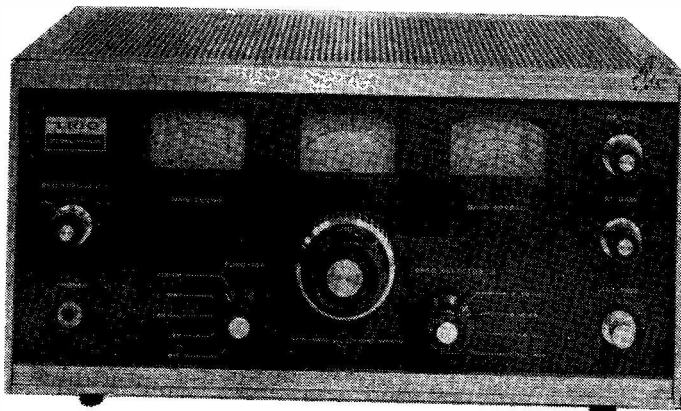

JR599 RECEIVER

Nine wave-bands covering 1.8-29.7 MHz, 144-146 MHz and 10 MHz WWV, SSB, CW, AM and FM. AF output is more than 1 watt. S Meter. Squelch control. BFO. Variable AF and RF controls. 4-16 ohm output and jack for phones. Power requirement 100/240v. AC, 12/14. DC. Size: 270 x 140 x 310 mm.

£132.50 Plus £13.25
VAT
Carriage paid

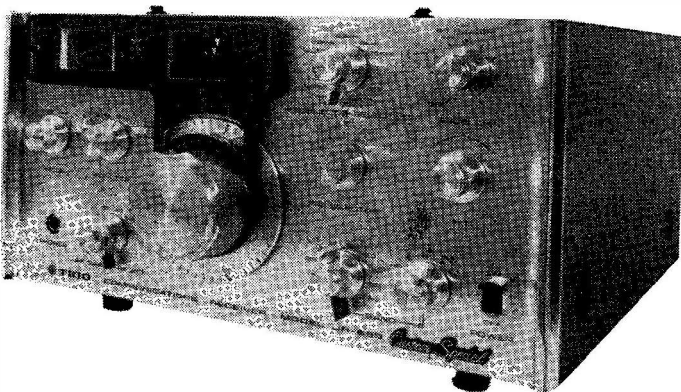

INCORPORATING LASKYS RADIO
AND G. W. SMITH & CO. (RADIO).

CALL INTO YOUR NEAREST BRANCH

CENTRAL LONDON

- 10 Tottenham Ct. Rd. W1 01-537 2232
- 27 Tottenham Ct. Rd. W1 01-636-3715
- 33 Tottenham Ct. Rd. W1 01-636 2605
- 42/45 Tottenham Ct. Rd. W1 01-636 0845
- 87 Tottenham Ct. Rd. W1 01-580 3739
- 257/8 Tottenham Ct. Rd. W1 01-580 0670
- 3 Lisle St. WC2 01-437 8204
- 34 Lisle St. WC2 01-437 9155
- 118 Edgware Rd. W2 01-723 9789
- 193 Edgware Rd. W2 01-723 6211
- 207 Edgware Rd. W2 01-723 3271
- 311 Edgware Rd. W2 01-262 0387
- 346 Edgware Rd. W2 01-723 4453
- 382 Edgware Rd. W2 01-723 4194

- 109 Fleet St. EC4 01-353 5812
- 152/3 Fleet St. EC4 01-353 2833

ESSEX

- 86 South St. Romford 70-20218

SURREY

- 1046 Whitgift Centre, Croydon 01-681 3027
- 27 Eden St. Kingston 01-546 7845
- 32 Hill St. Richmond 01-948 1441

KENT

- 53/57 Camden Rd. Tunbridge Wells 0892-23242

LEICESTERSHIRE

- 45 Market Place, Leicester 0533-537678

All Branches open from
9 a.m. to 6 p.m.
MONDAY TO SATURDAY

TR2200 TRANSCEIVER

Fully transistorised portable VHF transceiver. Will transmit and receive on six channels between 144-146 MHz. 1 watt transmitter. 12v. DC internal or external supply. Built-in charger. Complete with microphone and 144.48, 144.72 and 145.32 crystals.

£79.50

Plus £7.95 VAT. Carriage paid.

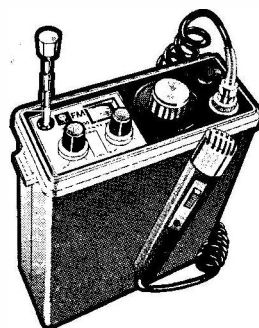

All Mail Orders and enquiries to Head Office;
LASKYS, AUDIOTRONIC HOUSE,
The Hyde, London, NW9 6JJ
Telephone: 01-205 3735 and 5651
BARCLAYCARD AND ACCESS WELCOME
Part of the Audiotronic group of companies.

North West Electric

ALL PRICES ARE INCLUSIVE OF VAT
SPEAKER CABINET. 7½" x 5½" x 5" fitted with 7" x 4" 8Ω speaker, 3 watts. Grey finish as Trio/Eddystone, £5.75 plus post 25p.

CABINET FOR FREQUENCY COUNTER. 12" x 3" x 6" with cut out for suit 8 digit readout. Ventilation louvres, silver stove enamelled, £3.57, post 30p.

NEW BOARDS MANUFACTURED TO OUR SPECIFICATION, COMPONENTS NOT INCLUDED IN PRICE OF BOARD.

READOUT BOARD. 4 Digit, uses GNP7 Wire ended, side viewing, Tubes. 7490 Dividers, 7475 Latch and 74141 Nixie driver. Printed for reset 0 can be wired to reset 9. Board £1.65 each, post 10p. Board size 4½" x 3".

TIME BASE BOARD. Gives all pulses needed to control readout for counter. Uses 7400 Osc. 1 MHz 6 off 7490 divider chain to 1 cycle. 7474 Clocked dual. D, 7413 Schmitt trigger, 7400 pulse outputs, 2N3708 Latch output. Board, £1.65 each, post 10p. Board size 4½" x 2½".

8 DIGIT READOUT BOARD ASSEMBLY. £4.95 each, post 10p. Printed to use ZM1020 1" dia end readout tubes. Front board takes holders for ZM1020s and 7414N Nixie drivers. Back board takes 7490 and 7475 Quad latch. Boards mount back to back to make an ideal assembly for frequency counter etc. Board size 10" x 2½". Front or Back board available, £2.47 each, post 10p.

All boards are High Quality print on fibre glass. Holders for I.C.'s low profile 14 or 16 pin, 17p each, post paid and including 5 off.
READOUT TUBES. ZM1020 1" dia. end viewing £1.50 each, post 5p.

Postage where unstated 5p each; any excess would be refunded. We welcome all enquiries, however small. Stamped addressed envelope please. Hours of business: 9.30 a.m.—6 p.m. Tues. Fri. 9 a.m.—5 p.m. Sat. Closed all day Mondays.

NORTH WEST ELECTRICS

769 STOCKPORT ROAD, LEVENSHULME MANCHESTER 19 Phone: 061-224 4911
 MEMBER OF THE RADIO AMATEUR RETAILERS ASSOCIATION

REG. WARD & CO. LTD. (G2BSW)

WE ARE OFFICIALLY APPOINTED K.W. AGENTS FOR THE SOUTH WEST (Somerset, Dorset, Devon, Cornwall)

KW Atlanta with p.s.u.	£210.00
KW 2000B with p.s.u.	£240.00
KW 2000C TCVR; 8 A.C. p.s.u.	£245.46
KW 202 Receiver with matching speaker	£148.18
KW 204 Transmitter	£160.00
KW 1000 Linear	£135.45
KW 101 VSWR Meter (52 or 75 ohm)	£8.26
KW 103 VSWR Meter and Combined Power Meter	£12.50
KW E-Z Match, 10-90m. ATU	£16.55
KW 107 Combined E-Z Match, VSWR and R.F. Power Indicator, Dummy Load and Antenna Switch for 4 Outlets	£46.36
KW Trap Dipole 70' 75 ohm Twin Feeder	£15.00
KW Trap Dipole 97' Coaxial Feeder	£16.55
KW Trap Dipole with Balun	£18.55
KW 3-way Antenna Switches (for coax)	£4.27
YAESU	
FR50B Amateur Bands Receiver	£59.00
FT101 260w. Transceiver, with mic.; spkr. and built-in A.C./D.C. p.s.u.s.	£246.00
FR50 + Cal. WVVV	£43.00
FT200 Transceiver and FP200 A/C PSU	£190.00
FR400SDX R.c. (with 160 and 2m.)	£175.00
SP400 Speaker	£11.00
Caslon 24 hour Digital Clocks	£7.42

EDDYSTONE RECEIVERS
 EC10 Mk. II £99.00; New Model 1000, £246.50.

WE ARE THE DISTRIBUTORS OF EDDYSTONE PROFESSIONAL RECEIVERS FOR THE SOUTH WEST.

SHURE MICROPHONES
 Model 444, £13.50; Model 201, £5.70.

USED EQUIPMENT: Yaesu FR400DX (as new) £120.00 inc. VAT. Trio 9R59DS (good), requires sep. spkr., £40.00 inc. VAT.

ANTENNAE J-Beam 2 metre Beams in stock. Also Joystick and Joymatch A.T.U.'s, Stolle Ant. Rotators. 140ft. coils 14G. Copper Antenna Wire and Ribbed insulators. T-insulators. U.H.F. Co-ax. Plugs and Sockets. 75 and 52 ohm Co-ax. Cable.

R.C.A. VALVES for KW and Heathkit equipment, 6146, 6146B, 6HF5, 6LQ6, 6GCS, 6EA8, 6CW9, 6GK6, 6CM6, 6CL6, 6CB6, 6BN8, 6H56, 6EW6, 12BA6, 12BE6, 12B26, 6J56C, etc. and many other types.

TRADE INS WITH PLEASURE. OUR STOCK OF GOOD SECOND HAND EQUIPMENT CHANGES DAILY — LET US KNOW YOUR REQUIREMENTS.

Due to currency fluctuations prices of imported equipment are liable to alteration. Add 10% VAT to all prices except used equipment.

WE STOCK R.S.G.B. PUBLICATIONS, LOG BOOKS, Etc.

HP TERMS AVAILABLE CARRIAGE EXTRA ON ALL ITEMS
AXMINSTER — DEVON Telephone: 33163

Waters & Stanton Electronics

NO GARDEN IS TOO SMALL!

- * Element length 11ft.
- * Turning radius 6ft.
- * 10-15.20 metres
- * 1.5 kW rating
- * No traps to burn out

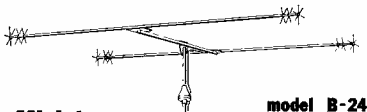

model B-24
Miniature Band, 2 Element BEAM Antenna

£35.75 inc. VAT plus £1.50 carr.

By MINI-PRODUCTS INC. USA

DON'T DELAY SEND S.A.E. FOR DETAILS TODAY

MINI-BEAM STOCKISTS

The following dealers will shortly have Mini-Products antennas in stock. Owing to the heavy demand together with shipping delays in the USA we and our dealers have a waiting list pending fresh supplies. We do however have large programmed orders with the manufacturers and hope that most models will be ex stock by the spring. Your local dealer will be glad to send you literature on the complete range and remember by collecting from him you save yourself £1.50 carriage!

Mini-Beam Stockists

- Amateur Radio Shop, 13 Chapel Hill, Huddersfield.
- Holdings, 39/41 Mincing Lane, Blackburn, Lancs.
- J. & A. Tweedy Ltd., 79 Chatsworth Road, Chesterfield, Derbyshire.
- S. May Ltd., 12/14 Churchgate, City Centre, Leicester.
- Coulsdon, Surrey.
- Amateur Radio Bulk Buying Group, 20 Thornton Crescent, Old Coulsdon, Surrey.

ROTATORS—BRAND NEW CDE AR30, £27.50; AR40, £32.50
COAX. 50 ohm, 15p; 75 ohm, 8p; 300 ohm feeder, 7p.
COMPACT 80/40 DIPOLE, £9.90.

MFJ SUPER SSB/CW FILTER

We are sole agents for this fabulous little filter that will sharpen up the selectivity of any receiver. It simply plugs into the receiver headphone socket and has three positions of selectivity down to 80Hz with an extremely steep skirt and no ringing. In its widest position it enhances SSB and the way it brings the weakest of signals out of the heavy QRM on 40 metres has to be heard to be believed. The unit employs the latest in circuitry and comes ready for use. Our initial stocks were snapped up by callers but by the time this appears we hope to have them in stock again.

PRICE: £11.00 plus VAT

There is also an interesting range of audio amplifiers, kits and xtal calibrators in the MFJ range. SAE for full details.
 MFJ 25/50/100 kHz xtal calibrator module, £8.50.

SUNDRIES

High Power Wightraps	...	(p.p. 20p)	£3.68
"Milliwatt" subscription QRP journal	£1.60
1½" ferrite rings	23p
HP2A TVI filters	£1.43
50 ohms coax...	yd. 15p
300 ohm feeder	yd. 7p
PL259 plugs (genuine amphenol)	ea. 35p
Insulators	ea. 10p

DON'T FORGET—

- * Barclaycard or Access—simply quote number.
- * Full H.P. Facilities—33% deposit.
- * All prices include VAT.
- * All products previously advertised available.

HOCKLEY AUDIO CENTRE . 22 SPA ROAD . HOCKLEY . ESSEX

Hours of Business: 9.5.30 Monday-Saturday

Early Closing—Wednesday.

Tel. Hockley 03704 6835

SOLID STATE MODULES

63 WOODHEAD ROAD, SOLID, LOCKWOOD
HUDDERSFIELD, HD4 6ER

Telephone: 0484-23991

Before you buy equipment you consider some or all of the following :—

PRICE, SERVICE, QUALITY, PERFORMANCE

Different people give these considerations different priority. WE treat them all equally.

When you select our products you get the best of all the above factors.

MEMBER OF THE A.R.R.A.

FOLLOW THE LEADER

We were the first firm, still advertising in this magazine, to offer Dual Gate MOSFET converters for V.H.F., F.E.T. converters for U.H.F. and F.E.T. pre-amplifiers. That was about 6 years ago.

We are now, the only one advertising a 2 metre transverter. You can be assured that the firms who follow the leader will be hard at work, right now, looking at our Europa, and its success.

It is common practice when a leading firm has a monopoly, to charge a high price and reduce the price when the competition catches up. We have never followed this policy. We put a fair and properly costed price on every item we manufacture. You may have noticed that this makes life difficult for our competitors.

You can't go wrong if you BUY FROM THE LEADER.

DUAL GATE MOSFET CONVERTERS FOR 2 METRE OR 4 METRES—SENTINEL—SENTINEL X AND SENTINEL M.F.—Ex Stock

Look at these features :

- * Protection against reserve supply connection and excess voltage.
- * Protection against MOSFET failure.
- * High performance—low 2dB Noise Figure, 30 dB gain.
- * High overtone crystals with no frequency multiplication on all the common I.F. 2 and 4 metre converters.
- * By far the most popular converters around.
- * Excellent after sales service + 12 months guarantee.

SENTINEL

2 METRE I.F.s SUITABLE FOR USE WITH MOST GENERAL COVERAGE RECEIVERS—Ex Stock
2-4 MHz and 4-6 MHz. Double conversion design using 2 mixers and no crystal oscillator multiplication. These techniques minimise breakthrough from out of band signals. Sizes: $2\frac{1}{2}'' \times 4'' \times 1\frac{1}{2}''$. Price £15-12.

2 METRE I.F.s SUITABLE FOR USE WITH AMATEUR BAND RECEIVERS OR TRANSVERTERS—Ex Stock
28-30 MHz and 27-7 MHz. These converters use 116 MHz range crystals with no frequency multiplication. This overcomes the problem of unwanted signals from the fundamental and harmonics of the 38 MHz crystals generally used in other converters. Other I.F.s in stock 9-11 MHz, 14-16 MHz, 18-20 and 24-26 MHz. £15-12.

4 METRE I.F. 28-28.7 MHz. £15-12.

SENTINEL X DUAL GATE MOSFET 2 METRE CONVERTER—Ex Stock

This is a deluxe version containing an internal mains power supplier or battery operation. It has a front panel RF gain control. Size: $5'' \times 1\frac{1}{2}''$ front panel $4''$ deep. Stock I.F.s: 2-4 MHz, 4-6 MHz, 27-7-29.7 MHz, 28-30 MHz. Price: £21-45.

THE SENTINEL M.F. DUAL GATE MOSFET 2 METRE TO MEDIUM WAVE CONVERTER—Ex Stock

Receives 2 metres on a conventional M.W.B.C. receiver, very good used with a car radio, I.F. output 0.5 to 1.5 MHz for 144.5 and 145.6 MHz in two switched bands. Size: $5'' \times 1\frac{1}{2}''$ front panel, $4''$ deep. Price: £20-62.

SM 70 70CM CONVERTER

This one uses an I.F. output of 144-146 MHz. This has enabled us to produce a very high performance converter with a noise figure of 3.5 dB for only £15-12 (Use it with the Europa).

2 METRE PRE-AMPLIFIERS—Ex Stock

Perhaps I had better clarify the difference between our two models of pre-amplifier. The Sentinel Pre-Amplifier, which we have been making for 4 years, is designed for absolute optimum performance on noise, gain and selectivity. It is built in an aluminium box which matches our converters and has isolated +ve and -ve supply lines to make it compatible with any existing supply polarity. The PA3 is a small printed circuit amplifier (approx. 1 cubic inch) with solder pins for connections with small size the primary consideration. This was done to satisfy the large demand for a high

performance pre-amplifier to put inside transceivers (Japanese types and surplus ones) where it can be fitted in the receive aerial lead after the c/o relay. We have maintained the same gain figure, slightly inferior noise figure and a less than ideal selectivity characteristic. However its many users will testify to the great improvement in receive sensitivity realised.

SENTINEL LOW NOISE FET PRE-AMPLIFIER.

* Low noise figure 1 dB. Gain 18 dB. Price: £7-15.

PA3 DUAL GATE MOSFET PRE-AMPLIFIER

* Noise figure 2 dB. Gain 18 dB. Price: £5-50.

SSM EUROPA 10 to 2 METRE TRANSVERTER

As you will have seen from the new 2 metre band plan the SSB section is shown from 144.15 to 144.5 (285 kHz) with a footnote to the effect that the upper limit is flexible—extending up to 145 MHz. This, of course, recognises the fact that the use of SSB as a dx communication mode is growing as quickly on 2 metres as it did on the H.F. bands several years since. It is, therefore, important that your equipment can cover the whole band. The Europa will give you complete 2 metre coverage with 28-30 MHz H.F. equipment.

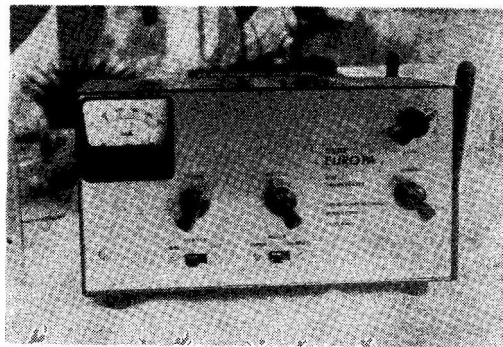

The Europa gives you :

- * Well established design with hundreds already in use around the world.
- * Direct plug into accessory socket in Yaesu-Sommerkamp equipment (plugs and multicore lead supplied!).
- * High transmit power—up to 200W input—50% efficiency.
- * Excellent receive converter performance. 2 dB noise figure.
- * Extremely stable and reliable operation.
- * Clean output on transit.
- * Attractive appearance—size $9'' \times 4\frac{1}{2}''$ front panel, $4\frac{1}{2}''$ deep.
- * Low price: £78-09 complete. £64-35 less valves—valves required are 2 off QQVO3/10, 1 off QQVO6/40A. Additional 12-6v. 2 amps transformer for use with 6.3v. A.C. heater Yaesu equipment (FT401, etc.), £3-30 or in a case to match the Europa, £6-50.

To obtain any of our products : We can despatch by return of post. We give same day C.O.D. service. You can call in here anytime to look at the gear. Or visit any of our retail distributors. Queries? Write or ring if you have any questions. Normal H.P. terms available. Export orders—please deduct 10% VAT from these prices. Paul G3MXG.

ADVERTISERS' INDEX

	Page
Aero & General Supplies ...	110
Amateur Electronics (G3FIK) ...	61
Antec	106
Ashley Dukes (Honda) ...	106
B. Bamber Electronics	<i>back cover</i> , 105
BBC	112
J. Birkett	100
British Amateur T.V. Club	100
British National Radio School	104
I. N. Cline	109
Cohen T.V. Aerials	105
Derwent Radio	110
Electro-Value Ltd.	109
G.I. Amateur Supplies ...	111
G3HSC (Rhythm Morse Courses)	106
G.W.M. Radio	104
Hamgear Electronics ...	98
Heath (Gloucester) Ltd. ...	66
D. P. Hobbs Ltd.	106
K.W. Communications Ltd.	57
Laskys	67
Lowe Electronics	60, 62, 63
S. May (Leicester) Ltd. ...	106
Microwave Modules	99
Miniwise	106
Mosley Electronics	65
Gerald Myers	111
North West Electrics ...	68
Partridge Electronics Ltd. <i>inside cover</i>	
Radio Shack Ltd.	64
The Radio Shop (Bristol) ...	105
R. T. & I. Electronics Ltd.	60
Semicon Indexes	106
Shure Electronics Ltd. ...	72
Small Advertisements ...	107-111
Solid State Modules	69
Southern Surplus Merchants	106
Spacemark	64
S.S.B. Products	100
Stephens-James	70
Strumech Engineering ...	100
Surplus Electronic Trading	108
S.W.M. Publications	<i>inside back cover, back cover,</i> 98, 100, 101, 102, 104, 112
Telecommunications International Agency Ltd. ...	103
T.M.P. (Electrical Supplies)	106
Reg Ward & Co. Ltd. ...	68
Waters and Stanton Electronics	68
West Midlands Gas	104
Western Electronics Ltd. 58, 59,	105
W. H. Westlake	108
Chas. H. Young Ltd.	65

SHORT WAVE MAGAZINE

(GB3SWM)

Vol. XXXII

APRIL, 1974

No. 366

CONTENTS

	Page
Editorial	73
SSB Transverter for Four Metres, by A. H. Dormer, C.Eng., F.I.E.R.E., G3DAH	74
An Auto-Mute Circuit, by F. G. Rayer, T.Eng. (CEI), A.I.E.R.E., G3OGR	80
Reflectometer Considerations, by E. Johnson, G2HR	82
Restoring a Rotator, by N. A. S. Fitch, G3FPK	83
Mobile Rally Calendar	84
VHF Bands, by A. H. Dormer, G3DAH	85
Communication and DX News, by E. P. Essery, G3KFE	89
New QTH's	94
The Month with The Clubs—From Reports	95

Managing Editor: AUSTIN FORSYTH, O.B.E. (G6FO/G3SWM)

Advertising: Maria Greenwood

Published at 55 Victoria Street, London, SW1H-0HF, on the last Friday of the month, dated the month following. Telephone: 01-222 5341 & 5342

Annual Subscription: Home: £2.75 (£3.20 first class) post paid
Overseas: £2.75 (\$7.00 U.S.), post free surface mail

Editorial Address: Short Wave Magazine, BUCKINGHAM, MK18 1RQ, England

Prices shown in advertising in this issue do not necessarily constitute a contract and may be subject to change.

AUTHORS' MSS

Articles submitted for Editorial consideration must be typed double-spaced with wide margins on one side only of quarto or foolscap sheets. Photographs should be lightly identified in pencil on the back with details on a separate sheet. All drawings and diagrams should also be shown separately, and tables of values prepared in accordance with our normal setting convention—see any issue. Payment is made for all material used, and it is a condition of acceptance that full copyright passes to the Short Wave Magazine, Ltd., on publication.

© Short Wave Magazine Ltd.

E. & O. E. VAT Reg. No. 239 4864 25

71

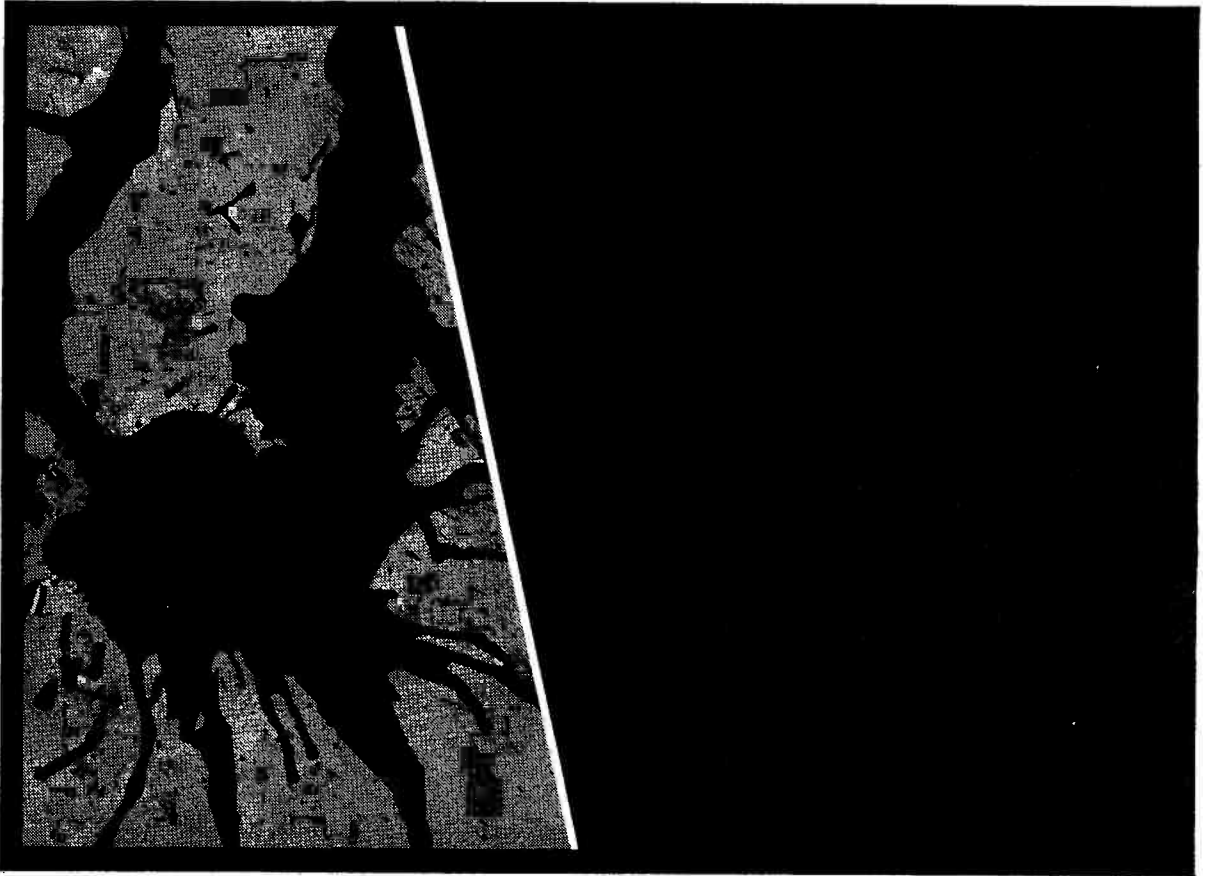

SSB-ers:

increase talk power, cut "splatter"



Our 444 base station microphone not only gives you increased talk power, but cuts "splatter" (and QRM complaints) to an absolute minimum! It has superbly tailored response, with sharp cutoffs below 300 and above 3,000 Hz and a rising response characteristic for maximum intelligibility. The 444's rugged, reliable Controlled Magnetic element has been proved in safety communications, and other tough professional communications applications. It delivers a clean signal to the transmitter at levels as high as crystal units! (And, unlike crystal and ceramic units, the element is totally immune to the effects of temperature and humidity.) The 444 also features an adjustable height stand that makes for comfortable "ragchewing" sessions, an optional-locking bar for push-to-talk or VOX operation, and a practically indestructible Armo-Dur® case. Write:

Shure Electronics Limited
Eccleston Road, Maidstone ME15 6AU



The SHORT-WAVE Magazine

EDITORIAL

“CALCULATORS FOR THE R.A.E.”

Reference that item on last month's Editorial page, we are now officially informed by the City & Guilds that calculators are *not* permitted to be taken in for the R.A.E., Subject No. 765, the next examination being on May 16, at centres up and down the country. However, this matter of the use of calculators, readily available for the sort of simple sums encountered in the R.A.E., is to be reviewed by C. & G. at the end of this year, it being recognised that pocket calculators are allowed in many professional examinations, and by Universities. After all, these calculators do no more than give a quick mathematical answer—provided you know how to answer the question. Anyway, in a subject like the R.A.E., where there is a choice of questions in Part II, you can dodge the mathematical ones altogether and still get pass marks.

* * *

BUREAUCRATIC EFFRONTERY

It seems that a licensed amateur at Thurnscoe, Yorks. (callsign not given) was ordered by the local Dearne Valley council—*ordered by his local council*, mark you—to “cease operating on the grounds of amenity and nuisance” (*sic*). His neighbours had complained of TVI. And who, do you think, clamped down on this council on his behalf? Not the *Daily Mirror*, reporting the matter in their issue of March 12, but the Post Office, who said that in the first place the amateur concerned was *not* causing TVI and that anyway the Dearne Valley Council had no authority whatever to close down, by their *diktat*, a licensed amateur—who happens, incidentally, to be a 54-year-old confined to a wheel chair with multiple sclerosis.

The *Daily Mirror* report is fair enough as to the facts. But one may ask, how compassionate can some neighbours be? Those who live in Whin Gardens, Thurnscoe, may be scratching their heads a bit by now.

And with what arrogance can local council officials,

who are no more than servants of the public and should constantly be reminded of that fact, invest themselves! After all, one of the functions of your local “chief executive” (as they like nowadays to be called) is to empty your dustbin.

* * *

WHAT, NO INDEX?

Normally, a full Index to the last Volume, as a free loose supplement, would have appeared with the March issue of SHORT WAVE MAGAZINE, with which we started Vol. 32. However, this was not possible due to the recent printing difficulties, it having been necessary to reduce machine work to a minimum while the 3-day week restriction remained in force. It is hoped that the Index to Vol. XXXI will be included in the May issue.

* * *

NORTHERN RADIO CONVENTION

This well-established annual event will be held on Sunday, May 12, as usual in the Exhibition Hall, Bellevue, Manchester, organised by the Association of Northern Radio Societies. Opening at 11.0 a.m., each member-Club will be represented by a stand, and there will also be trade participation, a raffle, an SS/TV demonstration, an inter-Club quiz and a constructors' contest. Details from D. G. Mott, G8BZY, 17 Newall Carr Road, Otley, Yorkshire.

* * *

MORE DISRUPTION

Just as this was going down, it was announced that a trade dispute in the printing industry would mean restricted working with effect from March 27—which could further delay publication. At the moment of writing it cannot be said when the May-June issues will actually appear.

Austin Forsyth
G6FO

SSB TRANSVERTER FOR FOUR METRES

RUNNING MEDIUM POWER—
DESIGN AND CONSTRUCTION

A. H. DORMER, C.Eng., F.I.E.R.E. (G3DAH)

THE transmitting licence limits the DC input to the final, Class-C stage of a four-metre transmitter to 50 watts. Assuming 100% plate-and-screen modulation, the instantaneous modulation envelope peaks will be four times this value, *i.e.* 200 watts, which is also the input peak envelope power (p.e.p.) permitted when the transmitter is operated under Single Sideband conditions.

Such power may be obtained from a QQV06-40A, but only by grossly exceeding the manufacturer's ratings, since the valve must be operated as a linear amplifier for SSB operation and the efficiency drops from about 66% to nearer 30%.

An alternative is to use one of the external-anode tetrodes of the 4X150 class, although this involves expensive power supplies, blowers and high voltage PA components and, to keep within the licence limitations,

means that the valve must be underrun and, therefore, operate inefficiently.

If the power quoted above is reduced by half, it becomes a practical, and economical, proposition to use the QQV06-40A in this application, with the nett result that the signal at the receiving end will be but 3 dB down, —less than one S-point on most receivers.

The transverter to be described has been designed to operate at the recommended voltages and currents for the '640A, and to handle 100 watts p.e.p. at the anode of the PA.

Circuit Description (See Fig. 1)

A triode-pentode valve operates as the generator and buffer of a 42 MHz signal which, together with an SSB signal around 28 MHz, is applied to a low-level, balanced, mixer valve and thence, *via* another buffer amplifier to the QQV06-40A PA. A simple drive control is provided to allow the correct conditions to be established in the final amplifier for local/DX working and to cope with other transmission modes.

Measurements with a spectrum analyser show the in-band spurious at the anode of the buffer amplifier to be negligible, and the only out-of-band signal of any significance, on 210 MHz, to be some 70 dB down on the main carrier at the antenna. This result can only be achieved if the SSB input signal is itself "clean", and it is

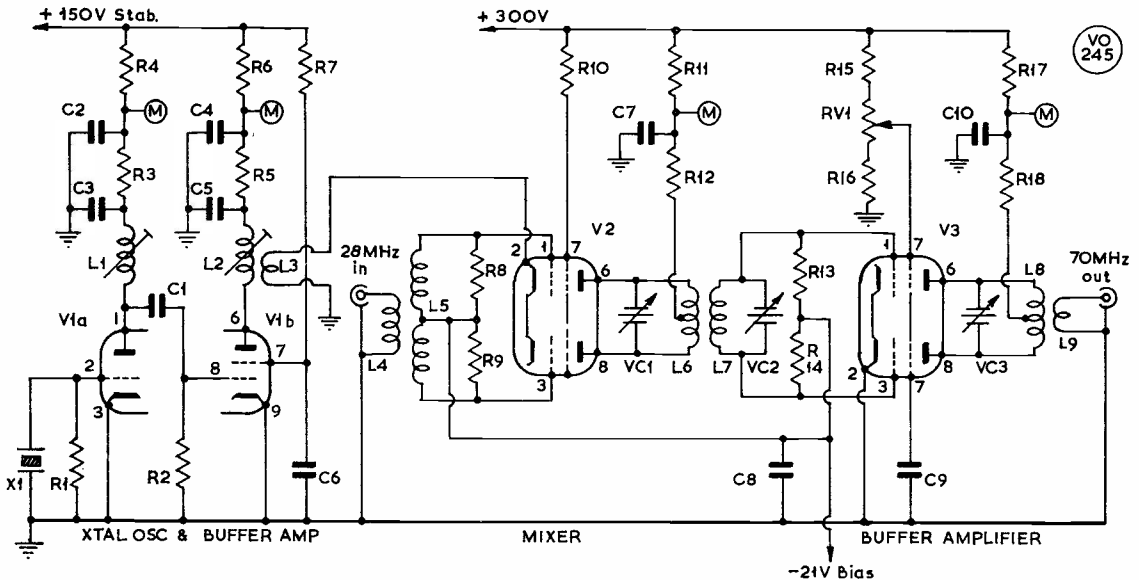

(M) = Metering points

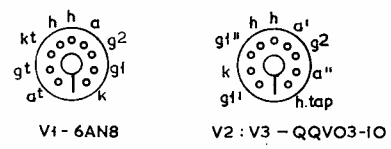
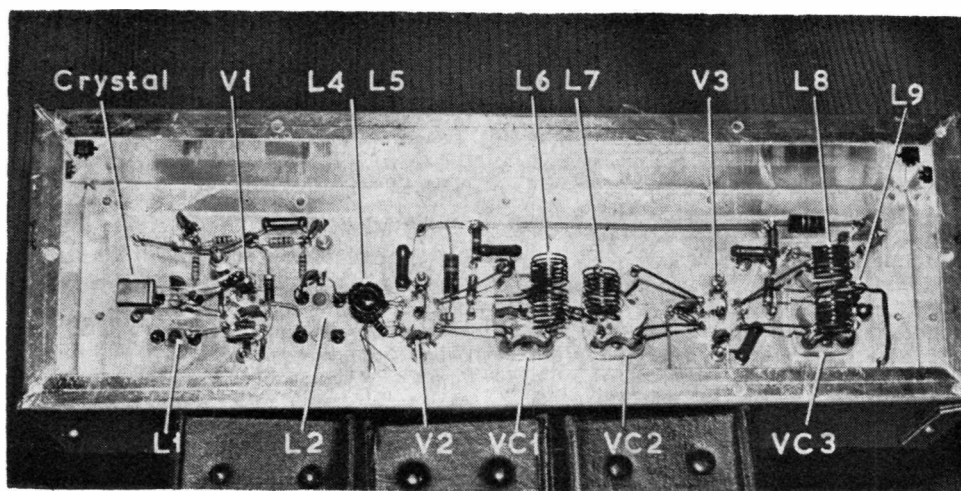

Fig.1 FOUR METRE TRANSVERTER DRIVER CHASSIS

V1 - 6AN8
V2 : V3 - QQV03-10

Fig. 1. Circuit of the Four-Metre Drive Unit for the G3DAH Transverter.



Under-chassis layout for the Drive Unit
—compare Fig. 1.

strongly recommended that a good passband filter be used at the output of the prime mover.

Many years of SSB and CW operating on both the HF and the VHF bands have convinced the author of the desirability of a "split-frequency" capability and no provision has been made in this design for transceiver operation although, if this is required it is necessary only to take an output from the anode of the 42 MHz buffer amplifier and use it as the injection voltage for a converter with a 28 MHz IF.

Xtal Oscillator and Buffer Amplifier

It cannot be emphasised too strongly that, in any design for a VHF transverter, the xtal oscillator should operate on as high a fundamental frequency as economics and technical considerations will allow in order that

there should not be a multiplicity of frequencies generated in subsequent harmonic amplifiers which may mix with the input signal to produce undesirable in-band or out-of-band radiation. There is obviously an upper frequency limit for the xtal which is reached when the difference between the injection and radiated frequencies is so small that tuned circuits after the mixing process cannot differentiate adequately between the two.

A number of combinations was tried before the present design was finalised. A 56 MHz xtal and 14 MHz SSB input looked promising, but produced an obtrusive in-band beat ($2f_1-3f_2$). A 41 MHz xtal and 29 MHz SSB combination worked reasonably well, but it was discovered that the output of the prime mover, which was then operating near the upper limit of its range, was not as good as could be desired. It was with some trepidation that 42 MHz and 28 MHz was tried, since $3f_1-2f_2$ came out in the band, but in the event, the use of a balanced, push-pull mixer and adequate filtering provided the necessary protection, and this combination was finally adopted. It also had the advantage that the whole of the 4m. band could be covered (with the FT-101 as the prime mover) which would not have been the case had the SSB frequency been on 14 MHz, unless switched xtals were used in the transverter.

The oscillator design is standard for overtone operation. The 6AN8 was used since the pin arrangement allowed a neat layout. An ECF80 or ECF82 should work equally well in this position, with minor circuit changes. If a single valve is used for the oscillator, it should be followed by a buffer amplifier. The buffer amplifier design requires no particular comment.

The Mixer

Balanced, push-pull mixers are superior to single-ended types in this application, since they can provide inherent discrimination against unwanted harmonics, and the QQV03-10 is a logical and readily obtainable choice.

Table of Values

Fig. 1. The Drive Unit Chassis

C1 = 33 μ F	R10 = 22,000 ohms
C2-C10 = .001 μ F, disc ceramic	R11, R12, R17, R18, R19 = 100 ohms, $\frac{1}{2}$ w.
VC1, VC2, VC3 = 15 μ F, butterfly preset	R13, R14 = 820 ohms, $\frac{1}{2}$ w.
R1, R2 = 100,000 ohms, $\frac{1}{2}$ w.	R15, R16 = 15,000 ohms, 2w.
R3-R6 = 1000 ohms, $\frac{1}{2}$ w.	VR1 = 20K pot., w/wound
R7 = 10,000 ohms, $\frac{1}{2}$ w.	Xtal = 42 MHz, HC-18U
R8, R9 = 470 ohms, $\frac{1}{2}$ w.	V1 = 6AN8, or equiv.
	V2, V3 = QQV03-10

TABLE OF COIL DATA

- L1, L2 = 20 turns 30g. on $\frac{3}{8}$ in. dia. slug tuned former
 L3 = One turn at cold end of L2.
 L4, L5 = Primary 8 turns 28g. enam. Secondary 11 + 11 turns 28g. wound on FX1597 ferrite ring.
 L6 = 6 + 6 20g. enam., $\frac{3}{8}$ in. dia., spaced wire diameter with $\frac{1}{8}$ in. centre gap.
 L7 = 8 turns $\frac{1}{8}$ in. dia. 20g. enam., $1\frac{1}{2}$ in. long.
 L8 = 6 turns 20g. enam., $\frac{3}{8}$ in. dia., with $\frac{3}{8}$ in. gap at centre.
 L9 = 2 turns $\frac{3}{8}$ in. 20g. at centre L8.

Notes: Chassis is 12 x 4 x 3in., with cover. Connectors are BNC 50-ohm. Meter for points M can be 0-50 mA. Unless otherwise stated coils are self-supporting.

Feeding the 28 MHz signal into the grids gives protection against the second harmonic of that frequency and the coupling circuit used eliminates the need for a further LC circuit. Oscillator frequency injection at the cathode of the mixer permits a neat lay-out and the third harmonic, although not cancelled by the push-pull action of the mixer, is sufficiently low in amplitude to be ignored. The mixer anode circuit is loosely coupled to the grid circuit of the following buffer amplifier, and the tuning of both is staggered to provide broad-band coupling and obviate the need for a front panel control.

Buffer Amplifier

A straightforward amplifier is included to provide additional selectivity rather than additional gain, and is a ready means of controlling the amount of drive to the final. Although there is enough output from the mixer to drive the PA in Class-AB1, the valve *should not* be omitted. With the layout shown in the photographs, it was not found necessary to use a screen across the buffer amplifier valveholder, but if, in other arrangements, there is any sign of instability, it is a simple matter to fit one.

The Linear Amplifier

The photograph shows the layout of the QQV06-40A stage, and the circuit diagram appears in Fig. 2, p.000. Note the screen across the chassis between grid and anode circuits. If a screening ring is not used with the valveholder, it is advisable to mount the valve so that the screen is level with the bottom of the anode plates.

Power Supplies

Many constructors will have suitable power supplies available, or wish to construct them with available components. The PSU shown in Fig. 3 has no unusual features with the exception of the variable supply for the QQV06-40A grid. A stable, low-impedance output is required here, and the arrangement shown is to be preferred to the usual wire-wound pot. across a negative

supply. The transmit/receive relay, which switches cut-off bias to the mixer, buffer amplifier and PA valves and earths the screen of the '640A in the "receive" position, is installed on the PSU chassis, but details are not included since constructors are likely to have their own preferences for station switching.

Caution: It should be noted that HT is applied to all valves from switch on.

Construction

The photographs show the transverter built on two chassis which are installed side-by-side in a cabinet with the power supply. The component layout should be obvious. Driver and PA could be built on a single chassis with additional screening between them. The arrangement used here was selected so that if, at a future date, it was decided to go for a larger PA stage, the driver chassis could be removed easily and installed elsewhere.

Both chassis are fitted with covers to provide complete screening, the lid of the PA box being made from perforated metal to afford ventilation.

Table of Values

Fig. 2. The Four-Metre PA Chassis

C1 = .001 μ F, 1 kV wkng., disc ceramic	VC1 = 12 + 12 μ F, split stator
C2 = .001 μ F, 500v. wkng., disc ceramic	VC2 = 20 + 20 μ F, split stator
Ft = All .001 μ F, feed thru	R1 = 1000 ohms, 1w. R2, R4 = 100 ohms, $\frac{1}{2}$ w. R3 = 100 ohms, 5w. V1 = QQV06-40A

TABLE OF COIL DATA

- L1 = One turn, $\frac{1}{2}$ in. dia., 18g. enam.
 - L2 = $3\frac{1}{2}$ + $3\frac{1}{2}$ turns, 18g. enam., $\frac{1}{2}$ in. dia., each section $\frac{1}{2}$ in. long, with $\frac{1}{2}$ in. gap at centre.
 - L3 = Six turns 1in. dia. 14g. enam., 1 $\frac{1}{2}$ in. long, with $\frac{1}{2}$ in. gap at centre.
 - L4 = Two turns 14g., 1in. dia., at centre of L3.
- Notes: Chassis 12 x 4 x 3in., with cover. Meters should be 0.5 mA for grid and 0.200 mA at anode. Connectors BNC 50-ohm type. Coils are wound to be self-supporting.

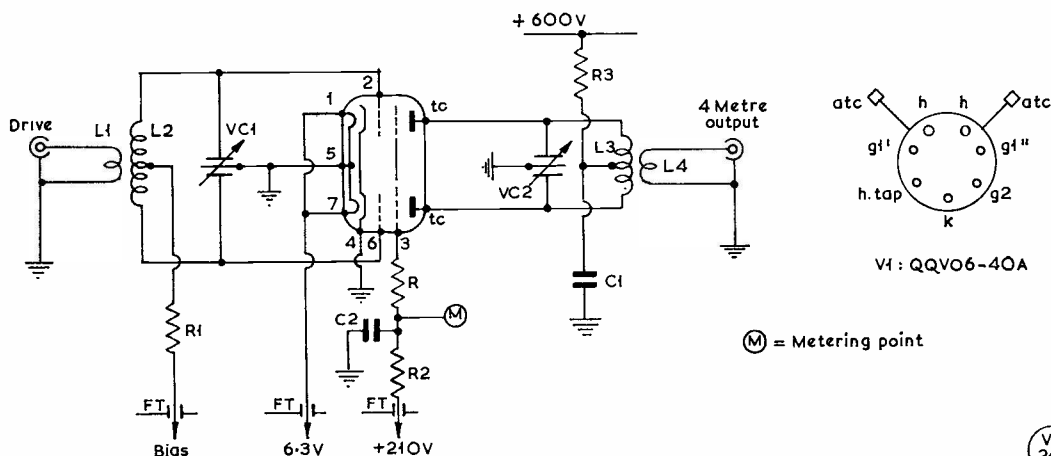
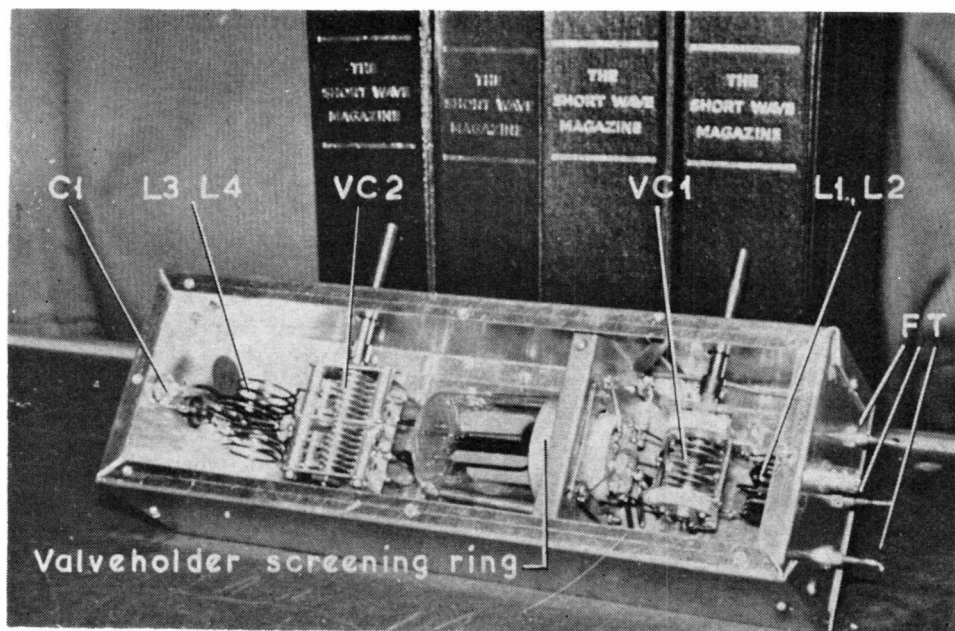

Fig.2 FOUR METRE TRANSVERTER PA CHASSIS

Fig. 2. PA section of the Four-Metre Transverter.





Detail for the Four-Metre PA chassis, input end to right.

Setting-Up

Apply voltage to the xtal oscillator and buffer stages and tune L1 and L2 for resonance. This should result in anode currents of 8 mA and 5 mA respectively. Apply voltage to the QV03-10 mixer and buffer stages. With no input from the xtal stage, the anode current of the mixer should be approximately 15 mA which should drive up to 28 mA on the application of the 42 MHz signal. Ensure that it does not rise above this figure since the valve maximum rating is 9 watts (30 mA at 30 volts). Apply a 28 MHz signal to the mixer grid, adjusting the level until the valve anode current rises by no more than 2 mA with the anode circuit resonant at 70 MHz. Resonate the buffer amplifier anode circuit. Gain control settings on the prime mover should be at normal. Do *not* reduce the 28 MHz signal by turning down the mike gain control since this will upset the operation of the SSB generator. An attenuator should be used to lose excessive drive. The ratio of 42 MHz to 28 MHz should be of the order of 10:1, so very little (half a watt or so) signal is required. With all circuits resonant, and the drive control pot. at maximum gain, an output of just under one watt should result. The anode current of V3 will vary between 5 mA and 25 mA depending upon the setting of the drive control. Check V2 and V3 grid circuits to ensure that no grid current is flowing. Reduce the input signal and set the spacing (normally about half-an-inch) between L6 and L7 until this condition is achieved. Connect the driver to the PA by a short coax link, the PA to a dummy load and output meter, and apply

operating voltages, setting the standing anode current of the 640A to 30 mA by means of the bias control. Approximately 30 volts of negative bias will be required. Apply a small amount of signal and resonate grid and anode circuits. Check for instability in the PA and proceed no further until any present has been cleared. With the drive control at maximum, adjust the coupling links L9 on Fig. 1 and L1 on Fig. 2 until a flicker of grid current shows on the 640A grid meter. These adjustments are interdependent, and the circuits must be restored to resonance after each adjustment.

The PA setting-up process should be completed as rapidly as possible and an eye kept on the plate current meter to see that the valve ratings are not being exceeded. The anode circuit should be adjusted for maximum output and the loading then increased until the output falls by about 10%. The dip in anode current at resonance should be barely perceptible. The application of an SSB signal should drive the anode current up to 165 mA on peaks, indicating 100 watts p.e.p. input. Check adjustments to ensure the continued absence of grid current in all post-mixer stages. The measured output under these conditions is 35 watts p.e.p. Grid and anode currents in the PA are measured on separate meters, the screen current measurement being made on the switched meter associated with the driver.

Finally, the usual warning: *Never* operate the amplifier without a load, and *never* apply the screen volts without anode volts.

All these adjustments are best made with a spectrum

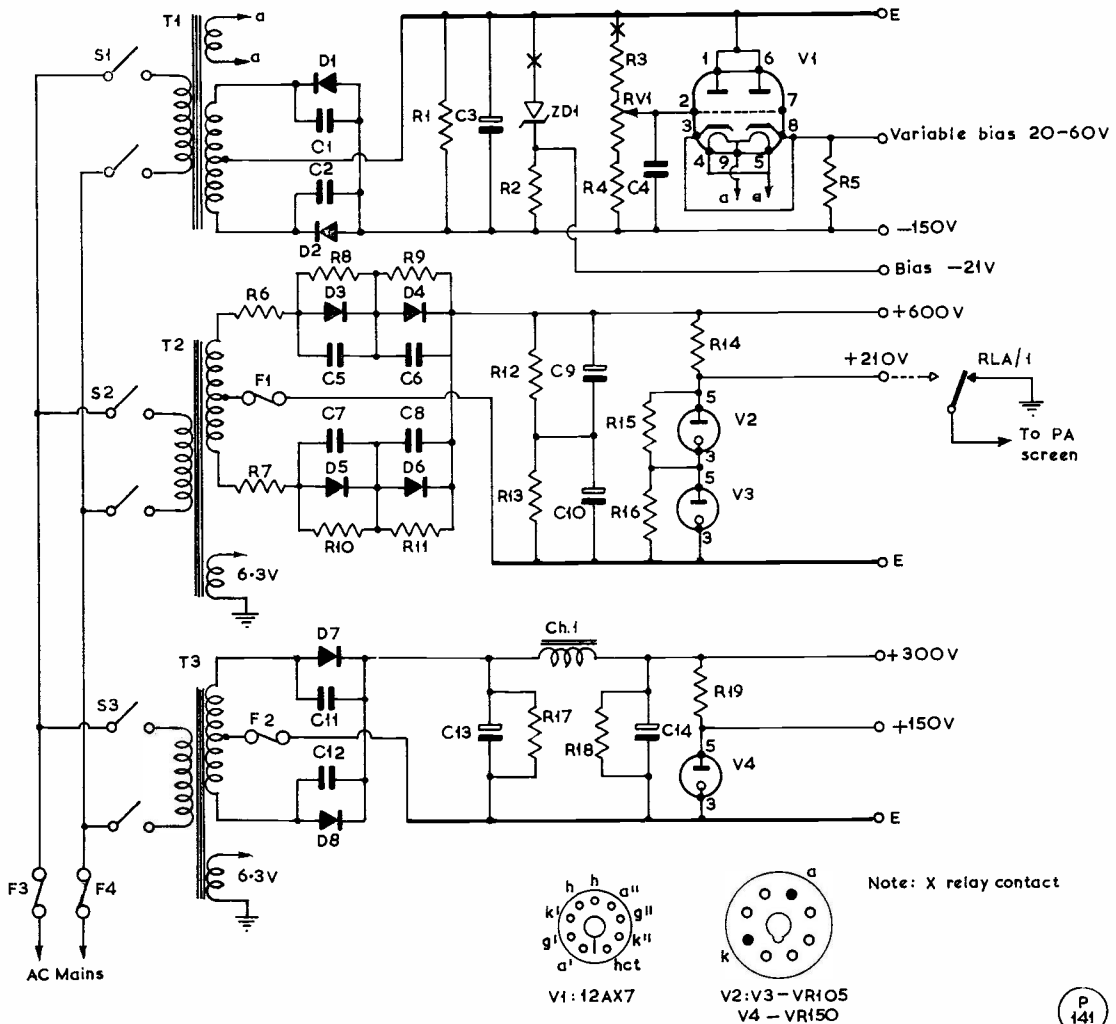

Fig. 3 FOUR METRE TRANSVERTER POWER SUPPLIES

Fig. 3. PSU for the prototype 70 MHz Transverter by G3DAH.

analyser at one's side, but in most cases this will not be possible. A simple way to get the driver broad-banded is to set the SSB input to give 70.2 MHz at the mixer anode and then adjust all subsequent driver circuits by off-setting slightly from resonance until, as is possible, the only adjustments which need to be made to cover 70.025 MHz-70.70 MHz are to the PA grid and anode. Coverage can be held within 1 dB.

Other Modes

With the DC input to the PA set at 50 watts, the transverter will provide about 17 watts output on FM and CW. For plate-and-screen modulated AM, the

input must be reduced, and the output is then 10w.

Conclusion

Consideration was given, when this project was in its initial stages, to the use of solid-state devices. However, while this would have been feasible and economic for the oscillator chain, it would have meant a string of amplifiers post-mixer, with the attendant possibility of instability, to say nothing of the cost of a linear power transistor capable of handling 100 watts of SSB at 70 MHz! There is still a good case—financially, technically and on the score of availability—for using those devices (known as valves) which glow red when switched on where power is required!

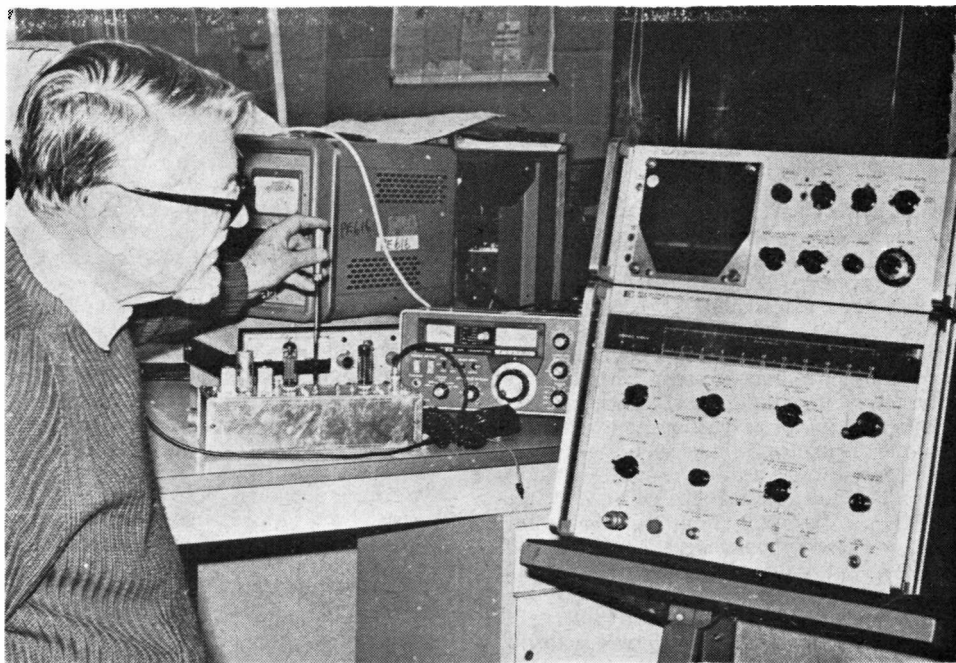

A spectrum analyser in use to set up the Drive Unit for the G3DAH Four-Metre Transverter.

Table of Values

Fig. 3. PSU for the 4-Metre Tx

C1, C2,	R14 = 10,000 ohms, 20w.
C5, C6,	R15, R16 = 47,000 ohms, 2w.
C7, C8,	R17, R18 = 100,000 ohms, 2w.
C11, C12 = .001 μ F disc cer.,	R19 = 10,000 ohms, 6w.
500v./1 kV	VR1 = 50K pot.,
wkng., as appropriate	w/wound
C3 = 200 μ F, 350v.	D1, D2,
wkng.	D7, D8 = 1N4006
C4 = .01 μ F	D3, D4,
C9, C10 = 100 μ F, 450v.	D5, D6 = 1N4007
wkng.	ZD1 = 21.5v. 400 mW
C13, C14 = 16 + 16 μ F, 450v.	zener
wkng.	Ch1 = 20 Hy, 100 ohm
R1 = 15,000 ohms, 2w.	F1, F2 = 100 mA fuse
R2 = 10,000 ohms, 1w.	F3, F4 = 3 amp. fuse
R3 = 4,700 ohms, 1w.	T1 = 125-0-125v. 50 mA
R4 = One megohm, 1w.	T2 = 450-0-450v.
R5 = 22,000 ohms, 2w.	250 mA
R6, R7 = 20K, 5w. wire-	T3 = 250-0-250v.
wound	75 mA
R8, R9,	V1 = 12AX7, or equiv.
R10, R11 = 120,000 ohms, $\frac{1}{2}$ w.	V2, V3 = VR-105
R12, R13 = 20,000 ohms, 20w.	V4 = VR-150

Note: Switches SW1, SW2 and SW3 are DPDT and should be mains type, such as *Painton*.

CLUB FOR FOREST OF DEAN

There is a proposal to form an Amateur Radio club for the Forest of Dean area, across the Severn from Gloucester. Those who might be interested, either licensed or SWL, are invited to get in touch with M. J. Prior, G3XMI, 8 Market Place, Coleford, Glos. (Tel. Coleford 2717.)

RUSSIAN PIRATE "BROADCASTING"

According to a note we have seen recently, in the USSR there is the same trouble with pirate pop-type music as we have here. They give themselves fancy titles and often transmit on frequencies which can be dangerous for the radio safety services. The only difference is that these activities are now officially categorised as being "anti-Soviet"—which means that when caught the perpetrators do time under the rigorous conditions of a Russian labour camp. No excuses are accepted about being an "enthusiastic radio amateur," with a benign smile from the Bench and a nominal fine, with perhaps forfeiture of the gear. In Russia, they go inside, and can stay there for a term of years.

USEFUL CATALOGUE

In looking through the latest Catalogue No. 7 issued by Electroval, Ltd. we found it was a compilation of more than 100 pages, listing a wide range of semi-conductors and transistors of all kinds; integrated-circuit units, many with diagrams; items such as knobs, potentiometers, resistors and capacitors in great variety; cores and pot-core assemblies in siferrit materials, with dimensions; connectors of many types; also switches, relays, transformers and miscellaneous radio parts and accessories. All items are individually priced and many are illustrated in line. This is a very useful catalogue for the home-constructor, as well as being interesting for the general reader. At 25p it is good value, if only as a general reference.—Electroval, Ltd., 28 St. Judes Road, Englefield Green, Egham, Surrey, TW20 0HB (Tel. Egham 3603).

AN AUTO-MUTE CIRCUIT

Tx/Rx INTER-UNIT

F. G. RAYER, T.Eng. (CEI),
A.I.E.R.E. (G3OGR)

AN automatic muting and isolating unit which allows the receiver to be permanently connected to the transmitting aerial can be very handy. It avoids the need for a change-over relay operated by the "transmitter on" switch or receiver standby, or a similar means of control. These methods can and do of course function satisfactorily, but can become a bit of a nuisance when more than one transmitter may be used. In such cases, it may be necessary to transfer other connections as well, when changing from one transmitter to another, so as to complete the muting or relay actuating circuits.

Changes like these are not necessary with the auto-mute unit described here, because it is actuated by the presence of RF on the aerial, from the transmitter. When the unit and receiver are connected together, and to the aerial, the necessary change-over from transmission to reception is obtained automatically, so far as the receiver is concerned. This means that a transmitter need only be connected to the same aerial system, with the knowledge that when RF is present the receiver will be muted, and also isolated from the source of RF.

A single 6C4 small power RF triode is used in the circuit, as in Fig. 1. If this does not fit in with the discipline of the art in its most modern mode, at least it fits well with the rest of a non-solid-state station, and in the

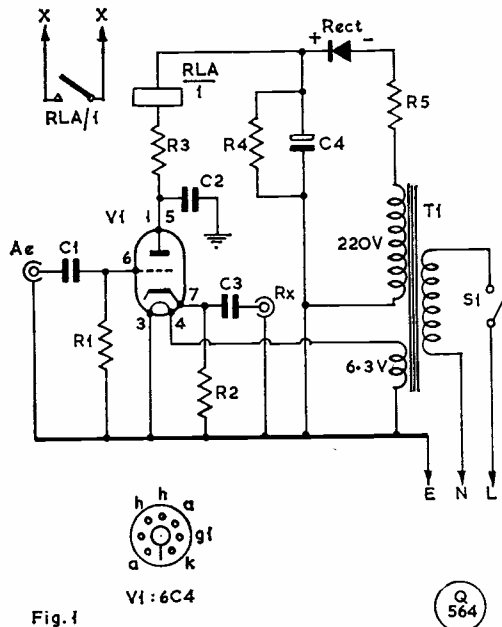

Fig. 1

Fig. 1. Circuit of the Auto-Mute unit

writer's case allowed the unit to be built with items to hand at small expense.

With no powerful RF present, V1 acts as a cathode follower, coupling the receiver *via* C3. This is a screened co-axial lead to the 75-ohm or similar aerial input socket of the receiver. At the same time, current through the relay holds this closed, giving a circuit from X to X.

When the transmitter is on, grid rectification in V1 builds up a high voltage bias across R1, almost cutting off V1. At the same time relay current drops, opening X-X, to silence the speaker.

With some set-ups, the circuit X-X may not be required. Where it is used, interrupt one lead from receiver to loudspeaker, fitting plugs which go into the sockets X-X. At the same time, a resistor of about 4.7 ohms, 1 watt, may be connected across the receiver output transformer secondary (speaker sockets) to load the receiver output stage when the speaker is disconnected. Whether or not sockets X-X have to be used depends on the relative positions of the transmitting equipment, microphone, and loudspeaker, and the volume to which the latter is adjusted, as well as upon other unknown factors such as stray coupling into the receiver, etc.

The grid blocking of V1 is fast enough for break-in with CW, but the relay circuit is of course intended for steady carrier conditions, or AM.

R5 is merely to limit peak current through the rectifier, and R4 is to prevent the HT line voltage soaring when current falls. A 22K 3w. resistor is suitable here, but if only a meagre source of HT is available (as, for example, from the receiver) then this would be unnecessarily wasteful and could be omitted. In a similar way, R2 and R3 could be subject to changes in value, to suit working conditions other than those given.

Construction

The unit is assembled on a 6 x 4in. flat plate, to which is bolted a 6 x 3in. flanged universal chassis runner. After assembly, this allows the whole to be enclosed by bolting on two 4 x 3in. flanged runners and another 6 x 3in. flanged runner, and fixing an additional 6 x 4in. flat plate with self-tapping screws. A few holes are punched for ventilation. Some form of case is necessary to avoid any accidental contact with HT or mains circuits, and the universal chassis box provides screening as well, and is inexpensive.

Fig. 2 shows the layout of components. The valve-holder could be fixed to a bracket, but is supported by two 3/4in. 6 BA bolts, with extra nuts so that the holder

Table of Values

Fig. 1. Circuit of the Auto-Mute

C1 = 22 μ F mica, <i>see text</i>	R2 = 100 ohm, 1/2 watt
C2, C3 = 0.01 μ F 500v. disc ceramic	R3 = 2,200 ohms, 1/2 watt
C4 = 32 μ F 450v. electrolytic	R4 = 22,000 ohms, 3 watt
R1 = 1 meg. 1 watt	R5 = 1 watt
	V1 = 6C4

Notes: Relay, 500-600 ohm or similar; T1, Converter transformer, 220v, 40mA and 6.3v. secondaries; rectifier, 800 p.i.v. $\frac{1}{2}$ A or similar silicon diode. Two co-axial sockets; two insulated sockets; Box: 6 x 4 x 3in. universal chassis with extra 6 x 4 flat plate, (Home Radio, Mitcham); Mains toggle on-off switch; B7G holder.

General view
of the Unit

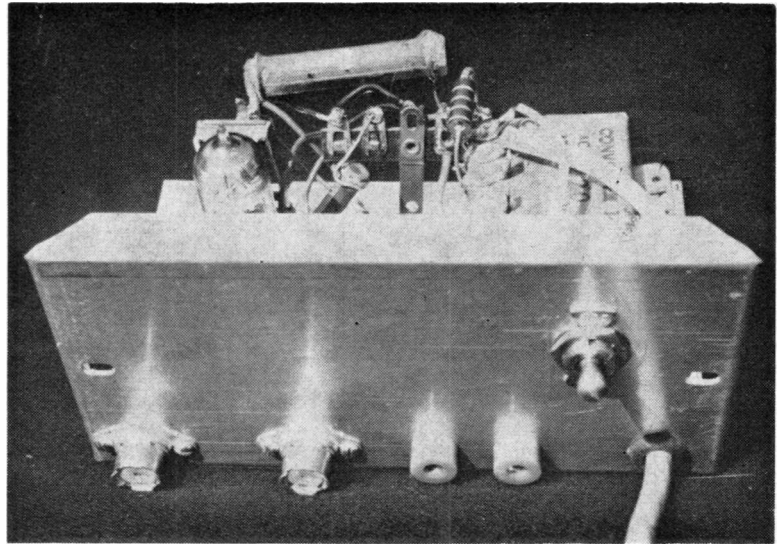

tags clear the metal easily. Leads are soldered to the holder tags before fixing the holder in place.

A tag-strip supports a few components. There would be no particular reason to place items exactly as shown.

It is important that C1 can easily withstand the peak voltage which will be present. With most equipment, a

1 kV capacitor should do. A coupling capacitance can be made, if wanted, by taking a *well insulated lead* from C1, and winding this for some inches round the aerial connection, where an end-fed aerial is used. With a dipole or tuner, a connection can be made with a coax "T." The RF voltages likely to be present naturally depend on the aerial arrangement, as well as upon the transmitter power. If the unit is connected into a 75-ohm dipole feeder, or 75 ohm lead from Tx to aerial tuner, the voltages will be much smaller, as example, than if the unit is connected into a $\frac{1}{2}$ -wave end-fed aerial circuit at its near, voltage-fed termination. C1 is of quite small value—say 10pF to 25pF. The larger values are more appropriate for lower power (say under 50 watts).

The relay was 600 ohm, but need not be this, provided it closes firmly with V1 drawing its usual current of about 10mA or so. It must be adjusted, if necessary, so that it opens when the Tx is putting RF into the aerial and V1 anode current falls. Current will naturally be less if the HT voltage is reduced, but a 150v. supply can be adequate. Should the switched circuit X-X not be required, then no relay is necessary at all.

Working

When working has been checked, the auto-mute, aerial and receiver can be permanently connected. It is then only necessary to switch the transmitter on and off, for full control. Provided C1 is not so large as to result in damage to the 6C4, V1 will protect the receiver against RF from the Tc, at all times. The unit is not intended for use with transistorised receivers which may have front-end circuits susceptible to damage by RF. These may well need protection by diodes.

It will be noted that if sockets X-X are used, no reception is possible unless the units is switched on. If this is overlooked it may be wondered why the receiving side of the station is dead!

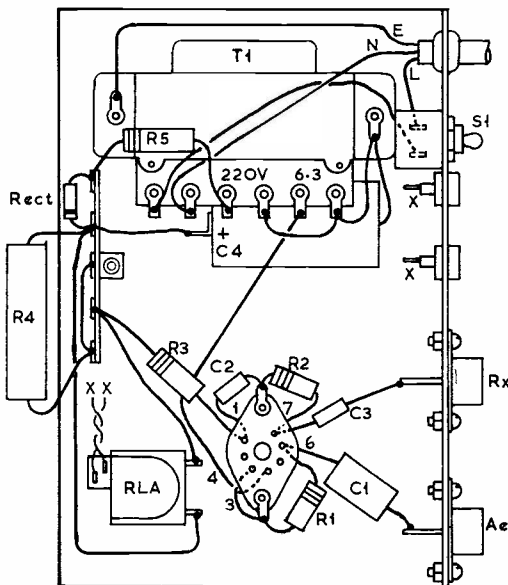

Fig. 2

Fig. 2. Suitable layout and wiring plan

REFLECTOMETER CONSIDERATIONS

READINGS AND MEANINGS

E. JOHNSON (G2HR)

MANY amateurs construct their own reflectometers the various circuits of which are relatively simple. The components are chosen such that the design is suitable for 50-ohm or 75-ohm line. It is a convenience to arrange that switchable resistors are used so that accuracy is assured on lines of both impedance. Often a meter is to hand of suitable range calibrated linearly in current. Although the calculation of SWR is little more than a simple mental exercise, it can be an irritation! At this stage it should be made clear that forward and reflected components are *voltage*, and it is more correct to refer to VSWR.

Calibration

The meter can either be calibrated from the formula

$$\text{SWR} = \frac{I_f + I_r}{I_f - I_r}$$

where f and r are forward and reflected readings respectively, or read from the illustrated graph. It is better to adjust forward reading to full-scale by the sensitivity control for ease of calculation, and is essential if one wishes to re-calibrate in SWR. Unless there is some overriding reason why, there is little point in re-marking the meter beyond half-scale which is an SWR of 3:1. The rest of the scale can be marked in a broad red arc, indicating an area to be avoided! It is in any case usually accepted that an SWR of 2 : 1 or less is acceptable.

Reflected Coefficients and Misconceptions

The reflected coefficient is given by the expression

$$\frac{\text{SWR} - 1}{\text{SWR} + 1}$$

In the case of an SWR of 3 the result is $\frac{1}{2}$. As this is expressed as a voltage, the reflected power is $\frac{1}{2}^2$, or $\frac{1}{4}$. A length of 50ft. of 75 ohm coax—and at many stations it would be much less than this—in a matched state, *i.e.*, “flat” line, could have an attenuation of but 1 dB. The additional loss with this SWR would be around 0.5 dB. Many text-books show this in graphical form. In the instance quoted the SWR would have to be around 12 for a noticeable loss of 3 dB. These losses are due to ohmic loss, dielectric loss plus a very small radiation loss. The *power* reflection coefficient in the latter case would be $(\frac{1}{13})^2 = 0.7$ approx. This appears a paradox, but contrary to ill-founded misconception, reflected power does not necessarily represent a loss. Apart from the real losses already quoted it is true that a reflected component suffers “go-and-return” attenuation, but this is small. Upon reaching the generator, *i.e.*, the PA valve, there is a gross mismatch, and the reflected power is re-reflected and adds to the forward component. The slight time-delay—perhaps a fraction of a μS —

is completely undetectable. It is only important when a TV receiver is badly mismatched to its aerial, when it can cause the effect known as “ghosting.”

It has been assumed that the feeder is connected direct to the ρi -section output of the transmitter, which the writer considers undesirable. The insertion of an ATU, *e.g.*, a Z-Match, will help harmonic attenuation, and the short length of coax between transmitter and ATU needs little adjustment of the latter to obtain the desirable 1 : 1 SWR.

TVI and Transmitter Damage

Provided a resonant aerial is fed at its current loop, and the radiator is not less than quarter-wavelength high, the coax feeder should present a good match. Any departure from this cannot be remedied at the “home” end. This point has been repeatedly made and should remove misunderstanding. A perfect match is unlikely to be attained, and the reflectometer will not give a strictly correct reading. This is due to the reflected component suffering the normal line attenuation on its return path. This is only of importance where the feeder is unusually long.

Of far greater importance is ensuring that the link between transmitter and ATU is terminated in its correct impedance at both ends, *i.e.*, substantially a 1 : 1 SWR. Only when this condition is satisfied can a low-pass filter show its designed attenuation curve. The correct impedance must be “seen” both at input and output.

Of major importance, particularly with SSB transmitters where p.e.p. has to be considered, is to ensure that a voltage loop is not reflected back to the PA stage, as can happen with a high SWR. This can spell disaster to the output valve(s). Several types of the latter have been found unsuitable for the use to which they

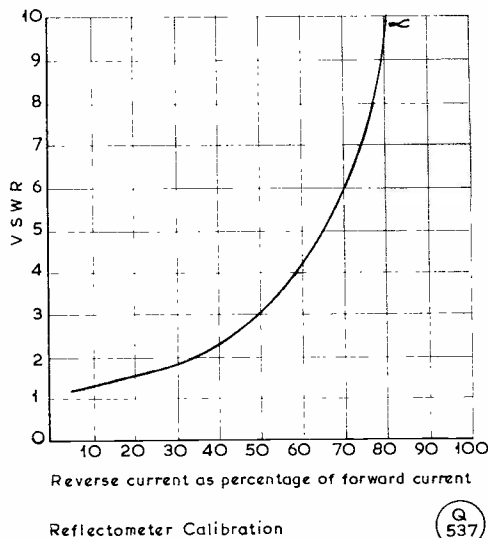

Typical Reflectometer VSWR Calibration Curve.

were put. Certainly one manufacturer discovered this. Little abuse was needed to destroy the output stage, and even melt the polystyrene coil former. AM transmitters can tolerate mishandling within reason. Many will know what a "bashing" the old faithful 807 will stand, but many TV-type line-output valves used in PA stages are stretched to the limit when subjected to treatment for which they were not designed.

To sum up, do not worry (too much!) if your SWR does exceed 2 : 1 but *do* remember the real reasons and not become too preoccupied with "lost" power. Briefly returning to half-wave dipoles, the low radiation resist-

ance of aerials less than a quarter-wave high can often be made to present a centre impedance of apparently the correct value by altering the radiator length. The impedance is complex however, as reactance is introduced which can lead to complications. The resistive component can still be low, and it is only this which is important on efficiency grounds. Let one emphasise that reference is made to *radiation* resistance. Ohmic resistance is relatively unimportant with resonant half-wave aerials or integral multiples thereof. Clearly, they can only be fed at current maxima, which means the fundamental and *odd* harmonics.

RESTORING A ROTATOR

REJUVENATING AN AR22

N. A. S. FITCH (G3FPK)

AT the end of October, 1961, having struggled to 164 countries worked in twelve years of Amateur Radio, the author decided to invest in a tri-band three-element beam rotated by the popular Cornell-Dubilier AR-22 unit.

This installation was dismantled at Christmas, 1967 by which date over 300 countries were in the bag. The present QTH was acquired in February, 1969, but the tri-bander Yagi and a tri-band Quad antenna were not erected and remained stored in the garage. The main interest at present is VHF and excellent results were obtained up to mid-April, 1973, using only about five watts output of amplitude modulation fed to a three-element Yagi in the loft.

It seemed a shame not to erect a better outdoor aerial system for two metres so this was done in April, 1973, by installing a ten-element Yagi at 35 feet, to be controlled by the old AR-22 rotator.

It was here that there was considerable disappointment for, whilst the rotator had quite easily swung the large HF band array, it was most reluctant to cope with the much smaller and lighter VHF beam. At first it was thought that not having been energised for over five years, the poor thing did not remember what it was supposed to do. Sometimes it would work first time, albeit rather sluggishly, whilst on other occasions it just buzzed until the thermal switch cut out.

Eventually, the whole assembly was cranked down and the motor dismantled and inspected. There was no obvious mechanical fault; the bearings were not seized up, nor had the lubricant dried out and the motor windings were in order.

Solution

Now the electrics of the system are very simple as shown in Fig. 1 and there is very little that can go wrong. At the suggestion of G3BXI, the phase shifting capacitor C1 was checked on the C/R Bridge. This is a Cornell-Dubilier component 25mm. diameter by 73mm. long in a "cardboard" tube, fixed to the chassis by a clip around its middle. It is marked, "100-120MFD 50VAC" and "Intermittent A.C. Duty" and obviously consists of

two electrolytics, back-to-back. It checked out at about 300 μ F in a rather half-hearted manner and it was obvious it had dried up over the years.

It was replaced by a couple of 250 μ F, 25-volt working items which happened to be handy, connected as in Fig. 2, the positive leads being soldered to tags "3" and "4" in the Control Unit. The two electrolytics were mounted on a four-way tag strip which was bolted to a vacant hole towards the rear left of the chassis. There is no connection to the earth tag.

When the Control Unit was reconnected the rotor worked promptly as it did when new, although the two electrolytics do get rather warm when the antenna is swung all the way around, even though the D.C. across each is only 17 volts.

It is hoped that these notes will be of use to others whose AR-22's have been behaving erratically.

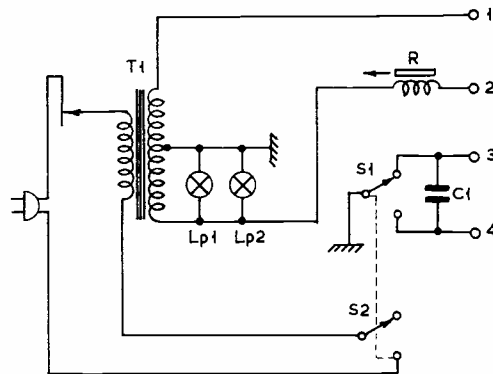

Fig. 1

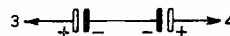

Fig. 2

Q
566

Fig. 1. Control circuitry in an AR22 beam rotator. R1, actuating solenoid; C1, phase shift capacitor; S1, motor reversing switch; S2, primary on-off switch; P, indicating lamps; T1, mains xformer (tapped primary). Fig. 2. The modification for C1, in Fig. 1, using a pair of 250 mF, rated 25v. working, capacitors.

MOBILE RALLY CALENDAR

The proposed A.R.M.S. Rally, to have been held on May 19 at R.A.F. Cosford, is definitely cancelled, due to there being doubts whether, in the prevailing circumstances, the attendance and trade support would cover the estimated £300 or so that the mounting of the Rally was going to cost.

With the new Wessex event on July 21 taken in, the full Mobile Rally programme looks like this:

April 21: North Midlands Mobile Rally at Drayton Manor Park, as in previous years. Located near Tamworth, Staffs., on the A.4091, within 12 miles of Intersection 4, M6, with AA signposting one mile from the A.5. Talk-in by G3MAR/A on two metres, G4CWJ on 80m. and G3GBU on Top Band. Map and further details from the secretary of the organising committee, A. Walton, G3ZKQ, 243 Barnes Hill, Birmingham, 29. (Tel: 021-427 3088, evenings.)

May 5: Spalding Tulip-Time Rally at Surfleet, 4 miles north of Spalding on the A.16. This is a pleasant riverside venue, with overnight camping and caravan facilities available. There will be trade stands, bring-and-buy stall, a raffle, refreshments on site, and tulips and vegetables for sale. Talk-in by G3VPR/P on 1980 kHz, G8HZF/P on 145.0 MHz and G3XBS on 70.26 MHz—R. Harrison, G3VPR, *QTHR*, is the contact man.

May 12: South Leicestershire Mobile Rally, Hinckley, with trade applications to M. B. Farr, G4CAJ, 23 Waterfall Way, Barwell, Leics.

May 19: Northern Mobile Rally, at a new venue—details later. D. G. Mott, G8BZY, *QTHR*.

May 26: Hull & District A.R.S. event at the East Riding College of Agriculture, near Beverley, Yorkshire, as in previous years. Organiser: L. D. Colley, G3AGX, *QTHR*.

June 30: Upton Mobile Rally, Worcester. Information from B. A. Jones, G8ASO, *QTHR*.

July 7: West of England Mobile Rally at Longleat, Wilts., as in previous years. Details: Brian Croker, G3ULJ, *QTHR*.

July 21: Cornish Club Rally, at venue yet to be arranged. Information from M. C. Locke, G3NKE, *QTHR*.

July 21: Wessex Amateur Radio Group Rally at Braemore House, Nr. Fordingbridge, Hants., with talk-in on 2-4-160m.—A. G. Emery, G3YWG, 7 Brunel Drive, Preston, Weymouth, Dorset.

August 11: Torbay Amateur Radio Society annual Mobile Rally at Newton Abbot Rugby Club ground, as last year—L. H. Webber, G3GDW, *QTHR*.

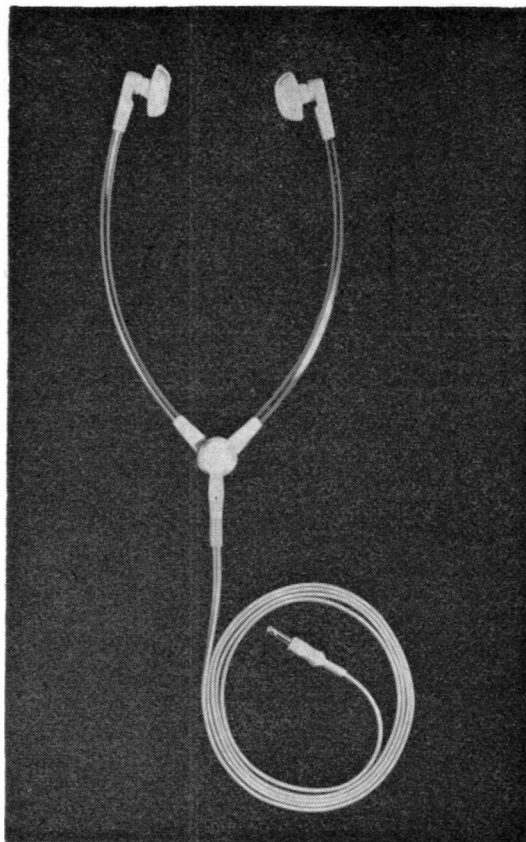

The new Danavox noise-reducing headset, in the under-clip or eardrop style now popular. Known as the "Gemini," it is most suitable for personal radio listening, particularly in noisy locations. The instrument can be fitted with a variety of ear pieces and lead combinations.

"SPECIALLY ON THE AIR"

As in previous years, we shall be glad to publish brief details of Special-Event stations, these being defined as on-the-air Amateur Radio installations for some local occasion—such as a fête, sports day, leisure exhibition, or whatever—which is open to the general public, and for which MinPosTel will issue a special "for duration only" callsign. The information we require is the date, the callsign to be used, the event for which the station is to appear, band(s)/mode(s) to be worked, and the name/callsign/QTH of whoever is to be responsible for the running of the station and the QSL procedure.

We should have these details *early* in the month *preceding* the month during which the event is to take place, as a separate item addressed to: "Specially On The Air," SHORT WAVE MAGAZINE, BUCKINGHAM, MK18 1RQ.

"Short Wave Magazine" covers the whole field of Amateur Radio and should be obtainable to order through any newsagent.

VHF BANDS

A. H. DORMER—G3DAH

ALTHOUGH *Oscar VI* has already exceeded its planned life by several months, the AMSAT organisation seems pretty confident that, with careful husbanding of the power supplies, it has some time to go yet. They draw the attention of potential users to the *AMSAT—Oscar VI Predictions Book—1974* which contains details of equator crossing times and longitudes for the rest of this year. This is available from *Ham Radio, Greenville, New Hampshire, 03048, U.S.A.* against 16 IRC's.

The spasmodic operation of *Oscar VI* while over Europe is largely due to the fact that there is no Oscar control station for this Continent (VE2BYG handles the North American control) and while this situation persists there will be a reduced number of productive orbits. Thanks, however, to the efforts of G3IOR and G3WPO it has now been agreed that Oscar shall be "on" for all evening orbits, which will be a big help for those who have to spend the daytime hours at the salt mines. The usual proviso is attached to this concession—if it is abused by stations using excessive up-link power, it will be withdrawn. In addition, orbits which are ascending to us and descending to the North American Continent, and which would normally be switched off by the Canadian control, (that is afternoon orbits during "on" days) will now be left on, and this will give us more operational time.

For those who may have missed it, we draw attention again to the *Oscar Newsletter* produced by G3IOR and distributed free to those who send s.a.e. to G3WPO, *QTHR*. This is a detailed, up-to-the-minute summary of Oscar information culled from official and user sources.

Oscar VII is now about two months behind schedule. The 10m. and 2m./70 cm. antennae are still being fabricated and some work remains to be done on the two-metre bandpass filter, but launch with the *ITOS-G* satellite is still predicted for July of this year. Full details regarding *Oscar VII* were given in "VHF Bands," February.

Contests

Results: This is getting to be a habit! G3NHE of Sheffield had added to his previous achievements by leading the field in the 432 MHz Cumulatives of last autumn. Congratulations, Martin.

Reports: Conditions do not appear to be up to much for the current set of 70 cm. Cumulatives and activity is correspondingly low. There was a slight lift during the session on February 21 which appeared to favour the North of the country. G3NHE (Sheffield) had 28 contacts that evening, better by far than anything heard or reported from the South.

Propagation for the 144 MHz Open contest over March 2/3 was variable. There was a minor Continental opening around 0200z and another about 1400z, but these yielded only F, ON and PA. In spite of these poorish conditions there seems to have been considerable activity, since stations-worked scores of over 250, and a few over 300, were reported. These must have been for comparatively local contacts, and the points-per-contact low. Compared with similar events, there was less portable activity than might have been expected, particularly from the favourable sites in GW, although the regulars, GW3UCB / P, GW3OXD / P, GW3FEC/P and GW8BHH/P were all available, at times with surprisingly good signal strength in the Southeast. Multi-path reflection was also much in evidence to add to the difficulties of working the DX.

Under these circumstances, one might have expected to hear much more CW than was apparent.

The unspecified upper limit in the new band plan for SSB working on two metres was clearly shown to be unwise by reason of the heavy QRM (some of it patently deliberate) from FM stations in particular, many of whom persistently operated below 144-25 MHz, and in some cases used the SSB calling channel as an FM calling frequency, all of which called forth some fairly acid comments from SSB operators and from those who wished to work them. Whether one subscribes to the new band plan or not, it cannot be denied that the band is rapidly becoming a two-mode affair, SSB or FM, with AM on the decline, neither being compatible with the other at close frequency spacing, and the sooner a satisfactory boundary between the two can be arranged the better for the high blood pressure of both groups. Such an arrangement should not, of course, preclude inter-mode working on appropriate freq.

Forthcoming Events: *April 21—70 MHz Open; May 4/5—144 MHz Open; May 12, 1200-1600z*, is the time for the mid-Severn Valley 2m. RTTY contest. Full details from Bob Fisher, G3PWJ, *QTHR*.

Conventions

Just a reminder that the Twickenham VHF Convention this year is on April 6/7 at the Winning Post Hotel as usual. Full details were given last month, p.34.

The Scottish VHF Convention has been arranged for September 28 at the University of Dundee Tower Block Lecture Theatre, with the subsequent dinner at the near-by Angus Hotel. Tickets for the Convention only at 40p. Dinner only at £2, and combined at £2-25. Accommodation will be available at the University if required. Further information nearer the time, but if you have any immediate enquiries the chap to contact is Frenk Hall, GM8BZX, *QTHR*.

Scottish Scene

GM8HBU of Glasgow has been pretty busy during the winter months. He has now completed the 150-watt FM Tx for 2m., and that, into a ten-ele., represents about

2.3 kW e.r.p. He has also completed the mods. to a Vanguard which now operates as an AM/FM Tx with fully tunable Rx, BFO, VXO and "bleeper" for any repeaters which may become accessible.

Ten GHz operation in Scotland is on the increase. GM3DXJ, GM3VBB, GM3FYB, GM3DDE, GM3OXX and GM8DIJ are all active on the band and GM4BHA, GM8DKB and GM8GEC are all building. GM3OXX and GM3VBB recently set up the Scottish record for 3 cm. with a QSO over a 21 km path, GM3VBB and GM3DXJ have had a 7 km contact and GM3DXJ and GM3FYB had a one-way QSO over 10 kms. Most stations are using Gunn diodes and horn antennae, and FM seems to be the popular mode.

Mobile operation is also finding more adherents, but a timely warning comes from GM6XI to those who are planning for mobile in the Edinburgh area, and who are not aware of certain local restrictions. Arthur's Seat, towering above the City, looks like a good site for mobile/portable operation, but this is Crown property, and any transmissions from there are strictly forbidden. This is not just a bureaucratic *ukase* for the sake of being bureaucratic. Rescue services operate in the area to assist the unwary who frequently get trapped on the rock faces or fall over the precipices and R/T is used for communications. There have been instances when such operations have been jeopardised by visitors with mobile equipment, and hence the ban. Similarly, Blackford Hill is out of bounds for mobile operation, as many Police and other public service terminals are installed there, to say nothing of the havoc which can be caused by QRM with the Royal Observatory installations. So watch it!

A new call in the Lothians is that of G8IOL, son of GM8BGV, (sounds like a film title, doesn't it?) and in the Kingdom of Fife, GM8IEN, under the tutelage of such experts as GM3OLK and GM3NFW, is already radiating a fine signal. GM6XI has now acquired a Vanguard for the specific purpose of driving a 432 MHz tripler, and this should give him a fair step-up in power. The regulated power supply for this rig has been

designed by GM8BJF and, with an Op-amp and three 2N3055's as series stabilisers, produces 10 amps at 13 volts. *Wow!* GM6SR is back on Two with a Vanguard, and GM8BJF has now completed the solid-state linear amplifier for his 2m. SSB transceiver.

GM8DMZ in Patna, Ayrshire, soon hopes to have 70 cm. SSB going with a 46-ele. antenna. He must have a good site there, since he had a fine contact with HB9ARI during the January opening on 2m. Jimmy Hunter, GM6ZV in Glasgow, is running AM on 70 cm. and, now that he has retired, expects to be more active on both the VHF and HF bands. GM3SAN, also of Glasgow, has SS/TV equipment for reception and hopes to be able to transmit pictures in the near future. Another Glaswegian, GM3SZP, is now running RTTY and has already had one contact on 2m., with GM8BKE.

Club & Group

The Sheffield Amateur Radio Club invite those interested to attend a presentation which they have arranged for April 22 at 7.30 p.m. This is to be given by Dr. B. Chambers, G8AGH, at Sheffield University, Department of Engineering, Mappin Street, Sheffield 10, and the subject is "Microwaves." Dr. Chambers is professionally engaged in this field and will demonstrate, with working models, practical approaches to the problems of transmission and reception on amateur microwave bands.

A similar practical demonstration of microwave techniques will be the subject of an address to be given by Dr. K. Smith of the University of Kent to the South East UHF/VHF Group at their next meeting on May 3. The lecture theatre in the Electronics Building at 7.30 p.m. is the place and time to note.

The UK FM Group (Northern) has a new secretary. He is P. Avill,

G3TPX, and he is *QTHR*.

The newsletter of the Central Scotland FM Group advises that 145.6 MHz should continue to be used for FM simplex working in that area. Although in the new band plan this channel is allocated as a repeater down-channel (albeit as a spare) there is little likelihood of QRM at the present time. It might pay to bear this in mind if you are planning to visit that part of the country. Although newly formed, the Group now has eighteen members and would welcome more. Write to Jimmy Shankland, GM8FM, *QTHR*, for further details.

The West of Scotland Amateur Radio Society is planning an expedition to the Campsie Hills for VHF/NFD, so look out for a good signal from there. Their previous expedition to those hills was hampered by lack of transport and lack of operators, but several forays are being planned for the next few months. If you want a sked, write to GM8HBU, *QTHR*.

Mercury is the title of the Journal of the Royal Signals Amateur Radio Society, and their current issue discusses the following frequencies for "get-togethers" of their members. VHF CW, 144.075 MHz; VHF SSB, 144.330 MHz; and VHF All Modes (Local), 145.330 MHz.

Not a Rally nor a Contest: The Northern U.K. FM Group will be organising a two-metre activity day on Sunday, April 14, the purpose of which is to encourage the use of FM up North. They plan to operate G3TPX and G3YLS/A from the site of a proposed talk-through (repeater) station at Staincross, Barnsley, Yorks. (G3TPX/*QTHR*), near Junc. 38 on the M1, where G3YLS/A will also be for the day operating all speech modes on two metres.

The focal point for the event is QTH/G3TPX, where there will also be a display of FM equipment. His phone number is 022-678 2517.

About The VHF Spectra

Obituary

We very much regret to have to record the death, on February 13, of Walter Shearing, G5TZ, Isle of Wight, at the age of 69. He died of leukaemia, after a long illness. In the marine, radio and TV trade from the early days, he was very active on two metres from 1948 and into the 1960's, always with an impeccable signal and perfect operating style, from a magnificent site on the Island which, in a sense, he inherited from Marconi, as it was the site of one of the original wireless stations. "Jumbo" was a great on-the-air personality and in his own way one of those few operators who really adorn a band.

Licensed about 1926, in the 1937-'38 era, he was among the first to venture on VHF (or 56 MHz, as it was then) using super-regen. Rx's and self-excited oscillator Tx. As soon as we "got" two metres, in 1948, he took that band up seriously and gained much distinction on it. (Editor.)

UHF Power Modules

A typical, transistorised, FM transmitter for 70 cm. usually takes the form of a narrow-band, multistage oscillator/multiplier strip preceding multistage power amplifiers, the whole thing relying upon a multiplicity of trimmers of one sort or another to give maximum output at a discrete frequency. There are obviously several disadvantages to such a system. It is not easy to design and set up without some fairly sophisticated test equipment, efficient interstage networks are not easy to achieve, nor are efficient output arrangements for matching the final amplifier to the antenna. The use of discrete components often results in degraded performance due to the inductances of the emitter leads (which reduce the gain of the transistor) and the base leads (which restrict the bandwidth).

Many of these disadvantages may be eliminated by the use of wideband UHF modules which are now becoming available. In particular, the new *Mullard* power amplifier modules are of interest. The BGY22 used on its own will give 2.5 watts output at 432 MHz for a drive of 50 mW and the BGY23 an output of over

8 watts for an input of 2.5 watts. The two devices can be cascaded and driven from a source such as the readily available BFY90.

There are some obvious precautions which must be taken when using such wideband devices that accept inputs of 380-500 MHz. Without adequate post-driver filtering, one would expect the output spectrum to contain harmonics from the oscillator/multiplier chain as well as intermodulation products. A high-Q break is obviously a "must" here, with another at the output of the power module but, given these safeguards, this would seem to be a very reliable way of putting out a clean signal without

any of the design problems associated with transistor output stages at UHF.

News Items

From Overseas: A new repeater has been established in the Dordrecht area of Holland. Input on 145.250 MHz and output on 145.850 MHz. Power is 8-10 watts to a vertical antenna.

It is reported that West German amateurs have selected 144.350 MHz as the local SSB calling channel, so now you know where to look for them. The move to the lower frequencies for SSB on 2m. seems to be proceeding much more rapidly abroad than it is in this country,

THREE BAND ANNUAL VHF TABLE

January to December, 1974

Station	FOUR METRES		TWO METRES		70 CENTIMETRES		TOTAL Points
	Counties	Countries	Counties	Countries	Counties	Countries	
G3NHE	19	2	40	13	25	9	108
G5DF	22	1	33	12	21	4	93
G3DAH	16	1	33	11	15	3	79
G3OHH	21	3	20	2	7	2	55
G3FIJ	14	1	21	7	5	3	51
G3XDY	—	—	25	7	13	4	49
G8GNE	—	—	30	8	7	2	47
G8ECO	—	—	34	5	4	1	44
G8GHZ	—	—	39	5	—	—	44
G8FWB	—	—	33	6	—	—	39
GW3KDG	—	—	28	10	—	—	38
G4AEZ	1	1	28	4	—	—	34
G8DGR	—	—	27	2	1	1	31
G3FPK	—	—	28	2	—	—	30
G8GXE	—	—	24	4	1	1	30
G3XSK	—	—	21	6	—	—	27
G8HQQ	—	—	24	2	—	—	26
G8GPR	—	—	22	3	—	—	25
GW3XJQ	—	—	16	7	—	—	23
G18EWM	—	—	15	8	—	—	23
GW4BXE	—	—	8	9	—	—	17
G8BPJ	—	—	11	2	—	—	13
G8HQA	—	—	8	2	—	—	10

The Table shows claims to date from January 1st, 1974 and will close on December 31st, 1974. Claims should be sent to "VHF Bands," Short Wave Magazine, Buckingham, MK18 1RQ at monthly intervals.

possibly because Continentals have always been more VFO-conscious than we have. Plans are for German repeater stations to be operating on their 1974 band plan frequencies with 600 kHz spacing by 1975. Many have already adopted the reduced Tx/Rx frequency separation.

Some of the best DX worked during the January openings must surely be the contacts between SM5BSZ (QRA JT41f, East of Stockholm) and two Spanish stations at a range of 2,300 km, getting on for 1,500 miles. Can any one in this country better that?

A new E.M.E. world record on 23 cm. was set up by VK3AKC and W2NFA on October 6 last. The Stateside Tx ran 500 watts from six 3CX100A5's and the Rx was preceded by a pre-amp with MT4000 transistors into a converter with V766 transistors in the RF stages. The antenna—wait for it—is a 60ft. diameter dish!! At the VK end, the Tx ran 160 watts input to two 3CX100A5's and the cascaded pre-amps used NEC1336 transistors. Antenna is a 20ft. dish and is manually tracked, quite a job. For information, the path loss was calculated to be 294 dB, which calls for quite a set-up at both ends.

At Home: Members of the Bury and Rossendale Radio Society have been experimenting with passive reflectors on 2m. without, they say, much success. This idea has been tried several times in the past with varying results and it would be interesting to know if such a "re-radiator" is being used successfully anywhere at the present time. This report came from G4BVE, QTHR, if you want to swap experiences.

GW3KGD is now up on 2m. SSB with a "Liner 2" and a six ele. beam, and operates from Haverford West in the rarish county of Pembrokeshire. G4HQ (Loughton, Essex) is building for SSB on 70 cm. and 4m. G3BA has got the 3-20A linear going on 70 cm., generating his SSB from the FT-101. The 4CX250B amplifier is in course of preparation. He has not neglected FM and has fitted a Burns Electronics SP-1 speech processor to the FV-101 external VFO and a single switch on the front panel gives him either facility. G3KMS (Bolton) also has QRO SSB on 70 cm., on which band he is active most evenings. G4ALN

(Chadwell Heath, Essex) is another with high power on 432 MHz—he runs a 4CX250B driven by a 3-20A to good effect. G3BW (Whitehaven, Cumb.) had QRP (circa one watt) of SSB going, but finds contacts difficult to come by at his rather remote location. He heard no stations at all during the February Cumulatives!

There is an increasing amount of SSB at the lower end of 2m. these days, although the shift from 145-4 MHz seems slower in the Midlands than in the South. It must be due to all those "Liner 2" rigs which are awaiting re-crystallisation at Matlock! The Continentals seem to have effected the transfer almost completely now.

Four-Metre SSB seems to be on the up-and-up with some 20 or so stations active on Sunday mornings although the late night activity, which was most welcome during the period when the "Box" was inactive, has dropped off.

You have a poor QTH with hills all round at a mile or two away. You need an antenna with medium gain, good front/back ratio, narrow bandwidth to give good S/N performance, reasonably small wind loading because of the exposed site and the 2in. dia. mast which must carry it, with good performance over the whole 144-146 MHz and it must take up little vertical space on the mast, which has to carry antenna for the other VHF bands as well as two metres. Many of these requirements conflict, but the best compromise—in the experience of G3HCW of Knottingley, Yorks., who has been experimenting with VHF aerials for many years—is the seven-ele. Yagi with twin reflectors on a 10ft. long, self-supporting, 1½in. boom. Readers in a similar situation may care to note. '3HCW

TWENTY-THREE CENTIMETRES

ALL-TIME TABLE

Station	Counties	Countries	Total
G8ARM	20	2	22
G3EHM	14	2	16
G4ALN	10	3	13
G8AOD	11	1	12
G5DF	3	1	4

is also trying to stimulate 23 cm. activity in Yorkshire. He and G8EOP are running QRP on the band with 60° corner reflectors. Incidentally, his CW sked on 2m. with G4CG in Barnstaple, Devon, over a 230-mile path, has now been going for 2½ years, six days a week.

Of the many who suffered gale damage to their antennae, G5DF (Reading) was one—he lost his 16-ele. stack and the 23 cm. dish. This puts him out of the DX picture until repairs can be effected. He reports progress on 23 cm. with a new long-Yagi (19 directors and very sharp), the Tx/Rx set-up consisting of a 2C39A in a box-cavity tripler and a Microwave Modules converter.

For Next Times

As we are gradually getting back to normal, closing dates for the next two issues for VHF material can be given as April 13 and May 11, addressed "VHF Bands," SHORT WAVE MAGAZINE, BUCKINGHAM, MK18 1RQ—which gives you plenty of notice.

Our sincere thanks to the readers of this piece who, through the recent difficult period, have helped us to keep the ball rolling and the fire in.

73 de G3DAH

NICE BOTTLE

The new Mullard YL1540 is worth a mention. It is a forced-air cooled coax power tetrode for VHF transmission, taking 3000v. on the plate at 780 mA, giving about 1 kW RF output and needing 53 amps. on the heater. As to its price, one-off, ask Mullard's—we daren't!

COMMUNICATION and DX NEWS

E. P. Essery, G3KFE

GONGOOZLER: An idle and inquisitive person who stands staring for prolonged periods at anything out of the common—H. R. de Salis, *A Handbook on Inland Navigation* (1901).

To gongoozle is one of the joys of Amateur Radio; to sit on a band, or even on a single frequency, and just listen to the parade, hour by hour. From a dead band, to the dawn chorus, the VK/ZL signals in the early morning, the JA's, then the W's through the day and into evening until the band becomes dead once more. However, gongoozling isn't much of a hobby on the bands when they are dead—and, Heaven help us, that's been the state of them for far too much of the available time, at least as far as the HF's go—indeed even Forty has been known to be unproductive, while Twenty upwards have been as dead as a doornail. This is, one supposes, the natural result of winter *plus* a dearth of sunspots, but at the weekend when this comes to be written, clocks go forward, spring is in the air, and both the lilac and the apple are showing spots of green, indicating the beginning of the Spring lift in weather and band conditions. As if this were not enough, there are indications, slight though they may be, of spots on the sun in the places one would expect them to be showing—who knows, the rise into a new cycle may not be so long deferred.

However, whatever we (relatively) old timers may think of the bands at this period, it has to be admitted that for many thousands of amateurs, this is all they have ever known; they have come to Amateur Radio since the last peak in conditions, which in itself was, if memory is to be trusted, not a patch on the early post-war period when, with many fewer amateurs on the air and far less elegant gear, it seemed that when conditions were right the world could be spanned on a watt or so with a bit of damp string—as conditions seemed to be for most of the time.

Top Band

A 160-metre WAC has always

been considered the apex of any DX ambition, and there is always interest in how many have managed it. Some time ago we gave a list and now, with thanks to W4WFL/1, we can up-date it by giving the chaps who have done it since January 1, 1973—namely OL1AOH, W4BRB, K4BHG, W4QCW, WB4JFK, K2GNC, W2BP, K4CIA, W2QD, WA8IJI, VK3CZ, W5RTQ, W4EX, W2LWI, W3IN, VE7UZ, JA7AO and JA1MCU to the end of February 1974, with additionally, G3XAP and W0NFL known to have done the trick but not having yet submitted the cards. As so often happens, the flow of claimants is now a trickle, but will soon become a flood, as people begin to realise it really is possible. However, for your scribe's money, the chap who deserves most congratulations is probably W5RTQ, as a glimpse of the Great Circle map will easily show—for most of his DX he has a *long* way to go before there is any sea-water at all over the paths.

Continuing about Top Band, we come to G2HLU (Reading) and his doings with a W3DZZ trap dipole, feeders strapped, working against an "average station's earth." Harold has now worked his first GM—not any old GM but GM3ANO (Sutherland), just to prove the job done properly; he couldn't have got *much* further North!

From G2HLU we turn to G2HKU (Sheppey) who continues to give the band the odd whirl; Ted found time to work SSB with PA0PN, DK3BJ and OH2BM, while his CW reached out for contacts with DK5OS, PA0CFW, GM3OLK and GM3YOR.

South Birmingham Radio Society have revised the rules for their Worked All Birmingham Postal Districts award, and now require you to work 25 of them, on Top Band, Eighty, Four, Two, or Seventy-cems, on or after March 1, 1974. In addition to the Transmitting Award, there is a section for SWL's. Non-members of the Club can obtain the award by sending their claim, with the cards and 25p plus

return postage, to R. Thompson, 23 Fox Hill, Selly Oak, Birmingham 29, who will also be pleased to forward the full Rules in return for an s.a.e.

EP2BQ seems from all accounts to have been going great guns of late on Top Band and has notched up a "First" by working 4U1TU. Another one who should stir 160 metres is VS5MC, for whom you should listen on 1803 kHz between 2200 and 2300. HC1XG is G3HVG and is QRV at weekends, on Top Band; contacts should be QSL'd via his father G8VG. It is understood that 4S7GV is on daily between 2330 and 0130 on 1804 kHz and has worked EP2BQ; 5B4AO is said to be on, *transceiving* on around 1824.5 kHz, which will make him a bit tricky for many people.

Eighty Metres

Is ignored by most people when they talk about DX, it being regarded largely as a natter band for the old-timers. However, an investigation of the natters will certainly prove that some participants at least, particularly on the subject of aeriels and feeders, do not believe the laws of Nature!

In terms of DX, though, there has always been the small amount of CW DX chased, and good DX at that, while in more recent years the HF end of the band has provided much good DX by way of net-MC operation, despite the deliberate QRM and bad language sometimes encountered. (*Why* do licensed amateurs indulge in this sort of behaviour? Is it another manifestation of the "Newcastle fans"?)

The SV chaps are now able to operate Eighty, having an allocation of 3500-3600 kHz, CW and Phone; the legal SV calls, we are told, are SV1AA to SV1IN inclusive, all others being either bootleggers assorted or just plain pirates.

G5NX sailed from Southampton on February 25 for his twenty-third trip to Australia, but this time with no /MM permit although he is carrying a receiver. He is going on the t.s. *Leonid Sobinov*, which was

at one time better known as the Cunard *Carmania*, and should be returning to the home QTH in Windermere sometime in June. The lack of a /MM ticket was a bit of a disappointment to G2NJ (Peterborough) who likes to work him on these trips. Changing tack a bit, G2NJ mentions the QRP chaps, his latest contacts being with G3CEL of Manchester who was running a couple of watts using two six-volt flash-lamp batteries as the main power source; interestingly enough, G2NJ was called by G3ENM as soon as his QSO was over, and told that G3CEL (on the flash-lamp batteries) was a steady 569 down in Weston-super-Mare.

G2HKU seems not to have had a lot of time for Eighty but on his SSB managed to hook up with CR3WB, VO1FX and 5T5DY, while CW yielded MIFOC.

Another one who looked at Eighty was G2HLU, who used it for a while on the first weekend of the ARRL CW contest. His only comment on it is not to offer a list of DX worked but rather to remark on how badly the band was "down" as compared with the same weekend the previous year. On a different line, Harold has been playing with one of these MFJ audio filters, and has found it very good. When he puts it in the "80 Hz" position he finds that adding his trusty FL8A does not make any significant difference, neither does his active audio filter, both of which have done good work in the past. As he says though, this sort of selectivity requires a stable receiver such as his KW-77, plus a very steady signal to receive—true, and a good enough reason for cursing all these twits who still, in this day and age, wander around the bands with signals that drift while they are sending and drift back again while they receive!

Forty Metres

Much-maligned as a band, especially at times when at the hours most of us can operate, it is still the only band open to give reasonable DX with simple aerials. For example, the use of a "5RV," a trap dipole, or a vertical such as the 14-AVQ at roof level can be enough to assure contacts at good DX, provided that one has, or can obtain, good enough CW selectivity for that mode, plus an aerial attenuator for use on CW or SSB.

Reporting the HF Bands

Nobody actually mentions Forty in terms of stations worked, mainly because we have been caught by the publishing hiatus. This being the case perhaps we should mention some of the DX which *is* available, as mentioned in Geoff Watts' *DX News-Sheet*, with times indicated alongside each one. This way we see, CW: GC2CNC, 1110; HR1AT, 0747; PJ2VD, 0426; PZ1BQ, 0305; W1FKD/VP9, 0221; 5T5FP, 2220; 6W8EM, 0058; 9J2BI, 2120; CP6FN, 0620; FG7TG, 2140; HI8LPN, 0350; HKØBKX, 2301; HV3SJ, 1750; JA2RJV, 1500; VS5MC, 1600—to name but a few. As for SSB: it showed AP2KS, 1428; HKØBKX, 0740; HS4AGN, 1235; JY3ZH, 2223; ST2SA, 2233; 5Z4LW, 2208; C31BC, 0758; CX4CR, 2145; HI8PAR, 2200; FG7XT, 2137; TI2AS, 0858; TR8VE, 2302 and VK7GK, 0800. Not a bad haul of stations all at good enough strength to be workable.

Here and There

The GI6YM Jubilee Award and Marconi-Kemp 75th Anniversary commemorative station, GB3MKB, will be active again over the Easter weekend from Ballycastle, and contacts will be allowed to count for the award in place of contacts which were not scored in the activity period, July last year. Frequencies to monitor over the period April 13-15 will be, on CW, 3520, 7010, 14050, 21020 and 28050 kHz, while SSB operation will be around 3775, 7070, 14150, 14190, 14300, 21250 and 28600 kHz. In addition GI6YM will be active over the weekend 6-7 April, and on April 25, the centenary of Marconi's birth—see p.24, March.

G4AFJ (Nottingham, *QTHR*) will be acting as QSL manager for VP8NO, who is better known as G3VUI; Mike will be on Adelaide Island by the time this comes to be read and will be staying there for a couple of years as a radio operator with the British Antarctic Survey. He has with him an FT-101 and a 14-AVQ, which latter will be supple-

mented by various wire aerials once he gets settled in.

We mentioned the DL/AGCW QRP Contest of January 6/7, and now we have a note from G8PG, to say that the logs were up by no less than half as much again on the previous shindig. Outright winner was DJ7HZ, with 8 watts to a lot of aeralis. U.K. entries were made by G8PG himself, G3DNF, G4AYS, G3VDW and G3JVJ, other entries coming in from as far afield as W6 and JA. WNØJXE was the first Novice entry ever, on 7 MHz only and with two watts to make 39th place—nice going. Gus adds that quite a lot of QRP activity takes place from his shack using a Ten-Tec PM3A at five watts, with which gear he raised 18 W/VE stations during the ARRL CW Contest, right through all that high-power QRM! Again, nice going.

Some of these exotic DX spots are pretty hard to find in the old school atlas. One of these is Spratly Island, which lies at Lat. 8°38' N by Long. 111°55' East, putting it in the South China Sea, about 440 miles S.E. of Saigon. It is eight feet high maximum at high tide, 2500 feet long by 1000 feet wide roughly, and difficult to land on because of the surge in the shallows for some way out. It is claimed by the Chinese.

Another such a one is Kingman Reef, reported as being soon to be added to the DX lists. This is in the Central Pacific, at the north end of the Line Islands, at 6°N by 162° West, about 920 miles south of Honolulu. It was discovered in 1798, annexed by the United States in 1922, and was used at one time as an experimental air station; it is believed that there was a naval airfield there during Hitler's War.

It is said that during April OH2BH plans a full-scale assault on Mount Athos, although details are not yet available. By the time you see this, the SM DX-pedition to Baja Nuevo and Serrana Bank will have played itself out—they will want their cards sent to SM3CXS, with s.a.e. or IRC's.

When W3JGM (seated left) was visiting in Northern Ireland he was at the joint station of G13VJ/G13JIM, 43 Holywood Road, Newtownards, Co. Down. Left to right, standing, are G13VJ, E16S and G14CSO, with G13JIM seated right. The gear at the GI station includes a Drake TR-4 transceiver, R-4C receiver and Heath SB-220 linear.



That expedition to Grand Turks and Caicos, in the West Indies, for the ARRL CW contest never came off, so the brethren intend to try a session signing ZF1AL, Grand Cayman, working all bands—and since W4BRB is of the party we can expect some Top Band activity. QSL's for this one go to WA4SVH.

For the Palmyra/Kingman Reef DX-pedition we have had no further solid information since last time, though it is known that planning is still going ahead.

The proposed China effort will, hopefully, sign the call BY1A and the operation will take place over April 19-21, using SSB on 14195 kHz, listening on 14200 upwards and 14275 kHz for working the W's. Donations are *not* wanted, and any QSL's should go to W1GEY, 321 Eastfield Drive, Fairfield, Conn. 06430.

Looking rather farther ahead, there are plans afoot to activate Clipperton Is., FO8C, probably during the early autumn. However at the time of writing no further details were known.

On the situation as far as operation from the mysterious Himalayan state of Sikkim goes, it is now understood that VU2KV and W6KNH are still trying to get things organised. This one rather looks as though eventually it will come off,

but the preliminary notice will be short, so a keen ear to the ground is called for by those who wish to work Sikkim, AC3 in Zone 22. (As a young schoolboy in Darjeeling, in the shadow of the mighty Himalayas, our Editor could look down on Sikkim without ever realising that he would one day become interested in it in the Amateur Radio context!)

It may be recalled that FL8OM and 4W1AF have been trying to organise a trip to Kamaran, in the Red Sea, off the Yemen coast. However, word has it that Yemenese troops have occupied it, resulting in loss of control by the South Yemen. This may well imply that VS9K will cease to be possible as a DX country. Perhaps we will hear more on this in due course.

On the Contests front, one that should not be forgotten is the Bermuda affair, running 0001 on April 20 to 2359 on April 21 for the Phone leg, and the same times May 4-5 for the CW. You exchange RST and county—the VP9's give their parish—and count three points per QSO, together with a multiplier of the number of Bermuda parishes worked on each band, the nine parishes being abbreviated as Dev, Ham, Pag, Pem, San, Smi, Sou, Stg and War. Certificates to winners in each call area, state and U.K. country. The overall winner of each leg gets a trophy

which is presented on October 18, with free transport out there and accommodation for a week's stay at one of the leading hotels in Bermuda, paid for by the Bermuda society. Though this is one of the more fatuous contests, the prize makes it worth winning! It has never had more than a small U.K. entry.

Twenty

If Twenty goes dead, for many people the world has come to an end! It's not quite as bad as that really—there are always the LF bands to try, if only you have taken the trouble to hang up an aerial!

G2HLU, oddly enough, found conditions worse on the LF's than on Twenty and Fifteen during the ARRL CW contest—possibly an effect caused by the distribution of activity?

G2HKU, despite all the business of losing aerials and feeders, managed to keep going in his usual fashion, although even he will admit that his ZL skeds on Twenty at 0800 are the worst he has known in years. However, it was not quite impossible, and contact was made with UL7NW, ZL1VN, ZL1AQ, ZL3SE and 9L1JT.

W4WFL/1 has, like your conductor, had many things to distract the mind from Amateur Radio activity, but Morgan did manage to get one new country up by way of 4W1GM; otherwise the tale has been of a few

casual QSO's mainly with the Caribbean and South American areas.

G3FYR (Petts Wood) refers to the articles by Moxon in *Wireless World* some time back which demonstrated how the terrain may be used to obtain consistent VK and ZL propagation with only a watt or two of SSB. Bill reckons his QTH is situated rather in the situation envisaged by G6XN, relative to the valley of the river Ravensbourne. This is a gentle inclined plane facing westerly and so, if Moxon is right, should give good propagation in the direction of U.S.A. This indeed seems to happen; and another conclusion that one can come to is that the ground-plane aerial is at its best when the operating frequency is very near to the MUF.

In a later letter, which arrived right on the deadline, G3FYR added his contacts for the month; disregarding the quite interesting crop of EU's, there were W2HDW, WB2MVI, W8LBI, UK6DAC, W1EP, VE2UN, WA3KOC, UA9CB, W1TW and W2GHK/4, the big chief of DOTM.

Another one who answered the plaintive cry for immediate response on the tail of our last piece was G3NOF (Yeovil). Don heard nothing from the Pacific except for KH6BB around 1700 over the North Pole. The early-morning conditions to VK and ZL have been patchy, with either one or the other area but not, usually, both. W's have come in around noon and stayed, sometimes as late as 2200, the W6, W7, VE7 lads being concentrated around 1700-1900z. Also, on some evenings the African stations have been coming in well. Notwithstanding this good stuff the band has been patchy in the extreme, and it has been necessary to catch the right times.

G4CXM (Paignton), very new on the air, reports on his first two weeks of activity—his very first QSO's being on 20m., with PY7AV and FY7AQ. He also worked CW (*good!*) to a number of DX stations, including VE7DLB, K7PGL and W5DRW. His DX on Sideband included no less than six VK's, also VQ9R, VE8RE (Victoria Is.), G3ZXN/MM (off the Azores) and, for his very first G, not far away near Exeter, G5QA, one of the DX lions. G4CXM is organised for 10-20-40m. with a trap dipole and an FT-DX401. After this very auspicious start, we expect to hear more of Raymond.

And we would also like to hear from many more in the recently-licensed category, even if their results are not very startling in the way of DX. One of the functions of this feature is to lead the beginner, and other beginners are always interested to read of how the newly-licensed are faring.

Talking Point

Some few weeks ago now your scribe had occasion to see a letter, not addressed directly to him, in which the writer beefed about old "KFE and his interminable lists of stations"—but he took no account of the fact that we can only comment

on the mail we receive and quote the lists of calls mentioned in the hope they may benefit some other station in the hunt for that elusive new country. But, you know, the title of this piece was changed from the original "DX Commentary" to its present title, years ago, just to enable it to take in the comments on the purely "communication" angle as well as DX. After all, the very definition of DX is something personal—what is DX to the VHF man is QRM to the HF chap, and what is DX to the 300-plus countries scorer is out of this world for the novice working his first QSO, to whom anyone outside his own shack



G3JNY, S. Ellis, 2 St. Mary's Close, Garforth, Leeds, with his XYL. He runs an FT-501 transceiver into a 14-AVQ aerial, with a beam in prospect. His other interest is clay-pigeon shooting.

Belfast YMCA Radio Club recently celebrated their golden jubilee, attended by senior Club members, with G13AV (centre) and original licensee of G16YM. Also in the picture are G15UR, G13NOH, G13AXI, G13ZJR and G13IVJ.

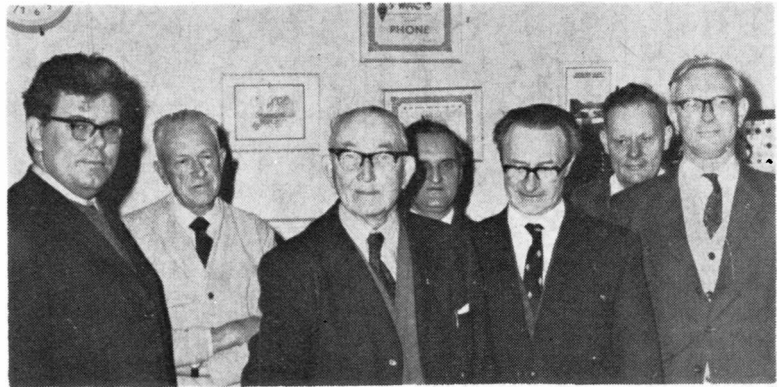

is DX. All these chaps can and do write in with news of their triumphs and their progress, and pleased we always are to give them a mention.

However, the novice excepted, one does not really think of Europeans as DX other than on Top Band, for example, nor, on say Twenty, do we really want to detail right out the strings of East-Coast Statesiders, although W6 and W7 is DX in any man's language.

The whole object of this feature being to keep the reader informed as to what is happening on the bands, it follows that lists of calls worked, in their proper context, are part of the process of disseminating information.

Fifteen

Hardly a shadow of its former self. However, there are gleanings to be taken have you but the patience and spare time to be on when the opportunities occur.

G3FYR has a W3DZZ-type trap dipole and a 12-AVQ to play with, and both have their uses. By picking the right time to operate, he managed to work 9J2BO, VE1TX, K1MTD, W0TRF, W2OGE, 4Z4KF, WA3AMO/3, W3SQ, WN8PMF, W4BW, W9CSL, WB4ZKX, WA5PQX, W5ARV, WB2FUH, K2HRH, UK6DAC, PY7AHO, UF6DX, W1AW, VE2UN and WA3KOC, plus a peck of European stuff. Interesting point: On 21 MHz, the trap dipole puts a thumping signal into the Moscow area and around the Black Sea, with the result that he gets even more calls than could reasonably be expected from this part of the world.

G3NOF reckons that things are

beginning to improve, as the days get longer, but 15m. is still very patchy. Africans and W's have been heard around 1400, the Africans having been there since as early as 1000z. VU popped up around 1300, and then again at tea-time the W's and Africans came in. The G3NOF QSO's, all SSB, were with W's, SV1GK, VU2CK, VU2DK and 9J2DT, but there were gotaways in the shape of 3B8AS and 5U7BB. Never mind.

Ten

Nary a word from anyone of DX activity. Of course there will always be the odd "opening" in the VHF sense, covering parts of Europe and even down to the Mediterranean. On occasion, propagation may be by Aurora and other such effects that send VHF operators into raptures. However, these sort of things, it has to be admitted, are pretty small beer when compared with the honest-to-goodness DX activity at the peak of the sunspot cycle—soon may it be here!

On a different tack, it is a fine band for running local nets, especially now that so many people have multiband rigs or transceivers which cover Ten.

Odd Points

Back in February, we mentioned that G3BID was contemplating a trip to Sint Maarten with W2JKN. Unfortunately, plans can be upset, and in the event G3BID developed an eye condition which stopped him going. However, he says he is looking forward to next year's event.

G2HKU offers a few QSL ad-

dresses, including CR3WB, via CT1BH; JY3ZH, via DJ9ZB; and CT3AB, to P.O. Box 643 Funchal, Madeira.

New call-sign block allocation gives A8A-A8Z to Liberia. Among the phoneys reported around of late, we hear of a "TI9NA" which was most certainly not any connection with the DX-pedition to that neck of the woods; and we would be prepared to bet that the "BV1PCZ" also reported around could well be another stinker. We have, on the other hand, news for the folk who are still looking for a contact with the Khmer Republic, or who want a card. It seems that the only satisfactory way to get XU1AA cards is to route yours via W1YRC, as apparently all the other possible routes have now dried up for one reason or another and sent their logs on to W1YRC. Another XU call to look out for soon will be XU1DX, a club station at the American Embassy. Authorisation had already been received at the time of writing but it had been sent back for correction of a minor error.

Deadlines

With a more normal work condition developing, we can give deadline dates for the next couple of issues as April 13 and May 11, addressed: CDXN, SHORT WAVE MAGAZINE, BUCKINGHAM, MK18 1RQ—but post at least two days earlier to be sure.

Our sincere thanks to the stalwarts who have helped us to keep this feature on the rails during the recent awkward period—even if at times it looked like trying to make bricks without much straw. 73 es BCNU.

NEW QTH's

This space is available for the publication of the addresses of all holders of new U.K. call signs, as issued or changes of address of transmitters already licensed. All addresses published here will be reprinted in the U.K. section of the "RADIO AMATEUR CALL BOOK" in preparation. QTH's are inserted as they are received, up to the limit of the space allowance each month. Please write clearly and address on a separate slip to QTH Section.

G4CMT, R. C. Andreang, 10 Vermont Street, Beverley Road, Kingston-upon-Hull, Humberside. (Tel. 0482 45140.)

G4CSF, B. Beckwith (ex-G8HSJ), 25 Whitfield Avenue, Glossop, Derbyshire.

G4CVF, B. Sheppard, 159 Willerby Road, Hull, HU5 5HH.

G4CVT, A. R. Tozer, 13, Wake Lawn, Southsea, Hants., PO4 8HU.

G4CXA, A. J. Cowley, 44 Epworth Road, Bentry, Bristol, BS10 6QF.

GM4CXF, J. Thomson, 6 King George Street, Invergordon, Ross-shire, IV18 0BB.

G4CXN, S. J. George (ex-G8HFZ), 100 Middlepark Road, Russells Hall Estate, Dudley, Worcs., DY1 2LJ. (Tel. Dudley 57395.)

GM4CXP, D. Dance, Station House, Maxton, St. Boswells, Roxburghshire, TD6 0RW.

G5BFV, J. M. Noeding (LA8AK), IMTR-RES-1.3LAB. P.O. Radio Station, Bearley, Stratford-upon-Avon, Warks., CV37 0HA.

G8HOQ, S. J. Whalley, Copperfields, Birchall Close, Leek, Staffs.

G8HXK, C. Tucker, 21 Westmere Crescent, Burnham-on-Sea, Somerset.

G8IAC, G. E. Brown, 14 Bramble Walk, Eggbuckland, Plymouth, PL6 5SJ. (Tel. Plymouth 776104.)

GM8IEH, Rev. S. J. Smith, St. Ninian's, Bowhill, Gardenden, Fife, KY5 0JG. (Tel. Cardenden (059-272) 224.)

G8IEM, M. A. Hall, 19 Britannia Road, Southsea, Hants., PO5 1SN.

G8IEX, G. T. P. Knott, 27 Edinburgh Road, Cambridge, Cambs.

GM8ILE, R. J. Scott, Monksford, 1 Edderston Road, Peebles, EH45 9DT.

G8IMA, A. J. Wisbey, 13 Colebrook Road, Norbury, London, S.W.16.

G8IMC, D. N. Chapman, 12 Cresta Gardens, Mapperley, Nottingham, NG3 5GD. (Tel. Nottingham 63828.)

G8IME, R. Skelding, 10 Peel Crescent, Ashton, Chester, CH3 8DB.

G8IMH, D. Fitch, 67 Hollyfield Road, Sutton Coldfield, Warks., B75 7SE.

G8INC, K. Davenport, 10 Woodend Lane, Hyde, Cheshire.

G8INP, G. P. Webb, 91 Gallows Hill Lane, Abbots Langley, Watford, Herts.

G8INW, K. M. Walker, 126 Thornes Lane, Wakefield, Yorkshire.

G8IPL, W. Ragg, 103 White Lion Park, Malmesbury, Wilts., SN16 0QR.

GW8IQC, M. J. White, 25 New Pastures, Newport, Mon., NPT 3GF. (Tel. Newport 54126.)

CHANGE OF ADDRESS

G3HEA, J. U. Burke (ex-9VIQT), Woodleigh, 15 Dalry Road, Stevenage, Herts., SG1 4AW. (Tel. Stevenage 4251.)

G3IRM, P. Lumb, 14 Linton Gardens, Bury St. Edmunds, Suffolk, IP33 2DZ.

G3KDP, A. G. Bounds, Amberley, 70 Mountpleasant Road, Camborne, Cornwall, TR14 7RJ.

G3LZV, C. A. Berry (ex-VS6EF/ZC5CB), 9 Cripps Close, Aylesham, Canterbury, Kent. (Tel. Nonington 840924.)

GM3MBP, R. P. Masters, 30 Strathalmond Park, Barnton, Edinburgh.

GM3MBP/A, R. P. Masters, Maryfield, Chirnside, Berwickshire.

G3XME, C. W. Wright, Romerstrasse 10, D-6201 Oberlibbach, Germany.

G3XNI, W. J. Hopkins (ex-GW3XNI), 10 Waverley Avenue, Exeter, Devon.

G3XSX, J. Harrison, 64 St. Oswalds Lane, Netherton, Bootle, Lancs., L30 5QQ. (Tel. 051-521 5614.)

G3XVL, C. J. McCarthy, 6 Lymington Avenue, Leigh-on-Sea, Essex, SS9 7AU.

GM3XWJ, S. K. Shakeshaft, 34 Munro Road, Jordanhill, Glasgow, G13 1SF.

G3YKB, J. B. Hodgson, 234 Gillingham Road, Gillingham, Kent, ME7 4QT.

GW4AEC, S. W. Davies, Park Dairy, 37 High Street, Portmadoc, Caerns.

G4BKY, S. G. Spencer, 57 The Quarry, Cam, Dursley, Glos.

G4CHN, D. Kelly, 42 Furness Grove, Norris Bank, Stockport, Cheshire.

G4CIY, J. A. Cass, 5 Lark Drive, Wellingore, Lincs. (Tel. Navenby 362.)

G4CWB, D. C. Andrews (ex-G8HYD), 63 Bulmershe Road, Reading, Berks., RG1 5RH. (Tel. Reading 666502.)

G5BBW, B. D. Woodall (W5MBO), 9 Birch Crescent, Aylesford, Maidstone, Kent, ME20 7QE.

G6SU, E. A. Parsons, Southcroft, Barmoor Lane, Ryton-on-Tyne, Co. Durham, NE40 3AB.

G8ARR, P. J. Edwards, 62 Oak Tree Lane, Selly Oak, Birmingham, B29 6HX.

G8ARU, J. T. Lumb, 14 Linton Gardens, Bury St. Edmunds, Suffolk, IP33 2DZ.

G8BNO, C. R. Street, Brockwells Cottage, Little Horsted, Uckfield, Sussex, TN22 5QS.

G8BPJ, D. S. Powis, 247 Sutton Road, Walsall, Staffs.

G8BZN, D. V. Goadby, 5 Queens Road, Hinckley, Leics., LE10 1ED.

G8DDB, W. F. Kirby (ex-DA4BK), c/o Sgts. Mess, R.A.F. Scampton, Lincoln.

G8EVP, D. R. Dabinett, 37 Hillside Avenue, Oakworth, Keighley, Yorkshire.

G8HDZ, P. Toirance, 15 Swanne House, Gloucester Circus, Greenwich, London, S.E.10.

G8HNS, R. J. Stanleigh, 31 Littleton Court, Blakeny Road, Patchway, Bristol, BS12 5RS.

THE MONTH WITH THE CLUBS

By "Club Secretary"

(Deadline for May issue: April 13)

Address all reports for this feature to "Club Secretary", Short Wave Magazine, Buckingham, MK18 1RQ

PERHAPS the most important news at the moment of sitting down to write this piece is the fact that the five-day working week and the consequent return towards normality were announced. This of course means that all those groups who found it necessary either to close down or to modify their routine will now be taking steps to return to their old ways—and they won't have time to get it mentioned in this column. The message is plain enough—if your Club changed its routine, ring up the secretary and ask him how they are playing things rather than miss a meeting.

This being said, we have quite a large clip to deal with, and so we will go straight in to the pile. The top one this time is from **South Birmingham**, who foregather at West Heath Community Centre, Hampstead House, Fairfax Road, West Heath. They have a formal meeting on the first Wednesday in every month, and in addition the Club shack is open every Friday evening.

Next comes **A.R.M.S.**, somewhat pre-occupied, naturally enough, with the summer and the rallies. It seems that the proposed rally at R.A.F. Cosford on May 19 is cancelled, in favour of an alternative date and venue rather later in the year when there is no clash of dates.

April at **Solihull** means a trip to the "Glover's Needle" in Worcester, where the highlight of the evening will be a skittles match, XYL's *versus* members. Last year the distaff side won, so no doubt the members have some scores to settle. This one is down for Friday, April 5.

Saturday, April 20 for **Crystal Palace**, at Emmanuel Church Hall, Barry Road, London S.E.22. The speakers will be G300U and G2FKZ, in the series of talks on Components, and this time they will be discussing Inductors and Transformers.

It is quite a while since last we heard from the **Wessex** crew. However, we understand everything is still in fine fettle, and meetings continue on the first Friday of each month and the Monday seventeen days later, at the Cricketers Arms, Windham Road, Bourne-mouth. For April 5, we are particularly to note that this is the AGM.

Every Monday is club-night at **North Staffs.**, the place to aim for being the Community Centre, Uubberley Road, Bucknall, Stoke-on-Trent. In general the first Monday is down to using the Club rig; the second is a Natter

session, the third Monday is a talk and the fourth a tape-and-slide lecture.

Another group holding meetings on a weekly basis are **Dunstable Downs**. Here there are "between weeks" on April 5 and 19, and no meeting on Good Friday, April 12. This leaves April 26, when G3GGK will be giving his talk on the "History of VHF Mobile Radio"—a large subject. Hq. is at Chews House, 77 High Street South, Dunstable.

April 16 is an important date for the membership of the **Sutton and Cheam** group, as it is their Annual General Meeting. The Library, Cheam, is the place to head for.

* * *

North Kent occupy the Congregational Church Hall, at Bexleyheath Clock Tower, on the second and fourth Thursdays of each month. April 11 is down for a discussion on NFD, and on April 25, Vic Drake of Jermyn Industries will be there to talk about Electronics Hardware.

Although they get together every Tuesday, primarily for R.A.E. and Morse, the main meeting for **Bury and Rossendale** is on the second Tuesday in the month, at the Community Centre, Mosses, Bury, with visitors always welcomed.

Colchester Radio Amateurs are still taking their meetings at the Army Amenities Centre, Reed Hall Avenue, as there has been no progress in the search for better accommodation. This being the case, we suggest it would be as well to contact the Secretary—see Panel—for the latest information.

On to **Coventry**. Here no detail is given as to the venue, but on April 5 and 26 they have "Nights-on-the-Air." April 23 is scrubbed as being in the holiday period, and on April 19 they have one of their light-hearted Quizzes, intended to entertain as well as be competitive.

* * *

Next we come to Bristol's **Shirehampton** group, anxious to make it clear there are at least two Clubs in the city, with Shirehampton looking after those on the West side of the City. Hq. is at Twyford House, High Street, Shirehampton, where they can be found every Friday evening. For more details, we suggest you contact

G4BOL, address as Panel opposite.

The hon. sec. of the **White Rose** group based on Leeds, tell us that their Mobile Rally will be happening on March 31, at Lawnswood High School. This date will be past by the time this is published, but we can say that the normal routine is of a weekly meeting at the Hq. address, 83 Town Street, Armley, Leeds 12, every Wednesday.

The Old Pheasant, New Street, Worcester, is home for the **Worcester Club**, and they have booked April 1 and 20 this month; the former date is the Annual Construction Contest, with a class for non-members (entry forms to be obtained from G8ASO) and the latter is a tape lecture session.

Verulam have an interesting one on April 17, when they will entertain, and be entertained by, Guy Moore, G3RVU, who will be talking about Quartz Crystals—we gather that members were so keen with the questions last time that this talk is to cover, as a second instalment, the applications side of Quartz crystals. As usual, the venue is the Market Hall, St. Albans.

One of the best, and most consistent, of the newsletters to come our way is the *Cornish Link* which as its name implied is the mouthpiece of the **Cornish Club**. The main meeting of the group comes on April 4, at the SWEB clubroom, Pool, Camborne, starting at 7.30, and is the AGM. Covering as it does such a large area, there are subsections for operating or territorial interests—such as the West Cornwall section, based on the Guildhall, Penzance, also the Newquay section in the town of the same name, and a VHF group still in process of being re-formed. Details on any of these from G3XTF—see Panel of Secretaries.

For **Echelford** the last meeting of which we have any details is that in March. However, we have the regular dates as being the second Monday and the last Thursday of every month, at St. Martins Court, Kingston Crescent, Ashford, Middlesex. Since there has just been an AGM, by the time this reaches print the programme will no doubt have been finalised.

A copy of the **Silverthorn** newsletter is to hand, the skilful editing bearing the mark of G2HR, who for long acted for them in letting us know of the Club goings-on. They have Hq. at Friday Hill House, Simmons Lane, Chingford, London E.4 where they get together each week. For more details, we refer you to G4AJA, as Panel.

B.A.R.T.G. write to mention their Convention, to be held this year at the Village Hall, Meopham, Kent, on May 18, running from 11.00 till 18.00. This location is on the east side of the A227, to the south of the village centre. As in past years, transport will be meeting trains reaching Meopham station at or before 1300. This one would seem to be a "must" for all the devotees of the art of RTTY.

Around April seems to be a favoured time for the annual general meeting of a radio club—**Torbay** have theirs in April, but they completely forgot to put the date on the letter, so we have to refer you to G3UIQ. However, we can say that they assemble in their Hq. at Bath Lane, 94 Belgrave Road, Torquay, monthly.

The Secretary at **York** sounds quite pleased with the way things are going there. They meet at the British

Legion Club, 61 Micklegate, each Thursday evening, and in addition there is a Sunday-morning net developing on both Top Band and Eighty. Visitors are always welcome to any meeting.

Barking must be one of the most active clubs in the country, getting together on no less than four evenings each week! Mondays are set aside for Morse practice, Tuesday for R.A.E. work, on Wednesday they operate the club stations, and on Thursdays there is an informal meeting and constructors' evening. The latter is where the main interest lies at the moment, as the group is to present a feature on "Past and Present Radio Equipment" at the local Town Show.

For **Acton, Brentford & Chiswick**, the next get-together is on April 16, when they will hear G3CCD demonstrating and describing his Transceiver for 144 MHz, which is home-designed and constructed. The venue for this one is, as usual, Trades and Social club, 66 High Road, Chiswick, London W.4.

Fridays at Sale Moor Community Centre are the main sessions for **South Manchester**, but they also have an Activity Night on Monday evenings for the VHF and D/F interests. Details of the Friday evening activities in April are: April 5, visit of G2AMV accompanied by a mystery guest lecturer; April 12, Radio Theory Questions and Answers; April 19, G4BJT talking about RF Spectroscopy; and April 26, a Home-construction competition. It is also understood that the D/F enthusiasts in the Club hope to run some practice events during the summer.

To judge by the report of their AGM the **Hereford** crowd are doing fine, although the committee are a bit unhappy that there are some members who don't turn up—it's no cause for serious worry, because if all the paid-up membership turned up regularly the society would be unique! To meet them, try the first and third Friday of each month, at County Control, Civil Defence Hq., Gaol Street, Hereford.

* * *

If any reader is interested in Amateur TV, he should certainly apply to join **B.A.T.C.**, which is the Club catering for their interests. Details can be obtained from the secretary at the address given in the Panel.

An informal discussion is lined up for April 11 at **Mid-Sussex** to decide what to do with the shack and the tower. Then on April 25, there will be a constructional contest. The venue for all normal meetings of the group is at Marle Place, Leylands Road, Burgess Hill, which is also the home of the Club station.

Yet another AGM crops up, this time at **Cray Valley**, on April 4. This one is at the United Reformed Church Hall, Court, as is also the Natter session on April 18.

Next we go down to the West Country, **Plymouth** to be more exact. The locals here have a place in Virginia House Settlement, Palace Street, St. Andrews Cross, where they can be found on the first and third Tuesdays each month. There is an open meeting on April 2, followed by the annual general meeting on April 16.

At **Wirral** the boys get together at the Sports Centre, Grange Road, West, Birkenhead on the first and third Wednesdays of the month, but unfortunately we do not have, from the newsletter at hand, any data on the

April programme. However, all is not lost; no doubt G3YGL (see Panel) would be only too pleased to oblige with all the latest gen.

The same situation arises in connection with **Wolverhampton**, so here again we have to point you in the direction of the Secretary. However, we are able to say that the general form of things is to have a meeting every Monday evening at Neachells Cottage, Stockwell End.

Now we have to mention a new formation in the Leicester area, to be known as the **Leicester Post Office** group. They have an Hq. at 66 London Road, where they assemble on the first and third Wednesdays of every month—and he would be pleased to hear from any potential new members.

All the meetings of the **Nottingham** group are held at Sherwood Community Centre, Mansfield Road. They have bookings here on Thursdays, and we notice on the 4th there is a "Forum" and on the 11th a talk on the Puff-meter, by G8HLD; this leads up to the AGM—what, another one?—which is on April 18.

One way of attracting interest, as lots of Clubs have proved, is to run classes leading to R.A.E., preferably to include a good amount of practical work; even if the class itself dies, there is usually a spin-off in the way of new members. **Mid-Lanark** realise this, and so they are going to try and set something up—anyone who is interested and within striking distance should get in touch with the hon. secretary at the address in the Panel. Hq., incidentally, is at Wrangholm Hall Com-

munity Centre, Jerviston Street, New Stevenson, Motherwell, and it is assumed by the writer that this will be the venue for any such classes. One hopes sincerely this one "gets off the ground." April 12 sees GM8BBA talking about the Club testgear and how it should be used, while on the 26th GM3YRK will give a talk on RSGB, to be followed by a Q. and A. session.

Just what keeps the **Sheffield** Club full of members in a relatively unpopulated part of the world is one of the minor mysteries of life to your conductor—nonetheless they do it, and rarely command less than a couple of dozen at an ordinary meeting. They get together every Thursday evening in the Church Hall, Ampthill Road, saving that this month there will be no meeting on April 11. This leaves the 4th for a Junk Sale; 18th for an R.A.E. Questions and Answer session; and the 25th for G8AFN to talk about Amateur Satellite Communication.

* * *

There are 455 members of **R.A.I.B.C.**, the Invalid and Bedfast club, including 28 YL's, spread over 14 countries. The Club can always do with members, both of the "full member" status, and also—perhaps more so—by way of the "helper" member, who can be conned at odd times into doing his turn at G3LWY's behest. Her address is in the Panel below.

The **Amateur Radio Society of Ireland** put out a very good journal, if the one at this desk at the moment is anything to go by; there is a very comprehensive piece

Names and Addresses of Club Secretaries reporting in this Issue :

ACTON, BRENTFORD & CHISWICK: W. G. Dyer, G3GEH, 188 Gunnersbury Avenue, Acton, London, W3-8LB.
A.R.M.S.: N. A. S. Fitch, G3FPK, 40 Eskdale Gardens, Purley, Surrey, CR2-1EZ.
BARKING: R. G. Clark, G8BXC, 62 Waltham Road, Woodford Bridge, Essex, IG8-8DN.
B.A.R.T.C.: D. Beattie, G3OZF, Mayerin, Churchway, Stone, Aylesbury, Bucks. (0296-74 354.)
B.A.T.C.: J. Rose, G6STO/T, Pinchbeck Farmhouse, Mill Lane, Sturton-by-Stow, Lincs. (Stow 356.)
BRISTOL (SHIREHAMPTON): R. E. Fineman, G4BOL, 5 Hillside Close, Frampton Cotterell, Bristol. (Winterbourne 774300.)
BURY & ROSSENDALE: C. Kirby, G8HQW, 2 St. Peters Place, Haslingden, Rossendale (4915), Lancs.
COLCHESTER: E. T. Jacobs, 26 Pondfield Road, Colchester.
CORNISH: H. Webster, G3XTF, Crandale, Gillyfields, Redruth (6905), Cornwall.
COVENTRY: G. A. Whenham, G3TFA, 33 Chapel Street, Bishops Itchington, Warwickshire.
CRAY VALLEY: P. F. Vella, G3WVP, 78 Hurst Road, Sidcup, Kent.
CRYSTAL PALACE: G. M. C. Stone, G3FZL, 11 Liphook Crescent, London, SE22-3BN. (01-699 6940.)
DUNSTABLE DOWNS: C. G. Powell, G8BPK, 1 Wenwell Close, Buckland Wharf, Aston Clinton, Aylesbury (630600), Bucks.
ECHELFORD: V. W. Higgs, G3VWJ, 205 Commercial Road, Staines, Middx., TW18-2QT.
HARROW: L. Light, G3KDL, 22 Chippenham Avenue, Wembley. (01-902 2570.)
HEREFORD: S. Jesson, 181 Kings Acre Road, Hereford.
IRELAND: Brendan H. Nichol, Hon. Sec., ARSI, P.O. Box 73, Athlone, Eire.
LEICESTER (Post Office): G. Overton, 35 Hazel Road, Loughborough, Leics.
MID-LANARK: D. H. Plumridge, GM3KMG, 7 Waterside Gardens, Hamilton, Lanarks, LM3-7PY.
MID-SUSSEX: J. Brooker, G3JMG, 20 Farnham Avenue, Hassocks, Sussex.

NORTH KENT: R. Wells, G4ARQ, 12 Bullbank Road, Belvedere, Kent.
NORTH STAFFS.: P. Bradbury, 36 Newstead Road, Abbey Hulton, Stoke-on-Trent, ST2-8HX, Staffs.
NOTTINGHAM: S. F. Claringburn, G8HLD, 49 Fernleigh Avenue, Westdale Lane, Nottingham, NG3-6FN.
PLYMOUTH: C. Mitchell, G3UVS, Kechil Rumah, Green Lane, Yelverton (2986), Devon PL20-6BW.
R.A.I.B.C.: Mrs. Frances Woolley, G3LWY, Woodclose, Penselwood, Wincanton, Somerset, BA9-8LT.
SHEFFORD: R. Squire, 10 Brittain's Rise, Lower Stondon, Henlow, Beds., SG16-6JT.
SILVERTHORN: C. J. Hoare, G4AJA, 41 Lynton Road, South Chingford, London, E4-9EA. (01-529 2282.)
SOLIHULL: L. G. Boswell, G4AEJ, 170 Kestrel Avenue, Yardley, Birmingham.
SOUTH BIRMINGHAM: R. J. Thompson, G8GDZ, 23 Fox Hill, Selly Oak, Birmingham, B29-4AG. (021-474 0533.)
SOUTHGATE: J. Batchelor, G3XMV, 22 Faversham Avenue, Bush Hill Park, Enfield, Middx. (01-360 6537.)
SOUTH MANCHESTER: D. H. Holland, G3WFT, 7 Alcester Road, Sale, Cheshire M33-3GW.
SPALDING: R. Harrison, G3VPR, 38 Park Avenue, Spalding, Lincs., PE11-1QX.
SUTTON & CHEAM: A. Keech, G4BOX, 26 St. Albans Road, Cheam, Sutton, Surrey.
TORBAY: M. Yates, G3UIQ, Top Flat, 23 Waverley Road, Newton Abbot, Devon.
VERULAM: H. Young, G3YHY, 93 Leaford Crescent, Watford (25633), Herts., WD2-5JQ.
WESSEX: A. G. Emery, G3YWG, 7 Brunel Drive, Preston, Weymouth, Dorset.
WHITE ROSE: K. R. Robson, G3VTY, Flat 7, 34 Saint James Drive, Horsforth, Leeds.
WIRRAL: F. Smith, G3YGL, 72 Church Road, Bebington.
WOLVERHAMPTON: J. P. H. Burden, G3UBX, 28 Coalway Road, Wolverhampton, WV3-7LX.
WORCESTER: B. A. Jones, G8ASO, 12 Woodside Road, Larkhill, Worcester (29208), WR5-2EG.
YORK: K. J. R. Cass, G3WVO, 4 Heworth Village, York.

on the modification of the Pye Vanguard for home station operation off the mains. Details from the Secretary—see Panel.

The Radio Society of Harrow come next, and here the venue is the Harrow Sea Cadets Hq. Woodlands Road. They get together every Friday evening, with a programme as follows: April 5, Morse Practice and Trouble-shooters Corner; April 12 cancelled due to the holiday date clash; April 19 Morse Practice plus practical work on the Club project; and April 26, a talk by G8BJO on domestic Electronic Servicing.

For Spalding the venue is the intriguingly-named Teachers Centre, Pinchbeck. Here they can be found on March 29, shifted from the normal April 5 date, and May 3, the latter to be devoted to the final preparations for their Tulip-Time Rally.

April's meeting is at "the usual place" and no date is given in the Southgate news letter—so we have to suggest that if you want to join them, you will have to get in touch with their secretary.

Deadline

With the return towards normal working, closing dates for this feature in the next two issues will be April 13 and May 11, addressed as usual to "Club Secretary," SHORT WAVE MAGAZINE, BUCKINGHAM, MK18 1RQ.

And here a word of thanks to those secretaries and scribes who have kept the news flowing even though at

times they may have felt it was like trying to fill a bottomless pit. By noting the dates given, we shall soon be back to normal. 73 *es tnx.*

NOTE ON R.A.F.A.R.S.

One of the Service organisations in the radio amateur field is the Royal Air Force Amateur Radio Society, with Hq. at R.A.F. Station Locking, Weston-super-Mare, Somerset, and callsigns G8FC and G3IRS. Current membership is around 600 and the last annual report shows that the RAF-ARS cash assets amount to £1,022. The Society is very fortunate in being able to charge its postages to the Service, itself a considerable asset that other Amateur Radio organisations would envy.

THOSE ITALIAN PREFIXES

For those who need to know, IW is the Italian prefix for stations roughly comparable with our G8/3's, *i.e.*, VHF only, but with a power limitation of 10 watts. The prefix II denotes special or commemorative stations only and is usually issued on a one-off basis with appropriate suffix letters, *e.g.*, II4FGM for the Marconi centenary celebration station.

HAMGEAR ELECTRONICS

Presenting our latest preselectors for the serious Dxr:—

THE P.M.IID, covering 1.5 to 34 MHz in five overlapping bands.

Has a built in PI tank antenna tuner.

Has a listen thru switch position.

Has an average gain better than 32 dBs, checked over the ranges.

Will suit most communications receivers, but not your transistor portable.

Has an FET plus two bipolars in cascade, common emitter mode with negative feedback.

Battery powered and priced at £11.50, plus 27p postage.

THE P.M.IIDX. Specification as the P.M.IID but has a mains power supply, complete with indicator and fuse. Price £15.15.

THE P.M.IIF. Specification as the P.M.IID but has a built in calibrator as well, with outputs at 1MHz, 500 kHz, 100 kHz, 50 kHz and 10 kHz. Complete with mains power supply, indicator and fuse. Price £22.50.

All units plus 27p postage.

Send for details of these and our other units.

Office, 2 Cromwell Road, Sprowston, Norwich,
NOR 65R

WORLD RADIO/TV HANDBOOK 1974

The World's only complete reference guide to International Radio & Television Broadcasting Stations. It includes: Frequencies, time schedules, announcements, personnel, slogans, interval signals and much more besides of value to the listener.

Lists all International short-wave stations, including frequencies, for each country; foreign broadcasts, long and medium wave stations (AM broadcast Band), TV stations and domestic programmes. Long recognised as the established authority by broadcasters and listeners. It is the only publication that enables you to identify BC stations quickly and easily. Enables you to fill more pages in your log book on the SW BC bands and helps you add more BC-station QSL cards to your collection.

£3.05

(The above price includes postage and packing).

from:

SHORT WAVE MAGAZINE

55 Victoria Street, London, SW1H 0HF

MICROWAVE MODULES LIMITED

11 CRANMORE AVENUE, CROSBY, LIVERPOOL L23 0QD Tel: 051-928 1610 9 a.m.-8 p.m.

DON'T BUY ONE...

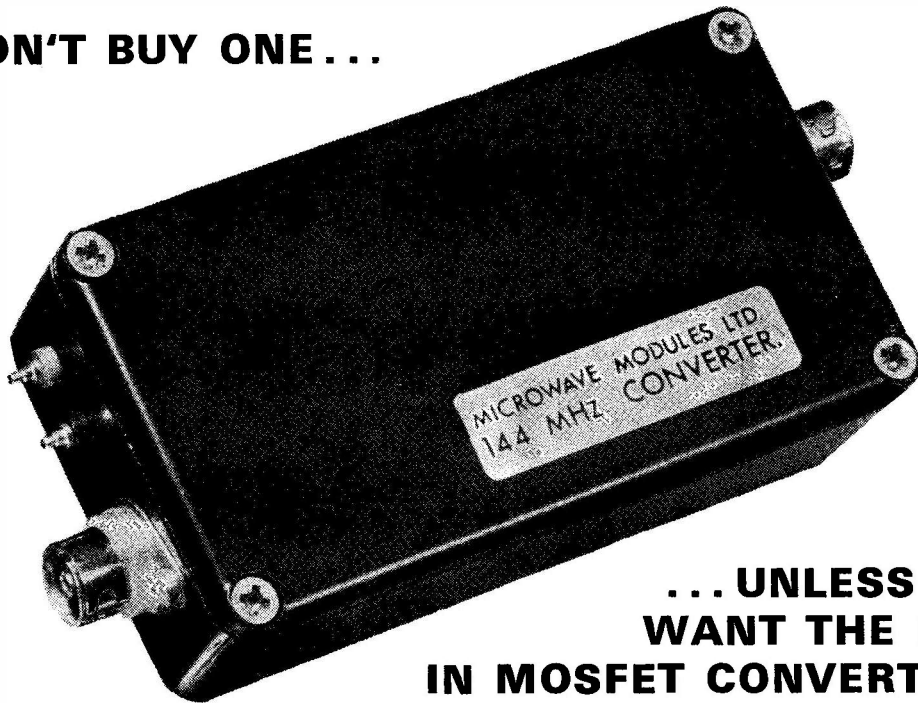

... UNLESS YOU WANT THE BEST IN MOSFET CONVERTERS!

TECHNICAL FEATURES:

- ★ Mixer designed for good signal-handling capability
- ★ Bandpass interstage coupling for good out-of-band rejection
- ★ Front-end mosfet well protected against static and RF power
- ★ Noise figure 2.8 dB. Gain 30 dB
- ★ Stable operation over wide supply voltage range (9-15 volts)
- ★ Housed in sturdy black-enamelled diecast box
- ★ I.F.'s available ex-stock : 2-4, 4-6, 14-16, 18-20, 24-26, 27.7-29.7, 28-30 MHz
- ★ PRICE INC. VAT £16.72

PLUS: UNCONDITIONAL 12-MONTH GUARANTEE WITH FREE SERVICE

The above 144MHz converter, and all our other products, are available ex-stock direct from us, and from our many retail outlets.

144 MHz CONVERTER FOR SSB

(see last month)

Noise figure : 2.8 dB max.
Gain : 27 dB typ.
Image rejection : 65 dB typ.
116 MHz output power : 5mW min.
Crystal oscillator : 116 MHz (zenered)
Frequency error at 144 MHz : 3 kHz max.
Power supply : 35mA at 12 volts typ.
Available ex-stock— Price inc. VAT £17.93

23 CM CORNER

1296 MHz CONVERTER Gain 25 dB, N.F. 8.5 dB I.F.'s available ex-stock : 28-30, 144-146 MHz
Price inc. VAT £26.40
1296 MHz VARACTOR TRIPLER Maximum input power at 432 MHz : 24 watts. Typical output power (at maximum input) : 14 watts.
Price inc. VAT £27.50
1296 MHz COAXIAL CABLE 50 ohm, attenuation at 1296 MHz 8 dB/100ft. diameter 10.3mm. (spec. UR67) Price 12p per ft. plus VAT

ALL EQUIPMENT EX-STOCK — ALL PRICES INCLUDE POSTAGE

G3EKX S.S.B. PRODUCTS G3EKX

EDDYSTONE EA12. One owner	£165-00
EDDYSTONE 940. One owner	£120-00
EDDYSTONE 680X. Excellent	£85-00
TRIO 9R59DS. Brand new	£54-00
LAFAYETTE HA700. Very little used	£42-00
EAGLE RX60N. .55 to 30 MHz	£20-00
CODAR AT5 with matching pack	£24-00
R208 RX. 10-60 MHz. 12v. or A.C.	£19-00
R209 RX. 1-20 MHz. 12v. only	£15-00
LM13 (8C221) with correct book A.C.	£25-00
H/B PYE RANGER. Complete boot model	£15-00
ADVANCE B4B. Very nice. .5 to 30 MHz	£25-00
TELEQUIPMENT S61B. New, boxed scope	£49-00
FURZEHILL V.T.V.M. 6 ranges	£9-00
B44 TRANSCEIVERS, 2. Unmodified (pair)	£25-00
B.E.M.E. Loop. Soiled. With A.C. I/P	£5-00
MURPHY TR821 Transceiver. 2m. H/B	£15-00

— ONLY CARRIAGE AND PACKING EXTRA —

QUARTZ CRYSTALS

Send a stamped addressed envelope with your detailed requirements and alternatives. Many thousands in stock. Metal cased, most types. Remember no money initially, just an "s.a.e. please."

SPECIALLY MATCHED VALVES FOR LONGER LIFE

PAIR MATCHED 6HF5's R.C.A. (30p)	£6-00
PAIR MATCHED 6146 R.C.A. (30p)	£6-20
PAIR MATCHED 6146B R.C.A. (30p)	£7-20

I FRANCES STREET, TRURO, CORNWALL Tel. 0872-862575

SPECIAL LIMITED OFFER of Distributors Discontinued Semiconductor Stock, available due to change of Policy. Assorted Items by FERRANTI, GE (U.S.A.), INTERNATIONAL RECTIFIER, MULLARD, NEWMARKET, PLESSEY, SPRAGUE, TRANSITRON. All Branded and with data where available. Consisting of TRIYSTRORS, ZENER DIODES, UNIJUNCTION TRANSISTOR, POWER TRANSISTOR, SILICON and GERMANIUM TRANSISTORS, TUNING VARACTOR DIODES, GERMANIUM SIGNAL DIODES, SINGLE and 3 PHASE BRIDGE ASSEMBLIES. First Selection 250 Pieces at £20, Second Selection 500 pieces at £12. Both lots ideally suitable for Schools, Colleges, Universities, Experimenters, etc.

GENERAL PURPOSE OP-AMPS Tested, Type 1 Direct Output at 15p, Type 2 Zener Controlled Output at 15p.

100 Untested 400mW ZENERS at 50p, 100 Untested 2 watt ZENERS at 50p.

UNMARKED 1 AMP SILICON DIODES Metal Cased (SO 16) 50 PIV at 10 for 33p, 200 PIV at 5p ea., 10 for 40p, 400 PIV at 7p ea., 10 for 55p, 800 PIV at 10 for 80p, 1000 PIV at 12p ea., 10 for £1.

PRESS FIT S.C.R.'s 8 amps 50 PIV at 22p, 100 PIV at 25p, 300 PIV at 33p, 400 PIV at 44p.

SPECIAL CLAMP FITTING 30 AMP SILICON RECTIFIERS 100 PIV at 4 for £1.

SUB-MINIATURE SILICON BRIDGES 10 amps. 100 PIV at 90p, 200 PIV £1-10, 400 PIV at £1-25, 600 PIV at £1-40, 800 PIV at £1-50, 1000 PIV at £1-85. 16 amp type 50 PIV at 90p.

4-7pf to 20pf SUB-MINIATURE CERAMIC TRIMMERS 3 for 10p.

CERAMIC FILTERS 10-7 MHz at 27p ea., 470 kHz at 46p. Both with data.

COMMUNICATION SERIES OF I.C.'s Untested consisting of 1xRF, 3xLF, 2xVOGAD, 2xAGC, 1xHeadphon Amp, 2xDouble Balanced Modulators, 1xMixer. The 12 I.C.'s for £3. Separate I.C.'s 27p ea.

FET's similar to 2N 3819. 3 for 60p.

VHF TUNING VARACTORS untested 80pf at 4 volt, 57pf at 8 volt with Q of 100 at 100 MHz 6 for 25p.

10-7 MHz F.M. I.F. I.C.'s like TAA 570 untested with data. 5 for 55p.

3 GANG 365pf TUNING CONDENSERS Sub-miniature size 2 1/2" x 1 1/2" x 1 1/2" at 60p ea.

DISC CERAMICS All 500v.w. 2-2pf, 3-3pf, 4-7pf, 6-8pf, 15pf, 27pf, 100pf, 180pf, 220pf, 330pf, 560pf, 680pf, 820pf, 1500pf, 2200pf, 3300pf, 4700pf, .01uf, .05uf. All at 16p doz.

J. BIRKETT

Radio Component Suppliers
25 THE STRAIT, LINCOLN, LN2 1JF.
Telephone: 20767

INSIST ON VERSATOWER

Acclaimed as the World's leading telescopic tower in the field of radio communication. Models from 25' to 120'

Enquiries to Western Electronics (UK) Ltd Osborne Road, Tetton, Southampton



Look for the name

STRUMECH

Strumech Engineering Co Ltd Coppice Side, Brownslands, Walsall, Staffs

AMATEUR TELEVISION — SSTV

Interested in amateur television, fast scan or slow scan ?

The British Amateur Television Club exists to inform, instruct and co-ordinate the activities of amateur television enthusiasts and publishes a quarterly journal "CQ-TV" covering reception, transmission, colour, constructional articles, SSTV news, contests, standards, etc.

Membership of B.A.T.C. costs only £1 per year, so why not send for an information leaflet today ?

Also available from B.A.T.C. :

"Slow Scan Television" by G3RHI at 25p plus 3p postage.

"SSTV Handbook" by W9NTP and WB8DQT published by 73 Magazine, 248 pages of SSTV information at £2 plus 20p post and packing.

THE BRITISH AMATEUR TELEVISION CLUB
64 Showell Lane, Penn, Wolverhampton, Staffs.

"DX ZONE MAP"

ANOTHER REPRINT !

In four colours, on durable paper for wall mounting. 35in. wide by 25in. deep. Giving essential DX information—bearing and distance of all parts of the world relative to the U.K., the 40 Zone areas into which the world is divided for Amateur Radio purposes, with major prefixes listed separately. Distance scale in miles and kilometres. Time scale in GMT. Marking of Lat./Long. close enough for accurate plotting. Hundreds of place names, mainly the unusual ones, and most of the rare islands

With new Prefix List revised to Sept. 1973

Price £1-20

including postage and special packing in postal tube to avoid damage in transit.

Publications Dept.

Short Wave Magazine Ltd., 55 Victoria Street, London, SW1H 0HF (01-222 5341/2.)

SOME TITLES DESCRIBED

ABC's of ANTENNAS

The introductory chapters cover the fundamentals of radio-wave propagation and basic antenna characteristics. The remainder of the book is then devoted to a discussion of the various types of antennas and their uses. Antennas for radio, television and two-way communications are included. Business radio, amateur, both mobile and fixed-station operation, are covered. The final chapter should be particularly appealing to those interested in microwave uses and radio-navigational systems. A perusal of this book will provide any student with an excellent foundation for more advanced study in antenna design.

92p

AMATEUR RADIO SSB GUIDE

Single-sideband receivers, transmitters, and transceivers are now available which have higher frequency stability and are much easier to tune than the early models. In this book, the author presents a guide to single-sideband and single-sideband equipment, which will be useful to any amateur considering or already operating SSB.

By W6TYH

£1-62

BEGINNER'S GUIDE TO RADIO

For many years "Beginner's Guide to Radio" has been extremely popular as an introduction to the subject of radio-and-how-it-works. The many advances made in recent times have rendered a new edition necessary.

This seventh edition has been completely rewritten and brought up-to-date to take account of the latest techniques and methods, and covers every aspect of the modern radio scene, while including the important basic information necessary for the newcomer to the subject.

The reader is guided from the first principles of electricity and magnetism, through radio waves, modulation and radio components, including valves and transistors, taking in radio transmitters and stereo broadcasting, and ending with hi-fi reproduction.

The book will be of interest to all who wish to understand the how-and-why of radio, whether it be for a hobby or a profession.

Seventh Edition

£1-15

RADIO AMATEUR OPERATOR'S HANDBOOK

The opportunity has been taken of bringing this edition—the twelfth—right up-to-date and of incorporating extensive revisions. The book covers in detail the Post Office regulations governing the issue of transmitting licences.

The purpose of this Handbook is to provide all the information which the operator of a radio station may need about such matters as Country Prefixes, Call Sign Areas, Frequency Allocations, Standard Frequency Transmissions, Time Factors, Distance Tables, and so on. For the newcomer, this manual enables him to find the basic answers and to obtain the maximum pleasure from his hobby.

54p

TRANSISTOR FUNDAMENTALS Vol. I

This book is a carefully planned programmed introduction to semi-conductors and the basic electrical circuits. It begins with a brief description of transistors and later devotes an entire chapter to an explanation of transistor principles. Sandwiched between these chapters are explanations of voltage, current, and resistance; and the all-important Ohm's Law and Kirchhoff's laws. The book also looks at the more complicated nature of inductance, capacitance, and resistance in AC circuits.

£1-95

RADIO CIRCUITS

By Thomas M. Adams

This volume goes into great detail in explaining the action of the various circuits used in radio receivers—also voltage analysis and signal substitution methods for servicing typical valve and transistor receivers.

£1-85

KNOW YOUR OSCILLOSCOPE

By Paul C. Smith

The oscilloscope provides you with a "third eye" which lets you see what is actually happening in electronic circuits. But you must know something of the nature of this valuable instrument, and how to use it, before it will serve you. This book presents complete information on the circuitry, functions, and applications of the oscilloscope in easy-to-understand language. Worthwhile reading for anyone who uses an oscilloscope... a "must" for service technicians and students.

£1-82

(American and English Books)

The above prices include postage & packing.

Delivery is from stock.

Available from

Publications Dept., 55 Victoria St., London SW1H 0HF

(Counter Service, 9.30 - 5.15, Mon. to Fri.)

SHORT WAVE MAGAZINE

01-222 5341

(Nearest Station: St. James's Park)

(GIRO A/C. No. 547 6151)

BEAM ANTENNA HANDBOOK

By William I. Orr, W6SAI 3rd edition

This completely revised 3rd edition of Bill Orr's popular book covers beam antenna theory, design, construction, installation, and adjustment. Includes ionosphere theory; transmission lines; matching devices; new Inducto-match system; parasitic beams; all-metal arrays; multiband beams; wire beams; 20 and 40 metre compact beams; design charts and SWR curves for beams—six to forty metres; how to evaluate your beam; test instruments and how to use them; different types of installation. A "must" for the serious DXer whether he buys or builds his beam.

200 pages

£2-13

HANDBOOK OF TRANSISTOR CIRCUITS

By Allan Lytel

Here is a collection of more than 200 practical transistorised circuits for use in counters, power controls, timers, indicators, photoelectric devices, power regulators, amplifiers, power supplies, oscillators, power converters, and other applications. Schematic diagrams, parts lists and descriptions of operation are included for each circuit.

Planned as a supplement and companion volume to author Lytel's previous book, *Transistor Circuit Manual*, many of the circuits employ such specialised semi-conductor devices as silicon-controlled rectifiers, photocells, zener diodes, and tunnel diodes, in addition to standard diodes and transistors.

This book is a handy source of information on the design, operation, and application of a wide variety of transistorised circuits. Engineers, technicians, students, and hobbyists will all find the circuits of interest and the material of value in research, development, experiment, and general studies of circuitry.

£2-39

PRACTICAL WIRELESS CIRCUITS

There are more than 50 different circuits detailed in this book. Transistor receivers, 22 in all, range from an ultra-simple crystal diode circuit to a very sophisticated 10-transistor communications Rx. Valve receivers cover MW, SW and FM. Transistor and valve amplifiers include preamplifier, PA and Stereo.

There is a chapter on transmitters and transceivers, and another on transmitter and receiver circuits for Model Control. Circuits for an extensive range of Test Gear cover everything from a simple Transistor Tester to a Comprehensive Multimeter, including a Pocket Signal Tracer (RF, AF and IF), also FM, Square-Wave and Noise Generators.

Among the special circuits are a recording level meter for tape recorders, an electronic photographic timer and a solar cell receiver.

The first few simple circuits are accompanied by step-by-step instructions to enable the absolute beginner to gain enough experience with circuitry building to tackle the more complicated work.

£1-35

ALL ABOUT CUBICAL QUAD ANTENNAS

By William I. Orr, W6SAI

This book discusses the theory, design, construction and operation of Cubical Quad antennas. It covers the Quad's history, operation and characteristics; multi-element and concentric Quads; the X-Q Quad with 3 dB gain over normal design; the new Tri-Gamma match; new, improved feed systems; new, sturdier construction; true angle of radiation; antenna tuning and maintenance. Contains data never before published! All you need to know about Quads!

96 pages

£1-82

110 SEMICONDUCTOR PROJECTS

Due to the rapid advances in semiconductor technology, many engineers and certainly most amateurs have found it impossible to keep track of the new devices that become available because of lack of readable information. This book introduces the reader to such outstandingly useful new devices as the field-effect transistor, uni-junction transistors, silicon controlled-rectifiers, silicon planar transistors and integrated circuits, giving their properties and methods of operation, with full constructional details of many exceptionally useful circuits.

Of particular interest to the amateur are simple amplifiers, lamp and relay driving circuits, electronic switches—operated by light, sound or contact with water—and delay circuits ranging from a fraction of a second to 35 minutes. Among the many circuits which will be of interest to the practising engineer are amplifiers with input impedance as high as 500 megohms, voltage and current regulators, waveform generators, analogue-to-digital converters and logic circuits. All circuits are designed around internationally available semiconductors.

124 pages, including 110 illustrations

£1-31

Technical Books and Manuals

(ENGLISH AND AMERICAN)

AERIAL INFORMATION

ABC of Antennas	92p
Aerial Handbook (Briggs)	89p
Amateur Radio Antennas (Hooton)	£1-89
Antenna Handbook, Volume 1	£1-79
Antenna Round-Up, Volume 1	£1-50
Antenna Round-Up, Volume 2	£1-80
Antenna Handbook, 12th Edition (ARRL)	£1-42
Beam Antenna Handbook, 4th Edition	£2-13
Quad Antennae 2nd Edition	£1-82
Simple Low Cost Wire Antennas	£1-75
73 Vertical, Beam and Triangle Antennas (by E. M. Noll)	O/S
73 Dipole and Long-Wire Antennas (by E. M. Noll)	O/S

BOOKS FOR THE BEGINNER

Amateur Radio (Rayer)	£1-63
Beginners Guide to Radio (7th Edition)	£1-15
Beginners Guide to Transistors	£1-15
Beginners Guide to Colour TV	£2-08
Better Short Wave Reception, 2nd Edition	£1-82
Course in Radio Fundamentals	£1-17
Foundations of Wireless and Electronics	£2-06
Guide to Amateur Radio	90p
Ham Radio (A beginner's Guide) by R. H. Waring	£1-75
How to Become a Radio Amateur	65p
Learning the RT Code	30p
Morse Code for the Radio Amateur	24p
Radio, by D. Gibson	87p
Radio Amateur Examination Manual	90p
Simple Short Wave Receivers (Data)	90p
Understanding Amateur Radio	£1-40

GENERAL

ABC of Electronics (by Farl J. Waters)	£1-60
FM & Repeaters for the R. Amateur	£1-63
ABC of FET's	£1-38
Easibinder (to hold 12 copies of Short Wave Magazine together)	£1-15
FET Principles, Experiments and Projects	£2-17
Making Transistor Radios (R. H. Warring)	£1-32
Guide to Broadcasting Stations (17th Edition)	84p
Having Fun with Transistors	£1-61
110 Semi-Conductors Project for the Home Constructor (Illiffe)	£1-31
How to Listen to the World—8th Edition	£1-90
110 Integrated Circuit Projects for the Home Constructor	£1-31
Know Your Oscilloscope (by Paul C. Smith)	£1-82
Microphones	£1-67
Practical Integrated Circuits (Newnes-Butterworth)	O/P
Practical Transistor Theory	£1-12
Practical Wireless Circuits	£1-35
Prefix List of Countries	24p
Radio Engineers Pocket Book (Newnes) (N.E.)	£1-27
Shop and Shack Shortcuts	£1-77
Single Sideband: Theory & Practice (by H. D. Hooton)	£3-52
99 Ways to IMPROVE YOUR SHORT WAVE LISTENING	£2-06

Telecommunications Pocket Book (T. L. Squires)	£1-33
World Radio and TV Handbook 1974 Edition	£3-05

HANDBOOKS AND MANUALS

Amateur Radio DX Handbook	£2-18
Electronic Circuit Handbook, Vol. 1	£1-43
Electronic Circuit Handbook, Vol. 2	£1-43
New RTTY Handbook	£1-82
Radio Amateur Handbook 1973 (ARRL)	O/P
Radio Amateur Handbook 1973 (ARRL) (Hard Cover)	O/P
Radio & Electronic Handbook	£1-33
Radio Amateur Operators Handbook, 12th Edition	54p
Radio Communication Handbook (RSGB)	£4-13
Rtty A-Z (CQ Tech. Series)	£2-28
Radio Handbook (W. I. Orr) 19th Edition	O/P
Surplus Conversion Handbook	£1-38
Television Interference Manual (G3JGO)	91p

USEFUL REFERENCE BOOKS

Amateur Radio SSB Guide	£1-60
Amateur Radio Techniques—4th Edition	£1-85
Care & Feeding of Power Grid Tubes (Elmac Division of Varian)	£1-61
Engineers' Pocket Book—6th Edition	£1-49
Guide to Amateur Radio	90p
'G' Call Book 1974	75p
Hams' Interpreter	80p
Hints and Kinks Vol. 8 (ARRL)	63p
Radio Amateur Examination Manual (N.E.)	90p
Radio Data Reference Book (3rd Edition)	£1-02
Radio, Valve and Transistor Data (Illiffe), 9th Edition	92p
Service Valve and Semiconductors Equivalents	36p
Single Sideband for the Radio Amateur (ARRL), 5th Edition	£1-68
Single Sideband (Theory & Practice) by H. D. Hooton	£3-52
Sun, Earth and Radio by J. A. Ratcliffe	92p
Surplus Schematics (CQ)	O/P
Transistor Pocket Book	£1-58

TRANSISTOR MANUALS

ABC of Transistors	£1-34
Field Effect Transistors (Mullard)	£1-97
Having Fun with Transistors	£1-61
Handbook of Transistor Circuits	£2-39
Transistor Audio & Radio Circuits (Mullard)	£1-98
Transistor Fundamentals: Basic Semi-Conductor Vol. III, and Circuit Principles, Vol. 1	each £1-95

VHF PUBLICATIONS

VHF Handbook, Wm. I. Orr	£1-81
VHF Manual (ARRL)	£1-38
VHF/UHF Manual (RSGB)	£1-85

Amateur Radio Awards (RSGB)	£1-40
Questions and Answers on Radio and TV	85p
Integrated Circuit Pocket Book	£2-65
International Transistor Data Manual (Semicon)	£5-60
Teletprinter Handbook (RSGB)	£5-27

O/P (out of print)
T. O/S (Temp. out of stock)

The above prices include postage and packing.

Many of these Titles are American in origin.

Available from

Publication Dept., 55 Victoria St., London SW1H 0HF

(Counter Service. 9.30-5.15. Mon. to Fri.)

(GIRO A/C. No. 547 6151)

SHORT WAVE MAGAZINE

01-222 5341

(Nearest Station: St. James's Park)

TELECOMMUNICATIONS INTERNATIONAL AGENCY LTD.

LINER 2 Add on amplifier module comprising of 40 watt PEP amplifier and preamp for the RX extremely simple to use with any liner 2 but could be easily adapted for use with any TX/RX requiring more power and better sensitivity. Spec:—RX preamp gain 15 dB NF <2.5 dB. Power amplifier. 10 watts PEP input for 40 watts PEP output. Power requirements 12.5v. DC.

Due to the increased demand and subsequent reduction in production costs we are able to pass this on to you in the form of a substantial price reduction.

For further details send S.A.E. Now Only **£53.25**

MURPHY FM40 PA Add on RF amplifier. 10 watts input <35 watts into 50 ohms output. Aerial changeover carried out by RF sensing amplifier, will operate with as little as ½ watt input. Operated on 12.5v. DC.

For further details send S.A.E. Price **£39.50**

MURPHY FM 40 TR 12 channel FM transceiver for the 2MTR enthusiast. Double conversion RX 0.5uV input for 20 dB sig./noise. Less than 1 dB increase in AF output for 100 dB change >0.5v. TX output into 50 ohms >35 watts. Deviation adjustable 0-15 kHz pre-emphasis characteristic from 300 HX to 3 kHz relative to 1 kHz. Supplied complete with microphone holder etc.

For further details send S.A.E. Price **£141.20**

TWO TONE GENERATOR Latest IC techniques used. An essential piece of equipment for achieving the maximum from your SSB equipment whether home made or manufactured.

For further details send S.A.E. Price **£20.85**

2 MTR MOSFET CONVERTERS Overall gain of 30 dB NF <2.5 dB unit required 12v. 28-30 MHz if output (others can be supplied on request).

Kit and instructions **£9.30**

Built and Tested **£14.25**

MURPHY ROVERS High and low band HYBRID TX/RX AM. QQV03-10 PA. Transistor. IF, inverter, audio, PSU etc. Ideal mobile for 2 MTRS. Supplied with all accessories, in good condition.

Boot Mount **£14.25**

Dash Mount **£17.75**

COSSOR COMMANDO Low band 12½ kHz AM mobile radio telephone. Solid state. Good condition.

Price **£50.00**

UEL VALIANT Midband High Power mobile complete with leads and accessories. Price **£23.50**

ULTRA Solid state VHF TX/RX. Lowband dash or boot mounter 12½ kHz as new. Price **£45.50**

DC STAB SUPPLY Small compact mains operated stabilised DC supply. Giving 12.5v. at 5 amps. Ideal for running mobile equipment as a base station.

Price **£14.50** New

NEW SLEEVED DIPOLES Superb construction fit into 2" mast. Ideal for base station aerial.

Price **£15.85**

VHF WHIP AERIALS Fibre glass aerials. Ideal for ¼ wave on 2 MTRS. Please state band to be used when ordering. Price **£3.25**

HAND SETS New SG Brown handsets. Price **£6.15**

TRANSISTORS Etc.
PT 4176D 44 watts **£3.35**

Terms CWO

PT 4176C 20 watts	£2.36
PT 4176B 10 watts	87p
PT 4176A 3 watts	50p
2N 4427 5 watts	75p
2N38866	58p
2N3819	33p
AF239	27p
ME1001	25p
2N 5180	58p
BF115	24p
BSX26	16p
BC108	16p
OA10	22p
ASZ21	33p
OAZ200	38p
OAZ207	38p
1N91	19p
CA3011	£1.07
BNC Free Sockets	22p
QQV03-10A	£1.70
5 pin type B Din plugs...	14p
5 pin type B Din sockets	14p
3P 4W wafer switch	22p
PL 259 Plugs, Sockets and Reducer	80p

NEW STUD UHF POWER DEVICES

TIA 6B 400 MHz 1 watt output	83p
TIA 4B 400 MHz 3 watt output	£1.70
TIA 7B 400 MHz 9 watt output	£4.18

Details and spec available on request.

CR100RX Good condition **£18.50**

Eddystone EC10 MK2 Including Eddystone mains PSU in good condition **£45.00**

GEC FM Base Station 12½ kHz type approved in extremely good condition. In working order, complete with desk controller **£75.00**

Murphy 821 Converted to 2MTRS 2 channel Tx. Tunable TX (Heathkit HW17 tuner) working **£25.00**

High Band Black whip aerials new **£1.20**

New Murphy PSU stabilised 12.5v. DC at 2.5 amps **£10.00**

New Murphy PSU stabilised 12.5v. DC at 8 amps **£20.00**

DC-DC inverter 24v. output at 2.5 amps. 12v. **£7.50**

Cathodeon Xtal Ovens **75p**

Relays. Aerial changeover 12v. DC **£1.25**

Coscor Motorbike mobile units. Lowband **£10.00**

Desk microphone kits including 200 ohm insert new **£2.00**

S.G.B. Base Microphone with stand **£6.50**

SGB Classic ultra modern base or mobile microphone dynamic **£8.00**

Reslo Dynamic microphones PTT **£2.50**

Murphy MR960 Boot mounted **£5.00**

New remote control units for above **£2.50**

L.S. Miniature 1½ 3 ohms. New... .. **£1.50**

Invertors 12v. in 6 volt out 5 amps **£1.75**

Murphy Rambler carrying cases **75p**

Relays 24v. Octal 2 P 2W **50p**

Octal Plugs **25p**

6 Channel Xtal switch assy. HC25 U Holders, concentric trimmers switch etc. **£1.00**

Fist Microphone stowage units. New **50p**

ALL PRICES INCLUDE VAT AND POSTAGE

P.O. BOX 4, BROCKENHURST, HANTS.

Mail Order Only

CALL BOOK 1974

**NOW AVAILABLE
FROM STOCK**

DX LISTINGS £3.82

U.S. (Only) ,, £4.25

The above prices include postage and packing.

Please order your copy early from:

Publications Dept.,
SHORT WAVE MAGAZINE
55 Victoria Street, London, SW1H 0HF
01-222 5341

Telecommunications Technicians

**Spread your wings and take off to
West Midlands Gas**

Any Telecommunications Technician worth his salt wants to work with the most advanced electronics equipment available. We at West Midlands Gas are proud to tell you that we use microwave radio, digital supervisory systems and UHF radio for telemetry and data transmission and also make extensive use of VHF/UHF mobile R/T systems. Our computer communications networks are amongst the most sophisticated in the country.

As you will see this calls for technicians who have attained ONC, have some knowledge of this kind of equipment and are keen to further their careers in a sophisticated telecommunications environment.

Salaries will be up to £1926 per annum with possible progression to Senior Technician in a range up to £2487 per annum on proven ability. Possibilities exist for further promotion to systems design and management posts through career development within the department.

The posts are based at Solihull but involve travel throughout the region. Generous re-location facilities will be made available in appropriate cases.

Applications quoting ref: No A584 to: Senior Personnel Officer, (Headquarters and Marketing), West Midlands Gas, Wharf Lane, Solihull, Warwickshire B91 2JP.

**WEST MIDLANDS
GAS**



become a RADIO-AMATEUR!

learn how to become a radio-amateur
in contact with the whole world. We give
skilled preparation for the G.P.O. licence

free! Brochure, without obligation to: SWB-4/4

**BRITISH NATIONAL RADIO & ELECTRONICS
SCHOOL P.O. BOX 156, JERSEY, CHANNEL ISLANDS**

NAME: _____

ADDRESS: _____

_____ BLOCK CAPS please

G. W. M. RADIO LTD.

All prices include VAT and post/c carriage.

TEST EQUIPMENT. All standard mains

NOISE GENERATORS CT82 for comparative Noise Factor measurements in Receivers covering 100 kc/s. to 160 mc/s. Clean condition, untested, £7.50.

RADIO TELEPHONES. All 25 kc/s. Cambridge dash mounting single channel L/B £23. Also H/B 6 channel, £30. Vanguard boot mounting, with control box, speaker and lead. AM25B H or L/B, £15. AM25T H/B £20. AM25 H/B 6 channel £30. Storno FM H/B single channel model CQM 13C/12 with control box, lead and mike, £12.50.

REED RELAYS. 4 pole normally open, 5v. DC coil as used in recent Electronic Keyer design, 16p each (plus 10p post for any number). Also reed inserts 1.85" overall (body length 1.1"). Diameter .14". Max. ratings 250v. DC and 500 mA. Gold clad normally open contacts, 69p per dozen, £4.12 per 100, £30.25 per thousand.

TRANSMITTER P.A. UNITS, STC T4188. Tunes 2-8 to 18 Mc/s., manual or 28v. motor driven. 13" x 8" x 8". Pair CV518 (4x150) 28v. blower cooled. Bases are NOT U.H.F. type. Ideal basis for linear amplifier construction, £8.75.

RACAL Frequency Standard and Power Supply Unit for Channelizer MA150. Comprises mains power unit giving outputs of 6.5v, 11.5v, Negative 78v. and 250v. stabilised. (Transformer HT rating is 450mA). Also contains 12v. crystal oven for 100 kc/s. crystal. Clean and untested, £7. RACAL SSB Adaptors RA218 for RA17 and RA117 Receivers, clean and untested, £30.

OSCILLOSCOPES. SOLATRON CD1212. 5" tube. TB 100 nanosecs. to 5 secs. Input 200 mic./volts to 100 volts. Clean condition and working order, with 24 mc/s. dual trace plug in unit, £80. Wide band 40 mc/s. unit, £20 (only sold with scope). Solatron 5235/2 (CT386a) DC to 10 mc/s. sensitivity 1mV per Cm., £44. Miniature CT52 DC to 1 mc/s. restricted time base 10 c/s. to 40 kc/s. but very useful, £22.

RECEIVERS B40a. "As new" condition, good working order. In original Ministry crates with all plugs, £55.

TRANSCIVERS. B44 Mk. 3. 3 channel, 4 metre, 12v supply and speaker built in. Clean, untested £10.

All Receivers and Test Equipment are in working order at time of dispatch
Carriage charges included ore for England and Wales only.

Telephone 34897

Terms Cash with order. Early closing Wednesday.

40-42 PORTLAND ROAD, WORTHING, SUSSEX

SERVICE ENGINEER

A vacancy exists in our Service Department for an experienced SERVICE ENGINEER with suitable qualifications, for servicing HF and VHF SSB and FM equipment. Salary will be over £1,800, dependent upon qualification and experience.

SALES ASSISTANT

A young, lively person holding a Class A or B Radio Amateur's licence is required to assist the Sales Manager. If you are interested in joining our team, we would be pleased to hear from you. Further details from the Managing Director, Western Electronics (U.K.) Ltd., Osborne Road, Totton, Southampton. Telephone Totton 4930.

THE RADIO SHOP 16 CHERRY LANE, BRISTOL, BS1 3NG
Telephone: Bristol 421196. STD Code 0272
Your West Country shop for electronic components and solid state devices
5 COMPUTER PANELS. 9" x 7" min 35 trans. OC44 EQ ACY17
2 Trim Pots min. 70 condensers. Min. 80 diodes inc. OA81 + resistors.
Most transistors have long leads. £1.25, post paid
2 METRE PRE-AMPLIFIER. Single F.E.T. Pre-amp. neg. earth.
Gain app. 12 dB. Circuit, instructions and components. All you need is a tobacco tin. £1.40, post paid
Prices include VAT. (TRIO STOCKISTS) Catalogue 10p, post paid

WANTED PYE RADIOTELEPHONE EQUIPMENT

Top Prices Paid

B. BAMBER ELECTRONICS
20 Wellington Street, Littleport, Cambs.
Tel. ELY (0353) 860185

AMATEUR AERIALS

J-BEAM, 2 METRE
& 70 CENTIMETRE ARRAYS
plus Stolle Rotators
plus 75 or 50 ohm cable

EX-STOCK

Ring Southend-on-Sea 32496 — ask for Ham Aerials

CASH WITH ORDER

COHEN T.V. AERIALS CO. LTD., 645 London Road, Westcliff-on-Sea

Walkie-Talkie No. 88 ex. WD 14 valve four channel transmitter/receiver unit, £6.50, carriage 68p. Limited supply. No. 19 ex. WD used transceiver valved unit, only £6.50, carriage £1.40. Salvage speaker, tape unit multi-valve receiver telemeter, sealed cartons, £4, carriage £1. Padded moving coil ex. WD unused headphones, great at £1.50 plus 35p p.p. 16 KV Meters ex. WD 3½", boxed, £5.50 plus 50p p.p. American ex. WD, featherweight, low resistance headphones, unused, £1.25 plus 25p p.p. Remington speech recorder valved unit, £5.50, 75p p.p. Grundig stenorett office recorder, less microphone, £8.50, carriage 75p. Loaded staff car aerials, unused ex. WD, £1.25, 25p p.p. 625 colour and black and white 9 element, 35 box grid reflector, heavy duty aerial, £3.25, 50p p.p. Two 4ft. tank aerial top sections, 90p. 35p p.p. Government Leather, new meter case and shoulder strap, 5" x 4½" x 1", 62½p, 20p p.p. Mains Motors, unused, powerful ½" spindle, £5, 75p p.p. Hoses, approx. 60" x ¾", 50p, 20p p.p. Large stock assorted ex. WD meters, cheap. Few (dirty cases) 38 AFV Sets, £5.50, p.p. £1.00 each. S.A.E. ALL PLUS 10% VAT.

SOUTHERN SURPLUS MERCHANTS, LTD.

66 London Road, Kingston-upon-Thames, Surrey
(Tel.: 01-546 9263)

DO YOU NEED TRANSISTORS, I.C.'s AND OTHER AMERICAN COMPONENTS TO BUILD THAT CIRCUIT IN QST, ARRL HANDBOOK, Etc. IF SO

RCA MOTOROLA ETC
CAN BE SUPPLIED SPEEDILY TO ORDER. ALSO ANY OF THE COMPONENT RANGE FROM

JAMES MILLEN J. W. MILLER HAL ESEL
BARKER WILLIAMSON

Toroid cores and kits as previous adverts, also data sheets available.
S.A.E. with all enquiries.

T.M.P. (Electronic Supplies)

3 Bryn Clyd, Leeswood, Mold,
Flintshire, CH7 4RU.
(Office Only)



V.H.F. CONVENTION 74

COME AND TALK TO US AT THE WINNING
POST ON APRIL 6TH.

AND MAKE SURE YOU LOOK FOR THIS ADV.
NEXT MONTH.

ANTEC

74 Upper Sherbourne Road, Basingstoke, Hants.
Telephone: Basingstoke 27527

Use your tape recorder to widen your horizons

Our unique self-test instructional tapes will guarantee you rapid and painless mastery of morse. Send now for full details of our efficient and inexpensive programme, or begin immediately by including £1.45 (which will be instantly refunded if you are not delighted) and obtain our introductory lessons by return of post.

(State whether cassette or lp tape required.)

MINIWISE PRODUCTS

PO BOX 99, BLETCHLEY,
MILTON KEYNES MK3 5BR.

MORSE MADE EASY !!!

FACT NOT FICTION. If you start **RIGHT** you will be reading amateur and commercial Morse within a month. (Normal progress to be expected.)

Using scientifically prepared 3-speed records you automatically learn to recognise the code **RHYTHM** without translating. You can't help it. It's as easy as learning a tune. 18-W.P.M. in 4 weeks guaranteed. For Complete Course 3 Records & Books send £4.50 P.P.I. etc plus 10% (overseas £1 extra.)

For further details of course Ring 01-660 2896 or send 4p stamp for explanatory booklet to:—S. BENNETT, G3HSC
(Box 14) 45 GREEN LANE, PURLEY, SURREY

THE INTERNATIONAL TRANSISTOR DATA MANUAL FOR 1974

The improved and updated 1974 edition will be available in April. Basic characteristics on upwards of 20,000 transistors of international origin with substitutes. Make sure of your copy. Order now direct from:

SEMICON INDEXES LTD.,
Free Post, Wokingham, Berks., RG11 1BR

Price: £6.20 in U.K. £7.30 overseas (includes surface mailing)

G3HEO **D. P. HOBBS LTD.** G8FAL

Most components for the Radio Amateur "J Beam" aerials. Bantex ⅝ whips. Denco coils.

Microwave modules 2m and 70cm converters.

SWR Bridges. Test meters. Transistors, Resistors, Condensers, etc. Trio equipment.

This month's bargain offer:

BSX20 transistors 15p each, 10 for £1.25.

BFS28 Dual-gate Mosfet 30p each, 10 for £2.50.

Post Free but add 10% VAT to all orders.

11 KING ST., LUTON, BEDS. Tel. 20907

PORTABLE PETROL ELECTRIC GENERATORS

HONDA

ALL MODELS, FROM THE INCREDIBLY QUIET HONDA E300E WHICH GENERATES 300 WATTS A.C. PLUS 12v D.C. AND MEASURES ONLY 13" x 12" x 9" TO THE HONDA E4000E, 4 KW DIESEL SET.

For brochure & full details, call, write or phone
GODALMING 23279

ASHLEY DUKES
FARNCOMBE STREET, FARNCOMBE,
GODALMING, SURREY.

G3ACQ OFFERS

Few only **TRIO JR599** 160 to 2 metre Solid State Multi Filter RX ½ kHz Readout, £145.75. **TRIO 9R 59DS** General coverage, £46.75. These will be superseded by later models at increased prices so buy now whilst limited stocks are available. **TS 515 REMOTE V.F.O.** £35. **SOLID STATE MODULES** Transverters Converters for V.H.F. XTALS as usual—s.a.e. please. Aerials by Hy-gain-Bantex-J. Beam. **YAESU GEAR FT/FR 50 Combo**—FT 75—always in stock.

S. MAY (Leicester) LTD.

12/14 CHURCHGATE, CITY CENTRE,
LEICESTER LE1 4AJ

Telephone 58662

SMALL ADVERTISEMENTS

("SITUATIONS" AND "TRADE")

6p per word, minimum charge £1.00. No series discount. All charges payable with order. Insertions of radio interest only accepted. Add 50% for Bold Face (Heavy Type). Box Numbers 15p extra. No responsibility accepted for transcription errors. Replies to Box Numbers should be addressed to The Short Wave Magazine, 55 Victoria Street, London, SW1H 0HF.

SITUATION

AMBITIOUS licensed Sales Manager required to join staff of leading Amateur Radio company. Salary negotiable, with usual staff benefits. Please write or call:—S.M.C., Ltd. (Western Electronics Trading Division), Osborne Road, Totton, Southampton, SO4 4DN. (Tel: Totton 2785/4930).

TRADE

SURPLUS from Transshipment: W2AU-type baluns, 1:1 and 4:1, with lightning arrester, normally £7.50, price £6.00 and 14p post/packing. Few only at this price.—T.M.P., 3 Bryn Clyd, Leewold, Mo'd, Flintshire, CH7 4RU.

TRANSFORMERS & Components for Transistorised DC-DC Converters for Mobile/Portable use. Designs from 60w. DC (transformer £2.40) to 2 kW p.e.p. SSB (transformers £17). Full details on request. Also large quantity of VHF mobile Equipment and Components.—B. M. Sandall, G3LGG, Amber Croft, Higham, Derby, DE5 6EH. (Send s.a.e. for lists).

ATENTION JR-310 Owners: Have your JR-310 converted into a JR-310 super-de-luxe — Top Band, Crystal Calibrator, improved 40-metre performance, 29.5 to 30.1 MHz (for two-metre converters) and Alignment checked, at cost of £16.50 inclusive VAT for receivers in as-new condition (sorry, no hashed-up specimens accepted). Securicor return carriage £3.30 if required. Accessories, VAT and post paid, for D-I-Y types (but sorry no gen.), SSB or CW filters, £16.50. Top Band crystal 3, crystal for 29.5 to 30.1 MHz, £3.30. Details for s.a.e.—G3LLL, Holdings, Ltd., 39/41 Mincing Lane, Blackburn, Lancs., BB2 2AE. (Tel: 59595/6).

Ex-Ministry 0-100 microamp. meters, 3-ins. diameter, price 50p. Ex-GPO 5-inch sidecutters, 40p, two pairs for 70p. Factory reject two-band radios, guaranteed repairable, £2.50 or five for £10. WANTED: Portable Oscilloscope, small walkie-talkie and communications receiver. Details and price delivered, please.—(Northern Ireland).—Box No. 5207, Short Wave Magazine, Ltd., 55 Victoria Street, London, SW1H-0HF.

FOR SALE: Five rolls second-quality p.v.c. insulating tape, 22 and 36 yards, 60p. sample 15p. Third-quality rolls, 40p, sample 10p.—Box No. 5203, Short Wave Magazine Ltd., 55 Victoria Street, London, SW1H-0HF.

QSL Cards: Tx, G8, SWL. One to four-colour designs. Good selection. Send s.a.e. for samples.—Printon, 105 Fleetwood Street, Preston, Lancs. PR2 2PT.

MAY Issue: To appear May 3, if possible Single copies at 32p post free will be sent by first-class mail for orders received by May 1st, subject to supplies being available.—Circulation Dept., Short Wave Magazine Ltd., 55 Victoria Street, London SW1H-0HF.

QSL CARDS and G.P.O. approved Logs (hard back), prompt delivery. Send 5p s.a.e. for samples.—Elmtree Press, Loog, Cornwall, PL13-1JT.

VERNITRON Ceramic Filter Resonators, 455 kHz. Special types for SSB and NBFM. Send s.a.e. for list.—Amatronix Ltd., 396 Selsdon Road, South Croydon, Surrey, CR2 0DE.

READERS ADVERTISEMENTS

3p per word, minimum charge 50p payable with order. Add 25% for Bold Face (Heavy Type). Please write clearly, using full punctuation and recognised abbreviations. No responsibility accepted for transcription errors. Box Numbers 15p extra. Replies to Box Numbers should be addressed to The Short Wave Magazine, 55 Victoria Street, London, SW1H 0HF.

READERS

WANTED: Wide filter for R.206 Rx, or scrap R.206; also TY2-125 and four jumbo five-pin valve holders. All letters answered.—Canale, GM3XFC, 18 Seaton Road, Arbroath, Angus, Scotland.

SELLING: KW-2000B with PSU, mint condition, first £145 secures. Buyer collects.—Bowman, 105 Benfleet Road, Hadleigh, Essex. (Tel: Southend-on-Sea 559303).

WANTED: K.W. Vespa Mk. II, must be in good working order. Details and price please. — Ayling, G4BNO, QTHR. (Tel. Bournemouth 46327).

WANTED: Crystals for 160m., 1.9-2.0 MHz, any size. Cash waiting.—Peters, 4 Spencers Bellvue, Lansdown Road, Bath, Somerset, BAI 5ER.

FOR SALE: HQ-1 Miniquad, 10-20m., with HZP balun, £30; **WANTED:** Lightweight rotor and 2m. power amplifier. Details and price please.—Selman, 14 Beacon Hill, London N.7.

SALE: Pye 62 transceiver, with 12v. battery, 35-watt linear, SWR bridge, ATU, key, headphones and mic., £25 or near offer.—Ring Cookson, Chelmsford 72390.

SELLING: National HRO receiver with 7 coil packs, good condition, £30 or near offer.—Bishop, 7 Mereclough Fold, Cliveger, Burnley, Lancs. (Tel. Burnley 29660, evenings).

OFFERING: Murphy Admiralty receiver, coverage 60-550 kHz and 1.5-30 MHz, new condition perfect working order; 170 "Practical Wireless" from August 1944. No sound offers refused. Moving, must clear. Buyer collects.—Manns, 25 Ivy Road, Hounslow, Middlesex.

SELLING: Trio receivers: JR-500S with SP5-D speaker, beautiful condition, £40; JR-310, with narrow filter, SP-5D, and replacement valves, £65.—Price, G8FIH, Sherwood House, Brimpsfield, Gloucester. (Tel: 045282-3382).

FOR SALE: Laboratory double-beam oscilloscope, good condition, £35.—Stenning, 14 Bell Crescent, Waterlooville, Hants.

FOR SALE: Racal RA-17, LF converter, RA-98 ISB adaptor, plus all Racal handbooks (RA-17 looks and works like new), £250 the lot.—Duce, G4BQF, 28 Thompson Avenue, Canvey Island (62394), Essex.

BETTER GET 'SET'

Famous No. 19 set trans/receiver TR50/51 2-8 MHz in 2 bands. 11 valve. 80T PA Power reqs. 12VLT 275VHT REC 500VTM. Rebuilt £12.50, carr. £1. Complete station 12 VOC PSU. Mic. Cables £23.50, carr. £2.50.

TR55
VHF 60-90 LHZS XTALSINC 3
channel 12 valve super Het

12 VDC Sync Internal Supply,
size 14" x 12" x 7" as new
£16.50, carr. £1.25

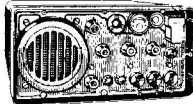

TE76/CT 52
Miniature OSCilloscope
£25, carr. £1.50



RE102 42' Mast 12-3' 6" x 2" sections
WIRE GUYS STRAINERS in carry holdall
£23.50, carr. £2

AE101. Telescope mast an-
tenna £3.75, carr. £1.25

Aerial rods 3' x 1" screwed
M&F ends 10. £2, post 50p,
25/£5 cp List 25p, refundable
with purchase

XTAL Calibrator No. 10
½ - 10 MHz Harmonics 30
MHz £3, post 50p

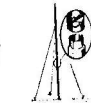
**Surplus Electronic Trading**

PO BOX NO. 19, HITCHIN, HERTS SGA 8TN

SPRING IS HERE!!

... time for mobile VHF

PYE VANGUARDS AM25B. Low band, 25 kHz, unit only, excellent condition, £8, post £1. 6 ch.

PYE VANGUARDS AM25B. High band, as above, £8, post £1. 6 ch. or single ch. in stock.

CONTROLS. Speaker, mic., all cables and control box for AM25B or AM25T, both 6 ch. and single ch., £10, post 50p, also Cambridge controls, same price.

PYE RANGERS. Low band, untested, but complete, £3 each, post £1. Ditto but may not be quite complete or need cleaning, £2 each, post £1.

PYE. 19" metal cabinet, £4.50, post £1.

AERIALS. Car mounting, New, ½ wave S/S 68-174 MHz complete with cable, £2.55, post 20p. 144-174 MHz ½ wave whips complete, £6.25, post 20p.

VALVES. QQVO3/10, 45p, post 10p; QQVO3/20, £1.90 each, post 15p. Smaller types ex-equipment, 20 for £1, post 20p, all from RTs.

FM 1 Sterne low band 33c mobiles £10 complete, post £1.25 kHz. Base Station, 33F type with 2 RCus and line equipment, £16, the lot post about £2. Newer Hybrid type Sterno, 1 only 25 kHz but convertible, £20, post £1.25. 6 ch. Ledex unit from AM25B, £2 each, post 25p.

CARRIERS for Vanguards and Ranger and Reporters, 50p each, post 25p, any number.

PYE UHF BASE STATION. Really nice job in rack cabinet. Transistor RX, with TT and line equipment, tested and good order, very cheap at £40 but you must collect. Weight about 1 cwt.

HUDSON AM108 low band mobiles, excellent condition, dash mounted PSU and Mod., complete with handset, £5.00 each, post £1.

WESTMINSTER 12½ kHz filters, £8 each.

XTALS in HCU, 12-879/12.885/12.881/9-447/9-448/9451/8968/8-971/7-997/11-155/37-275/37-287/52-025, all 40p each, post free.

SGB modern type telephone handset, good condition, blue, multi-way plug, £1.50 each, post 25p.

HUDSON Base Remote Control Units ... will operate most base stations, £3.00 each, post £1.

PYE Base Control Units, valve type, £3.00 each, post £1.

J. BEAM UHF Aerial, folded dipole with cable, used, £1.50, post 65p. Plenty of Odds and Ends in control boxes/mics/speakers, cables for Vanguards/Cambridges/25 kHz and 12½ kHz filters for same/spares for same/scrap sets of above for spares/remote control units for Pye bases. Let me know what you want. S.A.E. please.

W. H. WESTLAKE

WEST PARK, CLAWTON, HOLSORTHY, DEVON

0409-253758 if you phone.

SALE: Sommerkamp FL-1000, FL-200 and FR-100, with manuals, mint condition, £180.—Swinnerton, G6AS, QTHR. (Tel: 021-706 3709 after 6.0 p.m.).

WANTED: Trio JR-310 and 9R-59DS receivers, with handbooks; must be in excellent working condition. Details and price including carriage, please.—Arasu, School House, Brighton College, Brighton BN2 2AL.

WANTED: Circuit diagram for 19 Set Mk.III Rx, to buy or copy. Urgently required.—Plaice, 58 Lan Coed, Winch Wen, Swansea, Glam., S. Wales.

EXCHANGE OR SELL: Decca Legarto cassette recorder, mains/battery, auto record level, digital counter, brand new, accept £20 or would exchange. W-H-Y? **WANTED:** Jockey idler wheel, 2½-in. dia., suitable for 'Reps. R10' tape recorder.—Lindars, 52 Heathcote Drive, East Grinstead (23950), Sussex.

WANTED: 40-ft., 2-in. dia. mast with guys, also rotator. Details and price please.—Stewart, 8 Somerled Avenue, Paisley, Scotland.

SELLING: Eddystone EC-10 Mk.I receiver, mains and battery, immaculate condition, hardly used, £40 or very near offer. Will deliver.—Ring Penney, Kimpton (0438) 83202 (Herts.).

SALE: KW-107 Ae. tuning unit, £45; Asahi Echo-8G vertical with radials, 10-40m., with over 40 yds. co-ax, £22.50; 17 yards 12-core screened cable, £2.50; 45 yards 52-ohm UR-67 co-ax, £9.—Poulter, G3WHK, QTHR. (Tel: 01-337 0117).

FOR SALE: Unused Versatower (planning permission refused), 40-ft., £100; TH-6 beam, used but complete, £40. Buyers collect.—Whitehead, Church End, Weston Colville, Cambs. (Tel: 0223-829 524).

SALE: G.E.C. BRT.400E communication Rx, with SRCH.1067 handbook, virtually unused from new and in excellent condition, offers over £70. (Warks.).—Box No. 5205, Short Wave Magazine Ltd., 55 Victoria Street, London SW1H-0HF. (Or ring 0203-73840, evenings).

FOR SALE: Eddystone 888 Rx with S-meter, very good condition, £50; Telford TC-7, tunable IF 28-30 MHz, £32; "Microwave" double-conversion 2-metre converter, IF 4.6 MHz, £13; "G8AEV" 2-metre converter, IF 4.6 MHz, £5; Pye Cambridge AM-10D, two transmitting channels, and one fixed and tunable Rx, £28. **WANTED:** Roller-coaster coil, 3-in. dia. or more; Ham-M or TR-44 rotator; EC-8010 and EC-8020 valves.—Day, G8FSK, QTHR. (Tel: 08675 2215).

FOR SALE: Eddystone EC-10 Mk. II Rx, a beauty for £55. Cash only. **WANTED:** Codar Q-multiplier.—Ring Hall, 061-766 8937 (Manchester).

SELLING: Drake R4-B, less than one year old and as new, £200; Comdel speech processor, mint, £60.—Barry, G3UFU, 15 Fairlawn Court, London W4 5EE. (Tel: 01-994 6931).

OFFERING: HA-350 Rx with xtal calibrator and handbook; 8amp. Variac; Stepdown transformer, 10-amp., 240-115v.; U.S. Navy "calibmeter", CW60. ABM; Tuning unit Type Y180; 16 Morse keys, new, suitable for practice; UHF distribution amplifier; G.E.C. cassette recorder; Ajax battery/mains radio, MW/SW/Aircraft/Marine/VHF; 625/405-line 23-in. TV; Car radio, MW/LW/VHF, slight fault. Offers? Buyers collect. **WANTED:** Good general coverage receiver.—Earnshaw, 12 Clarke Brow, Middleton, Manchester.

SALE: Drake SPR-4 transistorised communications receiver, less than 20 hours' use, as new and in maker's packing (list price with accessories, £390), must be a bargain at £290.—Fletcher, 62 Moorbridge Lane, Stapleford, Nottingham. (Tel: Sandiacre 397446).

WANTED: Racal RA-17 or RA-117 Rx; Telequipment, or similar high-quality, oscilloscope; Eddystone 730 Rx; FM signal generator or wobulator to 30 MHz. Details and price please.—Lord, G3PHN, (Tel: 05304 4626, Ashby-de-la-Zouch).

FOR SALE: Sphinx SSB Tx, coverage 160/80/20m. and 40m. CW, perfect, £33. Buyer collects. (Nottingham)—Box No. 5206, Short Wave Magazine Ltd., 55 Victoria Street, London SW1H-0HF.

WANTED: R.1155 circuit diagram, will buy for £1 (or hire for 50p); R.1155 parts also required. (Lincs).—Box No. 5208, Short Wave Magazine Ltd., 55 Victoria Street, London SW1H-0HF.

WANTED: Manual for Lafayette KT-320 receiver, buy or borrow.—Hughes, 15 Princes Avenue, Liverpool 23 5RR.

OFFERING: Complete station: Collins TCS-12 receiver, coverage 1500-12000 kHz, 12v. 1A., with 12v. transformer; TCS-6 transmitter, Type T.1542A, with 6v. transformer, aerial loading coil and all ancillaries.—Ring Reid, 01-992 9164.

FOR SALE: Racal RA-117 professional communications receiver, coverage 0-5-30 MHz, with Wadley loop continuous tuning, 1 kHz readout, a superb receiver with a fine specification, lots of built-in features, usual Racal quality, £200.—Ring Jones, 01-764 3881 home, 01-920 8587 office hours.

FOR SALE: R.C.A. AR88 Rx, £38; S.27 Rx, coverage 28-145 MHz, £18; B.40 Rx, £16; RTTY terminal unit with tuning 'scope, Admiralty type. £12.—Ring Lord, G3PHN, 05304-4626 (Ashby-de-la-Zouch).

SALE: FT-75, FP-75, DC-75, FV-50B and G-Whip Multimobile with all coils, £145. Might split.—Ring Harrison, G3OPJ, Maidenhead 20399.

SELLING: Drake R4-B Rx, with extra xtals, £175; TR-44 rotator, unused, £30; Minibeam HQ-1, almost new, £30; K.W. E-Zee Match, £8; Tech TE-15 GDO, £8.—North, G3TRY, QTHR. (Tel: High Wycombe 881258).

SALE: Yaesu FR-400SDX Rx with all extras, brand new, in carton, £155; Collins 75S-1, with Q-multiplier and notch filter, £150; National HRO with 9 coil packs, coverage 50 kHz to 30 MHz, noise limiter, S-meter, miniature front-end, regulated metered power pack, £18-50; R.C.A. AR88D, with S-meter, speaker, very clean, £38.—Taylor, 5 Luther Road, Winton, Bournemouth (50400), Hants.

WANTED: Modern communications receiver, transmitter or transceiver; also want AR88. Will pay cash for the right equipment, and collect.—Taylor, 5 Luther Road, Winton, Bournemouth (50400), Hants.

SALE: Pye Cambridge series 12.5 kHz filters. Ministry approved, £7-50 plus your old 25 kHz blue filter.—Austen, 28 Valebridge Road, Burgess Hill (3409), Sussex.

HAVE YOU HEARD THE CALL OF THE EMU?

The EMU CALL. This new Emu unit will give your own Call sign in MCW from a small loudspeaker repeated once a minute at a speed of approx. 10 wpm. Placed at a suitable distance from the microphone it will give station identification in the background. This will ensure that you are not criticised for forgetting to give your call at the required intervals. Housed in an attractive two tone cabinet measuring 97 x 180 x 75 mm., it is self contained with its own PSU requiring only to be connected to the mains supply. The design employs 74 series TTL plus transistors. These units will be individually built and programmed with your Call sign. Delivery will be approx. 2/3 weeks. Full money back guarantee if not satisfied and returned undamaged in 10 days. Price: **£28.50.**

EMUPRESSOR. This well tried Unit speech processor that gives a 3dB change of output for a 40dB change of input is still available at **£7.80.**

EMUMARKER. This compact Xtal calibrator giving markers at 1 MHz, 100 kHz and 10 kHz, or in EMUMARKER 25 version a 25 kHz output instead of the 10 kHz. Either model now **£9.00.**

EMU FM UNIT. The Unit to convert your Rx for FM reception. Requiring only one connection to the main Rx, containing its own audio and output stages. Squelch and AFC output. Housed in a two tone box 2½" x 2½" x 6" **£13.50** or PC version at **£11.50.**

For fuller details see previous advertisements or write to :

I. N. CLINE

15 KNIGHT AVENUE, CANTERBURY
KENT, CT2 8PZ

Why go hunting for components when there's CATALOGUE 7

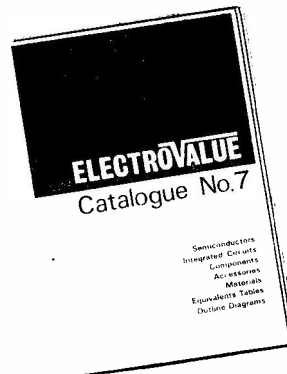

- 112 pages
- Transistors, I.C.s, Thyristors, etc.
- Rs and Cs of all kinds
- Pots

**GENUINE DISCOUNTS
COMPUTERISED HIGH-SPEED SERVICE**

25p
Post free including 25p refund voucher

Look it up in Catalogue 7 first. Packed with components, attractively priced, brand new and guaranteed to spec. You are more likely to get the things you want from ELECTROVALUE and there are excellent discounts, too.
Anything over £2 (except Baxandall speaker) send carriage paid—in U.K. And with Catalogue 7 you get a 25p Refund Voucher usable on orders for £5 or more list value. Catalogue 7 also includes useful diagrams and data.

ELECTROVALUE LTD.

(Dept. SWF) 28 St. Judes Road, Englefield Green, Egham, Surrey
TW20 0HB (Telephone: Egham 3603)
Northern Branch, (Personal callers only) 680 Burnage Lane, Manchester
(Telephone: 061-432 4945)

DERWENT RADIO

5 COLUMBUS RAVINE, SCARBOROUGH, Tel. SCA 65996
Showroom open Tuesday/Thursday/Friday/Saturday

KW 202 Rx and Spkr ...	£176-00	Transistors 2N3819 ...	38p
KW 204 transmitter ...	£187-00	2N3053 ...	26p
KW 107 match ...	£66-00	2N3055 ...	44p
KW EZ match ...	£22-00	RCA 3N140 & 141	80p
KW 103 swr and power...	£15-40	BC 107 108 109	12p
KW aerial switch ...	£5-50	Dosemeters ...	12p
KW Balun ...	£2-75	10PF variable capacitor	17p
KW Atlanta vfo ...	£39-00	25PF double bearing cap	30p
Yaesu FR50B ...	£71-50	30PF double bearing cap	30p
Yaesu FL50B ...	£82-00	50PF DIFF ...	19p
Unica UR1A ...	£27-50	100PF double bearing ...	33p
Skywood CX203 ...	£35-70	500pf two gang ...	66p
Lafayette HA800 ...	£62-00	90pf two gang ...	66p
Trio 9R59DS ...	£51-70	Liliput lamps, 6v. or 12v.	8p
Codar multiband kit ...	£12-65	Large Car Type crocs.	8p
TEIS GDO ...	£16-50	Mono stereo headphones	£2-65
Sentinel 2m. converter	£15-12	Decon printed cct. pen	75p
Sentinel 4m. converter	£15-12	300 ohm twin feeder yd.	8p
Sentinel 70cm. converter	£15-12	Telephone pick-up coil	38p
Sentinel 2m. pre-amp ...	£7-15	Veroboard assortment	60p
2 way intercom ...	£2-86	Veropins .1 or .15 ...	17p
2,000 ohm headst ...	99p	Egg insulators ...	6p
1-20v. D.C. p.s.u. IA stab.	£11-80	Panel "S" meter 2" ...	£1-80
2 1/2" speaker 8 ohm ...	38p	R substitution box ...	£1-80
3" speaker 8 ohm ...	48p	C Substitution box ...	£1-65
6 BA bolts pack ...	11p	Pre set caps 4.5 pf 3/20pf	5p
6 BA nuts pack ...	11p	10-40 10-120pf	3p
20 IC's with data ...	£1-10	Service head/mic. set ...	£1-40
G Whip tribander ...	£11-58	Panel mains neon ...	20p
Coils ...	£4-40	Meter test prods and leads	38p
G Whip 160/80m ...	£9-90	In line fuse holder ...	8p
G Whip flexiwhip ...	£9-46	20mm, fuse links 500ma	2p
Coils ...	£2-86	to 3A	44p
G Whip base mount ...	£1-59	36 chrome Whip aerial	88p
Wightraps standard ...	£3-00	56" chrome Whip aerial	13p
Wightraps high power ...	£4-10	Mini push switches ...	27p
Shure 201 ...	£6-50	Ali boxes 2 1/2" x 4" x 1"	27p
Dynamic 50K ohm P.T.T.	£3-95	2 1/2" x 4 1/2" x 1"	27p
"1" Beam Halo ...	11p	2 1/2" x 3 1/2" x 1"	30p
Boom mic (ceramic) ...	£4-95	2 1/2" x 2 1/2" x 1"	29p
4 digit impulse counter	12p	2 1/2" x 3" x 1"	27p
50 resistors ...	17p	7 1/2" x 4" x 1"	48p
50 1/2w. resistors ...	22p	3 1/2" x 4 1/2" x 2"	40p
50 capacitors ...	55p	3" x 5" x 1 1/2"	33p
50 disc ceramics ...	33p	Wander plugs black or red	4p
20 wire wound resistors	15p	Banana plugs black or red	5p
10 mixed potentiometers	50p	Phono plugs ...	7p
10 mixed wafer switches	80p	Phono sockets ...	12p
10 croc. clips ...	40p	Phono sockets four way	10p
Mixed sleeving pack ...	15p	Ferric chloride 1lb bag	35p
American flat 2pin plug	10p	10 .1mf 400v. capacitors	17p
Line socket for above ...	10p	10 mixed electrolytics ...	35p
14 and 16 way DIL sockets	17p	10 mixed silver micas ...	12p
Amphenol SO239 ...	33p	3 G60 cassettes (screw fix)	£1-00
Amphenol PL259 ...	40p	Morse practice oscillator	with key ... £1-50
SO239 single hold fixing	33p		
Reducer ...	8p		
Double sided copper clad	9p		

Second-hand equipment :

Sentinel 2m. converter	£12-00
Trio 9R59DS ...	£42-00
Pye hiband ranger ...	£8-00
Eddystone EC 10 ...	£40-00
Eddystone 750 ...	£60-00
Trio 9R59DE ...	£38-00
R.F. test oscillator ...	£11-00
KW 2000A D.C. p.s.u. ...	£25-00
TW 160m rx ...	£4-00
Labgear 160m tx & p.s.u.	£22-00
Codar AT5 tx rough ...	£40-00
Heath RF sig gen ...	£14-00
Heath GDO & UHF coils	£12-00
Ex WD morse key ...	53p

WANTED. 35 Codar CR70A Receivers for Education Authority.

Swan 350 D.C. p.s.u. ...	£30-00
Ten Tec PM23 Xceiver	£30-00
Heath 5" lab scope ...	£35-00
National NC 33 ...	£18-00
Eddystone 680x ...	£65-00
Codar AT 5 tx ...	£19-00
Codar T28 rx ...	£14-00
Codar 12v. p.s.u. ...	£10-00
Eddystone EC10 II ...	£60-00
Yaesu FR50b ...	£58-00
Yaesu FL50 ...	£65-00

QSL POCKETS for 120 cards 40p incl. VAT/Post.
We are looking for good condition modern transmitters and receivers etc. and will pay cash or give good trade in prices. Please let us have details with s.a.e. for offer. **DES WOOD, G3HKO**
PLEASE ADD EXTRA FOR CARRIAGE. S.A.E. FOR LISTS MAIL ORDER TO

(Telephone 63982)
28 HILLCREST AVENUE, SCARBOROUGH, YO12 6RQ

DON'T BUY A DIGITAL CLOCK

UNTIL YOU HAVE SEEN OUR LEAFLET AND SPECIAL DISCOUNT PRICE LIST FOR RADIO AMATEURS and S.W. LISTENERS. (s.a.e. please). WE ARE YOUR SPECIALISTS, HAVE THE MOST COMPREHENSIVE AND LARGEST STOCKS, CHECK EVERY INDIVIDUAL CLOCK, AND ALWAYS DESPATCH BY RETURN.

Aero & General Supplies

NANAIMO HOUSE, 2 RINGWOOD AVENUE,
LEEDS LS14 1AJ.
TEL. 658568

SALE: 26 SWG hard-drawn PVC-covered copper wire, 0.038in. o.d., 100yd. reels, £1-15 including postage. s.a.e. for sample.—Garlick, G3LCR, QTHR.

SELLING: Heathkit SW-717, bought assembled, two years old, price £25.—Ring Wood, 0442 51905, (Herts.).

SALE: Trio 9R-59DE general-coverage receiver, with speaker and headphones, in good condition throughout, £30. (Staffs.)—Box No. 5211, Short Wave Magazine Ltd., 55 Victoria Street, London SW1H-0HF.

MAY Issue: To appear early May, all being well—single copies at 32p will be despatched first-class mail on receipt from printers. Orders with remittance to: Circulation Dept., Short Wave Magazine Ltd., 55 Victoria Street, London SW1H-0HF.

SALE: Pye Cambridge AM.10D, six channel, aligned for two metres, transmit/receive crystals for 144.6 and 145.0 MHz and seven extra "receive" crystals, complete with microphone, manual and five-element beam, £30. Also 200 MHz Scaler, short version (see "Radcom", Jan. '73, p.34), complete in case, £14. Carriage extra, or delivery by arrangement.—Michaelson, G3RDG, QTHR, or ring 01-455 8831.

WANTED: I am looking for an RTTY converter Type BC.908B. Can you help, please?—Hamel, 11 Avenue de Picardie, 8000, Amiens, France.

FOR SALE: FR-50B, as new, coverage 10-15-20-40-80m., with calibrator, built-in two-metre converter, plugs and handbook, £57. AR88D receiver, in mint condition, with spare valves, phones and manual perfect I33. Two-metre Tx, with built-in SSM MF converter, can be used separately, £16-10. Brand new 805's, £4 each. 813 with base, £2-10. Carriage extra.—Davies, GW8EHR, 6 Church Road, Burryport, Carmarthenshire.

EXCHANGE: G.E.C. RC-410R for Collins R.389 or R.390A.—Passfield, 30 Greenleaf Close, Tulsa Hill, London S.W.2. (Tel: 01-674 5825).

FOR SALE: Property of late G2BYI: NCX-500 with NCX AC/PSU, ATU and Shure mic., £165; Hammarlund HQ-145X amateur band receiver, coverage 540 kHz-30 MHz, with bandspread and Hammarlund speaker, £65; AR88D with spares, £45; HRO, £20; CR-100 (B.28) £18. Multi-Elmac Rx, BC/160-10m., £25; Multi-Elmac Tx complete with mic., £25. All items with manuals. All "or near offer" plus carriage.—Byrne, G3KPO, QTHR. (Tel: 077584-485).

WANTED: War surplus 52 and 53 Tx/Rx Sets, and 62, 68 & 22 Sets, in any condition; two BF5 valve bases; 500 and 1000 pF Tx variable capacitors, must be very high-voltage type or even in vacuum; HT transformers, up to 4 kV at 500mA., and 7 kV at 1A; LT transformers 5v at 14A., and 5v at 75A. Smoothing capacitors, 16 or 32 mF at up to 10 kV.; low voltages considered, also any 813's plus bases and anode caps to suit. That's it until next month, all letters answered.—Jenkins, 30 Gainsborough Road, North Finchley, London, N12 8AG.

FOR SALE: Hammarlund SP-600JX receiver, with Hamgear ATU, crystal calibrator, preselector unit and handbook, all in good condition, price £80 or any reasonable offer? Buyer to collect.—Street, Greggs House, Collington, Bromyard (3319), Herefordshire.

SELLING: FR-SDX400 receiver, coverage 160-10m. plus 4m. and 2m., all modes, with matching speaker, mint condition, £150 or near offer. —Powell, G8BPK, QTHR. (Tel: Aylesbury 630600).

WANTED: Any information on Redifon G.12 receiver, particularly circuits of receiver and its external power supply.—Hooker, G8HK, 49 Melfort Road, Thornton Heath, Surrey CR4 7RS.

FOR SALE: Drake R4-B Rx, £160; FR-DX400 Rx, 1972 model with all options, £140. Buyers collect. (London).—Box No. 5209, Short Wave Magazine Ltd., 55 Victoria Street, London, SW1H-0HF.

SALE: Trio 9R-59DS Rx with voltage stabiliser, good condition, £40. Minimitter Tx, 150w., AM/CW, coverage 3.5 MHz to 28 MHz, £12. Buyer collects.—Smith, G4AJM, 20 Munhaven Close, Mundesley, Norwich, Norfolk.

SALE: FR-50B receiver, in case, with xtal calibrator, plugs, handbook and built-in switched Lowe-Weir 2m. converter, brand new, £70. No cheques please.—Davies, GW8EHR, Crossways Diner, 6 Church Road, Burry Port, Carmarthen.

SALE: Trio 9R-59DS Rx with calibrator and speaker, and Hy-Gain 18VT/WB 10-80m. aerial, £80 the lot.—Mills, York House, 13 Woods Lane, Dobcross, Nr. Oldham, Lancs.

SELLING: Yaesu FR-50B Rx, fitted with 160m., new, used, a few hours only, £63; Hamgear PM.IIA preselector, mains, new, £6-50. (Nottingham). —Box No. 5210, Short Wave Magazine Ltd., 55 Victoria Street, London, SW1H-0HF.

FOR SALE: Sommerkamp FL-200B transmitter, 240 watts p.e.p., coverage 10 to 80m., with Vox, £70. FR-100B receiver, AM/CW/SSB, 10 to 80m., with WWV and 100 kHz crystal calibrator, £65. Also Shure microphone, £3-50. All in superb condition. Complete station £130.—Ward, G4AOQ, 2 Lincoln Road, Oxford, OX1 4TB.

GI3ZIA GI AMATEUR SUPPLIES EI6CD

Proprietor—J. F. MacMahon

Stockist for **KW, TRIO, YAESU, EDDYSTONE**

Please add 10% VAT to all prices.

KW	YAESU	TRIO
2000E—£275	FT101—£280	JR301—£75
2000B—£240	FT401—£310	JR599—£160
202RX—£160	FT501—£428	9R-59DS—£49-50
204TX—£170	FL2000B—£195	Sentinel Converters
107—£60	FR50B—£67	CDR Rotators
101—£9-20	FL50B—£79	USED
103—£14-00		TSS10 + PS—£155
1000 LIN—£150		Collins KWMI—£125

Books—good selection of ARRL and RSGB—no VAT.

* Full range of accessories always in stock. Carriage extra.

10 CHURCH ST., ENNISKILLEN, N. IRELAND. Tel: 2955

ESSENTIAL BOOKS

HANDBOOK OF INTEGRATED CIRCUITS (ICs). EQUIVALENTS AND SUBSTITUTES. This book includes all available types of ICs made throughout the world at the present time which have some possible equivalent, substitute or alternative. Published Jan. 1974. 75p, post free.

HOW TO MAKE WALKIE-TALKIES FOR LICENSED OPERATION. Only 40p, p.p. 10p.

MOBILE RADIOTELEPHONE EQUIPMENT HANDBOOK. Gives circuits data and illustrations plus some valuable modifications for amateur use for commercial radio telephone equipment including PYF and other popular makes. Price £4 including postage.

HOW TO MAKE 2 AND 4 METRE CONVERTERS FOR AMATEUR USE. 60p, p.p. 15p.

THE GOVERNMENT SURPLUS WIRELESS EQUIPMENT HANDBOOK. Gives circuits, data and illustrations plus valuable information for British/U.S.A. receivers, transmitters, trans/receivers. With modifications to sets and test equipment. Latest impression, £3-25 including postage.

DIRECTORY OF GOVERNMENT SURPLUS WIRELESS EQUIPMENT DEALERS. Gives details of surplus wireless equipment stores and dealers including addresses plus equipment and spares that they are likely to have available. A valuable book, only 40p, p.p. 10p.

SECOND BOOK OF TRANSISTOR EQUIVALENTS AND SUBSTITUTES. Just published. Over 58,000 entries. Includes British, U.S.A. and Japanese transistors. Price 95p, post free.

COSMIC RADIO WAVES. Start a new hobby—RADIO ASTRONOMY. This big book of 444 pages is an ideal handbook both for the beginner and the established enthusiast. Numerous photographs and illustrations. Published by Oxford University Press. Price £2-50, p.p. 30p.

THE THEORY OF GUIDED ELECTROMAGNETIC WAVES The most comprehensive book yet written about: waveguides, transmission lines, cavity resonators. Over 500 pages. Ideal for anyone interested in Radar and UHF. Published at £11-50. Knock down price £4-50, post free.

THE SCATTERING AND DIFFRACTION OF WAVES. A goldmine of information for the experimenter, amateur and scientist. Profusely illustrated. Published by Oxford University Press at £1-60. Knock down price 80p, p.p. 20p.

MODERN ASTRONOMY. By a world famous astronomer. Start a new hobby. This informative book is an ideal handbook for the beginner and established enthusiast. Covers many developments in astronomy. Detailed illustrations. Published at £2-60. Knock down price, £1-25, p.p. 25p.

GETTING THE BEST FROM YOUR COLOUR T.V. Advice for colour TV owners and those about to acquire a set. Just published, 50p, p.p. 10p.

A COMPREHENSIVE WORKING HANDBOOK OF SATELLITES AND SPACE VEHICLES. A handbook that provides important data both tabular and graphical enabling space scientists, technicians and telecommunication engineers to acquire a greater working knowledge of satellite and space vehicle design, launching, orbiting, etc. Includes a detailed coverage of COMMUNICATIONS IN SPACE. An imposing book of 457 pages. Published at £8-20, but last dozen copies available at the trade price of £6-50, post free.

BEAT THE FUEL CRISIS. (Driving and Preparing your car for Maximum fuel Economy). 30p, p.p. 10p.

HANDBOOK OF RADIO, TV AND INDUSTRIAL TUBE AND VALVE EQUIVALENTS. Includes many thousands of British, U.S.A. European, Japanese and CV types of radio, TV and industrial valves and tubes, 40p, p.p. 10p.

COIL DESIGN AND CONSTRUCTION MANUAL. How to make your own RF and AF coils, chokes and transformers, 30p, p.p. 5p.

CONSTRUCTORS MANUAL OF ELECTRONIC CIRCUITS FOR THE HOME. Full data and instructions, 50p, post 10p.

HI-FI. P.A. GUITAR AND DISCOTHEQUE AMPLIFIER DESIGN HANDBOOK. Includes circuits up to 1100 watts output, tremolo, vibrato and fuzz box, etc., 75p, p.p. 10p.

ELECTRONIC NOVELTIES FOR THE MOTORIST, 50p, p.p. 10p.

HOW TO RECEIVE FOREIGN T.V. PROGRAMMES ON YOUR TV SET BY SIMPLE MODIFICATIONS, 40p including postage.

THE WORLDS SHORT WAVE, MEDIUM AND LONG WAVE RADIO STATIONS AND FM AND TV LISTING, 35p, post free.

PERSONAL CALLERS WELCOME AT OUR NEW SHOW-ROOM AND TRADE COUNTER at 138, Cardigan Road, Headingley, Leeds 6. The North's largest selection of Radio and Electronics books plus thousands of books on ALL SUBJECTS at discount prices.

GERALD MYERS

(SW)

Publisher & Bookseller

All mail orders to our new address at:

**138 CARDIGAN ROAD, HEADINGLEY,
LEEDS 6, YORKSHIRE, ENGLAND**

Tel. 787031

CALL BOOKS

INTERNATIONAL :

RADIO AMATEUR CALL BOOKS (1974)	
"DX Listings"	£3.82
"U.S. Listings"	£4.25
"G's" only 1974 Edn.	75p

MAPS

DX ZONE MAP (GREAT CIRCLE) In colour with Country/Prefix Supplement Revised to September 1973	£1.20
AMATEUR RADIO MAP OF WORLD Mercator Projection — Much DX Information — in colour. Second Edition	66p
RADIO AMATEUR MAP OF THE U.S.A. AND NORTH AMERICA State boundaries and prefixes, size 24" by 30", paper	62p
RADIO AMATEUR'S WORLD ATLAS In booklet form. Mercator projec- tion, for desk use. Gives Zones and Prefixes (New Edition).	£1.11

LOG BOOKS

Standard Log (New Glossy Cover)	62p
Receiving Station Log	46p
Minilog	26p

(The above prices include postage and packing).

MORSE COURSES

G3HSC Rhythm Method of Morse Tuition

*Complete Course with three 3 speed L.P. records with books including U.K. P.P.I. etc.	£4.95
*Beginner's Course with two 3 speed L.P. records with books including U.K. P.P.I. etc.	£3.63
*Single 12" L.P. Beginner's with book . including U.K. P.P.I. etc.	£3.02
*Single 12" L.P. Advanced with book . including U.K. P.P.I. etc.	£3.02
Three speed simulated GPO test. 7" d.s. E.P. record. including U.K. P.P.I. etc.	93p

Prices include postage, packing and insurance
in U.K. only *Overseas orders + £1.00.

Available from

SHORT WAVE MAGAZINE

Publications Dept., 55 Victoria Street,
London, SW1H 0HF 01-222 5341

(Counter Service, 9.30-5.15, Mon. to Fri.)

(Nearest Station: St. James's Park)

(GIRO A/C No. 547 6151)

ENGINEERS

BBC RECEIVING STATION

Caversham Park, Nr. Reading, Berks.

There are immediate vacancies for engineers to undertake the operation and maintenance of radio receiving terminal equipment. The duties include the reception of foreign broadcasts for monitoring and relay purposes, the technical monitoring of the BBC's own transmitters, frequency and field strength measurements and the investigation of interference and other reception problems.

Applicants, who must have normal colour vision and hearing, should be able to demonstrate an active interest in radio reception techniques, receiving aerials and propagation. The minimum qualification required is a City and Guilds Full Technological Certificate (Telecommunication) or an appropriate HNC.

There are opportunities for promotion and good club and canteen facilities are available. Starting salary is in the range £1815 to £2130 depending on experience, rising to a maximum of £2445. The majority of the staff are required to undertake shift duties for which a basic allowance of 8% on salary is paid. In addition there are generous actuality payments for night and week-end working.

Requests for application forms to

**The Engineering Recruitment Officer,
BBC, Broadcasting House, London**

W1A 1AA, quoting reference 74.E.4019/SW
and enclosing addressed foolscap
envelope. Closing date for completed
application forms, 30th April 1974.

BBC

MORE BOOKS DESCRIBED

RADIO AND ELECTRONIC HANDBOOK

by G. R. Wilding

Technicians and service engineers in the Radio and Electronics industry require a considerable amount of data which is spread over many books. It is often difficult and time consuming to locate in a hurry. Students, however, who may have to study a whole series of course-books will find a condensation of such information, which gets down to the essentials, extremely useful. *Radio & Electronic Handbook* has been designed to provide, on the one hand, a reference book and, on the other, a revision guide.

The intention has been to summarise basic electronics into four separate, easily assimilated sections, which will provide rapid reference to important principles, formulae and applications. These four main sections are: Direct current theory; Alternating current theory; Valve theory and applications; and Transistor theory and applications. Practical worked examples and circuits diagrams have also been utilised whenever necessary.

The concise presentation, which covers all the relevant ground, makes for easy learning and the book should prove invaluable for both practical and examination requirements. £1.33
149 pages including 84 diagrams.

QUESTIONS AND ANSWERS ON RADIO AND TV

3rd Edition

PREFACE

Curiosity is the keystone of learning. The man who "wants to know" has a far better chance of digesting and retaining information than he who ploughs through a set subject simply because it has been put before him.

Hence the "Question and Answer" form of this little book. Wherever possible, the questions have been arranged to follow the growth pattern of information. Questions arise from the previous answers. This means that the book differs from a standard textbook in that subjects are not cajoled neatly into place; except that main chapter headings give a guide to the line of questioning, the reader can treat these pages as bedside or benchside reading. Mathematics and unwieldy formulae have been avoided. Circuits and other diagrams give the basic information and confusing frills are omitted.

There are many textbooks to which the reader who wishes to augment the information given here can resort. These chapters will whet his curiosity 85p

HAVING FUN WITH TRANSISTORS

by Len Buckwalter

It covers 13 exciting transistorised projects, and while creating, one can learn, and while learning one can find enjoyment for himself, his family and friends as he builds such unusual items as BORIS, the talking skull, or a unit that enables you to see while blindfolded. All is described in a simplified form so that even a youngster can understand it. £1.61

100 INTEGRATED CIRCUITS PROJECTS FOR THE HOME CONSTRUCTOR

Integrated circuits are the most important new semiconductor devices to have been developed within the past decade. They are compact, easy to use and less expensive than their discreet transistor-resistor equivalents. This volume gives an entirely practical introduction to these devices by describing one hundred and ten constructional projects in which they can be used.

The projects range from simple low-level amplifiers to complex test equipment and include a number of hi-fi circuits and logic circuits. The integrated circuits used are internationally available types and all the projects have been designed, built and fully evaluated. The book should prove to be of practical interest to the professional engineer, the student and the amateur. £1.31

INTEGRATED CIRCUIT POCKET BOOK

by R. G. Hibberd

This book is a logical companion to the Authors' previous book—The Transistor Pocket Book, and is intended primarily for technicians and students whose courses include semi-conductors devices, but it will also be of interest to all those who are concerned with integrated circuits and their applications. £2.65

DICTIONARY OF TELECOMMUNICATIONS

R. A. Bones, B.Sc., Ph.D., ACIS, CEng., MIEE, AInstP.

Economic growth throughout the world is closely linked with the development and growth of telecommunication systems. Modern industry demands ever-improving facilities for its executives to be able to speak to each other from opposite sides of the globe; to be able to transmit drawings, documents and pictures rapidly over large distances; and now to be able to send data accurately and quickly from computer to computer.

Telecommunications is an industry with a high growth rate and, like all technologically based industries, a new language has developed: a language which grows daily as new materials, techniques and systems are developing. This dictionary is an attempt to document that language.

The wide range of definitions, including many reproduced from, or based on, British Standards recommendations, is supplemented by appendices including units and abbreviations, wavelengths and frequency bands, and signal reporting codes.

The concise explanations of the terms in use should prove valuable to engineers, students, technicians, and to all whose work or interest requires them to understand modern telecommunication terminology. £2.37

MICROPHONES

by A. E. Robertson

A general treatment, in twelve chapters with appendices. £1.67

WIRE ANTENNAS FOR RADIO AMATEURS

by W. I. Orr

What this Handbook contains:—How to build tested wire antennae (for two metres to 160m.—Top Band) that really get out—horizontals, verticals, beams, trap antennae, ground planes, etc.

"Invisible" aerials for amateurs in flats and other locations where radio and TV antennae are "prohibited."

Exact dimensions in feet and inches—also in metres and centimetres—for every antenna described—no guesswork!

How to build two "all-purpose" aerial tuners with 100 uses!

The truth about baluns. How to build an efficient, inexpensive balun for optimum antenna performance and accurate SWR readings

The construction of 2, 3, 4 and 5-band trap dipoles. How to make your own efficient traps and save real money.

Three-band dipole for 80, 40 and 15 metres—only one feedline! Ground plane aerials for VHF and 10, 15, 20 and 40 metres.

High-gain beam antennae especially suited for VHF FM. The efficient "folded Marconi" antenna for 40, 80 or 160 metres.

Clear explanations of resonance, radiation resistance, impedance, standing wave ratio (SWR), balanced and unbalanced aerials.

Plus—radial wire ground systems; lightning protection; wood masts; counterweights; the easy way to use coax connectors—and much more!

This book is an American publication by a well-known author in the field of Amateur Radio. £1.75

American & English Books.

The above prices includes postage and packing.

Available from

Publication Dept., 55 Victoria St., London SW1H 0HF

SHORT WAVE MAGAZINE

01-222 5341

(Counter Service. 9.30-5.15. Mon. to Fri.)

(Nearest Station: St. James's Park)

(GIRO A/C. No. 547 6151)

BAMBER ELECTRONICS

20 WELLINGTON STREET, LITTLEPORT, CAMBS. Tel.: Ely 860185 (Tue. - Sat.)

Pye Cambridge AM10B. We have a few sets, less PCBs, but TX section complete except for valves, sets only, no control gear, with circuits, High or Low Band, £5.75, carriage 50p.

Pye Cambridge AM10B. Sets only, no control gear, complete, with circuits, High Band, £15.00, Low Band, £13.00, carriage 50p.

Scope and Slow Scan Builders: BY185 Silicon rectifier sticks, 35 kV at 2.5 mA, £1.00 each.

Bumper Bags of Capacitors, mostly electrolytics, but a few ceramic, s/m, etc., £1.00 per bag.

Mains Transformers. 12V at 9A, plus 6V at 9A, plus 3V at 9A, few only, £3.50, carriage 50p.

Sloping Equip. Cases, 9in. x 15in. x 7in. HIGH, 8in. sloping front, brand new, boxed, £1.50, carriage 50p.

WANTED: ANY MANUALS OF RADIOTELEPHONE EQUIP., TEST GEAR, Rxs, Txs, etc., GOOD PRICES PAID, SEND LIST OR PHONE FOR OFFER.

Diecast Boxes (New, ITT)

3½ x 4½ x 1½	65p	3½ x 4½ x 2½	80p
3½ x 4½ x 3½	£1.10	6½ x 4½ x 2½	£1.20
10½ x 6½ x 2½	£1.85	8½ x 5½ x 4½	£2.25

2M Receive Xtals, HC6U, suitable for Cambridge, Vanguard, Westminster, etc., 51.7 MHz for 144.4, 51.70833 MHz for 144.425, 51.7166 MHz for 144.45, £1.00 each.

SPECIAL 50p PACKS

TOS Heatsinks, star type, 10 for 50p.

Pye Mike Inserts, brand new, 50p.

Valveholders, assorted, 10 for 50p.

Terryclips, mixed bag, 50p.

Tuning Caps, preset airspaced, 100pF, 4 for 50p.

5 Pin Din Plugs, 270 deg., 5 for 50p.

5 Pin Din Sockets, 270 deg., 5 for 50p.

Belling Lee TV Plugs, 6 for 50p.

Standard Jack Plugs, 4 for 50p.

Mullard Tubular Trimmers, 1 18pF, 6 for 50p.

Silver-plated PA Coils, mixed bag, 50p.

AC128 Transistors, 6 for 50p.

Rubber Grommets, mixed bag, 50p.

Electrolytics, mixed bag, 50p.

Silicon Rubber Sleeving, 1 mm. bore, 50 yds. for 50p.

Flexiform Grommet for odd shaped holes, 10 yds. for 50p.

Reed Relays, 12v. 400 ohm, 2 pole make, 2 for 50p.

Relays, 12v. 4 pole C/O, 3A 115v. contacts, 2 for 50p.

Bulbs, 6.3v. 3A., capless, 20 for 50p.

Cambridge Xtal Plates, containing 2 x HC6U xtal sockets and one 1 10pF tubular trimmer (no coils), 3 for 50p.

Miniature 4-core Screened Cable, 10m. for 50p.

Chrome Equip. Handles, new, 2½in. centres, 2 pair for 50p.

Valves, miniature CV types, 20 for 50p (our selection).

Bandpass Filters, 25-32.5 MHz RT type, 50p.

Pye Vanguard AM25B, sets only, no control gear. High or Low band, 25 kHz channel spacing, with 2nd conv. xtal and circuits, £8, carriage 75p.

Vanguard AM25B. We have a few sets, incomplete, suitable for spares or rebuild, with circuits. HIGH BAND, £4.75 + 75p carriage. LOW BAND, £3.75 + 75p carriage.

Vanguard AM25B Circuits of Tx, Rx, Inverter, Control gear, etc., 65p post paid.

Cambridge AM10D Circuits of Tx, Rx, Inverter, etc., 55p post paid.

CIRCUITS OF MOST PYE EQUIPMENT AVAILABLE—SAE WITH ENQUIRY.

VALVES

QQVO3/20A (ex equipment), £2.20.

DET22 (ex equipment), £1.00.

2C39A (ex equipment), £1.10.

4CX250B (ex equipment), £2.20.

YL1080 (quick heat QQVO3/10) (ex equipment), £1.00.

6BH6 (ex equipment), 2 for 50p.

5B255M (min. 807) (ex equipment, tested), £1.00.

6080 (new, Mullard), 55p.

12E1 (ex equipment, tested), 50p.

Please enclose SAE for all enquiries

TERMS OF BUSINESS: cash with order.

Callers welcome by appointment.

Please note that all prices include VAT.

POSTAGE AND PACKING CHARGE

20p ON ALL ORDERS, unless stated.

Subscription rate to Short Wave Magazine is £3.20 (First Class) £2.75 (Second Class) for twelve issues.

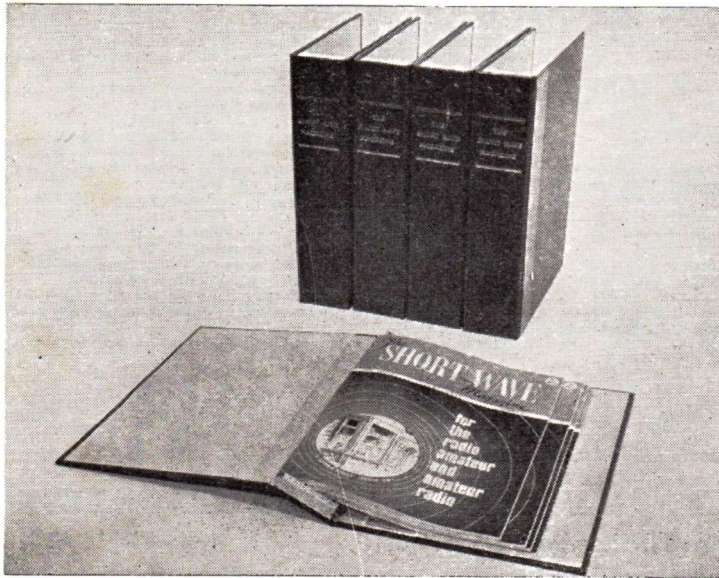

CREATE YOUR OWN REFERENCE LIBRARY

The "EASIBINDER" is designed to bind 12 copies of the Magazine as you receive them month by month, eventually providing a handsomely bound volume for the bookshelf.

No need to wait until twelve copies are assembled. As each copy is received, it is quickly and simply inserted into the binder. Whether partially or completely filled, the binder is equally effective, giving the appearance of a book, with each page opening flat.

Strongly made with stiff covers and attractively bound in maroon Leathercloth and Milskin, the binders have only the title gold blocked on the spine.

Price £1.15 post free.

(Available end of February 1974)

PUBLICATIONS DEPARTMENT
SHORT WAVE MAGAZINE
55 VICTORIA STREET
LONDON, SW1H 0HF

Printed by The Courier Printing Co. Ltd., Tunbridge Wells for the Proprietors and Publishers, The Short Wave Magazine Ltd., 55 Victoria Street, London, S.W.1. The Short Wave Magazine is obtainable abroad through the following: Continental Publishers & Distributors Ltd., William Dawson & Son Ltd.; AUSTRALIA AND NEW ZEALAND — Gordon & Gotch, Ltd.; AMERICA—International News Company, 131 Varick Street, NEW YORK. Registered for transmission to Canada by Magazine Post. April, 1974.