

*The*  
**SHORT WAVE**  
*Magazine*

25p

VOL. XXX

JULY, 1972

NUMBER 5



**WORLD WIDE COMMUNICATION**



## OUR AESU MUSEN MAIN DISTRIBUTOR

When you buy YAESU from their U.K. main distributor you get the best engineering standards in the world and superb performance too. All items carry the YAESU 12 months guarantee. We also do free labour on warranty claims, and carry an excellent stock of spares. Remember, we were FIRST to offer YAESU on the UK market and FIRST to give you SECURICOR 24-hour delivery; a standard of service which cannot be surpassed.

# WESTERN

### SHE'S A LITTLE BEAUTY! The FT-75 that is! A 10-80m. SSB TRANSCEIVER for ONLY £80 (carriage paid)



This latest addition to the ever expanding YAESU range is a real winner! Having tested it we can say the receiver side is very good and output power was not less than 15w. R.M.S. on any band. Operation could not be easier! You simply select the band, press the channel button and talk!

#### SPECIFICATION :

- Receiver :** Sensitivity : 0.5 $\mu$ V for 10 dB. S/S+N.  
Selectivity : 2.3 kHz (-6 dB), 4.5 kHz (-60 dB).  
Audio o/p : 1.8w.
- Transmitter :** Modes : SSB or CW. Power : 20w. p.e.p.  
Carrier suppression : better than -40 dB. at 1,000 Hz.  
Unwanted sideband : better than -40 dB.  
Response :  $\pm$ 3 dB., 40-2,700 Hz.
- General :** VXO swing : 3.5 MHz, 3 kHz ; 7 MHz, 6 kHz ; 14 MHz, 3 kHz ; 21 MHz, 20 kHz ; 28 MHz, 12 kHz.  
Size : 210w. x 80h. x 300d. m.m. Weight : 3.8 kg.  
Current drain : AC DC  
Standby 50w 1.4 amp.  
Heaters on 50w 3.5 amp.  
Transmit 80w 5.5 amp.  
Microphone included and 4 crystals (1 on 80, 40, 15 and 10m.)

**FT-75 (£20)** You are welcome to test the FT-75 at Totton

### FT560 (£195) Ex-Stock

**NOW BEAT THIS FOR VALUE!** 35p per watt! Even cheap kits cost 88p per watt! The FT560 operates SSB/CW on 10m-30m. at 560W p.e.p. i/p and has the following features: Built-in AC supply, VOX, 25/100 kHz crystal calibrators, WVVV to check the calibrator 1 kHz read-out on all bands and receiver incremental tuning. A CW filter can be fitted as an extra.

#### SPECIFICATIONS

Maximum Input Power : 560W PEP SSB, 500W CW.  
Sensitivity : 0.5 Microvolt for 20 dB S/N (SSB 14 MC).  
Selectivity : 2.3 kHz (6 dB down) 3.7 kHz (60 dB down) six pole crystal filter nominal shape factor 1.6 : 1. Optional 600 Hz CW filter is available.  
Frequency Range : 3.5 to 4, 7 to 7.5, 10 to 10.5 WVVV, 14 to 14.5, 21 to 21.5, 28 to 30 (Megahertz).  
Unwanted Side Band Suppression : 55 dB down (at 1000 Hz).  
Carrier Suppression : 50 dB down from full output.  
Distortion Products : More than 25 dB down.  
I.F. and Image Ratio : More than 50 dB down.  
Frequency Stability : Less than 100 Hz drift in any 30 minute period after warm-up.  
Audio Output : 1.5 watts, 350-2200 Hz, 8/600 Ohm impedance.  
Power Source : 117 or 234 volts A.C. 50/60 Hz.  
Dimensions : 15 $\frac{1}{2}$ " wide, 6 $\frac{1}{2}$ " high, 13 $\frac{1}{2}$ " deep.

### YAESU PRICES. CARRIAGE PAID BY SECURICOR. MANUFACTURERS 1 YEAR GUARANTEE.

FT101 fitted 160m. ...	£255.00	FM Unit for FR400 ...	£7.50	FV401 Remote VFO ...	£38.00	FP2AC/B AC supply with batteries ...	£34.00
FT101 transceiver ...	£240.00	FC2/4 or 6, 2, 4 or 6m. converter ...	£12.00	SP401 Speaker ...	£10.00	Crystals for FT2F ...	£1.60
FV101 Remote VFO ...	£38.00	CW filter FR400 ...	£12.50	FL2500 Linear amplifier ...	£118.00	YC-305 Frequency Counter ...	£79.50
FL2100 Linear Amplifier ...	£135.00	AM filter FR400 ...	£7.50	FT-75 AC PSU Speaker ...	£20.00	YC-305D 220 MHz Counter ...	£105.00
SP101 Speaker for FT101 ...	£10.00	SP400 speaker ...	£10.00	DC-75 DC PSU/mount ...	£20.00	FP50DX Low pass filter ...	£8.60
Fan FT101 ...	£8.00	FL400 Transmitter ...	£140.00	FR-50 Receiver ...	£52.00	Mobile mount FT101 ...	£5.00
FT200 Transceiver ...	£134.00	FL2000B Linear amplifier ...	£135.00	FL-50 Transmitter ...	£61.00	CW filter FT101, FT401, FT560 ...	£15.00
FP200 AC supply for FT200 ...	£38.00	FT560 Transceiver ...	£195.00	FV-50 VFO for FT-75, FL-50 ...	£26.00	YDB46 Hand microphone ...	£5.00
DC200 PSU for FT200 ...	£45.00	FV400S remote VFO ...	£38.00	FT2F 2m transceiver ...	£84.00	YDB44 table microphone ...	£12.00
FV200 Remote VFO for FT200 ...	£38.00	FT401 Transceiver ...	£215.00	FP2AC AC PSU for FT2F ...	£25.00		
FR400DX receiver ...	£120.00						
FR400SDX Receiver, 160-2m. ...	£160.00						

### USED EQUIPMENT (3 months guarantee)

KW Atlanta, new ...	£210.00	Heathkit SB101 plus c.w.f. ...	£160.00	Heathkit GR78, as new ...	£60.00	Swan 270, excellent ...	£170.00
KW Atlanta, mint ...	£160.00	Heathkit SB600, mint ...	£8.00	Heathkit HM-102, as new ...	£14.00	Swan 508, mint ...	£45.00
KW 2000A, v. good ...	£160.00	Heathkit SB300, v. good ...	£90.00	Yaesu FT400, superb ...	£160.00	Drake 2B + 2BQ, good ...	£70.00
KW 201, excellent ...	£75.00	Heathkit SB301, v. good ...	£99.00	Hammarlund HQ170A, v. good ...	£73.00	Digital 500, mint ...	£225.00
KW 202, mint ...	£110.00	Heathkit HP13A ...	£25.00	Hammarlund HX-50 ...	£90.00	Skywood CX203, new ...	£28.50
KW 600, excellent ...	£75.00	Heathkit HDP21A ...	£10.00	Hammarlund SP600X, v. good ...	£75.00		

**N  
E  
W**

**Y A E S U** FREQUENCY COUNTER, YC-305D, 220 MHz, £105.00 (available shortly).  
TRANSCIVER, 2m, FT-2 AUTO SCANNING, £129.00 (available shortly).  
RECEIVER, FR-50, 10-80m. See June Ad., £55.90.  
TRANSMITTER, 10-80m. See June Ad., £61.00.  
VFO, FV-50 for FL-50, FT-75. See June Ad., £26.00.

# ELECTRONICS (UK) LTD

## GREAT NEW RANGES OF ANTENNAS!

THE FINEST FROM JAPAN

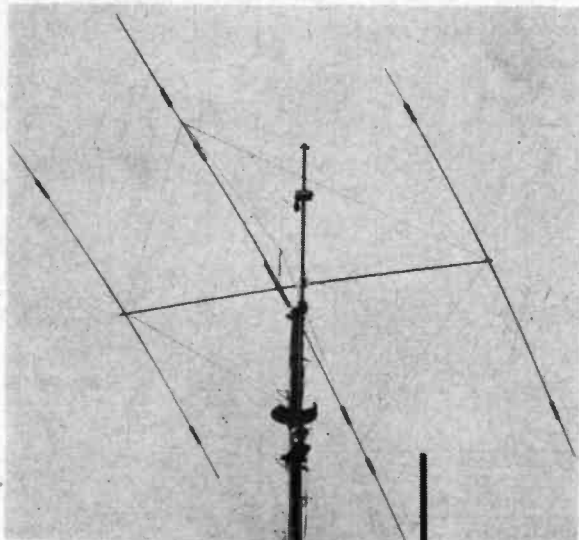

AS-3340

The ASAHI range of ANTENNAS

40m.-20m.-15m.-10m.

A 4-BAND BEAM!

The AS-3340 at only £76.50. Forward gain up to 8 dB. F/B 20 dB.

All ASAHI antennas are rated at 2kW pep.

Carriage paid Securicor

AS-3340. 10-40m. 3 ele. ...	£76.50
AS-33. 10-20m. 3 ele....	£62.50
AS-23. 10-15m. 3 ele....	£42.00
AS-203W. 20m. 3 ele. w'spaced.	£57.00
AS-154W. 15m. 4 ele. ...	£40.00
AS-153W. 15m. 3 ele. w'spaced.	£32.70
AS-104W. 10m. 4 ele. ...	£33.90
AS-103. 10m. 3 ele. ...	£29.95
ECHO-8G. 10-40m. Vert. 1 kW	£17.25
AS-2HG. 2m. Ground plane ...	£9.60
AS-303A. 10-80m. Mobile ...	£33.00

SWR METER ME-IIB ... £7.20

POWER/SWR METER ME-IIN £13.40

THE FINEST FROM CANADA

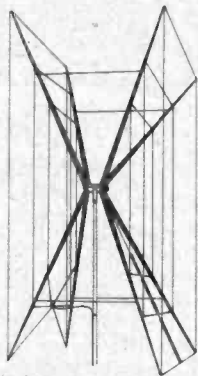

### GEM-QUAD £65.00

for 10, 15 & 20m.

- ★ Weighs only 21 lbs.
- ★ Withstands 100 mph winds.
- ★ Forward gain up to 8 dB.
- ★ Balun included.
- ★ Converts to 3 or 4 element quad.
- ★ Fibreglass tri-dectic spreaders.
- ★ Front/back ratio 25 dB.
- ★ Low angle radiation.

THE FINEST FROM THE U.S.A.

### HY-GAIN

HY-GAIN 18AVT/WB THE GREAT NEW WIDE BAND VERTICAL SELF SUPPORTING FOR, 10-80m. (ex-stock) £33.00. Take the wide band, omnidirectional performance of Hy-Gains famous 14AVQ/WB add 80 mtrs. plus extra heavy duty construction and you have the new 18AVT/WB ★ True 1/2-wave resonance on all bands ★ 52 Ω I/P ★ SWR of 2:1 or less at band edges ★ 1 kW (AM) ★ Radiation pattern has an outstandingly low angle ★ Roof or ground mounting.

Hy-tower, 10-80m. ...	£99.50
18V, 10-80m. vertical ...	£10.90
12AVQ, 10-20m. vertical ...	£16.50
14AVQ, 10-40m. vertical ...	£18.50
18AVT, 10-80m. vertical ...	£33.00
LC80Q, 80m. coil for 14AVQ ...	£6.70
TH6DX, 10-20m. 6 ele. beam ...	£88.00
TH3MK3, 10-20m. 3 ele. 2 kW ...	£69.50
TH3 Jnr., 10-20m. 3 ele. 600w. ...	£48.00
Hy-Quad, 10-20m. 2 ele. ...	£62.50
DB10-15, 10-15m. 3 ele. ...	£31.00
204BA, 20m. 4 ele. beam ...	£80.00
203BA, 20m. 3 ele. beam ...	£67.50
153BA, 15m. 3 ele. beam ...	£33.00
103BA, 10m. 3 ele. beam ...	£26.50
18TD, Reeltape portable dipole ...	£41.00
LA1 Lightning arrestor ...	£14.50
LA2 Lightning arrestor ...	£2.50

### MOSLEY (Carr. pd.) (Ex-Stock)

Mustang, 10-20m. 3 ele. 2kW ...	£41.50	TA33 Jnr., 10-20m. 3 ele. ...	£34.50	TA32 Jnr. 'E' for 2" mast ...	£25.00	Atlas Vertical 10-40m. guyed ...	£20.90
TA33 Jnr. 'E' for 2" mast ...	£35.00	TA32 Jnr. 1-20m. 2 ele. ...	£24.50	TA31 Jnr. Rotary dipole ...	£15.40	SWL Listeners dipole ...	£10.90

### BANTEX FIBREGLASS MOBILE ANTENNAS (Carr. 50p) including Case

70 1/2. 70 MHz, 1/2 wave ...	£3.00	BGA, 144 MHz, 1/2 wave ...	£6.15	Magnetic mount ...	£4.95	Note. Deduct 50p from price of aerial if base is not required.
144 1/2. 144 MHz, 1/2 wave ...	£2.75	B5, 144 MHz, 1/2 wave ...	£4.35	All aerials complete with base.		

### ANTENNA ROTATORS. Immediate delivery from Stock

AR20 (p & p 40p) ...	£20.00	AR22R (p & p 65p) ...	£25.00	TR44 (p & p 75p) ...	£47.00	HY-GAIN, 400 (p & p £1) ...	£98.00
				HAM-M (p & p 80p) ...	£70.00		

AGENTS: MIDLANDS—Andy Martin, G3UDR. Tel. Shipston-on-Stour 61839.  
BUCKS. —Ian Partridge, G3PRR. Tel. Chesham 024-054143.

CATALOGUE 15p please (no sac required).

- ★ Your 'one-stop' single source for masts, towers, rotators, antennas and equipment
- ★ Largest stock range in the U.K. ★ Money-saving packaged deals.

**WESTERN ELECTRONICS (U.K.) LTD. TELEPHONE: TOTTON 4930 or 2785**  
**OSBORNE ROAD . TOTTON . SOUTHAMPTON** **CABLE: 'AERIAL, SOUTHAMPTON'**

# WESTERN ELECTRONICS (U.K.) LTD.

★ Your "one stop" single source for masts, towers, rotators, antennas and equipment.

79' TELETOWER

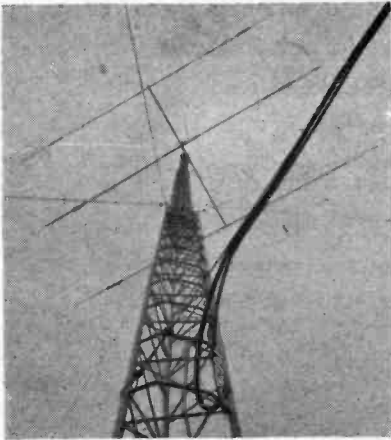

TELETOWERS

The finest value in guyed galvanised steel towers which telescope down to 25'.

42', £72-00	57' £93-00
79', £121-00	101', £161-00

30' HAMTOWER

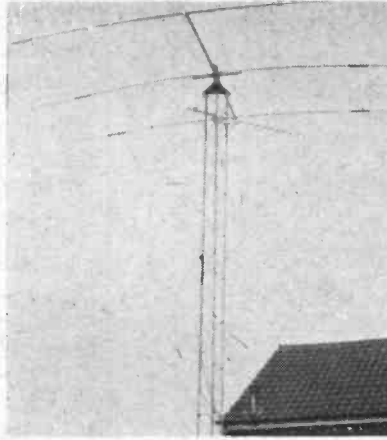

A self-supporting galvanised steel tower for HF band beams. Each 10' side weighs only 22 lbs., so the tower can be erected single-handed.  
Price : £55-00 carriage paid.

**VERSATOWERS**

Immediate delivery from our stock | Self-supporting tilt-over towers for 40', 60' and 85'.  
P40, £121-75, P60', £146-50, T85', £275-00.

TELOMAST with TA33

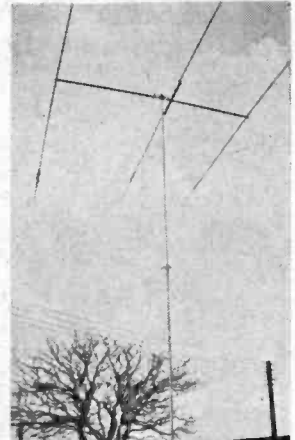

The best in galvanised steel telescopic rotatable masts, can be erected in minutes and extends vertically upwards.

Prices (carriage paid):

Mast only	Mast and Rigging kit
30' £14-40	£19-95
40' £16-50	£25-50
50' £19-50	£31-50

TOWER - MAST - ANTENNA - ROTATOR

CATALOGUE 15p. (No S.A.E. required).

WESTERN ELECTRONICS (U.K.) LTD.,  
Tel.: TOTTON 4930 and 2785.

OSBORNE RD., TOTTON, SO4 4DN, HANTS.  
Cables: "AERIAL", SOUTHAMPTON.

## GO MOSLEY BRITISH AND BEST

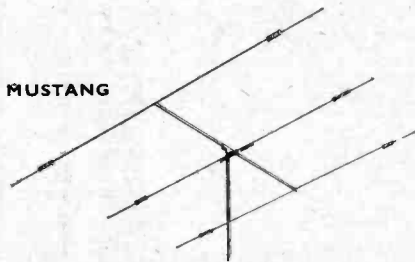

MUSTANG



10, 15 and 20 metres—  
HIGH POWER—2 kW pep. LIGHT WEIGHT—28lbs.  
LOW WIND LOADING—90 lbs. Price £40-00  
Carriage mainland £1-50

**SHORT WAVE LISTENERS.** Get the best Antennae as used by most commercial users for monitoring :

- Broadcast Short Wave Bands : SWL7
- Ham Bands, 11-18 metres : RD-5
- Rotary Dipole, 10, 15 and 20 : TA-31 Jr.

**FOR ALL ANTENNA DETAILS!**  
Send for complete Handbook, containing full details and prices of Antennas and other technical information. 25 pages, 15p

**GET FULL VALUE FOR YOUR MONEY — BUY ANTENNAE MANUFACTURED 100% IN ENGLAND**

Buy direct for Best Service.

### WE ARE THE ANTENNA PEOPLE

Rotators, Towers, Polythene cord and rope, Coax cable, Control cable, Twin feeder.

ATLAS	V-3 Jr.	A-310
ELAN	VTD-3 Jr.	A-210
TA-33 Jr.	TD-3 Jr.	TW-3X
TA-32 Jr. A-315		
TA-31 Jr. A-215		

Administrative Address only

**Mosley Electronics Ltd.** 40, Valley Road, New Costessey, Norwich, Norfolk Nor. 26K

**DRAKE'S TR-4  
SIDE BAND  
TRANSCEIVER  
from  
RADIO SHACK**



**More  
Performance  
at  
Lower Cost  
Through  
Engineering  
£265.00**

The Drake TR-4 is a product of years of transceiver experience and design improvements. The resulting performance makes it one of the finest transceivers available. Its operating handiness is not only evident in circuit design, but also in packaging. Compact and lightweight, it is ideal for mobile use, portable excursions, and vacations. USB, LSB, CW, or AM operation is at your finger tips with 300 watts P.E.P. of communication power.

Now available with plug-in noise blanker.

**INCLUDED FEATURES :**

- 300 Watts PEP input on SSB, 260 watts input on CW.
- Complete Ham Band Coverage: all necessary crystals for 80 thru 10 metre ham bands.
- Separate Sideband Filters : separate USB and LSB filters eliminate oscillator shifting and insure long term carrier vs filter alignment.
- Nominal 1.7 : 1 Filter Shape Factor : These filters stand among the industry's finest with 6 dB bandwidth of 2.1 kHz (chosen to slice thru QRM) 60 dB bandwidth of only 3.6 kHz and 100 dB ultimate rejection.
- Diode Detector for AM reception.
- CW Side Tone Oscillator for monitoring your CW transmission.
- New Finish : Scratch proof epoxy paint.
- Crystal Calibrator.
- VFO Indicator Light eliminates confusion of which main tuning knob controls the frequency when using an RV-4 remote VFO.
- Automatic CW Transmit Receive Switching, sometimes called "semi" break-in.
- Full AGC with Drake dual time constant system confines a 60 d signal change to a 3 dB audio change.
- Effective Transmitting AGC insures clean SSB output.
- Solid State Permeability Tuned VFO for low drift and accurate 1 kHz divisions on all bands.
- VOX or PTT for use on AM or SSB.
- Receiver S-Meter automatically switches to indicate transmitting AGC on transmit.
- Transmitter Plate Ammeter indicates Relative RF Output at the touch of a button.
- Adjustable Pi-Network.

**SPECIFICATIONS :**

**Frequency Coverage :** Full coverage on all amateur bands 10 thru 80 metres. in seven 600 kc ranges : 3.5 to 4.1 mc 7.0 to 7.6 mc 13.9 to 14.5 mc, 21 to 21.6 mc, 28 to 28.6 mc, 28.5 to 29.1 mc, 29.1 to 29.7 mc.  
**Solid State VFO :** Has linear permeability tuning. Tunes 4.9 to 5.5 mc for all ranges.  
**Dial Calibration :** 10 kc divisions on main tuning dial and 1 kc division on the tuning knob skirt. Effective length of circular dial scale is over 14 inches.  
**Frequency Stability :** High stability solid state VFO tunes same range on all bands. Drift is less than 100 cycles after warm-up, and less than 100 cycles for plus or minus 10% line voltage change.  
**Modes of Operation :** SSB Upper and Lower Sideband, CW and AM.  
**Misc. :** 20 tubes including voltage regulator ; two transistors ; 8 diodes ; 100 kc crystal calibrator built-in. Dimensions : 5½" high, 10½" wide, 14½" deep. Weight : 16 lbs.  
**Power Supply Requirements :** Due to the 300 watt P.E.P. input rating, the TR-4 will require supply capable of low voltage at high current with very good dynamic regulation. The voltage and current requirements are as follows :  
 1. 650 volts at 300 ma average and 500 ma maximum with 10% regulation from 100 ma to 500 ma and maximum ripple of less than 1%.  
 2. 250 volts at 175 ma with 10% regulation from 150 ma to 180 ma. This includes the effect of the 650 volt supply change if both voltages are obtained from the same transformer. Maximum ripple must be less than 1%.  
 3. -45 to -65v. DC adjustable filtered bias into 33K ohm load.  
 4. 12.6v. AC or DC at 5.5 amps.

**Transmitter Specifications :**

**Single Sideband :** 300 watts P.E.P. input power, VOX or PTT. Two special 9 mc crystal filters provide upper or lower sideband selection on any band, without the necessity of shifting oscillators. Unwanted sideband suppression of more than 60 dB and carrier suppression of 60 dB. Overall audio frequency response 400 to 2500 cycles at 6 dB down. Distortion products 30 dB down at maximum output.  
**CW :** Power input 260 watts. Carrier is shifted approximately 1000 cycles into one sideband, and mixer and driver are keyed. Grid block keying is free from chirps and clicks. Automatic transmit/receive switching when key is operated. CW sidetone oscillator for monitoring.  
**AM :** Controlled carrier AM screen modulator is built-in. 260 watts P.E.P. input. Low carrier power increases 6 times to 50 watts output at maximum modulation. This system is compatible with SSB linears. VOX or PTT. Diode detector used for receiving on this mode. Product Detector can be used by switching manually.  
**Output Impedance :** Nominal 50 ohms, adjustable with pi-network.  
**Microphone Input :** High-impedance.

**Receiver Specifications :**

**Sensitivity :** Less than ½ microvolt for 10 dB S/N.  
**I.F. Selectivity :** 2.1 kc at 6 dB, 3.6 kc at 60 dB.  
**AGC :** Full AGC on received modes—audio output varies less than 3 dB for 60 dB change in signal level. Any amount of AGC from zero to full can be had by adjustment of RF gain control. Time proven Drake AGC system provides fast attack and slow release with noise pulse suppression, no pumping or popping evident.  
**ANTENNA INPUT :** Nominal 50 ohms.  
**Audio Response :** 400 to 2500 cycles at 6 dB.  
**Audio Output Power :** 2 watts. Impedance : 4 ohms.

**TR-4 Accessories**

AC-4 120/240v. 50/60 Hertz Power Supply	...	...	£46.95
DC-4 12v. DC Solid State Power Supply...	...	...	£55.00
MS-4 Matching Speaker	...	...	£9.95
RV-4 Remote VFO allows separating Receive and Transmit frequencies on same ham band	...	...	£49.50
FF-1 Allows crystal control operation on Receive or Transmit or both with up to two channels	...	...	£11.95
PMK-3 Mobile Mounting Kit	...	...	£3.50
4-NB plug-in noise blanker	...	...	£44.50

**RADIO SHACK LTD.**

MEMBER OF AMATEUR RADIO RETAILERS ASSOCIATION

Just around the corner from West Hampstead Underground Station

**182 BROADHURST GARDENS  
LONDON NW6 3AY**

**Telephone: 01-624 7174  
Giro Account No. 588 7151**

# LOWE ELECTRONICS

119 Cavendish Road, Matlock, Derbyshire. DE4 3HE

Tel. Matlock 2817 or 2430 9 a.m. - 9 p.m.

Bill G3UBO

Alan G3MME

MAIN DISTRIBUTORS FOR YAESU MUSEN EQUIPMENT



The new Yaesu FT-75 meets the need for a very small mobile rig with fixed station potential. It is beautifully made and the performance is everything one has come to expect from Yaesu. It is crystal controlled on all bands with VXO, it is all transistor except 12BY7A driver and 12DQ6B P.A., the filter is top-notch and all in all it is yet another Yaesu winner.

**Bands :** 80, 40, 20, 15 and 10m. The following frequencies are fitted as standard, but others (up to a total of 3 per band) may be ordered : 3-565, 7-085, 21-400, 28-550.

**VXO range :** 80 and 20m. 3 kHz, 40m. 6 kHz, 15m. 20 kHz, 10m. 12 kHz.

**Power :** The transformers in both A.C. and D.C. p.s.u.'s. are tapped and on the highest A.C. p.s.u. tapping we obtained a measured output of at least 30W on all bands (35W on 10 !). This corresponds to an approximate input of 60W or more which is very comfortably within the capabilities of the 12DQ6B.

The receiver has a sensitivity of  $\frac{1}{2}$  microvolt for 10 dB S/N and the crystal filter (5173.9 kHz) has a nose bandwidth of 2.3 kHz and 6 : 60 dB shape factor better than 2 : 1. All this in a compact 8" x 3" x 12" deep.

Quite clearly a great deal of thought has gone into the design of the FT-75 and there are several very nice touches which appeal to us. The Rx not only has its own r.f. coils, but its own mixer coils as well. The dual gate F.E.T. r.f. amp. has excellent signal handling with amplified a.g.c. applied to one of the gates. Separate receiver and transmitter I.F. strips, a ring diode detector, etc. allied to a low price and small size make this rig very attractive to anyone owning a car.

As an optional extra there is the FV50C Remote VFO at £26. Note though, that there is no r.f. peaking control on the FT-75 and that the P.A. tune is pre-set, so the frequency excursion is rather limited by r.f. bandwidth from 75 kHz or so on 80 up to about 450 kHz on 10m. before acceptable performance is lost. In spite of this, it is a little cracker and for mobile I'm not so sure that xtal control isn't a bad idea.

#### New Yaesu Equipment :

FT-101 Transceiver, £240	FT-2 Auto, £129
FT-101 Fitted 160m., £255	FT-200 Transceiver, £134
FT-101 Fitted 160 and new PA coil, £255	FP-200 A.C. p.s.u./speaker, £38
SP-101 Matching speaker, £10	FV-200 Remote VFO, £38
FV-101 Remote VFO, £38	DC-200 Mobile p.s.u., £45
FT-101 Mobile Mount, £5	FTdx401 Transceiver, £215
FL2100 Linear, £135	FV-401 Remote VFO, £38
FRdx400 Super de Luxe Receiver £160	SP-401 Speaker £10
FLdx400 Transmitter, £140	YC-305 Counter, £79-50
SP-400 Speaker, £10	FT-75 Transceiver, £80
FL2000B Linear, £135	FP-75 A.C. p.s.u., £20
FT-2F 2m. Transceiver, £84	DC-75 D.C. mobile p.s.u., £20
FR-50B Receiver, £52	

The above equipment is ex stock and apart from sundry spares which go first class mail, we send all equipment by Securicor, who almost invariably deliver within 24 hours and more important, treat the gear gently. There is no extra charge for this service, nor for the fact that all equipment is thoroughly checked before despatch. Plus of course our unbeatable 12 month guarantee and our money-back guarantee.



While the Yaesu Musen FRdx400 receiver is just about the best you can get in the Amateur Band line, the price of £160 is beyond a lot of pockets, so to cater for the lower-priced field, we very proudly introduce the Yaesu Musen FR-50B at a very incredible £52. In spite of this rock-bottom price, the FR-50B is a very good Amateur Band receiver indeed and provides a high degree of sensitivity and stability.

Basically, it is a double conversion receiver covering 80 to 10m with a VFO for the first oscillator and a crystal controlled second oscillator. Being double conversion (5173.9 kHz and 455 kHz) explains the incredibly good image rejection figure of better than 50 dB.

When it comes to sensitivity, the 6BZ6 r.f. amplifier ensures 0.5 microvolt for 10 dB S/N ratio.

Selectivity is achieved by two ceramic transducer filter elements which give a nose bandwidth of 3.6 kHz at 6 dB and a skirt band width of 10 kHz at 50 dB. These figures are extremely good for equipment in this price class (even for equipment costing much more!). A high order of stability is achieved by a stabilized transistor VFO and VFO buffer amplifier. Other niceties of design are:

1. 100 kHz calibrator circuitry built in and only needs 100 kHz crystal plugging in.
2. Built-in speaker.
3. Tuneable BFO.
4. I.F. trap in r.f. circuit.
5. Nice geared drive to the VFO—50 kHz per turn of the tuning knob, readout to better than 1 kHz. This is the same drive as on the well known earlier (and much more expensive) FR-100B.
6. Triode first mixer for low noise.
7. "S" meter fitted.
8. Noise limiter fitted.
9. Gold bonded 1S1007 for AM detection.
10. Product detector (6BE6) for SSB/CW.
11. Built-in muting and monitor circuit for use with companion FL-50B transmitter.

Frequency range : 80m 3.5—3.8 MHz 20m 14.0—14.5 MHz 10m 28.0—29.2 MHz  
 40m 7.0—7.5 15m 21.0—21.5 WWV 10.0—10.5

Sensitivity : Better than  $\frac{1}{2}$  microvolt for 10 dB S/N ratio in the SSB mode.

Selectivity : 3.6 kHz —6 dB 10 kHz —50 dB.

Image rejection : 50 dB or more.

Audio : 1.5W 4/600 ohm output. Built-in speaker.

Power : 240v. A.C.

Size : 13" wide, 6" high, 10 $\frac{1}{2}$ " deep.

Weight : 17 $\frac{1}{2}$  lb.

Controls : BFO, monitor agc slow/fast/off, noise limited on/off, calibrator on/off, mode switch, AF gain, RF gain band switch, main tuning, preselector, zero set (for calibration), "S" meter zero (on rear panel).

Valves :	12AT7	Crystal calibrator	6CB6	1st IF amp./2nd mixer	6BE6	Product detector
	6BZ6	r.f. amp.	2SC372	2nd oscillator	1S1941	Noise limiter
	12AT7	first mixer	6BA6	2nd IF amp.	6BA6	BFO
	2SC373	VFO	6BA6	3rd IF amp.	6BM8	Audio
	2SC372	VFO buffer	1S1007	Am detector		

## LOWE ELECTRONICS,

119 CAVENDISH ROAD, MATLOCK, DERBYSHIRE, DE4 3HE.

Tel. MATLOCK 2817/2430

Hours : Tuesday to Saturday 9-5.30 (closed for lunch 1-2 and all day Monday).

Service and Sales : A good range of our equipment is available (evenings and weekends only) at the following : John G3JYG, 16 Harvard Road, Ringmer, Lewes, Sussex. Tel : Ringmer 812071. Sim GM3SAN, 19 Ellismuir Road, Baillieston, Nr. Glasgow. Tel : 041-771 0364. Alan GW3YSA, 35 Pen y Waun, Efail Isaf, Nr. Pontypridd, Glam. Tel : Newton Llantwit 3809.

Service only (evenings and weekends) : Dave Dryden G3BKQ, 205 Main Street, Thornton, Leics. Peter Ward G3XWX, 47 Radstock Avenue, Ward End, Birmingham, B36 8HD.

MEMBERS OF THE AMATEUR RADIO RETAILERS ASSOCIATION

# NORTH WEST ELECTRICS

769, STOCKPORT ROAD, LEVENSHULME,  
MANCHESTER, 19.

Phone: 061-224 4911

## G3MAX

**EDDYSTONE AND TRIO RECEIVERS. DIECAST BOXES.  
JACKSON CAPACITORS AND DRIVES. DENCO COILS.  
"RADIO SPARES" TRANSFORMERS AND COMPONENTS.  
"Q" MAX CUTTERS.**

**INTEGRATED CIRCUITS AND COMPONENTS FOR FREQUENCY COUNTERS AND CLOCKS**  
I.C.'s 7413N 40p, 7490N 86p, 7400N 22½p, 7473N 55p, 7414IN £1.12, 72710N 46p NEW TEXAS

HOLDERS for 14 way and 16 way 15p each  
DECADE COUNTER BOARD 12 way .15 uses 7490 and 7414IN 37½p  
DECADE COUNTER BOARD with fitting for Quad latch, 16 way .1 60p  
**NUMICATORS FOR DIGITAL READOUT.** £1.50 each. ZM1020 with base. End viewing 1" dia., 4 for £5, post paid.  
GNP 7AH side viewing 1½" high, ¾" dia. Miniature type A7001. 1½" high, ½" dia. POST 5p on any item.

**POT CORE.** .666 dia. With bobbin on ¼" Aladdin former. Type 10D, 14p, post 5p.

**POLYPROPYLENE ROPE.** 500lb. strain. 100 yd. reel, £1, post 15p.

**BARGAIN OFFER.** 100 yard drum 75 ohm high power coaxial cable. Attenuation per 100ft. 2-8 dB 200 MHz, 4 dB 600 MHz, 5-3 dB 800 MHz, £6.75, carriage £1.

**DENCO COILS.** All ranges in stock. 32p each, post 5p each coil. Please state valve or transistor type when ordering

**COAX LINK LEAD.** 8' 6" cable with 2 Burndept/Londex coax plugs, 35p, post 15p (50Ω impedance).

**5" DESYN INDICATOR, 75p,** post 25p.

**3" DESYN INDICATOR. 62p,** post 20p. Compass degrees and corrector on 5" Desyn only.

**VIBRATORS.** 12 volt synchronous. Type No. 12SR7, 50p each. Special offer 3 for £1, postage 15p.

**CONVERTER CHASSIS.** New spares for transistorised UHF tuner. Contains 4 gang min. var. cap. 4 tube trimmers, in screened sections, 25p, post 15p.

**PRINTED CIRCUIT BOARD** for Digital Clock. Printed Circuit Board for 4 Digit Readout. Size of boards 4" x 3". £1.50 each. Stamped Addressed envelope for details.

**JACKSONS** 6/36 slow motion dial and drive, £1.55, post 15p.

WE WOULD BE PLEASED TO RECEIVE QSL CARD FOR DISPLAY

**ALUMINIUM CHASSIS WITH BASE PLATE, 17" x 9½" x 2".** 32 B9A Valve Bases. 100 .01 disc ceramics. 100 res. 75 standoffs, 50p, post 30p. limited quantity. Stock clearance.

**FINNED ALUMINIUM HEAT SINKS.** 2" for single power transistor. 5" x 2" ready drilled for TO3, 25p. 5" x 4" undrilled, 37½p. 5" x 8", undrilled, 65p, post 10p.

**IF STRIP.** Ex R3673 Rx. 7.5 MHz with circuit. Less valves. 8 B7G PTFE holders. Sealed relay twin 500 ohm coil. 12-pin plug and socket, 50p, post 20p.

**CONVERTER 20 to 90 MHz.** 7.5 MHz IF. Ex 3673 Rx. 2/EF91's. 1-616 Osc., £1.25, post 20p. Some less valves, 75p, post 20p.

**TRANSFORMER.** Specially wound for Digital instruments. 200 volt 40 mA HT. 6 volt 1A. Two windings LT. Will supply 6v. 2A. or 12v. 1A. CT 2½" x 2" x 2½", £1.50, post 25p.

**CV416 (6F17) VALVE, 30p** each, post 5p, or 4 for £1.20, post paid.

**ALI. MINI BOXES.** With fitted lid. Post 5p per box.  
3" x 2" x 1", 33p      5½" x 4" x 1½", 43p  
4" x 2½" x 1½", 38p      4" x 2½" x 2", 38p  
4" x 4" x 1½", 38p      5" x 2½" x 1½", 38p

**INSTRUMENT CONTROL KNOBS.** Black with bright Ali. centre, ½" brass insert with grub screw. 1", 1½" and 1¾" dia., 15p each, post 5p each. Any excess refunded.

**Business Hours:** Tues.-Fri., 9.30 a.m. to 6.30 p.m.  
SATURDAY: 9 a.m.-5 p.m. OPEN ALL DAY.  
CLOSED ALL DAY MONDAY.

WE WELCOME ALL ENQUIRIES HOWEVER SMALL  
Stamped addressed envelope please for special offer list





### Heathkit SB-303 Receiver

**"By any standards a very fine receiver – and one by which others may be judged – few will equal it!"**

Extracts from the RSGB review April 1972 issue of RadCom on the Heathkit SB-303 all solid state high performance amateur bands receiver. This is what the amateurs at Heath set out to achieve – and succeeded – for you. Maintain that tradition which is the heritage of the Radio Amateur – to build and to learn. **DO IT THE HEATHKIT WAY.**

The Heathkit SB-303 delivers all the signal seeking capability you could possibly want, plus a complement of performance features most other receivers can only offer as a lengthy (and costly) list of options. The "303" brings you USB, LSB, AM, CW and RTTY, 80-10 meters; 15 MHz WWV reception; advanced all-solid-state circuitry for instant warmup, 100 Hz stability in 10 minutes, and superior tracking. Compare the specs below against all comers. Then order your "303" today.

**Kit SB-303**, 21 lbs., £175 + Carr 90p

**SBA-301-1**, optional 3.75 kHz AM crystal filter, 1 lb., £12 + Carr 30p

**SBA-301-2**, optional 400 Hz CW crystal filter, 1 lb., £11 + Carr 30p

**SB-303 SPECIFICATIONS** — Frequency range (MHz): 3.5 to 4.0, 7.0 to 7.3, 14.0 to 14.5, 15.0 to 15.3, 21.0 to 21.5, 28.0 to 30. Intermediate frequency (IF): 3.395 MHz. Frequency stability: Less than 100 Hz drift/hr. after 10 min. warmup under normal ambient conditions. Less than 100 Hz drift for  $\pm 10\%$  line voltage variation. Frequency selection: Built-in Linear Master Oscillator. Modes of operation: SSB, CW, AM, RTTY. Sensitivity: Less than 0.25  $\mu$ V for 10 dB S+N/N for SSB operation. Overall gain: Less than 1.5  $\mu$ V input for 0.5 audio output (single tone SSB). AGC Characteristics: Blocking — Greater than 3.0 V CW/SSB/RTTY. Dynamic Range — Greater than 150 dB CW/SSB, RF Attenuator — Variable 0-40 dB nominal. Selectivity: SSB —

2.1 kHz@ 6 dB down, 5.0 kHz maximum at 60 dB down (crystal filter supplied). CW — 400 Hz at 6 dB down, 2.0 kHz maximum at 60 dB down (crystal filter available as an accessory). AM — 3.75 kHz at 6 dB down, 10 kHz maximum at 60 dB down (crystal filter available as an accessory). RTTY — 2.1 kHz at 6 dB down, 5.0 kHz maximum at 60 dB down (uses SSB crystal filter). Image rejection: 60 dB or better. IF rejection. 3.395 — greater than 55 dB. 8.595 — greater than 50 dB. Spurious response: All below 1  $\mu$ V equivalent signal input. Temperature ranges: 10°C-50°C Ambient. Dial accuracy: Electrical — Within 400 Hz after calibration at nearest 100 kHz or 25 kHz point. Visual — Within 200 Hz. Calibration: Every 100 kHz or 25 kHz. Dial Accuracy: No more than 50 Hz. Antenna input Impedance: 50 ohm nominal unbalanced. Audio response: SSB — 350-2450 Hz nominal at 6 dB. CW (with accessory filter) — 800-1200 Hz nominal at 6 dB. AM (with accessory filter) — 200-3500 Hz nominal at 6 dB. RTTY — 1840-3940 Hz nominal at 6 dB. Audio output impedance: Speaker — 8 ohm. Headphones — Low impedance. Audio Output Power: 4 W at less than 10% distortion. Muting: Open external ground at mute socket. Power Requirements. 120/240 VAC, 40 W max. Front Panel Controls: Main tuning dial; function switch; mode switch; band switch; AGC switch; converter switch; AF gain/power on-off; RF gain/speaker disable; preselector; RF Attenuator. Circuit board controls: IF/Audio — Bias adjust; meter zero; meter full scale. Power Supply/BFO — +15 V adjust; 100 kHz adjust. RTTY — Wide shift; narrow shift; CW shift. Connections: Rear Panel — Phones; HF antenna; VHF antenna #1, VHF antenna #2; mute, anti-vox; speaker; HFO out; LMO out; BFO out; CW shift; 3 spare sockets; 3-wire line cord socket; accessory socket, VHF Converter, +15 VDC @ 25 mA, switched. RTTY Keyboard. Cabinet Dimensions: 6 $\frac{1}{8}$ " H x 12 $\frac{1}{2}$ " W x 13" D. Overall Dimensions (with knobs & feet installed): 7 $\frac{1}{8}$ " F x 12 $\frac{1}{2}$ " W x 14" D.

#### Attractive credit facilities available 10% deposit 12-24-36 months

Please note that on any credit agreement the service charge will be refunded if you complete payment within 3 months. After 3 months an early settlement discount of 5% on the outstanding balance is given.

Please address all enquiries & correspondence

HEATHKIT

Schlumberger

**HEATH (Gloucester) LTD.** GLOUCESTER  
GL2 . 6EE TEL. 29451

# Technical Books and Manuals

(ENGLISH AND AMERICAN)

## AERIAL INFORMATION

ABC of Antennas	90p
Aerials (By D. Sjobbema)	88p
Aerial Handbook (Briggs)	87p
Amateur Radio Antennas (Hooton)	£1-87
Antenna Handbook, Volume 1	£1-77
Antenna Round-Up, Volume 1	£1-47
Antenna Round-Up, Volume 2	£1-77
Antenna Handbook, 12th Edition	£1-40
Beam Antenna Handbook	£2-10
Ham Antenna Construction Projects	£1-47
Quad Antennae	£1-80
S9 Signals	87p
73 Vertical, Beam and Triangle Antennas (by E. M. Noll)	£2-40
73 Dipole and Long-Wire Antennas (by E. M. Noll)	£2-20
SWL Antenna Construction Projects	£1-38

## BOOKS FOR THE BEGINNER

Amateur Radio (Rayer)	£1-60
Beginners Guide to Radio (7th Edition)	£1-12
Beginners Guide to Electronics (N.E.)	£1-10
Beginners Guide to Transistors	£1-12
Beginners Guide to Colour TV	82p
Better Short Wave Reception	£1-80
Course in Radio Fundamentals	62p
Foundations of Wireless and Electronics	£2-02
Guide to Amateur Radio	50p
How to Become a Radio Amateur	59p
Morse Code for the Radio Amateur	15p
Learning the RT Code	27p
Radio, by D. Gibson	85p
Radio Amateur Examination Manual (N.E.)	89p
Short Wave Listener's Guide (N.E.)	O/P
Simple Short Wave Receivers (Data)	89p
Understanding Amateur Radio	£1-37

## GENERAL

ABC of Electronics (by Earl J. Waters)	£1-20
ABC of FET's	£1-35
ABC's of Short Wave Listening	£1-02
ARRL Calculator, Type A	92p
ARRL Calculator, Type B	O/P
Building Your Amateur Radio Novice Station (by W7OE)	£1-57
Easibinder (to hold 12 copies of Short Wave Magazine together)	90p
FET Circuits (by Rufus P. Turner)	£1-52
FET Principles, Experiments and Projects	£2-15
Guide to Broadcasting Stations (16th Edition)	60p
Having Fun with Transistors	£1-59
How to Listen to the World 1971—Edition	£1-37
Know Your Oscilloscope (by Paul C. Smith)	£1-80
Practical Ham Radio Projects (by W6NJV)	O/P
Practical Integrated Circuits (Newnes-Butterworth)	£1-01
Practical Transistor Theory	£1-10
Practical Wireless Circuits	£1-34
Prefix List of Countries	23p
Radio Engineers Pocket Book (Newnes) N.E.	£1-26
RCA Receiving Tubes Manual	£1-77
RCA Transistor Manual (N.E.)	£1-75
RCA Transmitting Tubes	£1-35
Shop and Shack Shortcuts	£1-75
Single Sideband: Theory & Practice (by H. D. Hooton)	£3-47

Television Explained Vol. II.	£1-37
Telecommunications Pocket Book (T. L. Squires)	£1-32
World Radio and TV Handbook 1972 Edition	£2-80
110 Integrated Circuit Projects for the Home Constructor	£1-22
49 Easy Transistor Projects	£1-01
110 Semi-Conductors Projects for the Home Constructor (Iliffe)	£1-37

## HANDBOOKS AND MANUALS

Amateur Radio DX Handbook	£2-17
Electronic Circuit Handbook, Vol. 1	£1-42
Electronic Circuit Handbook, Vol. 2	£1-42
Mobile Handbook, CQ	£1-40
Mobile Manual, ARRL	£1-40
New RTTY Handbook	£1-80
Radio Amateur Handbook 1972 (ARRL)	£2-85
Radio Amateur Handbook 1972 (ARRL) (Hard Cover)	£3-65
Radio Amateur Operators Handbook, 12th Edition	53p
Radio Communication Handbook (RSGB)	£3-50
Rtty A-Z (CQ Tech. Series)	£2-25
Surplus Conversion Handbook	£1-37
Transistor Substitution Handbook No. 10	£1-12

## USEFUL REFERENCE BOOKS

Amateur Radio SSB Guide	£1-59
Amateur Radio Techniques (N/E)	O/S
Amateur Radio Construction Projects	O/P
Amateur Radio Circuit Book	70p
Guide to Amateur Radio	50p
Engineers' Pocket Book—6th Edition	£1-48
'G' Call Book 1972	60p
Hams' Interpreter	63p
Hints and Kinks, Vol. 8 (ARRL)	62p
Radio Amateur Examination Manual (N.E.)	89p
Operating an Amateur Radio Stat.	25p
Radio Data Reference Book (3rd Edition)	£1-00
Radio, Valve and Transistor Data (Iliffe), 9th Edition	89p
Service Valve and Semiconductors Equivalents	35p
Single Sideband for the Radio Amateur (ARRL), 5th Edition	£1-67
Single Sideband (Theory & Practice) by H. D. Hooton	£3-47
Sun, Earth and Radio by J. A. Ratcliffe	91p
Surplus Schematics (CQ)	£1-22
Transistor Pocket Book	£1-57

## TRANSISTOR MANUALS

ABC of Transistors	£1-33
Handbook of Transistor Circuits	£2-35
Transistor Fundamentals: Basic Semi-Conductor and Circuit Principles, Vol. 1	£1-92
Transistor Fundamentals: Basic Transistor Circuits, Vol. 2	£1-92
Transistor Fundamentals: Electrical Equipment. Circuits, Vol. 3	O/P
Transistor Fundamentals: Student's Workbook	£1-92
Transistor Substitution Handbook, No. 10	£1-12
Using 'Scopes in Transistor Circuits	£1-77

## VHF PUBLICATIONS

VHF Handbook, Wm. I. Orr	£1-79
VHF Manual (ARRL)	£1-37
VHF/UHF Manual (RSGB) N/E	£1-80

The above prices include postage and packing.

Many of these Titles are American in origin.

Available from **SHORT WAVE MAGAZINE**  
 Publication Dept., 55 Victoria St., London SW1H 0HF . 01-222 5341  
 (Counter Service. 9.30-5.15. Mon. to Fri.) (Nearest Station: St. James's Park)  
 (GIRO A/C. No. 547 6151)

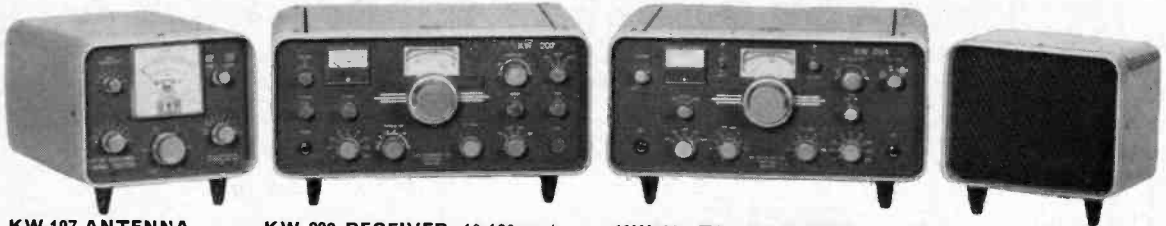

**KW 107 ANTENNA**  
Tuning SYSTEM

**KW 202 RECEIVER**, 10-160 metres SSB/AM/CW, with Mechanical Filter, built-in 'Q' Multiplier (Peak & Null), 500 kHz VFO covering all Bands.

**KW 204 TRANSMITTER**, 10-160 metres SSB/AM/CW. Successor to the famous KW "Vespa"—Perfectly matches the KW202 Receiver and is similar in appearance. 180 watts p.e.p. from trustworthy 6146's. Built-in Power Supply. Provides "side tone" CW monitoring. A beautiful compact efficient unit. Price £145 carriage extra.

**KW 202 SPEAKER**

Two Speed VFO Drive. Excellent Sig./Noise and sensitivity performance. Very attractive (similar in appearance to KW2000B). 100 kHz Crystal Calibrator price £140 carriage extra.

**2 Great Transceivers**  
DELIVERY IMMEDIATELY, FROM STOCK

**KW2000B** 10-160 metres SSB  
TRANSCIVER: 180 watts PEP  
10-160 metres, complete with A.C.  
p.s.u., VOX P.T.T., I.R.T./I.T.T.

**KW ATLANTA**  
10-80 metres.  
KW Atlanta and A.C.  
p.s.u.

**£240** carriage extra.

**£210** carriage extra.

or separate units

Matching **KW1000 LINEAR AMPLIFIER** for KW 204 and KW 2000B—also available. 1200 watt PEP max. Pair T160L/572B tubes including 2-5kv Power Unit built-in to KW2000B style cabinet £135 carriage extra. **KW 101** Standing-Wave-Ratio meter, £9.25. **KW 103** 5WR/Power meter 0-100 & 0-1000 watts £12.50\*. **KW103** with Dummy Load and Coax Lead, £20.50\*. **KW 107** Antenna Tuning System including E-Z Match, 5WR Ind., Dummy Load, Antenna Switch, 5 position, £40.00\*. Also KW Trap Dipole with twin feeder and 4 other types (only the original Trap from KW is good enough for you), KW E-Z Match ATV, KW Low Pass Filters, KW & HZP Baluns, etc. \*Carriage extra.



All Equipment Available through accredited agents

TRADE-IN EQUIPMENT AND MANY IMPORTED ITEMS AVAILABLE WRITE FOR DETAILS TODAY

**K. W. ELECTRONICS LIMITED:** 1 HEATH STREET, DARTFORD, KENT  
Tel.: Dartford 25574 Cables: Kaydublew Dartford

**EASY TERMS ON EQUIPMENT AVAILABLE OVER 12, 18 OR 24 MONTHS**



**SKYWOOD CX203 COMMUNICATION RECEIVER**

Solid state. 5 bands 200-420 kHz and .55 to 30 MHz. Illuminated slide rule dial. Bandspread. Aerial tuning. BFO. AVC. ANL. '5' meter. AM/CW/55B. Integrated speaker and phone socket. 220/240v. A.C. or 12v. D.C. Size: 325 x 266 x 150 mm. Complete with instructions and circuit, £28.50. Carr. 50p.



**UNR-30, 4 BAND COMMUNICATION RECEIVER**

550 Kc/s.-30 Mc/s. Incorporates variable BFO for CW/55B reception. Built-in speaker and phone jack. Metal cabinet. 220/240v. A.C. Brand new, with instructions, £15.75. Carr. 37p.



**LAFAYETTE HA.800 SOLID STATE AMATEUR COMMUNICATION RECEIVER SIX BANDS** 3-5-4, 7-7-3, 14-14-35, 21-45, 28-29-7, 50-54 Mc/s.

Dual conversion on all bands. 2 x 455 Kc/s. mechanical filters. Product detector Variable B.F.O. 100 Kc/s. crystal calibrator, "5" meter. Huge slide rule dial. 230v. A.C. or 12v. D.C. Size: 15" x 9 1/2" x 8 1/2". Complete with instruction manual, £57.50. Carr. paid (100 Kc/s. Crystal £1.97 1/2 extra).

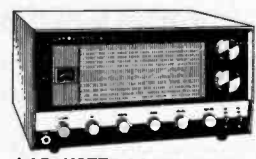

**LAFAYETTE SOLID STATE HA600 RECEIVER**

5 Band AM/CW/55B amateur and short wave 50 Kc/s.-400 Kc/s. and 550 Kc/s.-30 Mc/s. F.E.T. front end. 2 Mechanical filters. Huge Dial. Product detector. Variable BFO. Noise limiter. 5 Meter. 24 1/2" Bandspread. 230v. A.C./12v. D.C. Neg. earth operation. RF gain control. Size: 15" x 9 1/2" x 8 1/2". £50. Carr. 50p.

**HANSEN SWR-3 BRIDGE**  
Impedance 52 ohms. Also operates as field strength indicator, complete with telescopic aerial, £4.25 each, P.P. 17 1/2p. PL259 plugs to suit 37 1/2p each.

**HAMGEAR PRESELECTORS**  
PMIIA £9.20 and PMIIB, £8.25. P.P. 20p.

**TEIS TRANSISTORISED GRID DIP METERS**  
Six ranges. 440 Kc/s.-280 Mc/s. Operates on 9v. battery. Full instructions, £12.50. P.P. 17 1/2p.

**TRIO 9R59DS**

4 band covering 550 Kc/s. to 30 Mc/s. continuous and electrical bandspread on 10, 15, 20, 40 and 80 metres. 8 valve plus 7 diode circuit. 4/8 ohm output and phone jack. 55B-CW + ANL + Variable BFO + 5 meter + 5ep. bandspread dial + IF frequency 455 Kc/s. + audio output 1.5w. + Variable RF and AF gain controls 113/250v. A.C. Size: 7" x 13" x 10" with instruction manual, £57.50, Car. paid.



**TRIO 2 METRE FM TRANSCEIVERS** 144-146 Mc/s.

**TR7100** Car Transceiver 10 watt output £99.50 each.  
**TR2200** Hand Transceiver 1 watt output £69.95 each.

Full details on request.

**SPECIAL OFFER!**  
Matching SP5D speaker supplied free with above receiver.

FULL RANGE OF OTHER TRIO IN STOCK.  
TS150 with p.s.u., £180; JR310, £77.50; JR599, £190.

**G.W.SMITH & CO. (RADIO) LTD**

10 TOTTENHAM CT. RD. LONDON, W.1  
27 TOTTENHAM CT. RD. LONDON, W.1  
3 LISLE STREET, LONDON, W.C.2  
34 LISLE STREET, LONDON, W.C.2  
311 EDGWARE ROAD, LONDON, W.2

Tel: 01-637 2232  
Tel: 01-636 3715  
Tel: 01-437 8204  
Tel: 01-437 9155  
Tel: 01-262 0387

CALLERS WELCOME MONDAY TO SATURDAY 9AM-6PM

All Mail Orders to— 11-12, Paddington Green, London W.2  
Tel: 01-262 6562.

**LATEST CATALOGUE**

Our 6th edition gives full details of a comprehensive range of HI-FI EQUIPMENT COMPONENTS, TEST EQUIPMENT AND COMMUNICATIONS EQUIPMENT. FREE DISCOUNT COUPONS VALUE 50p. 272 pages, fully illustrated and detailing thousands of items at bargain prices. SEND NOW! STILL ONLY 37 1/2p. P. & P. 10p.

# AMATEUR ELECTRONICS

BIRMINGHAM 021-327 1497 021-327 6313

MEMBER OF THE AMATEUR RADIO RETAILERS ASSOCIATION

Thanks to the completion of the Gravelly Hill interchange, which for better or for worse has acquired the name of "Spaghetti Junction," all roads now lead to Birmingham and as we are located within easy access of Gravelly Hill we are, without doubt, the most conveniently located Amateur Radio retailer in the country. Over the years our range has grown and grown with the result that we are now equipped to meet every possible need in the amateur radio field and prospective customers will find a visit very well worth while. As readers will know, we carry large and ever-changing stocks of quality used equipment but this month we show below the range of new gear and accessories available off the shelf.



**Yaesu Musen**  
 FT-101 Transceiver ... £240.00  
 FT-101 Transceiver with 160m. .... £255.00  
 FT-200 Transceiver ... £134.00  
 FT-200 A.C. supply for FT200 ... £38.00  
 DC-200 D.C. p.s.u. for FT200 ... £45.00  
 FL-400 Transmitter 10m-80m. .... £140.00  
 FR-400 Receiver 10m-160m. .... £120.00  
 FR-400 SDX Receiver as FR-400 with additional 2 & 4m. converters FM Discriminator CW SSB AM and FM filters ... £160.00  
 FTDX-40 Transceiver 560w. PEP input ... £215.00  
 FT-25 2 metre Transceiver ... £84.00  
 FT2AC p.s.u. for FT2F ... £25.00  
 FL-2100 Linear for FT-101 ... £135.00  
 FL2000B Linear ... £135.00  
 FL101 Remote VFO for FT101 ... £38.00  
 SP-101 Speaker for FT101 ... £10.00  
 SP-400 Speaker for FR400 ... £10.00

YC-305 Frequency Counter £79.50  
 YD-844 Table Microphone £12.00  
 YD-846 Hand Microphone £5.00  
 Fan for FT-101 ... £8.00  
**Copal Clocks**  
 Model 222 24 hour ... £8.00  
 Model 101 24 hour ... £10.75  
 Model 701 24 hour Alarm ... £12.75  
 Model 601 24 hour ... £17.00  
**Rotators**  
 CDR AR10 ... £20.40  
 CDR TR44 ... £27.75  
 CDR AR22 ... £25.65  
 HAM-M ... £70.00  
**Trio**  
 TS-515 Transceiver with A.C. p.s.u. ... £235.00  
 JWR 310 Receiver ... £23.50  
 9R59DS Receiver ... £57.50  
 SP5D Speaker ... £4.50  
**KW**  
 KW200B Transceiver ... £240.00  
 KW Atlanta Transceiver ... £210.00  
 KW202 Receiver ... £140.00  
 KW20 Transmitter ... £145.00  
 KW107 Antenna Matching Unit ... £40.00  
 KW E-Z Match ... £15.00

**Hy-Gain Antenna Range**  
 12AVQ 10-15-20m. Vertical £16.50  
 14VQ 10-15-20-40m. Vertical ... £18.50  
 LC-80-Q Loading coil for 14AVQ 80m. ... £6.70  
 1BAVT-VWB 10-80m. Vertical ... £33.00  
 TH3 Mk. III 10-20m. 3 element 2 Kw Beam ... £69.50  
 TH3 Jnr. 10-20m. 600w. Beam ... £48.00  
 BN86 Balun ... £8.00  
**Asahi Antenna**  
 -3 band 3 element beam £62.25  
**J-Beam Range.** We stock the full range of 2 metre and 70 centimetres Antennae also their 16' portable mast and 4' extension piece.  
**G-Whip Antenna Range**  
 16m. Ranger ... £7.50  
 160-80m Duo Bander ... £9.00  
 10-15-20m. Tri Bander ... £9.50  
 10-15-20m. Multi Mobile £12.50  
 Coils for LF Bands ea. £4.00

**Sansai**  
 SE405 Mini SWR/Power Bridge ... £3.80  
**Osker Block Power Meters**  
 The de-luxe SWR Power Meter for the man who must have the best ... £18.00  
**T.T.C.**  
 Field Strength Meter ... £4.25  
 S.W.R. Power Meter ... £7.25  
 Field Strength Indicator ... £3.50  
 Mobile Hand Mike Hi-imp ... £3.38  
**Shure Microphones**  
 201 Hand Mike ... £5.75  
 444 Desk Mike ... £13.00  
**Madco Filters**  
 FL50A and FL75A B/Lee Connectors ... £6.00  
 FL50B and FL75B and PL259 Connectors ... £6.50  
 FH40 High Pass ... £2.10  
**Wighttraps**  
 Standard pair post paid £2.65  
 High Power pair post paid £3.90

Please remember we also extend a first-class service to customers in the general London area through the activity of our Southern Agents—J. H. Associates Ltd., Crickfield Lane, Bishops Scotford, Herts. Telephone 0279-55347. All enquiries to Bishops Scotford will be handled personally by Jeff Harris (G3LWM) who is also expected to home demonstrate wherever possible to those customers with a genuine interest.

A large S.A.E. will bring you our comprehensive stock list or details of any other item in our range. Excellent credit facilities with on the spot transactions. First class parking on our extensive forecourt for the caller.

## ELECTRON HOUSE, 510-514 ALUM ROCK ROAD, BIRMINGHAM 8

# STEPHENS - JAMES LTD.

70 PRIORY ROAD, LIVERPOOL, L4 9RZ

Tel: 051-263 7829

G3LRB  
G3MCN

\* \* \* \* \*  
The Widest Range of  
Equipment in the North  
\* \* \* \* \*

**Yaesu-Musen**  
 FT101 Transceiver ... £240  
 FT2F 2m Transceiver ... £84.00  
 FT200 Transceiver ... £134  
 FL500 Transmitter ... £140  
 FR500 Receiver ... £120/£160  
 Remote VFO's ... £38.00  
 SP400 Loudspeaker ... £10.00  
 FL2000B Linear ... £135  
 FL2100 Linear ... £135.00  
 YD844 Table Microphone £12.00  
 YD846 Hand Microphone £5.00  
 FT401 Transceiver ... £215  
 FT360 Transceiver ... £195  
 FR50B Receiver ... £52.00  
 FL50B Transmitter ... £61.00  
 FT75 Transceiver ... £80.00  
 FP75 A.C. P.s.u. ... £20.00  
 DC75 P.s.u. ... £20.00  
**KW Electronics**  
 KW202 Receiver ... £140  
 KW204 Transmitter ... £145  
 KW2000B Transceiver ... £240  
 KW2000B Remote VFO ... £39.00  
 KW Atlanta Transceiver ... £210  
 KW Atlanta VFO ... £37.00  
 KW107 Antenna Matching Unit ... £40.00  
 KW E-Z Match ... £15.00  
 KW103 SWR/Power Meter ... £12.50  
 KW Trap Dipole ... £12.50  
 KW Traps per pair ... £4.50  
 KW Dummy Load 50 ohms ... £7.00  
 KW Balun ... £1.95  
 KW105 Matching Unit ... £37.00  
**Trio**  
 9R59DS Receiver ... £57.50  
 JR310 Receiver ... £83.50  
 SP5D Loudspeaker ... £4.50  
 TR-7100 2M Transceiver ... £95.00  
 TS515 Transceiver ... £235

**Hy-Gain Antenna Range**  
 12AVQ 10-15-20m. Vertical £16.50  
 14VQ/VWB 10-15-20-40m. Vertical ... £18.50  
 18AVQ/VWB 10 through 80m. ... £33.00  
 TH6DX Tribander Beam ... £86.00  
 TH3MK3 Tribander Beam ... £67.50  
 TH3JNR Tribander Beam ... £48.00  
 TH2 MK3 Two Element ... £48.00  
 LC80Q Loading Coil ... £6.75  
 BN86 Balun ... £7.75  
 203BA 20m. 3 Element ... £68.50  
**G-Whip Antenna Range**  
 160m. Ranger ... £7.50  
 160/80m. Duobander ... £9.00  
 10-15-20m. Tribander ... £9.50  
 Coils for LF Bands each Basemounts ... £1.45  
 2 metre 5/8th Vertical ... £4.20  
 Multimobile ... £12.50  
**Lafayette**  
 HA500A Receiver ... £50.00  
**Test Equipment**  
 Tech 15 G.D.O. ... £12.50  
 Asahi SWR Bridge ... £7.50  
 Asahi SWR/Power Meter ... £13.50  
 TNK TW20B Multimeter ... £11.50  
 TNK TW50K Multimeter ... £8.00  
 Sansai SWR Bridge ... £4.00  
 TNK TW50 K Multimeter ... £8.50  
 TMLP436 Multimeter ... £7.00  
 C1000 Pocket Multimeter ... £3.25  
 Omega Noise Bridge TE701 ... £13.50  
 Omega Noise Bridge TE702 ... £19.50  
 Hansen SWR Bridge ... £4.50  
 TE16A Transistor Sig. Gen ... £7.95  
 Tech to 2 Oscilloscope ... £22.50  
 Medco High Pass Filters ... £2.40  
 TE 22D Sig.-Gen. ... £15.00

**Microphones**  
 Shure 210 ... £5.75  
 Shure 444 ... £14.00  
 Sentinel 2m. Converters ... £13.75  
 Sentinel 4m. Converters ... £13.75  
 Sentinel 70cm. Converter ... £13.75  
**Eddystone**  
 EC10 Mk. 2 Receiver ... £79.00  
 A.C. Power Unit ... £7.75  
 898 S. M. Drive ... £8.92  
 EB37 Receiver ... £98.00  
**J Beam**  
 We are now stocking the full range of J Beam antennae, at current prices. Lashing kits, masts etc.  
 Plastic QSL Card Holders.  
 Holds 12 cards. 10 for 25p, post 6p  
 Copal 222 24 Hour ... £7.50  
 Copal 601 24 hour Calendar ... £14.95  
 Antenna Rotators  
 Semi Automatic Bug Keys ... £20, £25, £40, £70  
 HZP Balun ... £4.50  
 Wight Balun ... £3.00  
 Wight Traps per pair ... £2.50  
 Dipole T Pieces ... 13p  
 Egg Insulators ... 3p  
 300 Ohm Twin Feeder ... per yd. 5p  
 50 Ohm coaxial cable ... per yd. 12p  
 75 Ohm Twin Feeder ... 5p  
 Tunable RF meters ... £4.00  
 PL259 Plugs ... 30p  
 Sockets ... 30p  
 Cable reducers ... 10p  
 Line connectors ... 90p  
 QVQO 3-20A ... £1.75  
 QVQO 3-10 ... 75p

**Codar**  
 AT5 A.C. P.s.u. ... £11.50  
 AT5 Mk. 2 Transmitter ... £22.50  
 PR40 Presetor ... £8.50  
 CR70A Receiver ... £27.50  
**Secondhand Equipment**  
 National NCX5 Mk. 2 ... £175  
 Collins 755-1 Rx ... £145  
 KW201 Receiver ... £85.00  
 Heathkit SB300 Rx. ... £95.00  
 Trio TS510 and A.C. P.s.u. ... £125.00  
 Sommerkamp FR500 Rx. ... £100  
 Lafayette KT320 Receiver ... £25.00  
 Eddystone EB35 with A.C. p.s.u. ... £60.00  
 KW Atlanta with A.C. p.s.u. VFO. VOX Unit ... £175.00  
 Lafayette HA600 Rx. ... £38.00  
 Collins 7551 Rx. ... £175.00  
 Inoue Tx. Rx. and p.s.u. ... £125.00  
 Sommerkamp FL2000 Linear ... £100.00  
 FT2F Transceiver ... £65.00  
 Osker Power Meter ... £15.00  
 KW200B Transceiver ... £180.00  
 Sommerkamp FL500 Tx. ... £120.00  
 Heathkit DX100U ... £35.00  
 Full range of Eddystone die-cast boxes, Stella cabinets, All panels and chassis, Panel meters, plugs, valves. Full information on all products sent on receipt of LARGE S.A.E. Return mail order service on all stocked items. Orders under 25p respectfully declined.  
 Carriage/postage extra, all items.  
 All RSGB Publications stocked at current prices.  
 Full demonstration facilities.

HP terms arranged on all orders over £25. Minimum deposit 10% on all equipment. Part exchanges welcomed. Equipment bought for cash. After Sales Service. Shop hours 9.30 to 1 p.m. 2.15 to 6 p.m. Half day is Wednesday

WE SHALL BE EXHIBITING AT THE A.R.R.A. TRADE SHOW LEICESTER OCTOBER 26-28th.

# SOLID STATE MODULES

Telephone: HUDDERSFIELD 23991

63 WOODHEAD ROAD,  
SOLID, LOCKWOOD,  
HUDDERSFIELD, HD4 6ER

We advise all potential buyers of equipment, of the type we manufacture to be careful to buy from a well established manufacturer, as we find many people coming to us, after having purchased unsatisfactory equipment, and having to buy again. We might say, "Buy by recommendation." Most of our present customers do! G3MXG.

CALL IN ANYTIME and inspect our own manufacture gear, also our range of Yaesu Musen and second-hand gear. All the gear should be in stock, but you can always ring for confirmation.

### THE SENTINEL 2 and 4 METRE CONVERTER

- ★ Low noise figure 2dB.
- ★ Gain 30dB.
- ★ Dual gate MOSFETs in the RF amplifiers and mixer for excellent overload and cross modulation characteristics.
- ★ Size only 2½" x 3" x 1½" aluminium case—silver hammer finish with black trim.
- ★ Stock IFs: 2-4 MHz, 4-6 MHz, 8-10 MHz, 14-16 MHz, 18-20 MHz, 23-25 MHz, 24-26 MHz, 27-7-29-7 MHz, 28-30 MHz.
- ★ 4 metre IFs: 4-4-7 MHz, 25-25-7 MHz, 28-28-7 MHz.
- ★ Price: £13-75.

### NEW—THE SENTINEL X DUAL GATE MOSFET CONVERTER

This new 2 metre converter is a deluxe version of our well established Sentinel converter. It has the same basic specification but may be used with an internal mains P.S.U. and with battery supplies. It features an RF gain control to reduce cross modulation and overload of the main receiver and may be switched between mains and battery. Size is 5" x 1½" front 4" deep. IFs from stock 28-30 MHz and 4-6 MHz. Price £16-50 less mains P.S.U. £19-50 including P.S.U. The Power Supply unit may be added easily in future.

Want to pep up your present 2 metre receiver?

### THE SENTINEL LOW NOISE FET 2 METRE PRE-AMPLIFIER

- ★ Low noise figure 1dB.
- ★ Gain 18dB.
- ★ Size and appearance to match the Sentinel Converter.
- ★ Price £6-50.

Want to receive 70 cms cheaply but well?

### SM70 70cm CONVERTER

- ★ Low noise figure 4-5dB.
- ★ IF output 144-146 MHz. By using the 70cm converter with a 2 metre converter you can have a high performance 70cm. unit at a low price—£13-75.

### THE SPITFIRE 2 METRE A.M. TRANSMITTER

- ★ 5 watts input. At least 2 watts output.
- ★ 12 volts operation.
- ★ Modulation wave shaping gives good, clean 100% audio.
- ★ Audio monitoring point for headphones.
- ★ Size 4½" x 2½" x 5½".
- ★ Front panel meter indicates R.F. output and modulation. Price £22-00.

### THE SPITFIRE MODULATOR

- ★ Same size and appearance as the transmitter.
- ★ 100% modulates our transmitter.
- ★ Price £10-00.

### SOLID STATE 9 MHz SSB GENERATOR

- ★ Selectable USB, LSB and CW.
- ★ 50 volts into 80 Ohms.
- ★ Sideband suppression 45dB. Carrier suppression 50dB.
- ★ A sound basis for your SSB transmitter.
- ★ Price £11-00 less filter and carrier crystals.
- ★ XF-9A filter £11-00. Carrier crystals £1-50 each.

### T.B.C. I. CONVERTS TOP BAND TO MEDIUM WAVE 600-800 kHz

- ★ Internal battery—switches straight through when OFF.
- ★ Ideal for car radio use when mobile. Price £7-50.

### YAESU MUSEN GEAR FROM STOCK

FT101 £240, plus top band, £255. FT200 Transceiver £134. AC supply £38. FT401 Transceiver £215. FT550 Transceiver £195. FR400 Super de Luxe receiver £160. Loudspeaker unit £10.

This we offer with service facilities at our premises—often carried out while you wait, as we do with our own equipment.

### SECOND-HAND GEAR

KW2000A £150. HA350 £55. THE ORIGINAL G2DAF MK II. Built by G2DAF himself, only £50. LG50 as new £27-50. Also as new KW202, £115.

KVG filters, SL600 series ICs and components as previously advertised.

May we draw  
your attention



MR 18 ONE OFF  
WS 33 TWO OFF  
TR 50 FOUR OFF  
Z104 ONE OFF

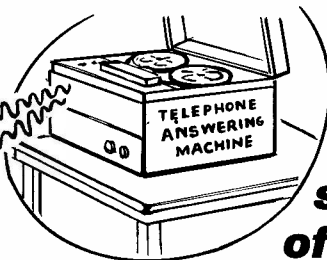

to the  
simplest way  
of ordering goods

from  
**HOME RADIO** (COMPONENTS)  
LIMITED

240 London Road, Mitcham. CR4 3HD Tel: 01-648 8422

It's late at night but that doesn't stop our young electronics enthusiast from ordering components. He dialled 01-648 8422 and phoned his requirements, knowing that our Answering Machine will store his message for us to deal with next morning. As a member of our Credit Account Service he is well aware of the advantages it brings him.

POST THIS COUPON with cheque or P.O. for 70p.

Please use block capitals

Name .....

Address .....

**HOME RADIO (Components) LTD.**  
Dept. SW, 234-240 London Rd., Mitcham, CR43HD

He has, for instance, a free supply of our pre-paid envelopes and order forms, for use when it suits him better to write his requirements, rather than phone them. This alone saves him quite a bit. Not to mention his time spent in buying stamps and envelopes!

We have over 300 customers in our Credit Account Service, some sending us several orders a week, others just a few a year; but they all appreciate the fact that after being in the service for 12 months we supply up-dated Catalogues and Price Lists free of charge.

Now—if you have not already got a copy of our Components Catalogue send the coupon with cheque or P.O. for 70 pence. More than 8,000 items listed, over 1,500 illustrated. Moreover, with the catalogue you get 10 vouchers each worth 5p when used as instructed.

If you call at our shop (open 9 to 5.30 Monday to Saturday, except Wednesday 9 to 1) you can buy the catalogue for 50 pence, thus saving the 20p packing and postage. Details and entry forms for our Credit Account Service are included in each catalogue. Send today.

The price of 70p applies only to catalogues purchased by customers in the UK and to BFPO addresses.

**GIEGER COUNTERS** (For mains or portable battery use). Latest Home Office release and probably the last of this well known Contamination Meter No. 1, this very useful instrument is used for the measurement of Radio-Activity. Indicated on an Internal Meter scaled 0.1 to 10 milli Rontgens/Hour, a socket is also provided for additional sound Monitoring on Headphones. This instrument is housed in a strong, light alloy case, placed in a carrying haversack with shoulder strap. Containing cable and hand held probe, instruction card, plus the latest plug-in Vibrator Power Unit. Which uses current small transistor radio batteries (4 Mallory long life RM12 or 4 Ever Ready H.P.7 or equivalent makes). For Mobile use anywhere. (Cost Govt. approx. £70 each). Supplied brand new in carton only £5.50, carriage 50p. An additional plug-in Power Unit for Laboratory use, operating from 100-120 volts or 200-250 volts A.V. mains is available. Supplied brand new in carton at only £2.50, post 50p. Headphones (not necessary) if required £1.50. A few Gieger Counters as above new but not boxed in cardboard carton available at only £4.50 Carr. 50p.

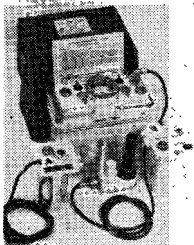

**TRANSCEIVERS.** Due to warehouse clearance we have for disposal, few only Transceivers No. 62 Mk. 2, made by Pye for the Navy and Army. Using a total of 11 valves, 1 R.F. and 2 I.F. stages, A.V.C., B.F.O. covering 1.5 Mc/s. to 10 Mc/s. (approx. 200 to 30 metres) in two switched bands. Can be used on RT or CW M.O. or Crystal. A very good internal ATU made of a rotating silver wire coil, tunable over the complete range, suitable for aerials. ftt. to 100ft., internal P.U. for 12 volt D.C. A meter is fitted for checking voltages A.V.C., etc. Housed in a metal waterproof case, approx. size 18" x 10 1/2" x 12 1/2". Supplied in very good used condition with headphones and mike, two spare valves, circuit, boxed. Few at £12.50, carriage £1. Airtested £1 extra. A few grade 2 sets £9.50, carriage £1. Airtested £1 extra. **CRYSTAL CALIBRATOR No. 10.** Range 500 kc/s. to 10 Mc/s., up to 30 Mc/s. on Harmonics. Size: 7" x 7 1/2" x 4". Power 300 volts HT, 12 volts LT. The Calibrator can plug into a Power Socket on the 62 Trans-Receiver which it was normally used with. Supplied in good used condition with circuit, £2.50, Post 50p or BRAND NEW IN CARTON with operating Manual and Circuit connectors to set £5, post 50p.

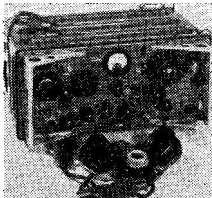

**WELL KNOWN NO. 19 TRANSCEIVERS MK. III** 2-8 Mc/s. on two switched Bands, 11 Valve Superhet, 807 TX P.A. Output, few only in Grade I condition (Rebuilt as New), £6.50, carriage £1.50. Brand New with Head and Mike sets £1.50. Mains Transformer for Receiver only supplying 275 Volts AC and 12 Volt LT £2. Or 500 Volt and 275 Volts and 12 Volts AC for Transmitter and Receiver £2.50, post for both 25p. These have been made specially for us for the 19 set.

**RITTY EQPT. CREED 7B TELEPRINTERS.** Brand New and Boxed in Wooden Transit Boxes £15 each, carriage £1.50, also all Auxiliary Equipment including Power Units, Terminal Units, 7B Paper etc. Phone your requirements.

**CLASS D WAVEMETERS NO. 2** Mains 100-250 AC, or 12 Volt DC Supply, complete in Grade I Condition with Leads, Headphones, Spare Valves, Calibration Charts Range 1.2-19 Mc/s. in Four Ranges (Over 30 Mc/s. on Harmonics), can be used as an Absorption Wavemeter utilising a Magic Eye Type Valve Indicator, or as a Heterodyne. Few only £10, carriage £1.50.

**12 VOLT 2.34 A.H. ALKALINE BATTERIES.** Nato Stock No. 6140-99-949-6145 completely unspillable, used for latest Army Transceivers, size only 7" x 2 1/2" x 3" approx. Made of 10 Alkaline cells moulded in Transparent Resin with unspillable Filler Caps. Supplied filled, Discharged. Remember these Batteries are meant to be practically Everlasting and never wear out, whatever condition they are left in or used. Supplied Brand New with Instruction only £4, or slightly used £3, post both 25p.

**PCR-I RECEIVERS.** Covers 860-2080 metres, 190-570 metres, 5.6-18 Mc/s., 1 R.F. and 2 I.F. stages, 6 Valves Internal Speaker, requires External Power Supply. 12 Volt LT 250 HT. Price in Grade I as New, £7.50, carriage £1.50, we also build an Internal Mains Power Unit 200-250 AC £2 each.

**MURPHY MARINE SHIP TRANSMITTERS** 1.5 to 16 Mc/s., VFO or Crystal, 40 watts RT or CW, Valves P.A. 3 5B/254M in Parallel. Modulation by 5B/254M. Two Panel Meters, size approx. 13" x 13" x 14" complete and clean but not tested. Less Power Supplies £7.50, carriage £1.50. A few similar PYE Units with same line up, but 13" x 15" x 14", have Calibrated VFO same price. Also a few matching Receivers at £10 each, carriage £1.50.

## JOHNS RADIO

Dept. B,  
424 BRADFORD ROAD,  
BATLEY, YORKS.

Phone: MORLEY 69696

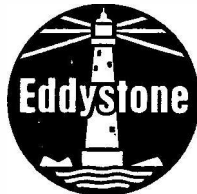

# "LISTEN TO THE WORLD WITH EDDYSTONE"

## Your local Eddystone dealer is:

### CHESHIRE

The Transistor Centre  
(Wilmslow) Ltd  
Green Lane  
Wilmslow 24766

### CORNWALL

R. V. Heming Ltd  
(Peter Heming G3WBW)  
Cliff Road, Newquay  
Newquay 2191

S.S.B. Products  
(Norman Birkett G3EKX)  
7 Little Castle Street  
Truro  
Devoran 862575

### DEVON

Graham Newbery  
(Reg Ward G2BSW) Axminster  
Axminster 3163

### ESSEX

F. E. Smith  
184 Moulsham Street  
Chelmsford  
Chelmsford 54594

### HAMPSHIRE

Southern Marine Radio  
(Southampton) Ltd  
Solent House, Town Quay  
Town Quay 22721

Wireless Supplies Unlimited  
264-266 Old Christchurch Road  
Bournemouth  
Bournemouth 24567

### IRELAND

John F. MacMahon  
10, Church Street, Enniskillen  
Co. Fermanagh, N. Ireland  
Enniskillen 2955

### ISLE OF WIGHT

Sherratt & Son  
81-82-83 High Street, Newport  
Newport 3358-9

### KENT

G. T. & R. Wilson  
12-14-16 Queen Street  
Gravesend  
Gravesend 63527/8

### LANCASHIRE

Holdings Photo Audio Centre  
Mincing Lane - Darwen Street,  
Blackburn BB2 2AF  
Tel. 59595

Stephen-James Ltd  
70 Priory Road, Anfield  
Liverpool L4 2RZ  
051-263 7829

North West Electrics  
769 Stockport Road  
Levenshulme, Manchester 19  
061-224 4911

Croffilm Ltd  
46 Friargate  
Preston PRI-2AT  
Preston 55244

### LEICESTERSHIRE

A. K. Davey Ltd  
New Street, Hinckley  
Hinckley 2173 and 4288

### LONDON

Imhofs (Retail) Ltd  
112-116 New Oxford Street  
W.C.1  
01-636 7878

R. T. & I. Electronics Ltd  
Ashville Old Hall  
Ashville Road  
Leytonstone, E.11  
01-539 4986

Radio Shack Ltd  
182 Broadhurst Gardens  
London, N.W.6  
01-624 7174

### NORFOLK

The Record Shop  
157 King Street  
Great Yarmouth

### NORTHUMBERL'D

Aitken Bros. & Company  
35 High Bridge  
Newcastle upon Tyne NE1 1EW  
Newcastle upon Tyne 26729

### SCOTLAND

L. Hardie  
542, George Street  
Aberdeen  
Aberdeen 20113

### WALES

Holt High Fidelity  
Pleaton Arcade, Swansea  
Swansea 53254

Holt High Fidelity  
8 Portland Street, Swansea  
Swansea 41032

### WARWICKSHIRE

Chas. H. Young Ltd  
170/172 Corporation Street  
Birmingham 4  
021-236 1635

**ADVERTISERS  
INDEX**

	PAGE
Aero & General Supplies ...	311
Amateur Electronics (G3FIK) ...	266
Belding & Bennett (Morse) ...	320
B.I.E.T. ... ..	317
J. Birkett ... ..	310
Burns Electronics ... ..	320
C.D. Telecomms ... ..	320
Colomor Electronics, Ltd. ...	315
Derwent Radio ... ..	311
E. & E. Services ... ..	309
Echelford Communications ...	314
Eddystone Agents ... ..	268
Eley Electronics ... ..	318
General Merchandise Credit, Ltd. ... ..	316
G.W.M. Radio ... ..	311
Heath (Gloucester) Ltd. ...	263
Holdings Photo-Audio Centre (Trio) ... ..	317, 320
Home Radio (Components) Ltd. ... ..	267
Imhofs ... ..	270
John's Radio ... ..	268
K.W. Electronics ... ..	265
K.W. Developments, Ltd. ...	319
Lowe Electronics ... ..	260, 261
May (Leicester) Ltd. ... ..	317
Markham Electronics ... ..	316
Marktyme ... ..	319
Mosley Electronics ... ..	258
North West Electrics ... ..	262
P. & P. Developments <i>back cover</i>	
Partridge Electronics, Ltd. ...	310
Radio Shack, Ltd. ... ..	259
R. T. & I. Electronics, Ltd. ...	310
Senator Crystals ... ..	309, 311
Small Advertisements ... ..	312-319
Smith, G. W. (Radio) ... ..	265
Solid State Modules ... ..	267
Spacemark, Ltd. ... ..	313
SSB Products ... ..	313
Stephens-James ... ..	266
Strumech Engineering ... ..	270
S.W.M. Publications <i>inside back cover, back cover, 264, 270, 312, 320</i>	
Taurus Electrical Services ...	318
The Amateur Radio Shop (Huddersfield) ... ..	320
The Radio Shop (Bristol) ...	309
The Trading Post ... ..	255
J. & A. Tweedy (Electronic Supplies) Ltd. ... ..	315
Reg. Ward & Co., Ltd. ... ..	314
Western Electronics, Ltd. <i>front cover, 257, 258</i>	
Yukan ... ..	317

# SHORT WAVE MAGAZINE

(GB3SWM)

Vol. XXX

JULY, 1972

No. 345

## CONTENTS

	Page
<b>Editorial—Announcements</b> ... ..	271
<b>Communication and DX News</b> , by E. P. Essery, G3KFE ... ..	272
<b>The Mobile Scene</b> ... ..	278
<b>The Rally Calendar</b> ... ..	279
<b>Extending Digital Frequency Meter Range</b> , by W. H. Fletcher, B.Sc., G3NXT ... ..	281
<b>Getting A 5/8th Wave for Top Band</b> , by M. D. Booth, G3YNO ... ..	283
<b>Frequency Modulation, Part I</b> , by A. J. Henk, G8DIK ... ..	284
<b>Aerial Adapter for Top Band</b> , by F. G. Rayer, A.I.E.R.E., G3OGR ... ..	288
<b>On the Relative Effectiveness of Beams and Linears</b> , by P. R. Cragg, G3UGK ... ..	289
<b>Calibrating A Bug</b> , by W. Baker, B.Sc., G3HDQ ... ..	290
<b>“SWL”—Listener Feature</b> ... ..	291
<b>VHF Bands</b> , by A. H. Dormer, G3DAH ... ..	296
<b>Items of Interest</b> ... ..	301
<b>Specially on The Air</b> ... ..	302
<b>The Month with The Clubs—From Reports</b> ... ..	303
<b>New QTH's...</b> ... ..	308

*Managing Editor:* AUSTIN FORSYTH, O.B.E. (G6FO/G3SWM)

*Advertising:* Maria Greenwood

*Published at 55 Victoria Street, London, SW1H-0HF, on the last Friday of the month, dated the month following. Telephone: 01-222 5341 & 5342*

**Annual Subscription:** Home: £2.75 (£3.00 first class) post paid  
Overseas: £2.75 \$(7.00 U.S.), post free surface mail

**Editorial Address:** Short Wave Magazine, BUCKINGHAM, England

## AUTHORS' MSS

*Articles submitted for Editorial consideration must be typed double-spaced with wide margins on one side only of quarto or foolscap sheets. Photographs should be lightly identified in pencil on the back with details on a separate sheet. All drawings and diagrams should also be shown separately, and tables of values prepared in accordance with our normal setting convention—see any issue. Payment is made for all material used, and it is a condition of acceptance that full copyright passes to the Short Wave Magazine, Ltd., on publication.*

© Short Wave Magazine Ltd.

# INSIST ON VERSATOWER

Acclaimed as the World's leading telescopic tiltover tower in the field of radio communication  
Models from 25' to 120'

Enquires to  
Western Electronics (UK) Ltd  
Osborne Road, Totton, Southampton

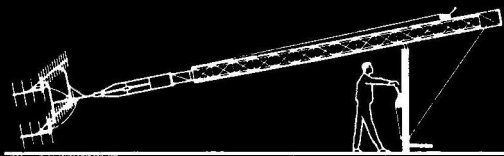

Look for the name

**STRUMECH**

Strumech Engineering Co Ltd  
Coppice Side, Brownhills, Walsall, Staffs.

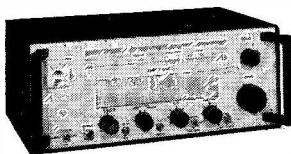

## new from eddystone

### Model 1000 Communications Receiver

Introducing the very latest communications receiver from the Eddystone stable. The model 1000 covers C.W., M.C.W., A.M. and S.S.B. having a frequency range of 30 MHz to 550KHz. Powered by integral battery pack (rechargeable) or A.C. mains (110-250v 50-60 Hz). Other features include single conversion using I.C., F.E. and bi-polar transistors, desensitising facilities, carrier level meter and separate fine tuning control. Variable selectivity is achieved by incorporating high grade ceramic ladder filters. A pre-production model of this remarkable new receiver can be heard and inspected in the Eddystone showroom at Imhofs.

### Other outstanding winners

**Eddystone EC10 Mk. 2.** Still 'Top of the Pops' in the modest price range of communication receivers. Embodies features usually only found in the more expensive designs. £79-00.

**Eddystone EB37.** A high performance transistorised receiver with long, medium and three short wave bands. Powered by batteries or A.C. supply. £102-90 (including £18-90 tax).

**Eddystone 830/7.** Wide range communications receiver. A high grade HF/MF receiver covering 300 KHz - 30 MHz in nine ranges with crystal control facilities. Many satisfied users acclaim it as 'the best ever'. £389-00.

Write for comprehensive leaflets on any of the above.

**IMHOFS**

MAIN EDDYSTONE DISTRIBUTORS



Dept: 11/7

112-116 New Oxford Street, London, WC1A 1HJ.

Tel: 01-636 7878  
R67

## CALL BOOKS

### INTERNATIONAL :

- RADIO AMATEUR CALL BOOK**
- "DX Listings" . . . . . £3-10
- "U.S. Listings" . . . . . £4-10
- The two together, covering the World . . . . . £6-80
- "G's" only 1972 . . . . . 60p

## MAPS

### AMATEUR RADIO MAP OF WORLD

Mercator Projection — Much DX Information — in colour. Second Edition . . . . . 65p

### DX ZONE MAP (GREAT CIRCLE)

In colour with Country/Prefix Supplement Revised to January 1972 . . . . . 85p

### RADIO AMATEUR MAP OF THE U.S.A. AND NORTH AMERICA

State boundaries and prefixes, size 24" by 30", paper . . . . . 60p

### RADIO AMATEUR'S WORLD ATLAS

In booklet form, Mercator projection, for desk use. Gives Zones and Prefixes . . . . . 85p

## LOGS BOOKS

- Standard Log (New Glossy Cover) . . . . . 55p
- Log and VHF Contest Log . . . . . 40p
- Receiving Station Log . . . . . 45p

(The above prices include postage and packing).

## MORSE COURSES

### G3HSC Rhythm Method of Morse Tuition

- \*Complete Course with three 3 speed L.P. records with books . . . . . £4-50
- \*Beginner's Course with two 3 speed L.P. records with book . . . . . £3-30
- Single 12" L.P. Beginner's with book . . . . . £2-75
- Single, 12" L.P. Advanced with book . . . . . £2-75
- Three speed simulated GPO test. 7" d.s. E.P. record . . . . . 85p

Prices include postage, packing and insurance in U.K. only \*Overseas orders + £1-00.

Available from

## SHORT WAVE MAGAZINE

Publications Dept., 55 Victoria Street, London, SW1H 0HF . . . . . 01-222 5341

(Counter Service, 9.30-5.15, Mon. to Fri.)

(Nearest Station: St. James' Park)

(GIRO A/C No. 547 6151)



# The SHORT-WAVE Magazine

## E D I T O R I A L

### ***Announcements***

***National Book Sale:*** Every year at about this time there is a National Week of Book Sales, when discounts are offered and remainders are marked down.

We have decided to fall in with this notion and therefore—till July 7 only—readers ordering any of the books and other items offered by our Publications Dept. and listed in this issue may take a discount of 10% on the published price.

Note that this Sale Week is till July 7 only and applies strictly as indicated—which, in fact, does offer a pretty wide choice.

For callers (only) we have a number of titles reduced even further. These may be examined and purchased during office hours (9.30 a.m. til 5.15 p.m.) up to Friday, July 7.

We have never before joined in with the National Book Sale Week—may be that this is the last time we shall try it!

\* \* \* \*

***Show Plan:*** We are advised that the Amateur Radio Retailers' Association have arranged their first exhibition for October 26-28, at the Granby Halls, Leicester, where there is not only more than ample stand space but also parking in the vicinity for about 5,000 cars. As well as all the conveniences and amenities of a big provincial exhibition centre, there will be talk-in facilities on the active mobile bands.

Arrangements are in the hands of The Secretary, A.R.R.A., Mr. L. J. Hellier (G3TED), 26-28 Nottingham Road, Loughborough, Leicester, to whom all trade enquiries should be directed.

Austin Forth,  
G6FO.

# COMMUNICATION and DX NEWS

*E. P. Essery, G3KFE*

THIS piece is being written, as one would expect, in the middle of the month popularly known as "flaming June." Wherever the flames have been, they have not been in the sky—particularly on NFD weekend, when no fire could possibly have been sustained for long!—but whenever your conductor has turned his receiver on, particularly on the LF bands, he seems to have been in close proximity to that terminal accompaniment of a heat-wave—an electrical storm, at S9 plus.

## Top Band

An interesting letter from G3WZD (Hassocks) encloses a recent cutting from the *Mid-Sussex Times*, concerning the radio amateur activities of G3HUA, who, as an airline navigator, is able to work the DX and then on occasion follow straight up by a personal contact to hand over the QSL. For himself, Duncan runs his G3WZD station with a KW-2000, a quarter-wave end-fed wire for Eighty and a six-foot whip mounted on the eaves of the house for Top Band, the location being a place with a postage-stamp garden, on the landward side of the South Downs. So far, the six-foot whip arrangement has managed to work out to GW on Top Band, but G3WZD feels a little despondent about the possibilities of aerial experimentation in such a small area. Speaking from his own experience of operation in a similar environment, your scribe would think that such pessimism is hardly justified; after all, it is well known that if you reduce the length of a dipole by half, neglecting loading losses you only reduce the signal size by ten per cent. Thus, a forty-five-foot vertical, inductively loaded, against a good earth—and this is the vital point—can brew up a very potent signal, if one is prepared to take time extracting the most out of it. One can even, for instance, take an end-fed random length, and coil it into the garden at shoulder-

height, fed against a good earth, and, by adjustment of the length to make the current maximum rise to the top of the stub mast above the house (and necessary adjustments to the ATU to enable one to load the thing as before), make the difference between only just S7 and a report of S9 plus 20 from the same station and under ground-wave conditions. And after all, G3WZD is in the same local area as another station who used to report in to CDXN regularly on Top Band, using ten watts to a "best bent wire," with strings of W's worked—so some bright ideas may yet be forthcoming from the locals!

Top Band seems to have been deserted by G3DCS (Ipswich), he having only worked a couple of G's in the period we are reviewing; and anyway, Enver has put up his KW-2000 for disposal, having obtained a very reasonable FT-400 to replace it as spare rig.

NFD is a bind in one way, says GM3YOR (Kirkcaldy) in that he has to disconnect everything and take it to the site; and then it all has to come back and be reconnected after the battle, which means a few days of enforced QRT—but what odds when NFD is such fun! EI9BG, OK1DWA, and OL5ANJ were raised on CW, GM3DZB and GM4BBL for Banff and Shetland, and DK2JX on SSB; sked contacts generated by letter-writing also added CW QSO's with Scilly and Caithness to the score, and this activity is reflected in Drew's position in the Table.

G2HKU (Sheppey) agrees with G8HX and his comments on manual *versus* machine Morse, as will be noted elsewhere. As far as Top Band went, Ted managed SSB contacts with DJØMR and PAØPN, plus CW with GI5DX, GM3FSV and OK1HBT.

The CQ World-Wide Top Band CW Contest results (January 29-30) are just to hand. In all there were 16 U.K. entries (rather better than usual), the top scorers being

GW3PUK 45,849 points; GM3IGW/A 43,776 pts.; and G3VRW with 20,240 pts. The U.K. multi-operator stations were G3KMI (six ops.) 8,970 points; GM3IGW/A (two operators) score as given; and GW3UCB (eight ops., no less) with 7,579 points.

First three on a world basis were K1PBW 67,320 pts.; W3IN 64,856 and W3GM 64,618 points. Logs were received from 76 prefix-areas (American States and Canadian Provinces counting individually) and the U.K. showing can be regarded as quite satisfactory and certainly competitive in terms of scoring—of the JA's entered not one made over 1,000 points.

## Eighty

In the mail this time, we have a letter from Rip Van Winkel himself! R-V-W has never held his own call but was for long the operator at VS2BX, using an unmodified 19 Set on Forty after the hostilities-only chaps got demobbed and took their gear with them. Now, two sunspot cycles later, he is a ship's operator, who has of late come back and is now brushing-up for R.A.E. So much by way of introduction; now he listens on occasion to the local scene with the ship's "Atalanta" receiver to the nets on Eighty. Even for a CW DX chaser, R-V-W finds the chat about roses and rheumatics, about busybodies who accuse all and sundry of TVI and BCI, and all the talk, technical, pseudo-technical, and non-technical, quite fascinating. More, he goes on to say that there is evident self-discipline to let everyone get a fair crack of the whip. He compares this with the commercial scene, where, he is convinced, the majority of operators in ships are "chimpanzees recruited from low-IQ echelons of the world's Zoos." As proof, he cites the tendency for all-and-sundry to tell others to shut up and then transmit when they should be listening—he has even heard the *originator* of a distress call being told

to shut up! Maybe Eighty—outside the immediate skirts of the DX net and on the DX net frequency, that is—has been mis-judged by us; but the activities of the people who deliberately disrupt DX net operations can hardly be regarded as “civilised.”

G3RFG (Lower Stondon) has not been very active, between a holiday in Austria and other forms of QRM; and, indeed, on Eighty, Stan has only one CW QSO to offer, that with K1LWJ.

Another who only offers one QSO of DX stature is G4AMT (Penzance) who found it very hard going but managed to complete a SSB contact with VE2GJ; there was a PY on offer, but he appeared to be just out of the band!

Conditions have been about normal for the time of year and sunspot cycle, opines G2DC (Ringwood), although the night static has been so heavy that it was hardly worth bothering to look for DX. Nevertheless, better times did appear here and there, for CW exchanges to be made with PY1AMO, PY5OS, VP9GD, UA9HAP, UA9UA, W1-5, W8, W9 and VE1-3.

Those 90 watts p.e.p. at G3WZD have been tried out on Eighty into the quarter-wave wire and have been getting out well, though not as well—naturally!—as their owner would prefer, his two best being a brace of PY's with whom contacts did not quite occur!

For G3DCS it was mainly CW; SSB was used for LX1BW, DL0BX, PA0OS and PA0PAU only but key-bashing accounted for I1SOL, UK3ACC, UQ2GQ, GC2FMV, YU3ZV, UB5CV, OK1ARH, SM5TK, SM0CBC and UA1ARO.

A couple of interesting QSO's for G2HKU were, first, DK3SS /OH0 and OZ1W—the latter hardly DX, but Ted recalled working him on Top Band just after the War; he said that nowadays the Czech licensing authority will not even consider it!

W6AM (Palos Verdes, California) seems to have eased up quite a bit on his 80-metre activity since he cleared the required number for his 5BDXCC, but he did make one catch of importance during the period on this band, in KC4DX on Navassa.



Station GB2MT was established by the Marconi Apprentice Amateur Radio Club on the occasion of the 50th Anniversary (Feb. 14, 1972) of the commencement of regular BC-type broadcasting from the original 2MT, Writtle, Essex. Operation was on 80m. and in this picture G4BAV is on the microphone, then G3LZQ seated, with G8BFV standing.

### Linear versus Beam

The somewhat academic question on this posed by your conductor has been taken up enthusiastically—and see the article on p.289 in this issue by G3UGK.

G3ZPF (Dudley) would, for preference take a good gainy beam every time; but, as he says, if one cannot put up a beam, due to planning-permission or other problems, then one must use the best aerial one can, plus full power to raise the signal strength at the far end. But again, a linear is a sure way to TVI in built-up areas. On the other hand, when operating at DX, the beam every time and to blazes with the power—the rest of the world will pin its ears back to hear you, but the beam will help you reduce the pile-up in your own receiver!

G3WW (Wimblington) is now fully retired and able to give more time to his favourite occupation. Richard comments, with considerable logic, that to work 'em, you have first to hear 'em properly. As an example, G3WW and G3HXM

both have Collins 75-S3B receivers, and TH-6DX beams, the former at 60ft. and the latter at 110ft. Both worked the same ZS6 station and while G3HXM can give an honest R5S8, Richard can only offer R5S6-6½, while on “transmit” G3WW gets 56, and G3HXM 58; adding the linear balances out on “transmit,” until again G3HXM puts his linear on, when the gap opens again. From all this, Richard deduces that, once one has got a yagi, aerial height is more important than a linear. However, there is a rider, which is that the law is upset to some extent when using a Quad, the Quad at 30 feet being the equal of the beam at 50. Analysing all this, G3WW comes down to the opinion that the root of it is the front-to-back ratio of whatever beam you have that does the trick, regardless of the forward gain.

G5PR (Petersfield) was asked to talk to the Farnborough gang about QRP DX'ing recently, and so he put five watts on to 21 MHz into a Windom. The first two hours produced six W's, with the best

report S8, and the ensuing week a WAC with the sole exception of VK, which was not heard during any of the operating sessions. G5PR made his own first WAC back in 1934 with five watts to a Hartley "one-lunger" powered by a couple of Marks & Spencer dry batteries.

To get over the minor troubles with his /M kilowatt, W6AM tells us, Swan used four 30-amp transistors in parallel to cope with the 120-amp "draw." However, as to its usefulness, Don now wonders how the blazes he ever managed before, the improvement is so great!

G2DC comes in at this point. Jack says a DX station should go for both beam and linear so he can put in a good signal, riding over the QRM, if he is in a sparsely populated area, but if in a built-up locality, then a beam alone is enough. The station in the U.K. or, indeed anywhere in Europe, should go for a beam only, as the use of a linear in populated areas is a good way of generating all sorts of QRM, both with locals and with TV sets. Indeed, Jack reckons that the use of QRO commercial linears on Forty and Eighty "makes the term amateur, facetious."

Just to round this off and to show that any one of the items in the station can upset the appercart along comes G3DCS with his clanger of the month. Enver spent two or three minutes calling a W on Eighty—a W with a fine signal, who did not come back to the call. Look over the rig—receiver side, and hence the exciter drive, were both tuned to 14 MHz, the PA to 3.5 MHz. Very QRP!

#### Forty Metres

G2DC found the QRM during the evening and sometimes, even, the early morning, made the DX mighty hard to work, although Jack did try a few sessions from 0330-0530 in the hope of pay-dirt—they resulted in contacts with PY5SE, PY7OS, LU2ESO, LUSCE, VP9AF, VP9CK, VP9BDA, VP9GD, VK3MR, W1-0 and VE1-7.

For W6AM, we note a 40-metre CW contact with KC4DX, plus a couple of interesting ones in G8DV and W9IGW/CE0 as the pick of his work.

Now to G2HKU, who picked up YV6JB on SSB, plus CW contacts

with DL8NU/OH0, and PY6AIQ.

Having found so little life on Eighty, G4AMT had one or two early-morning spins round Forty, between 0400 and 0700, finding more activity at the CW end, where he worked W1, W2, W4, W9, VE2JL, LU3AU, and TG9CD; with, for good measure, SSB exchanges with YV1PW, OJ0SUF, and KZ5PW.

A couple of W's, in K8DJF and K9CLO, were the only ones considered worth a mention by G3RFG, who quite obviously, after his trip away, felt more inclination for the heady delights of short-skip on 28 MHz.

#### Keying Note

G8HX certainly stirred things up with his letter on this subject, in the last piece. G2HKU comes out in favour of the straight key, with which one can slightly stress one's dashes in order to make the signal seem clearer.

Our correspondent "Rip Van Winkel" has to listen to Morse for upwards of eight hours each working day, and regards the "personalised" Morse as thoroughly reprehensible, with the occasional well-handled el-bug sounding almost symphonic by contrast, provided the signal is in any case R5. However, R-V-W continues, when the going gets really tough, then G8HX has a point; as he says, what DX-minded CW amateur has not found himself sweating and *willing* readability into his Morse when he has a W6 on the hook and echo is prevalent; then one tends to lengthen the dashes and make the dots clearly separated.

G8HX comes back at this point and rather, to your conductor's mind, demolishes his own argument by saying that if you take some *good* Morse, with a high beat note, and record it at top speed on a tape-recorder, then play it back at the slow speed, it will still sound good. The *Tass* press news broadcast, for instance, will easily pass such a test.

What it all seems to say is that one should always have a pump-handle key wired in parallel with the el-bug (or the mechanical one for that matter) to use when the going gets rough. But, and this is the bit that really throws your scribe, is that to lengthen the dashes the same as shortening the dots—so why the

blazes is the guy who has his dots far too fast relative to his dashes on a normal bug key so infernally hard to read? After all we have just argued he is *easier* to take! (Or have we!)

#### Twenty Metres

A funny old band is this; but whether your interpretation of funny is "ha-ha" or "curious," there is no gainsaying that this is where the action is, whether at sunspot maximum, or the other thing.

G3DCS, with his limited time for radio, looked on the band on occasion, and came out of it with UG5OC, VB2KOC, ZD7AV, G3WWM/OE and UH5OC.

G2DC reckons that conditions are a wee bit down, probably due to the falling sunspot index but that conditions have fallen very well into line with the predictions—so no complaints! The pre-breakfast VK/ZL openings by long-path have shortened, and not many CW VK's have been on; the fact that the W6 path has been open at the same time doesn't help, unless you want to work W6. Those screws have eased up enough for him to use the key a bit, so CW it was, with CR4AG, FO8DF, FO8RV (G5RV), JT1AE, KH6IJ, KH6FF, KD6USA, KS6CG, KX6EB, PZ1AV, TI2PZ, UA0KAB, UW0BW, VK1-7, VP9AD, VP9BC, VP9BK, VP9BDA, VP9EP, VP9GD, XE1DE, YK8RV (G5RV), ZL1-4, 5W1AK (an ex-G from Hull) 8P6AY, 9M2DW and 9Y4DF.

From W6AM, quite a few contacts on his favourite band this time, on CW for instance UQ5OB, UK1ZFI, who must have worked just about every DX'er there is by the time they had finished, and had run up 13,000 QSOs from Franz Josef Land—an average of almost 1000 contacts a *day!*—KB6DA, UP5OC, EA7RA, PA0JUY, VU2OMR, and I2TQ. Turning to SSB, we find KR8EA, UK1ZFI, EP2YL, W9ICW/CE0, FR7ZQ and FW8AB.

The tri-band aerial described last time round by G3ZPF (Dudley) has run into some snags, mainly resulting in gravity taking over from the masts. One way to stop the wind taking charge of 300-ohm ribbon is to cut out sections of the central "web" between the wires, using the household scissors; both G6FO and the

writer have had considerable success with the scheme. It reduces both windage and hygroscopic effects. Be the latter as it may, G3ZPF got fed up with picking up pieces of multi-band aerial and reverted to a more substantial dipole for 14 MHz, which showed conditions to have been very variable, with an all-band black-out on April 28, 1300z for about half an hour, with conditions gradually coming back to normal during the afternoon, until by nightfall the band was quite lively. (David wants someone to explain it all to him!) His contacts were all SSB, and included, between visits to the wreckage of the aerial, UJ50A, UG50E, UH50C, UH50E, UM50A, UQ50E, UQ50D, OD5AM, OD5FE, OD5GC, 9K2AL, 9K2CI, PZ9AC, KR6DO, OH0NJ, OJ0SUF, 9Y4VV, 5Z4IP, 5Z4NC, 5Z4MD, 5Z4GK, IM0BUP, IM0BJG (an expedition to La Madeleine Is. which count as IS1 for DXCC), HS2AGP, JX1AK, VK2AVA, VK2SG, VQ9R, VU2MX and 4YA51/MM (an ICAO station).

In his spare time from Top Band, GM3YOR reckons to tickle up Twenty occasionally; this process, using his dots and dashes, got him OX3BD, UH8BX, UL7GAJ, UL7OE, UA9LAC, WA1FJT, WB2CIR/2, W3BBC, W3AVM, K2JFJ and K4EJI, not to mention the PACC contest, for the "worked" column of the log.

G3RFG likes to look around, just to see all is as it should be, and this brought him exchanges with VE1VR, VE7GM, VK3MJ, VK3MR, W4ZC, W8PTW, W0JF and W0ZLN.

On the Maritime Mobile front, G2NJ (Peterborough) is the man to tell you who is who—and Nick added another to his collection when he came across YU3TUA/MM on Twenty CW on the afternoon of June 11.

A chap who varies his use of the bands each month but seems always to be on the right one at the right time is G2HKU, and this time Ted connected on Sideband with MID, HC1HV, HK1NR, HK4CAV, HP1SC, IM0BUP, UG50B, W6PGI/MM (cruising in the Med., aboard the *President Wilson* of 23000 tons) ZL3SE, 5VZBB and 9Y4T.

#### Here and There

First, the QSL addresses (from

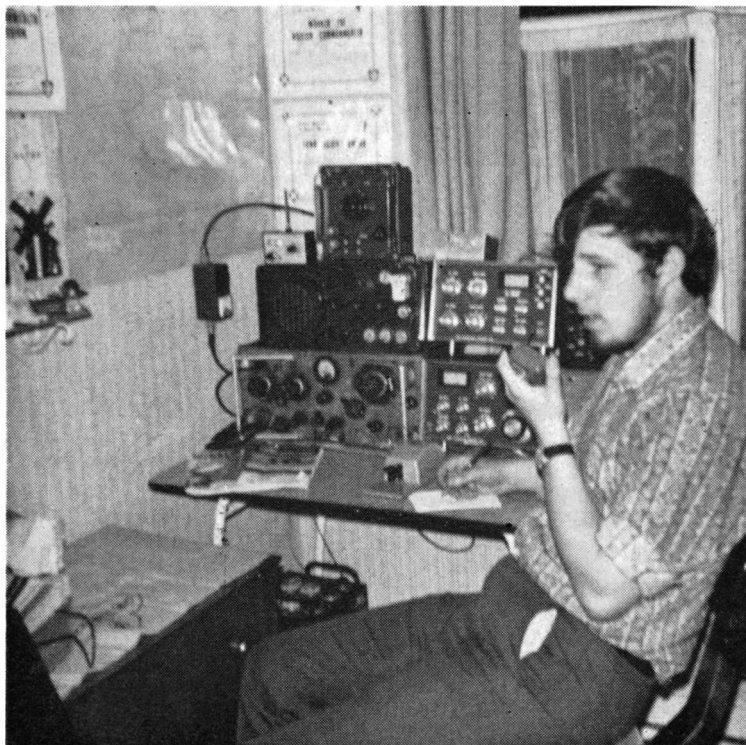

Here we have the station of James Baker, G3YHB, 86 Max Road, Liverpool, L14-4BJ, who started in the MinPost/Tel on the engineering side and was licensed in 1969. His present rig consists of Inoue IC-700T and IC-700R operated as a transceiver. The aeriels comprise a two-element boomless Quad for the 10-15-20m. bands, which are the main operating interest. G3YHB is now studying for the MPT marine operator's licence, which naturally has made CW the prime operating mode and contest working a particular interest—and he aims to be G3YHB/MM in due course.

G2HKU): HP1SC to Box 10494, Panama City; HK4CAV to Box 4596, Medellin, Colombia; and TR8VE, Box 13112, Libreville, Gabon Republic.

Chester Club are going to "do" the Orkneys this year; they will be at a site near Kirkwall from July 2 till July 8, using all bands 10-160 metres as conditions permit, signing GM3GIZ/P.

A couple of late notifications concern, oddly enough, the Presidential election campaign gradually getting up steam in the U.S.A. The national political conventions are both at Miami Springs, and from there, on July 10-13, will appear WD4USA for the Democrats, and WR4USA follows between August 21-24 for the Republicans; both will use 7072 and 14072 kHz for CW, 7272 and 14317 kHz SSB, and QSL's with 1RC should be sent to Special Event station (call), P.O. Box 501, Miami Springs, 33166,

U.S.A.

G3IDG (Basingstoke) brings up the question of the lengthening sequence of signals that seem to be involved in completing a contest CW contact. At one time it seemed to be enough, if you had it all, to go back with R. Then, for some odd reason, QSL became popular. Now, the latest variety of lunacy, is to send *Confm yr 559123*, with, for preference, a couple of errors in the play-back. Quite apart from the mere question of reading the Morse, why is it necessary for longer and longer phrases to be used to replace R, which was more than adequate anyway? Allan has a point here, and one cannot agree with the present trend; but perhaps it has come about because some contest organisers are starting to tread hardily on the chaps who send in bad logs.

#### Fifteen Metres

Once again we go through the

reports, and G3DCS is on top; Enver offers OAN4HA, 9Y4VU and CR6AI, all worked on CW.

W6AM comes in at this point, with a QSO with G6YL on CW (at a time when he happened to be entertaining G2FDF) HI3XGW on SB, W9ICW/CEO in both modes.

While enthusiasm for Fifteen was higher than the aerial death-rate, G3ZPF used the band, and came out with SSB to YB0AAO, 9M2CW, OD5HF, OD5LS, OD5FH, OD5GC, 9Q5RN, 9Q5DX, 9Q5IA, 9X5VA, 5Z4KZ, 5X5NA, 6W8AL, CR6IY, CR7IZ, FL8MM. PZ1AH and SX0E/72.

Fifteen for G3RFG seems to have been mainly a matter of working through the JA's, CW accounting for JA2LWA, JA3TXG, JA7AD, JA8MP, JA9GMA, JH1MDJ, JH1OTZ, JH1VOE and JH1WKS, plus JT0AE and PY7AHO.

Earlier we mentioned the five watts at G5PR—well, Clive has these to offer as proof of his contention that five watts is enough: ZE1DX, JH1BNC, ZS5BA, W7RO, PY7AHO, CP1AP, JA1QER, 6W8BD, HK7UL, UA9NN, 9L1GC, PY2ABJ and CP7GM—and don't forget they were all hooked in the one week, just to prove a point for a lecture!

On Fifteen, says G4AMT, he kept thinking how rough the band sounded, but when he came to reckon up his offering he found he had made two-way SSB contact with UK1ZFI, W6OCU, W6ZII, W6MSM, VQ9R, VQ9MC, VU2HLU, 5X5NA, 9M2DQ, OA5NBO, UL7NH, VE6EO, 9Q5HP, CR6AN, JA6BXY/MM (off CR7), JR1BDK, 5H3LV, one lone

W out of the sixth area in W0GX, ET3USF, and IM0BUP. So . . . what's the complaint?

It is nice to hear from GM3JDR (Wick) again—we almost thought he had sunk in the QRM on Forty! Nothing of the sort—he just took to the boats and rowed to Fifteen, where his CW came up with YV5DEK, UA9NN, UR50D, CE3ED, OH0MA, ZD8JK, UH50C, PY2BIB, CP1JV, VA2UN, WM2GK, KH6CHC, U18HC, VR1AA, KX6EB, UY50D, UA0DV, UG50D, UG50A, UK0CAS, PJ2HT, HB0XJL, YV1ABF, CR7FM, CR7EY, UK9QAA, UK7EAA, UK9CBD, UL7CT, HS5ABD, UK9AAD, 9L1GC, UJ8AW, UJ50A, UJ50C, UW0AJ, UM50E, UW0IW, OA6BB, HC2DX/8, HK3AVK, PY1MHN, PY1CPR, plus lots of JA, JR, JE and JH, and all W call areas. Not satisfied with this lot, Don set about the SSB end of the band with gusto, and hooked EP2JP, EL8G, PY1BHW, PZ1AK, SXOE/72, UL7YR, ET3ZU, CR3RY, 5VZBB, LU3AHR, LU9ACI, VP9MZ, SK0ITU, UJ50A, EP2BQ, VR1AA, lots of JA, JR, JH, JE and all W call areas.

G2DC found the periods from 0630-0730 and 1000-1200z to be about the best times of day for Fifteen, always provided that by not CQ'ing too much you can avoid the hordes of JA. 5W1AB was smothered by a bundle of SSB Italians all calling no matter who the 5W1 want back to—quite enough to make G2DC glad to find his pains had eased enough for him to go back to the peace of the CW end of the band! Commercial is a bit of a nuisance, the latest being a "thing" that starts at 21005 kHz, has whiskers every 15 kHz up the band, sends P continuously at RST 597, and appears to be a jammer blown off course! Jack's CW reached out to lots of JA's, JT1AE, KH6CHC, KX6EB, PJ8WP, VP9's, XE2BG, ZS1MS, ZS6OS, 9L1GC, 9Y4DB, 9K2BQ, all W call areas, VE1-5 and VE7.

**Ten Metres**

Now most definitely waning, with what little propagation there is almost all over the North-South paths. G3RFG likes the band, and his CW searches ferreted out DJ1ZT,

DK5EL, DL2BO, DL7AA, DL7EG, DL7MA, DL9DM, EA6BD, HG5CF, I1KTC, I1SMT, I2CZQ, LA2ZN, LU1DEN, OH2EH, OJ0SUF, OK3LO, OZ5FG, OZ9AO, SM3MQ, SM5BAX, SM5BCF/7, SM5RE, SM0DWK, UK2PAR, UP2BAW, YU2NU, YU1JRS, YU3APR, 8P6DR and 9L1GC.

That multi-band dipole at G3ZPF seems awfully sharp to Dave, who is now thinking rather along the lines of using, say, three dipoles for Ten on a common feeder, each one cut to cover a particular segment of the band—your conductor is not sure what would happen in such an arrangement but rather suspects it would "play up" somewhat.

Only one QSO on Ten is noted by W6AM, who rang the bell with the San Felix crew, W9ICW/CE0 just as soon as the band opened up.

From G3DCS, a terse footnote—"Ten metres . . . Nil!" sums it up nicely. It almost goes for G2DC also; Jack looked the band over several times, for contacts with Eastern Europeans, Asiatic Russians and a few Africans. There is even the odd W now and again, but they are all getting scarcer nowadays.

**Other Snippets**

The recent A51KV DX-pedition went QRT after only 880 QSO's, because the rains came on early and rendered the dirt roads somewhat tricky to use. However, Venkat did find time to tackle the repair of A51TY's SR-150 rig, so Yonten is now representing the prefix once again, often around 14217 kHz, and 1420z would be a time to try.

We hear that ZK1MA (Manihiki) is back home again, and active on the bands; he has been reported as dropping in to the Pandora's Box net, on 14277 kHz around 0500z for the early-birds. A QSL should go to W6KNH.

If you should hear a station signing with a PT prefix, don't write him off as a pirate. All the PY's in Brasilia are using the PT prefix; the QSL bureau for the Brasilia district is P.O. Box 07-0911, Brasilia, DF-70000, Brazil. Another good reason last month for not neglecting the PT prefix was that PT0MI and PT0WH, the former on SSB and the latter on CW, were on over the period June 17-20 from St. Peter and St. Paul Rocks. QSL's for

**COUNTIES TABLE**

**TOP BAND**

Callsign	Counties		Total Score
	CW	Phone	
GM3YOR	61	32	93
G3VLX	20	39	59
G3YPT	44	8	52
G4ALG	31	17	48
GW3WSU	—	44	44
G4AXP	—	43	43
G3DCS	14	—	14

*This Table will run till December 31, 1972. Starting date January 1, 1972. Any mode goes.*

PTØMI to P.O. Box 19073, Sao Paulo, Brazil, and for PTØWH to P.O. Box 19094, Sao Paulo.

Among the SV stations, SVØWMM is on from Crete—his cards are *via* WB2JGZ—and SVØWY from Rhodes. Both are early birds—SVØWY is to be found from 0300 to 0400z, around 14260 to 14280 kHz daily, but SVØWMM seems to prefer a late breakfast time—he has been noted at 0925 on 14170 kHz and occasionally in the evenings too.

Another new prefix crops up, with 7Y7; we are advised that Michel and Annick, 7XØGM and 7XØGA will be using the 7Y7 prefix during the whole of July. It seems that Annick is more active than her OM; she has been reported on 14120 kHz anywhere between 0800 and 1500z, and on 21270 kHz from 1500 till 1930. Michel has been heard then, as high as 21345 kHz, at 1950z. Their cards go through the 7X QSL bureau; but 7XØJG, who is OK1VJG, prefers to have his QSL's sent through the OK bureau.

On a different tack, the June DX Tests on *Top Band* have had some interesting results. PY1DVG has so far worked DL9KR, EI9J, G3VYF, G3YMH, GW3UPK and OK1ATP; he is now at a new QTH with a seventy-foot tower and inverted-Vee, and from the new place, so far, has worked KP4AST, VP8KF and W1HGT. VP8KF is very QRV at the time of writing, and is known to have worked EI9J, FPØCA, PY1DVG, and W1HGT. There are two calls to look out for in KP4-land on 160m.—KP4AST is on around 0400, transmitting on 1807-1810 kHz, with a dipole at 145 feet, with which, so far DL9KR, PY1DVG and VP8KF have been raised. The other is KP4DLW, who is making his preparations and may well be active on Top Band by the time this is read.

EL2CB is operating on 1828 kHz, and LU8BAJ is on both 1804 and 1827 kHz. The latter is definitely getting out and so far has contacted PY1DVG, PY2BJH, VP8KF, ZD9BM, and ZP9AY. Till the end



At the first Hull and District Amateur Radio Society Mobile Rally on May 28, at the College of Agriculture, Beverley, Yorks. the Top Band talk-in station signed G3AMW/A.

of July, looking on 1860 kHz may well prove to be a good idea, for ZS4PB will be QRV there about 0200z and ZS6KO will also be around. ZL3OX is operational and worked W4EX on March 24 last. EP2BQ seems to be going great guns and has worked quite a few G's—one at least got him back to a CQ which was a bit of a surprise!

Changing tack again—the winds are changeable!—we have an amusing footnote from G3DCS, who was working a G4, when a “thing” came and sat on them, deliberately QRM'ing them, and playing music into the bargain. However, the G4 happened to have “connections”—so when he announced to G3DCS that he and a colleague had got cross-bearings to locate the offender to within a mile or so, the QRM suddenly stopped—another one to appear in the lists of pirates convicted in due course, and we hope he gets a good stiff'un.

Talking of “things” your conductor seems to have one very locally to him—although G3KFE has not been troubled, G3ERN and other locals on Top Band have

suffered considerably . . . a pity this pirate has a *very* local SWL with a directional receiver!

#### Conclusion

Now, masters, we seem to have come to the end of our mail for this month; a thin clip, with so many of the contributors on holiday or tilling the soil and mowing the grass. To them, and to any of the readers who may be similarly cursing the weather, we wish all the best for a happy holiday, or nice flowers—and may the XYL never even mention the dread word “decorating!”

Meantime, we must give you the deadline for August, which is to arrive by first post on July 10, addressed as always to “CDXN,” SHORT WAVE MAGAZINE, BUCKINGHAM. 73, *es DX*.

*Editorial Note:* Closing dates for the next few months (issue dated in brackets) are: Aug. 7 (September); Sept. 11 (October); Oct. 9 (November) and Nov. 6 (December). Air-mail correspondents, in particular, may like to log these, since surface-mail copies take so long to reach them.

\* \* \* **THE MOBILE SCENE** \* \* \*

**RECENT EVENTS REPORTED AND THE RALLY CALENDAR**

There are several more Rally events to be taken in this time—it is also interesting to note that of the 17,400+ U.K. amateurs now licensed (including both categories, A and B) more than 3,300 have the additional /M permit. Greater part of mobile activity is still on Top Band but there are also many more G8/3's going mobile and a small minority who can work the HF bands. We hear of 21 MHz CW contacts with W6 and VK while running down the M.1 at 70 m.p.h.—not really a form of /M operation to be encouraged, even if you are a very good driver and an ace performer on the key (strapped to your leg or mounted on the steering column!).

On May 28, there were two Mobile Rallies, both in very poor Wx conditions—though they seem to have had it rather better for the Hull & District Amateur Radio Society event up at Bishop Burton, East Yorkshire, which was a “first Rally attempt” by this Club. They had chosen a splendid *locale* (at the East Riding College of Agriculture) and drew an attendance reckoned as 300 cars, about one-third of which were fitted /M, some 50 of them being worked by the talk-in stations on Top Band and two metres. Their planned events were well supported—except that for the Best Mobile Rig, which had to be abandoned because of the Wx. Looking back

on it all, the Hull chaps feel happy with their result, and they made a small profit on the event—not large, but satisfactory.

For the Chiltern Amateur Radio Club affair at High Wycombe—again at what in the ordinary way would be a very attractive site—they had a rotten day; cold, showery and very windy. Nevertheless, they drew a total attendance estimated at 1,200, arriving in about 350 cars. A well-prepared numbered programme costing 5p was not only a guide to the ground but also the raffle ticket, and (a useful point, this) contained the addresses of the 15 or so firms who had taken trade stands for the event.

The talk-in results are interesting: For the first time of which we have record the number of /M's worked on Two exceeded those on T/B, though in fact the bulk of the traffic was carried on 160m. because many operators were able to work G3CAR before leaving home. Generally speaking, the event is categorised as “very successful” in spite of the weather, and many of their visitors were from considerable distances. At any rate, all the traders say they will be “there again next year”.

Their one mistake, admitted by the organisers, was to have held their event at the Bank Holiday weekend, because many people (including a lot of Chiltern's own members) were away. (We have always advised against holding Mobile Rallies during holiday periods, or on a Saturday.—*Editor.*)



Can you find yourself here? The view across the main hall during the Northern Mobile Rally at Moor Grange School, Leeds, on May 21. They had a good attendance, this being the latest in the Northern Amateur Radio Mobile Society's series of Rallies.



The Lowe Electronics stand at the Northern Mobile Rally, Leeds, on May 21. "The Bandit" himself is on the right and he had a fine display of the equipment he advertises.



At the Hull Society's first Mobile Rally at Beverley, Yorkshire, on May 28, one of the stands was that of York Photo-Audio Centre—G3ZKS expressed himself as very pleased with results.

#### THE RALLY CALENDAR

- July 2:** Annual Mobile Rally at South Shields, Co. Durham, taking place at Redwell School, Prince Edward Road (B.1300), South Shields. Access on to B.1300 from either the A.183 or the A.1055. Talk-in on Top Band and two metres, with trade stands, competitions, a prize draw and refreshments locally available. Information from: F. Harrison, G3SFL, 42 Woodlands Road, Cleodon, Nr. Sunderland, Co. Durham.
- July 9:** Cornish Radio Amateur Club ninth annual Mobile Rally at the Truro Rugby Football Ground (NGR.839449), with talk-in from 10.0 a.m., signing GB3CRC, on 1875 kHz AM, 3720 kHz SSB, 70-375 MHz AM, and 144-30 MHz AM. There will be trade stands, a raffle, refreshments on site and a showing

of the film of the Club's recent Poldhu station activity in connection with the Marconi Anniversary.—P. King, G3WKP, Nirvana, Comprigney Hill, Truro (4788), Cornwall, for information and enquiries.

- July 9:** Exeter Amateur Radio Society Mobile Get-Together at Woodbury Castle, Woodbury Common, near Exeter, gathering at 2.0 p.m. with talk-in on T/B and Two.—A. W. Bawden, 232 Exwick Road, Exeter, EX4 2BA.
- July 16:** Rally laid on by Scarborough Amateur Radio Society at Burniston Road Barracks, as last year. Information: J. Cutter, G3VAN, *QTHR*.
- July 16:** Upton Mobile Rally, organised by the Worcester & District Amateur Radio Club at Hill Secondary School, Tunnel Hill, Upton-on-Severn, Worcs.—this is about a mile west of the R. Severn and will be

well sign-posted. Talk-in by G8JC/A on 1910 kHz and G3GJL/A on 70.26 and 145 MHz. There will be raffles and trade stands, a bring-and-buy stall for the sale of gear on commission, events for the children and it is also hoped to have a model aircraft display during the afternoon.—B. A. Jones, G8ASO, 12 Woodside Road, Larkhill, Worcester (29208), WR5 2EG.

**July 22:** Southdown Amateur Radio Society's first Mobile Rally, at Milton Gate, 2 miles W. of Polegate, near Eastbourne, Sussex, on the A.27. This is being held to coincide with the annual Polegate Steam Engine Rally, a well-known event at which all manner of steam-powered machinery is on view. All proceeds from car park and entrance fees go to local charities. Further information from: T. Seabrook, G3ZQB or E. F. Moore, G3JFM, 74 Wannock Avenue, Lower Willingdon, Eastbourne, Sussex.

**July 13:** Wessex Mobile Rally at Braemore House, near Fordingbridge, Hants., organised by the Wessex Amateur Radio Group, with talk-in on 2m.-4m.-160m.—A. G. Emery, G3YWG, 7 Brunel Drive, Preston, Weymouth, Dorset.

**August 13:** Torbay Amateur Radio Society Mobile Rally at the Rugby Football Ground opposite Newton Abbot Race Course, with indoor accommodation, licensed bar and refreshments. Talk-in by G3NJA on 1865 kHz, with another station on two metres and GB3TMR on the HF bands, looking for the DX.—L. G. Webber, G3GDW, 43 Lime Tree Walk, Newton Abbot, Devon.

**August 13:** Annual Derby Mobile Rally by Rykneld Schools, as in previous years. Details from T. Darn, G3FGY, *QTHR*.

**August 20:** Saltash & District Amateur Radio Club Rally at Saltash Grammar School, with all the usual side-shows and activities, most of which can be under cover. Ample free parking on site. Details from: I. Aldridge, G4AJU, 302 St. Peter's Road, Manadon, Plymouth, Devon PL5 3DU.

**August 20:** Bromsgrove & District Amateur Radio Club Mobile Picnic in the grounds of Avon Croft Museum, Bromsgrove.—J. Dufrane, 44 Hazelton Road, Bromsgrove, Worcs.

**August 20:** Mobile Rally organised by the East Kent Radio Society at Westgate Hall, Canterbury, opening at 12 noon, with free parking immediately adjacent. Attractions will include (apart from the ancient City of Canterbury itself) trade stands and side shows, with the sea not far away. Taking the M.2, Canterbury is about 1½ hrs. from London. Talk-in stations on 1980 kHz and 145.00 MHz will be sited to give good signal strength along the motorway. For those unfamiliar with the district (or without /M gear for a talk-in) a sketch-map is available for the price of an s.a.e.; one or two more trade stands could possibly be accommodated—all on application to: P. S. Nicholson, G3VJF, 21 Woodvale Avenue, Chestfield, Whitstable, Kent.

**August 26-27:** Stratford-on-Avon Radio Club Mobile Rally at the National Agricultural Centre, Kenil-

worth, Warwickshire, which offers splendid facilities for an event of this kind. As the Rally will coincide with the National Town & Country Festival and the Stoneleigh Transport Carnival, there will be plenty of interest for the whole family—including a vintage car and motor-cycle display, working steam-powered machinery, and all the other attractions of an Agricultural Show in the heart of England. A special HF-band station GB3TCF will operate in the Crendon building. Further information from: M. J. W. Webb, G3OOQ, 14 Townsend Road, Tiddington, Stratford-on-Avon (5973), Warwickshire. Should be a very nice day out.

**August 27:** Mobile Rally at Kimberley Barracks, Deepdale Road, Preston, offered by the Preston Amateur Radio Society for 12 noon till about 5.0 p.m., with talk-in on 2m./160m. Ample free parking, refreshments and licensed bar. Details: G. W. Earnshaw, G3ZXC, 12 Withy Parade, Fulwood, Preston, Lancs., PR2 4JN.

**September 24:** Harlow & District Amateur Radio Society annual Rally at Magdalen Laver Village Hall, as in previous years. For details: V. Heard, 106 Vicarage Wood, Harlow, Essex.

**October 1st:** Peterborough Radio and Electronic Society Rally, to be held at Walton School, Mountsteven Avenue, Peterborough, 11.0 a.m. till 5.0 p.m., with talk-in by G3QS on 1980 kHz and G8FFC on 145.00 MHz. Entrance fee of 10p will also cover price of raffle ticket.—A. H. Jackson, 57 Peterborough Road, Castor (353), Peterborough.

And now one Mobile Rally non-event to be reported: We are informed by their hon. secretary D. J. Fayers, G3YKC, that the Swindon Amateur Radio Club will *not* be holding their usual Rally this year.

Reports and photographs covering Mobile Rallies should be sent in as quickly as possible after the event to: "The Mobile Scene", SHORT WAVE MAGAZINE, BUCKINGHAM. Any pictures that we can use are paid for, immediately on appearance.



"... sorry I couldn't come back to that last over ..."

## EXTENDING DIGITAL FREQUENCY METER RANGE

INTO TWO-METRE BAND  
— INEXPENSIVE PRE-SCALER  
FROM 20 to 145 MHz

W. H. FLETCHER, B.Sc. (G3NXT)

**F**OLLOWING the publication of several excellent articles last year a number of digital frequency meters have been constructed by amateurs. These have generally had an upper input frequency capability of around 20 MHz.

With the popularity of VFO's in the two-metre band, there is a growing demand for a quick and easy system of frequency measurement. When a supply of 300 MHz counters appeared on the surplus market (available from *J. Birkett, Lincoln*) the author decided to attempt to produce a pre-scaler for his own Digital Frequency Meter, capable of accepting a 146 MHz input. The circuit is shown in Fig. 1. The counters are from an e.c.l. series of digital integrated circuits and have a frequency range of 40-300 MHz for a sinusoidal input. It is not, therefore, necessary to shape the input waveform and the amplifier is only required to increase the sensitivity of the pre-scaler and to limit any large signal inputs. A differential amplifier configuration was chosen for the input amplifier as it has a self-limiting action. In addition a silicon diode is connected across the input to the first transistor. Together with the emitter-base diode of the transistor, this limits any input signals to  $\pm 0.5$  volts. The transistors used for the input amplifier were obtained from the same source as the counters. The pair are contained in a single 8-lead TO5 can and are described as having an  $F_T$  of 2 GHz.

The 10-ohm resistor in the collector lead of the first transistor is there to reduce any tendency to instability

and should be soldered as close to the transistor as possible. The emitter resistor is chosen so that a current of about 20 mA will be drawn from the negative supply. With different DFM's, the supply voltages available may vary from those used in the prototype. A negative voltage of between -5 and -9 volts will be satisfactory provided that the value of the emitter resistor is adjusted according to the formula

$$R = \frac{(V - 0.5) \times 1000}{20} \text{ ohms}$$

Using three counters, the pre-scaler divides the 145 MHz input by 8, giving an output at 18 MHz. The rated output is 400 mV p-p which is more than adequate to drive most DFM's. In order to obtain a correct readout of the input frequency, it is necessary also to divide the time-standard input to the counting gate in the main counter by 8. This is achieved by breaking the input to the gate and inserting an SN7493 4-bit binary counter between the last 7490 decade counter and the counting

### Table of Values

Figs. 1 and 2. Pre-Scaler Circuitry and Counter Modifications

C1 = .01 $\mu$ F, disc ceramic	R3 = 270 ohms <i>see text</i>
C2, C3, C4, C5, C6, C7, C8, C9, C10, C16, C17, C18, C19 = .001 $\mu$ F, disc ceramic	R4 = 15,000 ohms
C11, C12, C13, C14, C15 = .001 $\mu$ F cer. feed-thru	IC1, IC2, IC3 = 300 MHz counter
VC1 = 2-11 $\mu$ F trimmer	IC4, IC5, IC6 = 7490 decade counters
R1 = 68 ohms	IC7 = 2N7493 4-bit binary counter
R2 = 10 ohms	D1 = 1N918 or similar
	L1 = 3½t. 20g. ¼in. dia. pulled out to ¼in. long
	Tr1 = 2 GHz dual transistor

Notes: The counters IC1-IC7 and the 2 GHz dual transistor Tr1 available from *J. Birkett, Lincoln*.

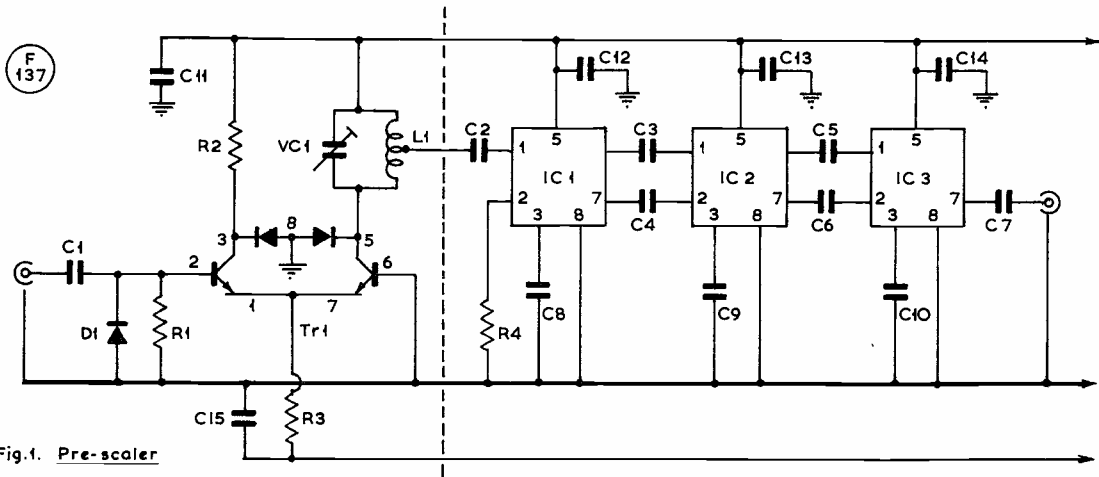

Fig.1. Pre-scaler

Fig. 1. Circuitry of the G3NXT Pre-Scaler.

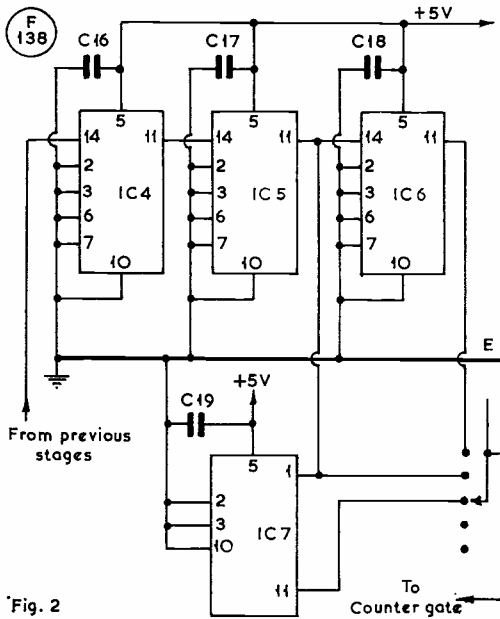

Fig. 2. Modification to Time Standard Divider Chain.

gate. In this application the first flip-flop in the 7493 is not used and the input is taken direct to  $B_{in}$ .

Unless the counter is to be used on two metres only, it will be necessary to switch the time standard input to the counting gate between the output of the 7493 and the other outputs from the divider chain. The details of this switching will vary depending on the design of the counter used. The author uses DTL IC gates but GW3JGA suggested mechanical switching to select the time standard input and it should be relatively easy to feed the output of the 7493 to an appropriate position on the switch wafer. A simplified circuit is given in Fig. 2.

If the input to the 7493 is fed with a 1 kHz signal, the meter will have resolution of 1 kHz on 2 metres. A one-cycle input would give a resolution of 1 Hz but this would involve an 8-second counting period which is considered too long. In order to avoid any ambiguity it is desirable that the frequency meter have a 6-digit readout. It should be relatively easy to add extra count/display decades if necessary. Alternatively, the counter can be allowed to over-scale. A 4-digit readout of say 145.760 MHz would then appear as 5.760 MHz.

As the input to the pre-scaler is at 145 MHz, it is necessary to use VHF construction techniques. The prototype was built on a piece of copper-clad Paxolin board mounted in a brass case measuring 4in. x 2½in. x 1in. (A tobacco-tin would probably make a good substitute). The layout of the circuit is shown in Fig. 3. The input amplifier is screened from the counter section by a vertical strip of brass. Both the input dual transistor and the counters are housed in 8-lead TO5 cans. These were mounted by passing their leads through holes previously drilled in the P.C. board, using a No. 62

drill with a piece of 0.1in. matrix Veroboard as a template. The holes for the signal, supply and decoupling leads of the transistors and counters were countersunk on the copper side of the board with a ⅜in. drill. Before fitting, the leads were bent to align them with the holes in the board. Afterwards leads 4, 6 & 8 of the dual transistor and Nos. 4 & 8 of each counter were bent over and soldered to the copper laminate. Feed-through condensers of 0.001 μF were soldered through the laminate adjacent to pins 5 of each counter and at the supply points for the input amplifier. All supply wiring was completed on the plain side of the board.

The remaining components were soldered directly to the IC leads, to the feed-thro' condensers or to the copper laminate as appropriate (taking care not to short any of the IC leads to earth!). With the short leads involved, this form of construction proved quite sturdy.

The power supplies required by the pre-scaler are relatively modest and it should be possible to draw them from the associated Digital Frequency Meter. The supplies required are +5 volts at 40-80 mA and -6 volts at 20 mA. As explained earlier, the negative supply voltage can vary between -5 and -9 volts provided that the emitter resistor of the input amplifier is adjusted as suggested.

In the prototype the input for the pre-scaler is obtained by hooking a loop of wire around the outside of the screened PA compartment in the author's two-metre transmitter.

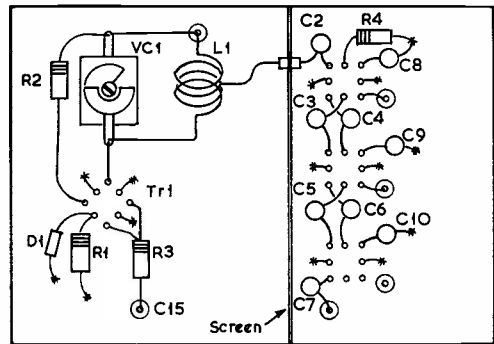

Fig. 3

Fig. 3. Constructional Layout for Pre-Scaler.

### SPECIALISED ELECTRONICS COURSES

The Enfield College of Technology, Microelectronics Centre, offers two-week practical courses in July, September and December, and evening classes on Microelectronics Design on Thursdays from September 28. Full details of all these courses, of considerable value to students in the field, can be obtained from: Mrs. D. P. Linnell, Short Course Secretary, Faculty of Technology, Enfield College of Technology, Queensway, Enfield, Middlesex. (Tel: 01-804 8131.)

## GETTING A 5/8TH WAVE FOR TOP BAND

### LOADING A QUARTER-WAVE WIRE FOR MAXIMUM EFFECTIVE RADIATION

M. D. BOOTH (G3YNO)

HAVING an urge to try his hand at Top Band DX, the author was faced with the inevitable problem of finding an aerial which would do the job effectively without being an impossible length and an impracticable height. After more than a little experimenting, the aerial described here was found to be the best proposition, and can be put up by anybody who has sufficient room for 132ft. of wire.

The conventional quarter-wave is a poor performer for anything but local contacts, because most of its radiation is ground-wave, and very little goes out as sky-wave. The basic sky-wave aerial is a half-wave—however few of us have sufficient room to put up 264ft. of wire, the G3YNO QTH being no exception.

A compromise was therefore attempted in the form of a three-eighth-wave, 198ft. of wire, loaded with the ATU to an electrical half-wave. This worked quite well, but had two disadvantages. First, the wire was bent round the garden in a somewhat messy fashion and secondly, results showed that most of the sky-wave was high angle, as reports dropped off badly beyond the 300-mile mark. The modified version overcomes both these problems by two simple expedients: A loaded quarter-wave whip was added to the end of the three-

eighth-wave wire, making the electrical length five-eighth-wave. Secondly the one-eighth-wave section of the wire nearest the transmitter was loaded with a coil to reduce its physical length.

The physical appearance of the resulting antenna is shown in Fig. 1. At G3YNO the 132ft. wire is supported at both ends by 30ft. masts. However, end A could well be taken to a house or a tree without impairing the performance; end B needs to be a mast to support the whip. The length of the feeder from the ATU to point A is immaterial as long as it is top-loaded with a coil to an electrical eighth-wave. You can check this by resonating the section by itself as a quarter-wave on 80m. The loaded whip can be any type from a small mobile whip to as big as you like, provided it is loaded to a quarter-wave. The aerial is fed through the ATU, Fig. 2, parallel tuned to bring the entire system to an electrical three-quarter-wave, which is a current-fed low-impedance antenna, suitable for the unmatched output of most Top Band rigs. It is then only necessary to adjust the ATU for resonance and maximum RF current. Of course, the better the earth system, the higher the current, but currents in excess of 0.5A should be possible with a 10-watt carrier.

#### Results

Results have been most encouraging. The loaded whip radiates low-angle sky-wave, as well as the overall system radiating high angle, with the result that coverage is continuous from the near limit of the sky-wave, about 100 miles, to as far as the skip will take the signal. Very little ground-wave appears to go out, so don't expect good reports from the locals on this system! Inter-G working on SSB yields reports of 5-8/9 or better from all parts of the U.K. and quite reasonable reports have been given from the Continent, also on SSB. Reports on CW are similar, although the writer could not be described as a CW fanatic! As yet no attempt has been made at "across the Pond" working.

While it is not claimed that this antenna is the ultimate for chasing DX, it is hoped that it might serve as an inspiration to those who are convinced that their gardens are too small to put up large enough aerials to work Top Band DX. So soup up your quarter-wave, and you will be surprised at what is possible!

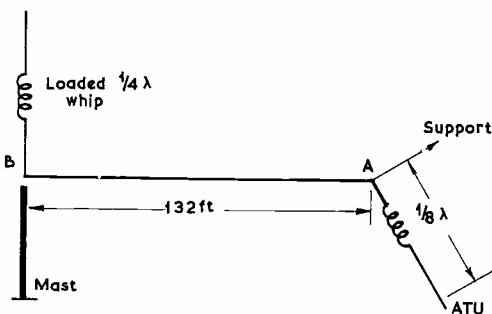

Fig. 1

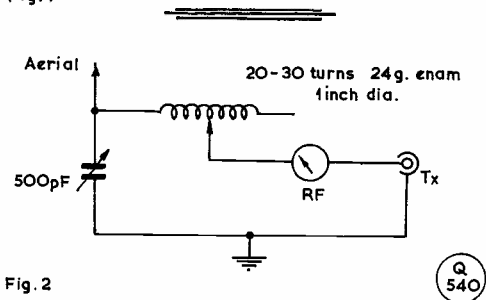

Fig. 2

#### ALWAYS WANTED

Photographs and articles of Amateur Radio interest. Potential contributors should read the notes on p.101 of the April issue of SHORT WAVE MAGAZINE, also the item "Authors' Mss." which appears on the Contents page of every issue. These explain how the work should be tackled. As regards photographs, these can be on any subject in the Amateur Radio context and preferably should be about post-card size. We are not interested in negatives, colour prints, transparencies or tiny strips of film, whether developed or not. Prints should be lightly identified on the back, in pencil, with full details on a separate sheet. All material that we can use is paid for immediately on publication. Send to: Editor, SHORT WAVE MAGAZINE, BUCKINGHAM.

## FREQUENCY MODULATION

### A TREATISE ON THE SUBJECT — WHAT IT IS AND WHAT IT OFFERS — SOME PRACTICAL CONSIDERATIONS

#### Part I

A. J. HENK (G8DIK)

**E**MINENT men have spent many years studying frequency modulation, and more is constantly being found out about it, so complex can FM theory be—as is the case with almost any type of modulation! In an article such as this it is impossible to go deeply into all aspects of the subject. Much over-simplification will be necessary in explaining the various phenomena encountered.

This treatment is aimed primarily at the amateur operator who is perhaps curious about or interested in FM, and would like to know exactly what it is and what it has to offer, what it will and will not do, what its advantages and disadvantages are, and what the Ministry's regulations require. Although some block diagrams are given, this is not a constructional article and actual circuitry is not included.

There is an increasing interest in FM and this is the main inspiration for this article. There is a great deal to be obtained from using this type of modulation, and the advantages are certainly not being realised. It is hoped that these notes will help to give FM the reputation it deserves—and for the right reasons.

#### What is Frequency Modulation?

The verb "to modulate" means to regulate, to adjust, to vary. In amplitude modulation it is the peak-to-peak value of the carrier current (or voltage) which is varied in accordance with the speech signal. This results in a signal bandwidth of which is equal to twice the highest frequency present in the changing envelope of the carrier. Logically, in *frequency* modulation, the amplitude is held constant and it is the *frequency* of the transmitted signal which is varied by the audio output. As the transmitted signal frequency actually changes during modulation, it is clear that extra bandwidth will be required to accept the frequency change, additional to that represented by the AF signal. It should be clear that an FM signal will always occupy more bandwidth than an equivalent AM signal with the same modulation. Or is it? We shall see.

#### What FM has to Offer

It is for relatively local working—such as that for which the VHF bands are eminently suited—that FM really comes into its own. Perhaps the most striking feature of FM is the improvement it gives in signal-to-noise ratio effects.

Noise consists of random variations of both the

amplitude and the phase of a signal. In the AM case, this noise, at any rate the amplitude variations it causes, is superimposed on the signal recovered at the receiver detector. If the S/N ratio is to be improved it is necessary (assuming the noise is constant, as it usually is) to increase the signal either by pushing up the modulation depth or, if 100% modulation is insufficient, by increasing the transmitter power, or at least that fraction of it which enters the receiver. (An exception is balanced amplitude modulation which is incapable of over-modulation in the usual AM sense. However, the extra power is still required.)

When the frequency, and not the amplitude, of the signal is being modulated, there is no need to make the detector respond to amplitude changes—indeed, it must *not* if satisfactory performance is to be obtained. These changes are removed by a limiter, which can be considered as a circuit which both amplifies and clips the signal, so that the output amplitude is determined by the limiter and not by the input. This assumes that the input exceeds a certain amplitude, and this is ensured in practice by providing sufficient pre-limiter gain to operate the circuit on noise when no signal is present.

The action of the limiting process can be seen from Fig. 1. We assume that the signal is large, in this case larger than the two battery voltages (assumed equal). When the input goes positive, the amplifier input will rise until it reaches  $V_1$  (battery voltage), whereupon D1 conducts and prevents the voltage rising further. Similarly, when negative, D2 conducts and fixes the lower voltage limit. The "surplus" input voltage appears across R, holding the diode in conduction. The amplifier input amplitude is thus determined solely by the voltages  $V_1$  and  $V_2$ , and is independent of the input signal amplitude. This squared-off wave is then restored to a suitable value for detection by the amplifier. In most receivers, a tuned circuit is included which converts the square-wave back into a sine wave, but it is convenient to consider this as part of the detector. Some types of detector require square waves, some sine waves. We shall come to this again later. It should be realised that, although Fig. 1 is a good illustration of what limiting is, and can be made to work extremely well, it is not usually the most convenient approach for a variety of reasons, and there are many better circuits.

To return to the theme of S/N ratio improvements, we have now removed from the signal the random, amplitude variations responsible for noise in AM systems. We are left with only the random phase variations, and this leads to improved performance in two ways.

In order to understand the first way, it is necessary to compare the effects of frequency and phase variations in an FM system. If we take two sine waves of slightly differing frequencies, and start them off in phase, it can be seen that, as time goes by, the phase difference between the two waves steadily increases. (Fig. 2). As the frequency difference increases so the rate of change of the phase difference increases. We can therefore say that the *frequency difference is related to the rate of change of the phase difference*, and this is true at any frequency—even when one is zero. In this extreme case (the most useful for the formulation of this relationship) we can drop the word "difference" and say that frequency is

proportional to the rate of change of phase, which leads us to the familiar expression:—

$$f = k \cdot \frac{d\theta}{dt}$$

where k is the constant of proportion equal to  $\frac{1}{2\pi}$

A signal in which phase is changing rapidly can

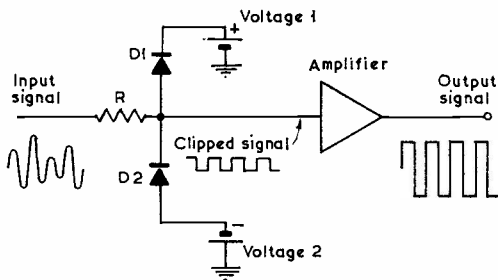

Fig.1 Principle of the Limiter

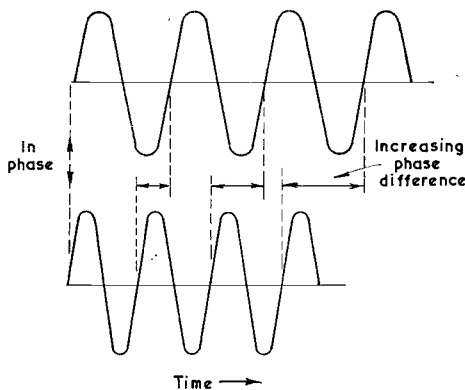

Fig.2 Phase relationship of two waves of differing frequency

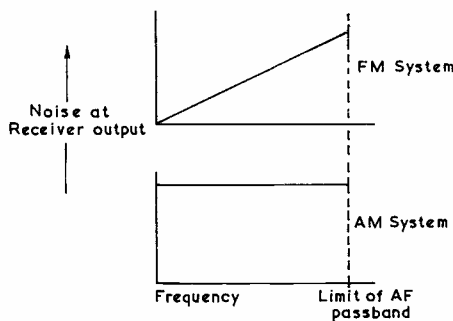

Fig.3 Relative Noise characteristics of FM and AM Systems

M 197

therefore be seen to contain a high frequency, and when the change is slow, the frequency is lower.

In our noisy signal, with its random phase changes, a given change happening rapidly will represent a high-frequency sideband, *i.e.*, one which is well spaced from the carrier, whereas the same phase change happening slowly will produce a lower sideband. Since a larger audio voltage will move the transmitter frequency further than a smaller one, we can expect the faster phase changes (the high frequency ones) to produce a larger noise output from the receiver than the slow ones (lower frequencies). As fast-and-slow changes are equally possible in a random signal, we can expect the noise at low frequencies to be lower than at higher frequencies. As our FM system becomes less noisy at lower audio frequencies, a corresponding AM system will have the *same noise-density at all audio frequencies*. These two types of noise distribution are shown diagrammatically in Fig. 3. The effect of this in practice is to give FM noise a different character from AM noise. The former has a gentle hiss compared with the rather more rushing type of noise heard on AM signals from distant stations. Note that phase modulation does not share this advantage, and has a noise structure more like AM.

The second way in which FM can be made to give superior signal-to-noise performance involves changing the signal. We have seen how the noise in the signal/noise fraction is less with FM than with AM. Can we, therefore, increase the signal and make matters even better without needing more transmitter power? Fortunately, we can. In the case of AM we ran out of carrier power, *i.e.* reached an overmodulated condition, when we tried to increase the audio level. Frequency modulation is incapable of over-modulation in this sense (at least within reasonable limits) as we can increase the amount of frequency change (the deviation) as much as we like. There is a penalty, of course (there always is) and in this case it is an increase in bandwidth due to the extra frequency swing involved. However, within tolerable bandwidth limits, a very useful improvement in signal-to-noise ratio can be realised.

**Some Practical Considerations**

Before finally leaving this noise aspect, there is a further point in favour of FM. We have, so far, dismissed the possibility of increasing transmitter power, but let us not be too hasty about this. Assume that we have an AM transmitter rated at 10 watts RF output: This rating applies to the CW signal provided by the transmitter with no modulation. However, when 100% modulation is applied, the RF current falls to zero during one half of the modulation cycle and rises to twice its steady value during the other half. As the current doubles, so does the voltage applied to the aerial, and the power (voltage *times* current) increases by a factor of four. A 10-watt AM transmitter must therefore be capable of a *peak* output of 40 watts. Its circuitry and power supplies must therefore also be capable of accommodating the voltages and currents required to produce 40 watts, although the *average* power, which affects the heat dissipated in the transmitter, is only 10 watts. If, as is generally the case (particularly in transistorised equipment) the output stage is limited, not by heat dissipation but voltage or current, a conversion to FM

can mean more power and a more efficient transmitter with the same output stage, possibly giving four times as much power.

Another advantage of FM which follows on the foregoing is its relative immunity to impulse interference. This is clear from the action of the limiter in removing the amplitude spikes (which can rise to many times the peak modulation amplitude with AM) leaving only a phase disturbance. This, coupled with the noise response of an FM receiver to phase-modulated noise (Fig. 3 again) gives an interference pulse which sounds more like a "tick" than the full blooded "thump" so familiar in AM systems.

In order to realise the noise and interference advantages that FM has to offer, the limiter must be operating satisfactorily on the wanted signal. In other words, the signal must be stronger than the noise present with it at the receiver input. If the signal falls below this rather critical threshold, the noise, rather than the signal, operates the limiter, and the audio signal-to-noise ratio worsens very rapidly. Below this threshold (which can in fact be made very low with a good front end) the receiver will provide a worse S/N ratio than it would with AM, but above it the FM advantage over AM increases very rapidly. The exact threshold sensitivity varies not only with receiver front-end noise, but with deviation and bandwidth. A good VHF receiver would have a threshold of well below  $1 \mu\text{V}$  and local and semi-local VHF stations tend to be much above this figure. It is only when a station is "down in the noise" that AM is superior. However, an AM facility should be retained for weak DX stations.

Although there are more advantages to be gained from this type of modulation, we shall be content to make a brief mention of only one more—distortion, or rather, freedom from it. Because of the low modulating powers involved, and the ease of modulating without the use of heavy iron-cored components it is much easier to provide good low-distortion modulation than is the case with AM. The advantage of this lies not so much in the fidelity of the reproduced speech (the author's speech clipper can introduce considerable harmonic distortion and is still considered good by amateur standards) but in bandwidth requirements. Surprising? Read on.

### Bandwidth Requirements

Before becoming too deeply immersed in the problems of bandwidth, it is necessary to introduce a few simple terms or definitions. We have already mentioned *deviation*, which is the amount by which the modulation changes the transmitter frequency. For a sine wave modulating signal, the deviation will change sinusoidally, from zero up to a peak value in one direction (positive, *i.e.*, an increase in frequency) down again to zero, then negative to its lower peak value (frequency now lower than nominal). This can then have any value from zero to some maximum, and for calculating bandwidth and describing the signal swing, the peak value is always used. Note that a peak deviation of  $+50 \text{ kHz}$  will result in a total frequency change of  $+50 \text{ kHz}$  relative to nominal down to  $50 \text{ kHz}$  below nominal (negative peak) causing the total swing to be  $100 \text{ kHz}$ . Deviation can be seen to be measured in Hz or whatever multiple is

convenient (in our example kHz) and its peak value is represented by  $f_d$ .

Another symbol we shall need will be for the *maximum modulating frequency*, that is the highest audio frequency applied to the modulator. For this we use  $f_m$ .

The bandwidth of an FM signal depends on the relationship between these quantities, and it is convenient to define the ratio of  $f_d$  and  $f_m$  as the modulation index B. Thus we can write:

$$\text{Modulation Index} = B = \frac{f_d}{f_m}$$

As an added complication, the bandwidth of an FM signal is theoretically infinite, so we have to draw a line somewhere. For the purposes of this article, and good radio amateur practice, this has been taken as the  $-40 \text{ dB}$  point, that is, the bandwidth is that outside which the remaining energy is  $40 \text{ dB}$  or more below the unmodulated carrier value. This is entirely adequate for amateur purposes because the signal is falling rapidly beyond this point. Strictly speaking, however, the carrier

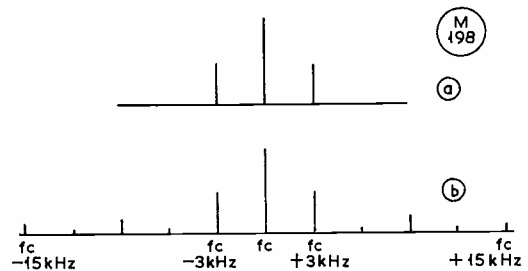

Fig. 4. Spectrum of AM signal

- (a) 3 kHz pure tone modulation  
(b) 3 kHz modulation with distortion up to 5th harmonic

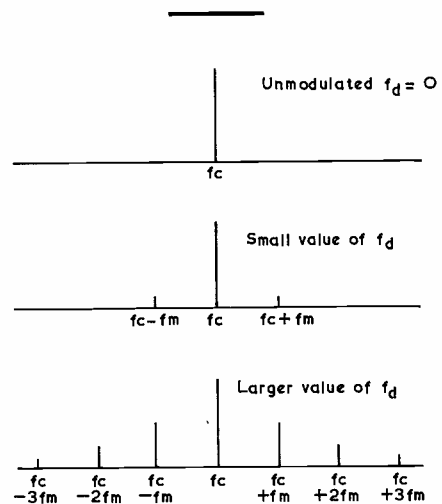

Fig. 5 Spectrum of FM signal with various values of deviation



frequency should be chosen to be a little more than half the band width inside the band limits (an extra 10 kHz margin will suffice).

#### Question of Bandwidth

On, then, to the real meat of bandwidth. Because of the frequency swing associated with FM we would expect to need more bandwidth than for AM and, in theory, this is true. But things are not always what they seem, and an examination of the AM case will make a good starting point.

Suppose we have an AM transmitter modulated with an audio tone of 3 kHz at 100% modulation. The spectrum of this signal, assuming the modulation to be sinusoidal, is shown in Fig. 4a. The bandwidth can be seen as  $f_c \pm 3$  kHz, *i.e.*, 6 kHz total. In any practical case, however, distortion will be present, and the spectrum will be more like that of Fig. 4b. A good amateur transmission may have a total harmonic distortion content of around 5%. The majority of this will probably be third harmonic, but it is not unreasonable to find about 2% of the fifth harmonic present (even harmonics will be very low if a good push-pull modulator is used) corresponding to an audio frequency of 15 kHz. When modulating an RF carrier, these 15 kHz sidebands will be about 40 dB below the carrier level, thus our bandwidth as defined to the 40 dB agreed above will be  $2 \times 15 = 30$  kHz. It can be shown that the low-distortion frequency modulator can produce a satisfactory FM signal with a bandwidth less than this. This type of FM would not represent an all-round solution on VHF with the allotted bandwidth, but it would provide quite a lot of the advantages outlined earlier and, surprisingly, would have a narrower bandwidth than the corresponding AM system.

To pursue this point a little further. A linear amplifier can introduce distortion into the envelope of an AM signal in the same way as a modulator. It is, moreover, even more difficult to design a low-distortion linear amplifier than it is to achieve a comparable figure in a conventional Class-C AM system. If we consider only the frequencies close to the carrier, harmonics being largely attenuated by the tank circuit(s), we can expect greater difficulty in containing the sidebands due to the distortion effects when the linear amplifier is used. This difficulty is particularly serious with SSB as there is no carrier (theoretically!) and the sideband components can fully load the linear. Spectrum occupancy curves have been published for SSB as well as AM and FM, and this problem is clearly illustrated—the “spread” of a typically good SSB system extends well beyond that of its AM and FM counterparts at —60 dB and below. We have, then, the paradoxical situation where the system which seems to have so much to offer in theory (SSB) is, in its practical realisation, inferior in spectrum occupancy to FM! This point is not generally appreciated by the radio amateur (although well-known in professional circles) and is one of the reasons why SSB is not seen in VHF mobile radio telephone service where spectrum space is scarce. An operator who has lived close to an amateur using SSB on two metres will, however, be only too well aware of the effects, and need not blame his receiver for the splatter he suffers!

The bandwidth occupied by an FM signal depends not only on the modulating frequency  $f_m$ , but also upon the deviation  $f_d$ . As in the AM case, the spectrum consists of side frequencies spaced from the carrier frequency and appearing both above and below. Surprisingly, perhaps, the spacing of the sidebands is not affected by the deviation, but is equal to the modulating frequency. It is their *number*, not their spacing, which is determined by  $f_d$ —that is to say, the wider the deviation (the greater  $f_d$ ) the more sidebands will be produced, and therefore extend further from the carrier, all spaced by  $f_m$ . This is illustrated in Fig. 5.

(To be continued)

#### AUSTRALIAN LICENSING PROPOSALS

In recent issues of SHORT WAVE MAGAZINE (*see* p.431, September, '71 and p.86, April, '72), we have discussed the Australian approach to the thorny topic of Novice Licensing. Our VK colleagues have spent much time and effort—and pages of print in their *Amateur Radio*—working out the problem and have now come up with the proposal that there should be four grades—A, B, C and D—of licence. All involve some form of examination, theory and/or Morse, at various levels, the present position of individuals being safeguarded. In other words, nobody would have to go through it all again to retain their licence status in their grading, though up-grading would involve the appropriate tests.

The proposed Grade D licence, getting nearest to the Novice conception and the lowest grading, would still require an examination, at a lower theoretical level and a 5 w.p.m. Morse test. This would allow operation crystal-controlled only with a maximum of 10 watt input, in segments of the 21 and 28 MHz bands.

These are at present proposals, put before the Australian licensing authority for further consideration and, it is hoped, implementation.

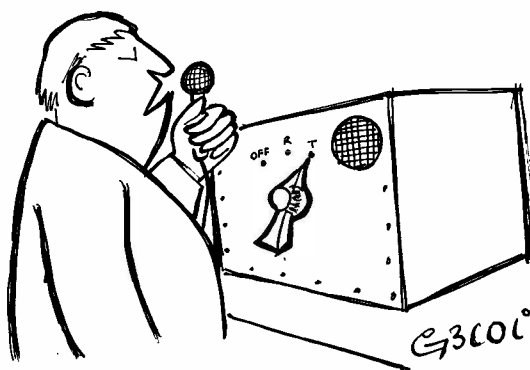

“... the rig here is pretty straightforward ...”

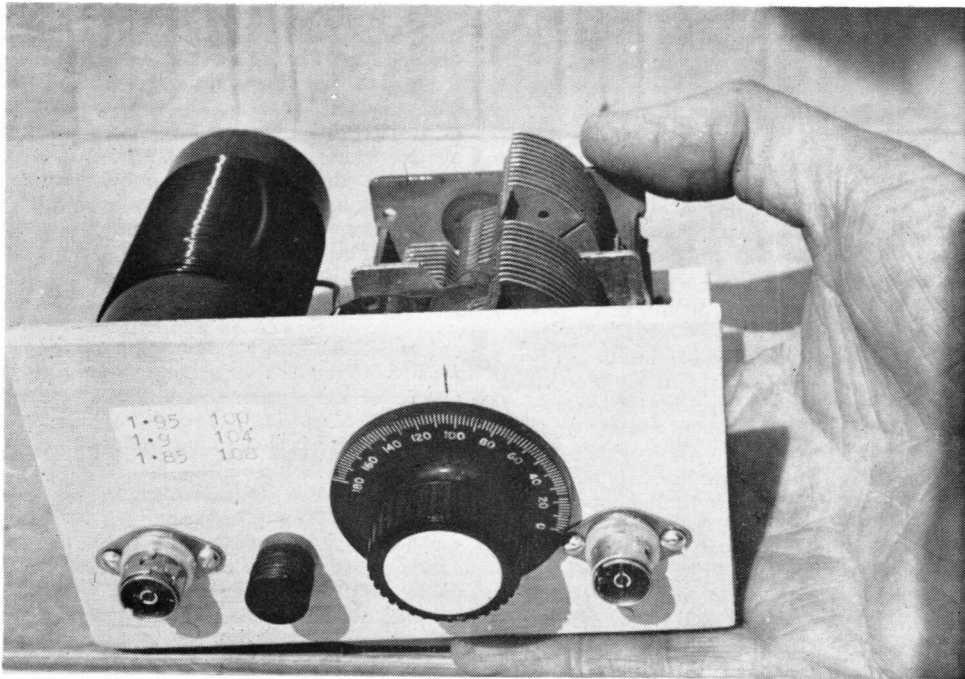

## AERIAL ADAPTER FOR TOP BAND

TO USE AN HF DIPOLE

F. G. RAYER, A.I.E.R.E. (G3OGR)

As is well known, a dipole intended for one of the HF bands can be used on an LF band by strapping the feeder at the bottom end, and using the whole as a type of Marconi aerial tuned against earth. This is one of the ways in which a signal can be put out on Top Band, when only a HF dipole is available.

When this method has been used by the writer, using a co-axial fed HF band dipole, results have always been quite good. But the actual change-over of purpose of the aerial has involved such irritating procedures as finding a suitable co-axial socket, wiring inner to outer, taking the resulting single lead to an all-band tuner, and adjusting the latter.

It was decided to do away with all this by making the simple unit in Fig. 1. This has a ready shorted co-axial socket for the aerial, another socket for a co-axial lead to the transmitter, and is left permanently adjusted and tuned, as it serves no other purpose. Thus, it is only necessary to pull the HF band dipole plug out of the HF transmitter, plug it into the adapter unit, and all is at once ready for Top Band transmission.

### Points on Adjustment

As plenty of capacitance can be useful, VC1 is a 2-gang broadcast receiver capacitor, with two 500  $\mu\text{F}$  sections in parallel. There is no need for this exact value, and similar components are easily obtained if not already to hand.

With the capacitor located as shown, there are some hand-capacity effects, but they were unimportant. The capacitor can be placed at the earthed end of L1, but it is then necessary to use a separate winding for transmitter coupling, instead of merely tapping this lead to L1 at some point B.

Tapping A allows the actual number of turns in circuit to be adjusted. Once suitable working conditions have been found, these tappings are soldered on permanently.

The usual HF-band dipole and feeder will be shorter overall than a  $\frac{1}{4}$ -wave on 160m., and tappings and tuning have to be found by trial. If a SWR indicator is available, place it in the coax lead to the transmitter. Then adjust A, B and VC1 so that the PA loads to the wanted input, with minimum reflected power.

With no SWR indicator, proceed in the same way. That is, until the unit allows the aerial system to load the transmitter normally.

With all systems of this kind, a good earth connection helps to increase radiation efficiency.

### Quantities

L1 can be 56 turns of 22g. enamelled wire on a 1 $\frac{1}{2}$ in. diameter paxolin tube, with point B seven turns from the

earthed end. However, other reasonably large inductors, of fairly stout wire, can be equally suitable, and L1 will have to be adjusted to suit the radiating system, as mentioned.

A signal can be put out on 80m. by similar means, using a HF band dipole, if this should be the aim in view. It is then unlikely that VC1 need be over 500  $\mu\mu\text{F}$ , while L1 will generally need fewer turns.

If the need is for a tuner for Top Band, using a single end-fed wire, then substitute a terminal for the shorted co-axial socket.

**Construction**

This is very simple, and need not follow that shown, which was to allow the whole to push into an insulated box. The sockets could be on the top, sides or back. With a metal box, the aerial socket must of course be adequately insulated, as must VC1 and the spindle. (An insulated extension could be used here). L1 should be at least half a diameter from the metal sides, and more, if possible.

In order that a plug-in-and-switch-on procedure can be maintained, VC1 settings should be marked. Do this for a few frequencies spread through the wanted part of the band. A longish radiating system will give flatter tuning than a short aerial-earth layout.

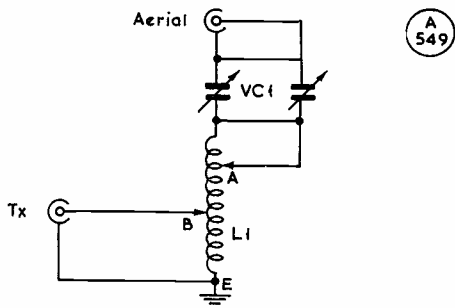

Fig.1 Circuit of the Unit

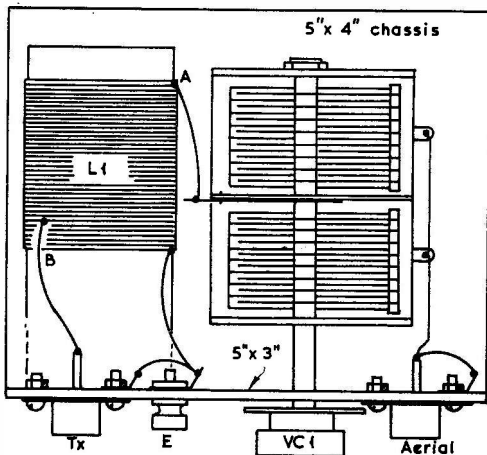

Fig.2 Suggested Layout

ON THE RELATIVE EFFECTIVENESS OF BEAMS AND LINEARS

P. R. CRAGG (G3UGK)

*A treatise inspired by the discussion on this subject — "The Question of Power"— on pp.212-213 of our June issue.—Editor.*

THIS question is discussed here from the standpoint of an operator in the British Isles, as most of us will never know the peculiar delights of "being DX", and hence the station requirements of a DX operator must be of purely hypothetical interest.

In order to make any sort of valid comparison, a decision has to be taken, as to which of the many varieties of beam should be discussed. A linear is a linear is a linear, after all, 400 watts p.e.p. being much the same, regardless of which valve type produces it. (Let us assume that a commercial piece of equipment is under consideration, with reasonable linearity, for what that is worth in practical terms).

The beam, on the other hand, comes in a variety of shapes, sizes, performance figures and price. Should we consider a full-size beam for each of the HF bands (surely another hypothetical case for the average U.K. operator) or one of the many multi-band devices, with their attendant reduction in efficiency? Do not forget that the linear will produce some 6 dB actual gain, whereas the best of the multi-band beams would be hard put to it to give this sort of increase on 20 metres.

Having thus dismissed both mono- and multi-band beams, for different reasons, there remains the Quad. A properly tuned and adjusted Quad will produce considerably more gain than the linear, and is thus worthy of serious consideration.

**Quad Considerations**

Have you ever actually seen a full-size 10/15/20 metre Quad at close hand? It is enormous! On the grounds of size alone, the aesthetic features of this array—whilst being of great beauty to the proud owner—provoke rather different reactions from neighbours and Planning Committees. Having overcome these objections, a small army is needed to hoist the thing into the air—and then repeat the operation to get it correctly tuned. It is a reasonable assumption that it never will be properly adjusted, the owner having got fed-up with the manual labour involved, long before the euphoric condition of 12 dB gain and a front-to-back ratio of 30 dB is achieved, on all three bands. More likely final figures will be 6-8 dB and 20 dB respectively.

Now is has to be rotated, and the wind load on a Quad dictates the expenditure of not less than £47 at current prices on a rotator with enough braking action to prevent the aerial windmilling in every breeze. While on the subject of QRK, it is reasonable to price the aerial at £65. Yes, it would be a lot cheaper to build one, but then it is also a lot cheaper to construct a linear, and remember we are discussing commercial equipment. There are cheaper Quads available, of course, but not with optimum spacing and maintenance-free fibre-glass spreaders, combined with light weight and the capability

to withstand 100 m.p.h. gales. Total cost, including the multi-core cable for the rotator, would be in excess of £115.

The next point is maintenance, of the rotator if not of the aerial. At regular intervals it will need cleaning, lubricating and checking, if it is to remain reliable, and the whole question of raising and lowering the entire mast/aerial assembly returns. (Unless, of course, the operator is lucky enough to be able to afford a wind-up, tilt-over tower. Very expensive, and a great worry in times of windy weather.)

### Points on The Linear

So much for the beam; now let us discuss the linear. Probably a little more expensive, though not much more than the beam, but it will cover five bands, not three. It will produce as much actual gain as the practical Quad, and a great deal more than most multi-band beams. Your signal will sound stronger at the other end, owing to the increased "punch", especially if it has an effective ALC, resulting in less of that infuriating "hope to meet you again under better conditions" sort of QSO.

What about TVI? It is said that a linear will create more than a beam. A very arguable point this, as Murphy's Law states quite categorically that any DX will be located in a direct line from your aerial to a TV aerial. A strong amateur signal present at a TV aerial is no less effective at producing interference because it comes from a beam rather than from a linear. In point of fact, it can be shown that the use of a linear will actually reduce TVI, due to the addition of two tuned circuits, and the increased efficiency of a low-pass filter

between exciter and amplifier working in a correctly matched line.

One serious practical disadvantage of a linear is its requirement of a feeder cable with low VSWR. With an antenna such as a trap dipole the use of an ATU is virtually obligatory, and it can be exceedingly difficult to find components with the necessary voltage rating. The alternative, of having separate dipoles for each band, brings back the question of appearances. A satisfactory compromise is to use the trap dipole on 80, 40 and 15 metres only, where the VSWR will be suitably low, and to have a dipole or vertical for 20 and 10 metres.

Linears, of course, tend to be fairly expensive to run, possibly using as much as 500 watts of mains power on standby, but like the telly-box, they can be switched off when not required.

One final point not yet mentioned is the ability of a beam to reject signals coming from the back and sides, thus aiding reception. True, on the surface, but in its own way, the linear can produce a similar effect. To take an example, one encountered every day on 20 metres, imagine an I1 at 30-over-9, calling on top of the W at 5-and-9 one is trying to work. Front-to-back ratio of the beam will reduce the I1 to 10 over, and increase the W to about 8 over. The I1 is still stronger, and while it is now easier to read the W, the I1 is unlikely to go away, as he can hardly hear *you* at all off the back of the beam. With the linear-and-dipole arrangement you stand a very good chance of blasting the I1 off the band altogether, resulting in perfect copy of the W, not just improved.

Conclusions? Fairly obvious; if you can operate the HF bands at all during TV hours, then a linear will do everything a beam can, and a whole lot more.

## CALIBRATING THE BUG

W. BAKER, B.Sc. (G3HDQ)

**W**HY not calibrate that bug key, so you'll know the speed you're sending at?

In "correct" Morse the duration of dashes and spaces are all fixed in relation to the dot, thus:—

<i>dash</i>	= 3 dot units
<i>space between dots and dashes</i>	= 1 "
<i>space between letters</i>	= 3 "
<i>space between words</i>	= 7 "

The rate of sending words-per-minute is therefore determined by the rate at which the key produces a string of dots. All we have to do then in order to calibrate the key is to count the dot-rate at various settings of the speed control, and divide the figures obtained by the number of dot units in an average word.

But how do we decide what is an average word when the number of letters in a word can vary from 1 to 15 or more, and the duration of a code letter can vary from a single dot unit for the letter "e", to 13 dot units for the letters "y" and "q"? Fortunately, the length of the average word with its associated space has been arbitrarily fixed for the purpose of code speeds at 50 dot units, or a string of 25 dots. Hence,

$$\text{code speed in w.p.m.} = \frac{\text{dot rate p.m.}}{25}$$

and 12 w.p.m., for example, is equivalent to a dot-rate of 300 per minute.

### Counting the Dots

Except at very low speeds it is not possible to count individual dots, but for speeds up to about 15 w.p.m. it's not difficult to count groups of four over a short period. If we count groups of four for 9½ seconds we get the code speed in w.p.m. directly, without calculation. At higher speeds up to about 25 w.p.m., a mark can be made for each group of four dots during the timed period and the number of dots counted afterwards.

The job of counting can be made easier if a two-speed tape recorder is available, and the upper limit of calibration extended. Record a string of dots at the higher speed, and count on playback at half speed for twice the period of time. A two-speed tape recorder is also useful when calibrating a mechanical bug key that may not give a long enough string of dots for accurate timing at the actual speed.

Finally, calibration of a fully automatic key is made easier by counting a string of dashes instead of dots. It is easy to see that if the key is correctly set up, the dash rate will be exactly half the dot rate at the same speed setting. Hence

$$\text{code speed in w.p.m.} = \frac{\text{dash rate p.m.}}{12.5}$$

• • • SWL • • •

SHORT WAVE LISTENER  
FEATURE

By Justin Cooper

SOMETHING ABOUT IC's—POINTS  
ON PRESELECTION—QUERIES AND IDEAS  
FROM A HEAVY MAIL—THE  
TABLES UP-TO-DATE

SOMETIMES people write in, discussing their idea of a "dream receiver" and talking at length of transistors, valves and integrated circuits—but more often one receives hints that the writer of the letter would like to know more about these marvellous IC's.

Broadly, we can divide the tribe into two groups. The first are the *digital* ones, the property of which is to change state from an output "switched on" to "switched off," or *vice versa*, under the influence of some control signal. Such devices can be used in our field to make counters to tell our frequency accurately, to make el-bug keyers which can guarantee a correct mark-space ratio for perfect Morse, and for various sequential control functions. Digital IC's are the basis of most modern computers.

The other group can be described as *linear* circuits. The simpler ones are called operational amplifiers, often known "op-amps," and comprise a simple amplifier with terminals for input, output, DC supplies, and some feedback to which can be connected external circuitry as required. These can be made to do most of the things one would expect an amplifier to do, of course, within their power limitations.

More elaborate linear IC's are used in the communications field, some providing AGC, and others acting as a complete RF/IF strip-and-detector, to which one only need add the coils, capacitors and IF cans, a few resistors and an integrated circuit AF amplifier to have a complete receiver.

Why, then, have these "beetles" not swept the valves and transistors into limbo? Various reasons can be adduced for this. The first is that most of the circuitry is inside the little plastic package, and so the chances are that a fault will result in a beetle to change—and just you watch a service engineer try to unsolder fourteen or so pins without damaging the printed circuit! Another one of considerable importance is the sad fact that with all the effort which has been directed into semi-conductor technology, the overload characteristics are still not what they ought to be in the presence of big signals. However, it is true to say that in 1972 it is easier than ever before to home-build a receiver of quite good performance, using the linear IC's supplied by most of the big British manufacturers, or imported types such as the range by National Semiconductors, who look to have more interest in communications IC's than most. As a final thought, these last make an IC which could be used as the main part of the receiver, and also be set to work as the sideband generator of the transmitter—thought for transceiver designers!!

The Letters

*M. P. Reynolds (Swanington)* has been listening on the bands for a couple of years now, with the help of a Joystick and a Trio 9R-59; one gathers his major interest lies on Eighty.

A Codar CR-70A, with a preselector, an ATU, and an aerial switching unit, couple *M. North (Bristol)* to the amateur bands, by way of a much bent 132-foot end-fed and an indoor whip. Of this queries, the RB5 on Ten is quite OK—Russian VHF-only calls use R instead of W, and they are allowed to use frequencies from 28 MHz up. The other two sound remarkably like "intruders"

---

SWL T. Pearce, Stoneleigh, Kilgelly, Pembrokeshire, West Wales, runs an Eddystone 840A and the Rx section of an ex-Army 29 Set as his receivers, aerials being a 66ft. wire and a dipole for 15 metres.

---

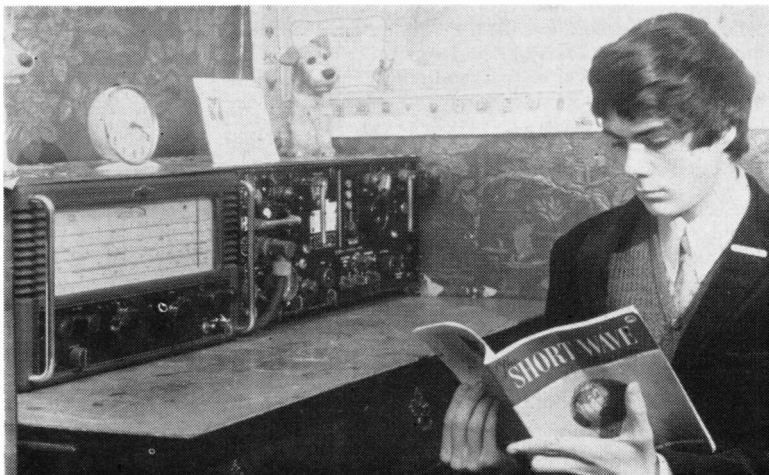



building a shed for the shack, acquiring a pole for the eight-element Yagi, and generally getting ready for a G8/3 call just as soon as that result comes in. To both these lads, our best wishes.

Similar congratulations must be accorded to *P. Harris (Surbiton)* who has now become G4BDQ, and is roaming Top Band with an indoor aerial, although a forthcoming enforced move may result in something a little better—anyway, he says operating is more fun than SWL'ing, anyway!

Having tripped over 4U1ITU on the band, *A. West (Herne Hill)* wants to know a little more about it. 4U1ITU is the amateur-band set-up at the International Telecommunication Union Hq. in Geneva, where the International Amateur Radio Club (IARC) has its being, primarily for any amateurs who may be on the ITU staff, or delegates to ITU functions. In addition, any licensed amateur who is in the area may, we understand, operate the station. Incidentally, IARC is probably the most truly international of all the "international" groups, with active members and officials from both sides of the Iron Curtain in the Club. The article by G3YMH in the June issue of *SHORT WAVE MAGAZINE* mentions experiences when visiting 4U1ITU, Geneva. 4U1 is the special prefix reserved for ITU stations operating on the amateur bands.

A question about the HPX Ladder by *T. Rootsey (Ilford)* rather laid us flat—he asks if anyone has ever managed to be at the top of both the Phone and the CW sections at the same time. Not to the recollection of your old scribe, Terry, so if you do make it, you will have generated another "first." Terry has been rather busy of late, as he has been sent to London University to tackle an advanced qualification, so not only has he had to confine his listening to what little time is left after studies, but his XYL has been pushed into recording the lists for his HPX, combing through his rough logs; and not just the Phone one, at that, for Terry has now made a start at the CW end as well!

### Goofs

Your poor old J.C. must have been off his beam when he wrote the May piece. No less than three slips to be rectified! The first one is to the address of *M. F. Winiberg (Penzance)*; we seem to have kept his 1971 card and slipped it into the 1972 Table—however, as has now made a clean start we can soon sort that one out.

Not quite so easy to account for is the letter from *W. Edwards (Tadworth)*. Somehow we managed to omit taking in his scores—but what is worse is that we said he was doing O-Levels when the course he is attending in fact covers ONC. However, we will be able to put the record straight this time.

Our third prize goof concerns the *Bingham* family, in *Carrickfergus*. Here there seems to be so much complication that both Noel and your conductor are at a loss! However, we hope that what appears this issue does in fact represent the true situation.

\* \* \*

Another technical point crops up in the letter from *H. Alford (Burnham-on-Sea)* who wants to know how one takes into account the gap in the middle when making up a half-wave dipole, or for that matter how one takes

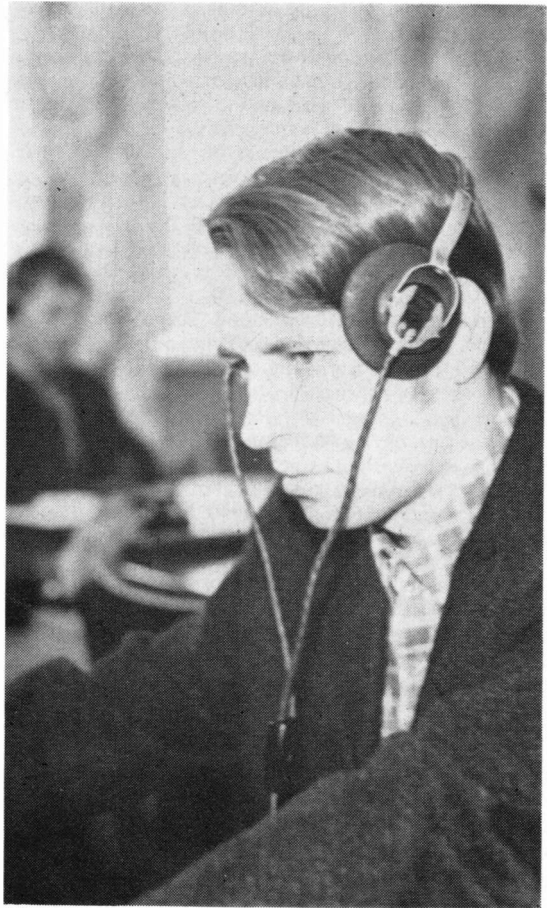

This picture is of particular interest because it is of SWL Dmitry Vlasev, a keen DX chaser in the UA4 district of Russia. Unless as a transmitter, one does not hear much of the Russian SWL's, though there must be many thousands of them.

into account the bit of wire which goes through the end insulators and is twisted back to make the fixing. A Good Question, on which SWL Alford (and, indeed J.C.) has seen conflicting opinions. The proper answer is that the gap at the centre should be small as is conveniently achievable, and the ends cut to an excess length. The aerial can then be trimmed, by cutting an inch at a time off each end, until a simple SWL Bridge reads its lowest at the middle of the band of interest. Your J.C. does this by exciting the aerial with a grid-dip oscillator or signal generator, through a simple impedance bridge and plotting SWR versus frequency. This bridge is made of a handful of resistors, some disc ceramic decouplers and uses for its indication the station multimeter. This is the method which takes account of all the possible errors due to end-effects, proximity problems, and the gap in the middle; and it pays dividends, because it is the only way in which you can be *sure* the aerial is doing its best.

*K. Kyezor (Perivale)* has again been suffering the demon Work, which has kept him from making the lift

in his score which he would have liked to see. However, he is going to North Wales soon, he hopes, and may have use of a receiver so as to be able to add to the totals. On the other hand, your conductor would suspect that once in that beautiful part of the world, SWL will be forgotten in favour of exploration.

Strange how an SWL generates another: *D. J. A. Noakes (Cranbrook)* met Norman Henbrey and as a result found the amateur bands; as if that were not enough, he came away from *chez G4XF* with no less than ten years of back-numbers of *SHORT WAVE MAGAZINE*. Sam now has the mammoth task of reading them all through.

That *JYADO/MM* discussion has taken another turn—the operator is now using the call *JY4AH/AM*, and still operating /Aeronautical Mobile. *H. Stephenson (Newcastle)* reports this. He, by the way, has a personal target, which is to pass *J. V. Parker* of Newcastle, in the Table, as he does not have much hope of overhauling *Stew Foster!* To add to our information on this *JY/AM* station, *GW4AQR (Bangor, Caerns.)* heard him on Twenty, *en route* from Amman to Madrid; it was an added interest to note how the beam heading changed as the aircraft progressed along its course.

Lots of questions in the letter from *O. Cross (Bexley-heath)*. First, those Russian U.K. prefixes; all are Club calls, and can, with care, be related to the normal prefix of the area they are in. The *VEØ* prefix has Owen puzzled, but he answers his own question—they are all aboard ships. Then there comes the question of the sound of the modulation from *IT9SPW*, and the effective way in which it cuts its way through the *QRM*. Difficult to say, but one would think it is truly an echo effect due to a shack with few if any soft furnishings to deaden the reverberation. This enhances the “attack” on the microphone.

*R. Carter (Blackburn)* has been having trouble with noise on the bands, which builds up during the day; one would think these could be due to weather conditions rather than man-made. Anyway, they annoyed Ben so much that he went out of his way to overhaul the aerial system and to give the receiver the once-over, which can never be a bad thing anyway!

*H. Rogers (Ullesthorpe)* has lately been away on courses connected with his work, which has held him down a little. Ken comes back on this *QSL* business and says he personally has had a good return, not to mention lots of letters of encouragement, although *QSL* cards through the Bureau can take a year or eighteen months to get through the system! As far as *QSL* returns are concerned the only weak area for him is in respect of reports sent to two-metre operators. *Bad!*

Various correspondents mention a station signing “*4YA51/MM*”, operating on 14 MHz, among them *R. Smye (Wirral)* and *I. Brown (Newtownabbey)*. The latter says the station is set up in a training ship belonging to ICAO (this is the International Civil Aviation Organisation) and its Air Traffic Control division. This, of course, would not necessarily give a clue to the nationality of the ship, or indeed of the station, because *4Y* is the prefix series for anything to do with ICAO, as a look at the current Prefix List will show.

*J. H. Sparkes (Trowbridge)* seems to have found most of the stuff that was available, and he comments on *U4L*,

having to spend time correcting Europeans who tried to turn him into a *UA4*; this one was in fact a “Lenin Memorial Day” exercise by *Ulyanowsk Club*, who normally sign *UK4LAA*. *QSL*'s should be directed to *UA4LN*. On a different line, *SWL Sparkes* is finding the going a bit harder now the 650 mark is passed, so he has taken to the foreign-language signals, with the aid of a copy of our *Hams Interpreter*, and benefited much thereby.

No letter came in with the list from *N. Askew (Coventry)* but there were a couple of cuttings from the local paper. The first one refers to *TVI* troubles suffered by *G5PP*—at least the paper had the decency to admit *Bob's* transmitter was not at fault, although they had the cheek to say that this was “a surprise finding.” However, we gather the *GPO* interference people have sorted out fifteen of the sixteen complainers in *G5PP's* favour, with the last one waiting a reply from the makers. Good for *G5PP* for sticking to his guns! The other cutting implies a harmonic relationship between the *UHF BBC1* channel in Coventry, and the local oscillator frequency of a *VHF* set operating on the 405-line channel *ITV* signal, which can, and apparently does, cause all sorts of funny things to happen to colour *TV* signals. The biter bit, methinks!

*J. Woods (Woodbridge)* has been trying out *Vee* aerials, and has come to the conclusion that the best compromise is a pair of 101-foot wires, fed through 30ft. of 300-ohm ribbon feeder to an *ATU* and thence to the receiver.

Now to *C. A. Lancaster (North Ferriby)* who has lots of academic study on his plate to impede his *SWL* interests not to mention parental objections to his “infernal machine” of an *R.209*—they should see your old *J.C.'s* shack, half-way through the writing of this piece!

\* \* \*

*L. A. S. Poole* hails from *Winchmore Hill*, in North London, and sends in a nice first list—what is more, he has put his oddities in a neat little pile at one end and frankly admits they are more than likely mis-readings. However, after we had run the blue pencil through, he still has 289 for a first entry.

Scraping the dust off the *B.40* sums up *R. C. Jones' (Reigate)* approach to the coming holiday season—his *A-Level* studies have been keeping him away from the receiver that much! However, those *A-Levels* are more important in the long run, they having a direct and causal relationship with their owners earning-power later in life.

In *Shenfield* there is a new listener on Two, namely *R. Philpot*, who as a result has a shorter *HF* list. His set-up is a *Mosfet* dual-gate converter, coupled to a halo through 45 feet of coax, and the main receiver is a *Trio 9R-59DS*.

A nice long *HPX* list with no other comment comes in from *J. Gravell (Burry Port)* who seems to have looked around at various times, judging by the stations he has claimed.

Both the *ATPW* Tables feature the name of *W. B. Taunton (Meopham)*; Bernard usually listens for an hour from 0600-0700 and then for another spell from 2000 to 2100, the favoured hands usually being 14 and 21 MHz.

*J. Fitzgerald (Gt. Missenden)* has another long list—he certainly has hotted up the pace since he started to



use a real receiver instead of his old two-portables set-up. John raises a good point in connection with SXØE/72, who could be regarded as an SXØ or an SX72. On reflection, your scribe is rather inclined to plump for the latter interpretation.

R. *Shilcock (Lye)* is another of these list-but-no-letter types—he can afford to be with a score of 1200, even if he has been a correspondent for quite a long time!

J. *Halden (Newcastle, Staffs.)* has not been so active as of yore, due to the pressures of R.A.E., and, doubtless, work. The main thing is that it is *not* a sign of loss of interest, but rather of finding other facets of a hobby interest which probably is different for every amateur.

Another trio of "HPX entries only" come next, and they are from, respectively, B. *Hughes (Worcester)*, G. S. *Taylor (Rugeley)*, and E. W. *Robinson (Bury St. Edmunds)*, all of whom have been with us for quite a long time.

E. *Parker (Hove)* has Had a Thought. If the "possible" total of prefixes were the score of S. Foster at the moment, and if Ernie can keep up his present rate of progress, then in seventeen years from now (by which time he will be 74) he should be at the top of the Table! Those with four-figure scores had better look out; this chap seems persistent!

On to C. K. A. *Verstage (Old Basing)* who queries K1SJM/AM, because he claimed to be on an air-sea rescue helicopter in Florida. J.C. has to admit he finds this reasoning somewhat difficult to follow—after all, the only possible objection to use of a "chopper" for /AM working could be the one about wire aeriels, which are never used these days anyhow—so it is quite likely K1SJM/AM was all he claimed to be.

Both the DX'ing members of the *Proud* family, in *Letterston* are brief and to the point this month. O.M.G. G. comments on a couple of early-morning sessions which yielded VK/ZL and JA additions to the score and reckons it was well worth setting the alarm for them. On the other hand junior op. Steve has A-Levels ahead, and says simply "no time for listening, let alone writing"!

A. *Rowland (BFPO 53)* has a long letter this time; he heard a JA6HBS/YL on Fifteen and wonders whether the suffix in fact has any significance beyond the obvious. Still with the JA's, Alan has heard one or two signing JE1 from Japan—probably a new series. Changing tack a little, the acquisition of a Hamgear preselector has so shown-up the receiver itself that the decision has been made to tolerate a week or so of QRT while the Rx is treated to some overdue maintenance—always a good idea, this.

On to D. A. *Shepherd (Kingswinford)* who has received much help from G8FUI and G8CXB in the year since first he appeared in this piece and the table—in the latter he has all but trebled his score, but still finds there is room for improvement in the operator—which is the sort of approach that pays dividends in Amateur Radio.

Those exams. are getting too close for comfort, says A. *Judge (Bishops Stortford)* who as a result is going to be all but QRT till they are out of the way—but he still seems to get on whenever there is some *real* DX about, either CW or SSB.

Our last letter in the clip this time is from H. M. *Graham (Harefield)* who finds his QSL return runs at

## NEW HPX LADDER

(Starting January 1, 1972)

SWL	PREFIXES	SWL	PREFIXES
PHONE ONLY		PHONE ONLY	
C. K. Verstage (Old Basing)	466	L. A. S. Poole	
L. Thomas (Castleford)	448	(London, N.21)	289
O. L. Cross (Bexleyheath)	446	P. Barker (Sunderland)	275
J. V. Parker		Z. Parmigniani (Stockport)	275
(Newcastle-on-Tyne)	424	G. Ridgway (Basildon)	268
N. Gerdes (Basingstoke)	398	P. N. Newman (Thame)	265
M. Kitchener (Hitchin)	381	K. M. Rogers (Ullesthorpe)	256
A. Williams (Stockport)	377	A. K. Milner (Grantham)	252
M. Marsden (Ilford)	364	M. North (Bristol, 19)	234
R. Philpot (Shenfield)	360	M. Winberg (Penzance)	230
Mrs. R. Smith (Nuneaton)	351	R. Smye (Parkgate, Wirral)	225
A. West (Herne Hill)	333	R. Jones (Caerphilly)	216
B. Stone (Penzance)	321	R. Jones (Reigate)	210
J. Gravell (Burry Port)	319		

Listings include only recent claims. Starting score 200.  
Rules as for HPX—see p.560, November 1971 issue.

about 67%, which seems to be about the best for most people, no matter how hard they try. Maurice found Twenty suffering from an overdose of short-skip, and Fifteen much the more rewarding, yielding as it did such calls as CP1FG, ET3GK, HK1CMX, WA4KCH /HKØ, IC8CQF, KV4AD, KZ5YY, T12CHA, UF5ØD, 5H3LV, 9Q5RN, 9X5YF, as well as LU, PY and YV. Ten metres only gave ZS and 9J2—the band now has very much a North-South feel to it, and it won't be long before all that will be heard will be local nets and the odd DX due to anomalous propagation.

### Nw QRU so QRT

As our CW friends would have it. Once again, we have run through the pile, with all its interest, its chuckles and its occasional touches of sadness, until next time. For that the deadline will be first post **July 25**, and the address; SWL, SHORT WAVE MAGAZINE, BUCKINGHAM. That is all you need put on your envelope—writ clear and bold.

### IMPORTANT MERGER (Lasky's and G. W. Smith)

A new company called Audiotronics Holdings, Ltd. has been formed to amalgamate the Lasky Group with the G. W. Smith business. Both are very well known in radio and electronics retail trade, with combined annual sales of about £5 million, giving profits last year of some £677,000. The founders of the two businesses are Mr. Harry Lasky and Mr. George Smith, who between them have 14 retail outlets for hi-fi and electronic equipment of every sort as well as a wholesale division and a mail-order department with about a quarter of a million customers listed. It is the intention to make a public flotation of shares in Audiotronics, Ltd. in the autumn, through the Stock Exchange. The two constituent companies, Lasky's and G. W. Smith, will continue to trade under their separate names and will retain their individual identities.

ONCE again, the DX has been hard to come by over the last few weeks, although there have been minor lifts. For example, 70 cm. was quite good at the beginning of May, 2m. opened up for a short while around the middle of the month, although deep QSB and lowish signal strengths made contacts difficult, and the late evening on May 21 produced a fair N/S path, while June 2 saw 2m. open for Continental contacts, with DJ9DL probably the best signal (on CW).

It is difficult to recall a time when VHF/UHF propagation has been so poor for so long and so late into the year. At least it matches the weather!

#### VHFCC Awards

The three claimants for the VHFCC Award this month all operate on two metres.

Fred Munster, G8DYC of Derby, was first licensed in August 1970 (at the age of 56!) and gains Award No. 151. He runs a Pye base-station running 38 watts input to a QQV03-20A with a pair of EL34 modulators, the antenna being an 8/8 in the attic. For reception, he has a Mosfet converter tuning 4-6 MHz into an Eddystone EC-10. Although the QTH is up at 180ft., he is badly screened to the South, but this didn't stop him from getting his only Continental DX in the shape of F8BOM who is, perversely enough, almost due South of Derby. Fred's main interest is in portable working from up in the Derbyshire hills, and he raises a point here which perhaps merits repetition: While the VHFCC Award is open for portable operations, the contacts must *all* have been made from the same site, and claimants will be required to certify that this proviso has been observed.

From Wolverhampton, John Richardson, G8EBF, now runs some 100 watts of NBFM from a QQV06-40A, this mode being dictated by the TVI which he experienced with his lower-powered AM rig. Receiving set-up consists of a Nuvistor converter running 3-5 MHz into an Eddystone 940 and the antenna is a ten-ele. Skybeam at 34ft. The 350ft. a.s.l. site has got him some nice DX. He also seems to have the knack of getting in the QSL cards since he quotes his return rate as some 75%, which is one of the highest we have seen lately. His

# VHF BANDS

A. H. DORMER, G3DAH

Award is No. 152.

A very detailed and well-presented claim comes from Tim Price, G8FIH (Brimpsfield, Glos.). He commenced operations in December 1971 from an 850ft. a.s.l. site in the Cotswolds which he modestly says "is fairly good in most directions"! The Tx is a modified Pye base-station running 25 watts to a QQV06-40A in the final, the Rx a Trio JR-500SE with a Microwave Modules converter, and the aerial an 8-ele. Yagi at 27ft. He also is going NBFM to reduce the TVI, and hopes that the change will not reduce still further the QSL/QSO rate which stands at about 37%. Award No. 153 has been issued to him.

#### Beacons and Repeaters

Beaconry seems to be going through a bad patch these days. GB3CTC has been off the air for some time and reports from the locals suggest that it may well be the Autumn before it is operational again. The ripple on the Wrotham beacon persists. GB3DM is playing up. It is transmitting a continuous carrier and is very weak in the South, (although conditions may have something to do with this). GB3GM on 2m. is still reported 7 kHz low in frequency and has been intermittent in operation. GB3GM on 4m. has not been heard for over a year now. TVI is the problem.

"Checkpoint Charlie", the German VOR beacon just outside the low end of 2m., has apparently

closed down. F3THF has also had its troubles. It was transmitting a continuous carrier for some time, and the frequency has been somewhat unstable. *Via* G8DPV comes the information that the keying system for this beacon consists of a perforated disc revolving at 1 r.p.m. with a lamp and photo-cell to produce the necessary FSK, and the suggestion is that the lamp fails from time to time! However, he learns from F1BZN, who lives close to the beacon, that this system is to be replaced shortly by logic circuits. In spite of poor propagation conditions, HB9HB continues to be received on most days in the South of this country.

On 70 cm., the future of GB3GEC is still uncertain, but it is possible that the service may be "continued under new management." PAØVD has not yet completed the re-build of his beacon, but when it does come on the air the QRG is likely to be 432.10 MHz.

The first British repeater (talk-through station) is now active in the Cambridge area and on test for one year. Callsign is GB3PI, input frequency 145.15 MHz and output on 145.75 MHz. A 1700 kHz tone will open the device for one minute. The 600 kHz spacing does not conform to the current Continental (mainly German) standards, but it is understood that there is a move afoot to revise these. Power at GB3PI is 15w. with a vertical dipole.

The date for *Oscar VI* is now given as Nov. 72.

#### Anjou—1

The French balloon-borne transponder, *Anjou 1*, reported in our last, was launched on May 28 and operated as planned, although it seems that only French stations were able to work through it. G2JF reports first signals heard at 0950z and last at 1030z. He logged 21 different stations (all French) during this period. In Basingstoke, G8CCH heard three AM and one SSB transmission between 1010z and 1025z. All were subject to severe QSB and reached a maximum of 5 & 6 at about 1020z. Further away, G3XIX in Felixstowe only received the transmissions for a very short time, 1024z-1027z, noting odd bursts of FM and SSB during that

period. G4ALN (Romford) first heard the beacon signal at 1021z at RST-339 increasing to RST-549 at 1024z and remaining at this level until 1040z, when all signals disappeared. At G3DAH, the beacon was audible from 0955z to 1022z, and all modes of transmission were heard, the strongest signal being that of F9FT at RST-589 on CW. No contacts were made in spite of repeated calls on 70 cm., using the apparently accepted phraseology of "CQ Sonde Anjou" which readers may care to note for future reference. Many thanks to all those who sent in reports.

#### DX-Peditions

Paul Widger, ex-GM8AGU and now G8AGU, and GM3JFG are off on their travels again during September 7-12. This year they will be operating on 2m. with CW, SSB, FM and AM from the Isle of Arran (Buteshire) and hope to be able to take 4m. gear with them also. Full details nearer the time, but this is one to note in the diary, bearing in mind the conspicuous success of their earlier trips.

The March & District Radio Amateur Society (which one notes abbreviates neatly to "MADRAS") have organised an expedition to Huntingdonshire over the period August 19/20. The callsign will be G3PMH/P on all bands, and the operating schedule is as follows: *Sat. 19th*, 1700z-2300z AM on 145.2 MHz, with the first 10 minutes in each hour for CW. 433.0 MHz by arrangement on 2m. *Sun. 20th*, 0800-1000z, 145.41 MHz SSB; 1000-1200z, 70.26 MHz AM and CW; 1200-1400z, 433.0 MHz AM and CW and 1400-1500z 145.2 MHz AM.

Kirkwall, Orkneys is the location for an expedition organised by the Chester & District Amateur Radio Society over July 2-8. Callsigns are GM3GIZ/P and GM8GIZ/P and the party will comprise some five operators and several SWL's. Frequencies are 145.67 MHz and 145.93 MHz for AM, with CW in the usual segment at the low end of two metres. Operating times are quoted as 2200z to 2359z only, but it is to be hoped that they may find it possible to lay on some early morning (0700z) working, since propagation from so far North is likely to be better at

### THREE BAND ANNUAL VHF TABLE

January to December, 1972

Station	FOUR METRES		TWO METRES		70 CENTIMETRES		TOTAL pts.
	Counties	Countries	Counties	Countries	Counties	Countries	
G5DF	26	2	46	6	24	2	106
G3DAH	21	2	40	5	21	3	92
GD2HDZ	12	3	45	6	11	2	79
G3NHE	—	—	48	7	19	2	76
G3OHH	33	4	16	2	11	2	68
G8BXX	—	—	33	2	24	2	61
G8CIW	—	—	46	9	—	—	55
G3FIJ	10	2	25	5	9	3	54
G3BW	—	—	45	6	—	—	51
G3YRH	—	—	33	5	8	4	50
G4ALN	—	—	27	4	14	1	46
G8FAG	—	—	41	4	—	—	45
G8FIH	—	—	37	3	—	—	40
G3EKP	13	6	16	2	1	1	39
G3DAO	—	—	32	6	—	—	38
G8EMS	—	—	34	3	—	—	37
G4AJE	—	—	31	3	—	—	34
G8FUI	—	—	26	2	5	2	35
G8DWT	—	—	32	3	—	—	35
G8CBU	—	—	27	2	4	1	34
GM8BDX	—	—	25	4	2	2	33
G8BKR	—	—	21	2	8	2	33
G8BMD	—	—	23	4	—	—	27
G8AGL	—	—	25	1	—	—	26
G8FKL	—	—	23	2	—	—	25
G8ERM	—	—	21	2	—	—	23
G4AVX	—	—	20	3	—	—	23
GW3CBY	—	—	15	2	3	2	23
G8FNH	—	—	20	2	—	—	22
G3PQF	—	—	19	2	—	—	21
G8COG	—	—	19	2	—	—	21
GM3ZVB	—	—	16	3	—	—	19
F6BQH	—	—	7	3	—	—	10
G8GBH	—	—	6	2	—	—	8
G8DBX	—	—	6	2	—	—	8
G8FVI	—	—	7	1	—	—	8
G3MEW	—	—	6	1	—	—	7
G8FSO	—	—	4	2	—	—	6

Just a reminder that the Tables go through to December 31, 1972. The Three-Band Annual Tables show claims to date for the year commencing January 1, 1972. Claims should be sent to:—"VHF Bands," SHORT WAVE MAGAZINE, BUCKINGHAM as they accrue.

those times than in the evenings. Of course, QSO's will be easier to come by during an evening session when the operating population is likely to be more numerous, but the DX ought to be better earlier. Those interested in skeds should write, with s.a.e., to Ian Jolly, G8EOO, *QTHR*.

Not exactly a DX-pedition, since he lives in Cornwall and operates from there when he is not at R.A.F. Brize Norton, Oxon, but G8DPV plans extensive operation from the Mevagissey area between July 8 and 31. Frequency will be 144-16 MHz and he will be looking East and calling CQ at 1400z and 1500z most afternoons, and will be out portable most evenings. He hopes to have 8 watts and a multibeam available for 70 cm. at the same time, which will make him an even more attractive target!

G3BA/G3BHT/G3URV will be /P from near Cromer, Norfolk, for the July 2m. contest. SSB on the hour with CW, AM and NBFM available as required.

Here is one that is a heck of a long haul, but which *might* just be on if the tropo, is right: DM3ML, the Dresden Club, will be operating from the island of Usedom in the Baltic (QRA Locator H071f) from July 30 to August 10. They will be on from 1830z each day with CW, SSB and AM running 90 watts input and a 9-ele beam. QSL's to: Amateurfunkstation DM3ML, 8027 Dresden, Technische Universität Dresden, Postbox 52—GST. And the best of British!!

\* \* \*

This Column frequently receives letters announcing that G3---/P will be operating in some rare spot on such-and-such a date, or that a certain GM (say) is looking for contacts on 2m. We are always pleased to publish these facts, but it would help quite a lot if we could give more detail. Consider GM---/P half-way up Ben Nevis, for example: It would be more productive all round if one knew the mode of transmission as well as dates and times. If CW operation is planned, will he be calling and listening in the "window", calling in the "window" and listening at the bottom end of the band, or sending and receiving in the usual CW segment? In many

instances, this information is supplied, but it is pretty frustrating for the chap on the receiving end if he does not know in rather more than bare outline just where, how and when to respond.

Another aspect of this form of activity upon which it may be profitable to muse is the reason for it. If it is just for fun, or to test out equipment, or a particular site, then operations are obviously at the whim of the organiser(s), but if the object is, as is frequently the case, to provide some rare DX, then not only is it desirable that the fullest details of the operation should receive advance publicity, but also that the *results* should be made known, not merely from the general point of view, but also to give other prospective users some indication of the merits, or demerits, of the site. Again, if the object of the exercise is to make DX contacts, then there is a very good argument for using more CW than appears fashionable at present. The GM3GWC/P operation is a recent example, in that they were heard at 250+ miles on many occasions and would have been workable on the key but, propagation being what it was at the time, their AM signals were just not getting through at sufficient strength to make contacts probable rather than marginal. This is no reflection on their abilities, but is used merely to illustrate a point. And we might also mention "expeditions," given useful publicity here, from whom not another word is heard, either on the air or by way of a report on their results. So how about it, you DX-peditionaries?

#### The Scottish Scene

The big news from GM this month was undoubtedly the George Watson's College expedition. A detailed analysis is in course of preparation, but it can be noted here that they visited 10 counties in G, GM and GW and worked over 400 different stations in all. Unfortunately, the schedule was not completed fully, due mainly to the weather; to troubles with the mechanical transport, which cost them both time and money; and to minor troubles with the electronics, but it remains a very creditable and welcome effort. The meticulous arrangements made well in advance

for every site paid off handsomely, as witness the warm reception they had everywhere. *Verb. sap.!*

Every Tuesday night at 1900z is the time to look for 70 cm. activity in Edinburgh and district, since these are their activity nights. Calls to note are GM3FYB, GM3OXX, GM8BJF and GM8BCB among others. GM3OXX, operating from Merrick Mountain in SW Scotland during Field Day, made it with GI on 70 cm. You may like to know that he is planning another "Munroe" during the third week of July. At least nine sites will be visited and he is offering a special "award" to any operator who contacts him from at least five of these. The starting point is Criarlarch, and all the sites will be in Perthshire.

GM3IVZ (Kirkcaldy) is now reported thawed out after his recent, four-month-long trip to UA, and is back on the 2m. air with his potent NBFM signal. His neighbour, GM3AEY, seems to have deserted 2m. for some time while under the spell of his newly acquired electronic organ—on which he is no mean performer—but then he is no mean performer on 2m. either, so how about it, Harry? GM3OWU and GM8BJF have both got Pye Bantams modified for 2m., and can be heard from the Pentland Hills on many occasions. Jack Wilson, GM6XI, now has a "G3BA Mk. III SSB transverter" going on 2m. in conjunction with his Sommerkamp FL-500, with excellent results. The other Jack Wilson, GM3KJF, is now going great guns from Ayr, and looks likely to become as well-known on 2m. as his Quad made him on the HF bands. GM8BRM/P continues to lay down a good signal into the South from well North of Aberdeen, although he foxed the locals a bit by going /P from Edinburgh recently. GM3BQA has added to his aerial farm in North Berwick with the erection of a Parabeam for 2m. at a height of 70ft., which he estimates to be slightly better than the 8/8. Incidentally, apologies to Jimmy and Ian Lamb, G6LD, for the incorrect titling in the photograph on p.216 of last month's issue. GM3BQA is on the extreme left with G6LD on the right of the picture.

The recent get-together in Perth of

VHF enthusiasts from the North and East of Scotland was another success. Those meetings are of particular value for keeping the more isolated operators in touch, and one might expect to see more of them in other parts of the country.

Finally, it is with regret that we have to announce the death of David Richmond, GM3XVJ, following an operation. Although only 23 years of age, he was a graduate of Edinburgh University and a member of a research team at the MPT in that City. His friends among the radio amateurs from Ayrshire and Edinburgh will sadly miss this courteous and friendly two-metre operator.

### Happenings

The Normanton, Yorks., Grammar School A.R.S. is setting up a special 2m. station during the whole month of July in connection with the 380th anniversary of the founding of that establishment. The callsign allotted is GB8NGS which, it may be noted, is the first Class-B special licence to be issued. Operating times are pretty flexible depending upon local circumstances, but frequency is likely to be 145.60 MHz and skeds may be fixed *via* David Lockwood, G8F50, 7 Northfield Road, Sharlston Common, Wakefield, Yorks.

G3QG (Luton Hoo) reports copying YU3APR of Loubljana at RST-36/79 while he was in QSO with DL?RI between 1000-1030 clock on 2m. CW on June 6. Did anybody else hear this contact? While on the subject of anomalous propagation, reports of sporadic-E openings on VHF would be welcomed by F8SH, who is now the official IARU Region 1 focal point for correlation of such reports. His address is:—Serge Canivenc, 6, rue du Pont Hélé, Kervoalan, 22 Perrosquirec, France. G3FZL, *QTHR*, is collating reports on auroral openings. Details should be given in each case of date and time, beam heading and, if possible, signal strength in dB above noise.

G2DN has succeeded in setting up a schedule on 4m. with G3FET, who is now ZC4LR in Cyprus. The ploy is for the U.K. to transmit on 4m. and listen for replies on 28.5 MHz, 21.25 MHz or 14.15 MHz depending upon prevailing propagation conditions. Their listening

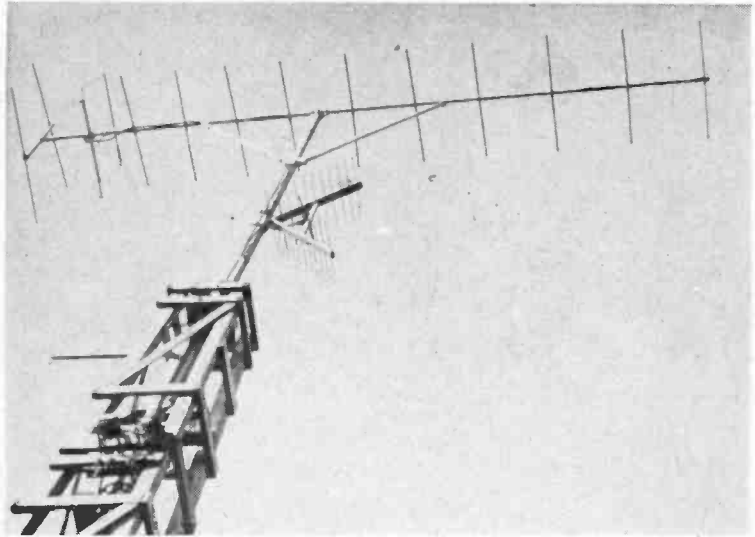

The home-constructed tower and beam system now in use by Frank Hall, GM8VZX, 45 Priory Cottages, Lunanhead, Forfar, Angus. Rotation of the mast section is by means of a wind-screen wiper motor geared down through an HRO dial mechanism to give a speed of one r.p.m. Unusual is the corner reflector for 70 centimetres, just below the two-metre beam.

times were based on a four-day rota system which commenced on June 10. As this date is so far in advance of publication, it would be advisable for 4m. operators to check with G2DN, *QTHR* (enclosing s.a.e.) as to whether the sked is still standing, and at what times.

### Three Band Annual Tables

Good to see several newcomers to the Tables this time, and in spite of the generally poor conditions on all the VHF/UHF bands, the scores continue to creep up, the contest season helping, of course.

Just to clear up any misconception, your own country and your own county each score one point. Several claims have been submitted recently which have not taken this into account.

### Contests

The Mid-Severn Valley Teleprinter contest, held on May 14 this year, resulted in a win for G3PWJ with a total of eight QSOs and 26 points. His best DX was with G3OLM at 185 kms, who gained second place. The consensus of opinion was that propagation was very poor and activity disappointing. Solid contacts were made the more difficult by the number of AM and

NBFM stations operated within 20 kHz of the allotted RTTY channel of 144.6 MHz. Some 20 stations were active during the event.

Conditions for the 2m. contest on May 21 were very variable with the East/West axis probably the most favourable for DX. The GW portables seemed to be doing reasonably well, and G3NYY/P in Herefordshire was knocking up a fine score, but generally speaking totals were well down on last year. Some high scores noted were those of G4BEL (*ex*-G8BBB) with 92 at 1500z; GW8ERP/P with 105 at 1210z; and GW3OXD/P with 100 at 1730z. GW3ZTH (Bridgend) made it into London and with GC2FZC (Guernsey) for some good DX. French stations were audible in the North for brief periods during the morning. G3NHE of Sheffield comments that CW proved a blessing—one third of his 62 contacts were made using this mode and accounted for half his points—and wished there were more activity at the bottom end. Personal observation suggests that brass-pounding is on the increase on 2m. if not on the other VHF bands.

The 70 MHz contest over the weekend June 10/11 did not produce any world-shattering DX—200 miles if you were lucky—with QSB very

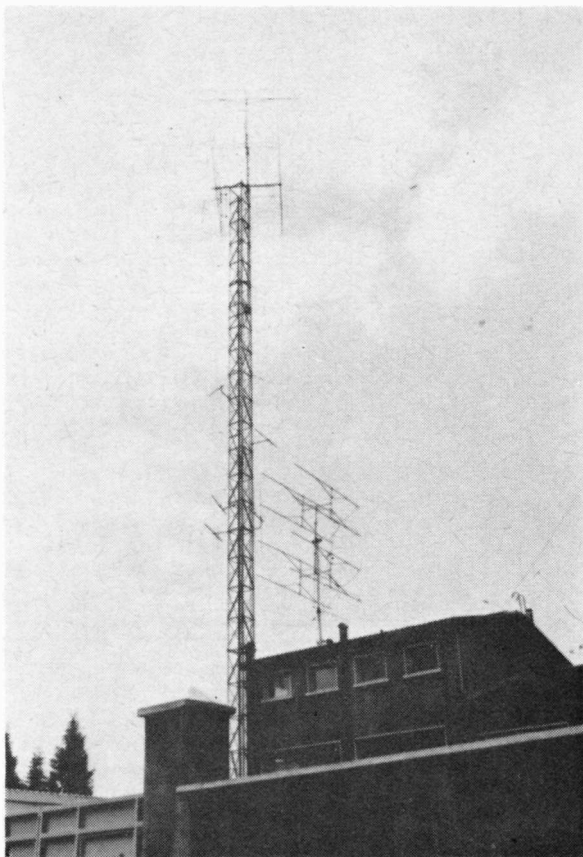

The F9FT aerial complex consists of an 80ft. tower carrying a 16-ele beam for two metres, with a multi-element array for 432 MHz on the house. F9FT, Mark Tonna, 134 Bd. Sauphinot, Reims 31, is a TV aerial manufacturer doing a large business throughout France. Though most French stations appear to be using F9FT beam designs, it is only a minor part of his activities—all-same J-Beams over here.

pronounced on even relatively short-haul contacts. As might be expected, the Welsh portables were getting their share of what DX there was, and in England, G3WOS/P near Luton and G3KSU/P near Ryde, I.o.W. piled up good scores. There appeared to be little SSB operation, but CW activity was high, and an ability to use the key paid off handsomely under the prevailing conditions, although it was noticeable that some groups tended to use inexperienced operators, particularly during the night watches, which slowed down the contest exchanges quite a bit. The timing appears to have been generally popular—the increase in activity after the TV stations had closed down was quite remarkable.

It is regretted that the dates given

for the submission of logs after the IARU Region I contest in September are incorrect. Entries should be postmarked not later than the second Monday following the contest weekend.

*Forthcoming Events:* The next 144 MHz contest runs from 1700z on July 1 to 1700z on July 2, and the 432 MHz event between 0900z and 1700z on July 23.

#### News Items

Joe Ludlow, GW3ZTH (Bridgend, Glam.) is trying to form a UHF/VHF Group in the area on the lines of those established in other parts of the country. Would those interested please get in touch with him at 1 Maes Glas, Cefn Cribbwr, Bridgend, Glam. He is also interested in 2m. skeds on SSB/CW

on Sunday mornings and Monday evenings. The two-metre SSB activity in that area is now quite high and includes GW3FSP, GW3NDB, GW3NJW, GW3LEW, GW3TMM, GW3XYW, GW3YSA, GW3ZTH, GW8EWR and GW3EYG.

Encouraged by an increase in local activity, G3MEW in Portsmouth has returned to two metres after an absence of some six years. He runs an HW-17A transceiver with an 8/8 at 45ft. from a sea-level QTH, and is looking for skeds during normal working hours. Contact him *QTHR*. G8EMS in Leeds is now QRV on 70 cm. with a 46-ele. beam at 40ft. He must have quite a good site there since he reports regular reception of the London beacon. When not operating the Leeds University station G3LUU, Chris Young (G8DWT, Reading) runs 80 watts to a QQV06-40A and a parabeam from the home QTH, and is looking for skeds on 2m. during the ten weeks summer vacation; he is *QTHR*. He has a bit of a hate about VFO's on 2m., particularly when they are used for continued out-of-Zone operation on the DX station's frequency! He suggests that one way to get round this menace would be for the DX stations to announce that they are tuning up or down from the frequency of the station they have just worked. He has got something there! He has plans for 70 cm. with 150 watts to a 4CX250B—so if you want Berkshire here is a chance to get it.

G8BBB of Ely, Cambridgeshire is now G4BEL, having just missed getting G4BBB, which has gone to Geoff Edwards (*ex-G8CRA*) of Malvern, Worcs. G8FDK/P operates portable on Wednesday evenings on 144-144 MHz from Hay Tor in Devon and G8EAO/P is on 144-29 MHz on Thursday evenings from Redruth, Cornwall—a couple of useful ones. G8DYX has now fitted up a 27ft. caravan as a shack and finds that this expedient not only tidies up the house, but also provides him with a comfortable mobile/portable radio room. G8DVS near Reading is QRV on 70 cm. and looking for contacts most evenings.

Take heart all those who are still waiting to hear their first aurora! G3BW of Whitehaven, Cumberland,

has just heard his first one (on April 28) some 24 years after we were first allotted 2m.! He logged GB3GM, GB3GI, SK4MPI, SM5LE, SMØDRV, SM5DWF and GM3UAG on this occasion, which seems to have been limited mainly to the North of the country, as was a short-lived *Ar* opening on May 28. He has still to work his first Continental, but that will come along when (and if) propagation conditions improve. He is on SSB most evenings from 1900 BST onwards in addition to monitoring the channel in the early mornings and at lunch-times, and as he says, if anyone can work him, then there is a good chance that they can also work GI, GD and GM, since Bill can just about see those countries from his QTH, always providing that AM/FM stations will leave the SSB calling channel clear for its allotted purpose. He is having a lot of trouble in this respect—and he is not the only one!

SM6PU is interested in working 70/28 MHz cross-band. He has already logged TF3VHF and his best effort to date was on July 16

last year when he heard (on 70.26 MHz) G3WDS, GI3CIJ and GI3RNY, but he frequently hears the FM broadcast stations at good strength. He has a converter with a TIXMO-5 in the front end and an NC-303 with a 6-ele. beam. Write to him, Olof Karlsson, Svalhult, 51054 Målsryd, Sweden, to fix skeds.

#### Deadline

Deadline for the next issue is July 8. The address for news, views, claims and comment remains:—"VHF Bands," SHORT WAVE MAGAZINE, BUCKINGHAM. Cheers for now and *vy 73 de G3DAH.*

**Stop Press:** The afternoon of Sunday, June 18, saw a powerful Auroral manifestation, the opening being between about 3.30 and 6.15 p.m. Much EU/DX was about, with SM and UR2 also coming through. We have no further details at the moment of writing but hope that those who were in on this *Ar* event will let us have full reports—in the meantime our thanks to G3COJ (High Wycombe) for the preliminary info, G3DAH being away as GM3DAH/M until the July 1-2 Contest.

A.J.D.

#### REMINDER—R.A.E. COURSES

Reference the note on p.224 of the June issue, we have already had a number of notifications for R.A.E. courses to be offered for the 1972-'73 session. Organisers of other courses not yet notified should let us have details as soon as possible, for taking into the first R.A.E. Course List to appear in the August issue. Address to: R.A.E., SHORT WAVE MAGAZINE, BUCKINGHAM.

#### ITEMS OF INTEREST

A new definition: *LIDAR*, the use of radar-laser techniques in the study of the troposphere relevant to radio-wave propagation, particularly at millimetre wavelengths.

\* \* \*

The 15th Jamboree-on-The-Air, the great Scout international QSO Party held on the amateur bands, will be during the weekend October 21-22. The U.K. organiser is L. R. Mitchell, G3BHK, 28 Darwall Drive, Ascot, Berks.

\* \* \*

Harry Wilson, EI2W, has for years been well known as an active and very successful operator on the 2m/6m. bands, with many EI/VHF "Firsts" to his credit. But what may not be so well known is that he is also an eminent Dublin business-man, with wide commercial interests. He has recently gone into print with a book called *Common Market or Common Sense*, which is an erudite treatise on this difficult topic and is evidently the fruit of much painstaking research. For all with a serious interest in the pressing economic problems of our time, his book will be useful and interesting reading. *Common Market or Common Sense*, by H. L. Wilson (EI2W), very well produced in hard-back, costs £2.50.

\* \* \*

In recent tests, *Concorde 001* (the French version of our SST partnership) has been repeatedly flown hands-

off by its autopilot at heights down to only a few feet (meaning 10ft. or so) above the runway. This is possible because the whole autopilot mechanism involves very sophisticated electronic control and communication circuitry, designed and produced by Marconi-Elliott Avionic Systems, Ltd. This sort of result can only be regarded as a major triumph in the practical application of electronics—it hardly matters if the pilot does fall asleep, provided he has pushed the appropriate button beforehand.

\* \* \*

There are now some 17,500 U.K. amateur licences in issue in the U.K., of which around 3,300 are in the Class-B category (G8/3) operating exclusively on the VHF bands. Mobiles licensed total about the same as the G8/3's, with a proportion of 19% or so of the latter holding permits for mobile, and operating mainly on two metres.

While these are "penny-numbers" compared with American figures, the fact remains that our totals are higher than any EU country, and considerably in excess of radio amateur licences held in, say, Australia or Canada. The only country that is proportionately greater in terms of amateur population is New Zealand, which has more ZL's licensed per 1,000 of the population than any other country in the world—but then their total population is only about one-third of that of the City of London! So it comes back to penny-numbers in terms of ZLQTH's in the *Call Book*.

## SPECIALLY ON THE AIR

The notice under this heading in the June issue of *SHORT WAVE MAGAZINE*, pp.213-214, has produced a surprising result—no less than a dozen new entries for special-event stations, to be appearing before the public. If there are any more to come—as we hope and would welcome—we suggest that those concerned with organisation should study the notes on p.213, June—after all, in the general interests of Amateur Radio, we all want to see a good result on these public occasions.

**GB8NGS, July 1-31:** This is the first such licence to be issued with the GB8 prefix. It is in support of the celebrations connected with Normanton Grammar School 380th anniversary, and activity will be on two-metre AM/NBFM phone only. Sked arrangements are invited.—D. Lockwood, G8FSO, Sharlston Common, Wakefield, Yorkshire. (We do not altogether approve of blanket plans of this sort, which are not really practicable—one month on two metres only as a “special occasion”!)

**GB3YPS, July 5-6:** Operated at Heworth Croft by York Amateur Radio Society on all bands 160m. to two metres, AM/SSB, in conjunction with the Yorkshire Philosophical Society's Summer Fair.—J. A. Rainbow, 14 Temple Road, Bishopthorpe, York.

**GB3SFG, July 6-8:** For the Finchley Carnival at Victoria Park, Southgate, London, N.3, operated by the Southgate Radio Club on 160m. and two metres.—A. C. Edwards, G3MBL, 244 Ballards Lane, London, N.12.

**GB3WCS, July 7-9:** At the Comprehensive School, Bilston Road, Willenhall, Staffs., to demonstrate Amateur Radio and the work of the School to the public. Operation will be AM/160m., CW/SSB on 10-80m., and two-metre AM/NBFM on 145.26 MHz, with special QSL cards.—C. J. Pedley, B.Sc., G3YHN, at the School.

**GB3BWF, July 8:** To celebrate the festival of 1,000 years of Christianity at the village of Berkswell, Warwickshire, station put on by the Mid-Warks. Amateur Radio Society, covering 10-80m., with a special commemorative QSL card.—A. C. Outhwaite, 2 St. Annes Close, Leamington Spa, Warwickshire.

**GB2DTS, July 9:** At the Dagenham Town Show, operating all HF bands and VHF, with talk-in on Top Band and two metres. Visitors will be very welcome for a family occasion.—H. Davidson, G3FZP, 223 Salisbury Avenue, Barking, Essex.

**GB3RM, July 12-15:** Put on by the Royal Naval Amateur Radio Society at the Royal Marine Barracks, Eastney, Portsmouth, operating on 3720 kHz and VHF. A special QSL card will be issued.—J. S. Allen, R. N. Amateur Radio Society, H.M.S. *Mercury*, Leydene, Petersfield, Hants.

**GB2SCW, July 13-15:** At the Recreation Ground, Stowmarket, on the occasion of the local Carnival Week, working SSB on all bands 10-160m. and AM on two metres. All contacts will be confirmed

by a special QSL card.—A. P. Ashton, G3XAP, 30 Ford View Road, Stowmarket, Suffolk, IP14 2BL.

**GB2MHC, July 15:** Fête at Rossall School, Fleetwood, Lancs., in aid of the National Society for Handicapped Children, with all-band activity and talk-in on 160/2m. for the event—visitors are invited for the main fête attractions. QSL direct for stamp or s.a.e.—R. Bellerby, G3ZYE, Physics Laboratory, Rossall School, Fleetwood, Lancs.

**GB3QE, July 15:** Put on by the South Birmingham Radio Society for the local Queen Elizabeth Hospital Open Day, station will be up on 160m. and the HF bands, offering a QSL card minted for the occasion.—R. Thompson, 23 Fox Hill, Selly Oak, Birmingham, 29.

**GB3CMG, July 15-16:** At the Summer Fête of the Grammar School, North Downs Road, Cheadle Hulme, Cheshire, to operate three or four stations covering the HF bands on SSB, also two metres and 70 cm. AM/FM. Skeds for VHF particularly welcomed.—G. J. Smith, G3ZOD, 22 Naples Road, Stockport, Cheshire.

**G3OHB/A, July 29:** The Cornish Club's exhibition station at the Mawnan-Smith Festival, Falmouth, to cover all bands as practicable, also an SWL station for visitors.—P. King, G3WKP, Nirvana, Comprigney Hill, Truro, Cornwall.

**LA1SS, August 3-9:** From the Norwegian Scout Camp near Oslo, operating all amateur bands, with a special QSL card to confirm contacts.—V. Segalstad, LA4LN, Heggeliviein 44, Oslo 3, Norway.

**GB3BIC, August 5-12:** Located at the Berkshire International Scout Camp in Windsor Great Park, running full-scale activity over 10 to 80 metres and Two, with a special card for all QSO's.—L. R. Mitchell, G3BHK, 28 Darwall Drive, Ascot, Berks.

**G3CAR, September 2:** For the annual Wycombe Show, organised by the Chiltern Amateur Radio Society, operating on all bands 10-80m., AM/CW/SSB. Contacts will be confirmed by special QSL card, and visitors welcomed for the occasion.—A. C. Butcher, G3FSN, 70 Hughenden Avenue, High Wycombe (24835).

All QSL's for these stations should be sent *direct*, with s.a.e., to the contact-man named under each heading. Because of the callsign confusion, GB special-event stations expecting cards “inwards *via* bureau” should lodge capacious and well-stamped envelopes, clearly addressed with the GB callsign in use for their event, with *all* U.K. bureaux—otherwise it is not possible for bureau managers to deliver cards. This is because GB stations in the special-event category, being “for duration only”, are not listed anywhere outside these pages. Hence, no follow-up is possible unless a bureau manager notes the QTH for all the GB stations we publish—and there is no reason why he should have to do that, and bear the postage, when the GB station organisers can lodge envelopes. It is for this reason that we give a QSL contact for each entry.



# THE MONTH WITH THE CLUBS

By "Club Secretary"

(Deadline for August issue: July 7)

(Please address all reports for this feature to "Club Secretary", SHORT WAVE MAGAZINE, Buckingham.)

A CLUB Secretary writes in this month with a somewhat alarming problem. Despite what seems to be on paper an outstandingly good programme, and a reasonable Hq. to assemble in, the membership is fast dropping to the point of extinction, and this secretary is understandably puzzled as to the reason.

Perhaps some of the more successful groups will get their secretaries to write in and offer advice to this unfortunate Club. In the meantime, your scribe will make a few points from his own experience, both as the key of the piece each month, and as one who has been in office in some group or other for most of the years since he first became interested in Amateur Radio.

Obviously, the main point is the programme, and another the venue. If these are OK, then you must look to more subtle things. For example, is the place easy to get at? Does the meeting happen on a convenient night? Does parking present a major problem in the Hq. area? Does the meeting allow time for informal nattering? Do the executives of the Club appear at all condescending when they address the meeting from the top table, or offer the thanks vote at the end of the talk? Are there any members who dislike any others—such can often be the poles of a magnet, to sunder the loyalties of the members.

Almost anyone reading this piece can think of many more questions which could, and indeed should, be asked when the Club is losing its numbers. But on the other hand there is always normal wastage, due to loss of interest, moving away, and so on. Is it just that recruitment has failed to match this wastage, in which case no alarm need be felt but a vigorous membership campaign should be initiated in the local press and publicity media, in addition to reporting to this piece. After all, readers of this *Magazine* are already interested, so you would expect them to think of joining anyway; your local press will pick up those whose interest has not yet gone so far.

## Western Parts

Our first port of call is **Torbay**, where the group are now "opening the shop" on every Friday, at Bath Lane, 94 Belgrave Road, Torquay.

**Hereford** get together at the County Control, Civil Defence Hq., Gaol Street, weekly on Fridays. There is something organised for most of these sessions, with the accent in summer on outdoor activities such as /P trips to the hills. This is one of those Clubs for which a publicity drive has produced many new members.

In the Bristol area there are two Clubs regularly reporting. One is **Bristol**, where we are to advise all members to keep in touch with the Secretary, and a special meeting is imminent, all because the Hq. at 41 Ducie Road, is to be knocked down and redeveloped, which means a new venue has to be found and the membership at large advised. Let us all hope everything turns out well and the new Hq. is better than the existing one.

Also in the City is the **Bristol Shirehampton** group. The same correspondent tells us the crowd here are often on the air with the Club HW-101, and simultaneously they can run R.A.E. and Morse classes in separate rooms. More details from G3SXY at the address in the Panel, p.305.

At **Yeovil**, membership is up on last year, and many of them were there for the AGM recently, to record their pleasure, and to elect G3NOF back to the secretarial post. Any Thursday you can find the chaps at the Youth Centre, 31 Park Lodge, The Park.

**Plymouth** has got itself a new hon. secretary in G4BCX, who advises there will be lecture-discussion on Aerials, to be followed-up later by an exercise in the practice of the subject, on Dartmoor. The talk is down for July 4, and on the 18th there is an Open Night.

## Northern England

A sizeable hunk of country, this, for the number of reports we see each month. Let us take **Wakefield** first, who mention dates on July 11, when members are asked to bring along their Test Gear to form subjects for a discussion. Then on July 25, there will be G8FSO, on Space Communications. Further details, of course, can be obtained from G3XVU, as Panel.

A monster crossword adorns the front page of the **Tyneside** newsletter; as well is the detail we always want for this piece, which is the bit that says they can be found at any time on Monday evenings in the Community Centre, Vine Street, Wallend. Formals are on July 3, which is a business meeting, and July 17 for a film show.

**Border** next—the bit of the Border in question being around Berwick-on-Tweed, and the venue the Tweed View Hotel, at 1500 clock on the last Sunday in each

## THIS YEAR'S M C C

Will be over the weekend November 4-5. Rules in the October issue, due out on September 29. Procedure will be much as in recent years.

month, with a break till August 27 for their usual summer QRT.

**Thornton Cleveleys** have their place at the St. John Ambulance Brigade Hq., Fleetwood Road North, which lies behind the Police station in Thornton, where they will be on July 5 for a talk by G3ZYE about Lasers and Radio-Activity. July 19 is an "away" when a small party will visit H.M.S. *Inskip*. There is also a Constructional group meeting on Mondays at Rossall School, booking via G4APP.

Over to **Warrington**, who can be found at the Thames Board Mills Social Club, Alford Hall, Manchester Road, on July 4, for G4AUX to lecture on Mobile Working, and on July 18 for a talk the details of which will be announced later.

A very good attendance is forecast by **Bradford's** secretary for the session on July 18, when Harry Moore, G3WVD, will give a talk entitled the "Harmonious Blacksmith." Prior to this one, on July 4, there is a trip organised to the Rank-Leak-Wharfedale works. The venue is 10 Southbrook Terrace, Great Horton Road, Bradford 7.

A new departure for **Northern Heights** is their News Letter, with all the useful information from our point of view saving one thing—it doesn't say which Club owns it! However, we knew all right, the instant we spotted the G3MDW callsign as hon. secretary. Arthur mentions the Peat Pitts Inn at Ogden, as the Hq.; and they will be there on July 5 (before setting off to Halifax Police Hq., and again on July 19 for a Ragchew.

### Nationals

Here our first one is **British Rail**, whose membership covers all the many working for that organisation and its offshoots, the main contact between members being by way of nets, both U.K. and overseas, as the Club is affiliated to a world-group of railwaymen representing radio amateur operators on railways on both sides of the Iron Curtain, in Europe, and the Americas.

**WAMRAC** have stand space at the Methodist Conference at Albert Hall, Nottingham, till July 7, as well as their regular net contacts and *Newsletter*; the group is open to all Methodists, and others who may be interested, throughout the world.

Perhaps the most important part of the current issue of the **RAIBC** group's *Radial* this month is in a corner of the back page, where it mentions that parts of the *Radio Communication Handbook* are now available in four volumes of Braille, for the help of blind amateurs, or SWL's hoping to take and pass R.A.E. despite their disability.

No need to say which group of people the **Royal Navy A.R.S.** serves. However, we could add that they have a grade of associate membership open to those in the Merchant Navy or foreign navies. To that we could add that there is a *Newsletter* which is much better than average and contains some very good chuckles in each issue.

Then there is **BATC** for those interested in Amateur Television; for them the Club runs all sorts of useful services, so much so indeed that one wonders how a /T licensee can manage without joining!

### Eastern and Midland

Here the most important part must come first; to announce to those concerned that the **Great Yarmouth** group have had to leave their former Hq., and so have made their new home in the Central Library, where they will be listening to lectures, demonstrations, or whatever on the last Tuesday in every month, from now on.

**Cheltenham** (RSGB group) have a date for G2FWA on July 6, when Edgar will be showing off his signal-generator-cum-wobbulator, which will feed a constant level of signal into the receiver front-end or through filters. Venue, by the way, is the Royal Crescent Hotel in Clarence Street, which is perhaps better known as the Great Western.

At **Stourbridge** they are always thinking-up new ideas for their entertainment; on July 9, for instance, the chaps will be on the Severn Valley Line, to operate GB3SVR from the train—a pity we have not the promised list of times and frequencies, but no doubt a rapid call to the hon. secretary (see Panel p.305) will produce the answers.

Sad to relate, there is no indication of the date or venue of their get-togethers in the *Newsletter* of the **Newark** crowd, although we have no doubt that a line to G8CUO—see Panel—would produce the desired information, post-haste.

About the only time we hear of the **Government Communications** (Cheltenham) group is when they put in their annual appearance in MCC. However, this year their Open Day was even more of a success than usual, with 114 signed in and a total nearer 150. Apart from the VHF talk-in, the Club HF-band aerials were terminated in the canteen by way of wide-band aerial couplers to a battery of delectable receivers by Plessey, Rascal, G.T. Electronics, Redifon, Eddystone, Collins and Davco which were there "for the twiddling." Then there was teletype—three different makes operating "live" and a microwave set-up by G3BNL. In addition to all this there was a bumper raffle with over 100 prizes; the Western Electronics show station; and a demonstration by the GCHQ Training Centre. In conclusion, the hon. secretary asks will we see him in 1973?—to which your conductor for one answers "Yes!"

For the **Midland** group, the venue is that place well-known to all Birmingham residents, the Midland Institute in Margaret Street; for July 18, George Beasley, G3LNS, will be showing slides of and talking about his trip to Bermuda in 1971.

An interesting point crops up in the letter from the **Derby** hon. secretary. Fred says that the social side is taking over from Contest activity as something outside normal meetings—so much so, indeed, that apart from running a couple of dinner-dances each year, they are planning a third function, to take place around Christmas time. Perhaps that is why, after a massive subscription rise, they still have over 150 members paid-up on the books. Meetings are Wednesday evenings, with Mondays as "Activity Night," at 119 Green Lane. Formals look to be on July 5, the Surplus Auction; July 7 for the Mid-Summer Dance at the Regency Rooms, Wharncliffe Road, Ilkeston; July 12 for a talk on medium-wave propagation by G3VGW of Radio Derby; July 19 for a Film Show; and July 26 for an Open Evening.

**Nottingham** next and on Thursdays, we gather, at the

Sherwood Community Centre, Mansfield Road. The details are as follows: July 6, a forum; July 13, a VHF Activity Night from the Hq.; July 20, Talk and Slides of their C31FA expedition; and July 27, G3YVT showing the uses of an oscilloscope in the Amateur Radio station.

Another "double act" like the one at Derby is that at **South Manchester**. Here, the main meetings are at the Sale Moor Community Centre, while the VHF group has a different evening each week at the Club shack, Greeba, Shady Lane, Manchester 23. July main meetings are listed as: July 7, setting-up of a show station at North Cheshire Technical College, Timperley—albeit the Hq. will be open as usual; July 14, G3UKM on Aircraft Navigation; July 21 an outside meeting at the Manchester Flower Show, Platt Fields; and July 28, a talk, by G3ZKO, on an Integrated Circuit Receiver.

For **South Birmingham**, if form is anything to go by, the meeting date will be July 5, at Hampstead House,

Fairfax Road, West Heath—we say "if form is anything to go by" because, unusually for him, the hon. sec. has slipped-up and given us the June information. For that reason, perhaps it would be as well, if you are thinking of going there, to get in touch with the secretary at the address in the Panel, below.

Still in the Birmingham area, we have **Slade**, where the meeting-place is Church House, High Street, Erdington. As for the dates, they are July 14 and 28th; but we have no details about what is to be going on.

Not so very far away is **Coventry**, where a kindly secretary actually suggested we relegate him to the Box of Short Notices—simply because he has nothing formal organised for July with most of his members on holiday. Thus, it is "Open Evenings" for a good old natter or some impromptu entertainment, every Friday in July, at 121 St. Nicholas' Street, Radford Road, Coventry.

Another in the same part of the world again; this

### Names and Addresses of Club Secretaries Reporting in this issue :

- ACTON, BRENTFORD & CHISWICK: W. G. Dyer, G3GEH, 188 Gunnersbury Avenue, Acton, London, W.3.  
 BASINGSTOKE: P. Sterry, G3CBU, Ashley, Orchard Road, Salisbury Gardens, Basingstoke.  
 BEDFORD: J. Bennett, G3FWA, 47 Ibbett Close, Kempston (2427), Bedford.  
 BISHOPS STORTFORD: E. P. Essery, G3KFE, 17 Ascot Close, Parsonage Lane, Bishops Stortford (2501), Herts.  
 BORDER: C. H. Crook, G3YOG, 19 Hatters Lane, Berwick-on-Tweed.  
 BRADFORD: R. Harker, 65 Whitby Road, Bradford BD8-9JN.  
 BRISTOL: R. W. Thompson, G3TKF, Stapledown, Hill Drive, Failand, Bristol.  
 BRISTOL (Shirehampton): E. J. Davis, G3SXY, 72 North View, Westbury Park, Bristol (33284), BS6-7PZ.  
 B.A.T.C.: J. Rose, G6STO/T, Pinchbeck Farmhouse, Mill Lane, Sturton-by-Stow, Lincs. (042-776 356).  
 BRITISH RAIL: L. C. Carter, G3LCC, 35 Barnfield Gardens, Kingston-upon-Thames, KT2-5RH.  
 BROMSGROVE: J. Dufrance, 44 Hazelton Road, Marlbrook, Bromsgrove, Worcs.  
 BURNHAM BEECHES: Miss N. Appleby, G8ENX, 42 Sutton Avenue, Slough, Bucks.  
 CHELTENHAM (RSGB): E. Janes, G2FWA, Hillside, Bushcombe Lane, Woodmancote, Cheltenham. (Bishops Cleeve 2229.)  
 CHESHUNT: R. Ludwell, G3ZZQ, 26 The Springs, Turnford, Broxbourne, Herts.  
 CHILTERN: P. J. Perkins, G3OUV, Loakes House, Loakes Park, High Wycombe (21612), Bucks.  
 CORNISH: J. Farrar, G3UCQ, Elm Cottage, Ventonleague, Hayle, Cornwall.  
 COVENTRY: C. Jaynes, 20 Belgrave Road, Wyken, Coventry.  
 CRAY VALLEY: P. F. Vella, G3WVP, 78 Hurst Road, Sidcup.  
 CRYSTAL PALACE: G. M. C. Stone, G3FZL, 11 Liphook Crescent, London, SE23-3BN (01-699 6940).  
 DERBY: F. C. Ward, G2CVV, 5 Uplands Avenue, Littleover, Derby (21931), DE3-7GE.  
 DERBY (Nunsfield): Mrs. V. Holt (address wanted).  
 DUNSTABLE DOWNS: C. G. Powell, G8BPK, 1 Wenwell Close, Buckland Wharf, Aston Clinton (600), Aylesbury, Bucks.  
 ECHELDFORD: V. W. Higgs, G3WVJ, 205 Commercial Road, Staines, TW18-2QT, Middlesex.  
 EDGWARE: A. J. Masson, G3PSP, 62 Coldharbour Lane, Bushey, Herts., WD2-3NY (01-950 6827.)  
 GOVT. COMMUNICATIONS (Cheltenham): E. A. Fowles, G3PEO, c/o GCHQ, D/C1, Oakley, Priors Road, Cheltenham, Glos.  
 GREAT YARMOUTH: A. D. Besford, G3NHU, 49 Blake Road, Great Yarmouth, Norfolk.  
 HEREFORD: S. Jesson, 181 Kings Acre Road, Hereford.  
 HULL: Mrs. Mary Longson, 4 Chester Road, Wold Road, Hull, HU5-5QE.  
 LOUGHBOROUGH: M. Roberts, G8FER (address wanted).  
 MIDLAND: N. Gutteridge, G8BHE, 68 Max Road, Quinton, Birmingham 32. (021-422 9787.)  
 MID-SUSSEX: E. J. Letts, G3RXJ, 87 Meadow Lane, Burgess Hill (3552), Sussex.  
 NEWARK: D. Rowan, G8CUO, 13 Fleming Drive, Newark, Notts.  
 NORTHERN HEIGHTS: A. Robinson, G3MDW, Candy Cabin, Ogden, Halifax (44329), Yorkshire.  
 NORTH KENT: M. Lee, G4BAL, 46 Harman Drive, Sidcup, DA15-9LY.  
 NOTTINGHAM: S. Claringburn, 49 Fernleigh Avenue, Westdale Lane, Nottingham, NG3-6FN.  
 PLYMOUTH: A. Helm, G4BCX, 94 Cotehele Avenue, Keyham, Plymouth.  
 R.A.I.B.C.: Mrs. Frances Woolley, G3LWY, Woodcose, Penselwood, Wincanton, Somerset.  
 REDDITCH: R. J. Mutton, G3EVT, Summerhayes, Mill Lane, Oversley Green, Alcester (2041).  
 ROYAL NAVY: RS A. G. Walker, Hon. Sec. RNARS, H.M.S. Mercury, Leydene, Hants.  
 SHEFFORD: A. Sullivan, G2DGF, 12 Glebe Road, Letchworth, Herts.  
 SLADE: J. E. Drakeley, 186 Conway Road, Chelmsley Wood, Birmingham, 37.  
 SOLIHULL: A. W. Bagley, G3XPY, 266 Warwick Road, Olton, Solihull, Warks. (021-706 3688.)  
 SOUTHGATE: J. Batchelor, G3XMV, 22 Faversham Avenue, Bush Hill Park, Enfield, Middx. (01-360 6537.)  
 SOUTH BIRMINGHAM: R. J. Thompson, 23 Fox Hill, Selly Oak, Birmingham, 29.  
 SOUTH MANCHESTER: D. Holland, G3WFT, 7 Alcester Road, Sale, Cheshire, M33-3GW.  
 STOKE-on-TRENT: R. G. Procter, G8CRS, 8 Birch Road, Bignall End, Stoke-on-Trent, ST7-8LB.  
 STOURBRIDGE: B. Powell, 17 Mill Road, Cradley Heath, Warley, Worcs.  
 SUTTON & CHEAM: J. Korndorffer, G2DMR, 19 Park Road, Banstead.  
 THAMES VALLEY: C. B. Seaman, G3ATF, 40 Park Road, Ashford, Middx.  
 THORNTON CLEVELEYS: R. Bellerby, G3ZYE, 4 The Cop, Fleetwood, Lancs. (Clevelleys 6826.)  
 TORBAY: Mrs. G. Western, G3NQD, 10 Truro Avenue, Hele, Torquay.  
 TYNESIDE: G. Lowden, 21 Winifred Gardens, Wallsend (627878), NE28-6EF.  
 VERULAM: H. Young, G3YHY, 93 Leaford Crescent, Watford, WD2-5JQ.  
 WAKEFIELD: M. Garner, G3XVU, 13 Kingsdale Avenue, Drighlington, Bradford, BD11-1EY.  
 W.A.M.R.A.C.: Rev. A. Shepherd, G3NGF, The Manse, Kendal Road, Tebay, Penrith, Cumberland. (Orton 275.)  
 WARRINGTON: D. F. Catherwood, G3ZRN, 9 Summerville Gardens, Grappenhall, Warrington, Lancs.  
 WEST KENT: H. Richards, 17 Reynolds Lane, Tunbridge Wells.  
 WIMBLEDON: F. W. Hill, G3WDO, 20 Sunnymead Road, London, SW15-5HY.  
 WINCHESTER: D. Wright, G8DZU, 19 Fordington Avenue, Winchester (61133).  
 WIRRAL: A. Fisher, G3WSD, 84 Glenmore Road, Oxtou, Birkenhead, Cheshire. (051-652 5078.)  
 WORCESTER: B. A. Jones, G8ASO, 12 Woodside Road, Larkhill, Worcester (29208) WR5-2EG.  
 YEOVIL: D. L. McLean, G3NOF, 9 Cedar Grove, Yeovil, Somerset.

one is **Solihull**, where the July 4 meeting is in the Malt Shovel for a beer and a natter for 2100 clock onwards. Then comes the formal meeting, July 18, at the Manor House, which is also in High Street, with G3PYR talking about "Getting going on Top Band and Two."

Still we remain in the same parts, the next one to appear being **Bromsgrove**, where the booking is made at the Royal Oak, Barley Mow Lane, Catshill, for the second Friday in every month. As for the programme, G4AAL has been roped in to give a stereo demonstration and talk.

Rather further North this time, to almost the limit of the area, to find **Wirral**, on the first and third Wednesdays in each month, at the Sports Centre (ex-Drill Hall) Grange Road West, Birkenhead. July 5, is given over to a talk and demonstration of the Trio TS-510 transceiver, which should be of general interest, and July 19 is down for a discussion.

### South-East and South

Like your scribe, G3LHN of the **Thames Valley** crowd is in haste to write before the deadline—good for him! If it can be organised, it is believed that G3JIP will be able to give his postponed talk, on TVI; however, there will certainly be a foregathering on the due date, namely the first Wednesday of the month, at the Three Pigeons, Portsmouth Road, Long Ditton.

The second Thursday each month appears to be the form at **Southgate**, where the troops parade at the Civil Defence Hut, opposite Arnos Grove Tube station; however we cannot at the time of writing be sure what exactly is in store for those who attend—perhaps a line to G3XMV (as Panel) would resolve the difficulty.

At **Dunstable Downs** the accent seems to be on VHF and Amateur TV, as well as the more run-of-the-mill activities. For instance, there is talk of running a Club net on 432 MHz, on a frequency which is in the area of interest for types who want to go on and triple to 23 cm.! They are to be found, these keen lads, at Chews House, Dunstable (77 High Street, to be more precise), on any Friday evening.

Someone else with problems! **Edgware** were shocked to hear that their spiritual home was to be demolished in the coming autumn, and they are frantically on the lookout for a new place. For the moment, though, they continue at St. George's Hall, 51 Flower Lane, Mill Hill, with July 10 noted for a talk on Raynet, and an informal on July 24.

At **Sutton and Cheam** most of the *Newsletter* to hand is given over to acquainting everyone with what were to be NFD arrangements, although there is a hint that the present list of events ends on July 18, which must therefore be one of their dates. For the rest, we must advise you to get on to G2DMR, address as in Panel, p.305.

July 13 and July 27 are the dates to be booked if you are a member or intend to visit **North Kent**. The first date is down for a practical session, on the Crystal Calibrator, and the second is a Junk Sale; both are at the Congregational Church Hall, Chapel Road, Bexleyheath, where the doors will be open at 7.30.

At **Basingstoke**, the venue is Chineham House, Popley and the dates are July 1st and 15th, the latter being down for G3CBU to step from the secretarial

### SHORT CLUB NOTICES

CLUB NAME	HEADQUARTERS LOCATION	MEETING DAY MONTHLY
Bishops Stortford	British Legion, Windhill	July 17
Burnham Beeches	Hedgerley Scout Hut	July 6, 20
Chiltern	Ernest Turner works, Totteridge Road	July 12, 26
Cornish	SWEB Clubroom, Pool, Camborne	July 6
Crystal Palace	Emmanuel Church Hall, Barry Road, S.E.22.	July 15
Derby (Nunsfield)	Nunsfield House, Boulton Lane, Alvaston	Fridays
Echelford	<i>Not quoted</i>	July 27
Loughborough	Bleach Yard, Wards End (adj. Hatherstone House)	Fridays
Hull	592 Hessele Road.	Fridays
Mid-Sussex	Marle Place, Leylands Road, Burgess Hill	July 13, 27
Redditch	Old People's Centre, Park Road, Redditch	July 13, 27
Shefford	Church Hall, Amphill Road	Thursdays
Stoke-on-Trent	2A, Racecourse Road	Thursdays
West Kent	Art Centre, Monson Road, Tunbridge Wells	July 7, 21
Wimbledon	St. John Ambulance Hq., Kingston Road, S.W.19	July 14, August 11
Worcester	Crown Hotel, Broad Street	July 3

*N.B.*—In each case, Secretary's name and address appears in Panel, p.305.

seat and give his talk on AF and RF Oscillators. In addition, the group will be represented by a show station at the Open Day of the local Cheshire Home, Le Court, near Liss, which is reached by way of the B.3006 Liss to Alton Road.

The **Cray Valley** lads like to make sure of things by sending both a *Newsletter* and also a separate note of the current dates—such duplication is by no means misplaced, as they can prove this time, when the letter saved the day by telling us it is all happening at the Congregational Church Hall, Court Road, Eltham, on July 6—"Satellite Communications" by G3NPA, and July 20 for the Natter Nite.

A philosopher sits in the chair at **Bedford**, and comments that there is never a month when there is enough DX worked, or a month to fit in all the activities! To sum it all up, they get together at the "Dolphin" in the Broadway, every Thursday evening, starting at 7.30. July 6 is down for G2CLP to talk on Transmission Lines, and July 13 Bob Woodhouse on the Deltahet Receiver. July 20 is for G4AHE, who takes as his subject Transistors at Work, and G3FWA has the chore of running the Quiz of July 27. Visitors are always welcomed.

That, we might add, also goes for visitors to the **Acton, Brentford and Chiswick Club**, at 66 High Street,

Chiswick, where they have Hq. For July, we must book July 18, to listen to Dr. Max Smith, G5KD, demonstrating his FT-DX401 and its capabilities.

It is quite a routine to get at the Winchester chaps when they are in session. First find Antrim House, 37 St. Cross Street, and then enter the house by the door at the extreme left at the front of the house, down the steps and across the basement to a door with the Club name inscribed on it. Here you will find them on every Friday, with the odd exceptions such as Good Friday, or the Christmas one. Additionally, the lads will be showing the flag at the local Community Association, at Stanmore Lane County Junior School on July 8, and at the Montgomery of Alamein School Fête in Romsey Road on July 15; any more detail can be obtained from G8DZU—see Panel—by letter or phone.

The first Friday in each month sees the Cheshunt group at the Methodist Church Hall, Theobalds Grove, the topic for July 7 being the use of ICs in the field of instrumentation. Also, on July 9, they have an Annual Field Day, with GB2CRC in operation from Goffs Oak Playing Field.

Once against G3SBA has been pressed into service by Verulam Club—this time for a talk and demonstration of the arts and crafts of RTTY, in the Town Hall, St. Albans, on Wednesday, July 19, 7.30 for 8.0 pip-emma.

### Conclusion

So there it is; another pile of Club reports all dealt with—at least, the ones that landed in time were dealt with! For next month, to fall into that happy category, which entitles you to call yourself an Efficient Hon. Sec., make sure you send us in the August programme, with dates and venue, not to mention a note of the secretary's name and address. And *please* don't give your address just as "QTHR"—it slows down the work. Deadline, then is July 7, addressed as ever to "Club Secretary," SHORT WAVE MAGAZINE, BUCKINGHAM.

### Editorial Note

Would hon. secretaries please take notice of the following closing dates—by which we must have reports—for the next few appearances of "Month with The Clubs" (month of cover date in brackets): Aug. 4 (September); Sept. 8 (October); Oct. 6 (November); and Nov. 3 (December). These are all *Fridays*, the piece being written over the ensuing weekend—so to make sure of being on time it is advisable to post first-class on the Wednesday—and be sure to use the "Short Wave Magazine, Buckingham" address.

## BARTG CONVENTION

The British Amateur Radio Teleprinter Group held their first-ever convention at the Village Hall, Meopham, Kent on Saturday, May 20. Now this may sound an out-of-the-way spot, but in the event the organisers had things well under control, with talk-in stations for



At the BARTG Convention on May 20, G3BPT (pipe) talks things over with G8ATV (Malmesbury, Wilts.), the latter being in the R.N. and soon off to Hong Kong. G3BPT is the keeper of the Wrotham beacon GB3VHF. The RTTY boys felt that their first convention had turned out to be a very successful occasion.

mobiles and a number of vehicles available for transport of visitors to and from the local railway station. These out-of-town events have some attraction for the organisers in that accommodation is more readily available at the right sort of price than it is in London, parking is usually less of a problem and it can make a pleasant trip out into the country for the family. The convention certainly realised one of its objects in that it attracted well over 100 devotees who were thus able to get together in congenial surroundings and swap notes.

A live RTTY station, operating with the Group callsign G4ATG, was set up and was exchanging traffic with sundry callers. A number of trade stands, offering useful "goodies", were doing reasonable business. Among these, Burns Electronics, who are now dealing in good quality, small components as well as completed test gear and communications modules, had some useful IC socket-pin strip which enabled a 14 pin in-line socket to be made up for under 13p, and a new line in the "Multiverter MC3 Assembly" which consists of a handsome case to house three converters with switched outputs and built-in power supply, mains and 12v. D.C.

The two-metre talk-in station was operated by G3VZV with assistance from G3GJW, and the 4m. station by G3IIR. Over 50 mobiles were counted in the car parks by 3 p.m.

There is evidence of growing interest in RTTY, so much so that the Group are compiling their own *Radio Teleprinter Handbook* which should be ready for publication towards the end of the year. An enjoyable occasion.

A.H.D.

"Short Wave Magazine" covers the whole field of Amateur Radio and can be obtained to order through any newsagent.

# NEW QTH's

This space is available for the publication of the addresses of all holders of new U.K. callsigns, as issued, or changes of address of transmitters already licensed. All addresses published here will be reprinted in the U.K. section of the "RADIO AMATEUR CALL BOOK" in preparation. QTH's are inserted as they are received, up to the limit of the space allowance each month. Please write clearly and address on a separate slip to QTH Section.

**DA2ZA**, T. J. Hodgetts (*G4AYD*, ex-*DA4BA/G8EUW*), H.Q. Tels. Group, H.Q. B.A.O.R., B.F.P.O. 40.

**G4AOO**, W. A. Winterburn, 28 Montagu Road, Spotborough, Doncaster, Yorkshire, DN5 8DH.

**GM4API**, D. Heberton, Taymount, 4 Prospect Terrace, Newport-on-Tay, Fife. (*Tel. Newport-on-Tay 2389*.)

**G4AYD**, T. J. Hodgetts (*DA2ZA*, ex-*DA4BA/G8EUW*), H.Q. Tels. Group, H.Q. B.A.O.R., B.F.P.O. 40.

**GW4AYJ**, J. R. D. Morgan (ex-*GW8ERZ*), Northcote, 1 Myrtle Grove, Sketty, Swansea, Glam.

**G4BAN**, P. F. Godfrey, 5 Parkway, Southgate, London, N.14-6QU. (*Tel. 01-882 4288*.)

**G4BDQ**, P. Harris, 17 Langton Road, East Molesey, Surrey.

**G4BDW**, J. Bagley, 23 Stanmore Crescent, Carterton, Oxon, OX8 3UF.

**G4BEF**, C. W. Barnes, 21 Mottram Close, Norwich, Norfolk, NOR. 41-H. (*Tel. Norwich 52998*.)

**G4BEV**, J. Small, 11 Crowland Way, Formby, Lancs. (*Tel. 36-71775*.)

**G4BEZ**, J. Phillipson (ex-*G8BNJ*), 1 Rochester Close, Cheltenham, Glos., GL51 5DJ.

**G4BFJ**, M. C. Potter, 48 Buckles Way, Banstead, Surrey. (*Tel. Burgh Heath 55196*.)

**G8FGP**, G. H. Fox, 83 Oakridge Road, Basingstoke, Hants.

**G8FKO**, G. H. Lewis, Fermain, Lytton Road, Basingstoke, Hants.

**G8FOT**, Amateur Radio and Electronics Society, University of Manchester Institute of Science and Technology, P.O. Box 88, Sackville Street, Manchester, M60 1QD.

**G8FRP**, Mrs. Ann Cross, 29 Masefield Road, Wheatley Hills, Doncaster, Yorkshire.

**G8FWB**, D. L. Bulpett, 72 Fivefields Road, Highcliffe Park, Winchester, Hants.

**G8FXD**, H. R. Goodwin, 102 Foley Road West, Streetly, Sutton Coldfield, Warks.

**GM8FYC**, J. Gdula, 10 Plora Terrace, Innerleithen, Peebles-shire.

**G8GBS**, D. Ogden, 27 Freckleton Drive, Bury, Lancs. (*Tel. 061-764 3015*.)

**G8GBV**, I. M. Cage, 25 Petersham Drive, Alvaston, Derby, DE2 0JU.

**G8GCP**, Worthing and District Amateur Radio Club, Rose Wilcott Centre, Littlehampton Road, Worthing, Sussex.

**GM8GCY**, J. M. Heron, 19 Macnochie Place, Fraserburgh, Aberdeenshire, AB4 5TH.

**G8GDC**, R. F. Laver, 22 Vicarage Wood, Harlow, Essex.

**G8GDD**, F. Moss, 334 Ings Road, Kingston-upon-Hull, Yorkshire.

**G18GDG**, J. Frame, 66 Beverley Gardens, Bangor, Co. Down.

## CHANGE OF ADDRESS

**G3CYL**, G. J. Bennett, 7 Coxheath Road, Church Crookham, Nr. Aldershot, Hants.

**G3CEG**, B. King, Rhoda's Cottage, Whiteway, Stroud, Glos. GL6 7EP. (*Tel. Miserden 395*.)

**G3EJS**, J. W. Oliver (ex-*9J2RO*), c/o D. Alexander, P.O. Box 182, Hilton, Natal, Republic of South Africa.

**G3FPJ**, A. A. Littlewood, Hempstone Park Farm, Littlehempston, Totnes, Devon. (*Tel. Totnes 3789*.)

**GW3OKM**, J. R. Mitchell, 18 Camden Crescent, Brecon, LD3 7BY.

**G3OTD**, W. J. Spilman, 73 Wainfleet Road, Skegness, Lincs.

**G3SAR**, R. M. Warner, North Lodge, St. Julians, Sevenoaks, Kent.

**G3SNU**, K. G. Selleck, Westphalia, Coplands Lane, Dartington, Totnes, S. Devon, TQ9 6DJ. (*Tel. Totnes 3040*.)

**GM3SYD**, S. Beauchamp, 22 Greens Way, Newmachar, Aberdeenshire, AB5-OSL.

**G3VCJ**, R. C. Warrick, 122 Barnhorn Road, Little Common, Bexhill-on-Sea, Sussex.

**G3WAM**, M. G. Taplin, Camelot, Moor Lane, Sculthorpe, Fakenham, Norfolk.

**G3WZD**, D. M. Fiskin, 30 Parklands Road, Hassocks, Sussex.

**G3XAY**, W. M. Richards, 5 Churchside, Howden, Goole, Yorkshire, DN14-7BS.

**G3XDV**, M. Dennison, 36 St. Andrews Road, Deal, Kent.

**G3XFZ**, G. K. Laycock, 41 Mill Road, Fareham, Hants.

**G3XJS**, P. Barville, 20 Forge Close, Holmer Green, Bucks.

**G3XWA**, J. A. Ennis, 14 Station Road, Saltash, Cornwall, PL12 4DY.

**G3YGM**, M. A. Osborne, 2 Coastguard Station, Trevoze Head, Padstow, Cornwall.

**GM3ZDH**, R. A. Dixon, 17 Henrietta Street, Wick, Caithness.

**G3ZDW**, R. Hyde, 45 Sheepwalk, Swinderby, Nr. Lincoln, Lincs.

**G4AVB**, D. G. Simmons, P.O. Box 18010, Nairobi, Kenya.

**G8ASF**, J. Mountford, 19 Sheppard Street, Stoke-on-Trent, Staffs.

**G8BVR**, G. Oddy, Greyrigg, Thornby, Thursby, Carlisle, Cumberland.

**G8ETL**, G. D. D. Hooper, 12 Bramble Crescent, Durrington, Worthing, Sussex. (*Tel. Worthing 62013*.)

**G8FGE**, N. R. Sharpe, Victoria House, The Green, Sarratt, Rickmansworth, Herts. (*Tel. Kings Langley 66591*.)

## AMENDMENT

**G3PFJ**, J. D. Harris, 3 Chimney Mill, West Stow, Bury St. Edmunds, Suffolk. (*incorrect in May issue*.)

**G3ZOZ**, Dr. D. M. H. Cogman, 30 Downage, London, NW4 1AH. (*Tel. 01-203 2118*.)

**G8FYD**, F. A. Blake, Fourfield, Lashford Lane, Dry Sandford, Abingdon, Berkshire (*incorrect in May issue*.)

# THE SENATOR CRYSTAL BANK

G3UGY

Phone: 01-769 1639

## CRYSTALS FROM STOCK AT KEEN PRICES

**SENATOR CRYSTALS: the first place to contact when you need good crystals quickly.**

Here are just a few of the popular frequencies actually in STOCK now:

kHz	MHz
100 in HC13/U ... £2.50	25 000 in HC6/U ... £1.60
454 in HC6/U ... £1.75	26 500 in HC18/U* ... £1.60
455 in HC6/U ... £1.75	28 045 in HC25/U ... £1.60
456 in HC6/U ... £1.75	28 500 in HC25/U ... £1.60
500 in HC6/U ... £1.75	30 000 in HC6/U ... £1.60
	32 500 in HC18/U* ... £1.60
	34 000 in HC18/U* ... £1.60
	34 500 in HC18/U* ... £1.60
	35 000 in HC18/U* ... £1.75
	35 500 in HC18/U* ... £1.75
	38 666 in HC18/U* ... £1.35
	40 000 in HC18/U* ... £1.60
	42 000 in HC18/U* ... £1.60
	70 000 in HC18/U* ... £2.00
	71 000 in HC18/U* ... £2.00
	72 000 in HC18/U* ... £1.75
	72 425 in HC18/U* ... £1.75
	72 500 in HC25/U* ... £1.75
	72 525 in HC18/U* ... £1.75
	96 000 in HC18/U ... £2.00
	116 000 in HC18/U ... £2.80

\* = Also in HC6/U

11-1916 MHz in HC6/U for RX × 12 + 10.7 MHz = 145-000 MHz 2M Mobile	£1.60
12-0833 MHz in HC6/U for TX × 12 = 145-000 MHz 2M Mobile	£1.60
8-7825 MHz in HC6/U for TX × 8 × 70-260 MHz 4M Mobile	£1.60
29-780 MHz in HC6/U for RX × 2 + 10.7 MHz = 70-260 MHz 4M Mobile	£1.65
6-74666 MHz in HC6/U for RX × 12 = 10.7 MHz = 70-260 MHz 4M Mobile	£1.60
11-710 MHz in HC6/U for TX × 6 = 70-260 MHz 4M Mobile	£1.60

**NEW FREQUENCIES now available:**

1-6202 MHz and 1-6184 MHz in HC6/U (spacing 1.8 kHz) at	£1.80 each
33-6666 MHz in HC6/U	£1.60
43-3333 MHz in HC18/U	[1.70
46-6666 MHz in HC18/U	£1.70
47-3333 MHz in HC18/U	£1.70
48-3333 MHz in HC18/U	£1.70
58-000 MHz in HC18/U	£1.70
10-86667 MHz and 9-975 MHz in HC6/U (TX/RX crystals for glider channel 130-400 MHz at	£1.70 each

And here's our STOCK range of BRAND NEW HC6/U 8 MHz for 2M:

8-002 8-007 8-012 8-018 8-021 8-0266 8-032 8-041 8-043 8-047 8-048 8-0555 8-058 8-061 8-070 8-081 8-092 8-100 8-104 8-107

All at £1.25 each, post free.

The following frequencies may be suitable for your PYE Cambridge, Ranger, Vanguard, etc., etc. Check up with crystal multiplication data and crystal spec., in equipment manuals for suitability.

8-0555 MHz in HC6/U for TX × 18 = 145-000 MHz 2M Mobile	£1.25
44-7666 MHz in HC6/U for RX × 3 + 10.7 MHz = 145-000 MHz 2M Mobile	£1.80
8-100 MHz in HC6/U for TX × 18 = 145-800 MHz for RAEN	£1.25
45-0333 MHz in HC6/U for RX × 3 + 10.7 MHz = 145-800 MHz for RAEN	£1.80
12-975 MHz in HC6/U for RX × 12 = 10.7 MHz = 145-000 MHz 2M Mobile	£1.60

Prices for specially manufactured SENATOR Crystals are as follows (made to Ministry of Defence Standards):

50— 149.9 kHz in HC13/U	£4.60
150— 499 kHz in HC6/U	£3.85
450— 500 kHz in HC6/U	£3.50
501— 999 kHz in HC1/U	£4.50
1-000— 1.39 MHz in HC6/U	£3.20
1-40 — 20.00 MHz in HC6/U (18/U & 25/U over 5 MHz)...	£2.00
20-00 — 59.99 MHz in HC6/U; HC18/U; HC25/U	£2.25
60-00 — 79.99 MHz in HC6/U; HC18/U; HC25/U	£2.50
80-00 — 114.00 MHz in HC6/U; HC18/U; HC25/U	£7.00
141-00 — 175.99 MHz in HC6/U; HC18/U; HC25/U	£8.75
176-00 — 200.00 MHz in HC6/U; HC18/U; HC25/U	£12.00

**Mail Order SENATOR CRYSTALS Dept. S.W., 36 Valleyfield Road, SW16 2HR**

*Advertising in "Short Wave Magazine" guarantees the largest and most effective coverage of the U.K. radio amateur interest*

**THE RADIO SHOP** Dept. SWM, 16 Cherry Lane, Bristol, BSI 3NG.  
Tel.: Bristol 421196. STD Code 0272

**2 METRE CONVERTER KIT.** 9V Neg. earth feeding 28-30 MHz. Consisting of: RF BF180, Fet. mixer, crystal osc. BF180, and multiplier BF180. Complete with all components, instructions and aluminium box. Not for beginners. Price £5 post paid.

**2 METRE PRE-AMP.** Single F.E.T. Pre-Amp. Neg. Earth gain app 120B circuit. Instructions & Components. All you need is a tobacco tin. Price £1.20 post paid.

1972 CATALOGUE 5p POST FREE.

**2 METRE CONVERTERS**

LOW NOISE R.F. STAGE F.E.T. MIXER. Xtal controlled multiplier chain. Aluminium case. Size: 4" x 3" x 1 1/4". I.F.'s 4-6, 18-20, 24-26, 28-30 MHz, £10-50 each.

2 METRE LOW NOISE CASCODED F.E.T. PRE-AMPS. Aluminium case. Size: 2 1/2" x 1 3/8" x 1 1/4". £4-50 each.

**E & E SERVICES**  
72 ELMSTONE ROAD, RAINHAM, KENT





## Quartz Crystals

ANY frequency between : 24-000 to 24-333 MHz for 2m. Made to order to .005% tolerance at 50p each, post free.

Holder choice : HC6/U, HC18/U, HC25/U.

State frequency and holder style required.

## SENATOR CRYSTALS

36 VALLEYFIELD ROAD,  
LONDON, SW16 2HR

Sole agents for NKD Crystal Co.

**THE TRADING POST** **G8FET**  
7 CASTLE ST., HASTINGS, T. H. RANSOM  
SUSSEX. TEL. HAS 4

95p Inc. P.P.	2 METRE XTALS	HC6/U
24-025 MHz = 144-150	24-172 MHz = 145-056	
24-038 " = 144-228	24-182 " = 145-092	
24-041 " = 144-246	24-198 " = 145-188	
24-058 " = 144-348	24-205 " = 145-230	
24-070 " = 144-420	24-212 " = 145-272	
24-085 " = 144-510	24-220 " = 145-320	
24-110 " = 144-660	24-232 " = 145-392	
24-125 " = 144-750	24-245 " = 145-470	
24-135 " = 144-810	24-258 " = 145-548	
24-142 " = 144-852	24-268 " = 145-608	
24-150 " = 144-900	24-278 " = 145-688	
24-162 " = 144-972	24-288 " = 145-728	
24-166 " = 144-996		

SPECIAL OFFER: 1 MHz HC6/U @ 75p  
XTALS CUT TO ANY FREQ. IN HC6/U  
—HC18/U—HC25/U  
PRICES ON APPLICATION

## G. W. M. RADIO LTD.

**TWO METRE** Transmitter sub units. Contain 2 x 6S16, 2 x 6064, QV04-7 and TT15 valves, £2, post paid. **REED RELAYS** for G3FCW keyer, 4 reed, normally open, 200 ohm coil, 15p each, post for any number 10p. Reed inserts 1.85" long (body length 1.15" diameter .14"). Gold clad contacts switch up to 500ma at up to 250v. DC, 63p per dozen, £3.75 per 100, £27.50 per 1000, post paid.

**CALIBRATOR FREQUENCY CT432.** 110/250 AC 12" x 6" x 7 1/2", 100 kc/s., 1 mc/s. and 10 mc/s. outputs from integral crystals. Provision for external crystals in the range 100 kc/s. to 10 mc/s., 4 front panel bases suit most types. R.F. sources may be fed in and calibrated by beating against desired crystal. Audio output to headphone socket. In Ministry packing and as new condition, £12.50, carriage paid.

**PYE VANGUARD AM25BV** Radio Telephones. Around 100 mc/s. 12 volts, less crystals. In good clean condition, less control boxes and cables. £15 carriage £1. A few Cambridge available.

**NSF LEDEX** 24v. Solenoid switch motors, 12-way. New and boxed, 65p, post paid. McMurdo Morse Keys. 2 1/2" x 1" key on base with Send/Receive switch. Lead and 4-pin Plessey plug, new and boxed, £1, post paid.

**MURPHY MARINE SHIP TRANSMITTERS.** 1-5 to 16 Mc/s. VFO or crystal. 40 watts RT or CVV. Valves P.A., 3 5B/254M in parallel, modulation pair 5B/254M. Two panel meters. Size 13" x 13" x 14". Complete and clean but not tested. Less power supplies, £11 carriage paid. A few similar Pye units with same line up but 13" x 15" x 14" have calibrated VFO, same price.

Pocket Dosimeters, 15p, post paid. Meters 1 1/2" dia. 500 microamps calibrated 0-10, 75p, post paid.

**TRANSFORMERS.** Unused Radiospares "Heavy Duty" 205-245v. to 350-350v. 150ma. 6-3v. 2-5a, 6-3 3a, 2a (tapped at 5v. 3-5a), £2, post paid. "Midget Output" 50p post. New Gardner potted 200-250v. to 12-7v. 2-5a., £1, post paid.

Used. 200-250v. to 800-700-300-200-0-200-300-700-800v. 800 and 700 at 200ma, 300 to 100ma, 200 at 50ma when used simultaneously. 5v. 2a, 4v. 7a, 6-4v. 7a, 6-4v. 1a. £4, carriage paid.

All Receivers and Test Equipment are in working order at time of dispatch. Carriage charges quoted are for England and Wales only.

Telephone 34897

Terms: Cash with order

Early closing Wednesday

40-42 PORTLAND ROAD, WORTHING, SUSSEX

SCA  
63982

## DERWENT RADIO

SCA  
65996

SHOWROOM, 5 COLUMBUS RAVINE, SCARBOROUGH

**WE ARE LOOKING FOR GOOD USED  
EQUIPMENT AND OFFER TOP CASH OR  
TRADE-IN PRICES.  
S.A.E. FOR OFFER.**

All goods offered in last month's ad still available.

See you at South Shields & Scarborough Rallies.

28 Hillcrest Avenue, Scarborough, Yorks.

## DON'T BUY A DIGITAL CLOCK

UNTIL YOU HAVE SEEN OUR LEAFLET AND SPECIAL DISCOUNT PRICE LIST FOR RADIO AMATEURS and S.W. LISTENERS. (s.a.e. please).

WE ARE YOUR SPECIALISTS, HAVE THE MOST COMPREHENSIVE AND LARGEST STOCKS, CHECK EVERY INDIVIDUAL CLOCK, AND ALWAYS DESPATCH BY RETURN.

## Aero & General Supplies

NANAIMO HOUSE, 2 RINGWOOD AVENUE,  
LEEDS LS14 1AJ.

TEL. 658568

## HAMGEAR ELECTRONICS

### PRESELECTORS

**P.M. IIA** This is a preselector covering from 1.8 to 32 Mc/s. in six overlapping ranges. Having a built-in antenna coupler to tune the antenna followed by a pentode to boost the signal up at 25 dB., before it reaches the Rx. With internal power supply, mains On/Off, indicator lamp and primary fuse. Price £9.20.

**P.M. IIB** This is a preselector with the same spec. as above, 1.8 to 32 Mc/s. and antenna coupler except it is solid state with an F.E.T. plus Bipolar. Price £8.25.

Both these preselectors are recommended for use only with communication receivers.

### CRYSTAL CALIBRATORS

Get acquainted with our calibrators:

**P.M. IV** 1 Mc/s. with 1,000 c/s modulation.

**P.M. V** 1 Mc/s. and 100 kc/s. with 1,000 c/s. modulation.

**P.M. VIII** 1 Mc/s., 100 kc/s. and 10 kc/s. with 1,000 c/s modulation. This one has the ability to be tuned zero beat to a frequency standard transmission such as M.S.F.

Both P.M. V and P.M. VIII have integrated decade counters, nothing to go out of adjustment.

All the units are battery powered and as such are quite portable.

All give beats up to at least 30 Mc/s.

Priced at £5.75, £7.75 and £11.75 respectively.

Postage and packing, 25p.

2 1/2p stamp for illustrated leaflets

29 CARLYLE ROAD, NORWICH

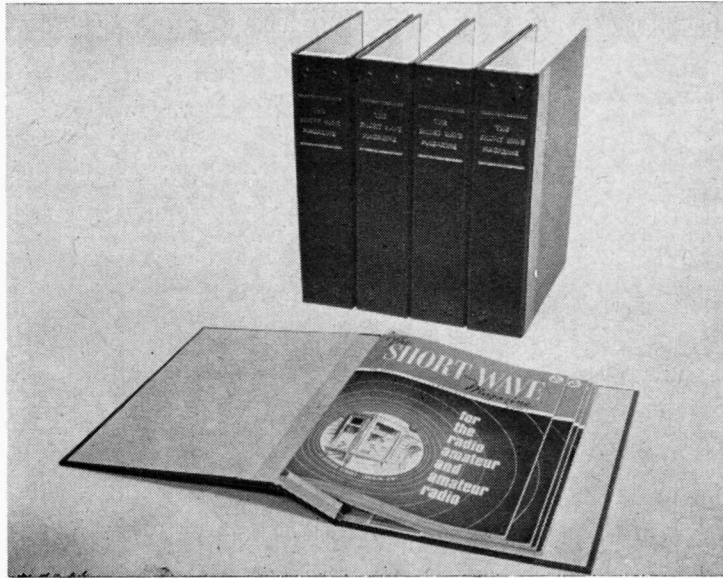

## CREATE YOUR OWN REFERENCE LIBRARY

The "EASIBINDER" is designed to bind 12 copies of the Magazine as you receive them month by month, eventually providing a handsomely bound volume for the bookshelf.

No need to wait until twelve copies are assembled. As each copy is received, it is quickly and simply inserted into the binder. Whether partially or completely filled, the binder is equally effective, giving the appearance of a book, with each page opening flat.

Strongly made with stiff covers and attractively bound in maroon Leathercloth and Milskin, the binders have only the title gold blocked on the spine.

Price 88p post free.

PUBLICATIONS DEPARTMENT  
SHORT WAVE MAGAZINE  
55 VICTORIA STREET  
LONDON, SW1H 0HF

### SITUATIONS

**C**HARTERED Electronic and Radio Engineer offers design services, part or full-time. Seven years in the design of Avionics and PCM systems; experience solid-state VHF and SSB designs; amateur licence 12 years; member F.O.C.—Ring Oldbury (Glos.) 4559.

### SMALL ADVERTISEMENTS

("SITUATIONS" AND "TRADE")

5p per word, minimum charge £1.00. No series discount. All charges payable with order. Insertions of radio interest only accepted. Add 50% for Bold Face (Heavy Type). Box Numbers 12p extra. No responsibility accepted for transcription errors. Replies to Box Numbers should be addressed to The Short Wave Magazine, 55 Victoria Street, London, SW1H 0HF.

### TRADE

**G**OVERNMENT Surplus Wireless Equipment Handbook; Contains circuits, data, illustrations and valuable information for British & U.S.A. receivers, transmitters and trans/receivers. Includes modifications to sets and test equipment; price £2.85, post/packing 15p. **WANTED:** All types of communication receivers and test equipment; top prices paid. What Have You?—Gerald Myers (SW), 18 Shaftesbury Street, Leeds, LS12-3BT, Yorkshire.

**S**TAY AT The Cornwall Ham-Radio Holiday Centre. Self-catering furnished accommodation. Six-element beam; 65ft. tower; 90 awards.—Full details from Bernard Broughton, G3XBR, St. Tudy, Bodmin, Cornwall.

**Q**SL Cards for Tx and SWL. Send s.a.e. for samples stating which type required.—Beaumont, G5YV, 8 Ashfield Avenue, Morley, Leeds, LS27-0QD.

**Q**SL Cards: for Tx, G8 or SWL. One to four-colour designs; large s.a.e. for samples; good selection.—Red Rose Publicity (Pennington), 34 Aqueduct Street, Preston, Lancs.

**A**UGUST Issue: Due out July 28. Single-copy orders 25p, post free, to reach us by Wednesday, July 26, for posting on July 27.—Circulation Dept., Short Wave Magazine Ltd., 55 Victoria Street, London, SW1H-0HF.

**YORK PHOTO-AUDIO CENTRE.** Yaesu FT-200, FT-101, FT-400DX, YC-305, etc., all available ex-stock. Trio TS-515 Transceiver, £235 (new models). TR.2200 two-metre portable transceiver, £69.95. TR.7100 two-metre car transceiver, £99.50, and all existing models available from stock. Codar A.T.5 Mk. II, £22.50; PSU, £11.50; CR-70A Mk. II receiver, £27.50. **Hamegear:** The full range of Calibrators, Converters and Preselectors ex-stock. **Credit terms** are available on all equipment of value £25 or over, with little or no deposit and up to 24 months to pay. We are prepared to consider your Camera Equipment in **Part Exchange** and we will accept good quality Communications Gear in exchange for Cameras or Hi-Fi apparatus. We stock Nikon, Pentax, Rollei, Minolta, Zenith, Olympus, etc., etc. and in our Hi-Fi Dept. we have B. & O., Trio, Sanyo, Yamaha, Koss, Sinclair, etc., etc.—51 Fossgate, York, YO1-2TF, Tel: 56176, or York 25798 after hours.

**Q**SL CARDS and G.P.O. approved Logs (hard back), prompt delivery. Send 4p stamp for samples.—Atkinson Bros., Printers, Looe, Cornwall, PL13-1LA.

**W**ANTED: Crystals, 2 to 3 kHz spacing, range 430 to 480 kHz; qty. 50-100 at any frequency in this range required, also one-third quantity 2 to 3 kHz lower in frequency. Please quote details and price.—G3LLL, Holdings, 39/41 Mincing Lane, Blackburn, BB2-2AF, Lancs.

**QSL Cards.** Two-colour. Attractive design, variable features, from £3.15 per 1,000 (inclusive). Send foolscap s.a.e. for samples.—A.R.A. Press, 46 Moat Avenue, Green Lane, Coventry.

**SIGNETICS N5111A Integrated Circuit** as used in FM Detector described May issue "Short Wave Magazine," price £1.25, plus 5p post/packing.—E. & E. Services, 72 Elmstone Road, Rainham, Kent.

**READERS ADVERTISEMENTS**

2½p per word, minimum charge 50p payable with order. Add 25% for Bold Face (Heavy Type). Please write clearly, using full punctuation and recognised abbreviations. No responsibility accepted for transcription errors. Box Numbers 12½p extra. Replies to Box Numbers should be addressed to The Short Wave Magazine, 55 Victoria Street, London, SW1H 0HF.

**READERS**

**SALE:** Lafayette HA-350 Rx, excellent condition, £55 o.n.o. Also 50-watt CW Tx, £5.—Bensley, 7 Keeble Drive, Washington, Lincoln (790954).

**IRISH READERS:** Grayshaw SG-50 signal generator, 100 kHz to 80 MHz in six ranges on fundamentals, £10. Grayshaw CR-50 Bridge, 10 pF to 100 mF and 1 ohm to 10 megohms, in fourteen ranges, £8. Hamgear PM-11 preselector and antenna tuner, 1.6 MHz to 32 MHz in six ranges, gain 20-30 dB, £8. All 220v. AC working, and all as new.—Hodge, Avonlea, Ursuline Road, Waterford, Ireland.

**FOR SALE:** Eddystone EC-10 Mk. II, with mains unit, Joystick tuner, excellent condition, £55.—Thompson, 18 Pen-y-Garn, St. Davids, Pembrokeshire.

**WANTED:** Command receivers BC-454 A or B, and BC-946B. Also any of this series covering Top Band with any ancillary equipment. Details and price, please.—Cresswell, G4AMF, 4 Hall Street, Hoyland, Barnsley, Yorkshire. (Ring Barnsley 743414 after 6 p.m.).

**WANTED:** Good Drake Rx and Tx, AR88D or similar good general coverage Rx. Modern VHF receiver, coverage up to 140 MHz.—MacMahon, G13ZIA, QTHR, or ring Enniskillen 2188 (home) or 2955, business.

**FOR SALE:** Hallicrafters SX-101, excellent condition, offers? Heathkit HW-32A with handbook and carton, mint condition, £50. QF1 Q-multiplier £6.50. Mohican, good condition, with manual, £25. Trio, VFO-5, brand new, £23. Trio JR-310 SSB Rx, 3 months old, £68.—MacMahon, G13ZIA, QTHR, (phone Enniskillen 2188 after 7 p.m.).

**SELLING:** Army communications receiver, AC mains operated, £11.50, carriage paid. UHF receiver, 450-470 MHz, AC operated, £16.50 carriage paid. Naval UHF Rx tuning 250-700 MHz with speaker/amplifier and complete aerial system, £70. Send s.a.e. with enquiries.—Hayward, Sunnyfields, Lighthouse Road, St. Margaret's Bay, Nr. Dover, Kent.

**G3EKX S.S.B. PRODUCTS G3EKX**

<b>EDDYSTONE EC10 Mk. 2.</b> Latest	...	...	£79.00
<b>EDDYSTONE 1000</b>	...	Price to be announced	
<b>EDDYSTONE 935</b> speaker, £3.71 A.C. mains unit 924	...	...	£7.75

---

<b>TRIO TS510/PS510.</b> Latest transceiver.	New	...	£180.00
<b>TRIO JR310.</b> Superb ham bands Rx.	...	...	£79.50
<b>TRIO 9R59DS.</b> Latest general coverage Rx.	...	...	£57.50
<b>TRIO SP5D.</b> Speaker	...	...	£4.37

---

<b>PAIR MATCHED 6HF5's</b> R.C.A.	...	(20p)	£5.50
<b>PAIR MATCHED 6146</b> R.C.A.	...	(20p)	£5.00
<b>PAIR MATCHED 6146B</b> R.C.A.	...	(20p)	£6.20

★ OVERHAULED RX's and TX's ★

<b>HALLICRAFTERS SX100.</b> Superb	...	...	£95.00
<b>EDDYSTONE 940.</b> Mint. Boxed	...	...	£115.00
<b>H.R.O. with 9 COILS.</b> Power Unit. Speaker	...	...	£20.00
<b>COLLINS T.C.S. TX</b> plus Manual	...	...	£15.00
<b>INVICTA/PYE RADIO.</b> Trawlers	...	...	£8.00
<b>AIRMEC. RADIO.</b> RF stage	...	...	£12.00
<b>TRIO 9R59DS.</b> Mint. Boxed	...	...	£48.00
<b>MARCONI V.T.V.M.</b> (As New)	...	...	£6.00

PLEASE INCLUDE CARRIAGE AND PACKING

**DUMMY LOAD.** 100 watt, non-inductive 78-75 ohm. (400w in oil) 1/P via STD. T.V. CO-AX Socket. (15p) £3.00

---

**NEW XTALS.** All metal types. Mixed, not ex-govt, 80 kc/s. to 110 Mc/s. "State your requirements." S.A.E. essential ... (5p) ea. 50p

**R.C.A. ROTARY RELAYS.** 12v. 1/P.D.C. superb job. Ideal for aerial switching ... (15p) ea. 55p

**7 LITTLE CASTLE STREET, TRURO**  
**Tel. DEVORAN 862575 CORNWALL**

**Samson's Latest Models !**

- **ETM-2b Keyer**
- **ETM-3b Squeeze - Keyer**

both with watchmaker-assembled keying movement, silent reed relay, speed control, sidetone.

**ETM-2b**—Successor to the well-known ETM-2, used by coast stations and big ships the world over. ● Glass-fibre printed circuit, 11 transistors, 6 diodes. ● Ratio control. ● Mercury or penlite battery supply. £22.45 (£23.80 with mercury batteries).

**ETM-3b**—In its latest form it now has 4 IC's, 9 transistors, 3 diodes. ● Use either as foolproof iambic-mode squeeze-keyer (characters made with fewer paddle movements—cuts effort) or as a normal twin-paddle electronic keyer. ● Constant 3 : 1 dash-dot ratio. ● AC power supply, 110/240V. £25.95.

ALSO: ETM-2bS and ETM-3bS (change-over relays) and ETM-2Z and ETM-3Z (heavy-duty relays). SAMSON STA Speaker/Amplifier for all ETM Keyers, £2.75.

---

**JUNKER** precision hand key, £8.95. **RTTY CONVERTER-KEYER**, Model TTU, £115. 88mH **TOROIDS**, 75p/pair. **PRINTSET** Basi-kits. **SSB 90° AUDIO** Phase Shift Networks.

---

All goods post-paid UK. Send stamp for Catalogue SP5.

**PLEASE NOTE OUR NEW ADDRESS:**

**SPACEMARK LTD.**  
**THORNFIELD HOUSE, DELAMER ROAD,**  
**ALTRINCHAM, CHESHIRE.**  
(Tel.: 061-928 8458)

## ECHELFORD COMMUNICATIONS

11 BROADWAY,  
KINGSTON ROAD,  
STAINES, MIDDX.

Telephone: Staines 54401

### New items in stock include :

KW2000B Transceiver and mains P.S.U. ....	£240.00
KW Ezee Match ATU .....	£15.00
KW Trap Dipole .....	£14.00
KW 52 ohm Dummy Load .....	£7.00
KW 103 SVWR Meter .....	£12.50
Trio JR310 Receiver .....	£84.50
Trio SP5D Speaker .....	£4.50
Trio 2 Metre SM Car Transceiver TR 7100 on demonstration	£99.50
Tavasú Mobile Whips and Coils	
Whip and base with 6ft. 50 ohm coax ... (P/P 25p)	£2.88
Whip, base, adaptor and 160m. coil ... (P/P 25p)	£5.95

J-Beam arrays—we are official London stockist, full range in stock.

Large range of Eagle components always in stock.

R.S.G.B. publications including maps, always available.

### Second-hand items available at time of preparation include :

KW Viceroy SSB Rig ...	£75.00
KW 160TX .....	£21.00
TW 2 TX and mains p.s.u. ....	£37.50
Taylor 67A signal generator .....	£18.00
L6300 Tx and mains p.s.u., mint condition .....	£37.50

### ALL ITEMS CARRIAGE EXTRA LARGE S.A.E. FOR LISTS

Hours of Opening :

Monday—Saturday 9 a.m.—5.30 p.m. Half Day Thursday (1 p.m.)

H.P. Terms available on all items over £25.

A. G. WHEELER, G3RHF M. STANSFIELD, G8DNM

## REG. WARD & CO. LTD.

(G2BSW)

WE ARE OFFICIALLY APPOINTED K.W. AGENTS FOR THE SOUTH WEST (Somerset, Dorset, Devon, Cornwall)

KW Atlanta with p.s.u. ....	£210.00
Remote VFO .....	£37.00
KW 2000B with p.s.u. ....	£240.00
Remote VFO .....	£39.00
KW 202 Receiver .....	£140.00
Matching Speaker .....	£8.00
KW 204 Transmitter .....	£145.00
KW 1000 Linear .....	£135.00
KW 101 VSWR Meter (52 or 75 ohm) .....	£9.25
KW 103 VSWR Meter and Combined Power Meter .....	£12.50
KW E-Z Match, 10-80m. ATU .....	£15.00
KW 107 Combined E-Z Match, VSWR and R.F. Power Indicator, Dummy Load and Antenna Switch for 4 Outlets	£40.00
KW Trap Dipole 70' 75 ohm Twin Feeder .....	£14.00
KW Trap Dipole 97' Coaxial Feeder .....	£15.00
KW 3 way Antenna Switches (for coax) .....	£3.75

### EDDYSTONE RECEIVERS

EC10 Mk. II .....	£79.00
EA12 .....	£205.00
830/7 .....	£372.75

WE ARE THE DISTRIBUTORS OF EDDYSTONE PROFESSIONAL RECEIVERS FOR THE SOUTH WEST.

Trio Equipment Model 9R59DS .....

SECOND HAND EQUIPMENT in stock: Eddystone 840, £30; Codar CR70A Comm. Receiver, £16.50; K.W. Atlanta Transceiver, £175; K.W. Vespa Mk. II Transmitter and p.s.u., £95. Lafayette HA600 General coverage Rx., £38. Trio 9R59DS (as new) £45. Star SR600 Receiver (Amateur Bands), £50. Yaesu FL200B Transmitter, £80.

### SHURE MICROPHONES

Model 444 .....	£14.40
Model 201 .....	£6.00
Model 202 .....	£6.60

ANTENNAE Distributors for J/Beam and Joystick. Joystick ATU's etc.

R.C.A. VALVES for KW and Heathkit equipment, 6146, 6146B, 6HF5, 6LQ6, 6GE5, 6EA8, 6GW8, 6GK6, 6CM6, 6CL6, 6CB6, 6BN8, 6HS6, 6EW6, 12BA6, 12BE6, 12B26, etc. and many other types.

TRADE INS WITH PLEASURE. OUR STOCK OF GOOD SECOND HAND EQUIPMENT CHANGES DAILY - LET US KNOW YOUR REQUIREMENTS.

WE STOCK R.S.G.B. PUBLICATIONS, LOG BOOKS, Etc.  
HP TERMS AVAILABLE

AXMINSTER — DEVON

Telephone: 3163

**WANTED:** KW-1000 Linear, reasonable price, details please.—Flaherty, G3MZS, 92 Over Lane, Belper, Derbyshire.

**SALE:** Inoue transmitter and receiver, plus substantial home-built PSU, £120. Also Swan 350 with PSU, £120. Delivery any reasonable distance.—Smith, G3JKS, QTHR, (Tel: Doncaster 841786).

**SALE:** Trio 9R-59DS Rx and SP-50 speaker, both in perfect condition, £40.—Matthews, 34 Beaconsfield Road, Newcastle-on-Tyne NE4 5JN.

**DISPOSING:** Eddystone 888A in good condition, complete with external S-meter and handbook.—Mellor, 34 Southdown Road, Shoreham-by-Sea (4107), Sussex.

**SALE:** Hammarlund HQ-180, incorporating Telechron clock timer, £120, (mint); Hallicrafters SX-28, re-aligned, £25; two-metre transceiver with mains PSU, speaker and generator, £35; Minimitter 150-watt transmitter, £30.—Edwards, G3KSR, 14 Leaside Way, Southampton SO2-3DU.

**FOR SALE:** Heathkit DX-100U, in excellent condition, £29 or EXCHANGE for good 2-metre gear.—Wallace, G8FRL, 7 River Court, Ferry Lane, Cambridge.

**SELLING:** Eddystone S.640 HF communications Rx, with handbook and spares, £17 o.n.o. Minimitter TOP 2-7 Tx, 160/40 metre, AM/CW, spares, £18 o.n.o. "Coastal Radio" LF Rx, with PSU, £5 o.n.o. **WANTED:** Good HRO, CR-100, etc.—Macrae, 8 Leaholm Road, Benton, Newcastle-on-Tyne (66-2837), NE7 7NN.

**FOR SALE:** Trio 9R-59DS Rx, with crystal calibrator, power stabiliser and Trio headphones, £28. Buyer to collect (after 4 p.m.).—Ritchie, 6 Mildura Court, Church Lane, Hornsey, London, N8-7NS.

**WANTED:** Codar A.T.5 Mk. II, with matching PSU, or W-H-Y? Also T.28 Rx.—Sweeney, G3TFS, 58 Grosvenor Road, Epsom Downs, Surrey. (Tel: Ashted 72689).

**WANTED:** Original Panda aerial coupler, in first-class condition, no mods.—Hurst, 31 Avondale Road, Fleet, Hants.

**WANTED URGENTLY:** Cambridge AM-10D High-Band in good condition.—Box No. 5092, Short Wave Magazine Ltd., 55 Victoria Street, London, SW1H-0HF.

**SALE:** Eddystone 840C receiver, in good condition, going for £29 cash.—Attwood, 25 Castle Road, Dagenham, Essex.

**SELLING:** "G2DAF"-type Mk. II Tx set of final conversion crystals HC6/U, PA coils and switch, PA meter, 2/QV06-20 valves, some chassis and metalwork, £10 the lot. R.C.A. AR77E Rx, coverage 550 kHz-30 MHz, with manual, £12. Pye Ranger PTC-2007 with circuitry, £5. Copies "RSGB Bulletins" and "Short Wave Magazine", 1959-1969, 50p per year for each. Buyer collects at these prices, or by arrangement, s.a.e. details. Offers? **WANTED:** Handbook or circuitry for Class-D No. 2 wavemeter.—Bell, G3JON, QTHR, or ring Sheffield 367774 (home), 732333 (office).

**SELLING:** Superior BC-221AA, grey hammer case, built-in power supply, £20 o.n.o.—Lumb, G3IRM, 22 Harvey Road, Bury St. Edmunds, Suffolk.

**ON OFFER:** Hallicrafters SX-111 amateur band receiver, dual conversion, variable selectivity, switched sidebands, £59. HA-800, three months old, £30. Part-exchange receivers welcome. — Snowden, Swainsea Lane, Pickering, Yorkshire.

**SALE:** Perdio Town-and-Country portable, coverage LW, MW, shipping—offers? **WANTED:** Receiver with two-metre coverage.—Williams, 204 Dysart Road, Grantham, Lincs.

**FOR SALE:** Crystal filters 10.7 MHz, specification on request, £3.50 each. Crystal 10.250 MHz, 50p each. BF115 transistors, short leads, tested, 15p each.—Ring Quirk, Yateley 83048, (Surrey) after 6 p.m.

**SELLING:** Trio 5R-59DS receiver, tuning 550 kHz to 30 MHz, headphones and aerial, in mint condition with instruction manual and original packing case, £40 or near offer?—Orlyk, 42 Grand Parade, Brighton, Sussex.

**FOR SALE:** G.E.C. RC-410 synthesised receiver with all manuals, offers over £300. Heath 610 Monitor scope, £38. LM-14 frequency meter and PSU, £17. Tech. TE-20D VVTM, £12.50. AKG 200E microphone, (unused), £20.—Barry, G3UFU, 15 Fairlawn Court, London, W4 5EE.

**COMPLETE Station For Sale,** comprising TS-510D, PSU, K.W. E.Z-Match, SWR meter, microphone, handbook, etc., 12 months old, in mint condition, price £150. Buyer to inspect and collect.—Marsden, G3ZHP, 5 Smithy Lane, Skelmanthorpe, Huddersfield, Yorkshire.

**WANTED:** Eddystone 830/7 receiver, in full working order, with manual; also Redifon R.145.—Box No. 4932, Short Wave Magazine, Ltd., 55 Victoria Street, London, S.W.1.

**SALE:** Trio 9R-59DS receiver, fitted HT stabiliser, £40. Hamgear Preselctor, £5.—King, 12 Towers Avenue, Maghull, Liverpool, L31-OAJ.

**AUGUST Issue Short Wave Magazine due out on Friday, July 28.** Single copies at 25p post free can be supplied to orders reaching us by Wednesday 26th, for despatch on Thursday 27th, the day before publication. These copies go out flat in an envelope. Orders with remittance to:—Circulation Dept., Short Wave Magazine, Ltd., 55 Victoria Street, London, SW1H-0HF.

**EXCHANGE OR SELL:** Tape reading, perforating, printing equipment comprising Remington Model 25 solenoid-operated electric typewriter, 8/5 channel reader, 8/5 channel punch and processing unit; manufactured by Datek Systems; operates in Atlas code but can be converted to others. Price £120 or EXCHANGE SSB transceiver with Top Band coverage. Will haggle. Also many microswitches, various types including double-pole changeover.—Salt, Cruets, The Village, Buckland Monachorum, Yelverton, Devon.

**FOR SALE:** Hammarlund HQ-180A, 540 kHz to 30 MHz, with bandspread 80-10m., matching speaker, 24 hr. clock and manual, in very good condition, £125 or near offer. Consider Part Exchange KW-77, SX-100, Gonset G.76, G.77, Heath HX-20, Cheyenne Mobile, or W-H-Y?—Perrin, G4AFY, 30 Franchise Street, Kidderminster, Worcs. (Tel: Bob, Kidderminster 61752, 6-7.30 p.m.).

## MI-19467-A MASTER OSCILLATORS

These R.C.A. units which are used in the ET 4336 transmitter and which were supplied as a separate item, each in its own slide-in metal case, are ideal as the heart of any high-power transmitter, unmodified as a low-power (approx. 20w.) transmitter, or as a basis for modification to suit individual requirements. They incorporate a 6-position oscillator switch (covering 1 to 5 MHz); a 3-position Multiplier switch (covering 2 to 10 MHz); a D.C. current meter, and oscillator and multiplier coils with "turns counting" mechanisms for precise tuning. Power requirements are H.T. and L.T. for the 807 valve used in the unit, and are brought in by an 8-pin Jones plug on the rear of the chassis. The basic frequency coverage of the oscillator is 1 to 10 MHz, which can be extended to 20 MHz when used as the oscillator section of a higher power transmitter or when used on its own. All these and many more details are covered in full in the extremely comprehensive instruction/service manual (supplied with each unit) containing wiring and circuit diagrams, adjustments, photographs, etc. **BRAND NEW.** Price per unit is £8.50 including 2, 807 valves. Carriage 75p.

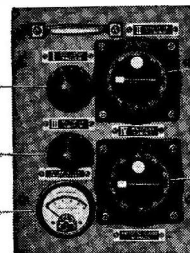

## COLOMOR ELECTRONICS LTD.

01-743 0899

01-748 8006

170 GOLDHAWK ROAD,  
LONDON, W.12.

G2CTV

G3ZY

### J. & A. TWEEDY (Electronic Supplies) Ltd.

#### SPECIALISING IN AMATEUR RADIO EQUIPMENT

Full range of YAESU, KW, TRIO and EDDYSTONE equipment, also a large selection of aerials for the Amateur always in stock including MOSLEY TA31JR, £14; TA32JR, £23; TA33JR, £34.50; Atlas vertical, £20.50; conversion kits TA32/33, £14; TA31/32, £12.

#### J BEAM

2 HO Halo	£1-20	2/8	£4-60	70M/MBM/46	£9-60
2 HM Halo	£1-30	2/12	£4-15	4/3Y	£3-85
2/4Y	£2-65	2/16	£7-65	4/4Y	£5-10
2/6Y	£3-20	PM2/2	£2-60	New Portable mast	
2/8Y	£3-80	70/16	£5-10	Model SPM 16ft.	
2/10Y	£8-20	70/14Y	£6-45	high, Wt. 5 lbs.	
2/14P	£13-00	70/18P	£6-50	£4-45	
				4ft. extension for double arrays	•80

#### HY GAIN VERTICALS

12AVQ	£16-50	14AVQ	£18-50	18AVT/WB	£33-00
-------	--------	-------	--------	----------	--------

<b>TAYASU MOBILE WHIP with Base and Co-ax</b>		£2-88	
160 mtr. resonator	£2-75	80 mtr. resonator	£2-75
40 mtr. resonator	£2-47	20 mtr. resonator	£2-20
15 mtr. resonator	£2-20	C.P. adaptors	33p
Packaged deal consisting of one of each piece		£13-75	
P. and P. 16p. Packaged deal 37p.			

G-Whip Antenna range now in stock.

**Caslon Clocks.** Copal 601, £13.75; Copal 222, £6.65; Copal 101, £8.80 Post free.

**Boom Mike.** Model C-Ceramic, £4.95; Model X Crystal, £4.60.

#### USED EQUIPMENT

Drake 2C with calib.	£65-00	Hallicrafters SX111	£78-00
KW204, Mint	£115-00	KW2000B with AC p.s.u.	£170-00
KW500 Linear	£48-00	KW600 Linear	£60-00
Sommerkamp FTDX150	£160-00	FLD X500	£95-00
Marconi CR100	£14-00	RCA AR88	£32-00

OPEN TUESDAY TO SATURDAY, 9 a.m. to 5.30 p.m.

HP Terms available

Part exchanges

64 Lordsmill Street, Chesterfield, Derbyshire

Tel. Chesterfield 4982 or 68005 (evenings)

## MARKHAM ELECTRONICS

Technical  
G3FPQ

YAESU TRANSCEIVERS

SALES  
XYL

All ex-stock—delivery free—12 months' guarantee  
excluding valves and semi-conductors—unbeatable value—  
our prices and H.P. rates are the lowest available.

- FT101:** Ultra modern complete station—260w. P.E.P. input. Fully transistorised save for driver and P.A. Complete with microphone and built-in speaker ... .. **£225**
- FT200:** (Less P.S.U.), 260w. P.E.P. input. All usual operating facilities such as selectable USB/LSB, VOX, 100 kHz calibrator, clarifier  $\pm 5$  kHz are included. A modern transceiver with YAESU quality. ... .. Only **£120**
- FP200:** AC power supply and speaker unit for FT200 ... .. **£35**
- FTDX400:** 560w. P.E.P. input. Similar to FTDX560 but no W.V.V. band and no provision for CW filter. Limited number only ... .. **£160**
- FTDX560:** 560w. P.E.P. input. W.V.V. band and provision for installing C.W. filter, selectable USB/LSB, VOX, 25/100 kHz calibrator, clarifier  $\pm 5$  kHz, ANL and AC power supply all built-in ... .. **£180**
- FTDX401:** As FTDX560 plus built-in P.A. cooling fan, C.W. filter and sensational new noise blanker unit ... .. **£200**

FTDX400, FTDX560 and FTDX401 are all variations on the same basic design and represent unbeatable value for a high quality 560w. P.E.P. transceiver with built-in AC P.S.U.

**MARKHAM OAK, BUCKS HORN OAK,  
FARNHAM, SURREY.**

Telephone Bentley (Hants) 3168 (evenings)

**Interested in Leasing  
your equipment over  
4/5 years and keeping  
up to date?**

*Write or get your dealer to write  
to:*

**G8KA**

**General Merchandise  
Credit Ltd.,**

**Cranbrook,  
Kent.**

**Minimum package deal £200.**

**H.P. Terms over 3 years also.**

**SALE:** Trio transceiver TS-510 with PS-510 power supply and speaker, little used, mint condition, £135.—Nichols, G3NXF, QTHR, Tel: 0562-4842 (Kidderminster).

**FOR SALE:** American amateur transmitters, receivers, frequency meters, antennae in good used condition at very reasonable prices. Write for quotations.—Box 8352, Savannah, Georgia, U.S.A. 31402.

**WANTED:** S.B filter 9 MHz or IF, also Eddystone 898 dial. Details please.—Box No. 5093, Short Wave Magazine Ltd., 55 Victoria Street, London. SW1H-0HF.

**WANTED:** Trio 9R-59DS or similar model, or Lafayette HA-600 for: £20-£30? W-H-Y?—Ring, Bukin, Reading 883169.

**SALE:** FT-DX100B transceiver, coverage 80-10m., AC/DC operation, Vox, in original packing, very little used, £135.—Barry, 47 Gerald Road, Wollaston, Stourbridge, Worcs.

**SELLING:** R.C.A. AR88D, 12 months old, cost £85, with headphones, set of spare valves and manual. Fair offers, buyer collects. **WANTED:** KW-77 receiver.—Newey, 23 Leahouse Road, Oldbury, Warley, Worcs.

**EXCHANGE OR SELL:** Hitachi "Navigator" four-band portable radio, tuning 185 kHz to 12 MHz, with BFO, D/F, as new, £13.50. Avo valve tester, in wooden case, excellent condition, £6. Collins TCS-12 transmitter, new valves and modified, no PSU, £7.50. Or EXCHANGE above items for good receiver.—Miller, 160 Heath Street, Hednesford, Staffs.

**SALE:** Hallicrafters S.36A and S.27C, continuous coverage 27 to 225 MHz, good condition, £20 the pair.—Ring Morris, Gerrards Cross 85556 (Bucks.), after 6.30 p.m.

**SELLING:** Pye Vanguard, working on 145 MHz, complete with harness and receiver crystal, £35 or near offer.—McLay, c/o LUOTC, 20 Oxford Street, Liverpool 7, or ring 051-427 3855.

**WANTED:** Urgently, circuit diagram of Inoue IC-700T. Will photocopy and return immediately.—Cooper, 12 Black Barn Lane, Usk, Mon.

**WANTED:** High-grade receiver for VLF. General coverage type such as Racal R.217, T.D.M.S. No. 5 or No. 6. Also high-grade teleprinter such as Teletype 28RO.—Passfield, 30 Greenleaf Close, Tulse Hill, London, S.W.2. (01-674 5825).

**FOR SALE:** Trio TS-510 transceiver and power supply in as-new condition, any trial at my QTH, price £130.—Kellow, G3ZHK, Glenvale, St. Dominick, Saltash, Cornwall. (Ring St. Dominick 543, evenings).

**SALE:** Trio JR-310, as new, £60 or near offer. Buyer collects.—Woodcock, 4 Fairway Crescent, R.A.F. Newton, Notts., NG13-8HJ.

**OFFERING:** Eddystone EC-10, nice condition, £38 offer? Delivery possible.—Hayes, 17 Halifax Close, Wroughton, Swindon, Wilts.

**WANTED:** Circuit, manual, or any other information on R.209 Rx. Purchase or loan.—Wilmot, 39 Dropmore Road, Burnham, Bucks.

**SALE:** R.C.A. AR88D, in good condition and re-aligned, £40. Marconi TF-912A 75-ohm RF watt-meter, £10. Avo electronic test-meter, £10.—Morgans, G8CUJ, 14 Southfleet Road, Swanscombe, Kent.

**FOR SALE:** BC-221 with charts, £13. Marconi CR-100/8 receiver, revalved and re-aligned, with S-meter, hotted-up front-end, £25.—Ring Owen, 061-445 0179 (Manchester) after 2 p.m.

**SELLING:** Creed 71D/3 triple-headed auto transmitter (five-unit tape reader), independent magnetic clutches, mains motor, perfect working order, £15. Prefer buyer collects.—Hodgson, G3YKB, QTHR.

**SALE:** R.C.A. AR88D, modernised cabinet and knobs, fitted product detector and new valves, with Hamgear P.M.II preselector and calibrator, £40 the pair.—Ring Mangell, Bristol 41368.

**WANTED:** Marconi Atlanta receiver, top price paid for good specimen. Also pair of Walkie/Talkies required. **SELLING:** R.C.A. 8156L; Redifon R50M; both as new.—Cain, G3DVF, 18 Oaky Balks, Alnwick, Northumberland.

**FOR SALE:** Sony CRF-230 receiver, 23 wavebands, world zone, 48 transistors, 32 diodes and FET's; AC mains or battery, car or boat, brand new, in carton with manual, £200. (List price £379).—Ring Berry, Hereford 65222, after 6 p.m.

**SELLING:** Grundig satellite-amateur transistor battery/mains portable communications receiver, covers VHF, LW, MW, marine, 49m., plus all amateur bandspread wavebands (160-10m.), SSB unit, few weeks use, mint, £90. (Feb. 1972 list, £139).—Ring Tarry, Darwen, 0254-73777 (Lancs).

**RECEIVERS:** Eddystone 940, EA-12; Hallicrafters VHF BC-348, £12.50. BC-221, £10. Collins P.T.O., £5. Bandpass filter 2.6 kHz; large UK navigation map. Meters: 20 micro-amp, 54mV; Headphones; £1 each. Please send s.a.e.—Wright, 249 Sandy Lane, Hindley, Wigan (55948), Lancs.

**PROPERTY of the late Peter Bradley, G8KZ:** RME-69 receiver with preselector and speaker, £20. JXK two-metre converter, £10. Scophony-Baird tape recorder, £10. BC-221 frequency-meter, with charts, £15. AVO valve tester, with charts £10. Hammarlund HQ-145 receiver, with matching speaker, £50. To inspect ring Beaumont, Canterbury 63588 after 6.0 p.m. All items cash-and-carry, buyers to collect.—Beaumont, 23 Montford Close, Hales Place, Canterbury, Kent.

**SELLING:** Swan 500C, with Vox, 508 VFO and PSU, in very good condition, £250 or near offer. Trio JR-599 "custom special" receiver, mint, £140 or offer. LM-14 frequency meter, with PSU and charts, £20.—Hutchinson, G3VGH, 78 Strensall Road, Huntington, York (769245), Y03-9SH.

**DISPOSING:** Bendix receiver covering 150 to 1500 kHz continuous, with two RF stages, suitable for DX on long-wave and medium-wave bands or as IF/AF unit, with BFO, IF 110 kHz, mains powered, 3-ohm speaker output, price £5, carriage extra. Also an Electoniques valve-type amateur band coil pack, 1.6 MHz IF, as new, £9.—Collins, G3THX, QTHR.

**YUKAN SO PROFESSIONAL THE SELF-SPRAY YUKAN AEROSOL WAY-**  
**Get these air drying GREY HAMMER NOW! OR (CRACKLE) finishes**

Yukan Aerosol spraykit contains 453g, fine quality, durable easy instant spray. No stove baking required. Hammers available in grey and blue, 92p carr. pd. Modern Eggshell Black Winkle (Crackle) producing a 3D textured finish, 32p carr. pd. all at 87p per push-button self-spray can at our counter. Also durable, heat and water resistant Black Matt finish (339g, self-spray cans only) 77p carr. pd.

**SPECIAL OFFER:** One can plus optional transferable snap-on trigger handle (value 25p) for 98p carr. pd. Choice of 13 self-spray plain colours and primer (motor car quality) also available.

Please enclose cheque or crossed P.O. for total amount direct to:  
**DEPT: SW7 YUKAN, 307a EDGWARE ROAD, LONDON W2 1BN**  
 We supply many Government Departments, Municipal Authorities, Institutes and Leading Industrial Organisations—We can supply you too. *Now British—even better*

Other Yukan Air Drying Aerosols, 453g, at 92p carr. pd. include: Zinc Chromate Clear Lacquer Metallic: Grey, Blue.



**HOLDINGS** PHOTO AUDIO CENTRE

**Swop your camera for YAESU TRIO?**

Transceivers and receivers on dem. Send large S.A.E. for R.S.G.B. test report on JR.310 with our top band, 144 MHz con. use cal. unit etc. Borrow a manual for 7 days. 12 month guarantee.

**HOLDINGS PHOTO AUDIO CENTRE,**  
 39/41 MINCING LANE, BLACKBURN, BB2 2AF.  
 Tel: 59595/6



**FREE TO ENGINEERS**

Whatever your age or experience you must read New Opportunities. It describes the easiest way to pass A.M.S.E., A.M.I.M.I., City & Guilds (all branches), Gen. Cert., etc., and gives details of courses in all branches of engineering Mechanics, Electrical, Civil, Auto, Aero, Radio, TV, Building, etc. You must read this book.

Send for your copy today—FREE!  
 B.I.E.T., B30, Aldermaston Court, Reading, RG7 4PF  
 Accredited by the Council for the Accreditation of Correspondence Colleges

**BRITISH INSTITUTE OF ENGINEERING TECHNOLOGY**

**G3ACQ OFFERS:—CRYSTALS 1.8-3.5-7-14-21-28 MHz 6-9-16-17-35-36-70-80 MHz for VHF all at 65p post paid. 3.5 MHz spot for 9R59 owners calibrator 75p post paid. TRIO-9R59DS-JR500-JR310—the new TS515 to order also YAESU MUSEN S.W.B.—G.D.O.'s—24 hr. digitals Sig Gen—testmeters, £3 to £40 all in stock. 1 only PANADAPTOR 1.6 or 465 kHz if £45. SOLID STATE MODULES CONVERTERS 2-4-70 cm.**

**S. MAY (Leicester) LTD.**  
 12/14 CHURCHGATE, CITY CENTRE,  
 LEICESTER LE1 4AJ  
 Telephone 58662

Member of Amateur Radio Retailers Association

## TAURUS ELECTRICAL SERVICES

(Prop.: G3TED)

All prices include carriage

**SPECIAL OFFER.** Ferric Chloride Powder for printed circuit etching. Full instructions. 1 lb. bag, 40p; 3 bags, £1

<b>CIRCUIT BREAKERS.</b> Small 5cc or 10cc ... ..	50p
<b>SMALL RECTIFIER BRIDGES.</b> 60PIV 2cc ... ..	25p
<b>FIELD TELEPHONES.</b> Tele "F" ... each £4; pair	£7.50
<b>DC MULTIPLIER UNITS</b> for CT54, V-Voltmeter ...	30p
<b>SMALL CONTROL BOXES</b> with Lamp, etc. Bargain ...	25p
<b>TRANSISTORS ACY20.</b> New ... ..	25p or 5 for £1.00
<b>U.H.F. DUMMY LOAD 7715</b> with Cavity Capacitance Unit and position indicator. Few at	£5.00
<b>RF INDICATOR 7150.</b> Complete with 1 amp RF Meter with Loading Resistors. 50 watt with coax connections. New and good. Few at ... ..	£5.00
<b>JUST ARRIVED 8ft. MET. BALLOONS,</b> new in sealed tins with valve and stopper	£1.00
<b>AMERICAN VALVE TERMINAL UNITS, TA182/U.</b> TELE TYPE KLEINSCHMIDT TT98B/FG. Good condition Teleprinters, neat looking. 115/230v. AC 50 or 60Ω. 184 watts max. ... ..	£27.00
<b>SMALL 4ft. FOLDING AERIALS</b> ... ..	50p
<b>AIRCRAFT MACH METERS, NEW</b> ... ..	80p
<b>AIRCRAFT AIRSPEED SWITCHES, NEW</b> ... ..	70p
<b>MIXED XTALS.</b> Our assortment, 10 for	£1.00
<b>NEW VARIABLE CONDENSERS (BOXED).</b> Spindle both ends, two types : 74PF + 74PF. 750v. D.C. (Polar type 015) ... ..	75p
102PF Single (Polar type 012) ... ..	50p
<b>MINIATURE ROTARY TRANSFORMERS.</b> 28v. D.C. in 250v. D.C. at .06 out. Will run off 12v. giving approx. 150v. out. ... ..	75p
<b>MIN. DIODE EQUIV. IN4007.</b> 1,000 PIV at 1½ amps. 18p each or	£2.00 doz.
<b>EPICYCLIC SLOW MOTION DRIVES.</b> 8-1 ratio	20p
<b>MAINS SMALL MOTORS.</b> 1 REV/HR. Power full ... ..	50p
<b>SPECIAL OFFER</b> of QV03-10's. Tested ... ..	55p
New 6CL6's. Tested ... ..	55p
6L6's. Ruggedised. New ... ..	80p
<b>TELEPHONE HANDSETS</b> ... .. each	40p
E180CC valves ... ..	25p
<b>SPEAKERS</b> —New. 1½" 40Ω ... ..	35p
<b>BY100's.</b> Tested ... ..	15p ea. £1.50 doz.
<b>TRANS. CALL UNITS</b> (mains intercoms.) Complete ... ..	£2.20
<b>MARGIN DISTORTION TEST SETS.</b> In new condition with handbook. Delivered ... ..	£7.50
<b>OP-AMPIC's 709C.</b> New, marked ... .. each	20p
<b>2N3055 POWER TRANSISTORS N-P-N.</b> New ... .. each	60p
<b>POWER TRANSISTOR PROTECTION THERMOSTATS.</b> New ... .. each	20p
<b>NEW GETS POWER TRANSISTORS.</b> Matched pair ... ..	30p
<b>25 MIXED NEW VALVE HOLDERS</b> ... .. each	30p
<b>NEW MULLARD NIXIE TUBES</b> ... .. each	£1.25

26/28 NOTTINGHAM ROAD, LOUGHBOROUGH  
Telephone 5131

*To become a Direct Subscriber costs you (first-class posting) £3.00 for a year of twelve issues, starting any time now. Orders to Circulation Dept., Short Wave Magazine, Ltd., 55 Victoria Street, London, SW1H-0HF*

### BICYCLE RADIOS

**A Modern style Headlamp with built-in Hooter and powerful Radio.** Supplied with anti-thief padlock, £6.50 + 25p carr.

**Powerful 12 volt D.C. Motors.** Two will drive child's pedal car if suitably geared, £1.50 + 25p carr.

**Ex-Govt. Telephone Handsets.** Connect together with 4½v. battery and buzzer to operate, 75p pair + 25p carr.

**Beckman 40 Mc/s. Counter** (valve) with 120 Mc/s. range extender, £35 the pair. 1 Mc/s. ditto without extender, £18. Buyer collect.

**2 Kelvin Hughes Echo Sounder Chart Recorders,** £10 each. Buyer collect.

### ELEY ELECTRONICS

112 GROBY ROAD, GLENFIELD,  
LEICESTER.

**FOR SALE:** Heathkit HW-100 Transceiver with HP-23 PSU, speaker and spares, in excellent condition, price £115 or near offer.—Oleson, GM3MQO, Q14Rf, or ring Prestwick 79245.

**WANTED:** Circuit diagram and plug connections for the LM-13 frequency meter, buy or borrow.—Goacher, 51 Norman Road, Swindon, Wilts.

**WANTED:** Teleprinters, up to three if price is right, must conform to current amateur standards.—Jarvis, GM8APX, Rannoch School, Perthshire. Scotland. (Tel: Kinloch Rannoch 379).

**BARGAIN:** New Sony Global Receiver Type CRF-150, coverage LW, MW, ten SW bands and VHF, double-superhet circuit, uses 19 transistors and 12 diodes, with built-in speaker, telescopic aerial and external terminals, cost £126.50, a bargain at £85.—Leighton, Tangle Cottage, Womersley, Guildford, Surrey.

**SALE:** Low-Band 2207 Ranger, 6-40 PA, believed Tx on 4m, but Rx unmodified, complete with handbook but less control box, £10.—Oughton, G4AEZ, 48 Morley Hill, Enfield, Middlesex.

**SELLING:** Eddystone 940 RX with plinth speaker, no modifications and a good specimen, £90 or near offer. Delivery Securicor.—Lamb, Old Bakery, The Green, Funningly, Doncaster.

**FOR SALE:** Codar A.T.5, T.28, DC PSU, 12MS, control unit, 12RC and G3FIF mobile whip for 160m, and 80m., complete with all cables, £32 or will split, carriage paid. K.W. Vanguard Mk. II, coverage 160-10m., £25. Minimitter MR. 37 Rx, £5. Buyer to collect these items.—Jones, GW3TMP, QTHR.

**SALE:** Heath HR-10B receiver, two speakers, Joystick aerial with ATU, radio table, etc., all brand new, £50 or near offer. Buyer collects.—Naylor, 8 Carlton Grove, Bispham, Blackpool, Lancs. (Tel: Blackpool 55656, after 7.30 p.m.).

**MANUALS:** B.40, RA-17, Collins TCS, CR-150, £1.75; T.1154, BRT-400, R.1155, R.1355, £1.50; AR88LF, CR-100, S.27, S.36A, £1.25; SP.600, Collins J4, £2; No. 18, 19, 31, 52, 88, 206, 62 Sets 75p. Postage 7½p Many others.—Brooks, 5 Farrant House, Winstanley Road, London, S.W.11.

**SALE:** KW-2000A, AC power supply, Shure 201 mic., excellent condition, for quick sale £130 or near offer.—Patrickson, G3TQS, 48 Fairfield Road, Taunton, Somerset.

**SELLING:** CRT Unit Type 2, £6.50. Calibrator Unit with AC/PSU, £3.50. CRT AC mains PSU, £6.50. American CRT D/F unit, £8.00. Twin CRT unit, £5. VHF Rx, AC mains, coverage 20 to 100 MHz approx. £15. All carriage extra, s.a.e. with enquiries.—Hayward, Sunnyfields, Lighthouse Road, St. Margarets Bay, Dover, Kent.

**FOR SALE:** K.W. Vanguard AM/CW Tx with Top Band coverage, in good condition, £30.—Clark, GM3WSR, 3 Concorde Way, Spencerfield, Inverkeithing (4466), Fife, Scotland.

**WANTED:** FT-101 or KW-2000B, mint condition essential, also AR rotator. Interested in possibilities complete station.—Perrett, G3PYA, 155 Wellingborough Road, Northampton.

**SALE:** R.C.A. AR88D receiver, in excellent condition, with speaker and manual, £60 or near offer.—Ring Billington, 01-656 9882 (London) after 7.0 p.m.



**FOR SALE:** Eddystone EC-10 Mk. II, few hours' use only (new price £79) asking £69, buyer to collect.—Ring Northey, Watford 38339.

**SELLING:** R.206 Mk. II receiver, tuning 500 kHz to 30 MHz, incorporating as mods. S-meter, Q-multiplier, crystal filters, muting and home-built PSU—has helped me work over 100 countries—price £25 or near offer, will deliver up to about 50 miles.—Stewart, G3TTR, QTHR, Tel: Crawley (Sussex) 23826.

**WANTED:** Manual for the Lafayette HE-80, or its circuit diagram.—Rozier, 17 Gregory Court, Lakefield Road, Wednesfield, Wolverhampton, Staffs.

**SALE:** Eddystone 840C receiver, in excellent condition, buyer to collect, price £30 or near offer.—White, Room 2, De Crespigny Park, Denmark Hill, London, S.E.5. (Tel: 01-703 4534).

**SELLING:** RC.411/R professional receiver, having digital frequency indication, phase-locked loop, full synthesising, tuning 15 kHz to 31.0999 MHz (no gaps) in 32 bands, each covered in steps of 1 kHz and 100 Hz, with vernier tuning 0-100 cycles plus 10 kHz and 100 kHz controls (any spot frequency in range set in seconds), stability better than one part in 100 million per day drift, sensitivity better than 0.5 microvolt in A1, A3A, A3J modes, with four positions of crystal selectivity, three settings of AGC, RF and AF level metering, audio output of one watt and 10 mW, on plug-in PC boards, all solid state, incorporating over 540 semi-conductors and 18 integrated circuits. Best offer over £450.—Box No. 5094, Short Wave Magazine, Ltd., 55 Victoria Street, London, SW1H-0HF.

**FOR SALE:** Cossor-built R.107 receiver, with BFO, etc., mains or 12v. DC operation, excellent condition, £12. CT.206 Valve Voltmeter, £5.—Ring Barker, 01-764 6186 (Surrey).

**CLEARANCE:** RME-70, TCS-12 (both needing attention), DB-20, Oscillator Type 145, Osc. 37/PSU, R.E.E. two-metre converter/PSU, R.208, SCR-522 Tx with spare chassis, RF-26, RF-27 (modified). The Lot, untested, for £18. (South East London).—Box No. 5095, Short Wave Magazine Ltd., 55 Victoria Street, London, SW1H-0HF.

F.T. 101 Transceivers, and full range of Japanese equipment from Stock. Checked by K.W. Engineers. Usual K.W. courtesy and service.

*Easy terms available.*

**K.W. Developments Ltd.,**  
 1, HEATH STREET,  
 DARTFORD, KENT.  
 Telephone: Dartford 25574

# SOUND BARGAINS

**BEST OF ALL WORLDS**

**GIANT POWER MULTI-WAVEBAND COMMUNICATIONS RECEIVER**

WITH 3 in 1 AC/DC POWER SUPPLY SYSTEM  
 MAINS/BATTERY plus BUILT-IN BATTERY BOOSTER

VHF, FM, AM, AFC, AIR BAND, PUBLIC SERVICE AND WEATHER BANDS

**OUR PRICE £10.50**  
 + 40p P. & P.

**THIS NEW 1972 RADIO.**  
 No less than 3 VHF BANDS. Picks up Aircraft Transmissions, Pop Pirates, Taxis, Ambulances, Local Radio, Continental and all BBC, VHF Stations plus fascinating Public Service Transmissions we are not allowed to mention! Even TV sound in certain areas.

**PLUS A SPECIAL WEATHER-BAND**  
 Frequency ranges : MW540-1600 kHz, FM88-108 MHz, Airband 108-145 MHz, VHF 145-175 MHz, 23 semi-conductors, 12 transistors, 11 diodes and thermistors. Automatic frequency control. 31" telescopic aerial. Runs off mains AC 230-250 volts or off 4 U2 batteries, or use re-chargeable nickel alkali cell. Finished in strong leather grained case with carrying handle. Approx. size 10 1/2" x 6 1/2" x 3 1/2". Written guarantee. Special magnetic ear-piece for personal listening, dry batteries FREE. **HURRY!** Limited quantity only from Marktyme. Money back guarantee.

**MARKTYME**

**TUNE INTO THE WORLD WITH THIS AMAZING COMMUNICATIONS RECEIVER.**

A truly exceptional unit in performance and looks—leatherette with stainless steel trim. Looks good anywhere. Use either as a portable with standard batteries or plug it directly into 220-240 volt domestic mains supply. 14 Transistors : 9 diodes : 1 thermister. Internal ferrite rod antenna plus telescopic aerial. Separate tone, volume and tuning controls with push-button selectors for the 8 WAVEBANDS. Complete with Hi-Fi earphone for personal listening.

Frequency ranges : Long wave 150-350 Kcs. Medium 350-1605 Kcs. Marine 1.6-4.5 Mcs. Short Wave 12-24 Mcs. FM/VHF 88-108 Mcs.

Aircraft 108-135 Mcs. **PUBLIC SERVICE BANDS 135-174 Mcs.** Fully guaranteed.

**OUR PRICE £28.95**  
 + 50p P. & P.

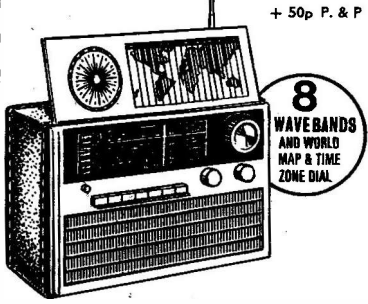

**SAVE NEARLY £14**

on this **DELUXE CASSETTE TAPE RECORDER and PLAYER**

**OUR SLASHED PRICE £13.95**  
 PLUS 30p P.L.P.

**COMPLETE WITH REMOTE CONTROL MICROPHONE**

**MADE TO SELL AT RECOMMENDED LIST PRICE OF £26.97**

**MAINS/BATTERY**  
 It's true! Less than half the recommended price. Accepts 30, 60 and 90 minute Philips Cassette Tapes. Separate volume control, rapid re-wind and input socket for remote control microphone. Only £13.95 + 30p P. & P. Send £14.25. C60 Cassette and battery 45p extra. Now available Battery Cassette Recorder, £12.99 + 30p P. & P.

N.B. The Ministry of Post & Telecommunications has pointed out that a licence (not generally available to the public) is required for reception of transmissions by Fire Brigade, Aircraft, Shipping, etc.

(Dept. SW3), 372 EDGWARE ROAD, LONDON, W.2. Tel. 01-723 0094  
 Callers welcome Monday to Saturday 9 a.m. - 6 p.m.

## THE AMATEUR RADIO SHOP

G4MH

13 Chapel Hill, Huddersfield. Tel: 20774

(MEMBER OF AMATEUR RADIO RETAILERS ASSOCIATION)

Agents for Yaesu Musen, Eddystone, K.W., Trio, Codar, J Beam, Solid State Modules, etc.

## New :—

FT 101 ... ..	£240	KW 204 ... ..	£145
FT 401 ... ..	£215	KW 202 ... ..	£140
FT 200 ... ..	£134	KW 107 ATU ... ..	£40
AC PSU ... ..	£38	Eze Match ... ..	£15
FRDX 400 ... ..	£160	Trio TSS10 ... ..	£190
FLDX 400 ... ..	£140	Trio JR599 ... ..	£185
FR50B ... ..	£52	Trio JR310 ... ..	£83.50
KW 2000B ... ..	£240	Trio 9R59DS ... ..	£57.50
The 4MH Modulator	£11.50	} Pair	£22
The 4 MH 2 mtr. Tx	£11.50		

Morse Practice Oscillator, 90p; 2 Mtr. 8 MHz Xtals, 75p; 2 Mtr. Converters (SSM), £13.75; Pre amp, £6.50. Rotators, Publications, S.W.R. Meters, Dummy Loads, etc.

## Second-hand :—

KW 2000A + p.s.u. ...	£145	Eddystone 750 ... ..	£48
KW Vespa II. Mint ...	£90	(inc. L/S, S. Meter)	
KW 202 Rx ... ..	£115	Eddystone EC10 I ...	£40
KW 201 Rx (inc. Cal.) ...	£75	Eddystone 840C ... ..	£38
KW Valliant ... ..		AR77E ... ..	£24
+ Mobile p.s.u. ... ..	£28	HA30 Rx. Mint ... ..	£25
Trio JR310. Mint ... ..	£65	HA350 Rx. ... ..	£55
Trio JR500 ... ..	£45	Home Built 2 Mtr Tx inc.	
Trio 9R59DS ... ..	£40	Modulator. 75 watts... ..	£18

WE WILL BE AT SOUTH SHIELDS, SCARBOROUGH

Ring for special requirements to bring with us.

HP, FULL SERVICE, CAR PARK, CLOSED TUESDAYS.

## RADIO COMMUNICATION HANDBOOK

Fourth Edition of the  
Original RSGB "Amateur Radio Handbook"

Price £3.15

(+ post and packing 35p.)

Available from stock

Order from

**PUBLICATIONS DEPT.**  
**SHORT WAVE MAGAZINE LTD.,**  
55 VICTORIA STREET, LONDON, SW1H 0HF

## "DX ZONE MAP"

In four colours, on durable paper for wall mounting, 35in. wide by 25in. deep. Giving essential DX information—bearing and distance of all parts of the world relative to the U.K., the 40 Zone areas into which the world is divided for Amateur Radio purposes, with major prefixes listed separately. Distance scale in miles and kilometres. Time scale in GMT. Marking of Lat./Long. close enough for accurate plotting. Hundreds of place names, mainly the unusual ones, and most of the rare islands.

With new Prefix List revised to January 1972.

Price 85p

including postage and special packing in  
postal tube to avoid damage in transit.

Publications Dept.

Short Wave Magazine Ltd., 55 Victoria Street,  
London, SW1H 0HF (01-222 5341/2)

## BURNS ELECTRONICS

### NEW MOSFET CONVERTER FS2/FS4 144/70 MHz

In order to improve receiver performance with today's crowded band conditions a new converter has been designed. Prime features are MOSFET RF stage. Shottky diode ring mixer and selective multiplier chain resulting in improved rejection of spurious responses and strong adjacent channel signals. Isolated supply rail, reverse polarity protection, 9-12 volt DC operation and dimensions as per FC2/FC4 series.

Price : £18.00

### MULTIVERter MC3

A package of VHF/UHF converters with common IF output, for 432, 144, 70 MHz or HF bands as required. Up to three of our converters may be fitted. Basic unit is for 9-12 volt external DC supply but optional mains PSU available for internal fitting. Case style matches our popular Crystal Calibrator. Minimum of one converter fitted.

Price : Basic frame £6.50 plus "less case" cost  
of each converter. Mains PSU £3.00 extra

Crystal Calibrator CC-10 Mk. III ... ..	£25.60
Wavemeter TC-101 ... ..	£18.30
Frequency Standard SD-11 ... ..	£78.00
FET Converter FS2/FS4 ... ..	£18.00
FET Converter FC2/FC4 ... ..	£16.20
Low Pass Filter FL2/FL4 ... ..	£6.20
Test Oscillator TO-701 ... ..	£10.00
FM Detector FMD-1 ... ..	£6.70
Assembled and tested	£8.20

For further details on these equipments and our new comprehensive component catalogue send 10p or cash with order to :—

**THE COTTAGE,**  
**35 BEULAH HILL,**  
**LONDON, SE19 3LR**

## MORSE MADE !!!

**FACT NOT FICTION.** If you start **RIGHT** you will be reading amateur and commercial Morse within a month. (Normal progress to be expected.)

Using scientifically prepared 3-speed records you automatically learn to recognise the code **RHYTHM** without translating. You can't help it, it's as easy as learning a tune. 18-W.P.M. in 4 weeks guaranteed. For Complete Course 3 Records & Books send £4.50 (overseas £1 Extra).

For further details of course Ring 01-660 2896/01-668 3255 or send 4p stamp for explanatory booklet to :—

G3HSC (Box 14) 45 GREEN LANE, PURLEY, SURREY.

**LET SECURICOR COLLECT YOUR OLD HAM, HI-FI, OR PHOTO GEAR,** and deliver **NEW TRIO or YAESU.** We arrange and pay for collection. You pay only £1 return carriage if price not agreed. Fair enough! Send full details of what you want and what you have, for provisional price subject to test and inspection.

**HOLDINGS PHOTO AUDIO CENTRE,**  
39/41 MINCING LANE, BLACKBURN, BB2 2AF  
Tel: 59595/6

## C. D. TELECOMMS (L'pool)

44 IMPERIAL CHAMBERS,  
62 DALE STREET, LIVERPOOL, L2 5SX

Radio Telephones. Mobile 10 watts A.M. All transistorised Rx. Valve Tx. PTT mic. 12v. DC. Lo-Band. Few only at ... £23.50 (carriage paid)

V.H.F. Rxs. This is a small self-contained Rx as used by Fire, Police, Ambulance. Double-superhet multi-channel Xtal-controlled. Built-in spkr. Ideal for conversion to 2m. Mains operated ... .. £25.00 (carriage paid)

U.H.F. Rxs. F.E.T. Front end. Available next month. Anticipated price... .. £40.45

Still Available. 15 watt R/T mobiles, as advertised April S.W.M.

Terms of Business: Cash with order. Cheques, etc. made payable to C.D. Telecomms. Callers by appointment.

## SOME RECOMMENDED TITLES BRIEFLY DESCRIBED

### BEGINNER'S GUIDE TO RADIO

For many years "Beginner's Guide to Radio" has been extremely popular as an introduction to the subject of radio-and-how-it-works. The many advances made in recent times have rendered a new edition necessary.

This seventh edition has been completely rewritten and brought up-to-date to take account of the latest techniques and methods, and covers every aspect of the modern radio scene, while including the important basic information necessary for the newcomer to the subject.

The reader is guided from the first principles of electricity and magnetism, through radio waves, modulation and radio components, including valves and transistors, taking in radio transmitters and stereo broadcasting, and ending with hi-fi reproduction.

The book will be of interest to all who wish to understand the how-and-why of radio, whether it be for a hobby or a profession.

Seventh Edition

£1.12 post free

### 49 EASY TRANSISTOR PROJECTS

This book is for the electronic hobbyist who is interested in developing projects that can be fun as well as useful. Most projects can be constructed in one evening using only a few inexpensive parts. Many of the parts can be salvaged from old radio and television chassis.

Each project is presented in an easy-to-understand way, with a parts list and a schematic diagram. Many value substitutions can be made in resistors and capacitors without affecting the end result, providing that the proper transistors, coils, and transformers are used.

Projects in this book, which include an AM radio, an FM receiver, light relay controls, audio amplifiers, code practice oscillators and test equipment—each designed with only two transistor types.

£1.01 post free

### 110 INTEGRATED CIRCUIT PROJECTS FOR THE HOME CONSTRUCTOR

Integrated circuits are the most important new semiconductor devices to have been developed within the past decade. They are compact, easy to use and less expensive than their discrete transistor-resistor equivalents. This volume gives an entirely practical introduction to these devices by describing one hundred and ten constructional projects in which they can be used.

The projects range from simple low-level amplifiers to complex test equipment and include a number of hi-fi circuits and logic circuits. The integrated circuits used are internationally available types and all the projects have been designed, built and fully evaluated. The book should prove to be of practical interest to the professional engineer, the student and the amateur.

£1.22 post free

### 110 SEMICONDUCTOR PROJECTS

Due to the rapid advances in semiconductor technology, many engineers and certainly most amateurs have found it impossible to keep track of the new devices that become available because of lack of readable information. This book introduces the reader to such outstandingly useful new devices as the field-effect transistor, unijunction transistors, silicon controlled-rectifiers, silicon planar transistors and integrated circuits, giving their properties and methods of operation, with full constructional details of many exceptionally useful circuits.

Of particular interest to the amateur are simple amplifiers, lamp and relay driving circuits, electronic switches—operated by light, sound or contact with water—and delay circuits ranging from a fraction of a second to 35 minutes. Among the many circuits which will be of interest to the practising engineer are amplifiers with input impedances as high as 500 megohms, voltage and current regulators, waveform generators, analogue-to-digital converters and logic circuits. All circuits are designed around internationally available semiconductors.

124 pages, including 110 illustrations

£1.37 post free

Some of the Books described here are American in origin

The above prices include postage & packing.

Delivery is from stock.

Available from

SHORT WAVE MAGAZINE

Publications Dept., 55 Victoria St., London S.W.1

01-222 5341

(Counter Service, 9.30-5.15, Mon. to Fri.)

(Nearest Station: St. James's Park)

(GIRO A/C. No. 547 6151)

### RADIO AMATEUR OPERATOR'S HANDBOOK

The opportunity has been taken of bringing this edition—the twelfth—right up-to-date and of incorporating extensive revisions. The book covers in detail the Post Office regulations governing the issue of transmitting licences.

The purpose of this Handbook is to provide all the information which the operator of a radio station may need about such matters as Country Prefixes, Call Sign Areas, Frequency Allocations, Standard Frequency Transmissions, Time Factors, Distance Tables, and so on. For the newcomer, this manual enables him to find the basic answers and to obtain the maximum pleasure from his hobby.

53p post free

### HAMS INTERPRETER

This valuable book written by DLICU contains a collection of phrases and expressions designed to assist those amateurs who wish to enlarge their knowledge of various languages for use on amateur radio—it is a must for every DX'er.

63p post free

### PRACTICAL INTEGRATED CIRCUITS

This is the first British book to be published on micro-electronics for the amateur experimenter. With circuit diagrams, layouts and easy instructions, it shows how to construct ten practical radio and electronic devices using integrated circuits (IC's) which are now available at low cost from many component stores. Micro-electronics—the big development in electronics since the transistor—involve complex circuits in the form of tiny "chips", incorporating several circuit elements, to which it is only necessary to make connections. Various kinds of micro-circuits are already available to amateurs, with new ones regularly coming on to the market. In this book the authors provide, in addition to practical projects, an introduction which shows clearly the present state of the art and a summary of the items available commercially. The advent of the integrated circuit (IC) opens up a fascinating new field for the electronics student, constructor and experimenter. This book shows how to get started and produce some really interesting and worthwhile equipment.

£1.01 post free

### HANDBOOK OF TRANSISTOR CIRCUITS

By Allan Lytel

Here is a collection of more than 200 practical transistorised circuits for use in counters, power controls, timers, indicators, photoelectric devices, power regulators, amplifiers, power supplies, oscillators, power converters, and other applications. Schematic diagrams, parts lists and descriptions of operation are included for each circuit.

Planned as a supplement and companion volume to author Lytel's previous book, *Transistor Circuit Manual*, many of the circuits employ such specialised semi-conductor devices as silicon-controlled rectifiers, photocells, zener diodes, and tunnel diodes, in addition to standard diodes and transistors.

This book is a handy source of information on the design, operation, and application of a wide variety of transistorised circuits. Engineers, technicians, students, and hobbyists will all find the circuits of interest and the material of value in research, development, experiment, and general studies of circuitry.

£2.35 post free

### PRACTICAL WIRELESS CIRCUITS

There are more than 50 different circuits detailed in this book. Transistor receivers, 22 in all, range from an ultra-simple crystal diode circuit to a very sophisticated 10-transistor communications Rx. Valve receivers cover MW, SW and FM. Transistor and valve amplifiers include pre-amplifier, P.A. and Stereo.

There is a chapter on transmitters and transceivers, and another on transmitter and receiver circuits for Model Control. Circuits for an extensive range of Test Gear cover everything from a simple Transistor Tester to a Comprehensive Multimeter, including a Pocket Signal Tracer (RF, AF and IF), also FM, Square-Wave and Noise Generators.

Among the special circuits are a recording level meter for tape recorders, an electronic photographic timer and a solar cell receiver.

The first few simple circuits are accompanied by step-by-step instructions to enable the absolute beginner to gain enough experience with circuitry building to tackle the more complicated work.

£1.34 post free

# P. & P. DEVELOPMENTS

**Havant 72657**  
Shop Hours

WE SPECIALISE IN VHF EQUIPMENT  
FOR THE PROFESSIONAL AND AMATEUR!

**Cosham 74695**  
Evenings, Weekends

## V.H.F. GOODIES FOR HAMS

**STORNO VISCOUNT'S MARINE TYPE.** 24 volt operation, FM radio telephones, small hybrid construction using QQV0310 PA. £22.50 P.P. £1

**PYE RANGERS HIGH BAND.** AM Dash mounted type 2007 transistor p.s.u. Complete in working order. £11.50 P.P. 50p

**PYE HIGH BAND AM BASE STATIONS.** Complete transmitter and receiver with control panel and internal power supplies. Complete and working. £25 P.P. £1

**COSSOR TYPE TI09/R109.** Low band AM Base Station. Very good condition, complete in working order. £27.50 P.P. £1.25

**BASE STATION GEC LOW BAND.** QQV03/20A in final. Complete RX/TX in unused condition and this unit is FM. £30 P.P. £2

**STORNO MAINS OPERATED BASE STATION.** FM ideal for 4 metres. Immaculate condition complete but less control units. £20 P.P. £1

**B44 MARK 3.** Ideal for 4 metres. £8 P.P. 75p

**DIE CAST BOXES.** 4½" x 3½" x 2". Brand new but manufacturers surplus. £5 P.P. 50p

**PYE CAMBRIDGE AM 10B.** High Band AM complete with control unit, in working order. £34 P.P. £1

**VHF FIBRE GLASS WHIP AERIALS.** Ideal for cutting to quarter wave on 2 metres. £1 carr. paid

Unmarked ceramic trimmers, zero to 10 pf. each 5p

Mullard ceramic trimmers type COOEA/6E. 0-6 pf as used in many converters. each 13p

Eagle equipment. Send large S.A.E. for catalogue. Trade enquiries welcome.

Terms of business: Mail Order only, C.W.O. min. order 25p. Carriage prices for delivery outside England and Wales will be extra. Viewing of equipment by appointment. Send S.A.E. for all enquiries.

**LOW BAND GEC FM COURIERS.** Personal RT Units of modern design and appearance. Double superhet receiver 1.5 uv at 15 dB sig/noise transmitter 500 mwrw output. Complete with mic, earpiece and circuit diagram. £18 P.P. 75p

**GEC LANCONS.** Mid Band RT's FM not less than 250 mwrw output double superhet receiver 1uv sensitivity at 15 dB sig/noise. £10.50 P.P. 50p

**MARCONI OCEAN PHONE BASE STATIONS.** High band FM 16 channels QQV06/40A in final. Complete mic handset £32 P.P. £2

**PYE CAMBRIDGE 12½ kHz.** AM 10B high band 6 channel. Complete with all accessories. £60 P.P. £1

**PYE BANTAM.** Low Band FM, complete in very good condition. £39.50 P.P. 50p

Some 12½ kHz. Price on request

**DASH MOUNTED HIGH BAND CAMBRIDGES.** Few only. £25 P.P. £1

**COSSOR CC15.** Boot mounted low band mobiles, ideal 4 metre, QQV03-20A in final, complete with mic, control box, speaker and leads. £22.50 P.P. 75p

**PLESSEY TX/RX.** Similar to the 20002 high band. £10 P.P. 50p

**STORNO CQM13 MOBILES.** High band FMTX/RX, complete with handset and control box. £17.75 P.P. 75p

**TRANSMITTER INVERTER SUPPLIES AS NEW:**

24v. D.C. input 425v. D.C. output 125 watts. £4.50 P.P. 50p

24v. D.C. input 600v. D.C. output 125 watts. £4.25 P.P. 50p

24v. D.C. input 500v. D.C. output 250 watts. £5 P.P. 50p

**HUDSON VHF FM BASE STATION.** Complete low band TX/RX. Ideal 4 metres, good condition. £22.50 P.P. £1.50

**COSSOR CC40 BASE STATION.** Complete high band base station includes RX/TX and RF adaptor, which includes another TX module. In cabinet but less connecting leads. Good condition. £30 P.P. £2

QQV03/10's. each 65p

19 LONE VALLEY, WIDLEY, COSHAM, PORTSMOUTH, HANTS.

*For some recommended titles, taken from our main list of publications in "Short Wave Magazine" every month and briefly described when space allows, see May '72, pages 136 & 184.*

## WORLD RADIO/TV HANDBOOK 1972

The World's only complete reference guide to International Radio & Television Broadcasting Stations. It includes: Frequencies, time schedules, announcements, personnel, slogans, interval signals and much more besides of value to the listener.

Lists all International short-wave stations, including frequencies, for each country; foreign broadcasts, long and medium wave stations (AM broadcast Band), TV stations and domestic programmes. Long recognised as the established authority by broadcasters and listeners. It is the only publication that enables you to identify BC stations quickly and easily. Enables you to fill more pages in your log book on the SW BC bands and helps you add more BC-station QSL cards to your collection.

£2.80

(The above price includes postage and packing).

from:

**SHORT WAVE MAGAZINE**  
55 Victoria Street, London, SW1H 0HF

## "CALLBOOK"

The "Call Book" proper is now published only once a year, in December, in two parts, "U.S." and "DX Listings."

Supplements to both editions appear at quarterly intervals, obtainable by prior order direct from the publishers.

We supply the "Call Book" as an annual publication, as required at any time during the year. We shall not be handling the quarterly supplements. These will be available only direct from the publishers.

This comprehensive reference lists about 300,000 licensed radio amateurs in the United States Directory and 160,000 or more in the rest of the world (contained in the "DX Section"). In the U.S. Section, licence classifications are shown with revised listings of new licences, names and addresses. The CALLBOOK also includes much incidental DX information. Every amateur operator and SWL needs the CALLBOOK to get the most out of Amateur Radio.

DX Listings £3.10

US Listings £4.10

The two together, covering the World, £6.80

The above prices include postage and packing.

Your order to:

Publications Dept.,

**SHORT WAVE MAGAZINE**

55 Victoria Street, London, SW1H 0HF  
01-222 5341