

The

SHORT WAVE

Magazine

4s.
20np.

VOL. XXVIII

MAY, 1970

NUMBER 3

TRIO

Stand-by to receive



important announcement: Trio TS-510 and PS-510 price reduction to £180 the pair

Full information on these and all other Trio models including: VFO-5D (Variable Frequency Oscillator for TS-510) £32; JR-500SE receiver £69. 10. 0; 9R-59DE receiver £42. 10. 0; JR-310 receiver (illustrated right) £77. 10. 0; SP-5D speaker £4. 7. 6 and HS-4 headphones £5. 19. 6 are available from your local Trio dealer or direct from us.



exclusive United Kingdom distributors

b.h.morris and co. (radio) limited

84-88 Nelson Street, London E 1 2DY. TEL: 01-790 4824

THE FIRST NAME IN COMMUNICATIONS

THE FIRST NAME IN COMMUNICATIONS

THE FIRST NAME IN COMMUNICATIONS

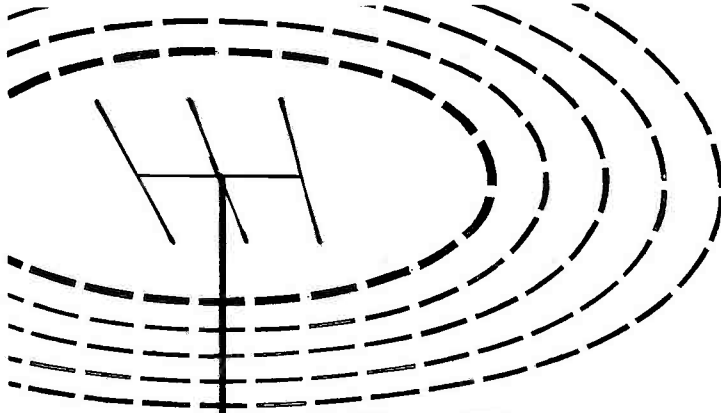

**Far-
reaching
results**

KW transceivers

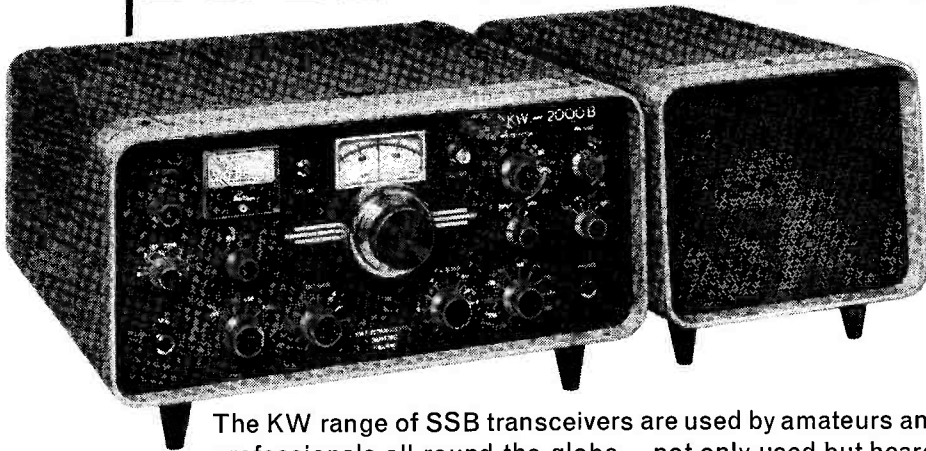

The KW range of SSB transceivers are used by amateurs and professionals all round the globe — not only used but heard. Illustrated above is the well known KW 2000B, a quality equipment with really outstanding performance, 180 watts P.E.P. 10-160 metres complete with AC PSU, VOX, P.T.T., I.R.T./I.T.T.

Write NOW for fully illustrated technical specification on this and other SSB equipment. KW research and development engineers are always improving existing equipment and designing new.

KW
ELECTRONICS
LIMITED

K. W. ELECTRONICS LTD.

1 HEATH STREET, DARTFORD, KENT

TEL: DARTFORD 25574 CABLES: KAYDOUBLEW DARTFORD

**Your local
Eddystone
dealer is :**

Whole
"LISTEN TO THE WORLD WITH EDDYSTONE"

CHESHIRE

The Transistor Centre
(Wilmslow) Ltd
Green Lane
Wilmslow 24766

CORNWALL

S.S.B Products
7 Little Castle Street
Truro
Feock 575

DERBYSHIRE

J. & A. Tweedy (Electronic
Supplies) Ltd
64 Lordsmill Street
Chesterfield
Chesterfield 4982

DEVON

Graham Newbery
(Reg Ward G2 BSW) Axminster
Axminster 3163

ESSEX

F. E. Smith
184 Moulsham Street
Chelmsford
Chelmsford 54594

Unique Radio Ltd
6 The Facade, High Road
Goodmayes, Ilford
01-590 8277

HAMPSHIRE

Southern Marine Radio
(Southampton) Ltd
Solent House, Town Quay
Town Quay 22721

Wireless Supplies Unlimited
264-266 Old Christchurch Road
Bournemouth
Bournemouth 24567

IRELAND

John F. MacMahon
10, Church Street, Enniskillen,
Co. Fermanagh, N. Ireland
Enniskillen 2955

ISLE OF WIGHT

Sherratt & Son
81-82-83 High Street, Newport
Newport 3358-9

KENT

G. T. & R. Wilson
12-14-16 Queen Street
Gravesend
Gravesend 63527/8

Percy Powell Radio Ltd
54 High Street
Tunbridge Wells
Tunbridge Wells 26534

LANCASHIRE

Stephens-James Ltd
70 Priory Road, Anfield
Liverpool L4 2RZ
051-263 7829

N.W. Electrics
52 Great Ancoats Street
Manchester M4 5AB
061-236 6276

Croffilm Ltd
46 Friargate
Preston PR1 2AF
Preston 55244

LEICESTERSHIRE

A. K. Davey Ltd
New Street, Hinkley
Hinkley 2173 and 4288

LONDON

Imhofs (Retail) Ltd
112-116 New Oxford Street
W.C.1
01-636 7878

R. T. & I. Electronics Ltd
Ashville Old Hall
Ashville Road
Leytonstone, E.11
01-539 4986

Radio Shack Ltd
182 Broadhurst Gardens
London, N.W.6
01-624 7174

MIDDLESEX

Gurney's Radio Ltd
91 The Broadway, Southall
01-574 2115

NORFOLK

The Record Shop
157 King Street
Great Yarmouth

NORTHUMBERLAND

Aitken Bros. & Company
35 High Bridge
Newcastle upon Tyne NE1 1EW
Newcastle upon Tyne 26729

NOTTINGHAMSHIRE

George Francis
93 Balderton Street
Newark
Newark 4733

SCOTLAND

L. Hardie
542 George Street
Aberdeen
Aberdeen 20113

Larg & Sons (Dundee) Ltd
16-24 Whitehall Street
Dundee
Dundee 26061/2/3

SURREY

Home Radio (Components) Ltd
240 London Road
Mitcham CR4 3HD
648-8422

SUSSEX

Cosh and Hammond
29 Beach Road, Littlehampton
Littlehampton 4477 or 4478

WALES

Holt High Fidelity
Picton Arcade, Swansea
Swansea 53254

Holt High Fidelity
8 Portland Street, Swansea
Swansea 41032

WARWICKSHIRE

Chas. H. Young Ltd
170/172 Corporation Street
Birmingham 4
021-236 1635

YORKSHIRE

Derwent Radio
28 Hillcrest Avenue
Scarborough
Scarborough 63982

Philip Cann Ltd
Chapel Walk, Fargate
Sheffield S1 1GJ
Sheffield 29225/6

Short Wave (Hull)
24a Newland Avenue
Hull, HU5 3AF
Hull 408953

R. A. Coates
5 Bridge Street, Whitby
Whitby 2622

*Point to note by Advertisers in "Short Wave Magazine"—as well as covering
the U.K. radio amateur interest, we supply bookstalls all over the country,
also schools, libraries and the radio-electronics Industry*

IT'S HERE ———

TRAP MASTER

IT'S SPRINGTIME!

AND SPRINGTIME IS ANTENNA TIME



V-3 Jr.

BACK BRITAIN
Manufactured 100% in England

MUSTANG	£36 0 0	DI-2	£5 10 0
ELAN	£25 0 0	SWL-7	£8 10 0
TA-33 Jr.	£30 0 0	RD-5	£8 10 0
TA-32 Jr.	£21 0 0	A-315	£21 10 0
TA-31 Jr.	£12 15 0	A-215	£15 10 0
VTD-3 Jr.	£10 15 0	A-310	£20 0 0
TD-3 Jr.	£7 0 0	A-210	£14 10 0

SOME PRICES

Rotators, Towers, Polythene cord and rope, Coax cable, Control cable, Twin feeder, SWR indicators and many more Antenna accessories.

Send for *HANDBOOK/CATALOGUE* containing full details and prices of Antennae and technical information, 35 pages, 2/6 refundable on purchase of an Antenna.

Carriage and Insurance Extra

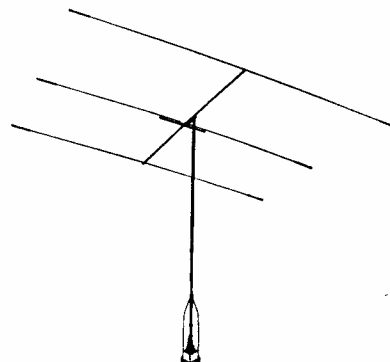

ELAN

Telephone: Costessey 2861, orders only

Mosley Electronics Ltd. 40, Valley Road, New Costessey, Norwich, Norfolk Nor. 26K

Announcing . . .

Two additions to the EMSAC range

PR1 2 metre pre-amplifier (144-146 mHz). Employs two FET's in cascade circuit to give signal boost of over 15 dB. Low noise level. Self contained batteries. BL sockets input and output (SO239 to order). On-off switch. Mounted in small diecast box. Complete with battery (PP6).

£5 P. & P. 4/6

KM1 A versatile keying monitor. May be used as a RF monitor or as morse practice oscillator. When used as a monitor the KM1 is inserted in the lead between the Tx and antenna (or tuning unit). BL sockets are fitted as standard but SO239 are available to order. When used as a practice oscillator the unit is keyed directly through a keying jack on the front panel. An internal loudspeaker is provided complete with volume control and on/off switch. Headphones may be plugged into the front panel. A Jack and lead are also supplied for plugging into an Rx in which case the output of the Rx and the output from the monitor are combined and are available from the monitor phone-jack or loudspeaker. Power from internal battery (PP6) 9v. 2-3ma. Case, grey and aluminium 6½" x 4" x 4" high. Price (less battery).

£8 P. & P. 4/6

Also available . . .

CN1 2 metre converter IF 28-38 mHz. 2 nivistor cascode RF amplifier. NF better than 3 dB with 39.666 mHz crystal. £8 10s. P. & P. 4/6

CN2 As above in grey and aluminium case 8½" x 7" x 4½" high. Built-in mains p.s.u. £13 P. & P. 6/6

CN3 4 metre version of CN1 £8 10s. P. & P. 4/6

CN4 4 metre version of CN2 £13 P. & P. 6/6

PS1 Mains p.s.u. for CN1 or CN3. 15ma. at 150v. and 1 amp. at 6.3v. Ready to connect. £3 P. & P. 4/6

TU2 Antenna tuning unit for receivers. Pi-network. 1.8 mHz to 30 mHz. Nice cabinet, 6½" x 4" x 4" high £4 10s. P. & P. 4/6

TU4 Transmatch for 3.5-30 mHz. 150 watt bandswitched. 8" x 6" x 6" high. £11 17s. P. & P. 6/6

GV1 All band vertical. 23 feet, all mountings, etc. £4 12s. P. & P. 7/6

GV2 Triband vertical 14-30 mHz. Single 50 ohm feeder. £10 10s. P. & P. 7/6

GD1 Multi-band dipole 5RV type. 102 feet 18 SWG plus 30 feet 300 ohm ribbon plus 80 feet twin 72 ohm. Glass fibre joints. Complete. £4 P. & P. 4/6

GD2 Smaller version. 51 feet top plus 90 feet of 300 ohm ribbon and 72 ohm twin feeder. £3 P. & P. 4/6

6CW4 RCA nivistors 10/6. 38.666 mHz (HC18/U) crystals 25/-.
All spares stocked for EMSAC equipment.

The EMSAC range also available from G3RYV, 20 Allenby Road, Maidenhead, Berks. Tel.: Maidenhead 22551.

Evenings/weekends. SAE with enquiries please.

G3IAR, ELECTRONIC & MECHANICAL SUB-ASSEMBLY CO. LTD.

HIGHFIELD HOUSE, ST. CLARE HILL ROAD, WEST KINGSDOWN, KENT. Tel.: West Kingsdown 2344

SSSB

TRIO'S TS-510 ULTRA-ACCURATE RECEIVER

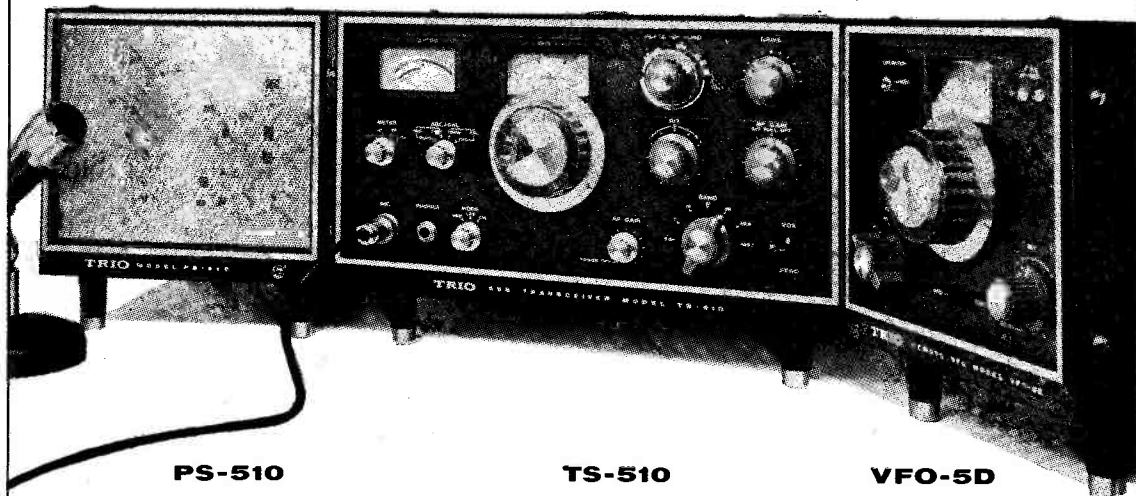

PS-510

TS-510

VFO-5D

TRIO's TS-510 has opened countless SSB vistas through its creative design that enables it to operate at constant maximum power with top durability. This transceiver uses a high frequency crystal filter and covers all ham bands from 3.5-29.7MHz. Because the TS-510's frequency coverage has been compressed to 25KHz for one complete dial rotation, tuning in on SSB signals is easy. By using TRIO's PS-510 (Power supply and speaker) and VFO-5D (Variable frequency oscillator) optimum results may be obtained. The PS-510 operates on an AC power supply through a 6-1/2" speaker. The VFO-5D has a double-gear dial covering 25 KHz per rotation.

TS-510 SSB TRANSCEIVER

- Receive and Transmit Frequencies: 3.5MHz-29.7MHz
- Receive Sensitivity: 0.5 μ V, S/N ratio of 10dB at 2.5MHz-21MHz
1.5 μ V, S/N ratio of 10dB at 28MHz
- DIMENSIONS: 13"(W), 7"(H), 13-5/8"(D).

VFO-5D VARIABLE FREQUENCY OSCILLATOR

- Frequency Range: 3.5MHz-29.7MHz
- Oscillator Method: VFO unit-clapp Osc. Circuit
Xtal Osc. Unit-Pierce C-B Circuit
- DIMENSIONS: 7-7/8"(W), 8-21/32"(H), 7-9/16"(D)

PS-510 POWER SUPPLY AND SPEAKER

- Designed as an A. C. power supply unit exclusively for the SSB transceiver TS-510
- 6-1/2" communication speaker is incorporated
- DIMENSIONS: 8"(W), 7-1/8"(H), 14-5/8"(D)



the sound approach to quality—

TRIO
TRIO ELECTRONICS, INC.

TRIO KENWOOD ELECTRONICS S.A.

160 Ave., Brugmann, Bruxelles 6, Belgium

Sole Agent for the U.K.

B.H. MORRIS & CO., (RADIO) LTD.

84/88, Nelson Street, Tower Hamlets, London E.1, Phone: 01-790 4824

AMATEUR ELECTRONICS G3FIK

TRIO COMMUNICATIONS EQUIPMENT. By the time this appears in print we hope to have our new communications room in operation in which the whole range of TRIO products will be displayed in fully operative order. Our intention is to provide the customer with the opportunity to see each individual piece of equipment in action, so to speak, in comfortable surroundings where he may make an unhurried assessment of its capabilities. It never fails to amaze us how so many people are prepared to buy on the strength of high pressure advertising without actual knowledge of the product and even in the field of communications we encounter customers who are quite happy to walk out with a piece of equipment straight off the shelf without having seen a dial lamp illuminated. This to us is simply asking for trouble and with this in mind we have provided the staff and facilities to give the customer every protection in this respect. The same service, of course, applies to used equipment also which may be examined at leisure and for the Audiophile we shall have second-to-none demonstration facilities. In our experience half the problem with shop demonstrations lies in the congestion which often ensues but in providing separate departments away from our serving area we hope we have overcome this. By next month we hope to start listing our stocks of used equipment again but in the meanwhile would remind readers of the availability of the following.

	£	s.	d.		£	s.	d.
TTC SWR BRIDGES C3005. A high quality unit employing separate meters indicating simultaneous forward and reverse reading	6	10	0				
TTC SWR BRIDGES C3042. Single meter version of the above	4	12	6				
TTC DYNAMIC 'FIST' MICROPHONES WITH PTT. 50k impedance and beautifully built	3	10	0				
TTC FL-30HA FIELD STRENGTH METERS. Tunable, 1-250 Mc/s.	4	2	6				
TTC C3041 FIELD STRENGTH METERS. Wide band, 1-250 Mc/s.	2	12	6				
WIGHTRAPS 80 THRU 10. Lightweight fully potted Per pair	2	5	0				
TECH TE-15 TRANSISTORISED G.D.O.'s. Six Band, 440 Kc/s. to 280 Mcgs.	12	15	0				
G-WHIP MOBILE ANTENNAE. Full details of these FB whips by return post.							
MEDCO LOW PASS FILTERS. All types are available from stock and the prices quoted below as with all accessories listed here include postage and packing.							
FL50A. 50 ohm with Belling Lee coax sockets	4	12	6				
FL50B. 50 ohm with Amphenol style UHF connectors	5	2	6				
FL75A. 75 ohm with Belling Lee connectors	4	12	6				
MEDCO HIGH PASS FILTERS. The best answer for TVI at present available	1	10	0				
TRIO SP-5D SPEAKERS. Styled to match the well-known 9R-59DE but electrically perfect also for the JR-310 and JR-500 Receivers	4	12	6				
TRIO HS-4 LIGHTWEIGHT PADDED HEAD-SETS. First-class for communication and very comfortable to wear	6	2	6				
TRIO 9R-59DE RECEIVERS. We have just taken into stock a few of these in used but first class condition both electrically and physically. Carriage paid from				32	10	0	
TRIO JR-500SE RECEIVERS. Again a small quantity is offered in similar excellent order. Carriage paid from				57	10	0	
AR88D RECEIVERS. We have once again started stocking reconditioned sets in first class order in all respects. Prices				47	10	0	
Full details upon application.							
BC221 FREQUENCY METERS. Several grades available all with correct calibration charts and fully tested. from				22	10	0	

Finally we should like to draw the attention of our visitors to the fact that we are located on the East side of Birmingham some three miles from the centre and it is by no means necessary to travel through the city centre in all cases. For instance, if coming from the Coventry direction or the M1 in general be sure to look out for the Stonebridge roundabout midway between Coventry and Birmingham. At this point turn off to the right and we are located some eight miles from the island on an alternative route which leads directly into the city via Castle Bromwich.

AMATEUR ELECTRONICS, ELECTRON HOUSE, 518-520 ALUM ROCK ROAD, BIRMINGHAM 8

Telephones : 021-327 1497, 021-327 6313

Peter Seymour Ltd.

Introducing the NEW SWAN DE-LUXE CYGNET Model 270

SPECIFICATIONS :

Power Input : 260 watts P.E.P. in SSB voice mode, and 180 watts in CW mode.

Frequency Range : 3.5-4.0 mc, 7.0-7.3 mc, 14.0-14.35 mc, 21.0-21.45 mc, 28.0-29.7 mc.

C.F. Networks : Crystal Lattice Filter. Same as used in the Swan 500C. 2.7 kc band width at 6 dB down. 4.6 kc wide at 60 dB down. Ultimate rejection exceeds 100 dB.

Grid block CW keying with off-set transmit frequency. Solid state VFO circuit temperature and voltage stabilized.

Receiver sensitivity better than 1/2 microvolt at 50 ohms for signal-plus-noise to noise ratio of 10 dB.

100 kc Crystal Calibrator and dial-set control.

S-meter for receiver, P.A. Cathode meter for transmitter tuning.

Improved AGC and ALC circuit. Separate R.F. and A.F. gain controls.

Sideband selector.

Voltage input : 200/240 volts 50 cycles, 12-14 volts DC.

Dimensions : 5 1/2 in. high, 13 in. wide, 11 in. deep.

Net weight : 24 lb. £285.

Brochures on request

410 Beverley Road, Hull, Yorkshire
Tel. 0482 41938 (mornings), 0482 29014 (afternoons)

CQ-CQ-CQ de G3VQM/KW

Well lads this is the last time I shall be pestering you to buy the best amateur radio equipment in the Country because I am, with great regret, leaving the K.W. fold as of April 30th. However, I leave things in the capable hands of Rowley, G8KW who will continue to be ably assisted by Dick Thorburn. They will be very pleased to attend to your whims and fancies and you can always rely on them to give you a fair deal.

I have always had great confidence in K.W. equipment and run an all K.W. station at G3VQM. My confidence remains and I shall be watching current development for the new "goodies" when they emerge from the factory. If you want the best gear available at the price you will be watching with me!

For those who need good equipment now I can promise you great delight with the K.W. Atlanta or K.W.2000B. These are available ex-stock so why not pop a cheque in the post pronto (H.P. deposit 1/3rd)? You can't do much better but you can do an awful lot worse!

Best 73 to you all de Mike.

KW ELECTRONICS LTD
1 HEATH STREET, DARTFORD, KENT
Telephone : Dartford 25574

LAFAYETTE HA.800 SOLID STATE AMATEUR COMMUNICATION RECEIVER SIX BANDS 3.5-4, 7-7.3, 14-14.35, 21-45, 28-29.7, 50-54 Mc/s.

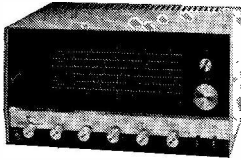

Dual conversion on all bands. 2 x 455 Kc/s. mechanical filters. Product detector. Variable B.F.O. 100 Kc/s. crystal calibrator. "S" meter. Huge slide rule dial. Operation 230v. AC or 12v. DC. Size 15" x 9 1/2" x 8 1/2". Complete with instruction manual, £57/10/-, Carr. paid (100 Kc/s. Crystal 39/6 extra).

TRIO TS 510 AMATEUR TRANSCEIVER with speaker and mains P.S.U., £180.
TRIO JR310 AMATEUR BAND 10-80 Metre Receiver, £77/10/-

R209 Mk. II COMMUNICATION RECEIVER

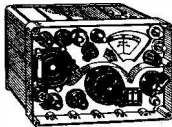

11 valve high grade communication receiver suitable for tropical use. 1-20 Mc/s. on 4 bands.

AM/CW/FM operation. Incorporates precision vernier drive, B.F.O. Aerial trimmer, internal speaker and 12v. D.C. internal power supply. Supplied in excellent condition, fully tested and checked, £15. Carr. 20/-.

HAMGEAR PRESELECTORS Mains operated 1.5-3.30 Mc/s., £7/10/-, P. and P. 4/-.

AR88 MAINS TRANSFORMERS Brand new, boxed, 59/6. P.P. 5/-.

ADMIRALTY B.40 RECEIVERS



High quality 10 valve receiver manufactured by Murphy. Five bands 650 Kc/s.-30 Mc/s. 1/1F 500 Kc/s. Incorporates 2 R.F. and 3 I.F. stages, bandpass filter, noise limiter, crystal controlled B.F.O. calibrator, i.F. output, etc. Built-in speaker, output for phones. Operation 150/230 volt A.C. Size 19 1/2 in. x 13 1/2 in. x 16 in. Weight 11 1/2 lbs. Offered in good working condition, £22/10/-, Carr. 30/-. With circuit diagram. Also available B41 L.F. version of above. 15 Kc/s.-700 Kc/s., £17/10/-, Carr. 30/-.

DUMMY LOAD RESISTORS Carbon 30Ω 35w., 5/6. P.P. 1/6.

CRYSTAL CALIBRATOR No. 10

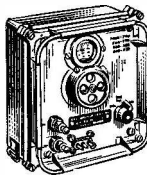

Small portable crystal controlled wavemeter. Size 7 x 7 1/4 x 4 in. Frequency range 500 Kc/s.-10 Mc/s. (up to 30 Mc/s. on harmonics). Calibrated dial. Power requirements 300v. DC. 15mA and 12v. DC 0.3A. Excellent condition, 89/6. Carr. 7/6.

JOYSTICK AERIALS Full range of Aerials and Tuners in stock.

Latest Catalogue

The latest edition giving full details of a comprehensive range of H.F. EQUIPMENT, COMPONENTS, TEST EQUIPMENT and COMMUNICATIONS EQUIPMENT. Over 230 pages, fully illustrated and detailing thousands of items - many at bargain prices. FREE DISCOUNT COUPONS VALUE 16/-

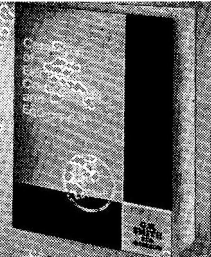

SEND NOW - ONLY 7/6 P&P!!

Note! Fourth Edition now printing - reserve your copy now!

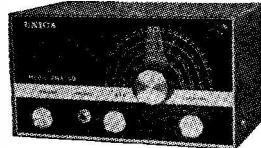

TRIO 9R-59DE

4 band covering 550 Kc/s. to 30 Mc/s. continuous electrical bandspread on 10, 15, 20, 40, and 80 metres. 8 valve plus 7 diode circuit. 4/8 ohm output and phone jack. SSB-CW. ANL. Variable BFO. S meter. Sep. bandspread dial. IF frequency 455 Kc/s. audio output 1.5w. Variable RF and AF gain controls. 115/250v. A.C. Size: 7 1/2" x 15" x 10" with instruction manual, £42. Carr. paid.

TRIO COMMUNICATION TYPE HEADPHONES. Normally £5/19/6, our price £3/15/- if purchased with receiver.

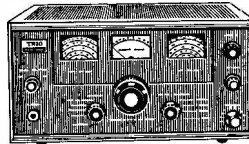

UNR-30. 4 BAND COMMUNICATION RECEIVER

Covering 550 Kc/s.-30 Mc/s. Incorporates variable BFO for CW/SSB reception. Built-in speaker and phone jack. Metal cabinet. Operation 220/240v. A.C., supplied brand new, guaranteed with instructions. £13/13/-, Carr. 7/6.

JUST ARRIVED!! UR-1A SOLID STATE COMMUNICATION RECEIVER

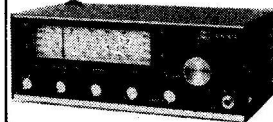

4 bands covering 550 Kc/s.-30 Mc/s. continuous. Special features are use of FET transistors, S Meter, built-in speaker and telescopic aerial, variable BFO for SSB reception, noise limiter, bandspread control, sensitivity control. Output for low impedance headphones. Operation 220-240v. A.C. or 12v. D.C. Size 12 1/2" x 4 1/2" x 7". Excellent value. Only £24. Carr. 7/6.

CLASS D WAVEMETERS



A crystal controlled heterodyne frequency meter covering 1.7-8 Mc/s. Operation on 6 volts D.C. Ideal for amateur use. Available in good used condition £5/19/6. Carr. 7/6. or brand new with accessories £7/19/6. Carr. 7/6.

CLASS D WAVEMETERS No. 2

Crystal controlled 1.2-19 Mc/s. Mains or 12v. D.C. operation. Complete with calibration charts. Excellent condition, £12/10/-, Carr. 30/-.



TE15 TRANSISTORISED GRID DIP METERS

Six ranges. 440 Kc/s.-280 Mc/s. Operates on 9v. battery. Full instructions. £12/10/-, P.P. 3/6.

HANSEN SWR-3 BRIDGE

Impedance 52 ohms. Also operates as field strength indicator, complete with telescopic aerial, 69/6 each. P.P. 3/6. PL259 plugs to suit 7/6 each.

CODAR EQUIPMENT

	£	s.	d.
CR.70 Receiver ...	21	0	0
CR.45 Receiver ...	13	10	0
CR.45 Kit from ...	10	10	0
PR.30 Preselector ...	5	19	6
PR.30X (Built in P.S.U.)	7	19	6
RQ.10 Q Multiplier ...	2	10	0
RQ.10X (Built in P.S.U.)	8	17	6
CC.40 Control Unit ...	6	15	0
AT.5 Transmitter ...	16	19	6
T.28 Receiver ...	15	19	6
12/MS Mobile P.S.U. ...	11	10	0
12/R Control Unit ...	2	10	0
RTS Mains P.S.U. ...	8	10	0
Mini Clipper Kit ...	2	9	0

NEW LAFAYETTE SOLID STATE HA600 RECEIVER

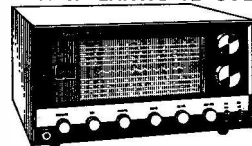

5 Band AM/CW/SSB amateur and short wave 50 Kc/s.-400 Kc/s. and 550 Kc/s.-30 Mc/s. F.E.T. front end. 2 Mechanical filters. Huge dial. Product detector. Variable BFO. Noise limiter, S Meter. 24 1/2" Bandspread. 230v. A.C./12v. D.C. Neg. earth operation. RF gain control. Size: 15" x 9 1/2" x 8 1/2". Wt. 18 lbs. Exceptional value, £45. Carr. 10/-.

TRIO JR-500SE AMATEUR RECEIVER

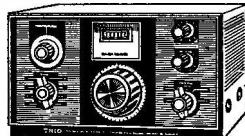

7 separate ranges between 3.5 and 29.7 Mc/s. 7 valves, 2 transistors and 5 diodes plus 8 crystals: output 8 and 500 ohm and 5000 ohm phone jack. Crystal controlled oscillator. Variable BFO. VFO. AVC. ANL. S meter. SSB-CW. Stand-by switch. special double gear dial drive socket for connection to a transmitter. 115/250v. A.C. Mains. Size 7 x 13 x 10 in. with instruction manual and service data, £65. Carriage paid. Package deal: JR500SE with SP5D speaker and H54 headphones, £69/10/-.

RCA COMMUNICATIONS RECEIVERS AR88D

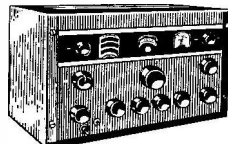

Latest release by ministry BRAND NEW in original cases. 110-250v. A.C. operation. Frequency in 6 Bands. 535 Kc/s.-32 Mc/s. continuous output impedance 2.5-600 ohms. Incorporating crystal filter, noise limiter, variable BFO, variable selectivity, etc. Price: £87/10/-, Carr. £2.

CLEAR PLASTIC PANEL METERS

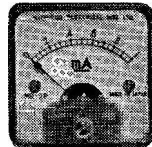

First grade quality, Moving Coil panel meters, available ex-stock. S.A.E. for illustrated leaflet. Discounts for quantity. Available as follows. Type MR. 38P. 1 1/2/3 1/2 in. square fronts.

1-0-1mA	27/6	150mA	27/6	750v DC	27/6
2mA	27/6	200mA	27/6	15v AC	27/6
5mA	27/6	300mA	27/6	50v AC	27/6
10mA	27/6	500mA	27/6	150v AC	27/6
750mA	27/6	3v DC	27/6	300v AC	27/6
1 amp	27/6	10v DC	27/6	500v AC	27/6
2 amp	27/6	20v DC	27/6	S meter 1mA	
5 amp	27/6	100v DC	27/6	32/-	
100A	37/6	500-0-500A	20mA	VU meter	42/-
100-0-100A	35/-	1mA	27/6	50mA	27/6
		1mA	27/6	500v DC	27/6

FULL RANGE OF OTHER SIZES IN STOCK. SEND S.A.E. FOR LEAFLET.

G. W. SMITH & Co. (Radio) Ltd.

3, LISLE STREET, LONDON, W.C.2
34, LISLE STREET, LONDON, W.C.2
311, EDGWARE ROAD, LONDON, W.1

01-437 8204
01-437 9155
01-262 0387

All Mail Orders to 147 Church Street, London, W.2

Open 9-6 Mon.-Sat. (half day Thurs. at Edgware Road)

N. W. ELECTRICS

52 GT. ANCOATS STREET
MANCHESTER 4

061-236 6276

G3MAX

EDDYSTONE RECEIVERS AND BOXES
JACKSON, DENCO, REPANCO, etc.

Aluminium Chassis with Base Plate. 17 x 8½ x 2".
32 valveholders B9A 100 0-01 disc ceramics. Erie.
500V, 100 resistors, 75 standoff insulators, 10/-, post
4/6.

Racal RA. 17. Tuning heart, 2 to 3 Mc/s. Conversion
to 100 kc/s. Film strip scale. Calibration to 1 kc.
Geared tuning mechanism, ratio approximately 20/1
with flywheel, brake, etc. Die-cast construction.
6064 osc., 6BE6 mixer. All units tested before
despatch. Excellent condition. In maker's packing,
£12, carriage £1.

Special Offer. 115V AC motor. 1/30 h.p., 5/16"
spindle. Size 5" long x 4" diameter, 17/6, postage
paid. Brand new AEI.

Vibrators. 12 volt synchronous. Type No. 12SR7,
10/- each. Special offer 3 for £1. Postage 2/6.

Cathode Ray Tube. Brand new. 5FP7A, 25/-,
post 4/6.

Eddystone Vibrator Pack. 6v. D.C. input. 250v.
65 mA. D.C. HT. Brand new, 45/-, 4/6 p.p.

Geiger Counter. New in carrying case, £3, also with
power supply AC mains input £6, post 10/6 each.

CV416 (6F17) Valve, 6/- each, post 1/-, or 4 for 24/-,
post paid.

CT54 Valve Voltmeter. 4" meter. 0-480 volts AC to
DC in six ranges, with multiplier for 2-4 Kv. range.
0-10 Megohm in five ranges. Frequency response 20
c/s to 200 Mc/s with valve-type probe. Power require-
ments 2 x 1-4, 75 and 15-volt batteries (not supplied).
All tested before despatch. Price with circuits
£7/10/-, post 10/-, AC power supply components
and gen., 28/- . This is only supplied with a valve
voltmeter.

Business hours: 9 a.m.-6 p.m. Tuesday-Saturday
CLOSED ALL DAY MONDAY

CRYSTALS IN STOCK NOW!

LARGE STOCK OF OTHERS

CRYSTAL TYPE Q10 10/- EACH

2184	2638	2844	2854	2868	2875	2889	2910	2924	2931	2938	2945
2950	2952	2966	2968	2980	2987	3008	3023	3072	3081	3102	3142
3278	3403	3411	3432	3446	3460	3467	3474	3881	3495	3841	3921
4140	4182	4257	4399	4410	4415	4417	4418	4420	4422	4427	4431
4435	4444	4465	4469	4473	4478	4654	4689	4703	4710	4724	4808
4860	4889	4966	5010	5491	5499	5506	5514	5521	5551	5566	5589
5599	5604	5611	5619	5626	5630	5641	5642	5649	5654	5659	5671
5680	5687	5692	5695	5697	6337	6537	6540	6552	6557	6559	6567
6582	6590	6597	6612	6627	6634	6637	6640	6642	6647	6649	6652
6657	6659	6662	6664	6667	6672	6677	6791	8364	8439	8837	8839
8854	8862	8864	8871	8888	8913	8953	8956	8967	8971	8983	

CRYSTALS TYPE 10X 10/- EACH

7533	7550	7566	7583	7600	7616	7633	7650	7666	7683	7700	7716
7733	7750	7766	7866	7875	7883	7900	7916	7933	7950	7966	7983
8118	8166	8150	8183	8216	8250	8266	8283	8300	8316	8333	8350
8366	8416	8433									

CRYSTALS HC6/U 10/- EACH

2805	2854	2948	2868	2985	6611	6657	6686	6840	7552	7567	7657
7664	7685	8953	9453	9871	13227	13229					

CRYSTALS TYPE 2M 10/- EACH

12237	12250	12262	12287	12312	12337	12357	12362	12387	12412		
12437	12462	12487	12512	12537	12562	12587	12612	12637	12662		
12687	12712	12737	12762	12787	12837	12875	12962	12975	12987		
13062	13087	13112	13137	13162	13187	13212	13237	13262	13272		
13312	13337	13387	13412	13437	13462	13487	13540	13590	13640		
13690	13740	13790	13840	13890	13940	13990	14848	14898	14948		
14998	15048	15098	15148	15198	15248	15298	18347	18372	18497		
18662	18747	18872	18997	19122	19247	19372	19497	19662	19747		
19872											

B7G CRYSTALS 10/- EACH

2638	2854	2868	2875	2876	2889	2910	2931	2938	2945	2952	2954
2966	2980	2987	3008	3081	2023	3102	3105	3250	3255	3270	3285
3298	3302	3404	3411	3425	3432	3446	3453	3460	3467	3481	3495
3800	3805	3950	3985	3993	3995	3997	4031	4195	4220	4516	4570
4575	4595	4654	4668	4675	4689	4703	4745	4781	4808	5010	5060
5105	5420	5480	5491	5499	5506	5514	5521	5548	5551	5566	5581
5584	5589	5604	5611	5619	5621	5625	5626	5630	5641	5642	5644
5649	5650	5659	5671	5680	5687	5690	5691	5692	5695	5697	5701
5710	5711	5714	5730	6210	6270	6337	6440	6500	6510	6537	6540
6552	6557	6563	6567	6577	6580	6582	6590	6597	6612	6627	6634
6637	6640	6642	6647	6649	6650	6652	6657	6659	6662	6667	6672
6677	6679	6720	6753	6810	7585	7612	7770	7992	8160	8280	8364
8515	8545	8820	8837	8839	8841	8845	8854	8862	8864	8871	8879
8885	8888	8896	8913	8930	8947	8953	8956	8961	8967	8971	8973
8983	322	324	329	338	339	342	kHz.				

FT243/ZCC CRYSTALS 10/- EACH

6075	6106	6140	6150	6175	6433	6561	6605	6650	6616		
6650	6675	6858	7140	7380	7575	7588	8500	9166	9191		
9800	10225	10684	10857	11033	11418	12183	12350	13175	13266		
13300	14750	14975	15060	15340	15380						

CRYSTALS FOR 4 METRES TX

7783	7800	7816	7833	7850	...	Type 10X 15/-, Type 2M 25/-
------	------	------	------	------	-----	-----------------------------

MINIATURE TYPE 2m. 10/- EACH

15012	15037	15062	15087	15112	15137	15162	15187	15212	15237
15262	15287	15337	15362	15437	15462	15475	15487	15512	15537
15562	15587	15612	15637	15622	15687	15712	15737	15837	15887
15912	15937	15962	15987						

2000 pf Tx. Variable capacitors £2

103BE Mobile VHF TX/RX, 12 volt, FM, with conversion
sheet for 2m. 10 watts output, QQV03-20A PA, with control
unit, mic, speaker, cables. Size 5 x 10 x 18. Carr. 30/- ... £12

WE WANT TO PURCHASE RADIO TELEPHONE
EQUIPMENT, AIRCRAFT RADIO AND MANUALS
TECHNICAL INFORMATION SERVICE FOR AIRCRAFT RADIO

S.A.E. enquiries. Mail order.

Shop open Saturdays and by appointment

State call sign when ordering or TX's will be disabled

BAGINTON ELECTRONICS

G3TFC (SALES) Ex ZC4JC

Market Corner, Baginton, Warks., CV8 3AP

24-hour Robophone. Coventry (OCO3) 302668

To Our 'Amateur' Customers...

FIRST BRITISH PACKED KITS OF MODELS HW-100 AND HW-17A SHOULD BE AVAILABLE BY END OF MAY

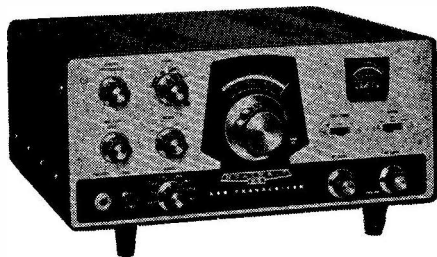

HW-100 SSB-CW TRANSCEIVER

KIT K/HW-100

£137 . 8 . 0 Carr. 11/-

Full specification gladly sent on request

KIT K/HW-17A

£80 . 4 . 0. Carr. 6/-

Send for full specification

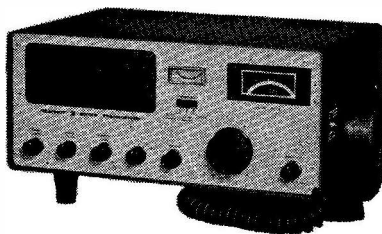

HW-17A 2M AM TRANSCEIVER

SPECIAL INTRODUCTORY OFFER

CASH WITH ORDERS PLACED FOR HW-100 TRANSCEIVERS BEFORE AUGUST 31, 1970, ARE SUBJECT TO A £15 CASH DISCOUNT (Not applicable to credit sales)

SPECIAL PACKED PRICES STILL AVAILABLE

K/SB-101 with K/HP-23A £222 Carriage £1 (Normally £200 14s. and £30 18s. respectively)
K/HW-100 with K/HP-23A £159 Carriage £1 2s. (Normally £137 8s. and £30 18s. respectively)

SEE CURRENT CATALOGUE FOR OTHER BARGAINS



Many more kits to choose from in the 1970 FREE Catalogue
Send for your copy today!



A Schlumberger Company

DAYSTROM LTD., Gloucester GL2-6EE

I require full details of Heathkit Transceivers.

NAME

ADDRESS

..... POST CODE.....

Dept. 56/5

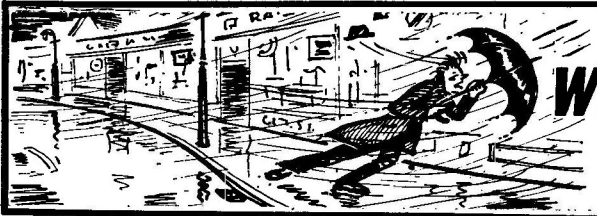

Why live the **HARD** way?

We're making life **EASY** for you!



Why waste time and energy tramping round the shops trying to locate components—especially when the British weather turns it into a battle worse than a lone journey across Antarctica? For many years the Home Radio Components Catalogue has enabled thousands of enthusiasts to order by post. We've built up a mail-order service second to none. But recently we've gone a step further! Now you need not even walk to the post box. With our Credit Account Service you can telephone any time of day or night, week-ends included! If your call comes out of shop hours a recording machine takes your message. For full details of this service just drop us a line or phone 01-648-8422. After you have used the service for 12 months we regularly send you an up-to-date catalogue—FREE.

If you've not already got a Home Radio Catalogue, send the coupon with cheque or P.O. for 12/6 (8/6 plus 4/- p & p). Even if you don't intend to use our Credit Account Service you certainly need the catalogue—it has 350 pages, lists over 8,000 components and has over 1,500 illustrations! The price of 12/6 applies only to catalogues purchased by customers residing in the U.K.

Please write Name and Address in block capitals



Name

Address

HOME RADIO LTD., Dept. SW, 234-240 London Rd., Mitcham, CR4 3HD

R. T. & I. ELECTRONICS LTD.

where equipment is fully overhauled

G.E.C. BRT-402-E	£85 (40/-)
NATIONAL HRO-500	£450 (40/-)
EDDYSTONE 670A	£25 (20/-)
TRIO 9R59DE with crystal cal. and stabiliser	£38 (20/-)
HEATHKIT DX-100-U Transmitter	£55 (60/-)
MONARCH HAM-I	£14 (20/-)
TRIO JR-500-SE	£60 (20/-)
G.E.C. BRT-400	£75 (40/-)
EDDYSTONE 750	£50 (30/-)
EDDYSTONE 800	£25 (25/-)
HAMMARLUND HQ-180	£140 (30/-)
LAFAYETTE HA-63-A	£20 (20/-)
KW77 receiver	£85 (30/-)
KW2000A Transceiver complete with A.C. p.s.u.	£185 (50/-)
KW VICEROY Transmitter, Mk. 3a	£105 (60/-)
HAMMARLUND HQ-140 receiver, with p.s.u.	£40 (40/-)
REDIFON R.153 receiver (similar to R50M) with p.s.u.	£85 (60/-)
SOMMERKAMP FR-100-B receiver	£90 (30/-)
ADVANCE E.2 SIGNAL GENERATOR, 100 kc/s-100 mc/s	£35 (20/-)
R.107 receiver	£15 (40/-)
R.206 receiver with p.s.u.	£25 (60/-)

WE CAN ALSO SUPPLY ANY MAKE OF NEW EQUIPMENT—and have pleasure in giving a few examples which are normally in stock:

AVOMETERS, Model 7, Mk. 2, £34/8/3; Model 40, Mk. 2, £34/8/3; Model 8, Mk. 4, £37/4/-; Model 9, Mk. 4, £37/4/-; Multiminor, Mk. 4, £12/12/6 (free). Trade and industrial enquiries welcome.

S.G. BROWN'S HEADPHONES, Type "F," 120 ohms, 2,000 ohms, 4,000 ohms, £4/14/6 (3/6). Earpads for same, 9/- per pair. Type 3/C1100 noise excluding (with superb fitting), high quality, electro-dynamic, £7/16 (3/6).

KW EQUIPMENT. KW Atlanta transceiver, £250. Vespa Mk. 2, transmitter with A.C. p.s.u., £135. KW-201 amateur band receiver, £111. Also Calibrator, £6; "Q" mult., £8/10/-; KW-2000-B Transceiver, with A.C. p.s.u., £240; D.C. p.s.u., £42. KW-1000 Linear, £135. KW-600 Linear, £115. KW E-Z match, £12/16/-; KW Match, £8/14/6. Antenna switch, £3/19/-.

CODAR, AT5, £16/19/6; 250/S, £8/10; T28, £15/17/6; PR30X, £7/19/6; CR70A, £21; 12/MS, £11/10/-; 12/RC, £2/10/-, etc., etc.

PARTIRIDGE "Joystick," "Joymatch," etc. Lists and details on request.
TRIO EQUIPMENT—Transceiver, TS-510 c/w A.C. p.s.u. and spkr., £180 (40/-); VFO-5D for TS-510, £32 (10/-). Receivers, JR310 bandspread, £7/10/- (20/-); JR-500-SE, bandspread, £68 (10/-); 9R59DE, 540 kc/s-30 mc/s., £42/10/- (10/-); 9R-59, 540 kc/s-30 mc/s., £34/13/1 (15/-). Loudspeaker, SP-5D "Speaker-mate" to match trio receiver, etc., £4/7/6 (7/6). Headset HS4, £5/19/6. Write for special offers.

Our latest list of over 50 receivers, and many other interesting items sent free upon receipt of your s.a.e. CARRIAGE for England, Scotland and Wales shown in brackets. TERMS: C.W.O., Approved Monthly Accounts, Hire Purchase and Part Exchange. Special facilities for export. Enquiries invited.

- At R.T. & I.
- ★ We have full H.P. facilities
- ★ Part exchanges are a pleasure
- ★ We purchase for cash
- ★ We offer a first-class overhaul service for your electronic equipment, whether you are an amateur or professional user

REMEMBER THIS PRICE REDUCTION!

TRIO TS-510 c/w A.C. p.s.u. and spkr.,

now offered to you at **£180 NEW!**

This really is good value!

OFFICIALLY APPOINTED EDDYSTONE

AGENTS

	£	s.		£	s.	d.
830/7	299	0	Edometer ED902 Mk. 2	27	10	0
EA12	195	0	AC Mains Units 924	6	15	0
940	158	0	Receiving Aerial 731/1	4	16	0
EC10 Mk.2	69	10	Plinth Speaker 906	4	5	0
EB35 Mk.2	64	10	General Purpose			
	(plus PT)		Speaker 935	3	7	6
EC10	59	10				

R. T. & I. ELECTRONICS LTD.

Ashville Old Hall, Ashville Road, London, E11 Tel: 01-539 4986

LOWE ELECTRONICS

WELLINGTON STREET, MATLOCK, DERBYSHIRE
 Matlock 2817 (2430 after 6 p.m.) BILL G3UBO

AGENTS

Alan G3MME
 4 Southwick Street, Southwick, Brighton.
 Southwick 4887

Sim GM3SAN
 19 Ellismuir Road, Baillieston, Nr. Glasgow.
 No 'phone yet

FT500

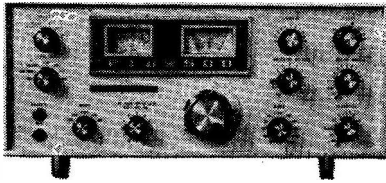

500W PEP

VOX, PTT, MOX. 100 and 25 kHz marker RIT, Metered ALC. All the usual optional extras fitted as standard, £250. With extra 6 xtal CW filter, £270

FR500

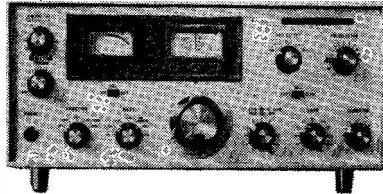

Top band to 2m.

The no compromise AM, FM, SSB and CW receiver for the man who wants the best, £160

FT250

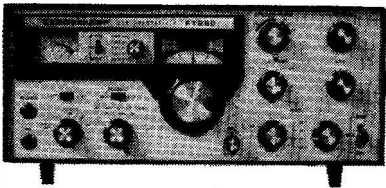

240W PEP

VOX, PTT, MOX. 100 kHz marker. RIT Metered ALC. Again, usual extras are standard, £160, p.s.u., £45

FL500

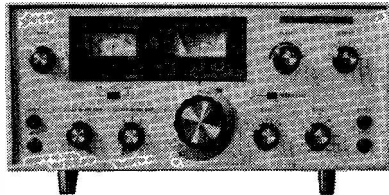

240W PEP

Companion to the FR-500 for transceive or split frequency. Matching it in quality and performance, £145

FT150

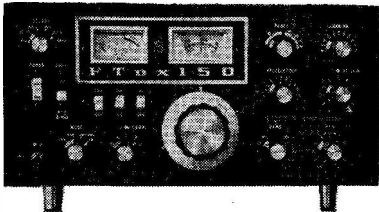

120W PEP

All-transistor except driver and PA. Both AC and DC power supplies built-in. Specially designed for mobile. VOX, PTT, MOX, 100 kHz marker, RIT, £215

FL2000

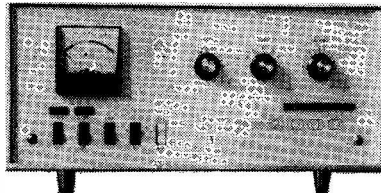

To complete the station, there is the FL-2000 linear. 1200W PEP input. Comfortable legal limit output. Built-in SWR meter, etc., £110

Hear them — any band, any part of the world, any time

Try them — at Matlock, or any of the Agents

Radio Shack Ltd

★ London's Amateur Radio Stockists

Just around the corner from West Hampstead Underground Station



We are pleased to announce that we are now Eddystone appointed agents and have a full range of their equipment in stock

EDDYSTONE RECEIVER AND ACCESSORY PRICE LIST

	£	s.	d.
Model 830/7 Communication Receiver ...	285	0	0
Model EC 10 Communication Receiver ...	59	10	0
Model EC 10 Mk. II Communication Receiver ...	69	10	0
Model EB 35 Mk. II Broadcast Receiver ...	64	10	0
Plus Purchase Tax	17	14	9
Model 940 Communication Receiver ...	158	0	0
Model EA 12 Amateur Band Communication Receiver	195	0	0
A.C. Mains Unit Catalogue Number : 924 ...	6	15	0
Plinth Speaker Catalogue Number : 906 ...	4	5	0
General Purpose Speaker Catalogue Number : 935	3	7	6
High Quality Headphones: LP 2921 ...	8	5	0
Receiving Aerial Catalogue Number : 731/1 ...	4	16	0
Edometer Catalogue Number : 902 ...	27	10	0
Telescopic Aerial: LP 3126 ...	2	5	0

SOME OF OUR NEW EQUIPMENT

	£	s.	d.
Trio TS 510 Transceiver with PS 510 p.s.u./Speaker ...	180	0	0
Trio JR-310 Receiver, SSB, CW, 3.5-29.1 MHz ...	77	10	0
Trio JR500SE Receiver, Amateur Bands, SSB, CW, etc. ...	69	10	0
Trio 9R-99DE Receiver, SSB, CW, S-meter, etc. ...	42	10	0
Hallicrafters Hurricane SR2000, SSB Transceiver ...	544	0	0
Hallicrafters Cyclone SR400, SSB Transceiver ...	395	0	0

We also stock Drake, Swan, and KW Equipment. Digital Clocks, Antenna Switches, Shure Microphones, Hustler and Halsion Mobile Whips, Polythene Rope, Log Books, etc.

SOME OF OUR USED EQUIPMENT

	£	s.	d.
Hammarlund HX-Fifty Transmitter, SSB, 160-10m. ...	97	10	0
Heathkit SB-401 Transmitter, as new, all crystals ...	175	0	0
Heathkit SB-301 Receiver, as new ...	150	0	0
Murphy VHF Rx, 40-260 MHz, BFO, Carrier Meter ...	65	0	0
Murphy Base Station complete with Rx. High Band, to convert to 2m. (QQVO 640A) ...	35	0	0
NCX-5 Mk. 2, SSB Transceiver ...	210	0	0
Pye 2m. Transmitter, with crystal ...	25	0	0
Pye 4m. Transmitter, with crystal ...	17	10	0
Sommerkamp FL200B Transmitter ...	105	0	0
Star SR 200 Receiver, Amateur Bands ...	30	0	0
Trio 9R59DE Receiver, as new ...	33	0	0
Trio JR500SE Receiver, Amateur Bands ...	50	0	0

RADIO SHACK LTD.

182 BROADHURST GARDENS, LONDON, N.W.6.
 Just around the corner from West Hampstead Underground Station
 Telephone: 01-624 7174 Cables: Radio Shack, London, N.W.6.
 Giro Account No.: 588 7151

Fast Mail Order for the Amateur Radio Enthusiast!

AERIAL EQUIPMENT

COPPER WIRE 14G, H/D, 140ft 37/6, 70ft 19/-. Lengths are approx. Actually sold by weight. P. & P. 5/-.

TWIN FEEDER 300 ohm Ribbon 8d. per yd. Also 75 ohm 8d. per yd. P. & P. any length 2/-.

INSULATORS, Egg 6d. ea. Short Stick 1/- ea. Ribbed Ceramic 2/6 ea. Dipole Centre Pieces 2/6 ea. All plus postage.

TOUGH POLYTHENE LINE. ML1 (100lb) 2d. per yd. or 12/6 100 yds. ML2 (220lb) 4d. per yd. or 25/- 100 yds. ML4 (400lb) 6d. yd. only. P. & P. all line 1/6.

SUPER AERAXIAL 75 ohm for above 2/3 per yd., 50 ohm 300W. Super Coax. 2/6 per yd. P. & P. all cables 2/6.

RAYMART ABSORPTION WAVE-METER, 3.5-35 Mc/s, £1. 10. 0. P. & P. 5/-.

"RAYMART" SUPER BANDCHECKER

This instrument is an adaptation of the simple Absorption type wavemeter and by utilising a diode and a sensitive meter its application is considerably widened.

In addition to the familiar use of checking output frequency the increased sensitivity enables it to be used for many other applications such as :

- Checking of Multiplier stages in Multi Stage transmitters.
 - Neutralising R.F. Amplifiers.
 - Standing waves on coax Cables.
 - R.F. Pick up in wiring.
 - R.F. Pick up in Microphone leads, etc.
- Price £4. 4. 0 (3.5-35 Mc/s.) or, including 160 Metre Band £4. 10. 0. P. & P. 5/-.



EQUIPMENT EX STOCK

EDDYSTONE

EC10 Mark 1	£59	10	0
EC10 Mark 2	£69	10	0
EB35 Mark 2	£82	4	9
940 13V de Luxe SW. RX	£153	0	0
EA12 Amateur Band Super	£195	0	0

TRIO

JR310	£77	10	0
JR500SE	£69	10	0
9R59DE	£42	10	0

K.W.

2000B with psu	£240	0	0
Vespa with psu	£135	0	0

AR22 Rotator plus carriage	£25	0	0
----------------------------	-----	---	---



The Widest Range of Components in the Midlands

★ HIRE PURCHASE
 ★ PART EXCHANGE

CHAS. H. **YOUNG** LTD.

At your service G2AK, G3LAY, G3VFN
 Please print your address. No C.O.D. under £1.

Please note we are closed all day Wednesday

170-172 Corporation Street,
 Birmingham 4. 'phone 021-236 1635

INDEX TO
ADVERTISERS

	PAGE
Amateur Electronics (G3FIK)	132
Amateur Radio (C. H. Young)	138
Baginton Electronics ...	134
Belding & Bennett (Radar)	192
Daystrom	135
Derwent Radio	183
Echelford Communications	186
Eddystone Agents ...	129
Eley Electronics	188
EMSAC ... <i>inside back cover</i> ,	130
G.W.M. Radio	191
Hamgear Electronics <i>inside back cover</i>	
Henry's Radio	185
Home Radio, Ltd. ...	136
Imhof	189
K.W. Electronics <i>inside front cover</i> ,	132
Lowe Electronics	137, 182
Minitenna	188
B. H. Morris & Co. (Radio) Ltd. <i>front cover</i>	
Mosley	130
Multicore	184
N.W. Electrics	134
Partridge Electronics	186, 188, 192
Partridge (G3PRR) ...	192
Peter Seymour <i>inside back cover</i> ,	132
Radio Constructor ...	185
Radio Shack	138, 190
R.T. & I. Electronics, Ltd.	136
Small Advertisements ...	185-192
Smith, G. W. (Radio) ...	133
Spacemark, Ltd.	188
SSB Products	191
Stephens-James, Ltd. <i>inside back cover</i>	
S.W.M. Publications <i>back cover</i> 140, 183, 184, 187, 192	
Taurus Electrical Services	190
Telecomms (G3SED) ...	189
The Amateur Radio Shop	192
Trio (Japan)	131
J. & A. Tweedy (Electronic Supplies), Ltd.	184
VHF Communications ...	184
Western Electronics ...	186
Yukan	192

SHORT WAVE MAGAZINE

(GB3SWM)

Vol. XXVIII

MAY, 1970

No. 319

CONTENTS

	Page
Editorial	141
QRP Transceiver for Two Metres, <i>by J. E. Kasser, G3ZCZ</i>	142
Simple SWR Bridge, <i>by J. S. Cushing, G3KHC</i>	146
Adjusting for Resonance	148
Construction of an Outside Shack, <i>by J. Hawkins, G3LXD</i>	150
NBFM with The HW-30, <i>by P. J. S. Bendall, G3NBU</i>	153
"SWL"— <i>Listener Feature</i>	154
The Mobile Scene	159
Book Review—The ARRL <i>Radio Amateur's Handbook</i> , 47th Edn., 1970	160
Communication and DX News, <i>by E. P. Essery, G3KFE</i>	161
VHF Bands, <i>by A. H. Dormer, G3DAH</i>	168
The Month with The Clubs— <i>From Reports</i>	174
New QTH's... ..	180
The Other Man's Station—G3WVD	181

Managing Editor: AUSTIN FORSYTH, O.B.E. (G6FO/G3SWM)

Advertising: Maria Greenwood

Published at 55 Victoria Street, London, S.W.1, on the last Friday of the month, dated the month following. Telephone: ABBey 5341/2 (STD 01-222-5341)

Annual Subscription: Home: 45s. (48s. 1st class) post paid
Overseas: 45s. (\$6.00 U.S.), post free surface mail

Editorial Address: Short Wave Magazine, BUCKINGHAM, England

AUTHORS' MSS

Articles submitted for Editorial consideration must be typed double-spaced with wide margins on one side only of quarto or foolscap sheets, with diagrams shown separately. Photographs should be clearly identified on the back. Payment is made for all material used, and it is a condition of acceptance that full copyright passes to the Short Wave Magazine, Ltd., on publication.

© Short Wave Magazine Ltd.

Technical Books and Manuals

AERIAL INFORMATION

ABC of Antennas	17/-
Aerial Handbook	15/9
Amateur Radio Antennas (Hooton)	O/P
Antenna Handbook, Volume 1	33/6
Antenna Round-Up, Volume 1	27/6
Antenna Round-Up, Volume 2	33/6
Antenna Handbook, 11th Edition	26/6
Beam Antenna Handbook	40/6
Ham Antenna Construction Projects	27/-
Quad Antennae	35/-
S9 Signals	17/-

BOOKS FOR THE BEGINNER

Amateur Radio (Rayer)	26/6
Basic Mathematics for Radio and Electronics	22/8
Beginners Guide to Radio	O/P
Beginners Guide to Electronics	16/-
Beginners Guide to Colour TV	15/8
Better Short Wave Reception	35/-
Course in Radio Fundamentals	11/9
Dictionary of Electronics	8/6
Foundations of Wireless	23/-
Guide to Amateur Radio (N.E.)	8/10
How to Become a Radio Amateur	11/-
How to Improve Short Wave Reception	20/-
Morse Code for the Radio Amateur	2/4
Learning the RT Code	4/9
Novice Handbook, Tx & Rx	35/-
Radio, by D. Gibson	13/9
Radio Amateur Examination Manual	5/9
Short Wave Listening	16/-
Short Wave Listener's Guide	13/8
Short Wave Receivers for the Beginners	O/P
Understanding Amateur Radio	26/6

GENERAL

Official (I.T.U.) Chart of International Frequency Allocations	35/6
CQ Anthology 1952-59	27/6
Eliminating Engine Interference	17/-
Guide to Broadcasting Stations	6/9
How to Listen to the World	26/6
Introduction to Valves	9/4
Radio Experiments (Rayer)	17/3
RCA Silicon Power Circuits	23/-
RCA Receiving Tubes Manual	30/-
RCA Transistor Manual (N.E.)	30/-
RCA Transmitting Tubes	15/-
Radio Astronomy for Amateurs	O/P
Soldering Handbook	22/6

Shop & Shack Shortcuts	34/6
Television Explained Vol. I	26/6
Television Explained Vol. II	26/6
World Radio & TV Handbook 1970 Edition	43/6

HANDBOOKS AND MANUALS

Amateur Radio DX Handbook	42/-
Electronic Circuit Handbook, Vol. 1	27/6
Electronic Circuit Handbook, Vol. 2	27/6
Mobile Handbook, CQ	27/-
Mobile Manual, ARRL	27/-
New RTTY Handbook	35/-
New Sideband Handbook, CQ	28/-
Novice Handbook Tx & Rx	35/-
1970 ARRL Handbook (paper)	55/-
1970 ARRL Handbook (cloth bound)	70/-
Radio Communication Handbook (RSGB)	69/-
Radio Handbook, W.I. Orr (17th)	O/P
Surplus Conversion Handbook	26/6
Transistor Substitution Handbook	17/-

USEFUL REFERENCE BOOKS

Amateur Radio Techniques	14/3
Amateur Radio Construction Projects	21/-
Amateur Radio Circuit Book	13/4
Elements of Radio Engineering	16/-
Guide to Amateur Radio (N.E.)	8/10
Engineers' Pocket Book	15/10
Hams' Interpreter	9/6
Hints & Kinks, Vol. 7 (ARRL)	11/9
Radio Amateur Examination Manual	5/9
Operating an Amateur Radio Stat.	2/8
Radio Amateur Operator's Handbook	6/6
Radio Valve Data	11/8
Radio Data Reference Book	14/6
Radio Engineer's Pocket Book	12/6
Service Valve & Semiconductors Equivalents	5/6
(Amateur) SSB Radio Guide	31/-
Single Sideband for the Radio Amateur (ARRL)	26/6
Surplus Schematics (CQ)	23/6
Q & A on Audio	10/-
Q & A on Electronics	10/-
Q & A on Transistors	O/P

VHF PUBLICATIONS

VHF Handbook, Wm. I. Orr	35/-
VHF Manual (ARRL)	26/6
VHF for the Radio Amateur	O/P
VHF/UHF Manual (RSGB)	23/-

The above prices include postage

Available from **SHORT WAVE MAGAZINE**

Publications Dept., 55 Victoria St., London S.W.1

01-222 5341

(Counter Service, 9.30-5.15, Mon. to Fri.)

(Nearest Station: St. James's Park)

(GIRO A/C. No. 547 6151)

The SHORT-WAVE Magazine

E D I T O R I A L

Tension *At this moment of writing, it was not certain what would be the eventual outcome of the tremendous drama being played out in Apollo 13. Whatever it may be, brave men will have been subjected to extreme tests, mental and physical. Highly sophisticated apparatus and equipment will have had to withstand strains which could only have been envisaged as a remote, though contingent, possibility. At best, the whole experiment—for that is no more than space exploration can be at the present juncture—will have been a catastrophic failure, costing hundreds of millions for no discernible result.*

★ ★ ★ ★

VHF *Those who have worked their share of DX and are now finding the HF bands uncomfortably crowded have various directions in which to turn for new outlets to satisfy that compelling urge to communicate—one of these escape routes is, of course, VHF.*

Given that the true radio amateur is he who gets his satisfaction by overcoming difficulties in order to achieve an objective, there can be little doubt that, for those new to them, the VHF bands offer a real challenge. Though the most that can be expected in the way of DX—used in this context as a relative term—is working Europeans when conditions are particularly favourable, the making of such contacts under the peculiar circumstances that obtain on VHF is an enormous satisfaction in itself.

Over the years, large numbers of U.K. amateurs have, at one time or another, operated on the VHF bands. Many have given up because of, on the one hand, the lack of DX and, on the other, the apparent lack of activity when conditions are only good enough for local working. These are valid arguments, as all who work the VHF bands regularly will know. But it is also true to say that on two metres, for instance, short-haul contacts can be enjoyed at any time, with loud signals both ways, virtually free of QRM; indeed, much of the local-net work now being carried out every weekend on Top Band could be transferred to two metres with better signals all round—and an entirely new range of ideas to discuss and problems to solve.

Furthermore, there is on the most-frequented VHF bands, two metres and 70 centimetres, a great deal of interesting experimental work to be done—not much of it will be new or original in the strict radio engineering sense, but it would be entirely new experience to those who so far have kept to the HF bands.

What it all comes to is that the keen amateur who wants to get the most out of Amateur Radio will sooner or later have to try his hand at VHF—even if only to make a change by getting away from the turmoil of the HF bands!

*Austin Foster,
G6FO.*

QRP TRANSCEIVER FOR TWO METRES

TRANSISTORISED LOW-POWER Tx/Rx FOR PORTABLE OPERATION

J. E. KASSER (G3ZCZ)

As the author says, the design discussed here represents about the cheapest and easiest way of achieving communication by Amateur Radio. It is therefore not a sophisticated high-power job but a simple hand-held device capable of giving results up to 40 miles or so, depending upon location and aerial alignment. The secret of its success lies in the fact that the Rx detector is super-regenerative, the most sensitive method of detection extant—though not without certain drawbacks and limitations of its own. The super-regen. principle has been known for many years—indeed, early GDX line-of-sight results on five metres, long before Hitler's War, were dependent on efficient super-regenerative-detector type receivers, working with the SEO transmitters then in common use by the amateur VHF fraternity. Later designs such as this one, both commercial and amateur, have gone back to the super-regen. principle for transceivers, while using crystal-control on the Tx side.—Editor.

THE 2N918'er is a very low power two-metre transmitter-receiver. The transmitter runs a DC input to the PA of less than 100 mW. The receiver is of the super-regenerative type, yet when used with a dipole aerial a reliable operating range in excess of 20 miles can be obtained.

The Transmitter

The source of RF energy is a crystal-controlled oscillator (Tr1) at a frequency of about 72 MHz. This is doubled to 144 MHz by another 2N918 transistor (Tr2) operating as a Class-C common-base frequency multiplier. This oscillator multiplier circuit is similar to the type of circuitry used in VHF converters.

The PA is another 2N918 connected in the common-base mode. A screen is fitted across the transistor to isolate the tuned circuits of Tr2 and Tr3 to prevent feedback into the PA. All stages are inductively coupled, two twin loops being placed in the "earthy" end of the tuned circuit coils. The transmitter is built using the "no-lead" VHF technique, adopting a straight-line layout with the oscillator at one end and the output at the other. The output is taken by way of a tuned loop L6 inductively coupled to L5.

The DC input to the PA is less than the manufacturer's stated maximum dissipative power for the 2N918, ensuring that the PA transistor will not be damaged under any operating conditions, even if the aerial lead becomes disconnected during "transmit." This is an

important point to consider when operating portable, well away from test and repair equipment.

The modulator is a three-stage R/C coupled amplifier using BC109 transistors. The output stage is in Class-A and runs at twice the DC input than the PA. The modulation transformer T1 is chosen to give at least a 3:1 voltage step-up between the collector circuit of Tr6 and the PA. The mike lead is decoupled by a capacitor, to suppress any RF picked up on the microphone cable. Ferrite bead chokes are also used to block any RF from getting into the modulator. It may seem surprising but even with 15 mW of two-metre RF being radiated, RF breakthrough can still occur and precautions must be taken to prevent it.

There is no volume control since it is not needed! The mod. level is controlled by voice intensity and distance from the mike insert. Since the PA is operating in the common-base mode there will be some feed-through of RF from the driver stage (Tr2). This makes it difficult to cause 100% downward modulation, ensuring that the carrier does not get broken up. By shouting into the microphone the upward mod. level can be made to exceed 100% but in normal operation, speaking clearly and slowly, 100% of the reports are R5.

The Receiver

The first transistor is also a 2N918 (Tr7) used as an untuned input common-base RF transistor. A shield is placed across the transistor to help stabilise its operation. The output tuned circuit is inductively coupled to the tuned circuit of the super-regenerative detector (Tr8). The coils are laid next to each other with the "earthy" ends together, using as little coupling as possible. The detector tuned circuit has two variable capacitors: One, a preset trimmer, is used as the band set condenser; the second, a variable condenser with only one fixed and one variable plate, is the actual tuning control and covers 144 to 148 MHz over the 180° of spindle travel. The super-regen. detector is an FET transistor. Regeneration can be controlled by VR1. The feed-back capacitor Cg is a pair of thin insulated wires twisted together for about half an inch. (The wire is the same type as that used for the emitter coupling loops, L2 and L4, in the transmitter.) The RF and squelch frequencies are filtered from the audio, which is passed to a simple amplifier, Tr9; this transistor is a BC109. The amplified demodulated signal is passed through a level control VR2 to the audio output stage driver transistor (Tr10) which is yet another BC109. The Class-B output stage is a pair of BFY50's (Tr11 and Tr12) with a diode in the base bias network giving a measure of temperature stability.

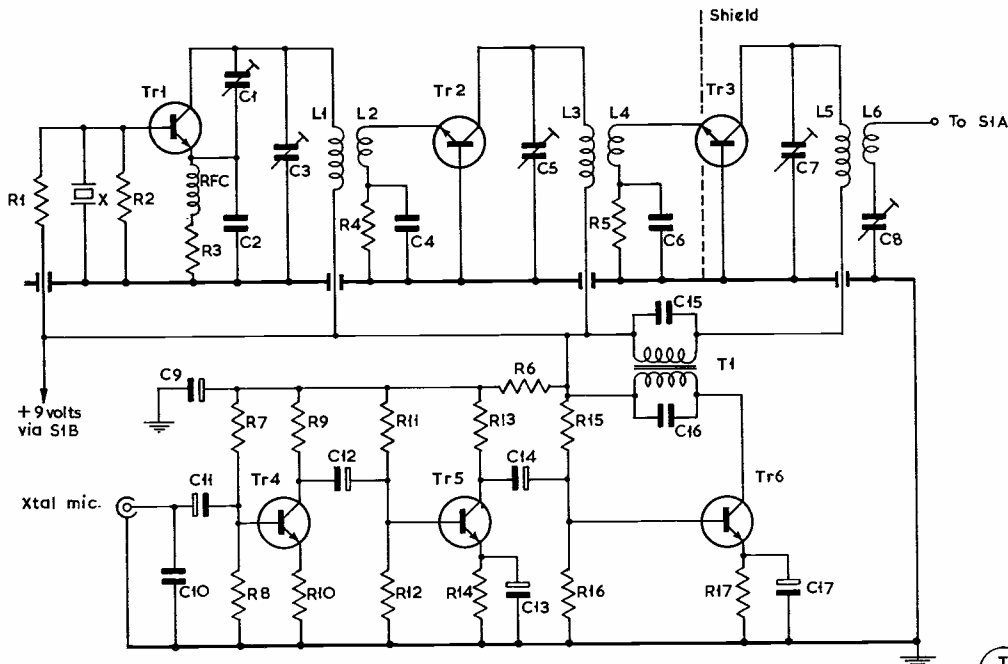

Fig.1. TRANSMITTER SECTION

T
568

Fig. 1. Transmitter section of the Transceiver.

Switching and Monitoring Circuitry

The aerial lead is switched by one pole of a two-pole two-way Yaxley type wafer switch, S1, used as the send-and-receive switch. Coaxial cable is connected to the transmitter output and receiver input and is brought to the Yaxley switch S1/A. The inners go to the switch tags with a similar piece of cable between the aerial input socket and S1/A. The centre conductor of that piece of cable goes to the common switch tag. All three outers are soldered together.

The supply-positive lead passes from the battery through the on-off switch (S2) to the send-receive switch, S1. S1B switches the supply between the transmitter and receiver so that the receiver is completely off during "transmit," and vice versa. A momentary "bleep" is heard in the speaker during change-over, this being due to the charging of the decoupling capacitors occupying a finite time when the supply is initially switched on.

The battery voltage is indicated on the front panel by the 50 μ A meter M1. The meter is switched by S3 to either an output indicator or the voltmeter.

The voltmeter is a non-linear suppressed-zero type. A zener diode (D2) is in series with the voltmeter circuit to expand the scale at about the 9-volt position so that small changes of battery voltage can be seen easily.

A two-turn loop of wire is wound around the inner of the aerial lead at S1/A (L9). RF picked up in the loop

Table of Values

Fig. 1. Transmitter section of the Transceiver

C1, C5,	R7, R15 = 82,000 ohms
C7, C8 = 10 μ F, preset	R8 = 18,000 ohms
C2 = 27 μ F	R9 = 4,700 ohms
C3 = 25 μ F, preset	R10, R14 = 1,000 ohms
C4, C6,	R11 = 56,000 ohms
C10 = .001 μ F	R12 = 27,000 ohms
C9, C12,	R13 = 3,300 ohms
C14, C17 = 10 μ F, elect.	T1 = Mod. xformer,
C11 = 30 μ F, elect.	1:3, 200 mW
C13 = 200 μ F, elect.	transistor type,
C15, C16 = .005 μ F	100:300 ohms
R1, R16 = 10,000 ohms	Tr1, Tr2,
R2 = 1,500 ohms	Tr3 = 2N918
R3, R4,	Tr4, Tr5,
R6, R17 = 100 ohms	Tr6 = BC109
R5 = 10 ohms	

TABLE OF COIL VALUES

- L1 — 6 turns 18g., to 7/16th-inch diameter.
- L2 — Two turns thin insulated wire inside L1.
- L3 — 5 turns 18g., as L1.
- L4 — As L2 but wound inside L3.
- L5 — Winding as L3.
- L6 — As L2 but wound inside L5.
- L7 — Winding as L3. Rx, Fig. 2.
- L8 — 4 turns 18g., to 7/16th-inch diameter, over half-inch, next to L7. Rx, Fig. 2.
- L9 — Two turns insulated wire over output coax lead, Fig. 3.
- Cg — Thin wires twisted together, to form low-value capacitor. Rx, C6, Fig. 2.

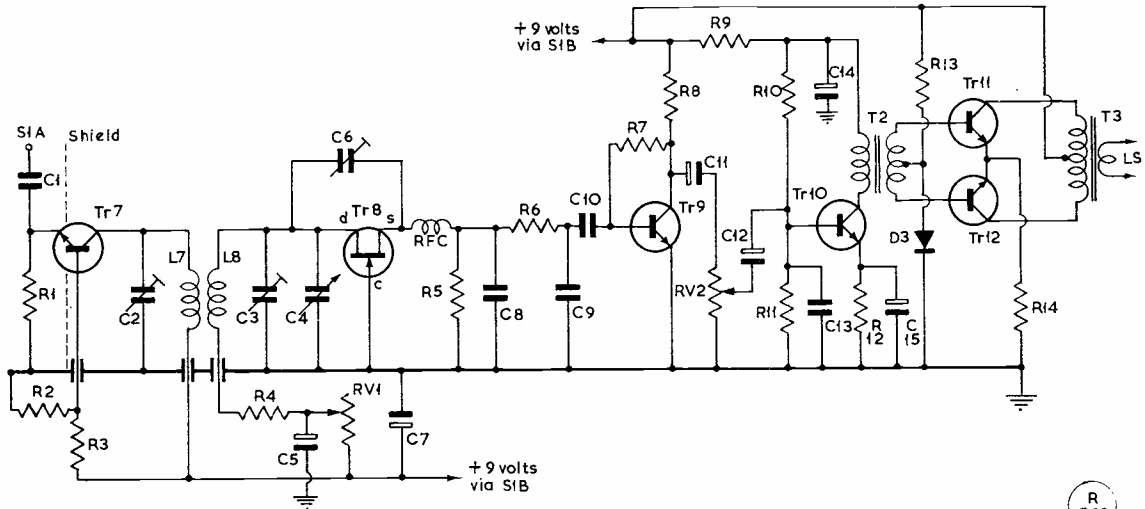

Fig. 2. RECEIVER SECTION

R
549

Fig. 2. Receiver section of the Transceiver.

Table of Values

Fig. 2. Receiver section of the Transceiver

C1 = 56 μ F	R6 = 15,000 ohms
C2 = 15 μ F, preset	R7 = 100,000 ohms
C3 = 25 μ F, preset	R14 = 5 ohms
C4 = 2 μ F, preset	RV1 = 10K, variable
C5, C11, C12, C14, C15 = 10 μ F, elect.	RFC = 0.5 μ H
C6 = C _g , as Fig. 1.	D3 = OAZ204
C7 = 25 μ F, elect.	T2 = Driver xformer, push-pull, 200 mW transistor audio
C8 = .005 μ F	T3 = Output xformer, push-pull, 200 mW transistor audio
C9 = .01 μ F	Tr7 = 2N918
C10 = 0.1 μ F	Tr8 = 2N3819
C13 = .001 μ F	Tr9 = BC109
R1 = 1,800 ohms	Tr10, Tr11, Tr12 = BFY50
R2, R11 = 18,000 ohms	
R3, R10 = 82,000 ohms	
R4, R9, R12 = 1,000 ohms	
R5, R8, R13 = 10,000 ohms	

is rectified by D1 and applied *via* S3 to the meter M1. The meter will show a deflection that will kick on speech peaks. (See Fig. 3, opposite.)

There is no calibration on the meter. In use the voltage reading is steady, dropping with elapsed time, while the RF pick-up will change depending on the proximity of nearby objects or length of cable between transmitter and aerial. In use, however, a change can easily be seen if something goes wrong.

The Aerial

The usual aerial used with this little rig is a simple dipole of $\frac{1}{4}$ in. brass rod with an insulating centre piece. The coaxial cable from the transceiver is directly connected to the dipole elements without any matching components. This has the advantage of simplicity, yet the system works well.

The end section of the aerial has a tendency to meet the operator's optical sensory equipment, in accordance with Murphy's Law. When using the set-up, care must be taken to ensure that the two are kept well apart—otherwise, you might get your eye poked out!

Construction

All RF circuits are built on pieces of copper laminate board. "In line—no lead" VHF constructional techniques are used and layout follows the circuit. The audio sections are built on *Veroboard*. The whole piece of equipment is thus a collection of modules wired together in a box—this is a diecast box 8 $\frac{1}{2}$ x 6 $\frac{1}{2}$ x 2ins. with the front panel as one of the long sides.

The crystal microphone and a telephone earpiece (used as the loudspeaker) are in a G.P.O.-type telephone handset attached to the unit.

Getting It Going

Setting up the equipment is very simple using a GDO and diode-loop detector. (A diode-loop detector is a small two-turn loop similar to L2 in series with a diode and a decoupled 50 μ A meter.) In use the loop is tucked into the tuned circuit coil and the circuit tuned to the required frequency. The frequency of operation is monitored by the GDO. Resistors of 1K should be fitted in the emitter leads of Tr2 and Tr3 during line-up to protect them.

The receiver is set up by tuning in a local two-metre station, the GDO or the transmitter with the bandset condenser, then using the bandspread condenser to tune across the band. The receiver as such will cover the VHF broadcasting band 90-180 MHz and may be set to 144 MHz very easily using the GDO to give a rough calibration.

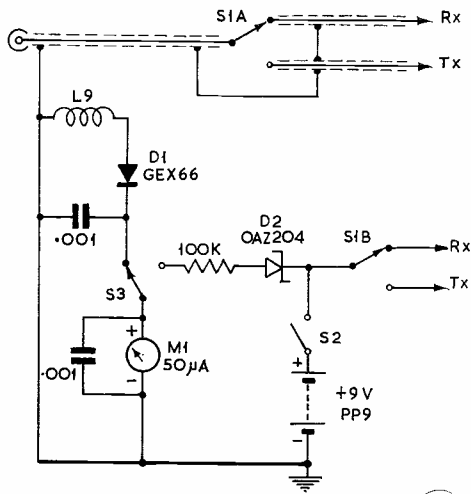

Fig. 3. Switching section



Fig. 3. Switching for the Transceiver.

Results In Use

This may be considered the most important part of this article since there is not much published information on results obtained with QRP. Running the 2N918'er at an input of 80-90 mW (depending on the battery voltage) results have been pleasing and quite surprising. The first QSO was made after calling a station who had called CQ. Using this low power a reply was not seriously expected, but a 59 report was received. Since that time over fifty stations have been contacted in and around the London area.

The 2N918'er was operated under at least three different conditions, which were:—

- (a) A proper portable site with a five-element Yagi.
- (b) With the dipole aerial stuck out of a top-floor office window.
- (c) Portable, at ground level using a hand-held dipole while waiting at various bus stops (!).

Under conditions (a) and (b) contacts are on average of the order of 15-25 miles, the best one to date being a contact under condition (b) over a path-length of 40 miles from a QTH in North West London. Stations contacted under condition (a) gave the Yagi a 2S-point improvement (59 to 57) over the dipole. Modulation has been reported to be "good"; a report of 53 was received over one 15-mile path.

Using the dipole, the wide selectivity of the super-regen. detector is no problem since the aerial can be rotated to null-out an interfering signal or peak a wanted one. Occasionally, it is necessary to rotate the aerial between "send" and "receive" to null out the QRM on "receive" yet push up the signal in a wanted direction

on "transmit." If a station can be heard on the receiver it can usually be worked.

Stations have been worked over non-line-of-sight paths, through trees, houses and hills. At ground level the signals seem to bounce off buildings, setting up standing-wave type patterns, since moving the aerial physically may drastically change the received (and transmitted) signal. A 59 signal may drop into the noise if the aerial is moved a yard off the optimum. It may also be necessary to tilt the dipole from the horizontal to bounce a signal in a given direction.

While working under condition (b) with the dipole supported on a broom handle outside a metal frame building, contacts have been made with stations diagonally opposite the dipole through the building. In fact, over one 15-mile path the report was RS-59 when the dipole (and operator) was placed on the roof of the building and RS-56 from the window. The signals appear to have bounced off a neighbouring building, since the dipole position at the window was critical.

Consumption from a PP9 battery is 60 mA on "transmit" and 30 mA on "receive." The lifetime of the battery will depend on how long the unit is operated at a time. The battery also recovers its voltage in the spells between operating. Running it for about one hour a day with occasional three-hour spells, the life-time of the battery is of the order of six weeks. This must surely be the cheapest way of communicating through Amateur Radio!

WE ARE ALWAYS INTERESTED

To see articles of Amateur Radio application and interest, for possible publication in SHORT WAVE MAGAZINE. All such material that we can use is paid for at good rates, immediately on publication. The article should be typed double-spaced on one side only of quarto or foolscap sheets, with wide margins, and the Magazine setting convention (which means how you see it in print) used throughout, e.g., PA and not p.a. or P.A.; mA and not mills or MA; HT, not h.t. or H.T.; RF, not r.f. or R.F.; kHz and not Kc/s, kc/s or kc's, etc., etc. Diagrams should be neatly drawn on separate sheets, using the C, R, L nomenclature—which means in turn that values should be shown in a table, just as you see tables of values in print in any issue of the Magazine. The easiest way to draw neat circuits is to use squared paper, with a transparent ruler and a thin ball-point pen.

We pay out upwards of £120 a month to outside contributors to SHORT WAVE MAGAZINE, and are always on the look-out for new talent. Special rates are often paid for material of exceptional value or interest and, in general, illustrated constructional articles are the most remunerative.

Articles, or enquiries regarding the sort of material that might be acceptable, should be addressed to: Editor, SHORT WAVE MAGAZINE, BUCKINGHAM.

To become a D/S costs only 45s.—or for first-class posting, 48s.

SIMPLE SWR BRIDGE

FOR LOW POWER TRANSMITTERS

J. S. CUSHING (G3KHC)

This is the sort of matching device which would be particularly useful on the LF bands—though, indeed, it has applications for all bands. It is the simpler type of substitution bridge and basically the indication is “go” or “no-go,” as actual readings are not possible—though it could be calibrated against a Bridge (such as the Heathkit Reflectometer) which does give positive readings. The instrument as described here will give a positive indication for coax-fed dipoles, since a zero or near-zero reading should be obtained if the actual SWR is in the region of 1:1—which it ought to be with a centre-fed dipole.

—Editor.

THE particular advantages of this standing-wave ratio bridge are its ease of construction, the small number of standard components used, the use of a fairly robust meter and providing the layout is satisfactory, no tiresome adjustments are necessary. Additionally, it gives useful results from Top Band to Four Metres. There is a small price to be paid for this simplicity. It can *not* be left continuously in circuit as a monitoring device, and is not straightforward to use with some high power transmitters. Its main application is with transmitters in the 10 to 20 watt class.

Circuitry

The circuitry behind any SWR bridge comes down to some variation of the Wheatstone Bridge and this one is no exception. It is used in a similar manner to any other bridge circuit—that is, adjustments are made until the indicating device shows a *null*.

Although the components are standard types and few in number one rule must be followed. They must be suited to radio frequency use. But all this means is carbon resistors, a carbon track potentiometer (VR1) and disc ceramic capacitors.

Considering the components in more detail and referring to Fig. 1, it will be seen that R1, R2, and R3 are listed as 1% tolerance. This has been done to emphasise the necessity of not risking trouble by picking out junk-box items. The best plan then is to obtain 1% resistors if possible, failing that 2% or perhaps 5% tolerance. Another point arising here is that R1 and R2 should match within 1% or 2%; there is no need for them to be exactly 47 ohms, they may be a few ohms more or less, providing they *match*. All this means of course obtaining 1% or 2% resistors in the first place, or be prepared to do some fairly careful measuring with a reliable resistance bridge. As for R4 and VR1 there is no need for accuracy; R4 is only a safety precaution and could well be two or three times greater in value. For VR1, 25K is about right but there is no need to keep exactly to that value. Disc ceramic capacitors are suggested for C1 and C2 as they are good for RF work

and cheap; silvered mica ones will do as well. Remember, cardboard cased capacitors and some others are not intended to handle RF. No particular type of diode is specified, as the junk-box should provide one. That used was from an old TV receiver. The coaxial sockets are standard surface mounting type, and although a jack socket is shown for the meter connection, some other type of socket could well be satisfactory. A suitable meter is one with a f.s.d. of 500 μ A. A more sensitive one may be used with extra series resistance for safety.

Construction and Layout

The constructional side of this bridge is straightforward. It is easily made up in a 2-oz. tobacco tin, or something of similar size. The main things to keep in mind are to make a sound job of assembly and soldering and to use a pair of pliers as heat shunt to avoid cooking R1, R2, and R3 as well as the diode.

Layout is usually fairly important. That shown in Fig. 2 proved satisfactory and it is recommended. This means positioning the components and wiring so that the finished job looks much the same as Fig. 2. There is no point in measuring the drawing with a rule. Working to the nearest millimetre is not called for and the drawing is not to scale! A screened lead to the meter is a sensible precaution.

Testing the Bridge

Before the bridge can be used with certainty it must be tested. To do this a Top Band Tx is best (alternatively, try a Tx running 10 to 20 watts input at as low a frequency as possible) together with a 70-ohm dummy load and an RF ammeter. A dummy load can be made by wiring in parallel a few carbon resistors—for example, ten 680-ohm one-watt resistors serve nicely and cope with a ten-watt transmitter, without cooking, for long periods. The load and ammeter are connected in series and plugged into the Tx.

After warming up adjust the PA tuning and loading to give maximum current into the dummy load, at the same time checking the input to the PA to see if the correct input power is taken. It is worthwhile being meticulous about this tune-up as the whole object is to adjust the Tx to give full output into a 70-ohm

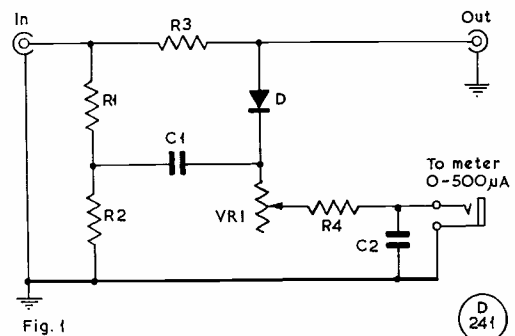

Fig. 1. Circuit of the Bridge. Values are: C1, C2, .005 μ F disc ceramic; R1, R2, 47 ohms, 1% $\frac{1}{2}$ -watt; R3, 75 ohms, 1% $\frac{1}{2}$ -watt; R4, 1K, $\frac{1}{2}$ -watt; VR1, 25K carbon track; D, crystal diode, any available type; Meter, 0-500 μ A, or better if available.

load. One possibility should be remembered: A tank can have tuning and loading adjustments which will not permit loading into 70 ohms; if this is so some re-design of the PA tuning is indicated. Before proceeding make careful note of all PA settings.

The second step is to connect the Tx to the "in" socket of the bridge with a short length of 70-ohm coax, but leaving the "out" socket with no connection at all. With the Tx running, adjust VR1 to give full scale deflection of the meter, remembering to check if the PA settings are correct.

The last step only involves plugging the 70-ohm load into the "out" socket, when the meter reading should fall to zero. A reading of a few microamps may exist above absolute zero; in the case of this simple instrument that can be ignored. If, however, a zero reading is not obtained the cause must be found and put right before the bridge can be used. (Some simple wiring error seems a likely reason.)

Using the Bridge

A SWR bridge is nearly always used to facilitate aerial tuner unit (ATU) adjustments, the method being as follows: Start by repeating the procedure for checking the bridge (if necessary) but in any case repeat the second and last check to ensure the bridge indicates a high SWR (when the "out" socket has no connection) and a low SWR when the 70-ohm load is connected.

Now connect the bridge in circuit between Tx and ATU, using two convenient lengths of 70-ohm coax. Before switching on see if the PA settings are correct and VR1 has not been altered. Then switch on the transmitter and, without making any adjustments to the PA, adjust the ATU until a low reading is seen on the meter.

The method of adjusting any ATU is as follows: First reduce the coupling by moving out the link coil, or slacking off any other form of coupling. If the main coil is tapped, the aerial is connected to the highest or lowest tap and moved progressively along the coil, at the same time altering the variable capacity at each tapping point. As the correct tap is approached the bridge meter will fall towards zero and by careful choice of tap and setting of the variable capacitor the meter reading will fall well towards zero. The coupling may now be increased a little at a time, trying the effect of varying capacitance and tap as well, as the three adjustments interact slightly. The final adjustment is to increase the coupling so that a low reading is obtained on the meter. If the coupling is tightened beyond the optimum the SWR will rise.

The foregoing applies particularly to the ATU circuit in Fig. 3, which is series tuned, but could just as well apply to a parallel tuned circuit. With other types the procedure is substantially the same, and is, in brief: Slacken coupling, tune for resonance (vary taps if provided), increase coupling. Before going on the air the bridge is taken out of circuit.

On first reading of the foregoing the setting up of Tx, bridge and ATU will seem complex, though a trial run or two will soon show how easy it is. A summary of the steps followed is given to assist initial trials.

- (1) Load Tx into 70-ohm load.

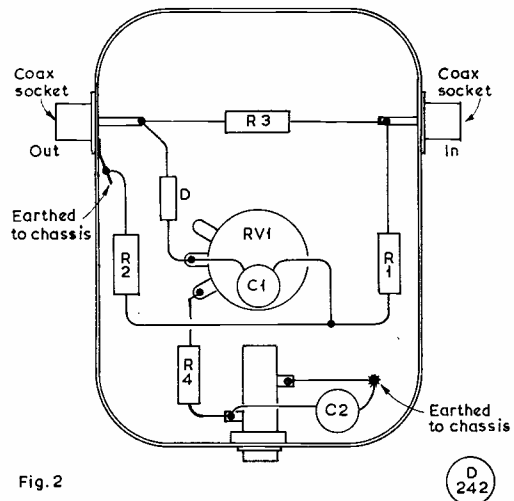

Fig. 2. Suggested physical layout and general construction. A 2-oz. tobacco tin would be a suitable container.

- (2) Note PA settings of Tx.
- (3) Connect bridge "in" socket to Tx. ("Out" socket is left open-circuit.) Set VR1 for full scale deflection on meter.
- (4) Connect dummy load to "out" socket; meter should read zero, or very near.
- (5) Connect bridge between Tx and ATU.
- (6) Tune ATU for minimum reading on bridge meter, but make no alteration to PA tuning.
- (7) Remove bridge from circuit.

Generally speaking, stages 1 and 2 will only have to be done once to establish the PA settings, and provided VR1 is not touched only steps 5, 6, and 7 are needed for a quick check.

Higher Power Transmitters

This bridge is intended for use with low power Tx's and was in fact made initially for use with Top Band gear, though it was later found to give satisfactory results over all bands to four metres. The problem of use with higher power transmitters depends mainly on the type used. There should be no trouble with SSB transmitters, for they are usually tuned up by inserting carrier, so the procedure is to follow the instructions already given above, and to use just enough carrier to go through the adjustments. In the case of CW and AM 'phone transmitters the problem is less easy. It is not permissible to lower the RF output by detuning the PA, so the only solution is to reduce grid drive to the PA or reduce the HT voltage, or even do both. Whether these can be done depends on a particular Tx.

[over

Meter Readings

The bridge described is strictly not a meter, as it will not measure a standing-wave ratio with any degree of accuracy. This point should not be forgotten. Any attempt to calculate the SWR from these meter readings will not give accurate answers, so it is best to think of it as an indicator, rather than a meter, and to interpret readings as follows:

A reading of near zero, or zero, indicates a satisfactory state of affairs, *i.e.*, the SWR is low. A reading elsewhere on the scale indicates that things are not right with matching on the output side. One hesitates to give an arbitrary figure, but assuming a 500 μA meter, a reading below 50 μA would be good and above is bad.

General Points

Preliminary use of the bridge will perhaps be with an existing set-up. If the gear has been carefully adjusted by trial and error (and experience), the bridge will (probably) confirm the settings. In this case the value of a SWR bridge may not be appreciated and there may be a tendency to think the bridge does not earn its keep. The full value will not be found until later when a new ATU or aerial is tried. Then, adjustments are made so easily and meter readings are so positive that any doubts will quickly vanish. In the case where the bridge does not agree with established settings, it is best to obtain reports comparing established settings against new settings. The new setting should give better reports, though the improvement may not be marked.

When an aerial system is set up using this bridge it may be wondered at how many points within a given

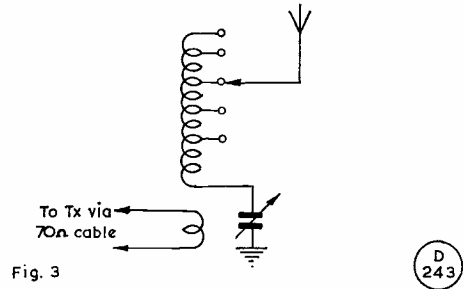

Fig. 3. A typical Top Band aerial coupler. The use of the Bridge with this type of ATU is discussed in the text.

band should the SWR be checked. It is hard to generalise but from an operating viewpoint a good plan is to make adjustments at the centre of the band, and when frequency is moved to peak up the ATU and Tx, relying on the aerial ammeter and field strength meter.

Simple dipole aerials may be effectively checked by placing the bridge in the coaxial lead. By varying the Tx frequency the point in the band where the SWR is best may easily be found, alternatively the length of aerial can be altered for best results at any spot frequency.

Sharp-eyed readers will have noticed a likeness to a circuit in the *ARRL Handbook*. Acknowledgement is gladly given to the source of inspiration for the bridge described here.

ADJUSTING FOR RESONANCE

THE PRACTICAL APPROACH

ILLUSTRATED here is a method of adjusting an aerial for length in order to obtain resonance in some desired part of a band. There is no need to stress the difference in performance between an aerial system that is correctly resonated and one that is non-resonant—or, to put it at its crudest, is being “forced to accept power.”

To perform correctly and to the best effect, any aerial system—which in itself is an external circuit—must be in resonance with its source of RF power. This means that, with the single exception of an end-on wire (which can be brought to resonance artificially by means of an ATU or loading coil at its fed end), any other type of aerial—whether it be a dipole, a Quad, a multi-band system, or whatever—must be at or near resonance in the required band(s) before it can accept power effectively.

In a particular case, illustrated in the diagram herewith, the problem was to achieve resonance in the external circuit A-X-A' at the HF end of the 80-metre band.

The aerial itself will be recognised as the Collins multi-band doublet with the “G5RV” modification. When first erected, the distance C-C' was 92ft., instead

of the 102ft. recommended, with an (open-wire) feeder length of 39ft. (instead of 34ft.).

Resonance Check

With an adequate length of 72-ohm coax—in this case about 30ft.—to bring the feeder into the station, the system was checked for resonance on 80 metres. It came out at 4.5 MHz, about 800 kHz too high and obviously unacceptable. Feeding into the bands-HF on which the system is also intended to work would show an even larger non-resonant error.

By the method indicated in the diagram—which will be self-explanatory—8ft. of wire was added to both ends and the feeder shortened to 34ft. Resonance was then obtained at 3.8 MHz. Though still not low enough, it was obviously a great deal better than before. A further small adjustment of A-B-C and A'-B'-C' moved the resonant point further down the band and produced good responses within the HF bands.

The point to bring out here is that any such system, symmetrical about its feed point, can be adjusted in the same way, *i.e.*, by lengthening or shortening the sections A-B-C and A'-B'-C', equally and together. Of course, this cannot be carried too far, because on some HF band—15m. and certainly on Ten—a current antinode could appear in the A-B-C, A'-B'-C' sections if these are extended too far. Probably, 20% or so of total length is about the effective limit—that is to say, 10ft. at each end between A-C and A'-C'.

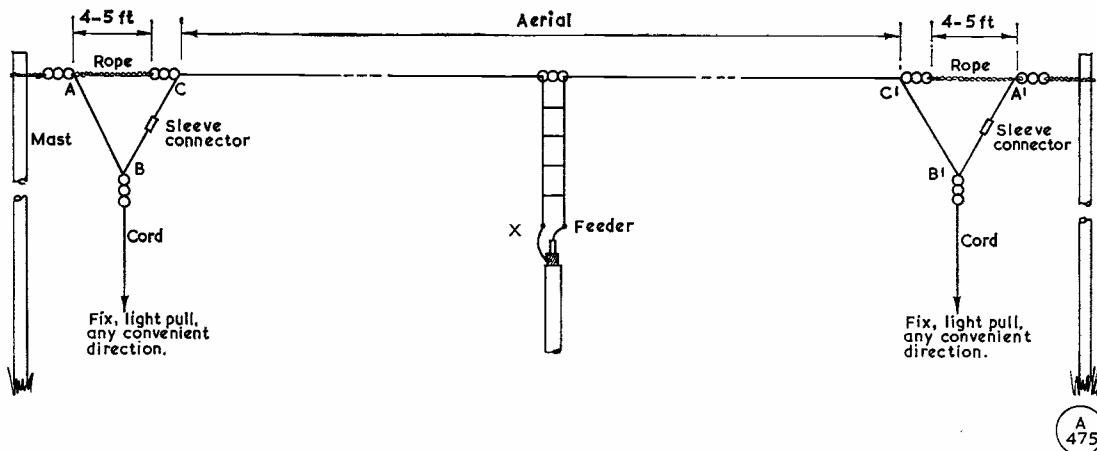

The aerial layout discussed.

By the use of sleeve connectors—the screwed brass inserts taken from strip terminal blocks—connections can be made easily and electrically secure, while also allowing for quick adjustment. When lengths and joints are finalised, they should be heavily doped with clear *Bostik* (by using the clear stuff, you can see where the screws are if it becomes necessary to dismantle the thing). As a footnote, it might be mentioned that this method of using screw connectors for outside work on aerials is far superior to attempting to solder aerial joints.

Method of Measuring Resonance

In the system shown in the diagram, the resonance check should, strictly speaking, be made at point X. But this is outside, and not at all easy to get at with the necessary apparatus. In any case, the 70-ohm coax is (or should be!) no more than an “RF pipe” conveying power to the system, and should not affect its resonance characteristic. If it does, then the whole set-up is not working correctly.

The way in which resonance is actually checked is important if reasonable accuracy is to be achieved. The requirements are a calibrated GDO, a *ditto* absorption wavemeter and a general-coverage receiver. Though both GDO and abs. meter may be regarded as giving reliable readings in ordinary use, with an aerial load any reading on the GDO must be suspect as regards frequency because the oscillator will inevitably be “pulled” by this load.

Coupling between coax feeder end and GDO is made by a small loop of a few turns, to slip over the GDO coil, and mounted on a coax socket, into which the aerial feeder plugs. The coupling should be adjusted so that while a positive dip can be found on the GDO, it is not pulled right out. The Rx, with only a foot or two of wire as pick-up, is then tuned for maximum S-meter deflection—in effect, it picks up the signal radiated by the aerial at the GDO dip point. The actual GDO reading is used only as a rough guide for where to search for the beat on the receiver.

It is thus the *receiver that is measuring the actual*

resonant frequency of the aerial system, and this will be found to differ by anything up to 3 mHz from what the GDO says—hence the need for this Rx check. In fact, it is useless trying to make measurements of this sort with a GDO alone.

To take the checking process a bit further and make absolutely sure one is in the right band with the aerial system, the absorption wavemeter is coupled lightly to the GDO and adjusted till the Rx S-meter falls back. The reading on the abs. w/meter dial will settle this point. Thus, we have the GDO as the RF power source; the Rx for the actual measurement of the resonant frequency; and the absorption wavemeter to check the band.

For those who may be interested, the apparatus actually used for these resonance tests is always a *Heathkit* GDO, a *Raymart* Bandchecker, an *Eddystone* S.750 general-coverage Rx with S-meter, and a KW-77 receiver for in-band readings. It is easily possible to get an accuracy of ± 25 kHz for an actual resonance point on 80m., this representing about the “broadness” of the system illustrated on the 80-metre band. In the case of this particular aerial, once it had been brought well into the band, good GDO dips were obtained within the HF bands—this being, of course, the multi-band system often described as the “G5RV.” A half-size version, also in use on the site, behaves in the same way, as regards resonance, in the 10-15-20m. bands.

ALWAYS IN NEED

We are, of good photographs of Amateur Radio interest, suitable for general illustration in these pages. Prints should be clear and sharp, black-and-white and about postcard size preferred. Negatives are *not* wanted nor, in general, can we return pictures. The details about the print should be on a separate slip, lightly gummed along one edge only (for easy separation) on the back of the photograph. All that we can use are paid for immediately on publication. Address is: Editor, SHORT WAVE MAGAZINE, BUCKINGHAM.

CONSTRUCTION OF AN OUTSIDE SHACK

IDEAS AND SUGGESTIONS
BASED ON EXPERIENCE

J. HAWKINS (G3LXD)

Some people at least will already have done something like this. Others will be casting about for ways and means, and perhaps regarding the constructional work as too difficult, expensive or complicated. This article shows how the job can be tackled in a straightforward and workman-like manner, to produce a satisfying result.—

Editor.

SOMETIME or other the question arises of where best to have the station shack. Answers will depend largely upon what indoor accommodation is available, i.e. spare room, loft space, cupboard under the stairs, etc., any outbuildings already in existence or space in the garden where a shack could be erected.

Having suffered several unpleasant years of loft-space-shack type occupation, sandwiched between two TV aerials and troubled with heat, cold, TVI and the need to be quiet at night (not to mention the timebase whistles to S7), the move to a new QTH was seized upon as an opportunity to relocate the equipment.

With very little finances available a form of construction was conceived, adhering to the broad principles of keeping the cost and knowledge of carpentry required to a minimum and of keeping the weather out. Also, it was made so that it could later be doubled in size without too much trouble or waste of materials, as and when further funds became available. A prototype was made initially to prove its worth and was found very acceptable. The finished shack is dry, draughtproof and reasonably elegant whilst being relatively cheap to make. The basic design, shown in the diagram, has a 4 × 6ft. ground area with eaves 6ft. and 7ft. high respectively. It uses four mutually supporting panels plus roof and floor. To double the ground area all that is necessary is to turn panel A round and attach it with screws or coach-bolts to panel B and to construct a further wall "mirroring" these two. Panel D is trimmed down to the height of panel C. Roof and floor of course need doubling, too.

Construction

The walls consist of 2in. × 1in. deal battens behind hardboard sheets, exploiting the basic pre-cut sheet dimension of 4ft. × 8ft. (all your squaring is thus done for you). It is easiest to stand these large sheets up against the corner of the house or garage wall to cut them. Where added strength is required, such as lower edges or door post, 2in. × 2in. deal is used. Having sponged them and left them flat overnight the hardboard panels are laid, rough side up, on a flat surface. Measure up as appropriate, e.g. 6ft. one side and 7ft. the other for panel A, and so on, and cut. Saw and assemble the 2in. × 1in. battens on the hardboard. There is no

objection to the use of unprepared timber and it works out cheaper. Nail at sides where possible and, reversing everything, turn the whole thing over and nail from the shiny side. Use galvanised wire nails, 1½in. for the panels and 3in. or 4in. for heftier end fixings. Provided tracer holes are drilled where splitting *could* occur no difficulty will be encountered. Substituting screws for nails gives a stronger fix but puts the cost up and slows the job down. All four walls and the door are made in this fashion. Windows can be created either by arranging the batten framework on the desired wall to frame a suitable aperture and then by cutting it out afterwards or, as in the writer's case, by using a secondhand window which will itself add rigidity.

The whole success of a project often depends on a "secret ingredient" and in this case it is *Aquaseal* GT55 waterproofing tape marketed by Berry Wiggins and obtainable from builders' merchants at 4s. 6d. for a 2in. × 24ft. roll. This tape is a sort of oily, gooey molskin which can be smoothed over or around almost anything and seals completely. It will also take paint. Prior to screwing up the wall sections together a strip of this tape is cut, doubled lengthways and inserted fold outwards down each joint. Any inaccuracies in carpentering are thus taken up and further tape can be smarmed across any dubious external cracks or nail holes.

The Roof

The roof is also made of hardboard wrapped with lightweight roofing felt and braced with one 2in. × 1in. batten (two in the larger version). As an overhang is desirable for water shedding the roof area will require 6ft. 4in. cut from an 8ft. panel. The other dimension of 4ft. will not quite cover the slope, unfortunately (you can blame this on Pythagoras) so that one must fill in either at the top ridge or bottom with a narrow strip. Once again waterproof tape can be used over nail holes,

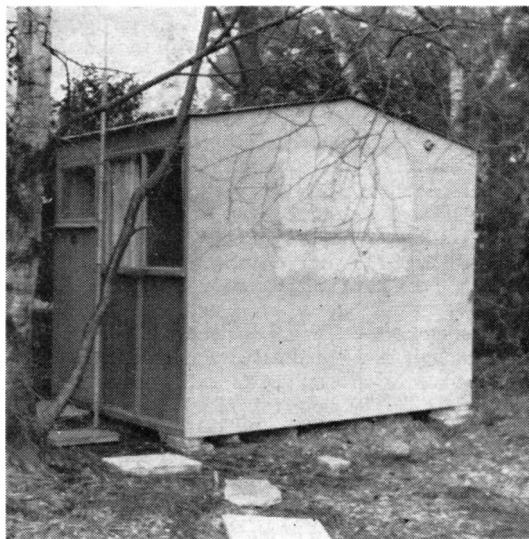

View of the outside shack as completed by G3LXD. It is intended to cut a large window-opening in the nearer wall, to be fitted with two individual panes of glass.

Q
435

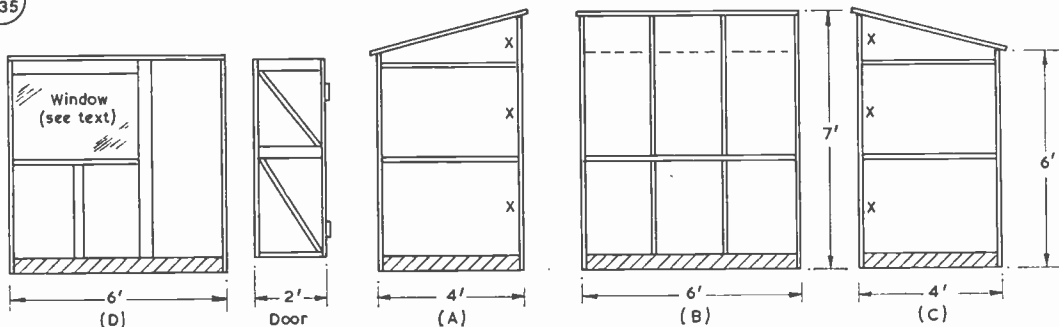

DESIGN FOR OUTSIDE SHACK

General arrangement and construction. Only external measurements are shown. Positioning of battening is a matter of choice, and can be varied to accommodate own fittings. Shaded battens are 2 x 2in., remainder 2 x 1in. To double floor area Panel A is attached to Panel C with quarter-inch coach bolts at points X, interposing water-proof tape (see text). Panel B is cut down to match D, and a new panel constructed to mirror (A) and (C).

and where the roof touches the walls.

The Floor

Flooring depends on what is available, but it is recommended that the shack walls be raised off the ground and the floor laid independently on its own bearers for ventilation. However, it should be possible (albeit rather cold on the feet in winter) to erect it directly on a hard surface such as paving stones or concrete provided the shack is set down on a cement or brick oblong, possibly incorporating a roofing felt or "polythene bag dampcourse."

Erection

With the aid of a "volunteer" the erection procedure is straightforward. Roughly level the plot, offer up and screw the four sides together using the tape as mentioned. Then push the four walls square using, say, a large offcut of hardboard with a known right-angle on it as a guide and finally adjust the level of all walls by raising with bricks, etc., or if really necessary, digging beneath a little. Keep the door shut whilst putting the shack together. Get help to support the roof panel when fixing.

The writer was fortunate to be able to procure seven 10in. x 8ft. planks of chipboard for 45s. which nicely provide the floor of the 6ft. x 8ft. shack. Having set the shack about two inches off the ground rows of bricks and odd stout pieces of timber were laid across the 6ft. width, each row spaced about 18 inches, thus allowing the air to circulate. On top of this were laid polythene bags (originally containing rolls of fibreglass) cut into sheets followed by the chipboard planks. On top of the planks another layer of polythene was put using up any off-cuts of roofing felt. Some old but serviceable carpet and underlay finished off the job.

Such a 4ft. x 6ft. shack will at least provide an independent "operating position." The 6ft. x 8ft. version is remarkably spacious. This sectional construction method lends itself very well to internal cladding with polystyrene in roll or tile form, for temperature and noise

control. It must be remembered, however, that this sort of design is not only draught proof but is fairly air proof, too! So if prolonged spells of operating are contemplated some ingress of fresh air must be catered for even if only around the door. Electric heating would seem to be the best as oil heaters are greedy so far as oxygen is concerned.

Timber costs vary, but 2in. x 1in. deal generally costs about 5½d. per foot, hardboard sheets can be obtained at 11s. each if you shop around. Rolls of roofing felt come out at about 8s. 6d. If some materials are already to hand then the outlay is even less. Even so, the writer's roomy 8ft. x 6ft. shack probably cost less than half the price of a commercially-made job and considering it to be weatherproof, to an extent tailor-made and floored, it seems money well spent.

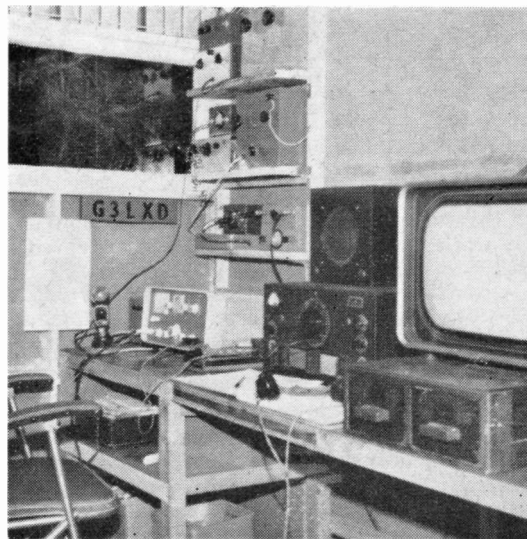

Station of G3LXD, as installed in his garden shack. The fitting and jointing of the battens and shelving is a matter of individual ability with carpenter's tools.

TVI—WHERE IGNORANCE IS NOT BLISS

CONFUCIUS he say: "Man who offendeth not his neighbour, hath much better chance of slinging 160-metre dipole across his garden."

Most TVI is caused eventually by the TV set. Because the XYL soon lets you know if you are coming through on your own set, having a clean picture yourself is no guarantee that you will not get a brick slung through the shack window one Friday shortly after 1900 hours GMT. After all, he has just paid £300 plus £11 licence for his UHF, single standard, all-transistor, walnut-veneered, imitation plastic, super panchromatic, 1971 model colour TV set. Your TCS cost £7 10s. in 1960, didn't it?

Seriously, though, the modern TV just asks for it. The printed circuit construction offers little screening to LF signals. The large currents entering *via* the coax socket can flow all over, causing all sorts of havoc. Transistors are more susceptible to overload by unwanted signals than were the good old valves. No attempt is made to keep RF out of the coax entry. All the filtering is a 1,000 pF capacitor shunted by 1.5M in series with inner and outer. This prevents the aerial rigger from being electrocuted, and is the only British Standard which manufacturers feel obliged to observe. This doesn't stop the LF RF from entering the set—1,000 pF is only 75 ohms at 2 MHz. It also doesn't stop the line timebase muck from getting up the coax.

If this safety filter were to be incorporated into a high pass filter—it only needs smaller capacitors plus a couple of small coils as extra components—then a lot of needless recrimination could be avoided.

The advent of 3-Channel UHF should make life easier, due to the larger separation between "us" and "them." Unfortunately, few viewers seem to be aware of the improved quality of the picture, and I see dealers are still installing VHF/UHF arrays. Good business, but pretty anti-social.

With acknowledgements to G3OHX, in the Greenford Amateur Radio Society's "Newsletter" for April.

"DC/DC POWER SUPPLIES"

REFERENCE this article, in the March issue of SHORT WAVE MAGAZINE, G3NXC (Birmingham), comments as follows:

"The article by G3SRY was very interesting. However, I feel that a word of warning on this type of converter should be given.

A converter using the master-slave principle suffers the disadvantage of being very dependent upon the mark-space-ratio of the master. If the master astable multi-vibrator does not provide an accurate 1:1 msr a DC flux level is set up in the core of the transformer. Should the core be operating normally near saturation (and what amateur components are not pushed near the limit!) then this additional component of flux may cause the transformer to saturate. When this happens the proud constructor will be forced to wave a sad goodbye to his unhappy power transistors.

A better way of utilising the master-slave technique is to make the power stage, or its low-power driver, into a bistable and then trigger this from the astable multi-

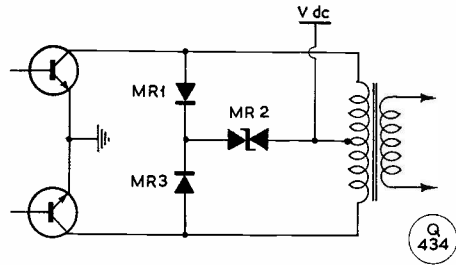

The circuit referred to by G3NXC. MR1 and MR3 are fast-switching diodes. MR2 is a zener diode, for a voltage higher than the maximum DC input.

vibrator. This ensures that the power stage is operating at an accurate 1:1 msr. Also, if you want to be really pedantic, the power transistors should be matched for Vce (*sat*) at the full load.

Another point concerning transistorised DC/DC converters generally is the suppression of voltage spikes at the collectors of the power transistors. These spikes are caused by the energy storage in the leakage inductance of the power transformer. This problem can be attacked by a pincer movement:

First, the power transformer should be designed to minimise leakage inductance by using bifilar wound primaries coupled tightly to the secondary. Secondly, by the use of collector catching diodes. The sketch above shows the principle of this technique. Two points need special mention—one is that the diodes need to be of a fast switching type, and the other is that the zener voltage should be higher than the maximum expected DC input voltage."

COURSES ON INTEGRATED CIRCUIT TECHNOLOGY

We are asked to say that Enfield College of Technology is now offering short practical courses, of two weeks' duration, on the principles of integrated circuit design, fabrication and testing, with practical work in the Microelectronics Laboratory at the College—one of the best-equipped and staffed in South-East England. Course A will already be in session by the time this appears. Course B is scheduled for July 6-17, and Course C for September 14-25. Enquiries regarding these Courses—which are for those at HNC level (Course B), or of graduate-engineer status (Course C)—should be made to: J. B. Butcher, MA, C.Eng., M.IEE, A.Inst.P. (G3LAS), Director, Microelectronics Centre, Enfield College of Technology, Queensway, Enfield, Middlesex. (Tel: 01-804 8131).

SCOUT JAMBOREE-ON-THE-AIR

The next, thirteenth, JOTA—now an established event in the Amateur Radio calendar, world-wide—will be held over the weekend October 17-18, from 0001z on the Saturday till 2359z on Sunday, 18th. Further details will be given nearer the event. The U.K. organiser is: L. R. Mitcell, G3BHK, 28 Darwall Drive, Ascot, Berks.

NBFM WITH THE HW-30

MODIFICATION TO AVOID TVI

P. J. S. BENDALL (G3NBU)

FOR about three years, since it was bought as the mobile rig for G3NBU/M, the Heathkit HW-30 "Two'er" has also been used as main-station transmitter, for which it was fitted with a wander-plug socket connected to Tx HT, to operate a low-current relay for aerial change-over. The detector voltage is, of course, cut when the rig is used with an external receiver.

TVI Problem

During this period it was found that under certain conditions the audio modulation could appear on the sound channel of a television receiver—sometimes on TV sets up to a quarter of a mile away *even when mobile!*

After discussing the problem at the local Club it was decided that narrow-band frequency modulation ought to effect a cure. As it is intended anyway to use NBFM in a 50-watt two-metre Tx under construction, the method was tried on the HW-30. General opinion had it that if a silicon rectifier is loosely coupled to a crystal oscillator through a 15 μF trimmer, with a DC bias of about 10-12v. applied with audio superimposed, the variation

of the apparent capacitance across the crystal would produce frequency modulation.

Modification

A BY127 was to hand and, keeping leads to a minimum, its anode was earthed and a 15 μF trimmer connected from the cathode side to the grid of the oscillator. Audio and bias were fed through a 100K resistor. The +10v. bias was obtained by a potentiometer arrangement, consisting of a 470K resistor to HT+ and a selected value of resistor to earth. Similarly, the required level of audio was pott'ed off the modulation transformer. Amplitude modulation was taken off the PA by moving the PA feed direct to the main HT.

Provided that the diode is not run into conduction one cannot get too much audio. The actual deviation is set by adjustment of the trimmer—in the case of G3NBU, on-the-air tests were carried out with a local and the correct setting for the trimmer was found at about the third attempt. The audio break-through on TV was found to have disappeared completely, with a good NBFM signal going out. An unexpected dividend was to find that, with the microphone input shorted, the CW signal went up about two S-points—the reason for this is not immediately apparent!

The modification involved is shown in the accompanying diagrams; it is as well to have the HW-30 manual available when carrying out the work.

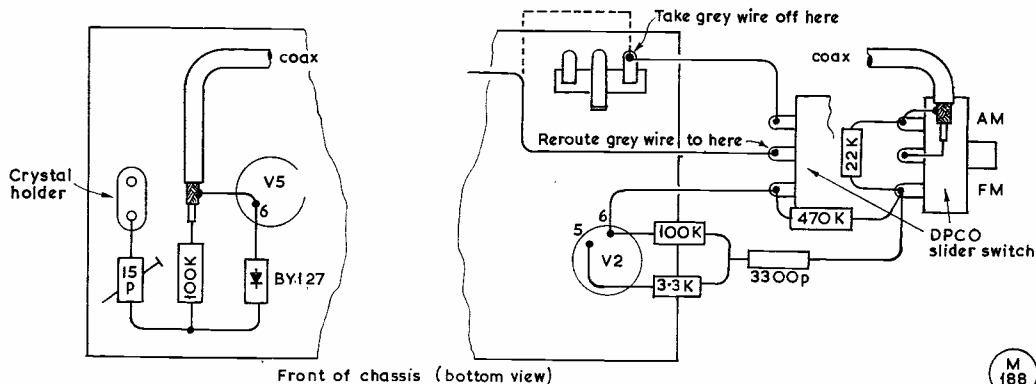
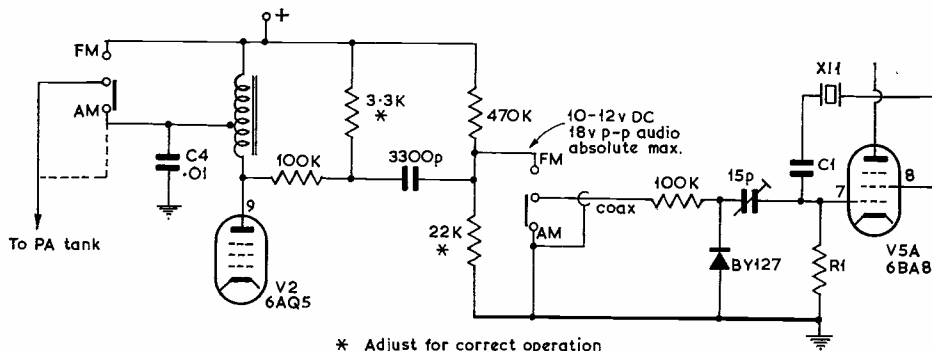

Modifying the Heathkit HW-30 for NBFM



SHORT WAVE LISTENER FEATURE

ORGANISING THE STATION — POINTS ON AERIALS, EARTHS AND RECEIVERS — THE GOSSIP IN THE MAIL — HPX RULES AND THE LADDER

By *Justin Cooper*

OCCASIONALLY, one gets a letter commenting on the nice tidy look of a shack photograph published in these pages, usually along the lines of "However does he keep it like that?" A good question, and one not entirely irrelevant to our theme.

A lot, of course, depends on the individual; some people are just plain uncomfortable trying to work in a tidy shack, and for them it would be pretty silly to try and enforce tidiness. However, for most of us there are good and sensible grounds for keeping the junk down and having a good old clear-out from time to time, as well as the normal processes of putting things away. Basically, one has a SWL shack for SWL'ing; and that shack should be organised to do so with the maximum of both pleasure and efficiency. For reliability if no more, the shack wiring should be well carried out and neat, with no taped and twisted joints; multiway power adaptors are not only a nuisance and unreliable but contribute significantly to the shock and fire risks. If everything which is needed for a listening session can be brought into action instantly as needed, with no stretching and straining, it is pretty pointless to cover the essential switches by great loads of old magazines and junk, so that you have to clear the raffle away before you can get to them! If one is lucky enough to have a shack in the true sense of a separate room rather than a corner of the living area, then one can so fix things that on one side is the workbench, on another the operational gear, and, stowed away out of sight in a cupboard, the junk. If workbench space is at a premium, or room generally, it is a good thing to make an investment in one of those nice soldering irons that only commence heating when the iron is lifted off the stand, but get up to working temperature in a few seconds and are then thermostatically controlled; that way you know your bit will be hot and have heat in hand for most jobs on the one hand; and on t'other at least you know if the iron is on the stand it is cold. There is nothing more annoying to turn round in the shack, smell burning, and after quite a while, find that when you moved you put the tail of your jacket on to the element of the iron!

Heat, light, and ventilation are all also of importance; not just to avoid being put off going in the shack on a cold winter's evening, but because attention to these things generates more efficiency and less fatigue, an

important factor in a hobby which by its very nature tends to involve long and late hours.

Technical Point

The first of these comes from *B. Hughes (Worcester)* who mentions the problems he has with electric shocks due to a nylon carpet. This one arises anywhere when furniture of the metal-tube type, or earthed metal electrical equipment, is in use. A typical case is the writer's lab., where a tubular chair is used, sitting on a plastic-tiled floor, and upholstered in some plastic type of material. If one is sitting at the bench, and an experiment is being carried out which involves a considerable amount of stretching to operate switches and controls, one occasionally gets up to get a cup of coffee and receives a man-sized "belt" in the region of the back of the knee joint. After this had happened on several occasions, an investigation was mounted to find out just what was going on, with rather startling results. It seems that the movement and shuffling-about on the chair has the effect of charging up the metalwork to quite a high level of static; and when one stands up the metalwork promptly discharges by the short path from the metalwork to the back of the knee. The point was finally proved to a sceptic by sitting on the chair and wiggling one's posterior about a few times, carefully getting off in a manner which avoids discharging the chair, and then discharging it to the metalwork of a nearby drawing-board. If the exercise is repeated a couple of times while the draughtsman is out of the lab., a big enough charge of static electricity is built up to convince even the most hardened sceptic who approaches the drawing-board! The effect is noticed in a car sometimes in high summer; the wriggling about in the course of getting out of the car is enough to build up a high static level which promptly discharges through the hand placed on the handle to shut the door.

Prefixes

With this issue of "SWL" comes a reprinting of the full HPX Rules (see p.156) which should reduce the incidence of queries on "How to join the Ladder" a wee bit! Perhaps it would be as well to mention at this point that the SHORT WAVE MAGAZINE Prefix List has now been re-issued and brought up to date with all the current Prefixes available at February 1970. This list

is an absolute "must" for anyone seriously listening around the amateur bands, to resolve questions pertaining to the whereabouts of stations heard on the bands. It contains first a list of Countries arranged in Prefix order—to identify the location of a prefix heard on the band; secondly, a list of Prefixes by Countries, which is used to find which prefix to listen for when it is desired to log signals from a given country; and, thirdly, a list of International Numerical Prefixes, which will be of assistance in determining the location of any new prefix which may be brought into use in the future. As if this were not enough, the list also gives the Zone number of a country or prefix—these being the numbers allocated by *CQ Magazine* for their famous WAZ and HAZ awards. The Prefix List alone is priced at 1s. 6d., but it is issued free with every copy of our full-colour *DX Zone Map*, which, using as it does the Great Circle projection, gives true distance and direction from London to all parts of the world at a glance, together with a world time scale which indicates whether or not the desired DX is asleep at the time when you can listen!

The Mail

W. H. Butcher (Towcester) continues to make pretty meteoric progress up the Ladder; Butch however, has a problem with the short-skip European stuff on Twenty which often comes up and sinks the DX without trace. This is a function of aerial design, as far as reducing the incidence of the problem is concerned, and once the semi-local signal has appeared on the aerial at the DX frequency there isn't a lot that can be done about it. However, careful aerial design to give best low-angle radiation will help, by reducing the pick-up of stuff reaching the aerial from high angles. However, it has to be admitted that this is at best only a palliative.

A CR-45 Codar receiver is used by *K. Webb (Slough)* in conjunction with various aerials, including a short indoor wire and a twelve-foot vertical whip. As Keith says, carefully used, the simple TRF receiver is capable of surprisingly good results—indeed it was the standard type of receiver in U.K. amateur stations right up to the

beginning of the second World War. In terms of sheer sensitivity, they are hard to fault if properly built and used, but, of course, the selectivity is woefully lacking compared with modern superhet designs, and the stability is also pretty poor.

Up in *Hull*, the *Singletons, John and Shelagh*, have changed the HRO/640 set-up to a Trio JR-500SE; John is so-so about the change, but Shelagh reckons the new box is a cracker, as her HPX total shows.

Our other YL entrant, *Lynne Hyder (Southampton)* has a rather shorter list, thanks to the pressure of A-Level swotting; but she mentions that J.C. has at least three readers in the Hyder home alone—thanks!

The best of all reasons for dropping out of HPX is given by *R. Hyde (R.A.F., Locking)* who has acquired the callsign G3ZDW. His first essay was from the Club station with a call into the middle of the pile-up surrounding KX6DQ, who came back immediately—an omen for the future of G3ZDW, we hope!

M. Williams (Sleaford) has a couple of queries in BY—for a second time!—and 5R8BC. As for the former, J.C. is rather inclined now to feel that the BY1PK station is OK, although he has not personally seen a QSL card. 5R8BC is quite definitely a good call, name of Victor, but SWL Williams has lurking suspicions that the one he logged on Eighty SSB may well have been an impersonation.

Another one in line for congratulations is G8DLQ, on Two already with one watt to a 30F5 PA stage; we know him better as *R. Berkolds (Chatham)*. Also a VHF addict is *M. Pipes (Derby)* who wants to know if prefixes heard on Two can be counted into his HPX total. Of course, as long as they are new prefixes—no band is singled out for special treatment in the HPX context.

J. Haig (Hitchin) is cross indeed about the deliberate QRM'ing of the 80-metre DX on SSB by stations wanting to use the DX channel for tuning-up or local QSO's. J.C. has noticed this; and it is surprising how the idea of Phone DX on 3-5 MHz seems to divide into a pro- and anti- faction. There are those who complain of the high-handed attitude of the DX-net towards newcomers; and the net complains bitterly about deliberate QRM on

On p.29 of the March issue we showed an SWL station attributed to one "James Husband"—actually, the name should have been James Batchelor, address as there given. SWL Batchelor is also very interested in small-lathe work and model engineering and here we see the other side of his shack, with tools and equipment and a fine-looking model locomotive at lower right. The radio side is out of the picture, to the left, and is as shown in March.



the DX channel. Although J.C. is no DX hound, his own sympathies are *entirely* with the net. On the rare occasions when he has fired up into the DX net he has always received a welcome, and good operating tactics. However, the DX Net, quite rightly, get annoyed at the BF's who break in and generally mess things up by sheer lack of *nous*—these are generally the types, who, having been told where they get off, proceed to sit on the channel and generate QRM deliberately, arguing that they have been excluded with malice aforethought! The DX Net never fail to welcome a station who has taken the trouble to study the form and call-in on the right frequency at the right time.

Last time out we mentioned that *R. Allisette (St. Peter Port, Guernsey)* had become GC8DCO, and now we have to report that he will not be using his call for a while yet as he is joining the Merchant Navy as a career; but Dick can extract a crumb of comfort in hoping that his duties will allow him a chance to learn Morse and hence maybe get a full ticket in course of time.

The silence of *B. McCombe (Peterborough)* is fully accounted for; Brian has been building himself a Heathkit HW-100 ready for the day when he gets his licence. The beast is completed, and, we gather, has been air-tested by G3KPO with gratifying results, so all that remains is to get that Morse up to scratch!

J.C. really thought that *D. Henbrey (Northiam)* had sunk without trace, although father *N. Henbrey* still reported in pretty regularly. However, deleting David from the HPX Ladder had an effect somewhat akin to the dropping of a bomb—a list of prefixes as long as your arm! Norman and Dave are now using a KW-77 receiver and liking it, as indeed does your scribe.

Talking of explosives, *S. Foster (Lincoln)* had a man-sized rocket for your poor old conductor this time. Last time around, we gave the “thumbs down” to LF4 as a prefix; this one, together with LJ is used for club-type calls in Norway. OI is being used in OH-land as a commemoration, HO for HP during the Pan-American Games in Panama City, and HS4 and HS5 calls apparently being used by U.S. Servicemen, as reciprocal permits are all brought to notice by Stewart.

Those winter gales certainly give the aerials a pounding. *P. N. Butterfield (Wakefield)*, apart from mock O-Levels, has suffered a fault on the receiver, which took some time to find, and then the gales came. The first one fetched down the aerial itself, and the second one completed the job by bringing down the mast as well!

G. Dover (Nottingham) was casting apprehensive eyes at his skywire during the snows, but fortunately it held fast, so that Geoff was able to look in on some of the major Contest weekends, and so pick up many of the prefixes he still wanted. An ATU has been put into service with some success, and the next move is to add a set of earth radials to improve the response on Top Band, where the aerial does not seem to be perking too well.

Noise on Twenty is mentioned by *J. Williams (Tan-y-Fron, Wrexham)*. On several occasions he found the whole band covered in a noise like a hornets' nest. It was far from being a local phenomenon, as it seems stations in both SM and II were on and complaining about the same noise. It is difficult to assess the cause of this although it is likely to be of natural origin.

These exams have also reduced the listening time of

HPX RULES

- (1) The object is to hear and log as many *prefixes* as possible; a prefix can only count once for any list, whatever band it is heard on.
- (2) The /M and /MM suffixes create a new series; thus G3SWM, G3SWM/M and G3SWM/MM all count as prefixes, and, where it is known to be legal, /AM also.
- (3) Where a suffix determines *location*, the suffix shall be the deciding factor, thus W1ZZZ/W4 counts as W4. Where the suffix has no number attached, *e.g.* VE1AED/P/SU, VE2BUJ/P/SU they are arbitrarily counted as SU1 and SU2 respectively, and the same holds good for similar callsigns.
- (4) When the prefix is changed both the old and the new may be counted; thus VQ4 and 5Z4 both count.
- (5) The object is to hear *prefixes*, not countries, thus there is no discrimination between, say, MP4B- and MP4AK - which count as one prefix.
- (6) Only calls issued for Amateur Radio operation may be included. Undercover and pirate callsigns will not be credited, nor may any MARS stations be claimed.
- (7) G2, G3, G4, etc., all score separately, as do GW2, GW3, GW4, etc., and in the same way K2, W2, WA2, WB2, WC2, WN2, all count even though they may be in the same street.
- (8) Send your HPX list, in alphabetical and numerical order, showing the total claimed score; with subsequent lists, it is sufficient to quote the last claimed score, with the new list of prefixes, and the new claimed total, with your name and address on each sheet, to “SWL,” SHORT WAVE MAGAZINE, BUCKINGHAM, to arrive before the SWL deadline for that particular month.
- (9) Failure to report for two consecutive listings, *i.e.* four months, will result in deletion from the Table, although there is no objection to a “Nil” report to hold your place.
- (10) **Starting Score 200.** Phone Table is mixed AM/SSB, with a separate CW Table. No mixed Phone/CW Table, nor will AM-only or SSB-only entries be accepted.
- (11) Lists will be based on those shown in the current *Short Wave Magazine* list of Countries and Prefixes, dated February 1970, and with the current edition of the *DX Zone Map*.

NOTE: The *DX Zone Map* costs 14s. 9d. and includes the latest Prefix List. The *Prefix List* alone, by countries, prefixes and zones, alphabetically both ways, costs 1s. 6d. with large s.a.e. Publications Dept., Short Wave Magazine, Ltd., 55 Victoria Street, London, S.W.1.

J. Brackenridge (Maybole) drastically; however Jim says neither of his receivers will work on MW so instead of listening to "pops" he can do a bit on the bands!

S. Cooper has a Phone entry to HPX—which makes his claim of a WN2 prefix "out of court." The point here is that the American Novice calls are restricted to CW. On a different theme, Stewart and some friends intend to do a spot of /P listening in July from a castle at Banchory, Kincardineshire, using nice aerials like Quads and Yagis for the HF bands, long-wire and vertical types on the LF allocations. This should be quite a holiday!

A "nil" report comes in from *A. Wood (Husthwaite)* who seems to have landed, for the moment at least, in Ward 2 of County Hospital, York. Alan is another one who has an extra incentive to get on and pass the Morse, as he has become the proud owner of the late G3BNM's transmitter, and wants to fire it up.

Dear me! A query on 7Z3AB—never! *J. Singleton (Blackburn)* wrote him off as a miscopying of 3Z3—but in fact he is quite genuine and the 7Z prefix is just a variation on the HZ theme.

From *R. Smith (Basingstoke)* comes sad news—his hopes of sitting the R.A.E. have been well and truly dashed, at least for this coming exam—he was three days too late turning up at the local college for his entry to be accepted; nevertheless, with A-Levels due in June, it is probably as well.

Having lashed out on an Emsac converter which gives excellent results on a dipole, *P. Sharman (Bromley)* has become a little more ambitious, and is busy building a nine-element Yagi array to bump up the received signals. The next step rather sounds like a rotator!

A change of receiver to the Minimitter MR 44/11 has enabled *R. Treacher (Eltham)* to listen on all bands 160-10 metres, albeit Bob continues to favour the late evenings and early mornings on Eighty, a band on which 85 countries have now been heard.

D. Browning (Bishops Stortford) continues his steady climb up the HPX Ladder, using all bands, and during the ARRL Phone contest managed to dig all the U.S. States out of the QRM by dint of a bit of hard listening. As always during these affairs, the ultimate selectivity lies in the human brain and its ability to

SWL's PSE NOTE

We are arranging to allow more time between publication date and the deadline for the next "SWL." Thus, closing date for forthcoming issues will be May 18 (July "SWL"), and July 20 for September. Address is "SWL," Short Wave Magazine, Buckingham.

just disregard noises it does not want to hear.

R. Carter (Blackburn) has listed some HPX queries in his letter, but in fact all of them are good prefixes. SWL Carter's receiver is playing him up somewhat; the fault, it is gathered, has been found—which is the main thing!—but it rather sounds as though some realignment has still to be done to get it peaked up and right "on the nose," as we say.

* * *

A new way of achieving a good earth connection is claimed by *D. Henry (Edinburgh)* who has used a roll of cooking foil. He dug out a hole 2½ feet deep, about three feet long and two wide. The end of the roll of kitchen foil is laid in the bottom of the hole, covered with a few inches of soil, and then folded back on itself, more soil put in, folded back, and so on, till one ends up with about thirty square feet of surface area in the ground connection. David reckons the system works, but does not mention how he makes the connection to the aluminium foil. Changing direction a little, SWL Henry has been having a certain amount of no-success with his ATU design. The answer is to work on a basis of 1½ pF per metre of wavelength, e.g., 60 µF for Forty, and prune the coil to meet this requirement. As for the aerial tapping, the general rule is to tap it as high up the coil as may be, consistent with a reasonably "flat" tuning needing no slow-motion drive on any band, and good signal strength.

A first entry, injected well up the Tables, is from *N. Askew (Coventry)* who has been around since 1959, in the early years using a regenerative home-brew with acorn valves, followed by a BC receiver, an R109, and latterly a Heathkit RG-1.

[over

SWL set-up operated by Richard Burrows, 100 Fell Lane, Kelghley, Yorkshire, who has a fine array of gear and who in earlier years used to write in to this feature, when his layout was a good deal less ambitious. He comments on the low level of activity locally, though there are many licensed stations in the district.

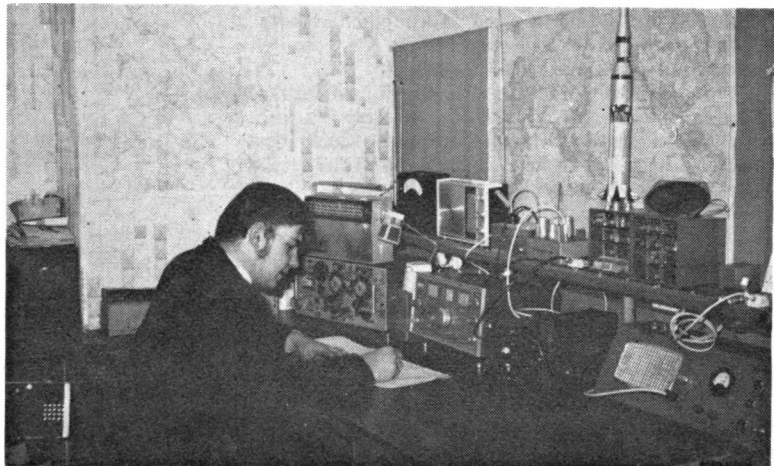

cards back from the Bureau, and is quite pleased at the rate of reply. In general, one can expect a higher rate of return if the reports sent out are more detailed.

Quite deliberately, *M. Quinton (Wotton-u-Edge)* has deleted those prefixes in his list which were logged before December 1, 1968. Mike has done so because he has only kept full records since that date, and he now reckons that he can compare strengths on signals still in the list, and so learn more about the secrets of DX propagation. A good idea, this.

A Trio 9R59 and R.1475 receiver sit in the shack of *A. J. Smith (Leicester)*, the latter being used in conjunction with a crystal-controlled converter based on an old RF-24 unit. For aerial, there is a sixty-foot end-fed wire, coupled to the receivers by way of a suitable ATU. Although this is his first letter and table entry, reader Smith has been listening for about ten years.

That list-without-a-name we mentioned in January turns out to be from *D. Waters*, who was horrified when on surfacing from exams and going back through the issues for a proper look, he realised his error. However, all's well that ends well, as J.C. had kept the entry to one side and was able to tie up the loose ends and put the Table entry in.

Well, well! Some years ago, one of the first to reach the magic 1000 prefixes and head the ladder was

a character by the name of *P. Cayless (Exeter)*. After a very long lay-off, due to change of job and a variety of other commitments, Pete has popped up again with a starting entry in both the Phone and the CW lists. All it wants now is for his old rivalry with T. Popham of the same city to flare up again, and it will be quite like old times. However, Pete is proposing over the next twelve months or so thoroughly to re-organise the shack, and replace the existing HE-30 plus PR-30X and dipoles by something a little more ambitious.

A photograph—not contrasty enough, alas—came with the letter from *Ken Taylor (Sunderland)*. This shows a neat and well laid-out bedroom shack, with three receivers available. An HA-700 is the mainstay, backed up by a 19 Set, and a BC receiver, as well as a nice array of QSL cards surrounding a map of the world.

Conclusion

So there it is once again; as usual, we have had to do a little judicious selecting in referring to the letters, but all the Table Entries have been taken in. For those who raised questions on HPX, the reprinting of the Rules in this issue will doubtless be of help. For next time, the deadline will be first post **May 18**, with your letters addressed as always to "SWL," SHORT WAVE MAGAZINE, BUCKINGHAM. Till then, good DX.

THE MOBILE SCENE

BY the time this appears in print, one of the biggest Rallies of the Season—the North Midlands at Drayton Park, Tamworth—will already have taken place. However, there are many more to come and the list following includes several additions and amendments. Only those events notified direct to us are included here—there may be some others, regarding which we are not given any positive information.

It is intended, as in previous years during the Rally Season, to cover (with pictures) those meetings for which we receive detailed reports following the event. To this end, organisers are asked to let us have, as quickly as possible after their Rally, notes on such points as attendance; an estimate of the number of actual /M's present, by bands if possible; a count of the mobiles worked by the talk-in stations; and any other relevant information thought likely to be of interest for publication.

In particular, we want good photographs taken on Rally occasions, with descriptive details on a slip separate from the print itself. All pictures we can use are paid for immediately on publication—so it is worth getting the film out of the camera without delay!

What it comes to is that Rally organisers should arrange for somebody to be collecting the required information, and taking the photographs, the whole then to be put together in a report for us.

All correspondence for this feature should be addressed "The Mobile Scene," SHORT WAVE MAGAZINE, BUCKINGHAM.

May 3: Spalding & District Amateur Radio Society's Tulip Time Rally, at the picnic site

at Surfleet, four miles north of Spalding, Lincs., on the A.16. Talk-in will be given on Top Band and two metres, from 10.0 a.m., with G3VPR/P on 1980 kHz and G3XBS/P on 145.8 MHz. There will be trade stalls, a bring-and-buy sale, and a raffle. Refreshments available on site, which also allows overnight camping and caravanning. Further details, with maps and information on the famous tulip fields, from: R. Harrison, G3VPR, 38 Park Avenue, Spalding, Lincs., PE11-1QX.

May 3: Thanet Radio Society Mobile Rally at King George VI Park, Ramsgate, Kent.

May 10: Rally and exhibition at Hanwell Community Centre, Westcott Crescent, London, W.7, opening at 1.0 p.m. by the Mayor of Ealing. Talk-in on 2-4-160m. by GB3EAL, of the Ealing District Amateur Radio Society, organisers of the event. Attractions will include trade stands, raffles and surplus equipment sales. Refreshments will be available on site, there are no parking problems, and the locality will be sign-posted by the AA and RAC. A lot of effort is going into the planning of this event and it should be a good day out for /M's and their families. Information: A. P. Teale, G3SGT, 16 Whitestile Road, Brentford, Middlesex.

May 17: The annual Northern Amateur Radio Mobile Society Rally, at Moor Grange School, Parkstone Avenue, West Park, Leeds,

16—off the north side of the Ring Road, West Park, A.6120. Reception from 12 noon, talk-in on Top Band and possibly 4 metres, trade stands, a surplus stall (bring yours for sale, but *no junk*, please!) and a prize draw. Free car parking, no charge for entry and refreshments available on site. Further details from: D. Binns, G3MGI, 80 Gipton Wood Road, Leeds, LS8-3AQ.

June 14: First Elvaston Castle Mobile Rally, to be arranged by the Nunsfield House (Derby) Amateur Radio Group.

June 14: R.N. Amateur Radio Society's tenth anniversary Rally at the R.N. Signal School, H.M.S. *Mercury*, Leydene, Nr. Petersfield, Hants.

June 20-21: Anglian Mobile Rally, at the Show Ground, Ipswich, Suffolk. Due to last year's success, this has been made a two-day event, for which Trade support is invited. There will be covered space in a large marquee. Overnight caravan parking will be available. Further information: B. W. Garnham, G3SJO, 17 Sutton Park Avenue, Colchester, Essex.

June 21: Rally at Singleton Park, Swansea, organised by the Univ. Coll. of Swansea Amateur Radio Society.

June 28: Thirteenth South-West of England Mobile Rally, at Longleat Park, Nr. Warminster, Wilts., organisation as in previous years.

July 5: Eleventh Mobile Rally to be put on by the South Shields & District Amateur Radio Society.

July 5: Amateur Radio Mobile Society Carnival Rally at R.A.F. Station Alconbury, Hunts. This year's A.R.M.S. event will again be one of their large-scale affairs—fuller details later. Advance information from: N. A. S. Fitch, G3FPK, Hon. secretary, A.R.M.S., 40 Eskdale Gardens, Purley, Surrey, CR2-1EZ.

July 5: Cornish Radio Amateur Club annual Mobile Rally—site and details to be confirmed.

July 19: Rally to be organised by the Scarborough Amateur Radio Society, at Burmston Road Barracks.

July 26: Saltash & District Amateur Radio Club's Rally, at Saltash School, Weardle Hill, Saltash, with talk-in stations on 160m. and two metres, signing GB3SAL. Enquiries to: J. A. Ennis, G3XWA, 19 Coombe Road, Saltash, PL12-4ER, Cornwall.

August 16: The well-known Rally event at Derby, the 13th in their series, organised by the Derby & District Amateur Radio Society, at Rykneld Schools, Derby. (*Details later.*)

August 16: Torbay Amateur Radio Society Mobile Rally, at Newton Abbot Rugby Club ground, on the main Newton Abbot-Exeter

road. Details: L. Webber, G3GDW, 43 Lime Tree Walk, Newton Abbot, South Devon.

September 20: Peterborough Mobile Rally, at Walton School, Mountsteven Avenue, Peterborough. Further details from G3KPO, *QTHR*.

All items for inclusion under the Mobile heading should be sent, at least six weeks before they are to appear in print, to: "Mobile Scene," SHORT WAVE MAGAZINE, BUCKINGHAM.

"THE RADIO AMATEUR'S HANDBOOK"

47th Edition, 1970

The latest issue of the *ARRL Handbook* is a fully-revised version of previous editions. It has been making an annual appearance for the last 40 years and more, and as such is the most up-to-date and comprehensive guide to the procedures and techniques of Amateur Radio, in all its many aspects, available in print today. Indeed, throughout the world, it has always been regarded as the "Amateur's Bible." Tens of thousands of copies of each edition are sold, and it is one of the best-sellers in the American List of Technical Books generally available to the public.

Now, let's have a look inside. The contents are divided into 25 chapters, covering the theory, design, construction and operation of all manner of amateur-band equipment, from Top Band to UHF, including transmitters, receivers, aerial systems; test gear and measuring apparatus; power supplies; tools and workshop practices; portable and mobile rigs and antenna systems for them; constructional methods, and the use of materials.

Of particular interest (to the general reader outside the U.S.) is the catalogue section, which in more than 40 pages lists and illustrates all the latest American equipment, of which one hears so much on the air! The section on the characteristics of valves and semi-conductors—divided into receiving, transmitting and power supply categories, covering everything from the small Rx types to large Tx valves and rectifiers for heavy PSU's—alone takes up over 30 pages, constituting a full reference, of course including base-connection diagrams for valves and semiconductor lead nomenclature. (This section has its own index.)

The remaining 600+ pages, profusely illustrated with circuit diagrams and clear pictures of practical amateur-band apparatus, from low-power to QRO, are in good print, with the text well set out and all the technical matter written in easy language for the understanding of the radio amateur. And there is a comprehensive Index, fully cross-referenced.

As always, the new edition of the *ARRL Handbook* is again the standard text-book for all with an interest in Amateur Radio—whether theory or practice, as SWL or active amateur, professional radio communications engineer, or electronics laboratory technician.

The Radio Amateur's Handbook, 47th Edn., 1970, of 670 pages, costs 55s. (paper cover), or 70s. in hard-back, post free, in secure packing. Available for immediate delivery, from stock, of the Publications Dept., Short Wave Magazine, Ltd., 55 Victoria Street, London, S.W.1.

COMMUNICATION and DX NEWS

E. P. Essery, G3KFE

THE general summary for last month could well be taken as "never a dull moment"—whatever band you favoured. Ten metres and Top Band seemed to be the pick of the crop, the former because of the sustained good conditions and the latter because of the interesting nature of the activity. This being so, your conductor will say no more, but get into the matter at hand.

Ten Metres

Here we have an allocation the characteristics of which can change rapidly from being all-same VHF to first-class around the world. This month it has quite definitely had its "DX Hat" on its head, and not just in daylight hours, either.

For G3KFE this band provided the pleasure of the month, in the form of a QSO with 9J2KP during the Easter recess. Not much in the way of DX, possibly, you may say. The point here is that Alan and your scribe have been looking for a

contact since he went out to Zambia, and this was the first one; and at that, it would not have happened had not G6WA telephoned over a considerable distance to G3KFE, and had not 9J2ER been standing by with his QRO and big signal to help when the going got a little tough, at the Zambian end. To both stations—Thanks!

G3NOF (Yeovil) is a perfectionist; and although he worked quite a lot on the band, Don felt that the usual 28 mHz erratic behaviour was a little too noticeable to be quite to his liking. Fading was also rather deep at times. Nonetheless, single-side-band contacts were made with AX9RY (Papua), ET3ZU, KR6QM, VK9BB (also in Papua), VP7DL, VP8KF, VQ8CV, VU2BEO, YA1EXZ, ZD3K, 4S7PB and all the W wall areas.

It is rather interesting to note how the innovation of Five-Band DXCC has affected the operating habits of the top operators, and in particular W6AM (California) who shows 148

countries confirmed in the six-band table, but has already racked up 118 in 5BDXCC!

Although G3XTJ (Palmer's Green) considers himself to be rather inactive on Ten Metres, he is up to 98 countries; his prizes for the month go to VP2VI, VP2VJ and MP4QBK, all raised with SSB.

At G2DC (Ringwood) activity has been somewhat sporadic, but on the other hand, Jack, as usual, always seems to choose the right times to bait his hook. The pattern, in general, was mainly weekend operating, with the mornings good to the East and evenings in the opposite direction, often till late at night. CW QSO's were recorded with AX6RU, AX6HD, MP4BHM, VK9GR, VQ8CR, VS6BC, ZD5X, 5H3KJ, 5Z4LS, 5Z4LW, lots of 9J2's, and all W and VE districts.

A couple of new ones for Ten pleased G3DO (Four Oaks); FR7ZW and UK2FAA were on the other end of these. In addition, one should mention A2CAZ, CR4BC,

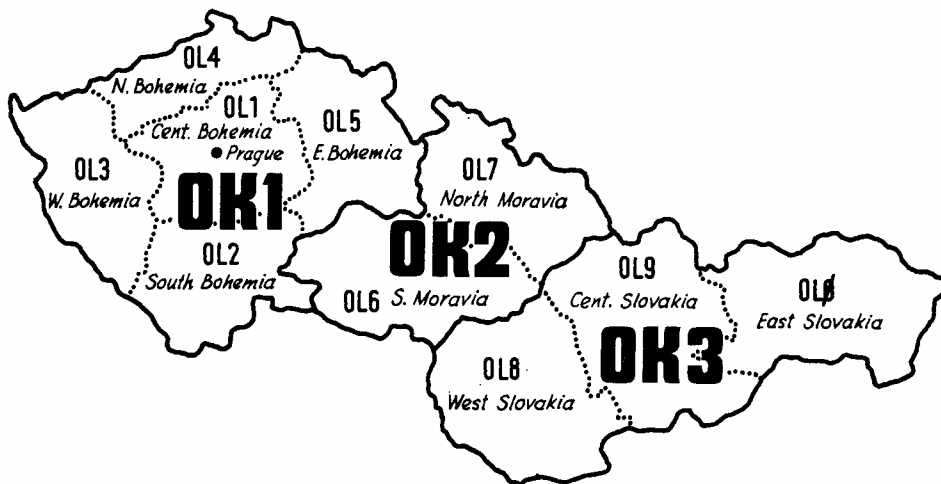

Map of the OK callsign area. Prefixes OK1-3 are used by holders of full licences. OK4 is allotted to amateurs operating from ships of the Czechoslovak merchant fleet. Stations specially on the air come up with OK5/OK6 as prefixes. Certain non-amateur experimental stations working in our bands sign OK7. If you are fortunate enough to hold a Czechoslovak reciprocal licence, your prefix would be OK8. The OL's are all novice operators confined to Top Band and two metres.

Acknowledgements "Region I News" of the I.A.R.U., April 1970

CT3AW, DU1IK, EL2's, FG7XL, KG6AQY, VP8KD, VS5PH, and 9V1OF—all sideband contacts.

It is quite an event to have a report from G3IGW (Halifax) other than for Top Band, but this time Mike has excelled himself and applied his RF to five of them. Ten however, receives but brief mention—just a CW QSO with HS5ABD.

The build-up in conditions during the month is particularly noted by G2HLU (Reading). A new one towards the end of the period was CT3AW, and VQ8CR was hooked on all three HF bands as a little compensation for the return of the card from VQ8CC a while back, marked "no QSO." Looking to the early part of the period, Harold's little dabble in BERU was particularly frustrating, marking as it did the bottom of a trough in conditions on all bands. However, as already indicated, the rise during the month was quite marked, and indeed provoked G2HLU into slinging up a vertical dipole as well as the "ZL Special," to work out to somewhere other than North.

A first report from G3WTV (Torquay), who has Sommerkamp gear tacked on to an aerial farm consisting of a TA33-Jr. for the HF bands at a height of 80ft., and inverted-Vee dipoles for Eighty and Forty metres, the former at 65 and the latter at 55 feet. Keith found Ten in, as he puts, it, "grand shape" during most of the time, with AP2MR, AX9DM and AX9RY (both on Papua), CT3AS, EL2S, EP2BJ, EP2DX, HS1ABU, JA's, KR6QM, KR6VX, LU2DEK, MP4BBA, OA4LA, PZ1CU, VP2VI, VQ8CW, HC8GS, UH8BX, XE2EX, XE2IH, ZS's, 5H3LU, 5N2AAE, 9J2PU, 9V1OJ all booked in, not to mention the odd gotaway.

At G3YDX (Newquay) a very pessimistic outlook seems to have prevailed, but withal Ron summoned up enough enthusiasm to try Ten on occasion, coming out of it with 5N2AAF, CR7IZ, VP2LX, VP2MW, CR6's, EP2TW, FR7AB, 6W8XX and ZF1GC, all sideband, not to mention 9Y4AA, 9Y4VU, HK3AVK, KH6RS, OX3ZO, VS6AF, VS6FK, OA4PF, FY9YQ, CX9BT, CX1BBV, HS4ABS, 6W8XX and ZD9BM—which hardly argues poor conditions!

Here and There

From G3MLN (Gerrards Cross) comes a letter discussing the usual fatuous activities of one "AP1RIL" who appeared on All Fools Day on Forty. G5BB was even more amused by the size of the pile-up.

A contest with a mite of extra interest is being laid on by the Bermuda Amateur Radio Club. Although it has been run annually since 1959, this year the scope has been widened to include all the U.K. countries. The dates are, Phone 0001 June 20 to 0200z on June 21, CW the same times on July 18/19, bands 3.5 MHz to 28 MHz. Exchange RS(T) plus the State, Province or county, with as many VP9, W, or VE stations as you can at three points per QSO. On each band, total the parishes of Bermuda you have worked, and add the band totals of parishes together. Use it as a multiplier to your QSO points score. Full details may be obtained, with log sheets, from VP9MI, P.O. Box 275, Hamilton, Bermuda.

Now, what do you get for your effort if you put up a good score? A trophy, or certificates signed by the Governor, to the leaders in each U.K. country. In addition, the winners in each country will be transported to and from Bermuda *gratis*, and put up similarly at the Top of the Town Hotel for one week, to enable them to attend the annual banquet of the club and receive their awards personally. Logs to be received by the Contest Committee, Radio Society of Bermuda, not later than August 15, 1970.

Next, a DX-pedition for the entertainment of the EI lads comes up for mention. Limerick Radio Club will be going to Bere Island off South-West EI, over Whit weekend, May 23-May 25, and will be on all bands Top to Ten, signing EI0AO (Atlantic Ocean), with SSB and CW in alternate hours of the operation. QSL's to EI5BX, *QTHR*.

No doubt many operators on the HF bands will have heard a station signing JY1 on Twenty, usually around 14200 to 14300 kHz from 1600-1700 and after 1930z. This call is owned by King Hussein of Jordan, who at present runs Drake gear to an 18-AVQ aerial, although it is understood that Collins equipment is in the offing, *plus* a Mosley Classic beam. A QSO results in a

"FIRST-YEAR-OF-OPERATION" LADDER

Top Band Only

Callsign	Date		Countries
	Licensed	Counties	
<i>Phone and CW</i>			
G3YMH	3/6/69	66	16
GM3YOR	30/7/69	62	10
G3YPT	20/8/69	53	14
G3YXM	1/12/69	53	10
<i>CW Only</i>			
G3YMH	3/6/69	62	16
G3YPT	20/8/69	49	13
G3YXM	1/12/69	13	8

A first entry for this ladder must contain a statement of the date of first licensing or of commencing operations if later.

fast return to a QSL aimed at P.O. Box 1055, Amman.

By the time this is published the *CQ WW WPX Contest* will have taken place, and it is understood the PYs would have been using a new string of prefixes—ZV, ZW, ZX, ZY and ZZ—for the event. These will translate directly into the normal PY calls and the QSL's go to the PY (suffix) address as given in the *Call Book*.

It is believed that on May 10 the USSR will be running a Phone Contest but the usual CW affair is being deleted from the calendar; however at the time of writing there is no firm news one way or the other.

As a result of the lack of clarity in the "First Year" table G3ZCC (Chingford) sends in an entry covering the HF bands; he uses a TT21 PA on AM and CW with 100 watts input on 80-10 and a modified CR-100 receiver. Mike was first licensed on January 30 and is clearly piling up a respectable score on the HF bands; we hope he will show an entry in the six-band table ere long.

A DX-pedition for the county-chasers on 160, 80 and 40 metres is being mounted by G3LGN and G3UGC, with a KW-2000A and KW-2000B as equipment, over the weekend 16/17 May. Annan, Dumfriesshire, is the selected spot, at NGR 143672 and WAB Reference NY-16.

G3SWH writes to dispute the G3JFF claim to be the first G-Maritime mobile to maritime mobile contact, saying that there were several earlier ones, and citing his own QSO with G3RSP/MM on *Esso-Mercia*, while G3SWH was in s.s. *Ottawa*, on January 18 last year. G3KFE has a feeling in fact

it goes back quite a bit further even than that.

On to G3ZES (Barking) who had just got his first three weeks on the air completed when he wrote. Eight countries worked on Top Band already, plus TA2E as a gotaway, and a large number of counties, suggest that in spite of the moaning of the old-timers, at least some of the new 'uns are going to be good operators with big signals. Alan, having made such a good start, has now to QRT until he completes his examinations.

From G3PHT we hear that from April 30 to May 3, a group of YV's will be operating from Aves Island, signing YV0AL. CW frequencies will be 21050, 14050, and 7010 kHz; but SSB will be used on 28595, 21295, 14195, 7080, and 3795 kHz, listening up to 10 kHz HF. QSL's via W2GHK.

DL7FT's ZA expedition is down for May 10, and the gear is said to be all ready; but funds are short, though donations to W6KNH may be enough to avoid a cancellation on this ground. It is now understood that ex-TA2BK also has hopes of a ZA call when he goes there for ten days to visit relations.

Fifteen Metres

G3WTV was looking out for a contact with FR7ZG, Guy, and thought he had found him one afternoon on Fifteen. When raised, the FR7 Keith called turned out to be FR7ZW; fifteen minutes later another FR7 was raised—but still no contact with Guy! That's the way it goes. As some small compensation, G3WTV made two-ways of it with HC2GG/1, HK5DE, FB8XX, FR7ZD, FR7ZW, PY7AAU, VP2VI, VP5TH, UQ8CW, ZE1CX, 3V8AL, 5N2ABB and 5N2ABH.

From G3IGW comes a report of "scores of JA's on Sideband," with CW contacts to H55ABD, JX5CI, VQ8CR and VS9MZ to balance the account.

A new one on the band came the way of G2DC, when Jack connected with YB3DC, who is on regularly from 1500-1600z, usually lurking around 21010-21020 kHz, with a "slightly distinctive" signal—good copy, though—derived from a single 807 fed into a dipole. QSL to Box 27, Surabaya, Indonesia. For the rest, MP4BHM, assorted VK's, VS6AA,

VS6FX, VS6BC, VP7DX, VP9BK, VQ8CR, 9G1HM, 9V1PV, 9V1PA, and all W/VE districts.

His Top Band wire is used by G3XTJ on 15 metres to good effect in spite of its tendency to be a bit directional; be that as it may, it booked in PJ9GF, JX5CI, OJ0MI, ZC4BX, VS6AA, VP7DX, EA8HA, KV4GP, OH0NJ, ZM3FK, 9G1HM, hordes of W6's and W7's, and some JA's.

Only one QSO on Fifteen is mentioned by W6AM, who has clearly been giving Eighty the full treatment; his one was CR3KD, 21337 kHz, at 2252 GMT, with WA3HUP Mc'ing things.

VK/ZL/JA paths have been opening frequently, according to G3NOF, the long one from 0730z and the short one from 1000. W's were in from noon to midnight, and even later. A gotaway was EA9AA, but

the bell was rung on AX9EP (territory of New Guinea), HL9UZ, JX7MN, KH6FGA/KG6, KR6LY.

To add to his troubles of last month, G3YDX (Newquay) has now got TVI on the band from a neighbour who has just bought a colour TV set, which put him right "out of court." Ron is moving to an area where aerials are taboo altogether—but he reckons to get going again somehow even if it means a Joystick decorated to look like a lampstandard!

Our 21 mHz specialist GM3JDR (Wick) has been a bit out of luck this time, as his CW activity was wiped out by a faulty keyer; this meant Sideband only, giving HS4ABW, MP4MBB, KP4FS, 9M2BO, ZE1DP, 8P6BQ, FR7ZW, 9V1PP, VQ8CW, ZS5FF, UW9DZ, CX9BT, 9Q5GI, HSIABU, PZ1AH, MP4BBA, FG7TD, HT1BW,

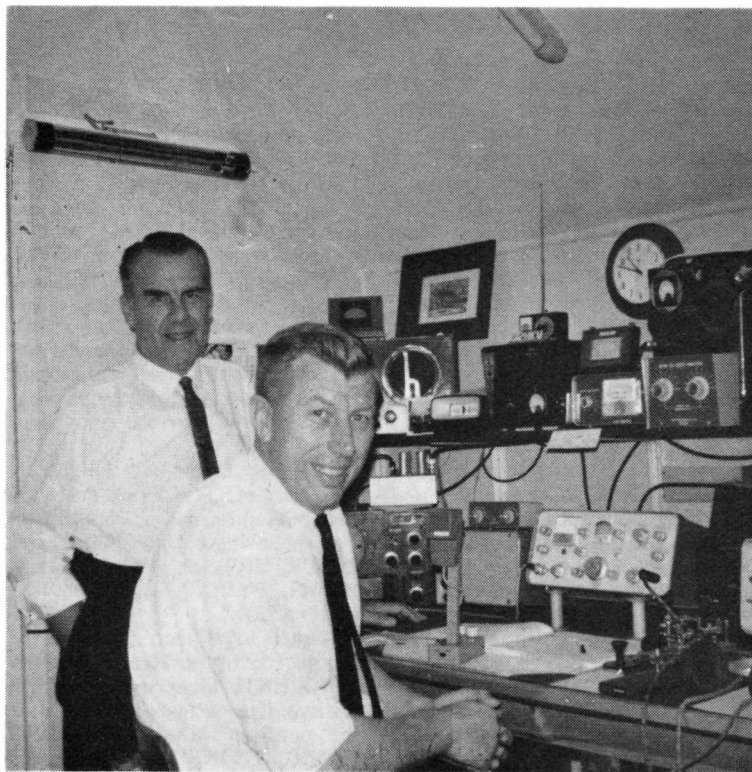

G2HKU, Ted Trowell, in his shack, Hamlyn, Saxon Avenue, Minster, Isle of Sheppey, Kent. It is built into the roof-space of the house, and with the gear all bands are worked. Standing is ON4CC, well known on the DX bands, who was running SSB as long ago as 1950 and has been winner in three successive ARRL DX contests. G2HKU himself has been writing in regularly to this feature for many years.

C31CR, HK4CAV, VQ8CZ, PY7GAH, YV5AG, UW9YE, 9Y4BFC, PY8HC, XW8BX, UA9MP, ZD8DE, JW7UH, KC4AAD (1945z), ZS2AG, CR7IK, 9Q5GV, HS1ABO, AX5DO, UV9OR, KR6FQ, all W and VE districts and a total of 66 JA stations.

At G3VLX (Sidcup) the motto is still "softly, softly, catchee monkey" but the pace is steadily being stepped up as confidence is gained. The trap dipole and Sommerkamp was given an airing or two on Fifteen, and logged W, VE, JX4YM, CT1AW, YT1BCD and UP2PA. As a newcomer to the HF bands, Deryck is quite surprised at the stuff he can raise, with only a trap dipole, home brewed at that. Sometimes it gets a bit on the frustrating side, competing with the QRO-plus-beam boys, but it is, G3VLX claims, best to adopt the "sour grapes" attitude and to claim these lads have it all the easy way and no fun! *Hmmm.*

Bits and Pieces

A late note passes on a first impression of the recent RTTY contest as seen from G8CDW, Ted Double (Enfield). Asia, Africa, and South America were none too well represented, EL2BD being about the only African, and KR6JT with KG6NAA giving Asia. On the other hand there was no shortage of European and North Americans, so that some considerable scores were rolled up, exchanges in the 150-160 mark being swapped by quite a few stations towards the end. G8CDW found conditions pretty fair, with good propagation on, in particular, Ten and Fifteen. It is, we gather, too early to make any predictions as to the eventual outcome, but the results may well be available at the end of May or beginning of June.

Last month we cried a halt to the reminiscences of the early years which stirred up so much interesting correspondence; and so it must remain—however, your conductor cannot help noting one memory, from G8HX (Mansfield), who recalls as his crowning achievement in the pre-War years having a shack in his bedroom, and upending a two-volt accumulator all over the bed!

G2FUX (Ringwood) comes in at this point with the news of the resignation of W3HQO from the

Ex-G Club after so many years, on health grounds. Changing his subject, G2FUX mentions the Amateur Radio Friends of Ockendon, and the award they put out, the rules of which we covered in these columns some months ago. It seems that as a result of the efforts of those who have claimed the award, the Ockendon Venture has made over £270, the figure for 1969 being only £40. If you *must* chase wallpaper, then this is the award to go for—if you don't, then try it anyway! You can always salve your conscience by thinking you are improving your operating ability and helping a Good Cause. For details, drop a line to Frank Fletcher, G2FUX, 53 St. Ives Park, Ringwood, Hants, BH24-2JX.

Still with G2FUX, we gather that Peter Dodd, G3PBD/GD3PBD/7Q7PBD is now travelling *overland* to ZL and will be operating /Mobile from any of the countries *en route* where he may find it possible to get a permit.

Twenty Metres

Like Piccadilly Circus—if you hang around long enough you are *sure* to snag a specified station—the only problem being to avoid a TVI complaint and/or the QSO being wiped up by QRM! It must be said, though, that for those who give their TVI problems best, and stick to Top Band with their transceivers, Twenty is well worth a whirl after the Idiot's Lantern has ceased its nightly drivelling, remaining open quite often till hours when respectable citizens are long since abed.

That trap dipole and the gear in the shack of G3VLX are gradually spreading their wings, contacts on Twenty having been registered with ZC4CV, JX3MN, VE's, YV1LA, PY1MI, PY5EX, ZD7SD, 4Z4BG and YA1EXZ.

Rather more than usual in the way of activity on 20m. is reported by G2HKU (Sheppey) with SSB sessions late at night and early in the mornings to record. YV2KG, CR4BC, VEØNED/MM (who told Ted the "N" in his call signified a station on a RCN ship), YV5AYY, PY2DSQ, HK3OJ, VP2VI, HR1WSG (a new one), 6Y5SR, HC8GS (another new country) all came into the net between about

midnight and 0230 GMT, while ZL3SE, ZL3JQ, ZL2KP, AX2LX and XE1E were booked in between about 0650 and 0730z. Unearthly hours these Sheppeytes keep!

When first the band opens up in the morning, the skip is very short with USSR and I stations, followed by ZL, the VK's being a little later, around 0730 to 1100. Some mornings a few W6 and W7 stations were present at rollcall. 1600z onwards has seen shortpath openings in the general direction of JA, KR6, KC6, and KJ6. Evenings have been pretty good to North and Central America—and if G3NOF says they were good, they were exceptional. A look at the fugitives from the G3NOF form of justice first: The line-up takes in AX9XI, AXØKW, AXØLD, KC6ES, KJ6CF, SU1MA, VK9LB, VR6TC, ZD7SD, DU1DBT and FY7YQ. However, Don was not to be deprived of his scalps, which included AP2KS, AX9DS (New Guinea), AX9JL likewise, ET3ZU, FB8ZZ, JA's, KG6NAC, KL7CVX, KR6HB, KV4GN, MP4TDA, MP4TDK, VEØNA, VP2AN, VP2LL, VP2LX, VP9BK, VR4CG, VU2BEO, ZD9BN (Gough Is.), 4S7PB, 5N2AAN, 5Z4JD, 6W8BD, 7Z3AB, 9Q5CO and 9N1RA.

Strange how even the real DX is still at the whim of the XYL; W6AM noted contacts with FP8AP on all three HF bands, and drily adds an aside to the effect that "Gus is much more active, as Mrs. FP8AP is visiting in Paris." Clearly, instead of DX-peditions there should be special shack-equipped retreats to which XYL-haunted types can hide for a spell of intensive operation free of the chores of the apron and the paint-brush!

Bags of enthusiasm from Ed, G3XTJ, who got around to making and hanging up a thirty feet dipole for Twenty. Results so far are encouraging, with TA1HY, 6Y5AH, EA8FS, C3ICT, SV's, AX3 and AX6 in the book.

Most of the keen DX'ers go for the morning session before work as the best time for operating, and G2DC is no exception. From 1100 to 1500 the band fills chock-full of EU stuff, often with raucous notes and clicks like an electronic banyan-tree. If you take a digging tool to this lot, it is often easy to extract the

Far East signals—a fine selection being available. Nothing new was worked by Jack's CW, but his QSO's with AP5HQ, VU2JN, VU2WP, VQ8CR, VQ9CD, VS6BC, VS6FX, VS9MZ, VP7DX, VP9BK, XE2BBO, ZM1AAT/K, ZM1BN/S, ZM3PO/C, 9V1PB, 9V1PA, VK1-8, ZL1-4, VE1-7 and all W call districts show the quality of what was around.

G2HLU spread his activities over most bands, with 14 mHz yielding three contacts of interest in VQ8CR, VQ9CD and AP5HQ, both the latter being useful new acquisitions.

Our newcomer from Torquay, G3WTV, rather neglected Twenty in face of the undoubtedly transient nature of the 28 mHz DX, but did take the odd look in the late evening or after the witching hour, looks which enabled him to work HC8GS, TA1NC, VP2GEE, YV5BQU, 6Y5GA and 9U5CR, the latter being an all-time new country.

Eighty Metres

Noticeably, a lack of interest in the letters which will probably change as we come more into summer conditions. A certain number of stations persist in making the operation of the SSB DX Net nearly impossible with their deliberate jamming and tuning-up on the DX channel. However, it is now understood that several of the offenders have been positively identified, in this country and abroad, and the details forwarded to the licensing authorities in the countries concerned for action. As far as the U.K. stations are concerned let us hope the authorities will just confiscate the offender's equipment and give it to RAIBC where it can serve a *useful* purpose.

G8HX, being a CW man, has not suffered *too* badly from the attention of the Lids at the other end of the band. However, he has a different problem—plenty of thumping reports from U.K. and the nearer Europeans but no DX! Efforts to rectify this situation have been made, resulting in an aerial current up by a third for the same input, on both 80m. and Top Band. Sounds as though Frank has one of those oddball aerial/propagation problems at his location that make the whole study of aerials so fascinating. Like, for

Reporting the HF Bands

instance—G3KFE can scare up S9 reports on his Top Band SSB from anywhere except Harlow, where he will be lucky even to get a QSO. No known explanation, and no effect made by changing round the aerials.

Being after 5BDXCC, W6AM has set his mind to clearing up the contacts for the one outstanding band, 3.5 mHz. We find HR2HHP, VP2EX, CE3OE, KC6ES, KZ5NR, PJ9DFT, W4DRD/VP9, CO8XL, KV4FM, HT1HSM, XE2PIS, all mentioned in the first letter and worked on SSB, around the 3798 kHz mark; the second letter takes over with the CW, listing such stations as TF2WKF, FP8AP, FP8BO, FR8AP, EL2CB, EL2AW, and all of them raised in two days.

G3VLX has obviously had a stab or two at DX on Eighty, and indeed seems to have got out better there than elsewhere. ZM4NH, ZM3GQ and VE2MY were all raised without too much trouble during the early morning spell.

All new countries on Eighty for G3WTV were CR4BC, HC2GG/1, HI7CAF, HK3BQM, HK0BKM, JW7UH, KG4AS, KZ5DA, OA8V, PZ1AH, W4RDD/VP9, YV5BTS, ZB2AY, ZL4NH and 3V8AL; the JW7 constituted an all-time new one for any band.

An all-time first was also registered by G3YMH, who made his linear take power on Eighty and for about a week paddled a key, raising PA, LA, OK, SM, DK, DM, 3Z, ON, UP2, OZ and YT, just to prove the gear would go reliably. But after a week of this sort of thing Ron found there was not the same sort of thrill in it as there is in Top Band DX-chasing and so came back to his old haunts.

Just about everyone can rationalise his particular choice of bands. GW3UUZ (Nash Point Lighthouse) has a perfect spot for LF operation, as anyone who has heard his booming great signal will agree; sitting on a salt-water "ground" and with a perfect take-off in each direction, not to mention a couple of hundred-foot towers conveniently spaced and

rigged so that aerials can be hoisted in a storm of rain without getting wet. This being the case, Andy reckons that to go to the HF bands would make it all so easy that he would lose interest. Andy says "leave the little boys' bands at the top to the little boys and come on down to the LF bands where the men are!" Someone is possibly having a little stir?

CW yielded G3IGW most of his contacts on Eighty, naturally; mentions included AX3APN, KV4CI, ZA2BB, offered without comment, ZL1AH, and 6Y5SR. The SSB produced fewer contacts but still of considerable interest—G31CT, OJ0MI, VP2VI, and 9L1RP among them.

G2DC has always felt the best time for 80m. is from about 0500 to 0800z, which means either staying up late or getting up early. However, since the last period tends to be somewhat bothered by QRN and the development of commercial signals, the vote goes to staying up late. In the course of these researches, G2DC found VP7DX, VP9BK, ZC4CB, ZM3GQ, ZM3FZ, ZM3AW, ZM4IE, VR1-2-3-7 and all the W districts.

Forty Metres

Quite a crop this time in the way of reports. G3XAP (Stowmarket) swears he has been on Forty all the month—even though your scribe called him a couple of times on Top Band! In the second leg of the ARRL affair, Phil rolled up 185 stations, oddly enough the exact number worked in the first leg. All districts of W were represented, plus VE1-2-3-4-7 and VO. During the rest of the period 38 W's included all districts. One of them, W7RM, was using a five-element beam (*Ye Gods!*), but others in the list doubtless had something a trifle simpler, including PY7BQO, 6W8BA, AP5HQ, UM8FM, CX3AN, TF5TP, LU3DD, CT3AS, HB0XGR.

G3YTS (Kippax), after your conductor's comments last time out, sent another report, and agreed with

the guess that he had earlier been an SWL—seven years' apprenticeship, in fact. Forty CW is Rob's forte, and he worked all the W call areas, assorted VE's including VE7BD, VK3FC, LU7AS, PY2FCJ, CT3AW, CT3AS, FH3KJ, ZC4CB, ZB2BO, ZM3GQ, HBØGR, UK9HAC, C31CT. Incidentally, Rob forgot to put his call on his letter, which led G3KFE into some researching to find who he was!

After all the efforts putting up the ground-plane for Forty, the thing went sick and had to come down again, laments G3YDX (Newquay), who records only two contacts on it, with F9UC/FC and EP2BK.

Again on this band there is evidence of G2HKU burning the midnight oil, contacts on Forty SSB being booked up to LX1BW, UK6LAZ—that station in Taganrog mentioned last time—PZ1CU, which was a new country for Ted—YV2KG, YV1BI, YV4UA, HK6BRK, and 9Y4MM, all around 0100z. G2NJ (Peterborough) is still mostly on Forty and mainly interested in the /MM stuff, but he is occasionally to be heard on other bands; thus, YO4ASG/MM was raised about 2200z on March 15 on Forty CW and then again seventeen days later on Twenty CW, the interesting point here being that he did not seem to have changed his position much in the interim.

Sad to say, G3XTJ rather neglected 40m. in favour of other pastures. However YV1EJ and YV4UA responded to his SSB blandishments in the wee small hours, plus AP5HQ, all W districts other than 7, and an assortment of VE's on CW.

Again, only the new ones are mentioned by G3WTV, who found on Forty the following additions: HK3WO, HK6BRK, HR1ALT, PZ1AH, VP7NH, VP9GE, and XE2IH, with several other new ones who seemed to scent him coming and went QRT!

W6AM mentions several interesting contacts, and of course as one goes up in frequency so does the effect of his antenna farm on results become more marked. Forty gave HO1HE (who is *ex*-HPIHE), UK5LAK, UW3AJ, and YU3DRA—remember that W6AM is well on the other side of the world.

G3YMH seems to have been

seduced from 40 metres by the attractions of Top Band, although he did have a few late dabbles which produced the Europeans and a few W's.

Quite an interesting contact is singled out for a mention by GW3UUZ. On March 1, at 1930, Andy worked an ON, for a report of 579. So what? But the guy was using 400mW to a couple of transistors, and feeding his precious milliwatts into a Joystick!

CW-only operation by G3IGW was the order of the day, and it seems to have paid off quite well as the list shows AP5HQ, FR7ZX, VP7DX, VS6BC, ZD5X, ZM4BO in the early evening, 5H3KJ, 5H3LV and 9J2RQ.

Let G2DC have the last word. As he says, Forty is pretty grim till around midnight; last month, about 2000-2130, there were VK's there for the taking, but never a QSO completed thanks to the QRM. The DX is there if you scratch for it; all you have to do then is hang on tight! Jack proved his point by working VP7DX, VP9BK, ZC4CB, ZM3GQ, ZM3FZ, ZL3AW, ZL4IE, VE1-2-3-7, and all the W call areas.

Now Top Band

And there is precious little space left in which to tell the story, so it will have to be somewhat of a summary.

9H1BL duly appeared, with G3VPS in the driver's seat, and at once a horrible discovery was made. TVI! This put a stop to all the skeds arranged for before 2300 GMT. Cards were promptly sent out to advise of the rearrangement—but the one aimed at G3KFE and the back-stop one sent by G3WPO both went astray in the post. Anyway, with help from DL9KRA, it all got sorted out and some 80 people who were prepared to sit up into the early hours got there. Thanks to the hard work put in by G3WPO, DL9KRA, and others, as far as is known every one who tried got across, in spite of quite deliberate jamming, and some unmannerliness that is more akin to the 3.5 MHz than 1.8 MHz band. G3FKE, having had his first sked fail, did not get the message, and so did not line up in the queue.

The same problem—TVI—hit the Alderney affair; they were supposed

to be coming on at 8.30 clock, after seeing-off a good dinner, to work all and sundry. However, a couple of QSO's later, it was discovered that although the hotel TV was clear, the chap next door wasn't. Of course, he insisted on sticking the programme out to the end, keeping G3KFE out of bed till 0130 clock, but at least we got the QSO! The same team were on from Guernsey, and Sark, to give many of the newer operators a first chance at these islands. A good show.

Other stations mentioned as gracing Top Band with their presence include OY1R (over whom some doubt is felt), a 5B4NZ who calls for QSL's *via* G3BZU, 4U1ITU, and an ET3USA/MM whose pedigree your conductor will only believe if and when he sees the card.

Now to the forthcoming events on Top Band: By the time this reaches print, G3SVK's tour will be all but over, and scores all the way round will no doubt have risen markedly. GM3OGJ and GM3FSV will be filling in West Lothian on May 29-30.

The Marconi Commemoration affair will be repeated in 1970, GB3FI being on Flatholm Island and GW3VKL/P at Lavernock Point (both off the Glamorganshire coast) and both looking for contacts on May 17. The QSL card for this one is rather interesting, being a three-page fold-out design, which gives room for some pictures of the original gear, comments of the learned men of the day on the results, and George Kemp's diary for the days of the tests between the two points.

Back to DX-peditions. Those looking for Perth should know that G3KRH and G3ONS will be going to that county, from May 30 to June 5. However, lest it be thought that no other activities are contemplated, GM3NVU tells us quite firmly that the county was chosen mainly for the fishing!

Piracy is breaking up again, with GM3XYG reporting in to the effect that his latest batch of cards include quite a few duds, for contacts on 20m. CW, a band not yet worked.

Another doubtful crops up again in the form of EP2RG/MM, who is mentioned by several people. However, nobody mentioned the receipt of a QSL card; so the

assumption has to be he was a phoney. Indeed, most of the /MM QSO's are phoney, although it is a known fact that the OK's are allowed /MM on Top Band; OK4CM/MM is quite definitely good and QSL's.

Note on MDT

This little event—not a contest but just a test to see what is possible in the way of GDX on Top Band in daylight—was scheduled for Sunday, April 12. As it turned out, conditions were poor; it was a very wet day all over the country, with the inevitable result that the ambient noise-level was high. Practically everyone was complaining of “QRN”—actually, noise mainly generated by HV overheads, and not static in the accepted meaning of QRN. Fading was evident on practically all distant signals, such as there were.

From a noisy location in North Bucks., an aggregate of about 2½ hours' listening at intervals during the period resulted in some 30 CW stations being logged, mainly in the G3Y-- and G3Z-- categories. Most were well operated and all seemed to be getting QSO's, even if not GDX. The best contact logged was G3XHI/GW3YGH, in the late afternoon, the distance being about 140 miles. Two G3's in Burnley, Lancs., heard working one another at about 4.15 p.m., were both R5 at 130 miles from our Bucks. monitoring point.

It was noticeable that, as on previous occasions over the years when an MDT has been arranged, conditions improved considerably during the late afternoon. The best period to be on (for this particular MDT) was undoubtedly 4.0-5.0 p.m. Support for the Test did not appear to be over-enthusiastic—however, some interesting QSO's were heard and it is hoped that it was useful for those newer operators who did take part.

G3TNO (Horsham) also reported, independently, on MDT. Out of 17 CW contacts, he worked three stations at over the 100 miles—G3WRJ, G3CLW and G3YXW. He confirms our impression regarding conditions—and also suggests that MDT should be laid on every 3-4 months or so, just to see how daylight conditions on 160m. vary with the time of year. Yes, good idea.

The Tables

All the entries have been taken in, although we must make it clear that the “countries” column of the Top Band First-Year Operators' Ladder refers to 160m., as also does the Counties line. To avoid any misunderstanding on the part of future entrants, the heading will be amended.

Sign-Off

So there it all is, with a bit of a squeeze. At the time of the deadline it looked as though we had no real news to report; but then a record-sized crop of mail descended on your scribe from all angles, changing the piece almost from hour to hour. However, all the letters have been read, all the entries have been taken in and checked, and if anyone has been left out, and not mentioned by name or call in the piece, our apologies, and we hope to hear from you again next time. Blame it all on the rate of change!

Deadline for our next will be **Monday, May 11**, for the *June* issue appearing *May 29*. Closing dates to follow are: *June 8*, for the July issue; *July 13* (August); and *August 10* (for September issue). Address is simply, and only: CDXN, SHORT WAVE MAGAZINE, BUCKINGHAM. Keep the DX ball rolling, and *73 de KFE*.

Late Flash—MDT: Just as this issue was going down, MDT reports for April 12 were received

TOP BAND COUNTIES LADDER

Station	Confirmed	Worked
<i>Phone and CW</i>		
G2NJ	98	98
G3HDO	98	98
G2HKU	96	96
G3WPO	94	96
G13WSS	92	95
G3XTJ	86	94
G3VLX	83	97
G3XDY	79	91
G8HX	76	83
G3XTL	62	78
G3KFE	52	71
G3LXD	44	67
<i>Phone only</i>		
G2NJ	98	98
G3TSL	94	97
G3WPO	90	91
G3VGB	90	95
G3PQF	81	92
G3XTJ	68	84
G3XDY	52	77
G13WSS	50	64

(Failure to report for three months entails removal from the Table. Claims may be made at any time. Six months of “Nil” reports will also result in deletion.)

from: G3YRA (Broadstairs), GM3YOR (Kirkcaldy), G3MEW (Portsmouth), G3XNS (Crawley), G3XDY (Cleethorpes), G3SKC (West Drayton), G3GMK (Southampton), G3OGR (Upton-on-Severn) and G3VFA (Broadstairs). In general, they confirm our summary of conditions as already given. Nearly all made at least a few over-100 mile contacts. These, and any other MDT reports received, will be discussed more fully next time. Evidently, there was more activity than we thought.—*Editor*.

VHF BANDS

A. H. DORMER, G3DAH

PROPAGATION has had its ups and downs during the last month, with nothing really remarkable in the way of DX. From a good site in the South, French stations South of Paris have been audible on a number of occasions, but generally activity has been low, and what distant contacts have been made were all marred by deep QSB. DLØER has been heard weakly, and the Cornish beacon, usually a good indicator of conditions in Kent and Essex, has made only spasmodic appearances. Pressure has been low over most of the country, and the high to the South-West of Ireland, which might have brought some relief from the tedium, moved away North-West before its effect was really felt. Generally, North/South paths seemed to have been better than East/West.

VHFCC Awards

A record number of Awards has been made this month—eight. All but one were gained for operations on two metres, the single exception being that of G8ART who made it on 70 cm. Obviously, there is a close correlation between these Awards and the number of contacts possible on any band, and it is a sad reflection on the current levels of activity on Four and 70 cm., that to date only four Certificates have been issued for contacts on the former, and only nine for Seventy-

cems, whereas fifty-nine have been gained on Two. That all the shy, retiring types are to be found outside 144 MHz can be ruled out as demonstrably false, and propagation conditions, poor though they have been during the winter months, cannot *entirely* account for lack of contacts—so back one comes to the old conclusion that the bands are not being used to the full, and with that arises the spectre of chunks being carved off them.

Agreed, transmissions on 70 MHz are a bit fraught in many parts of the country because of TVI, and, fortunately, pressure to reduce our allocations there seems to be easing. But cases of incurable TVI on 70 cm. are rare and it is on *this* band that most avaricious eyes are being cast, and which we must protect by greater occupancy. The writing was on the wall as long as two years ago and the situation does not seem to have improved much in the interim. Perhaps not enough publicity has been given to the active steps being taken by groups up and down the country to make Mondays a 70 cm. activity night. And probably not enough support is being given to them by those who are aware of this venture. Whatever the cause the dictum of Col. Severin of the Cabinet Offices at the Twickenham VHF Convention two years ago—*Use or Lose*—is too serious and too near the awful truth to ignore.

G3PTM operates on two metres from a QTH at Solihull in Warwickshire. The equipment comprises a QQV03-20A at 40 watts input with AM and NBFM modulation, an FET converter with TIS88's in cascode and an AR88. The antenna is a six-over-six at 38ft. Although some 3,000 contacts have now been made with 870 different stations in 17 countries and 76 counties the QSL return rate is only about 40%. On 70 cm. it is even worse since although 165 different stations have been worked on that band the QSL return is only 35%.

Keith Fisher, G3WSN, gains his Award from Great Baddow near Chelmsford in Essex. The Tx runs a QQV03-20A with 35 watts input for AM and a QQV06-40A at 75w. for CW. The converter has two 2N3819's in cascode and tunes 24-26 MHz into an AR88. The

stand-by converter is an E88CC job. The antenna system is unusual—a twelve-over-twelve slot-fed array at 38ft.; it seems to be causing some consternation among the natives, since an acrimonious discussion is now going on with the local Council, who are muttering about future planning permission for erections of this type. Decently installed, such an antenna can look a lot tidier than some of the cock-eyed multiple arrays for TV one sees, and which apparently are accepted without demur (because, of course, *they* are in the holy cause of TV!) Keith also runs 70 cm. and four metres, and plans are in hand for a QRO job for Two.

From New Barnet, Herts., Steve Berry, G8ART, claims the Award for 70 cm. The gear runs 40 watts input to a QQV03-20A, a BF180 pre-amp into RF and mixer stages using AF186's, the IF/AF strip being an AR88. The antenna was originally a 24-ele at 26ft., but this was later changed for an 18-element at 40ft. Although the QTH is high, about 200ft. a.s.l., there is bad screening in all directions except to the South and East, but a move to a site 350ft. a.s.l., with a good take-off in all directions, is in prospect, and that should improve matters, particularly on 23 cm., in which band Steve is also interested. The RTTY equipment is still in use and runs 50 bauds and 150 watts with a DL6EQ T/U.

A pair of 4CX250B's in Class-AB1 has helped Bryan Pickers of Markfield, Leicestershire, to gain the two-metre Award. A TIS88A VFO on 28-30 MHz is followed by a TIS88A buffer and an E180F amplifier, and this chain feeds the frequency translator described in the February, 1970 issue of *SHORT WAVE MAGAZINE*. The end-product then drives a screen-modulated QQV06-40A on two metres, and this in turn provides the input to the final. Ample drive is available from the QQV06-40A to push the 4CX250's into Class-C for CW operation. On the receiving side, an FET converter with a dual-gate Mosfet in the mixer stage gives 24-26 MHz into an AR88. The antenna is a *Skybeam* at 30ft. Altogether a very nice set-up. In spite of contacts with some 200 stations during the opening last

October, and promises of a QSL from all but one operator, it has taken until now to get all the cards in. The initial return rate was about 22%!

Ted Double, the indefatigable BARTG Contests and Awards manager, gets his Certificate for AM working on two metres from Enfield, Middlesex. Since May 1969, some 220 stations have been worked using a 3-1416 Base Station, suitably modified to improve the modulation level, and a converter with two 6CW4's in cascade in the front-end, feeding 28-30 mHz to either a Star SR-200 or a Hammarlund HQ-120A from a six-element Yagi in the roof space. The whole station fits into a desk in the lounge of a second floor flat on a busy road, with consequent agonies of QRN. The QTH is about 150ft. a.s.l. with best take-off to the South and East, as bad screening from adjacent buildings and rising ground makes operation on other headings difficult—in fact, Ted says that as far as he and two metres are concerned, England consists of that territory to the East of a line from the Wash to the Isle of Wight! As his BARTG activities would suggest, he is also interested in RTTY, and although not at present equipped for transmission in that mode, he has been receiving for a number of years now. A regular task is the monitoring of RTTY transmissions from PA0AA, the Headquarters station of the VERON. Summing up his impressions of two metres, Ted finds it to be a good band for local QRM-free contacts, but at the same time offers opportunities for experiment and DX-hunting when conditions are right, a view with which few would disagree.

Between spells of duty as a Police officer, Dave Button, G8AEL, finds time to operate on two metres, and it is for his work on that band that he gains his Award from Poddington, a small village in the North of Bedfordshire. The county is emphasised as the postal address as given in the Callbook is Northants, and this can lead to jubilation, disappointment or misunderstanding, as the case may be, for county chasers if not noted. The G8/3 callsign hides the identity of G6SLO/T who obtained that call some 20 years ago and only went for the sound licence when the Class-B

tickets were introduced. Although equipped for 70 cm., most operation nowadays is on Two, the Tx being a modified Pye Base station, and the Rx a 6CW4 converter tuning 5-7 mHz into an Eddystone 840A. The antenna is a "handraulically" operated six-element *J-Beam* at 42ft. His QTH is 260ft. a.s.l. but rising ground to the South makes contacts in that direction difficult unless propagation is particularly good. In fact, fewer than ten London stations have been worked, although DX to the North and West is plentiful, and Cornwall has been raised to the South West. The presence of nearby 11 kV power lines, and the pole outside the shack carrying 230 volts to fifteen different houses, doesn't help very much, either! Dave is also equipped for RTTY and still remembers the thrill when he first saw his own callsign coming back on the teleprinter. He enjoys contests and working the DX, but does not make a chore of either activity. He does *not enjoy* gabbled callsigns, and "funny" (?) men in the background during a QSO, and in that he is by no means alone. His thanks are passed to all those who sent him their QSL cards and, if he owes anybody one and they will drop him a line, he will send one by return and refund postage!

Knottingley in Yorkshire is the QRA of Ernest Ashby, G8HCW, most of whose contacts were made

during the period 1966/67, as he has been away from home for the last two years, and although he could offer 100 cards from Yorkshire stations *alone*, the others took a little longer to accumulate. The 120ft. a.s.l. site is screened to the East and South-East, but pretty good in other directions. Little difficulty is experienced in working the west-coast Lancashire stations over the Pennines, for example. Ernest claims to be the only station in the West Riding *not* to have worked G3DAH. Must see about that! The two-metre Tx runs 25 watts to a QQV03-20A on AM and NBFM, the latter a necessity due to the "Tennessee Valley Indians," although the Post Office has cleared him and the fault lies with the local set users. The converter is a double E88CC cascade with an ECC81 mixer, producing 4-6 mHz into a CR-100. The antenna is a stack of four two-over-two *J-Beams* at 40ft. with 82in. spacing, and Ernest still hides his head under the blankets when the wind gets up a bit! He also operates on four metres, but in his part of the country this band has its drawbacks—the Indians again, of course.

Lastly, Bob Fuller, G8CEZ operating from Gloucester. His two-metre Award was gained with a Pye Base station Tx initially, although he now has a 4X150A with 150 watts input modulated by a pair

THREE BAND ANNUAL VHF TABLE
January to December, 1970

Station	FOUR METRES		TWO METRES		70 CENTIMETRES		TOTAL pts.
	Counties	Countries	Counties	Countries	Counties	Countries	
G2JF	—	—	35	8	15	4	62
G3DAH	7	1	35	8	2	1	54
G3OHH	10	2	27	2	5	2	48
G8APZ	—	—	25	2	10	1	38
G15ALP	5	3	17	6	—	—	31
G3EKP	5	2	8	3	2	3	22
G3COJ	—	—	11	4	5	1	21
G8AUN	—	—	17	3	—	—	20
G8BWW	—	—	14	4	—	—	18
G8BKR	—	—	7	2	4	2	15

The Three-Band Annual Table shows total claims to date from the year commencing January, 1970. Readers are reminded that claims should be sent as here-to-fore to SHORT WAVE MAGAZINE, BUCKINGHAM. Summaries by bands will be published at regular intervals.

of 6146's. At the start of activity in November 1968, he used a valve converter but now has an FET type *à la* DL6SW, which tunes 24-26 mHz into an AR88. The antenna is a ten-element *J-Beam* at 26ft. The QTH at 60ft. a.s.l. is screened to the South and East by the Cotswolds, but he gets out pretty well in other directions. Congratulations to all concerned.

One word about the QSL cards which are required for verification purposes. For a number of reasons, which do not need elaboration here, it is requested that these should be sent to G3DAH within *one week* of receipt of his request for them. Cards not so received may render the claim void.

DX-peditions

The Verulam Club foray to the Northern counties, of which preliminary notice was given in last month's "VHF Bands," has now been firmed. Operation will be with the call sign G3VER/P, on 145-420 mHz for SSB and AM, and on 144-098 mHz for CW. They will have about 200 watts p.e.p. input for SSB, 150 watts on CW and 60 watts on AM. No contacts will be made in the mornings, but skeds can be arranged by s.a.e. via G8BNR, *QTHR*, from 1930z each evening. Skeds are timed at five-minute intervals, with the last 15 minutes of each hour a free-for-all. Operation will normally finish around midnight, but if EA and CT are coming in, will go on a little longer! First day is Sunday, August 9, and the last is Thursday, August 13. Calls on frequency will be accepted during the sked period, but not outside it. However, they will be looking around their transmit frequency, and 5 kHz or so HF or LF should do the trick. All contacts will be QSL'd *via* the Bureau. Operators will be G8BNR, G8BJK, G8ATO and G3ZDN.

Reports suggest that G3YKR/P, who has been trying from Lundy Island, in the Bristol channel, was not very well received in the Midlands and the South of the country, which is a pity for the Island hunters, and also for 'YKR. For those who don't know it already, Lundy counts as Devonshire, so, if you are looking for that county for VHFCC, and worked the expedition, you are in. Pity conditions were so poor.

The Cambridge University Club also apparently had a fairly lean time of it, as GD3TPF/P in Castle-town. Their best DX may well have been the QSO with G2JF on March 18.

Although not perhaps a DX-expedition, an unusual *sortie* is being arranged by G6AEV/T, who will be portable from Dunstable Downs on Friday, June 12. Operation will commence at approximately 8 p.m. on 70 cm., with a talk-back channel on two metres. The transmission will be 405-line, positive modulation, with an output of about 20 watts. A second trip is planned for Sunday, July 12, from about midday until nightfall. Skeds will be welcome, so an s.a.e. to G3VZV/G6AEV/T or G8AYB, *QTHR*, should receive a prompt reply. The call on two metres will be G8DDC/P.

The G3BA/G3BHT trip will go off as planned on May 25. The itinerary is being kept open deliberately, but among the counties it is proposed to visit are: Dublin, Leix, Waterford, Carlow and Tipperary. SSB will be on the usual frequency of 145.41 mHz, with AM and CW on 145.5 mHz—send an s.a.e. to G3BA, *QTHR*, for skeds and a copy of the sked list. They will be running higher power than on previous trips and, remembering their success last time, this should be an excellent opportunity to knock off a few rare ones, particularly perhaps for the G8/3's, who were not on two metres at the time of the earlier expedition.

News From GM

It is with deep regret that the death on April 30, at the early age of 46, of Fraser Shepherd, GM3EGW, must be reported.

This great amateur, in the finest sense of the word, did much, in association with Harry Mackie, GM3FYB, to advance VHF operations in Scotland, and indeed his first contact as soon as he was licensed just after the War, was on VHF. He was the holder of several GM "Firsts" on both two metres and 70 cm., and his patience and enthusiasm are demonstrated by this fact, and the nightly skeds which he maintained for so long with G5YV in Leeds. He was an efficient constructor of gear for the VHF bands, and was ever ready to assist

those less qualified in this respect. He leaves a widow and three children, to whom all sympathy goes.

VHF activity in Scotland is mainly concentrated on two metres as the terrain is so often unsuitable for 70 cm. working. It has been enlivened by the advent on the band of several new G8/3's who are making good use of some of the transistorised units which AJH Electronics have been selling up there. Even old-timer GM6XI has succumbed! Portable operation is now a regular feature at weekends, and in this connection GM3OXX is very active, as are GM3OWU, GM8BJF and GM3YOK, all in the south Scotland and therefore all possible from England. Mobile working is also on the increase and GM8BKE/M from Bearsden is laying down a good signal in the Edinburgh area and beyond. G8BQX, operating mobile during a recent visit to Scotland, did a very good job in giving contacts from some of the more remote areas, and his efforts seem to have been very much appreciated.

GM8APX did not make it from Schiehallion over the contest weekend, after all. The local Mountain Rescue Team, who were to have humped the party and the gear up there on special stretchers (!), took one look at the weather, and said that their job was to rescue people from mountains and not to get them stuck up there, so, in the event, operations took place from Rannoch Station, 990ft. a.s.l., in Perthshire. Only one QSO was made, with GM8CZF, and that gave them the three points as a total contest score. Hard luck.

An active VHF Group is now running in the Lothians area, led by GM3DXJ, and seems to be the ideal mixture of "boffins" and beginners. They hold regular meetings at various locations, and will be competing in the coming VHF/NFD. Old timers GM6XI and GM6SR, the original "Scottish Radio," are still running their regular Sunday morning two-metre sked at 1030 clock and would welcome breakers, and GM6FGJ is nearly always about when there is any sort of opening, tropo. or auroral.

Just a reminder that visitors from other countries will be made very

welcome by the local amateurs, and that if they are proposing to take any gear with them, prior notification will have mutual advantages in the recommendation and selection of good VHF sites.

A further reminder that the Scottish 1970 VHF Convention is scheduled for October 4 in Dundee. Later information in this space.

Conventions and Meetings

The Midlands Amateur Radio Society have a General Meeting on May 12 at 7.45 p.m. at the Birmingham and Midlands Institute, Margaret Street, Birmingham, 3. The building adjoins Great Charles Street, and is some 250 yards into the City from the Post Office radio tower. The speaker on this occasion will be John Stace, G3CCH, who will be giving a talk on Meteor Scatter and Moonbounce techniques—about which, of course, he knows a great deal.

There was a capacity attendance of almost 50, including contingents from Northants and Derbyshire, when the Leicestershire VHF Group had Vic Hartopp, G8COB, from *J-Beams* along at their last meeting to talk about the new Multibeam for 70 cm. The Group are planning a series of visits to places of technical interest during the summer months, and details may be obtained from Jack Hum, G5UM, *QTHR*.

The next Meeting of the South East UHF/VHF Group takes place at Wye College, University of London, near Ashford, Kent, on May 8 at 7.30 p.m., when the speaker will be G3HWR, Heath Rees, who will be introducing many members to the mysteries of UHF operation. Visitors are welcome, and further details of future meetings may be obtained from hon. sec. G3DAH, *QTHR*.

The South Bucks. VHF Club meets next on Tuesday May 5 for a talk on transistors in amateur equipment. The place, as always, Bassetbury Manor, High Wycombe.

As mentioned in the April issue of *SHORT WAVE MAGAZINE*, the first EI/VHF Convention is scheduled for May 24 next at the County Arms Hotel, Birr, Co. Offaly. (That should be a new county for many VHF operators.) Lecturers are to be G3BA, G3BHT and EI6AS. All the usual attractions will be

laid on. Tickets cost 42s. for entrance, lunch, high tea and a programme for the lady visitors, which includes a visit to the Slieve Bloom Mountains. The Hotel can offer bed and breakfast for 30s. a head over the period of the Convention, and applications for accommodation and tickets should be made *before May 16* to Bob Williams, EI7AF/GI3UIG, 31 Main Street, Birr, who is the organising secretary. Talk-in stations will be active from

1000 clock on 70.26 MHz and 3.675 MHz.

Finally, the major U.K./VHF Convention at Twickenham will have come and gone by the time this issue appears, and a full report will appear in our next.

The March Aurora

Several more reports are now to hand on experiences during the aurora on March 8. G3COJ of High Wycombe, Bucks. was first alerted

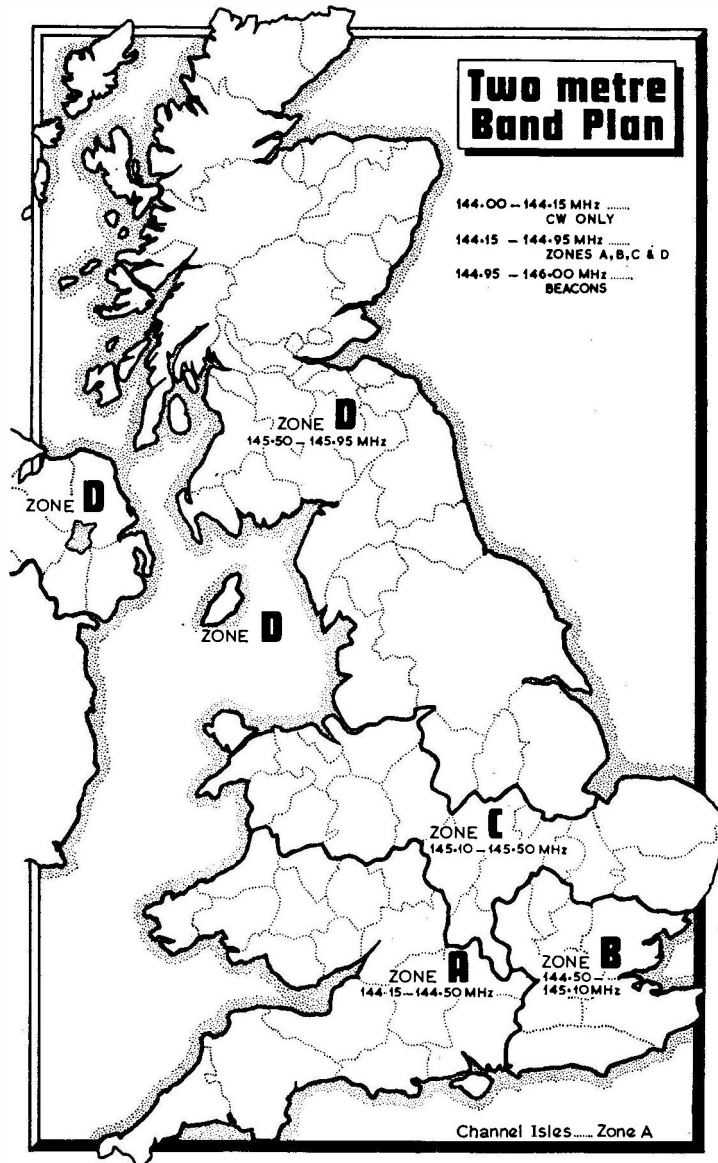

Acknowledgements "Region 1 News," I.A.R.U., April 1970.

by the broadcast from WWV, and came on the band just after 4 p.m. At that time he was hearing good signals from GM, GI, GW, G and PA. Beam heading was North, and signals faded at 1650z. The auroral effect reappeared at 1822, with a preponderance of Continental stations, although EI6AS was still a good signal. G3USB was R5 on SSB and G8BNR was heard on the same mode. The most interesting "got-away" was GI5SJ, who was also missed during the five-metre opening in August, 1948! Brian reports further that HF conditions were disturbed over the Easter weekend, although there was no evidence of an aurora on the VHF bands. Stations worked/heard were:—GI5ALP, GM3UAG, GW3FSP, GW3GWX, G3BJD, PA0HVA, GI3RXV, GW2HIY, G3JYP, LX1SI, EI6AS, G3NEO, OZ9OR, G3TKF, GW3LJP, SK6AB, G3CCH, 3Z2RO and LX1DU. Most signals were strongest with the beam due North, but 3Z2RO peaked N.N.E. and LX1SI peaked N.E.

Inevitably, EI6AS in Dublin had himself a fair ball during the aurora. He worked G6XX, G6CW, GI5SJ, G3USB, G3OXD/A, G3LTF, ON5UI, G2WS, G3DAH, G3IMV, G3JYP, G3NNG, G6GN, GI5AJ, G3CCH, OZ9OR (they must both have been pleased with that one!), G6RH, GW3FSP, PA0HVA and ON4RY. An interesting station heard but not worked was OK1AWL. Albert had only raised one station up to the start of the aurora, and that was GW2HIY, and had just remarked that he could do with an aurora when the panadaptor started to exhibit signals all over the bottom end of the band, looking and sounding like Sunday morning on 20 metres!

G3BHW of Margate, Kent was on in plenty of time to catch both the first and second openings. He worked SK6AB, SM6CZY/7, OZ9NI, GW3MFY, DJ7RI, PA0CSL, LX1SI, OZ7CX, 3Z2RO, PA0MS and DJ9DL. He also heard the OK1AWL, HB9QQ and a UQ2.

G3YUA, Bryan Pickers of Markfield near Leicester, was just taking a rest from the cross-modulation, over-modulation and key clicks of the contest, with the beam pointing

to the South East, when he heard "... G3LTF calling the most ridiculous DX." He whipped the antenna round to the North, and after the initial impression that he had the most dreadful IF breakthrough, cottoned on to the fact that he was in on his first aurora. He heard, and called many times without success, the following: GW2HIY, GW3FSP, GW3MFY, GI3RXV, GI5AJ, EI6AS, F3YT, PA0AWN, PA0CSL, PA0HVA, PA0FAS, OK1AWL, LX1SI and 3Z2RO. He says that after three hours of almost continuous calling without any replies, he went QRT as his vision was becoming obscured by the steam generated by the tears falling on the glowing key!

G8BYV in Norfolk had a go using AM, but without success. It is perhaps not tautological to emphasise that although contacts *have* been made *via* aurora using AM, SSB and NBFM, it is not an easy matter at all, and does require a certain technique which can really only be acquired with practice.

Finally, a Dutch colleague reports that LA and OH were worked from Holland during the second half of the manifestation. However, no reports have come in of any British QSO with the Finnish station.

Curiosa

G8AEL Bedfordshire, reports an unusual occurrence on two metres on the night of March 27, while he was working G8ALQ some fifteen miles to the South of him. At 1845z 'ALQ reported sudden rapid and deep signal strength variations in 'AEL's transmission which were more indicative of a fault than they were of normal QSB, as the signal was swinging wildly between S9 and S3. Coincidentally with this report, 'AEL observed a bright light in the sky travelling in an arc from East to South-East, lasting for about three seconds, and leaving a bright green trail behind it. Subsequent checks between the two stations, and with G3KAN in Northampton, who had been monitoring the two transmissions, and who had also observed the wide variations in signal level, revealed all to be in order technically, so it looks as if this is another instance of in-and-out of phase reflections from the ionisation trail

left by some piece of space debris which had entered the atmosphere and was burning up. G8AEL, QTHR, would be pleased to hear from any other operator who may have experienced this phenomenon—and so would this Column.

Another unusual occurrence is that reported by G3PFR of Norley, Cheshire. On March 1 at just after 1400z he heard UA3CW and OE3VR on 144.05 MHz. Signals were strong but very "fluttery." There was also a powerful French-speaking station on SSB on 144.62 MHz. The beam heading for these stations was approximately E.S.E. and very broad. Bursts of solar noise had been noted earlier in the day at 1000, 1030 and 1200z. GB3VHF was just audible at 1030, at 1040 was S9+ and at 1005, S3. During the period when the DX was being copied, at was S9+ 10 dB, disappearing into the noise at 1425 hrs. During the evening of that day, F3LP was heard on AM and SSB for short bursts of ten to fifteen seconds, and the same effect was noted on GB3VHF.

Now, if one excludes the possibility that there was some breakthrough on the converter (which might account for the UA and the OE) the only other possibility which presents itself is that there was some unusual ionospheric condition present at that time. The beam heading is suggestive of Sporadic E, which might have accounted for the OE, but the UA seems too far North for it. No reports have been received of auroral reception on that day, and no reports of unusual meteor activity. Again, comments would be welcomed by Dr. Dixon and this Column.

GI5ALP of Londonderry, who expects to have his second colinear up shortly, which should further improve his two-metre signals into England, is pressing on with the 70 cm. varactor which is being a bit temperamental at the moment. It will produce 20 watts when warmed up, but after a period of inactivity, the output has dropped to five watts or so. All very mysterious!

G3NNQ was startled to have a reception report from the pilot of a light aircraft during the two-metre contest last month. It transpired afterwards that the airborne receiver suffered from severe second-channel interference.

G3PQY has been receiving a video transmission on Channel 49 which he cannot identify. Both BBC and ITV deny any knowledge of it, and he wonders if any reader can help. The transmission bears 155° from Hull, and consists of a bar pattern. There is no accompanying audio. Looks like a Continental.

News Items

ZB2BO, Flat 9, Sandpits, Gibraltar, contrary to previous expectations, will be active from the Rock during the summer Sporadic-E season. Frequencies are 70.2 mHz, 70.26 mHz and 70.47 mHz, with 70.2 mHz as the first choice. As the beacon keyer is still out there, John will use that from time to time when the conditions seem right, and will then look for calls on the same QRG.

With G3Z-- and G8D-- callsigns being heard fairly frequently on the bands these days, it is interesting to note that our French colleagues are not far behind with the issue of new calls. G2JF reports working FIBAT in QRA "B176j" and F1BAQ in "BK55d." Both obviously very new. It will be recalled that the F1-- stations correspond to our B-Licence holders, so don't try and work any of them on CW. Incidentally, F1ASD and F1ASI will operate from Andorra during the May two-metre Contest. Callsigns will be C31CU and C31CV. They are taking a solid state Tx with them, and an eighteen-element beam.

Two newcomers to the band who are putting out good signals from Essex are G8DKM, who runs one watt with a Snowflake Tx, and an indoor beam, and G8DHS, who has a very pleasant-sounding 20 watts of NBFM. They are both interested in TV, 'DKM who specialises in reception of commercial TV/DX stations, and has already logged transmissions from DL, EA, SP, LA, SM, UA, I, F, and PAØ, while G8DHS who now has a Vidicon (and the scan coils for it!) is building up a solid state Tx.

One operator who worked G15ALP during the lift in propagation on Sunday March 29, was G5MA of Great Bookham, Surrey. One recalls that years ago, as GM5MA/P, Bob was a pioneer of the

DX-pedition ploy, and gave many a contact on two metres from the rarer Scottish counties long before anyone else had thought about it. His trips were a popular feature of the summer VHF scene.

G3ZCE, Bognor Regis, Sussex, ex-G8AWY, is looking for CW skeds on Two. He is on most evenings around 9.30 p.m., from 116, Aldwick Road, Bognor Regis.

G8DLP of Kings Bromley, Staffordshire, now has a series-gate modulated QV06-40A on two metres. His interest in Amateur Radio was first stimulated during his school days, by G2HQ, subsequently the late GW2HQ, but the Morse test proved a bit of a stumbling block. The advent of the G8/3 licence awakened the old urge again, and Richard took and passed the December 1969 R.A.E. without and trouble. He is usually to be found on 145.53 mHz.

Bill Green, G3QG, who operates on Two from the Wernher Collection at Luton Hoo, has now got a new omni-vee antenna up at 130ft. and is very pleased with the results. At 520ft. a.s.l. this type of radiator is fine for all round looking, and has pushed up the received signal strength of the Wrotham beacon by four S-points, with corresponding increases in other directions also. He would welcome skeds and DX reports.

G8AMD, Sutton Coldfield, has been conspicuous by his absence from the SSB channel recently, but he has not been wasting his time. He is now licensed as G6AFC/T and can at present muster a full three watts of peak white with 405 or 625 lines from a Pye dual standard camera. Test equipment and generators he has in plenty, and he is now much occupied with the construction of a pretty advanced vision-and-sound transmitter which should be capable of delivering 100 watts of peak white and 20 watts of sound carrier. The arrangement uses linear power amplifiers, and the video is first raised to a 70 mHz IF before translation to 70 cm. The transmitter will also handle colour. Nice work!

G8BMI has been making preparations for the portable season. By dint of what appears to be much bribery-and-corruption, he has persuaded various unsuspecting

members of his family to convey him and the gear to 1300ft. up on Ilkley Moor in the most appalling conditions of hail, rain and wind typical of an English summer, for a quick dry(?) run. All went well, though, and he now has a TR.2002 Tx (all-same March SHORT WAVE MAGAZINE), an EMSAC converter, a CR-70A and a two-element beam with 38ft. mast ready to go.

Contests

Dates to note are May 2-3 for the 144 mHz Portable, which coincides with the IARU Contest, and May 30-31 for the 432 mHz Open.

During the Four-Metre Contest over the weekend April 11-12, propagation conditions showed some improvement compared with the previous event. Two of the GW/P's, GW3NUE and GW3TXR, were good signals in Kent, S5-6 for much of the time. GM3VPK/P, from near Port Drummore, Wigtownshire, made a brief appearance around 2.0 a.m. on the Sunday morning, at RST-559; he was laying down a good phone signal in the Midlands just after the start of the Contest, but faded away later.

Activity was low to start with due, one imagines, to the TVI difficulty, but scores of over 60 were being passed towards the end.

Going back to the September IARU Contest: This was adjudicated by the OK VHF Group, and the results have only just been received—oh, well, one must allow for their troubles in that unhappy country. So far as the U.K. is concerned, congratulations go to G2JF, GW3HAZ and GD3WMS for their performances during this Contest. G2JF was third in the two-metre fixed-station section; GW3HAZ first in the Seventycem and second in the 23 cm. sections; and GD3WMS third in the 70 cm. portable. These are, of course, "all Europe" placings.

Deadline

Deadline for the next issue is **May 9**. The address for all VHF claims, news and comment is: "VHF Bands," SHORT WAVE MAGAZINE, BUCKINGHAM. Cheers for now, and 73 de G3DAH.

THE MONTH WITH THE CLUBS

By "Club Secretary"

(Deadline for June issue: May 8)

(Please address all reports for this feature to "Club Secretary," SHORT WAVE MAGAZINE, Buckingham.)

IT is perhaps as well, once in a while, to look at the relationships between this piece and the life of any Club. Basically, it exists to advise local members of the dates and subjects of the group meetings; and, of course, to help someone moving into a new area or just taking up the hobby to find kindred souls. In addition, an alert hon. secretary will have a "weather eye" on the column for ideas which can be translated into an evening's entertainment for his members.

However, it has to be realised that this is a two-way process. We cannot give publicity to a Club if we do not have the basic information, and we cannot, with the best will in the world, make much of recent events as a substitute for the current programme. We must have a feed of current information each month, and it must be in to us before the deadline; a late arrival is filed and if possible used the following month, but is by that time usually back in the realm of history. The pressure on space is such that history has to receive only brief mention.

Thus, if we are to help as much as we can, we have to have certain information each month, by a certain time. The deadline is published at the end of the piece each month and also in the titling. Dates forward are also frequently given. A letter sent in during May, should reach us in time for the deadline, and contain details of the activities concerning *June*. The date is essential, as a reader is obviously wanting to know which date to book in his diary. Similarly—and this applies particularly in the case where we are advised by way of a copy of the group newsletter—we must have the venue clearly stated. Add to this the name, address and telephone number of the hon. sec., so that a prospective member or visitor may make an advance contact if he feels it needed, and so that we have it on file to help us to answer any "blind" letters which originate from someone asking how to get in touch with a local group. As a final detail, make quite sure that if a particularly important "do" is either restricted in numbers or ticket-only, we are advised, so that we can say so and thus avoid disappointing a possible new member.

All we need to add to that is that, sadly, we cannot accept a "block booking"—meaning that even if we are delighted to see a complete year's programme from a club—which we are—it is just not possible for your conductor to "store" such information. His shack just isn't big enough, and the risk of late changes being missed is far too great.

The Reports

Now for a look at the reports, by regions; this time the top of the pile is taken up by the groups who spread beyond geographical boundaries.

Membership of the Royal Navy club requires as a qualification service at some time in the R.N. or the Merchant Navy; a grade of membership is also embodied which covers the members of foreign navies. Contact is maintained mainly by way of the "Newsletter," the Hq. station G3BZU, and various nets. Facilities offered are too numerous to mention here, but for the full story, contact the secretary at the address in the Panel.

Mobileers are, naturally, a speciality of A.R.M.S.; mobileers on Top Band, on VHF, DX-chasers or rag-chewers. The current issue of *Mobile News* has a couple of good pieces covering the technique of HF/DX chasing from the car, and on the other hand methods of installation of a satisfactory mobile set-up. One of the best they have done for some time.

From G2FUX, the U.K. hon. sec., comes a letter with the sad news that W3HQO has had, on health grounds, to resign as president of the Ex-G Club. He is, however, continuing to produce the *Ex-G Bulletin*, though future issues will come in quarterly rather than every couple of months. Turning to the *Bulletin* itself, one finds much of the chat one could expect from a gang who are all resident far away from "home." W3CTR has a very good contribution on Grimsby, his home town, from which it is very evident that someone has "done his homework," on the detailed history of the town.

South-East England

This could broadly be defined as the area where Channel 1 TV makes operation on the HF bands impossible!

Cheshunt have just held an AGM and so are no doubt chasing up the programme for the future. However, the date to reserve is the first Friday in each month, at the Methodist Church Hall, opposite Theobalds Station, Cheshunt, and the time for kick-off is 7.30 p.m.

At Surrey, where the lads get together at the "Swan and Sugarloaf," South Croydon, the May meeting sees them judging their "QSO of the Year" contest, for which one has to bring the card along to the meeting. As if that were not enough, judging of the Constructional Contest is also noted against the third Tuesday in May.

Verulam have their informal meetings taking place again at Salisbury Hall—home of Nell Gwynne's ghost,

moated, a Tudor building on an older site. More recently, it was the home of that Sir Nigel Gresley who designed the fastest steam engine in the world, and the birthplace of the Mosquito fighter-bomber of World War II; the prototype is on display, along with a Vampire and a Venom. May 6 it is, at 7.30. For the formal (lecture) session, St. Albans Town Hall Council Chamber is booked on May 13, for Mr. C. Gordon, of Goonhilly fame, to talk about Short Wave Communications Past, Present and Future.

Crystal Palace have booked the "TVI Clinic" of G3XIW and G3JGO; it is to be noted that this means a change of date to May 9. For details, contact G3FZL, as in the Panel on p.177.

On to Echelford, where the venue is St. Martins Court, Kingston Crescent, Ashford, Middlesex. May 11 will see G3HBW taking the stand, his subject being unspecified but presumably VHF. For May 28, they have G3FZL and G3OOU from Crystal Palace, to talk about VHF developments, and then turn to Calibration equipment.

There are two meetings in May for the North Kent crew, although the Newsletter does not give the Hq. address. These dates are the 14th, for the all-important Annual General Meeting, and the 28th, when the final arrangements for NFD will be settled.

Not very far away is Cray Valley, who have their corporate being in the Congregational Church Hall, Court Road, Eltham, where they entertain G3FZL on May 7; Geoff will be taking as his theme recent developments in VHF Techniques. There is also a Natter Nite, on May 21.

Capacitors are actually quite complex items—this will be demonstrated to the Bishops Stortford chaps on May 18 by G3LWM, who knows as much as most about the little beasties. Here the Hq. is in the British Legion Club, Windhill.

Unfortunately our programme for Guildford stops short at May, as the AGM came up in the previous month. However, we do know that the normal dates are the second and fourth Friday in each month, at the Model Engineering Hq., Stoke Park, Guildford, and that there are also joint activities with the lads at the University of Surrey.

Normally, Edgware have a standard booking at St. George's Hall, 51 Flower Lane, Mill Hill; but one is scrubbed out this time owing to a clash with the Bank Holiday. The only May meeting is on the 11th, and will be addressed by S. W. Amos, who takes for his theme "Transistors." However, to make up for the lost evening there is a Sunday "do"—a Direction-Finding Contest, details being obtainable from the hon. sec.—see Panel.

Dorking have May 12 for an informal session in the club shack at the Wheatsheaf—a shack which is, in the main the fruit of their labours of the last few months. On May 26, the lads are to have a constructional exhibition, for which entries are wanted, even if the years *have* passed since it was first conceived!

Now to Kingston, where on May 13, Part 1 of a series on "Biasing, Coupling, and Decoupling" will be given by G3GVU, who will be dealing with valve circuits. The second part comes up on June 10, when G3OSQ takes the same theme and applies it to semiconductors. Both are at Hq., the "Penguin Lounge," 37 Brighton Road, Surbiton.

Greenford have their three dates for May down as the 1st, 15th, and 29th. For the first, there is a Questions and Answers Session, the second is given over to the old standby—a Junk Sale—but the third is, at the time of writing, still to be finalised. All are in Room 1, the Community Centre, Oldfield Lane, Greenford, Middlesex.

G3VXZ, Mike Frey, is a flight engineer with BOAC;



For the fifth annual dinner of the Fareham & District Amateur Radio Society, the total sitting was 42, with Douglas Briggs, G2QK, president, in the chair. This attendance included 17 licensed members and five SWL's. As a Club, Fareham is one of the most active in the South-West and has its own callsign, G3VEF. The hon. secretary is G3XIV, standing third from right in our picture.

this makes him well-qualified to talk to **Maidenhead** about the communications and navigational equipment used on the Boeing aircraft of that line. This one is on May 4, at the Victory Hall, Cox Green, Maidenhead, which is also the venue for the informal of May 19.

Over to **Shefford**, who get together every Thursday evening at the Church Hall in Amphill Road, Shefford. May 7 is given over to R.A.E revision; a good thought for the last meeting before the examination. May 14 is TVI Evening, with a discussion on the causes and the cures. A week later, on May 21 the NFD rig will be operated, and the last event of the month, which comes on the 28th, will be a D/F Hunt.

The **Worthing Schools** group seem to be off to a good start, and have been given 60 watts-worth of transmitter for 144 mHz, which should set them up nicely. They get together every Friday at Worthing High School in Bolsover Road, running a programme which includes lectures, a Morse class, constructional work, and just plain rag-chewing. For details, contact the Secretary—see Address Panel.

Crawley must surely be the most successful of the radio clubs in the New Towns, by an enormous margin. This group are to be found in Trinity Congregational Church Hall, Ifield, Crawley, on May 27, when they will give ear to the words of wisdom of G3GRO, on "UHF for the Amateur." Prior to this—the normal monthly meeting of the club—comes the annual Dinner/Dance at the Airport Hotel, on May 8, for which tickets must be obtained either from the hon. sec.—see Panel—or from G3FRV.

At **Purley** they have a full weekend in May given over to a "dummy run for NFD" which at the time of writing looked to be set for the 9/10th. May 1 is a Natter Nite, at the small hall of Hq., and the formal session on May 15 in the larger room will be devoted to a discussion of computers and what makes them tick, initiated by G8ASV. Hq., incidentally, is at the Railwaymen's Hall, 58 Whytecliffe Road, Purley. Starting time is at 8, and don't come early as it upsets the caretaker!

In order to give the maximum assistance to members taking the forthcoming R.A.E., at **Southdown** the May 4 meeting will be devoted to this topic—and a very good idea, too. Venue is the Victoria Hotel, Latimer Road, Eastbourne, time 8.0 p.m.

Scotland and the North

It is always a matter of wonder to your scribe that more of the groups North of the Border do not trouble to report in, at least occasionally; it means that any SWL who writes asking about a Club in his area gets an unsatisfactory answer and is possibly lost to the hobby. There are at least a dozen, and probably more, groups who are known to exist from hearsay, but have never shown a report, let alone an MCC entry. However, to lead off this time we have the only Scottish "regular."

For May 14, **Lothians** have a Junk Sale to help the members stir up the stuff in their shacks; May 28 is so close to NFD as to be inevitably given over in the main to the final details; but it is understood they will be taking time during the evening to play off a Construction Contest. For details, and the venue, get in touch with GM8BPL, as indicated in the Panel on p.177[†]

Northumbria are now formally in existence and have

already doubled their numbers to 28 members, who get together every other week at the Black and Grey Inn in Morpeth. However, we gather they have already had at least one evening away from Hq.; on April 23 they went round the Welwyn works at Bedlington.

Anyone with an interest in Amateur Radio and a spare Friday evening in or near Milnthorpe should head for 24 Park Road, in Milnthorpe, the Hq. of the **Westmorland** crew. The committee at the time of writing was scratching about to finalise a full programme of events for the forthcoming year and on into 1971, the details of which we will no doubt hear of in due course. The lads now have a club call, G3YWR, which is on the air on Club evenings on Top Band, and looking for contacts—which should be fairly easy for such a rare county! It is also emphasised that, being so far North of the industrial areas they really have to work to get new members, which is another way of saying they will warrant a great welcome to anyone who visits them.

Blackpool and Fylde recently had their AGM, and elected their officers for the new session. This group meets every Monday evening at Pontin's; for full details get in touch with G3OCX—see Panel—who seems to be doing another year in office.

Spenn Valley have their annual dinner at Cleckheaton on May 9; tickets at 32s. 6d. from Norman Pride, G8BSC—and as in Panel. Their Hq. is at the Grammar School in Heckmondwike on Thursday evenings, albeit it is felt that if a visit is proposed it would be as well to make certain of the form by contacting G8BSC.

Now, to **Northern Heights**, where G3MDW is still doing the Secretarial chore, as he has done so well for so long. He mentions that he still has a few spare dates for the W1BB Mark II Top Band DX tape-and-slide lecture, if secretaries of other clubs care to contact him. For themselves, the gang seem to be settling well in the temporary Hq. at the Peat Pitts Inn, Ogden, and are making noises about staying there. On May 6, they are off to Emley Moor to look at some of the commercial colour TV gear, and on May 20 the postponed talk by G3IKS on the anodic treatment of aluminium will be given.

If you intend to look up the **Wirral DX Association** chaps, get in touch with G3OKA well ahead, as they get together in each other's homes, on the last Thursday in each month. For mid-June, plans for their trip to Hilbre Island are well advanced—all we *don't* know is where that Island is!

The Amateur Radio Club of **Nottingham** have a place at the Sherwood Community Association, Woodthorpe House, Mansfield Road, where they foregather weekly on Thursday evenings. Final arrangements for their station at the Festival of Nottingham in July will be the matter in hand on May 7, and on the 14th there is a film show, featuring the Snowy Mountain project. John Curnow, G6CW, a well-known and very active old timer, takes the stand on May 21, to talk about how one goes about getting on SSB, starting his talk at 8.15 p.m. Finally, on May 28 there is an Open Night.

Every Tuesday evening the **Lincoln** chaps go to No. 2 Guardroom of Sobraon Barracks, Breedon Drive, off Burton Road, where visitors are always welcome. They can be found on most Club nights operating

G3IXH, their own call, on Two, and looking for QSO's, especially to the South.

On Saturday, May 23, the **Hull** chaps propose a visit to Rugby Radio, details of which can be obtained from the Secretary—see Panel. The normal weekly Friday evening affairs, of course, carry on throughout the month. Thus, on May 1, there is a practical demonstration on Semiconductors, by G3SSA and G3AGX, while May 8 is an SWL night conducted by John Singleton. G3LDB has the floor on May 15, to talk maths, and construction is down for May 22. Practical Printed Circuits are dealt with by G3PQY on May 29.

The AGM hurdle has been passed at **Mansfield**, and G8HX continues in his seat as hon. secretary. For the new session it is hoped that one or other of the members will give a short talk at each meeting. For all the details, contact G8HX, address as in Panel below.

Wales and West

It rather looks as if the **Plymouth** chaps have two meetings in each month, on the first and third Tuesdays. May 5 is quite certainly allocated to the AGM. For the Hq. details, we have to refer you to G3YDU—see Panel. However, we can say that this seems to be thriving, lively crowd, who can, when the occasion demands, rake up enough people to sting commercial firms into coming along and giving a talk to a large audience, and have a regular monthly newsletter in

addition.

The **Hereford** chaps seem to have obtained the permit to put up their aerial farm at Hq., the Civil Defence Centre, Gaol Street, Hereford, which should give them quite a lift as they have been negotiating for some time. As to the programme, we have no details for May, owing to the recent incidence of an AGM. However, the hon. secretary will be very pleased to give details.

There are three dates in the **Saltash** calendar for May. On the 1st, they get down to the serious business of planning for their Mobile Rally, which, incidentally, is slated for July 26. G3VVP takes over on May 15, to continue giving the real gen. on Transistors, and on May 29 there is a limited-number trip to the ITA transmitter at Caradon Hill—names to the hon. sec. as soon as possible. The Hq. is at Burraton Toc H.

North Devon are getting together at Crinnis, High Wall, Sticklepath, Barnstaple, every other week, which gives them a Surplus Sale on May 13, and a Natter on the 27th.

Three dates are noted by the **Chippenham** Secretary—May 12, when there is a mini-D/F Hunt; May 19, when they take on the Bristol crowd at *darts*, at the Queens Head at Box as agreed neutral ground; and finally May 26, when G2HIF, Cliff Sharpe, is coming along to talk about the design of tank circuits in transistorised PA stages.

As usual, the main meeting of the **Cornish** group, at the SWEB Clubroom, Pool, Camborne, will be divided

Names and Addresses of Club Secretaries reporting in this issue :

A.R.M.S.: N. A. S. Fitch, G3FPK, 40 Eskdale Gardens, Purley, Surrey, CR2-1EZ.
 BISHOPS STORTFORD: A. Stanley, G3WUR, 43 Havers Lane, Bishops Stortford (57251).
 BLACKPOOL & FYLDE: J. Boulter, G3OCX, 175 West Drive, Cleveleys, Blackpool.
 CHESHUNT: J. V. Beavan, G3GBL, 41 Albury Ride, Cheshunt, Herts.
 CHIPPENHAM: P. Strand, G3UTO, Whiteoaks, 8 Brookwell Close, Chippenham (3723), Wilts.
 CORNISH: J. Farrar, G3UCQ, Elm Cottage, Ventonleague, Hayle, Cornwall.
 COVENTRY: C. Jaynes, 20 Belgrave Road, Wyken, Coventry.
 CRAWLEY: G. Bowden, G3YVR, 51 Leighlands, Pound Hill (3253), Crawley, Sussex.
 CRAY VALLEY: D. Buckley, G3VLX, 234 Halfway Street, Sidcup (01-850 6945).
 CRYSTAL PALACE: G. M. C. Stone, G3FZL, 11 Liphook Crescent, London, S.E.23 (01-699 6940).
 DORKING: R. Greenwood, G3LBA, 8 Deacon Close, Downside, Cobham, Surrey.
 EAST WORCS.: R. J. Mutton, G3EVT, Summerhayes, Mill Lane, Alcester (2041).
 ECHELFORD: R. Hewes, G3TDR, 24 Brightside Avenue, Laleham-on-Thames (Staines 56513).
 EDGWARE: E. H. Godfrey, G3GC, 15 Oxenpark Avenue, Preston Road, Wembley, Middx.
 EX-G: F. W. Fletcher, G2FUX, 53 St. Ives Park, Ringwood (3561) Hants.
 GREENFORD: F. C. Reid, G3VMD, 34 Carlton Avenue, Harlington, Middx. (01-848 0235).
 GUILDFORD: A. Coker, G3WHM, 48 Charlock Way, Burpham, Guildford.
 HEREFORD: S. Jesson, 181 Kings Acre Road, Hereford (3237).
 HULL: Mrs. M. Longson, 4 Chester Road, Hull, HU5-5QE.
 KINGSTON: N. Dudman, Dunham Lodge, 88 Sandy Lane, Teddington, Middx.
 LEICESTER: F. D. Rawcliffe, G3UGM, 215 Glenfield Road, Leicester, LE3-6DL.
 LINCOLN: G. O'Connor, 61 Steep Hill, Lincoln (24113).
 LOTHIAN: W. Marshall, GM8BPL, 15 Craigleith Hill, Edinburgh, EH4-2EF.
 MAIDENHEAD: E. C. Palmer, G3FVC, 37 Headington Road, Maidenhead (20107), Berks.
 MANSFIELD: F. N. F. Bewley, G8HX, 116 Westfield Lane, Mansfield (25208), Notts.

MIDLAND: H. L. Bate, G8AMD, 88 Darnick Road, Sutton Coldfield, Warwickshire.
 MID-WARWICKSHIRE: K. Young, G3ZCG, 56 Chapel Street, Bishops Itchington, Nr. Leamington Spa (Harbury Wells 273).
 NORFOLK: G. Purcell, 29 Seton Road, Taverham, Norwich.
 NORTH DEVON: H. G. Hughes, G4CG, Crinnis, High Wall, Sticklepath, Barnstaple, Devon.
 NORTHERN HEIGHTS: A. Robinson, G3MDW, Candy Cabin, Ogden, Halifax (44329).
 NORTH KENT: A. Watt, G3WZJ, 67 Glenhurst Avenue, Bexley (Crayford 22564).
 NORTHUMBRIAN: J. Temple, G3XAI, 4 Coquerdale Place, Bedlington, Northumberland.
 NOTTINGHAM: J. Smith, 21 Duke Street, Arnold, Nottingham (265921), NG5-6GP.
 PETERBOROUGH: D. Byrne, G3KPO, Jersey House, Eye (351), Peterborough.
 PLYMOUTH: J. Peters, G3YDU, Treetops, 43 Holtwood Road, Plymouth (77878).
 PURLEY: A. Frost, G3FTQ, 62 Gonville Road, Thornton Heath, Surrey, CR4-6DB.
 ROYAL NAVY: RS. A. Walker, H.M.S. Mercury, Leydene, Petersfield, Hants.
 SALTASH: J. A. Ennis, G3XWA, 19 Coombe Road, Saltash, Cornwall, PL12-4ER.
 SHEFFORD: C. W. Stedman, G3XWS, 10 Wychwood Avenue, Luton, Beds.
 SOLIHULL: H. D. L. Clark, G3YOY, 222 Kineton Green Road, Olton, Solihull, Warwickshire (021-706 0485).
 SOUTHDOWN: L. E. Tagliaferro, 9 Tugwell Road, Hampden Park, Eastbourne.
 SPEN VALLEY: N. Pride, G8BSC, 100 Raikes Lane, Birstall, Nr. Leeds (Bailey 3925).
 STOURBRIDGE: B. Kennedy, G8CVK, 14 Wynall Lane, Wollescote, Stourbridge (Lye 3608).
 SURREY: R. Morrison, G3KGA, 33 Sefton Road, Croydon, CRO-7HS (01-654 5982).
 TORBAY: Mrs. G. I. Western, G3NQD, 110 Truro Avenue, Hele, Torquay.
 VERULAM: W. Dennis, G3NCK, 129 Colney Heath Lane, St. Albans, Herts.
 WESTMORLAND: J. Forrester, 44 New Street, Carnforth, Lancs.
 WIRRAL DX: J. A. Share, G3OKA, 21 Curlender Close, Bidston, Birkenhead, L41-7BN.
 WORTHING SCHOOLS: S. Watson, 43 Clive Avenue, Worthing.

For the Birmingham Exhibition & Boat Show earlier this year, the Midland Amateur Radio Society put on a stand, with their own station G3MAR/A, operating a KW-2000A on several bands. They also had an interesting display of equipment showing the progress of Amateur Radio over the last 40 years. In our picture are, left, G8ASW, organiser, and G3KPT, president of the Club.



into two parts; first the "potted talk" by G3VGO on Digital Clocks, and then the main talk on Ex-Service receivers, to be given by G3POB. There are also sections operating in Newquay and Falmouth as part of the main organisation.

The recent **Torbay Annual Dinner** was attended by no fewer than 94 members, friends and visitors, which speaks well of the strength of the organisation. Regular meetings are on Saturdays, at Hq., Bath Lane, rear of 94 Belgrave Road, Torquay; the last meeting in May is specifically given over to the "final orders" for NFD. Sidetracking a little, our latest news is that G3LKJ is now out of hospital, back at home, and making progress, which pleases the members greatly.

The Midlands

Looking at the clip, it seems as though our delineation of the regions on the map of England has thinned the pile markedly.

At Norfolk the highlight of the month is definitely the visit of G6CJ and his famous "aerial circus." For this one the club have booked the Assembly House, Norwich, where there is room for eighty; it therefore follows that if one wants to attend what is always a memorable occasion—the best exposition of Aerials and their tricks your scribe has ever seen—then a rapid contact with the Secretary is called for to ensure you have an *entrée*. This one is down for May 18. The business session for May is on the 4th, at the Brickmakers Arms Hq., which is in Sprowston Road. This is also the spot for the informal natter slated for May 11; but the normal date, for May 25, falls on a Bank Holiday, and is therefore deleted.

Talking of Aerials, the other "king-pin" in this field is undoubtedly Vic Hartopp of *J-Beams*, who was the attraction for April at Mid-Warwickshire. Sad to say, the note advising this particular lecture arrived much too late, and so had to be passed over for the current pile; 28 Hamilton Terrace, Leamington Spa, is the Hq. and for the details of the regular get-togethers here, it is

suggested you get in touch with G3ZCG at the address in the Panel; incidentally, we note he has become G3ZCG as a change from VS6AL and G8ARZ—congratulations.

Five Fridays are available in May, and Coventry use them all. Three—May 1, May 15, and May 29—are devoted to operating the Club station, with Morse tuition on the latter two dates as a supplement. May 1 shows no Morse class, but instead a "last-ditch" R.A.E. lecture. May 8 sees the chaps entertaining another group, not specified, to a Quiz, of the "University Challenge" TV programme type—an entertainment they have run before with success. As for May 22, this is devoted to a visit to Baginton Airport. The "home" events all take place at the City of Coventry Scout County Hq., 121 St. Nicholas Street, Radford Road.

The Old People's Centre, Park Road, Redditch, is Hq. for the East Worcs. gang, and they meet here for a natter on May 14. However, on May 28, they are going to visit the West Mercia Police Hq., at Hindlip Hall, Worcester—assemble there at 8.15 p.m. One would think, although the letter from G3EVT does not say so, that this visit is probably a limited-number affair, and so it is advised that he be contacted—see Address Panel—if it is intended to join the party.

May 19 is the date set for the Solihull crew to assemble at the Manor House, 126 High Street; it is understood that a Question and Answer session has been laid on. Incidentally, the Solihull lads go out /P on occasions, signing G3GEI/P, and contacts so made will be QSL'd 100%.

Lucky chaps! Peterborough members can look forward to summer at their riverside hideout, where camping, sailing, or just listening to the operators on Sunday afternoons can be enjoyed, at Alwalton, off the main A1 road.

The March issue of the **Midland News Letter** contains one of the clearest expositions of the GEOREF system your scribe has ever seen—indeed the first he has ever understood! Still on the VHF tack, May 12 sees them

at the Midland Institute listening with attention to G3CCH, John Stace, talking about Meteor Scatter and E-M-E communication—he is one of the experts in this field, and an experienced lecturer.

At Leicester, no formal programme has been arranged for the month of May, so that the Club can concentrate on preparations for Field Day. Outdoor activities actually began on March 22, when a kite-borne aerial launched from Beacon Hill gave good results on Top Band, using gear belonging to G3XXK.

Stourbridge now have their G6OI permanently installed at Hq., and they are on the air regularly on Monday evenings, from 8.0 p.m., around 1915-1925 kHz. They have an enterprising expedition planned for July 4—a /M

trip on the privately-operated Welshpool-Llanfair Railway, with the willing co-operation of the Society which runs this line; a 32-seater rail coach is being reserved for them, together with a 1 kW 230v. AC power supply unit. We can imagine that this will be a very popular foray.

Deadline

Not so many late reports this month—well done! But we still have rigorously to exclude those that *are* late, otherwise this feature would never get to press.

Closing dates for the next few months are, Fridays: **May 8** (June issue); **June 5** (July); and **July 10** (for August). The address is simply: "Club Secretary," SHORT WAVE MAGAZINE, BUCKINGHAM. Don't be late!

SPECIAL-ACTIVITY STATIONS

Those amateur stations to be "performing before the public"—see p.94, April issue—are now listed as follows:

GB3BS, May 10: For the Scout Rally Camp in Amptill Park, Beds., to be attended by Sir Charles MacLean, Bt., the Chief Scout. The station will be operated on 3525 and 7025 kHz CW; 3.7+ and 7.025 MHz SSB; and 144.79 MHz for VHF. A special QSL card will confirm all contacts, and the address is: J. Bennett, G3FWA, hon. secretary, Beds. & District Amateur Radio Club, 47 Ibbet Close, Kempston, Bedford.

EI0DMF, May 15-24: In conjunction with the Dundalk Maytime Festival, organised by the Dundalk Amateur Radio Society and running CW/SSB on all bands 10-80m. during 1100-2300z daily. A special QSL card will confirm all contacts. (Note: Callsign may be EI1DMF).—W. J. Scully, EI2I, 48 Woodland Drive, Ard Easmuinn, Dundalk, Co. Louth, Eire.

GB3TIC, May 16-31: For a display of local activities organised by the Crawley Council of Social Service, in St. John's Church Hall, Town Centre, and operated by members of the Crawley Amateur Radio Club. Open to the public, May 23, 10.0 a.m. to 5.0 p.m.—G. C. Reid, G3OUX, 11 Coombe Close, Langley Green, Crawley, Sussex.

GB3WRA, September 5: Operating from the 24th annual Wycombe Show, on The Rye, High Wycombe, on all bands 10-160m., AM/CW/SSB. Visitors will be very welcome.—A. C. Butcher, G3FSN, 70 Hughenden Avenue, High Wycombe, Bucks.

We shall be glad to give publicity in this space to similar notices, which should be set out in the form shown here, and addressed to: "Special-Activity," SHORT WAVE MAGAZINE, BUCKINGHAM.

THE SMALL ADVERTISING

Every month, literally £1,000's worth of amateur equipment changes hands through our regular Readers' Small Advertisement columns, which for years now have constituted the most buoyant exchange-and-mart in the business. We do not, of course, guarantee results but what we do say is that your notice will have the widest

possible coverage of the U.K. Amateur Radio market. The rate (for readers' private advertisements) is 3d. a word, minimum charge 5s.—which has been maintained for over 20 years and, these days, hardly meets the setting charge, let alone shows us any profit. (Even the 25% extra for bold face does not do that.)

Where there is any doubt or difficulty about counting words or estimating the cost, send us a blank cheque, endorsed "not over £1," or some such reasonable amount depending upon your own estimate of the cost, and we fill it in correctly—probably for less than you would have made it out yourself!

All small advertisements should be sent, with remittance, to: Advertising Dept., Short Wave Magazine, Ltd., 55 Victoria Street, London, S.W.1. Note that we can *not* accept these advertisements over the telephone, and payment *must* be included with the order—we cannot invoice and charge small amounts.

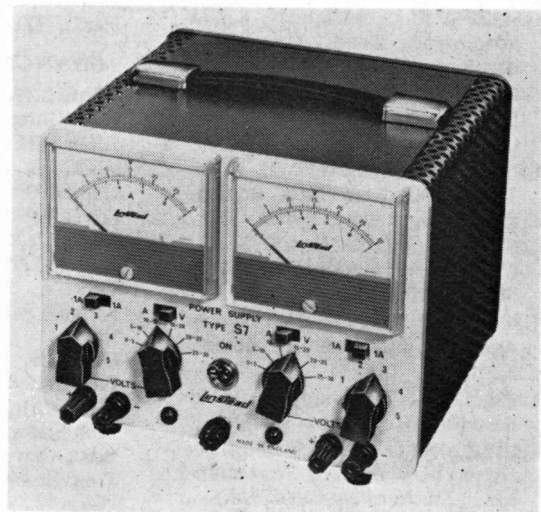

A dual stabilised PSU, each side delivering 0-30v. at 1 amp. Outputs are floating and may be series-connected to give 60v. 1 amp., or in parallel for 30v. 2 amps. Each side is separately metered, for both voltage and current indication, with outputs controllable in 5v. steps. Type S.7, by Linstead Electronics, London.

NEW QTH's

This space is available for the publication of the addresses of all holders of new U.K. call signs, as issued, or changes of address of transmitters already licensed. All addresses published here are reprinted in the U.K. section of the "RADIO AMATEUR CALL BOOK" in preparation. QTH's are inserted as they are received, up to the limit of the space allowance each month. Please write clearly and address on a separate slip to QTH Section.

- G2FSH**, A. H. Vaughan (*ex-2FSH*), 65 London Road, Great Tarpots, Benfleet, Essex, SS7 5TG (*re-issue*).
GM3XQK, J. Nisbet, 14 Isles Terrace, Newmilns, Ayrshire. (*Tel. Newmilns (Ayrshire) 347.*)
G3YKG, R. H. Brooks, 85 Maple Road, Horfield, Bristol, 7.
G3YSC, Amateur Radio Club, Youth Sports Centre, Melrose Close, Loose, Maidstone, Kent. (*Tel. Maidstone 43317.*)
G3YVM, J. D. Bradshaw, 9 Sydnor Road, Stoke Newington, London, N.16.
G3ZBC, R. H. Conway, 40 Chiltern Avenue, Northampton.
G3ZBK, E. Rowe, 22 Circular Road, Tottenham, London, N.17.
G3ZCU, P. Moir, 19 Lindisfarne Road, Dagenham, Essex. (*Tel. 01-599 7935.*)
G3ZEM, R. Henderson, 47 Teesbrooke Avenue, Hartlepool, Co. Durham.
G3ZEN, A. N. Glaser, 15 Dorset Gardens, Mitcham, Surrey, CR4 1LX. (*Tel. 01-684 6157.*)
G3ZEP, R. H. Tinning, 58 Coxwold View, Wetherby, Yorkshire.
GM3ZFB, J. G. McKinley, 8 Old Woodwynd Road, Kilwinning, Ayrshire. (*Tel. Kilwinning 2430.*)
GW3ZFL, J. Bartlett, 6 Cornwall Road, Newport, Mon., NPT 7SR. (*Tel. Newport 74297.*)
G8DBE, J. C. Edwards, 11 Jolley Trooper Caravan Site, Bradenstoke, Chippenham, Wilts.
G8DDC, Dunstable Downs Radio Club, Chews House, High Street South, Dunstable, Beds.
G8DLQ, R. Berkolds, 73 Barberray Avenue, Davis Estate, Chatham, Kent.
G8DLX, M. T. Crampton, 14-B Percival Road, Rugby, Warks.
G8DLZ, P. G. Lea, 57 Firsview Drive, New Duston, Northampton. (*Tel. Northampton 52842.*)
G8DMB, W. E. Green, 16 Raymond Road, Hellesdon, Norwich, Norfolk, NOR. 38-M.
G8DMG, M. Stokes, 4 Thornleigh Avenue, Thornes, Wakefield, Yorkshire.
G8DMK, C. D. Harfield, 3 Woodland View, Bromley Cross, Bolton, Lancs., BL7 9NS. (*Tel. Bolton 55051.*)
G8DNF, C. M. Eley, 17 Page Heath Lane, Bromley, Kent, BR1 2DR.
G8DNK, D. Parker, 2 Glebe Gate, Thornhill, Dewsbury, Yorkshire.
G8DNR, H. T. Mason, 1 Heather Close, Cophorne, Sussex. (*Tel. Cophorne 2603.*)
G8DNZ, B. C. Winch, 30 Westwick Gardens, Cranford, Hounslow, Middlesex. (*Tel. 01-759 0048.*)
G8DOE, S. Freedman, 3 Avenue Terrace, Crownfield Avenue, Newbury Park, Ilford, Essex. (*Tel. 01-590 0324.*)
G8DOG, J. Moore, 20 Eastleigh Croft, Walmley, Sutton Coldfield, Warks. (*Tel. 021-351 1244.*)
G8DOH, A. J. Seeds, 20 Elm Park Gardens, Dover, Kent.
G8DOQ, M. G. Milson, No. 3 Flat, 9 Crossgate, Durham City.
G8DOS, J. W. Atlee, 57 Bacon Lane, Edgware, Middlesex. (*Tel. 01-952 6570.*)
G8DPL, J. R. Ayers (*ex-VP8KA*), 13 Henley Close, Cove, Farnborough, Hants. (*Tel. Camberley 23440.*)
- CHANGE OF ADDRESS**
- G2BIM**, L. W. J. Leask, 51 Sidford High Street, Sidmouth, Devon, EX10 9SH. (*Tel. Sidmouth 4359.*)
G2HCG, B. Sykes, Shaldon Pines, Church Brampton, Northampton. (*Tel. Chapel Brampton 3767.*)
G3AQQ, J. Kelsall, 3 Station Road, Bishops Cleeve, Cheltenham, Glos.
G3ATH, H. Pain, c/o Officers' Mess, R.A.F. Patrington, Hull, Yorkshire.
G3AWD, S. A. Wood, 51 Fairway, Petts Wood, Kent.
GW3DSV, R. W. P. Wilson, Pen-y-Bont Stores & Post Office, Pen-y-Bont, Oswestry, Salop. (*station in Denbighshire*). (*Tel. Llansantffraid 261.*)
G3FMR, T. Dwyer, 9 Thorndon Court, Eagle Way, Warley, Brentwood, Essex.
G3GB, H. B. Shields, 10 Deal Street, Newton Heath, Manchester, M10 6QF.
G3HVI, S. Baskeyfield, 46 Golborn Avenue, Meir Heath, Stoke-on-Trent, Staffs.
G3KNB, K. A. Ballance, 7 Honiton Close, Weeping Cross, Stafford. (*Tel. Stafford 62105.*)
G3LEX, R. Reed, 52 Chestnut Avenue, Grays, Essex.
G3LZC, A. E. Stirland, 98 Aldreds Lane, Heanor, Derbyshire, DE7 7HG. (*Tel. Langley Mill 4214.*)
G3ODH, S. B. Smythe, 7 Hylands Close, Epsom, Surrey.
G3PSP, A. J. Masson, Ph.D. (*ex-GM3PSP*), 1 Manns Road, Edgware, Middlesex, HA8 7NG. (*Tel. 01-952 0412.*)
G3THM, L. P. Best, 1 Ashdale Avenue, Pershore, Worcs.
G3TRH, R. Farrance, 8 Philbrick Crescent East, Rayleigh, Essex, SS6 9HQ.
G3VER, Verulam Amateur Radio Club, c/o 6 Leggatts Wood Avenue, Watford, Herts.
G3VSN, J. Bradbury, 27 Derwent Road, Kinsbourne Green, Harpenden, Herts.
G3WFQ, G. W. Stacey, 119 Sandy-mount Road, Wath-on-Dearne, Rotherham, Yorkshire.
G3WQK, Southdown Amateur Radio Society, c/o L. E. Tagliaferro, 9 Tugwell Road, Hampden Park, Eastbourne, Sussex.
G3WTF, R. J. Cockerham, 7 Beechwood Grove, Moorhead Lane, Shipley, Yorkshire.
G13YDO, W. J. McNally, 6 Spring Way, Neillsbrook, Randalstown, Co. Antrim.
G3YRY, J. D. Gales, 68 Kier Hardie Avenue, South Stanley, Stanley, Co. Durham.
G8BQO, W. G. Taylor, 42 Ormston Avenue, Horwich, Bolton, Lancs., BL6 7EB.
GW8BXD, R. H. Edgecombe (*ex-G8BXD*), 94 Larch Grove, Malpas, Newport, Mon.
G8CAC, M. G. Barker, 3 Burley Close, Desford, Leics.
G8CPJ, I. R. Lever, 65 Dynes Road, Kemsing, Sevenoaks, Kent. (*Tel. Otford 2945.*)
GM8RY, F. E. Wyer, 8 Antonine Court, Kinneil, Bo'ness, West Lothian.



THE OTHER MAN'S STATION

G3WVD

THE subject of our story this time—H. Moore, 269 Leeds Road, Ilkley, Yorkshire—was licensed in September 1967, and since then he has built up a very fine station, not all of which is shown in this picture.

At G3WVD, the accent is on constructional work and much more time is spent on this than in on-the-air operating. There are always several constructional projects in hand—one of these being a 4CX250 linear amplifier—for which a wide variety of test gear is available.

The main transmitter is a K.W. Vespa, with a Heathkit RA-1 receiver, a modified B.44 and a four-metre transceiver for mobile use. Other Tx equipment includes an 80/160m. AM transmitter and a 150-watt rig for 80 metres. The aerial layout involves a 68ft. self-supporting tower carrying a 3-element three-band rotary beam, mounted on a motorised elevated platform to give full remote control. One end of an 80m. dipole is supported by this mast, and there is also a Cubical Quad for four metres.

G3WVD has been laid out with safety in mind and wherever possible cables are laid in trunking, with sections isolated by emergency push-buttons. A key switch enables the whole station, including antennae, to be locked safe.

On the mechanical side, the workshop section (not shown here) includes a lathe, grinder, drilling machine and sheet-metal bender, together with a wide variety of tools suitable for radio and light electrical constructional

work.

Standing in an acre of garden beside the River Wharfe, G3WVD has excellent facilities for aerial installation, of which he makes full use.

* * *

We are always glad to have offerings for "The Other Man's Station" series, which has been a regular feature of SHORT WAVE MAGAZINE for more than 30 years. The prime requirement is a good, clear, sharp photograph—preferably black-and-white and about postcard size—with full information about the station and the operator, including such details as date of first licensing, experiences and interests in Amateur Radio, gear used, activity on the air and DX results achieved, also (where permissible for publication) personal details such as age, profession or occupation and ambitions in the Amateur Radio context. All this can be in "own words"—we write the story from the information given, to fit the space available. Payment at full rates is made immediately on publication.

Some of the contributions we are offered for "The Other Man's Station" come in either with a very poor photograph or not really enough detail. If the picture is a good one, the story should be enough to make a page. Stories which are not sufficiently detailed but include a good print are held as general illustration for "Communication and DX News."

Address your offering to: "Other Man's Station," SHORT WAVE MAGAZINE, BUCKINGHAM.

SOMETHING LIKE AN AERIAL

A recent issue of the excellent *New Scientist* discussed a fresh approach to antenna design for communication with submerged submarines—a Naval requirement under operational conditions. The lower the frequency that can be used, the less the attenuation of the wave on its passage through sea-water; in fact waves of 50-100 Hz would not be too low. But it is very difficult to design aerials to work with any sort of efficiency at the lower frequencies, and they have to be made very large (meaning *miles* in length) if they are to radiate an effective signal at such frequencies. The limit hitherto has been 10 kHz, which itself involves a huge mast-supported system. (One such can be seen up on the Solway Firth.)

The new project is to use a transmitter frequency of 45 *cycles* (Hz), guaranteed to penetrate the ocean to great depths in any part of the world from a single station, in this case in the U.S. To be effective, the system to radiate at this frequency (which is, of course, mains) called for an aerial made up of cable buried in chess-board fashion, in rectangles of eight square *miles*, over an area of 150 × 150 miles! The calculated total power involved is 800 megawatts, provided by a number of transmitters in parallel, feeding their power to the rectangle intersections, at a current of 40 amps. This would produce an ambient ("local") magnetic field of one gauss and an average electric field of 0.35 *volts* per metre. Since a massive system of this sort also calls for soil of low electrical conductivity in flat country, the Chequamegon National Forest area in the State of Wisconsin was chosen by the U.S. Navy planners.

Then the real trouble started. The anti-faction soon proved that such powerful VLF fields could cause all sorts of side-effects—like ringing all the telephones in the area, blacking out TV reception, and electrifying fences, to say nothing of the effects on plant and animal life. It was also shown that there would be "hot spots" in the radiation pattern (at the current antinodes) where the field-strength, and therefore the effects, would be well above the average.

So the Chequamegon Forest site has had to be abandoned temporarily, and other sites are now being sought in the desert areas of Nevada, Texas and New Mexico. In the usual large-handed American fashion, the research grant allocated for this extraordinary project is said to be \$20 million, and the eventual cost of the system \$1,500m.

U.K. CALLSIGN SEQUENCE

The current callsign series in issue in the U.K. is G3/ZAA-ZZZ. According to the latest issue of *Region I News*, produced by G2BVN for the member-societies of IARU Region I, the next sequence to be issued by our P. & T. Dept. will be G4/AAA-ZZZ. The G4 prefix was last used during 1939, for the G4/2 callsigns then being allotted to newly-licensed U.K. amateurs. Relatively few G4/2 calls were actually issued—Hitler's War came too soon—and there are not many of them to be heard round the bands today.

LOWE ELECTRONICS

WELLINGTON STREET, MATLOCK,
DERBYSHIRE

Matlock 2817 (2430 after 6 p.m.) BILL G3UBO

AGENTS

Alan : G3MME

4 Southwick Street, Southwick, Brighton

Sim : GM3SAN

19 Ellismuir Road, Baillieston, Nr. Glasgow
No 'phone yet

To be honest, I'm at a bit of a loss. I should be writing this at the end of March, but as I'll be away for two weeks then, I have to write it at the beginning of March and I haven't a clue what the second-hand stock will be in two months' time! Ah well, bash on, not to worry, eyes down looking for a full house. One thing for sure, I'll have some good second-hand stuff, bit of nice test gear and the usual odds and ends. Mikes, keys, keyers, monitors, filters (mechanical, crystal, H.P. and L.P.), headsets, S.W.R. meters, calibrators, and zo on, und zo forth. So send me your large s.a.e.'s and I fill 'em.

What else. Oh yes—we're starting "Motorway deliveries." Sundays (Rallies permitting) Willy will take the van and beetle off either down the M1, up the M1/A1, or up the M6, stopping at selected points bang on time, taking off exactly 15 minutes later. Hence you can meet Willy to pick up purchases, knowing that they haven't been bashed to bits, or just look at gear you are interested in, without obligation. We must stick to one rule, however, and that is that Willy will arrive exactly on time and take off exactly 15 minutes later. It's the only way we can be fair to the man down the line. Yes, Charlie, I know you only live ½ mile from the M1—I know it wouldn't take a minute just to slip up the road and drop the rig off, but the answer is NO!!

Rallies: I'll be at various of the forthcoming Mobile Rallies, so look forward to taking some cash off you. While you're there, take a look at my regulated power supplies—ideal for transistor work—switchable 3, 6, 9, 12 volts or I have another type continuously variable to 15 volts. Prices run from £5/10/- to £8/10/-. These are really nice little tools, well worth taking a butcher's hook at.

Got gear to sell—if it is nice we'll sell it for you on 5% commission.

Got any laboratory test gear—we could well be interested.

Want H.P.—surely, no problem on anything over £38.

Hours : Tuesday to Saturday, 9-5.30 (closed for lunch 1-2). Closed all day Monday.

73 de Bill
VE8DP/G3UBO

GUIDE TO BROADCASTING STATIONS

15th Edition

Illiffe & Son Ltd. Size: 7 1/4" x 4 3/4". 136 pages. 6s. 9d. post free.

The information given in this fifteenth edition of GUIDE TO BROADCASTING STATIONS has been completely revised and brought up to date although it must be remembered that some stations make frequent changes in operating characteristics.

Authorized and unauthorized long- and medium-wave stations operating in the European Broadcasting Area, which includes the Western part of the U.S.S.R. and territories bordering the Mediterranean Sea, are listed both in order of frequency and geographically. The details have been checked against the latest information available from the European Broadcasting Union. Also included is a list of the stations outside Europe which can be heard under favourable conditions.

There are nearly 4,000 entries in the list giving frequencies, wavelengths and power of the world's broadcasting stations operating the short-wave bands.

In this edition are included lists giving a selection of the more powerful European television stations and VHF sound broadcasting stations. All British stations are included in both these lists.

CONTENTS:

Long- and Medium-Wave European Stations Some L.W. and M.W. Stations outside Europe: Short-Wave Stations of the World: Map of Broadcasting Regions: European Standard Frequency Transmitters: Short Wave Broadcasting Bands: Wavelength and Frequency Conversion: European Television Stations: European VHF Sound Broadcasting Stations: Internationally Allocated Call Signs.

Available from—Publications Department

SHORT WAVE MAGAZINE
55, Victoria Street, London, S.W.1

**Swop your camera
or HI-FI for a Trio
TS-510 TRANSCEIVER
now
only
£180 with power supply**

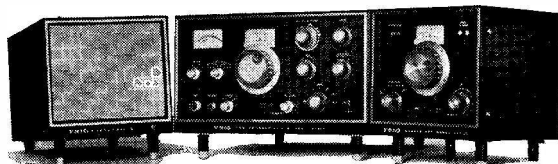

VFO-5D Unit £32 extra

TRIO

S.W. & HI-FI EQUIPMENT ON DEMONSTRATION

HOLDINGS PHOTO/AUDIO centre
Mincing Lane/Darwen Street, Blackburn
Tel. 59595 XXXXXXXXXX Closed Thurs.

DERWENT RADIO S.A.E. LISTS

SCA 63982	SHOWROOM, 5 COLUMBUS RAVINE, SCARBOROUGH		
KW Atlanta and AC p.s.u.	£250	PTT dynamic mic.	39/6
KW 2000B and AC p.s.u.	£240	Garex heavy duty p.s.u. kit	£4 12
KW Vespa II and AC p.s.u.	£135	Garex dual p.s.u. kit	£6 18
KW 201 receiver	£111	Eddystone 830/7	£285
KW Q multiplier	£8 10	Eddystone Edometer	£27
KW E-Z match	£12 10	Eddystone 940	£158
KW P.E.P. meter	£16 10	Eddystone EA 12	£195
KW 3 way coax A/E switch	£3 3	Eddystone EC 10	£59 10
KW balun	£1 15	Eddystone EC 10 Mk. II	£69 10
KW traps and T piece	£3 10	Eddystone mains p.s.u.	£6 15
KW low pass filter	£4 14	Eddystone 898 dial	£6 6
KW trap dipole	£11 10	Eddystone plinth speaker	£4 6
KW dummy load	£5 10	Diacast boxes 8/8, 11/11, 18/11	£6 10
Lafayette HA600	£45	Codar AT-5 transmitter	£16 19
Trio JR 310	£77	Codar T-28 receiver	£15 17
Trio TS 510 and AC p.s.u.	£180	Codar 250/S	£8 10
Trio JR-500 receiver	£69	Codar 12/MS	£11 10
Trio 9R59DE receiver	£42	Codar 12/RC	£2 10
Trio SP-5D speaker	£4 7	Codar PR-30	£5 19
Trio HS-4 headphones	£5 19	Codar PR-30x	£7 19
Eagle SWR bridge	£9 19	Joystick standard	£5 10
Eagle RF 45 tuning meter	£2	Joystick de-luxe	£6 11
Katsumi el bug	£7 15	Joystick 4RF tuner	£7 2
Medco LP filter, Belling	£4 10	Joystick 6RF tuner	£4 10
Medco HP filter, Amphenol	£5	Joystick 3A tuner	£4 4
250 ohm carbon pots	5/-	Amphenol PL 259 ptf	6/-
Jackson C804 25pf var	4/6	Amphenol SO 243 ptf	7/6
Hallcrafters SX 122A	£199	Repenco coils and trans- formers.	
Hallcrafters SX 133	£149	100 kc/s. B7G xtals	25/-
G Whips 160/80	£9	Selection 50-odd xtals, our choice, rebate on un- wanted xtals. Box	£2
G Whip tribander 14-28	£9	6J56A valves, RCA	35/-
G Whip multi mobile	£15 10	6LQ6 valves, RCA	46/-
G Whip base mount	£1 10	6GK6, RCA	16/-
Garex 2m. converter		Halsion mobile Ae	£6 17
28-30 Mc.	£10 7	Halsion extra coils	£3 17
Garex 2m. tx	£8 15	Teisco B1002 dynamic mic	£2 12
Garex 2w. 2m. tx kit	£16 10	TTC 5 band RF meter	£3 19
Garex 15w. 2m. tx kit	£4 17	Antex soldering iron 15w.	£1 12
Garex Standard mod. kit	£4 15	Antex soldering kit	£2 7
Garex de-luxe mod. kit	£7 17	2 way intercom	£2 15
Garex popular p.s.u. kit	£3 15		
Garex xtal checker	70/-		

Wanted: We are always pleased to hear about your trade-in equipment and are looking for good condition KW, Eddystone, and TW items in particular. We can offer cash, radio equipment or new photographic equipment in part exchange.

PACKAGE DEALS. WE CAN BEAT ANY ADVERTISED OFFERS. GIVE US A RING

H.P. on any items over £35 in value. One third deposit and up to two years to pay. Payments may be by Post Office Giro. You may also place your orders by Giro. Our account number 64 041 0006.

Second-hand equipment in stock			
Heath OS-2 scope	£20	Eddystone EA 12	£140
CDE rotator and control	£16	KW Viceroy II and p.s.u.	£80
Lafayette HR 40	£15	Heath RA-1	£30
J Beam 10m yagi	£14	Hallcrafters SX III	£70
AR 88LF	£33	Pye Lowband reporter	£5
Eddystone 840A	£30	Pye Hiband reporter	£4
KW 2000A and AC p.s.u.	£190	Hiband ranger	£10
KW Vespa and AC p.s.u.	£115	Heath RG-1	£27
KW Valiant and DC p.s.u.	£30	Minimitter 2-7 TX	£18
Trio JR 500	£55	Eddystone 750	£30
Trio TS and AC p.s.u.	£150	Shure 201	£2
Hallcrafters SX 43	£35	Trio 9R59De	£33
Trio VFO	£20	Hallcrafters S85	£30
Minimitter Mercury tx	£30	AR88D	£35
Collins filter	£25	AVO 8. Mint	£17
Codar AT-5	£13	EC10 mains p.s.u.	£4
Codar T-28	£12	KW 2000 and AC p.s.u.	£135
Codar PR 30	£4 10	Eddystone EC 10	£40
Lafayette HE-80 receiver	£30	Eddystone EC 10 II	£60
Class D w/meter	£6	KW Vanguard 160-10	£48
Lafayette HA 500	£38	Labgear LG 300	£30
Inoue IC 700R	£75		

Please add extra for carriage, S.A.E. for lists

28 Hillcrest Avenue, Scarborough, Yorks.

RADIO COMMUNICATION HANDBOOK

New Fourth Edition of the Original RSGB "Amateur Radio Handbook"

Price 69s.

(includes 6s. post and packing)

(Counter Price: 63s.)

Available from stock

Order from:

PUBLICATIONS DEPT.
SHORT WAVE MAGAZINE LTD.,
55 VICTORIA STREET, LONDON, S.W.1

G2CTV G3ZY

J. & A. TWEEDY (Electronic Supplies) Ltd.
SPECIALISING IN AMATEUR RADIO EQUIPMENT

KW Atlanta £250	KW Yeapa Mk. II £135
KW 2000 B £240	KW 201 Rx £111
KW EEZEE Match ...£12 10s.	KW L.P.F. £4 14s.

TRIO TS510s with AC power units
First class transceivers at £180 each

TRIO 9R59DE £42	TRIO JR500SE £65
TRIO JR301 £77 10s.	TRIO JR500SE with speaker and phones ...£69 10s.

LAFAYETTE HA600 Solid state Rx mains or battery ... £45

TAVASU AERIALS (CHESTERFIELD)

100in. Whip complete with 50Ω co-ax and base £2 12 6	20 metre resonator £2
160 metre resonator ...£2 10 0	15 metre resonator £2
80 metre resonator ...£2 10 0	P. & P. 2/6 per item extra.
40 metre resonator ...£2 5 0	Mobile packaged deal. One of each item £12 10s. plus 7/6 postage and packing.
Chrome-plated adaptor ... 6 0	

AR88D Smoothing chokes 10/6 each including P. & P.

TAVASU 2 metre beams 5 el. £2 9 6	
TAVASU 2 metre beams 8 el. £3 1 6	
TAVASU 70 cm beams 9 el. £2 0 6	
TAVASU 70 cm beams 15 el. £5 3 6	

carriage 5/6 extra

USED EQUIPMENT

AR88D £40	Heathkit SB301 as new ... £110
FR100B incl. top band... £90	Pyramid Linear £45
Sommerkamp FT100 ...£125	BC221 £16

Codar, Eddystone, Joystick, etc.

OPEN TUESDAY TO SATURDAY, 9 a.m. to 5.30 p.m.

H.P. Terms available Part exchanges

64 Lordsmill Street, Chesterfield, Derbyshire
Telephone Chesterfield 4982 or 77866 (evenings)



VHF COMMUNICATIONS

VHF COMMUNICATIONS has specialised itself to the publishing of exact and extensive assembly instructions for transmitters, receivers, converters, complete transceivers, measuring and auxiliary equipment, antennas, etc. which can be easily duplicated. It also features information regarding the development of electronic equipment, measuring methods, as well as technical reports covering new techniques, new components and new equipment for the amateur. The latest advances in the semiconductor, printed circuit and electronic technology are considered in great detail. All special components required for the assembly of the described equipment, such as epoxy printed-circuit boards, trimmers and coil formers, as well as complicated metal parts and complete kits, are available either from the publisher or national representative.

VHF COMMUNICATIONS is a quarterly, published in February, May, August and November. Each edition contains approximately 60 pages of technical information and articles. The subscription rate is £1 10s.; individual copies are available at 7s. 6d. each.

Editors: Robert E. Lentz, DL3WR.
Terry D. Bittan, G3JVQ/DJØBQ.

Publisher: UKW-BERICHTE
D-8520 Erlangen, Gleiwitzerstr. 45.
Federal Republic of Germany.

Representative for U.K.: Microwave Modules Ltd.
4, Newling Way, Worthing, Sussex.
Tel.: 0903-64301.

ERSIN



5 CORE SOLDER

for quick, easy, reliable soldering

Contains 5 cores of non-corrosive flux, instantly cleaning heavily oxidised surfaces. No extra flux required. Ersin Multicore Savbit Alloy also reduces wear of copper soldering iron bits.



SIZE 5 HANDY SOLDER DISPENSER
Contains 10 ft. coil of 18 s.w.g. Ersin Multicore Savbit Alloy. 3/- each.



SIZE 15 HANDY SOLDER DISPENSER
Contains 21 ft. coil of 60/40 Alloy, 22 s.w.g. Ideal for small components, transistors, diodes, etc. 4/- each.



SIZE 12 SAVBIT
Ideal for home constructors. Contains 75 ft. of 18 s.w.g. Ersin Multicore Savbit Alloy on a plastic reel. 15/- each.



BIB MODEL 8 WIRE STRIPPER AND CUTTER
Strips insulation cleanly and quickly, fitted with unique 8 gauge wire selector. Plastic handles. 10/- each.

From Electrical and Hardware shops. If unobtainable, write to: Multicore Solders Ltd., Hemel Hempstead, Herts.

Short Wave Listening

PHILIPS PAPERBACK

SHORT WAVE LISTENING by J. Vastenhoud. Size: 8½" x 5½".
107 pages. Numerous text diagrams.
Price 16s.

This book is intended as a guide for the benefit of the increasingly large numbers of regular listeners to short wave transmitting stations and also for radio amateurs who are interested in short wave listening.

The first group includes many emigrants who in their new country are anxious not to lose touch with their homeland, and those who are intending to emigrate and will thus in future have to do much of their listening on short waves. The second group is of those enthusiasts who regard short wave radio as an indispensable medium for the exchange of information internationally in the broadest sense and employ it in order to widen their knowledge of other countries. The book, which deals with the possibilities and problems of short-wave reception on the level of popular science will enable the reader to discover a whole new world of his own.

CONTENTS

Short Waves	Do Any Regulations Exist
The Principles of Short-Wave Transmission	Governing the use of Frequencies in the Short-Wave Bands?
Practical Short Wave Transmitting	DX-ing In Practice
Short Wave Prediction	DX-ing With a Tape Recorder
Sources of Interference	DX-ing Using a Frequency Meter
The Aerial	Some Commonly Used DX Terms in Three Languages
The Correct Choice of Receiver	Transmission of Time Signals at Standard Frequencies
Communications Receivers	Some of the More Important DX Clubs

Available from stock:
PUBLICATION DEPT.
SHORT WAVE MAGAZINE
55 VICTORIA STREET, LONDON, S.W.1

SMALL ADVERTISEMENTS

("SITUATIONS" AND "TRADE")

9d. per word, minimum charge 12/-. No series discount. All charges payable with order. Insertions of radio interest only accepted. Add 25% for Bold Face (Heavy Type). No responsibility accepted for errors. Replies to Box Numbers should be addressed to The Short Wave Magazine, 55 Victoria Street, London, S.W.1.

TRADE

JR-500SE, £69 10s. Free Top Band Conversion?

Free Headphones? Free Crystal Calibrator? Free Speaker? Choose any two of these and get part exchange on Photo or Hi-Fi equipment, plus 12 months guarantee and free carriage. Cash or H.P. Send s.a.e. for full details.—**Holdings Photo/Audio Centre, 39-41 Mincing Lane, Blackburn, Lancs., BB2-2AF.** Tel: 59595.6. (Closed all day Thursday).

R RECEIVER BARGAINS: Ex-Navy Murphy HF/MF, 13-valve, coverage 60 kHz to 30 MHz, without PSU, £16. B.40, £17. B.41, £10. PCR-2, with BFO, PSU and speaker, £12. CR-300/1, without PSU, £12. R.209, 6-volt version, £12. All these carriage extra and plus deposit on returnable crate. Crystal Calibrator No. 10, 60s., plus 7s. 6d. post/packing. Other types, R.107, HRO, AR88, etc., available from time to time, but at my prices they move fast, so write or ring Torrington 2411 (STD 08052) any time for details of current stock.—**P. R. Gollidge, G3EDW/ex-9J2W, Glen Tor, Torrington, North Devon.**

QSL Cards and Log Books, GPO approved, cheapest and best. Prompt delivery.—Samples from **Atkinson Bros., Printers, Looe, Cornwall.**

QSL & SWL Cards, letter-heads and address labels to your own design, from 45s. tax paid. Clubs welcome. Quotation from G3JQH, Printers.—26 Hamesmoor Way, Mytchett, Camberley, Surrey.

QSL Samples, excellent range at the right price. Also Log Books at 7s.—**Bailey & Co., Greenfield Place, Weston-super-Mare, Somerset.**

QSL Cards: Two-colour, attractive design, variable features, from £3 3s. per 1,000 (inclusive). Send foolscap s.a.e. for samples.—**ARA Press, 46 Moat Avenue, Green Lane, Coventry.**

QSL Cards for Tx and SWL. Send s.a.e. for samples, stating which type required.—**Beaumont, G5YV, 8 Ashfield Avenue, Morley, Leeds, LS27-0QD.**

JUNE Issue: Appears May 29. Single-copy orders, 4s. (4s. 3d. "first-class" mail) to reach us by Wednesday, May 27, for posting on May 28.—**Circulation Dept., Short Wave Magazine, Ltd., 55 Victoria Street, London, S.W.1.**

DISPOSING: BBC Mobiles, Type 59G five-channel, overhauled to specification and lined up on two metres, complete with microphone, PSU, cables, circuit and 2m. Tx xtal, price £12 10s. including postage/packing.—**Ring Earl, Hoddesdon (Herts.) 63453.**

READERS ADVERTISEMENTS

3d. per word, minimum charge 5/-. payable with order. Add 25% for Bold Face (Heavy Type). Please write clearly, using full punctuation and recognised abbreviations. No responsibility accepted for transcription errors. Box Numbers 1/6 Extra. Replies to Box Numbers should be addressed to The Short Wave Magazine, 55 Victoria Street, London, S.W.1.

WANTED: R.206 and R.107 Receivers; must be in first-class condition.—**Edwards, 42 Kingswall, Malmesbury, Wilts.**

FOR SALE: K.W. Vespa Mk.I Tx, complete with PSU, £80; Eddystone 888A receiver, with S-meter and speaker, £65; both these in excellent condition. CR-100 receiver, in good working order, £17. Creed 7B Teleprinter, price £8. Prefer buyers to collect.—**Tibbert, 397 Uttoxeter Road, Derby (32180).**

HENRY'S RADIO LTD.

COMPREHENSIVE CLEAR
CONCISE CATALOGUE

★
ALL TYPES OF
ELECTRONIC
COMPONENTS, TEST-
EQUIPMENT, KITS and
BUILT UNITS.

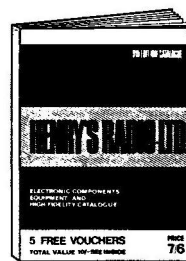

Over 300 pages fully detailed and illustrated with more than 6,000 stock items. Everything for amateur and professional use. Complete with 5 vouchers. 10/- value, for use with purchases.

ORDER AS CATALOGUE A. PRICE 7/6. p.p.2/-

HR HENRY'S RADIO LTD.

Mail Order Dept., Components,
Organ Dept.
303 EDGWARE ROAD, LONDON W.2.
Telephone: 01-723 1008-9.

High Fidelity and Equipment Centre
309 EDGWARE ROAD,
LONDON W.2.
Telephone: 01-723 6963

OPEN MON-SAT 9am-6pm. THURS 9am-1pm.

FREE Cut-out art supplement of
WORKSHOP PLANS
for Simplified
Solid-State Distortion Meter

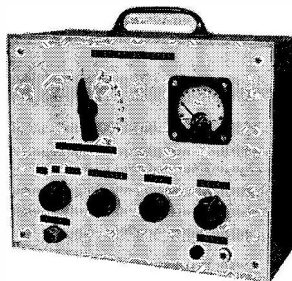

Full
working
diagrams
including
Printed
Circuit
board
layout.

Many other first class articles Plus
EXCLUSIVE MOTORING OFFER

All in MAY issue of

THE
RADIO CONSTRUCTOR

ON SALE NOW 3/6

Echelford Communications

32 FELTHAM HILL ROAD, ASHFORD, MIDDX
Ashford (MX) 55265 any time up to 9.30 p.m.



We regret that as from 1st June we will be forced to increase the cost of the ECHELCOM 2 and its mains power supply. This has been due to increased cost of components, etc. Orders received up to 31st May will be at the old prices (see previous advertisement).

The new prices will be :-

Echecom 2 kit form with mike, etc.	£25 0 0
Echecom 2 kit less crystals and mike... ..	£21 0 0
Echecom 2 ready built with mike, etc.	£32 0 0
Echecom 2 ready built less microphone and crystals... ..	£28 0 0
Mains power supply kit	£9 10 0
Mains power supply ready built	£10 10 0

We shall be attending the following rallies in May/early June:—
May 10th : Ealing Mobile Rally, London, W.7
June 14th : Elvaston Castle Rally, Derby

S.A.E. for list of new and secondhand items

Hours of business:

Monday, Tuesday, Thursday, Friday	9.00 a.m.—6.00 p.m.
(Closed for Lunch 1-2 p.m.) Saturday	9.00 a.m.—5.30 p.m.

CLOSED ALL DAY WEDNESDAY

A. G. WHEELER, G3RHF

JOIN THE STERILE SOCIETY WITH A

JOYSTICK VFA

REGD.
AND ABOLISH HARMONICS!

Partridge Electronics Ltd., Broadstairs, Kent

FOR SALE: Home-built G3OGR-type Tx for 80/160m., with PSU, needs setting up, £6. Semi-auto Bug Key, 40s. Stocks & Dies for electrical conduit, 3in. and 1in., 30s. Creda Corvette water heater, rated 2 kW, no plumbing needed, 60s. Transformer, 220-250v. input, output at 24v. 85 VA, 10s. Buyers to collect.—Stamp, 12 Butler Estate, Digby Street, Bethnal Green, London, E.2.

WANTED: Hy-Gain Vertical Type 14-AVQ aerial. Also Dow-Key series 71 coax relay; and a digital clock.—Eaton, 80 Mole Street, Sparkbrook, Birmingham 12.

FOR SALE: Creed 7B 24v. motor, silence cover and table, with DL6EQ-type T.U. (but no polar relay), price £20. Hartley Type 13A double-beam oscilloscope (no probe unit), £18. Frequency Meter LM-10 (all-same LM-14), with charts and manual, £22. Would consider delivery within 40 miles S.E. London, otherwise buyers collect.—Box No. 4896, Short Wave Magazine, Ltd., 55 Victoria Street, London, S.W.1.

WANTED: Heathkit SB-200 Linear amplifier, must be in excellent condition. Also two 813 valve bases.—Kellow, c/o Callington Motors, Ltd., Tavistock Road, Callington, Cornwall.

SALE: Codar 250/S power supply unit, £7. Codar T.28 receiver, £13. Both new, ordered in error.—Cockayne, 9 Foresters Terrace, Teignmouth, Devon.

WANTED: Small two-metre QRP transceiver, suitable to carry around for portable work. Either home-built, Printset designed, or W-H-Y?—Box No. 4894, Short Wave Magazine, Ltd., 55 Victoria Street, London, S.W.1.

SELLING: On behalf of deceased's XYL, an Eddy-stone 680 receiver, price £40. Also a Heathkit DX-100U, £35, all in FB condition, with other gear. (Northumberland).—Box No. 4895, Short Wave Magazine, Ltd., 55 Victoria Street, London, S.W.1.

MANUALS: For S.36A, S.27C, SX-28, CR-100, CR-300, AR88LF, BC-312, BC-348, R.1294, R.1355 and R.1155, 25s.; B.40 and Cossor 339, 35s.; R.209, SX-24, 10s.; also R.206, R.216 and P.104, 15s. All postage extra. Many others available, VHF/UHF.—Brooks, 5 Farrant House, Winstanley Road, London, S.W.11.

SALE: Geloso G.209 receiver, coverage 10-11-15-20-40-80 metres, price £40.—Wozny, 3 Manor Avenue, Higher Marston, Nr. Northwich, Cheshire.

SELLING: Heathkit DX-40U with home-built VFO for 40-80m., £22. National HRO, with coil packs and PSU, £18. Jap El-Bug key type DA.1, £10.—Sear, G3VOK, 21 Priestleys, Farley Hill, Luton, Beds.

WANTED: High-Band dash-mounting Pye "Ranger," in any condition. Also a Mosley TA-33Jr. antenna.—Harman, 9 Calverton Road, Stony Stratford, Wolverton, Bucks. (Tel: Stony Stratford 3346, after 5.30 p.m.)

FOR SALE: Trio Transceiver TS-500 with PS-500 power supply. Very little used. Asking £160 or reasonable offer.—Limehouse, G3WTN, 5 Argyle Road, Whitby, Yorkshire.

SELLING: R.216 receiver, with manual, £55 10s. S.R.C.A. AR88D Rx, with S-meter, spectrum analyser (panadaptor), speaker, headphones, set of spares and valves, £80. Nordemende "Globetrotter" amateur receiver, with BFO, etc., £75. Hallicrafters monitor for 144 to 175 MHz, £17.—Ring Sutcliffe, Bradford 676556, after 6.0 p.m.

WESTERN ELECTRONICS

"TOWERS ABOVE ALL ELSE"

★ Your 'one stop' single source for masts, towers, rotators and antennas

LOCK RING	30'	£12
LOCK SCREW	40'	£14
	50'	£17

GUY PLATE
Thr. paid, mainland.

RETAINING PIN

Telomasts telescope down to 10', are rotatable and are ideal for fixed station installations, field days and expeditions.

TELETOWERS
The finest value in galvanised steel telescopic towers; all telescope down to 25', 42', 69', 57', 69', 79', £109; 101', £143, carr. paid.

VERSATOWERS
Self-supporting tilt-over towers are available for 20', 40', 60' and 85' at £92, £121, £146 and £260 or 120' guyed at £360.

TELOMAST

HAMTOWERS

30' self-supporting galvanised steel tower with climbing rungs incorporated. Easily erected single handed, £42 10s. carr. paid.

PACKAGED DEALS. Save yourself money by taking advantage of a special reduction on purchasing tower + rotator + antenna.

Catalogue (1/3 in stamps) from

24 HOOK STREET, HOOK, SWINDON, WILTS.

Tel. Wootton Bassett 2792

WANTED: Racal RA-17 Model L Rx, with hand-book. Must be in excellent condition, inside and out. Details and price, pse.—Diamond, G3UEE, QTHR.

SELLING: JR-500SE Rx, covers Top Band, with ATU, RF attenuator, pre-selector, Q-multiplier, crystal calibrator, headphones and speaker, all only 7 months old, £70 takes The Lot.—Rooney, 11 Bowden Drive, Hornchurch, Essex.

FOR SALE: Trio 59-RD receiver, in excellent condition, with stabiliser and 3.5 mHz crystal calibrator, price £33. Would be interested in a modernised HRO-5T in immaculate condition, with metal capacitors, in Part-Exchange. (Yorkshire).—Box No. 4897, Short Wave Magazine, Ltd., 55 Victoria Street, London, S.W.1.

SELLING: KW-2000A Transceiver with AC/PSU, in mint condition, not 12 months old, price £165.—Niman, G3LGN, 9 Montgomery Drive, Unsworth, Bury, Lancs. (Tel: 01-766 2942).

SALE: R.C.A. AR88LF receiver, coverage 75-550 kHz, 1.5-30.0 mHz, price £35. R.1475 Rx, with PSU, tuning 2.0 to 20 mHz, £8. A/R-T-13 Tx, operating over 200 to 600 kHz and 2.0 to 18 mHz, price £12 10s. All complete with valves and in good condition. Also an R.C.A. Type 710A Signal Generator covering 370 to 560 mHz, £18 10s.—Ring Jay, 021-454 8305 (Birmingham), any time.

FOR SALE: Four-speed Brennel tape deck, capable of taking 14in. tapes, with 10 unused and two used 14in. Emitapes. Best offer secures, buyer to collect.—Pointon, G3MTX, 2 Holmesdale Road, Bexhill (177), Sussex.

HAS Anyone the circuit diagram, suitable modifications or handbook for the BC-788, or Indicator for it? Also wanted a 50-100 watt amplifier, in any condition, for a local group; offering £6 max.—Mekka, 15 Bourne Road, Farmcombe, Surrey.

SALE: Eddystone EC-10 Mk.I receiver, in good condition, price £35 or near offer.—Osborn, 20 Great College Street, London, S.W.1. (Tel: 01-930 0281.)

FOR SALE: Lafayette HE-80 receiver, five bands plus 6m. coverage, in very good condition, £40 or near offer.—Fletcher, 20 Hartley Avenue, Highfield, Southampton, SO2-3QZ.

SELLING: G2DAF-type Tx, with all crystals, PSU and in perfect working order, also Z-match.—Outhwaite, 23 South Eden Park Road, Beckenham, Kent. (Tel: 01-777 1103.)

WANTED: Eddystone receiver with horizontal dial, may be partly cannabised, but having cabinet, chassis, tuning gang and IF section.—Lindars, 52 Heathcote Drive, East Grinstead (23950), Sussex.

FOR SALE: Eddystone EC-10 Rx, with PSU, in mint condition, six months old, price £48. Prefer buyer collects.—Radwell, 20 Little Holbury Caravan Park, Lime Kiln Lane, Holbury, Hampshire.

WANTED: An all-band CW transmitter, anything considered; could collect London area.—Ring Brown, G3OVE, 01-777 9180 (West Wickham, Kent).

FOR SALE: G.E.C. BRT-400K communications receiver, 12-valve superhet, mains operated, complete with handbook and in first-class condition. Offers over £100.—Hanraads, 24 Lutterworth Road, Arnesby, Leicester (or ring Peatling Magna 229 after 7 p.m.).

SALE: IF Type T.U. ZA-39384 and PSU, with cables, £6. BC-312 receiver, £10. Grundig tape recorder TK-40, £35. Buyers collect.—Austin, 173 Ashford Road, Thanington, Canterbury, Kent.

OFFERING: Eddystone EC-10 receiver, as new; few hours use only. Advertiser purchased EC-10 Mk.II. Highest offer secures. Buyer should examine, operate and collect. (Dorking area).—Box No. 4898, Short Wave Magazine, Ltd., 55 Victoria Street, London, S.W.1.

TRANSISTORS: Surplus, new and tested, OC71, at 1s. 6d. each, or 10s. dozen. Mixed miniature diodes, 50 for 10s.—Wilson, 49 Medway Crescent, Gateshead, Durham.

CALL BOOKS

INTERNATIONAL:

INTERNATIONAL:	
INTERNATIONAL CALL BOOK	
(Spring Edition)	
"DX Listings"	45/6
"U.S. Listings"	69/6
The two together, covering the World	£5/10/0
"G's" only (1970)	7/3

MAPS

AMATEUR RADIO MAP OF WORLD	
Mercator Projection—Much DX Information—in colour. Second Edition	9/-
DX ZONE MAP (GREAT CIRCLE)	
In colour with Country/Prefix Supplement Revised to February, 1970.	14/9
Black and White only	5/6
(plus 1s. 6d. with Country/Prefix Supplement)	
RADIO AMATEUR MAP OF THE U.S.A. AND NORTH AMERICA	
State boundaries and prefixes, size 24" by 30", paper	8/9
RADIO AMATEUR'S WORLD ATLAS	
In booklet form, Mercator projection, for desk use. Gives Zones and Prefixes	17/-
QRA LOCATOR MAP	
(R.S.G.B.)	9/-

LOG BOOKS

Standard Log	7/9
Log and VHF Contest Log	7/9
Receiving Station Log	7/3
Spiral bound (A.R.R.L.)	12/-
Minilog, 4" by 6" (A.R.R.L.)	5/6

(The above prices include postage)

MORSE COURSES

G3HSC Rhythm Method of Morse Tuition	
Complete Course with three 3 speed L.P. records with books	84/-
Beginner's Course with two 3 speed L.P. records with book	60/6
Single 12" L.P. Beginner's with book	50/-
Single, 12" L.P. Advanced with book	50/-
Three speed simulated GPO test. 7" d.s. E.P. record	15/-
Plus 5% for postage and insurance	

Available from

SHORT WAVE MAGAZINE

Publications Dept., 55 Victoria Street, London, S.W.1 01-222 5341

(Counter Service, 9.30-5.15, Mon. to Fri.)
(Nearest Station: St. James's Park)

(GIRO A/C No. 547 6151)

ELECTRONIC KEYS

SAMSON ETM-2 KEYS—Used at Coast Stations and on some of the world's largest ships. 11 silicon-planar transistors, 6 diodes. Silent dry reed relay, 400V, 1A contacts. 10-60 wpm. Sidetone. Superb keying lever. Only 4in. x 2in. x 6in. ! Complete, £21 post paid (£22/4/0 with mercury batteries).

PRINTSET ET5 KEYS BASI-KIT—8 transistors, 9 diodes. Mini-relay. 9-50 wpm. Sidetone. Basi-kit from W. Germany, £6/0/3 post paid. Bauer keying lever unit, 37/6 post paid.

14 page Catalogue SP5 describes these and other RTTY, VHF, SSB kits and units.

SPACEMARK LTD.

14 PICCADILLY,
MANCHESTER 1.
(Tel.: 061-237 0817)

G3XKF MINITENNA G3XKF COMMUNICATIONS EQUIPMENT

We prefer you to inspect our equipment and collect

GONSET G77 mobile Tx with power supply covering 80-10 60w. ...	£27 10 0
HALLICRAFTERS HT40 Tx 80-10 75w. ...	£18 10 0
I035 Scope ...	£25 0 0
I049 Mk. 3 Scope with trolley ...	£35 0 0
PYE Base Station, 4 metres working on four... ..	£20 0 0
B44 Mk. 2, original condition ...	£4 10 0
HALLICRAFTERS S27B , to clear ...	£15 0 0
Boot-mounting PYE (High Power), complete ...	£12 10 0

WANTED—TRANSMITTERS AND RECEIVERS

J. SHARRATT
EDLESBOROUGH, DUNSTABLE, BEDS.

Tel. Eaton Bray 297

SPECIAL OFFERS

SAVE BENCH SPACE WITH THE "EAGLE" MINI-LAB SEVEN TEST INSTRUMENTS IN ONE UNIT SIZE 3½ x 6½ x 2½in. deep

- (a) Field strength meter to 140 Mc/s.
- (b & c) Resistance/capacity substitution box (five values of each).
- (d & e) AC and DC voltmeter—four ranges to 500 volts (200 µA meter).
- (f) Modulated RF signal generator on 455 Kc/s (adjustable).
- (g) Audio oscillator on 400 cycles.

Brand new with test leads, telescopic aerial, instructions in simulated leather carrying case, £5/18/- plus 2/- carriage.

New sealed saline-activated batteries for lifejackets, will give 3-5 volts at 0.3 amps. for approximately 10 hours when dipped in salt water. Have magnesium plates inside which burn brilliantly if ignited, 2/6 plus 1/- post.
IF YOU ARE A BOATMAN THIS ITEM MAY SAVE YOUR LIFE.

New 3-digit resettable revolution counters for tape recorders, etc., 3/- plus 6d. post.

G.E.C. mobile transmitter receivers, 12-volt DC input transistor inverter receiver p.s.u., rotary Xformer Tx p.s.u. QOV03-20A P.A. valve, complete with speaker, control box and handset, £5 plus 12/6 carriage.

Eight Marconi I.F. alignment generators, 10-7 Mc/s. A superb instrument with 2 meters, S.A.E. details, £10 plus 10/- carriage.

Thirty new boxed re-entrant loudspeakers, 7½in. long, 6½in. wide, £2 plus 5/- post.

Seven BC221 frequency meters, 125 Kc/s-20 Mc/s, with Xtal and correct charts, £16/10/- plus 12/6 carriage.

FOR CALLERS ONLY

Nine double Solartron stabilised p.s.u., mains input, output variable to 500 volts 200 mA TWICE plus LT's in 19in. rack cabinet, £8/10/-.

Twenty various Solartron oscilloscopes, CD513/523/518/568/711, £15-£40.

ELEY ELECTRONICS

112 Groby Road, Glenfield, Leicester, LE3-8GL

THE STICK THAT DOES THE TRICK

JOYSTICK VFA

REGD.

NO KIDDING!

WORLD RECORDS DON'T COME THAT EASY!!

Partridge Electronics Ltd., Broadstairs, Kent

FOR SALE: Hallicrafters CRX102 solid-state portable Rx, coverage 144 to 174 mHz (includes two-metre band), as new, and bargain at £10.—Pople, 133 Upton Road, Bexleyheath, Kent. (Tel: 01-304 0518.)

OFFERED: Murphy stereo-gram, late 1969 model, price £65 or first offer; to be collected.—15 Waverley Gardens, Grays, Essex.

SALE: Marconi Signal Generator Type 390G, 16 to 150 mHz, £20. Triplet Signal Generator 1632, 240v. AC, £15. Two Command transmitters, less valves, 25s. each. Command modulator, with valves, 60s. Two Londex relays, 240v. AC, 40s. Electrostatic meter, 5 kV, 20s. All items as new and in original packing. Also a CR-150 Rx, resprayed case, few mechanical mods., £30. Cossor Type 339 Oscilloscope, with spare CRT and manual, £10. QRO PA for 144 mHz, Admiralty, as new, offers? Transmitter, 100w., modulator 100w., worth seeing, offers?—Ward, G3HBM, 7 Regent Street, Burnham-on-Sea, Somerset.

OFFERING: Codar CR-70A Rx with Hamgear PM2 preselector, both only two months old and hardly used, £25 or near offer.—Thwaites, 40 Broomhill Road, Dartford (26496), Kent.

SALE: K.W. Viceroy Mk.III transmitter, with extra half-lattice filter, few hours use only and as new, £85 or near offer.—Winton, 8 Broomagebank, Main Street, Larbert (2604), Stirlingshire, Scotland.

DISPOSING: Wavemeter Class-D Mk.II, with spares, £4 10s. Wavemeter Class-D No. 2, battery-mains input, 1 to 19 mHz, new and with spares, £10. Valve Tester, Type I117, new, £10; Mx 94-9AV for same, 40s. EE8 field telephones, 40s. TF-144 thermocouple, 20s. Telescopic masts, 20ft., ex-Army, 50s., or two for £4. TRCI AB-101 masts, with guys and all attachments, rotatable base, 35ft., £10; 70ft., £18 10s. Three-element beam to match, 70-100 mHz, £5. Manuals, new, SCR-522, 30s.; BC-624 Rx, 10s. Carriage at cost all items. WANTED: Manuals or circuits for Army equipment R.210, C.11, C.13, C.42 or C.45, etc., etc., also ex-R.A.F. equipment TR.1986, etc. W-H-Y?—Clarke, Copper Coin, Old Galgorm Road, Ballymena, Co. Antrim, Northern Ireland.

SELLING: Heathkit GC-1U Mohican receiver, with Daystrom manual, Joystick VFA aerial and Type 3A tuner, extension speaker and headphones, price £30, buyer to collect.—Sherwin, 12 Bridport Avenue, New Moston, Manchester, M10-0NQ. (Tel: 061-681 5851.)

OFFERING: Prize-winning Top Band AM mobile station, complete with transistor 12v. PSU, microphone and FS meter, at £28. Can be seen working.—Niman, G3LGN, 9 Montgomery Drive, Unsworth, Bury, Lancs. (Tel: 061-766 2942.)

NEW Valves: ECC81, ECC85, ECF80, ECH81, EF85, EF89, EBC81, ECL80, EABC80, EM81, EZ80, EF40, EF41, EL41, EL42, UF41, UF42, at 3s. each, plus 6d. post and packing.—Cooper, 13 Churchfield Road, Outwell, Nr. Wisbech, Cambs.

FOR Achill Island, Ireland, in late May, loan or purchase of two-metre gear wanted. Also LA19 winding details for portable supply.—Walsh, G8CEF, Birkenshaw, The Ridge, Little Baddow, Essex. (Tel: Danbury 3314.)

SALE: National NCX-D mobile PSU for NCX-3, little used and as new, with manual, connector plug, etc., £30.—Porter, G3AQY, High Street, North Thoresby, Grimsby, Lincs.

BARGAIN Sale: BC-221M frequency meter, with charts, £15. CR-300, £10. Aircraft receiver 7303, in black crackle cabinet, perfect condition, £4; chassis only, 40s.; both these with valves. Aircraft-type cross-over meters 100 microamp. f.s.d., good for SWR bridge, etc., 20s. Aerial tuning units by Sunair Electronics (U.S.A.), super job in black crackle case, including 10-inch Air Dux coil, rotary switch, etc., 60s. Aerial tuning units Type 7305, motorised inductor, in nice case, bargain at 50s. Absorption wattmeter AF No. 1, large meter, gift at £5. Small 24v. DC motors, with brake, 5s. Control Unit Type 7306, includes 0-500 microamp. meter, 20s. 'Scope Indicating Unit Type 221, bargain £5. Rejector tuning unit for 1-2 to 10 MHz, calibrated dial, brand new in neat case, 40s. CR-300 Rx, not working but suitable for spares or rebuilding, £4. Carriage extra all items.—McCraig, GM3BQA, Woodlands, North Berwick, East Lothian, Scotland. (Ring 2519, evenings.)

OFFER: Trio 500-SE, bought brand new and not used, £45 or near offer.—Ring Capell, 01-749 1863.

FOR SALE: Star SR-200 Sideband receiver, as new, with padded headphones, price £30 or offer.—Warner, 4 Lane End Road, Spinneyfield, Rotherham (3226), Yorkshire.

SELLING: Codar CR-70A receiver with PR-30 pre-selector, speaker and headphones, at £15. Also Perdio "Town & Country" portable receiver, £10. Buyers to collect.—Coulter, 145 Bourne Vale, Hayes, Bromley, Kent.

SALE: Home-built Tx, 50 watts AM/CW, for 3-5 to 28 MHz, Gelofo VFO, with internal modulator and PA PSU's, £10. BP5 Tx/Rx, coverage 1-9 to 8 MHz, requires PSU, £5. TA-12 Tx, £5.—West, GW2DPD, 6 Robinswood Crescent, Penarth, Glamorgan, CF6-2JE, South Wales.

DISPOSING: KW-201, with calibrator, absolutely new condition, and little used, in maker's carton, give-away price £70.—Haines, 12 Cemetery Road, Laceby, Grimsby, Lincs.

SALE: K.W. Vespa Mk.II, hardly used, £100. Hammarlund HQ-180 receiver, £80. Hamscan Panadaptor, 455 kHz (American Heathkit), £20. Multi-meter, new and boxed, 50K ohm-per-volt, £4. Codar Preselector, powered, £4.—Ring Dobie, 01-397 5552 (home), or 01-636 3676, extn. 309 (office), May 3 or later.

SALE: Antenna Tuning Units (U.S.A.)—tune your vertical by remote control. Fully enclosed in black crackle case, including air-spaced coil, solenoid-controlled multi-contact rotary switch, large feed-through insulator, etc. Ideal for an all-band Vertical, or W-H-Y, price £6, carriage paid.—McCraig, GM3BQA, Woodlands, North Berwick (2519), East Lothian, Scotland.

FOR SALE: Solarton 'Scope (time base not working), AC/DC amplifiers, £10. Another, in good order, £25. Cossor Type 1035 DB 'Scope, £14. Marconi valve voltmeter, £8. Signal Generator 801, £20. R.C.A. Panadaptor (needs tube), £5. Pye Rangers: AM, 90s.; FM, £5. Fifty copies "QST," 20s.—Ring Liming, East Horsley (Surrey) 3982.

TOP quality polypropylene non-rot rope. Diameters, 1/4 in., 1300 lbs. breaking strain; 5/16 in. +1890 lbs. B/S; and 3/8 in. dia., 3100 lbs. B/S. Send s.a.e. for sample.—Powell, GW3HUM, 21 Tanybryn Estate, Valley, Anglesey.

JUNE Issue Short Wave Magazine, due out May 29. Single-copy orders 4s. (or 4s. 3d. "first-class") post paid to reach us by Wednesday, May 27, for despatch on Thursday, 28th. These copies are sent flat in an envelope.—Orders, with remittance, to: Circulation Dept., Short Wave Magazine, Ltd., 55 Victoria Street, London, S.W.1.

WANTED: Eddystone S.750 receiver in good and unmodified condition, will collect around Northern England.—Platt, G2VO, Underhill, Glenlyon Drive, Keighley, Yorkshire.

TELECOMMS G3SED

AMATEUR—MARINE—MOBILE
COMMUNICATIONS

COMPONENTS SALES AND SERVICE

CRYSTALS! CRYSTALS! (type HC6U)

39518-5	39555-5	39592-6	39629-6	39666-7	39703-7
39740-7	39777-8	39814-8	39851-9	39888-9	39925-9
39963-0	40000-0	40037-0	40074-0	40111-1	40148-1
40185-2	40222-2	40252-3	40296-3	40333-0	40370-4
40481-5	40444-5	40407-4	40629-6	40666-7	40703-7
40703-7	40740-7	40777-8	40814-8	40851-9	40888-9
40925-8	40963-0	41000-0	41037-0	Mhz, etc., etc.	

Limited supply so please state a choice of three to avoid delay. 12/6 each POST PAID.

RACAL FREQUENCY COUNTER type SA28, 19in. rack mounted with mains power unit. 0-10 Mhz frequency coverage (valve type). Would cover 0-200 Mhz with an additional unit. ONE ONLY offered at £29.

ADVANCE AUDIO GENERATOR JI-B. Frequency coverage 15-300 c/s. 300-4,000 c/s, 4 Kcs-50 Kcs, in three ranges. Output 5 or 600 ohm. 20 Db attenuator. 4 months old, £19, carriage £1.

RTTY receiving station complete, consisting CREED 7B page and tape printer, soundproof cover and perspex half cover. Scope monitor unit. F.S.K. unit, signal distribution panel and all necessary power units. Whole assembly 19in. rack mounted, £29.

GLASS INSULATORS (2in. egg type), 3/6 each OR 4 for 9/-, post paid.

VALVES: 813's 33/-, 807's 3 for £1, 2E26's 30/- each. All post paid.

METERS: 5 amp. RF square 14/- each, post paid.

Secondhand receiving and transmitting equipment.

PANDA CUB £25, CODAR AT5 £13, ATS PSU £4, DX100U £39, CR100 £18/10/-, HRO £16, BC639 £14, B40 £18.

Don't forget we are always looking for trade-in receiving and transmitting equipment to fill the empty spaces!

Terms: Cash with order

Telephone Portsmouth 60036

73's From 73 TWYFORD AVENUE,
STAMSHAW, PORTSMOUTH, HANTS.

Listen to the World with Eddystone



When you own an Eddystone communications receiver, you have the broadcasting world at your finger tips—wherever you happen to be—on land or at sea. The reputation these sets have attained is proof of their excellence and reliability and at Imhofs, there is a special Eddystone department, where you can see, hear and compare all models listed here.

Same day despatch to any part of the world; free delivery in the U.K.; plus after sales service for which Imhofs and Eddystone are world famous.

EDDYSTONE EB35 Mark II broadcast receiver AM/FM transistorised. A high performance all-band receiver, can also be used as a 'Hi-Fi' tuner. Powered by 6 SP2 torch cells, or, with Type 924 power supply unit, from AC mains. £82.4.9d.

EDDYSTONE 940 (13 valve) communications receiver. A connoisseur's instrument combining 'Professional' appearance with performance; has a world-wide reputation, two RF stages ensure high-sensitivity. £158.0.0d.

EDDYSTONE EC10 transistorised communications receiver. An enthusiast's receiver at a modest price. Embodies features usually only found in much more expensive designs. Powered by 6 SP2 torch cells or Type 924 power unit (AC). £59.10.0d.

EDDYSTONE EC10 Mark II transistorised communications receiver. A de-luxe version of this famous design now incorporating 'S' meter and limited fine tuner. £69.10.0d.

EDDYSTONE EA12 'Ham Band' receiver. Built to professional standards but specifically for the amateur enthusiast. High sensitivity for all reception modes CW, MCW, AM and SSB. FSK adaptor available as ancillary £195.0.0d.

There is an Eddystone Communications receiver for any frequency between 10k Hz and 870 MHz, full details from Imhofs or your local Eddystone agent.

IMHOF'S

MAIN EDDYSTONE
DISTRIBUTORS



Dept: 11/5

112-116 New Oxford Street, London, WC1 Tel: 01-636 7878

Taurus Electrical Services SUMMER SALE

TELEPRINTERS, AVERAGE CONDITION ... £12 10 0 DEL.
 TELEPRINTERS, AS NEW, BOXED ... £27 10 0 DEL.
PORTABLE DISTORTION AND MARGIN TESTERS
 No. 1, complete with Hand Book ... £7 0 0 DEL.

100 SMALL CONDENSERS, 2Pf to 1 MFD .. 8/6 post paid
 10 NEW POTS ... 15/- post paid
 50 MIXED HIGH STABS ... 8/6 post paid
 MORSE KEYS with head and JACK PLUG
 TRANSISTOR PACKS, 6 transistors, 9 diodes,
 etc., including OCI70's, OC42's, OA42, OA91... 6/6 post paid
 OR £3 0 0 doz.

VALVES

NEW G.P.O. RELAYS 1000Ω and 4000Ω ... 6/- post paid
 MINIATURE LAMP HOLDERS, L.E.S., red,
 green, yellow, white, blue ... 2/3 post paid
 25/- dozen

L.E.S. bulbs to fit, 6.3V or 12V ... 1/- each
 or 10/- dozen

METER TEST PRODS. ... 5/3 pair, post paid
 12 MIXED ELECTROLYTICS ... 7/6 post paid
 12 MIXED PAPER CONDENSERS ... 15/- post paid

EX-G.P.O. TELEPHONES, LESS DIAL ... 18/6
 WITH DIAL 25/- DEL.

NEW TYPE TELEPHONE CARBON MIKE
 INSERTS ... 2/3 post paid
 25/- dozen

26-28 NOTTINGHAM ROAD, LOUGHBOROUGH, LEICS.

Telephone 5131

Also at

88 ARKWRIGHT STREET, NOTTINGHAM

RADIO SHACK

LONDON'S AMATEUR RADIO STOCKISTS
 HY-GAIN ANTENNAS AND ACCESSORIES

VERTICAL ANTENNAS AND ACCESSORIES	£	s.	d.
18 HT 6 thru 80 metre Vertical 'Hy-Tower' ...	92	10	0
12 AVQ 10 thru 20 metre Vertical Trapped Antenna ...	13	10	0
14 AVQ 10 thru 40 metre Vertical Trapped Antenna ...	19	10	0
18 AVQ 10 thru 80 metre Vertical Trapped Antenna ...	32	10	0
18 V 10 thru 80 metre Vertical Antenna ...	8	10	0
12 RMQ Roof Mounting Kit for 12 AVQ ...	7	10	0
14 RMQ Roof Mounting Kit for 14 AVQ ...	8	10	0
LC 80Q 80 metre Loading Coil for 14 AVQ ...	6	5	0

TRI-BAND BEAMS AND QUADS	£	s.	d.
TH6DXX Super Thunderbird 6 Element 10-15-20m. Beam ...	85	0	0
TH3MK3 Thunderbird 3 Element 10-15-20m. Beam ...	67	10	0
TH3JR 3 Element 10-15-20m. Beam 600W PEP rating ...	44	10	0
TH2MK3 Thunderbird 2 Element 10-15-20m. Beam ...	44	0	0
Hy-Quad 3 Band 2 Element Cubical Quad. Sgl. Feed Line ...	52	10	0

DUO-BAND BEAMS	£	s.	d.
DB24B 20 and 40 metre Duo-Band Beams ...	95	15	0
DB10-15A 10 and 15 metre Duo-Band Beam ...	48	0	0

HIGH PERFORMANCE MONO-BAND BEAMS	£	s.	d.
402BA 2 Element 40 metre Beam ...	72	0	0
204BA 4 Element 20 metre Beam ...	62	10	0
203BA 3 Element 20 metre Beam ...	67	10	0
153BA 3 Element 15 metre Beam ...	31	10	0
103BA 3 Element 10 metre Beam ...	24	10	0
BN 86 Broad Band Ferrite Balun for use with any Beam ...	7	10	0

Carriage extra on all items

ANTENNA ACCESSORIES AND CO-AX	£	s.	d.
TE 7-01 Omega-T Systems Antenna Noise Bridge 1-100MHz ...	13	10	0
TE 7-02 Omega-T Systems Antenna Noise Bridge 1-300MHz ...	19	10	0
EACO 4-way Coaxial Antenna Switch 52 ohm UHF Conn. ...	4	5	0
RG-8A/U Heavy Duty 52 ohm Coaxial Cable per yard ...	5	6	0
PL-259 Connectors for RG-8A/U Cable ...	5	6	0
PL-258 Adapters for joining two PL-259 Connectors ...	15	0	0

Custom Line Hy-Gain and Models not listed quoted on request.
 Just around the corner from West Hampstead Underground Station.

RADIO SHACK LTD.

182 BROADHURST GARDENS, LONDON, N.W.6

Telephone: 01-624 7174 Cables: Radioshack London NW6

Giro Account No. 588 7151

AVAILABLE at Godshill, Isle of Wight, bed and breakfast accommodation with evening meal; h. and c. in all rooms, comfortable TV lounge, and baby-sitting facilities. Also a 4-berth caravan with all amenities.—Berden, G3RND, Bridgecourt Farm house, Godshill (606), Ventnor, Isle of Wight.

OFFERING: Heathkit HP-23A PSU by Heathkit, with manual, unused. Offers?—Gordon-Laycock, G3XYD, 33 Douglas Avenue, Watford (43516), Herts.

SALE: Binary Computer, with a few dry joints (!) otherwise OK; contains new components, such as 14/OC71, 7/ACY22, 21/OA81, 64 resistors, 14/0.22 mF, 14/6.4 mF 25v. elect., 9 switches including 7 biased toggles 12-pole 2-way rotary, xformer 6.0-6v. ½ amp. PSU, in neat metal case, £7 10s., offers? Eight-transistor, S'ch. pulse proportional R/C Tx (s.a.e. for details), £7 10s. WANTED: QQV06-40A.—Lord, G8DQZ, 39 Station Avenue, Walton-on-Thames (24770), Surrey.

FOR SALE: Hammarlund HQ-170 Receiver, in fine condition, price £80.—Ring Major, 01-845 0920, evenings. (London).

DISPOSING: Heathkit DX-100U Tx, in very good condition, £45; SB-10U Sideband Adapter, perfect, at £25; the pair give first-class performance. KW-500 linear amplifier, perfect, £45. Hammarlund HQ-180 receiver, in beautiful condition, £100. R.C.A. AR88 Rx, new IF transformers, potent job and in very good condition, £35. All with manuals.—Boys, G3WVI, Crowthorne Farm, Crowthorne (2589), Berks.

OFFERING: Synthetic guy-line, ¼-in. dia. polypropylene, 2d. per foot. First-grade ¼-in. dia. terylene, non-stretch, high Govt. specification, 4d. per foot (any length), post free. Nylon thimbles, 10d. each; immediate despatch, or 5d. stamped envelope for samples. Flat-twin feeder, 75-ohm, 6d. per yard, any length, post 2s.—Warrick, G3VCJ, Riggling Locker, 50A Queens Road, Buckhurst Hill, Essex.

WANTED: SSB Transmitter, CW monitor, Trap Vertical, will collect. SALE: Dawe VTVM Type 613B, £5; Marconi VTVM TF-428B, £4, or near offer. (Midlands).—Box No. 4899, Short Wave Magazine, Ltd., 55 Victoria Street, London, S.W.1.

FOR SALE: National HRO Senior receiver, coverage 1.0 to 30 mHz, with full set of coil packs and PSU, in reasonable condition, £20 or near offer, or EXCHANGE for AP.75 or SL.75 deck, with cash adjustment. Buyer to collect.—Wolstenholme, Hannah BL, "B" Flight, R.A.F. Station Locking, Somerset.

SELLING: R.C.A. AR77E receiver, in clean condition and good working order, with manual. Offers?—Gordon-Laycock, G3XYD, 33 Douglas Avenue, Watford (43516), Herts.

BACHELOR Amateur, retired early, active and fit, seeks comfortable home and board in West Country where facilities exist for modest aerial farm. House on high ground with good views preferred but offers and suggestions welcomed. Permanency in mind.—Box No. 4900, Short Wave Magazine, Ltd., 55 Victoria Street, London, S.W.1.

SALE: FT-DX150 Transceiver, little used and in mint condition, £190 or very near offer, carriage paid or deliver to reasonable distance. Three volumes "Electrical Engineering," by Kemp, 40s.—Jones, GW3TMP, QTHR.

SELLING: Eddystone VHF receiver, Model 770R, covering 19 to 165 mHz, in excellent condition, price £100. Two English Electric Vidicon camera tubes, type P.862, used, £7 10s. the pair. Brand new G.E.C. KT88 valves, 15s. each. Carriage extra all items.—Hine, 7 Castleton Avenue, Riddings, Derby, DE5-4FG.

HELP! Can anyone sell or loan handbook for the Avo CT.38. Also required: A 25-amp shunt for CT.38 and 25 mHz coil unit for TF.144G.—Jackson, 38 Haslemere Road, Thornton Heath, Surrey.

FOR SALE: Trio JR-102 communications receiver, as new, with manual, £25 or near offer.—Ring Billington, 01-656 9882 (London) after 7 p.m.

WANTED: CW Filter, 400-cycle, for Heathkit SB-300E receiver.—Box No. 4903, Short Wave Magazine, Ltd., 55 Victoria Street, London, S.W.1.

FOR SALE: (Brand-new XYL wants new car!). So my KW-2000B with PSU, in perfect condition and used 10 hours only, has to go at £215, carriage paid, insured, in maker's carton.—Box No. 4901, Short Wave Magazine, Ltd., 55 Victoria Street, London, S.W.1.

WANTED: Any receivers or transmitters by Collins, in fair or repairable condition, such as 51-J 1, 2 and 3; R388, R390; 75-S3B, 32-S3, and Collins PSU's. Please give details.—Kurt Baer, m.s. Mebo 1, Z/Z Hafen, Scheveningen, Holland.

FOR SALE: Stereo pre-amp. by H. H. Scott, with Dynakit 70-watt stereo power amplifier, the two together, complete with transformer to 115v., bargain at £45 or near offer. Buyer collects.—Hanson, 23 Cambridge Road, Leytonstone, London, E11-2PL.

EXCHANGE or SELL: T.W. "Communicator" for 160 metres FOR a two-metre T.W. "Communicator", or sell the 160m. job for £50. Also offering, in as-new condition, Trio JR-310, £67 15s.—Jones, G5ZT, 3 Bircham View, Austin Crescent, Eggbuckland, Plymouth (T76552), Devon.

FOR SALE: Eddystone EA-12 receiver, still under guarantee, with two Call Books ("DX" and "U.S." Listings), price £150.—Cropper, 72 Church Street, Middleton, Manchester.

SALE: Joystick, de luxe, with Type 3A tuner, as new and in manufacturer's carton, £7.—Melvin, GM3ZBR, 43 Coxton Place, Glasgow, E.3, Scotland.

BARGAIN: Absolutely as new and in perfect condition, Trio TS-510 transceiver, at £160, carriage included. (Getting mobile gear for car!).—Box No. 4902, Short Wave Magazine, Ltd., 55 Victoria Street, London, S.W.1.

FOR SALE: Property of the Late G5CV, Douglas Walters, comprising a rack-mounted HRO, with PSU and HF/LF coil packs, £22 10s. or near offer. Hansen SWR meter, £4. Calibrator for Heathkit RA-1, including 100 kHz crystal, 40s. W.B. speaker in cabinet, 35s. Eddystone Speed Key ("bug"), die-cast case and mountings, 40s. An early model Avometer, £5. FL3C audio filter, very sharp for CW, 10s. Valves: Elmac 4-125A, £4 15s.; R.C.A. 815, 10s. Ex-Navy coax relay, 35s. Xtal 1802 kHz, 5s. Hammarlund Tx type split-stator variable condenser, 9s. Large auto-transformer, 230v./110v. with lower taps, 60s. Moving-coil 0-300 mA meter, 10s. Osram ACT-6, 20s.; KT-8C, 10s. HZP 75-ohm Balun, 20s. Twenty-six assorted Rx valves, 40s. the lot. Transport by arrangement. Enquiries to.—Addie, G8LT, Spring Hill, Wappenham, Towcester, Northants., NN12-8ST.

SALE: Sommerkamp FR-100B receiver, perfect and absolutely mint, with manual and in original packing. Genuine bargain at £80. (South Wales).—Box No. 4904, Short Wave Magazine, Ltd., 55 Victoria Street, London, S.W.1.

SELLING: Pye two-in-one transistor car/portable Radio Mk.II, LW/MW, 12v. pos./neg. or 9v. internal battery, car mounting receptacle, with circuit and in good condition, £12. Cavity Wavemeter, ex-R.A.F. W.1549, calibrated over 420 to 460 mHz, 30s. Original mains PSU for PCR-2 receiver, 35s. U.S. eleven-valve miniature IF amplifier, 60 mHz, less valves, 15s. Hudson Type AM.108 Mk.II High Band R/T set, 12v. pos./neg., with handset, 16 valves, transistor PSU, AF and circuit, £12. American military 25-watt audio amplifier, six valves, push-pull 6L6's into 3 ohms output, for 115v. mains, in 19-in. cabinet, £4. All transport extra, or buyers inspect and collect.—Cockle, 14 Leewood Way, Effingham, Surrey. (Tel. Bookham 5439).

S.S.B. PRODUCTS

CORNWALL

XTALS! XTALS! XTALS!

Wide range. STATE YOUR REQUIREMENTS. S.A.E. to obtain reply. 100 kc. to 100 mc/s. AVERAGE price new only 10/- ea. MOSTLY HC6/U, also FT241a new xtals only channels, 36, 60, 313, 345, 346, 8/- ea., add always 1/- P. & P.

R.C.A. ROTARY RELAYS, 12v. Negligible loss up to 2 metres ... 11/6 ea. + 4/6

BIRKETT'S BETTER BEAMS, 2 metre W/S 5 cle
Yagi with bracket ... 49/6 + 12/6

COLLINS TX LOADERS. One in a case, one without, the two only ... 12/6 + 6/6

NEW, NEW, BM3, luxury black and chrome, xtal mic's ... only 32/6 + 4/6

NEW R.C.A. MATCHED 6HF5's, set of 4 ... £10 + 4/6
6HF5 new, single ones ... 2 gns. ea. plus 10/7 P.T. each + 2/6

NEW 6146 valves £2 ea., MATCHED pairs ... £4 plus 4/6 post

SCARAB XTALFILTERS KITS for tx's, including carr. xtal instructions, etc. ... £7 10s. + 2/6

CABINETS, ATTRACTIVE/STRONG/SPRAYED, with pnls. SPHINX type ... £4 + 12/6

EDDYSTONE 940. LATEST MODEL ... £158

EDDYSTONE EC10, Mk. 2, £69 10s., Mk. 1 ... £59 10s.

EDDYSTONE EB 35, Mk. 2 (including tax) ... £82

EDDYSTONE PWR. UNIT FOR EC10's and EB 35's ... £6 10s.

EDDYSTONE EA 12. Latest ... £185

TRIO TRANSCEIVER TS510 and pwr. unit PS510 ... £180

TRIO Ham RECEIVER JR500SE. New ... £65

TRIO. LATEST HAM receiver, JR310 ... £74

TRIO GENERAL COV. 55 to 30 mc/s. B. spread dial, 9R59DE ... £39

TRIO PHONES, HS4 £5/19/6, SP-5D speaker ... 85/-

RECONDITIONED RECEIVERS, ETC.

REDIFON R50M, covers 13.5 kc to 32 mc/s. Wide range... £78

R.C.A. AR88D, not had much use. Very very clean ... £55

LYE RANGER 2 metre converter (4-6 mc/s i.f.), powered ... £10

COSSOR WOBBLULATOR, model 343, with leads, diode, etc. ... £12 10s.

MARCONI TF 144G signal generator, marvellous attenuator ... £25

BLUE PETER 4-waveband radio set, trawler band II only ... £10

MARCONI 52 set with multi-vib. xtal osc. 240v. A/C i/p ... £15

PYRAMID LINEAR parts. Full set and instructions ... £50

Carriage extra on all goods please.

7 LITTLE CASTLE STREET, TRURO
TEL. FEOCK 575

G. W. M. RADIO LTD.

METERS. 2 1/2" round 500 ma, 3 1/4" square 5 ma calibrated 0-400 amps. 3 1/2" square Moving Iron 100 volts, 15/- each, post paid. Oblong 6" x 4 1/2" 250-0-250 Microamps calibrated 2.5 volts, 750 mV, 50 mV, 4 1/2" x 4 1/2" 204 microamps, calibrated 3v., 10v., 100 ohms, 35/- each, post paid.

RECEIVERS. R1475, 2-20 Mc/s. Large slow motion dial, etc., with original power unit for 12 volts D.C. or 230 volts A.C. Less connecting cables, all connections marked, £11, carriage £1.

RECEIVERS. B40. 640 kc/s. to 30 Mc/s. Speaker A.C. power unit built-in. Bandwidth switched 1, 3 and 8 kc/s. Crystal calibrator, circuit diagram, £22/10/-, carriage 30/-.

AVO 7, fully reconditioned with test leads and leather case, £13, registered post paid.

WEATHER FORECASTING EQUIPMENT. Rainfall gauges, consisting of copper funnel, collecting bottle and measure with chart for year, 30/-.

Wet and Dry bulb Hygrometers with relative humidity charts, Centigrade, 24/-.

8-day Thermographs readily available charts, £7/10/-.

All post paid.

AERIAL VARIOMETER TUNERS for 91 set, 16/6, post paid.

HEADSETS for 19 or 22 set with microphones, used, 10/-, post paid.

RACAL RA17. Aerial trimmer capacitors 220pf, 5/-, post paid.

CENTRE ZERO AMMETERS. 30 amp. for cars, 7 amp. for motor cycles, 8/6 either, post 1/6.

CRYSTAL CALIBRATORS No. 10. Excellent condition, £3/10/-, post paid.

WALTHAM pocket watches, unissued, £3/10/-, registered post paid.

VALVES, new 5U4, 6/- each, post paid, or 6 for 23/-, post paid.

RELAYS PO 3000 type, new, 1000 ohms, 2 make 2 break 5 amp. contacts, 7/6, post paid.

SINGLE GANG 500 pf VARIABLES, new and boxed, 6/-, post paid.

COSSOR 1035 scopes, £17/10/-, carriage paid.

PYE RANGER Low Band 12-volt Radio-telephones, complete with Mike and vibrator, ideal for 4-metre conversion, £10, carriage paid.

SPARES FOR MARCONI 52 RECEIVER. Valves ARP3, 12Y4G, 12SC7, all new and boxed, 5/- each or 6 for £1. Meters, new, 15/-, reprinted handbook with circuits, etc., 5/-, all post paid.

VALVE VOLTMETERS No. 3 CT208. Very good condition, £23, carriage paid.

BRASS NAVIGATORS ROLLING ROLLS, 30/-, post paid. Spare batteries, 2 cell for Miners lamps, sent dry, 25/-, post paid.

FOR CALLERS ONLY

AR88 RECEIVERS, from £35

All Receivers and Test Equipment are in working order at time of despatch.

Carriage charges quoted are for England and Wales only

Telephone 34897

Terms: Cash with order.

Early closing Wednesday.

40-42 PORTLAND ROAD, WORTHING, SUSSEX

WANTED: Hallicrafters Communications Receivers, all types, early or recent, incomplete or non-working models considered; particularly required are the SX-28, S.40A, SX-42, SX-100 or W-H-Y? **FOR SALE:** Hammarlund SP-600JX6, perfect, £90; also Oscilloscope, £20; Circuit Analyser, £8. Would Part Exchange for any of the Hallicrafters items.—Wise, 9 St. Quintins Close, Cowbridge (3371), Glam., South Wales.

WANTED: Information on Wavemeter Type W.1631, variable over 15 to 10,000 megacycles. Will copy or purchase, refunding all expenses.—Rawlinson, G8BJR, QTHR.

PROPERTY deceased SWL: PCR receiver, with Joystick antenna, speaker and phones, in good condition, £10.—Hodges, 21 Grove Road, Northampton, NN1-3LH.

SALE: Marconi Signal Generator Type TF 801A, 10 to 300 mHz, sine/square modulation, £65. Solartron scope Type 513, £37. Airmec Ohmmeter Type 861, 1 ohm to 10 megohms in six ranges, with 6in. scale, £12. Will deliver short distances.—Ring Aylett, 45-66910 (Hatfield), or 01-882 2261 (London).

MICROPHONES: Two Reslo RV ribbon, £5 each, or both together in home-built cabinet with long screened leads, £11; Two Acos Mic. 16, £6 each. Post Office 6ft. rack, fitted castors, six unused 19in. panels, chassis and dust-covers, £8. Geloso 4/102 VFO, unused, £6. TU5B, RF Units 26, 27, 15s. each. Labgear wide-band coupler, 10 to 80m., unused, £4. Command BC-453 Q5'er, £4; BC-433, 0.5 to 1.5 mHz, £4; 6.0 to 9.0 mHz, 50s.—Knight, G2FUU, QTHR, or ring Nazeing 2274.

FOR SALE: R.107 receiver, with S-meter and manual, £11 or near offer. B.44 VHF transceiver, with crystals, 60s. Codar PR-30 preselector, mains, 70s. ATU, 20s. All in good condition.—Jones, 53 Northgate, Pontefract, Yorkshire.

DISPOSING: Marconi Atalanta 13 valve communications receiver, coverage 50 kHz to 30 mHz; many refinements and with speaker. Suit keen SWL. Price £60, would deliver to 15 miles.—Ekgberg, G3YRR, 109 Abbey Road, Grimsby, Lincs.

SELLING: Panoramic Adaptor, 465 kHz IF, 200 kHz sweep, Type BC 1031A, in excellent condition, with handbook, £29. Facsimile equipment, Model R.300/1 Creed, continuous recorder, with manual, £38. G2DAF-type Rx, complete except for mains transformer, 898 dial, engraved front panel, £29. Q.C.C. B7G crystals, complete sets for G2DAF-type Rx filter and carrier oscillator, as new, £8; also for K.W. Viceroy Tx filter and carrier oscillator, as new, £5. G.E.C. BRT-402E Rx, with S-meter, separate IF and RF gains, variable selectivity, crystal filter and BFO, coverage 150 kHz to 30 mHz, price £65. Eddystone S.750 receiver, covers 500 kHz to 32 mHz, in mint condition, £50. Solartron oscilloscope Type CD.643S, with manual, £50. Francis & Lewis triangular-type ball-mounted tower, three 10ft. lengths, packs flat, with guys, or free-standing with base, £25. R.C.A. AR88 Rx, good condition, £36. Transformers: 10v. 20 amp., 40s.; 20v., 20 amp., 60s.—Lord, G3PHN, Newfield House, Moira, Burton-on-Trent, Staffs. (Tel. Swadlincote 7537.)

FOR SALE: Trio JR-500SE, hardly used, in original carton, with guarantee, £50. Halson Whip, with coils for 20-40-80-160m., £8 10s. Geloso 1110/SR crystal microphone, with stand, as new, £5; ditto without table stand, 90s. Pair of Eagle 12-transistor walkie-talkies, 28 mHz, in original boxes (cost £35), at £27. Eagle headset/boom type microphone, £7 10s.—Parker, G3DUV, 1 Blackwell Road, Wyld Green, Sutton Coldfield, Warks. (Tel. 021-354 7240, evenings; 021-327 2466, day.)

★ THIS MONTH'S SELECTION ★

Silicon Rectifiers; guaranteed; 200 p.i.v. at 10 amps ... 2/6 ea.
 400 p.i.v. at 2 amps ... 2/6 ea.
 800 p.i.v. at 750mA ... 3/- ea.

Also untested HT types, marked 2EX, unknown p.i.v. but usable on 240v. AC up to about 3 amp. No guarantees but useful to have around. (Two free surge-limiting resistors with every 4 diodes) ... only 7/6 doz.

VEROBOARD. Offcuts at approx. 65% normal price. Sizes from 2½ x 1in. for 6d. to 6½ x 7in. for 8/- (some plug-in types as well). Please state size and hole spacing preferred so we can send nearest available. Any excess cash will be refunded.

Slow Motion Drives. The well-known 6:1 epicyclic type, brand new ... 3/- ea.

NEW LISTS now available, large SAE please
 SEE YOU AT THE RALLIES!

Handling charge 1/6 up to 15/- order value, 2/6 for all other orders

IAN S. PARTRIDGE, G3PRR
 122a Eskdale Avenue, Chesham, Buckinghamshire

RADAR SPOTTER

PROTECT YOUR DRIVING LICENCE WHICH IS PRICELESS!

Completely self contained, ready to clip on sun visor. Detects radar speed traps and is covered by domestic licence. Ham and Radar Scatter signals picked up even round bends up to approx. 1/3 of a mile. (Up to 2 miles warning on Motorways).

Six months guarantee. Size: 4½" x 3½" x 3" £13.5 0 inc. P/P. For details ring 01-660 2896 or 8d. stamp. C.O.D. 5/- extra.

Belding & Bennett (Box 14) 45 Green Lane, Purley, Sy.

The Amateur Radio Shop

13 CHAPEL HILL, HUDDERSFIELD. Telephone 20774

New TRIO :	TS510 and P.S.U.	£180 0 0
	JR310	£77 10 0
	JR500	£65 0 0
	9R59DE	£42 10 0
CODAR :	AT5	£16 19 6
	T28	£15 15 0
	CR70	£21 0 0

2 Mtr. Converters, TX's, Aerials.

Second-hand : KW201, Q Multi and Calibrator, £90 ; NC190, £48 ; EDD. 840C, £42 ; SR550, £35 ; 9R59DE, £35 ; Galaxy 300 Transceiver, £80 ; H.R.O., £18 ; CR100, £17 and many others. 2E26 valves for N.F.D. R.C.A. New, 17/6 each. B.C.C. Mobile Rx 80-100 mHz with circuit, £3.

YUKAN SELF-SPRAY SO PROFESSIONAL THE YUKAN AEROSOL WAY—

Get these air drying **GREY HAMMER** NOW! OR **BLACK WRINKLE** (CRACKLE) finishes

Yukan Aerosol spraykit contains 16 ozs. fine quality, durable easy instant spray. No stove baking required. Hammers available in grey, blue, gold, bronze. Modern Eggshell Black Wrinkle (Crackle) oil at 15/11 at our counter or 16/11, carriage paid, per push-button self-spray can. Also Durable, heat and water resistant Black Maxx Finish (12 ozs. self-spray cans only) 13/11 carriage paid.

SPECIAL OFFER: 1 can plus optional transferable snap-on trigger handle (value 5/-) for 18/11, carriage paid. Choice of 13 self-spray plain colours and primer (Motor car quality) also available.

Please enclose cheque or crossed P.O. for total amount direct to:

DEPT. P/3 YUKAN, 307a, EDGWARE ROAD, LONDON, W.2.

We supply many Government Departments, Municipal Authorities, Institutes and Leading Industrial Organisations—We can supply you too.

Open all day Saturday. Closed Thursday afternoons.



PARTRIDGE PROUDLY PRESENT OUR LATEST ADDITION
 —JOYMATCH TYPE SM A.T.U. USED WITH—

JOYSTICK VFA

REGD.

Or with any aerial—High "Q" Peaks SW/MW Bands, £5.10.6 (5/6 p.p.): 16g. ins. aly. wire 10/- per 100ft., post free

Partridge Electronics Ltd., Broadstairs, Kent

PETER SEYMOUR LTD.

LOOK—the HAMMARLUND HQ215, solid state brand new, originally manufactured to sell at £250 plus. Our price £150. Place your orders now.

- SOMMERKAMP FRDX 500.** As new, with 160 metres £100
- KW 2000B.** New with p.s.u. £240
- KW VESPA Mk. II.** Complete with p.s.u. 160 to 10 metres £140
- TRIO JR310.** As new £65
- COLLINS 75A4** £220
- SHURE 201 MICROPHONES** £5 10
- SWAN CYGNET.** Model 260. As new ... £165
- LAFAYETTE HA600.** Fully transistorised Receiver. 550 Kcs. to 30 Mcs. with separate amateur band spread £45
- LAFAYETTE PF60.** Transistorised VHF receiver. 152 to 174 Mcs. Built-in speaker and mains unit. As new £30
- RCA AR85 61L.** 60 Kcs.-30 Mcs. £175
- EDDYSTONE 888A.** 160 to 10 metres. Amateur bands only. Dual conversion. Product detector £75
- EDDYSTONE S-METER** suitable for 640, 740, 750, 888 £5
- EDDYSTONE PLINTH SPEAKER** £3
- EDDYSTONE DIE-CAST SPEAKER** £3

Full H.P. facilities on equipment over £35. One-third deposit. Up to 24 months to pay. Let us know your requirements.

410 BEVERLEY ROAD, HULL, YORKSHIRE
Please note Telephone No.
0482 41938 (mornings), 0482 29014 (afternoons)

Crystals from EMSAC

- HC18/U.** 38-666 mHz. Large stocks held, 25/-
Return delivery guaranteed.
- HC6/U.** 40, 42, 44, 45 mHz. Small stocks held 30/-
- FT243.** Your own frequency. 2-9 mHz. 21/-
2-3 weeks delivery.
- HC6/U.** Stock frequencies 11 to 100 mHz 25/-
Own frequency 15-55 mHz. 40/-
2-3 weeks delivery.
- HC18/U.** Stock frequencies 4-126 mHz 25/-
2-3 weeks delivery.

Write or telephone West Kingsdown 2344 for your nearest stock frequency. All crystals post free.

G3IAR

Electronic & Mechanical Sub-Assembly
Co. Ltd.

Highfield House, St. Clare Hill Road,
West Kingsdown, Kent

Tel.: West Kingsdown 2344

G3LRB

G3MCM

STEPHENS-JAMES LTD.

- | | |
|---|--------------------------------------|
| KW Atlanta. Transceiver ... £250 | Trio JR310 £77.10 |
| KW200B. Transceiver ... £240 | Trio 9R59DE. Receiver £42.10 |
| KW Vespa. Transmitter ... £135 | Trio Headphones ... £5.19.6 |
| KW201. Receiver ... £111 | Trio SP5D Speakers ... £4.7.6 |
| KW1000. Linear ... £125 | Lafayette HA600 ... £45 |
| KW E-Z Match ... £13.10 | Lafayette HA800 ... £57.10 |
| KW Baion ... £1.15 | Eddystone EA12 ... £195 |
| KW Antenna switch ... £3.3 | Eddystone 940 ... £153 |
| KW Low Pass Filters ... £5.9 | Eddystone EC10 Mk. II £69.10 |
| Trio T5510. Transceiver ... £180 | Eddystone EB35 ... £82 |
| Trio JR500. Receiver ... £69.10 | |

Superior performance mobiling with the G-WHIP range of antennae. Lightweight design. Helical wound. "Ranger 160m." £7.10. 160/80m. duo-bander, £9. Tribander 10-15-20m., £9.9. Basemounts, £1.9.6. Full details sent on request. New Multimobile self-selecting 5 band without coil changing. Luxury mobiling.

Hy-Gain Antenna Range

- Verticals :**
- 12AVQ 10-15-20m. ... £13.10
- 14AVQ 10-15-20-40m. £19.10
- 18AVQ 10 through 80m. ... £32.10

Beams :

- TH3MKC Tribander ... £67.10
- TH2MK Tribander ... £44.10
- TH3Inr. Tribander ... £44.10
- Hansen 50 ohm SWR Bridges ... £4
- Hansen FS Meters ... £2.15
- TTC RF Meters, tunable £3.19.6
- High Pass Filters ... £1.7.6
- Semi-automatic Bug Keys ... £4.10
- PL259 Plugs ... 6.0
- PL259 Cable Reducers ... 1.6
- PL259 Sockets ... 6.0
- TECH 15 G.D.O. ... £11.10

Second-hand Equipment

- AT5 mains p.s.u. ... £6
- KW Vanguard ... £30
- Eddystone 888 ... £60
- Codar DC p.s.u. ... £80
- KW500 Linear ... £55
- BRT400 Rx ... £65
- KW200A D.C. p.s.u. ... £30
- FR100B Rx ... £90
- FL1000 Linear ... £80
- KW Valiant Tx ... £15
- Lafayette HA 600 ... £37
- Trio 9R59DE ... £35
- Trio JR500 ... £50
- 10 metre G-Whip ... £3
- 15 metre G-Whip ... £3
- FR500 Rx ... £100

Codar Equipment

- AT5. 160/80 Transmitter ... £17.0.0
- AT5 A.C. p.s.u. ... £9.0.0
- D.C. Mobile p.s.u. ... £11.10.0
- PR30X Preselector ... £8.10.0
- T28. 160/80m. Receiver ... £16.10.0
- RQ10 "Q" Multiplier ... £8.17.6

- 2m. 5 element Beams ... £2.9.6
- 2m. 8 element Beams ... £3.2.6

Antenna Rotators :

- £14.19.6, £18.18.0, £25, £40

Complete range of Eddystone and Datum diecast bases now in stock. "Stella" cabinets, chassis, panels. Full details for S.A.E.

- | | |
|----------------------------------|---------------------------------|
| 300 ohm twin feeder, yd. 8d. | 24-hour Digital Clocks |
| 75 ohm twin feeder, yd. 8d. | £14 and £21 |
| Dipole "T" pieces ... 1.6 | R4B Receiver ... £240 |
| Ceramic Insulators ... 1.0 | T4B Transmitter ... £250 |
| 50 ohm co-axial cable, yd. 2.0 | TR4 Transceiver ... £315 |
| Eddystone 898 SM dial ... £6.6.9 | |
| Jackson SM dial ... £1.4.0 | |
| Eddystone speaker ... £3.7.6 | |
| WIEN aircraft radio ... £11 | All RSGB publications in stock. |
| Low Pass Filters ... £5.9 | |

H.P. and Credit items arranged on all orders over £35. Part exchanges welcome. Carriage/postage extra all items. S.A.E. enquiries please.

70 Priory Road, Anfield, Liverpool 4

Tel. 051-263 7829. Half-day Wednesday.
No parking problems.

We are approximately 1/2 mile from the Liverpool and Everton Football grounds.

HAMGEAR ELECTRONICS

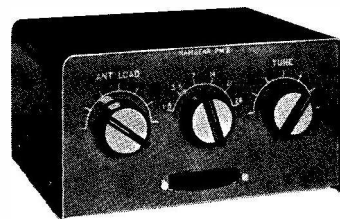

Try this preselector on your communication receiver, a pentode amplifier with built-in antenna coupler covering from 1.8 to 32 mcs completely. A gain of up to 25 Dbs, improving image rejection and low level signals. A new low line case blue silver with ultra modern controls. Mains powered. Price £7.16.0. send for details.

29 CARLYLE ROAD, NORWICH

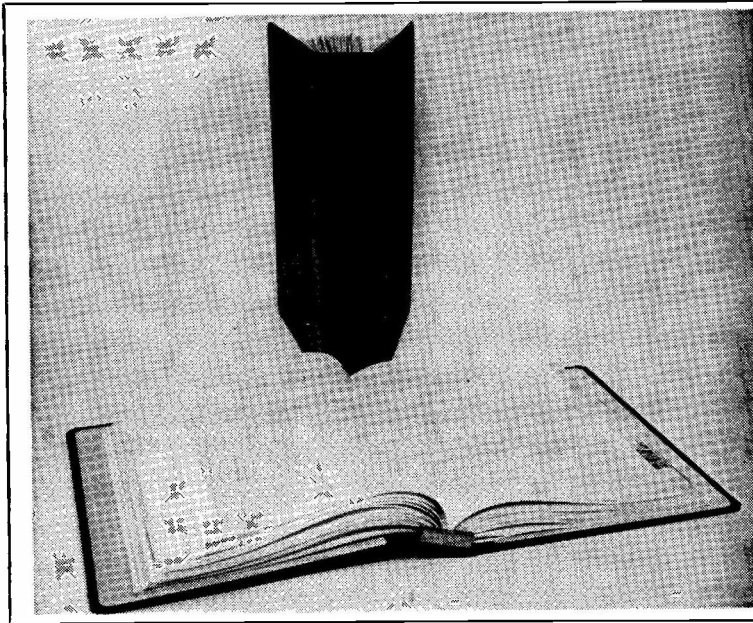

CREATE YOUR OWN REFERENCE LIBRARY

The "EASIBINDER" is designed to bind 12 copies of the Magazine as you receive them month by month, eventually providing a handsome bound volume for the bookshelf.

No need to wait until twelve copies are assembled. As each copy is received, it is quickly and simply inserted into the binder. Whether partially or completely filled, the binder is equally effective, giving the appearance of a book, with each page opening flat.

Strongly made with stiff covers and attractively bound in maroon Leathercloth and Milskin, the binders have only the title gold blocked on the spine.

Price 14s. 6d. post free.

**PUBLICATIONS DEPARTMENT
SHORT WAVE MAGAZINE
55 VICTORIA STREET
LONDON, S.W.1**

"CALLBOOK" SPRING EDITION

*Limited Quantity Only
Please order your copy early*

Known the world over as the CALLBOOK, this comprehensive reference lists about 300,000 licensed radio amateurs in the United States Directory and 160,000 or more in the rest of the world (contained in the "DX Section"). The entries grow with every issue! In the U.S. Section, licence classifications are now shown. Each issue is an entirely new book with revised listings of new licences, names and addresses. The CALLBOOK also includes much incidental DX information. Every amateur operator and SWL needs the latest CALLBOOK to get the most out of Amateur Radio.

DX Listings 45/6 US Listings 69/6
The two together, covering the World, £5/10/0
Post free

Available only from
Publications Dept.,
SHORT WAVE MAGAZINE
55 Victoria Street, London, S.W.1
01-222 5341

WORLD RADIO/TV HANDBOOK 1970

The World's only complete reference guide to International Radio & Television Broadcasting Stations. It includes: Frequencies, time schedules, announcements, personnel, slogans, interval signals and much more.

Lists all International short-wave stations, including frequencies, for each country; foreign broadcasts, long and medium wave stations (AM broadcast Band), TV stations and domestic programmes. Long recognised as the established authority by broadcasters and listeners. It is the only publication that enables you to identify BC stations quickly and easily. Enables you to fill more pages in your log book on the SW BC bands and helps you add more BC-station QSL cards to your collection.

Price, same as last year (no increase!) ... **43/6**
post free

Available from:
SHORT WAVE MAGAZINE
55 Victoria Street, London, S.W.1