

The

SHORT WAVE

Magazine

4/-

VOL. XXVI

SEPTEMBER, 1968

NUMBER 7

KW SSB EQUIPMENT

*is chosen
where reliability
is always first*



KW 2000A

SSB TRANSCEIVER

180 watt PEP, 10-160 metres, complete with AC psu, VOX, P.T.T.

KW VESPA MARK II

TRANSMITTER

For all HF Bands. 220 watts PEP SSB, AM, CW.

KW 1000

LINEAR AMPLIFIER

1200 watts PEP with built-in psu and SWR indicator

KW 201

AMATEUR BANDS COMMUNICATIONS RECEIVER

SSB CW, and AM; 10-160 metres

KW
ELECTRONICS
LIMITED

Write for illustrated detailed specification on the above and our list of KW Tested, "Trade-in" equipment

K. W. ELECTRONICS LTD.

1 HEATH STREET, DARTFORD, KENT

TELEPHONE: DARTFORD 25574

CABLES: KAYDUBLEW DARTFORD

Other KW Products Antenna Switch (3 position) · E-Z Antenna Match Unit · PEP Meter · Match SWR Indicator · Low-Pass Filters · Trap Dipoles · Balun · Dummy Load · Q Multipliers

Eddystone

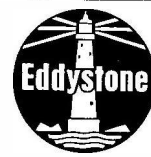

Amateur communications receivers

EA12 An amateur bands double-conversion superheterodyne receiver, for a.m, c.w, and s.s.b reception. For all amateur channels between 1.8 MHz and 30 MHz in nine 600 kHz bands with 28 MHz to 30 MHz in four bands.

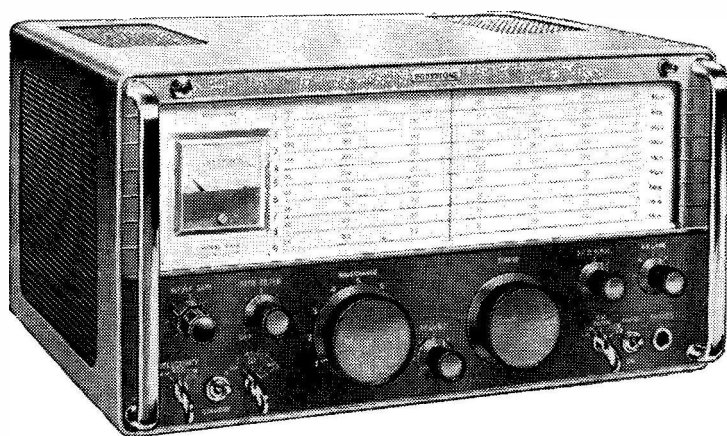

Primary features. Crystal-controlled 1st oscillator, 2nd oscillator with continuously variable selectivity to 50 Hz, muting switched or by external relay, twin noise limiters, for a.m/c.w, and s.s.b, short-term drift better than 20 Hz and less than 100 Hz in any one hour, 'S' meter calibrated in nine levels of 6 dB and dB levels beyond 'S9', two a.g.c time constants, deep slot filter, independent r.f, i.f, and audio gain controls with outputs for f.s.k and panoramic adaptor.

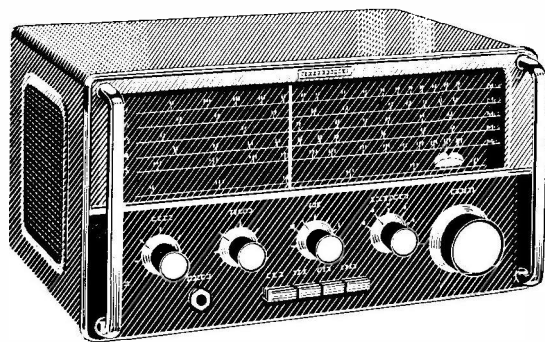

EC10 communications receiver

The fully transistorized EC10 communications receiver, supreme in its class, covers both medium-wave broadcasting and all shortwave service to 30 MHz. Incorporating the famous Eddystone tuning drive, with logging scale and auxiliary vernier, shortwave reception is particularly simple. Battery-operated or from optional a.c mains unit.

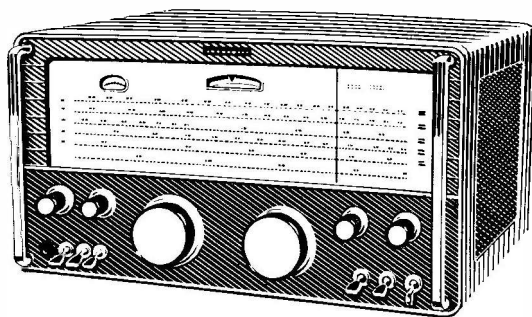

940 H.F. communications receiver

An outstanding 13-valve receiver with two r.f and two i.f stages, silicon diode noise limiter circuit and high quality push-pull output. Built to a professional specification, facilities include provision for c.w, a.m, and s.s.b reception over the range of 480 kHz to 30 MHz in five bands. Suitable for 110/125 V and 200/250 V. 40-60 Hz a.c mains.

Comprehensive information from your Eddystone distributor or: Eddystone Radio Limited, Eddystone Works, Alvechurch Road, Birmingham 31. Telephone: 021-475 2231. Telex: 33708

THE MOST RELIABLE SERIES OF TRANSCEIVERS EVER OFFERED

SWAN EVOLUTION

ASK THE AMATEUR WHO OWNS ONE

The new model 500C is the latest evolutionary development of a basic and well proven design philosophy. From the very beginning, with the introduction in 1961 of the first single band SSB Transceiver, Swan has followed a steady course of improvement by evolution. You might think that we would finally reach the point of leaving well enough alone, but with some 18 licensed hams in the engineering, sales and production departments of our organisation, it just isn't possible. Thus, the new model 500C, with greater power and additional features for even more operator enjoyment.

RCA recently introduced a new heavy duty "blast rated" tetrode, the 6LQ6. With a pair of these rugged tubes the final amplifier operates with increased efficiency and power output on all bands. PEP input rating of the 500C is conservatively 520 Watts. Actually, an average pair of 6LQ6's reach a peak input of over 570 Watts before flat-topping!

Further refinement of the famous Swan VFO results in even greater mechanical and thermal stability and more precise dial calibration. Custom made planetary drives, machined to extremely close tolerance, provide velvet smooth tuning.

The 500C retains the same superior selectivity, of course, that we have been offering. The filter is made specially for us by

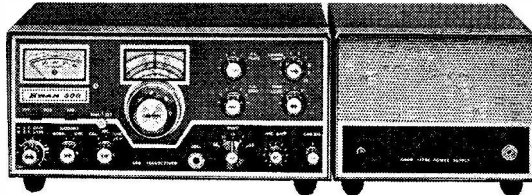

THE NEW SWAN 500C 5 BAND - 570 WATT TRANSCEIVER

C.F. Networks, and it's no secret that it is a better filter than is being offered in any other transceiver today. By moving the I.F. to 5500 KC, and increasing the number of tuned circuits in the receiver, we have achieved substantial improvement in image and spurious rejection. These improvements, coupled with additional TVI filtering, result in what we believe is the cleanest transceiver on the market.

For the CW operator the 500C includes a built-in side-tone monitor. Also, by installing the Swan Vox Accessory (model VX-2) you will have break-in CW operation. Thus, the model

VX-2 now fulfils a dual function, both automatic voice control and break-in CW keying. Grid block keying of a pure CW carrier is employed with off set transmit frequency.

The 500C embodies the Swan's well known dedication to craftsmanship, performance and reliability, with a service policy second to none. When you visit your Swan dealer and look over the 500C, we are sure that you will be glad we couldn't "let well enough alone"

SWAN 500C	£263 0 0
SWAN 350C. Our improved standard model, now in production,	£216 0 0
570W ACCESSORIES	
MATCHING AC POWER SUPPLY 230XC	£65 0 0

PETER SEYMOUR LIMITED

410 BEVERLEY ROAD, HULL, YORKSHIRE

Telephone: 41938 (43353 after 7.30)

GO MOSLEY BRITISH AND BEST

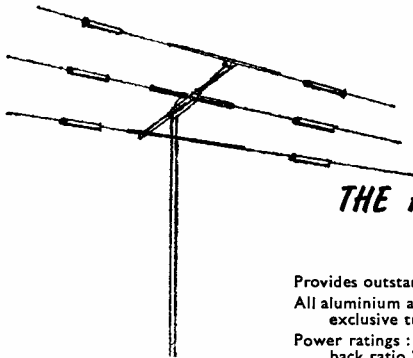

THE FAMOUS TA-33 Jr. FROM MOSLEY OF ENGLAND BRITISH MADE FROM BRITISH MATERIALS

Provides outstanding performance on 10, 15 and 20 metres, coupled with light weight (20 lbs.).

All aluminium alloy and stainless steel construction, exceptional broad band characteristics, over full Ham bands, exclusive trap design, choice of mast fittings, single co-ax 52 ohm feed point.

Power ratings : 300 watts AM/CW, 600 watts, p.e.p. SSB, input to final. Forward gain up to 8dB. Front to back ratio 20dB or better. Standing wave ratio 1.5 to 1 or less.

Maximum Element length 26ft. 8in. Boom length 12ft. Turning radius 14ft. 9in.

Variations: 2 Elements which is known as the TA-32 Jr.
Dipole driven Element known as the TA-31 Jr.
(Use Horizontal or Vertical.)
Conversion kits available.

Prices: TA-33 Jr. £27.5.0 fits up to 1½ in. mast.
TA-33 Jr.E. £27.15.0 fits up to 2 in. mast.
TA-32 Jr. £19.5.0 fits up to 1½ in. mast.
TA-32 Jr.E. £19.15.0 fits up to 2 in. mast.
TA-31 Jr. £11.1.0 fits up to 1½ in. mast.

Carriage & Insurance Extra.

We sell direct or through our distributors
Southern Area : K.W. Electronics Ltd.
Midland Area : Swanco Products Ltd.

FOR ALL ANTENNA DETAILS :
Send for complete Handbook, containing full details and prices of Antennas and other technical information. 25 pages, 1/6

Telephone: Costessey 2861 orders only

Mosley Electronics Ltd. 40, Valley Road, New Costessey, Norwich, Norfolk Nor. 26K

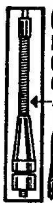

COLLAPSIBLE AERIAL A fully adjustable highly efficient Whip aerial made to exacting specifications. Copper plated sections. Brass base. An ideal aerial for Tx/Rx use. Easily adaptable for cars, scooters, walkie-talkies, etc. Brand new in maker's boxes. Only £1 each, p. and p. 2/6. Two aerials for 35/-, post free.



Brand new fully transistorised Communications Receiver. Specifications: 4, complete ranges 500 Kc/s. to 30 Mc/s., covering all amateur bands: shipping and trawler bands, and broadcast bands. A highly efficient double tuned superhet comprising R/F aerial tuning section, A.V.C. and built-in B.F.O. for C.W. or SSB reception. Operates from 9 volt battery provided that fits internally. Ideal for fixed or mobile reception. With speaker and headphone output. Hammer finished robust steel case of pleasing modern design. Size approx. 9" x 7" x 6". British manufacture. Due to huge purchase we can offer these excellent receivers at less than half their normal price. Complete with handbook. Now modified for improved performance. Price £16/10/- Carriage 15/-.

AIRCRAFT/POLICE BAND RECEIVER

A small transistorised receiver that will receive civil aircraft and police fire/ambulance broadcasts. Operates from a 9 volt battery that fits internally, 6 transistors. Robust metal cabinet size approx. 6" x 4" x 4". Attractive front panel. Speaker or headphone output. Price £8/10/-, carriage 10/-. Few only. Brand new and unused.

MOVING COIL HEADPHONES AND MICROPHONES

Brand new in makers' cartons, 25/-, P. and P. 5/-.

TRANS/RECEIVERS AIR/SEA/RESCUE TYPE

Must be dismantled or exported. Complete with mike/speaker aerial. Work up to 100 miles. Cost Govt. over £40 each. £2/10/- per set, 10/- P. and P. 2 sets £5, post free.

MINIATURE TRANSISTORISED B.F.O. UNIT

This is a miniature transistorised B.F.O. unit (tunable) that will enable your set to receive C.W. or S.S.B. reception. Compact. Single hole fitting. This small unit will fit anywhere. Size only 1 1/2" x 1 1/2" x 1 1/2". Complete with fitting instructions, 49/6, post free.



These excellent receivers were made for the GOVERNMENT by a famous manufacturer. They will cover the complete 40 Metre Amateur Band, Aircraft, Marine and other Government Stations. It is a 5 valve Superhet and works from standard dry batteries. Built in a robust metal case size 10" x 6" x 4". Half moon calibration tuning dial. Phone or speaker output. Not new but in excellent condition, £3/10/-, Carriage 10/-. Complete with associated transmitter that covers same band only £5/10/-, Carriage 10/-.

IMPEDANCE MATCHING UNITS

These high quality instruments are a compact unit that are highly suitable for matching a high impedance output from a radio to a low impedance pair of headphones or speaker. They can also be used in reverse i.e. low impedance output to high impedance reproducer. Also ideal for microphone and pick-up matching. Brand new in plastic and metal case. Price 17/6 each. P. and P. 2/6 or 2 for 30/-. P. and P. 2/6.

VALVE SALE

- 807, 6/- each, p/p 9d. or three for 15/-, post free.
- 6V6, 3/- each, p/p 9d. or three for 7/6, post free.
- 6K7, 2/- each, p/p 9d. or three for 5/-, post free.
- 6K8, 3/6 each, p/p 9d. or three for 10/-, post free.
- EFS0, 1/6 each, p/p 9d. or three for 3/-, post free.
- 6H6, 2/6 each, p/p 9d. or three for 6/-, post free.
- OZ4, 9d. each, p/p 9d. or three for 2/-, post free.

All valves guaranteed and insured in transit.
New Component Centre open at this address.

GLOBE SCIENTIFIC LTD Dept. SW15.
24 CAWOODS YARD, MILL STREET, LEEDS, 9.

NEW STYLE PRESELECTOR

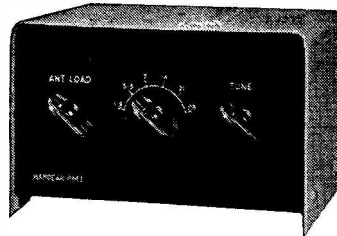

This preselector is primarily designed with the short wave listener in mind, giving a good front end combined with the advantages of a PI tank antenna tuner. Covering the range 1.8 to 32 mc/s. inclusive. The power pack is built in. A crystal calibrator at 1 mc/s. is included, the whole being priced at £9.18.0, or less calibrator at £6.18.0. Send for leaflet

HAMGEAR ELECTRONICS
29 CARLYLE ROAD, NORWICH

G3LRB

G3MCM

STEPHENS-JAMES LTD.

NEW! Trio TS-500 Transceiver. Full coverage all bands 80-10m. 200 watts P.E.P., VOX, MOX, IRT, 17 valves, 3 transistors, 15 diodes. Pair 6146B in PA, 1 uv s/n ratio. Precision double gear tuning mechanism. I.K.C direct readout. Double conversion superhet. Solid state VFO. Using new developed Trio crystal sideband filter provides superior shape factor and clear crisp SSB quality. Built-in crystal calibrator circuit. Complete with matching VFO unit for remote transmit/receive facilities. All complete with matching power supply unit in ultra modern styling cabinets. TS-500, £165, A.C./p.s.u., £38, TS-VFO, £28.

Second-hand Equipment		Trio 9R-59DE Receiver	£39.15
LG300 RF Section	... £22	Trio 1R-500SE Receiver	£60
Minimitter Tx	... £25	Lafayette HA700 Receiver	£37.16
AR8BD	... £45	Lafayette HA600 Receiver	£45
Heathkit Apache Tx and SB10 Adaptor	... £85	Star SR200 Receiver	£40
Eddystone 750	... £40	2C Receiver	£120
KW201 Rx	... £35	R-4B Receiver	£235
Eddystone 740	... £20		

Sommerkamp Line		NEW! G-WHIP Mobile antenna range.	Lightweight design. Helical wound. Superior performance.
FR500 Receiver	... £130	Ranger 160m. centre loaded whip	£7.19.6
500 cps. Mech. Filter and 160m. crystal extra.		Tribander 10-15-20m.	£8.16
FL500 Transmitter	... £145	Duo-bander 10-15 ...	£5.13
FT500 Transceiver	... £250	Duo-banders 10-20 ...	£6.4
FL100 Linear	... £100	Single banders	£4.7
FT150 Transceiver	... £215	Conversion coils for the LF bands.	S.A.E. for full details.
KW2000A with A.C. p.s.u.	£232		
KW Vespa Mk. 2 with p.s.u.	£135		

Hansen S.W.R. Bridges	£3.10	HY-Gain Antenna Range.	
DA Electronics Keyers	£16	12AVQ 10-15-20m.	
Tech. Transistor GDO	£11.10	Vertical	£14
FS-1 Field Strength Meter	£2.5	14AVQ 10-15-20-40	
Egg Insulators	... 6d.	Vertical	£17.10
Chassis from	... 3.6	18AVQ 80-10m.	
Panels from	... 1.0	Vertical	£29.15
Bug Keys	... £4	TH3MK3 Triband beam	£65
		TH3MK2 Junior Triband	£38.10

AR-158 All Transistor Receiver	FM 88-108 mc; AM 525-1650 kc; SW 25m-75m; MB 1-6 mc/s-4 mc/s; VHF 1 110-136 mc/s; VHF 2 148-174 mc/s. Mains or battery	33 gns.
PL259 Plugs, 5/-	Cable reducers, 1/6	50 ohm co-ax, 1/9 and 4/9 yd. Chassis. Speakers and cabinets. Knobs. R.S.G.B. Publications.

New range of 20 swg plastic covered heat resistant steel cabinets in various sizes.
Versatile range of towers available.
Large range of Aircraft receivers, by Park Air Electronics, Aiwa, Volstait, Nova Pal. From £17.

MONTRONICS 2 METRE TRANSMITTER
2 metre transmitter AM/CW modes with 40 watts D.C. input on 2 crystal controlled frequencies in the CW portion and one in the AM end. Built-in power supply for 100-250 volt 50-60cs. Built-in modulator giving 100% modulation. Keyed R.F. Carrier for CW working. Output impedance 50-80 ohm rear chassis mounted UHF socket. Audio response 500 Hz (Max.) to 4 KHz (Min.) at 3 dB. Built into attractive 20 swg steel plastic covered. Heat resistant cabinet. Dimensions: 11" x 7" x 7". Unique feature of plug-in units.
PRICE: £60 delivery September/November.

H.P. terms and Credit terms arranged. Part exchanges. Carriage and postage extra all items. S.A.E. enquiries please. After sales service.

70 Priory Road, Anfield, Liverpool 4
Tel.: 051-263-7829. Half day Wednesday.
We are approximately 1/4 mile from the Liverpool and Everton Football grounds.

J. B. LOWE

50-52 Wellington Street, Matlock, Derbyshire

Tel.: Matlock 2817 (2430 evenings)

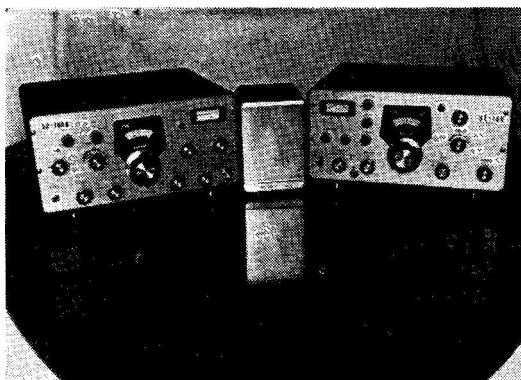

SOMMERKAMP — STAR — INOUE

I promised you some more pretty pictures and here they are—Star ST-700, £135 ; Star SR-700, £115 ; Star SR-200, £40 ; Inoue IC-700R, £85 ; the matching Tx and p.s.u. also available at £80 and £30 respectively —or as a package deal £180 the lot.

Hansen SWR bridge £3 10s. ; Katsumi electronic keyer, £7 15s. ; monitor, £7 15s. ; TE-18 G.D.O. £11 10s. ; Tech VTVM, £16 ; Speech compressor £7 15s. ; Converters 21 or 28 mc/s., £9 10s. These and other choice bits and bats will be on Stand 18 at the RSGB show.

Sommerkamp—certainly, but as I sell the stuff as fast as I can get it, there's not much point using up advertising space.

Second-hand stuff—lots of it, and all A1, just give me a yell if you want something.

Send a large s.a.e. for lists.

NEW, NEW, NEW. For the benefit of you chaps down South, we are opening up a small branch in the Brighton area where you can go along and play with the latest gear. Alan Whitford, G3MME, will preside—his outstretched hand ready to pluck the wallet from your nerveless fingers, his beady little eyes glittering like P holes in the snow. Brighton, they tell me, is the land of the Wide Boys—I am studying spivery at night classes. No longer do I sell you a beat up s/hand falling-to-pieces rig at £100 but I can do you a nice rig at 1½ less 10 and I should be ruined already.

Anyway, by the time you read this we should be fixed up, so if you want to twiddle knobs and things give me a yell and I'll tell you where to go. (That doesn't sound very nice !)

Service : Still up to the eyes, but we can cope if necessary.

Don't forget—make a date for Stand One Eight and don't be late, 'cos the Show will be great.

And that, Gentlemen, shows you the depths of depravity to which Bill Lowe will sink.

73,

The Bandit.

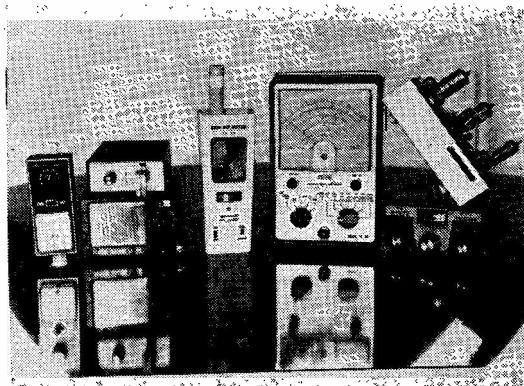

NEW Heathkit Solid-State 2-Meter AM Transceiver

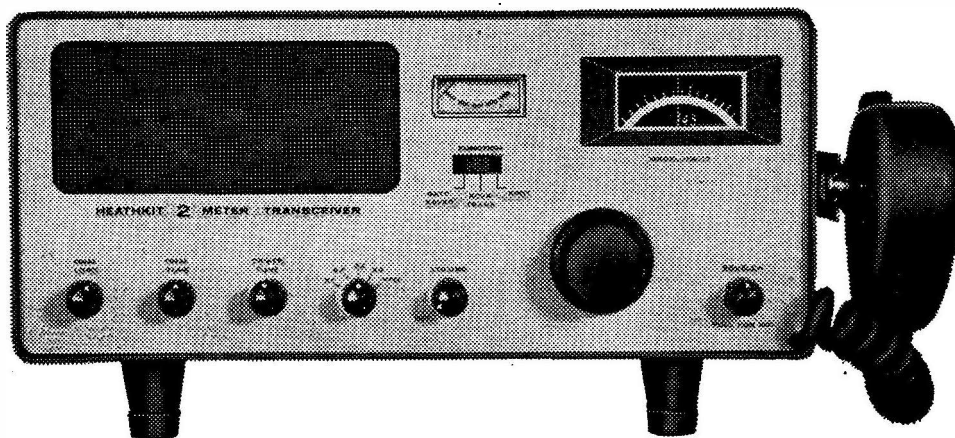

• Frequency Range 143.2 to 148.2 MHz • Solid-state, dual conversion superheterodyne receiver • Pre-built, pre-aligned FET tuner • Spot function for finding transmit frequency on receiver dial • Hybrid transistor-tube type transmitter design • 8 to 10 watts power output • 4 crystal sockets plus provision for external VFO such as Heathkit HG-10B (page 40) • Built-in 120-240 VAC power supply • Optional DC mobile supply (see below) • PTT operation, electronically switched • Front panel meter for signal strength and relative power output • Built-in automatic noise limiter and squelch • Lighted dial • Built-in speaker • Battery saver feature for low current drain during mobile monitoring • Low profile aluminium cabinet for easy mobile mounting • Gimbal mount included for mobile use • Ceramic PTT microphone included • 15 transistors, 20 diodes, 3 tubes, 2 circuit boards • Builds in about 20 hours.

The Heathkit HW-17 in detail. It's really a separate receiver and transmitter in one compact, versatile package (the only common circuitry are the power supply and the audio output/modulator). The solid-state dual conversion, superheterodyne receiver with a pre-built, pre-aligned FET tuner has a lighted dial with 100 kHz calibration, automatic noise limiter, squelch, and 1 uV sensitivity. Selectivity is 27 kHz at 6 db down. The front panel meter indicates received signal strength and relative power output. A 3-position switch on the front panel has a "Spot" position for finding the transmit frequency on the tuning dial, a Receive/Transmit position, and a Battery-Saver position.

A 3" x 5" speaker is built in.

Modulation is automatically limited to 100% or less. A front panel selector switch chooses any of four crystal frequencies or an external VFO (the Heathkit HG-10B VFO . . . is perfect for this job).

Front panel controls include Final Load, Final Tune, Crystal-VFO switch, Main Tuning, Squelch with ANL switch, Battery Saver-Receive/Transmit-Spot switch; rear panel has S-meter Adjust, Headphone jack, Power socket, VFO power socket, VFO input, and Antenna connector (50-72 ohms, unbalanced).

HW-17 SPECIFICATIONS—RECEIVER: Frequency coverage: 143.2-148.2 MHz. Dial calibration: 100 kHz. IF Frequencies: Double conversion: 1st IF: 24.965 MHz; 2nd IF: 2 MHz. Sensitivity: 1 uV input for 10 dB S/N - N. Selectivity: 27 kHz @ 6 dB down. Input impedance: 50-72 ohm, unbalanced. Audio output: 1 watt @ less than 10% distortion. Headphone jack: Low impedance, accepts PL-55 type plug (standard 2-conductor 1/4" sleeve). Transistor complement: (2) 2N4416 RF Amplifier, 1st Mixer; SE5023 HF variable oscillator; (4) 2N3694 2nd Mixer, crystal oscillator, 1st IF amplifier, 2nd IF amplifier; (2) 2N3393 Audio Preamplifier, Squelch amplifier X29A829 Squelch Gate; 2N1274 Audio Driver; (2) 40050 Audio/Modulator output. Transmitter: Frequency coverage: 143.2-148.2 MHz. RF Power input: 25-30 watts. RF Power output: 8-10 watts. Mode: Type A3 (AM). Modulation: Automatically limited to 100% or less. Output Impedance: 50-72 ohm, unbalanced. Crystal sockets: Accepts FT-243 type holders, pin diameter .093", pin spacing .466" and HC6/U type in diameter .050", pin spacing .466". Transistor/tube complement: 7050 Oscillator/Amplifier Tripler-Tripler; I2GN7 Doubler/Driver; 8156 Power Amplifier; (2) 2N3393 Microphone Preamplifier, Microphone Driver. Temperature range: -20° to +50° C. Power requirements: 120 or 240 VAC input. Receiver Trans.—20 watts; Batt. Saver—8 watts; Spot—35 watts; Transmitter—100 watts. Cabinet dimensions: 14 1/4" W x 8 1/2" D x 6 1/4" H including microphone and mounting feet. Net weight: 13 lbs.

Kit k/HW-17, 2M Transceiver (less crystals) 17 lbs. £69 2s. P.P. 10/6

Kit k/HWA-17-1, Transistorized DC supply, 5 lbs. £13 19s. P.P. 4/6

DAYSTROM LTD.,

Dept. SW-9

(For all enquiries please use coupon on right)

GLoucester ENGLAND. Telephone: 29451

Retail Stores: LONDON, 233 Tottenham Court Road. BIRMINGHAM, 17-18 St. Martins Hse., Bull Ring

HEATHKIT Amateur Radio Equipment

ASK FOR DETAILS OF EXTENDED PAYMENT PLANS OVER £10 (UK only)



HW-100 5 Band SSB-CW Transceiver . . . Solid-state FET VFO. Covers 80-10 metre bands. Switch selector USB, LSB or CW. 180 watts input PEP SSB—170 watts input CW. Crystal filter.
Kit HW-100, 18 lbs. £125 . 0 . 0 P.P. 9/-
 Ready-to-use £165 . 0 . 0 P.P. 9/-

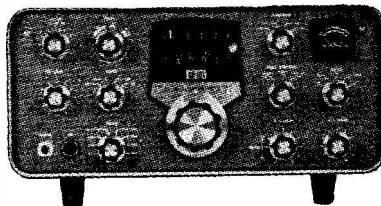

SB-101 80 Through 10 Metre SSB Transceiver . . . 180 watts PEP SSB, 170 watts CW (the practical power level for fixed/mobile operation). Features USB/LSB on all bands, PTT & VOX. CW sidetone, and more. Unmatched engineering and design.
Kit SB-101, 23 lbs., £185 . 12 . 0 P.P. 9/-
 Ready-to-use £225 . 12 . 0 P.P. 9/-

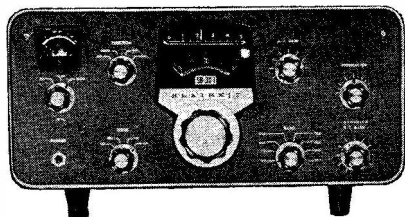

SB-301E Amateur Band Receiver . . . SSB, AM, CW and RTTY reception on 80 through 10 metres + 15 MHz WWV reception. Tunes 2 metres with SBA-300-4 plug-in converter.
Kit SB-301E, 23 lbs. (less speaker) £140 . 12 . 0 P.P. 9/-
 Ready-to-use £170 . 12 . 0 P.P. 9/-

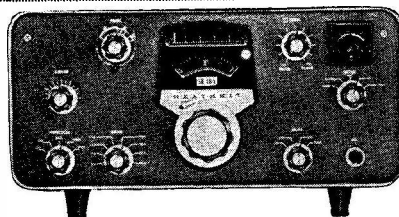

SB-401E Amateur Band SSB Transmitter . . . 180 watts PEP SSB, 170 watts CW on 80 through 10 metres. Operates "Transceive" with SB-301—requires SBA-401-I crystal pack for independent operation.
Kit SB-401E, 34 lbs., £157 . 10 . 0 P.P. 10/6
 Ready-to-use £192 . 10 . 0 P.P. 10/6
SBA-401-I crystal pack, 1 lb., £17 . 3 . 0 P.P. N.C.

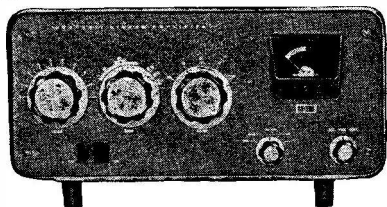

SB-200 KW SSB Linear Amplifier . . . 1200 watts PEP input SSB, 1000 watts CW on 80 through 10 metres. Built-in antenna relay, SWR meter, and power supply. Can be driven by most popular SSB transmitters having 100 watts nominal output.
Kit SB-200, 41 lbs., £120 . 18 . 0 P.P. 10/6
 Ready-to-use £145 . 18 . 0 P.P. 10/6

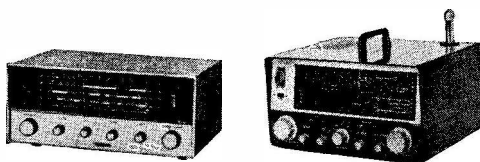

GR-64 Short Wave Receiver . . . Covers 1 MHz. to 30 MHz., plus 550 kHz. to 1620 kHz. AM band. Many special features for such a modest price. For 115, 230v. 50/60 Hz. A.C. mains operation.
Kit GR-64E £22 . 9 . 0 P.P. 9/- Ready-to-use £29 . 9 . 0 P.P. 9/-
GC-1U "Mohican" General Coverage Receiver . . . 10 transistors, 5 diode circuit. Tunes 580-1550 kHz. and 1.69-30 MHz. in 5 bands. 6" x 4" speaker.
Kit GC-1U £37 . 17 . 6 P.P. 10/6 Ready-to-use £45 . 17 . 6 P.P. 10/6

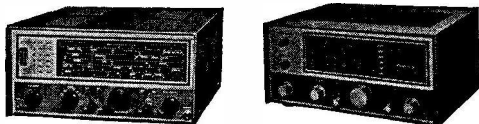

RG-1 High Sensitivity General Coverage Receiver . . . High performance at lowest cost. Covers 600 kHz. to 1.5 MHz., 1.7 MHz. to 32 MHz. Full specifications available.
Kit RG-1, 18 lbs., £39 . 16 . 0 P.P. 9/-
 Ready-to-use £53 . 0 . 0 P.P. 9/-
RA-1 Amateur Bands Receiver . . . Covers 10-160m. Half-lattice crystal filter at 1.6 MHz. Switched USB and LSB for SSB. Provision for fixed, portable or mobile uses.
Kit RA-1 £39 . 6 . 6 P.P. 9/- Ready-to-use £52 . 10 . 0 P.P. 9/-

Showroom : GLOUCESTER, Bristol Road.

HEATHKIT

Please address all mail order enquiries to:—
DAYSTROM LTD., Dept. SW9, GLOUCESTER

- Enclosed is £ post paid U.K.
- Please send model(s)
- Please send FREE Heathkit Catalogue.

NAME
 BLOCK CAPITALS
 ADDRESS

Prices and specifications subject to changes without notice.

TECHNICAL
 LATEST
 PUBLICATIONS
 ISSUES

ABC OF ANTENNAS (Foulsham).....	Post Free
ABC OF TRANSISTORS (by G. B. Mann).....	16s. 9d.
AERIAL HANDBOOK by G. A. Briggs (2nd Edn.).....	21s. 0d.
AMATEUR RADIO (by F. G. Rayer).....	15s. 9d.
AMATEUR RADIO ANTENNA HANDBOOK. (by H. D. Hooton, W6YTH).....	26s. 0d.
AMATEUR RADIO CIRCUITS BOOK.....	25s. 0d.
ANTENNA HANDBOOK Vol. 1, by K7GCO (Cowan Publication).....	11s. 2d.
ANTENNA ROUND-UP (by CQ) Vol. I.....	33s. 6d.
ANTENNA ROUND-UP (Vol. 2).....	27s. 6d.
ANTENNA HANDBOOK (A.R.R.L., 10th Edition).....	33s. 6d.
BASIC MATHEMATICS FOR RADIO AND ELECTRONICS.....	21s. 6d.
BEAM ANTENNA HANDBOOK, 3rd Edition.....	18s. 3d.
BETTER SHORT WAVE RECEPTION.....	33s. 0d.
CHART OF INTERNATIONAL FREQUENCY ALLOCATION—GENEVA (Official 10 Kc to 40 Gc), New Edition. 24in. x 16in. wide folding pages.....	27s. 6d.
CQ ANTHOLOGY 45-52.....	35s. 0d.
CQ ANTHOLOGY (1952-1959).....	18s. 6d.
COURSE IN RADIO FUNDAMENTALS (A.R.R.L.).....	27s. 6d.
DICTIONARY OF ELECTRONICS (Penguin).....	11s. 6d.
ELECTRONIC CIRCUITS HANDBOOK Vol. I.....	8s. 6d.
ELECTRONIC CIRCUITS HANDBOOK Vol. II (Tom Kneitel).....	27s. 6d.
FOUNDATIONS OF WIRELESS.....	27s. 6d.
GUIDE TO AMATEUR RADIO (New Edition).....	22s. 6d.
GUIDE TO BROADCASTING STATIONS.....	6s. 7d.
HAM ANTENNA CONSTRUCTION PROJECTS.....	6s. 9d.
HAMS INTERPRETER.....	27s. 0d.
HANDBOOK OF HAM RADIO CIRCUITS (by W9CGA).....	9s. 6d.
HINTS AND KINKS Vol. 6.....	28s. 0d.
HOW TO BECOME A RADIO AMATEUR (A.R.R.L.).....	11s. 6d.
"HOW TO LISTEN TO THE WORLD".....	11s. 0d.
LEARNING MORSE (Iliffe).....	O/P
THE MORSE CODE FOR RADIO AMATEURS (R.S.G.B.).....	2s. 3d.
LEARNING THE RADIO TELEGRAPH (A.R.R.L.).....	1s. 9d.
MOBILE HANDBOOK (Published by CQ).....	4s. 6d.
MOBILE MANUAL (Published by A.R.R.L.).....	26s. 6d.
NEW RTTY HANDBOOK.....	27s. 0d.
NEW SIDEBAND HANDBOOK (by CQ).....	35s. 0d.
NOVICE HANDBOOK, Tx and Rx.....	27s. 6d.
OPERATING AN AMATEUR RADIO STATION (A.R.R.L.).....	25s. 0d.
PORTABLE TRANSISTOR RECEIVER.....	2s. 8d.
QUAD ANTENNAE.....	3s. 0d.
RADIO AMATEUR EXAMINATION MANUAL.....	28s. 6d.
RADIO AMATEUR HANDBOOK (A.R.R.L.), 1968.....	5s. 9d.
	Paper Edition 50s. 0d.
	Buckram Edition 60s. 0d.
RADIO AMATEUR OPERATOR'S HANDBOOK (Data Publications).....	5s. 6d.
RADIO AMATEUR CALL BOOK (U.K. only, 1968).....	O/P
RADIO DATA REFERENCE BOOK.....	14s. 0d.
RADIO HANDBOOK (Wm. I. Orr) (17th Edition).....	88s. 6d.
RADIO VALVE DATA (Iliffe), Eighth Edition.....	10s. 7d.
SERVICE VALVE AND SEMI-CONDUCTOR EQUIVALENTS (R.S.G.B.).....	5s. 6d.
SSB EQUIPMENT.....	3s. 3d.
S9 SIGNALS.....	9s. 6d.
SHORT WAVE LISTENING.....	13s. 2d.
SHORT WAVE RECEIVERS FOR THE BEGINNER (Data Pubs.).....	6s. 6d.
SHORT WAVE RADIO AND THE IONOSPHERE (Iliffe).....	11s. 9d.
SINGLE SIDEBAND FOR THE RADIO AMATEUR (A.R.R.L.) (4th Edition).....	26s. 0d.
SURPLUS SCHEMATICS (Published by CQ).....	23s. 0d.
SURPLUS CONVERSION HANDBOOK (including "Command Sets").....	26s. 0d.
TECHNICAL TOPICS FOR THE RADIO AMATEUR.....	10s. 8d.
TELEVISION EXPLAINED (Iliffe) (New Edition).....	26s. 0d.
TRANSISTOR RADIO HANDBOOK (Editors and Engineers).....	46s. 0d.
UNDERSTANDING AMATEUR RADIO.....	21s. 6d.
VHF HANDBOOK (Orr W6SAI).....	27s. 6d.
VHF MANUAL by A.R.R.L. (New).....	24s. 6d.
VHF FOR THE RADIO AMATEUR (CQ).....	30s. 0d.
WORLD RADIO AND TV HANDBOOK, 1968.....	43s. 0d.

Available from **SHORT WAVE MAGAZINE**
 Publications Dept., 55 Victoria St., London S.W.1 • 01-222 5341
 (Counter Service, 9.30-5.15, Mon. to Fri.) (Nearest Tube Station: St. James's Park)

♣ Technicians Marvel Over The Complete Perfection

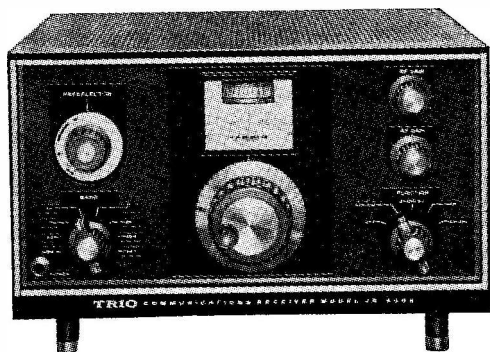

Model JR-500SE CRYSTAL CONTROL TYPE DOUBLE CONVERSION COMMUNICATION RECEIVER

- * Superior stability performance is obtained by the use of a crystal controlled first local oscillator and also, a VFO type 2nd oscillator.
- * Frequency Range: 3.5 MHz—29.7 MHz (7 Bands)
- * Hi-Sensitivity: 1.5 μ V for 10 dB S/N Ratio (at 14 MHz)
- * Hi-Selectivity: ± 2 KHz at -6 dB ± 6 KHz at -60 dB
- * Dimensions: Width 13", Height 7", Depth 10".

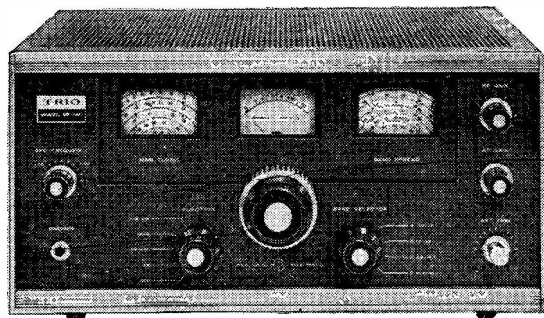

Model 9R-59DE BUILT IN MECHANICAL FILTER 8 TUBES COMMUNICATION RECEIVER

- * Continuous coverage from 550 KHz to 30 MHz and direct reading dial on amateur bands.
- * A mechanical filter enabling superb selectivity with ordinary IF transformers.
- * Frequency Range: 550 KHz to 30 MHz (4 Bands)
- * Sensitivity: 2 μ V for 10 dB S/N Ratio (at 10 MHz)
- * Selectivity: ± 5 KHz at -60 dB (± 1.3 KHz at -6 dB) When use the Mechanical Filter
- * Dimensions: Width 15", Height 7", Depth 10".

TRIO

a product of TRIO Corporation, Tokyo, Japan.

Sole Agent for the UK

B. H. MORRIS & CO., (RADIO) LTD.

84/88 Nelson Street, Tower Hamlets, London E. 1. Phone: 01-790 4824

Exclusive Distributor in European Continent

TRIO KENWOOD ELECTRONICS S.A.

160 AVE., Brugmann, Bruxelles 6, Belgium

TO: B.H. Morris & Co., (Radio) Ltd. SW

Send me information on TRIO COMMUNICATION
RECEIVERS & name of nearest TRIO retailer.

NAME :

ADDRESS :

BOOKS IN STOCK

Amateur Radio Construction Projects	21/-
Beginner's Guide to Radio	9/-
(Newnes)	
Beginner's Guide to Colour Television	15/8
(Newnes)	
Beginner's Guide to Electronics	15/6
Electronic Transistor Circuits	25/9
(Foulsham)	
Q. & A. On { Audio	10/-
(Newnes) { Electronics	10/-
{ Transistors	10/-
Handbook of Transistor Circuits	36/-
(Foulsham)	
Introduction to Valves	9/4
(Iliffe's)	
Practical Transistor Theory	21/-
(by E. A. Wiesner)	
Radio Astronomy for Amateurs	31/-
(by Frank Hyde)	
Remote Control by Radio	10/9
(Philips)	
Radio and Electronic Hobbies	22/-
(by F. C. Judd, G2BCX)	
Radio Engineers Pocket Book	11/-
(Newnes)	
RCA Silicon Power Circuits Manual	23/-
RCA Receiving Tubes Manual	23/-
RCA Transistor Manual	23/-
RCA Transmitting Tubes	15/-
Shop and Shack Shortcuts	34/6
(by W6TNS)	
Short Wave Amateur Radio	23/6
(by PAØHH, Philips Technical Library)	
Short Wave Listening	13/2
(by J. Vastenoud)	
Short Wave Listener's Guide	13/6
(Foulsham)	
Transistor Transmitters for the Amateur	22/-
(Foulsham)	

CALL BOOKS

"G's" (1968) O/P

SUMMER EDITION

"DX Listings" £2/2/6

"U.S. Listings" £3/4/6

The two together, covering the World £5/2/6

MORSE COURSES

G3HSC Rhythm Method of Morse Tuition

Complete Course with three 3 speed L.P. records with books	84/-
Beginner's Course with two 3 speed L.P. records with book	60/6
Single 12" L.P. Beginner's with book	50/-
Single, 12" L.P. Advanced with book	50/-
Three speed simulated GPO test. 7" d.s. E.P. record	15/-

MAPS

AMATEUR RADIO MAP OF WORLD

Mercator Projection — Much DX Information — In Colour. Second Edition	8/9
---	-----

DX ZONE MAP (GREAT CIRCLE)

In colour (Revised to October 1966)	14/9
(See S.W.M. page 643, January 1967)	
Black and White only	5/6
(See S.W.M. page 661, January 1967)	

RADIO AMATEUR MAP OF THE U.S.A. AND NORTH AMERICA

State boundaries and prefixes, size 24" by 30", paper	8/6
---	-----

RADIO AMATEUR'S WORLD ATLAS (NEW EDITION)

In booklet form, Mercator projection, for desk use. Gives Zones and Prefixes	16/-
--	------

LOG BOOKS

RSGB Standard Log	7/3
RSGB Log and VHF Contest Log	7/3
RSGB Receiving Station Log	7/3
RSGB Radio Station Log Book	7/3

A.R.R.L.

(Spiral bound)	12/-
--------------------------	------

A.R.R.L.

(Minilog) 4" by 6"	5/6
------------------------------	-----

(All the above prices include postage.)

Available from **SHORT WAVE MAGAZINE**

Publications Dept., 55 Victoria Street, London, S.W.1 . 01-222 5341

(Nearest Tube Station, St. James's Park)

THE BIG FOUR BY NOVA TECH

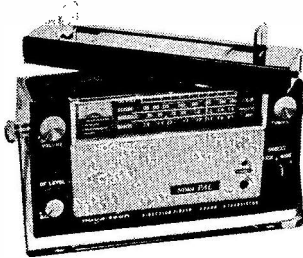

NOVA PAL

3-band R.D.F. 9 transistors
 190-400 Kc. with rotating ferrite antenna
 550-1600 Kc. and connection for external
 1600-4500 Kc. aerial.
 Suitable for yachtsmen.

£27 . 0 . 0

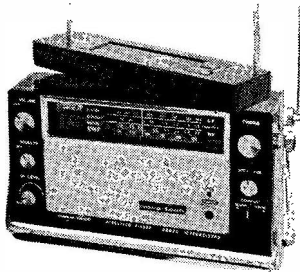

AVIATOR II

12 transistor 4-band R.D.F./VHF.
 190- 400 Kc. with rotating ferrite antenna,
 550-1600 Kc. 3 removable telescopic whip
 1600-4500 Kc. antennas, twin plug antennas for
 108- 136 Mc. best air-borne reception. Long
 range extendable whip provides
 maximum signal input on the
 ground.

£53 . 10 . 0

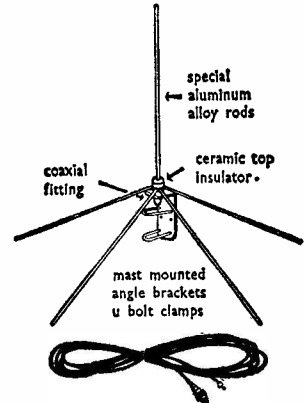

£7 . 15 . 0.

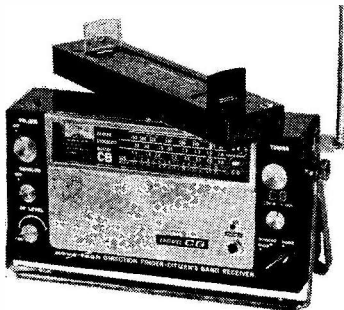

NOVA CB.

13 transistors 5-band R.D.F./CB.
 190- 400 Kc. With rotating ferrite antenna
 550-1600 Kc. twin-plug antennas and tele-
 1600-4500 Kc. scopic antenna.
 CB low 27 Mc. For CB BAND SQUELCH
 CB high 27 Mc. CONTROL.
 23 channels over 2 Bands.

£53 . 10 . 0

IMPROVE YOUR VHF RECEPTION WITH MODEL NT-4 ROOF ANTENNA

The Nova-Tech Model NT-4 Roof Antenna is designed to provide maximum signal input to your Aviator II. It consists of non-directional antenna cut to the aviation band, 4 drooping radials for positive ground plane, co-axial fittings and 50 feet of matching 52 ohm coax cable.

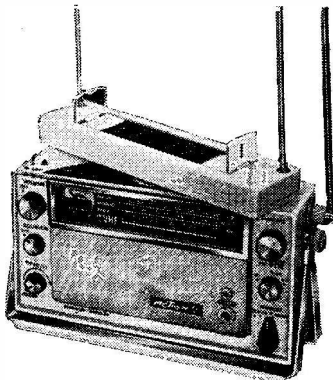

ACTION

5-Band R.D.F./VHF. AM-FM. 14 transistors
 190- 400 Kc. with rotating ferrite antenna,
 550-1600 Kc. twin plug V.H.F. antennas,
 1600-4500 Kc. telescopic V.H.F. antenna.
 30- 50 Mc. For V.H.F. BAND SQUELCH
 (low AM-FM) CONTROL.
 150- 175 Mc. (high AM-FM)

£53 . 10 . 0

Units are completely portable and operate on 4 x 1.5v. internal batteries and are covered by our unconditional 10-day money back guarantee

FULL PARTICULARS OF TRADERS TERMS, AND LITERATURE from

nova tech inc.

72 WARDOUR STREET, LONDON, W-1. Telephone : 01-437 4589

NEW LAFAYETTE SOLID STATE HA600 RECEIVER

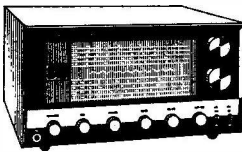

5 Band AM/CW/SSB amateur and short wave 50 Kc/s.-400 Kc/s. and 550 Kc/s.-30 Mc/s.

F.E.T. front end. 2 Mechanical filters. Huge Dial. Product detector. Crystal calibrator. Variable B.F.O. Noise limiter. S Meter. 24" Bandspread. 230v. A.C./12v. D.C. Neg. earth operation. RF gain control. Size: 15" x 9 1/2" x 8 1/2". Wt. 18 lbs. Exceptional value, £45. Carr. 10/-, S.A.E. for full details.

LAFAYETTE HA350 AMATEUR BAND RECEIVER, £67/10/-

LAFAYETTE HA700 AM/CW/SSB AMATEUR COMMUNICATIONS RECEIVER

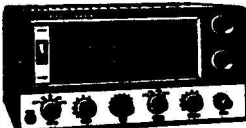

Eight valves, 5 bands incorporating 2 MECHANICAL FILTERS for exceptional selectivity and sensitivity. Frequency coverage on 5 bands 150-400 Kc/s., 550-1,600 Kc/s., 1.6-4.0 Mc/s., 4.8-14.5 Mc/s., 10.5-30 Mc/s. RF stage, aerial trimmer, noise limiter, B.F.O. product detector, electrical bandspread, S meter, slide rule dial. Output 4 or 8 ohms. 220/240 volt A.C. Size 7 1/2" x 15" x 10". Brand new, guaranteed with handbook, 36 gns. Carr. 10/-.

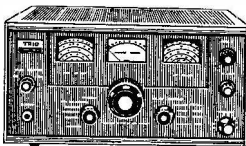

TRIO 9R-59DE

4 band covering 550 Kc/s. to 30 Mc/s. continuous and electrical bandspread on 10, 15, 20, 40, and 80 metres. 8 valve plus 7 diode circuit. 4/8 ohm output and phone jack. SSB-CW. ANL. Variable B.F.O. S meter. Sep. bandspread dial. IF frequency 455 Kc/s. audio output 1.5w. Variable RF and AF gain controls 115/250v. A.C. Size: 7" x 15" x 10" with instruction manual, £35. Carr. 12/6.

TRIO JR-500SE AMATEUR BAND RECEIVER, £62/10/-

EX-AM CONTROL BOX with two Londex 7026 24v. D.C. Aerial Change-over Relays. New, 39/6. Carr. 5/-.

ADMIRALTY B.40 RECEIVERS

Just released by the Ministry. High quality 10 valve receiver manufactured by Murphy. Five bands 650 Kc/s.-30 Mc/s. I.F. 500 Kc/s. Incorporates 2 R.F. and 3 I.F. stages, bandpass filter, noise limiter, crystal controlled B.F.O. calibrator, I.F. output, etc. Built-in speaker, output for phones. Operation 150/230 volt A.C. Size 19 1/2in. x 13 1/2in. x 16in. Weight 114 lbs. Offered in good working condition, £22/10/-, Carr. 30/-. With circuit diagram. Also available B41 L.F. version of above. 15 Kc/s.-700 Kc/s., £17/10/-, Carr. 30/-.

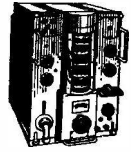

CLEAR PLASTIC PANEL METERS

First grade quality. Moving Coil panel meters, available ex-stock. S.A.E. for illustrated leaflet. Discounts for quantity. Available as follows. Type MR. 38P. 1 21/32in. square fronts.



50µA	37/6	5mA	25/-	1A	DC 25/-		
100µA	35/-	10mA	25/-	2A	DC 25/-		
200µA	32/6	20mA	25/-	5A	DC 25/-		
500µA	27/6	50mA	25/-	3v	DC 25/-		
50-0-50µA	35/-	100mA	25/-	10v	DC 25/-		
100-0-100µA	32/6	150mA	25/-	20v	DC 25/-		
500-0-500µA	25/-	200mA	25/-	50v	DC 25/-	500v	DC 22/6
1-0-1mA	25/-	300mA	25/-	100v	DC 25/-	750v	DC 22/6
1mA	25/-	500mA	25/-	150v	DC 25/-	15v	AC 22/6
2mA	25/-	750mA	25/-	300v	DC 25/-	50v	AC 22/6

Larger sizes available—send for lists

CLASS D WAVEMETERS

A crystal controlled heterodyne frequency meter covering 1.7-8 Mc/s. Operation on 6 volts D.C. Ideal for amateur use. Available in good used condition £5/19/6. Carr. 7/6. or brand new with accessories £7/19/6. Carr. 7/6.

TE15 Transistorised Grid Dips. 440 Kc/s.-270 Mc/s. £11/11. P/P 3/6. RCA AR88 Speakers. Brand new, 59/6. Carr. 7/6. Electronic Keys, £18. P/P 5/-. SWR Bridges, 69/6. P/P 3/-.

CODARE EQUIPMENT

CR.70 Receiver	£ s. d.
CR.45 Receiver	19 10 0
CR.45 Kit from	11 7 0
PR.30 Preselector	9 10 0
PR.30X (Built in P.S.U.)	7 4 0
RQ.10 Q Multiplier	6 15 0
RQ.10X (Built in P.S.U.)	8 8 0
CC.40 Control Unit	6 10 0
AT.5 Transmitter	16 10 0
T.28 Receiver	15 10 0
12/MS Mobile P.S.U.	11 5 0
12/RC Control Unit	2 7 6
AT5 Mains P.S.U.	8 0 0
Mini Clipper Kit	1 19 6

JOYSTICK AERIALS AND ELECTRONIC QUINCES DUCTS IN STOCK.

OPEN
9 a.m.—6 p.m.
EVERY DAY
MON. to SAT.

G. W. SMITH & CO. (RADIO) LTD.

3-34 LISLE STREET, LONDON. W.C.2

Phone: GERRARD 8204/9155

PART
EXCHANGES
WELCOME

Ordering Components
is **FUN**
with THIS Catalogue
in your hands!

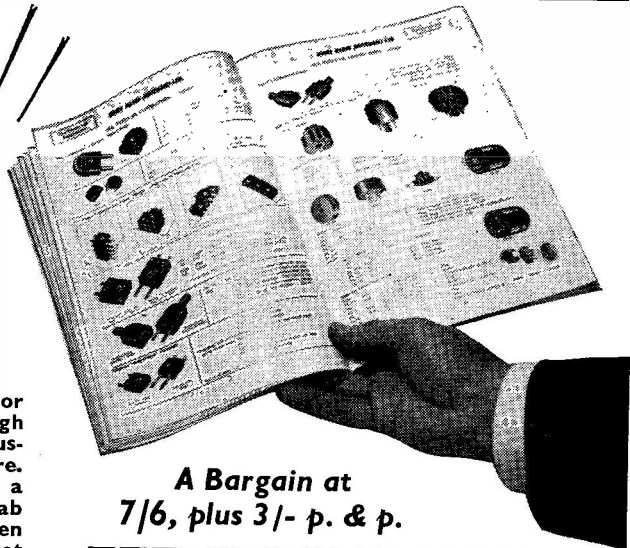

**A Bargain at
7/6, plus 3/- p. & p.**

Ever had trouble locating a particular piece for your project? Ever wasted time thumbing through confusing price lists? Ever been foot-weary and frustrated tramping round the shops? Sigh no more. Just sink into an armchair and enjoy life with a Home Radio Catalogue! Pick your parts. Grab your pen. Make for a letter-box. Your chosen items will be with you almost before you can get back to the armchair.

This catalogue really is a must if you're interested in radio and electronics. It has 256 pages, over 7,000 items listed, over 1,300 illustrations. With each catalogue we supply a Bargain List, a Book Mark giving Electronic Abbreviations, an Order Form and an Addressed Envelope. All this for only 7/6 plus 3/- post and packing. By the way, every catalogue contains 5 vouchers, each worth 1/- when used as directed. Send the coupon today with your cheque or P.O. for 10/6.

Please write Name and Address in block capitals

NAME

ADDRESS

Home Radio (Mitcham) Ltd., Dept. SW, 187 London Road, Mitcham, CR4 2YQ.

INDEX TO
ADVERTISERS

SHORT WAVE MAGAZINE

(GB3SWM)

PAGE

Amateur Electronics	
(G3FIK)	446
Baginton Electronics	447
D. J. Bean	446
A. Busfield	447
Charles H. Young	456
Croftfilm, Ltd.	447
Daystrom	396, 397
Derwent Radio	454
Echelford Communications	449
Eddystone Radio	cover ii
Eley Electronics	cover iii
Finnigan Speciality Paints	456
G3HSC (Morse Records)...	456
George Francis	445
Globe Scientific, Ltd.	394
Graham Newbery	449
G.W.M. Radio	455
Halsen Electrical Services...	456
Hamgear Electronics	394
H.P. Radio Services, Ltd....	455
Henry Electric, Ltd.	447
Henry's Radio, Ltd.	cover iii
Home Radio, Ltd.	402
A. Imhof, Ltd.	451
Jack Tweedy, Ltd.	446
J. B. Lowe	395
JXK Converters	451
K.W. Communications,	
Ltd.	450
K.W. Electronics	front cover
Minitenna Products	447
Mosley Electronics	393
Multicore	446
Nova-Tech Inc.	401
N.W. Electrics	cover iii
P. & H. Electronics	446
Peter Seymour, Ltd.	393, 404
Radio Shack, Ltd.	404
Rex Radio	450
R.T. & I. Electronics	448
Small Advertisements	448-456
Smith & Co. Ltd.	402
S.S.B. Products	448
Status Supplies	447
Stephens-James, Ltd.	394
Swanco Products, Ltd.	452, 453
S.W.M. Publications	cover iv, 398,
	400
Taurus Electrical Services...	454
Times Instrument Co.	cover iii
Trio Corp.	399

Vol. XXVI

SEPTEMBER, 1968

No. 299

CONTENTS

	<i>Page</i>
Editorial	405
Combined Tx/PSU for Stand-By Operation, by A. D. Taylor, G8PG...	407
Modification Note—The G3RNL HF-Band Transverter	410
Simplified Transverter for The Two-Metre Band, by P. W. Waters, G3OJV	411
Fred Goes Mobile, by G3COI	413
The Mobile Scene	415
“SWL”—Listener Feature	419
Communication and DX News, by E. P. Essery, G3KFE	425
VHF Bands, by A. H. Dormer, G3DAH...	432
The Month with The Clubs—From Reports	436
Courses for The Radio Amateur's Examination	442
New QTH's	444

Managing Editor: AUSTIN FORSYTH, O.B.E. (G6FO/G3SWM)

Advertising: Maria Greenwood

Published at 55 Victoria Street, London, S.W.1, on the last Friday of the month, dated the month following.
Telephone: ABBey 5341/2
(STD 01-222-5341)

Annual Subscription: Home and Overseas, 45s. (\$6.00 U.S.) post paid

Editorial Address: Short Wave Magazine, BUCKINGHAM, England

AUTHORS' MSS

Articles submitted for Editorial consideration must be typed double-spaced with wide margins on one side only of quarto or foolscap sheets, with diagrams shown separately. Photographs should be clearly identified on the back. Payment is made for all material used, and it is a condition of acceptance that full copyright passes to the Short Wave Magazine, Ltd., on publication.

© Short Wave Magazine Ltd.

Radio Shack Ltd



London's Amateur Radio Stockists

Just around the corner from West Hampstead Underground Station

R. L. Drake's Magnificent 4B

T-4XB Transmitter and R-4B Receiver

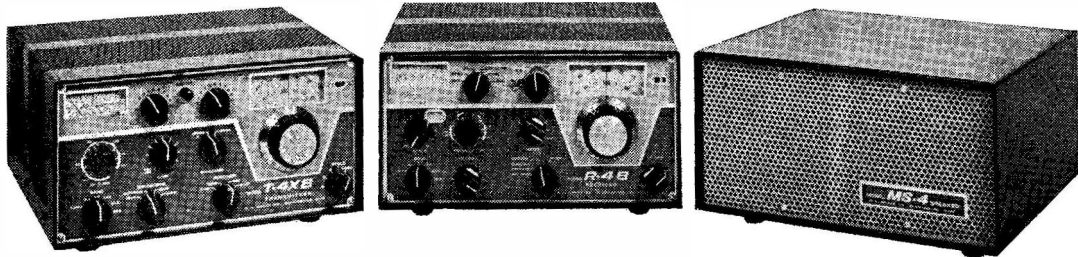

T-4XB £235.0.0 AC-4 p.s.u. £59.10.0 R-4B £225.0.0 MS-4 £12.10.0

All the rest of the Drake equipment including 2-NT CW Transmitter and the TR-4 transceiver.

Entire range of Hy-Gain and Mark Mobile Antennas amongst the rest of the gear at

RADIO SHACK LTD.
STAND No. 30 AT THE SHOW

182 BROADHURST GARDENS, LONDON, N.W.6.
Just around the corner from West Hampstead Underground Station
Telephone: 01-624 7174

PETER SEYMOUR LIMITED

410 BEVERLEY ROAD, HULL, YORKSHIRE

Telephone: 41938 (43353 after 7.30)

	£	s.	d.
NATIONAL HRO500, recent full works up-dating	550	0	0
KW VESPA with P.S.U.	135	0	0
KW VICEROY Mark IIIA. Mint condition through-out	120	0	0
EDDYSTONE 680X, latest model	85	0	0
SEMI-AUTOMATIC Bug Key	4	12	6
LEVELL, transistor A.C. Microvolt meter, type TM3A, 15 microvolts to 500 volts in 16 ranges	35	0	0
VOLSTATIC V.H.F. SKYMASTER, covers long, medium and 108-138 Mc/s. The best aircraft band portable in the U.K. (including carriage)	24	10	0
DENTSU. Fully automatic all transistor electronic keyer, mains or battery input, 2-60 w.p.m.	16	10	0
TRIO 9R59DE, 550 Kc/s.-30 Mc/s. Immediate delivery	39	15	0
DRAKE TR3, 80-10 metres 30W. PEP, non-standard P.S.U.	205	0	0
MULTIBAND DIPOLE TRAP SETS, with full instructions, full encapsulated, per pair 80-10 mtrs.	2	10	0
TRIO JR500SE crystal-controlled Osc., tunable IF system, full coverage 80-10 metres. Amateur bands only. Two mechanical filters, transistorised VFO, etc. New	68	0	0
HA700, 550 Kc/s.-30 Mc/s. mechanical filter product detector, "S" meter, etc. New	37	16	0
DRAKE TR4. New	295	0	0
MATCHING A.C. P.S.U.	59	10	0
MATCHING SPEAKER MS4	12	10	0
DRAKE R4B RECEIVER	225	0	0
Full details of the Drake equipment are available on request.			
KW VICEROY MARK III	100	0	0
MARCONI TF144G signal generator 80 Kc/s.-25 Mc/s., first class condition	12	10	0

	£	s.	d.
SWAN 2 metre transverter, 240W. PEP. Ex stock	155	0	0
HALLICRAFTERS SX146 with full complement of CF filters, including 500 cycle and 5 Kc/s. and accessory calibrator, as new, cost over £200	145	0	0
EDDYSTONE 940, as new, 480 Kc/s.-30 Mc/s.	95	0	0
EDDYSTONE 840C, as new	49	0	0
EDDYSTONE 888A with mounting blocks	75	0	0
SHURE 201 Microphones	5	10	0
PRESTEL, field strength meter/VHF-UHF receiver, built-in speaker, "S" meter, all transistor, 40-230 Mc/s. and 470-900 Mc/s. AM/FM, sensitivity better than 2 uV. New	105	0	0
TRIO, TS500 Transceiver with P.S.U. and remote V.F.O., complete	199	0	0
EDDYSTONE E.C.10 with mains and battery P.S.U.	45	0	0
CODAR ATS and P.S.U. 160/80 metres	24	10	0
CODAR T15, all transistor mobile or station receiver, 160/80 metres	15	10	0
SWAN 500, as new with new 230XC P.S.U.	265	0	0

All items carriage free

We are now in a position to take orders for the latest G.E.C. Digital read-out receiver, delivery August, £1,248; also the latest Redifon R408.

FOR fine quality receivers, consult us.

NOTE: Should you wish to part-exchange any good quality photographic equipment, our mail order camera department can quote you on trade-ins. We can also supply any new photographic equipment, and can take into stock items of Amateur Radio equipment, existing H.P. settled.

FULL H.P. FACILITIES ON EQUIPMENT OVER £35
25% DEPOSIT UP TO 24 MONTHS TO PAY. LET US KNOW YOUR REQUIREMENTS

The SHORT-WAVE Magazine

E D I T O R I A L

Competition

With the advent of the autumn season—though this is being written on that blazing afternoon in August—once again we offer to authors and potential contributors to SHORT WAVE MAGAZINE a mildly competitive exercise in writing material suitable for publication in these pages. The requirements are simple:

A constructional article, fully illustrated, on (a) Some piece of apparatus for the HF bands, either Tx, Rx or Transceiver—or (b) Similar equipments for VHF (two and/or four metres), with separate categories for the centimetre bands 70, 23 and 13 cm.

This makes a total of twelve separate headings under which material could be submitted. For the article considered best in each or any of these sections we offer an immediate on-acceptance prize of 25 guineas. Additionally, payment at full space rate will be made for each accepted article as it is published.

And if, out of all this, something of exceptional interest should emerge—thought likely to change basic thinking in the radio amateur context, or start some new trend in Amateur Radio—an overall prize of 50 guineas will be awarded.

Having stated the Requirements and the possible Rewards, the Conditions are as follow:

(1) The competition opens with effect from appearance of this issue, and an article offered for it under any head must reach us by November 30; (2) Material should be prepared and set out in the form in which it would be expected to appear in print—this means in the first instance strictly to the Magazine convention as regards signs and symbols; secondly, that it should be typed double-spaced, with wide margins, and all

WORLD-WIDE COMMUNICATION

drawings, tabular matter and captions on separate sheets, with photographs separately identified; (3) Any contribution submitted should be clearly entered under one or other of the categories mentioned, e.g., HF/Rx, VHF/transceiver, or whatever; (4) Any article offered under the foregoing conditions will be accepted for prize consideration only on the understanding that (a) if not found eligible for a prize, it is also offered for publication at usual rates in the ordinary way, and (b) that full copyright passes to Short Wave Magazine, Ltd., on publication; (5) That the decision of the Editor will be accepted as final as regards all matters affecting this competition.

There are those who will say that what we are offering is not so much a writer's competition as a bait to attract new contributors. In fact, it is both. We would be only too glad to find, emerging from it all, a writer in the radio amateur field to whom the top prize of 50 gns. could be awarded, with merit prizes of 25 gns. in the other categories.

*Austin Forster,
G6FO.*

COMBINED Tx/PSU FOR STAND-BY OPERATION

PRACTICAL EQUIPMENT FOR
THE BEGINNER

A. D. TAYLOR (G8PG)

A SPARE power supply is a most useful item to have about the shack. It can be employed to provide power for items of test equipment and for newly constructed projects which are at the bench-test stage. If such a PSU is being constructed its usefulness can be greatly increased by putting it on a slightly larger chassis and building a small standby transmitter to go with it. By adding a switch and a three-pin socket it is then possible to use the unit either as a self-contained transmitter or as a power supply for external items. In the equipment built by the writer the PSU gives 300 volts DC at 80 mA and 6.3v. AC at 3A. The companion transmitter is a crystal oscillator/power amplifier running at 15 watts in the 3.5 mc band. By suitably altering the size of the tank coil the same circuit could be used on Top Band or 7 mc.

The transmitter has been designed for maximum simplicity and the cost of constructing it is very small. Quite apart from its use as a standby rig, therefore, it should also appeal to the beginner who wishes his first effort at transmitter construction to be a simple, low-cost sure-fire project. By minor modifications to the switching arrangements, the facility of the power supply as an independent unit can be dispensed with and instead it becomes possible (a) To use it to operate an associated receiver and (b) To power both transmitter and

Table of Values

Fig. 1. Circuit of the Tx/PSU

- | | |
|--|---|
| C1, C2 = 8 μ F, 350v.
wkng., elect. | R4 = 50,000 ohms, 2w. |
| C3 = .001 μ F, 350v.
wkng., mica | Ch.1 = 10 Hy
(Radiospares) |
| C4 = .002 μ F, 350v.
wkng., mica | Ch.2 = Pri. midget L/S
o/p xformer |
| C5 = 1 μ F, 350v.
wkng., elect. | L1 = See text |
| C6 = .001 μ F, 350v.
wkng., mica | RFC = RF choke, 2.5 mH |
| C7 = 250 μ F, var. | Sk1 = 3-pin socket |
| C8 = .001 μ F, 550v.
wkng., mica | T1 = Mains xformer:
Sec. 300-0-300v.
80 mA, 5v. 2A,
6.3v. 3A |
| R1 = 47,000 ohms, $\frac{1}{2}$ w. | V1 = 5Z4 |
| R2 = 15,000 ohms, $\frac{1}{2}$ w. | V2 = Triode, $\frac{1}{2}$ -12AU7 |
| R3 = 22,000 ohms, $\frac{1}{2}$ w. | V3 = 5763 |

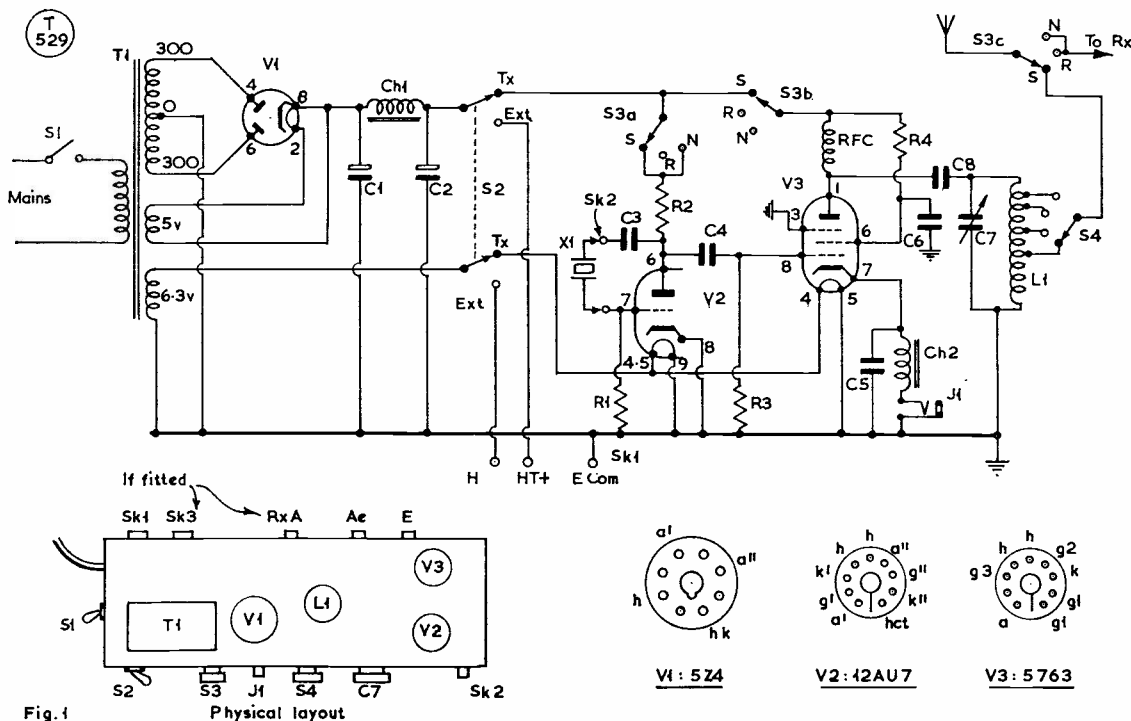

Fig. 1

Fig. 1. Circuit of the Combined PSU/Tx.

receiver from an external vibrator unit for portable operation. These modifications to the basic circuit are described later in this article.

The Circuit

The circuit is shown in Fig. 1. The power supply is a conventional full-wave rectifier (V1) using a capacity-input filter. A 6.3 volt heater winding is provided, one side of which is permanently grounded. Switch S2, a double-pole, double-throw toggle, connects the HT+ line and the "live" side of the heater winding to either the transmitter or socket SK1. When the switch is in the latter position no power is applied to the transmitter and the full rated load of the PSU can be taken by a piece of external equipment connected to SK1.

V2 is the transmitter crystal oscillator, in a simple Pierce circuit. In this the crystal is connected between the anode and grid of the valve, so no tuning is required. One of the merits of the Pierce is that it will oscillate well with virtually any type of crystal.

V3, the PA valve, is a 5763 rated for a maximum input of 300v. at 50 mA. A mixture of grid-leak and cathode bias is provided and the components associated with the cathode circuit constitute an effective key-click filter which gives a very pleasant keying characteristic. The tank circuit is parallel-fed as this allows the coil which, apart from the valves, is the only transmitter component above chassis, to be kept at earth potential. The taps on the tank coil, together with the aerial tapping switch S4, result in a simple and flexible method of matching into a variety of loads. When S4 is switched to the lowest tap it is easy to match into a coaxial cable feeding an aerial tuning unit. It is recommended that an ATU be employed when operating from a fixed location. When operating portable it will be found that selection of the correct tap by S4 will allow the transmitter to be fully loaded into lengths of wire between 10 and 150 feet without the need for an external tuning device.

It will be noted that no permanent metering is provided. Tuning is carried out by jacking a 0-50 mA meter into J1 instead of the key.

Construction

The version constructed by the writer is assembled on a chassis 12 inches long, 3½ inches wide and 2 inches deep, which is fitted with a baseplate. The use of a baseplate is recommended, particularly if portable operation is envisaged, as it protects the under-chassis components and wiring from damage. The chassis size suggested should be adequate for the experienced constructor, but the beginner will find layout and wiring easier if the width of the chassis is increased to 5 inches.

No miniature components are employed except the key jack and the electrolytic capacitors, though the smoothing choke suggested is also smaller than the average. The mains transformer is of the drop-through type, thus providing electrical safety and mechanical strength.

Coil L1 is wound on a grooved 1¼-inch diameter

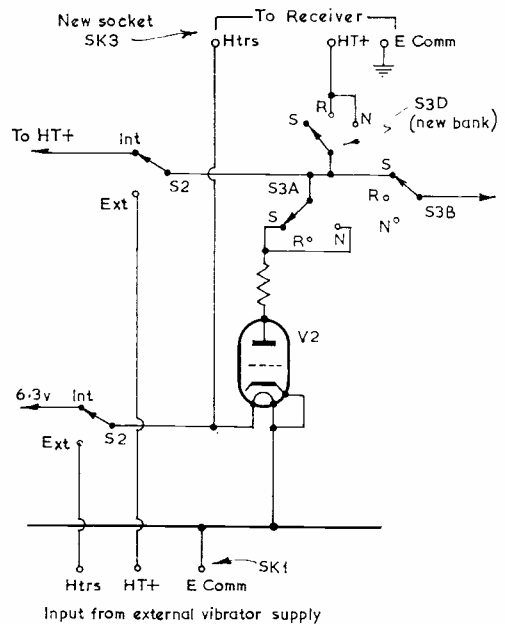

Fig. 2

T
530

Fig. 2. Modifications explained in text.

Eddystone former of the plug-in variety. The pins are cut off the former and it is bolted to the chassis. The two ends of the winding and the wire from the taps are brought down the inside of the former and pass through a hole drilled in the chassis to reach S4 and the RF choke. The taps are made by cleaning a small portion of the coil winding wire at the appropriate point and soldering a suitable length of 22g. plastic covered wire to the cleaned area. (If a different colour is used for each of the connections identification is made easy.) The winding itself consists of 24 turns of 22g. enamelled copper tapped at the 6th, 11th, 18th and 24th turns. With the grooved former used adjacent turns are spaced by twice the wire diameter, which makes the soldering of the taps easy.

Two Warnings!

When using the equipment shown in Fig. 1 it is essential to observe the following precautions:

- (1) When connecting the power supply to external equipment which has one side of its heaters earthed, ensure that the "live" ("Htrs") and the earth connection on Sk1 are connected to the corresponding points on the equipment being supplied. If this is not done, and the two chassis are earthed, the heater winding will be short-circuited via the earth system.

(2) Do *not* switch the transmitter to "send" unless a crystal is plugged in. Bias for V2 is derived from the rectified grid current flowing through R1, and this current will only flow if V2 is oscillating.

Setting-up and Tuning

When the wiring has been checked, plug a suitable crystal into Sk2, connect the aerial and earth and set S2 to the "Ext" position. Connect the mains supply and switch on S1. Using a voltmeter, check that the rated HT voltage of T1 appears between the "HT+" pin and the earth pin on Sk1, and that there is 6.3v. AC between the "Htrs" and earth pins on the socket. Set S3 to "net" ("N") and switch S2 to the "Tx" position. Allow the transmitter valves to warm up, then check the crystal frequency with a receiver. A strong beat should be heard. (It will be necessary to "throttle the Rx back" quite a lot.) If an ATU is being used, tune it to 3.5 mc. Jack a 0-50 mA meter into J1 and switch S3 to "send" ("S"). Adjust C7 to resonance as indicated by a maximum dip in the meter reading and if an ATU is in use peak it for maximum aerial current. Try each position of S4 in turn, re-dipping the PA after each change, until the position is found which produces maximum cathode current when C7 is tuned to resonance. The correct setting of S4 should give a cathode current reading of about

50 mA if 300 volts of HT is being applied. When S4 has been correctly set, unplug the milliammeter and jack in a key. The transmitter is then ready for use.

Modifications

Fig. 2 shows how the modifications already mentioned can be carried out. The wiring to S2 is re-arranged so that the switch can be used to isolate the transmitter from the mains power supply and connect it to the output from an external vibrator source, fed in *via* Sk1. At the same time S3 is replaced by a 4-bank switch and the extra bank (S3D) is used to switch the HT supply to an associated receiver when S3 is in the "receive" ("R") and "net" ("N") positions. An additional 3-pin socket, Sk3, connects power to the receiver, the heater supply being permanently wired to it.

While not quite "two for the price of one," the equipment described is an easy way to provide standby transmitting facilities. The transmitter is simple to construct and operate and very cheap to build. On various occasions it has been used to train R.A.E. students who have not previously adjusted or built a transmitter, and they have invariably commented on the simplicity of construction and operation. It should therefore appeal both to the experienced operator who wishes to have a useful piece of standby equipment and to the beginner who is trying to find a simple circuit for his first attempt at transmitter construction.

G3BZU CODE PROFICIENCY TESTS

Among recipients of a 40 w.p.m. certificate—offered by the R.N. Amateur Radio Society, hon. secretary R/S W. Metcalfe, G3TIF, P.O. Mess, H.M.S. *Mercury*, Leydene, Petersfield, Hants.—is G3MGP of Tamworth, Staffs. Others at the 40 w.p.m. level, listed in the July R.N.A.R.S. *News Sheet*, are G3JBA, G3RWL, G3TIF and G3WAU. There are also about 30 awards out for speeds in the range 20-35 w.p.m. Details of the G3BZU Morse Test Runs appeared on p.160 of the May issue of SHORT WAVE MAGAZINE.

BRITISH AMATEUR TELEVISION CLUB

The BATC 1968 Convention will be held on Saturday, September 14, at the ITA Conference Suite, 70 Brompton Road, London, S.W.3, 10 a.m. to 6.0 p.m., and there is free admission for all interested in Amateur TV. There will be an exhibition of A/TV equipment and lectures on topics of amateur television interest. We are glad to notice from the latest issue of *CQ-TV* that the BATC is in a satisfactory financial position. The surplus on operations for the year to December '67 was £178, and the Club's nett assets stand at the healthy total of £840. The

hon. secretary of the B.A.T.C. is N. Hampton, G6OUH /T, 19 Grove Crescent, Kingsbury, London, W.9. The Convention arrangements are being made by D. S. Reid, 71A Rose Valley, Brentwood, Essex.



"... And now looking over the *gand* for any gossigle call..."

To ensure a regular copy, become a Direct Subscriber—45s. post free, year of twelve issues, starting any month.

MODIFICATION NOTE—THE G3RNL TRANSVERTER

CURING INSTABILITY

IT has been found, with some models of the G3RNL HF-band Transverter—see SHORT WAVE MAGAZINE, January 1968—that instability can occur on “transmit.” This is due to feed-back coupling on the aerial change-over contact of the relay—a small amount of Tx output can be coupled back into the signal path *via* the mixer anode tuned circuits.

A simple modification, involving the addition of a relay with one change-over contact, can be incorporated to avoid this trouble. The sketch herewith shows the circuitry for the modification. The section dotted is as given in Fig. 2(A) on p.681 of the January issue.

In the Table of Values on p.680, a better choice would be, for C5, 100 $\mu\mu\text{F}$; C16, .01 μF ; and R9 should have been shown as 100K. The value of R19 is 1,000 ohms and not as given in the left-hand column of the Table.

REMEMBER—EUROPEAN BAND PLAN

Though perhaps more honoured in the breach than in the observance, it should be borne in mind by all AT-station operators that there is currently in force what is known as the European Band Plan, agreed by all IARU member-societies in 1966, after much painful discussion and argument. Here, then, are the *Phone Areas* which all telephony stations should observe: 3.6 to 3.8 mc; 7.04-7.10 mc; 14.10-14.35 mc; 21.15-21.45 mc; and 28.2-29.70 mc.

The *CW Areas* are: 3.5 to 3.6 mc; 7.0-7.04 mc; 14.0-14.10 mc; 21.0-21.15 mc; and 28.0-28.20 mc.

While CW is permitted all through these bands, in

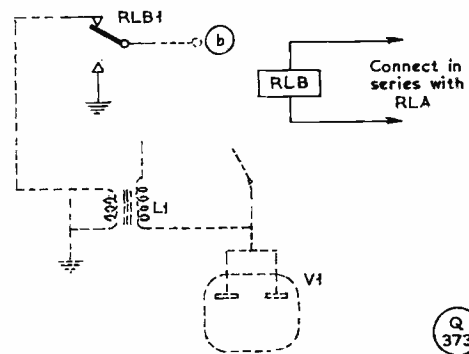

fact it is not very popular (and seldom so used) on the Phone sections. There is no plan for Top Band (few European countries have 1.8-2.0 mc, anyway), though in the U.K. the habitués are aware of a tacitly agreed dividing-line at about 1900 kc, with CW mainly in the lower half.

Though there can be no *compulsion* about the matter, it would be a very good thing if all concerned would keep to the European Band Plan, which was worked out to make things easier and pleasanter for everybody.

DUAL-GATE VHF TRANSISTOR

An interesting arrival on the transistor front is the new FET-MEM554, which is of series-gate construction, making it the equivalent of a cascode amplifier. It can be used, on frequencies as high as 400 mc, as an RF amplifier and linear mixer, with a feed-back capacity of only .02 $\mu\mu\text{F}$. It is a low-noise device, with high RF gain—typically, 18 dB at 200 mc with NF of 3.0 dB. Gates 1 and 2 of the FET-MEM554 can be separately connected, e.g., Gate 1 for an input signal, and Gate 2 for a gain control or second RF signal.

The neat modular PSU's, Series 30, introduced recently by A.P.T. Electronic Industries, can be housed in this rack-mounting frame—the 19-inch size, with a front panel secured by four locking screws, enabling the Units to be slid out independently.

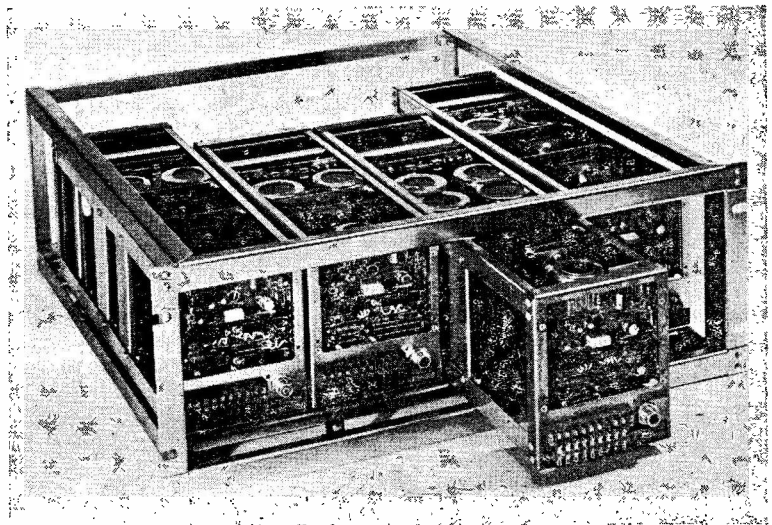

SIMPLIFIED TRANSVERTER FOR THE TWO-METRE BAND

TO GIVE SUFFICIENT OUTPUT
FOR A CLASS-AB1 LINEAR
AMPLIFIER

P. W. WATERS (G3OJV)

THE unit described here is a small transverter-driver unit for the two-metre band. It was produced to enable the writer to use his Heathkit SB-400 Sideband Tx for VHF working, on the transverter principle—as discussed in recent issues of SHORT WAVE MAGAZINE. The circuitry adopted is simple and straightforward and, with the exception of the QQV03-10 output valve, all the necessary parts were salvaged from an old low-band VHF “business radio” equipment.

With the circuit shown, working properly, a few watts of SSB drive input at 28 mc will give a good 2w. p.e.p. output on the two-metre band, and this should be ample to push a medium-power linear amplifier in Class-AB1.

Circuit Arrangement

The first half of V1 is fed from a separate 150v. stabilised HT line, with a third-overtone xtal oscillator to produce 38-667 mc. At G3OJV, the crystal

itself is an HC-6U type with a marked fundamental frequency of 12-889 mc. The overtone output is tripled to 116 mc, near enough, in the second half of V1. The buffer amplifier stage V2 was included to ensure that plenty of oscillator-injection would be

Table of Values

Circuit of the Two-Metre Transverter

C1, C2,	R4 = 2,200 ohms
C4, C7,	R6, R10 = 220 ohms
C9, C11,	R7, R8 = 6,800 ohms
C13, C15 = .001 μ F disc cer.	R11 = 50-ohm 10w.
C3 = 47 μ F	input load
C5, C8,	R12 = 100 ohms
C12 = 25 μ F, trimmers	R13 = 240 ohms, 1w.
C6 = 22 μ F	R14 = 27,000 ohms
C10 = 15 μ F	R15 = 39 ohms
C14 = 15 μ F, trimmer	V1 = 12AT7
C16 = 15 \pm 15 μ F, var.	V2, V3 = EL91
R1, R2 = 10,000 ohms	V4 = QQV03-10
R3, R5,	
R9 = 47,000 ohms	

COIL DATA

- L1 — 12 turns 22g. enamelled, $\frac{3}{8}$ in. dia., slug tuned, tap 3t. from grid end.
- L2 — 4 turns 20g. enam., $\frac{3}{8}$ in. dia., $\frac{1}{8}$ th in. long.
- L3 — 2 $\frac{3}{4}$ turns, 18g., $\frac{1}{2}$ in. dia. by $\frac{1}{2}$ in. long.
- L4 — 4 turns, 18g., $\frac{3}{8}$ in. dia., by $\frac{1}{2}$ in. long.
- L5, L6, L9 — Single-turn p.v.c. links.
- L7, L8 — 4 turns 18g., $\frac{3}{8}$ in. dia. by $\frac{3}{8}$ in. long.

Notes: All coils are self-supporting except L1. All resistors rated half-watt 10%, except as shown. R11 is the soak-resistor for the Sideband drive input; adjustment of SSB excitation should be as explained in recent articles on Transverters.

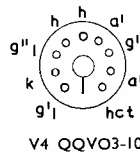
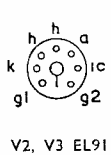
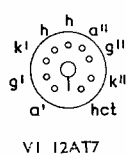
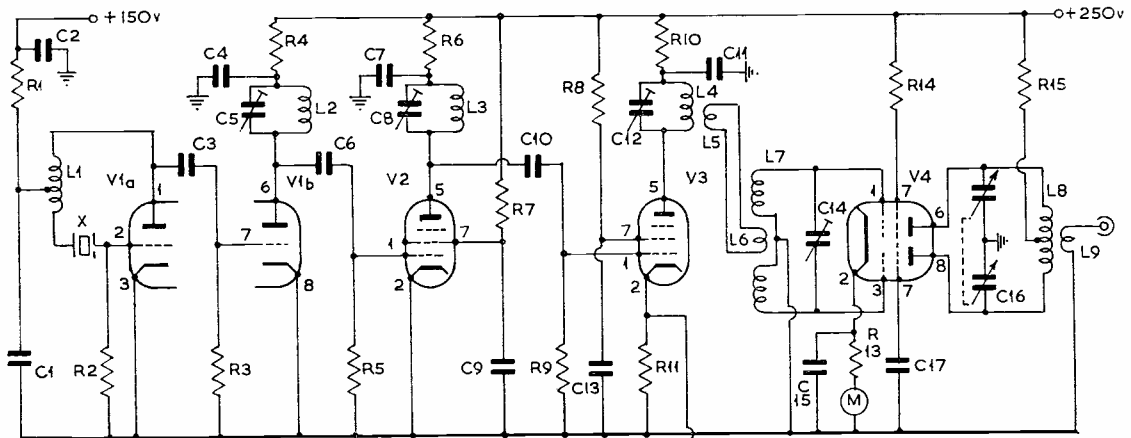

T
519

Circuit of the G3OJV Transverter.

available for the mixer, V3.

Sideband injection from the SB-400 at 28 mc is fed to the cathode of V3. The tank side L4, C12 is tuned to the product frequency of 144 mc, and in turn is linked in to the grid of V4, the two-metre output stage.

This is the QQV03-10, operated in Class-A. If a metal screen is fitted across the valve-holder, so that grid and anode sides are isolated to the extent that they cannot "see" each other, the stage will be found to be perfectly stable. This is a usual precaution when running straight amplifiers at VHF, and needs to be carefully done if "shocking noises" are to be avoided.

Alignment Procedure

There should be no difficulty about this if it is done methodically, as follows: The slug in L1 should be adjusted, and set, till the crystal goes into oscillation easily, and picks up immediately HT is switched on—it is no use going further till this condition is achieved. Final setting of the slug should be such that maximum grid current is shown in V1b, consistent with easy and certain starting.

Then, C5 should be set for maximum grid current into V2 at 116 mc. The anode circuit of this stage is also tuned to 116 mc—by which time there should be at least 1 mA of drive into V3. C12, C14 are then set up for maximum grid current in V4, which can be affected by variation of the link coupling. Note that all the foregoing adjustments will be found to interact to a certain extent—which means going over them to arrive at full drive to V4.

Having carried out this procedure, it only remains to bring the anode circuit C16, L8 to resonance and set the 28 mc SSB input so that the cathode current of V4 just shows variation on speech peaks.

The drive output may then be fed either to a linear amplifier, or into a two-metre beam, as a low-power Tx. If operated "barefoot" in this way, it would be better to short out the cathode resistor R13 of V4 and apply some fixed bias so that the stage is operated in Class-AB1.

Under these conditions—representing about two watts p.e.p. only—local results have been very favourable, using a 6-ele beam at 30ft. As an example, G3DAH at 45 miles has been worked with an S9 report.

Of course, a sideband transverter unit of this kind should be regarded not as a basic transmitter for two metres, but as a driver for a straight amplifier running 90-100 watts input. The QRP result can be regarded as of esoteric interest only!

INTERESTING GPO STATISTICS

They say that more than 100,000 radio transmitters for private two-way communication are now licensed in the U.K. What began 20 years ago as a modest experiment in Business Radio has now grown into an important facility with a wide variety of users, ranging from ambulances, taxis and the motoring organisations, to doctors, veterinary surgeons, public utilities (like the electricity,

FREQUENCY RELATIONSHIPS FOR SIDE BAND TRANSVERTERS

The table below shows how required SSB output frequencies can be obtained with different drive inputs and conversion crystals.

BAND	DRIVE FREQUENCY mc	CONVERSION FREQUENCY XTAL mc	OUTPUT FREQUENCY mc
2 METRES	28·410	6,500 × 3 = 19·5	145·41
	14·010	7,300 × 3 = 21·9	145·41
	21·210	6,900 × 3 = 20·7	145·41
4 METRES	14·325	6,225 × 3 = 18·675	70·350

gas and water boards, and such), the organisers of sports events and such esoteric bodies as mountain-rescue teams and off-shore vigilantes. There are now 75,000 land-based transmitters for private mobile radio, working to maintenance vehicles and small portable receivers, such as are used by road and building contractors.

More than 2,300 transmitters are licensed for private working from ships and yachts around the shores of the U.K., operating on spot frequencies, with 2182 kc as the local calling and distress wave. Private aircraft, including gliders, and their ground stations add up to another 2,500. The greater part of the private-users' traffic (except yachts and other small craft) is carried on UHF/VHF, where the frequency space has become available as the result of years of development—by the Post Office, the manufacturers and the co-operation of users. This development has, in round terms, multiplied the channel-availability by at least eight over the last 15 years.

According to this latest GPO survey, there are now (count as at July 29) about 14,000 licensed radio amateurs in the U.K. Another 14,000 licence holders operate in the model control category, using low power on the 27 mc band. And, believe it or not, there are nearly 3,000 "induction communication systems"—which also have to be licensed—whereby a personal-call facility can be provided in hospitals and factories.

G6CL, MAYOR OF ENFIELD

On the formation of the new London Boroughs, those of Enfield, Southgate and Edmonton were amalgamated to form the Borough of Enfield, one of the largest in the GLC area. Its new Mayor is well known far beyond the confines of his civic boundaries—Alderman John Clarricoats, OBE, JP (G6CL), who will be remembered as for many years the very energetic General Secretary of the Radio Society of Great Britain. Having retired from that onerous position some time ago, G6CL has since been devoting himself more and more to public affairs (in which he has always had an active interest—he was mayor of his own borough of Southgate in 1955), culminating in election to his present important office. We congratulate him, and wish G6CL, and his Lady Mayoress, success and good health in what is undoubtedly a very responsible job.

FRED GOES MOBILE

By G3COI

CQ CQ CQ . . . Fred's voice began to fray at the edges. He had read that article about mobile being the way to beat the tedium of town motoring. He had been calling solidly for past half-an-hour and the mileometer had advanced by 3 points. The efficient heater had by now filled the car with hot diesel fumes from innumerable lorries and buses but Fred was oblivious and continued to call, using every conceivable variation of wording and phonetic, but each time he went over, from the speaker slung beneath the dash on a bent nail would emanate a great bellow of hash. At last the grim Stroke Mexico operator began to feel that perhaps not all was well with the rig—surely activity on Top Band could not be this low? He pulled quickly over to the kerb amid the hooting and bawled cruderies of his fellow traffic to whom he had made no hand signals. (The window was jammed anyway). He untwisted the two dangling bits of black wire that served as an ignition switch and the uneven throbbing of the thoroughly thraped Mini shuddered to a steaming halt. With it ceased 90% of the hash and what seemed to be several QSO's could be heard. Fred carefully tuned over the band in search of either a clear spot or a CQ. Ah! here was one—he netted as well as he could but as he had no means of switching off his signal blotted out all the band on any VFO setting. (He netted by the thumbnail method—I mention this in case any reader is mystified regarding how one can net when one's signal blots out the entire band).

I suppose everybody has heard of the thumbnail method of netting—in case there are any new subscribers perhaps I had better give them a brief run down. The first requirement is a genuine QSO with the rig in question. Having got this going well, the operator with the blocking net signal asks politely what the other chap thinks his frequency is. Now, if the other chap has no measuring stuff or a crudely calibrated receiver it's too bad but most are accurate to 50 kc or so nowadays. Anyway, let's say this other chap comes back with "1905-89 kilohertz," why, all you do then is to mark your dial with your thumb nail. Repeat these instructions with several QSO's spread about the band at random and you will have a set of thumbnail marks that can take you anywhere.

Thus netted Fred. He switched to transmit and put out another lengthy call. He went over with a deft twist of multicoloured wire to hear . . . CQ CQ CQ *This is George three* . . .—it was old Syd, who couldn't be more than two miles away judging by the colossal impact of his signals, which were vibrating spent matches from the magnetic ashtray clinging to Fred's receiver. Fred let him sign and gave him a quick call in the form of a jocular reference to his "having a poor receiver." Six rounds of complete silence broken only by the bell-like tinkling of the beacon round about 1900 kc. Puzzled, our thick friend again fired up his EL84 and tuned carefully. Yes, all the indications were that he *was radiating* on 160. The neon bulb embedded in chewing gum on

top of the loading coil was a pretty pink and the vibrator hummed at the minimum level, thus coinciding with the dip that would have been shown on a PA current meter if a PA current meter had been fitted. Test number three was not carried out (grasping the voltage end of the whip with the moistened fingers) as Fred's fingers had not yet healed from damage incurred in previous tests.

He gave Syd a long, anxious call and went over. Blow-me-down if he wasn't calling CQ again. A bead of perspiration fell from our hero's brow on to the bare horn contacts in the centre of the steering wheel, momentarily setting off the low buzz of the mud-filled klaxon. The noise startled him and he kicked upwards into the welter of wire at the back of the dashboard—his usual method for silencing unbidden horn activity. Desperately he thumbed through an ancient copy of the *Call Book* to find Syd's QTH. Setting off he gave Syd another call but although Syd's voice became louder and louder, none of his remarks were addressed to Fred—*It was obvious that Fred was not getting out!*

At last Fred pulled up outside Syd's QTH and sat patiently as Syd once more put out a plea to the waiting band. Syd was getting weary now and should really have gone QRT because the string leading from his foot, out of the shack and down to the kitchen and XYL, had already been tugged with increasing heartiness, twice.

. . . and standing by for any possible call. . . . Fred called with desperate confidence, but as soon as he realised that still no answer was coming he leapt from his car and dashed round to the back of the house and up to Syd's shack. Without ceremony he pushed open the door revealing the eloquent back of the incumbent operator. (He wore overalls bearing the legend "See you further down the log"). "Hey, Syd what's up with your Top Band receiver?" shrilled our hero, "I've been calling you for the last half-hour." Syd revolved slowly on his sorbo-covered stool, making a noise like a balloon accident. "You're not likely to get a reply," said Syd, with immense control and dignity, "I'm transmitting on Eighty."

SUGGESTION WORTH PURSUING

There are more than 40 Cheshire Homes in the United Kingdom. Several already operate a licensed amateur station and there are at least five equipped for listening on the amateur bands. Unquestionably, these will have been helped by Clubs or individual amateurs in their locality. It is the hope of Gp. Capt. Leonard Cheshire, VC, DSO**, DFC*, RAF (Bomber Command), that all Homes of his Cheshire Foundation should eventually have a licensed AT-station. Clubs already actively pursuing this ideal include Chippenham & District (the Greathouse Home) and Bristol Amateur Radio Club (supporting the Cheshire Home at Timsbury). This still leaves about 30 Homes without known radio amateur support to get them on the air. It can mean (for anyone wishing to help) a long period of indoctrination, instruction for the R.A.E., and eventually the provision of equipment. If you, or your local Club organisation, would like to help, the address to write to is: Cheshire Foundation, 7 Market Mews, London, W.1.

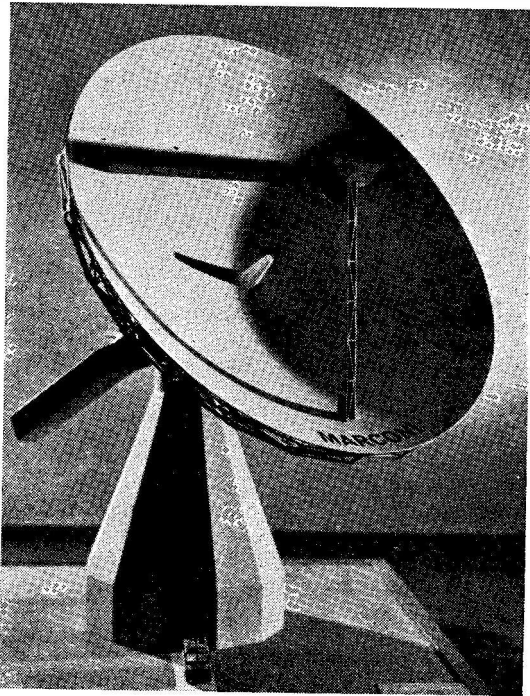

This is a representation of the 90ft. diameter UHF dish being provided by the Marconi Co. under their recent space-order contract with Cable & Wireless—worth over £2m. and the largest of its kind ever placed in Europe. Ground stations, using such a dish, at Bahrain and Hong Kong will work to the satellites and the system will give communication over about half the inhabited area of the world.

LOW NOTE FROM ZS

In a recent issue of *Radio ZS* of the South African Radio League—sometimes printed in both English and Afrikaans—it was briefly stated that “the editor and members of the *Radio ZS* committee regret to announce that they will not be available for another term of office. It has been decided that it was time for new blood to take over. A new editor and committee will have to be found to ensure the smooth running of *Radio ZS*.” All we can say is that this is a sad and unexpected development—because for many years *Radio ZS*, though a small and not very powerful periodical in the radio amateur press of the world, has faithfully mirrored what has been going on in South Africa in the Amateur Radio context. *Radio ZS* has always been a neat and well produced little magazine, and it is to be hoped that continuance will be possible.

ICF's AND LOCAL RADIO

The experimental broadcasting service—under which transmissions of local interest are radiated on FM/VHF at a number of centres in the more populous parts of the country—is making slow progress in the face of a certain amount of apathy and some financial stringency. It has, of course, been suggested that this service would have much better chances of success if it could be operated on MF—but as the Post Office has pointed out, in the present crowded state of the medium-wave BC band, the interfer-

ence problem would become intolerable, “especially after dark.” Then the suggestion was that the little-known International Common Frequencies, 1484 and 1594 kc, agreed under the Copenhagen Plan of 1948 for internal QRP working, might be utilised for low-power local coverage services—but at such frequencies the mutual interference, especially in the relatively confined area of the U.K., would remain and make after-dark local BC operation impracticable. If local broadcasting is to continue, it must be kept to VHF. And if it is to become really successful, the service provided must be such as to induce more people to buy more VHF receivers.

“THE OTHER MAN’S STATION”

For more than 20 years—and, if you care to go back into the period before Hitler’s War, it could be 30 years—we have made a regular feature in *SHORT WAVE MAGAZINE* of The Other Man’s Station. This could mean a picture of you with the equipment you operate. We do not mind whether offerings are of old timers, new timers or young aspirants just spreading their wings on the amateur bands. What we want is (a) A good, clear black-white photograph, with (b) An autobiographical account written, in your own words, about how you got started in Amateur Radio and what your current activities and interests are, with a run-down of the gear shown in your picture. With this and the essential details you send in with it, we write a page-story—for which you are paid at space rates, immediately on publication. All material offered for The Other Man’s Station should be sent to: Editor, *SHORT WAVE MAGAZINE*, BUCKINGHAM.

“BBC RADIO CAR”

In the “World at One” Home Service news programme on August 9, the BBC radio car was in action again. There were only a few unnecessary pop-noises, and the steady background hiss was down to well below speech level. So there is an improvement. But we haven’t yet got the clean, well-modulated transmission that we ought to have from a BBC radio vehicle operating static-mobile. It may seem extraordinary, but there it is.

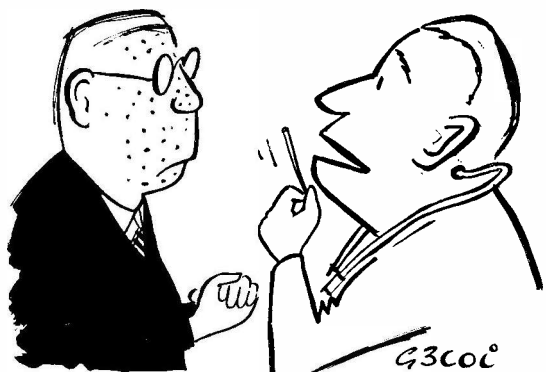

“. . . and you say you got those spots from a bug? . . .”

THE MOBILE SCENE

NOTES ON THE LEE-ON-SOLENT,
SOUTH SHIELDS, COLCHESTER, NEWQUAY
AND SALTASH RALLY EVENTS—
NEWS AND PICTURES

The last two months have covered not only the "British summer holiday season" but also a busy period in the Rally Calendar—with varying fortunes as regards Wx and attendances. One clear fact, however, is that this year's Rally activity has been the greatest yet.

Going back to June 15, they had a beautiful Saturday for the Lee-on-Solent event, organised by the R.N. Amateur Radio Society and held in conjunction with the R.N. Air Day at H.M.S. *Daedalus*. The /M attendance amounted to 48, of whom seven were worked on Top Band, another seven on 4 metres, and a couple on two metres. The control station signed GB3RN and was exceptionally well located at the top of Portsdown Hill, 320ft. a.s.l., enabling many other fixed stations to be worked. (According to the report in the R.N.A.R.S. *News Sheet* for July it also "cut out QRM from the band of the Royal Marines and small boys fingering PA valves!") However, the fact remains that for the quality of the entertainment offered on this Naval occasion, the visiting mobile attendance was low—proving (as so often in the past), that Saturday events are just not on for the majority of the mobile fraternity. It is the day when local shopping and other domestic chores and responsibilities simply have to take first place.

* * *

The ninth Rally organised by the South Shields & District Amateur Radio Club was held on the local Bents Park recreation ground on July 7. In warm and

sunny Wx they welcomed about 400 people in 120 cars, of which 40 were fitted /M—the largest attendance yet recorded at South Shields. Competition winners were: G3WOB (mobile turnout); G3PHO (frequency test); G3VRO (quick construction competition); G3RKL (visual radio quiz); and GM3LIB (audio quiz). For the fourth successive occasion, G3MQT (Hastings) was the longest-distance traveller.

* * *

The Colchester event on July 14—held at the local Zoo, with the talk-in station signing GB3ZOO on Top Band and VHF—started under storm conditions around mid-day, followed by clearance and a fine afternoon. But inevitably, attendance from all but the immediate locality must have been affected, and the talk-in station packed up early. However, the undoubted interest and attractions of the site are such that one hopes the Colchester group will run a Rally there again next year.

* * *

For the Cornish Radio Amateur Club's Rally at Pentire Headland, Newquay, on July 21, all (we are told) went smoothly—Wx perfect, with hot sunshine all day; a large and happy crowd, including many interesting mobiles, on holiday in the district; all the talk-in gear worked perfectly, with plenty of on-the-air activity; a selection of interesting display stands; and coverage for the event on local TV. Altogether, says the report, "a thoroughly satisfactory day"—well done, C.R.A.C.

* * *

The new Grammar School at Saltash, Cornwall, was the venue on July 28 for the fourth Mobile Rally arranged by the Saltash & District Amateur Radio Club, in perfect weather, on a hill-top site with panoramic views. The final count was well over 500 people, including many amateurs who were on holiday in the south-west, as well as visitors from distant parts—G2DC/G3JAF came all

Taken on the occasion of the Cornish Radio Amateur Club's Mobile Rally at Pentire Headland, Newquay, on July 21. All that tentage, and the aerials, had to be erected for the event—for which they had perfect Wx and a very good attendance.





The stand put on for the Saltash Mobile Rally by the firm of Newbery, Axminster—of which the proprietor is Reg. Ward, G2BSW (seen here), who has been in the radio business for many years. The display included a fine selection of Eddystone equipment, for which Newbery's are agents in the South Devon area.

G3VYP, recently on tour in Scotland signing GM3VYP/M, covered 1700 miles up there and kept in QSO throughout with nearly 40 different GM's, running 15 watts AM into a whip ae. mounted on the roof of his Triumph. His gear, shown here, is a Minimitter mobile Tx and home-built transistor converter for the car radio.

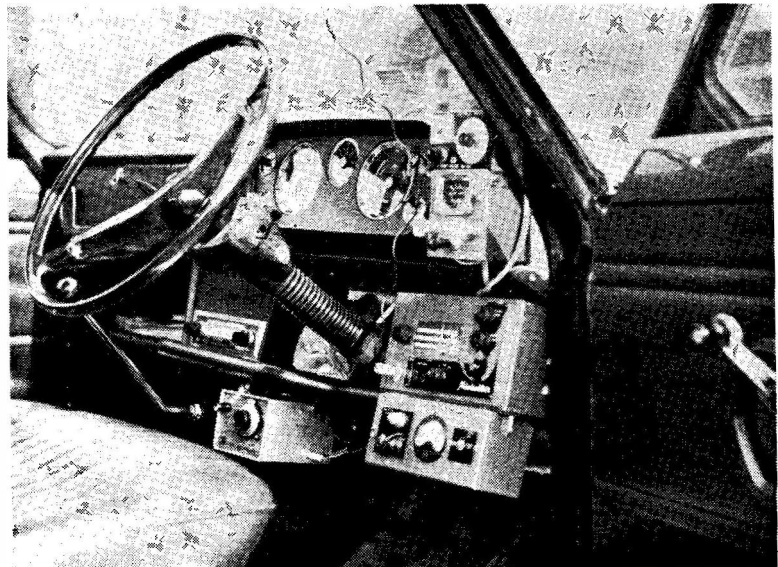

the way from Hampshire. The Rally was formally opened by Arthur Edwards, G6XJ, and for many present it was of great interest to meet one who has for so long been identified with the honoured name of Eddystone. The RAIBC was represented by G3VUC, and G3UBY, with SWL Burton, ran free trips for the children on the River Lynher. Prize-winners were: G3WWK/M and G3WKP/M, longest distances worked to control, GB3SAL; for frequency measuring, G3NXV; valve identification, G8AFA; and G3NPA, for a competition called "DX-darts." There were well over 100 prizes for the raffle—and at the end it was generally agreed that this was the most successful Mobile Rally yet held by the Saltash group.

* * *

On p.356 of last month's issue, the picture of G2IK/P

was wrongly identified—that shown was actually the Bristol Group's field day station, and had nothing to do with Longleat. Just one of those unfortunate mix-ups. . . .

A letter from G3VYP/M (Castle Bromwich) describes his holiday mobile trip round Scotland, and records his appreciation of the hospitality and co-operation of the GM's, who kept him busy on the air all through his tour of 1,700 miles, proving that "almost complete coverage of GM is possible running only 15w. AM on three bands using a mobile whip mounted on the roof."

The Rally Calendar

Following are the Rally events to wind up the 1968 Season, which has been the busiest and most successful on record.

September 1: Mobile Rally to be held by the Preston Amateur Radio Society in the car park of the



This picture may give some readers a few ideas for station layout and construction—it is of the very fine home-built console shown by G3VVP (seated) at the Saltash Mobile Rally on July 28. Standing are G3SN (right), president of Saltash, with Arthur Edwards, G6XJ, who officially opened the Rally.

North End's Football Ground. There will be various indoor displays, and talk-in stations will be on the air from 10.0 a.m. Further information from: G. Windsor, 26 St. Gregory's Road, Preston PR1 6YB, Lancs.

September 1: Mobile Rally at Pipers Hill Common, south of Bromsgrove, Worcs., on the B.4091, organised by the Bromsgrove & District Amateur Radio Club, with talk-in on Top Band.—J. Dufrane, 44 Hazelton Road, Marlbrook, Bromsgrove, Worcs.

September 2 (Bank Holiday): Peterborough Mobile Rally. Venue is on the riverside park, between the swimming-pool and the boat-house, with plenty of space for free parking and picnicking. Commence 2.30 p.m., but talk-in station G3DQW will be on 1980 kc at 1 p.m., also G3RED on 4m. and G3UWT on two metres. Special exhibition of old-time wireless gear, as used in the 1920's. Trips down the river. Usual trade-stands and lucky dip! Large marquee if wet.—D. Byrne, G3KPO, Jersey House, Eye, Peterborough. (*Eye* 351.)

September 13-15: Fourth International Amateur Convention at Knokke, Belgium, with a varied programme for all comers, as in recent years. It is now too late to apply for other than special reservations, advance notification having been given in previous issues. The



On the left, Edna Cooper, G3UGO, president of the Cornish Amateur Radio Club, visiting one of the stands set up for the very successful Mobile Rally near Newquay on July 21.

organiser is Lucien Vervarcke, ON4LV, Lippenslaan 284, Knokke 1, Belgium.

September 22: Mobile Rally in conjunction with the local carnival at Ipsley, near Redditch, Worcs., off the B.4095. Talk-in on Top Band by the East Worcs. Amateur Radio Group.—L. Hickenbotham, G3HZG, 95 Oakenshaw Road, Redditch, Worcs.

September 29: Harlow & District Amateur Radio Society

All talk-in stations for the Saltash Mobile Rally on July 28 signed GB3SAL. The 160-metre control is here seen being operated by G3XCU.

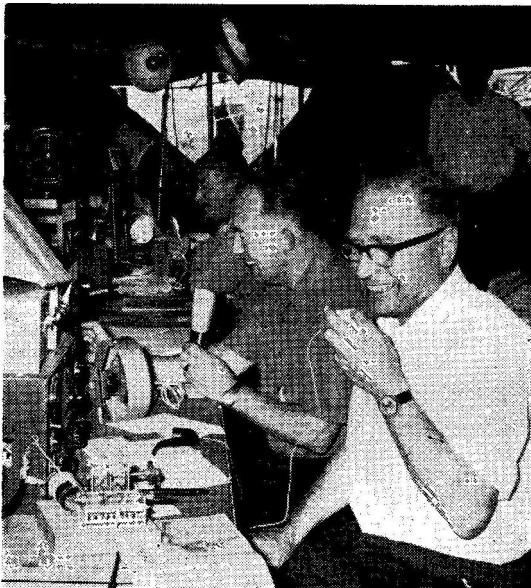

For their Rally at Newquay, the Cornish group ran their three talk-in stations—on 160m., 80m. and 4m.—under the same cover, and in order from the back are G2BHW, G3THT and G3NKE. According to reports, all this gear worked very satisfactorily.



At the Saltash Rally, one of the prize-winners was G3JAF (Lynton, Hants.), right, seen receiving his award (for the longest distance travelled) from G6XJ—who himself won a valuable prize, which he immediately re-donated for the benefit of the RAIBC.

annual mobile rally at Magdalen Laver Village Hall, a few miles from Harlow on the east side of the A.11, with local sign-posting on the day. Talk-in on 1870 kc, also on the 4-metre and two-metre bands, controls signing G6UT/A. All the usual attractions for this regular event. Information from: R. A. Sinclair, G3VAD, 244 Stanstead Road, Hoddesdon (66806), Herts.

Reports, notes, news and photographs for the "The Mobile Scene" in the next issue should reach us by *September 7*, latest, addressed: Mobile Scene, Editor, SHORT WAVE MAGAZINE, BUCKINGHAM.

AMATEUR RADIO IN GERMANY

Of the 14,000 amateurs now licensed in Germany, about 10,400 are members of D.A.R.C. (the national society), which has a total membership of some 18,700—meaning that a large proportion, about 44%, are in the SWL or just-interested categories. This seems to be now the tendency with most National Societies. It may not be generally realised that the DL's are permitted two narrow frequency-areas—1825-1835 kc and 1985-1992 kc—on what we know as Top Band. There are reciprocal licensing arrangements with several European countries, including the U.K. (*Based on data given in "Region 1 Bulletin," July issue.*)



SHORT WAVE LISTENER FEATURE

NOTES ON NOISE REDUCTION—AND ON EFFECTIVE EARTHING — MANY READERS AWAIT R.A.E. RESULTS — NEWS, IDEAS AND COMMENTS

By *Justin Cooper*

By the time this piece is read, the RAE results will probably have come out; and to those who have passed go our congratulations, our condolences to the unfortunates who have not made the grade, and the same varieties of wish to all those readers, in whatever context they may have been doing it, who have been examined in their knowledge of some subject—and we might comment that we have covered *most* of the readers that way!

One of the topics not touched upon to any extent in this piece is that of noise levels. Here we have two problems, natural noise, and man-made noise. As far as the former is concerned, we can make a further subdivision into that picked up on the aerial and that generated in the receiver. Natural noise picked up on the aerial we are, to a great extent, stuck with, although a certain amount of help comes with the use of directional aerial systems. The noise generated by the receiver also we have to a great extent have to endure, although on the LF bands it is not usually so important, and in any case it can be kept to a level specified by the maker of the receiver if regular maintenance is done and the set kept in perfect alignment, particularly the front-end stages.

Man-made noise is somewhat of an individual problem. In the first place there is noise generated by incorrect use of the controls, which can easily bury signals of interest due to cross-modulation effects and similar effects; here the cure is the use of a good ATU or a matched aerial system, together with the lowest practical RF gain control setting, which last will not only reduce cross-modulation but also show the receiver selectivity to the best advantage. Additional selectivity, by reducing the receiver bandwidth, will help with both receiver front-end noise, and, to a lesser extent, wide-band aerial-borne noise, in that the signal-to-noise ratio will be directly related to the bandwidths used for this type of noise.

As for the local man-made noises not generated by receiver mis-operation, these can be minimised in quite a few ways. First, getting the aerial up high and in the clear will help, locating the ATU at the point where the aerial approaches the noisy zone, so that coaxial feeder can be run through the noisy zone to the receiver. Of course there are noises generated by dry joints and corroded connections in the aerial, and for these the cure is obvious—what is not so easy to grasp is that such joints may well act as diodes and generate spurious signals themselves! On the earth side, one should bear in mind

Ohms Law, and ensure that there are no places where the same piece of wire is carrying noisy earth currents to ground and our hard won DX. To deal with these is relatively easy, in that one must either use a good separate earth for the station, or if one has no option but to earth to a water pipe, to make sure that the connection is to the rising main where it actually rises, and if possible far below the point at which the mains safety earth is bonded to the pipe. It should be remembered that the earth has resistance in the pipe. Hence, any common length (of conductor or pipe) between mains and RF earth system, must result in voltage drops across the resistance of the length concerned—which means the mains noise appears mixed up with the DX! It boils down to the proposition that just picking up earth for the aerial system at the power-point is not just bad practice safety-wise, but also will bring up the apparent noise-level quite considerably. Again, there is the point that most local noise of this annoying sort is *extremely* short-range stuff, and the noisy areas are usually within the house and loft, so that there is something to be said for *screening the earth lead* if it goes from the shack through noisy areas of the house in the electrical sense.

One should also remember that the water in the pipe has very little to do with the conductivity of the water system to earth—pure water is a good enough insulator to be used with high-voltage transmitting valves as a coolant for the anodes, through jacketing. It is well to remember that the making of good water-tight joints in pipes often results in the two pieces of pipe being insulated from each other, to the detriment of the earthing—so that bonding the pipes together may be necessary across any pipe-joints that are not plumbed. Any joints in the system should be soldered, and then corrosive flux carefully neutralised before finishing with a protective lick of paint.

Finally, when all this is done, one can filter the mains input to the receiver, and then set to work to locate and suppress any noise-generating electrical apparatus at source—such items as elderly electric light bulbs, fluorescent tubes, thermostats, electric controls for central-heating systems, and their fans and pumps, are often the sources of noise not so easily identified as the more common washing-machines, hair-dryers, electric drills and so on.

When you have done all this, the result should be a revelation, and conditions on the bands will seem *far* better!

[over

The Mail

Top of the heap is *Jim Dunnett (Singapore)* who has parted company with both HRO and R.1475 receivers, and has not to date had his AR88 back from the comprehensive overhaul, although he understood it to be on a final "soak" test at the time of his writing.

Congratulations are in order to *J. Fitzgerald (Gt. Missenden)* who has secured his B.A. degree, and, as he says, "resumed normal service on the bands" for a while. However, there is still some way to go, as he has to do a year of teacher-training up North yet.

Stewart Foster (Lincoln) is one of the Angry Young Men—because the writer discounted XP1AA last time out in a fit of absent-mindedness, for which there was no excuse—after all, it is written down in the Prefix List that goes with the *DX Zone Map* hanging on the wall of J.C.'s shack!

One of several who are waiting patiently for RAE results to come through was *R. Schofield (Liverpool)*, who is filling in the time with Morse studies, prefix hunting, and the modification of a 19 Set. Roy has put up separate dipoles for the bands from Forty to Ten, and is running a programme to evaluate them against the Joystick.

Another poor suffering soul is that of *J. A. Ennis (Saltash)* who has returned to HPX'ing in order to calm his nerves during the waiting period before the RAE results come out!

R. Allisett (Guernsey) has just escaped from the O-level inquisition, and so though to spend rather more hours at the receiver—but alas, he had to go into hospital, and then was to take a holiday trip to G, which two events have between them reduced his listening time to zero. Not to worry, Dick, that is what a hobby is about—and when, like J.C., you have a long white beard which gets mixed up with the receiver dials, then you realise the best thing of all about a hobby is the lack of any need to press on with it *unless you want to*. It is nice to think of all those VK/ZL stations on Twenty or Fifteen, or even on Top Band—and then turn over again and go back to sleep!

A Gelo-so-KW converter has made life a little easier for *D. L. Hill (Edinburgh)*, but not enough to enable him to put in the elusive last few prefixes to justify an entry in the CW HPX Table—no doubt the next outing will see the magic 200 up, as we get out of the summer doldrums.

While most of our correspondents had finished their examinations at the time of the deadline, an exception was *S. M. Phillips (Dukinfield)* who was writing in the interval between exams. His listening time is further being reduced by electrical QRM—indeed the chap who first puts on the market a non-QRM-producing washing-machine deserves to be awarded a monopoly!

Talking of electrical noises, *H. M. Graham (Harefield)* lives a couple of hundred yards away from a hospital whose grounds back on to his own, and he believes that the hospital is the cause of a lot of the noise which enters his receiver, on the LF bands particularly. This could be quite a point, as the hospitals are full of electric gadgets of one sort and another and most are noise producing. Possibly a suitable approach would be in order.

Wire in the loft, 132ft. of it, and a Joystick, are the aerials in use with a CR-150 by *P. Levitt (Worksop)* who makes an initial entry for the Ladder. Incidentally, this is as good a point as any to clear up a couple of misconceptions among readers of this piece. A long-wire aerial is, by definition, one that is longer than a resonant length—or, in other words longer than a half-wave at the frequency in question; thus a 132 footer would quite definitely be a long-wire on, say, *Twenty*, but equally surely *not* a long-wire on Top Band or Eighty. If in doubt it is far better to refer to the thing as an end-fed wire of such-and-such length, when there will be no possibility of misunderstanding. Another one is the use of the word "antenna"—which in English means the sensory organs found in pairs on the heads of certain insects and *crustacea*. The use of "antenna" in the radio sense may be correct in the American language, which is *not* the same as English; and until we become another State in the Union, English we shall use! Seriously, though, it is well to realise that often the indiscriminate switching from the English to the American word, or the other way, carries with it the loss of a subtle shade of meaning which may in the technical sense be important.

D. J. C. Bushell (Evesham) has been somewhat tied down by examinations and things, but has managed to add some new prefixes to his total from his temporary location at Evesham, although we have deleted his "HP6CC," heard on 14.2 mc at midnight on July 16 as a probable misreading; it would be interesting if one of the many European takers for this one could confirm what the callsign really was.

R. Gape (Leigh-on-Sea) has climbed back on his soap-box again. This time he is comparing VHF operating practices to HF habits, to the detriment of the former. Robin feels the transmitting chaps should mention the frequency of the station with whom they are in QSO on each occasion they go over, as he has been more than a little frustrated in not being able to find the DX. Fair comment in some ways, but it has to be remembered that 144 mc is VHF, where there are not only highly directional beams, but where only relatively few stations are able to VFO with any sort of stability. The key to finding one's way about is the U.K. VHF band-plan, which tells you where to look for stations in various parts of the country, and a *Call Book* (in which the band plan is given). It must be admitted that VHF is not ideal territory for SWL'ing, but it can be very rewarding indeed once the technique has been acquired.

Still on this "operating" tack, *I. Cooper (Alnwick)* comments on the widening of his scope brought about by learning Morse, and the rapid rate of his progress—seems that a month or so ago he could not copy a slow CQ, whereas now he can take callsigns and so on at above twenty words a minute. As he has done this by listening only, he has had a continually widening experience, and this has enhanced his interest in Amateur Radio. Ian now has to wait for the RAE pass-slip, and is whiling away the time by building gear and getting up his Morse speed so that when the time comes he has plenty in hand.

A first letter and Ladder entry comes in from *D. Holbrook (Newport, I.o.W.)* who decided to have a dabble at HPX as he had a little more time to spare after the RAE. He uses a CR-100 in conjunction with a ninety-footer, but has plans in stew for a Quad aerial on

the HF bands.

Remember that missing name last time, which your conductor claimed was worth a pint of mild-and-bitter? *D. Douglas (Dundee)* it was, and within a day or so of the last appearing, back came a postal order from David for the price of a pint—and it went down well! Thanks indeed.

R. C. Waterman (Aberlady, E. Lothian) has been a lot less active of late, due to a holiday job which leaves him little spare time. However, it's all in a good cause, as most of the money earned is being put by to cover the costs of some much-wanted additions to his rig.

Bit Hard!

An impossible task is set for us by *I. Poole (Leeds)*, who wants us to produce a list of "ungood" prefixes! Have a heart, Ian, there are new ones fermenting in the brain of some pirate or another every day, quite apart from the—probably larger—number which are generated in the mind of the receiver operator and mislodge. None of us is perfect at reading a signal through QRM albeit the transmitting station usually manages to lose only the rear-half of the call, and it can be sorted out by the other station anyway. As instances of misloggings, Ian has 9PØ and 9E5 among his queries.

On the other hand a 9E3 or 9F3 is genuine, these being contest prefixes used by ET3FMA; SK has already been mentioned in these pages as a variation on the SM theme. These answer the questions raised by *R. Hyde (Oakham)*, who has in the spare time left him after listening, eating, and sleeping, realigned the IF of his receiver, with results that have surprised him. This is so often the way, particularly with an older receiver, where the slow deterioration is not usually noticed until the beast is compared with another one under the right conditions.

The Lads from Lincoln—*Bill Felton* and *David Rollitt*—both seem to have been working hard on the Morse, and both seem a little downcast, although there is no hint of surrender. David has been interviewed by the BBC for their "Youngsters Talking" series, which goes out to Europe at 1800z each Saturday, and of course, managed to get Amateur Radio mentioned. As a matter of interest the interview arose out of a previous session, when he and his parents were interviewed in "Woman's Hour" about the family business which has been handed down in the family right through from its inception in 1793, from Rollitt to Rollitt.

Changing tack somewhat, *A. Wood (Husthwaite, York)* has an RF-27 unit which looks to be in fair nick; he has ideas about using it for 28 or 70 mc, but would like to hear from anyone with data on a suitable conversion—letters should go direct to him at 4 East View, Husthwaite, York, YO6-3TE. Alan is an addict of the ½-5RV aerial, which he reckons brings in the DX a couple of S-points better than the long-wire, although this of course may be to some extent due to earthing problems in feeding the other aerial.

A return to the fold—*P. Cayless* is back with us again after missing a couple of issues. Peter is sorely troubled by cards from SWL's! It seems there is some publication in the States which lists names and addresses of listeners with a view to them exchanging QSL's! As Peter says, it seems a pretty half-baked sort of idea.

The completion of the A-Level examinations has

allowed *D. Whalley (Corsham)* to set to work with the HA-63 receiver, and the first entry to the HPX table shows the results of a month of listening. For aerial, David has about 150 feet of wire bent into the garden at varying heights.

Since his examinations were got out of the way the LF bands have been the main interest for *J. E. Jenkinson (Oxford)* with various exhibition stations booked in. Our correspondent is of the opinion that most of the I's have no receivers—they always seem to drop straight on top of the DX he is listening to! This is only partly fair, as one has to realise that the mechanics of propagation are such that these situations can easily occur, and if one took all the precautions, by listening for several minutes to a clear channel before launching a call, every station on the

HPX LADDER

(Starting January 1, 1960)

SWL	PREFIXES	SWL	PREFIXES
PHONE ONLY		PHONE ONLY	
S. Foster (Lincoln)	987	C. J. A. Morgan (Wallsend)	319
D. Rollitt (Navenby)	931	B. G. Bashford (Worthing)	317
A. W. Nielsen (Glasgow)	889	D. Richards	
J. Singleton (Hull)	854	(Welwyn Garden City)	315
K. Southgate (Leigh-on-Sea)	813	H. N. Plumridge (Eastleigh)	311
W. Felton (Lincoln)	792	G. W. Brind	
R. G. Preston (Norwich)	679	(Kingston-on-Thames)	308
J. Fitzgerald (Gt. Missenden)	651	G. T. Theasby (Keighley)	307
D. Skidmore (Derby)	639	D. Stuart (Caistor)	301
G. Bowden (Crawley)	628	R. Bence (Cardiff)	298
J. Dutton (Ilkeston)	626	S. M. Phillips (Dukinfield)	293
R. Allisett (Guernsey, C.I.)	616	J. H. Weiner (Coventry)	292
I. Poole (Leeds)	601	P. Duvoisin (Witham)	290
A. Hydes (Enfield)	600	B. W. Lowe (Worsley)	282
N. Henbrey (Northiam)	596	D. J. C. Bushell	
W. Moncrieff (Hampton)	590	(Cirencester)	276
C. P. Davis (Leicester)	587	D. Whalley (Corsham)	275
M. A. Lount (Leicester)	583	R. Schofield (Liverpool)	273
M. G. Toms (Ilford)	580	R. E. Barratt (Manchester)	271
J. P. Scragg (Stockport)	567	A. Walsh (Eiland)	270
Mrs. M. Worby (Dartford)	533	R. Bagwell (Frimley)	270
D. Sapsworth (East Ham)	514	J. A. Ennis (Fareham)	267
W. C. Torode		D. Palmer (Fareham)	258
(London, W.C.1.)	513	A. Wood (Husthwaite)	254
Edwards (London, S.E.20)	504	S. Jassel	
B. Thomas (Castleford)	499	(Newcastle-on-Tyne)	250
G. Dover (Nottingham)	491	R. Hodge (Gloucester)	249
K. Plumridge (Eastleigh)	487	P. Levitt (Workshop)	242
D. Henbrey (Northiam)	484	Rev. D. P. Brewster (Oxford)	240
H. M. Graham (Harefield)	478	R. Lewis (Oswestry)	235
B. Geary (Leicester)	455	C. R. Adams (Manchester)	224
C. Claydon (Kinghorn)	453	D. Holbrook	
I. Cooper (Alnwick)	435	(Newport, I.O.W.)	216
N. Whiting (Leeds)	430	I. Bateman (Bradford)	214
R. Woods (Slough)	424	R. A. Era (Birmingham)	212
M. Broadway (Selby, Yorks)	417	K. M. Duggan	
D. L. Hill (Edinburgh)	408	(Huddersfield)	211
S. Cusworth (Wakefield)	406	D. Reynolds (Dudley)	210
A. Pyne (Budleigh Salterton)	398	T. W. Hyder (Southampton)	210
R. A. Gape (Leigh-on-Sea)	391	P. Wilkinson (Pricetown)	209
D. Henry (North Berwick)	379	C. Shearing	
P. L. Spindler (Ilford)	376	(St. Agnes, Cornwall)	202
J. E. Jenkinson (Oxford)	370		
R. Walters (Etwell)	368		
A. Long (Coventry)	360		
M. L. Jones			
(Leamington Spa)	356		
B. Gilbert (Aylesbury)	353	C. Claydon (Kinghorn)	530
S. Haseldine		P. Cayless (Exeter)	501
(West Bridgford)	351	J. M. Dunnitt (Singapore)	447
L. Rowland (Birkenhead)	351	C. Harrington (Maidenhead)	410
L. Gildersleeve		R. Hyde (Oakham)	304
(Newton Abbott)	348	K. M. Duggan	
D. Robinson (Birmingham)	338	(Huddersfield)	280
J. M. Dunnitt (Singapore)	335	J. Edwards (Penge)	266
T. J. Bucknell (St. Albans)	330	K. Southgate (Leigh-on-Sea)	232
R. C. Waterman		C. P. Davis (Leicester)	224
(E. Lothian)	329	R. Lewis (Oswestry)	204

(NOTE: Listings include only recent claims. Failure to report for two consecutive issues of "SWL" will entail removal from the Table. Next list, November issue, for which the deadline will be September 20.)

band would be listening and none transmitting—which would be somewhat of a bore! Also, of course, there is the problem of sudden changes in propagation, particularly on Ten, where one can put out a CQ on an apparently dead band, and go over to find a rare DX station sitting on the same frequency and the remainder of the band full of QSO's. But there is no doubt that often this sort of thing is the result of plain Clottery.

Also a bit hot under the collar is *D. Waldron (Nottingham)* who went to a local club and felt a little out of things, as the members mainly talked among themselves; but we must be fair and say that anyone who joins a club of any sort has a few awkward moments at the first few meetings, while he is getting to know the members and they him—on both sides there is the natural instinct of reserve, which only familiarity by regular attendance breaks down, and any great attempt at forcing the process on one side only leads to more reserve on the other. Most adults realise this instinctively, but the younger generation often “jump in where angels fear to tread.”

* * *

A novel use for an old one-valve set pops up in the letter accompanying the list from *R. Bagwell (Frimley)*—he has a Trio 9R59, and a seventy-foot wire; in the middle is the old one-lunger, now revamped as an ATU.

David and Norman Henbrey (Northiam) seem to have been enjoying the summer activities, as David's list only shows an increase of 14, while Norman is static this time—but J.C. is ready to take a bet this does *not* mean a falling interest. Similarly, a small increase in his Ladder total against the name of *K. Plumridge (Eastleigh)* is caused by domestic commitments of one sort and another, so that all his listening has been the odd few minutes once in a while in the early morning, around 0500.

IZ6KDB has been puzzling *R. Bence (Cardiff)*; quite OK, from Ponziane Is., by 1IKCB and 1 others.

Good news from *Frank Smales (Pontefract)* who was able to get back to work on June 10, after no less than 29 weeks of illness; naturally it was tough going at first, but Frank hoped to be able to stay the course, and indeed had done so to the time of writing. On the DX/TV front, he has had quite a month of it. Swiss TV was notable for its absence but Yugoslavia, Poland and Spain were at times so steady as to provide a whole evening of viewing. Perhaps the high-spot of the month was Maasser-el-Chouf, Lebanon, appearing on channel E4 on June 30. Quite an eventful time!

Skywire problems have bedevilled *C. Morgan (Wallsend)* who sends in a first list of 319 prefixes; it appears the thing fell down and was broken by a cement-mixer being driven over it in the course of road-repairing operations; just to set things to rights the postman then tripped over it and broke it again. As a result the nice new CR-150/2 which now graces the shack has had to be tied to a 25-foot length of wire going vertically upwards, which seems to be giving a good account of itself.

The station of *C. R. Adams* is temporarily closed down, the reason being a move which is due to come off shortly to a new home, just in *Cheshire*, north of Wilmslow. However, having the gear down has given a lot of spare time which has been put to good use in that Colin has been preparing for the December RAE, which he intends to sit.

HPX RULES

- (1) The object is to hear and log as many *prefixes* as possible; a prefix can only count once for any list, whatever band it is heard on.
- (2) The /M and /MM suffixes create a new series; thus G3SWM, G3SWM/M, and G3SWM/MM all count as prefixes, and, where it is known to be legal, /AM also.
- (3) Where a suffix determines *location*, the suffix shall be the deciding factor, thus W1ZZZ/W4 counts as W4. Where the suffix has no number attached, e.g. VE1AED/P/SU, VE2BUJ/P/SU, they are arbitrarily counted as SU1 and SU2 respectively, and the same holds good for similar callsigns.
- (4) When the prefix is changed, both the old and the new may be counted; thus VQ4 and 5Z4 both count.
- (5) The object is to hear *prefixes*, not countries, thus there is no discrimination between, say, MP4B- and MP4K- which count as one prefix.
- (6) Only calls issued for Amateur Radio operation may be included. Undercover and pirate callsigns will not be credited, nor may any MARS stations be claimed.
- (7) G2, G3, G4, etc., all score separately, as do GW2, GW3, GW4, etc., and in the same way K2, W2, WA2, WB2, WC2, WN2, all count even though they may be in the same street.
- (8) Send your HPX list, in alphabetical and numerical order, showing the total claimed score; with subsequent lists, it is sufficient to quote the last claimed score, with the new list of prefixes, and the new claimed total, with your name and address on each sheet, to “SWL,” SHORT WAVE MAGAZINE, BUCKINGHAM, to arrive before the SWL deadline for that particular month.
- (9) Failure to report for two consecutive listings, i.e. four months, will result in deletion from the Table, although there is no objection to a “Nil” report to hold your place.
- (10) **Starting Score 200.** Phone Table is mixed AM/SSB, with a separate CW Table. No mixed Phone/CW Table, nor will AM-only or SSB-only entries be accepted.
- (11) Lists will be based on those shown in the current *Short Wave Magazine* list of Countries and Prefixes, as given on pp.561-566 of the November 1966 issue, and with the current edition of the *DX Zone Map*.

NOTE: The *DX Zone Map* costs 14s. 9d. and includes the latest Prefix List. The *Prefix List* alone, by countries, prefixes and zones, alphabetically both ways, costs 6d. with large s.a.e. Publications Dept., Short Wave Magazine, Ltd., 55 Victoria Street, London, S.W.1.

A nice letter from *Steve Culnane (Harrow)*, who is a member of the Radio Society of Harrow. Steve wants to put in his entry for HPX on an annual basis; but with regret we have to say that the rules must be adhered to—but there is no objection to an entry followed by several “Nil” reports, just to keep the seat hot, before the next entry. The whole thing here is the system, which shows on the card for an individual the HPX total after checking, plus the month in which it was entered; thus after the paperwork is done, all that remains is to weed out those cards which show a “dead” entry, before making up the Table. A nil report just alters the month column. Incidentally, Steve would like to go on VHF—anyone any ideas on a cheap converter? If there are, perhaps they would contact him at 38 Torver Road, Harrow, Middx.

D. Palmer has a fault on his CR-100, which doesn't play; however, putting the aerial on the grid of the first RF stage produces appropriate noises, so the fault should not take much tracking down from there—although it has to be admitted the wiring run is a brute to chase through. However it is not impossible, and doubtless has been sorted out by now.

JX6, 4M2, and 5A3 are all queried by *Tony Walsh (Elland, Yorks.)*, and all are OK. Your J.C. was amused by Tony's comment on the mis-spelling of his name last time “. . . if you print my name wrong it makes me look a bit thick!” Sorry about that one!

A change of receiver for *W. C. Torode (London, W.C.1)* who has “chopped in” his Eddystone 888A in favour of a new KW-201, which he reckons to be better on the SSB stuff. Fair do's, but it has to be said the old 888 was—and is—no sludge at SSB, and is a fine tool on CW in the J.C. shack, although he would admit to a liking for a KW-201 himself!

* * *

For the keen-eared chaps who like 21 mc, 9V1OG has a message: He would be glad to have SWL reports—honest ones, please—on his signals as there seems to be a little difficulty in getting out, in spite of a two-element beam at 150 feet. The times are 1500 to 1800 GMT, Fifteen SSB. All that is asked for is date and time, RS report, and an indication of condx at the time. In such circumstances an honest report is of paramount importance, even if it is RS-22, and will get a card accordingly. The address is: M. V. Kathrens, 9V1OG, 34D Far East Mansions, Kim Yam Road, Singapore, 9.

S. Cole (Rogerstone, Mon.) was saddened to hear of the passing on of GW2BBO, who helped him a lot. GW8AOY has also been leading Stephen along the path which should eventually result in a callsign, with answers to queries and the loan of books.

The activity on SSB/DX on Forty surprised *T. Bucknell (St. Albans)* who had previously avoided the band. While the activities of the 40-metre DX gang may not be to everyone's taste, there is no doubt that the condition of the band, with more intruders than amateurs, is such that this kind of net operation is about the only way to share out the DX so that all can make a go of it.

Like *C. Morgan, R. Lewis (Oswestry)* has been suffering the interaction between aerials and the force of gravity. The long-wire parted company in a wind, and one of the two egg-insulators has still not been found. However, all the cases of aerials that fall down are due to

neglect of fundamental principles of mechanical engineering, and the key appears in our friend's letter. He used the wire from a TV scan coil assembly to make his aerial. Now, this is thinnish wire, and with any such stuff one should *never* have heavy insulators. For instance, if the wire has a breaking strain of a couple of pounds, it cannot be expected to prop up a pound of insulator and still stay aloft in a gale. Wire of 28g. insulated with curtain rings from Woolworths and strung up with nylon lacing twine is quite capable of staying up a couple of years or more in the form of a half-wave for Top Band.

William Mantovani comes from *Hooton Pagnell* which is not far from Doncaster; he queries in his first letter to this piece the status of 6O1AT, heard on Forty, and described by G3MTL as “phoney as a clockwork orange.” Well, now! Actually 6O1AT could as easily be OK, as the prefix is that for Somalia, and has appeared in many logs to cross this desk—so unless G3MTL knew the real one and spotted something wrong, there seems no problem. Incidentally, reader Mantovani says there are only a couple of SWL's known to him in the Doncaster area, although he is not hard up for licensed types. If there are any more about, perhaps they would care to get in touch, the address being 5 Main Street, Hooton Pagnell.

Not so very far away lives *S. Phelan (Goole)* who has his radio being in a reinforced-concrete shed at the bottom of the garden, into which he has put SR-550 and HE-80 receivers, plus converters for 144 mc and Seventy-cems. An Inverted-Vee is fed at one end for HF, while the VHF signals are taken in by rotatable beams. Rotation is by the “armstrong” or “hydraulic” method. Stuart is interested in corresponding with other VHF SWL's; letters direct, please, to him at 9 Limetree Gardens, Goole.

R. Era (Birmingham) missed the May examination application date by a couple of days, and so he is now very impatiently waiting for December to come along. He wants to know what MARS stations are and why they are excluded. Easy; the HPX ladder refers to *amateur* prefixes, and MARS (“Military Affiliate Radio System”) stations are not strictly amateur, so out they go!

C. Shearing (St. Agnes, Cornwall) is the owner of a 14 mc beam, and a dipole and ground-plane for Forty, which both have been used to advantage for his first HPX list. Receiver is an R.107, used in conjunction with a PR-30 preselector.

Another first list (what a lot of newcomers this time!) comes in from *D. Reynolds of Dudley*, who claims 215, but goes down to 210 due to his inclusion of various /P calls and a ZM6. David queries a “D1DBP” who was heard working CT2AA—it sounds rather as if it were a

KEEP WITH US!

Next appearance of this feature is in our November issue, due out on October 25. Closing date for all SWL correspondence is Friday, September 20, addressed “SWL,” Short Wave Magazine, Buckingham. Remember also that we are always interested in good photographs of SWL stations (and operators), any that can be used in these columns being paid for on publication—but they must be clear, sharp prints.

misreading of a call sign.

Yet another first-timer is *G. Dover (Nottingham)* who sends in the accumulated results of several years of listening, to make a total of 491. Geoff has already passed the RAE, but has never found the time for Morse, due to the distraction of getting his degree and Dip.Ed. However, at 22, he is now on the look-out for a job, and in the meantime is no doubt spending rather more time on the receiver. Incidentally, Geoff. is one of the few SWL's who uses a home-built receiver—a double superhet with all mod. cons.—which is a little startling when one realises the amount of home receiver-brewing that goes on

among the licensed chaps.

Deadline

That's about it, apart from remarking that we have not mentioned several people who only made entries in the Tables—but a look at the list should convince them all is well. For the rest your letters are as welcome as ever, especially if they arrive *before* the deadline, which is first post, **September 20**, addressed "SWL," SHORT WAVE MAGAZINE, BUCKINGHAM. Meantime, remember we are going through a couple of months of good conditions so keep your ears pinned back for *real* DX! 73

SPECIALLY ON THE AIR

Stations scheduled to make an appearance on some public occasion locally during the coming month are as follows:

GB3SRC, till Sept. 2: Silverthorn Radio Club's annual camp at Carroll's Farm, Sewardstonebury, near Chingford, E.4, working all bands 1.8 to 28 mc, also two metres, AM/CW/SSB, QSL via G3VMO, *QTHR*. (No cars on site; please park in yard.)

G3WIH/P, Sept. 2: At Gadebridge Park, Hemel Hempstead, for the Town Carnival, operating SSB on 10-80m., AM on Top Band and RTTY demonstration on 20m. Two-metre working also possible. Other call signs to be used: G3UZP/P, G3VMK/P and G8ATQ/P. Reports and QSL's to: A. J. Green, G3UZP/G3WIH, *QTHR*.

GB3EIF, till Sept. 9: Operated by the Lothians Radio Society in conjunction with the Edinburgh International Festival, from the Mountbatten Building of the Heriot-Watt University, running SSB on the 10-80m. bands. Convenir: V. W. Stewart, GM3OWU, 9 Juniper Avenue, Juniper Green, Midlothian.

GB3WRA, Sept. 7: Operating from the annual Wycombe Show, High Wycombe, Bucks., running AM/CW/SSB on the 4m. to 160m. bands. Visiting amateurs will be specially welcome. Further information from: A. C. Butcher, G3FSN, 70 Hughenden Avenue, High Wycombe, Bucks.

GB3UCL, Sept. 28-October 4: Exhibition station to be operated during Introduction Week at University College, London. Main activity Mon.-Tues. on 20m. and 80m. bands, using KW-2000A. Stations calling asked to remember local noise level will be high. Special QSL and all contacts acknowledged. G3UCL, *QTHR*.

MAGAZINE CLUB CONTEST

This year's MCC—the annual Top Band inter-Club tussle, and the 23rd in the series—will be taking place over the weekend November 9/10. Rules in full will appear in the October issue of SHORT WAVE MAGAZINE, due out on September 27. It would help us a lot if Clubs thinking of entering, *but not having taken part in recent years*, would let us know as soon as possible, so that they can be included in the identification-code lists.

ELEVENTH SCOUT JAMBOREE, OCTOBER 19-20

During the next few weeks, up and down the country, plans will be under discussion for participation in this annual event—whereby Scouts throughout the world are brought into contact by radio on the amateur bands. It usually means either (a) Scout groups locally making contact with a radio amateur in the district, able to work DX on the HF bands, and prepared to demonstrate his station in action on the air, or (b) A DX operator who would like to help getting in touch in the first instance with the District Commissioner or the local Boy Scouts Association—see telephone directory. Thereafter, it is a matter of mutual arrangement. Operation consists essentially of working the bands to find other Scout groups, identified by the call "CQ Jamboree"—used by all stations taking part in the event, which is *not* a contest, but simply a QSO Party. Detailed information can be obtained from the U.K. Organiser, L. R. Mitchell, G3BHK, *QTHR*.

WOLFE AWARD FOR GM3GTP

It was announced recently by the Ministry of Technology that Alexander Russell, GM3GTP, 27 Deveron Road, East Kilbride, Lanarkshire—who is a principal scientific officer at the Ministry's National Engineering Laboratory, near Glasgow—had been made the recipient of a Wolfe Award. This was for his work in developing a simple but extremely accurate electronic method of making very small measurements, or controlling linear or radial movements. An accuracy of better than 1/1,000th of a millimetre is obtainable without complex equipment. Using multi-track optical gratings, the displacement of the grating is identified electronically and displayed on digital indicators. Manufacturing licences for the new Russell technique have been granted to four important companies.

The value of a Wolfe Award is £500, and we congratulate GM3GTP on his achievement. Though not at present active on the air, his amateur projects include experimental work with tape recording and the circuitry of electronic organs.

JUST TO DRAW YOUR ATTENTION

To the Editorial announcement in this issue. Any potential contributor able to meet the requirements and offer competent and well-presented material will have an opportunity for one of the selective prizes.

COMMUNICATION and DX NEWS

E. P. Essery, G3KFE

CONDITIONS generally seem to be somewhat on the upgrade, as seen from here, in spite of the irritations induced by the Wx and the odd interruption due to work—indeed, your scribe would say that he himself has seldom, if ever, had such a good month on the air.

Ten-metre Doings

The gleam of joy here comes in from G3TLX (Edgware) who has had QSO's with MP4BEU, KZ5HC, ZS, 5N2's, ZE1AK, SV0WP, YV4MC, 5Z4's, ZC4, 9J2's, CR6, CR7, 5U2AB, 7P8AR and VK's, using just a Heathkit DX-40U and vertical dipole at ground level—quite a nice collection.

G3NOF (Yeovil) has listened around on quite a few occasions, but heard very little except weak ZD8, ZE, ZS signals, with no actual contacts to record. A similar situation prevailed at G2DC (Ringwood) although Jack feels the trouble is more one of lack of activity than of actual bad conditions; he booked in the odd stray African station but little else.

A noticeable absentee from Top Band of late has been G3VMK, who wrote in from Padstow during his holiday, to say the reason was that he had acquired a Heathkit SB-101 and a linear—but so far nothing doing on Ten that was worth noting.

Finally, a letter that should stir up at least a certain amount of activity—VP8KF, who used to be G3VPW, is now on from Port Stanley in the Falklands, and looking for QSO's on the HF bands, including 28 mc, which will be monitored for openings to the U.K. VP8KF would very much like contacts with his old buddies, and with stations from the Nottingham area. QSL's should go to G3TWV, George Francis in Newark, to whom duplicates of the logs are sent about once a month.

About Top Band

To look at the other end of the spectrum, we can start by mentioning that VP8KF was surprised to notice

that when he got his VP8 ticket it provided for 100 watts DC input on *all bands including* 160 metres, and from his letter your scribe infers that John intends to be on all the bands, which pretty clearly means Top Band is included—and one could well imagine he would have some takers. John works G3VVU in Nottingham fairly often on sked on HF, and so a listen out for the latter on the HF bands 15-20m. may well be a way of making 160m. arrangements.

That expedition to the Channel Islands by G3SVK and company certainly stirred things up, and most of the regular Top Band reporters mention it. G3APA (Coventry) had not been on the air since the early part of 1967, but when he heard of the possibility of Sark operation Ted put up the aerial again; although he has himself operated from Sark on two occasions (in 1961 and 1965) he lacked a contact with the Island from home. Ted duly got one, by way of a QSO with GC3LDH/P—and re-

mind your scribe of many pleasant contacts on Top Band way back in 1959 into the bargain.

G3KFE was around when GC3SVK opened up from Sark, but was drowned in what he would suspect was about the biggest pile-up ever heard on Top Band. It took until the third day before the trick was turned, and then it was a case of back first call! The strategy for working them in Alderney seemed therefore to be defined—wait till the worst of the crush is over on the third day. Never were hopes more rapidly shattered! For various reasons there was no second chance—so we have to wait for another time.

Another unexpected contact was with G3VLX (Sidcup) who came back to a call from the /M gear when in Redhill, Surrey. Deryck seems to have taken just about all there has been going in the way of expedition contacts. GI3SVK/A gave him Londonderry; GM3VAR/P Berwick; GC3LDH/P Sark; GC3SVK/P

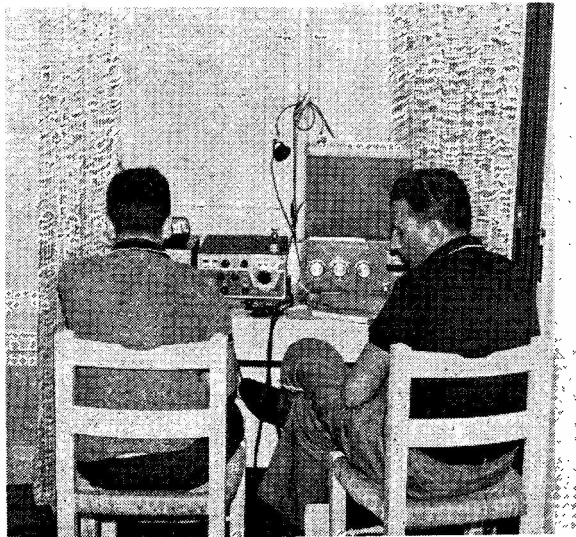

The IZ6KDB set-up on Ponza, in the Pontine Is. off the Tyrrhenian coast of Italy, during May last, with back views of I1KDB and I1AJ. They made 1800 contacts with 103 countries in 31 zones, using a two-element trap beam erected specially for the occasion.

Alderney; and GC3LDH/P Guernsey. These plus GB2NI in Fermanagh added up to a round half-dozen new ones—incidentally, the latter at one stage was going great guns alongside the GC3SVK signal, both booming in at 59, which must have put an awful lot of people into a tizzy wondering which one to go after first.

Recent remarks about the shortage of Cumberland on Top Band has led to a note from G3WCM (Workington) who is ready, willing and able to dish out QSO's to anyone lacking it on CW—which should please G3WQQ (Brighton), who remarks in the course of his letter how much he wants a contact with Cumberland.

Seven more counties have fallen to the hook of G3WUD (Bramhall) who, as he forecast last month, has improved his aerial and earth system; an end-fed half-wave in the form of an inverted-Vee, with an earth consisting of three old chassis, six hundred feet of thick copper wire, and yards of chicken netting buried

in a minor stream leading into a nearby pond. Robert comes back at us on the question of daylight DX contacts, and says that he, G3XGC, GW3VPL, and G3LYW are running daylight tests—1100 GMT around 1991 kc, and they would welcome other stations into their net.

That misbehaving modulator at G3XGD (Sheffield) has been mended, the offending component having been the modulation transformer; so some of his activity has been transferred to the A3 mode. Glyn feels, however, he has about reached the limit with the present aerial system, and so is hatching all sorts of cunning plots to improve it.

G3WJS has moved from Dorset to Halstead in Essex, where the only source of QRN is the weather, and TVI is virtually non-existent. The new place is reckoned to be rather better on Top Band than the old, although the lack of a stick has held up the erection of the promised half-wave. In terms of contacts, there have been GC3TTN/P and GC3TUX

ALL-BAND ZONES AND PREFIXES TABLE

Starting date: January 1, 1968

Station	Zones	Prefixes
G3LZQ	40	240
G3IAR	39	307
G3SED	24	110
G3AAQ/M	23	213
G3PQF	22	163
G3IDG	20	74
G3VPS	18	182
G3WPO	18	149
G3WJS	16	186

/A, both on Alderney; GC3LDH/P on Guernsey, Jersey and Sark; GM3VAR/P for Berwick; GM3VGU/P Peebles; also GB2NI Fermanagh, and several others of equal interest, with a couple of OE's and a pair of PA's as gotaways.

G2NJ advances to 97 counties on phone by way of GC3SVK/A, and also worked GW3KOR/P in Caernarvonshire, GB2NI for Tyrone, and, on the key, GM3VGU/P in Peebles.

Quite a problem for G2HKU—staying off the air long enough to complete his new Linear—was pretty obviously solved by leaving the linear and operating the rig. On his 160m. SSB Ted worked PA0PN, also GW3VYF/P Montgomery; GD3XJR, GC3XJN/A Alderney; GM3VAR/P Berwick; GC3SVK/P Sark; GB2NI Fermanagh; GC3SVK/P Alderney; GB2NI Armagh; GC3KNZ/P Guernsey; GC3TTN/P Jersey; and GM3VGU/P in Peebles. CW was not neglected, with Jersey, Sark, Alderney, Berwick all accounted for, also GM3GIZ/P for Orkney, GW3VYF in Montgomery; and OK8AAA, who turned out to be G3LQB in disguise, operating the first station to be licensed under the new mobile rules over there.

Tony, G3WPO, denies having worked PA0PN—see last month's piece—and is convinced by this of something he has suspected before, which is that he has a pirate. On the long-haul DX front, Tony heard a K1X?? one morning at 0319, coming in at 369.

Talking of pirates, a note from GW3VOW, who quite definitely has one of these ginks using his call.

SIX-BAND DX TABLE (All-Time Post War)

Station	Countries	28 mc	21 mc	14 mc	7 mc	3.5 mc	1.8 mc
W6AM	345	131	140	345	116	54	7
G2DC	335	169	307	327	163	108	20
G3DO	334	188	231	327	90	83	9
G3NOF	310	155	202	294	34	39	1
G3LZQ	246	119	153	194	71	38	8
G3IAR	215	100	155	191	82	65	11
G3IGW	204	123	152	167	122	86	42
G8DI	187	80	132	164	77	46	8
G3NYQ	147	35	70	107	40	30	21
G3VDL	132	46	96	96	45	22	—
G3MDW	115	46	66	82	20	15	7
G3PQF	141	82	42	77	83	49	9
G3IDG	121	72	87	54	27	19	11
G3VPS	84	—	28	59	50	28	14
G3SED	85	2	18	55	38	32	37
G3WJS	52	—	—	41	28	35	11

Note: Placings this month are based on the "14 mc" Column.

There are cards coming for contacts before he was licensed, for bands he does not work, claiming Plymouth or Manchester as the home QTH, and name of Jim—the real one is different—and at least two of the cards are acknowledging the receipt of cards! Until February this year the real one was in Hereford, before taking up the GW prefix on moving to Bridgend, Glam.

The spate of Channel Islands GDX on Top Band is noted by GM3UVL, who profited to the extent that his last one outstanding—Sark—was worked, among several other interesting contacts. However, it is one thing to work them, but quite a different matter to get the cards in; Leicester seems to be full of stations that craved the GM3UVL card—and duly got it—but never stumped up with the other half of the courtesy.

The GW3VYF/P operation in Montgomeryshire is reported on by its operator, who set up shop on top of a hill 750 a.s.l. with quite excellent aerial facilities. The result was a couple of hundred contacts, the accent being on two-way SSB, although that is not to say that there were no AM or CW QSO's. The cards are being dealt with, through bureaux or direct as requested at the time of contact; the incoming ones can either go *via* the bureau or to G3VYF at his new address, 11 Sturrocks, Vange, Basildon, Essex. Incidentally, GW3VYF received a most interesting report on his 160m. signals from an SWL in Sweden, giving him 59, by comparison with G3TZZ 59, GW3UMB 59, G3TSL 59, G3UGF 59, GD3VWN 56-7, GM3XPQ 57, G3WBH 56, G2HKU 56-7, G3FAU 58, G3XPE 55 and G3TUP 58—all these being heard around 2300 on the evening of July 20, using an HE-30 with a 90ft. indoor aerial.

July 28 seems to have been a good evening for some real Top Band DX, as G3XDK (Maidstone) saw things; between 0200 and 0400, Jeremy worked VE1ZZ, K1PBW, and of course W1BB/1, who peaked 599.

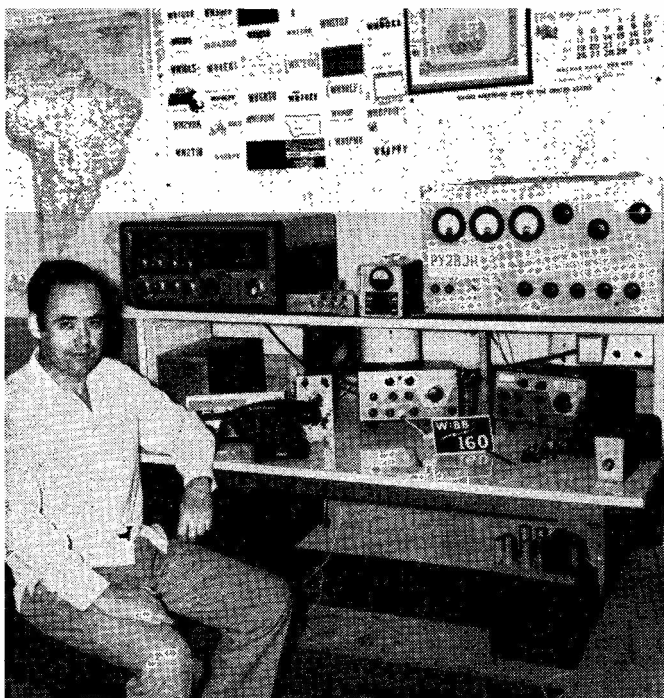

Station of PY2BJH, operated by Hercilio Ferreira, Box 8403, Sao Paulo, SP, Brazil. He is one of South America's leading 160-metre operators, and the holder of several Top Band DX awards. His main operating frequency is 1827 kc.

The aerial at G3XDK is only a quarter-wave at 25 feet high, but tuned against a pretty good earth system with five quarter-wave radials, many short ones, plus some earth stakes, proving once again that the secret is *in* the ground rather than above it, although high hopes are held for a proposed new aerial of 180 feet with something like 50ft. in the vertical section.

Going back to that suggestion of a CW calling frequency, G3IDG rather blights it by pointing out the presence of Ostend Radio on 1820 kc, and wonders anyway why it should be felt to be needed? The point would surely be that at times of very low activity it would serve the useful purpose of inducing people to monitor the frequency on which they are most

likely to find a station, and that would be fine as long as they then QSY for the actual QSO. There is always the problem that if they go LF, as far as 1816 kc, say, they may well find themselves tangled with the 2nd harmonic of the 908 kc BBC signal which appears in so many people's receivers.

G13WSS (Holywood, Co. Down) sent in his note before his holiday, and was cursing his luck in having picked the week when the Channel Islands and GB2NI expeditions were to have come on! However, consolation came by way of Londonderry, Montgomeryshire, Kincardine (GM3WHC/P), Perthshire (GM3NXA), and G3XGC for Cambridgeshire. Cyril would now dearly love to remove Oxford from his list.

Twenty Metres

That note last time about chasing American counties touched off an interesting comment from G3DO (Sutton Coldfield). He mentions the USA/CA award which is sponsored by *CQ Magazine* for chasers of

Reporting the HF Bands

American counties, and says he hooked the first 500 and got them confirmed in time to get the first such certificate issued to Europe. Doug spends a lot of time at this difficult DX game, and has now got to within striking distance of 2000 counties. One or two of the points of interest are that you need the "U.S.A. Counties Award Record Book" from *CQ*, and the (U.S.) POD 26 Post Office Directory which shows which county each town is located in; and in Louisiana you don't call them counties, but "parishes"—but they still score the same in this contest. As for picking them out, G3DO says most are to be found on the HF Bands, but 40 and 80 SSB have been quite prolific at times. The County Hunters Net operates on 14336 kc from 1900 GMT and provides lots of counties by way of /M stations.

Reverting to our particular mutations, G3DO mentions only two QSO's on Twenty this time, both SSB—JX4EJ (Jan Mayen) and

VQ8CG, who has his cards by way of G3APA.

The new KW-2000A continues to delight G3VPS (Wartling) who has spent much time with it, exploring all the bands. On 20m., YN2 and UD6, both SSB, were new ones for him, as was JA on CW. In addition to these, W, VE, PY, LU, SV, ZC4, TF3AU /P and 9M2 were booked in on SSB, and rarer parts of Russia on CW.

G8DI (Liverpool) sounded quite alarmed when he wrote his card. He seemed to have lost the knack—but relief came when he hooked KS4CG on Twenty at 0600 on August 2 to go up one in the Table.

KZ5, VP7, PJ3, FG7, VP8JH, VS9MB, OA4QN, CR6, PY, VE7, assorted VK's, VS5RCS, CX2CO, 5Z4's, 4A1EK, OD5, SV0 and many others all fell to the lure of the G3TLX callsign on Twenty, on which band he runs 70 watts to a DX-40U and vertical dipole.

Quite the most noticeable thing about the month's conditions as far as G3NOF (Yeovil) was concerned was absence of the early-morning stuff from the Pacific, and next the amount of static which made itself a nuisance in the evenings. However, SSB contacts were made with VK's on some mornings and W6/7 on others, with good openings to S.E. Asia in the evenings around 1800. Thus, the log shows AP2MR, KA7CW, KH6GDQ, KH6GJN, MP4BEU, MP4BGU, MP4TCE, PX1KT, PX1VV, PX1YY, TG4VH, TG9EP, VE7's, VK's, VP2AZ, VP7NC, VP7NF, VQ8CG, VR6TC, W6, W7, W4UAF/KH6, 9J2MG and 9Y4VT.

Now to G2DC, who found things at the CW end rather similar to those described by G3NOF on SSB. The band was usually very overcrowded, with short-skip, first-hop stuff, DX, commercials, funny noises and what-have-you. From 0600 to 0800 the VK/ZL/W6 stations were easily findable and workable, but the Pacific around 0900 to 1000 seemed to be missing—not there was VK9RJ (Nauru) with whom Jack would like a QSO; many VK's have told him he is on regularly, but he seems to mainly use Sideband phone, so of course G2DC has to lie in wait. An interesting contact was with VK2BPZ, using QRP to a Joystick only 8ft. above ground.

The counties worked by G3WQQ

on Top Band gave a lead-in for him to mention VK3AYI, with whom he has a regular sked on Twenty AM phone, also G5JZ. VK3AYI used to be well-known along the South Coast for his /M and /P doings on Top Band under his old G3SYI call. VK3AYI hopes to have SSB replacing the AM by the end of the year, if all goes well.

Now to G2HKU, on his little island, who mentions CW contacts with VK3XB and VK3KS (who are respectively husband and wife), and SSB QSO's with ZL2KP, ZL3SE, VP2AZ (with WB6HGH operating), F0HI/M/FC (who is G3KFT on holiday) and VP5CB on South Caicos Is., who is K3NAU in his other hat.

G3WPO, from Burgess Hill found YV, PY, PJ2, MP4TCE, 9M2DQ, ZL3JO, HS1EL and YN1CW in his wanderings around Twenty, albeit he does not mention the mode used.

QSL Addresses

Most of this information comes in from G3NOF to whom thanks are due. *VR6TC*, Box 1, Adamsville, Pitcairn; *DUIFH* to W6DQE; *PX1VV* to DL3VV; *TG4VH* to WA5PQK; *9X5SM* direct, or via the bureaux; *TL8GL* to PO Box 704, Bangui; *F0HT/M/FC* to G3KFT; *VU2OLK* to Box 53, Bangalore; *XW8AX* to W6KTE; *3V8AA* to F5OJ; *PX1KT* to F3KT; *GB3NEW* to GW3VKL; *ZD8GA* to WA6AHF; and *FR7ZS* to Box 130, St. Pierre, Reunion Is.

Here and There

G3IDG changes our line of thought from DX to licensing conditions, and in particular the EI licensing conditions. They are limited to the compulsory first year on CW as we used to be in this country, with an initial 25-watt top limit on 7 and 14 mc only. They can then graduate to a full ticket with 150 watts phone or CW. Perhaps were this adopted again in the U.K. we would have some better phone as well as CW operators, and less of a problem of staffing NFD stations each June. (It is worth noting that the G.P.O. lifted the original first-year CW-only requirement without reference to anybody!)

Talking of snappy operators VS6DR, who was on the CR9AK expedition, told G3GIQ (Ealing) that some of the stations they worked

TOP BAND LADDER

(G3V-- and G3W-- stations only)

Station	Counties	Countries
G3VMW	96	20
G3VGR	94	20
G3VYF	88	19
G3VTY	86	13
G3WQQ	85	16
G3WDW	83	9
GW3VPL	82	17
G3WUD	82	14
G3VLX	81	10
G3VLT	80	16
G3WPO	75	17
G3VMQ	73	16
G13WSS	71	9
G3VMK	68	17
G3VES	63	16
G3VOK	61	15
G3VSL	60	11
GW3WWN	54	7
G3WDG	52	8
G3VPS	48	13
G3VWC	34	7
G3WJS	27	7

complained bitterly when they refused to stop and chat, to exchange names and all the rest of it. Considering that they averaged better than a QSO a minute over the whole of the operating period, a lot of people would have been disappointed had CR9AK stopped to chat. Some folk want both to have their cake and eat it—or else are so dim they just don't realise what is going on when a rare station comes on from some desired location.

Another /MM station to report becoming operational is G3VDO /MM, who wrote from the m.v. *London Banker* to give his spot frequencies as: 7-01, 7-08, 14-02, 14-16, 14-24, 14-28, 21-03, 21-24, 21-36, 21-42, 28-04, 28-32, 28-48 and 28-56 mc all crystal-controlled as required by his /MM licence, using Sommerkamp gear. The ship is on a regular run from the Far East to U.S.A., arriving New York around the time this piece comes out, and staying on the East Coast for four weeks before setting off for the return trip to the Far East. G3VDO /MM will be looking for U.K. contacts.

Harking back to a paragraph in this piece in July of *last* year, SWL Peter Brent was then in Malta, compiling reports on stations heard there. As promised then, he has landed himself with the chore of writing no less than 800 reports on U.K. stations and their contacts, some of them heard on a triple-diversity receiver, and the majority when an RA-17L receiver became available.

Anyone who has worked MP4TCF may be interested to know that Peter is in Abu Dhabi, supervising a £6m. road project in the desert, where the shade temperature is 115 degrees. He uses a KW-2000A at the moment but has "a big fat after burner" on order, which should bring his signals up a bit. On the aerial side, there is a four-element folded inverted-Vee arrangement beamed on the U.K. These civil engineers certainly stick together—we have all these details from G3WET, who as remarked before is an engineer on water supply projects—and in his spare time he will be QSL manager for MP4TCF.

Events on Fifteen Metres

In a letter to Geoff Watts, W4YKH tells about his recent trip to Grand

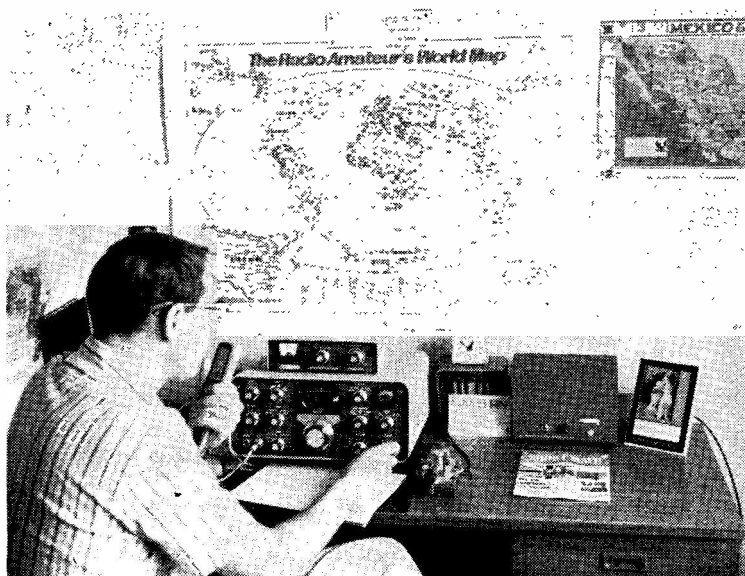

Derek Gough, SM5RN, comes from Bolton, Lancs. but is now a naturalised citizen of Sweden—his QTH over there is Fabodvagen 30, 142-00 Trångsund. SM5RN is employed by the Swedish Broadcasting Corporation, on the TV side, and they have a radio amateur Club group of 30 members, with their own call sign SK0AC. Before making his home in Sweden, Derek Gough was a sea-going operator with the Marconi Co.

Cayman and operation from there as ZF1CP. Conditions were far from good on 21 mc in spite of a TA-32 which they found (yes, *found!*) stored at the West Indian Club, Georgetown, Grand Cayman, where his sister-in-law and her husband are managers. Because of this it seems that ZF1CP will be operational again.

Nice to hear from G3XAP (Stowmarket) who has, unless memory fails, changed his location since the days when he reported so regularly to our SWL piece. Phil has acquired a K.W. Vanguard transmitter which is used on CW in conjunction with the fine Eddystone 888A receiver. Most of his operating has been on 21 mc CW and the dipole has made contact with all W call areas except W7, also VK2VN, VK3XB, CM1AR, VE2IJ, VE2BKA, LU3DSI, JA8DAX, PY, YV, ZE and a crop of assorted UA's, to give a total since the exercise commenced of 49 countries worked. Sadly, TVI on Ch. 1 is upsetting the apple-cart, but it is hoped to have that problem cured, as the trouble has already been isolated.

A couple of interesting contacts on 21 mc SSB for G3DO were with

VP8KF and F0JH, whose home call is G3VAL. For G3NOF, there are TVI problems on 5 metres, and so his operating has to be restricted to non-goggle hours; however, holidays and the restriction of Saturday and Sunday-morning telly has enabled Don to work FR7ZS, JA's, MP4MBB, MP4MBC, VK9HR (New Ireland), VS6DR, VU2DKZ, VU2OLK, ZC4MO, ZC4TK, ZS's, 9G1DY, 9G1GD, 9M2DQ, 9M2NF, 9Q5CP and 3V8AA. Another to work 9G1GD on this band is G3WPO, for his only recorded foray over the period.

G2DC is really pessimistic about the state of Fifteen, which in his view has not been so poor for many a month past; often it is well into the afternoon before the band opens up. However, there is for all of us the consolation that this is usually a transition period to the (hoped for) good conditions of September and October.

On the other hand the longest list in the letter from G3TLX covers operation on 21 mc, and includes such as EA0TU, CP3CN, KV4, KZ5's, SV0WP, VQ8CC, J's, VS6FX, YV, XW8, VU2LN, MP4DAT, all W

TOP BAND COUNTIES LADDER

Station	Confirmed	Worked
<i>Phone and CW</i>		
G2NJ	98	98
GM3UVL	95	98
G3APA	95	96
G2HKU	83	89
G3WQQ	71	85
G3WPO	69	75
G8HX	68	83
G3WDW	63	83
G3VMQ	55	73
G3IDG	55	61
G3VLX	54	81
GI3WSS	49	71
G3UGF	36	76
G3WJS	21	56
G3XGD	12	43
G3SVK/A	—	78
<i>Phone only</i>		
G2NJ	96	97
G3VGB	68	86
G3WPO	48	61
G3VMQ	38	54
G3UGF	36	73
G3PQF	25	60

(Failure to report for three months entails removal from this Table. Claims may be made at any time.)

call areas, VE's, ZD8J, VS1AG, EL2Y, EA8, OY2H, HC1GC, 5A, 9J2's, 9V1, 9H1, CE3ZK, KX6BU, VK, CR6, 6W8, ZC4, 4L1A, 9Y4 and an assortment of the commoner sort of DX. *Whew!*

The 21 mc band received a certain amount of attention from G3VPS, who managed contacts with UM8, JA and JH, plus UI8, W's and VE. No doubt that appetiser will form into something quite spectacular by next month.

It must be quite a while since last we heard from G3GIQ, who has been pretty inactive. However, in spite of a sick beam, a recent spell of another sort of illness forced him back to the

shack where he managed CR9AK, EL2I, HL9TW, KJ6CF, KR6NR, WA6SIB/KS6, KW6AA, K5ALU/MM, VS6DR, VU2OLK, ZD5R, ZL3RW, 5W1AS and 6W8AL. Among the escapees were numbered FR7ZS, KS6BX, KX6GL and 9K2AB.

Forty and Eighty

A couple of neglected bands, these, although Lord only knows why! As an example of what is possible on them, your scribe took a couple of quick bites at Forty—the first resulting in CN8AW, and the second ZS1JA, both SSB.

G2DC, as always, stuck to CW. He comments that the band is pretty hopeless up till 2300z, and that the phone chaps are moving lower and lower down into the CW area. The latter is fair comment, but it would also be equally fair to say that the present plan, if adhered to rigidly, would in fact leave virtually nothing of a phone allocation—it having been done without any reference to the conditions of the band in the first place. The right answer is for a bit of give-and-take—there are not a great number of phone operators on Forty, and they can stay as high up the band as is possible bearing in mind the QRM situation. Jack found the mornings by far the best, with VK, ZL, most of the W calls, and other interesting stuff. However, sad to say, Eighty was not so hot, and no DX was even heard.

The eight watts available to G3XGD do not go up the spout all that well at 3.5 mc, but nonetheless a cautious first appraisal of the band resulted in quite a crop of local all-round phone contacts, with reports averaging RS-56—so no doubt a few more QSO's will be made on CW before coming to a firm decision that there must be a Big Rig in the Shack—we all go through it!

G3WJS is quite a devotee of Eighty and on it he raised OA3LL, UQ2KCS and LX2BQ, while EP2BQ, 4X4's, UF6HW, UW9WB, VE1ZZ and many W's, also VO1AW and PY2SO were heard but lost in the QRM of the recent WAE contest.

Forty was tried quite a lot by

G2HKU last month, and he worked UQ2DV, YV1BI, YV1EL, 9Y4KR, VK3HW, VK3ZL, EA6BG, ZS1JA, PZ1CF, 5N2AAX, OX3DX, 3V8AA and CT1PQA/M, who said that all mobile licences in CT have three letters after the prefix. Some of these QSO's represent good DX stuff—look again.

G3VPS tried hooking one leg of his Top Band dipole into the aerial socket, found it loaded up, and proceeded to work PX1SZ—some folk get all the luck!

A similar unusual approach to aerial theory by G3WPO, who hopefully pumped 220 watts SSB into his Top Band array, loading coil and all, resulted in contacts with OX3OE, OY5NS, 9M2DQ and TA2BK. Forty was then gone into a little more thoroughly, with a V-dipole, producing ZC4MO, PY6GP, PY2SO, ZC4MO, VU2LN, 3V8AA and HB0AAI. So the DX is there and can be worked.

Finally, let G3TLX have the last word on the LF bands. Ron worked, on 3.5 mc; G6ZY/CN, CT1, ZP9AY, TF5TP, PY, and W, also PY, LU, F0HI/M/FC, VK's, 6W8DQ, PY's, ZS's and CN8, with a solitary phone contact, on AM, with ZS1JA, from whom he managed an RS-34. G3TLX feels optimistic enough about Eighty to set himself various VK skeds, although at the time of writing he feels it to be a little early in the season.

Deadline

With which we ring down the curtain for another month. A pleasure to put together, just as much as it is a pleasure to hear from you all who write in with news, views and comments on this-and-that. The deadline for next time is first post **September 9**, and the address, as ever, "CDXN," SHORT WAVE MAGAZINE, BUCKINGHAM. Till then 73, es GL.

(And for those who write in from distant places, by airmail or otherwise, closing dates for the next few issues are: October 7, *November*; November 11, *December*; and December 9, for *January 1969*—which will start us off on another year.)

VHF BANDS

A. H. DORMER, G3DAH

AGAIN, not a very exciting month. After the good two-metre opening to Scandinavia at the beginning of July, and one or two minor lifts during the remainder of the month, it was not until August 4-5 that the Continental stations reappeared at any sort of reasonable signal strength—and then the best path appeared to be to the East rather than to the South or the North-East, although some SM's and OZ's were coming through on the Saturday morning and G3LQR was able to work an LA. A good signal came from SM6CSO, on CW and SSB at the low end of the band, and from OZ9MR. It was reported that SP2RO is now active on SSB but no information is at present available of any contact with him from this country.

Conditions during the Two-Metre Contest on August 3-4 were not particularly good and were poorest on the Sunday morning, when activity also seemed to have dropped off badly. Paths were generally very unstable with QSB swings of up to 50 dB on some signals. There was some good DX about, though, even if intermittently, with GM5PI/P from Wigtown audible on both phone and CW in the South and G3NIN/P from Barrow-in-Furness also good on CW. Five GW port-

ables were worked from Herne Bay, with GW3NUE/P at Brecon being the most consistent.

Incorrect, or downright thoughtless, operating procedures again marred this Contest. There were far too many phone stations operated in the CW portion of the band, and these were not residents in that zone, but mainly /P. Incredibly bad modulation was noticed on at least three of these offenders, as well as on other portables, and this, coupled with a gabbled callsign given without phonetics, must not only have cost them contacts, but made things difficult for many other contestants looking for weak CW DX. It isn't even as if there were some outstanding advantage to be gained from operating on these low frequencies since, to quote the example of GW3NUE/P again, he operates on correct channels for phone and CW and yet was giving the highest serial number heard during the Contest. Presumably, the idea is to catch the stations tuning from the low end up, but this does not always bring the desired result because experienced Contest operators using phone will frequently tune from 144.1mc up for another phone contact rather than waste time tuning the CW end unless they are specifically looking for West Country phone stations. If self-discipline is ineffective in these cases (and enough attention has been drawn to this malpractice to have penetrated all but the thickest) the answer may well be to discipline these offenders by refusing to work them until they have learned manners—even at the expense of a few points.

August 9-10 showed another good lift, again mainly East/West with PAØ and DJ/DL prominent. EI6AS/P gave many stations their first contact with Co. Carlow on the Friday night and with Wicklow on the Saturday morning. This was on SSB, too! For those who have been hearing EI5BH, it should be noted that he is in Westmeath and not Offaly. His QTH is right in the centre of EI and there is an estimated 72 dB path loss between it and the Irish Sea, so he will take a bit of winking out.

Four Metres

Conditions were better for the four-metre Contest on July 21, with many fine contacts made on tropo-

GI3VPK/P in Fermanagh and GI3HCG in Co. Down were good signals in the South, as was EI2W, reported by G3JHM (Worthing, Sussex) to be 59+ for hours on end, although he couldn't raise him!

There has been, as expected, a fall-off in Sporadic-E openings on Four during the month, although some occurred between July 6 and 20th, and others were reported between August 3 and 6th.

On July 15, a very high noise-level on Four was recorded by many operators. This reached S9+ between 1725 and 1800z and was repeated at a slightly lower level later in the evening, but no explanation has been offered to account for this phenomenon.

ZB2AB has returned to this country, so the principal operator at ZB2VHF is now G3SLI. Both ZB2BC and ZB2BO are still active from the Rock, the latter working GI3VKP/P on July 18 for a nice bit of DX.

9H1AY has taken over the organisation of 9H1MB and hopes to have it operational soon. He is building a converter but is having difficulty in getting hold of a 56 mc xtal for it. Another overseas station interested in Four is TF3EA in Iceland, who is in a very favourable location for both Sporadic-E and Auroral contacts.

In the context of spor-E propagation, the reception of GB3GM in Thurso by G3JHM, G3PLX and G3GVM *et al* on July 8 is most interesting as this is the first recorded report of reception from GM on 70 mc by this mode. G3TCT (Guildford, Surrey) had a fine DX contact with GM3JAZ/P in the Orkneys during the same period. The Thurso beacon has also been heard on M/S by G3JHM and G3JVL, the "ping" rate reaching 200 per hour at times during the last week of July. It is worth keeping an ear open on the beacon frequency of 70.306 mc, as reception will be a very good indication of conditions favourable to long distance contacts *via* the spor-E mode and in the North/South direction.

The reception of G3SX, G2AYQ, GI3ALT, EI4BQ, EI4BK, EI8AU, EI9AD and GI3FFF by SWL Stelberg in Konigswinter is particularly interesting as it shows that the skip on 70 mc will come down to 550 miles. These are also the first recorded G/GI/EI reception reports

on 4 metres by Sporadic-E since the contacts with France back in 1958. Heinz is still trying to stir up interest in cross-band contacts in Germany by discussion in *DL-QTC*, and DL6EH, well-known on Two, now has a converter for four metres.

MP4 stations in Bahrein have the four-metre band. Even if U.K. contacts are going to be difficult for them, they should be able to make it with ZE *via* Transequatorial.

A new world record was set up for four-metre phone with the contact between ZB2VHF and GM3EGW on June 14, as mentioned here last month. Congratulations to them both.

EI6AS, a regular two-metre man had a go at four-metre portable and was delighted to get a call from GC3OBM (Guernsey). So, presumably, was GC3OBM.

An official announcement has now been made about an extension of the existing four-metre band by 75 kc down to 70.025 kc but, as in the case of the change on 70 centimetres, no date has yet been fixed for its introduction. This would seem to be an opportunity for the introduction of a four-metre band plan, if one is required at all!

Seventy cems

The usual comment about this band—where have all the signals gone? The answer is, of course, on to Two, in many cases at the expense of so mutilating the 70 cm. transmitter that operation on that band is no longer possible without much rearrangement of equipment. The situation in the South appears to be more serious than in the North. Both G8AWS (Wirral, Cheshire) and G8AUE (Shottle, Derby) confirm that it is possible to go on 70 cm. any evening and call CQ with a reasonable chance of getting a reply. G8AUE regularly copies the sked between G8AKE in Leicester and ON4HN, and G8AWS, from his wonderful /P site in Wales, also has very little trouble in getting contacts. However, the lack of activity on the band is certainly one of the factors which has operated to lose us such a large chunk of it, another being the extreme pressure by civilian and military agencies for frequencies in that part of the spectrum.

At a date yet to be announced, but by no means in the remote future,

our allotment will become 425-429 mc and 432-450 mc. This is not nearly as bad as it could have been, and the /T amateur will still be able to transmit his audio in the communication portion of the band and the video, with either 3.5 or 6 mc separation, in the remainder.

One wonders how much of a *quid pro quo* the granting of facilities for operation on Two by the G8/3's was, in view of the haste with which the announcement of the reductions on 70 cm followed!

23 Centimetres

The *mystique* seems to be going out of this band very rapidly and activity is increasing at a great rate. Readers may be interested to know how one operator set about getting on the 1296 mc band.

The original 70 cm. PA consisted of a pair of PC88's taking an input of eight watts, a transistor converter with AF139's in the front end and an 18-ele Parabeam at 30 feet. It was decided that this set-up could well form the basis of gear for 23 cm. and the first job was to increase the Tx input to 50 watts by adding a simple QV03-20A stage. A new modulator was then required which could double on 70 or 23 cm., so this was constructed using a pair of EL34's in Class-AB1 with 1 kV on the anodes. (Surprise—surprise, but they *will* take it!) The tripler to 23 cm. took the form of a radial cavity made from an old brass shell case with a RF 2C39A inside. This gave an output of four watts RF for 20 watts in, which, incidentally, is rather better than the efficiency obtainable from a '3-20A tripler on 70 centimetres.

On the receiving side, the AF139's in the 70 cm. converter were replaced with AF239's and fed from a K6AXN-type 23 cm. converter with a 70 cm. IF. A G3BHW type transistor converter for portable work was constructed at the same time. The aerial decided upon was a 5ft. parabola at 20 feet fed with *Aerialite* 363 cable.

The gear was put on the air for the first 432/1296 mc Contest during which five stations were worked, all but one being S9 both ways. Subsequent results have included S9 exchanges with G2RD (Caterham, Surrey) a distance of 115 miles, G3GWL (Bletchley) at 85 miles and

G3BNL/M in Gloucester at 86 mile. Since May of this year, thirteen different stations have been worked on 23 cm. with results often superior to those on 70 cm. with higher power!

The cost? Aerial and feeder, £4. 10s.; the tripler 25s., including valve; and the converter £5.

And who did all this? G8AUE of Shottle in Derbyshire, who acknowledges with thanks the help and advice given by G8AUF and G3BNL. A fine effort, indeed. For a contact with Ian, tune to 1297.4 mc just after 9.30 p.m. on Mondays and Saturdays, or to 1297 mc about 8.30 p.m. on Wednesdays.

All of this leads up to the idea that it might be a good thing to make known through this column, the operating times, locations, frequencies and so on, of all active 23 cm. operators, so that there is just that little greater chance of a successful contact. The pre-arranged sked on 432 mc is still probably the surest way of getting a QSO, but the unexpected is often very agreeable! Activity does not perhaps warrant making the Three-Band Annual Table into a Four Band Annual, but if 23 cm. operators would care to send in claims, together with operating details, a separate list could be published.

And 13 Centimetres

A new record for a two-way contact on this band has been set up by G3BNL and G3EEZ, the former operating portable from a site at Painswick, 10m. south of Cheltenham, to G3EEZ/P, located 7m. north-west of Wolverhampton. The distance is 60 miles and RS-59 signal reports were exchanged. Preliminary trials had been run from Markfield in Leicester to Wolverhampton, and these had shown the feasibility of making a contact over 50 miles. The first success came when G3BNL—operating /P from a site at Cleeve Hill, Gloucester—made contact with the Wolverhampton site at 52 miles, with RS-59 reports both ways. Subsequent efforts to establish QSO over a 130-mile path were bedevilled by equipment troubles—but both operators are convinced that this is on, and further attempts will be made when the holidays are out of the way.

The 13-centimetre gear at G3BNL consists of a GL6442 valve in the

PA, running 2.5 kV pulses of 1 sec duration with a p.r.f. ("pulse recurrence frequency") of 1 kc on 2360 mc. The aerial is a 2ft. 6in. parabolic reflector with dipole feed. The receiver consists of an xtal mixer cavity with a two-stub tuner, into a cascode head-amplifier, into four stages of amplification at 60 mc. Output from this goes into a wide-band amplifier, Schmidt trigger, audio filter and amplifier. Under construction is xtal controlled equipment, Tx 2305.8 mc and Rx 2304 to 2310 mc. The rig will be all-transistor on the Rx side and up to 1150 mc in the transmitter, which then goes into valves and varactor.

That interest in this esoteric band also is increasing is evidenced by the fact that G2WS, G8ANZ, G3TND and G3OBD are all building for it.

News Items

The March & District Amateur Radio Society has formed a Club net on 144.863 mc, with at least a dozen stations from as far afield as Cambridgeshire, Norfolk, Suffolk and Lincolnshire. To meet the expressed wishes of non-members, they have decided that net stations will make a point of checking the band for outside calls at 2000z whenever they are around. Apparently, a number of GDY stations have been hearing the net but have been unable to break in!

Old-timer G3WW (March, Cambs.) is back on the two-metre air with SSB after an absence of eleven years. He comments, as have so many other Sideband operators on Two, that he cannot get any replies to his CQ calls from other than SSB stations. This cuts both ways, as many a *cri de coeur* has been heard from AM operators that they cannot get an answer from the SSB man! However, Richard is fully equipped with one receiver for the SSB calling frequency and another for the whole of the two-metre band whatever the transmission mode, and emphasises that when he says that he is "tuning the band" he really does mean the whole of it.

EA4AO reports from Madrid that EA4JZ and EA4JS will be active from Santander in the north of Spain for the next two months or so and will be looking for U.K. contacts on two-metre SSB. These calls have been specially issued for the occasion and

THREE-BAND ANNUAL VHF TABLE

January to December, 1968

Station	FOUR METRES		TWO METRES		70 CENTIMETRES		TOTAL pts.
	Counties	Countries	Counties	Countries	Counties	Countries	
G3LAS	39	5	47	13	10	1	115
G3DAH	23	2	47	13	10	1	96
G8BBB	—	—	48	12	26	5	91
G3COJ	8	3	41	8	18	3	81
EI6AS	17	7	32	6	—	—	62
G8AAZ	—	—	34	6	16	1	57
G3AHB	—	—	24	5	7	2	38
G8BJK	—	—	32	6	—	—	38
G3XFW	—	—	5	2	11	2	20
G8AYN	—	—	13	1	5	1	20
G8APJ	—	—	17	3	—	—	20

Scores are from January to December. Position overall is shown by the total in the last column. Scores for individual bands will be summarised from time to time to show positions. Entries may be made for a single band, any two or all three. Claims should be sent in as often as possible to enable the Table to be kept up-to-date.

cover the identities of two very well-known Spanish amateurs, EA4DT and EA4ER respectively. The operating frequency is 144.197 mc, with VFO control between 144.00 and 144.50 mc. Operating times: When there is any good extended tropo. about but particularly between 1600 and 2400z each day.

G8BEN, son of the late G2UQ, is active from Peterborough on two metres and 70 cm. and is looking for DX skeds. G3VFC (Rainham, Kent), now has the gear for video on 70 cm. and would like to arrange an exchange of pictures at around the 30-mile mark. His A/TV call is G6ADZ/T.

PA0HVA reports that he was very glad to hear the G stations on during the July two-metre contest, as this helped him in no small way to win the Dutch Section with 40,583 points for 172 QSO's, of which 40 were with G stations at an average distance of 400 kilometres.

For those interested in recording their "number of SSB stations worked on Two," it may be noted that PA0IJ has now knocked off more than 400. It surely pays to turn the beam towards the Continent if there is a sniff of a lift since the ratio of SSB to AM stations is increasing rapidly over there, par-

ticularly in Germany.

G8AAZ (Wimbledon, London) is shortly to move to Jersey where he will become GC8AAZ. Operating frequency on Two will be 144.255 mc, and as he proposes to take the transmitter and a beam out with him to the high ground to the north of the Island (known well to A.J.D., many years ago) he should be a good signal, at least in the South. (He will also become GC6RAX/T, the first in the *Call Book*.)

Paul Quast, EI5BH, who is ex-PK4PQ, has had some good DX from a difficult QTH—best so far being G3CCH (Scunthorpe, Lincs.), about 290 miles from Westmeath. He is another advocate of the early-morning QSO which he says works wonders for him. Apart from the sparrow-chirp activity, he is QRV every evening from 1900 to 2400 local—frequency was 145.87 mc the last time he was heard down in Herne Bay.

DL0ER, the German beacon in Essen, is back on the air again after some weeks of absence. Frequency is as before.

Latest on the new two-metre French beacon has been received from "official beacon-keeper, F8SH." F3THF started transmitting on July 1st, 1968 on 144.073

mc with 50 watts of RF—that is to say with about 1 kW e.r.p., the aerial being a vertical stack of two horizontally polarised, nine-element Yagis. This system is erected on the first platform of a water tower near Lannion, on the northern coast of Brittany, about 60 miles east of Brest. The aerial is a good 165ft. above ground, or 255ft. a.s.l. The geographic position of the beacon is 03° 27' 12" W. and 48° 45' 28" N. QRA Locator YI13d, and the beam heading is 90° true. Operation is continuous. There were the usual slight mishaps which occur whenever one starts with equipment on a semi-permanent basis, but everything is going very well now and the beacon is being heard regularly and well in the Paris area, and even somewhat further. Stations in Rheims, some 340 miles to the east, and also in Nancy at 450 miles, report regular reception by day and night. The beacon is actually operated on an experimental basis and will be closed down some time during September to enable changes and adjustments to be made, to ensure increased reliability. VHF experimenters working Moonbounce and Meteor Scatter have already been notified of the operation of F3THF. Reception reports will be welcomed by M. S. Cantivenc, F8SH, at 6 Rue de Pont-Hélé, 22 Perros-Guirec, France. G8BJP (Margate, Kent) has been

working as a Maritime Mobile in the Channel and North Sea with French and Dutch callsigns as appropriate. As an ex-Lt. Cdr., his French call of FØIC was not inapt. It is hoped to give some details of his experiences, and gen. on the arrangements to be made when such a trip is planned. It does not seem to be generally realised that when an operator is /MM at sea, he becomes /MA (Maritime Anchor) as soon as he drops the hook.

An interesting, and for this country, an unusual, exercise was organised by G3EMU (Canterbury, Kent) recently. This took the form of a fox-hunt where the fox was G3EMU parked in a well-concealed location with a small two-metre transmitter, and the hunters were a number of local two-metre mobiles. The "fox" put out short test calls every fifteen minutes on which the hunters took bearings, the winner being the car which located G3EMU first. On this occasion, the "fox" was static, but a possible variant is that he could be mobile. The participants seem to have enjoyed themselves, and this is perhaps an idea for Club Secretaries. G3EMU is considering repeating the event, and those who wish to have further details should write to him, *QTHR*.

While on holiday in the Isle of Wight, G3BA/M, using ten watts and a halo, worked F9VX/M in Toulouse who was running two

watts to a quarter-wave vertical. This must be a mobile-to-mobile record for two metres! Admittedly conditions were very good on the night of June 30 but reckoning that there was a 12 dB path loss due to the 90° difference in the propagation planes, it really is *quite* an achievement! Tom followed this up with a contact with F9NL in the Pyrenees—nice going.

Contest

The major contest of the year, VHF Field Day in Region I, takes place over the weekend September 7-8. Times are 1800z on Saturday to 1800z on Sunday. As in previous years, these dates and times coincide with the IARU Region I Contest, so there should be plenty of EU activity. **Late Flash:** Just reported *ARTOB* balloon to be flown from Hannover Sundays Sept. 1st and 8th, 1000z onwards. Ground stations transmit on 144.10 mc. and receive on 145.41 mc. Balloon expected to reach height of about 6 miles one hour after launch and should be usable from U.K.

Deadline

Deadline for the next issue is **September 7**. Address is "VHF Bands," SHORT WAVE MAGAZINE, BUCKINGHAM. Cheers for now and *73 de G3DAH*.

AGONY OF CZECHOSLOVAKIA

Once again one of the small countries of Europe, inhabited by a gentle, cultured and intelligent people with a long history, has been brutally assaulted by sub-humans armed with sub machine-guns. There will be some readers at least who, seeing this, will remember what Hitler did to the OK's thirty years ago. And, again, there is nothing forceful or positive that we do about it. At the moment of writing, the OK's were still in the air—and no doubt many of them were helping with the setting up of local BC stations, through which much of the hard news about what was happening in Czechoslovakia came to the outside world. But the Russian grip was tightening, and it could be that OK activity on the amateur bands had been extinguished before this appears.

IDEA OF WHAT IT COSTS

There is a new freezer-trawler under construction at a yard in Aberdeen, being built for Hull owners—this is a ship which will fish in what are called "distant waters,"

meaning into and beyond the Arctic Circle, under very rigorous conditions. In these days, such ships are fitted with highly sophisticated radio equipment—not only for long-distance communication, but also for emergency, D/F and local working, dock and inter-ship. The total value of the radio communication contract for this vessel—won by Redifon, Ltd., with their SSB apparatus as part of the main installation—is just £9,000. The gear will be in charge of a radio officer trained on the equipment, and appointed by arrangement with Redifon, Ltd.

AMALGAMATION OF IDEAS

It has been announced that the following learned societies and associations: The Institution of Electrical Engineers, the Electronic & Radio Engineers, the Institute of Mathematics, and the Physical Society, are to form a body called the Standing Committee of Kindred Societies "to co-ordinate the activities arising from their common interests." The committee will also consider "ways in which the four societies may work together to provide improved services for members."

The Nombrex signal generator Model 31 covers 150 kc to 350 mc in eight over-lapping ranges, with a calibration accuracy of better than 2% throughout. The Model 31, which is all-transistor, also has switchable 400-cycle modulation on a separate output socket, and the impedance out is 400 ohms, with continuously variable RF signal attenuation, maximum 100 mV.

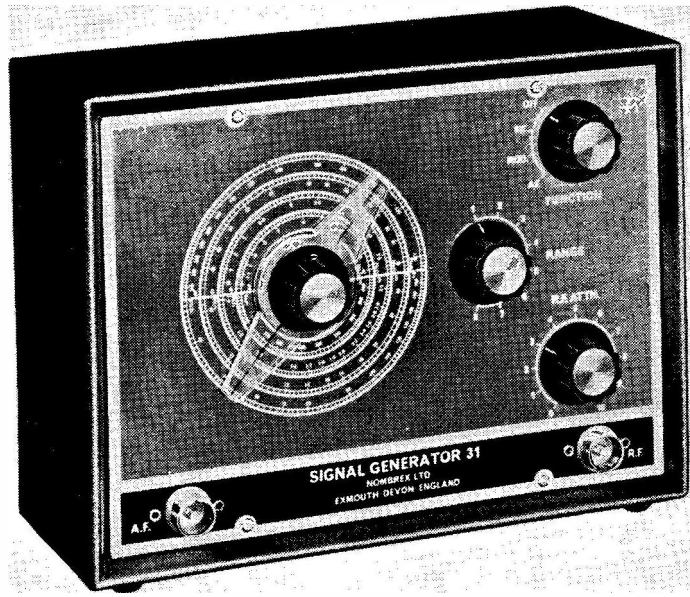

The sketches at right show a method—suggested by G6FV (Sittingbourne, Kent)—of substituting silicon rectifier diodes for usual rectifying valves, like the 5R4GY (top) and 5U4G. The diodes are BY-100's, and the resistors R should be 220K rated 1/2-watt. Connections are as seen from the top of the base.

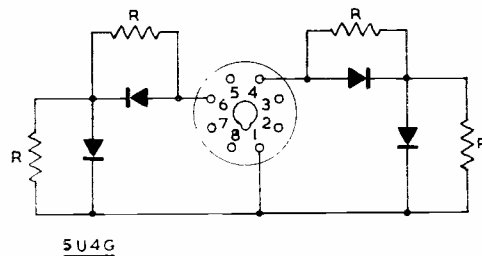
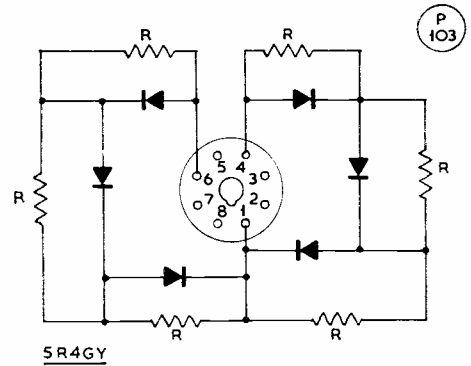
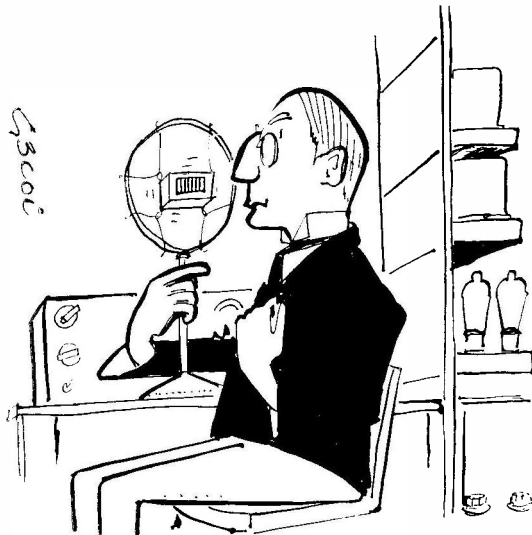

“... The old reliable AM mode is much preferred here ...”

“Short Wave Magazine” was established in 1937, is still entirely independent, enjoys the support of radio amateurs throughout the U.K., and goes to all English-speaking countries overseas.

THE MONTH WITH THE CLUBS

By "Club Secretary"

(Deadline for October Issue: September 6)

(Please address all reports for this feature to "Club Secretary," Editorial Dept., SHORT WAVE MAGAZINE, Buckingham.)

THIS month, as always, it falls to our lot to remind everyone of the **annual MCC affair**, which this year is slated for November 9/10. Times and hours, as also the rules, will be essentially the same as last year. In the meantime, it would be appreciated if all the Clubs who propose entering this time, and have not done so for a couple of years, would help us by writing in and letting us know *immediately* in order that we may set about the business of allocating codes. Most years, we get some groups that do not make a firm decision one way or the other until the fifty-ninth minute of the eleventh hour, and end by telephoning for an identification on the day of the first leg! Even worse, from our point of view, are the groups who make a last-minute decision, and do not advise us at all, but take a code *which we may already have allocated* to a late entry, so that there are two Clubs using the same code, to the confusion of all and sundry, not least the invigilators.

As one of the prime objectives of a CW Contest is to improve operating stands, the code form used last year will be retained, and more attention paid to incorrect loggings—particularly the cases where a group has a contact with another Club, and logs it as a single-pointer; in previous years this has been allowed to the full value, but this time the group making the error will be only allowed the single point. This, after all is only interpreting the letter to the rules, but it should go a way towards ensuring care is taken in the logging and operating.

For the rest, let us just suggest you all look to your powder, that it is dry, and to your gear that it works, and may the best man win!

The Reports

Kicking off with the North of England and Scottish clip, **Hull** have meetings down for each Friday at 592 Hessle Road; on the 6th they have a session comparing the HRO and 750 receivers, but Friday 13th is pessimistically noted as a question mark. September 20 is set aside for a Junk Sale, and on the 27th, Pete Hall talks about RTTY.

Derby are certainly thriving—they had 160 *paid-up* members on the books at the last count! September 4 features a Junk Sale, while on the 7th they are engaged both in the VHF Field Day and a Fete at Staunton Harold. A trip to the Test House of International Combustion should be of interest on September 11, and on the 18th there

is a Practice Direction-Finding Event; those not involved can get together in the clubroom on that evening. Finally, on September 25, Dud Charman's tape lecture on "The Human Machine as a Radio Operator" will be heard. All the home events are at Room 4, 119 Green Lane, Derby, and visitors are assured of a welcome.

Halifax and District have recently gone through the AGM, and now have *no* transmitting matters on their committee. A Junk Sale is in the offing, and various items for the programme are being finalised, but at the time of writing no firm information was available; so we have to refer you to the new Hon. Sec.—see Panel p.441.

It is a little unusual to hear from groups in Scotland, although we know of several thriving ones. **Aberdeen**, for instance, has a membership of about 60, who are regularly to be found on Friday evenings at the Club Hq., 6 Blenheim Place, Aberdeen; there is a programme of interest to all, and visitors are specially welcomed. And they are looking forward to a film of their doings over the Field Day weekend, which it is hoped to have ready for showing in October.

Lothians have not "reported in" themselves this time, but from a member we hear that there are plans afoot for a special station during the Edinburgh International Festival, albeit it is understood there is, at the time he wrote, still some doubt about the matter. For any amateur in the area, a line to the hon. sec. at the address in the Panel should bring all the information that is needed.

Wakefield next; they get together at the Youth Centre, Zetland Street, Wakefield, on alternate Tuesdays. September 10 is allocated to operation on the air with the group call G3WRS, while the 14th is given over to a Junk Sale.

A fairly slack month for **Northern Heights** is to be followed by a busy September; on the 11th there is the Pea-and-Pie Supper—an annual event, this, which is much enjoyed—followed on the 22nd

MCC IS HERE AGAIN!

Dates are November 9-10. Rules and ident. lists October issue. Clubs not having participated before in this Magazine Club Contest on Top Band, and wishing to enter this year, should let us know as soon as possible.

by another annual in the Foxhunt. September 25 will see G6LD talking about "Modern Receivers." That leaves one date open, September 18 namely, when they are once again going to hear the W1BB tape-and-slide lecture, so that it is fresh in mind when they come to his new one late in October.

The lads at **Spenn Valley** will be back in business in September, starting with a talk on TV/DX, which will be given by G8AKQ of Holme Moss. As for September 26, the theme is music, as G3USH is down to discuss Electronic Organs. There is a programme for the coming months already in being, and copies were being printed at the time of writing.

A change to new Hq, at the former Civil Defence Headquarters, Upton Road, Bidston, Birkenhead, will enable the **Wirral** lads to indulge in a wider range of activities. They assemble on the first and third Wednesday of each month; thus September 4 is down for a talk by G3UFO on Transistorised Transmitters, and on the 19th, a discussion of the preparations to be put in hand for NFD 1969.

Now to **Pudsey**, who, as we have remarked before, are a cheerful crowd, and thoroughly enjoy their Club life. They wish their thanks to be expressed to G3UCZ who has so ably transmitted Slow Morse over the last five years but has now found it necessary to stop; G3WGW is now doing the chore, which is greatly appreciated. In the way of future events, they have coach trips organised to both the Preston and Peterborough Mobile Rallies, and later in the season to the Amateur Radio Show. The September calendar gives a Construction Evening on September 4, a talk on Oscilloscopes by G3VTY on the 11th, an Operating night a week later, and a Junk Sale rounds off the month on the 25th.

A new publicity officer takes over for **Liverpool**, and mentions their very successful station, GB2LS, which has operated over the three days of the Liverpool Show for the last ten years; during that time they have worked 3377 stations, in 108 countries—DXCC in 30 days! The autumn programme is now in the course of preparation, and for details of this we have to refer you to the hon. secretary.

Not far away are the **South Manchester** group, who have a problem at the moment. It seems that Manchester Corporation, who are the owners of their Hq., have decided to demolish it, and so the hunt is up for a new place. This means that any intending visitor should phone G3SMM on 061-973-6676 for the last-minute situation, as it is to be expected that the venue, at least for the moment, will be somewhat flexible.

Fulford have gone through the period of the summer doldrums that seems to afflict so many groups; beginners and Morse classes are proving quite popular, and there is an informal lecture given on alternate Thursdays. For all the latest details, contact the hon. sec. at the address given in the Panel.

Ashton-u-Lyne may not have been reporting recently but they are still active, with meetings regularly on Fridays, 7.30 p.m. at No. 6 Stamford

Street, Stalybridge. They have their own call G3BND, which is to be re-activated on Top Band. Unfortunately, the photographs sent, covering their very successful participation in the Northern Radio Societies annual convention at Belle Vue, Manchester, were not quite good enough for reproduction.

New Groups

A novel method of getting together prospective members of a new group has been thought up by Peter Sladen, of **Bulwark, Chepstow, Mon.** He invites anyone to come to his home, 44 Burnt Barn Road, on September 26, for a film show, of radio amateur interest; if there is enough support then they will form a group in the area. Let us hope that we soon hear that a successful start has been made.

Anyone in the area around **Hawick, Roxburghshire**, who is interested in the formation of a group, is asked to get in contact with GM3WIG, to see if something can be set up.

Remarks in "Communication and DX News" recently about the lack of activity in **Cumberland**, have brought in a letter from G3WCM; in it he says that if anyone has enough interest then a club could be put together. Contact, in the first instance, either G3WCM, or G3WBT. Both these groups are in areas where the amateurs are relatively "thin on the ground" and the formation of clubs would do much to increase the interest and activity, and it is to be hoped that every success attends their efforts.

Next in this section, we must mention the re-formation of the **Lincoln Short Wave Club**, where Bill Felton, whose name appears so regularly in our "SWL" feature, has been elected to the hon. secretary's job. We gather that regular meetings are to be held at No. 2 Guardroom, Sobraon Barracks, Bredon Drive (off Burton Road), Lincoln, and at the time of writing Wednesday evenings looked to be the routine; however, a check with Bill at the address in the Panel would probably be worth-while first, in case the evening has been changed to suit more people.

A group who appear to be starting with a bang are the **Mid-Cheshire** crowd, who are getting together at Oak House Farm, Beeston Drive, Over, Winsford, Cheshire. On September 4, they are preparing for VHF NFD, on the 11th the programme gives a lecture—subject to be announced—followed on the 18th by the serious matter of having a first Annual General Meeting; on the 25th G6LEE/T will tell them all about Amateur TV. In addition, over September 26-28 they are putting on a demonstration station at Winsford Rotary Club Hobbies Exhibition in Winsford Civic Hall.

Southern Area

A group with an hon. secretary who is really devoted to his job is **Maidenhead**, of which G3FVC took the trouble to write during his holidays. On Monday, September 2, G3MED is to give a talk about SSB, while on September 17, informal session, G3WKX will be put on the air, probably on 144 mc.

September 12 and 26 are the dates on which the

Mid-Sussex crowd foregather, at Marle Place Further Education Centre, Leylands Road, Burgess Hill; on the former date G2UJ will be talking on "High Stability Oscillators," while the second meeting will be an informal at Hq.

A serious attempt to get the lads on to 144 mc seems to be in the wind at **Fareham**, where they are modifying 22 Pye Rangers recently acquired. This forms the object of the evening on September 1, getting the beasts going, while the following week there is to be no meeting because of the clash with VHF Field Day. September 15 has a "What is your problem?" session laid on, when the Brains will endeavour to answer the questions. Simple fault-finding is the topic of the talk to be given on September 22, as part of a series aimed at the newcomer to the hobby. Hq. is Portchester Community Centre, Fareham, and to find them all you have to do is follow the coax into the clubroom! Every Sunday evening at 7.30 p.m.

Guildford get together at the Model Engineering Club Hq., Stoke Park, Guildford, on alternate Fridays; there is also a 70 mc Club Net, each Thursday evening at 9.0 p.m. For other details, contact the hon. sec.—see panel, p.441.

Harlow next, where the main effort at the moment is being put into making sure that the Mobile Rally goes well; as it is usually the last one of the season, this year's being set for September 29, lots of people come along for a "last look at the whips" before putting away the /M gear for another year, and so the Harlow chaps try their hardest to make their Rally good. The venue, as ever, is to be Magdalen Laver, and the hon. secretary will gladly give all the details, as he will of the regular meetings on Tuesdays at Mark Hill Barn, Harlow.

Not far away, the lads at **Bishop's Stortford** are still getting together on the third Monday in each month, in the upstairs room at the British Legion Club in Windhill. September 16 is the first of a series of three talks to be given by G3KFE on Receivers, over succeeding months.

North Kent have Hq. at the Congregational Church Hall, adjacent to the Clock Tower, Bexleyheath, on alternate Thursdays. September 12 is down for a Film Show, but we have no information as to the doings on the 26th, although it is believed to be an informal.

RMA Sandhurst only occasionally report in; this time they had the trip to Clackmannanshire, signing GM5PM/P, during August, and there will be a special-activity station with a GB callsign at the RMA and Staff College Horse Show, on September 21-22.

With great regret, **Verulam** report that G3GJX, who has been such a stalwart member of the group for years, has left to live in Surrey. The meeting in September at Cavalier Hall, St. Albans, is on the 18th, when Mr. Ched Gordon of the GPO will talk about the satellite tracking system at Goonhilly. In addition to this, an informal at Salisbury Hall occurs on September 4.

Over at **Crawley**, September 25 will be a red-letter day, as Dud Charman, G6CJ, will be giving his famous aerial lecture. This should on no account be missed. In order to cover expenses a charge of 5s. a head will be made to all members and visitors who turn up at Trinity Congregational Church Hall, Ifield Drive, Ifield, Crawley. The time for this one is 8.0 p.m. *sharp*. For more details, contact the hon. sec.—see Panel.

September for **Stevenage** means on the 5th a talk on Radio Control, and on the 19th Fred Henshaw, G8BBO will discuss Printed Circuits and the manufacture of them for amateur purposes. Looking forward to October, there is the well-known G3DGN talk on Lasers down for the 3rd, and Daystrom's Demonstration on October 17. Hq. is at the Hawker Siddeley Dynamics canteen, Stevenage.

Not far from Stevenage is **Dunstable Downs**, with a group which is going from strength to strength. Hq. is at Chews House, Dunstable, each Friday evening, and the wives are in attendance as well to take part actively as to look after the chore of brewing-up. They stress that they are out for new members, not just the transmitters and SWL's but also the chap who "just wants to build a wireless."

Another strong and active group are at **Reigate**, who gather at the George and Dragon, Cromwell Road, Redhill; they have a members'ip list of 43, according to the 99th copy of *Feedback* and a quick count shows 29 of those to be licensed. On September 4, last points will be settled about the VHF Field Day activity, and then G3SGA will give his "Introduction to Single Sideband."

Brief report from **Farnborough**—to the effect that next meetings are on September 10 (on TVI) and September 24 (on VHF/M, by G3EDD), both 7.30 p.m. at 310 Farnborough Road.

The **South Coast VHF** group have recently been having an interesting series of discussions with ZB2BO, ZB2AP, and SWL Heinz Stelberg on the results of the Sporadic-E season, and on the placing of a 70 mc beacon in Europe. Activity-wise, the main thing is VHF NFD, for which they will be putting in strong effort from a site at Canctonbury Ring. The hon. secretary here is G3JHM, well known for his work on the VHF's.

National and International

Here we include the clubs that have no local affiliations, but are more widespread.

Firstly, **British Railways**, who are associated with the international FIRAC group, who recently held their 1968 Congress at St. Urban in Austria. The chairman of BRARS, G3SCW, attended and has a very interesting account of the events in the current *Newsletter*. We are asked to point out that the hon. secretary of this group is H. A. J. Gray, at the address in the panel, to which all correspondence should be addressed. Members'ip of BRARS is now up to 54.

RAIBC caters for the disabled and blind element of our hobby, and has a most interesting and chatty newsletter called *Radial*, which your scribe always looks forward to reading; this month there

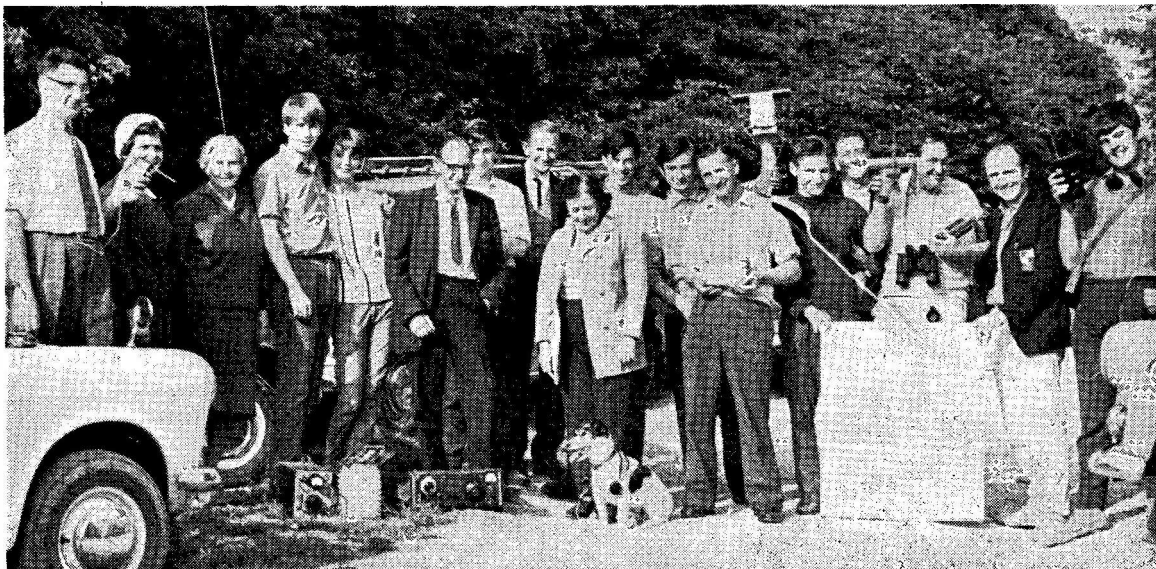

On p.375 of the August issue, we pictured a happy-looking D/F party in the South-West. Here is another—at Holme-on-Spalding-Moor, East Yorkshire, on July 27, when members of the Hull & District and Goole clubs were out for their own D/F event, organised by G3PQY and G3SSA. With them were G3PJR, G3RDM and G3VBI, also SWL's Hall, Griffiths and Rodmel—with their efficient D/F receivers. The placard was a map of the area to be worked over for the Tx hunt.

is an account of the trip by G3OFU and G3VOA to Wiesbaden to demonstrate the "Possum" equipment. RAIBC needs to get to know about those eligible for membership, and it needs supporters to enable it to carry out its aims—and of course funds, an area in which quite a few Clubs help by allocating the profits of one of their activities to RAIBC, who really do appreciate such help.

WAMRAC is for those radio amateurs and SWL's who are of the Methodist persuasion; what between the lack of recognition by the authorities and the illness of the hon. secretary's wife, things have been rather troubling for them; but it does look as though their luck is on the turn, and G3NGF seems to have hit upon the right formula for ensuring success.

The **Ex-G Club** explains its origin and objects pretty clearly in its title; operation is by way of the bi-monthly *Bulletin* and the regular nets—each Sunday at 1900z on 14346 kc, and in addition there are check frequencies of 3-835 mc, 21-350 mc and 28-650 mc for phone, plus 14-065 mc CW, where members are likely to be found looking for contacts.

The **Civil Service**, of course, are everywhere, and naturally there is a Radio Club to cater for them—the Civil Service Radio Society. This crowd have a fine Hq. at the Civil Service Sports Centre, in Monck Street, London, S.W.1. with a shack, lecture facilities, and somewhere to eat and drink. The regular meetings are slated for the first and third Tuesday of each month, with a programme which will include such topics as SSB, Transistors, Hi-Fi and FM, together with visits to places of interest. The hon. secretary, address as Panel, will be glad to give full details.

The London Area

This is a little difficult to define, so we must hope that any group which has been translated accidentally into the Southern clip, or *vice-versa*, will not be unduly cross about it.

Edgware are back again after their summer recess. They kick off with an informal on September 9, and on the 23rd they get together again for a topic yet to be announced. Hq., incidentally, is at 51 Flower Lane, Mill Hill.

Echelford are finding their membership rising at a greater rate than ever before—which is a pretty good advertisement! They can be found at the Hall, St. Martins Court, Kingston Crescent, Woodtorpe Road, Asford, Middlesex, on Thursday, September 26, for a lecture on Single Sideband.

Quite a few groups have difficulty in filling a newsletter, but not so **Purley**, who put out *Splitter* each month, and have plenty of material in hand to enable the editor to exercise his scissors. They get together twice a month; September 6 in the small hall for a natter, and September 20 in the large one to hear some of the Wimbledon crew, led by G3EPU, talk about Radio Astronomy.

Surrey RCC cover the Croydon area and meet at the Blue Anchor, South Croydon; we have no information as to what is on for September, so we have to commend you to the hon. sec.

Chiswick Trades and Social Club, 66 High Road, Chiswick, is the home of the **Acton, Brentford and Chiswick** crowd, and on September 17 they will gather to hear G3XPC giving a talk entitled "My First Contact." This is the sort of thing that is always interesting, to newcomers and old timers alike.

lover

Cray Valley have G3TR coming to them on September 5, to talk about RSGB, at their place at the Congregational Church Hall, Court Road, Eltham, while on September 19 they have a natter-session at All Saints' Church Hall, Bereta Road, New Eltham, S.E.9.

On to **Wimbledon** and **South London Mobile**, where the editor of the *News Letter*, G3EPU, has really let himself go on his front page about the lack of contributions—and then goes on to one of the most interesting issues seen of late. The group meet at the St. John Ambulance Hall, 124 Kingston Road, South Wimbledon, on the second and last Friday in each month, starting at 2000 clock.

The Midlands

The **Leicester City Show** comes off on September 2-3 and the local lads will be putting G3LRS on the air as part of the exercise. The hard work is to be done on the 1st, and they will need all the help that can be obtained. Meet at the Club Hq. at 10.0 a.m., or later at the Abbey Park Showground.

There are five Mondays in September, albeit no meeting on the first one (September 2 is Bank Holiday) for the **Norwich** boys. On the 9th there is a natter session, while the 16th is given over to dealing with business matters. September 23 is down for a talk on Impedance Matching, and the month is rounded off by G3RQY, who will talk about his holiday in YU and OE.

Midland assemble in the Midland Institute, Margaret Street, Birmingham, on the third Tuesday in each month; unfortunately we have no details of the September doings, but with a group of more than 100 members one would expect that they will have *something* cooked up for September.

On now to **Peterborough**, who have their Mobile Rally on September 2, and then follow it up with a Maritime Mobile Direction-Finding Contest on the 15th. For the latter the venue will be on the River Nene at Alwalton, a half-mile on the Stamford side of Kate's Cabin corner, where the Peterborough-Leicester Road crosses the Great North Road A1. Anyone with a portable receiver tuning 1980 kc can take part, but a boat of some sort will be a distinct advantage!

Coventry have four things to do in September. The first meeting, which is on the 6th, is for the final preparations for VHF NFD; a week later, on the 13th, G3ROD is to give a talk on a technical topic which is not disclosed. September 20 sees them operating the Club transceiver on the air, and the finale to the month is on the 27th when they have the AGM. The hon. sec. would very much be pleased if those members who cannot, for one reason or another, attend the latter, would let him know beforehand.

Five meetings for **Wolverhampton**, all at Hq., Neachells Cottage, Stockwell Road, Tettenhall, Wolverhampton, this month, were it not for the fact that the first Monday in the month falls on the Bank Holiday. Thus, they have September 9 for a Film Show, preceded by the Morse class; on the 16th a natter and work on the redecoration of the

Hq., again preceded by slow Morse; on the 23rd an Informal which will be used as preparatory to the AGM; and on the 30th the committee will make the final preparations for the AGM while more slow Morse goes on elsewhere in the Hq.

Redecoration is also in hand at **Rugby**, and with it the installation of a new Club station, which will at first consist of an 888A receiver and Panda Cub transmitter; in addition the Rugby RAEN station is installed in the shack. The club call, incidentally, is G3BXF. A great interest of this crowd for many years has been Direction-Finding, and this season they have taken part in no less than 24 such events! For details of the group, contact the hon. sec., address as in the Panel.

We boomed last time round in giving the date of the Church Stretton Traction Engine Rally as September 12 — it should have been stated as September 2—and of course the **Salop** lads will be there with their exhibition station. The 12th date is in fact for a Junk Sale at Hq., the Old Post Office Hotel, Milk Street, Shrewsbury. The rest of the Thursdays in the month are all informals, and things really start in October, after the summer season.

Wales and West of England

At the monthly meeting of the **Rhyl** crowd in July, they had a three-man demonstration of construction techniques; first, a description and demonstration of the finer points involved in "chassis-bashing" including joining and soldering aluminium, and a discussion of the metal-finishing processes which can be applied by the constructor; secondly, a practical demonstration of the art-and-craft of soldering, both on conventional wire and on printed-circuits and *Veroboard*; and to round off a practical demonstration of the alignment of a home-built transistor superhet receiver. One would feel this is something that could be done by many groups as a means of filling an evening. As for September, Rhyl are having the annual Junk Sale on the 10th, at the Silver Band Room, off Windsor Street, Rhyl.

From *Tamar Pegasus* we get it that **Saltash** are still meeting every other Friday at Burraton Toc H Hall starting at 7.30 p.m. Just what is on the programme for September is not, at the time of writing, known, but no doubt a quick line to the hon. secretary (*see* Panel) will bring all the desired information.

Rhondda have just revived their newsletter after a lapse of seven years—and it kicks off with a couple of good, old-fashioned, axe-grinding paragraphs that augur well for its future. They have an exhibition station on at the Rhondda Transport Flower Show on September 7, and it is understood that the Hq. is at the Pengelli Hotel in Treorchy—but the hon. sec. would no doubt be very pleased to pass on the information—*see* Panel.

Yeovil have had a club for as long as the writer can recall, although we have not heard from them for some time. However, this month their p.r.o. writes in to give details of activities—but we can't

decipher his fist! They have a full programme ahead, to include tape lectures and film shows.

Cornish have a late change of programme for their main meeting at the SWEB Clubroom, Pool, Camborne, which takes place on September 5, to replace the "potted talk" by a Junk Sale; the main lecturer still remaining as G3WJP, who is to discuss his African experiences—this being a continuation of an amusing talk given back in May last year.

A social meeting is planned for September 17, at the George and Dragon, Rowde, by the **Chippenham** gang for the benefit of the members in outlying parts; it is hoped that some of the chaps from Swindon, Bath and Bristol groups will come, and to that end there will be talk-in by G3UFW on Top Band. It is also hoped that those with no club affiliations will drop in. The date for September 3 at Hq. is scrubbed, due to the fact that the meeting-place is being renovated. The Chippenham group normally assemble every Tuesday evening at 7.30 p.m. at Chippenham High School, Hardenhuish

Lane, Chippenham.

Hereford also mention the "summer lay-off"—meaning a slowing-down of Club activities due to holidays and such, but nevertheless they have been having regular meetings with attendances of about 20; not at all bad, as apart from the season of the year, Hereford is not a populous district in the Amateur Radio sense. Club projects (Rx and test gear) are in hand for the winter season, under the capable direction of G3HVX. A headquarters is still a problem here, but they have a temporary meeting place at Trinity Hall, Whitecross Road, Fridays, September 6 and October 4, 7.30 p.m.

Deadline

Don't forget that MCC will be coming up again over the weekend November 9/10, and watch the October issue for rules and identification lists.

And that's it for this time. Deadline for next issue, October, is **September 6 latest**, addressed "Club Secretary," **SHORT WAVE MAGAZINE**, BUCKINGHAM.

Names and Addresses of Club Secretaries reporting in this issue:

ABERDEEN: F. Baxter, GM3VEY, "Playa D'Or," 22 Leggatt Avenue, Aberdeen.
 ACTON, BRENTFORD & CHISWICK: W. G. Dyer, G3GEH, 188 Gunnersbury Avenue, London, W.3.
 ASHTON-U-LYNE: K. Greenough, G8BEQ, 120 Mossley Road, Ashton-u-Lyne, Lancs.
 BRITISH RAILWAYS: H. A. J. Gray, Eleven, Swanton Drive, East Dereham, Norfolk.
 BISHOPS STORTFORD: A. Stanley, G3WUR, 43 Havers Lane, Bishops Stortford (4519, day only), Herts.
 CHEPSTOW: P. Sladen, 44 Burnt Barn Road, Bulwark, Chepstow Mon.NP6-5NG.
 CHIPPENHAM: N. Cutter, G3PQG, 1 Fosseyway Close, Colerne, Chippenham, Wilts. (Box 664.)
 CIVIL SERVICE: D. McLennan, G3KGM, 52 Pinewood Avenue, Sidcup, Kent. (01-300-0767.)
 CORNISH: W. J. Gilbert, 7 Poltair Road, Penrhyn, Cornwall.
 COVENTRY: C. Jaynes, 20 Belgrave Road, Wyken, Coventry. CV2-5AY.
 CRAWLEY: R. G. B. Vaughan, G3FRV, Tralce, 5 Filbert Crescent, Gossops Green, Crawley (23359), Sussex.
 CRAY VALLEY: D. Buckley, G3VLX, 234 Halfway Street, Sidcup, Kent. (01-850-5945.)
 CUMBERLAND: F. Childlow, 64 Mitchell Avenue, Northside, Workington, Cumberland.
 DERBY: F. C. Ward, G2CVV, 5 Uplands Avenue, Littleover, Derby (21931).
 DUNSTABLE DOWNS: G. Bath, G3NMZ, 9 Chalton Heights, Chalton, Luton, Beds.
 ECHELFORD: M. Clift, G3UNV, 45 Fordbridge Road, Ashford (59628), Middx.
 EDGWARE: G. S. Fitton, G3RAA, 18 Beverley Drive, Edgware, Middx.
 EX-G: F. Fletcher, G2FUX, 53 St. Ives Park, Ringwood, Hants.
 FAREHAM: J. A. Rampton, G3VFI, 23 Oxford Close, Fareham, Hants.
 FARNBOROUGH: D. G. Arigho, G3NVM, 6 Frensham Close, Yateley, Hants.
 FULFORD: G. B. Widnell, G3XJT, 5 Heslington Croft, Fulford, York (77501).
 GUILDFORD: A. Wilkes, G3SLH, Schiehallion, Hookley Lane, Elstead, Godalming, Surrey.
 HALIFAX: D. G. Perkin, 16 Bentley Avenue, Lightcliffe, Halifax.
 HARLOW: R. A. Sinclair, G3VAD, 244 Stanstead Road, Hoddesdon, Herts.
 HEREFORD: B. R. Edwards, G3RJB, 5 Powys Walk, Hereford.
 HULL: Mrs. Mary Longson, 4 Chester Road, Wold Road, Hull.
 LEICESTER: N. Tomlinson, G8BOA, 33 Merton Avenue, Leicester.
 LINCOLN: W. Felton, 4 Eastfield Close, Welton, Lincoln.
 LIVERPOOL: I. Barton, G3TYE, 23 Moss Side, Liverpool, 14.
 LOTHIAN: A. J. Masson, GM3PSP, 20 Merchiston Park, Edinburgh, 10.
 MAIDENHEAD: E. C. Palmer, G3FVC, 37 Headington Road, Maidenhead (20107), Berks.

MID-CESHIRE: D. Bendelow, 191 St. John's Gardens, Over, Winsford, Cheshire.
 MIDLAND: C. J. Haycock, G3JDJ, 29A Wellington Road, Handsworth, Birmingham, 20.
 MID-SUSSEX: E. J. Letts, G3RXJ, 87 Meadow Lane, Burgess Hill, Sussex.
 NORFOLK: M. J. Cooke, 76 Falcon Road West, Sprowston, Norwich (46093). NOR-73R.
 NORTHERN HEIGHTS: A. Robinson, G3MDW, Candy Cabin, Ogdens, Halifax (44329).
 NORTH KENT: P. T. Baber, 64 Latham Road, Bexleyheath, Kent (01-303-8655).
 PETERBOROUGH: D. Byrne, G3KPO, Jersey House, Eye, Peterborough.
 PURLEY: A. Frost, G3FTQ, 62 Gonville Road, Thornton Heath, Surrey. CR4-6DB.
 R.A.I.B.C.: Mrs. F. Woolley, G3LWY, 331 Wigan Lane, Wigan, Lancs.
 REIGATE: D. Thom, G3NKS, Bankside, 58 Garlands Road, Redhill, Surrey.
 RHONDDA: C. M. Parry, GW3PHH, 34 Ca'er-Gwerlas, Tonyrefail, Porth. Glam.
 RHYL: A. Antley, GW3UTG, Fairholme, Fairfield Avenue, Rhyll (1362).
 RUGBY: R. T. Craxton, G3IKL, 103 Clifton Road, Rugby.
 SALOP: W. Lindsay-Smith, G3WNI, 22 Kingswood Crescent, Copthorne, Shrewsbury.
 SALTASH: J. A. Ennis, 19 Coombe Road, Saltash, Cornwall.
 SCOTTISH BORDERS: G. Shankie, GM3WIG, 8 Ettrick Avenue, Hawick, Roxburghshire.
 SOUTH COAST VHF: D. T. Hayter, G3JHM, 4 Newling Way, Worthing, Sussex.
 SOUTH MANCHESTER: W. M. Furness, G3SMM, 16 Coniston Avenue, Sale, Cheshire (061-973-6676).
 SPEN VALLEY: N. Pride, G8BSC, 100 Raikes Lane, Birstall, Nr. Leeds (Batley 3925).
 STEVENAGE: D. R. French, G3TIK, 98 Austen Paths, Stevenage, Herts.
 SURREY: R. Morrison, G3KGA, 33 Sefton Road, Croydon, Surrey. CRO-7HS (01-654-5982).
 VERULAM: J. Thomas, G3RXA, 9 Highland Drive, Hemel Hempstead (55136), Herts.
 W.A.M.R.A.C.: Rev. A. Shepherd, G3NGF, 52 Thanet Street, Clay Cross (2184), Chesterfield, Derbyshire.
 WAKEFIELD: E. Price, G3TQV, 23 Elmwood Road, Horbury, Wakefield.
 WIMBLEDON: K. Alexander, 23 Pepsy Road, West Wimbledon, London, S.W.20.
 WIRRAL: J. Phillips, G3PXX, 16 Collingham Green, Little Sutton, Wirral, Cheshire.
 WOLVERHAMPTON: J. P. H. Burden, G3UBX, 28 Coalway Road, Wolverhampton.
 YEOVIL: D. L. McLean, G3NOF, 9 Cedar Grove, Yeovil, Somerset.

COURSES FOR THE RADIO AMATEUR'S EXAMINATION

The list following is of centres at which instruction is offered for the Radio Amateur's Examination, Subject No. 55 in the City & Guilds of London syllabus. This list is not necessarily complete but it includes all centres of which we have been notified.

Readers wishing to know about the availability of an R.A.E. course locally should apply to the Principal of the neighbourhood College of Technology, Evening Institute or College of Further Education, or the local office of the Education Authority, quoting "Subject No. 55, Radio Amateur's Examination, City & Guilds." If staff locally cannot give you an immediate answer, they should be able to find out and let you know. Please *do not* apply to us—we have only the details given here. The point is that these courses are arranged at many evening institutes and colleges of further education, in all parts of the country, and it is from the office of a local education authority that information should be available.

Because instruction in Subject No. 55 comes under arrangements made by the Education Authority, the fees are nominal and the instruction is professional—often by instructors who themselves hold an amateur licence.

Books for The Course

In addition to the reading that may be recommended by individual course instructors—by whom students should be guided—we can say from many years' experience that much can be learnt for the passing of the R.A.E. from the following books: *Amateur Radio* (26s.); *Guide to Amateur Radio* (6s. 7d.); *Radio Amateur Examination Manual* (5s. 9d.); *Short Wave Radio and The Ionosphere* (11s. 9d.); and—for a standard textbook that will be a reference for years—the 1968 issue of the *Radio Amateur Handbook* (50s.).

All these books are obtainable through our Publications Dept., Short Wave Magazine, Ltd., 55 Victoria Street, London, S.W.1. All prices are post free and any of these titles can be supplied from stock.

Instruction Centres

- Barry:** At College of Further Education, Colcot Road, on Tuesday evenings for R.A.E. theory and Thursdays (Morse and practical work), 7.30-9.30 p.m., starting Sept. 23. Enrolment during evenings week beginning Sept. 9, at the College. Club station GW3VKL will be in operation for students. Lecturer, D. H. Adams, GW3VBP. For further information apply to the College secretary.
- Bedford:** At the Westfield F.E. Centre, starting in September. Enrolment and other details from J. R. Clarke, G3OWQ, 12 Robin Hill, Brickhill, Bedford.
- Bedworth, Warks.:** At the Evening Institute, Nicholas Chamberlaine School, on Monday evenings, starting September 16, enrolment Sept. 10-12, 7.0-8.30 p.m. Instruction by R. G. Titterton, G3ORY.
- Boreham Wood:** At the College of Further Education, on Wednesdays, 7.0-9.0 p.m., starting on Sept. 18, enrolment evenings Sept. 9-10. Lecturer, G. L. Benbow, M.Sc., M.I.E.E. (G3HB).
- Bradford:** At the Technical College, Great Horton Road, on Monday evenings, 7.0-9.0 p.m., starting on September 23, registration Sept. 9-13 (not Wednesday), 6.30-8.30 p.m. No fees payable for students under 19 on Sept. 1st.
- Burslem:** At the Northern College of Further Education, Morland Road, enrolment Sept. 6, 8, 9. Enquiries to Electrical Engineering Dept., or the lecturer, K. H. Parkes, G3EHM, QTHR.
- Corbridge, Durham:** Course to be held at the County School, commencing mid-September, details from: V. Allison, G3TNX, 14 Silverdale Drive, Winlaton, Blaydon-on-Tyne, Co. Durham.
- Coventry:** At the Technical College, Butts, on Wednesday evenings, 7.0-9.0 p.m., enrolment period Sept. 9-12, course fee 40s., with Morse tuition available. The College operates its own station G3UVW, and students will have access to it under supervision of the organiser, F. J. Chandler, G3HHM, who will be glad to deal with enquiries, at the College.
- Crawley:** At Ifield Evening Institute, Lady Margaret Road, Ifield, on Monday evenings, 7.0-9.0 p.m., starting Sept. 23, enrolment Sept. 18-19, after 6.0 p.m. Fees for under 19's 26s. 6d., over 19, 66s. 6d. Instructor, A. J. Gibbs, G3PHG, who will be glad to give any further information.
- Durham:** At the Technical College, Framwellgate Moor, starting on Sept. 27, 6.30-9.30 p.m. on Fridays weekly, with prior enrolment. R.A.E. theory and Morse practice will be included by the lecturer, P. G. Martin, B.Sc., G3PDM.
- Harlow:** At the Technical College, The High, on Friday evenings, 7.0-9.30 p.m. Lecturer, E. P. Essery, G3KFE, 17 Ascot Close, Parsonage Lane, Bishop's Stortford, who will be pleased to give full details.
- Heanor:** At South-East Derbyshire Coll. of Further Education, Fridays 7.0-9.0 p.m., starting Sept. 20; enrolment Sept. 9-10, 6.30-8.30 p.m. Apply Heanor Branch of the College, in Ilkeston Road.
- Hemel Hempstead:** At the Dacorum College of Further Education, Marlowes, on Tuesdays and Fridays, 7.0-9.0 p.m., fees 70s. or 35s. for juniors, enrolment Sept. 9-11. Course organiser, from whom all details can be obtained: C. Burke, G3VOZ, 30 Green Lane, Bovingdon, Hemel Hempstead.
- Huddersfield:** At Ramsden Technical College, Queensgate, courses in R.A.E. theory and Morse code, starting in September, on Monday and Friday evenings. Enrolment Sept. 9-11, and enquiries to the course tutor, R. Hey, Dept. of Engineering.
- London (Beckenham):** At the Adult Education Centre, 28 Beckenham Road, on Thursday evenings, 7.0-9.0 p.m., starting Sept. 26. Fees are graded according to age; enquiries and information: M. D. Bass, B.Sc., G3OJE, 42 Clevedon Road, London, S.E.20.

London (Chingford): At the Community Centre, Friday Hill House, Simmons Lane, Chingford, E.4, commencing Monday, Sept. 23. Enrolment week from Sept. 16, fees for seniors 38s. 6d., juniors 14s., and applications will be considered from those under licence age. Course instructor. J. Johnson, G2HR, QTHR.

London (Holloway): Organised by Grafton Radio Society at Montem School, Holloway Road, N.7 (Room 55), on Mondays for R.A.E. Theory, 7.0-10.0 p.m., instructor R. Smart, G3MMC, commencing Sept. 23. Morse tuition Wednesdays, 7.30-9.30 p.m., starting Sept. 25. Enrolment any evening Sept. 16-20. 7.0-9.0 p.m., at the School, fees 35s. for one course or 40s. for both.

London (Ilford): At the Ilford Literary Institute, Cranbrook Road, starting on Sept. 25, enrolment Sept. 9-12, 7.0-8.30 p.m. at the Institute, for R.A.E. theory and Morse. Fees vary from 40s., to 25s. for juniors. This course has been passing students through R.A.E. since 1948. Apply in the first instance, with s.a.e., to: W. G. Hall, G8JM, 48 Hawkdene, North Chingford, London, E.4.

London (Streatham): At the Youth Centre, Conyers Road, S.W.16, Mondays (theory) and Fridays (practical), 7.30-9.30 p.m., with a licensed station available. Starting Sept. 9, course instructor B. R. Meredith, G2CYV. Further details from: the Warden, Streatham Youth Centre.

London (Walthamstow): At Marsh Street Youth Centre, Walthamstow, E.17, starting early in September, and made suitable for anyone beginning radio study. Enquiries and details for enrolment: K. Smith, G3JIX, 82 Granville Road, Walthamstow, E.17.

Loughborough: At the Technical College, Dept. of Electrical Engineering, Radmoor, Tuesdays, 6.0-7.0 p.m., Morse, and 7.0-9.0 p.m. (R.A.E. theory). Commencing Sept. 17, fee 74s. 6d., and lecturer D. R. Doughty, G3FLS.

Peterborough: At the Technical College, Eastfield Road, 7.15-9.30 p.m., one evening a week, in R.A.E. theory and Morse. Details from: D. Byrne, G3KPO, Jersey House, Eye, Peterborough (Tel: Eye 351).

Plymouth: At the Technical College, Tavistock Road, starting mid-September, Monday evenings, 6.30-9.0 p.m., lecturer D. M. Webber, G3ENX.

Princes Risborough: At the Evening Institute, County Secondary School, Merton Road, starting Monday Sept. 16, 7.0-9.0 p.m., for R.A.E. theory, with Morse course on Wednesdays. Enrolment Sept. 11-12. Lecturer R. E. Whiting, G3POF. Details from the Institute in the evenings, or through L. Emmett, G3VKO, QTHR.

Ramsgate: At the Technical College, starting in September. Details from: R. Trull, G3RAD, 1 Approach Road, Broadstairs.

Sheffield: At the Western Road Evening School, Sheffield 10, starting on Wednesday, Sept. 25, at 7.0 p.m. All details from: J. Bell, G3JON, 30 Alms Hill Road, Sheffield S11-9RS (Tel: 367774).

Shipston-on-Stour: At the High School, Darlingscote Road, on Wednesday evenings, commencing in September. For details see local press and notices at the School.

Slough: At the College of Technology, William Street, on Thursday evenings, 7.0-9.30 p.m., enrolment (at the College) Sept. 11-13, 2.0-4.0 p.m. and 5.30-8.0 p.m. Instruction will be in both R.A.E. theory and Morse, under G3FVC and G3WQC. The College has its own station signing G3XPL.

Weybridge: At the Brooklands County Technical College, Heath Road, starting Monday, Sept. 16, 6.30-9.0 p.m., enrolment (at the College) Sept. 9-10, 2.0-4.0 p.m. and 6.0-8.0 p.m. Enquiries to J. E. Lacey, G3GLB, Dept. of Mechanical & Electrical Engineering.

AMATEUR RADIO EXHIBITION

The International Radio & Communications Exhibition—known colloquially as the "Amateur Radio Exhibition"—will be at the New Horticultural Hall, London, S.W.1. (as last year) over the period October 2-5 (Wednesday to Saturday, all day). As usual, various events are being planned to coincide with the period of the Exhibition, which is under the management of P.A. Thorogood, G4KD. The October issue of SHORT WAVE MAGAZINE will be available at our stand.

HOW TO GET IT

A regular copy of SHORT WAVE MAGAZINE can be obtained either by order through a local newsagent, or by sending us a postal order for 4s. each month, or by direct subscription, which costs 45s. for a year of 12 issues, starting any month and sent post free anywhere in the world. Orders, with remittance 45s. by cheque or postal order, to: Subscription Dept., Short Wave Magazine, Ltd., 55 Victoria Street, London, S.W.1. Publication day is the last Friday of each month (dated the month following) and direct-subscriber copies are posted early the Thursday before.



“... Says his last wish is to be allowed time to pass the R.A.E. ...”

NEW QTH's

This space is available for the publication of the addresses of all holders of new U.K. call signs, as issued, or changes of address of transmitters already licensed. All addresses published here are reprinted in the U.K. section of the "RADIO AMATEUR CALL BOOK" in preparation. QTH's are inserted as they are received, up to the limit of the space allowance each month. Please write clearly and address on a separate slip to QTH Section.

G3VDO/MM, I. Hacking, R/O, m.v. *London Banker* (GLWU), c/o London & Overseas Freighters Ltd., 8 Balfour Place, Park Lane, London, W.1. (Also *G3VDO/MA.*)

G3XBA, J. T. Worrall (*DL2AH*), 101 Stainton Grove, Barnard Castle, Co. Durham.

G3XKF, J. Sharrat, 10 Pebblemoor, Edlesborough, Dunstable, Beds. (Tel. *Eaton Bray 297.*)

G3XLC, F. Cooke, 3 Laburnum Place, Meir, Stoke-on-Trent, Staffs.

G3XLG, R. J. Spreadbury, 145 Alt Road, Formby, Lancs.

G3XLM, R. N. Lee, 60 Thornby Avenue, Kenilworth, Warks. CV8 2DY.

G3XMT, M. Steele, 993 Manchester Road, Cowlersley, Huddersfield, Yorkshire.

G3XNS, N. T. Sheppard, 10 Worth Park Avenue, Pound Hill, Crawley, Sussex. (Tel. *Pound Hill 3321.*)

G3XOD, R. Horsman, 1 Hillside Avenue, Kingswood, Bristol. BS15 2BP.

G3XOE, G. H. O'Donnell (*ex-EI4G*), 60 Mayfield Road, Whitfield, Dover, Kent.

G3XOY, L. Wood, 103 Victoria Road, Mexborough, Yorkshire.

G3XPK, J. R. Dore, 5 Neston Way, Handforth, Wilmslow, Cheshire.

G3XPL, Amateur Radio Club, Slough College of Technology, William Street, Slough, Bucks.

GM3XPQ, G. H. Black, Sandsound Schoolhouse, Tresta, Shetland.

G3XQD, Amateur Radio Society, R.A.F. Carlisle, Cumberland.

G3XQG, R. A. Cooney, 10 Ruskin Avenue, Dalton-in-Furness, Lancs.

G3XQJ, G. H. Wren, B.Sc., 8 Aspin Park Drive, Knaresborough, Yorkshire.

G3XQM, A. Finch, No. 3 Flat, 17 Park Crescent, Brighton 7, Sussex. BN2 3HA. (Tel. *Brighton 683986.*)

G3XQP, Dr. A. J. French, 35 Hanover House, St. John's Wood High Street, London, N.W.8. (Tel. *01-722-1072.*)

G8BLI, M. L. Hollebon, 59 Blenheim Park Road, South Croydon, Surrey.

G8BQH, M. J. Marsden, 27 Vine Road, Stoke Poges, Slough, Bucks.

GM8BQP, S. Nicoll, Druum Dearg, Muir of Ord, Ross-shire.

G8BQX, J. Ridd, 8 Beaufort Road, St. Leonards-on-Sea, Sussex. (Tel. *Hastings 29965.*)

G8BRX, E. R. Aust, 2 Spur Road, Waterlooville, Hants. (Tel. *Waterlooville 52345.*)

G8BSC, N. Pride, 100 Raikes Lane, Birstall, Leeds, Yorkshire. (Tel. *Batley 3925.*)

CHANGE OF ADDRESS

E18AR, Bro. John Shortall, De La Salle House, Bruff, Co. Limerick.

G2BSW, R. J. Ward, Alauna, Venlake Close, Uplyme, Lyme Regis, Dorset.

G2BUL, G. L. V. Butler, 9 The Heath, Chaldon, Caterham, Surrey. CR3 5DJ.

G2FXG, A. S. Green, Longhalves Cottage, Longhalves, Freshwater, Isle of Wight. (Tel. *Freshwater 2850.*)

G3FD, H. T. Brock, 56 Chapel Lane, Hadleigh, Essex.

GM3FSD, G. W. Bolton, 7 Chesters Brae, Southdean, Hawick, Roxburghshire.

G13GRD, W. J. C. Curtis, 8 Station Road, Kesh P.O., Enniskillen.

G3HRV, W. A. Gardner, 38 Brackley Street, Walkden, Worsley, Lancs.

G3JZW, H. W. Gadsden, 4 Beechwood Court, Dunstable, Beds.

G3MCX, W. J. Kennedy, 5 The Ridge, Orpington, Kent. BR6 8AP. (Tel. *Orpington 32072.*)

GM3MXN, T. Sorbie, 3 Lammer Wynd, Larkhall, Lanarks.

G3MYF, W. H. Walton, 15 Queens Terrace, Otley, Yorkshire.

G3OGK, G. R. Kennedy, 23 Hollytree Close, Hoton, Loughborough, Leics. (Tel. *Wymeswold 658.*)

G3OOR, D. G. Roberts, Beaubrysan House, 8 Northover, Ilchester, Somerset.

G3OTO, E. G. Barker, 12 Hollin Head, Roundwood Road, Baildon, Shipley, Yorkshire.

G3PAE, N. V. Clarke, Moorville Hall, Cellarhead, Werrington, Stoke-on-Trent, Staffs.

G3PEN, D. J. Penny, 8 Strudwick Close, Braintree, Essex.

G3PEN/A, D. J. Penny, 175 Burrow Road, Chigwell, Essex.

G3PXV, R. E. Wiseman, 18 Akrotiri Square, R.A.F. Watton, Thetford, Norfolk.

G3RCV, Cray Valley Radio Society, 139 North Cray Road, Sidcup, Kent.

G3SET, G. D. Aram, c/o Officers' Mess, R.A.F. St. Mawgan, Newquay, Cornwall.

G3SEV, K. T. Adkins, 14 Buckingham Road, Tring, Herts.

G3UCG, E. Robinson, 33 Foundry Street, Birdsroyd Lane, Brighouse, Yorkshire. (Tel. *Brighouse 2571.*)

GM3VCZ, A. McInnes, 6 Albert Street, Wick, Caithness.

G3VLF, T. W. Beamed, Merriefield, Bishops Castle, Salop.

G3VSK, T. W. McCurry, 9 Darwynn Avenue, Swinton, Mexborough, Yorkshire.

G3VYF, M. R. Lee, 11 Sturrocks, Vange, Basildon, Essex.

G3WTI, Mrs. Betty Robinson, 33 Foundry Street, Birdsroyd Lane, Brighouse, Yorkshire. (Tel. *Brighouse 2571.*)

G4IV, E. T. Carter, Greystones, Porthtowan, Truro, Cornwall.

G6NB, D. N. Biltcliffe, Hilltop, Pulpit Lane, Oving, Aylesbury, Bucks.

G8BDA, P. J. Harvey, 46 Hamlet Road, Chelmsford, Essex.

AMENDMENT

GW3BJZ, T. Richards, 31 Aberffrw Road, Mountain Ash, Glam.

G8BMV, M. Goodrich, 26 Frome Road, Chipping Sodbury, Bristol, Glos. (*appeared incorrectly as G8BMY in June 1968 issue.*)



GEORGE FRANCIS

G3TWV

FRANCIS for EDDYSTONE

EB35	£60	6	3
EB36	£57	0	0
EC10	£53	0	0
EA12	£195	0	0

All dials and accessories in stock.

FRANCIS for K.W. ELECTRONICS

KW2000A	£232	0	0
KW VESPA	£138	0	0
KW201	£110	0	0

Full range of H.P. and L.P. Filters, Q-Multipliers, Dummy Loads, PEP Meters, EZ Match.

FRANCIS for SWAN

All Swan equipment available.

FRANCIS for TRIO

9J-59DE	£37	10	0
JR-500SE	£68	0	0
New Transceiver	Complete, no extras to purchase	£231	0	0

FRANCIS for LAFAYETTE

HA700	37	gns.
HA500	42	gns.

FRANCIS for PARKAIR ELECTRONICS

Skybandit	£23	10	0
Concorde	£17	15	0
Complete 2 metre Tx	£80	0	0

FRANCIS for JOYSTICK

Joystick Standard	£4	15	0
Joystick De Luxe	£5	19	6
3A Tuner	£3	12	6
4 Tuner	£4	4	0

FRANCIS for SHURE

Shure 201	£5	0	0
Shure 444	£10	10	0

FRANCIS for AIWA

ARI59. FM, AM, LW, SW1, SW2, MB	36	gns.
ARI58. FM, VHF1, VHF2, SW, AM, MB, up to 174 Mc/s.	36	gns.

FRANCIS for GRUNDIG

Yacht Boy. Covers 20, 40, 80, 160. All models in stock	39	gns.
--	-----	-----	-----	----	------

FRANCIS for MICROPHONES

Acos Mic. 40	19	11	
Acos Mic. 45	19	11	
PIEZO DX73	1	10	0
Planet CM70	1	10	0
Foster MDF902	10	gns.	
Hand Mic.	15	0	

We have a large stock of microphones.

FRANCIS for ODDS and ENDS

3-pin Din Plugs and Sockets; 5-pin Din Plugs and Sockets; 2-pin Din Plugs and Sockets. Jack Plugs, chrome, 2/3; Jack Plugs, bakelite, 2/-; 2.5 mm., 3.5 mm. Plugs and Sockets. Fuses. Chassis. Cables. Tuning Condensers. Transformers. Controls. Knobs. Valve bases. Switches. Neons. Resistors. Phone Plugs. Sockets. Speakers. Headphones, 13/9. Stereo, 68/9. Solder Irons, Solder. Our stocks are large.

Send for Lists. S.A.E. please.

SPECIAL OFFERS

Hook-up Wire, 100ft. for	...	2	0
Magnetic Counters	...	6	0
100 High Stabs	...	5	0
50 Condensers, Silver mica	...	1	6
300+100+100+16 mfd, 300 volt	...	5	0
400+200+50+16 mfd, 300 volt	...	5	0

All spares BRAND NEW and not ex-Government.

FRANCIS for ROTATORS

AR22	£22	0	0
------	-----	-----	-----	-----	---	---

FRANCIS for CABLES

75 ohm. Ordinary, 7d. yd.; 75 ohm Low Loss, 1/10 yd.; 52 ohm Ordinary, 1/4 yd.; 52 ohm Low Loss, 2/3 yd.; 75 ohm Twin, 6d. yd.; 300 ohm Ribbon, 6d. yd.; Egg Insulators, 6d. each; PL259 Plugs, 4/9; PL259 Sockets, 4/9.

FRANCIS for CONDENSERS

We have a very large selection. Your enquiries please.

FRANCIS for TEST GEAR

Handy little Tester, 1000/ohm per unit. Only	...	1	19	6
Audio Generator, TE22	...	£15	0	0
RF Generator, TE20	...	£12	10	0

We hold a large stock of small and large Panel Meters. Send for lists.

FRANCIS for TRANSISTORS and VALVES

OC44, OC45, OC71, OC72, 2/1 each; OC81, 2/3; OC83, 2/2; OC170, 3/-; OC171, 4/-; OC26, 7/6; AC126, AC127, AC128, 2/7; AF114, 4/-; AF116, AF117, 2/6; BSY26, BSY28, BSY65, BSY95A, BFY18, 3/-; OC75, 2/6; 2N706, 2/-; GET880, 6/-; BC152, 15/-; AC176, 11/-; S78MP Silicon 800PIV, 750MA/S, 2/5 each; over 7,000 sold already. OA81, 1/6; OA202, 1/10; 151150, 3/9; BY126, 3/9; 6HF5, 39/-; 614B, 52/6. All valves in stock for Swan and KW.

HALSON MOBILE COILS TO CLEAR	£3	2	6
20, 40, 80 metres only.						

No order too small. Goods dispatched by return. 6d. stamp for catalogue and lists.

Part Exchanges. Postage Extra.

93 Balderton Gate, Newark, Notts.

Tel. 4733; after 6 p.m. 2578

★ **BARGAIN OF THE MONTH** ★

HA500

Indistinguishable from new

£32.0.0

★

ERSIN



5 CORE SOLDER

**for quick,
easy, reliable
soldering**

Contains 5 cores of non-corrosive flux, instantly cleaning heavily oxidised surfaces. No extra flux required. Ersin Multicore Savbit Alloy also reduces wear of copper soldering iron bits.



**SIZE 5
HANDY SOLDER
DISPENSER**

Contains 10 ft. coil of 18 s.w.g. Ersin Multicore Savbit Alloy. 2/6 each.



**SIZE 15
SOLDER
DISPENSER**

Contains 21 ft. coil of 60/40 Alloy, 22 s.w.g. Ideal for small components, transistors, diodes, etc. 3/- each.



SIZE 12

Ideal for home constructors. Contains 90 ft. of 18 s.w.g. Ersin Multicore Savbit Alloy on a plastic reel. 15/- each.



**BIB MODEL 8
WIRE STRIPPER
AND CUTTER**

Strips insulation cleanly and quickly, fitted with unique 8 gauge wire selector. Plastic handles. 9/6 each.

From Electrical and Hardware shops. If unobtainable, write to:
Multicore Solders Ltd., Hemel Hempstead, Herts.

Amateur Electronics G3FIK

TRIO TS-500 TRANSCEIVER. This equipment is now coming into increasing use in this country as evidenced by the number of TS-500's now to be heard on the bands and without doubt everything points to this excellent transceiver becoming an established piece of Amateur gear within a very short space of time. It goes without saying, of course, that provided that the price involved is attractive this alone will sell and when this is accompanied by a product which is beautifully styled and of excellent design, finish and construction, the trap is well and truly laid indeed. We use the word trap intentionally because so often in the past the unwary purchaser of imported equipment has soon become disenchanted when the question of spares and after sales service has arisen. Not so with the TRIO! We offer the following service with all sales of the TS-500.

1. A home QTH demonstration without obligation.
2. A full twelve months guarantee.
3. A first class spares service.
4. An equipment loan scheme to keep you operating during service.

If you are on the point of changing your rig or going sideband may we give you the opportunity of seeing the TS-500 in action at your own QTH? **G3WQR** has schedules for demonstrations within a radius which includes the London area and we can arrange visits at very short notice. Fully illustrated details upon request of course.

TRIO 9R-59DE. Small stocks remaining at the old price of ... **35 gns.**
TRIO JR500SE. A truly excellent ham band receiver... **£68 0 0**

Our stocks are continually changing which sometimes results in advertised items no longer being available so an S.A.E. is always well worth while if you have any particular requirement for commercial or ex-Ministry equipment. We do, of course, specialise in reconditioned AR88's both D and LF and, conversely, URGENTLY require AR88's in any quantity. At the time of going to press we have a fair selection of commercial A.M. and SSB equipment including Collins, KW and Eddystone etc.

Part exchanges.

Credit facilities.

518-520 ALUM ROCK ROAD, ALUM ROCK, BIRMINGHAM 8

Telephone: 021-327-1497

MORSE TAPE SERVICE

Individual morse lessons to AMATEUR LICENCE standard. Each tape at the speed you require. No repetition of text, avoiding familiarity. Deposit 7/6 (refundable) for first tape, then 2/6 per tape.

For details of this unique service, S.A.E. to :-

D. J. BEAN, G3TJQ
51 HEATHFIELD SQUARE, LONDON, S.W.18

G3ZY

G3ZY

J. & A. TWEEDY (Electronic Supplies) Ltd.

Appointed Dealer and Stockist for

Eddystone, KW, Electroniques, Codar, Sommerkamp, Trio, etc.

New Equipment

Eddystone : EC10 £64, 940 £140, 840C £70, EA12 £195.

KW Electronics : 2000A with A.C. psu £232, Vespa Mk. II with psu £135.

Codar : AT5 £16/10/-, A.C. psu £8, D.C. psu £11/5/-, RQ10X £8/8/-, RQ10 £6/15/-, PR30X £7/4/-, PR30 £5/10/-, T28 £15/10/-, CC40 £6/10/-, CR70A £19/10/-.

Sommerkamp : FLDX500 £145, FTDX500 £250.

Trio : JR500SE Rx £68, 9R59DE £39/15/-, TS500 Transceiver £165, PS 500 A.C. power unit and speaker £38, VF05 £28.

Tavas Aerials : Mobile 4 section 100" chrome plated whip with 5 feet of 50 ohm uni radio 43 high quality co-ax cable £2/12/6. Stoutly made weatherproof resonators. 15 mtrs £2, 20 mtrs. £2, 40 mtrs. £2/5/-, 80 mtrs. £2/10/-, 160 mtrs. £2/10/-, Chrome adaptor 6/- each. Packaged deal £12/10/-, Postage : Packaged deal 7/6 ; odd items 2/2 each.

VHF Aerials : 5 element 144 mhz 52/6, 3 element 70 mhz 45/6, 8 element 432 mhz. 39/6. Mounting bracket included. Postage and packing extra

G3LGG : 432 mhz converters with psu £8/5/- plus 6/- P.P

Used Equipment

Olympic T150 a snip at £30, R109 £10, HE40 as new £12, SR55u £38, Hammarlund HX50 and HQ170A. Top band to 10 metres. 24 hour clock in 1b. condition £190, Heathkit HW32A transceiver £50, Green 2M20A £38.

HP TERMS AVAILABLE

TRADE-INS ACCEPTED

64 Lordsmill Street, Chesterfield, Derbyshire

Tel.: Chesterfield 4992 or Holmewood 505 (evenings)

G3RWN

G3RTO

P. & H. ELECTRONICS

AIRMEC C864 Rx. 15 kHz to 30 MHz, in 7 ranges	£75
R209 Rx. 12v. D.C. input. 1 MHz to 20 MHz	£18
PYE PTC290 VHF xtal-controlled Rx. Mains input	£6
2M Tx. T1540. Mains input. Less xtal and mike	£10
DX40 WITH VFU	the pair £30
CLASS D No. 2 WAVEMETER (the fancy one!) Mains in	£16
COSSOR 1035, D.B. scope	£25
HARTLEY 13A D.B. scope	as new £25
AIRMEC COUNTER EQUIPMENT comprising Oscillator Type 213, Electronic Switch Type 202, Divider Type 212 and Counter Type 865, 4 units	£40
3 CHANNEL RECORDER, Evershed & Vignoles, OS 2186 GA with spares kit, paper, manual	£45
OC22 & OC24 22:5w. R.F. New—not ex. equipment	£12/6
LIGHT SENSITIVE RESISTORS. Ericsson K42. Average 250 ohm in daylight, 250 Kohm dark resistance	8/6
NOR GATES, 4 high speed NOR gates on panel with circuit and layout	7/6
REED SWITCHES. 100 amp-turns operating. 600v. D.C. breakdown. 250 mA D.C. 1A A.C. contacts	2/-
COILS, 3,600 ohm and 100 ohm, to take up to 4 reeds	2/-

HUNDREDS OF OTHER ITEMS, callers welcome: Mon. to Fri., 1800 till 1930 hours. Sat., 0930 till 1800 hours. Sun., 1000 till 1300 hours. Otherwise please include sufficient to cover postage and packing. Please include S.A.E. with inquiries. No terms; but part exchanges with pleasure.

P. & H. ELECTRONICS
3 CHURCH STREET, EASTWOOD, NOTTS.

Status Supplies

Relays 2000 series 1000 Ohm multi contact, 5/-, P & P 1/-.
 Telephone Rectifiers, low voltage, 5/-, P & P 1/-.
Mains Transformers
 PRI 230v. 50c. Sec. 50v. (SOMA) 6.3v. (Ba) 4v. (1a), 25/-, P & P 5/-.
 Oil-filled PRI 220 230v. Sec. 35v. (5a) 6.3v. (2a) 225v. (27 ma), 25/-, P & P 5/-.
 Oil-filled PRI 230v. 45-65c. Sec. ov 70v. 75v. 80v. (4a), £2/10, P & P 10/-.
Capacitors. 30 assorted .05PF to 1MFD (our selection), 10/-, post paid.
For the enthusiast
 Remote control unit type 7746.
 Contents 1 relay type 4c and 1 type 1c sealed multi-contact, 25/-, P & P 5/-.
Aerial Type Junction Box Type 7089A
 Contents 1 relay type 4c sealed multi contact, 2 aerial relays Londex type 7026. Coil V 18/24 D.C. coil resistance 400 Ohms. R/FN type connector 50 Ohm input. Input capacitance .05 PF contacts S/P C/O, 45/-, P & P 5/-.
 Send S.A.E. for full component lists. CASH WITH ORDER.

Head Office:
 Dept. 5, STATUS HOUSE, WILKINSON AVENUE,
 WEST PARK DRIVE BLACKPOOL. Tel. 62788 (2 lines.)

Croftfilm Ltd.

Eddystone, Heathkit, Radiospares, Sinclair, Eagle, etc.

Kits, Parts, Spares, Plugs, Leads, Hi-Fi Audio, Gram Decks, Amplifiers, Aerials

Everything for the Amateur, Experimenter and Hi-Fi Enthusiast

46 FRIARGATE, PRESTON, PRI 2AT

Telephone: 55244
 24 Hour Answering Service

G3XKF G3XKF
Minitenna Beam Products

Use a MINI-TEN 2 Element Beam for your ten metre contacts. Overall length 10ft. 8in. Weight 8½ lbs.
 Only £8 19s. 6d. (Post and packing 10/-)

Brand New, R.C.A. OSCILLATORS, type PX No. C.I. Size : 19" x 19" x 16". Comprising: Crystal Oven, V.F.O., Balanced Modulator, 2 x 6V6 output, low pass filter, internal calibrator. Coverage : 160, 80, 40 metres, with built-in 230v. supply. Must have cost originally £400. Offered with manual for £15 each. Buyers collect.

MINITENNA BEAM PRODUCTS

(J. Sharratt)

EDLESBOROUGH, DUNSTABLE, BEDS. Tel. Eaton Bray 297

ASTRO-MARINE SALES

EDDYSTONE AGENTS - CODAR - HALSON
 JOYSTICKS - COMPONENTS

Hickok, sig. gen., 90 kc/s. to 50 mc/s. with output meter, £8.10.0. Carr. 10s.

H.R.O. with 8 coils, £18. Carr. £1.

H.R.O. rack p.s.u., £5.10.0. Carr. £1.

No. 19 set, £4. P.s.u. 12v., £2.10. Carr. £1 and 10s.

No. 31 set, £5. Carr. 10s. No. 38 set, £2.10. Carr. 10s.

45/47 Eastborough, Scarborough, Yorks.

Telephone : SCAR 5402

BAGINTON ELECTRONICS

- G3TFC (SALES) Ex ZC4JC
- XTAL CONTROL UNITS. 34 xtals, 3 outputs, 36.495 to 39.74 in 250 kc. steps. 13.54 to 13.99 in 50 kc. steps and 29.697 to 30.597 in 100 kc. steps. 3 valves type CV138 with circuit. P. and P. 4/6 £3
 - BENDIX RAIJ RX. 2.5-20 mc. Long and Medium, 1.6 mc. IF, BFO. Octals. Circuit. P. and P. 10/- £8
 - COLLINS ARRIS/51H3 RX. 1.5-18.5 mc. 6 Bands, 70E2 PTO L.O. 70E3 PTO BFO. Automatic or manual tuning, size 10 x 8 x 20. HT250 LT24. P. and P. 15/- £60
 - COLLINS 180K. 10 channel preset remote ATU £40
 - COLLINS AN/ART13 TX. 1.8-18 mc. VFO or xtal. P.A. 813, MOD 81 Is. HT 400-1100. LT 24v. Circuit. P. and P. 30/- £10
 - AT18/ARCI VHF TX/RX. 100-156 mc., 832 PA, HT 350-500v., LT 24v., 8 watts output. Circuit. P. and P. 20/- £8
 - HALLICRAFTERS RX. TRCI. Single channel. 70-100 mc., 115 or 230v. A.C. Circuit. P. and P. 20/- £7
 - R2/ARR3 RX. Tunable 60-100 mc., approx. 24v.-250v. P. and P. 10/- £5
 - 1815 VHF SIG. GEN. AM or FM 99-156 mc. 230v. A.C. P. and P. 20/- £12
 - MARCONI ADI07 TX UNITS. 2-18.5 mc. 150-200 watts. MODULATOR. PP 829Bs, Clipper, Filter. Circuit. P. and P. 10/- £4
 - PA UNIT. Parallel 29Bs. 829B driver metered. P. and P. 10/- ATU. Variable inductor 2000 pF variable metered. P. and P. 10/- £4
 - DRIVE UNIT. CV173 out. Blower cooled. Circuit. P. and P. 7/6 £3

BAGINTON ELECTRONICS (SALES)
 MARKET CORNER, BAGINTON, WARKS. (near Airport)
 Postal Code CV8-3AP. Tel. TOLL-BAR 3688
 Robophone 24 hour service.

HENRY ELECTRIC LEEDS

TELEPHONE LEEDS 622131

- TRIO SSB TRANSCEIVER TS 500. 200 watts PEP. 80 to 10 metres. also CVT and AM. Beautiful. Efficient and outstanding value for money. Transmitter with external matching power supply, £203. Trio VFO 5 which greatly extends the versatility of the equipment at £28, carriage £1. A LARGE sae for full specs.
 - TRIO 9R59DE. General coverage receiver 550 KHz to 30 Mhz. Bandspread turning over Amateur bands. Employs two mechanical filters, product detector and large easy to read "5" meter. Large sae for leaflet. £39/15/-, carriage 10/-.
 - TRIO JR 500SE COMMUNICATIONS RECEIVER. All Amateur Bands from 3.5 Mhz to 29.7 Mhz. Direct reading down to 1 KHz. Dial speed ratio of 28-1. Incorporates solid state VFO with output for external Tx control, £68, carriage 10/-, Large sae for leaflet.
 - HEATHKIT DX100U. Misc. Hardly used. Built by Daystrom, £57, carriage 30/-.
 - SKY BANDIT. Aircraft bands VHF Air Port Tower, Approach control and Emergency communications. Private and Air Line traffic PLUS BROADCAST AM, £23, P.P. 5/-.
 - CONCORDE TRANSISTOR RADIO. Aircraft Band VHF and Broadcast, as above. Strong clear signals from flying aircraft and distant Air Control Stations. £17/15/-, P.P. 3/-.
 - EDDYSTONE General Coverage Communications Receiver Model 840 C, 480 KHz to 30 Mhz. Very smart appearance and excellent performance. Complete with matching plinth speaker, £45, carriage £1.
 - CODAR PR30X. Most popular preselector. Self-powered version 20 db gain and substantial image rejection. First-class condition, £6, P.P. 5/-.
 - CODAR RQ10X Q MULTIPLIER/FILTER. For IFs 450 to 470 kc/s. provides considerable increase in selectivity either peaking or rejecting a signal. The RQ10X is the self-powered version. Outstanding Condition, £6/15/-, P.P. 5/-.
 - LAFAYETTE HE 30, coverage 540 KHz to 30 Mhz, in excellent condition, £21, carriage £1.
 - TVI BANISHED. High passfilters sharp cut off below 40 Mhz. Neat metal case clips on to back of offending TV set. Short fly lead and coax plug and socket. Just insert in the TV line. A boon, 25/- each, P.P. 2/6.
 - LEARNING MORSE? Code Oscillators. All-Transistor, Speaker and jack for earphone. Key terminals and pitch control. Very smart appearance, 65/-, P.P. 2/6.
 - GBKW TRAP DIPOLES. For all amateur bands, 80 to 10 metres. Complete with coaxial cable and ribbed glass pyrex insulators, ready to install, £10/12/6, P.P. 5/-.
 - DURAL MASTS, 28ft. x 2in. Dural masts. In two sections of 14ft. each complete with sturdy jointing sleeve, base plate and two guy clamps, price £12/15/-, carriage paid.
 - CERAMIC COIL FORMERS, 2½in. diameter x 4½in., long grooved for winding, 21/- each.
 - ANTENNA INSULATORS, ribbed heavy duty, 7in. long, 10/- each, 3½in. long, 5/3 each, P.P. 1/6.
 - Beehive, egg and dipole centre insulators also available, P.P. extra.
 - Shack Table metal shade adjustable angle lamps in black or white enamel finish (other colours available). Sturdily built, heavy base for stability, £3, P.P. 3/-.
- Make the National Amateur Radio Organisation strong. Join the R.S.G.B. Get your application forms from us. Greetings to old-timers Ted King G3DCC, John Spafford G4RB, John Van Puyenbroek G2AVP and many others for QSOs of more than 20 years ago De AP2N.

HENRY ELECTRIC LTD., 60 HARROGATE RD., LEEDS 7

R. T. & I. ELECTRONICS LTD.

where equipment is fully overhauled

KW2000, with A.C. and D.C. p.s.u.'s	£175 (60/-)
R.C.A. AR-8516-L, 18 waveband, 80 kc/s-30 mc/s.	£175 (40/-)
Hammarlund HQ-180-A, 540 kc/s-30 mc/s., triple conversion	£165 (30/-)
Eddystone EA12, bandspread receiver	£150 (30/-)
Hammarlund HQ-180, 540 kc/s-30 mc/s.	£140 (30/-)
Eddystone 770U/2, 150-500 mc/s.	£120 (30/-)
Hammarlund HX-50 transmitter, 10-160 metres	£115 (40/-)
Hammarlund HQ-170, bandspread receiver	£110 (30/-)
Hammarlund HQ-110-A, bandspread receiver	£95 (30/-)
Eddystone 888A, bandspread receiver	£85 (25/-)
Heathkit DX-100-U transmitter, with SB-10 s.s.b. unit	£75 (60/-)
Heathkit DX-100-U transmitter	£55 (60/-)
Lafayette HA-350, bandspread receiver	£55 (25/-)
Eddystone 680X, 480 kc/s-30 mc/s.	£85 (30/-)
Eddystone 840C, 480 kc/s-30 mc/s.	£48 (25/-)
Heathkit GC-1U "Mohican"	£35 (20/-)
Eddystone 840A, 480 kc/s-30 mc/s.	£35 (25/-)
Lafayette LA-5-A, 108-136 mc/s., aircraft receiver	£17/10 (15/-)
BC-221 frequency meter, with original charts	£25 (15/-)

WE CAN ALSO SUPPLY ANY MAKE OF NEW EQUIPMENT—and have pleasure in giving a few examples, which are mainly in stock:—

AVOMETERS, Model 7, Mk. 2, £25; Model 40, Mk. 2, £25; Model 8, Mk. 3, £27; Model 9, Mk. 2, £27; Multiminor, Mk. 4, £10 (post free).

S. G. BROWN'S HEADPHONES, Type E, £120 ohms, 2,000 ohms, 4,000 ohms, £37/6 (3/6). Earpads for a.m., 6/- per pair. Type 3C/1100, noise excluding (with superb fitting), high quality, electro-dynamic, £6/6- (3/6).

KW EQUIPMENT. Vespa Mk. 2, transmitter with A.C. p.s.u., £135. KW-201 amateur band receiver, £111. Also Calibrator, £6; "Q" mult., £8/10/-; KW-2000-A Transceiver with A.C. p.s.u., £232; D.C. p.s.u., £42. KW-1000 Linear, £135. KW-600 Linear, £115. KW Vanguard, £85. KW E-Z match, £12/16/-; KW Match, £8/14/6. Antenna switch, £3/3/-; CODAR, AT5, £16/10/-; 250S, £8; 128, £15/10/-; PR30X, £7/4/-; CR70A, £19/10/-; 12/MS, £11/5/-; 12/RC, £2/7/6, etc., etc.

PARTRIDGE "Joystick," "Joymatch," etc. Lists and details on request.

TRIO EQUIPMENT. Receivers, JR-60-U, 540 kc/s-30 mc/s. and 2 metres, £61/19/- (25/-); JR-500-SE, bandspread, £68 (10/-); 9R59DE, 540 kc/s-30 mc/s., £37/10/- (10/-); 9R-59, 540 kc/s-30 mc/s., £34/13/- (15/-); Transceiver, TR-500-E, £165; PS-500-E A.C. p.s.u., £38; VFO-5 v.f.o. unit (not essential for station), £28, OR enquire for package deal. Loudspeaker, SP-5D "Speaker-mate" to match trio receivers, etc., £4/2/-.

Our latest list of over 50 receivers, and many other interesting items sent free upon receipt of your s.a.e.

CARRIAGE for England, Scotland and Wales shown in brackets.

TERMS: C.W.O., Approved Monthly Accounts, Hire Purchase and Part Exchange.

R. T. & I. ELECTRONICS LTD.

Ashville Old Hall, Ashville Road, London, E11 Tel: 01-539 4986

SMALL ADVERTISEMENTS

("SITUATIONS" AND "TRADE")

9d. per word, minimum charge 12/-. No series discount. All charges payable with order. Insertions of radio interest only accepted. Add 25% for Bold Face (Heavy Type). No responsibility accepted for errors. Replies to Box Numbers should be addressed to The Short Wave Magazine, 55 Victoria Street, London, S.W.1.

ADVENTURE OPPORTUNITY!

BRITISH Antarctic Survey requires **Wireless Operators** to serve in the Antarctic. Good pay and conditions for accepted applicants—money in the bank when you come home. Candidates must be able to work reliable CW at 20's. Salary, etc., according to qualifications and aptitude.—Applications for **Personnel Officer, British Antarctic Survey**, 30 Gillingham Street, London, S.W.1. (01-834 3667.)

TRADE

TRIO Equipment: Save 2s. 6d. in the £: Example 9R59DE, listed £39 15s., our price £35, carriage paid. Also a G2DAF-type Mk. I Transmitter, in Imhof cabinet, price £40. And an AR88LF, fitted 1/2-lattice filter, audio AGC, £25.—**Couplphone Productions, Ltd.**, 18 Roper Street, Whitehaven, Cumberland.

RETAIL Outlets wanted for new/unused surplus. Good Quality and Good Profits. Write for details. —Box No. 4685, Short Wave Magazine, Ltd., 55 Victoria Street, London, S.W.1.

QSL Cards for Tx and SWL. Send s.a.e. for samples, stating which type required. Prices from 10s. 6d. per 100, purchase tax and post paid.—**Beaumont, G5YV**, 8 Ashfield Avenue, Morley, Leeds.

SERVICE SHEETS: On Radio, Television and Tape Recorders, 1925-1958 models, from 1s. each by return post, with free fault-finding guide. Catalogue covering 6,000 models, 2s. 6d. Please include s.a.e. with enquiries.—**Hamilton Radio**, 54 London Road, Bexhill, Sussex.

QSL Cards: Two-colour, attractive design, variable features, from £3 3s. per 1,000 (inclusive). Send foolscap s.a.e. for samples.—**ARA Press**, 46 Mont Avenue, Green Lane, Coventry.

QSL Cards and Log Books, GPO approved, cheapest and best. Prompt delivery.—**Samples from Atkinson Bros.**, Printers, Looe, Cornwall.

OFFERED by Jim Fish: Silicon rectifiers, 880v. 500 mA, 2s. 6d. Printed boards, 6-transistor, 1s. Radio knobs, 1s. a dozen. Skirted valve holders, B9A, 5s. the dozen. Pre-set air gap trimmers, 20-60-100 mmF, 1s. each. Valves: 6L7M, 6F6M, 6J5M, 954, 955, 1s. 6d. each. Tavasu mobile aerial, complete for 160m., £5 6s. Five-element beams for two metres, 52s. 6d.; three-element for 70 mc, 45s. For aerial poles, etc., see advertisement p.386 August issue. Please add postage.—**Fish, G4MH**, 28 Banks Avenue, Golcar, Huddersfield, Yorkshire.

SPARES for AR88D and AR88LF receivers. Send s.a.e. for lists. AR88 medium-sized knobs, set of eight for 12s. HRO coil packs, range 180 to 430 kc, 10s. each, postage 4s. 6d.—**A. J. Reynolds**, 5 Headland Way, Lingfield, Surrey.

OCTOBER Issue due for publication on **September 27**. Single-copy orders, 4s. post free, should reach us on **Wednesday 25th**, for despatch on **Thursday 26th** and delivery in the U.K. on publication day.—**Circulation Dept.**, Short Wave Magazine, Ltd., 55 Victoria Street, London, S.W.1.

S.S.B. PRODUCTS, DERBY

NEW:

SPHINX. Mk. 2 Tx. 80 watts. Complete	£85 (£1)
PYRAMID 80 watt Linear. All parts	£52 (30/-)
CANNONBALL TX. 160m. or 80m. versions	£38 (8/-)
DELTA. Coaxial rel., A.C. i.p. PTT	£7 5s. (4/6)
NAPOLEON. S.V.R. Bridge. 70-80 ohm.	£5 5s. (4/6)
DUMMY LOAD. Carbon. 100 watt. 70 ohm. i.p.	£3 (3/-)
SCARAB XTAL FILTER KIT. Inc. carr. xtal	£7 (2/-)
SCARAB FILTER and carrier xtal. 3" x 1" x 2"	£8 7s. 6d. (2/-)
SILPLUG. Replace 5v. rect. 500v., 30/- x 750v.	40/- (2/-)
2 METRE. 5 el. W/S Beam plus Masthead clamp	49/6 (6/6)
1000 WATT PL-CHOKER. 4 BA. fixing F.B. c/ck	9/6 (1/-)
SCARAB XTALS. Filter xtals plus carrier xtal	102/- (1/-)
G2DAF XTALS (including sockets) L.F.	each 33/-
	Final H.F. each 27/-
6HF5. New matched valves within 1 m/a.	each 36/6 (2/3)
6146. New matched valves.	each pair 65/- (3/6)
	each 32/6 (2/3)
6HF5 BASES. Brand new American. Plenty at each	4/6 (6d.)
TRIO T.S.500 Transceivers. 80-10m.	£165 (£1)
TRIO P.S.500 Power Unit. 240v. i.p.	£38 (25/-)
TRIO V.F.O. to go with T.S.500	£28 (6/-)
TRIO COMPLETE OUTFIT. All three units—Special Price	95/- (4/6)
DYNAMIC MIC. DM16HL with lead. Only	£9 5s. (4/6)
BM3 MIC. with lead, neck cord. New. Boxed each	32/6 (4/6)
BM3 MIC. inserts. New Stock. Only	each 9/6 (1/-)
BUG KEY K102. Few left at only	£9 5s. (6/-)
ELECTRONIC KEYS. Type DA1. Few at each	16gns. (7/6)
SPHINX and PYRAMID Cabinets. Chassis and pml.	
plain. Latest design, very modern. Real Bargain	99/6 (9/6)

BELOW SECOND-HAND BARGAINS ALWAYS:

H.P. Part Exchange

HALLICRAFTERS S36. 27-145 mc/s. Very good condition. speaker	£36
VANGUARD TX NEW 6146 and SILPLUG. Good condition	£40 (30/-)
EDDYSTONE 888A. Very excellent condition. Hammer grey	£65 (£1)
SR.550 rec. 160m. to 56 mc. Ham bands. Bargain at	£38 (15/-)
COSSOR 343 WOBULATOR. Tested O.K. Good condition	£9 (15/-)
GZYH 2m. CONVERTER. 28-30 mc. i.f. Bargain	£6 (4/6)
CLASS D WAVEMETER. 240v. reconditioned F.B.	£9 (7/6)

Please send s.a.e. or 8d. stamps for our latest lists. More lines to offer and always a by return safe service.

S.S.B. PRODUCTS, 7A EDWARD STREET, DERBY 42909/42961

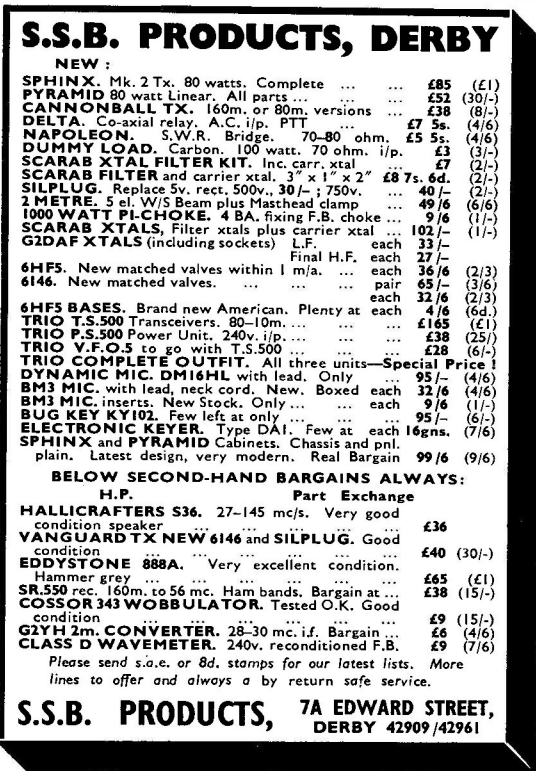

READERS ADVERTISEMENTS

3d. per word, minimum charge 5/-, payable with order. Add 25% for Bold Face (Heavy Type). Please write clearly, using full punctuation and recognised abbreviations. No responsibility accepted for transcription errors. Box Numbers 1/6 Extra. Replies to Box Numbers should be addressed to The Short Wave Magazine, 55 Victoria Street, London, S.W.1.

WANTED: Heathkit VF-1U VFO; also Joystick and tuner, ATU.—Idiens, G3XBP, 77 Amersham Road, High Wycombe (29317), Bucks.

WANTED: Minimitter 2-7; T.W. two-metre Communicator for AC mains; Hallicrafters VHF receiver; two-metre converter; and an R.1084. (Berkshire).—Box No. 4684, Short Wave Magazine, Ltd., 55 Victoria Street, London, S.W.1.

FOR SALE: Home-built Heathkit RA-1 receiver (S-meter kaput!) with speaker and 100 kc xtal calibrator. Resolves SSB easily. Price £20, and can deliver to reasonable distance.—Kemble, G3UYK, QTHR.

SALE: Telequipment 'Scope Type S.51A, 5in. tube, printed circuit construction, new and hardly used, cost £55, accept £40.—Wigham, 18 Glen Helen Street, Salford 5, Lancs.

WANTED: Drake T-4X transmitter; would consider TR-3 or TR-4 transceiver. Also a linear amplifier, such as KW-600, KW-1000, SB-200 or similar.—Coull, Avenue House, Littlestone, New Romney, Kent.

SALE: Eagle RX-60N, perfect, coverage 55 kc to 30 mc, with S-meter, BFO, AVC, really lively down to 20 mc. Price £9 collected, or would exchange for Joystick and tuner with cash adjustment.—Loose, 43 Willows Crescent, Birmingham, 12.

WANTED: CR-100 or HRO receiver, must be in excellent condition, with PSU.—Jones, 113 King George V Drive, Cardiff (754437), South Wales.

FOR SALE: Codar PR-30 preselector and RQ-10 multiplier, at 60s. each.—Adam, 5 Vicarage Road, Stoneleigh, Coventry, Warks.

SALE: Heathkit GC-1U Mohican receiver, £23. R.107, price £10. CR-100, completely rewired and sprayed as new, £22. Two No. 36 Sets, at £10 each. Assorted valves, new, 200 for £20.—Bosten, 22 Barrington Road, Newton Aycliffe, Co. Durham. (Tel. Aycliffe 2454.)

SELLING: Channel Master automatic rotator, used one week only, £15 or near offer.—Ginder, 222 Whetstone Lane, Aldridge, Staffs.

WANTED: Heathkit DX-100U Transmitter; must be in good condition, with no mods. (Leicestershire).—Box No. 4685, Short Wave Magazine, Ltd., 55 Victoria Street, London, S.W.1.

SALE: HRO, eight GC coil packs, also R.208. Both in good order, £15 the pair. Or would EXCHANGE for good vertical aerial array, SWL with mast, or what-have-you?—Cole, 4 Baldwin Street, Hawcoat, Barrow-in-Furness, Lancs.

SELLING: Eddystone 870 Rx, £8. Codar PR-30X preselector, £4. RQ-10X, £5. Leak Variscope III and TL25, £20. Also Eddystone 940 Rx on plinth—what offers? Part-exchange suggestions on receivers welcomed.—Snowden, Swainsea Lane, Pickering (2560), Yorkshire.

OFFERING: Vanguard Tx, coverage 10 to 160 metres, £30 or near. Labgear LG.50 transmitter, 10 to 80m., £20 or offer. Both these in good working order. Moving QTH, so HF bands QRT. Prefer buyers inspect and collect.—Keeble, G3TUU, 7 Woburn Avenue, Kirby Cross, Frinton-on-Sea, Essex.

SALE: BC-221 frequency meter, complete with charts, £15. Class-D wavemeter, complete, £5 10s. Crystal calibrator, No. 7 Mk. I, 10-100-1000 kc, £4. Test Set BG3, 160 to 220 mc, with 5 mc check points, £4. Douglas coil winder, fitted turns counter, £4. All items at near offer, and callers only.—Griffiths, 5 Swanage Road, Small Heath, Birmingham, 10.

WANTED: An AC PSU No. 24 (for the R.216 Rx), in matching cabinet.—Kerley, 23 Rushton Road, Cheadle Heath, Stockport (9245), Cheshire.

EDDYSTONE IN DEVON

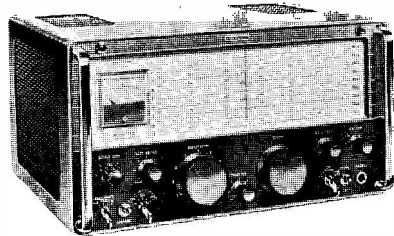

EA12 £195

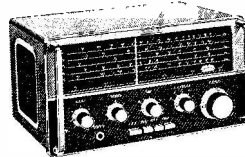

EC10 £64

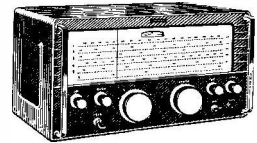

840C £70

FULL H.P. FACILITIES

S.A.E. FOR LISTS

GRAHAM NEWBERY

(Reg Ward, G2BSW)

AXMINSTER DEVON

Phone: Axminster 3163

Echelford Communications

32 FELTHAM HILL ROAD, ASHFORD, MIDDX

Many visitors to Echelford Communications ask—Why Echelford? What does it mean? Those of you who live in S.E. England will know that a town of no small size in Kent is called Ashford, as with the towns of Newport, the county becomes as important as the town itself (The GPO have a stamp "Nor known Ashford Kent try Middlesex"). To avoid confusion with Ashford, Kent history was delved into.

So it came to be that a village in Middlesex referred to in the Domesday book as "Exforde" became "Echelford" in the middle ages and around the 17th Century it became "Ashford." The river bearing the name has long since disappeared into a gravel pit! Although the name may belong to the middle ages—Echelford Communications belongs to the 20th Century.

Now to this months musts:—

HALSON MOBILE WHIPS. Complete with one coil £6 17 6
Extra coils (160, 80, 40, 20) £3 17 6

TELESCOPIC WHIPS, as used on Halson, open to 8ft. 6in. £2 5 0

J. BEAMS for 4 Metres, 2 Metres and 70 cms.

ECHELFORD 4 METRE TRANSMITTER. 5W to final (s.a.e. for details) £30 0 0
(2 metre version available shortly)

100 mixed 1W and 2W Resistors, 2/3 a bag (post free) or 3 bags for 6/- (post free).

RSGB, Data and Iliffe publications in stock.

ASHFORD MIDDLESEX—3 miles south of London Airport

Weekday opening times 9.00-6.00 (Lunch 1-2).

CLOSED ALL DAY WEDNESDAY

ASHFORD (MX) 55265 up to 9.30 p.m. any evening.

ALAN WHEELER G3RHF

K. W. COMMUNICATIONS LTD.

A selection from our second-hand list of tested trade-in equipment.

TRANSMITTERS :

KW VALIANT. AM/CW. 10-160 metres. No p.s.u., fair	£20
KW VESPA Mk. I. SSB/CW. 10-160 metres. No p.s.u., very good	£80
KW VESPA Mk. I. with A.C. p.s.u., very good	£95
KW A.C. p.s.u. (KW2000A). Less speaker and cabinet	£30
HEATHKIT APACHE. 10-80 AM/CW. Very good	£65
SB10 SSB Adaptor. Choice of two, very good	£28
DX40U with V.F. IU V.F.O. As new	£40
DX60A. Crystal controlled, provision for V.F.O. As new	£35
LABGEAR LG-50 with A.C. p.s.u. Good	£25
PANDA PR-120-V. 120 watts AM/CW. Fair	£30

RECEIVERS :

KW "Q" Multiplier. Good	£6
COLLINS 75-S-3B. Immaculate. As new	£285
COLLINS 75-S-1. Very good	£155
DRAKE R4. As new	£145
Drake 2B Receiver, very good	£80
EDDYSTONE 840C. Very good	£60
EDDYSTONE 680X. Very good plus speaker and feet	£65
HALLICRAFTERS SX117. Very good	£100
HQ 100A. General coverage. Bandsread. Very good	£70
HQ 180. General coverage. Triple Conversion. Very good	£120
HQ 170A Hambander, with speaker, as new	£165
HEATHKIT MOHAWK Hambander. Very good	£75
RG-1. General coverage. Good	£35
LAFAYETTE HA350. 240v. As new	£55
MINIMITTER MR44. Good	£35
H.R.O's. Some coils. Good	£15
SR550 Hambanders, choice of two	£45

Carriage extra all items

K. W. COMMUNICATIONS LTD.

1 Heath Street, Dartford, Kent. Tel.: Dartford 25574 or 21912

G5JV REX RADIO G3JVM

HALLICRAFTERS S120 receiver, absolutely as new, 550 kHz to 30 MHz plus professionally made cabinet to house this Rx, Codar Preselector and Q Multiplier ... £20 0 0

NEW TRIO EQUIPMENT :

9R59DE. Continuous coverage receiver, 550 kHz to 30 MHz (4 bands) incorporating mechanical filter ... £39 15 0

JR500SE. Amateur bands only 3.5 MHz to 29.7 MHz (7 bands). Exceptional stability through use of crystal controlled first oscillator and transistorised Vaccar variable frequency oscillator for tunable I.F., for selectivity a mechanical filter is used ... £68 0 0

TS500. S.S.B. Transceiver 3.5 MHz to 29.7 MHz (7 bands) Double conversion. 200W PEP input on S.S.B. and C.W., 17 valves, 3 transistors and 15 diodes. Built-in crystal calibrator, plus many other features. Only ... £165 0 0

PS500. A.C. power supply and speaker unit for above ... £38 0 0

VFO 5. Variable frequency oscillator for use with TS500 to enable complete split frequency operation, as on all Trio 500 series direct reading of frequency at 1 kHz intervals ... £28 0 0

PICKSTONE. Instant heat soldering irons ... £3 9 6

TENN-A-LINER. Automatic rotator No. 9528 ... £19 19 0
Alignment bearing for above No. 9523 ... £3 17 6

Aluminium masts, wall brackets, etc., all sizes in stock.

Your old equipment taken in part exchange or bought for cash.

329 Kilburn Lane, London, W.9

Telephone : 01-969 1770

SHOWROOMS AT 301 KILBURN LANE W.9

SMALL ADVERTISEMENTS, READERS—continued

MUST Sell Heathkit RA-1 receiver, in mint condition, just been fully checked through and aligned by manufacturers, £40 or near offer, or will take in PART EXCHANGE a good AR88D.—Durrant, 1 Stonegate Grove, Meanwood, Leeds 7, Yorkshire.

FOR SALE: Hallicrafters S.240 receiver, four bands plus VHF, mains, purchased April '68 for £51 and little used, bargain at £40.—Thorn, 36 Willow Way, Dovercourt, Essex.

SELLING: R.C.A. AR88D, in good condition, with manual, £35.—Jones, G3WPJ, 17 Bowood Road, Taunton, Somerset. (Tel. Taunton 81192, night.)

EXCHANGE or Sell: Lafayette HE-30 communications receiver, bandsread, AM/CW/SSB, with Q-multiplier and speaker, in new condition, £20 or near offer—or Exchange for tape recorder of reputable make. (Midlands).—Box No. 4686, Short Wave Magazine, Ltd., 55 Victoria Street, London, S.W.1.

FOR SALE: No. 52 Set, with case, calibrator, built-in 250v. PSU and manual, offered in brilliant condition and ready to plug in, at £16. Also brand new portable oscilloscope by Heathkit, beautifully built and in full working order, price £25.—Mobbs, Cross Farm, Waldron, Heathfield, Sussex.

SELLING: Labgear LG.50, with mods. to give T9 note, recent new mains transformer, PA and other valves, price £25.—Brown, 125 London Road, Holyhead, Anglesey.

EXCHANGE: Complete dark-room equipment, including two enlargers, for good communications receiver, or sell at £60.—Morgan, 9 Langstone Court, Cwmbran, Mon., South Wales.

FOR SALE: Eddystone 750 receiver, £35. Any offers for the following: Woden UM2 modulation transformer; an oil-filled mains xformer giving 620-0-620v. 248 mA, 465-0-465v. 48 mA; another similar rated 50v. 2A, 5v. 5.6A, 5v. 3A, 6.3v. 5A, 6.3v. 2A, 6.3v. 1A and 6.3v. 0.6A. Smoothing choke, 20 Hy 60 mA. Two rotary converters, 28v. DC input to give 540v. DC at 250 mA. A 1/6th h.p. DC motor, 220v. Will deliver in South Wales area.—Box No. 4688, Short Wave Magazine, Ltd., 55 Victoria Street, London, S.W.1.

SALE: Factory-built Heathkit RA-1 receiver, in immaculate condition, hardly used and still under guarantee, with 100 kc crystal calibrator and speaker unit, asking only £35, with free delivery to any reasonable distance.—Knights, G3TQY, Ashar, Cross Road, Tadworth (3247), Surrey.

SELLING: Eddystone S.750 double-superhet general coverage receiver, £40 or near offer. Also J-Beam aerials complete: Two-metre, 4-ele Yagi, 27s. 6d.; 14-ele long Yagi for 70 centimetres, 60s.—Newey, 23 Lea-House Road, Oldbury, Warley, Worcs.

EXCHANGE or Sell: HW-100 with PSU; Pyramid 800w. linear amplifier, 10-80m., with internal PSU, aerial relay, ALC and four spare 6HF5's, all brand new. Offers for cash, or Exchange KW-2000 or KW-2000A. (Cornwall).—Box No. 4687, Short Wave Magazine, Ltd., 55 Victoria Street, London, S.W.1.

FOR SALE: Eddystone EB-35 receiver, in as-new condition, price £45.—Saxby, Studio 59, 59 Shaftesbury Avenue, London, W.1. (Ring 01-437 3141, day, or 01-723 6455, evenings.)

SELLING: An Eddystone EC-10 receiver, in excellent condition, price £30. Buyer to collect, or pays carriage.—Bristow, G3XCX, 33 Woodland Avenue, Goole, Yorkshire.

FOR SALE: Home-built gear, consisting of general-coverage 5-valve + 2-transistor superhet receiver, tuning 550 kc to 17 mc. Includes Q-multiplier, S-meter and BFO; needs external PSU. Price £12 or near offer. Also EF184 preselector, covering 600 kc to 30 mc, £4. Send s.a.e. for further details.—Turner, 225 Westborough Road, Westcliff-on-Sea, Essex.

SMALL ADVERTISEMENTS, READERS—*continued*

FOR SALE: Clarion battery tape-recorder, complete with microphone, headset and two tapes. Only 9½ in. x 5 in. x 3½ in. Little used and in new condition. Cost £23, will accept £12 for quick sale.—Leask, 4 The Myrtles, High Street, Sidmouth, Devon.

SALE: An R.C.A. AR88LF in good condition, price £35.—Daws, 44 West Park Grove, Leeds 8, Yorkshire. (Tel. Leeds 664362.)

MANUALS Available: B.40, 38s.; BC-348, BC-312, CR-100, S.27C, 25s.; AR88D, AR88LF, SX-28, 20s.; Collins TCS, Cossor 339, 35s.; AR77E, SX-20, SX-23, SX-24, S.36, R.220, R.1132A, HRO-MX, S.640, 358X, R.206, R.208, R.209, R.107, 12s. 6d.; R.1155, 30s. 62H, P.104, R.216, CR-150/4, 19 Set Tx/Rx, 18 Set Tx/Rx, 46 Set Tx/Rx, No. 62 Tx/Rx, 52 Set Tx/Rx, 88 Set Tx/Rx, T.1154 Tx, 15s.—Brooks, 5 Farrant House, Winstanley Road, London, S.W.11.

WANTED: K.W. Vespa or similar all-band AM/SSB Tx in part exchange for nearly new Sphinx Mk. II, or direct cash transaction.—Linney, G3VQL, QTHR. (Tel. Shrewsbury 51733.)

WANTED: Z-match ATU, K.W. or similar.—Taylor, GMBUNJ, 23 Haughgate Terrace, Leven, Fife, Scotland.

SELLING: Factory-built Heathkit DX-100U, in excellent condition, £45, buyer to collect.—Woffenden, G3UGB, 89 Beechen Drive, Fishponds, Bristol.

SELLING: Some miniature electrolytic capacitors, suitable for transistor applications, all at 4d. each, or 3s. per assorted dozen—5 mF 6v., 10 mF 15v., 30 mF 6v., 50 mF 6v., all working voltages. Postage 4d.—Forster, G3WKQ, 12 Mitchell Road, Palmers Green, London, N.13.

WANTED: "Town and Country" portable Rx by Perdio, must be in tip-top condition and working order, with no modifications. Can collect to 50 miles radius. All letters answered.—Perryman, G2APN, QTHR.

SALE: Heathkit GC-1U Mk. II Mohican Rx, factory built and only 8 weeks old, in mint condition, £28. B.44 Mk. II 4metre transceiver, fully converted, tunable Rx side, with 4 xtals and built-in vibrator PSU, price £8 plus carriage.—Ballance, G3KNE, QTHR.

SELLING: Trio 9R-59DE receiver, brand new and boxed, £25 or near offer. Codar A.T.5 and AC/PSU, £15.—Garvey, 7 Osmund Street, East Acton, London, W.12.

SALE: Hallicrafters S.27 receiver, £21. TBY-8 Tx/Rx, coverage 27 to 80 mc, £7. Waveform generator, £3. PSU mains, 6v. 13A DC, 220v. DC, £5.—Box No. 4689, Short Wave Magazine, Ltd., 55 Victoria Street, London, S.W.1.

WANTED: IF Unit Type No. 125, 7.5 mc, serial no. 1282, for the R.3673 receiver, must be complete and working. Also a 3-valve oscillator and crystal holder for the R.1392A Rx, complete and in working order, and a clear circuit diagram for R.1392A receiver.—Corner, 41 Smarts Lane, Loughton, Essex.

WANTED: Lafayette or Trio communications receiver, such as HA-230, HE-30, 9R-59, HA-700, HE-80 or 9R-59DE. Good price offered for receiver in perfect condition. Also Joystick aerial, with tuner. Please write with full details.—Mann, G8BBW, Ashdown, Miles Lane, Cobham (2391), Surrey.

FT-241A Crystals: Many available in accurately matched sets for CW and SSB, also single crystals for 370-440 kc and 470-540 kc. Transistorised converters for 2m. and 4m., several IF's available, price £9 less PSU, or £10 10s. with internal mains PSU. Modulators, 50 to 100 watt, several with internal mains PSU, complete and in new condition, prices vary according to facilities. Transformers, rated 60 and 100w., for 12v. input DC/DC transistorised converters, various output voltages. Send large s.a.e. for full details any item.—Sandall, G3LGK, 21 Dale View, Ilkeston, Derbyshire, DE7-4LD.

EDDYSTONE SHOWROOM



Visit the Eddystone Showroom at Imhofs and see all the popular models on permanent side-by-side demonstration. You can hear and compare the models that interest you and obtain the most expert advice about this range of superb communication receivers and accessories. Same day despatch to any part of the world, tax free for export and free delivery in the U.K. After sales service second to none.

- EB35 — £66.13. 4.
- EB36 — £56. 5. 0.
- EC10 — £64. 0. 0.
- 840C — £70. 0. 0.
- EA12 — £195. 0. 0.
- 940 — £143. 0. 0.
- 830/7 — £295. 0. 0.

Send today for full details

AT IMHOFS

Main Eddystone Retail Distributors for the London Area
 Alfred Imhof Limited, Dept. 11/9,
 112-116 New Oxford Street, London WC1. 01-636 7878
 R48

FET CONVERTERS

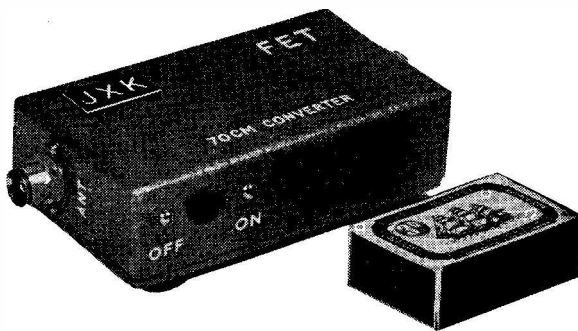

- 2 METRE FET CONVERTER.** TIS88A cascode front-end. NF less than 1.0 dB. 2 MHz. bandpass coupler ahead of 3N141 dual gate MOSFET mixer. Cathodeon VHF sub-miniature crystal. Silicon planar injection stages. High Q break. Power: 12v. at 9 ma. D.C. Positive earth. IFs: 12-14, 14-16, 18-20, 20-22, 24-26, 28-30 MHz. £16
- 2 METRE SSB TRANSVERTER CONVERTER.** Spec. as above less injection stages but including high Q break tuned to injection frequency. IFs: 14 MHz. (130 MHz. inj.), 28 MHz. (116 MHz. inj.). £12
- SATELLITE CONVERTER.** 136-138 MHz. Spec. as 2 metre unit. IFs: 20-22, 28-30 MHz. £16
- FET PREAMPLIFIERS.** TIS88A cascode front-end. NF less than 1.0 dB. 2 MHz. bandpass coupler preceding 2N3819 source follower 75 ohm output £12
- 4 METRE FET CONVERTER.** Spec. as 2 metre unit. IFs: 2.1-2.7, 4.1-4.7, 18.1-18.7, 29.1-29.7 MHz. £16

Post and packing 3/9 per item

JXK CONVERTERS
 Peel House, Porters Lane, Ospringle, Faversham, Kent.

SWANCO PRODUCTS LTD. of COVENTRY

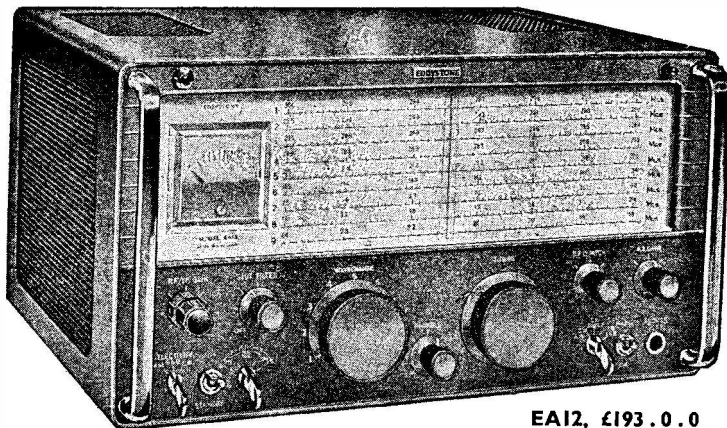

EA12, £193.0.0

Stock



EB35, £62.10.0

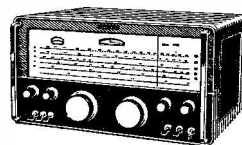

940, £143.0.0

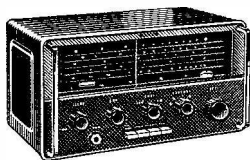

EC10, £53.0.0

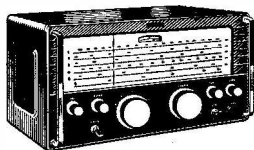

840C, £70.0.0

S.A.E. Illustrated Brochure to:

SWANCO PRODUCTS LTD.

247 Humber Avenue, COVENTRY

Telephone: Coventry 22714

SMALL ADVERTISEMENTS, READERS—*continued*

WANTED: B.40 receiver in new condition. **SALE:** Two 20ft. 2in. dural scaffold poles, £5 each. Cowl-gill motor, unboxed but new, £4; another similar, boxed, £5. Selsyn indicator Tx/Rx, 50v. 50-cycle, new, £5. Manual for the R.C.A. AR-8516L, 70s. All items plus carriage. (Lancs).—Box No. 4690, Short Wave Magazine, Ltd., 55 Victoria Street, London, S.W.1.

WANTED: Medium or high-power AM Tx for two metres; Sideband converter; linear amplifier. Offers, please.—Badger, G3OHC, 23 Aulton Road, Four Oaks, Sutton Coldfield, Warks. (Tel. 021-308 4858.)

SELLING: K.W. Viceroy Mk. IVA CW/SSB Tx, excellent quality, £100. AR88D, in good condition, with handbook, £30. Transformer, 1750-0-1750v., 0-62 kVA, £4. Heater xformer for 813, 20s. McElroy bug key, 40s.—Mawdsley, 129A Metchley Lane, Harborne, Birmingham, 17.

SALE: Receivers: Eddystone EA-12, mint, £115; Eddystone 840A, good, £20; Lafayette HA-350, mint, £50; R.C.A. AR88D, mint, £40; Star SR-700A, brand new, £100 (all these Rx's complete with manuals). Also a Minimitter MR-44, as-is, £5; BC-348, as-is, 60s.; R.1132, tunable VHF, looks OK, 60s. battery operated, looks OK, 60s. Codar Preselector PR-30, as new, 60s. Test equipment: Hartley Type 13A 'Scope, complete with all accessories and in very good condition, price £18; BC-221T, with original charts, also in excellent condition, £20; American multimeter, similar to Avometer, bargain at £5. Carriage extra on all items, but prefer cash-and-carry deal.—Dumbleton, G3HCM, 11 Woodburn Close, Allesley Park, Coventry (73460), Warks.

FOR SALE: Tuning Unit Type TN-16, 60s. Airmec VTVM, Model 712, £5. Dawe Instruments L/C/R Bridge, £10. Rack-mounting variable output PSU, stabilised, £5. Cash-and-carry.—Ring Passfield, 01-674 5825 (South London).

SELLING: A National NCX-5 Mk. II single-sideband Transceiver, with digital readout to 100 cycles, in perfect order and appearance. Current price (if you could get one), £350. Asking £200 complete station, PSU, microphone, key and speaker.—Kirk, G3GTW, 1 Townsend Avenue, Sedgley (4736), Nr. Dudley, Worcs.

FOR SALE: USM-45 Frequency Calibrator, 50 mc to 11,000 mc, .005%, brand new and boxed, £50. Signal generators: TS-155C/up, £45; TS-413, 75 kc to 40 mc, £40. Manuals: AR88, BC-221, OS-8B/U, USM-38, TS-34. Exchange for receiver, W.H.Y.?—Wright, 249 Sandy Lane, Hindley, Wigan (55948), Lancs.

WANTED: American tuning Units Type TN19/APR4 and TN-54/APR4, must be in good working order.—Hayward, Sunnyfields, Lighthouse Road, St. Margarets Bay, Nr. Dover, Kent.

OFFERS, please: TCS-12 Tx; NC-81X receiver with manual; TRE/TS-224 and manual; Halson BBC /ITV converter; 12in. TV, no cabinet; wavemeter covering 950 to 1200 mc; Valves: 4/250TH with bases; 2/813; 2/829; 2/872A; 4/836; 4/5R4GY; and 2/5Z4G. Mains transformers: 5v. 100A; 6-3v. seven times, 19A total; 620-550-375-200v. at 250 mA + 5v. 3A twice. Kent recorder-controller, 10in. chart; "QST" for 8 years 1945-'52; "Short Wave Magazine" for 11 years, 1954-'65. Cash-and-carry, pse.—Ring Cross, G3FN, Sheffield 35140, after 6 p.m.

REQUIRED: An Eddystone 888A, FB condition essential. For **SALE:** HRO, with all coils, speaker and PSU, £20 or near offer.—Pryse, 36 Hart Road, Byfleet, Surrey.

SALE: Lafayette HA-500 receiver, few months old and hardly used, in immaculate condition, £39 or near offer.—Wickham, 9 Wensleydale Gardens, Hampton, Middlesex.

SMALL ADVERTISEMENTS, READERS—continued

SALE: Hammarlund HQ-180 receiver, as new, with auto-transformer and handbook, £100. National HRO, table model, with PSU and 8 coil packs, full set bandspread, including 21 mc, in good condition, with manual.—Ring Askew, Sedbergh 236 (Yorkshire).

SELLING: K.W. Vanguard Tx Mk. I, 10 to 80 metres, £25. Hallicrafters SX-28 receiver, 550 kc to 42 mc, rack-mounting version but has cover, £18 or near offer. Dynamic microphone, with stand, 40s. B.44, modified for mains and 4 metres, £5. Can deliver, but prefer buyer inspects and collects.—Forster, G3WKQ, 12 Mitchell Road, London, N.13. (Tel. 01-807 1974.)

OFFERING: £30 for a recent Eddystone 840C receiver, state age. To be delivered to Grays, Essex.—Box No. 4691, Short Wave Magazine, Ltd., 55 Victoria Street, London, S.W.1.

EXCHANGE: Leica M2, F3.5, 5 cm Elmar, 9 cm Elmar, Leicameter MC, fitted Benser case and Leitz E/R case, manual FOR a Sideband Transmitter.—Caldwell, G8US, 3 Milton Avenue, Bath, Somerset.

SELLING: W.1191A precision heterodyne wave-meter, complete with crystals and calibration charts, coverage 200 kc to 20 mc, £10. Marconi VHF signal generator Type 6, brand new, £10. TV waveform/pulse generator Type 51, with PSU, £10. Audio amplifier with PSU, £4. Marconi RF/AF signal generator, with PSU, £10. Mains PSU Type 234, £5. VHF Rx R.1933A, tunable 60 to 80 mc, brand new, £10. VHF front end, tunable 180 to 250 mc, £5. Carriage extra; please include s.a.e. with enquiries.—Hayward, Sunnyfields, Lighthouse Road, St. Margarets Bay, Nr. Dover, Kent.

EXCHANGE: Marconi C.52 remote receiver, very good condition, mains PSU, for Joystick and 3A, or any Type 4 tuner, or W.H.Y.? Taker collects Rx.—Newton, 25 Haddington Way, Aylesbury, Bucks.

SALE: Eddystone 888A with S-meter and manual, in immaculate condition, £60, buyer to collect.—Boddington, 1 Davenport Drive, Castle Vale, Birmingham, 35.

SELLING: B.40 communications Rx, 540 kc to 30.5 mc, FB miniature front-end, £20. Codar A.T.5 Tx, mint condition and hardly used, £12 10s. Brand new TBS Rx, tuning 60 to 80 mc, with internal PSU and manual, £7 10s. or near offer. Will deliver up to 40 miles, carriage extra thereafter.—Sellers, G3VOE, Mill Road, Eastrington (254), Goole, Yorkshire.

FOR SALE: Sphinx SSB Tx with delta control unit and Vox, in good condition, price £45.—Marriott, G3VVC, 21 Thorley Hill, Bishop's Stortford (4796), Herts.

MANUALS: Original with circuits: Canadian W/S No. 58, 25s.; Waveform generator Type 51, 30s.; IFF Rx R.3067, R.3090, oscilloscope Test Set Type 74, 40s.; Calibrator unit Type 120, 30s.; Mains PSU Type 3, 10s.; VHF crystal monitor Type 4, 10s.; VHF aerial system Type 3, 5s.; VHF aerial system Type 2A and 10, 5s.; UHF Test Set Type 28, 10s.; R.208 Rx, 20s.; Crystal calibrator Type 18, 20s. R.3066, R.3102A, R.26, Indicator Types 20 and 48A, Modulator 20, Tx's Type T.3065A/B, 30s.; American Loran equipment, 40s.; VHF rack and control gear, R.1392A, etc., 30s.; Rebecca Test Set Type 31, etc., 30s. Following give Circuits Only: VHF 1933A, 40s.; CRT-1, 20s.; Control Units Types 381, 704, 20s.; Signal generator Type 6, 20s.; UHF special Rx Mk. II, 5s.; R.220, 10s.; and TS-31, 10s.—Hayward, Sunnyfields, Lighthouse Road, St. Margarets Bay, Nr. Dover, Kent.

WANTED: R.216 receiver, in good condition, and complete with PSU, cash-buy or Exchange Eddystone EC-10.—Bailey, G8BBA, 29 Alexandra Street, Stone (2748), Staffs.

WANTED: Minimitter X-20 Beam Array for 20 metres.—Tucker, G3FTA, 4 St. Margaret's Road, St. Leonards-on-Sea, Sussex.

SWANCO PRODUCTS

LIMITED
G3NAP AMATEUR RADIO SPECIALIST G3PQQ
NEW EQUIPMENT

	£	s.	d.
Sommerkamp F-Series Equipment:			
FR-DX 500 double conversion superheterodyne with crystal-controlled first mixer, 160-10 metres	130	0	0
FL-DX 500 SSB/AM/CW transmitter, 240 watts PEP, complete with built-in power supply and antenna relay	145	0	0
FL-DX 2000 linear amplifier, 960 watts PEP	100	0	0
Sommerkamp FT-DX 150 transceiver, 80-10 metres	215	0	0
Sommerkamp FT-DX 500 transceiver, 80-10 metres	250	0	0

Swan Line Equipment:			
Swan 500 SSB transceiver, 30-10 metres	250	0	0
Swan 350 SSB transceiver, 80-10 metres	216	0	0
Swan 230-XC power supply (to suit 500 or 350)	49	0	0
Swan 410 VFO and adapter	61	15	0

Hallicrafters Equipment:			
SX-130 Communications receiver	86	15	0
SX-120 Communications receiver	148	5	0
SX-146 SSB receiver, 80-10 metres	137	5	0
HT-46 SSB transmitter, 80-10 metres	192	5	0
HA-1 electronic keyer	42	15	0

Eddystone Radio Ltd.:			
Eddystone EA12 Amateur bands receiver, 160-10 metres	193	0	0
Eddystone 940 Communications receiver	143	0	0
Eddystone 840C Communications receiver	70	0	0
Eddystone EC10 receiver	53	0	0
Eddystone EB35 receiver	62	10	0
Eddystone EB36 receiver	56	5	0

Trio Communications Receivers:			
Trio JR-60 14 tubes amateur communications receiver, 540 kc/s-30 mc/s, plus 142-148 mc/s	61	19	0
Trio 9R59 9 tube communications receiver	34	13	0
Trio 9R59DE 8 tube communications receiver	39	15	0
Trio JR500SE Amateur bands receiver 80-10m.	68	0	0
Trio TS-500 SSB transceiver complete with a.c. P.S.U. and split frequency V.F.O., 80-10m, 200 watts PEP	231	0	0

Lafayette Communications Receivers:			
HA-500 Amateur bands receiver, 80-6 metres	44	2	0
HA-700 Communications receiver (with product detector)	37	16	0
HA-350 Amateur bands receiver, 80-10 metres	67	10	0

K.W. Electronics Ltd.:			
K.W. 201 Amateur bands receiver, 160m-10m.	111	0	0
K.W. Vespa Mk. II transmitter (with P.S.U.)	135	0	0
K.W. 2000A SSB transceiver, 160m-10m. (with P.S.U.)	232	0	0

Mosley Electronics (Beams):			
TA-33Jr. Triband three element beam	27	5	0
TA-32Jr. Triband two element beam	19	5	0
TA-31Jr. Triband dipole	11	11	0
V-3Jr. Triband vertical	8	5	0
TD-3Jr. Wire trap dipole	6	15	0
Channelmaster rotators	13	13	0
Channelmaster rotators (automatic)	18	18	0

Park-Air Electronics Ltd.:			
2 metre transmitter (complete with mic., etc.)	80	0	0
Jet Set Aircraft receiver	12	0	0
Sky Bandit Aircraft receiver	23	10	0
Kurer Aircraft, short, medium, and long wave receiver	42	15	3

Swanco/CSE Equipment:			
Swanco/CSE 2A10 solid state transmitter	43	7	0
Swanco/CSE 2AR solid state receiver	44	0	0
Swanco/CSE type II A.T.M.A. mobile/fixed/portable antenna	9	15	0
Swanco/CSE safety mobile microphone, Type MM2	11	7	11
Swanco SP.144 2 metre converter	10	10	0
Swanco 100 kc/s. calibrator	5	19	6
Halson Mobile antenna, now all weather, all bands system	6	17	6
Extra coils (when more than one band is required)	3	17	6
Swanco Quad Spiders (per pair)	6	10	0

Echelford Communications Equipment:			
Echelford BI/4 transmitter for 4 metres	30	0	0
Echelford M1/4 transmitter (mains or mobile)	40	0	0
Echelford C1/4 4 metre converter	10	10	0

Full range of **Drake Equipment** available to order.
Full range of **Heathkit Equipment** available to order.

Codar Radio Company:			
CR.70A receiver	19	10	0
PR30	5	10	0
PR.30X	7	4	0
R.Q.10	6	15	0
R.Q.10X	8	8	0
CC-40	6	10	0
CR.45K	9	10	0
CR.45RB	11	7	0
AR5 transmitter	16	10	0
250 volt P.S.U.	8	0	0
12/MS P.S.U.	11	5	0
12/RC control	2	7	6
T28 receiver	15	10	0
Mini-Clipper	1	19	6

Partridge Electronics:			
Joystick std. set	5	10	0
Joystick de-luxe	5	19	6
Type 3 tuner	2	15	0
Type 3A tuner	3	12	6
Type 4 tuner	4	4	0
Type 4RF tuner	6	6	0
Shure Microphones:			
Shure 201	4	10	0
Shure 202	5	5	0
Shure 444	10	12	6
Shure 401A	5	10	0
Shure 2755K	4	2	6

SECOND-HAND EQUIPMENT
Many items in stock including: LG-50, DX-100, SB10, K.W.76, 840C's, etc. Your enquiries please.

Full Service Facilities—receivers re-aligned, transmitters serviced, etc. Illustrated Catalogue 7/6, post paid.

SWANCO PRODUCTS LIMITED

247 Humber Avenue, COVENTRY
Telephone: Coventry 22714 Hours: Mon.-Sat. 9 a.m.-6 p.m.

TAURUS ELECTRICAL SERVICES

Prop: G3TED

Transistor Panels EX New Equipment.
OC35 on Heat Sink, 8/9, post paid.
OC36 on Heat Sink, 9/3, post paid.
Mixed Transistors on Panels with Diodes, etc. Types: BCY30, 2N1500, 2N1499A, MDS31, GET882, 25103, GET104, OC203, 12 and 15v. Zenners, etc. All guaranteed panels with at least 20 transistors, plus various components. All new Bargains at 20/-, post paid.
Silicon Planar Transistors by Fairchild P346 N.P.N. 550 Mc/s working, 7/6 each, post paid.
600M Amplifiers. 19" rack mounted. Mains supply, £3.
Lightweight headsets. 600Q imp., 9/6, post paid.
Transistors, A.F., 3/9 dozen, post paid.
New Ferrite Pot Cores, 1/6 each or 15/- dozen, post paid.
Transistorized Morse Oscillator Modules. Will drive speaker or phones, 18/9, post paid.
QVQ3/12 or 10, 15/-, post paid.
New and Boxed Mains Relays, 2 pole 2-way octal base, 17/6, post paid.
New Nylon Jack Plugs 2/6; Jack Sockets, 2/9 or 5/- pair, post paid.
Tank Aerials. Three 4' sections making 12', 8/6. P. & P. 5/- any number Bases, 4/6. P. & P. 2/-
Breast Sets. Safe for Mobile Operation, 10/-, post paid.
Xtal Insets to fit above Breast Sets, 7/6. P. & P. 9d.
Creed 7B Teleprinters. Used, £15. P. & P. 30/-
Creed 7B Teleprinters. As new, £30. P. & P. 30/-
 All spare parts for **Creed 7B Teleprinters** in stock.
Head Sets. 19 set type or type DLR, 11/-, post paid.
Small Stand-off Insulators by Eddystone, 1/- each.
Dry Battery Packs. 72 and 1½ and 1½, 4/6 each. P. & P. any number 3/-
New Key Switches. Less knobs, 2/6. P. & P. any number 1/-
New Small Condensers, Not Junk. 200 for 25/-, post paid.
Multi-Test Meters. 1000Q/V, 37/6.
Multi-Test Meters. 20,000Q/V, £35/-
Xtal Lapel Mikes. Complete, 4/6.
New Boxed Army Type Morse Keys, 5/6, post paid.
JUST ARRIVED. B40 Receivers, £22, post paid.
SPECIAL OFFER OF MIKES, D x 73 Pizo Dynamic, £3 7/6, post paid.
M.E.11 Dynamic with Flexible Desk Stand, £4 12/6, post paid.
ACOS Xtal (metal), MIC45, £1 2/6, post paid.
CM20 Xtal (plastic), 9/6, post paid.
CM70 Xtal Stick with Accessories, £2 7/6, post p id.
VALVEHOLDERS, B9A and BTG, 8d. each, Octal Ceramics, 1/3.
BY100 Rectifiers, 3/9 each, **SM78P Siliconcs** 800P/V 750M/A, 3/9.
Thyristors, 400 FIV 8 amps, 9/6 each.
TRANSISTORS

ATTENDING MOST MOBILE RALLIES

26/28 NOTTINGHAM ROAD, LOUGHBOROUGH, LEICS.
 Telephone 5131

SCA 63982	DERWENT RADIO	S.A.E. LISTS	
KW, SOMMERKAMP, EDDYSTONE, HALLICRAFTERS, CODAR, LAFAYETTE, TRIO, SHURE, TW, HEATHKIT, JOYSTICK, STAR and many others			
KW 1000 Linear Amp.	£135	Trio 9R59DE Receiver	£39
Star SR 700A Receiver	£115	Trio Matching Speaker	82/-
Star SR 700 Transmitter	£135	Hansen SWR Bridge	70/-
Star SR 200 Receiver	£40	DM 501 Microphone	55/-
Lafayette HA 350	£68	DM 307 Microphone	88/-
Lafayette HA 500	£44	Cosmocord 39/1	32/6
Nova Pal d.f. Receiver	£27	Acos 45 Microphone	19/6
KY 102 Bug Key	£4	Belling hi pass filter	18/6
Shure 201 Microphone	£5	Fanon 28.5 mc. Walkie	
Eagle SWR Bridge	£9 19	Talkies £12 10 pair or £6 10 each	
Eagle RF 40	£3 5	Low Z, Padded Headsets 42/6	
Eagle RF 45	£2 8	Copal Digital Clock	£12 7
Halsion 160m. Mobile Whip	£6 17	Garex 2m. Transmitter Kit £11 5	
Halsion extra Coils each	£3 17	Garex 2m. Converter	£8 18
Multimeters AS100D	£12 10	Codar AT5	£16 10
500	£8 17	Codar T28	£15 10
U 50D	£6 15	Codar 250/S	£8
JP 5	£5 10	Codar 12/MS	£11 5
DA-1 Electronic Keyer	£18	Codar 12/RC	£2 7
Eddystone EA12	£64	TE18 mains gdo	£11 10
Eddystone EA12	£195	TE15 battery gdo	£11 10
Eddystone 940	£143	Katsumi elbug	£7 15
Sommerkamp FR 500	£130	Katsumi compressor	£7 15
Sommerkamp FL 500	£145	DA-1 keyer	£18
Trio TS 500 and A.C. p.s.u.	£203	Lafayette HA700	£37

ALL GAREX P.S.U. KITS IN STOCK ALSO YUKAN SPRAY PAINTS, STELLA INSTRUMENT CASES
 We would like to hear about your trade-in items large or small.

Second-hand Equipment	
Heathkit DX 40	£15
Hallcrafters HT 40	£15
Geloso 4/101 vfo	£6
Hallcrafters HA 5 vfo	£16
Green & Davis LA 600	£6
Marconi BFO up to 40 kc/s.	£3
Cowl Gill Motor	£20
Star SR 550	£38
Eddystone EC10	£42
Eagle RX80	£26
Heathkit RG 1	£27
Heathkit RA 1	£30
TW 4m. Converter	£10
Geloso/KW hamband converter	£10
HRO's, p.s.u., coils from	£18

Please add extra for carriage.

28 HILLCREST AVENUE, SCARBOROUGH, YORKSHIRE

SMALL ADVERTISEMENTS, READERS—continued

COMPLETE Station of the late GM?SLW, comprising a Heathkit DX-100U with SB-10U Adaptor; G3BDQ-type Rx; Rx Type 20; B.44/3; and a BC-221 with charts. Selection of 2m. and four-metre preamplifiers, converters and transmitters. Channel Master control unit with rotator. Two-metre 6/6 Yagi, 4-ele beam for four metres. Also usual test equipment, valves and components. Offers and enquiries (s.a.e.).—Auld, Hillview, Halkirk, Caithness, Scotland.

ALL SMALL Advertising you see in these columns is paid for at the rate of 3d. a word (minimum charge 5s.), which just about meets the cost of preparation and printing. It is not economic to give space away—anything worth having is worth paying for. We do not guarantee results, but what we do guarantee is that any advertising in "Short Wave Magazine" ensures the largest and most effective coverage of the U.K. amateur interest. Readers' advertisements for the October issue should reach us as soon as possible, with remittance. If you are in doubt about how to estimate charge, send a blank cheque (yes—many people do!), marked "not over £2," or whatever, and leave it to us to calculate the cost—which will probably be cheaper than if you had worked it out for yourself!—Advertising Dept., Short Wave Magazine, Ltd., 55 Victoria Street, London, S.W.1. (If you want bold face, like this, the extra charge is 25%. For Box Numbers it is another 1s. 6d.)

SELLING: R.C.A. AR88D, with manual, £30. Codar CR-66 Rx, with PR-30 preselector and matching speaker, £9. All in good condition and working order, buyer to collect.—Webb, G3VGI, QTHR. (Tel. Slinfold 243.)

WANTED: Recent R.A.E. Course, Morse records, and back issues "Short Wave Magazine" and "RSGB Bulletin."—Davies, Machen Vach, Lower Machen, Newport, Mon., NP1-8UW, South Wales.

WANTED: Transceiver, such as KW-2000A, National NCX-5 or Swan, must be in mint condition. Will collect.—McPherson, 11 Mount Street, Fleetwood, Lancs.

SALE: Avo C/R Bridge, £4, carriage extra. Crystal Type 10XJ, 8790 kc (Ch. 36), ideal for HF filter applications, 17s. 6d. doz. Valves 5B/254M, miniature 807, 15s. pair.—Edwards, G3KGN, 126 Danescroft Drive, Leigh-on-Sea, Essex.

RTTY: Creed 7B, two Teletype TD-14, resprayed grey hammer, plus scrap 7B, the lot for £20. Hallcrafters SX-140 amateur-band Rx, £15. B2 Rx/Tx, with coils but no PSU, £5. Four 811A's, 15s. each. Johnson match-box ATU, £8. BC-221 dial and drive assembly, 30s.—Quantrill, G3OPF, 10 Milford Avenue, Stony Stratford, Bucks.

WANTED: A T.W. mains PSU/speaker suitable for use with the TW-2 and TW-160 transceivers.—Box No. 4693, Short Wave Magazine, Ltd., 55 Victoria Street, London, S.W.1.

EXCHANGE or SELL: K.W. Viceroy Mk. II, in mint condition, for sale—or would Exchange for a National NCX-3 or KW-2000. (Ireland).—Box No. 4692, Short Wave Magazine, Ltd., 55 Victoria Street, London, S.W.1.

WANTED: Volumes 1 to 5 of "Short Wave Magazine"; an offer of all five Volumes in one lot preferred. Please state price asked, and cost of postage to U.K. address.—Otter, Chalimbana Secondary School, Private Bag E.I., Lusaka, Zambia.

SALE: In one lot, K.W. Viceroy Mk. III CW/SSB Tx; KW-77 receiver; K.W. Match-SWR indicator; K.W. E-Zee Match. All in excellent condition, and going for £140. Owner moving QTH. Prefer buyer collects.—Creedy, GW2DXS, White Horse Hotel, Overton, Wrexham (265), Denbighshire, North Wales.

SMALL ADVERTISEMENTS, READERS—continued

SALE: Eddystone Mk. I S.770R, the VHF receiver for 19 to 165 mc AM/FM, price £90.—Rutter, 4 Crompton Avenue, Blackpool, Lancs. (Ring 64680 after 7.0 p.m.)

WANTED: Drake 2B receiver, complete with speaker and Q-multiplier; price and full details, pse. Have For SALE: An Eddystone 888A, with S-meter, offers?—Page, Church Cottage, Tutshill, Near Chepstow, Mon., NP6-7PT, South Wales.

SELLING: Communications receiver covering 10-160m., 16 valves, with mechanical filter and Eddystone 898 dial, professional finish and appearance, £50 or reasonable offer. Linear amplifier for 10-80m. bands, 2/813, with 2.5 kV PSU, £35. TH3-Jr. Beam, as new, £25. Vibroplex bug key, mint, £10.—Bray, G3RWQ, 54 Grange Avenue, Worcester.

UNIQUE Opportunity to acquire B.40 Naval communications Rx, covering 640 kc to 30.5 mc, Model D, not to be confused with earlier releases using obsolete valves. With external speaker and Admiralty manual, ready to plug in, sacrifice at £32 10s. or near offer.—White, 16A Belham Road, Kings Langley, Herts.

OCTOBER Issue "Short Wave Magazine" appears September 27. To get your copy in good time send 4s. by Wednesday 25th, with a note saying simply "October issue, pse." This will ensure despatch by post on Thursday morning, for delivery (in the U.K.) on publication day.—Circulation Dept., Short Wave Magazine, Ltd., 55 Victoria Street, London, S.W.1.

GOOD Guy Line, or Halyard material: Top-quality rot-proof polypropylene rope, brand new, 5/16in. diameter, breaking strain 1980lbs. Few hundred feet surplus available, for radio amateurs only, at special low price to clear. Send s.a.e. for small sample, and quote callign.—Powell, GW3HUM, 21 Tanybryn Estate, Valley, Anglesey, North Wales.

FOR SALE: BC-348M, as new and unmodified, £17 10s. BC-221N, less charts and cabinet, as new, £9. BC-455, 6.0 to 9.0 mc, 60s. BC-453, Q5'er, £4 10s. Triplett 1632 Signal Generator, as new, £15. Taylor 45A Valve Tester, £8. Crystal Calibrator No. 10, 55s. RTTY CRM-1 Indicator, £8. Filmstrip dial for R.216, 21s. BC-625 modulation transformer, 20s. S.27 output transformer, 17s. 6d. BC-221M manual, 17s. 6d.—Reynolds, 5 Headland Way, Lingfield, Surrey.

SELLING: Back numbers "Short Wave Magazine," March '61 to July '61, May '62 to May '64, and Feb. '65 to Feb. '68. All in excellent condition, 1s. each or £3 the lot, plus postage.—Seddon, 11 Sunway Grove, Leamington Road, Coventry, Warcks.

SALE: Eddystone EB-35 AM/FM receiver, two years old, hardly used, excellent performance. Transistorised portable, six ranges, high-quality headphones included. Cost £67 10s., bargain at £43 or near offer.—Ring Bignell, 01-462 2523.

FOR SALE: Hallicrafters SX-62A, continuous coverage 550 kc to 108 mc, in six switched bands, AM/FM, just realigned and checked over professionally, excellent appearance, sensible offers, please. R.C.A. AR88LF, 75 to 550 kc and 1.5 to 30 mc, perfect condition, £30. Pair 9-transistor Walkie-Talkies, new and in original packing, £17. Ham-Gear PM-1 preselector, self-powered, new, £5.—Pank, 33 The Highlands, Potters Bar, Middlesex. (Tel. Potters Bar 58333, evenings or weekends.)

SELLING: Eddystone 888 complete with speaker and S-meter, £50. Heathkit DX-40U and VFO, £25. PR-30X preselector, £5. All in working order, buyer collects.—Millman, G3PJY, QTHR, or ring 021-STE 6007.

EXCHANGE: HA-350 Lafayette receiver, in mint condition (only 5 months old) for Yashica-24 or similar twin-lens camera.—Allen, 14 Manor Park Parade, Lewisham, London, S.E.13. (Tel. 01-582 0974.)

EDDYSTONE specialists in Lancashire

SINCE 1948

H. P. RADIO SERVICES LTD.

(Managing Director: H. Panagakis)

51 COUNTY ROAD,
LIVERPOOL 4.

ANY MODEL CARRIAGE PAID
PER PASSENGER TRAIN

Interest free H.P. 12 months

Send 6d. stamp for literature

G. W. M. RADIO LTD.

RECEIVERS

ADMIRALTY B.40. 640 Kc/s. to 30.5 Mc/s. Speaker, A.C. power unit built in. Bandwidth switched 1, 3, and 8 Kc/s. Crystal calibrator. Large vertical calibrated illuminated dial. Circuit diagram, £22/10/-. Also B41 low frequency version 15 Kc/s. to 700 Kc/s., £10, carriage 30/- per set.
PCR2. 900-2,000, 200-550 metres, 6-22 Mc/s. No power unit, £6/10/-, carriage 15/-.
CR300, 15 Kc/s. to 25 Mc/s. complete with power unit for 230 A.C. and 230-24 Volts D.C., £13/19/-, carriage paid.
MARCONI B29 low frequency, £10, carriage £1.

TEST EQUIPMENT

MARCONI VALVE VOLTMETER. Type 6, TF428B/1, 1.5 to 300 volts A.C. or D.C., £3/10/-, carriage 15/-.
MARCONI A.F. ABSORPTION WATTMETER. 1 Microwatt to 6 watts, type TF956 (CT44), £14, carriage paid.
B.S.R. AUDIO OSCILLATORS. L050 20 to 16,000 cycles, £5, carriage paid.

VALVE VOLTMETERS CT54. 0-480 volts A.C. or D.C. up to 200 Mc/s. in 6 ranges. 0-10 Megohms in 5 ranges. Battery operated, 2 x 1.5, 75 and 15 volts (not supplied), £10, carriage paid. All the above test equipment is clean and in-working order.

AERIAL EQUIPMENT

LIGHTWEIGHT MASTS, 10 x 3ft. screw-in sections plus 14ft. collapsible whip, insulator, which can be fitted at base or top of 30ft. sections (i.e. 14ft. whip 30ft. high or 44ft. vertical aerial), set of guy ropes, pickets and ground spike, 65/-, carriage paid. Ideal for top band and eighty portable use. Packed measures 3ft. 6in. x 7in. dia. in canvas case.
TELESCOPIC 34ft. mast, guy ropes, pickets, base insulator, ground spike, even hammer. 7ft. collapsed, £6/10/-, carriage paid.
AERIALS, 7 strand copper, 150ft. or longer on reel with bakelite insulators, 17/6, post paid.

Siebe Gorman underwater torches, 50/-, post paid.
13 PIECE drawing instrument sets including compasses, dividers and parallel rule, etc., £4/15/-, post paid.
HEADSETS for 19 or 22 set with microphone, used 10/-, new 15/-, post paid.

ROLLER INDUCTOR tuners, 30 turns 1 1/2" dia., 12/6, post 4/6. Few only Ceramic transmitter switches 6 wafers 2 1/4" dia., each 1 pole 6 way, 7/6, post 2/6.

PARMEKO mains transformers 230 to 24 volts 2 amps fused and shrouded, 25/-, post paid. 10x Crystals 100 or 500 Kc/s., 12/6, post paid.
MAGNETS permanent, very large radar type will lift 14 lbs. easily, 30/-, carriage 7/6.

All equipment offered is complete but not tested unless otherwise stated. Carriage charges quoted are for England and Wales only.
Telephone 9097

Terms: Cash with order. Early closing Wednesday.

40-42 PORTLAND ROAD, WORTHING, SUSSEX

SMALL ADVERTISEMENTS, READERS—continued

STUDENT Needs The Money! Must sell Cannonball Tx, £30. Eddystone S.640 receiver, £20.—Gale, G3WOS, 17 School Close, Braunston, Nr. Rugby.

FOR SALE: Heathkit two-metre Transceiver HW-30, complete with 110v. unit, 12v. PSU and three xtals. In mint condition, and hardly used, £30.—Wilson, Woodlands, Dog Kennel Hill, Kiveton Park Station, near Sheffield, Yorkshire. (Tel. Kiveton 6773.)

SELLING: No. 52 Tx, coverage 20 to 160 metres, capable 100 watts AM or 150 watts CW, with mains PSU, pre-amp. for xtal microphone, ATU and all spare valves, +2/813, offered at £17 10s. or near. Also Codar RQ-10X, £5. **WANTED:** Coil packs for HRO receiver.—Ring Turner, 01-460 6326 (Bromley), after 7.0 p.m.

SELLING: Owing to purchase of Trio 9R-59, a Codar-66, at £11 or near offer, buyer to collect London area. All letters answered.—Box No. 4694, Short Wave Magazine, Ltd., 55 Victoria Street, London, S.W.1.

SALE: Eddystone EC-10 Rx, in new condition, £37. Also Jason JTV-2 FM tuner, £6.—Ring Riches, Wanstead 6347, any evening 6.30-7.30 p.m.

FOR SALE: De-Luxe Joystick, and tuner, £3. Dummy load resistor, 150w. 75-ohm, £4 10s. A pair of BLY-15 RF PA transistors, £5. A pair of YL1150 SSB PA valves, £5. Field-day PSU, 24v. in, 500v. DC out at 250w., gift at £6. All foregoing in new condition. Also used but tested 6146, 20s.; TT-21, 15s. Brand-new xtal holders, Type 2M 1/2in., 2s. 6d. dozen. Add a little for post, pse.—Cufler, G3MXF, 8 King's Avenue, Parkstone, Dorset.

MORSE MADE EASY !!!

FACT NOT FICTION. If you start RIGHT you will be reading amateur and commercial Morse within a month. (Normal progress to be expected.)

Using scientifically prepared 3-speed records you automatically learn to recognise the code RHYTHM without translating. You can't help it, it's as easy as learning a tune. 18 W.P.M. in 4 weeks guaranteed.

For details and course C.O.D. ring, s.t.d. 01-660-2896 or send 8d. stamp for explanatory booklet to:

G3HSC/F, 45 GREEN LANE, PURLEY, SURREY.

HALSON MOBILE ANTENNA—THE MOBILE SCENE
The Most Efficient! The Most Unobtrusive! and Base Loaded too
A COMPLETE MOBILE ANTENNA SYSTEM
Complete for one band, £6/17/6 + 3/6 P.P. Extra coils, £3/17/6 + 3/- P.P.
SWR and FSI, £4/19/6 + 3/6 P.P.

Our Agents: K. W.—Kent. N.W.—Manchester.
Chas. Young—Birmingham. Swanco Products—Coventry.
G. Francis—Newark. G. W. Smith—London.
Glasgow Electronic Services—Glasgow G.3.

Or direct from HALSON ELECTRICAL SERVICES
DOVER ROAD WORKS, ANSELD ROAD, BLACKPOOL
Tel. 62740

**HIGH GLOSS METALLIC
HAMMERED ENAMEL**

"Makes Fantastic Difference to Panels"

— say hundreds of enthusiastic users. "Crackle" pattern appears like magic on wood and metal. No undercoat. Air dries 15 min. to hard glossy finish. Heat, liquid and scratch-proof. Light and dark blue; bronze; silver; green; black.

Send 10/- NOW for trial
1/2-pt. tin. Colour samples
and instructions. Post free.

FINNIGAN SPECIALITY PAINTS. Dept. S.W.
STOCKSFIELD (Telephone 2280), NORTHUMBERLAND

**Fast Mail Order for the Amateur Radio Enthusiast!****AERIAL EQUIPMENT**

TWIN FEEDER. 300 ohm twin ribbon feeder similar K25, 8d. per yard. 75 ohm twin feeder, 6d. per yard. Post on above feeders, 2/- any length.

COPPER WIRE, 14G, H/D, 140ft., 30/-; 70ft., 16/-, Post and packing 3/3. Lengths are approx. only, actually sold by weight.

FEEDER SPREADERS. 6" Ceramic type F.S., 10d. each. Postage 2/6 up to 12.

CERAMIC CENTRE PIECE for dipoles Type AT, 1/6 each. P. & P. 1/-.

2 METRE BEAM, 5 ELEMENT W.S. YAGI. Complete in box with 1" to 2 1/2" masthead bracket. Price: £3 7s. Carriage 5/-.

SUPER AERAXIAL, 70/80 ohm coax, 300 watt very low loss, 2/3 per yard. 50 ohm 300 watt, 2/6 per yard. P. & P. 2/6.

TOUGH POLYTHENE LINE, type ML1 (100lb.), 2d. per yd. or 12/6 per 100 yds. Type ML2 (220 lb.), 4d. per yd. or 25/- per 100 yds., ML4 (400 lb.), 6d. per yd. Ideal for Guys, L.V. Supports, Halyards, etc. Postage 1/6 on all line.

CALLERS PLEASE NOTE

Our NEW Hours of Business

Mon., Tues., Wed., Fri., and Sat.

9.00 a.m. – 5.30 p.m.

Special

LATE SHOPPING NIGHT

THURSDAY

9.00 a.m. – 8.00 p.m.

NEW BOXED VALVES. 3/6 each, 4 for 10/-, P. & P. 2/-.

Types 6N7GT, 6AB7, 6AC7, 6SK7, 6SF7, 6SH7, 6F7, 956, U10, MSP4, IU5, 6G6G, X22, 958A.

ABSORPTION WAVEMETERS. 3-00 to 35-00 Mc/s. in 3 Switched Bands. 3-5 7, 14, 21 and 28 Mc/s. Ham Bands marked on scale. Complete with indicator bulb. A MUST for any Ham Shack. ONLY 25/- EACH. P. & P. 1/6.

SHORT WAVE KITS. One valve only, 45/-, phones, ant, and batts, 40/- extra if required. Ideal for Junior op.

VARIABLE CONDENSERS. All brass with ceramic end plates, ball bearings and ganging extension. 50pF, 5/9; 100pF, 6/6; 160pF, 7/6; 240pF, 8/6, and 300pF, 10/6. P. & P. 2/-.

SEALED RELAYS, 12v. 105Ω Coil Type A, 4 Pole, C.O., 15/-, Type B, 2 Pole, C.O. + 2 Pole Norm. on, 12/6. P. & P. 1/6.

AMATEUR RADIO
CHAS. H. YOUNG LTD.

The Widest Range in the Midlands

★ **HIRE PURCHASE**
★ **PART EXCHANGE**

CHAS. H. **YOUNG** LTD.

At your service G2AK, G3LAY, G3VfV

Please print your address. No C.O.D. under £1.

'phone 021-236-1635

170-172 Corporation Street,

Birmingham 4

N. W. ELECTRICS

52 GT. ANCOATS STREET
MANCHESTER 4, M4 5AB.

061 236
6276

THE NORTH'S LEADING STOCKISTS OF

OSCILLOSCOPES

- HARTLEY. 13A. Fully checked. ... £25
- COSSOR. 1035. £25
- COSSOR. 1035 Mk3. £50
- SOLARTRON. CD711S. Checked. ... £65

Carriage on any Scope £1.

Headphones, Modulators, RF Units 20 to 90 Mc. Rx, Valve voltmeters and control units still available as previous adverts.

Stamped addressed envelope for lists.

EDDYSTONE RECEIVERS & COMPONENTS

T.W. CONVERTERS

CABINETS

DIE CAST BOXES

CHASSIS

HALSON MOBILE AERIALS

DENCO COMPONENTS

'Q' MAX CHASSIS CUTTERS

We have tremendous stock of small components for Valve and Transistor Circuits, Meters, Test Equipment, G.D.O's. Field strength Meters. Specialists in repair, alignment of all types of communication receivers.

You deserve a rest—come down on 2-M ! with these PRINTSET Basi-kits from West Germany

28/144 MHz TRANSVERTER TRV4
Basi-kit only £2.17.6.

NEW 144 MHz LINEAR AMPLIFIER LPA-144
Basi-kit only £2.7.6.

144 MHz RECEIVING CONVERTER CRV4
(For receiving with TRV4 Transverter)
Basi-kit only £1.14.9.

14-page Catalogue SP5 describes these and other VHF, SSB, CW (El-Bug) and RTTY kits.

SPACEMARK Ltd. 14 PICCADILLY, MANCHESTER 1 (Tel: 061-237 0817)

ELEY ELECTRONICS

HOOK-UP WIRE. 5 x 20 yds. (= 100 yds. mixed colours), 6/- plus 2/6 post.

MODULATION TRANSFORMERS. Type 1—PP6V6 to QQV06-40. Type 2—PP6AQ5 to QQV03-10. Either type 8/6 plus 4/6 post.

HEAT SINKS to take 2 x OC35, etc., 2/6 plus 1/- post.

2 BLACKBURN DIGITAL VOLTMETERS. Working but require servicing. £25 each plus carr.

NEW MAINS TRANSFORMERS. 12 volt 8/10 amps., 6/- plus 4/6 post.

HC-6U CONVERTER XTALS. 12.7 mc/s., 3/- plus 6d. post.

WE STILL REQUIRE CERTAIN TYPES OF RELAYS AND NOTCHED RELAY CONTACTS. New Higher Prices Paid.

112 Groby Road, Glenfield, Leicester, LE3-8GL.

SHACK STANDARD

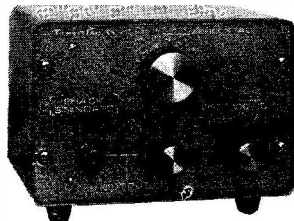

Precision Laboratory Frequency Standard. 100 K/Hz. and 10 K/Hz. B7G 5° X Cut Bar Quartz Crystal. All silicon solid state circuitry. An essential piece of equipment in every enthusiasts workshop. Price: £12.18.6 Postage 4/6d. For details please send S.A.E. to:

TIMES INSTRUMENTS
3 STATION ROAD, GREAT SHELFORD, CAMBRIDGE, ENGLAND

CATALOGUE

The most **COMPREHENSIVE—CONCISE—CLEAR—COMPONENTS CATALOGUE.** Complete with 10/- worth discount vouchers **FREE WITH EVERY COPY.**

- ★ 32 pages of transistors and semi-conductor devices, valves crystals.
- ★ 200 pages of components and equipment.
- ★ 65 pages of microphones, decks and Hi-fi equipment.

SEND TODAY 8/6 post paid

HENRY'S RADIO LTD.

303 EDGWARE ROAD, LONDON W.2. Tel. 01-723 1008/9 Mail order Dept. all types of Components, Organ Dept.

309 EDGWARE ROAD, LONDON W.2. 01-723 6963 High Fidelity Sales, P.A. and Test Equipment, Record Decks, etc.

Completely new 9th 1968 edition
300 big pages
6,500 items
1,200 illustrations

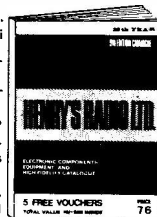

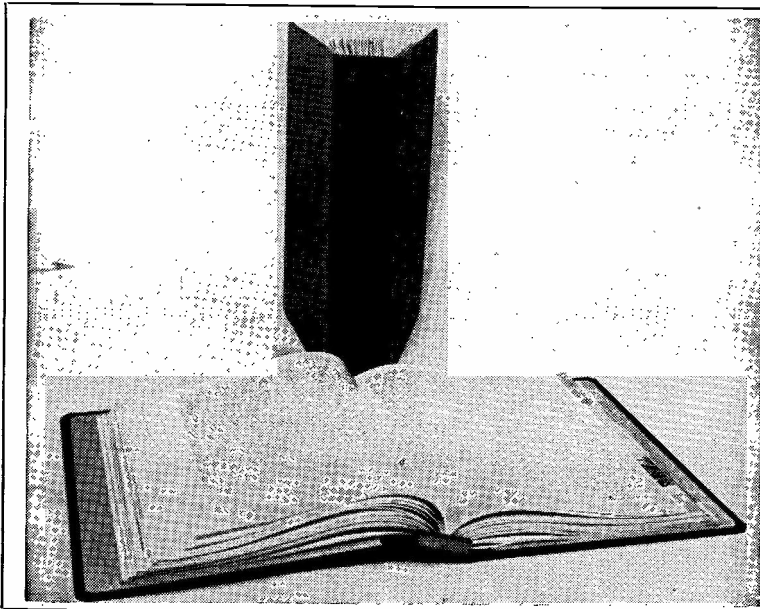

CREATE YOUR OWN REFERENCE LIBRARY

by binding copies of Short Wave Magazine in the "EASIBINDER."

The "EASIBINDER" is designed to bind 12 copies of the Magazine as you receive them month by month, eventually providing a handsomely bound volume for the bookshelf.

No need to wait until twelve copies are assembled. As each copy is received, it is quickly and simply inserted into the binder. Whether partially or completely filled, the binder is equally effective, giving the appearance of a book, with each page opening flat.

Strongly made with stiff covers and attractively bound in maroon Leathercloth and Milskin, the binders have only the title gold blocked on the spine.

Price 14s. 6d. post free.

PUBLICATIONS DEPARTMENT
SHORT WAVE MAGAZINE
55 VICTORIA STREET
LONDON, S.W.1

Advertising in "Short Wave Magazine" guarantees the largest and most effective coverage of the U.K. radio amateur interest

"CALLBOOK"

SUMMER EDITION

Now AVAILABLE

Limited Quantity Only

Known the world over as the CALLBOOK, this comprehensive reference lists about 297,800 licensed radio amateurs in the United States Directory and 142,800 or more in the rest of the world (contained in the "DX Section"). The listings grow with every issue! In the new U.S. Section, licence classifications are now being shown. Each issue is an entirely new book with revised listings of new licences, names and addresses. The CALLBOOK also includes much incidental DX information. Every amateur operator and SWL needs the latest CALLBOOK to get the most out of Amateur Radio.

DX Listings 42/6

US Listings 64/6

The two together, covering the World, £5/2/6

Available only from

Publications Dept.,

SHORT WAVE MAGAZINE

55 Victoria Street, London, S.W.1

01-222 5341

Short Wave Listening

PHILIPS PAPERBACK

SHORT WAVE LISTENING by J. Vastenoud. Size: 8½" x 5½".
107 pages. Numerous text diagrams.

Price 13s. 2d., post free

This book is intended as a guide for the benefit of the increasingly large numbers of regular listeners to short wave transmitting stations and also for radio amateurs who are interested in short wave listening.

The first group includes many emigrants who in their new country are anxious not to lose touch with their homeland, and those who are intending to emigrate and will thus in future have to do much of their listening on short waves. The second group is of those enthusiasts who regard short wave radio as an indispensable medium for the exchange of information internationally in the broadest sense and employ it in order to widen their knowledge of other countries. The book, which deals with the possibilities and problems of short-wave reception on the level of popular science will enable the reader to discover a whole new world of his own.

CONTENTS

Short Waves	Do Any Regulations Exist
The Principles of Short-Wave Transmission	Governing the use of Frequencies in the Short-Wave Bands?
Practical Short Wave Transmitting	DX-ing In Practice
Short Wave Prediction	DX-ing With a Tape Recorder
Sources of Interference	DX-ing Using a Frequency Meter
The Aerial	Some Commonly Used DX Terms in Three Languages
The Correct Choice of Receiver	Transmission of Time Signals at Standard Frequencies
Communications Receivers	Some of the More Important DX Clubs

Available from stock:

PUBLICATION DEPT.

SHORT WAVE MAGAZINE

55 VICTORIA STREET, LONDON, S.W.1