

The SHORT WAVE *Magazine*

VOL. XVIII

JUNE, 1960

Hutch

NUMBER 4

WORLD WIDE COMMUNICATION



For the
Radio Amateur
and Amateur Radio

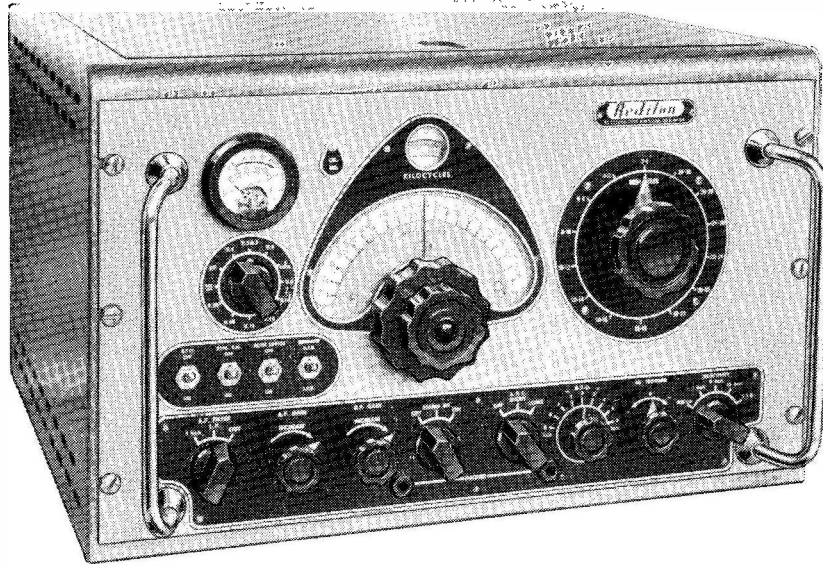

*The finest
Communications Receiver
in the world*

Redifon **R.145**

** Reviewed in this issue*

REDIFON LIMITED Communications Sales Division, Broomhill Road, London, S.W.18
Telephone: VANdyke 7281

A Manufacturing Company in the Rediffusion Group

CQ . . . CQ . . . CQ . . . HAMS



QTR ?

**Time you
bought a**

MULTIMINOR

OM !



THIS is an ingeniously designed yet inexpensive rectifier/moving coil instrument of pocket size and sturdy construction. It is extremely well made and simple to use.

Two models are available, Model 1 for use in temperate climates, and Model 2 for use under adverse climatic conditions.

It is fitted with a high-grade rotary selector switch of quite unique design, in which a series of 18 fixed silver-plated contacts, embedded in a moulded ring, are wiped by a double-contact rotor arm.

Full advantage has been taken of the latest printed resistor techniques to achieve compactness of size and economy of weight.

Specially designed extremely accurate test gear has been made to ensure that every Multiminator measures up to the prescribed standards of accuracy, and the final testing is of a particularly rigorous nature.

List Price : **£9 : 10s.** complete with Test Leads and Clips.

Leather Case if required 39/-

● Write for fully descriptive leaflet.

Pocket Size : 5 5/8 x 3 3/8 x 1 3/8 inches.
Weight : 1 lb. approx.

RANGE SELECTION :

Range selection is by means of a substantial switch, there being only two connection sockets for any measurement. The instrument has 19 ranges, a single scale being provided for current and voltage measurements and another for resistance measurements.

D. C. Voltage	A. C. Voltage	D. C. Current
0— 100 mV.	0— 10 v.	0— 100 micro A
0— 2.5 V.	0— 25 v.	0— 1mA
0— 10 V.	0— 100 v.	0— 10mA
0— 25 V.	0— 250 v.	0— 100mA
0— 100 V.	0— 1000 v.	0— 1 A
0— 250 V.		
0— 1000 V.		

Resistance
0— 20,000 ohms
0— 2 M/ohms

Sensitivity :

10,000 ohms per volt on D.C. voltage ranges.
1,000 " " " " A.C. " "

Accuracy :

On D.C. 3% of full scale value.
On A.C. 4% " " " "

To meet special requirements, instruments can be supplied to a higher degree of accuracy for a small additional charge.

AVO LTD

AVOCET HOUSE . 92-96 VAUXHALL BRIDGE ROAD . LONDON . S.W.1

A Member of the Metal Industries Group of Companies

Telephone : ViCtoria 3404 (12 lines)

TECHNICAL PUBLICATIONS - Available from stock

	Post Free
ANTENNA HANDBOOK (Published by A.R.R.L.) (8th Edition)	19s. 0d.
A COURSE IN RADIO FUNDAMENTALS (New Edition)	10s. 6d.
BASIC AUDIO COURSE	22s. 6d.
BASIC RADIO COURSE	19s. 0d.
BEAM ANTENNA HANDBOOK	22s. 0d.
BETTER SHORTWAVE RECEPTION COMMAND SETS (Published by CQ.) Information on conversion of many Command Transmitters and Receivers	12s. 6d.
CQ ANTHOLOGY	16s. 9d.
DXERAMA (3rd Edition)	16s. 0d.
DX GUIDE (New Edition)	16s. 9d.
ELECTRONICS MADE EASY	6s. 6d.
GUIDE TO BROADCASTING STATIONS (Twelfth Edition) pp.112	3s. 10d.
HAMS INTERPRETER (Published by OH2SQ)	7s. 0d.
HIGH FIDELITY (Gernsback)	12s. 6d.
HIGH FIDELITY CIRCUIT DESIGN (302 pp.) (Gernsback)	48s. 0d.
HINTS AND KINKS, Vol. 5	11s. 0d.
HOW TO BECOME A RADIO AMATEUR★	5s. 0d.
HOW TO LISTEN TO THE WORLD. LEARNING THE RADIO TELEGRAPH CODE	7s. 0d.
LOG BOOKS Spiral bound (Published by A.R.R.L.)★	4s. 6d.
LOG BOOKS Spiral bound (Published by A.R.R.L.)★	7s. 6d.
MOBILE HANDBOOK (Published by CQ) (Second Edition)	24s. 0d.
MOBILE MANUAL (Published by A.R.R.L.)	23s. 0d.
NEW SIDEBAND HANDBOOK (Published by CQ, latest issue)	25s. 6d.
NOVICE HANDBOOK	23s. 6d.
OPERATING AN AMATEUR RADIO STATION (Published by A.R.R.L.)★ ..	2s. 8d.

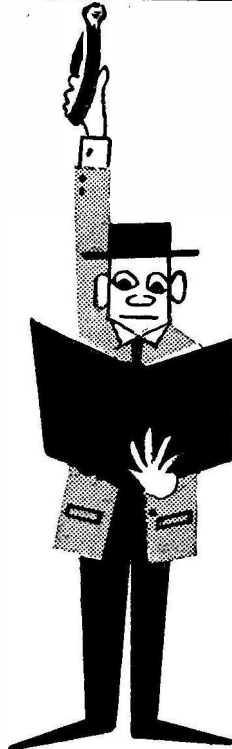

QUAD ANTENNAS	23s. 0d.
RADIO AND TV HINTS	8s. 6d.
RADIO DESIGNERS HANDBOOK (4th Edition) 1,498 p.p. (F. Langford Smith) ..	50s. 0d.
RADIO VALVE DATA (Iliffe)	5s. 9d.
S-9 SIGNALS	8s. 6d.
SCATTER PROPAGATION THEORY AND PRACTICE (H. W. Sams)	25s. 0d.
SHORT WAVE RECEIVERS For The Beginner	6s. 6d.
SINGLE SIDEBAND FOR THE RADIO AMATEUR (A.R.R.L.)	14s. 6d.
SURPLUS CONVERSION MANUAL Volume 1	21s. 0d.
Volume 2	21s. 0d.
TECHNICAL DICTIONARY (H. W. Sams)	16s. 6d.
TELEVISION INTERFERENCE - ITS CAUSES AND CURES	15s. 6d.
THE OSCILLOSCOPE	18s. 6d.
THE RADIO AMATEUR OPERATOR'S HANDBOOK (Data Publications)	3s. 6d.
THE RECORDING AND REPRODUCTION OF SOUND (H. W. Sams)	64s. 0d.
TRANSISTORS—THEORY AND PRACTICE (New Edition) (Published by Gernsback)	23s. 0d.
TRANSISTOR THEORY AND PRACTICE (Published by World Radio Handbook)	9s. 6d.
TRANSISTOR TECHNIQUES (Gernsback)	12s. 6d.
VHF HANDBOOK	24s. 0d.
WORLD RADIO HANDBOOK, 1959 Edition, 180 pages	8s. 6d.
WORLD RADIO HANDBOOK, 1960 Edition, 198 pages	16s. 6d.

(★ Not strictly applicable under U.K. conditions)

RADIO AMATEUR CALL BOOK

Special Note: In future, the CALL BOOK will be published in two parts: American Section only, appearing quarterly, at 41s. 6d. post free; Foreign (non-American) Section half-yearly in March and September, at 25s. post free. Will include latest call sign/address listings for all countries, including much DX data. The only complete directory to the radio amateur stations of the world.

SPRING EDITION (Reprint)
(Available end of June)

American Section, 41s. 6d.; Foreign (non-American) Section, 25s.
The two together at 60s. post free.

Now Available
WINTER EDITION (American Only)
30/- per copy, post free

New and Greater Edition of the

RADIO HANDBOOK (15th Edition)

Published by Editors & Engineers, W6-U.S.A. 800 pages, durable binding.
Price 60s. post free, from stock

THE RADIO AMATEUR'S HANDBOOK

LATEST (1960) EDITION

Published by the American Radio Relay League
Price (standard binding) 34s. post free
(Bound in whole Buckram, de luxe, 44s.)

DX ZONE MAP

Latest Revision—Paper Edition, 9s. 3d. post free
Linen Backed (de luxe) 11s. 9d. post free

MAGAZINES BY SUBSCRIPTION

	One Year
AUDIO	40s. 0d.
*CQ, RADIO AMATEUR'S JOURNAL	44s. 0d.
ELECTRONICS (Trade only)	160s. 0d.
POPULAR MECHANICS	32s. 0d.
POPULAR SCIENCE	48s. 0d.
QST, ARRL	43s. 0d.
HIGH FIDELITY	56s. 0d.
ELECTRONICS WORLD (formerly "Radio and Television News")	48s. 0d.
RADIO ELECTRONICS	36s. 0d.
SERVICE	24s. 0d.
TELEVISION	48s. 0d.

*Binders for CQ 30s. 0d.
Post free, ordinary mail only

Subscription Service for all American Radio and Technical Periodicals

SHORT WAVE MAGAZINE

Publications Department

55 VICTORIA STREET, LONDON, S.W.1

Telephone ABBEY 5341

OUTSTANDING PERFORMANCE!

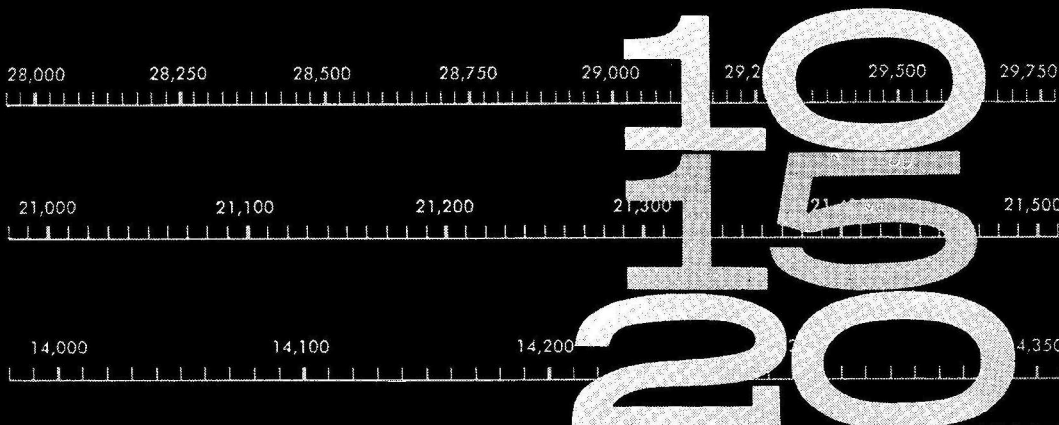

with TRAPMASTER aerials

-REGISTERED-

NO MATCHING DEVICE NEEDED!

You'll get consistently fine multi-band performance from Mosley TRAPMASTER aerials . . . automatically!

Amateur radio enthusiasts the world over have made TRAPMASTER their favourite . . . and Mosley the leading manufacturer of beam aerials in the United States!

TRAPMASTER is now made in England too!

These aerials are engineered and constructed to be fed with a 52-ohm coax line . . . no other tuning device necessary!

Write for complete information, no obligation of course!

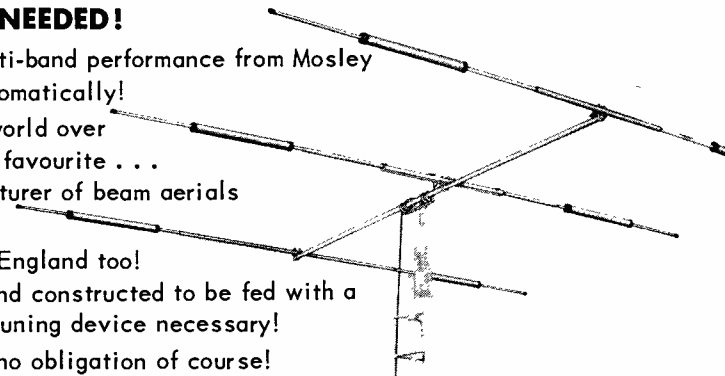

ALL USA MOSLEY AERIALS NOW AVAILABLE

Trap type aerials are, by far, the most popular of multi-band aerials. The Mosley TRAPMASTER line is the recognized leader because the unique design of Mosley traps assures stable operating performance under all weather conditions and because quality is reflected in every detail of TRAPMASTER aerials.

Streamlined grace combines with the look of rugged strength to make Mosley aerials pleasing to the eye . . . and completely acceptable to your neighbours!

O. J. Russell, G3BHJ, Manager

A subsidiary of MOSLEY ELECTRONICS, Inc.,
St. Louis 14, Missouri, USA

Mosley Electronics Ltd. 15 Reepham Road, Norwich, Norfolk, Telephone 45069

AUSTRALIA
MAGNECORD AUSTRALASIA Pty. Ltd.
Kyle House, 31 MacQuarie Place,
Sydney

RHODESIA
STUDIO FOUR
Salisbury,
Rhodesia

FINLAND
OSMO A. WIIO, OH2TK
Laajalahdentie 24 A1,
Mukkiniemi

DENMARK
HANS HOLTMAN, OZ9DC
SØBAKKEN 21,
Charlottenlund

G.W. SMITH & CO (RADIO) LIMITED

Phone: GERRARD 8204/9155
Cables: SMITHEX LESQUARE
3-34 LISLE STREET, LONDON, W.C.2

UNIVERSAL AVOMETER MODEL "D"

D.C. VOLTS	A.C. VOLTS	D.C. Current	A.C. Current
150 mv.	7.5 v.	15 ma.	75 ma.
300 mv.	15 v.	30 ma.	150 ma.
1.5 v.	75 v.	150 ma.	750 ma.
3 v.	150 v.	300 ma.	1.5 amp.
15 v.	300 v.	1.5 amp.	7.5 amp.
30 v.	600 v.	3 amp.	15 amp.
150 v.	750 v.	15 amp.	Resistance
300 v.	1,500 v.	30 amp.	1,000 Ω
750 v.			10,000 Ω
1,500 v.			

Supplied reconditioned as new, with internal battery, instructions and leads £8/19/6 each. P/P. 3/6.

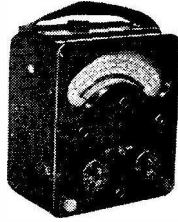

WESTON MODEL 772 TESTMETER

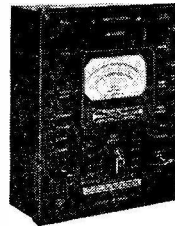

A.C. VOLTS	D.C. CURRENT	A.C. CURRENT
2.5 v.	100 micro/a.	500 ma.
10 v.	1 ma.	1 amp.
50 v.	10 ma.	5 amp.
250 v.	50 ma.	RESISTANCE
1,000 v.	100 ma.	ANCE
O.C. VOLTS	500 ma.	100 ohms
2.5 v.	OUTPUT	1,000 ohms
10 v.	METER	100k. ohms
50 v.		10 megohms
250 v.		
1,000 v.		

Supplied in perfect working order complete with internal batteries. £7/10/- P/P. 4/-.

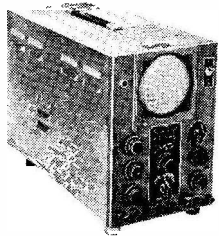

COSSOR 339 DOUBLE BEAM OSCILLOSCOPES

Operation 110/200/250 volts A.C. Ten position time base, 6 cps. to 250,000 cps. Amplifier 10 cps. to 2,000,000 cps. Perfect working order,

ONLY £15 EACH
Carriage 10/-

BRAND NEW MEDRESCO HEARING AIDS

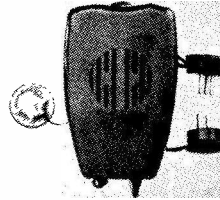

Fully tested, complete with earpiece, all necessary leads and battery pouch. Incorporates 3 miniature low consumption valves and sensitive crystal microphone. Price :

ONLY 32/6 EACH
plus 1/- P/P. Batteries 5/- extra.

ATTENTION MOBILEERS ! this is what you've been waiting for...

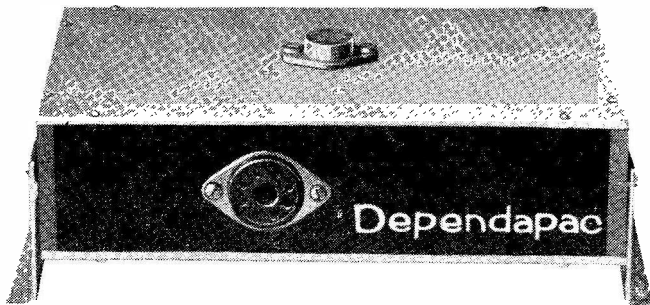

The only high powered transistorised D.C. conversion unit on the world market giving equal efficiency at 30 watts as at 150 watts !

It employs a system (patent applied for) of switching by relay the Transformer taps and bias enabling you to use it on your receiver at 90% efficiency and when the Transmit relay is actuated the efficiency is 85% at 150 watts. A typical supply for a 6146 in the final modulated by a pair of metal 6L6's, 807's or TT21's, 530 volts at 228 m/a and 265 volts at 110 m/a is easily

obtainable from any 12 to 14 volts input. Any combination of these output voltages may be used, providing the drain does not exceed 150 watts. Do NOT confuse the DEPENDAPAC with other more expensive units on the market rated at "120" watts but which cannot be used efficiently at 30 watts as current drain is much too heavy.

STAR FEATURES

- * Latest Texas Instruments Power Transistors.
- * Perfect Waveform.
- * Internal Relay Controls for both 'Receiver' and 'Transmitter.'

- * Total size 8½" x 5" x 2¼".
- * Full-sized ½" plates for heat sinks.
- * Adjustable mounting brackets.
- * Withstands Mobile wear and tear. We are in full production for the 1960 Mobile Season, so place your orders now. Price 21 gns.

**INDEX TO
ADVERTISERS**

	PAGE
Anglin	218
Avo. Ltd.	169 & 221
B.I.E.T.	<i>cover iii</i>
Brookes Crystals	222
Candler System	219
Communications (Air) Ltd.	223
Daystrom, Ltd.	<i>cover iv</i>
Dependable Relay Co., Ltd.	172
Forth Motor Co.	224
G3HSC	224
G.W.M. Radio	222
Harris, P.	220
Henley's	217
Home Radio	220
International Aeradio, Ltd.	219
K.W. Electronics	217
Labgear	174
Minimitter	218
Mosley Electronics, Ltd.	171
Norman Birkett, Ltd.	221
Peter Seymour	218
Redifon, Ltd.	<i>cover ii</i>
Rollet	224
R.T. & I. Service	223
Small Advertisements	219-224
Smith & Co. (Radio), Ltd.	172
Southern Radio	218
Southern Radio & Elec.	224
S.W.M. Publications	170
Whitaker	<i>cover iii</i>
Young	174

SHORT WAVE MAGAZINE

Vol. XVIII

JUNE, 1960

No. 200

CONTENTS

	Page
Editorial	175
120-Watt Three-Band Transmitter, <i>by J. N. Roe, M.I.R.E., F.R.S.A. (G2VV)</i>	176
A Simple Valve Voltmeter, <i>by J. M. Osborne, M.A. (G3HMO)</i>	185
Seven Bands in One Cabinet, <i>by F. W. Lloyd (G3IPR)</i>	188
DX Commentary, <i>by L. H. Thomas, M.B.E. (G6QB)</i>	190
The Redifon R.145 Communications Receiver	198
Notes on VHF Chokes, <i>by J. E. Robson, B.Sc., A.M.I.E.E.</i>	204
VHF Bands, <i>by A. J. Devon</i>	206
The Mobile Scene	209
Transistor Microphone Amplifier	211
New QTH's...	212
The Other Man's Station — GW3NMQ	213
The Month with the Clubs — From Reports	214

Managing Editor : AUSTIN FORSYTH, O.B.E. (G6FO)

Advertisement Manager : M. GREENWOOD

*Published on the first Friday of each month at 55 Victoria Street,
London, S.W.1. Telephone : Abbey 5341/2*

Annual Subscription : Home and Overseas 33s. (\$5.00 U.S.) post paid.

© Short Wave Magazine Ltd.

AUTHORS' MSS

Articles submitted for Editorial consideration must be typed double-spaced with wide margins on one side only of quarto or foolscap sheets, with diagrams shown separately. Photographs should be clearly identified on the back. Payment is made for all material used, and it is a condition of acceptance that full copyright passes to the Short Wave Magazine, Ltd., on publication.

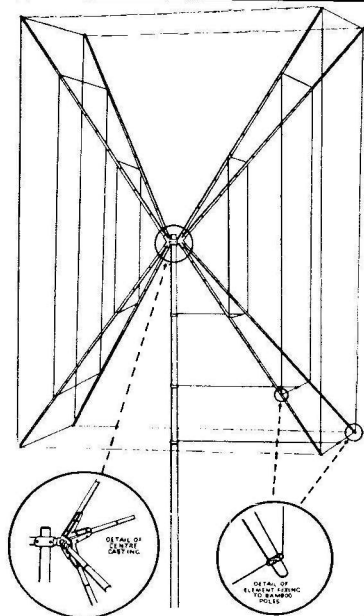

3 BAND QUAD AERIAL

14 Mc/s — 21 Mc/s — 28 Mc/s

CORRECTLY DESIGNED ELECTRICALLY
Correct Element Spacing for each Band

CORRECTLY DESIGNED MECHANICALLY
Non-Corrode Alloy Castings and U Bolts

FORWARD GAIN > 9 dB each band

FRONT/BACK RATIO > 30 dB each band

STANDINGWAVE RATIO < 2:1 each band

BOOM LENGTH ONLY 12 INCHES

COMPLETE WITH MAST HEAD CLAMP

Price - £17

Send for details today

Labgear Limited

Telephone : 2494 (2 lines)

Telegrams : Labgear, Cambridge

WILLOW PLACE,
CAMBRIDGE, ENG.

NOW IS THE TIME TO THINK ABOUT AERIALS

GELOSO VFO UNITS. 4/102 with New Dial and Escutcheon, Output on 80-10 metres for 2-807 or 6146's. Only £8.5.0. 3 valves to suit, 24/-, Post free.

MULTI-WAY CABLE $\frac{3}{8}$ " diameter, 7 coded wires. Ideal for inter-chassis connections or beam control. 1/3 per yard. Ditto, 10-way (5 pairs). Screened and plastic covered. 2/ per yard. P. & P. min. 1/6.

NATIONAL HRO. Crystal Filter Units, 455 Kc with crystal set and phasing controls, new, boxed, Only 19/6. P. & P. 1/6.

GOING MOBILE?

Then you cannot afford to miss this.

ROTARY CONVERTERS

6v. input, 250v. 125 mA output.

ONLY 17/6 P. & P. 3/-

also 12v. input, 490v. 65 mA Comp. or 440v. 100 mA intermit. 17/6 P. & P. 3/-.

12v. D.C. MINIATURE ROTARY CONVERTERS

Size only $\frac{1}{2}$ " x $2\frac{1}{2}$ " overall. Output 360v. 30 mA cont. rating, or 310v. 70 mA intermitent. ONLY 12/6 each or 22/- for 2, P. & P. 2/-.

Post and packing 2/-.
Special quotations for quantities.

AERIAL EQUIPMENT

TWIN FEEDER. 300 ohm twin ribbon feeder similar K25, 6d. per yard. K35B Telcon (round) 1/6 per yard. Post on above feeder and cable, 1/6 any length. **COPPER WIRE.** 14G, H/D, 140 ft., 17/-; 70 ft., 8/6, post and packing 2/- Other lengths pro rata. Stranded 7/25 140 ft., 10/-; 70 ft., 5/-, P. & P. 2/-.

RIBBED GLASS 3" AERIAL INSULATORS. 1/6 each or 6 for 7/6. P. & P. 1/6.

FEEDER SPREADERS. 6" Ceramic type F.S., 9d. each or 8/- doz. Postage 1/6.

CERAMIC CENTRE PIECE for dipoles, Type AT, 1/6 each. P. & P. 1/6.

2 METRE BEAM, 5 element W.S. Yagi. Complete in box with 1" to 2 1/2" masthead bracket. Price 49/-, P. & P. 3/6.

SUPER AERAXIAL, 70/80 ohm coax, 300 watt, very low loss, 1/8 per yd. P. & P. 1/6.

FOR THE DX ENTHUSIAST MOSLEY TRAP BEAMS

Vertical 3 Band V3 £7.10s.

3 Band 3EL Beam TA 33 dr £24.15s.

Also the **NEW Single Band Power Beams.** Send for details.

50 ohm, 300w. $\frac{1}{4}$ " coax Low loss. Ideal for Mosley and other beams, 1/6 per yd. P. & P. 1/6

ABSORPTION WAVEMETERS. 3.00 to 35.00 Mc/s in 3 Switched Bands. 3.5, 7, 14, 21 and 28 Mc/s Ham Bands marked on scale. Complete with indicator bulb. A MUST for any Ham shack. ONLY 19/6 EACH. post free.

HEADPHONES, H.R. type, 4000 ohms, very sensitive. Only 12/6 pair. P. & P. 1/6. C.L.R. (low res.) 8/6 P. & P. 1/6.

CONDENSERS. 8 mfd., 750 V, 5/6 each, post 1/6.

TRANSMITTER/RECEIVER AN/PPN-2. FREQ. 214/234 Mc/s. Complete in carry pack with 9 valves (5-3A5, 3-155, 1-1R5). WITH DUAL VIBRATOR PACKS (2v) & ANTENNA, full instructions Book, £3/10/0, carriage 7/6.

VARIABLE CONDENSERS. All brass with ceramic end plates and ball race bearings. 50pf, 5/9, 100-6/6, 160, 7/6, 240, 8/6 and 300pf, 9/6. Extension for ganging. P. & P. 1/-.

RACK MOUNTING PANELS: 19" x 5 1/2", 7", 8 1/2", or 10 1/2", black crackle finish, 5/9, 6/6, 7/6, 9/- respectively, P. & P. 2/-.

RELAYS (sealed) 12 volt 1 1/2" x 1" x 2". D.P.S.T. contacts, beautiful job, only 5/- each. P. & P. 9d.

AMERICAN 813 VALVES. New and boxed. £3.10s. each.

AR88 POWER TRANSFORMERS Genuine RCA, few only, £2 each. Carr. paid.

ACOS 39/1 STICK MIKE. List Price £3 3s. our price 39/6.

Full Range of
**DENCO, REPANCO AND
EDDYSTONE**
coils and components available

CHAS. H. YOUNG LTD.

Dept. 'S', 110 Dale End, Birmingham.

CENTRAL 1635

No C.O.D. on
Orders under £1.

Please print
your name
and address.

The SHORT-WAVE Magazine

E D I T O R I A L

VHF *Those who have worked their share of DX and are now finding the HF bands uncomfortably crowded have various directions in which to turn for new outlets to satisfy that compelling urge to communicate — one of these escape routes is, of course, VHF.*

Given that the true radio amateur is he who gets his satisfaction by overcoming difficulties in order to achieve an objective, there can be little doubt that, for those new to them, the VHF bands offer a real challenge. Though the most that can be expected in the way of DX — used in this context as a relative term — is working Europeans when conditions are particularly favourable, the making of such contacts under the peculiar circumstances that obtain on VHF is an enormous satisfaction in itself.

Over the years, large numbers of U.K. amateurs have, at one time or another, operated on the VHF bands. Many have given up because of, on the one hand, the lack of DX and, on the other, the apparent lack of activity when conditions are only good enough for local working. These are valid arguments, as all who work the VHF bands regularly will know. But it is also true to say that on two metres, for instance, short-haul contacts can be enjoyed at any time, with loud signals both ways, virtually free of QRM; indeed, much of the local-net work now being carried out every week-end on Top Band could be transferred to two metres with better signals all round — and an entirely new range of ideas to discuss and problems to solve.

Furthermore, there is on the most-frequented VHF bands, two metres and 70 centimetres, a great deal of interesting experimental work to be done — not much of it will be new or original in the strict radio engineering sense, but it would be entirely new experience to those who so far have kept to the HF bands.

What it all comes to is that the keen amateur who wants to get the most out of Amateur Radio will sooner or later have to try his hand at VHF — even if only to make a change by getting away from the turmoil of the HF bands!

*Austin Fobell
G6FO.*

120-Watt Three-Band Transmitter

FOR CW OPERATION ON
10-15-20 METRES

J. N. ROE, M.I.R.E., F.R.S.A. (G2VV)

There are points about the design of this transmitter which will be of interest to all readers, particularly those whose inclination is for CW working on the HF bands during TV hours. The TVI precautions are built in and the general construction is such that the RF output on all three bands is the maximum obtainable for the power used.—Editor.

THE majority of amateur stations are equipped for one or all of the 1.8, 3.5, 7 mc bands. Not all, however, possess a transmitter for the 14, 21, 28 mc bands. The latter is frequently one of those jobs under prolonged consideration. For those who may be classed in this category and who desire a simple, efficient home-constructed transmitter for CW operation on the DX bands, the design discussed here may offer a few ideas, in whole or part, for their particular requirements.

Whilst the design may be considered original, the circuitry is orthodox. Low constructional cost, compact assembly and ease of operation have been given paramount consideration. Surplus material is employed wherever suitable, and many of the components will already be on hand in most amateur stations.

Two chassis are used, one for the frequency multiplier circuits, the other accommodating the PA unit. Meticulous care has been taken as regards screening. This is of *major* importance in minimising possible TVI trouble. Particular attention has also been directed to the layout of components and associated leads. A number of home-constructed transmitters often require elaborate TVI proofing due to poor layout and lack of screening in the first instance.

The complete transmitter is assembled in a T.1154 metal framework and case; the aerial tuning unit is constructed in a surplus "valve spares" metal case. Both items can be purchased for a matter of a few shillings!

Additional requirements to the transmitter and ATU are a suitable power supply unit and a reliable VFO.

Circuit Analysis: Multiplier Unit—Fig. 1

This section of the transmitter consists of an EF80 Buffer (V1), QVO3-12 (5763) Buffer/Doubler (V2), QVO3-12 Doubler (V3). External VFO output is capacity coupled to the grid of V1; V1, V2, V3 employ conventional tuned anode coils with capacity coupling between stages. HT is applied direct to the tuned circuit components. This obviates additional condensers and permits short leads in wiring. Output from V3 is taken to the PA Unit via C15, variable drive control. Bandswitching is affected by ganged switches S1-S2. Keying is in the cathode circuits of V2, V3. Doubling is used for each band; the table indicates the frequency sequences for each band covered by the transmitter.

Band	External VFO Frequency	V1 Tuned	V2 Tuned	V3 Tuned O/P to PA
1	3.5 or 7 mc	7 mc	7 mc	14 mc
2	5.25 mc	5.25 mc	10.5 mc	21 mc
3	7 mc	7 mc	14 mc	28 mc

PA Unit, Fig. 2

This circuit embodies the familiar pair of 807's (V4,V5) in parallel with a 6L6 (V6) clamper to safeguard the PA in the key-up position. RF output from the Multiplier Unit is fed to the grids of V4,V5 via C25 and grid stoppers R13,R14. A jack is provided for grid current (drive) measurements. A ceramic three-position switch, S3, selects the PA coil ranges; RF output is fed to the ATU by individual link coils and associated coax sockets. Complete screening is provided between the PA anode and grid circuits and between the RF Unit and Multiplier circuits.

Circuit Commentary

The method of doubling from 5.25 mc—for 21 mc operation—was chosen, rather than the more usual mode of tripling from 7 mc, because of the increased output, and consequent greater degree of stability, thus obtained. For those who may not possess a VFO providing output at this frequency, tripling from 7 mc may be employed. Higher output will be required (via V1, V2, V3) from the VFO to supply sufficient drive to the PA Unit.

Series feed anode circuits in each stage were selected for reasons already given. The individual constructor may prefer to use parallel feed in which case the additional condenser required (see any Amateur Radio text book)

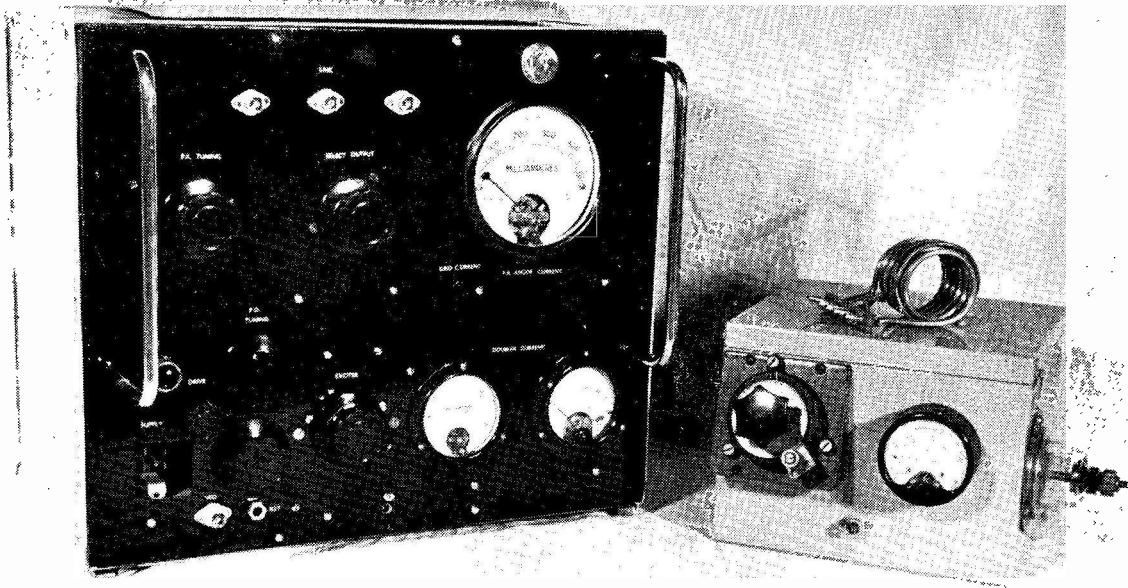

General impression of the transmitter designed and described by G2VV, with its associated aerial tuning unit, showing the 20-metre coil for the latter. The transmitter housing is a T.1154 case, stripped, cleaned and repainted, with new panels and separate chassis for the exciter and PA sections. The ATU also is constructed in a metal case.

must be included in the circuits. Any additional wiring necessary should be kept to a minimum.

Link coupling from the PA to the ATU is a method favoured by the writer. One of the main advantages of this system, when *correctly* matched and operated, is the elimination—at the aerial—of any lower frequency component present in the PA from preceding stages of the transmitter. To obviate possible losses or mismatching through switching, each PA inductance is individually link coupled to the ATU, selection of the desired range being achieved by a plug and socket feed through 75 ohm coax.

LT at 6 volts, 5 amps ; HT for Multiplier Section 300 volts at 100 mA ; HT for PA Unit 600 volts, 250 mA will be required. Minimum drive current for the 807 PA is 7 mA. Each HT supply should be adequately smoothed and fitted with a suitable bleeder resistor at the output.

Choice of Components

A few notes on choosing the more important items may be helpful. Reference to the Table of Values indicates that, wherever possible, component values and types have been "commoned." This reduces cost and permits the finished job to present a more uniform appearance. An example of this can be found with the .005 μ F condensers, of which there are

nine ; those actually used are surplus mica moulded types rated at 2,500 volts DC. The rating is, of course, much higher than required but being readily available and inexpensive presented an obvious choice. (Before using any surplus condensers and/or resistors they should be bridged for value and leakage.)

Items C23, RFC4 must be absolutely reliable and preferably new. C22, C27 should be of robust construction with high grade insulation. Ganged switches, S1, S2 can be of the wafer type or any suitable three-position assembly having good quality paxolin or ceramic dielectric. The PA waveband switch, S3, must be well made with ceramic or mycalex insulation and rated for 2,500 volts DC working. The type used in the PA Unit shown in the photographs is a surplus circular ceramic ex-radar equipment component having two banks and two wiper arms. The PA coils are mounted horizontally between the two banks and soldered directly to the actual switch contacts.

Condensers C1, C7, C12, C15 are standard Eddystone types and the insulated mounting brackets Eddystone No. 1007 ; insulated spindle couplings Eddystone No. 1008 are cut to required lengths. All valveholders are of the ceramic variety with screening cans for V1, V2, V3. Physical size of meters M1, M2, M3, M4

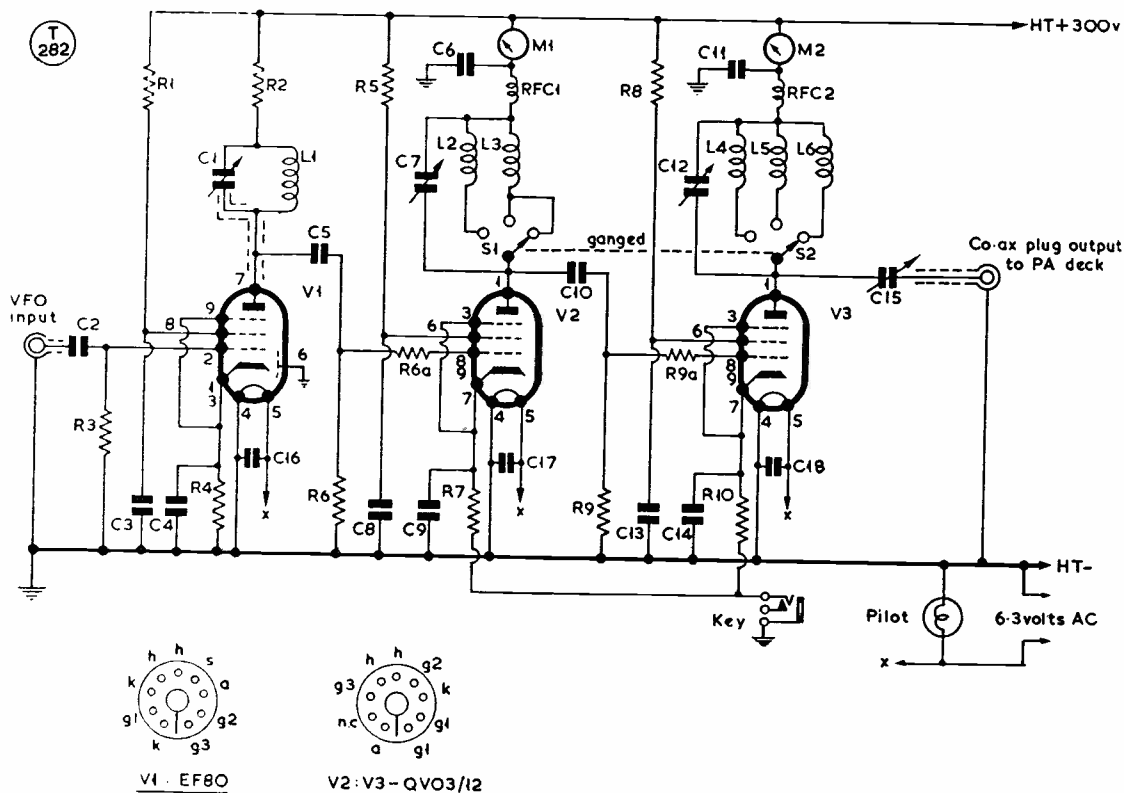

Fig. 1. Multiplier or exciter unit for the transmitter described in the article. This is built on a single chassis, with external VFO drive and output, on either of three bands selected, taken to the PA section, built on a separate chassis in the same housing. Ample drive is obtained on the three HF bands covered and all values are given in the table.

is entirely a matter for personal choice. The large meter shown in the PA Unit happened to be on hand and has been found rather comfortable to read during operation! The use of a smaller size meter for PA current would probably allow room, on the front panel, for the inclusion of a PA grid current meter. This would replace the jack fitted for external metering. Should a meter be fitted it must be screened from the other components on the top deck.

Although not indicated on the circuit diagram Fig. 2, C24 consists of two $.005 \mu\text{F}$ condensers in parallel. One is mounted on the top of the PA Unit chassis close to R16, the other being soldered directly to the g2 pins of V4, V5.

Coil Formers

All coils are home constructed and full winding details are given in the Table. With the exception of L6, all the multiplier coils are wound on 1-in. diameter polystyrene formers, each 3 in. in length. These "formers" are

actually polystyrene pill cases with lid (costing $5\frac{1}{2}$ d. each!) obtainable from any branch of a well-known retail chemist! As purchased, the lids are attached to the cases by a short polystyrene ribbon which should be cut off. By drilling a 4 BA hole in the centre of each lid it is transformed into a panel or chassis mounting coil base. The finished coil is simply slipped on to the base. No additional fixing, between base and former, is required. Small holes are drilled in the formers for securing the windings and sufficient wire should be left to allow direct soldering to switch contacts. *Note:* The coil wire ends are brought out to the exterior of the formers. L6, which is air wound, is mounted on a small ceramic strip and wired direct to its switch contact. Reference to the photographs shows the multiplier coils in position.

The PA and ATU coils (3/16 in. diameter copper tubing) should be closely wound on a suitable mandrel, about $1\frac{1}{2}$ in. diameter, allowing them to spring open to the required $2\frac{1}{4}$ in. diameter when removed. The ends of each

inductance should be shaped and hammered out flat. These ends are then cleaned, well tinned (a fairly heavy soldering iron is necessary for this operation) and arranged for soldering direct to S3 contacts in the case of L7,L8,L9 and for mounting on a plug-in base for L13, L14. The ATU coil bases and holder are a commercial product and comprise four plug/socket mountings on a mycalex strip (see Fig. 3 and ATU photograph).

The PA link coils are interwound at the HT end of each PA inductance, the ends being tightly twisted together, and taken to the appropriate co-axial RF output socket on the front panel as shown in the PA Unit photograph. The ATU coil, L13, has its link coupling interwound at the earthy end whilst the link coil for L14 is placed in the middle of the inductance (see ATU photograph).

Constructional Notes

No alterations to the 1154 housing and its framework are necessary. Both should be stripped of all original material and fitments and the housing cleaned for subsequent painting. The overall measurements of the T.1154 framework are 16½ ins. x 14 ins. x 8½ ins. (If desired, the front panel and the two chassis can be supplied by Philpotts Metalworks Ltd.,

Loughborough, who will also undertake drilling.) Made in 16 gauge aluminium, the panel is 16 ins. x 14 ins. and the two chassis 15 ins. x 8 ins. x 1¼ ins. each. The front edge of the lower (multiplier) chassis is cut away to ¾ in. deep to allow fitting over the base angle strip of the 1154 framework.

Reference to the photographs indicates the

Table of Values

Figs. 1-3. 120-Watt Three Band Transmitter

C1 = 100 μμF ceramic pre-set	R7, R10, = 500 ohms 2 watt
C2, C5, C10, C25 = 100 μμF ceramic or silvered mica	R6A, R9A,
C3, C4, C6, C8, C9, C11, C13, C14	R11, R12, R13, R14 = 47 ohms ½ watt
C24 = .005 μF Mica	R15 = 7,500 ohms 3 watt
C7, C12 = 100 μμF small type variable	R16 = 20,000 ohms 50 watt vitreous enam.
C15 = 50 μμF small type variable	RFC1, RFC2,
C16, C17, C18, C19, C20, C21, C22, C27 = 100 μμF ceramic or mycalex, 2,000 volts working	RFC3 = 2.5 mH wire ends
C23 = .001 μF 2,000 volts working	RFC4 = 1mH 300 mA with ceramic pillar mounting
C26 = .001 μF Mica	M1, M2 = 0-50 mA
R1, R3, R6, R9 = 47,000 ohms 1 watt	M3 = 0-250 mA
R2 = 15,000 ohms 1 watt	M4 = 0-1 amp. RF thermo
R4 = 150 ohms ½ watt	S1, S2 = Three position, ganged (see text)
R5, R8 = 10,000 ohms 1 watt	S3 = Three position, ceramic (see text)
	V1 = EF80
	V2, V3 = QVO3-12 (Mullard)
	V4, V5 = 807
	V6 = 6L6

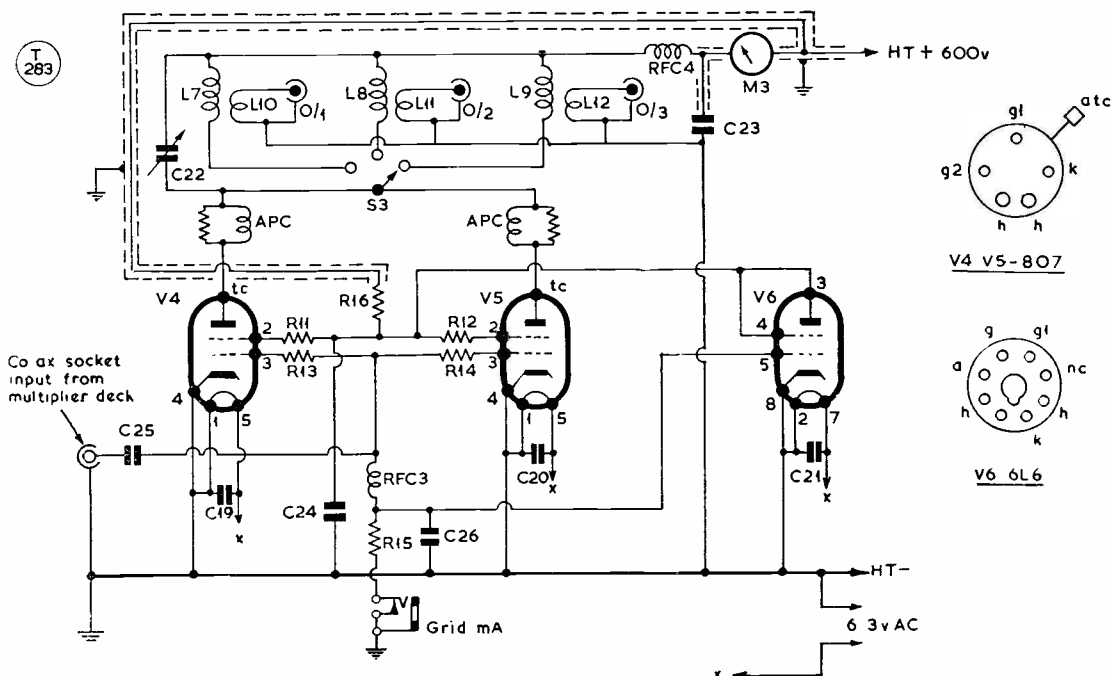
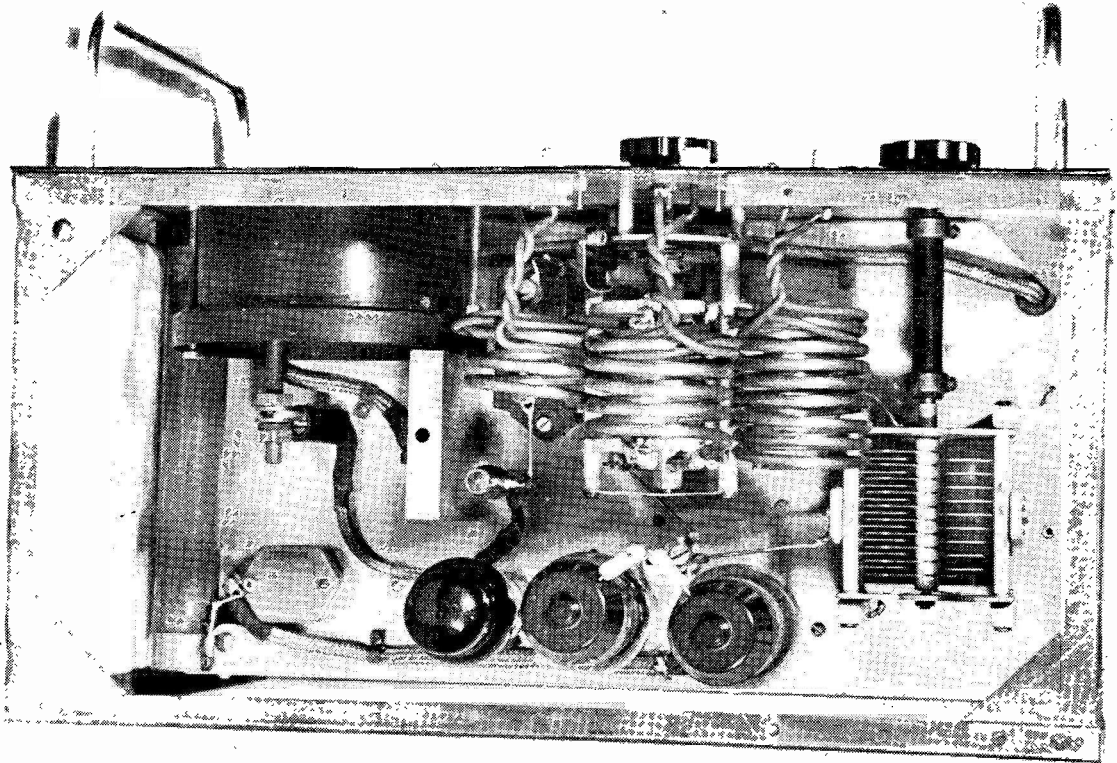

Fig. 2. RF power amplifier section of the 120-watt three band transmitter. The PA coils are wound with copper tube and are individually switched, ensuring highest efficiency, no RF being lost in heating shorted coil sections. With a 750-volt supply, a pair of good 807's and a KT66 clamper, this amplifier could be run at the full 150w. input on CW, giving about 110 watts RF output on all three HF bands. The photographs show the general construction and layout.



Looking down on the PA unit, from left to right: R16, C24, M3, V6, V5, V4, RFC4 between V6 and C23 (under L9). Note metal screen between RF section and M3 terminals. L9, L8, L7 are mounted on the PA band-switch S3, and the link coupling output coils are wound over the tank inductances. C22 is at the extreme right.

general layout of chassis components, which will vary in individual cases. The arrangement of panel and chassis components should be carefully considered before any drilling or assembly is undertaken. Particular attention is needed for the placing of C7, C12, C15 as these condensers have to be accommodated on individual insulated brackets on the lower chassis with room for the insulated couplers attached to the front-of-panel controls. The square cut out at the left of the panel (looking at the front) should be large enough to allow the cover of the four-pin Jones socket to pass through; the four-pin plug is mounted, on small angle brackets, on the lower chassis far enough back to allow an almost flush fitting with the front panel when the power socket is in position. When the panel and chassis are assembled, the VFO input socket, key jack and grid current jack pass through both and are secured to the front panel. S1, S2 (ganged) S3, M1, M2, M3, L2, L3 coil bases, pilot lamp holder, handles and the three RF output sockets are all fitted to the front panel. The

two chassis are secured to the front panel by 4BA bolts, the upper one being fitted with rear supports mounted on the lower chassis. Some essential details are given in Fig. 4. The Jones power plug—mounted on the multiplier chassis deck—should be screened by a suitable metal shield to avoid possibility of RF pick up from the tuned circuit components. Note that C1, L1 are fitted *under* the chassis. A convenient hole is drilled through the front panel and chassis to enable pre-set adjustments to C1.

In the PA Unit, the under chassis coax input socket is mounted on stand-off pillars for flush fitting to the base cover. It should be placed close to the grid wiring of V4, V5 (see photograph). The PA base cover is secured to the chassis by angle brackets and a self tapping screw at each end. When mounting components on the lower chassis and coils L2, L3 (fitted to their respective bases mounted behind the front panel) enough room should be allowed to enable the base screen to be removed at any time. It will then be possible, after taking out the end screws and coax input plug from the

multiplier section, to slide the screen—at an angle—through the space between the front panel and rear supporting bracket at the left hand side. Full access to the under chassis components and wiring of the PA Unit is thus ensured.

Resistor R16, on the PA deck, is self supporting, being wired between two ceramic pillar insulators. C24 is mounted on small ceramic spacers. M3 should be screened from the RF section.

Having decided upon the complete layout of all components, the necessary drilling of panel and chassis can be carried out. Mention may perhaps be made, at this stage, that the final assembly is completed by engaging the front panel to the 1154 framework through the existing 6 BA holes on either side.

Wiring the Multiplier Chassis

All component and point-to-point wiring is carried out in 18g, tinned copper—apart from the coil leads, where windings are soldered direct to S1-S2 contacts. Where necessary,

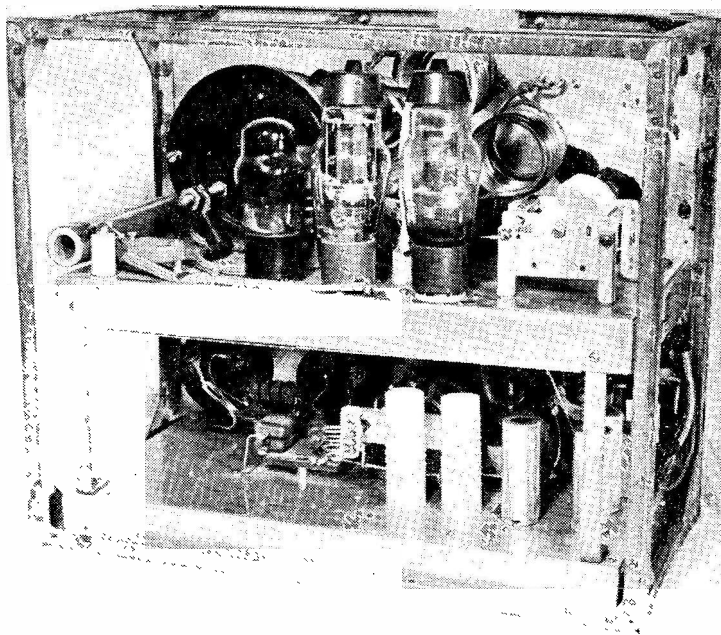

Rear view of the transmitter when removed from its case but fitted in the ex-T.1154 main frame. Top deck shows the PA unit, with the screen resistor R16 at left, then PA plate meter, 6L6 clamper, parallel 807's, PA band-switch and coils (behind valves) and PA tuning condenser C22 at right. The exciter unit is on the lower deck showing, from left, coils L6, L5, L4, band-switch behind coil assembly, valves in screening cans, with V3 to the right of L4, and V2, V1 behind the chassis supporting bracket.

insulating sleeving may be used, as in the case of the connections from the tuning condensers—passing through the deck—to the valve anode pins. Chassis wiring holes should preferably be fitted with rubber grommets. Where possible components are soldered direct to valve pins. Other leads, between components and valves, are kept as short and direct as possible. Remember that the wiring from the VFO input socket to C2 and the connection between C1 and V1 anode must be screened. Coax cable, with the sheathing bonded to chassis, may be used. The RF output from C15 is taken via a short coax lead, with plug attached, for connection to the input socket on the underside of the PA chassis. Wiring to the front panel components—M1, M2, S1-S2, etc.—should be prepared in readiness for attachment when the chassis is finally bolted to the panel. The supply leads from the 4-point power plug, on the chassis, are measured to the desired length for feeding to the upper (PA) chassis. It is only necessary to run two *separately screened* feeds—one for the HT 600v. + line, the other being the live 6v. line heater supply. HT— and the earthy side of the heater supply are wired to the common screening and chassis. In the final assembly the screened leads are bonded

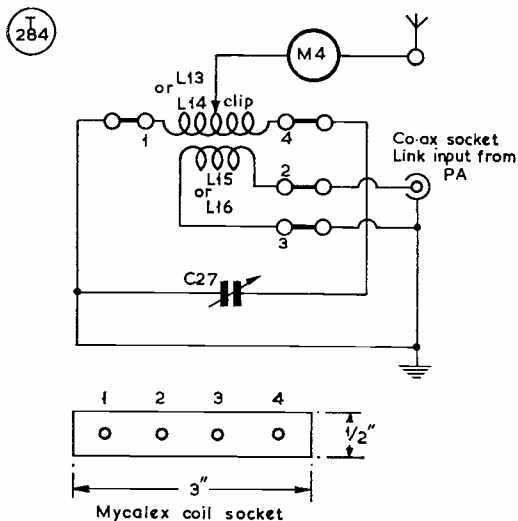

Fig. 3. Circuit arrangement of the Aerial Tuning Unit for the HF band transmitter described by G2VV. See tables for values.

together, with the live heater feed running to the underside of the PA chassis and the HT 600v.+ lead passing up, through a hole in the PA deck, to feed R16 and M3. The right hand side of the PA base screen is cut away to allow entry for the lead.

Wiring the PA Unit

This is a straightforward operation with short, direct point-to-point connections made in 16g. tinned copper. Pre-formed leads should be prepared for wiring to panel components M3, S3, etc., on assembly. Refer to notes under "Choice of Components" relating to C24. In the writer's case, S3, L7, L8, L9 were assembled and wired as a complete "turret unit" before fitting S3 to the front panel. The individual link coil leads to coax sockets should be arranged as illustrated in the PA deck photograph. Ensure that R16 is mounted with ample clearance from the deck, for safe operation.

Assembling and Testing

Before finally assembling the meters and controls, the front panel should be thoroughly cleaned and painted. Hand brushed, black Valspar Lacquer provides an excellent durable finish. When this work has been completed the front panel components should be fitted and the lower (multiplier section) chassis bolted in position. Do *not* fit the assembly to the T.1154 framework as this would hinder general accessibility during preliminary tests. A wiring check, using a continuity meter, can now be carried out on the chassis, and internal wiring connected to the meters. Then connect VFO, key, grid current meter, 6-volt heater and 300-volt

HT supplies to their respective sockets. No feed from the 600-volt supply is required at this stage.

With a 7 mc output from the VFO, put S1-S2 in the first position, *i.e.* 14 mc output from the multiplier. Using headphones, tune a receiver to the VFO signal and with a short insulated screwdriver adjust pre-set condenser C1 until an increase is heard in the received 7 mc signal; peak at this setting when the V1 buffer stage will be in resonance. With C15 fully meshed and the key circuit closed, tune C7, C12 to resonance, *i.e.* maximum dip position on M1, M2. Re-check settings on C1, C7, C12, in that order. With 300 volts HT, readings will be in the order of M1,M2 = 20-25 mA at resonance tune.

Leaving the VFO and C1 tuned to 7 mc, put S1-S2 in the third (28 mc output) position and tune circuits as detailed above. For 21 mc output set the VFO at 5.25 mc, tune C1 to resonance, following through with settings of

MISCELLANEOUS ITEMS

- 6 volt MES pilot lamp and panel type holder
- 2 Handles, 9 in. x 3 in. each
- 2 UX5 valve holders
- 1 Octal valve holder
- 3 B9A valve holders complete with screening cans
- 3 Insulated variable condenser brackets (for C7, C12, C15)
- 4 Insulated spindle couplings (for C7, C12, C15, C22)
- 1 4-point Jones type plug and socket
- 6 Coaxial sockets
- 4 Coaxial plugs
- 2 jacks, make-and-break type, (key, PA grid current)
- 1 Pyrex aerial feed stand-off insulator
- 5 24 in. skirted control knobs
- 1 One inch knob (C15)
- 1 Slow motion control (C27)
- 2 Small ceramic pillar insulators (for mounting R16)

Sundry nuts, bolts, washers, small screening plates, small tag connector panels, suitable screened wire for HT/LT wiring, coaxial leads, rubber grommets, 1/8 lb. 18 SWG tinned copper wire, 1/2 lb. 16 SWG tinned copper tube, 3/16 in. diam. for PA tank coils.

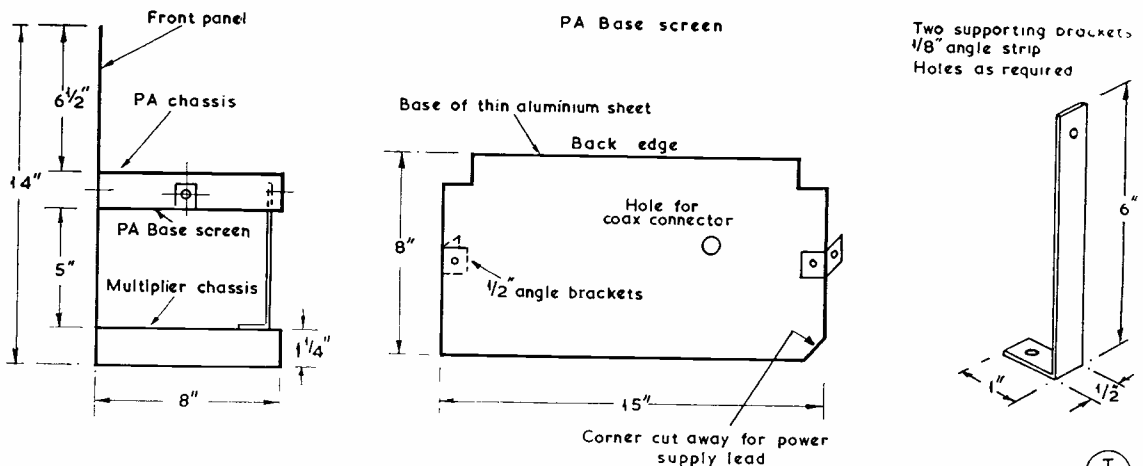

Fig. 4. Some of the mechanical details and dimensions for panel, chassis and brackets when building the G2VV transmitter on to an ex-T.1154 framework.

C7, C12.

Two points relating to the multiplier section may perhaps be noted here. First, the change in tuning settings of C1 for 7 mc and 5.25 mc is not critical. The circuit need only be peaked when absolute maximum output is required. Secondly, as the key—in the open position—is at HT potential a relay should be used in this circuit. A screened lead may be taken to an external relay unit (and click filter if required) or alternatively, ample room is available under the chassis to include a relay within the transmitter.

At the conclusion of these tests, all external leads should be removed from the front panel and preparation made for assembling the PA Unit in position. Fit the two rear supporting brackets to the lower chassis and place the PA chassis, less base cover, over the rear supports. Bolt chassis and front panel together, remembering that the grid current meter jack must pass through both. Finally, secure the rear brackets to the back of the chassis and fit the base cover. The transmitter should now present a solid mechanical appearance.

COIL WINDING DATA

L1 (5.25 - 7 mc):	18 turns 24g. enamelled copper, close wound
L2 (7 mc):	20 turns 24g. enamelled copper, close wound
L3 (10.5 - 14 mc):	13 turns 24g. spaced 3/16 in. between turns
L4 (14 mc):	10 turns 20g. tinned copper, spaced 5/16 in. between turns
L5 (21 mc):	7 turns 20g. tinned copper, spaced 5/16 in. between turns
L6 (28 mc):	4 turns 14g. tinned copper, air-wound, 3/4 in. diameter, spaced 5/16 in. between turns

All the above coils, with the exception of L6, are wound on 1 in. diameter formers — see text for details

L7 (14 mc):	8 turns 3/16 in. copper tubing, self-supporting, 2 1/4 in. diameter, closely wound
L8 (21 mc):	5 turns 3/16 in. copper tubing, self-supporting, 2 1/4 in. diameter, closely wound
L9 (28 mc):	3 turns 3/16 in. copper tubing, self-supporting, 2 1/4 in. diameter, closely wound
L10, L11, L12, L15, L16	Link couplings, 2 turns each of 16g. PVC covered, 2 1/4 in. diameter
L13 (14 mc):	6 turns 3/16 in. copper tubing, self-supporting, 2 1/4 in. diameter, closely wound
L14 (21 - 28 mc):	4 turns 3/16 in. copper tubing, self-supporting, 2 1/4 in. diameter, closely wound
APC	Anti-parasitic chokes: 4 turns 16g. tinned copper, 1/2 in. diameter, air-wound over 100-ohm 1-watt resistor bodies

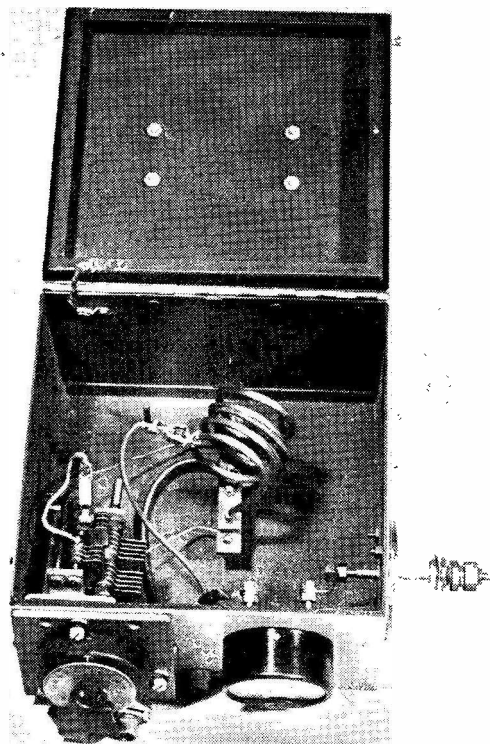

Aerial Tuning Unit for the G2VV three-band transmitter, showing the 10-15 metre coil in position and the aerial tap connected. The link winding is between the middle turns of the aerial coil. The 100 μF condenser, C27 in Fig. 3, consists of two 50 μF sections with a clip selector. The aerial connection is to the feed-through insulator on the right; note bonding between lid and case of this ATU.

The screened 600-volt HT and heater feeds, from the power plug, should be wired and cleated in position on the PA chassis. Do not rely on the cleat fixings for earthing purposes. Each feed should be bonded to the chassis at a convenient point. Complete wiring to the front panel components and to the switch-coil assembly. After all wiring has been carried out make a final continuity meter check and ensure that all HT points are correct for safe operation. With all valves in position apply the heater volts and the 300 volts HT supply to the multiplier chassis—do not apply the 600 volts HT, yet! With an external grid current meter in circuit repeat the tests already given for setting up the multiplier circuits — now finally adjusting C1, C7, C12 for maximum grid current reading. Adjust S3 to correspond to the frequency settings of S1-S2 (preferably 14 mc for initial tests) and apply the 600 volts HT to the PA Unit. With the clamper, V6 in operation, i.e., in the key up position, the standing current will probably be in the region of 80-90 mA.

With the key pressed, the "off tune" current will rise to 200 mA, or more, and this condition must not be held for more than a moment. Adjust C22 for maximum dip position on M3, when the current reading should be around 30-40 mA. In this resonant condition the grid current will be less than in the "PA HT off" position.

The transmitter should now be set up on 21 mc and 28 mc and checked through for correct tuning. It must be noted that at 28 mc, the grid current will be less than the figure obtained at 14 mc or 21 mc, whilst the PA resonant dip figure will be higher. Under normal operating conditions, the 807 screens should be working at about 250-275 volts.

Aerial Tuning Unit Construction

Designed for use with an end-fed 68 ft. aerial, this unit is assembled in a metal case measuring $8\frac{1}{2}$ ins. wide \times $8\frac{1}{4}$ ins. deep \times $6\frac{1}{2}$ ins. high. Construction and wiring, in 16g. tinned, is self explanatory from Fig. 3 and the ATU photograph; C27, of 100 $\mu\mu\text{F}$ total capacity, comprises two 50 $\mu\mu\text{F}$ sections with a clip lead for parallel connection. This arrangement permits greater flexibility in tuning. Only two coils are required—L13 for 14 mc and L14 covering 21 mc and 28 mc. The mycalex coil holder is raised on small pillars about $\frac{3}{4}$ in. above the bottom of the case. A slow motion dial is not essential but is an advantage for accurate tuning. (The one illustrated was removed from a surplus plug-in coil unit—the whole thing costing five shillings!). The lid of the ATU must be bonded to the case by flexible braid to ensure complete screening.

Installation and Operation

The ATU case and T.1154 housing, as illustrated, are finished in hand brushed "light battleship grey Valspar Lacquer." After placing the transmitter within the T.1154 framework, and fixing the front panel at either side, the completed assembly should present an easy sliding fit in to the 1154 housing. At G2VV, the ATU stands on top of the transmitter with an 8 in. coax lead connecting the RF output socket to the ATU link input socket. There is, however, no objection to a longer lead if the Unit is to be placed elsewhere. A reliable earth connection is made, to the transmitter and ATU case, in heavy gauge wire. The supply leads running from the power pack to the transmitter four-point Jones connector *must* be completely screened and the screening bonded to the common earth.

When the installation has been completed,

the transmitter 14 mc RF output socket should be connected to the ATU link input with L13 in position and the variable aerial tap connected at two turns from the "hot" end. Set C27 plates all out with the full 100 $\mu\mu\text{F}$ in circuit. Adjust the transmitter for 14 mc output, with the PA tuned to the maximum dip. Adjust C27 for maximum aerial current on M4 which will result in increased PA current as the transmitter is loaded. Experiment with the aerial tap position on L13 for the best all-round results. During these loading tests, a field strength meter will prove most useful. (Special note—before making any adjustments to the ATU aerial tap or coil, the PA 600-volt HT supply must be cut from the transmitter. This can be conveniently controlled by a switch or relay wired in the primary feed to the 600-volt transformer.) As a guide, the transmitter will be correctly loaded when the PA current almost equals the reading obtained when the tank circuit is in the "off resonance" position, without the ATU in circuit.

For 21 mc and 28 mc operation, tests should be carried out using C27 with full and half capacity settings (*via* the adjustable clip lead) and with various positions of the variable aerial tap on L14. Final settings will, of course, be determined by individual conditions.

TVI

The multiplier unit was checked separately for possible spurious emissions. Subsequently, checks were made with the completed transmitter running at 120 watts input. In each case no spurious signals were evident and no instability was experienced. In fact, the APC in each 807 anode lead was removed and the transmitter still remained "tame." These are included in the finished job as a worthwhile precaution. Checks were also made—with the transmitter running at full power—for possible LF radiation (from the preceding stages) and results were found to be satisfactory. Actual TVI tests were conducted on Bands I/III using three TV receivers of different makes and age. These were placed within a few feet of the transmitter operating at 120 watts input. On 14 mc and 28 mc no video or audio interference was experienced. On 21 mc, one set registered some patterning on Band I vision with no trouble on audio. No interference was present on the other two receivers. In view of the very close proximity of the transmitter and receivers, these checks were considered to be reasonably satisfactory. With home constructed transmitters no two will be identical and local sitings of aerial installations will be different in each

case, therefore each individual set-up must be considered on its own merits. Should any TVI troubles be experienced, it is suggested that a low-pass filter be included between the transmitter RF output and the ATU input.

General Concluding Notes

No mention has been made regarding the use of the variable drive condenser, C15. At 14 mc it may be desirable to reduce the amount of drive to the PA Unit. This can be accomplished by varying the setting of C15.

Readers will have their own ideas regarding a suitable VFO but it may be of interest to mention *en passant* that a Wilcox-Gay VFO is used at G2VV. For BK operation, the external VFO and transmitter may be keyed simultaneously, *via* a suitable relay. Apart from the aerial equipment already described, any

desired combination of ATU and aerial may be employed.

The transmitter, as described, operates comfortably up to 120 watts input. For those who may wish to push the figure to 150 watts it is suggested that the 600-volt HT supply be replaced by a power pack delivering 750 volts DC output. The components as specified are suitable for working at this increased voltage but it must be remembered that the 807's will be pressed just about to their limit!

Finally, the majority of contacts at G2VV have been made with the transmitter operating at 80-100 watts input. For those who might be interested in some of the results obtained (using an *indoor* 68 ft. end-fed aerial at a height of 17 ft.) reference may be made to the "DX Commentary" columns in recent issues of SHORT WAVE MAGAZINE.

A Simple Valve Voltmeter

CIRCUIT AND CALIBRATION

J. M. OSBORNE, M.A. (G3HMO)

This is an ingenious and practical piece of equipment for the amateur-station test bench and, in its way, can be just as useful as a G.D.O. It will measure RF voltages over a very wide range, and is easy to calibrate as a DC reference can be used; sensitivity is adequate within experimental limits. The constructional form is a matter of taste, but it should be built as a compact, portable unit with a short coax probe.

—Editor.

OF the many special pieces of test gear, such as oscilloscopes and G.D.O.'s in use by amateurs, the valve-voltmeter seems to be the exception rather than the rule. Possibly the commercial instruments (and the kits) set too high a standard—in both accuracy and price. To the amateur, the chief value of such an instrument is that it can give a sensible guide to the magnitude of RF voltages without appreciably loading the circuit to which it is connected. Very often a little ingenuity in making temporary modifications to a circuit under test will enable the circuit itself (or part of it) to act as its own valve-voltmeter. It should not be forgotten, for instance, that the AVC line and S-meter circuits are ready made valve-voltmeters.

However, it is much more convenient to possess a separate instrument and described here is one which may be constructed easily and cheaply.

Circuitry

The basic circuit of this type of valve-voltmeter is shown in Fig. 1 (a). If the voltage applied to X exactly balances the voltage produced by the cell, the meter reading in the anode circuit will be the same as when the switch is closed. In other words, the valve and meter are used to see that the known and unknown voltages exactly balance. If the valve is adjusted to cut-off we can balance the peak of an unknown RF source (as well as DC) by a

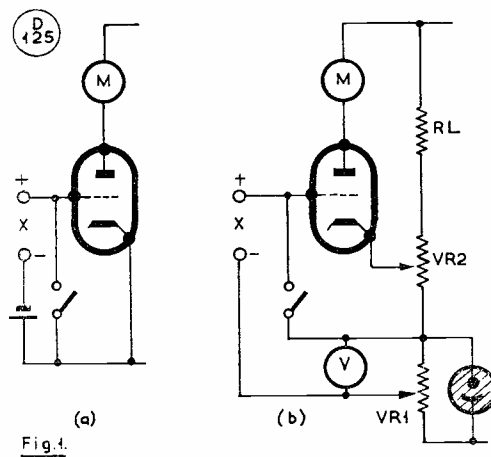

Fig. 1. The basic circuit of the valve voltmeter in (A) is developed into the skeleton circuit at (B), which is used to explain the complete circuit of the VVTM shown in Fig. 2.

instrument running continuously when it is likely to be used.

Calibration

To calibrate, a known AC or DC voltage is applied to the input, S1 being open. VR1 is increased until the eye just moves, this voltage now being marked on the potentiometer dial. This may be repeated for several voltages. Alternatively, a high resistance voltmeter (such as a Multiminor) is connected between the slider and cathode end of VR1 and the scale marked for a variety of inputs. If desired the voltmeter can, of course, always be used in this position and the scale left unmarked.

By making VR1 a logarithmic potentiometer the scale becomes more useful in the type of work for which the instrument is intended. From 5 to 10 volts is then as big a change on the dial as from 50 to 100 volts. The switch S2 enables the range to be altered by including a resistance R1 in series with VR1. If this is chosen to reduce the voltage across VR1 to one-tenth of the maintaining voltage of the neon, the scale is conveniently multiplied by ten times. If the neon voltage is, say, 110 volts on Range 1 then 3, 10, 30 and 100 volts are approximately equally spaced, and on Range 2 these readings become 0.3, 1.0, 3 and 10 volts. (To convert peak volts to r.m.s. multiply by

0.7.) The large overlap avoids the necessity of changing range which is undesirable when making comparative measurements. R2 is chosen to keep the resistance across the neon the same in both positions of the switch. This avoids fluctuations in the supply to the valve and magic eye.

C1 and C2 are RF bypass capacitors; C3, C4 and C5 provide RF smoothing so that the eye deflection is held steady.

The power supply used for the model gives about 400 volts. It is a matter of choice as to whether it is built in or not although doing so adds greatly to the convenience. Either way a small 350-0-350v. transformer with capacity filter to the rectifier will provide the necessary volts.

Provided the input lead is a short length of coax, the voltmeter behaves well into the megacycle region. For higher frequencies it would be desirable to use a valve of low capacity input mounted on suitable leads to enable the valve grid connection to be used as the probe. Any valve chosen for this position should have a very sharp cut-off, steep slope and (for low grid current) a low gas content. Using an SP61 in this position the voltmeter responds to changes of 0.1 volt or so. Accuracy is maintained down to 0.5 volts and useful indications can be obtained down to 0.1 volts.

BRIMAR VALVE NOTE

With reference to the item on p.133 of our May issue, on the subject of Brimar valves, we are asked to make it clear that the 6AF4A is intended for use as a UHF Oscillator, and the 6AM4 as a Grounded Grid Amplifier.

RESEARCH INTO TEMPERATURES IN OUTER SPACE

News of further research into the conditions obtaining in outer space comes from Bonn University Observatory which is shortly to begin an intensive investigation into the temperatures prevailing in interstellar gas. To this end, special amplifying equipment employing travelling wave tubes has been manufactured for the University by Marconi's Wireless Telegraph Co. Ltd., of Chelmsford. This consists of a dual channel amplifying system incorporating two travelling wave tubes in cascade in each channel. The radio telescope, a parabolic mirror of 83ft. diameter mounted on a pyramidal tower about 60ft. high, scans the sky picking up the cosmic continuum radiation emanating from galactic and extra-galactic radio sources under observation. The signals in the neighbourhood of the hydrogen line frequency (1420 mc) are amplified by one pair of travelling wave tubes, the other pair being used to amplify reference noise signals from a resistor at a known temperature. The outputs from the two amplifying channels are detected,

integrated and compared and the effective cosmic temperature determined; from these data contour maps are prepared. So accurate has the system proved in initial tests that a discrimination of 0.1°K has been achieved.

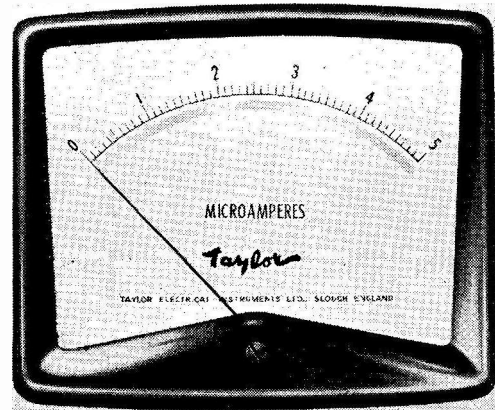

The smart new Taylor panel meter, in styled mouldings, incorporating the Taylor centre-pole movement. Scale lengths are from 2 to 5 ins., sensitivity is from 5 μ A, and the finish can be to choice to harmonise with existing equipment.

Seven Bands in One Cabinet

HEATER SWITCHING SYSTEM FOR ECONOMY AND RAPID BAND CHANGE

F. W. LLOYD (G3IPR)

When the author decided to venture on to the VHF bands he was faced, like so many of us, with the problem of space. In view of this, separate rigs were out of the question. After much thought the conclusion was reached that the VHF gear would have to be incorporated in the main transmitter case—this consisting of an orthodox Geloso VFO, with Top Band modification, into a QVO6-20. The next problem was that of change-over from HF to VHF so as to make use of the existing power supplies, the author having an intense dislike of unplugging and plugging in power supplies when a rapid change-over is required from band to band.

Then came the great idea. It was realised that if two transmitters were wired in parallel to a common power supply, the only valves that would be conducting (*i.e.* drawing current) would be those in which the heaters were running. This may sound very unorthodox, but if it is realised that an average 50-watt PA

presents to its power supply a DC resistance of about 50,000 ohms and its exciter section some 25,000 ohms, any other valves connected in parallel to existing supplies, with heaters off, would be fully protected by the DC path of the valves that are running. No current can flow through the inoperative valves whilst the main transmitter is working. This has been borne out in practice.

It will be seen from the circuit diagram that all that is necessary is a single-pole double-throw toggle switch, which does no more than change the *heater* supply from the HF to the VHF transmitter section. This switch, in the writer's case, is mounted on the main transmitter front panel.

Metering

The two-metre section is bolted to the main chassis, which thus takes care of the earth return. It is then only necessary to run a lead from the two-metre PA grid leak to the live side of the grid drive meter, leaving the original lead in position. The same thing applies to the two-metre PA anode lead. Thus it will be seen that we now have two transmitters in parallel connected to a common metering system. The only other connection now to be made is the two-metre exciter HT lead, which is simply taken to the existing VFO HT supply.

Modulation and Relays

As the HF transmitter PA is modulated *via* the PA meter, it is obvious that the VHF

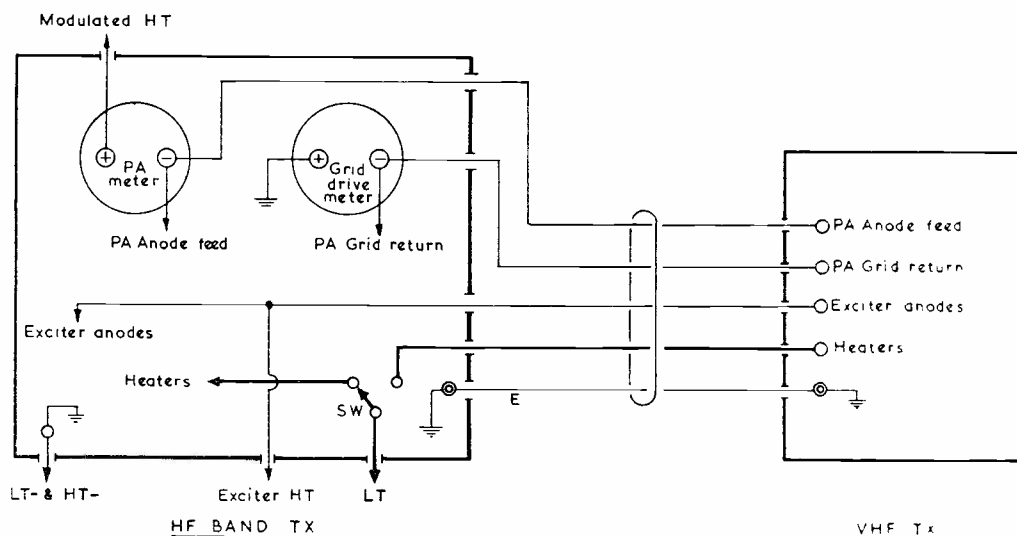

The problem at G3IPR was to run HF and VHF equipment from a common power supply in such a way as to take up as little space as possible while economising in metering. It is accomplished by having the two transmitter assemblies in one cabinet, with their LT feed line alone switched. The "cold transmitter in parallel" does not in any way affect the transmitter in use and change-over from one to the other is simply a matter of throwing the LT switch. In either case, the same external send-receive control is used.

section is modulated in like manner. All power relay contacts, in the writer's case, are inserted in the earth return centre tap of all transformer secondary windings, so the original send-receive change-over system required no alteration. As gear for two metres was in the writer's mind when the main rig was in the course of construction, provision was made for changing both HF and VHF aerials at the same time. This is achieved by the use of a surplus four-pole double-throw relay (from the junk box) which is also wired so as to short circuit to earth the inputs of both the converter and receiver respectively. This prevents damage to their RF sections whilst transmitting.

Further Considerations

Although in the present instance there was sufficient room in the main cabinet for two transmitters, obviously in many cases this would not be so. Then, the VHF rig can be

built as a self-contained unit and disposed of where possible. The necessary meter, HT and LT connections can be made *via* a five-way cable, and the corresponding socket mounted on the main transmitter. A heavy-duty cable is required to avoid LT current drop if a long section of lead is involved, as when the units are separated by several feet.

The system described and illustrated here has been in use at the writer's QTH for over a year without any trouble whatsoever. The total time taken to change from HF to VHF is approximately 30 seconds, *i.e.* the time taken for the valve heaters to warm up. Finally, this offering was prompted by the oft-repeated remark by good friends on the air: "Why not an article in *The Mag*, old man?" to whom it is now passed in the hope that they will find it sufficiently interesting. The writer is indebted to G3MWB who gave invaluable help in compiling these notes.

N.P.L. ANNUAL REPORT 1959

The wide range of research topics in modern physics covered by the work of the NPL is described in the latest Annual Report of the National Physical Laboratory, published by H.M.S.O. at 8s. 7d. post free.

In the new Basic Physics Division the programme has been aimed at investigating different aspects of the physics of polymers, by means of the most modern techniques for examining the atomic structure of matter. Success in understanding how the atoms are held together in plastics and other polymers would have far-reaching consequences. Only a beginning has been made so far. New work is also reported from the recently named Autonomics Division, where a start has been made on the problems of mechanical translation from Russian into English, using the ACE computer.

The programme of the Aerodynamics Division covers many aspects of research of importance to future aircraft and missile design and development, while the Standards Division has continued to foster international collaboration in several fields. In June last year the new international yard and pound already legalised by Canada and the U.S. were adopted for scientific purposes in this country. Determination of the density of mercury has been completed by measurements on samples from the standards laboratories of Australia

and America. A start has also been made on correlating U.K. and U.S. time and frequency services.

Spectro-radiometric methods have been tried successfully by the Light Division for the first time in the establishment of the standard scale of colour temperature. The Metallurgy Division is now equipped with some of the best modern research tools available for the study of metals, including an electron microscope and soft X-ray spectrograph.

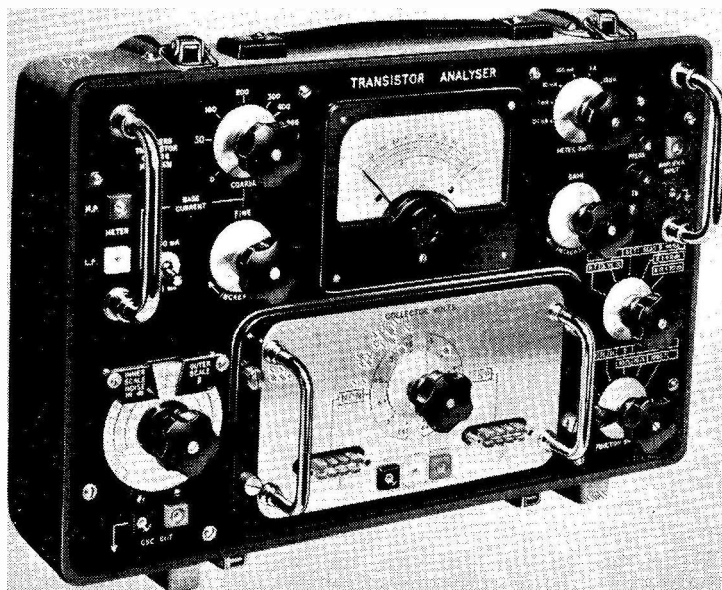

The Avo Transistor Analyser is a compact and portable battery-operated tester for checking transistors of the small-signal and medium-power types. It is suitable for taking out I_b/I_c characteristics, and beta can be measured at any predetermined point on the I_b/I_c curve. Noise comparisons over the range 100 c/s to 10 kc can also be made, using the internal 1,000-cycle oscillator.

DX COMMENTARY

L. H. THOMAS, M.B.E. (G6QB)

CONDITIONS on the HF bands are on the downward slope all right, but we are not downhearted yet. Some readers with less than five or six years' experience of the bands may be feeling the pinch and realising that working DX is not going to be quite so easy from now on. But, on the other hand, some of the old 'uns at the game will know that, in some ways, things could even be a little more pleasant than they have been.

Of course, if *all* the stations that have been using Ten and Fifteen take it into their heads to crowd on to Twenty, then QRM is going to be pretty fierce. But this doesn't seem to happen, and what one does notice is that operating hours appear to be spread out a little more.

On the credit side, we have a definite slackening off of the short-skip nuisance on Twenty—at some hours of the day—and also a noticeable improvement in DX conditions on Forty. This has all happened before and will doubtless happen again.

What we have got to guard against is making things more difficult for ourselves. We can't do much (in the present state of knowledge) about ionospheric behaviour, but we ought to be able to do quite a lot about human behaviour. The extension of the U.S.A. phone band has thrown most of the DX phone operators into a state of fierce resentment, and we shall clearly have to re-organise our ideas of band-planning. As someone remarked the other day, when someone sticks a five-ton lorry into an already crowded car park (and with official permission) it's the small cars that have to adapt

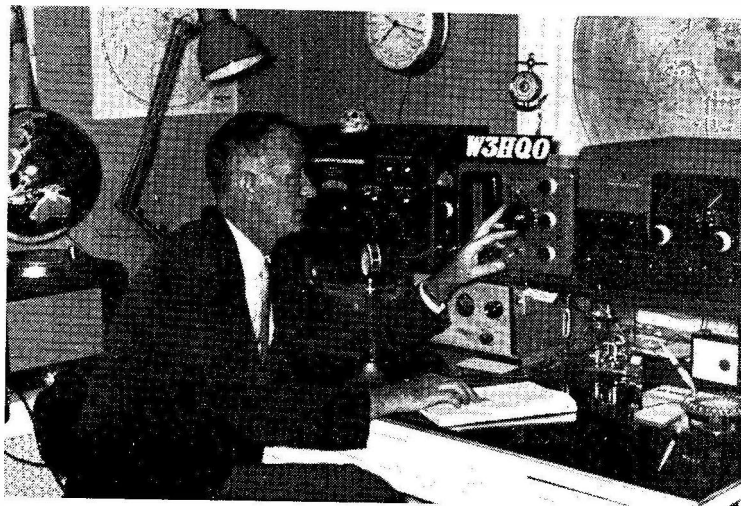

W3HQO

CALLS HEARD, WORKED and QSL'd

themselves to the new situation.

Similarly, the cutting-down of the 40-metre band, later on, will present new problems in that neighbourhood. Already it seems that the CW men in Region 1 will have to be content with only 50 kc; but if they have to share even that much with "bandits" from the phone fraternity, then they will have to work out a self-defence plan.

And all the time we have the outlaws, the couldn't-care-lessers and the out-and-out clots to deal with. One only has to listen for an hour or so to hear countless examples of misuse of the bands. A few days ago we were listening to a DX station on about 14015 kc (waiting for him to finish), when an el-bug-impelled string of dots came swooping over the frequency two or three times, settled more or less on the DX man and proceeded to call CQ. (It was a UO5, by the way.) His CQ was replied to, on the same frequency, by quite a near neigh-

bour. Both stations were S9. Within five minutes they were both using over-modulated phone—on 14015! And the UO5 quite obviously hadn't even bothered to listen on the frequency first—as if he cared, anyway.

Incidentally, the el-bug has introduced that new horror—the dot-splasher. For some reason when one of these atrocities swoops around, it seems even more annoying than the old-fashioned yoops and yowls of a continuous carrier being swished over the band.

So now we have a pretty situation to face. All bands were bursting at the seams years back; new stations are coming on all the time, particularly in those quarters where noise means more than *finesse* in operating; the bands are being squashed, not expanded; and within our own ranks we have countless operators who constantly do things for which they should lose their licences. Any solutions to suggest?

One thing we can, and must, do is to keep our own house in order—meaning the U.K. After last month's horrifying revelation that the OK's look on us in much the same way as we regard some of the middle-Europeans, we must certainly try and banish the lid from our midst. Supposedly, we must at least be charitable and assume that many stupid things are done just because the perpetrators don't know any better. So—unless they are that particularly vicious post-war phenomenon that "doesn't want to know"—they might possibly be cured if shown the error of their ways.

When the G's are known the world over for their good and polite operating (as they were once, long ago)—that will be the time for preaching, and not before. But short of sending out missionaries, how are we to preach? And how can a rational sort of band plan be agreed when there are countries that certainly won't take the slightest action if all their amateurs flout it? Ah, well—let's stop the moralising, turn to a more cheerful subject, and see what's been going on

DX Gossip

W2AYN/EP and W3ZA/EP are officially licensed by the Iranian Government, and the FCC permit the W/K stations to work them . . . monthly bulletin on the Malpelo Affair suggests that it should have taken place May 13-18—but you never know! We hope it did, this time . . . VR1B is either on SSB or due to be, shortly . . . VK5BA/VR4 is "highly doubtful" . . . VR2DA now back in VK-land.

There was to have been a trip, starting mid-May, which included FD8, ZD2, FF4, 7G1, Ivory Coast, Cameroons and Dahomey—planned by 9G1CX (ex-VQ4EO). We hope *this* one was OK, too . . .

QSL's said to be circulating in a big way from VU2ANI (via W8PQQ) and also from ETE3CE. 9N1GW and 1CJ are distributing unique QSL's, on rice paper, with English and Nepalese writing; send your QSL with an envelope stamped with a 7c stamp (if you have one!) to W. G. Ward, USOM/Nepal, Department of

State, Washington 25, D.C.

A new DX news sheet is published under the title of *The DX-er*, by SWL SM3-3104 (Sven Elfving, Selgardsgatan 15, Ornsköldsvik, Sweden). It is due to appear every third week, and the first issues have been pretty well packed with DX news.

W4KVX, whose well-known "DX" ceased appearance somewhat tragically with the fire that destroyed both his office and shack, is about to resume. Generous response by U.S. amateurs ensured that completely new equipment could be bought and housed, and "DX" will once more appear every week.

From SWL Peter Day (Sheffield): ZL3VH will be putting *Campbell Island* on the map from

June 1 onwards; probably a new "country" (the quotes are ours) . . . VPØRT due on from Anguilla soon . . . 9N1TB working Europe on 21 mc phone, 1730 . . . T19SB was on 14180 kc SSB, mid-April . . . VS9MB on 21 mc phone, 1530 . . . VS5GS (Brunei)—S9 on 21 mc phone, 1630-1730; Box 300, Brunei Town . . . W2AYN/EP is S9 plus 40, again 21 mc phone, 1645.

GW3AHN says that ZL4JF came up from Campbell Island, worked a few of the "Top DX'ers" in the Honour Roll of DXCC (by previous sked arrangement) and went off again! He will not be active again for another month . . . G2DC reports that Danny Weil has now set sail, under the control of the "Yasme Founda-

FIVE BAND DX TABLE
(POST WAR)

Station	Points	3.5 mc	7 mc	14 mc	21 mc	28 mc	Countries	Station	Points	3.5 mc	7 mc	14 mc	21 mc	28 mc	Countries
G3FXB	838	77	133	226	231	171	268	G8DI	342	36	67	101	75	63	133
G2DC	817	87	118	239	206	167	268	G8VG	341	37	79	132	54	39	153
G3FPQ	803	74	116	225	224	164	253	G3NOF (Phone)	316	8	15	45	129	119	163
G5BZ	795	66	121	270	206	132	278	G3DNR	314	11	30	91	97	85	134
G3DO	694	25	51	250	188	180	277	GB2SM	301	20	33	73	80	95	180
GW3AHN	673	16	55	204	248	150	267	G3BHJ	291	8	29	43	138	73	162
G3BHW	657	15	45	210	218	169	253	VO2NA	291	19	39	119	73	41	128
G13IVJ	651	41	70	183	194	163	234	G3WHP	282	17	34	84	35	112	148
G3ABG	606	56	90	191	141	128	215	G2DHV	274	22	30	133	64	25	153
W6AM	568	40	68	298	96	67	278	G2CWL	261	21	29	68	112	31	146
G2YS	541	73	93	171	120	84	190	G3LKJ	259	8	19	36	83	113	146
G3LET	521	40	119	189	120	53	208	G3JVU	252	27	44	93	43	45	112
UR2BU	505	24	56	154	148	123	194	G3JSN	240	31	47	51	61	50	98
G3IGW	487	51	79	117	122	118	174	G3JFF	236	20	55	109	43	9	116
G6VC	469	40	60	159	121	89	191	G3GHE (Phone)	231	13	28	33	79	78	135
G13NPP	442	25	46	106	147	118	186	G3MMP	209	6	27	45	65	66	95
GM2DBX (Phone)	433	34	31	162	105	101	178	G3NAC	208	8	34	57	74	35	101
W6AM (Phone)	429	23	62	284	49	31	284	G4JA	205	35	42	70	42	16	113
G3JZK (Phone)	421	17	62	95	143	104	192	G3NFV	201	12	23	26	53	87	117
UR2BU (Phone)	403	12	33	112	130	116	167	G3LAS	197	11	27	55	70	34	106
MP4BBW (Phone)	398	1	5	185	127	80	199	G3LZF	176	11	19	53	45	48	114
G3DQO	398	21	53	182	101	41	191	G3IDG	159	15	16	41	45	42	73
G3LHJ	357	17	39	108	131	62	169	G3MGL	98	4	25	38	9	22	57
G2BLA	342	36	63	80	84	79	131								

(Failure to report for three months entails removal from this Table. New claims can be made at any time)

tion." with ZL1AV as co-operator. They have a wealth of gear, including a 3 kW transmitter, installed in the boat. First calls are around the Caribbean (VP5, KS4 and KZ5 suggested), then out into the Pacific. CW, 14075 and 21075 kc; AM, 14195 and 21195 kc; SSB, 14405 and 21405 kc.

VR1D hopes to be on with 100 watts of phone from the Ellice Islands—he is ex-ZL1ABZ . . . 7G1A has been very active again on the HF bands, using 150 watts to a long wire . . . 7R1A is said to be the call of a new station on Franz Josef Island—seems pretty improbable.

KJ6BV has been heard on 21280 kc phone . . . VQ9HB also, 14 mc phone, 1700 . . . UAØYA is said to be the third Russian amateur active from Zone 23.

Top Band Topics

DX is out for the present, and this looks like becoming a mobile band at week-ends. Certainly the disadvantage of the relatively small aerials is off-set by the advantage that everyone has to use 10 watts, and you therefore aren't in competition with QRO stations all over the band, as is the case on 80 and 40 metres. Some of the 160-metre mobiles put astonishing signals over distances of 30-50 miles.

G3NWU (West Hartlepool) joins us for the first time, and has recently worked OK1KGG four times (579 both ways). The OK is looking for G's most evenings around 2100, and G3NWU uses a "vee-shaped dipole," working both CW and phone.

G3MIK (Cambridge) is now on the band with home-built gear and a 70-foot "near-vertical," to which he hopes later to add 280 feet of horizontal! He will be glad to sked with anyone wanting to work Cambridge, and hopes to get his WABC before leaving there (in June). During the Long Vacation he will be travelling in SM, OZ, LA, DL, PA, ON, F, I, HB, OE and possibly YU and SV! After all that, London . . .

G3JFF (Kingswear) added eight new counties, thanks to some of the obliging GW and GM stations who now seem much more numerous on the band—also

GC2FMV and G5LP (Northants).

G3NJQ (Norwich) objects to phones using the LF end of the band for long rag-chews. On behalf of all WABC-chasers, he says: "Please keep to the right end of the band." G3KOE (Harrow) works OK's and the like most nights; he has worked nine countries, 53 counties.

G2YS (Filey) will be working /M and /P between August 6 and 20, in Carmarthen and probably also Pembroke, Brecon and Cardigan. Both phone and CW, 1-9 to 2 mc, and also on Eighty.

G3NNO (Leeds) has now accounted for 63 counties, but cards are all behind; he mentions GM3FSV (Orkney), who works CW and SSB but has to stay between 1800 and 1900 kc because of Loran. Also G3MIK, G3MDR/A and G3OBT/A, all active in Cambridge.

G3NPB (Broughton) has applied for a phone WABC, having collected seven new counties at Easter; he is moving to Northumberland and promises to work the band from there (and he can start all over again and get another WABC!)

G3MWD (Chelmsford) joins the Ladder, and has worked 14 DL's, 26 OK's, five YU's, two HB's and two EI's; he still wants Hunts, Cumberland and Westmorland, though.

G3NVO (Middlesbrough) mentions G3NWR/GW in Radnor,

also GM3FSV in Orkney . . . G2NJ (Peterborough) had a report from G3LYK, now in *Libya*, who heard him late in January . . . G3FPQ (Elstead) worked 5A2CW and had a twenty-minute QSO (1875 kc) early this month.

G3NAA (Chelmsford) has worked seven countries, including EI7AF on phone (April 17), G3NMR/GW, GM2UU, OK and DL . . . G3NTU (Cannock Chase) raised OK1KGG and had an SWL report from Sweden.

G3MAB (Shipley) reports GM3FSV as saying that if he comes on CW he gets a pile-up, but on SSB no one will work him! G3MAB had a forty-minute QSO with DL2AH on May 10, both stations peaking at S9 plus.

G3APA (Coventry) also comments on the Orkney station, and on the manners of people who monopolise him (two of them held him for over an hour, with a queue waiting!) GM3FSV, according to G3APA, would welcome other SSB contacts on the band. GM3KHH is now in Banffshire, at a much better QTH for aerials, but unfortunately without mains. Any gen. about a reasonably priced generating set would be most welcome—GM3KHH, Innes House, Oran, By Buckie, Banffshire.

G3CSZ (Wirral), still running on his OC24 TTx while the batteries last, worked G3NWR/GW, G13NZZ, GM3CEA.



We don't know what he does there, but EL4A is at Robertsfield, Liberia, West Africa; he is one of the several very active W's who hold Liberian call signs.

GC2FMV, G3GQS (Cornwall) and OK1KGG—five times. Very fine work for a TTx. that.

Eighty and Forty

The only mention of Eighty comes from G3FXB (Southwick), who worked VQ2CZ both on that band and on Forty. On Forty he also raised VQ3CF.

Forty has quite a few DX specialists always looking around—including many who are heard doing excellent work but don't say much about it. G3LET (West-cliff) found the band "up and down," with the mornings especially disappointing. Also, he says, it's the exception now to hear W's before 2300, although the South Americans come in much earlier. Our pirate friend, "PK4LB," has been around again, but no one takes him seriously any more. G3LET worked OQ51G, W2AIS/KV4 and two LU's for new ones; also UAIKAE, VQ2CZ, CO. YV, ZC4, UA0 and VK.

G3JFF added SP, UA1, UB5 and FF8BF to his total. . . . G3ABG (Cannock) used the Russian DX Contest to work UA2, UC2, UA6, UB5, UP2 and UR2 on the band. . . . G3NAC (Bourton-on-the-Water) collected TA1DB, TF5TP, KP4YD, OY1AA, PY2BSD, UR2, LZ, UA3 and GC. . . . G2BLA (Welwyn) got well into Asia with UL7HA.

G2FQW (Worthing) says conditions have completely changed from February, with some evenings good for G and others good for DX; for the latter he is putting up a full-size two-element beam! G4JA (Baschurch) raised 4X4MD, TF5TP, PY and W, but FF8BF got away.

SWL Peter Day logged FF8BP and VP3ER on CW; on phone he scooped PY7AC (Trinidad Is.), CR4AP, 5A2CW and CN8CS. Known to be on, also, are VP2KD (0800, CW), VP5FP (0400, CW) and PZ1AX (0400, SSB).

Twenty Metres

If you have the time and the patience (and those well-known selective eardrums) there is little that you can't work on *Twenty*. Even now, with conditions as they are, it's all there. But the odd



ZS7P, Mlambanyati, Swaziland, has been suspected of piracy, for no good reason, as we have seen his licence. He is on SBB and runs a Gonset GSB-100 transmitter with a National NC-300 receiver.

casual glance at the band would convince most people that it's nothing more than a mass of Europeans and Russians. You have to *work* for it, which means digging!

G2DC (Ringwood) laments that you can't show your nose without hordes of UA stations answering. Apart from "rather sparse" VK and ZL during the early mornings, he has worked mostly W and VE. The W6's were working KC6JB around mid-day, but he couldn't hear the far end.

SSB is the thing now on this band, and G3DO (Sutton Coldfield) boosted his WPX score with OA4BN, FB8CP, TG9PS, JZ0HA, TI9SB, OD5CT, EA6AR and other Europeans.

MP4BBW (Awali) still heads the WPX phone list, and recent SSB contacts on 14 mc included YA1AC, DU7SV, ZS7P, FB8CJ, KG6NAB, BV1USE, HS1B, XZ2AD, TI9SB, HR3HH, FB8CM, KW6DB and many others. He tells us that W0AIW is organising a trip round some of the interesting islands off Africa, starting in mid-October; also that Ted Henry's globe-trotting "Argonaut" may open up from both Reunion and the Comoros.

On the latter subject, G3BDQ (St. Leonards-on-Sea) says he worked VQ9TED/MM (obviously the same Ted Henry), who said that for the next three or

four months he would be in Seychelles, Amirante Is., Mahé, Chagos, and then static in Seychelles from next February; he is testing KWM-1 and KWM-2 rigs, also the KWM-4 if available in time. G3BDQ, on his completely home-brewed SSB rig, raised AP2CR, OD5CT, HS1B, ET2US, TA3GI and EA6AR.

G3WP (Chelmsford) got in OH0, UJ8, UF6 and UP2 for four new ones on the band. G13NPP (Dungannon), on CW only, worked CE3DU, FY7Y1, F9UC/FC, LA1NG/P, SU1MS and 11M, UJ8, UM8, VS9ARF, 9M2GU and ZA2BAK (?)

G3BHW (Margate), also on CW, collected FG7XC and 7XF, ZA1KC and 2BAK (?), ZS3T, ZS7R, 7G1A and 9M2FS. He thinks ZA2BAK may be genuine; at least he beams in from the correct bearing and gives a QSL address—SHNUM, Tirana.

G13IVJ's CW raised CX1BZ, JZ0PC, KA2JS, KH6GP, T12CMF, UA0BB, 0GF, 0KDA and 0RM, UM8, VE8, VK's, VR2DK, YV1AD and ZL's. Phone netted IS1DKL, VK2-7, VK0WH (Macquarie), VP6WD and YN1MJR.

G3LPS (Blackburn) found the band pretty good between 1800 and 2000 for Asia and Africa. New ones for him were OX3UD, FQ8HK, OQ5QS, VS9ARF, VU2MD, 9K2AD, ZS3AZ and 3HX, ZS7R, UI8, ZE and the like.

All W districts were worked, but no VK's this month. VS9OA was on around 1900 one evening, but not worked.

G3NTU managed to hook KM6BW, but adds that he was operating /A from G4CP at the time! From G4CP's shack he made WAC in two hours. G3LHJ (Newton Abbot) raised UM8, PY and KH6BXU, all CW. G3FXB winkled out W2AYN/EP. G3DNR (Broadstairs) added OD5CT for a new one and also worked UF6 and UG6, but his total activity on the band was 30 minutes!

TOP BAND COUNTIES

LADDER

(Starting Jan. 1, 1952)

Station	Confirmed	Worked
G2NJ	98	98
G3JEQ	97	97
G6VC	96	96
G3JHH	94	94
G3HDQ	89	90
G3APA	82	87
G3JJZ	77	80
G6QN	73	80
G3MCY	71	73
G2CZU (Phone)	67	68
G3FS (Phone)	64	70
G3MWD	63	66
G3NFV	62	67
G3MYI	60	62
G3NBP (Phone)	60	62
G8VG	58	67
G3NBT (Phone)	58	60
GM2HIK	56	63
GW3NAM	55	69
G3MXJ	55	67
G3LNR	54	67
G3NNF	50	52
G3KOE	45	53
G13NPP	44	51
G3JFF	41	53
G3NNO	36	63
G3LZF	32	43
G3NVO	29	40
G3NJQ	29	37
G3NAA	27	39
G3NTU	26	38

(Failure to report for three months entails removal from this Table. New claims can be made at any time.)

G3ABG was pretty successful, with OD5CT, FA8EC, VU2XG, PY7AN, VK3MR (1800), HZ1AB, 7G1A, UQ2AE/MM and hordes of Russian prefixes. G3NAC's list shows VO1FB, EA8CP, PY1NBP and 4AD, XE1AX and VK3MR. G2BLA mentions VKØPM and 7G1A.

G4JA raised VU2AS, LA4CG/P, F9UC/FC and UM8; gotaways were PZ1AM, OR4TX, SU1IM and 9G1BQ. G3JFF hunted down TF5TP, F9UC/FC, HB4FM, UA9, UC2 and UP2. G2VV (Sunbury) was not long on the band, but acquired VU2RA at 0100 GMT, EA8BW and the usual W and VE.

G3JZL (Market Drayton), mostly latish in the evening, worked JA7AB, VS1FZ, KR6GY, UM8, UAØ, ZS6AZD, PZ1AM, YV6BR and VK3ARX; his one morning QSO with with VE6HM (0820).

G3NOF (Yeovil) is now at large on this band with SSB, and results speak for themselves—CR9AH, CX1AK, PY's, PZ1AX, VP9FR, SU, SV, VQ4FO, YV5FH and 5FK, W6, 5A1TI and 9G1BF, plus lots of East Coast W's and Europeans; he is using a home-built SSB exciter.

Fifteen Metres

Much better stuff on this band, for those equipped to deal with it! The QRM is not so fierce, except for the jungle-bells, and the peak hours are more convenient.

G3FXB worked phone with CR8AC, FF4AB, FQ8HR, I5TUF, KH6DJU, KW6DA/KM6, VP2ML, VP3VN, VP4LP, VP5AR, VP8EG, VS5GS, V S 9 M B, VQ6GM, W2AYN/EP, YV6BT and 9N1TB. And he went on with CW for KC6JB, KL7AMH, VK9GK, UAØBC and ØLA.

GW3AHN (Cardiff) also sends his usual fine list, including (phone) the EP stations, KW6DA/KM6, PJ3AI, VK9AN, VP2DU, 5BL, 5EM, 6WR, 7NB, VS5GS, Y V 5 A G J, 4S7YL, 9K2AL, 9M2DQ and 2GT, 9N1CJ and 1FV; his CW raised W2AYN/EP, JA1ACB, KG6AJT, UAØ, UH8, VS1KL, 4X4DF and 9K2AD. GW3AHN says there are ten or twelve 9N stations active, mostly using something like

DX-40's with simple dipoles, and not working into G very often. Also that CR8AC (AM) often operates from about 1900, and that CR8CD has been heard, too. AC3SQ is said to have been active, as has K6CQV/KS6.

G3JZL stuck to phone and worked 9G1CW, 9M2DW, CE1BD, VK, VP3HA, 6GN and 7NB. G3JFF raised JA3UI, TF5TP, ZL2 and 4, VE6AAV, KL7FAI and the usual W's and Europeans.

G4JA was pleased to work KX6BQ (579 at 2230, just before the band died), as well as VS1KL, TI2CMF, KL7, CE, JA and LU. G2BLA mentions UJ8KAA and UN1AH. G3NAC, on phone, collected IT1ZYP, PY and ZL. G3ABG, on CW, records VQ4HT, 4X4JN, ZS1RM, 7G1A, HZ1AB, VQ2IE, UI8 and UJ8.

G2DC was pleased to find the VK-ZL signals coming over the long path again in the mornings (0730-0830) and the Far East in the early evenings. It's also pleasant, as he says, hearing Africa, South and Central America without the appalling solid wall of W QRM. Worked—CX2BT and 5AF, TI2CMF, VS1KL and 1KB, VS6BJ, VS9AF, VP6AF, VQ3CF, VQ5EK, VK6KW and 6SM, ZD1AW, ZD2, MP4, 3V8NG, 7G1A, 9K2AD and 9M2BW. 9N1TB was worked on 21250 kc AM, and W2AYN/EP, also on 21250, was the only new one this month.

For G3DNR, KG6AJF on phone was a new one; VE6AAE/USU and UI8AG were others worked. G3LHJ had phone contacts with MP4BCV, DU6MJ, ZD6DT, XZ2KN, 4S7YL and 9N1TB; CW with CX2BT, LU8DQ, UI8 and ZS2AT.

GM3NQB (Hawick) raised his WPX score with a nice bunch of new prefixes, but is now moving 400 miles north—to Dounreay; we won't be hard-hearted and say he must start again! VE8TO, he says, is ex-GM3HLD, and looking for the Glasgow area.

G13IVJ sends a long phone list, which includes BV1US, DU6MJ, FM7WS, HK1OI, JA, KA, KH6, KL7, KM6BW, KW6DA/KM6, KZ5, OQ5, VK9AN, VP2ML, and 5BL, VR2DF, VS1FZ, 5GS and 9AE, VU's, XZ2KN, YV3AS,

ZL's, 4S7YL, 9M2DW, 2EZ and 2GA, 9N1FV and 1TB, and PJ2CE. On top of that fine lot he worked CW with AP2CR, JA1, 3, 6 and 7, KL7, KW6CS, VK9GK, VS1, VU and ZD1AW.

G3BHW reports phone with FF4AB, HP1AC and 1HC, 15TUF, W2AYN/EP, VP4TS, VS9MB, ZS3D and 9N1FV; CW accounted for FM7WU, HH2LD, KC61B, KG6AJD, MP4TAF, VP8EG, VS5GS, ZD1AW and 7G1A.

G3LKJ (Torquay) got his phone to EL2B, KW6DA/KM6, KH6BGF, MP4BCV, OA4DA, VP2GW and 8DQ, ZS9A, 4S7YL and 9K2AL; CW to VP8CC and 8EG, and ZP6AY. G13NPP scooped up 9N1FV, 1GV and 1TB, all phone; also W2AYN/EP, XZ2SY, VS5GS, FS7RT (SSB), VP2GW and 2SL, VS1, VS6, 9M2 and 4S7.

G3WP collected ZD2, UN1, U18, UAØ, HA, 5A2 and a few others; G2VV made it with TF5TP, ST2AR, PY4APZ, UAØBC, LU's, JA1ACB, ZC4RK and EL1WG/MM (South China Sea).

G3NWT (Sandiacre) used phone and worked VR2DF, 9N1TB, HZ1AB, VS5GS, 9M2DW and 2EZ, DU6MJ, VS1GQ, XZ2SY, VS9MB, W2AYN/EP, VP2GV and 2RW, TG9FI, VP3MC, PJ3AI, VP8DM and 8EH, FB8CO, VK, ZL and suchlike. One peculiarity was ZL2BE, coming in one evening on a path slightly north of east—confirmed by another local with a good beam.

G3GHE (Reading) stuck to phone and collected DU6MJ and 6IV, EA8, ELØM/MM (off Manila), FB8CD, FK8AU, HC2OM, HH2LD and 2KA, KH6, KR6, LU, TI2OE, VE6AAE/SU, VK9AS, VP2AE, 4LG, 5AK, 5WB, 9MSF, VR2CC and 2DF, VS1, VS9MB, ZB2, ZD2, ZP5CF, 9G1BA and 1CT, 9K2AL, 9M2DQ and 2GA, and 9N1TB. He tells us that GW3ITD/MM will *not* be operating with a ZD9 call, but is still hopeful regarding ZD7 and ZD8.

G3NOF, on phone, thought conditions were poor, but worked CP5EL, CX1FL, FQ8HX, HZ1AB, VP5BL and 6GN, ZD2, ZE, ZS, 5A2TA, 9G1BA and 1CT, and



G3DJQ is at Sutton Coldfield, Warks., and was first licensed in 1931 as VS2AD. Main interest is now SSB, for which the transmitter is an all-band-switched filter exciter driving an 813 linear PA. Station receivers are Eddystone 888A and S.750 and the aerial is a Mosley Tri-band for 10-15-20 metres. The only AM transmitter is a Heathkit DX-40U. The SSB transmitter is operated through a voice-control unit.

several /MM's. TVI on this band restricts his hours somewhat.

Ten Metres

This is the band where the falling-off in conditions has been most noticed — as one would expect. However, there is a surprising divergence of opinions and results, some writing the band off as useless while others have collected some interesting pieces.

G3NWT worked phone with FQ8AF, ZS3B and ZS7L, and wonders whether his ten-metre beam should now be wrapped up in cotton-wool for four or five years . . . G3EKW (Nottingham) found an opening on April 21 (1830) and worked CX2BT, KH6DMW, PY1BTC, VP9EU and W's . . . G3WP raised EL and YV (his first YV on any band) . . . G3LKJ made it with HC2KU, PJ2CA, TI5RV, ZD1AW, ZS7L and Russians, on phone; also with ST2AR and VS6EE on CW.

G3BHW says very little DX has been heard, but he did raise V/Q5EK, ZS3RO and 9M2EZ . . . GI3IVJ worked JA1, 2 and 6, and RAØ on CW; on phone, JA1, 2, 6 and 8, KP4, OA4IA, OQ5AV, ZD1AW and 6RM, and RL7, RI8 and the like . . . G3DNR collected VQ2, 5A and ZD2, on

phone.

G2DC reports working W, VE, VK, ZL, ZD1, ZD2 and CR6, but thinks we can now say good-bye to the band as a reliable DX provider for some years to come . . . G3JZL worked phone with EL8D, ZS, ZD2 and PY7 . . . G3FXB raised 15TUF and RA9XAT, the latter said to be not in Siberia but in "the autonomous Soviet State of Kommi." What goes on here?

G3NOF, also phone, worked CX6CG, EL2V and 4A, GW3ITD/MM, VQ2's and 4's, XZ2SY, ZC4's, ZD2 and ZS3B; he missed VQ6GM. G3NOF records an opening on April 23 (1800-2000) when the U.S. phone band was full of W6 and 7 signals, mostly working each other in local nets, and unaware that Europe was getting them.

News from Overseas

Mac Wilford, VP6WD (St. Michael) says that SSB DX out there has become non-existent since March 10—the fatal day when the U.S.A. phone band blew its top. It's impossible to work up in the old section, except very occasionally. (Some such scheme as that mentioned in last month's Editorial is obviously bound to come.)

[over

Doug Higgins (VQ6AB) says he will be on 7 mc every Saturday and Sunday from 2100 onwards, having already managed to work G's and SM's on that band; he's using only 40 watts, but getting through all the old 40-metre noises pretty well; he is also on 21 mc phone most afternoons — 1200 GMT onwards.

Peter Windle (VU2XG) has built up his WPX score and collected a few interesting "locals" such as W2AYN/EP, XZ2TH, JZ0PC, YA1BW (21 mc) and AP4UN; the latter said his name was Leif (ex-LA5PC) and that he was at Rawalpindi with the U.N. However, nothing further heard and no QSL. VU2XG's address is c/o Mails Branch (Bombay), Commonwealth Relations Office, Downing Street, S.W.1—the first amateur we have yet come across with a Downing Street QTH!

WPX MARATHON

Starting January 1, 1960

CW Only		Phone Only	
G6VC	249	MP4BBW (SSB)	216
G8DI	227	G3GHE	192
G3JVL	223	G3DO (SSB)	183
VU2XG	192	G3LAS	126
G8VG	157	G3LHJ	103
G3LZF	153	GM3NQB	100
G4JA	149	G3NEV	80
G3NWF	122	UR2BU	80
G3LAS	114	G3BHJ	74
G3DQO	114	GM2DBX	71
G3LHJ	113	G8VG	70
G3JVU	109	G2FQW	57
G3JSN	99	VO2NA	54
G3MXJ	97	G3MCN	53
G3MGL	94	G3JSN	47
G2BLA	90	G3DNR	41
VO2NA	90	G6VC	35
G3JFF	84	G4JA	24
G3WP	82	G3MGL	13
UR2BU	79		
G3DNR	65		
GM3LY1	58		
G3GMK	55		
G2BP	38		
G3NTU	37		

(Stations not reporting for three consecutive months will be deleted)

IT1AGA (Palermo) invites SWL reports on his activities, all bands, 1500-1700 and 2200-0100 GMT; he tells us that the Italian 80-metre band is 3613-3627 kc CW, and 3647-3667 kc Phone. QTH: Giuseppe de Luca, 18 via Generale Di Giorgio, Palermo, Sicily.

Miscellany

Apparently (although we don't seem to have heard of it) "certain people" have been putting it about that ZS7P is a pirate; the operator of this perfectly legitimate station, P. J. Lamont, has been so upset by this that he has forwarded for inspection a photostat copy of his licence, dated February 29, 1960. He tells us that he is the first resident ZS7 station on SSB. Just where the rumour started, or why, seems difficult to explain.

Three more sheepskins: The Low - Band Award (LBDXA) is for confirmed contacts with 75 countries on 3.5 mc CW, 75 on 7 mc CW, 25 on 3.5 mc Phone and 25 on 7 mc Phone. Don't send QSL's, but a full list thereof. Some may be requested, and failure to produce them will result in "permanent disqualification." Then the W-160 Award is for confirmed contacts with 10 different countries on One-Sixty — phone, CW or mixed. And finally the WAS-N is for confirmed contacts with Novice stations in each of the fifty States (after January 1959). Details of all these come from W8QHW/W4KSR—Don Havlicek, 3156 Timberview Drive, Cincinnati 11, Ohio, to whom application should be made.

And a Contest! The JARL will hold an "all-Asian DX Contest" from 1000 GMT, August 27 to 1600 GMT, August 28. Contacts are between Asian stations and those in other continents. Usual contest rules, except that the Serial Number is of five figures—RST and *your age!* YL's sign 00 for the last two figures. (No, we're not kidding—that's what it says!). What centenarians do about getting their age down to two figures we don't know . . . but at any rate it's an original idea and a change from the normal contest numbers. All bands—country multiplier and band multiplier; one point per

contact.

G2DC has recently obtained his WAE1 Certificate—one of the most difficult. He now holds both WAE and the Empire DX Certificate under both his calls—DL2RO and G2DC, and is the only single-operator station in the world to hold both of these with two calls. Nice going!

This year's "Topsfest" will be held at Walsall Road School, Cannock, on June 19. Visitors most welcome—VQ3CF and other DX notables will be present. There will be a trade exhibition, followed by tea at The Tavern on Cannock Chase, 5 p.m. Doors open 2 p.m.—G3ABG will be on 1900 kc from 1100 onwards to guide mobiles in.

G3NAC is now associated with the Club station at RAF Little Rissington (G3NGZ), where they recently worked VP8, ZL and PY on phone, using 30 watts and a dipole. Good start!

G4JA celebrates the completion of his first full year of activity, after being QRT for 29 years! During this last year he had 935 QSO's in 113 countries; WAC, WBE, FOC, Tops and RCC certificates have also been collected.

G3MGL (Gillingham) recently worked VP7BK on Grand Bahama—a new station for whom G3MGL was the first G; QTH is Jerry Hall, Raytheon Co., PAA/GB1-AAFB, Patrick AFB, Florida.

G3CWL (Leatherhead) will be operating from Monaco as 3A2DA, June 18 onwards for a few days, on 14 mc CW only. QRP, but he'll do his best for the G's.

GB2SM made fifth place in the all-band, multi-operator class of the CQ "Worldwide Contest" last year—good going considering their peculiar difficulties at that QTH.

On the evening of May 11, in one hour, G8DI heard PY1BWA, 2EW, 3QX, 4AO, 5TH, 6HL, 7AZ and 8YP (too bad there was no 9!) on Forty and Twenty. He raised the 3 and the 6, both new for this year's WPX Marathon.

G3WP is in trouble with the matching of his Tx to the ATU—a very common trouble, too, it seems. The SWR is so high that his low-pass filter just makes things worse! This is hardly a topic for discussion in this Commentary, but it crops up often enough to justify

a future article on the subject. Of all the single factors in the shack that make the difference between DX and no-DX, the problem of transference of RF power to the aerial system seems to be the greatest.

May we make one more appeal, please, now that the mail gets heavier and heavier each month, for a bit of segregation or sorting out in your letters. It would be appreciated if the news for each band could be clearly headed and kept in a separate paragraph or section. When working against time (and we do!) it helps a lot to have band headings, just as you find them in this Commentary, with miscellaneous gossip at the beginning or end—indeed, it will be a great help.

And now the usual acknowledgments to all our sources of information, particularly the *West Gulf DX Club*, the *Western Radio Amateur*, *The DX-er* (Sweden),

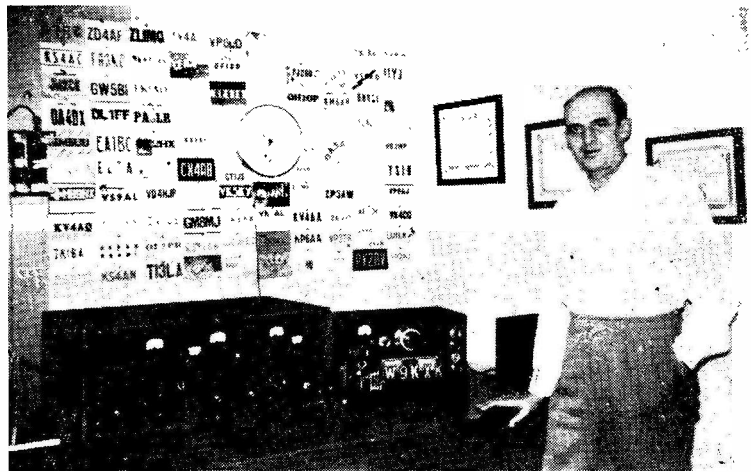

W9KXX, Waupaca, Wis., runs a Temco 600w. transmitter with an HRO receiver. His aerials are a two-element beam and a 40-metre ground plane.

and all our various informants, including the SWL fraternity. Keep it up, please, and let's have the next instalment (quite soon!) by first post on Friday, June 10,

addressed to "DX Commentary," *Short Wave Magazine*, 55 Victoria Street, London, S.W.1. Good luck until then—good DX, 73 and BCNU.

THE CONSTRUCTION COMPETITION

The entries received for this—see SHORT WAVE MAGAZINE, January and February issues—are now being scrutinised, and an announcement will appear in the next issue. Though some categories have produced a poor entry, that for Category A was larger than expected.

INTERNATIONAL CO-ORDINATION OF TIME AND FREQUENCY SERVICES

The United Kingdom and the United States have begun co-ordination of their time and frequency transmissions. This is in order to provide a uniform system of time and frequency transmissions needed for the solution of many scientific and technical problems in such fields as radio communication, geodesy, and the tracking of artificial satellites.

Participating in the project are the Royal Greenwich Observatory, the National Physical Laboratory, and the Post Office Engineering Department in the United Kingdom, and, in the United States, the U.S. Naval Observatory, the Naval Research Laboratory, and the National Bureau of Standards. The transmitting stations which are included in the co-ordination plan are GBR and MSF at Rugby; NBA, Canal Zone; WWV, Beltsville, Maryland; and WWVH, Hawaii. It is expected that by the end of 1960 the time signals from all the participating stations will be emitted in synchronism to the thousandth of a

second. Such accuracy has been needed for some time in tracking artificial satellites on a world-wide basis.



"... Your report is fair but could do better ..."

Always mention Short Wave Magazine when writing to Advertisers—It helps you, helps them and helps us

THE REDIFON R.145 COMMUNICATIONS RECEIVER

DISCUSSING AN OUTSTANDING DESIGN

ILLUSTRATED is a high-grade British communications receiver the general design of which is of considerable interest, while its performance puts it in the front rank on the world market. There is not the space here to cover the R.145 in full detail, but those features which make it of special interest are described, and much else can be deduced from a study of the photographs.

The first point is the frequency coverage and the method of achieving it. The R.145 tunes from 2.0 to 30 mc, in fourteen bands each exactly 2.0 mc wide, the coil sections for each band being mounted on a turret

assembly, rotated from the front panel. By using a series of crystal controlled oscillators, in effect one for each of the 14 bands, output at the first and variable IF of 2-4 mc is obtained on all bands. The second oscillator is thus a VFO tuning 2455-4455 kc for all bands, to produce the final IF of 455 kc—see block diagram at Fig. 1.

One important result of this arrangement is, of course, that a very high degree of frequency stability is achieved on all bands (because the 1st oscillator is CC), with the same dial coverage, a swing of 2 mc, on each band. The fourteen bands are selected in the sequence 2-4, 4-6, 6-8 mc and so on up to 28-30 mc ; thus, the main tuning dial reads directly in kc, e.g. with the band-switch on the 6-8 mc range, say, a dial reading of 1.1/31 would correspond to a frequency setting of 7131 kc; with the band-switch on the 20-22 mc range, this same dial reading would be 21,131 kc. Actually, the small scale can easily be read off to 0.5 kc; hence, a dial setting of 0.2/64.5 (which is simply a matter of looking first at the main scale and then at the small one) would, with the

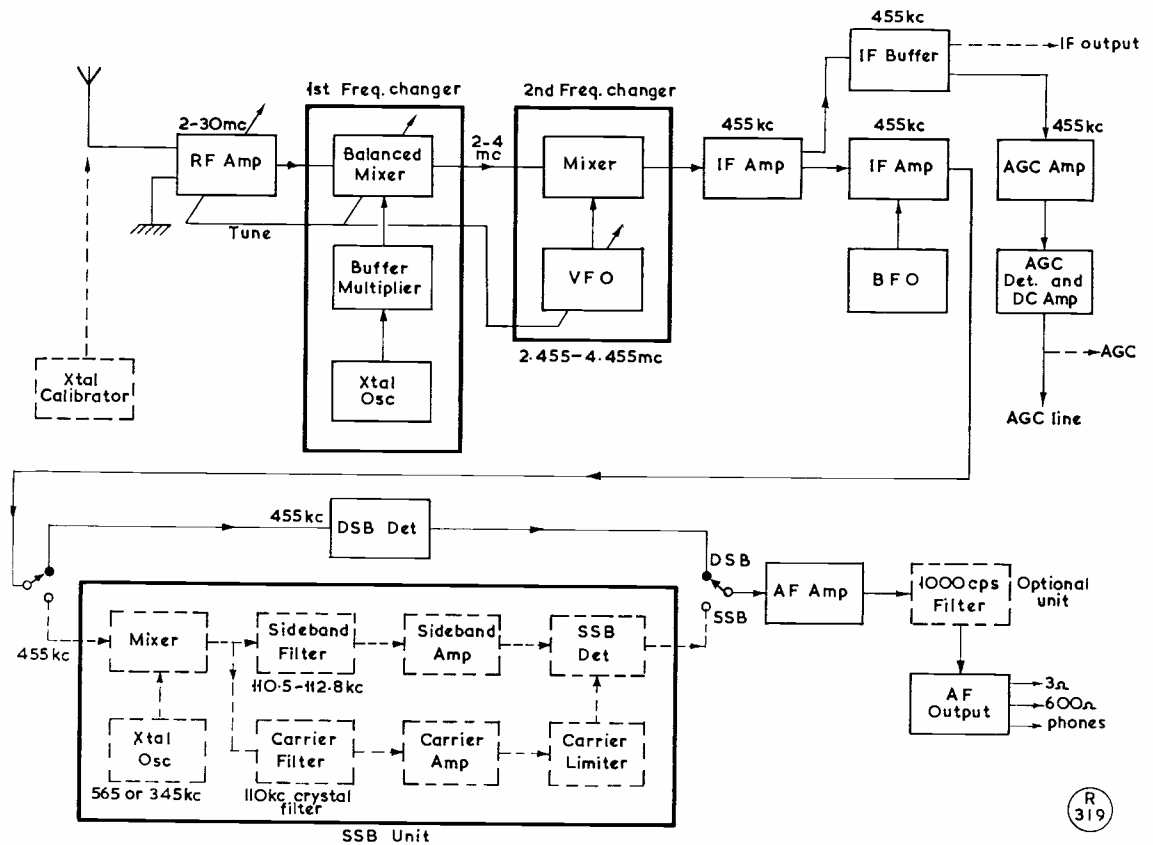
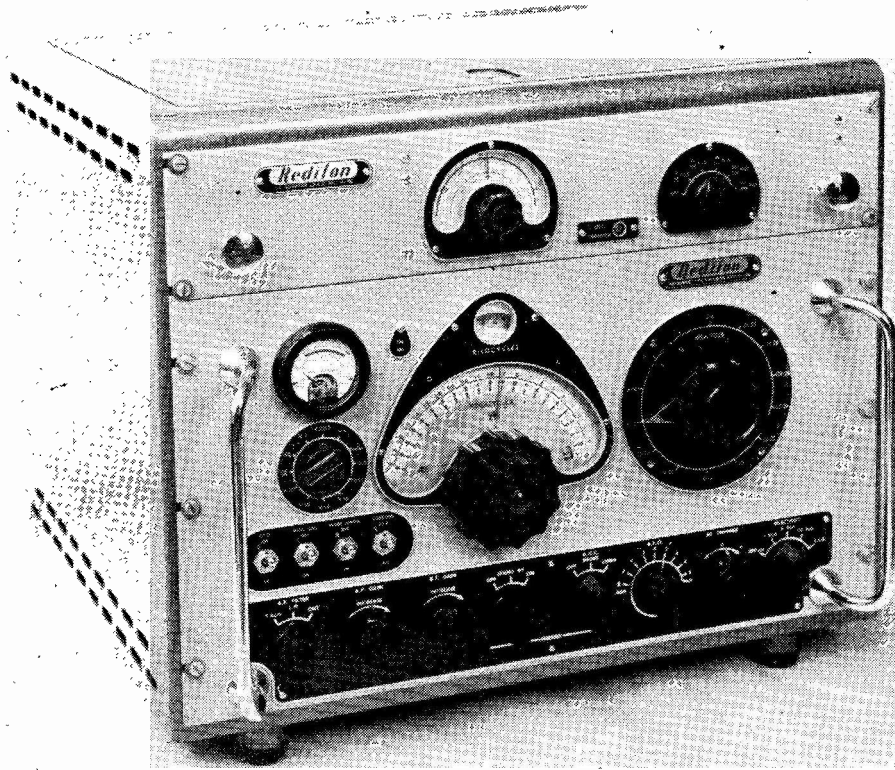

Fig. 1. Block schematic of Redifon R.145 receiver, which is an outstanding example of modern British design in the professional communications field. One of its most interesting features is that the frequency coverage of 2-30 mc is in fourteen switched bands, each exactly 2 mc wide, with a crystal controlled oscillator for each band. The 2nd frequency changer is tuned across 2455-4455 kc for all ranges, to produce a 455 kc IF. The result is exceptionally high stability and calibration accuracy over the whole tuning range, there being no band-to-band variation due to scale considerations. Basically, the receiver is a series of crystal-controlled converters with the IF tuned over exactly the same range for each band. The SSB Unit and crystal calibrator are optional extras.



General appearance of the Redifon R.145, as supplied complete with LF Adaptor, SSB Unit and Crystal Calibrator. The band selector control is on the right, and the main tuning dial is lower centre; the mechanical design and finish of this is such that a frequency can be read off, or set up, easily to within 0.5 kc at any part of the tuning range, while a skilled operator could interpolate to 250 cycles. The meter is switched to read at various check points and is also scaled 0-100 dB as an S-meter.

28-30 mc range switched in, mean a frequency of 28,264.5 kc in the 10-metre band. And this reading would be of "frequency-meter accuracy." A final check on calibration is given by the crystal calibrator—see Fig. 3.

It can be seen that the same order of stability (due to the crystal oscillator) and calibration accuracy (because of the 2 mc sweep over each band) are obtained throughout the tuning range—these are among the features which make the R.145 such a joy to handle; wavemeter tuning of this quality calls for a high degree of precision in the dial mechanism, and this in itself is a very nice piece of engineering.

Circuit Sequence

With a total of 26 valves involved in the complete receiver as shown here, it is not possible to reproduce the main circuit diagram in full as a single spread. The general arrangement is a tuned RF stage, EF93, into a balanced mixer, consisting of a pair of ECH81's connected with their outputs in push-pull; the signal input is applied to one valve only, but the heterodyne voltage (crystal oscillator) goes into both grids, so that there is no oscillator voltage component on the output side of the mixer. The crystal oscillator is an

E180F, with seven switched crystals (some double or quadruple to produce the correct injection frequency for particular bands) the oscillator switching being of course integral with the main band selector control.

The mixer in the 2nd frequency changer is an ECH81, and the VFO, tuning 2455-4455 kc, is an EF91 in a Hartley circuit. The ECH81 is a triode-heptode; the VFO drives on its triode grid, the heptode section being used as the mixer to produce the final 455 kc IF. The IF amplifiers at 455 kc are EF93's, and this section incorporates four degrees of selectivity: 12 kc, 6 kc, 1000 cycles and 300 cycles, the two sharpest positions being obtained by a crystal gate. The BFO, for CW reception, is half an ECC81, and has a frequency swing of ± 8 kc off the centre frequency, this swing being shown on a small calibrated dial on the front panel control. The other half of the ECC81 acts as a cathode follower to couple the BFO into the diode detector.

An elaborate system of AGC is used, with an EBC90, a three-position switch giving AGC off, short and long; the latter can be brought in when receiving CW. The detector is an EB91, one diode section of which acts as AGC hold-off. The audio stages consist of an EF91 into an EL90, these stages being coupled

together through a switchable audio filter; this gives either cut-off at 3 kc. 1000-cycle filtering or an "out" position for normal audio reception (the R.145 is capable of good quality on BC, as negative feed-back is applied across the audio output stages).

SSB Unit

This is optional, and is built on a separate chassis — see photographs — for which space is left in the main assembly. The circuit is given in Fig. 2, which should be read with the block diagram at Fig. 1. Heterodyne voltage is generated by either of two independent CC oscillators at frequencies of 565 or 345 kc, the output of the operative oscillator (selected for upper or lower sideband reception, as required) being mixed, with the 455 kc IF, in the control grid of an EF91; the sideband amplifier is a second EF91, coupled through a band-pass circuit tuned for 110.5-112.8 kc; the carrier

frequency at 110 kc (resulting from the selection of either upper or lower sideband oscillators) is separated from the sideband signal by a crystal resonator in the grid of another EF91, which functions as a carrier amplifier; whence it is fed, at constant level as a reconstituted carrier, to the SSB detector, an EB91. The output of the sideband amplifier is also fed to this EB91 stage (see Fig. 2), connected as a balanced demodulator. The audio frequency voltages, developed across the load resistors in the cathode of the left-hand section of the EB91 in Fig. 2, are fed out to the AF stages.

So much for the general circuit description.

Construction and Layout

The photographs of the receiver give a good idea of its appearance, which is most handsome, and the

[continued on page 202]

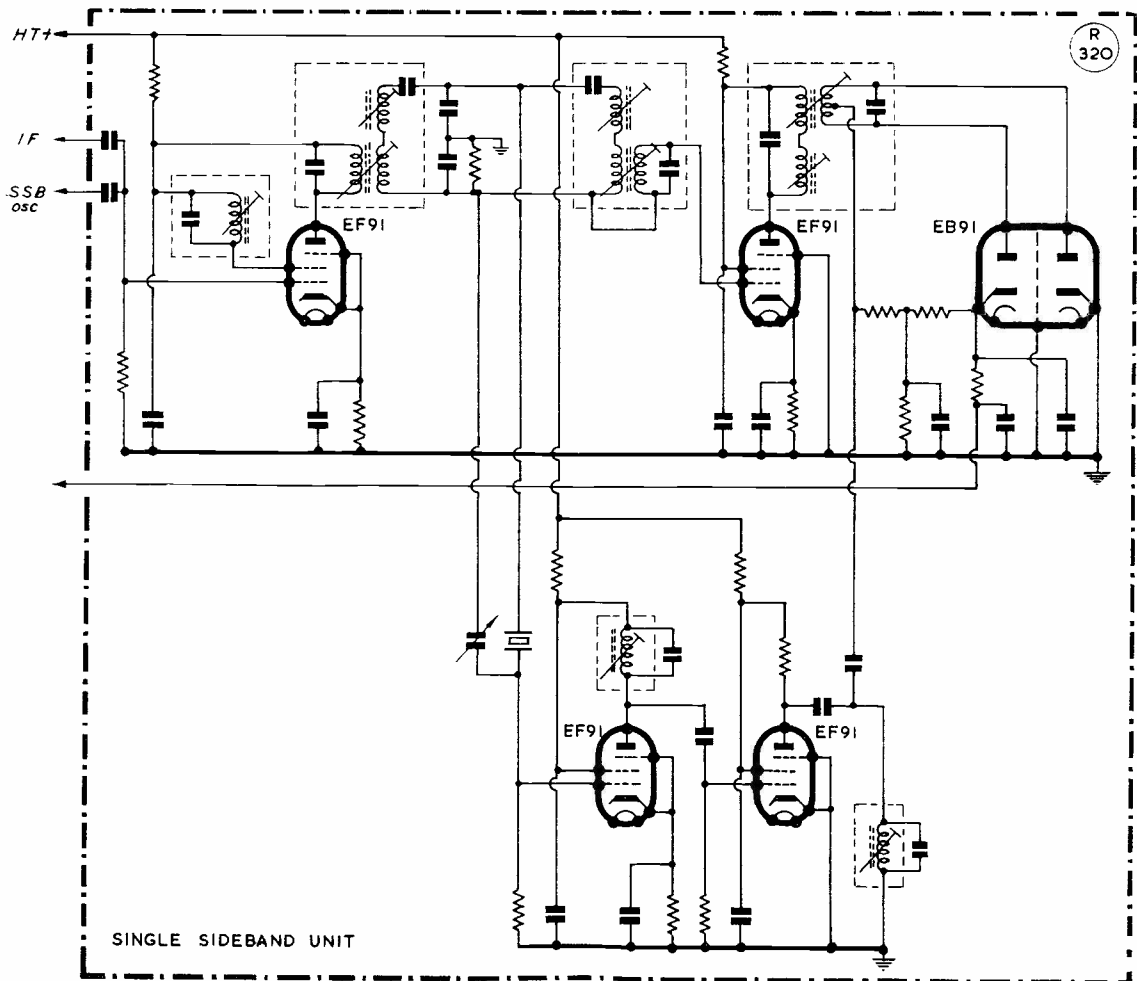
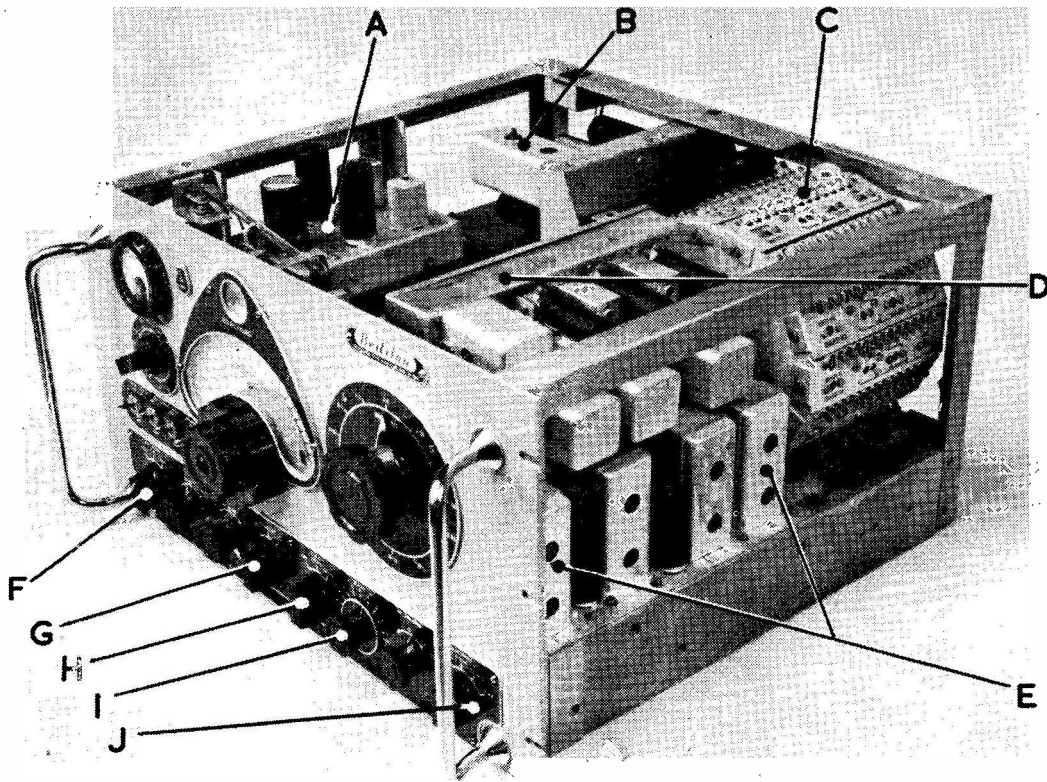

Fig. 2. Circuit arrangement of the SSB unit used in the Redifon R.145 receiver, the audio output being taken from the lowest (unmarked) connection point. Upper and lower sideband selection is given, with the crystal filter at 110 kc. The SSB section is brought in by front panel control, and the performance of the receiver on true sideband signals is quite striking. The panel meter can be switched for an SSB-tune position.



Main R.145 chassis withdrawn from the cabinet. Identified are : A, crystal calibrator unit ; B, 1st frequency changer, with RF stage ; C, 14-band coil turret assembly, rotated from front panel ; D, SSB section ; E, IF assembly ; F, audio filter control ; G, on-off-standby switch ; H, AGC control, off-short-long ; I, BFO swing, 1/8 kc ; and J, 4-position selectivity switch and SSB select. All controls are smooth and positive and the receiver is easy to operate once its potentialities have been grasped.

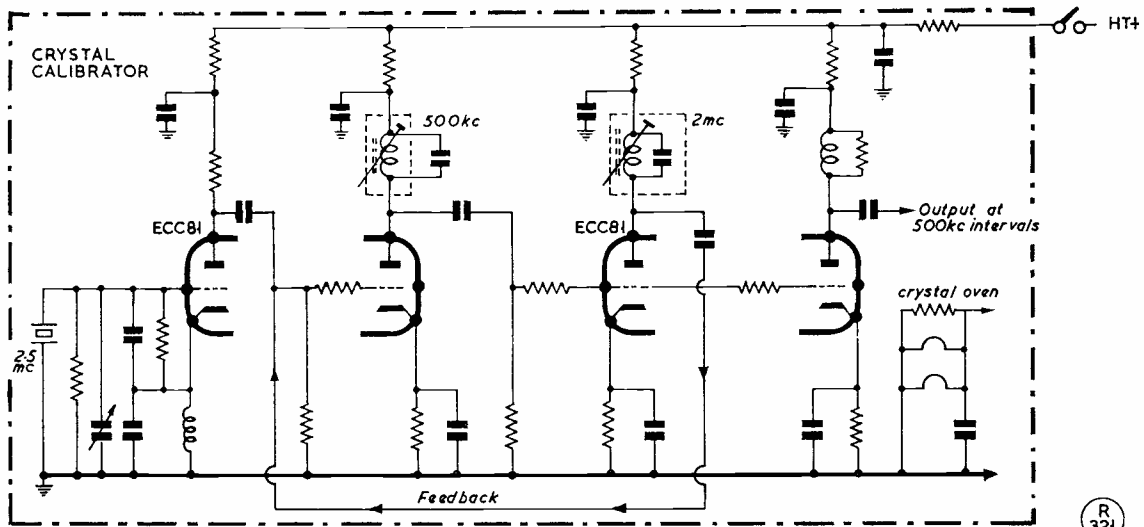
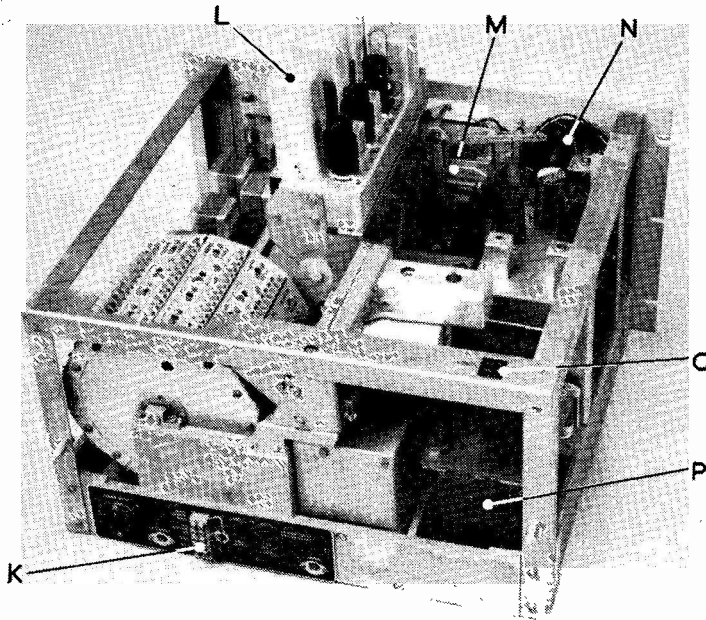

Fig. 3. Interesting crystal calibrator circuit used in the Redifon R.145. This produces beats at 500 kc intervals effectively throughout the whole tuning range. The crystal calibrator is an optional extra, for which mounting space is provided on the main chassis.

R 321



Showing the generally solid chassis construction of the Redifon R.145 receiver, which has a crystal controlled first oscillator on each of 14 switched bands, covering 2-30 mc. L is the SSB unit, raised in its mounting to give access to other parts of the receiver; M is the main dial fast-slow motion assembly; N is the switched meter; O is the connector for the LF Adaptor; and P is the power transformer. The back panel at K carries, in addition to the mains input and speaker outlets, with aerial and adaptor socket, an IF output at 455 kc and a connection to the AGC line - these are for auxiliary apparatus working with the receiver.

mechanical design, which is excellent. A solid chassis is carried in a framework which can be mounted either in a standard rack or in a cabinet, the latter being in two styles, depending upon whether it is to accommodate the R.145 alone, or the receiver plus its LF Adaptor (as shown here).

On the main chassis are mounted the various sections of the circuit - RF/mixer, crystal switching, crystal oscillator, VFO unit, IF section, audio side, power supply, SSB unit and crystal calibrator - constructed as separate assemblies. The coil turret contacts are rhodium plated throughout and are virtually untarnishable, which is essential for positive contact and noise-free operation. Accessibility is good both above and below chassis.

All controls are smooth and positive, and a switched meter enables check readings (laid down in the instruction manual)

to be taken at various parts of the circuit.

Operation

With so many panel controls and such versatility, it takes a little time to become accustomed to the R.145 and so to get the best out of it. While the general principles of receiver control apply, the R.145 performs a good deal better than others when one has learnt how to make proper use of the controls. These are: Band selector, main tuning, four-position selectivity, SSB select, AF gain, RF gain, BFO on-off, BFO swing, AGC control, aerial trimmer, noise-limiter, AF on-off filter, meter switch, upper/lower sideband selector, and crystal calibrator on-off.

The noise-limiter is of the series-shunt type and is very effective on pulsy noise. The S-meter is scaled 0-100 dB and there is a switch position enabling it to be used as an accurate tuning indicator on SSB. The aerial trimmer has a "best" setting from band to band, and is a front panel control. Head-
phone jacks are fitted on the front panel, with the speaker

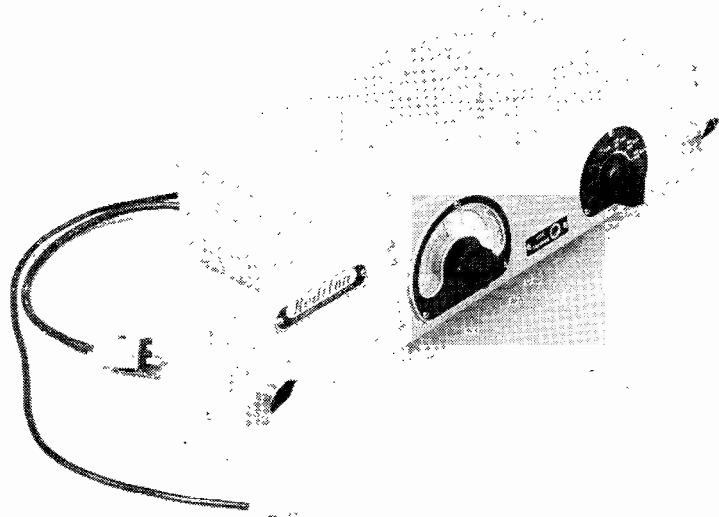

The LF Adaptor for the R.145 is a very neat add-on unit (which is an optional extra) to extend the coverage on the LF side of 2 mc - actually to as low as 15 kc, or 20,000 metres - in four switched bands over the range 15-1990 kc. The RF stage is a 6BA6 into an ECH81 triode-heptode operating as an additive frequency changer; the oscillator frequency, in the triode section of the ECH81, is fixed at 2 mc. From a consideration of the block schematic at Fig. 1, it can be seen that tuning is then carried out on the LF Adaptor which functions as an LF converter - with the main receiver at the appropriate setting in the 0-2.0 mc range on the dial.

connection at the rear of the chassis.

Additional Facilities

The 455 kc IF output at a level of about ½-volt can be taken from a low-impedance (75 ohm) socket on the rear chassis drop, to feed any ancillary apparatus with which the receiver may be used. Similarly, the AGC voltage can be picked up on this panel—see block diagram Fig. 1 and photograph—and there is also a 600-ohm output for inter-connection of the receiver on a transmission line system.

LF Band Adaptor

While the main receiver covers the 2-30 mc range, this can be extended downwards in frequency by means of an Adaptor unit (illustrated in one of the photographs) tuning from 1990 kc to 15 kc, or roughly 150-20,000 metres. The circuit of this Adaptor consists of a 6BA6 RF amplifier into an ECH81 operating as an additive frequency changer, with its oscillator side fixed at 2 mc. This works with the main receiver set on the 2-4 mc range, tuning being on the Adaptor dial. The switching is so arranged that when LF coverage is not required, the aerial connection is taken direct to the main receiver.

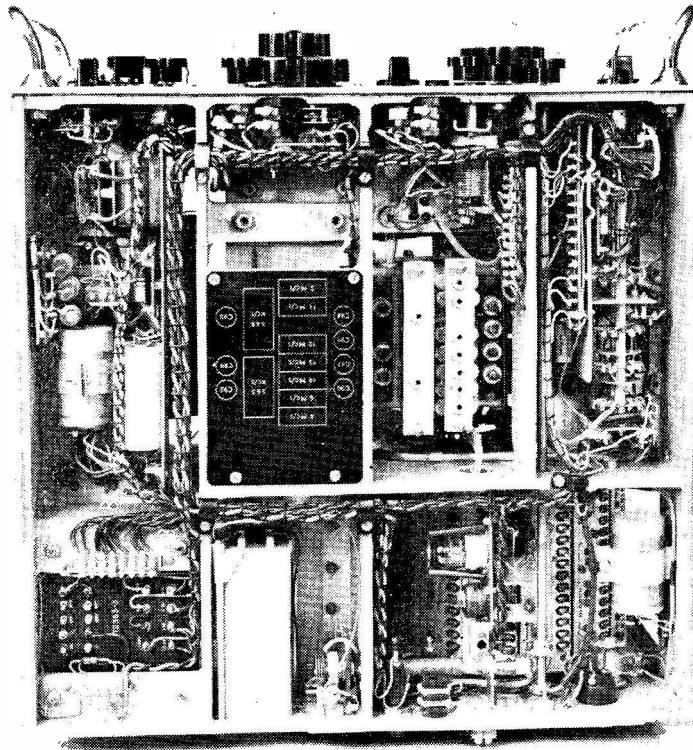

Under chassis view of the Redifon R.145, showing general layout and wiring. The power transformer is at lower left and the switch assembly at upper right is for selectivity control. The aerial trimmer is the small condenser in the compartment immediately below the engraved board; it is adjusted from the front panel through the rod and bevel-gear drive mechanism.

General

The R.145 is, of course, a "professional" communications receiver—indeed, it meets a stringent Ministry of Supply specification—designed for continuous operation on military and commercial circuits, and it finds its market in Service and Government establishments at home and overseas. From the

radio amateur point of view, it meets all the requirements of the modern AT station. It is a fine example of British radio engineering, by a manufacturer specialising in commercial communications equipment, and as such it is not cheap—but for a "Rolls-Royce receiver" you expect to pay the appropriate price!

THE LICENCE TOTALS

According to the Post Office, the total of U.K. amateur transmitting licences in issue at the end of April was 8,715. Of these, 846 included facilities for mobile operation and 78 for amateur TV transmission. A fixed station transmitting licence, obtained under the usual conditions, has of course to be held before /M or ATV permits can be issued.

STICK TO THE LETTER

The current amateur transmitting licence lays down clear rulings as to what is *not* permitted on the air—this includes allowing the station to be operated by non-qualified persons, and means that you cannot "hand the mike over to Joe" unless he also happens to hold an amateur licence. The Post Office has

recently been tightening up on this regulation, and a large number of amateurs have been warned about permitting unauthorised third-party operation, which in some cases has included "parties in the shack." While it is true that this regulation does bear hardly in a few special cases, it is nevertheless accepted by the great majority of amateurs as being in the best interests of all concerned.

POSTED TO WASHINGTON

In a recent list of Service postings appeared the following: Group Capt. C. K. Street, M.B.E., to British Joint Services' Mission, Washington, as chief signals officer. Group Capt. Street is G3DKS; he has been on the air from High Wycombe and from Hadley Wood, Middlesex.

Notes on VHF Chokes

FUNCTION, DESIGN AND
CONSTRUCTION

J. E. ROBSON, B.Sc., A.M.I.E.E.

The following notes are intended to be of use in the design and application of radio frequency chokes in VHF receivers. They are useful little components, and there is rather more to them than at first sight appears. First of all a typical circuit application will be covered, and then the action of the choke will be described. Finally, a recipe will be given so that receiver builders can roll their own.

Typical Circuit

Fig. 1 shows in skeleton form an RF amplifier V1 coupled to the next stage V2 by means of the choke RFC, and the condenser C1. The tuned circuit which provides the anode load of the RF stage is L and C2. The point at issue is the exact function of the radio frequency choke. It looks like an inductance, and it is shown as such on the diagram—but it isn't one really. It's a small *capacitance*.

In order to see how this is true, and just why it should be, consider Fig. 2 (a), which shows the set-up for investigating the behaviour of a parallel resonant circuit. A signal generator drives a tuned circuit *via* a high value of series resistance R_s , and a valve voltmeter measures the voltage developed across the tuned circuit. It is well known that the resulting curve of voltage output as the frequency of the signal generator is varied is as shown in Fig. 2 (b). The output is a maximum for some value of frequency, shown as f_0 , which is the resonant frequency. It is also well known that the shape of the curve depends upon the relative proportions of inductance and capacity in the tuned circuit—being broader as the value of inductance is high, and sharper as the value of capacitance predominates. Finally, as the losses in the circuit increase, so the curve is broader, and so does the peak value of output, at the resonant frequency, tend to fall.

Fig. 3 takes the matter a stage further. It demonstrates the actual values of the resistive and reactive parts of the tuned circuit over the frequency range of interest. These curves are marked R and X respectively. At frequencies well below resonance, both the resistance and

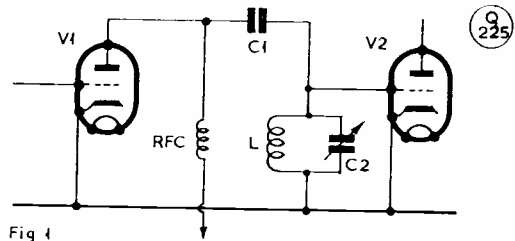

Fig. 1

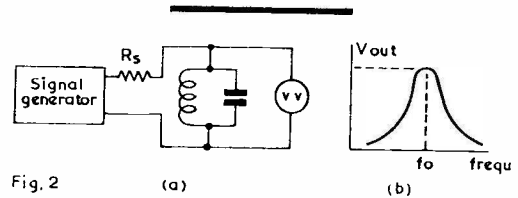

Fig. 2

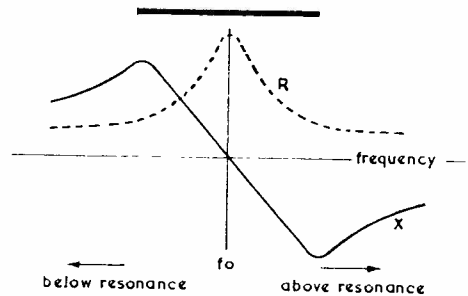

Fig. 3

The significance of these curves is discussed in the text.

reactive values are small, but they rise as the resonance frequency is approached. The reactance curve is on the positive side of the line, showing that the reactance is inductive. At resonance the resistive component is still high—this is the dynamic resistance value of the tuned circuit—but the reactive component has rather suddenly dropped to zero. This agrees with the basic fact that a tuned circuit at resonance is purely resistive. Above resonance, the reactance goes suddenly large and negative, showing that a parallel tuned circuit is capacitive at frequencies above its own resonance.

And this is where the RF choke comes back into the picture. It is deliberately made as a parallel resonant circuit, with a value of C as small as possible, and it is so designed that it is used at frequencies well above its resonant point. The result of this is that a small, constant value of capacitance is placed in parallel across the tuned circuit LC2 of Fig. 1. This amount, together with the valve output and input values of capacity, adds to the minimum value of the tuning condenser C2.

The only drawback is that the capacity swing of this condenser will be restricted slightly, but that effect is only of importance when the very widest frequency range is to be covered. If this effect is troublesome, one way of easing it is to use a small value for the coupling capacity C1. This tends to lower the actual value of capacitance across the tuned circuit, as C1 is in series with the self-capacitance of the RF choke.

Design of the Choke: Electrical

It is now possible to see just what is needed in the choke: A coil is to be wound with as small a self-capacity as possible, and that self-capacitance is to resonate with the coil inductance at some frequency well below the working frequency. At VHF the coil will obviously be a long single layered solenoid, and with this as a starting point the design follows on quite easily. A very useful feature of this type of construction is that the self-capacitance is mainly dependent upon the dimensions of the coil, and only to a minor extent upon the number of turns and the gauge of the wire. In contrast, the inductance depends markedly upon the number of turns, and so the two properties are to a large extent independent.

For the self-capacitance, the authority seems to be the articles by Medhurst. (*Wireless Engineer*, February and March, 1947, and quoted in Langford-Smith's *Radio Designer's Handbook*).

The formula is:

$$C = H D \mu\mu F$$

where D=coil diameter in cm., and H depends on the ratio of the coil length to diameter.

As to the inductance, the well-known formula by Wheeler is once again called upon:

$$L = \frac{r^2 N^2}{9r + 10l} \mu H$$

2r = coil diameter in inches

l = coil length in inches

N = number of turns

By means of these two formulæ, a coil can be designed for any given former. This leads on to the next section, the calculations being relegated to an Appendix.

Design of the Choke: Mechanical

This is the simplest part of all, and the recipe is: Use a one-watt resistor, of value of 100,000 ohms or greater, for the coil former. The leads are already made off, the resistance certainly will not damp the tuned circuit much, and the size is very convenient. Using the formulæ quoted above, and taking the dimensions of a Type 8 resistor, we arrive at the

following: To wind a VHF choke to operate at f mc, take a wire the diameter of which is given by 0.08f thou, and fill up the resistor with it.

As an example: A choke for a two-metre receiver will work at 145 mc. Multiplying 145 by 0.08 we have it that the wire diameter is 11.6 thou, and the nearest to this in enamel covered wire is 33 SWG. Hence a choke wound of 32 or 34 SWG would do very nicely.

For the sake of completeness, the factor for the Type 9 resistor is 0.045. Thus a 70 cm. choke could be wound on such a resistor with 26 gauge wire.

APPENDIX

The length-to-diameter ratio of a Type 8 resistor is 11/4, and the H-factor in the capacity equation is then 0.6. The length in centimetres is 0.64, and so the self-capacitance is 0.38 $\mu\mu F$. If the self-resonant frequency is chosen to be $1/\sqrt{2}$ of the operating frequency, we can then say that the wanted value of inductance is given by

$$L = \frac{10^6}{2 \pi^2 f^2 C} \mu H$$

where C = self-capacitance of coil, and
f = operating frequency.

But we know that

$$L = \frac{r^2 N^2}{9r + 10l}$$

and, instead of N, we can write l/a, where a is the wire diameter. And so, on combining the two formulæ and doing a little manipulation:

$$a = f \left[\pi r l \sqrt{\frac{2C}{9r + 10l}} \right]$$

We have for a Type 8 resistor that C = 0.38 $\mu\mu F$, r = 0.125 ins, and l = 0.625 ins, and on substituting these values the result follows that:

$$a = 0.08 f$$

HF LINK EQUIPMENT FOR TURKEY

Turkish engineers are being trained at Marconi College, Chelmsford, to take over the operation and maintenance of HF radio telecommunications equipment being supplied to Turkey and Iran by Marconi's Wireless Telegraph Co., Ltd. The equipment is being provided under a £225,000 order placed by H.M. Government as part of its programme of technical assistance to member countries of the Central Treaty Organisation. The apparatus includes HS31 3½kW HF independent sideband transmitters with associated HD51 independent sideband generating and monitoring equipment and HD20 Crystal Drives. At Teheran additional 30kW power amplification is provided by the Marconi linear amplifier, Type HS61. Use is made on the telegraph circuits of the new Marconi multichannel voice frequency telegraph equipment, Type HL13/14 providing quadruple diversity reception.

ONCE again, and as last month, the big news is of Aurora openings — by which we seem to have been visited more often than usual so far this season. The last big one was during April 30, with a minor occurrence on the afternoon of May 8, while the IARU Contest was in full swing; and for this, those /P's (and others) out without a key found themselves at a distinct disadvantage!

On Saturday, April 30, the opening developed during the late afternoon, between about 1520 and 1800 GMT. One of the outstanding results was a contact G3HBW/SP3GZ, giving Arnold his 18th country and putting him in the hot seat, with G5YV, in Countries Worked. An interesting EU heard by several southerly G's during this opening was HB9RG, and other EDX available included DM3ZI, DL6MH, DL9ARA and OZ5BK. Several good GDX stations were also coming through, from GI and GM, and as it was a Saturday afternoon, there was quite a reasonable level of activity — though we have heard many of the usual stories from those who missed it all, either because they were busy in the garden, or taking the family out, or visiting a sick friend, or whatever!

For the auroral appearance on May 8, there was much more activity, but the duration was far shorter — approximately 1515 to 1645 GMT, according to G3HBW's log. He mentions many DL's heard, such as DL1RX, DL3YBA, DL6QS, DL6WU and DJ4NGA, also F3ND and OZ3NH. The GDX coming through to the south of England included GM3DIQ, GM3KYI/P, GM3LAV/M and G13KYP/P. ON's and PA's were also being strongly received in the Midlands, and there were some interesting U.K. contacts by auroral reflection, e.g. G3HBW/GM3FYR-A, the latter being in Cornwall, and G2CIW/GM3HLH-A, with three other GM's also worked by G2CIW, who heard a total of some 25S. G15AJ was also available, and G3JAM reports several GM/GI's heard though not worked. GM3FYR/A (at St. Ives, Cornwall) lists about 30 GDX stations heard *via* aurora during 1700-1800

VHF BANDS

A. J. DEVON

GMT on April 30; he, most unfortunately, was not able to transmit because of TVI. At G3EHY, 11 countries were heard during the April 30 opening, nice ones being HB9RG and LA3GM.

Meteor Scatter Tests

Both G3HBW and G3FZL were involved in EDX attempts during the Aquarids appearance over May 5-7, with no very positive results, though G3FZL and OK2VCG identified one another; G3HBW was testing with OH1ML, who is on 144-148 mc. The density of the Aquarids Shower is not very high, and there will be better opportunities later on with the Perseids and Geminids. These MS tests demand very accurate frequency setting at both ends, as there is no time for searching in the ordinary sense; it is very much a matter of a "fleeting-opportunity target." Normally, only short bursts of a transmission are received, with fragments of call-sign, which can be very loud for a few seconds. It will be remembered that G3HBW/OE1WJ achieved a full two-way QSO by meteor scatter in January last, using the Geminids.

Interesting Possibility

The American project to put 100 ft. diameter aluminised balloons into orbit as passive reflectors has already been mentioned in this space. The first attempt, on May 13, was unfortunately a failure; the device fell back, as one of the rocket stages did not blow.

However, there will be future attempts, and as the intention is to put them into orbits which will bring them over Northern Europe at a height of about 1,000 miles or so, there is every possibility that they will be reasonably effective as reflectors for our two-metre signals. The Americans say these balloons should be easily visible under good conditions, so they will get a good deal of press attention; it is simply a matter of having a shot at it when a successful release is announced. The last stage of the rocket, which will travel more or less with the balloon if an orbit is achieved, is to carry a 108 mc transmitter, so a converter for this frequency would be useful, too. Some of the tunable Band II FM converters can be squeezed up into this region.

The IARU Contest

This took place over May 7-8, with conditions fair only, except for the aurora opening on the Sunday afternoon, already mentioned. However, on the evening of the 7th, some of the nearer EU's were being worked from the southerly part of the country. U.K. activity in general was not very high, there being about 35 known portables out. During Sunday, the scoring rate for the average /P station varied from 5 to 12 contacts per hour, one of the most active portables being G5HZ/P, who worked 66 different stations. G3FD/P had 58 contacts, of which 30 were with other /P's.

As this was one of the very few occasions when a real DX opening coincided with a contest, it is a great pity that more contest stations were not in a position to use CW, and able to make a snappy CW QSO. (The two things do not necessarily go together!).

VHFCC Elections

There are four to be entered this month: VHF Century Club Certificate No. 264 goes to F. Jackson, G3GIM, Catford, London, S.E.6, who, in just a year on the two-metre band, worked 154 different stations for 101 QSL cards, from 6 countries and 18 counties; he mentions that in that period he put out 210 CQ calls, of

which 87 produced a response. G3GIM uses an indoor 8-ele Yagi, rotated by handraulic power, with 40w. in the 829B PA, and a cascode converter into an S.640.

Certificate No. 265 is awarded to J. Hardy, G3KND, Farnham, Sy., who has worked four countries outside G, for which he showed 98 cards, with 19 others from DL, ON and PA. D. Pack, G3MPS, Farnborough, Hants., gains VHFCC Certificate No. 266; he shows cards for both two metres and 70 cm, with 7 countries worked, including two OZ's; the 70-cm contacts account for nine of his batch of QSL's. J. C. Brown, G3DBO, East Ham, London, E.6, puts in 101 cards for Certificate No. 267, he having started on two metres in March, 1959; his contacts outside G include DL and PA.

Again for the benefit of those who ask: For VHFCC we require not less than 100 QSL cards, with a *check list*, for two-way contacts on any VHF band from 50 mc up. The cards, check list and claim, with some details such as gear used and results generally since first coming on VHF, should be sent in by registered post, with sufficient return postage, to A. J. Devon.

VHF Convention

This was held on May 21, and was again a very well-attended affair, smoothly organised by G2AIW, supported by G3DQ and members of the London UHF Group. The dinner sitting was the largest yet, this being followed by the popular prize draw, for which some very handsome donations had been made by various manufacturers. The proceedings included, during the afternoon, two good talks—one by Dr. R. C. Jennison, of Jodrell Bank, and the other by Mr. K. Drummond (ex-2CRD, pre-war, ex-G2AUS), of Mullards, who succeeded in making much to do with Micro-waves both very interesting and ridiculously simple. As a working demonstration, G3HBW had his noise-factor measuring equipment set up, on which measurements were taken on a number of two-metre and 70-cm converters—in some cases, with rather surprising

results. It seems that 3.5 dB is about the lowest practicable figure for a good two-metre converter.

The prize-winners in the equipment display, judged by Dr. J. Saxton, of the Radio Research Station, Slough, were SWL Webber, for his complete 70-cm receiver; G3HBW for his parametric amplifier; and G3GHI for his two-metre transmitter. Included in the commercial display was some very nice two-metre gear shown by the firm of T. Withers, G3HGE, Enfield, Middx.

SSB on Two

An interesting point is brought out by G3NR (Bracknell), who is now regularly on 144.2 mc SSB; it is that when using what he calls "moderate p.e.p., say 50 watts or more," it is all too easy to overload receivers within the local radius of 30-40 miles, the result being hopeless distortion, with the SSB signal very difficult to resolve. The effect can be overcome only by reducing power considerably, or by turning beams away at both receiving and transmitting ends, or by cutting down gain not only on the main receiver, but at the converter front-end as well. G3NR/G3MED have had a two-way SSB contact (which, as it happens, your A.J.D. overheard), and G3NR says that he is now looking for the PA's who are known to favour this mode. Incidentally, at the VHF Convention on May 21, a tape-recording of an SSB contact during *aurora* conditions was played over; speech was almost R5, proving that sideband phone can be effective under these conditions.

Station News

G2C1W (Birmingham) says that there has been nothing startling in the way of tropospheric DX during the period, and activity has been generally on the low side, particularly on 70 cm., on which band he only found five stations to work. During the *aurora* opening on April 30, G2C1W heard six countries.

The Christchurch/Poole pair, G3OBB and G3OBD, are "coasting along nicely," with GC2FZC and G3MAR (Birmingham) worked by G3OBB on May 8, and

GM3DIQ heard *via aurora*; G3OBB also heard an unidentified GI, probably either GI5AJ or GI3KYP/P. G3OBD is building to go /M on two metres.

"During the contest, the hills of Derbyshire seemed well populated with S9+ phone stations, not many of whom were interested in CW"—that is how G8NM (Lincoln) found it on May 8. He makes claims for both Counties tables and remarks that though an increase of aerial height to 35 ft. has made the usuals louder, the "hoped-for increase in new stations to be heard has not materialised."

After about 10 years' absence, G5ZT (Plymouth) writes in to say that he is back on the two-metre band; he is on 144.45 mc (until a Zone A crystal is acquired), and comes up *daily* at 1230, 1345 and 1930 BST, running 20w, to an 832, into an 8-over-8 with a CC converter. He would like beams to be headed his way, and remarks that G3AS and G3JGJ in the south-west are consistent signals with him; he also mentions G3LMG (Tavistock) as a local

TWO METRES

COUNTIES WORKED SINCE SEPTEMBER 1, 1959

Starting Figure, 14
From Home QTH Only

Worked	Station
52	G3HBW
44	G2C1W
42	G5MA
36	G3LTF, G6XA
34	G3JWQ, G3KPT, G3LAR
30	G3AYC, G3NBQ, G5ML
29	GW3ATM
27	G3GSO
24	G3HWR
19	GW3MFY
18	G3CO, G3ICO
14	G3DLU, G3IOE

This Annual Counties Worked Table opened on September 1st, 1959, and will run till August 31st, 1960. All operators who work 14 or more Counties on Two Metres are eligible for entry in the Table. The first claim should be a list of counties with the stations worked for them. The list can be added to as additional counties accrue.

whose attention he hopes to attract!

For G3GSO (Derby), May 6 was the big day, because it was then that, after two years of trying, he worked Devon for the first time, in the shape of G5QA (Exeter); this puts him up to 36C in the All-Time. One expects that it was quite a nice QSO for G5QA, too!

G3JAM (Woodford Green) keeps up the bench-work, which at the moment is concentrated on the problem of accurate frequency measurement on the receiver. (A set-up like the R.145 described in this issue is the ideal; using a CC converter with the crystal knocking out at 120 mc exactly, which is quite easily arranged, and the R.145 switched to the 24-26 mc range, frequencies on the two-metre band can be read off the dial to an accuracy of 0.5 kc.—*Editor.*) G3JAM was there for the aurora manifestations on April 30 and May 8, and worked some DX, with many more stations heard. His count of different stations worked on two metres is now 289, of which 20 have been raised during the last couple of months.

The station signing GM3FYR/A

is actually at St. Ives, Cornwall; he has been there since April 23, on 144.9 mc, and no doubt the call will have been "rationalised" to G3FYR by the time this appears. He runs 50w. on phone and CW, and in future will be on 144.12 mc; some 14 contacts have been made to date, with many more stations heard *via* aurora when it was not possible to transmit. G3FYR also gets a strong signal on 145.26 mc, around noon, which sounds to him like a meteor-trail reflection; it comes through in short bursts and is only heard on sunny days—this could be scatter radiation from Dresden TV, as the frequency is about right.

Four-Metre Band

And who should emerge as a strong protagonist for the 70-meg band but our old friend Louis of G3EHY (Banwell, Som.), who says that "activity on this band is certainly on the increase." He has had many solid QSO's with G5YV, worked on schedule at 1030 BST on Sundays, and other northern stations QSO'd are G3IUD and G3KAG. G3EHY has now worked 15 counties on four metres, which would justify a table for

this band if we could get a few more entries. So the suggestion is thrown out—taking 8 counties as the starting figure, how many have you worked on the 70 mc band?

As a matter of more than ordinary interest, the aurora opening of April 30 was first observed by G3EHY on four metres—he had a spin round at about 3.0 p.m. that Saturday and, hearing an unidentifiable CW signal, turned over to two metres, and found that band full of stations calling CQ on the key. As Louis says, what a pity more people don't use CW for more of the time!

Now that 4-metre operation is open to all—see pp.541-542 February issue *SHORT WAVE MAGAZINE*—we may hope that there will be a great deal more activity by U.K. amateurs. The frequency range is 70.2-70.4 mc, which is like the old (pre-war) 5-metre band for U.K. working. A 3-ele flat-top, with a two-stage converter and 20 watts or so in the PA, will give you contact with the locals over a wide radius. There is a TVI problem for those whose neighbours take in on Channel 5 and, to some extent, on Channel 4, but in all but the very worst local cases, a well-tuned aerial circuit should eliminate TVI; use a filter with a cut-off at about 68 mc (easily designed from the book) and a sharply-tuned ATU. Unless you have Channel 5 viewers within 500 yds., this should put you right for FM working on 4 metres during TV hours. If you have taken the right precautions, any TV viewer who complains has only his set to blame—and unfortunately those of them who have simple receivers with the front end wide open will always complain. If you have taken all reasonable precautions, leave it to the Post Office.

Conclusion

And so once more it is 73 till we meet again on July 1st, which makes it **June 16** as the latest date for catching the next issue. Watch the pressure, the temperature and the weather map for the tropo openings, and send your reports and comments to the receipt of custom, *your A.J.D.*

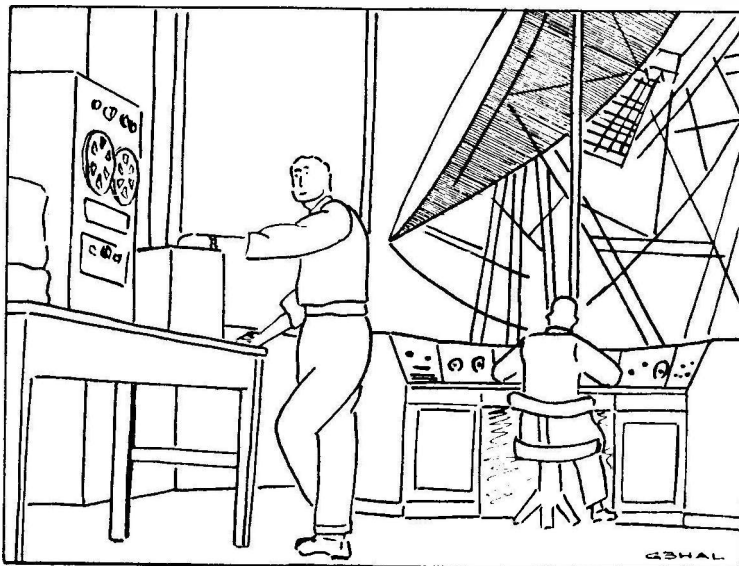

“. . . worked any good DX recently, Professor? . . .”

(with our respects to Jodrell Bank and Professor Lovell, who will take it in good part)

• • • The Mobile Scene • • •

THERE is no question that this is going to be the busiest and most interesting season yet as regards mobile activity, even if only in terms of the rallies organised to draw the /M crowd—and, by the way, the Post Office count of mobile licences issued stood at 846 as at April 30 last.

While we have no very full report on it, the Trentham Gardens affair on April 24 was as crowded and successful as usual; estimates of the number of people present vary between 1,500 and 2,000, and there were more mobile-fitted vehicles in the parks than ever before. Then, on May 8, there were two Rallies, that at Hugin, Ramsgate, bringing some 110 people in 35 cars, while at Cheltenham they had their best attendance yet, with more than 100 cars actually fitted /M. For the occasion, the Cheltenham group once again ran their driving-cum-navigation competition for visiting mobiles, involving a run through the Cotswolds, during which certain facts had to be collected from coded map references, points being scored for correct answers and for stations worked while /M. The first three in this contest were G6NW/M, G3LOV/M and G5PP/M. There was an interesting equipment display and a free prize draw to round off the proceedings.

A Mobile Rally of rather a different sort took place the following Sunday, May 15, when the A.E.R.E Amateur Radio Society entertained a large gathering at the Atomic Energy Research Establishment at Harwell. The local group had wisely decided that on such an occasion visitors might be more interested in what goes on at Harwell itself than in radio pure-and-simple.

The main attraction was a most informative lecture, with films, given in the large lecture hall by Mr. K. E. B. Jay (ex-G2HJ), while those who had been lucky enough to have their names drawn from the many applicants for it were taken on a tour of the "enclosed" part of the premises. The uranium graphite-moderated reactor, called BEPO, was visited and explained while actually running, and much interesting information given about the radioisotopes now being produced by BEPO for customers in industry and scientific establishments in many parts of the world. For those not *au fait* with radioisotopes, what they are and what they do, a very informative hand-out was available. Entries in the visitors' book for this most successful and interesting meeting totalled 261; there were 53 Top Band

and eight two-metre mobiles in the /M car park, and 38 of the visitors took the coach trip round Oxford. Members of the A.E.R.E. Amateur Radio Society, a relatively small group which has not long been on an organised basis, are to be congratulated on the way they laid this Rally on, the excellence of the lecturing and explanations given on the tour, and the smooth running of the event as a whole. It might also be added that the prizes for the draw were contributed almost entirely by the organisers themselves, and the very good tea which preceded the draw was provided by members' wives and their friends.

And now for the forthcoming attractions:

June 19: A.R.M.S. Mobile Rally at R.A.F. Station Croughton, Northants., which is actually a large signals establishment operated by the U.S.A.F. The meeting, which will open with first arrivals, is to gather at the Transmitting Site at Barford St. John. Make for Deddington, at the intersection of the B.4031 Buckingham-Chipping Norton with the A.423 Oxford-Banbury; Barford St. John is off the B.4031, about 2½ miles west of Deddington. Top Band talk-in will be given by G3NMS and on two metres by G3HTC/P, starting about 10.30 a.m., and G8KW/P will be operating an SSB station on the HF bands. Parties of 30 at a time will be taken round the Transmitter Hall, which contains a great deal of modern high-powered equipment, mainly remote-controlled by microwave relay; cameras will *not* be permitted on these tours. In connection with the Rally, the American authorities



G3JFH/M at the Cheltenham Mobile Rally on May 8, which drew a large attendance from all over the country, more than 100 cars in the park being equipped for mobile operation.

are hoping to make the occasion a meeting for all U.S. amateurs known to be in this country. In the event of it being wet, cover will be available. Those proposing to attend what should be a particularly interesting event need to bring a picnic lunch and/or tea, though a soft-drink, light beer, and ice-cream stand will be provided. A raffle and equipment display are being arranged, with various competitions for visitors (of all categories). For any further information write, enclosing s.a.e., to: V. A. Frisbee, G3KVF, A.R.M.S., 17 Delacourt Road, Blackheath, London, S.E.3.

June 25: Pembroke & District Amateur Radio Club Mobile Rally (and bucket-and-spade party) at Saundersfoot, nr. Tenby. Assembly is at 2.00 p.m. at the Argosy Café, which has a large car park. Talk-in will be by GW2OP/A and GW3LXI/M on 1876 kc, and it is *essential* that those attending should notify a few days in advance, so that catering arrangements can be made—tea will be 3s. 6d. a head. Visitors will be piloted round some of the sights of Pembs., including the great new oil-tanker terminal, while those interested in the writings of Dylan Thomas may like to know that he is said to have derived his inspiration for "Under Milk Wood" in the Saundersfoot neighbourhood. Reservations to: G. H. P. Price, GW3LXI, hon. secretary, Pembroke & District Amateur Radio Club, 1 The Parade, Pembroke, West Wales.

June 26: West of England Mobile Rally at Longleat House, nr. Warminster, Wilts. Grounds open 10 a.m. to 6 p.m., admission to Rally 1s. per head. Unlimited parking accommodation in reserved Rally car park, in one of the most delightful settings on the Longleat Estate. Ample catering facilities in the Longleat House Restaurant; no prior booking necessary. Attractions to include Morris Dancing displays at 3.0 and 5.30 p.m.; free prize draw; competitions for children; tickets at reduced prices for admission to Longleat House itself (residence of the Marquis of Bath). Prizes and certificates will be awarded for: (a) The mobile travelling the greatest distance *to-and-from* home on the *day* of the Rally; (b) The longest distance mobile-to-control contact on Top Band; (c) The best distance worked mobile-to-control on two metres; (d) The mobile recording the highest field strength at the control station from a designated point in the Rally grounds; and (e) The best mobile-equipped car in a *Concours d'Elegance*. These prizes will be presented by Lord Bath at 4.30 p.m. Control and talk-in stations will be G3CHW/A on 1900 kc and G3FKO/A on 145.3 mc, opening at 10.0 a.m.

July 3: Harlow & District Radio Society Mobile Rally, Village Hall, Magdalen Laver, nr. Harlow, Essex. Talk-in on Top Band will be given by G3ERN, and on two metres by G3JMA.

July 3: Peterborough & District Amateur Radio Society Mobile Rally at Hunstanton, Norfolk—the only seaside resort on the East Coast which faces due west! Talk-in will be given on Top Band and two metres, and there will be all facilities. The

meeting place is opposite the railway station.

July 10: South Shields and District Amateur Radio Club Mobile Rally.

July 17: Southern Counties Mobile Rally at Beaulieu, Lymington, New Forest, Hants. (B.3056, Lyndhurst-Beaulieu). Talk-in on Top Band by G3IVP/A on 1880 kc and G2HIF/A on 144.14 mc, opening at 10.30 a.m. Attractions will include mobile treasure hunt, visit to Lord Montagu's Vintage Car Museum and, if weather permits, trips on the river. Lunch at 6s. 6d. and tea at 3s. 6d. must be booked in advance, by not later than July 9. Programme of events available at 6d. Write, with s.a.e., to: R. Bassett, 42 Norham Avenue, Shirley, Southampton 76123.

August 9-12: During the period of the National Rally of Boats and supporting exhibition, the city of Stoke-on-Trent is co-operating with the Inland Waterways Association and, by the same token, the Stoke-on-Trent Amateur Radio Society and S-o-T Boat Club are getting together on what will in effect be a Marine-Mobile Rally, the first to be held in this country. A station signing GB3SOT (the Stoke-on-Trent special call-sign issued in connection with the city's golden jubilee celebrations) on 160-80-40 metres is being installed in the exhibition hall and, as many canal craft are expected to be converging on Stoke-on-Trent for the Rally, it is hoped to work, as /MM's or /MP's, those that may be fitted for amateur band operation. Since it may take some of them several days to reach the meeting place, any U.K. amateurs who happen also to run canal craft (operation /MM on canals and inland waterways is covered by the mobile licence) are asked to get in touch with: V. J. Reynolds, G3COY, hon. secretary, Stoke-on-Trent Amateur Radio Society, 90 Prince's Road, Hartshill, Stoke-on-Trent, Staffs.

August 20: Houghton-le-Spring & District Radio Club Mobile Rally, organised in connection with the Hetton Show, which is an important local occasion in Co. Durham. It includes such attractions as riding and jumping, the motor-cycle display team of the Royal Corps of Signals, and the events and competitions usually to be found at a country show. Lunch and tea will be available on the ground, which is at Easington Lane on the A.182, running between the A.19 and the A.690. There is an admission charge to the Show, and car window stickers can be obtained. For bookings and further information write, with s.a.e., to: S. L. McAteer, G3CKC, 20 Kirkdale Street, Low Moorsley, Hetton-le-Hole, Co. Durham.

And anybody reading through the foregoing programme of Rally events would agree that there is a great deal to interest the keen mobileer during the next few months.

THE MOBILE REGISTER

Following are the latest entries for the Register: G2AGK, Ward End, Birmingham (10-160m., *Armstrong Typhoon GUK650*); G2DHV, Sidcup (160m., *Standard Ten SXK459*); GW2OP, Freshwater East, Pembroke (160m., *Morris 1000 HNH50*);

G3JKU, Lancing, Sussex (80-160m., *Standard PPX36*); G3LCZ, Stockton-on-Tees (80-160m., *Ford Zephyr XVK671*); GW3LXI, Pembroke (160m., *Austin A35 922BDE*); G3MQT, Hastings (160m., *Morris Minor KAP364*); G3JNZ, Sherburn, Co. Durham (160m., *Morris Van LPY233*); G3NXU, Keynsham, Bristol (40-160m., *Vanguard KWV33*); and G6UT, Great Hallingbury, Essex (10-160m., *Morris Traveller 9277NO*).

This list will be added to from time to time, as further entries are received.

Transistor Microphone Amplifier

TWO-STAGE CIRCUIT FOR MOVING-COIL OR CRYSTAL TYPES

Two practical design problems frequently arise in the amateur station—changing from a carbon-type microphone to something capable of giving better quality, such as a crystal or a moving-coil microphone, and the construction of a high-gain voltage amplifier which can be used as a separate unit to work with existing audio equipment.

These requirements can conveniently be met by the transistor circuit shown in the diagram—this amounts to no more than a couple of “red spot” audio transistors of the 5s. variety for TR1, TR2, with a few resistors and condensers; the “red spots” are readily available, and the other items you will probably have in the junk box; total cost need not be more than 10s.-15s. if you have not got suitable audio transistors (such as OC71, TS13, GET4 and such) by you already.

Construction

The idea is that the circuit should be put together as a small unit in a screening box, which can be a flat tobacco tin, a round cigarette tin or, if modern miniature components can be used, even a typewriter-ribbon tin; all these have close fitting lids. The only external connections required are coax sockets for the microphone input and audio output and a termination for a pair of feed leads, one of which is earthy. If containers of the sort suggested are used, they can be given a coat of dark-green or grey hard-finish to disguise the origin while improving the appearance.

Circuit Points

It is interesting to note that merely by changing the value of R1, it is possible to accommodate a wide range of microphone input impedances—from about 5K for a moving-coil type to 500K for a crystal microphone.

Furthermore, the value of R1 within the range required for a particular microphone also affects to some extent the audio response and the voltage output of the amplifier overall. In general, a low value gives more output with “toppy” quality, while a high value results in a good frequency characteristic with reduced output. The values of R1 with which to experiment lie in the range 4,000-6,000 ohms for a relatively low-impedance microphone, and between 100K and 500K for the crystal types (which themselves vary widely in sensitivity and frequency response).

For convenience, the audio gain control can remain on the existing amplifier, as shown in the diagram. Audio outputs of from 0.5 to 1.8 volts can be developed across R7, depending upon the type of microphone used and the value of R1, as already explained.

The usual notes of warning must be sounded in constructing and testing this little amplifier: When soldering transistors into circuit, a substantial heat-sink must be provided between the transistor body and the hot point; a pair of pliers will usually suffice. Secondly, *always* disconnect the voltage supply when making

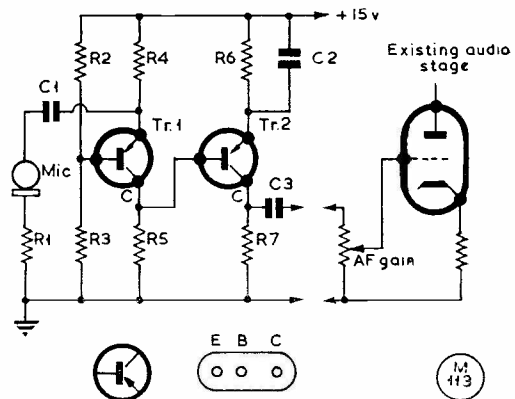

Simple two-transistor voltage amplifier for use with a moving-coil or crystal microphone, to give increased front-end gain into an existing amplifier.

Table of Values

Two-Stage Transistor Amplifier	
C1, C2	6 μF
C3	.01 μF
R1	(see text)
R2	39,000 ohms
R3	68,000 ohms
R4, R7	10,000 ohms
R5, R6	15,000 ohms
TR1, TR2	Red Spot (Henry's), OC71, TS1 GET4 (see text)

NEW QTH's

This space is available for the publication of the addresses of all holders of new U.K. call signs, as issued, or changes of address of transmitters already licensed. All addresses published here are reprinted in the U.K. section of the "RADIO AMATEUR CALL BOOK" in preparation. QTH's are inserted as they are received, up to the limit of the space allowance each month. Please write clearly and address on a separate slip to QTH Section.

- G3NUI**, A. T. Dobson, 58 Keppel Road, Chorlton - cum - Hardy, Manchester, 21, Lancs.
- G3NWO**, J. A. Lockett, B.Sc., 23 St. George's Avenue South, Wolstanton, Newcastle, Staffs.
- G3NXZ**, J. W. Howe, 18 Laburnum Grove, Conisbrough, nr. Doncaster, Yorkshire.
- G3NYQ**, J. A. Edson, Chalfonts, Menston Lanc. Burley, Ilkley, Yorkshire.
- GM3NZI/A**, B. G. Taylor, No. 1271 (Bathgate) Sqdn., A.T.C., 79 Mid Street, Bathgate, West Lothian.
- GM3NZI/A**, B. G. Taylor, Bathgate Academy, Bathgate, West Lothian. (Tel.: Bathgate 2801.)
- G3OBJ**, R. Coulson, 106 Salterford Road, Hucknall, Notts.
- G3OCB**, C. Bowden, Tretheague House, Stithians, nr. Truro, Cornwall.
- G3OCF**, J. C. Norman, 31 Derry-Hill Road, Redhill, Arnold, Notts.
- G3OCR**, S. D. Nutt, 1 Cromleigh Way, Southwick, Sussex.
- GM3OCV**, D. F. Connor, 66 Woodside Avenue, Rutherglen, Glasgow.
- GW3OCX**, J. Boulter, Cae Engan, London Road, Holyhead, Anglesey. (Tel.: Holyhead 2606.)
- G3ODB**, A. E. Pritchard, 8 Hollyshaws, Longmeadow, Stevenage, Herts.
- G3ODD**, E. M. Stables, Manor Farm, Hemingbrough, Selby, Yorkshire.
- G3ODK**, N. K. Mort, 28 Willow Crescent, Ribbleton, Preston, Lancs.
- GM3ODM**, W. McCrossan, 36 Etna Street, Craigneuk, Wishaw, Lanarkshire.
- G3ODQ**, R. A. Lester, Fairfield, Grove Road, Leighton Buzzard, Beds.
- G3ODU**, B. P. Carter, 4 Woodbastwick Road, Sydenham, London, S.E.26.
- CHANGE OF ADDRESS**
- G2DHV**, G. V. Haylock, 28 Longlands Road, Sidcup, Kent.
- G2UW**, A. J. S. Wilson, c/o Officers' Mess, R.A.F. Station, Uxbridge, Middlesex.
- G3BZZ**, T. Edgar, 8 Derwentwater Gardens, Whickham, Newcastle-on-Tyne.
- G3HNU**, J. L. Mangnall, 89 Greenhead Road, Huddersfield, Yorkshire.
- G3HWB**, F. V. Greenleaves, 97 Lowton Road, Golborne, nr. Warrington, Lancs.
- G3JBR**, D. P. Tipper, 408 Scalby Road, Newby, Scarborough, Yorkshire.
- G3JCV**, W. A. Hawkins, 39 Derek Avenue, West Ewell, Surrey.
- G3JKT**, J. Huggett, 113 Rosemary Road West, Clacton-on-Sea, Essex.
- G3JYJ**, E. Jackson, 30 Fontaine Road, Streatham, London, S.W.16.
- G3KAA**, L. S. Cutting, 43 Nappsbury Road, Luton, Beds.
- G3KFB**, K. Parkinson, B.E.M., 27 Worseley Road, Immingham, Lincs.
- G3KFC**, F. W. Clasby, 103 Stanley Park, Litherland, Liverpool, 21.
- G3KJW**, P. E. W. Alley, 75 Allport Lane, Bromborough, Cheshire.
- G3KUM**, D. Boddey, 10 Parkside Avenue, Ipswich, Suffolk.
- GW3KZM**, S. J. Bunce (*ex-DL2AE*), G.C.A., R.A.F. Station, Valley, Holyhead, Anglesey.
- G3LZQ**, J. Dunnington, 2 Luton Road, Spring Bank West, Hull, Yorkshire.
- G3MFW**, H. G. Woodhouse, Trenoweth, Porthpean, St. Austell, Cornwall.
- G3NFQ**, J. A. Cawley, Fosse Bank, London Road, Camberley, Surrey.
- G3NUM**, J. S. McKinley, Trio, Pond Park Road, Lisburn, Co. Antrim.
- G5RH**, D. Q. Aldridge (*ex-GM5RH*), c/o I.M.R. Co., Ltd., 49 Oxford Street, Southampton, Hants.

changes or tests. Thirdly, the terminal voltage of 15v. given on the diagram is right for the 5s. "red spots" suggested for TR1, TR2, but may be either too high or too low for other audio types that may be used.

(We acknowledge notes in the *Newsletter* of the Army Wireless Reserve A.R.S., as the basis for this article. —Editor.)

STEREOPHONIC BROADCASTING

A detailed survey of stereophonic broadcasting is given in the latest B.B.C. Engineering monograph, published by the B.B.C. Engineering Division, called *A Summary of the Present Position of Stereophonic Broadcasting*. The monograph discusses the various methods by which stereophonic programmes can be produced for sound recording or broadcasting, with

particular reference to stereophonic reproduction under domestic conditions. The problem of transmitting stereophonic programmes on existing radio-frequency channels, while providing for "compatible" reception on ordinary broadcast receivers, is considered; the principles and potentialities of the main systems so far proposed are discussed. Attention is drawn to the difficulties which would arise in distributing stereophonic programmes to transmitters by line at audio frequency.

This monograph is No. 29 in the B.B.C. Engineering Monograph series and can be obtained, price 5s. post free, from B.B.C. Publications, 35 Marylebone High Street, London, W.1.

Take Care — HT Can Kill

THE OTHER MAN'S STATION

GW3NMQ



THE operator of GW3NMQ, ex-ZC4BC and G3NMQ, is P. J. Crosbie, Royal Signals, who is in the Regular Army, serving with 21 Med. Regt., R.A., now stationed at Rhyl in North Wales.

It was three years ago in Cyprus that the ZC4BC call was obtained, under which 138 countries were worked. The U.K. callsign was issued in July last year, and since being posted to Rhyl in February, more than 100 countries have been worked as GW3NMQ—one of his objectives being to repeat as many as possible of the QSO's he made under the two previous callsigns held; for this GW3NMQ offers a memento, in the shape of a certificate of his own!

The equipment shown here consists of a K.W.

Vanguard transmitter and an Eddystone 840A receiver, with a crystal controlled converter for the 10-15-20 metre bands; a Calibrator No. 10 is also available. The main aerial is a three-band Cubical Quad, with "dipoles handy in case required." The band chiefly used has been 15 metres, but all three HF bands are worked as DX conditions dictate and opportunity offers. GW3NMQ also remarks that his rig is "nearly all commercial for the sake of efficiency." However, he did build the crystal-controlled converter unit—into a mess tin!

GW3NMQ is a keen stamp collector and, on the domestic side, hopes that his two young sons "will grow up to be additional QRM on the DX bands"! Well, good luck to him and to them.

RESULTS OF A CONTEST

While a club Top Band contest might be regarded as a somewhat "parochial affair," that organised by the Grafton Radio Society recently—and given some advance publicity in these columns—produced activity and an entry beyond expectations. The Grafton members leading were G3JVV first, with 132 points on CW and phone, the phone-only winner being G3KGC with 95 points. The open section, for non-members of Grafton, was won by G3ERN, with 48 contacts on CW and 63 on phone; entries were received from GM6RI, DL1FF and HB9QA, as well as from about a dozen G stations. Taking all logs, the total number of different callsigns mentioned was 187, from eight different countries; of these 187 stations, 57 were CW-only, 103 phone-only, and 27 worked both modes. There were 17 Grafton club members on the air for the event, which was exclusively a Top Band affair.

RADIOACTIVE ISOTOPES

To meet the increasing demand for radioactive isotopes and to continue to improve their service to users throughout the world, the U.K. Atomic Energy Authority announce a reorganisation of the isotopes production and marketing which has hitherto been

shared between the Radiochemical Centre at Amersham and the Isotope Division of A.E.R.E., Harwell. It has been decided to widen the scope of the Radiochemical Centre to form a single comprehensive organisation for producing and marketing all such isotopes.

Research into the properties of isotopes and new applications of them and their radiations will be continued by an Isotope Research Division at Harwell and at the Wantage Radiation Laboratories. This division will continue to operate the Isotope School. Both the Radiochemical Centre and the Isotope Research Division will remain part of the Research Group of the Atomic Energy Authority.

COSMIC SPACE SHIP

The latest Russian launching into space, made on May 13 on the eve of the abortive "Summit" attempt in Paris, has been so much written about that there is very little more to say here—except that when the orbit brought it over Northern Europe, it was a very strong signal on 19.995.5 kc. One of the long dashes had a characteristic regular gurgle, like a burst of high speed dots.

THE MONTH WITH THE CLUBS

By "Club Secretary"

(Deadline for July issue : June 10)

(Address all reports for this feature to "Club Secretary")

THE notable similarity of all the Club reports that reach us, month by month, must, it seems, indicate one of two things. Either the procedure at the average Club meeting has, as the result of long experience of these matters, become standardised, or else the Club movement is running out of new ideas.

One thing is certain—that a planned programme of some sort is essential. Most of the Clubs that have sprung up, faltered and faded away (and there has been a surprising number of them) have failed simply because nothing was planned, and the members turned up to meeting after meeting without knowing whether they were in for anything more than just sitting round the table and talking.

Plan your season in advance; circularise the membership with your programme; arrange as many visits as possible—to G.P.O. installations, BBC stations, Fire Brigade Hq. and similar establishments where commercial communication radio is used; and, above all, keep to a *regular* day of the week, or week in the month (because lots of people don't bother to read the notices!). You will then be well on the way to commanding a regular attendance.

News Sheets and Top Band Nets have also proved to be a most valuable means of keeping members together, and also of keeping them *au fait* with Club matters in general. Every Club must be treated, by the Committee, as though it were waiting to fall to pieces if neglected!

Blackburn now have a new Clubroom, at the West View Hotel, Revidge Road. There they meet every Tuesday at 8 p.m. In the autumn they hope to hold a joint Hamfest with the Bury Amateur Radio Society. **Bradford** held their AGM and elected G3MG1 president, G3EKE vice-president, G3NNO secretary, and G3KSS treasurer. Recent meetings have covered the Development of TV, Transistors and a "Top Score" Contest with valuable prizes. On June 14 they visit Holme Moss TV station.

Derby are having Open Nights on June 8 and 22, and "Fun with Tape" on the 15th; this will be a competitive event for members with Tape Recorders,

fellow members acting as judges of the entertainment provided.

Flintshire meet on June 6 for GW3JGA's talk on Audio Amplifiers; their next meeting will be on July 4, when a GPO official will talk on Subscriber Trunk Dialling. On August 14 they will hold a Bucket and Spade Party at Central Beach, Prestatyn. Meetings are now held in the Ffrith Hotel, Ffrith, Prestatyn, at 7.30 p.m.

Hull will be hearing about DX and How to Work It (by G3CSE) on June 14; on the 28th G3FLY will contribute some Notes on Metal Working. At each meeting they hold short sessions with the Club Tx, Junk Sales and raffles of small bits and pieces. Morse practice is also on tap if required. **South Birmingham** have their own mobile rally this week-end (June 4). On June 16 they will be at the Friends' Meeting House for a *post mortem* on the field day and a lecture.

Liverpool will be signing GB2LS at the Prescott Carnival on June 6, with G3HH talking in the mobiles. Meetings are fixed for each Tuesday in June—see "Calendar."

Acton, Brentford & Chiswick will be assembling on June 21 for a talk by G4LS on New Test Gear; and on July 19 to hear G6RC on SSB. Both meetings at 66 High Road, Chiswick, W.4. **Cheltenham** continue to meet on Wednesdays, and having enlarged

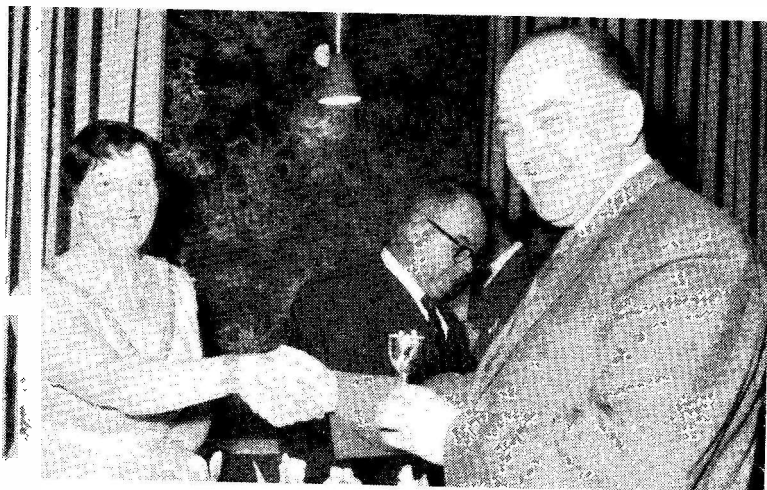

At the thirteenth annual dinner of the Thanet Radio Society, the Mayoress of Ramsgate presented a cup to G3FVV for his mobile Top Band transceiver, which was shown at the Thanet Mobile Rally on May 8.

their clubroom they usually open up from 7 p.m. onwards; they now have twice the previous space. Two SWL's are taking the next R.A.E., but it is hoped that this number will increase in the future. All the necessary instruction, together with Morse practice, is duly laid on.

Greenford will be hearing G4LS on the Antenna-match and other aerial apparatus on June 7; on the 21st G3IZW will give a practical demonstration of TVI-proofing; and on July 5 G3NXX will talk on The QSO and How to Conduct It. Later meetings will include a series of practical demonstrations of fault-finding.

Guildford recently held their AGM, at which the chairman, G3EWE, reviewed the year's activities and made an appeal for more members. After the election of officers the meeting closed with a general discussion. On June 24 they will meet to hear G3NTM talk

Names and Addresses of Club Secretaries reporting in this issue:

ACTON, BRENTFORD & CHISWICK: W. G. Dyer, G3GEH, 188 Gunnersbury Avenue, London, W.3.
 BARNET: D. K. Robinson, 3 Castle Road, London, N.12.
 BLACKBURN: K. Heap, G3NCZ, 138 New Bank Road, Blackburn.
 BRADFORD: M. Powell, G3NNO, 28 Gledhow Avenue, Roundhay, Leeds 8.
 CANNOCK CHASE: P. J. Davis, G3NTU, 45 Broad Street, Bridgtown, Cannock.
 CHELTENHAM: J. H. Moxey, G3MOE, 11 Westbury Road, Leckhampton, Cheltenham.
 CORNISH: W. J. Gilbert, 7 Poltair Road, Penryn.
 CRAWLEY: R. G. B. Vaughan, G3FRV, 9 Hawkins Road, Tilgate, Crawley.
 DERBY: F. C. Ward, G2CVV, 5 Uplands Avenue, Littleover, Derby.
 FLINTSHIRE: J. Thornton Lawrence, GW3JGA, Perranporth, East Avenue, Prestatyn.
 GREENFORD: E. Gray, G3CPS, 111 Ravenor Park Road, Greenford.
 GUILDFORD: S. W. Saddington, G2FXQ, 59 Hamilton Avenue, Pyrford, Woking.
 HALIFAX: A. Robinson, G3MDW, 7 Upper Brockholes, Ogden, Halifax.
 HARROW: S. C. J. Phillips, 131 Belmont Road, Harrow Weald.
 HASTINGS: W. E. Thompson, G3MQT, 8 Coventry Road, St. Leonards-on-Sea.
 HULL: G. G. Wray, G3MVO, 93 Wolfraton Lane, Willerby, Hull.
 INTERNATIONAL HAM-HOP CLUB: M. Allenden, G3LTZ, 16 Grovefields Avenue, Frimley, Aldershot.
 KINGSTON: R. S. Babbs, G3GVU, 28 Grove Lane, Kingston, Surrey.
 LEEDS: D. Dinsdale, 69 Spen Lane, Leeds 16.
 LIVERPOOL: H. James, G3MCN, 448 East Prescott Road, Liverpool.
 LOTHIANS: L. Lumsden, 33 Hillview Drive, Edinburgh 12.
 NORTH KENT: D. W. Wooderson, G3HXK, 75 Mount Road, Bexleyheath.
 PETERBOROUGH: D. Byrne, G3KPO, Jersey House, Eye.
 PLYMOUTH: R. Hooper, 2 Chestnut Road, Peverell, Plymouth.
 PURLEY: E. R. Honeywood, G3GKF, 105 Whytecliffe Road, Purley.
 R.A.I.B.C.: W. E. Harris, G3DPH, 4 Glanville Place, Kesgrave, Ipswich, Suffolk.
 READING: R. G. Nash, G3EJA, 9 Holybrook Road, Reading.
 SOUTH BIRMINGHAM: G. E. Simonite, G3JAO, 19 Wistaria Close, Birmingham 31.
 SOUTHGATE, FINCHLEY & DISTRICT: A. G. Edwards, G3MBL, 244 Ballards Lane, North Finchley, London, N.12.
 SPEN VALLEY: N. Pride, 100 Raikes Lane, Birstall, Leeds.
 STOKE-ON-TRENT: V. J. Reynolds, G3COY, 90 Princes Road, Hartshill, Stoke-on-Trent.
 SURREY (CROYDON): S. A. Morley, G3FWR, 22 Old Farleigh Road, Selsdon, South Croydon.
 SUTTON COLDFIELD: K. H. Varney, G3DMV, 149 Whitehouse Common Road, Sutton Coldfield.
 THANET: J. Barnes, G3BKT, 18 Grange Road, Ramsgate.
 WEST KENT: H. F. Richards, 17 Reynolds Lane, Tunbridge Wells.
 WHIPS: R. Toby, G2CDN M. 13 Wood Lane, Isleworth, Middlesex.

on The History of Radar.

Kingston have a programme which includes such subjects as Propagation, Heathkits, SSB and Mobile Operation. They meet on alternate Thursdays at the YMCA, Eden Street, Kingston, June dates being the 16th and 30th. Morse classes are held weekly, and visitors always welcome.

North Kent will hold their final field day briefing on June 9; on the 23rd they will hold the inquest, together with a Film Show. Both meetings at the Congregational Hall, Bexleyheath.

We note from the *Newsletter* of **Southgate, Finchley & District** that two members have been expelled from the Group for unlicensed operation, which they did not dispute. (Other Clubs please copy, if necessary!) At their May meeting they heard a lecture, illustrated by slides, on the History, Development and Technique of the Avometer. On June 9 G6OT will be talking on Impedance Matching.

Cornish met at the Falmouth YMCA on May 4 and heard some tapes, one made by ZS5JF and one by G3HZV. Discussions covered the diverse subjects of Aerials and the projected Club Dinner next November. **Crawley** will be meeting on June 23 at The Brewery Shades, when their guests will be members of the Thames Valley Club. G3JIP will be giving a talk. Several members took the recent R.A.E. and await results.

Halifax held their AGM and elected G3ADG chairman, G3MDW secretary-treasurer, and Mr. G. Sunter librarian and minute secretary. Starting in September, meetings will be on the first and third Tuesdays. Meanwhile, June 14 is booked for a lecture on Workshop Practice, and June 28 for an informal evening. On July 5 there will be a discussion concerning the Halifax Agricultural Show. Meetings at the Sportsmans Inn, Ogden, 7.30 p.m.

The **International Ham-Hop Club** now has 353 members, 137 of them in Great Britain and Ireland. W0GDH will be on a European "Ham-Hop" by the time this appears. **Peterborough** saw the latest Mullard films on Transistors at their May meeting, at which arrangements were also made for the Mobile

CLUB PUBLICATIONS

We acknowledge, with interest and thanks, the following Club publications: **Derby** (Newsletter No. 2, 1960); **Enfield** and **District** (Vol. 12, No. 1); **Purley** (April Newsletter); **Southgate, Finchley** (April and May Newsletters); **Hastings** ("Natter-Net Notes" No. 7); **North Kent** (Newsletter No. 34); **Mitcham** (May Newsletter); **Surrey** (SRCC Monthly News); **West Kent** ("QLF"); **Crystal Palace** (Newsletter No. 51); **Army Wireless Reserve** Amateur Radio Society ("Broadcast," Spring 1960); **R.A.I.B.C.** ("Radial," Vol. 6, No. 3).

CLUB CALENDAR IN BRIEF

Barnet: June 28, Lecture on Metal Rectifiers.
Liverpool: June 7, Field Day meeting; June 14, 21, Open Nights; June 28, D/F Contest.
Lothians: June 16, AGM.
Spun Valley: July 6, AGM.
Sutton Coldfield: June 9, Talk on Low-level Modulation; June 23, Mobile Night—outdoor exercise.
West Kent: June 24, Informal evening; July 8, Hi-Fi evening; July 22, Two Metres, Part II (G2UJ).

Rally at Hunstanton on July 5.

Reading have met for lectures on Workshop Practice and on the Suppression of Interference (GPO speaker). Some of their SWL's sat for the recent R.A.E., and a party from the Club also attended the Harwell Mobile Rally. Subject for a future lecture Feeder Lines and Matching Devices.

Cannock Chase held a successful Junk Sale and disposed of much reasonable gear at reasonable prices. Membership still grows, and some members travel ten miles or more to attend the meetings. At the next one G3HVY is giving a talk on SSB.

Plymouth held their AGM and elected G5ZT president, G3JYB chairman and Mr. Ron Hooper secretary. Two trophies were presented to member John Fallon for constructional work. Junk sales have proved very popular, especially with the younger members.

Stoke-on-Trent are going in for full-scale re-decoration (made possible by an anonymous gift of all the necessary materials). Morse classes, under G3COY, command a very good attendance; and preparation for NFD and the Boating Rally, a particularly interesting forthcoming event, are both taking up much time.

Surrey (Croydon) held their Constructional Contest, which was won by G3GHI with a two-metre transmitter; G2RD was second, with a frequency

meter, and even an electronic organ was exhibited. Next meeting, June 14 at the Blacksmiths Arms. On June 15 they are running a Motor Rally and Treasure Hunt—mainly social but with "radio connections."

Thanet held a very successful Mobile Rally at Ramsgate on May 8, with about 35 cars attending. There was even a visitor (SM5ATN) from Stockholm.

The **Whips** Radio-Mobile Group invites applications from keen mobileers. Its founder-membership exceeds 100, and many events have been and are being arranged. G3JFH/M gained first award at Trentham, and G6NW/M at Cheltenham. Informal impromptu meetings will be arranged throughout the season. See panel for Hon. Sec's QTH.

Harrow have a talk on Mobile Receivers, by G2TA, on June 17; on the 24th they will hear a recorded lecture, with slides, on The Human Machine as a Radio Operator, by G6CJ. The alternate meetings will be Practical Nights, and Morse tests for beginners will also be held. All meetings 8 p.m. in the Science Lab., Roxeth Manor Secondary School, Eastcote Lane, South Harrow.

Hastings had talks, during May, on Constructional Practices (G3MQT) and Films on Vacuum Practices and Ultrasonics in Industry. G3MQT will be visiting DJ3OD early in June and will describe his trip to Germany on June 14.

HENRI DE FRANCE COLOUR TELEVISION SYSTEM

A unique demonstration was given recently at the I.E.E., when two French authors, MM. R. Chaste and P. Cassagne, described a new system of colour television transmission. Scenes originating in Paris were seen in full colour by a large audience in London, on screens which differed little, if at all, in their external appearance from those of ordinary "black and white" TV receivers. Moreover, the transmitted pictures were compatible, which is very important, because it would provide a means of bridging the gap if a colour service were to be introduced; until a user bought a colour receiver, his existing set would still give him a black-and-white result from the colour transmission.

The demonstration itself was an interesting example of engineering co-operation. Those in the French companies responsible for the development of the system, with the French Posts and Telegraphs, the Radio Television Française, the British Post Office and the B.B.C., together set up a complicated radio link comprising sections of the existing Eurovision network, with additional microwave links of the type used by the B.B.C. As an additional precaution, a video recording was made in London beforehand of the complicated colour signals transmitted from Paris, to be used in the event of there being any breakdown in the radio link between the two capitals. It is satisfactory to report that the recorded version was not in fact required.



A Californian manufacturer has produced an all-transistor crystal controlled receiver intended specifically for the reception of WWV on 2.5, 5, 10, 15, 20 and 25 mc. Sensitivity is given as 2 μ V, with an S-meter for signal comparison at different locations, the receiver being intended for field work by survey and geophysicist teams who require a reliable and portable frequency and time standard.

Read Short Wave Magazine Regularly

What's better than Hi-Fi?

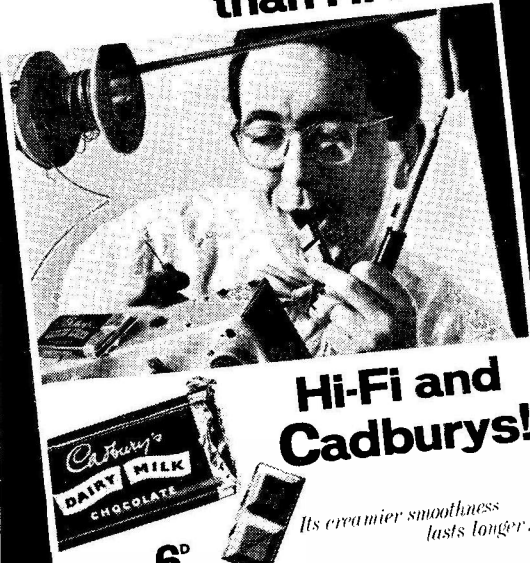

Hi-Fi and Cadburys!

Its creamier smoothness lasts longer!

6^D

Reproduction of CADBURY'S advertisement in the National Press.

What's better than Hi-Fi and Cadburys ?

Hi-Fi, Cadburys and HENLEY *

He's using a HENLEY-SOLON Soldering Iron with HENLEY Cable

**Henley's are now part of the AEI Cable Division*



AEI CABLE DIVISION

Associated Electrical Industries Ltd.
51 - 53 Hatton Garden · London EC1 · Phone CHAncery 6822

*... if you want a phone signal with "a punch" choose a K.W. transmitter you can't beat H.L.M.**

K.W.'s "VICTOR" "VANGUARD" & "VALIANT" employ plate and screen high level modulation. Results prove that low efficiency systems of modulation cannot compare with H.L.M.

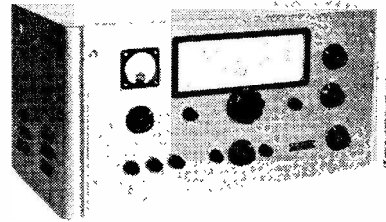

The KW "Viceroy"

(now fitted with A.L.C. if required)

- K.W. "VICTOR" complete 120 watt phone c.w. transmitter. Kit £70. Wired £87.10.0.
 - K.W. "VANGUARD" complete 50 watt transmitter. Kit 10-80m 54 gns. Wired 63 gns. (also 160m models).
 - K.W. "VALIANT" complete transmitter with VFO—add your own power supplies, mobile or fixed. Kit 10-80m £32.10.0. Wired £40.10.0 (also 160m models).
 - K.W. "VALIANT" c.w. only transmitter.
 - K.W. "VALIANT" A.C. Power Supply.
 - K.W. "VICEROY" SSB transmitter (world wide acclaim already).
 - K.W. SSB Filter Exciter (available shortly).
- (Victors, Vanguards & Valiants usually available ex stock.)

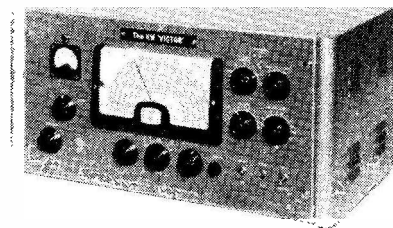

The KW "Victor"

RECEIVERS

GELOSO G209-R for CW-SSB-AM. HALLICRAFTERS SX100, SX101, SX110, etc. KW76 MOBILE. NATIONAL NC303, HAMMARLUND HQ170, etc.

AERIALS and BEAMS

MOSLEY Tribanders, GM3BQA Quad, 8KW Multiband Dipole with traps. New! The K.W. Junior Dipole, 56ft. top, complete ready to erect with 75ft. low loss co-ax, £7.5.0, with 97ft., £7.15.0. K.W. Match. SWR Bridge, £6.15.0—Low and High Pass filters. Have you tried the 8KW as a "V" Beam?—legs 45-90° apart, it really works

MICROPHONES

ELECTRO-VOICE (USA) Cardioid Ceramic Microphones—stick mic with heavy base for table, £7.10.0. GELOSO Hand/Lapel xtal, £2.2.0; Table Model, 4; gns.

*** High Level Modulation**

Send S.A.E. for details. Easy terms available on most of the above items.

K. W. ELECTRONICS LTD
Vanguard Works, 1 Heath Street, Dartford, Kent.
Tel.: Dartford 25574

G4GZ's BARGAINS

VALVES: EA50, EF50, 1/6. 6H6M, EB34, 6K7G, 2/-, 2X2, 6AG5, 6B8G, 6F32, 12SC7M, EF36, EF50(S), 2/6. 6AL5, 6AM6, ARP12, EAC91, EB91, EF91, EL32, TT11, VP23, Z77, 3/-, 1L4, 6C4, 6J6, EF39, 3/6. 6AC7M, 6AK5, 6SN7GT, 1626, 1629, DC70, DF73, DL70, 4/-, 6J5GT, EBC33, 4/6. 1T4, 6J5M, 6K8G, 6ST7M, 12A6M, 12K7G, 12Q7G, 12SJ7M, 12SK7M, 35Z4G, 959, 5/-, 3Q4, 6BH6, 6BJ6, 6F6M, 6Q7G, 6SJ7M, 6SL7GT, 6X4, ECC82, 12AU7, 5/6. 1R5, 1S5, 6AU6, 6BA6, 6BE6, 6SA7M, 6/-, 6X5G, 12AT7, 12AX7, 80, ECC83, GTIC, KT33C, PY80, 6/6. 6L6G, 12AT6, 7/-, 354, 6V6G, 12AU6, 12BE6, 12C8M, 42, EF80, EZ81, PY83, PCF82, VR150/30, 7/6. EL41, ECH42, 8/-, 5R4GY, 6A05, 6BW6, 12SQ7M, 35Z5GT, 830B, 8/6. 3A5, 6K8M, 6L6M, PCC85, 9/-, 50L6GT, EM80, 9/6. 12K8M, DET24, EABC80, EC80, EF86, GZ32, VLS631, 10/-, 446A, ECL80, 10/6. HK24G, 25/-, 811, 805, 30/-, 3E29(829B) 35/-, 4E27, 40/-, Post/Packing 6d. per valve, Free over £2.

MC METERS: 3 1/2" rd.fl. 0-500m/a., 0-2A., 0-30m/a, 0-15v. AC (MI Cal at 50cps) 15/- each, 2 1/2" rd.fl. 0-1m/a. 22/6. 2" sq.fl. 0-500m/a. RF TC., 11/6.

PARMEKO TRANSFORMERS. New Boxed, 200-250v. input. 750-630-0-630-750v. 96m/a. (OK for 140m/a.) 6.3v. 2a., 4v. CT 3a., £1 each. 620-550-375-0-375-550-620v. 250m/a. 5v. 3a. twice. 42/6. ET4336 trans. 190-250v. input. 10v. 10a. CT. 2 1/2v. 10a. CT twice, 28/6 each. 230v. input. 32, 34, 36v. 2a., 18/6 each. 200-250v. input. 1840v. 4m/a., 28/6. BC906D freq. meter 145-235m/cs., 32/6. Oscillator 37's used 35/-, Resistance Unit 231 (12, 50 watt 80 ohm carbon res.) 15/-, RF Amplifier AM33/ART New Boxed, £4/17/6. AR88 chokes (10H 100m/a.) 3 for 18/6, Xcals Octal 4.6m/cs. USA 2 pin 6159, 6181, 6203/cs., 6 for 7/6. Three pin USA 100k/cs., 17/6. B9A Moulded V/hldr. screens, 11/6 doz. Micalc ditto, 13/6 doz. 12V 4 pin UX vibrators, 3/- each, 22/6 doz., £6/10/0 per 100. AR88 W/change assemblies, 15/- each. National Velvet Vernier dials, 11/6 each. Four gang HRO tuning gangs, 37/6. Midget 3 gang 55 55 35 pfd., 3/- each, £3/10/0 box of 50. Pyranol 10mfd, 2,000v. oil-filled 25/-, Johnson 3,500v. spacing, .0005 variables, 28/6 each. Midget 2 gang .0005, 5/-, All these items carriage paid UK mainland. See previous advts. for fuller descriptions of some items.

JOHN ANGLIN

385, CLEETHORPE ROAD, GRIMSBY, LINCS. Tel. 56315

PETER SEYMOUR

FOR COMMUNICATIONS EQUIPMENT

	£.	s.	d.
GELOSO G207DR as new	40	0	0
GELOSO G210TR matching transmitter for above receiver	27	10	0
ZCI Mk II L.9-8 Mc/s. 12 volt input phone/cw Tx./Rx.	10	0	0
PANDA PR120V Tx. in new condition, 120W phone 150 CW, 200-250 AC input	65	0	0
EDDYSTONE S640 1.7-30 Mc/s. 230 AC input	20	0	0
EDDYSTONE S750 480 Kc.-32 Mc/s. 230 AC input	45	0	0
EDDYSTONE 358X brand new with 10 coils 40 Kc.-30 Mc/s.	15	0	0
MARCONI CR100/7 60 Kc.-30 Mc/s. with noise limiter	18	10	0
MARCONI CR300 15 Kc.-25 Mc/s.	15	0	0
DST 100 Mk II as brand new, 50 Kc.-30 Mc/s.	25	0	0
COLLINS TSC12 1.5-12 Mc/s. with power unit for 230 AC	8	10	0
R174 mobile receivers. Input 12, 6, 24 DC or 115 AC 1.5-18 Mc/s.	25	0	0
LIGHTWEIGHT HIGH IMPEDANCE HEADPHONES NOT EX-GOV.	14	0	0
POWER SELSYNS 230 AC input suitable for light beam rotators	2	10	0
AR88 mains transformers	30	0	0
HRO IF transformers, brand new	15	0	0
COLLINS BFO transformers 450-470 Kcs. with trimmer	5	0	0

URGENTLY REQUIRED GOOD QUALITY RECEIVERS. PART EXCHANGES CALLERS WELCOME ANYTIME. EXPORT ENQUIRIES

410 BEVERLEY ROAD, HULL, YORKS

Tel.: Hull Central 41938

The MINIMITTER MR44 COMMUNICATIONS RECEIVER

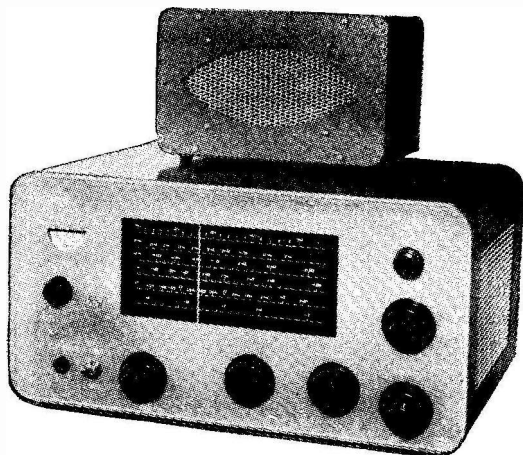

Complete Bandspread on 6 Amateur Bands — 11 Tubes — A.M. — C.W. — S.S.B. Double Superhet — Half Lattice Crystal Filter — Crystal Controlled Oscillator. "Q Multiplier" — "S" Meter — Audio A.V.C. for S.S.B. — Modern Styling. Price: £55. 0. 0. The Famous Minimitter Converters — The "Amateur Band" Price: £17. 0. 0. The MCB (8 Band) Price: £20. 0. 0.

Our 1960 Range of Mobile Equipment is now in production The G4ZU "Minibeam 10/15." Price £16. Telescopic Mast, £10. The 'Birdcage' is coming. A revolutionary new rotary beam aerial

For full details, please send SAE to

The MINIMITTER Co. Ltd.

37 DOLLIS HILL AVENUE, LONDON, N.W.2. Tel. PAD 2160

SOUTHERN RADIO'S WIRELESS BARGAINS

ATTACHMENTS for "18" Transceivers. ALL BRAND NEW. HEADPHONES, 15/6; HAND MICROPHONE, 12/6; AERIALS, 5/-; SET OF 6 VALVES, 30/-.

CONDENSERS. 100 Assorted. Mica, Tubular, etc. 15/-

CONTACTOR TIME SWITCHES. 2 Impulses per sec. in case 11/6

REMOTE CONTACTOR. For use with above 7/6

LUFBRA HOLE CUTTERS. Adjustable 1/2" to 3 1/2". For Metal, Plastic, etc. 7/-

MAGNETS. Strong Bar Type, 2" x 1/2" 1/6 each

MORSE TAPPERS. Midget type, 2/9; Standard, 3/6; Heavy type on base, 5/6. ALL BRAND NEW.

PACKARD-BELL AMPLIFIERS. Complete BRAND NEW with valves; relay, etc., etc. 17/6 each

QUARTZ CRYSTALS. Types F.T.241 and F.T.243, 2-pin, 1/2" Spacing. Frequencies between 5675 Kcs. and 8650 Kcs. (F.T.243) 20 Mcs. and 38.8 Mcs. (F.T.241, 54th Harmonic), 4/- each. ALL BRAND NEW. TWELVE ASSORTED CRYSTALS, 45/-, Holders for both types 1/- each. Customers ordering 12 crystals can be supplied with lists of Frequencies available for their choice.

QUARTZ CRYSTAL CASES (F.T.241/243) ... per dozen 10/6

RECORDING BLANKS. Brand new "Emidisc" ready for cutting. 13" 6/- each. 15 in metal case, £4.

RESISTANCES. 100 Assorted useful values. New wire end 12/6

SPECIAL OFFER. 12 ASSORTED METERS. Slightly damaged. Mainly broken cases (perfect movements). Including 3 Brand New Aircraft Instruments ... 12 for 45/-

STAR IDENTIFIERS. Type I A-N Covers both Hemispheres 5/6

TI154 TRANSMITTERS. Complete in transit case. New condition £2/5/-

TRANSPARENT MAP CASES, Plastic, 14" x 10 1/2". Ideal for Maps, Display, etc. 5/6

TRANSCEIVERS. Type "38" complete with 5 valves, etc. New condition untested by us but serviceable, no guarantee 22/6 each

ATTACHMENTS for Type "38" Transceivers. ALL BRAND NEW. PHONES, 15/6; THROAT MICROPHONES, 4/6; JUNCTION BOXES, 2/6; AERIALS, No. 1, 2/6, No. 2, 5/-; WEBBING, 4/-; HAVERSACKS, 5/-; VALVES, A.R.P. 12, 4/6; A.T.P. 4, 3/6. Set of FIVE VALVES, 19/- the set.

Post or Carriage Extra. Full List of Radio Books, etc., 3d.

SOUTHERN RADIO SUPPLY LTD

11 LITTLE NEWPORT ST., LONDON, W.C.2. GER 6653

SMALL ADVERTISEMENTS

("SITUATIONS" AND "TRADE")

9d. per word, minimum charge 12/-. No series discount; all charges payable with order. Insertions of radio interest only accepted. Add 25% for Bold Face (Heavy Type). No responsibility accepted for errors. Replies to Box Numbers should be addressed to The Short Wave Magazine, 55 Victoria Street, S.W.1.

SITUATIONS VACANT

DO YOU WANT an interesting, permanent position in the test or inspection departments of an industrial electronic instrument manufacturer; oscilloscopes, pulse generators, etc.; 40-hour, 5-day week?—Nagard, Ltd., 18 Avenue Road, Belmont, Surrey.

"LICENSED" Radio Engineers and Mechanics required for aircraft maintenance and installation work in U.K. —Apply: Chief Engineer, Dan-Air Engineering, Ltd., Lasham Airfield, Nr. Alton, Hants. (Telephone HERRIARD 282/3.)

TRADE

GRIP-DIP METERS, 1.8 to 210 mc. compact, self-contained, complete, 6-coil stand, batteries; 10 guineas, plus 2s. 6d. p.p. 2d. stamp for full details.—Elliott Electronics, 3 Sandgate Avenue, Tilehurst, Reading, Berks.

MAGNIFICENT Stereophonic Tape Reproducers, studio models and small types, for sale, in handsome walnut cabinets.—Ring B1S 1848.

SHORT WAVE RECEIVERS AND KITS from 19s. 6d. Valves, components, books, service sheets; Lists 3d.—Hamilton Radio(s), 237 Sedlescombe Road N., Hastings, Sussex.

ORDER YOUR "COMMUNICATOR" now for the 1960 mobile season. This unique 16-valve 2-metre Tx/Rx is at present available from stock. Price £90 with 12-volt transistor power unit. Deposit £9, and 12 monthly payments of £7 7s.—R.E.E. Telecommunications Ltd., 15a Market Square, Crewkerne, Somerset.

QSL'S and Logs by Minerva. The best there are.—Samples from Minerva Press, 2 New Road, Brentwood, Essex.

WANTED FOR CASH: Good clean communication receivers and SSB equipment. Please state price.—Short Wave (Hull) Radio, 30/32 Princes Ave., Hull. (Tel. 18953.)

QSL CARDS AND LOG BOOKS, G.P.O. APPROVED. CHEAPEST, BEST, PROMPT DELIVERY. SAMPLES. — ATKINSON BROS., PRINTERS, LOOE, CORNWALL.

EDDYSTONE 888A, with matching speaker; new January, 1960; still in makers' packing; £95. Collins 75A-1, with matching speaker and handbook, excellent condition, £110. Panda Cub, new condition, used only a few hours, £35. Minimitter Converter, 230v. AC or 12v. DC, £12 10s. Electronic Keyer with AC power supply and Eddystone bug key, £5. Army 88 Transceivers, £5 pair. ET-4336 Crystal Multiplier, £1 10s. New Parmeko heater transformers, 7s. 6d.; 3v. windings, £1 10s. Coax relays, 12-24v. DC, 10s.; 811's, 10s.; 832A's, 7s. 6d.; 829B's, £1. All carriage paid. — GM3BQA, 19 Edinburgh Road, Cockenzie, East Lothian.

Make no mistake . . . Morse is still the most important factor for the Radio Operator

The great advantage of The Candler System of MORSE TRAINING is that all the apparatus you need is your Short Wave Receiver and a simple Morse Key and Buzzer or Oscillator. No expensive Records and Players or miles of tape and costly Recorders—just the simple gear you will always be using in your Station.

Most important of all, you listen and learn from "LIVE" traffic—The Real Thing. That is why CANDLER has been teaching Morse Operators successfully all over the world for nearly 50 years.

And don't forget, you do not require a partner, you practise at home when you like and how you like and if you wish you can pay as you learn.

Write now enclosing 3d. stamp for Candler "Book of Facts" and particulars of Courses and plans of payment—without any obligation.

CANDLER SYSTEM CO.

(Dept. 55) 52b ABINGDON ROAD · LONDON · W.8

Candler System Company, Denver, Colorado, U.S.A.

INTERNATIONAL AERADIO LIMITED

require

INSTALLATION MECHANICS

Staff will be based at the Engineering Division of the Company, address below, but their main duties will be carried out overseas for varying periods installing telecommunications equipment for aviation use.

Applications will be particularly welcome from ex-R.A.F. personnel with the trade of Ground Wireless Fitter or ex-Royal Signals personnel with the trade of Instrument Mechanic.

Posts are permanent and pensionable and whilst overseas a generous allowance is paid.

APPLICATIONS TO THE PERSONNEL OFFICER,

INTERNATIONAL AERADIO LIMITED,
HAYES ROAD, SOUTHALL, MIDDLESEX

P.O. RACKS, standard pattern, 5ft. high, 70/- (10/-); de-luxe heavy pattern with channel sides drilled and capped 36in. high, 50/- (10/-), 72in. high, 90/- (12/6). **TAYLOR 10B EST SETS** only 63/- (5/-). **MILLIAMMETERS** 2½in. 0/1, 20/- (2/6); 0/30 or 0/100, 12/6 (2/6). **R.C.A. MODULATION DRIVER TRANSFORMERS** for ET. 4332, 15/- (3/6). **R.C.A. FILAMENT** ditto 190/260v. to 10v. 3.25A CT twice, 15/- (3/6). **85 WATT WODEN Modulation**, 42/6 (5/-). **200 WATT MARCONI** ditto 62/6 (7/6). **AMERICAN AUTO CIRCUIT BREAKERS**, re-settable 10, 15, 25, 35 amps, all 5/- (1/6). **MOTOROLA POLICE CAR TRANSMITTERS** 3½. Mc/s. F.M. 6v. input, 10 valves, 30 watts, £12/10/- (12/6). **BC-659J TRANSMITTER RECEIVERS** less valves only 35/- (10/-). **PLESSEY 6 FT. TRANSMITTER CABINETS** open front for standard 19in. panels, full length rear door with latch, ventilated top and sides, £4/10/- (20/-). **50 WATT POWER AMPLIFIERS**, rack mounting (less valves) 35/- (30 - includes 15/- returnable case). **40-IN. MOBILE WHIP AERIALS**, one piece, with loading coil base effectively increasing length to 12ft. American super finish, 35/- (5/-). **AMPLIFIERS AMERICAN**, 40/250 ohms input, 300 and 2,000 ohms output with 2-1215 and 2-12A6; 28v. input with dynamotor, 9in. x 5in. x 5in., 20/- (5/-). **1000v. 500 m/a POWER SUPPLY** from 230v. AC, £10 (20/-). **COLLINS HIGH-VOLTAGE AERIAL KNIFE SWITCHES** on 4½in. stand-off insulators on 5in. x 2in. base. SPST, 7/6 (2/6). **BENDIX FILAMENT TRANSFORMERS**, 230v. to 6.3v. 3a. C.T. 3 times and 6.3v. 1.3a. once, capable large overload, 20/- (3/6). **CHOKES, RELAYS AND TRANSFORMERS**. Hundreds of different types in stock—send for lists. **TELEPRINTER EQUIPMENT, RECTIFIERS AND CONVERTERS** for operating from Receivers. Lists available. **NEW AMERICAN TRYLON LATTICE LADDER TOWERS**, 50ft. high, with everything ready to erect. £60 carriage paid, England and Wales.

Send for 40 page list of over 1,000 different items

Amounts in brackets are carriage England and Wales.

We have large quantities of "bits and pieces," and can probably help your needs. Please enquire—everyone answered.

P. HARRIS

ORGANFORD

DORSET

HOME RADIO OF MITCHAM

WE ARE PLEASED TO ANNOUNCE

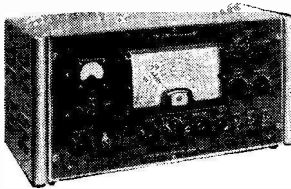

that we are now stocking and demonstrating the KW Electronics "VAN-GUARD" and "VAL-IANT" Transmitters and other items of Ham equipment. Our Mr. E. Jones (G3NQE) is available to assist you. Our special export department can arrange shipping to any part of the world and quote rates on request.

EDDYSTONE RECEIVERS & COMPONENTS

We carry the full range of EDDYSTONE Short Wave Components and can offer early delivery in rotation on all receivers. Some are available ex-stock, please send us your requirements. Special priority for export orders, and shipping rates, quoted on request, including export packing and full insurance.

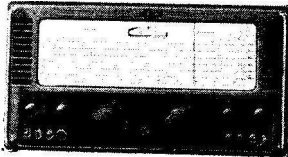

SPECIAL ITEMS. 52 ohm low loss coaxial, 1/6 yd., 14 swg copper wire enamelled, 5d. yd. Mosley vertical antennas, £7/10/-. Pyrex aerial insulators, 2/9. Aerialite model 81 doublet, 35/-. Cadenza crystal microphone, £3/13/6.

EXCLUSIVE COMPONENT CATALOGUE

128 pages and over 4,000 items with hundreds of illustrations. Available only from us. PRICE 2/- post 9d.

Dept. S, 187, LONDON ROAD, MITCHAM, SURREY.
Shop Hours: 9—6.30 p.m. (Weds. 1 p.m.) MIT. 3282

SMALL ADVERTISEMENTS. TRADE—continued

"TELECOMM" Transistorised Power Units for 12-volt Mobiles; 40w. 300v., £15; 70w. 400v., £18; 100w. 500v., £20.—R.E.E. Telecommunications, Ltd., Crewkerne, Somerset.

75 CONDENSERS, electrolytics, tubular, mica, visconal, all new, 10s.; 10 valves, receiving and transmitting (mixed), 10s.; instrument knobs, 1½in. dia., 4 for 2s. Add 1s. postage and packing.—Sound Vision, Anchor Street, Chelmsford.

READERS' ADVERTISEMENTS

3d. per word, min. charge 5/-, payable with order. Please write clearly, using full punctuation and recognised abbreviations. No responsibility accepted for transcription errors. Box Numbers 1/6 extra. Replies to Box Numbers should be addressed to The Short Wave Magazine, 55 Victoria Street, S.W.1.

EDDYSTONE 840A for sale, little used, in excellent condition, £35.—Ingham, 14a, Oxenholme Road, Kendal, Westmorland.

COLLINS 511-4 Communications Receiver. 30 wavebands, 18 valves, crystal controlled, crystal calibrator; recently overhauled and aligned at Collins Radio Works; in new condition. To be collected in London. Offers over £160.—Box No. 2273, Short Wave Magazine, Ltd., 55 Victoria Street, London, S.W.1.

DX40U Transmitter, £25; VFIU VFO, £7 10s.; Cossor 1045K Oscilloscope, £25; AVO Wide Range Signal Generator, £16 10s. All with manuals.—Cawley, Fosse Bank, London Road, Camberley, Surrey.

SELL: 580v. at 200 mA Transformer, 15s.; VCR 97 with mu-metal screen, 10s.; 20H 300 mA choke, 10s.; R1155 with built-in PSU, wkg., but needs attention, 45s., carriage extra. WANTED: September and August 1958 QST, two Johnson Type 500-E20, or similar variables, for Z-Match.—G3NXC, 178 Clay Lane, Birmingham, 26.

SALE, as new: Panda PR120V, £70. Tiger TR200, £125. Eddystone 888, £75. K.W. 2m. mobile Tx/Rx, £60. Pye PTC351D, 60 watts RF on 2m., cost £200, £100. ASB-8, £5. All above in mint condition; used few hours only. Pye PTC704, 15 watts RF on 2m., cost £120, £50. Tannoy 60-watt PA, Amplifier AB24/AC/60X, cost £84, £30. BC625A, £5. New guaranteed valves: QQVO6-40A, £3; 813, £3; 832, 30s.; 866A, 20s.; HK254, 30s.; QVO4-7, 25s.; 100T, 50T, RK20, RK28, 836, all 20s. A number of ½ and 1 kW tuning condensers, mod-xformers, HT xformers, etc. Offers considered.—W. G. Sherratt, 82, High Street, Newport, Isle of Wight (Telephone 3358.)

EF50's, new, in box, 2s., p/p 6d. GU20's, new, in box, £1, p/p 2s. BC-906D Frequency Meter, £1 10s. S. R. Walker, 34, Humberstone Road, Grimsby, Lines.

MOBILE Tx, 160 to 10 metres, built by G3ATL; cost £50, new; not used domestic QRM; highest offer from £25; first come. Tiger TR-300 Tx, purchased last year, very little used, cost £200, sell £150; TVI- and BCI-proof; real snip. Cossor Double Beam Oscilloscope, Model 1052, as new, with voltage calibrator Model 1433; offers?—E. J. James, Brooklands, Merthyr Tydfil, Glam.

SMALL ADVERTISEMENTS, READERS—continued

EXCHANGE: R.M.E.-69, plus D.B.-20 Preselector, in good condition, for AR77E, Eddystone 750, HRO Senior with B/S Coils, or Super-Pro; must be in good condx. - The Advertiser, Little Western, Duffield Road, Woodley, Berks.

COMPLETE STATION Panda Cub, CR100. Class-D Wavemeter, low-pass filter, key, mic., phones, The Lot, £46. - Roberts, 20 Gardener's Street, Dunfermline.

AVO VALVE TESTER, as new, £7. Command Receivers, Top Band (12v.), 55s.; 3-6 mc, 20s.; Grundig 500-L tape recorder (7½in.), £27; BC-610 rack power unit, PN-12A, 800-400 and 300v. at 450 mA, £6 10s.; Telefunken transmitting valves, RL-12P35 (3), 17s. 6d. each; R.T.C. Sig.-Gen., 120 kc to 75 mc, working, needs slight attention, 30s.-Spragg, 29 Rotherfield Road, Carshalton, Surrey.

FOR SALE: Power Supply using popular 620v. tapped transformer, swinging choke input, accept 59s. 6d. Deliver London. -- Box No. 2274, Short Wave Magazine, Ltd., 55 Victoria Street, London, S.W.1.

EX-G4WA, AR77E, £28; Tx Power Unit, 700v., £4. Modulator power unit, £2 15s. Modulator 50 watts, £4. T.1154B Tx, £1 5s., with PT15's, TU5B mod. for 160m., £3. 10in. L.S. £2. All o.n.o. Buyer collects.—M. Bird, Henrietta Road, Bath.

CRYSTALS for Two-Metre (and other) converters, and transmitters, ½in. Pin spacing: 9179-2, 16181-8, 12920-8, 14254-1, 14312-5, 14345-8, 10717-8, 14333-3, 14483-3, 14366-6, 10641-1, 11028-1, 12666-6, 92191-4, 10052-9, 10725-0, 11084-3. Ditto B7G: 12137-5, 14279-1, 11387-5, 12162-5, 10554-1, 14877-5, 13529-1 (all gold plated).—Jeapes, 165 Cambridge Road, Great Shelford, Cambridge.

FOR SALE: R208, £5; RA-10-DB Rx, 150 kc-10 mc, 240v. AC, £4. Both receivers in excellent condition.—D. Girling, 82 Louis Street, Kirkdale, Liverpool, 5.

WANTED: CR100, electrically complete but otherwise condition not important. Selling: R1155A N type drive, with built-in power pack, output stage, speaker and S-meter, £6.—A. King, Angel Hotel, Cardigan.

TOWER STEEL LATTICE, 30ft. top 10ft. telescopic 8 ins., parallel sides painted grey, £13.—J. M. Woodroffe, 16 Fulmer Way, W. Ealing, London, W.13.

COMMUNICATOR 2-metre mobile Tx/Rx; also 4-metre model; cost £85 each; accept £65 each, or £120 the two, as new. Communicator Top-Band mobile Tx/Rx, 9-valve, £40. All above with small 12-volt rotary converters. Minimitter transistor power supply, 12 volts in, 250v, 110 mA out, excellent condition, £5.—Box No. 2275, Short Wave Magazine, Ltd., 55 Victoria Street, London, S.W.1.

PAIR of "88" walkie-talkies, all accessories, £7 10s. 19 Set, complete, except PU, £4 (carriage extra).—43 Mill Lane, Hazel Grove, Cheshire, (Poynton 3228.)

FOR SALE: Panda Cub with chrome handles, excellent condition, £30 or nearest offer. — R. Hurst, G3JJU, 36a Westboro, Wimborne, Dorset.

WANTED: 150-watt, low-pass filter suitable for insertion into 100-ohm twin feeder.—G3IBT, 11 Ridge Street, Primrose Hill, Huddersfield, Yorks.



Safety first every time with these patented spring-loaded AVO Prodclips.

Cleverly designed for use as insulated prods, they are invaluable for reaching and holding test points which are difficult of access.

Suitable for use with AvoMeter, Multiminor and Avo Electronic Test Meter Leads.

post free 15/- per pair

AVO LTD AVOCET HOUSE,
92-96 VAUXHALL BRIDGE ROAD, LONDON S.W.1
VICtoria 3404 (12 Lines).

A MEMBER OF THE METAL INDUSTRIES GROUP OF COMPANIES
PC2

THE
SPOT

G3EKX
DERBY Tel. 41361

THE
SPOT

Full range of Eddystone receivers, new and reconditioned. Always 20 or more American and British Rx's to choose from. PART EXCHANGES. We regret (receivers) Callers Only.

BIRKETT'S BETTER BEAMS. 2 metre 5 element W.S. Yagi, with 2½" adjustable clamp. Latest 1960 version, 45/-, plus 3/- P.P.

Phasing lines for stacking, 2-BBB's, 17/6 each, 2/- P.P.

2 METRE 16 Ele. stack. Complete kit, 9 gns., with coax.

ALLOY TUBING. Sent anywhere in Br. Isles, any length up to 12', any quantity: ¾", 8d.; 1", 11d.; 1½", 1/1; 1", 1/6, per foot. Alloy masts 10' x 1½", 30/- each, 3/6 P.P. 14' x 2", 63/9 each, 7/6 P.P. 16' x 2", 75/- each, 7/6 P.P. 2" Alloy Mast Couplers, 8/6, plus 2/- P.P. Guy Clamps, 4/9 each, 1/6 P.P.

BAMBOO POLES, 8' x 1".

Eight for a Quad !! or 3/- each, carriage on one pole, 2/-; carriage on eight, 7/6.

80 ohm COAX, 4½d. yd., heavy quality, extra low loss super-coax, 1/6 yd. plus P.P. 300 ohm ribbon, 6d. yd.; 80 ohm flat twin, 6d. yd., 12½" 3-section whips, 8/6 and 2/6 carriage. Rubber bases, 5/- and 2/- P.P. Solid bases, 2/9 each.

PAIR 6L6 METALS, 12/6 pair, 1/6 P.P.

2 Metre Field Strength Meters, whip and meter, etc., 39/6 each, 3/6 P.P.

MINIMITTER TX, good condition, £56.

GELOSO V.F.O.'s and FRONT ENDS. Mikes, etc., etc. Flexible, unbreakable, clip-fixing, 4" **CAR RADIO AERIALS**, no holes needed. Ideal for Transistor sets, etc., 28/- each, 2/- carriage.

NIFE CELLS, 2/6 each, 1/6 each, P.P.

12 volt VIB UNITS, 250v. 80 M/A out. 19/6 each, 3/6 P.P.

813's **VALVES** new boxed, 50/- each, post free.

PYREX INSULATOR, ribbed, 1/- each, 6d. P.P. each.

NORMAN BIRKETT LTD
THE SPOT, 26 OSMASTON ROAD, DERBY

G. W. M. RADIO

MOBILE EQUIPMENT

Ex-Police Car Radio-Telephone.

TRANSMITTER, P.A. Chassis. QVO4-7, QQVO7-40, 12 volt aerial relay, 30/-, post 2/6. Rotary transformer 12 volts in 300 volts, 215 mA. out (intermittent) with four heavy duty relays, 15/-, post 2/6. Modulation transformer, push-pull 6V6 to TT12 or QQVO7-40, suit almost any 10 watt tetrode, 5/-, post 1/-. Valves all used, QQVO7-40 (829B), 10/-, TT12, 6/-, EF91, 1/-, all post 6d.

RECEIVERS, Eddystone 358. New delivery of this popular receiver. 45 kc/s.—30 mc/s. Bandwidth switched normal or Crystal Filter. A.V.C., A.N.I., B.F.O., etc. Complete with 230 A.C. power pack and 10 coils, £14/10/- carriage £1. Aerial tested before despatch.
CABLE INSULATION TEST SETS, up to 6,000 volts D.C., 230 A.C. pack, neat portable case, £5, carriage 5/-.
COSSOR 339 Scopes, last few, £10, carriage free.
CR100 Receivers, aerial tested, £17/10/-, carriage £1.
CR15T rotary power unit, 10/-, carriage 6/-.
ADMIRALTY sound powered telephone, no batteries needed just connect with two wires, 30/-, post 4/-.
CAPACITORS, 4uf 600 volt, paper, 1/-, post 6d., ditto 400 and 250 volt, 6d., post 6d. Free postage on lots of 12. 0.1uf 350 volt Sprague tubular 6d. Post free.

BARGAIN PRICE VALVES. Ex-equipment, heaters tested, replaced free if faulty. (Very few dud's so far.) Post 6d. each.

6V6G ...	3/6	6K7G ...	1/9
6K8G ...	3/6	6B8G ...	1/9
870 ...	3/6	NEW 12AU7	4/6
		EB91 ...	2/6

All equipment offered is complete but not tested unless otherwise stated.
 Terms: Cash with order. Early closing Wednesday

**40-42 PORTLAND ROAD
 WORTHING - SUSSEX**

HUNDREDS OF BARGAINS FOR CALLERS

BROOKES Crystals

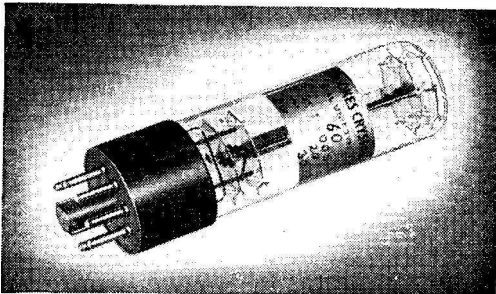

mean DEPENDABLE frequency control

● Illustrated above is a Type OB Crystal unit with a frequency range of 50-110 kc/s. Frequency Tolerance $\pm .005\%$ of nominal at 20°C.

ALL Brook's Crystals are made to exacting standards and close tolerances. They are available with a variety of bases and in a wide range of frequencies. There is a Brook's Crystal to suit your purpose let us have your enquiry now.



Brookes Crystals Ltd

Suppliers to Ministry of Supply, Home Office, BBC, etc
LASSELL STREET, GREENWICH, S.E.10
 Tel. GRGreenwich 1828 Grams: Xtals London, S.E.10

SMALL ADVERTISEMENTS, READERS—continued

FOR SALE: BC-348 receiver, complete with mains power pack, £20. Philips Tape Recorder, £45. Mains Transformer, 620-550-375-0-375-550-620v. 200 mA on 620v. at 550v. taps; also two 5v. 3A taps, 30s. 40m. Command transmitter, ready to go on the air, less power pack, 30s. Rotary transformers, 500v. and 250v., 10s. each.—Cpl. Jack, 21st Med. Regt., R.A., Rhyl. N. Wales.

JOHNSON VIKING VALIANT Tx. factory wired, J as new, with Johnson Matchbox, 200w. AM., £220; consider Eddystone 888A in part-exchange. Lancs.—Box No. 2276, Short Wave Magazine, Ltd., 55 Victoria Street, London, S.W.1.

R107 with manual, £9. HRO-Mx 9 GC coils, power pack, speaker, matching case, manual, £20. Both excellent condition.—Carver, 7 Ethelbert Road, Folkestone, Kent.

AR88 RECEIVER. £35; Eddystone 358X, £16 10s.; S-36, £30; Collins TCS speaker, 15s.; s.a.e. list.—R. V. Wright, 4a Nepal Avenue, Atherton, Manchester.

ALL NEW, UNUSED: W66 Wavemeter, 3000-15000 kc. 15s.; A.M. Morse Practice Set, 7s. 6d.; 6V6, VR105, 76, KTZ63, 6C6, 6D6, 6C4, at 5s.; 6L6, 6K8, 6K8G, 6B7, 42, 6AG7, 6BC7, 6BQ7, KT8C, at 7s. 6d.; 955, 3s. 6d. M/c meters 0/100, 0/200, 0/500, 0/50 mA at 5s. each. Please add postage; s.a.e. enquiries.—G8UO, 12 Cartmel Road, Keighley.

WANTED: Commercial Audio Oscillator (Heathkit considered), also commercial signal generator.—Price and full particulars to: Williams, 46 Regent Street, Stirchley, Birmingham, 30.

G4ZU Three-band Mini-beam with latest coax-fed radiator and twin boom; best offer over £12 secures. **FOR SALE:** Philips QB3/300 (4-125A), £1. **WANTED:** 4X150A; your price paid.—GW3LFM, 20 North Drive, Rhyl, Flints. (Tel. 1063).

R X, Q/Max 5/10, 1-1-30 mc. £12. Minimitter Amateur Band Converter, £12. Or £20 both.—Box No. 2279, Short Wave Magazine, Ltd., 55 Victoria Street, London, S.W.1.

FOR SALE: G.E.C. BRT-400E in excellent working order and condition; Crystal Cal., FSK; s.a.e.; £75. **WANTED:** Tuning gang for AR88.—Scott, Tattenhall, Nr. Chester.

FOR SALE: RCA AR88D, excellent condition, with S-meter, speaker, phones, spare valves, transformers, handbook, £47 o.n.o.—R. Saker, 27 Hempslow Avenue, Woodmansterne, Banstead, Surrey.

Q QVO3-20A. £1 10s.; QQVO6-40A, £2 10s.; 723A/B, £1 5s.; 829B, 17s. 6d.; 832A, 5B/254M, 5B/255M, 9s. 6d.; 5763, A1714, EY51, 7s. 6d.; others. **WANTED:** Crystals Channels 53, 55, 337 and 340.—Box No. 2280, Short Wave Magazine, Ltd., 55 Victoria Street, London, S.W.1.

PANADAPTER, latest BC-1031C, 450/470 kc IF, 115/230 volts AC, with full service manual, manufactured 1953, received brand-new Jan. 1960, £30; buyer collects.—G3KAS, 21 Lingwood Gardens, Osterley, Isleworth, Middlesex.

SMALL ADVERTISEMENTS, READERS—continued

BEAM ROTATOR. Ex-Admiralty Radar Scanner Type 268, mod. for AC operation; gears also modified to give 1½ turns/min. final drive to Beam. Desk Indicator with all controls, illuminators, dial, relay controlled; 1½-in. tubing, gear boxes and all gear to give the finest rotator in the U.K. for £20 (carriage paid). All-Band Tx, similar in all respects to LG.300, all new components, commercial metal-work and stoved finish, in FB condition, £25 (carriage extra). Power Unit/Modulator for above, ex-1131 Tx, built-in 24-volt DC supply for relays, 100% condition, UM3 mod. transformer, etc., spare set of valves, £15. Buyer arranges transport.—Write Box No. 2281, Short Wave Magazine, Ltd., 55 Victoria Street, London, S.W.1.

SALE: 36 Tx, complete, brand-new, £12 10s. (see February '59 Short Wave Magazine). Bennell, Mill House, Cryers Hill, High Wycombe, Bucks.

WANTED: AR88D Receiver spares, also coil pack.—G3GCO, 31 The Crescent, Donnington, Wellington, Shropshire.

COMMAND Rx. 190-550 kc, 85 kc IF, ideal for car radio, 50s. Service Valve Tester, £7 10s.—Jubb, 1 Cumberland Avenue, Grimsby, Lines.

CR-100 Receiver for sale; noise-limiter, S-meter, good appearance, working order, £12 10s.—P. Haddock, 19 Aldersyde Street, Bolton, Lanes.

WANTED: One each, T1154L and T1154H, in good condition, not modified; also Type 3 D/F Loop, Type 52A Resistance, Type 220 Relay.—Palmer, 62, Compton Road, Portsmouth, Hants.

CR100/2 with manual and spare parts; 16 resistances, 10 condensers, drive cord, output transformer, 9 valves; just re-lined with new valves and re-wired with new condensers. Deliver up to 35 miles free, after sale £21.—Phone EAL 4988 after 6 p.m.

WANTED: Short Wave Magazine, Vol. 15, Nos. 1, 2, 8, 10, 11, 12; Vol. 16, No. 7.—Cameron, Coombe Cottage, Pitchcombe, Glos.

PANDA PR-120V, £55. Radiovision Commander double superhet, £40. Genuine bug key, £2 10s. All in excellent order.—G4RS, 17 Tudor Avenue, Bebbington, Cheshire.

HARD-UP SCHOOLBOY wants 2-watt 5-band exciter, preferably working and cheap!—Gen to GM3NXO, 3 Caroline Place, Aberdeen.

FOR SALE: Transmitter 160/80, Phone/CW, power supply, in G4BI housing, photograph Bulletin, Oct, 1958, £14 o.n.o.—G3JJG, 21 Rastell Avenue, S.W.2.

WANTED: Panda Minibeam automatic aerial matching unit.—Dunk, Appegarth, Medstead Road, Beech, Alton, Hants.

FOR SALE: UHF Rx Hallicrafters S27; asking £20.—Write: 19a, Packhorse Road, Gerrards Cross, Bucks.

WANTED: Handbook of circuit details and operation for Receiver BC-433G.—Cash terms to J. R. Williams, 59 Victoria Road, Runcorn, Cheshire.

LET US POWER YOUR MOBILE

with the same care and "know how" as we do for aircraft and other technical users

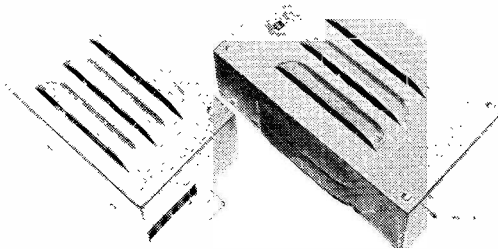

CA7 (Mark 1)

CA8 (Mark 2)

TRANSISTORISED POWER UNITS

for mobile marine or similar use where only low voltage D.C. is available and minimum current drain is essential.

CA7 (MARK 1) 50 watt, 12v. D.C. input 300v. D.C. 165 m/a output in grey crackle case 5" x 3½" x 2½". Transistors completely protected £12

CA8 (MARK 2) 100 watt, 12v. D.C. input 300/310v. 300 m/a and —120v. 10 m/a (Bias) in similar case to Mark 1, but 6½" x 4" x 2½" £17

THE ABOVE ARE TWO OF OUR STANDARD UNITS, BUT LET US KNOW YOUR PARTICULAR REQUIREMENTS, AND WE WILL WILLINGLY QUOTE FOR PROMPT DELIVERY.

Most mobile power problems can be solved by the use of our units . . . efficiently and economically.

COMMUNICATIONS (Air) LTD

HALF MOON STREET, BAGSHOT, SURREY
Bagshot 3089

SUPPLIERS TO THE AIRCRAFT INDUSTRY

BARGAIN OFFERS IN VALVES

OZ4 ... 5/-	6C5 ... 5/-	9D2 ... 3/-	EF36 ... 5/6
1R5 ... 7/-	6C6 ... 6/-	12A6 ... 6/-	EF39 ... 5/-
1S4 ... 7/-	6D6 ... 6/-	12AT7 ... 7/6	EF50 ... 4/6
1S5 ... 7/-	6F6G ... 6/-	12AU7 ... 7/6	EF80 ... 7/6
1T4 ... 6/-	6G6G ... 6/6	12AX7 ... 7/6	EF91 ... 5/-
2X2 ... 4/-	6H6 ... 3/6	12J5GT ... 3/6	EL32 ... 5/-
3D6 ... 4/-	6J5GT ... 4/-	12SN7GT14/-	FW4/500 ... 8/-
5R4GY ... 15/-	6J5 ... 5/6	12Y4 ... 4/-	H63 ... 10/-
5U4G ... 7/6	6J6 ... 5/6	28D7 ... 5/6	KT33C ... 9/-
5Y3GT ... 7/-	6J7G ... 5/6	42 ... 8/6	KTW61 ... 7/-
5Z3 ... 10/-	6K7G ... 3/6	77 ... 6/-	KTZ63 ... 7/-
5Z4G ... 8/6	6K8G ... 7/6	78 ... 6/-	ML4 ... 7/-
5Z4 ... 14/-	6L6G ... 9/-	80 ... 8/-	MU14 ... 8/-
6AC7 ... 6/-	6L6 ... 11/-	807 ... 5/-	P61 ... 3/-
6AG5 ... 6/-	6N7G ... 5/6	954 ... 4/-	Pen46 ... 5/6
6AK5 ... 7/-	6SA7 ... 7/6	955 ... 4/-	SP41 ... 3/-
6AL5 ... 5/-	6SG7 ... 8/6	5763 ... 11/6	SP61 ... 3/-
6AM6 ... 5/-	6SH7 ... 7/-	7193 ... 4/-	UBF80 ... 8/-
6B7 ... 10/-	6SJ7 ... 7/6	9003 ... 6/6	UCH81 ... 8/6
6B8G ... 4/-	6SK7 ... 7/-	AC6/Pen ... 6/6	UCL83 ... 10/-
6BA6 ... 7/-	6SN7GT ... 6/6	AC/P4 ... 7/-	UY85 ... 6/-
6BE6 ... 7/-	6V6G ... 6/6	EA50 ... 1/6	VR90 ... 8/-
6BW6 ... 8/6	6V6GT ... 7/6	EB34 ... 2/6	VR105 ... 8/-
6C4 ... 6/-	6X5GT ... 5/6	EB91 ... 5/-	VR150 ... 8/-
6C5G ... 5/-	7V7 ... 3/-	EBC33 ... 6/6	

Please add 6d. postage per valve. Orders over £2 10s., post free. Terms: Cash with order or C.O.D. (C.O.D. 2/- extra).

Our list of Communications Receivers in first class condition available upon request. S.A.E. please.

R. T. & I. SERVICE

ASHVILLE OLD HALL, ASHVILLE ROAD, LONDON, E.11
Telephone: LEYtonstone 4986.

SMALL ADVERTISEMENTS, READERS—continued

SALE: Panda Cub Tx. FB condition, latest model; 100 countries worked in 18 weeks on 25 watts AM; £35 o.n.o.—G3NUG, 127 Wise Lane, London, N.W.7. (MIL. 5553 after 7 p.m.)

PARMEKO Potted C-Core chokes and transformers. New and boxed, normal mains inputs; all post paid: 6.3v. 8A 200v. 20 mA 6.3v. 1A. 25s.; 2.2/2.6/3 kV 20 mA 4v. 1A. 25s.; 115v. 1A. 20s.; 50/55/60/65v. 1A. 15s. 6d.; 30-0-30 300/390v. 110 mA. 50v. 2A. 22s. 6d.; 20H 300 mA. 25s.; 12H 200 mA. 20s.; 5H 200 mA. 15s.; 2H 150 mA. 9s. 6d. Valves; 813. 30s.; 832. 7s. 6d.; 5U4G. 5s. Heathkit VFO with manual. £6.—Box No. 2277, Short Wave Magazine, Ltd., 55 Victoria Street, London, S.W.1.

VALVE SALE: EF80, ECH81, EB91, 5s. each; MH41, ECL80, U12, UU6, 7s. each; 200-0-200 voltmeter, 11s. Potentiometers 50k to 500k, 2s.—Baker, 17 Sandringham Drive, West Monkseaton, Northumberland.

COMPLETE STATION, first-class order. Can be seen any evening after six or week-ends on the air. Panda Gear including PR120V, ATU 150, 3-band Minibeam, impedance matching meter; also AR88LF, Class-D Wavemeter, Acos Mike 22, Labgear LP Filter, El Keyer with Vibroplex key, El T/R switch with Sidetone Muter; *Short Wave Magazines, Bulletins*; Valves, Resistors, Condensers, Transformers, Chokes, wire, etc., if required. Lot, £150 cash (no offers).—Please drop me postcard if intending to call: H. J. Lawn, 20 Croft Road, Godalming, Surrey.

NEW G. no equipment; grateful offers good surplus including frequency meter, to get on air. Essential, inexpensive, or terms (six junior ops. on establishment). Many Thanks.—Box No. 2278, Short Wave Magazine, Ltd., 55 Victoria Street, London, S.W.1.

URGENTLY REQUIRED: Mains Transformer for 12 Set, or scrap 12 Set with intact transformer. Please state price. RF-24, 12s. 6d.; RF-25, 12s. 6d.—Jubb, 1 Cumberland Avenue, Grimsby.

FOR SALE: Panda Cub, as new, very FB Tx. used for only a short time. Gone QRO. No reasonable offer refused. *Short Wave Magazines*, 1950 to 1959, offers? WANTED: Good Communications Rx, but must be of small or reasonable dimensions. Details and price to: G2AYG, 516 The Mount, Walmersley Road, Bury, Lanes.

WANTED: Panda or Minimitter ATU for 80-10 metres, in good condition.—Bryant, 56 Mount Crescent, Brentwood, Essex. (Brentwood 4049.)

10/15 MINIBEAM WANTED: also K.W. Multiband Dipole, modern bandspread receiver, and Cubical Quad.—Knight, Homefield, Upper Nazeing, Waltham Abbey, Essex.

WANTED: 12v. Mobile Tx/Rx; also 7 mc TVI-proof Mains Tx, low or medium power.—Box No. 2282, Short Wave Magazine, Ltd., 55 Victoria Street, London, S.W.1.

108 *Short Wave Magazine*, 65s.; *QST*, 1949, 25s.; 1951, 25s.; 1950 (less March and December), 20s.—R. Grain, 15 Waverley Gardens, Grays, Essex.

R 107. £8; TR19 power unit, 12/24v. input, 265/540v. output, £3. WANTED: 1000v. power pack.—G3MIX, 50 St. Mark's Crescent, Maidenhead, Berks.

SPECIAL AMATEUR LICENCE MORSE COURSE

COMPLETELY NEW METHOD takes all the drudgery out of learning Morse. Passes secured in all cases, even after previous failures.

By using **SPECIALLY** prepared recordings (3 speed L.P. player required) students learn automatically and without effort, perfect Morse in half the time required by any other method. S.A.E. full details. Advanced courses also available.

G3HSC, 45 GREEN LANE, PURLEY, SURREY.

GM3BQA TRIPLE QUAD

Patent 25132/57

Regd. Design 885769

SINGLE 75 OHM FEED ON 10-15-20 METRES

THE MOST SUCCESSFUL DX BEAM ANTENNA YOU CAN BUY NOW IN USE IN ALL CONTINENTS

£17.0.0 carriage extra

Complete with mast head clamp.

HEAVY DUTY BEAM ROTATORS

12-24 volts A.C. or D.C., £9/10/—, carr. extra.

SAE for details—

FORTH MOTOR CO. Dept. "M"

Edinburgh Road, Cockenzie, East Lothian, Scotland

NYLON • P.T.F.E

ROD, BAR, SHEET, TUBE, STRIP, WIRE

No Quantity too small

List on application

BRASS, COPPER, BRONZE, ALUMINIUM, LIGHT ALLOYS

H. ROLLET & CO., LTD.

6, CHESHAM PLACE, LONDON, S.W.1

BELgravia 4300

Works: 36 ROSEBERY AVENUE, LONDON, E.C.1

Branches at LIVERPOOL, MANCHESTER, BIRMINGHAM, LEEDS

G2ACC offers you—

Aerial Material: 14 S.W.G. h/d enamelled copper wire, 5d. yd. Coaxial cable: 72 ohm standard low-loss 9d. yd.; extra low-loss 1/7½ yd.; 50 ohm lightweight 0.159" dia. 9d. yd.; heavy-duty ¾" dia. 2/9 yd.

Balanced twin feeder: 72 ohm 6d. yd.; 150 ohm 9d. yd.; 300 ohm low-loss tubular 1/6 yd. Samples free. Pyrex glass insulator, 3" 1/6. Ceramic dipole insulator (for wire) 1/5.

Transmitting Valves: Mullard; QV06-20 (6146) 40/—; G.E.C.; TT21 33/9. Brimar; 5763 20/—; 5R4GY 17/6.

So-Rad Pi-Net PA choke: 150 watt r.f. input. Single ¾" dia. hole mounting with ceramic feed-through for HT 10.—

Postage extra on orders under £3.

Southern Radio & Electrical Supplies

SO-RAD WORKS . REDLYNCH . SALISBURY . WILTS

Telephone: Downton 207

H. WHITAKER G3SJ

Court Road, Newton Ferrers, SOUTH DEVON

Telephone 320
Newton Ferrers

(A.R.B. APPROVED)

Precision crystals of all types in a wide variety of bases covering the complete range 50 kc/s to 18 mc/s in fundamental frequencies. All are made to extremely fine tolerances and frequency adjustment can be given up to .005%. Plated electrodes of gold, silver, or aluminium with wired in spot welded contacts are available. Quotations can be given for any type of cut, or mode of oscillation, including a complete range for filters with zero temperature co-efficient over a sensibly wide temperature range.

Special Offer:

400 crystals in the range 7100 to 7150 kc/s inclusive. Brand new and unused post-war production. Specification: BT cuts, zero temperature co-efficient, gold plated electrodes, wired into FT 241 type holders with standard $\frac{1}{2}$ " pin spacing. Accurately calibrated. Better than average activity, EPR is better than 14 K. Ohms at 30 pf. input capacity. Price 18/- each, post free. All fully guaranteed and unrepeatable at today's prices. The offer applies only to the range mentioned above, all frequencies between 7100 and 7150 kc/s available.

VHF ENTHUSIASTS

No more change of doublers! A complete new range of crystals for DIRECT output up to 74 mc/s when using only a simple RF pentode oscillator such as Z77, EF80, etc., full details of this range on request.

FREE TO AMBITIOUS ENGINEERS

— THE LATEST EDITION OF ENGINEERING OPPORTUNITIES

Have you sent for your copy?

ENGINEERING OPPORTUNITIES is a highly informative 156-page guide to the best paid engineering posts. It tells you how you can quickly prepare at home for a recognised engineering qualification and outlines a wonderful range of modern Home Study Courses in all branches of Engineering. This unique book also gives full details of the Practical Radio & Electronics Courses, administered by our Specialist Electronics Training Division—the B.I.E.T. School of Electronics, explains the benefits of our Employment Dept. and shows you how to qualify for five years promotion in one year.

We definitely Guarantee "NO PASS — NO FEE"

Whatever your age or experience, you cannot afford to miss reading this famous book. If you are earning less than £20 a week, send for your copy of "ENGINEERING OPPORTUNITIES" today—FREE.

**BRITISH INSTITUTE OF ENGINEERING
TECHNOLOGY** (Incorporating E.M.I. Institutes)
(Dept. SE/24), 29 Wright's Lane, London, W.8

WHICH IS YOUR PET SUBJECT?

Mechanical Eng.,
Electrical Eng.,
Civil Engineering,
Radio Engineering,
Automobile Eng.,
Aeronautical Eng.,
Production Eng.,
Building, Plastics,
Draughtsmanship,
Television, etc.

GET SOME LETTERS AFTER YOUR NAME!

A.M.I.Mech.E.
A.M.I.G.E.
A.M.I.Prod.E.
A.M.I.M.I.
L.I.O.B.
A.F.R.Ae.S.
B.Sc.
A.M.Brit.I.R.E.
City & Guilds
Gen. Cert. of Education
Etc., etc.

PRACTICAL EQUIPMENT

Basic Practical and Theoretic Courses for beginners in Radio, T.V. Electronics, Etc., A.M.Brit.I.R.E. City & Guilds Radio Amateurs' Exam. R.T.E.B. Certificate P.M.G. Certificate Practical Radio Radio & Television Servicing Practical Electronics Electronics Engineering Automation

INCLUDING TOOLS!

The specialist Electronics Division of B.I.E.T. (Incorporating E.M.I. Institutes) NOW offers you a real laboratory training at home with practical equipment. Ask for details.

B.I.E.T. SCHOOL OF ELECTRONICS

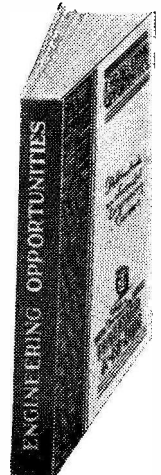

POST COUPON NOW!

- Please send me your FREE 156-page "ENGINEERING OPPORTUNITIES"
- (Write if you prefer not to cut page)
- NAME
- ADDRESS
-
-
- SUBJECT OR EXAM THAT INTERESTS ME (SE/24)

THE B.I.E.T. IS THE LEADING ORGANISATION OF ITS KIND IN THE WORLD

INTRODUCING TO YOU THE WORLD-FAMOUS

Easy-to-build kit-sets of highest quality at lower cost



HI-FI F.M. TUNER. Tuning range 88-108 Mc/s. For your convenience this is available in two units sold separately as follows: Tuner Unit (FMT-4U) with 10.7 Mc/s I.F. output (£3/2/- inc. P.T.). I.F. Amplifier (FMA-4U) complete with cabinet and valves (£10/10/6). Total

£13 12 6

HI-FI 16W STEREO AMPLIFIER. Model S-88, 10 mV. basic sensitivity (2 mV. available, 30/- extra). Ganged controls. Stereo/Monaural gram., radio and tape recorder inputs. Push-button selection. Two-tone grey metal cabinet

£25 5 6

6-TRANSISTOR PORTABLE. Model UXR-1. Pre-aligned I.F. transformers, printed circuit, 7 x 4 in. high-flux speaker. Real hide case ...

£15 18 6

DUAL-WAVE TRANSISTOR RADIO UJR-1. This sensitive headphone set is a fine introduction to electronics for any youngster

£2 16 6

RES.-CAP. BRIDGE. Model C-3U. Measures capacity 10 pF to 1,000 μ F., resistance 100 Ω to 5 M Ω and power factor. 5-450 v. test voltages. With safety switch ...

£7 19 6

AUDIO SIGNAL GENERATOR. Model AG-9U. 10 c/s to 100 kc/s, switch selected. Distortion less than 0.1%. 10 v. sine wave output metered in volts and dB's

£19 3 0

VALVE VOLTMETER. Model V-7A. Measures volts to 1,500 (D.C. and RMS) and 4,000 pk. to pk. Res. 0.1 Ω to 1,000 M Ω . D.C. input imped. 11 M Ω . Complete with test prods, leads and standardising battery ...

£13 0 0

R.F. PROBE. Model 309-CU. Extends the frequency range of our V-7A to 100 Mc/s and enables useful voltage indication to be obtained up to 300 Mc/s ...

£1 5 6

5 in. OSCILLOSCOPE. Model O-12U. Has wide-band amplifiers, essential for TV servicing, F.M. alignment, etc. Vertical freq. response 3 c/s to over 5 Mc/s without extra switching. T/B covers 10 c/s to 500 kc/s in 5 ranges ...

£34 15 0

ELECTRONIC SWITCH S-3U (Oscilloscope Trace Doubler). Enables a single beam oscilloscope to give simultaneous traces of two separate and independent signals. Switching rates approx. 150, 500, 1,500, 5,000 and 15,000 c/s. ...

£9 18 6

CAPACITANCE METER CM-1U. Direct-reading $4\frac{1}{2}$ in. scale. Full-scale ranges, 0-100 μ F, 0-1,000 μ F, 0-0.01 μ F and 0-0.1 μ F ...

£14 10 0

AUDIO WATTMETER. Model AW-1U. Up to 25 w. continuous, 50 w. intermittent ...

£13 18 6



CM-1U



S-33



USP-1



S-88



FM TUNER



S-3U



DX-100U



THE "GLOUCESTER" EQUIPMENT CABINET

AMATEUR TRANSMITTER. Model DX-100U. Covers all amateur bands from 160-10 metres. Self-contained including power supply, modulator and V.F.O. ...

£78 10 0

"HAM" TRANSMITTER. Model DX-40U. Compact and self-contained. From 80-10 m. Power input 75 w. C.W., 60 w. peak, C.C. phone. Output 40 w. to aerial. Provision for V.F.O. ...

£29 10 0

VAR. FREQ. OSCILLATOR VF-1U. From 160-10 m. Ideal for our DX-40U and similar transmitters. Price less valves £8/19/6

£10 12 0

6-W STEREO AMPLIFIER. Model S-33. 3 watts per channel, 0.3% distortion at 2.5 w/chnl., 20 dB N.F.D. Inputs for Radio (or Tape) and Gram., Stereo or Monaural, ganged controls. Sensitivity 100 mV. ...

£11 8 0

TRANSCRIPTION RECORD PLAYER RP-1U. 4-speed A.C. motor. Ronette Stereo/Mono pick-up. Complete with plinth. £12 10 0

HI-FI SPEAKER SYSTEM. Model SSU-1. Ducted-port bass reflex cabinet "in the white." Twin speakers. With legs (£11/12/6)

£10 5 6

"GLOUCESTER" EQUIPMENT CABINET. 46 $\frac{1}{2}$ x 30 x 21 in. deep. Mk. I houses: Record Player, Stereo Amplifier, F.M. Tuner, records, etc. Mk. II will house a Tape Deck in addition. Left in the white for finish to personal taste.

Mk. I ... £15 18 6 Mk. II ... £17 8 6

"COTSWOLD" HI-FI SPEAKER SYSTEM KIT. Acoustically designed enclosure "in the white" 26 in. x 23 in. x 15 $\frac{1}{2}$ in., housing a 12 in. bass speaker with 2 in. speech coil, elliptical middle speaker and pressure unit to cover the full frequency range of 30-20,000 c/s. Complete with speakers, cross-over unit, level control, etc., ...

£19 18 6

COMPLETE MATCHED STEREO OUTFIT. Includes RP-1U record player, S33 amplifier and twin SSU-1 speaker systems. Pedestal speaker legs optional (£2/14/- extra) ...

£42 10 0

STEREO-HEAD BOOSTER USP-1. Input 2 mV to 20 mV. Output adjustable from 20 mV to 2 v. 40-20,000 c/s. Also suitable as high-gain monaural amplifier ...

£5 19 6

AUDIO VALVE MILLIVOLT-METER AV-3U. 1 mV to 300 v. A.C. 10 c/s. to 400 kc/s ...

£13 18 6

JUST OUT! 2 $\frac{3}{4}$ " SERVICE 'SCOPE. Wt. 10 $\frac{1}{2}$ lb. £18 19 6

Prices include free delivery U.K. Deferred terms available on orders over £10.

Please send me FREE CATALOGUE (Yes/No)
Full details of model(s)

NAME

(BLOCK CAPITALS)

ADDRESS

SW6

DAYSTROM LIMITED

DEPT. SW6, GLOUCESTER, ENGLAND

A member of the Daystrom Group,
manufacturers of the

WORLD'S LARGEST-SELLING ELECTRONIC KITS