

2/6

The
SHORT WAVE
Magazine

VOL. XIV

JUNE, 1956

NUMBER 4



WORLD WIDE COMMUNICATION

H. WHITAKER G3SJ

Court Road, Newton Ferrers, SOUTH DEVON
(A.R.B. APPROVED.)

Telephone:
Newton Ferrers 320

Precision Crystals of all types in a wide variety of bases covering the complete range 50 Kc. to 18 Mc. in fundamental frequencies. All are made to extremely fine tolerances, and frequency adjustment can be given up to .005%. Plated electrodes of gold, silver or aluminium with wired in spot welded contacts are available. Quotations can be given for any type of cut or mode of oscillation including a complete range for filter circuits with zero temperature co-efficient over a sensibly wide temperature range. Our new works is equipped with up to the minute production technique methods, X-ray orientation ensuring accuracy of all cuts. Artificial aging by etching and plating by evaporation under vacuum ensure long term stability of the final calibration. Early delivery can be given of most types. Our regrind service is still available and in some cases we are prepared to quote for lowering the frequency of your existing crystals.

Special Offer :

200 kc. DT cut, zero temperature co-efficient over the range — 30° centigrade to + 55° centigrade. Frequency adjustment .005% or better. Mode : Face shear. Silver plated electrodes, wire mounted. Basing $\frac{1}{2}$ " pin spaced. Other bases to order, £1 each.

ATTENUATE THOSE HARMONICS

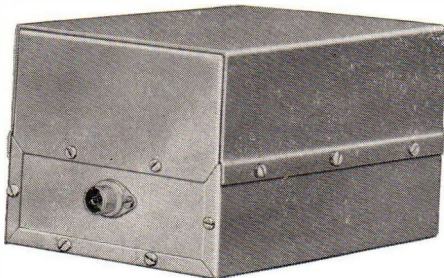

THE MOST EFFECTIVE LOW-PASS FILTER IN THE WORLD

Over 80dB Harmonic suppression. Insertion Loss less than 0.25dB

Price £6 ex-stock from :

Labgear (Cambridge) Ltd.

WILLOW PLACE, CAMBRIDGE. Tel. 2494

BROOKES Crystals

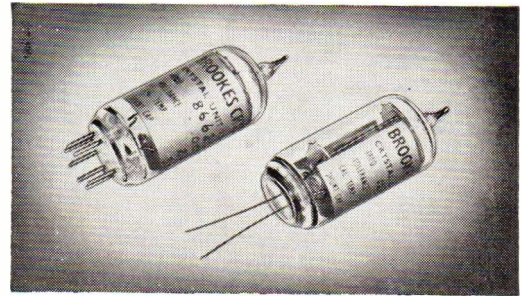

mean DEPENDABLE frequency control

● Illustrated above are two Type G Crystal units from a range covering 111 kc/s to 500 kc/s, and 3 Mc/s to 20 Mc/s.

ALL Brookes Crystals are made to exacting standards and close tolerances. They are available with a variety of bases and in a wide range of frequencies. There is a Brookes Crystal to suit your purpose—let us have your enquiry now.

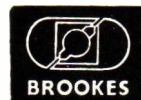

Brookes Crystals Ltd

Suppliers to Ministry of Supply, Home Office, BBC, etc.
181/183 TRAFALGAR RD., LONDON, S.E.10
Tel. GRenwich 1828. Grams: Xtale Green, London.



MODEL 7 50 RANGE
Universal AVOMETER

Fifty ranges...

in one instrument

THE wide scope of this multi-range AC/DC measuring instrument, coupled with its unfailing reliability, simplicity of use and high degree of accuracy, renders it invaluable wherever electrical equipment has to be maintained in constant, trouble-free operation.

It provides 50 ranges of readings on a 5-inch hand calibrated scale fitted with an anti-parallax mirror. Accuracy is within the limits laid down in Section 6 of B.S.S. 89/1954 for 5-inch scale industrial portable instruments. Range selection is effected by means of two electrically interlocked rotary switches. The total resistance of the meter is 500,000 ohms.

The instrument is self-contained, compact and portable, simple to operate, and is protected by an automatic cut-out against damage through inadvertent overload.

Power and Power Factor can be measured in A.C. circuits by means of an external accessory, the Universal AvoMeter Power Factor & Wattage Unit.

- CURRENT AC/DC**
0 to 10 amps.
 - VOLTAGE AC/DC**
0 to 1,000 volts.
 - RESISTANCE**
Up to 40 megohms.
 - CAPACITY**
·01 to 20 mFds.
 - AUDIO-FREQUENCY
POWER OUTPUT**
0—2 watts.
 - DECIBELS**
—25Db. to +16Db.
- Various accessories are available for extending the wide range of measurements.*

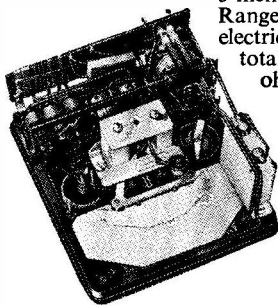

Size 8" x 7 1/2" x 4 1/2"
Weight 6 3/4 lbs.
(including leads)

List Price
£19 : 10s.

Illustrated Brochure
available on request.

...you can depend on



Sole Proprietors and Manufacturers—

THE AUTOMATIC COIL WINDER & ELECTRICAL EQUIPMENT CO., LTD.

AVOCET HOUSE · 92-96 VAUXHALL BRIDGE ROAD · LONDON · S.W.1.

Telephone: VICTORIA 3404 (9 lines)

Now Available for Immediate Delivery

THE RADIO HANDBOOK (14th Edition)

American, Published by "Editors and Engineers," 768 pages

60/- Post Free

RADIO AMATEUR CALL BOOK

Spring 1955/6 Edition

Abridged Edition excludes only American amateur stations. Otherwise complete with latest call sign-address listings for all countries, and including much DX data. In its 33rd year of publication.

Abridged Edition

Price 15s. Post free

Complete Edition

Price 31s. Post free

THE RADIO AMATEUR'S HANDBOOK

1956 Edition, 600 pages (Published by A.R.R.L.)

Price 31/6 Post free

	Post Free
SINGLE SIDEBAND TECHNIQUES	14s. 6d.
SINGLE SIDEBAND FOR THE RADIO AMATEUR	14s. 6d.
HINTS AND KINKS, Vol. 5	11s. 0d.
ANTENNA HANDBOOK (7th Edition)	19s. 0d.
ANTENNA MANUAL	28s. 0d.
A COURSE IN RADIO FUNDAMENTALS (New Edition)	10s. 6d.
HOW TO BECOME A RADIO AMATEUR (Published by ARRL)	5s. 0d.
LEARNING THE RADIO TELEGRAPH CODE	4s. 6d.
SURPLUS CONVERSION MANUAL	Vol. 1 21s. 0d.
	Vol. 2 21s. 0d.
MOBILE HANDBOOK (Published by CQ)	17s. 6d.
MODEL CONTROL BY RADIO	8s. 6d.
HIGH-FIDELITY TECHNIQUES	8s. 6d.
HIGH-FIDELITY	12s. 6d.
BASIC RADIO COURSE	19s. 0d.
PRACTICAL DISC RECORDING	6s. 6d.
RADIO AND TV HINTS	8s. 6d.
TRANSISTORS — THEORY AND PRACTICE	16s. 6d.
THE OSCILLOSCOPE	18s. 6d.
UHF ANTENNAS, CONVERTERS AND TUNERS	12s. 0d.
MOBILE MANUAL	22s. 0d.
OPERATING AN AMATEUR RADIO STATION	2s. 8d.
(Published by ARRL)	
BASIC AUDIO COURSE	22s. 6d.
SWEEP MARKER GENERATORS FOR TELEVISION RADIO	20s. 6d.
WORLD RADIO HANDBOOK	(1956 Edition) 11s. 0d.
BEAM ANTENNA HANDBOOK	22s. 0d.
HIGH FIDELITY by G. A. BRIGGS (Published by Wharfedale Wireless) ..	12s. 6d.
WORLD RADIO VALVE HANDBOOK	(1955 Edition) 5s. 10d.
	(1956 Edition) 14s. 6d.

MAGAZINES BY SUBSCRIPTION

	One Year		One Year
TELEVISION	48s. 0d.	POPULAR MECHANICS	32s. 0d.
TELEVISION ENGINEERING	32s. 0d.	SERVICE	24s. 0d.
CQ, Radio Amateur's Journal	44s. 0d.	ELECTRONICS, (Trade only)	160s. 0d.
AUDIO	40s. 0d.	POPULAR SCIENCE	45s. 0d.
RADIO AND TELEVISION NEWS	36s. 0d.		
QST, ARRL	36s. 0d.		
RADIO ELECTRONICS	33s. 0d.		

Subscription Service for All American Radio and Technical Periodicals.

SHORT WAVE MAGAZINE

(PUBLICATIONS DEPARTMENT)

55 VICTORIA STREET · LONDON · S.W.1 · ABBEY 5341

CALLING S.W. ENTHUSIASTS

COURSES FOR RADIO AMATEURS EXAMS AND P.M.G. 1st & 2nd CLASS CERTIFICATES (THEORY). ALSO GENERAL COURSES FOR S.W. LISTENERS

Take our special postal courses which have been written by experts both in these subjects and in modern methods of postal instruction. **E.M.I. INSTITUTES** are part of a world-wide electronics organisation, and many former students testify that our tuition was invaluable in ensuring their success in examinations.

SPECIAL PRACTICAL KITS are available as part of our Radio Courses. A typical course for beginners covers the design, construction and operation of a short wave 2 valve receiver. This equipment is supplied upon enrolment, and remains your property.

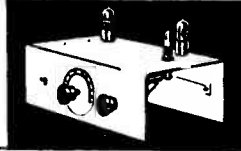

POST THIS COUPON TODAY

To E.M.I. INSTITUTES, Dept. 14 R, 43 Grove Park Rd., London, W.4.

Subject(s) of interest.....

Name

Address

JUNE

E.M.I. INSTITUTES

An educational organisation associated with the E.M.I. Group of Companies which include "HF MASTERS VOICE," MARCONIPHONE, ETC. I.C.43

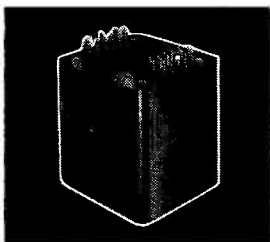

TRANSFORMERS

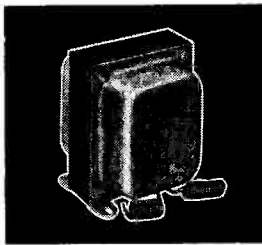
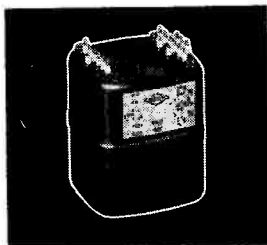

Cast Resin Transformers. Give complete mechanical and climatic protection for core and windings. Good heat dissipation.

Hermetically Sealed 'C' Core Units. A complete range covering transformers from 1 Va to 2 kVa and the usual range of chokes.

Potted Compound Filled Transformers. A wide range of capacities for transformers and chokes. Complete reliability. Suitable for exacting industrial and climatic conditions.

Shrouded and Open-Type Transformers. Combines first-class engineering with a popular highly competitive product. Vacuum impregnated and rigidly tested.

Microphone Transformer. For use with moving coil microphone, minimum hum, pick-up and maximum efficiency.

In addition to the types shown, we manufacture a great variety of Transformers for all electronic applications. Also Power Transformers up to 750 kVA.

Catalogues available on request.

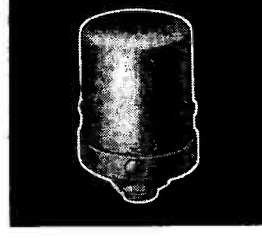
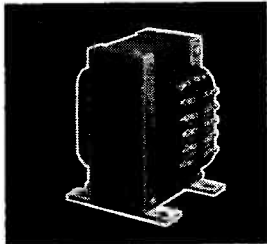
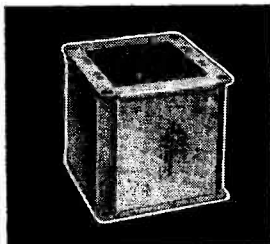

WODEN TRANSFORMER CO. LTD.,
 BILSTON, STAFFS. Tel. : BILSTON 41959.

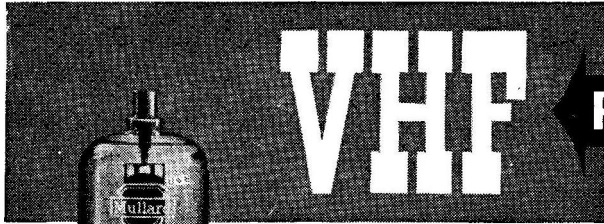

POWER TETRODES

for F.M. and television transmitters

Transmitter designers are now offered a wide range of v.h.f. tetrodes by Mullard, including the recently introduced tetrode QY3-65.

These high efficiency, high grain tetrodes make possible the design of transmitters with fewer valves and, consequently, reduced cost. The higher overall efficiency of equipments fitted with Mullard tetrodes results in lower running expenses—a factor in the growing popularity of these valves in the world market. Further details of the QY3-65 and other tetrodes in the Mullard range may be readily obtained from the address below.

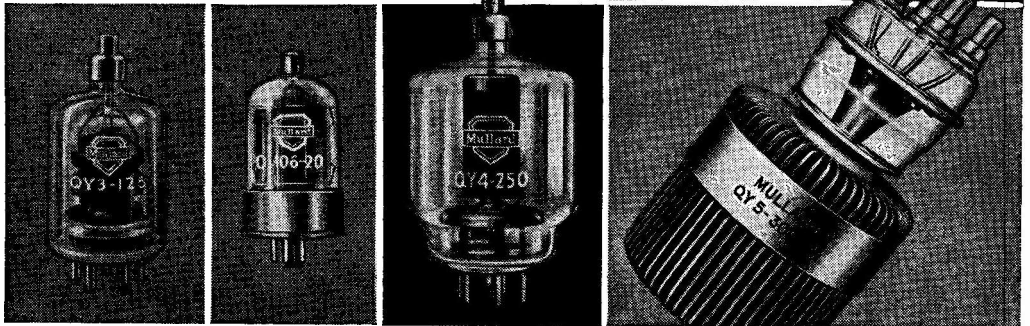
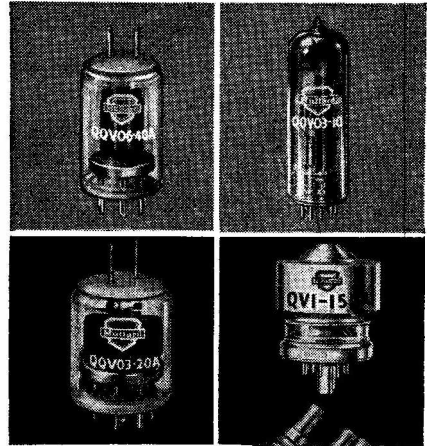

PRINCIPAL CHARACTERISTICS

MULLARD TYPE No.	AMERICAN TYPE No.	CV TYPE No.	DESCRIPTION	BASE	HEATER (V) (A)		Vamax. (V)	Pamax. (W)	TYPICAL LOAD POWERS & FREQUENCIES (W) (Mc/s)	
QY06-20	6146	CV3523	V.H.F. Power Tetrode	Octal	6.3	1.25	600	20	42	60
QQV03-10	6360	CV2798	V.H.F. Power Double Tetrode	B9A	6.3	0.83	300	2 x 5.0	20	175
QQV03-20A	6252	CV2799	V.H.F. Power Double Tetrode	B7A	12.6	0.42	600	2 x 10	14	100
QQV06-40A	5894	CV2797	V.H.F. Power Double Tetrode	B7A	6.3	1.3	750	2 x 20	11.5	200
QY3-65	4-65A	CV1905	V.H.F. Power Tetrode	B7A	12.6	0.65	3000	65	39	200
QY3-125	6155/4-125A	CV2130	V.H.F. Power Tetrode	B7A	6.3	1.8	3000	125	15	600
QY4-250	6156/4-250A	CV2131	V.H.F. Power Tetrode	B7A	12.6	0.9	4000	250	45	500
QVI-150A	4X-150A	CV2519	U.H.F. Power Tetrode	B8F	6.0	3.5	1250	150	224	50
QY5-3000A	6076	—	V.H.F. Power Tetrode	Special 4-pin	6.0	6.5	5000	3000	88	220
					6.3	14.1	4000	250	300	120
					6.0	2.6	1250	150	175	200
					6.3	32.5	5000	3000	800	75
									400	120
									156	165
									112	500
									3300	75
									*3500	220

* 2 valves in push-pull. Television service.

Mullard

MULLARD LTD., COMMUNICATIONS & INDUSTRIAL VALVE DEPT., CENTURY HOUSE, SHAFESBURY AVENUE, LONDON, W.C.2

**INDEX TO
ADVERTISERS**

	PAGE
Altham Radio	224
Anglin	223
Automatic Coil	169
Brookes Crystals, Ltd. <i>cover ii</i>	
Brown, S. G.	220
Candler System	221
E.M.I. Institutes	171
Harris, P.	222
Henley's	174
Henry's <i>cover iv</i>	
Home Radio	221
Labgear <i>cover ii</i>	
Lyons Radio	220
Mullard	172
North-Eastern Travel Agency	224
Proops	220
Radiocentre	224
Rollet, H.	223
Small Advertisements	221-224
Southern Radio	222
Standard Telephones & Cables, Ltd.	174
S.W.M. Publications Dept.	170
Universal Electronics <i>cover iii & 223</i>	
Whitaker <i>cover ii</i>	
Woden	171
Young <i>cover iii</i>	

SHORT WAVE MAGAZINE

VOL. XIV

JUNE 1956

No. 154

CONTENTS

	Page
Editorial	175
813 Band-Switched RF Amplifier , by <i>N. P. Spooner (G2NS)</i> ...	176
Ideas for DX Aerials	183
DX Commentary , by <i>L. H. Thomas, M.B.E. (G6QB)</i>	186
The Resonant Whip for Mobile Working on Top Band	194
SSB Topics , Conducted by <i>R. L. Glaisher (G6LX)</i>	199
Transmitter for Two Metres , by <i>W. F. Coulshed, B.Eng.(Hons.)</i> ...	202
VHF Bands	207
Design for a Communications Receiver, Part II , by <i>B. A. M. Herbert (G2WI)</i>	209
The Other Man's Station — <i>G5FI</i>	214
New QTH's	216
The Month with the Clubs — <i>From Reports</i>	217

Managing Editor : AUSTIN FORSYTH, O.B.E. (G6FO)

Advertisement Manager : P. H. FALKNER

Assistant Editor : L. H. THOMAS, M.B.E. (G6QB)

Published the Friday following the first Wednesday each month at 55 Victoria Street, London, S.W.1. Telephone : Abbey 5341/2

Annual Subscription : Home and Overseas 30s. post paid.

Copyright Reserved throughout the World.

AUTHORS' MSS

Articles submitted for Editorial consideration must be typed double-spaced with wide margins on one side only of quarto or foolscap sheets, with diagrams shown separately. Photographs should be clearly identified on the back. Payment is made for all material used, and it is a condition of acceptance that full copyright passes to the Short Wave Magazine, Ltd., on publication.

BRIMAR

SPECIFIED

for the

2-METRE TRANSMITTER

described in this issue

The BRIMAR types you want are:

12AU7
5763
6BW6

BRIMAR
VALVES and TELETUBES
— best for all equipments

Standard Telephones and Cables Limited

FOOTSCRAY, SIDCUP, KENT

FOOTSCRAY 3333

THE INSTRUMENT MODEL

Specially designed for soldering operations in the compact assemblies used in present day radio, television and electronic industries.

Weight $3\frac{1}{4}$ oz. excluding flexible.

Length 9in.

25 Watts
Voltage range
12, 24, 50
26/- each

100-110, 120-130, 200-220
220-240
24/- each

Interesting features

1. Bit $\frac{3}{16}$ " diameter, simple to replace.
2. Steel cased element also replaceable.
3. Detachable hook for suspending iron when not in use.
4. Moulded two part handle, remains cool in use.
5. Six ft. Henley Flexible.

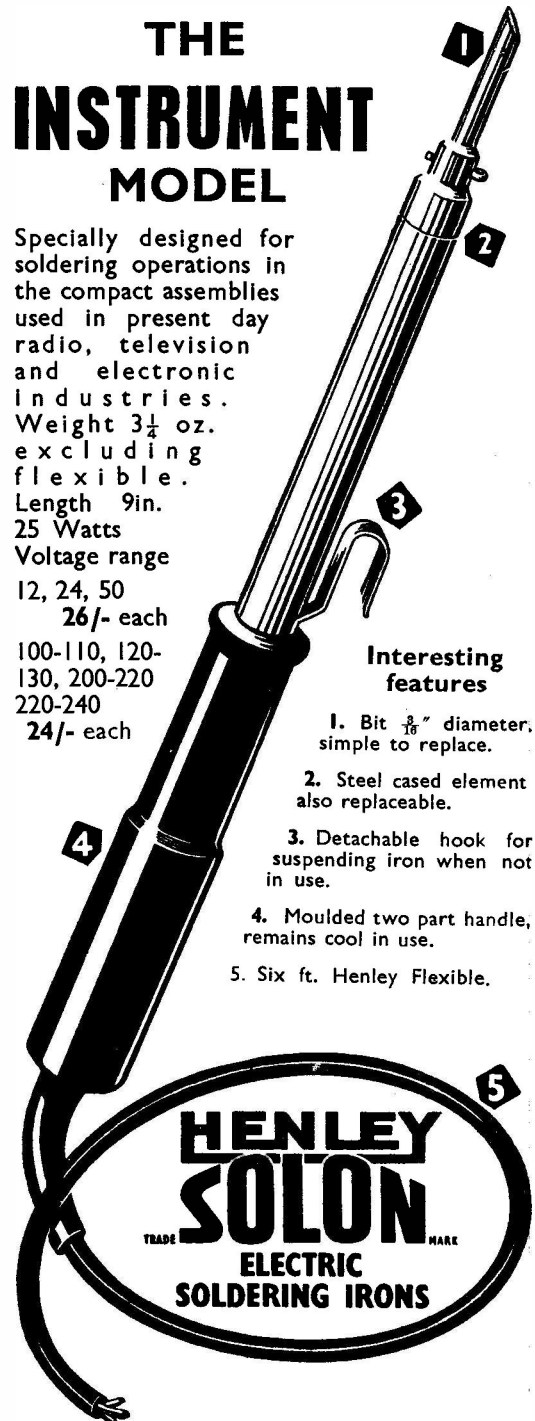

W. T. HENLEY'S TELEGRAPH WORKS CO. LTD.
51/53, Hatton Garden, London, E.C.1.

FOR THE EXPERIMENTER AND THE RADIO ENGINEER

The SHORT-WAVE Magazine

E D I T O R I A L

Noises *We have had occasion previously in this space to draw attention to the increasing difficulties caused by local interference effects — largely due to the harmonic relationships inextricably bound up with equipments mutually antagonistic in the radio sense. Though many people are shocked by the result, it is no new problem to those who first became concerned with these matters many years ago.*

The devastating effect of local TV receivers on the BBC long-wave Light Programme transmitter is well known — a crackling buzz which drowns it out in any district where TV receivers predominate. Then there is the interference produced, mutually, by TV receivers of different types looking at various stations in Band I and Band III. Here, a new hazard is that Band III converters for TV receivers on Channel I have their oscillators for Channel 8 right in our two-metre band. Then there is the problem of the very strong harmonics radiated by the numerous powerful Service stations now working point-to-point on the long-distance communication frequencies. Their beats appear everywhere. In this connection, there is the interesting situation that has developed between Kingston Blount (the high-power Forward Scatter VHF station, operated by the U.S.A.F.) and TV receivers over a wide area in Oxfordshire and South Buckinghamshire.

The BBC's Band II VHF/FM transmissions are near the police channels in many districts, and in any case are subject to Continental interference under the sort of conditions bringing good EDX on our VHF bands. All over the U.K., the HV overhead power-distribution system (the "grid") radiates a high local noise level, due mainly to dirty or cracked insulators. Before very long, we shall have added to this the noises to be produced by British Railways when they go over to electrification at 25,000v. AC collected.

Then there is the interference created by the BBC itself! Mother of all broadcasting systems, the BBC has made it quite clear that on their own high-power short wave transmitters harmonic radiation cannot be prevented. So, all round the bands, one hits upon squiggers carrying the news in Hindustani or the Paraguayan national anthem played by the band of the Garde Republicaine.

For the radio amateur, this may seem a depressing picture. But in point of fact, he does not worry unduly because he is not yet much affected. Spread over bands which themselves seem to be no more than a chaos of competing signals, he is nevertheless well able — by his operating ability and the codes peculiar to him — to carry on making contacts across the world.

And should he be pilloried for causing what seems to be local interference with the outpourings of the BBC or the ITA, he can always suggest so many other possible sources of the trouble that his accusers retire baffled.

*Austin Forth
G6FO.*

813 Band-Switched RF Amplifier

BUILT FROM "SURPLUS"
PARTS

N. P. SPOONER (G2NS)

Our well-known contributor discusses a 150-watt five-band PA built mainly from items out of the readily available TU series of "surplus" units. The design incorporates full TVI-proofing and all necessary constructional details are given.—Editor.

THE GEC tuning units used with the BC-375 MOPA transmitter have now been on the "surplus" market for quite a number of years, and while the TU5B, 6B and 8B, still command the best prices (because each happens to include an amateur band in its respective tuning range of 1500-3000, 3000-4500 and 6200-7700 kc), there are others in the "storage-soiled" and "callers-only" categories that prove excellent investments when dismantled.

The sight of these bargains, patiently waiting on the shelf for something to be done with them, prompted the writer to use them, with as many of their components as possible, when making up a new self-contained 5-band PA recently. It was also decided at the time that the chance should be taken of breaking away from the old insidious habit of running paralleled 807's at their maximum ratings whenever the occasion demanded. The present PA has therefore been built round a surplus 813 (VT-144), using modern technique that in itself offers nothing new but concerning which several aspects merit more detailed description because of their instructional and general interest.

813 as PA

For amateur 3.5 to 28 mc transmitters calling for consecutive band - switching without neutralisation adjustments, this beam power amplifier is to be strongly recommended in the final stage because of its ability to shoulder the work of two valves and idle while producing equivalent results. Its 7-pin base can be mounted so that the valve either sits vertically upright or hangs upside down; but when space only allows horizontal positioning the base should then be mounted so that the filament pins appear vertically one above the other with

the anode on edge. The beam-forming plates (connected internally to pin 5) are intended for operation at zero potential with respect to the filament and should therefore be wired to the centre-point of the filament circuit when AC is used. With a DC heater supply, pin 5 should be taken to the negative end of the filament. One very important point to note about the 813 is that while the anode shows no colour even when running at its maximum rating, the glass bulb becomes *very hot* during continuous operation and for this reason a clearance of at least 1/16th in. should be allowed between the bulb and the surrounding chassis, through a hole in which the valve is dropped until the chassis is level with the internal oblong or, in some makes of 813, the circular shield seen just below the anode. This method of sinking conveniently isolates input and output circuits, obviates neutralisation and ensures stability in operation. It might be mentioned, perhaps, that the writer heard quite recently of an inadequate clearance hole in which the heated and expanded glass actually punctured itself upon touching the surrounding chassis. Additional ventilation above and below the valve should be provided by drilling holes in the top cover and the base-plate of about ¼-in. diameter, it now being generally accepted that RF will creep out of any hole that is more than a ¼-in. in diameter. Energy that escapes in this unwanted manner obviously cannot receive the filtering given to that which is shepherded out of the PA compartment *via* low-impedance cable in the prescribed way. An original TU perforated plate will serve as a top cover if all the holes, except those in the two groups that come nearest to looking down upon the 813 top cap, are closed by bolting a metal sheet of the required size over them.

Circuit Discussion

As illustrated, the stage has shown both stability and a satisfactory degree of harmonic rejection; this should make it quite safe in areas served by a good TV signal, for receivers in which amateur frequencies have not been adopted for the IF's! In fringe areas, low and/or high-pass filters may in certain cases be found necessary, in addition to the go-between diplomacy of the Post Office shown towards complainants who are saddled with these deplorable IF's.

The input to the PA is variable and complete protection is afforded by a 6L6 clamper valve, along the lines of the writer's article in the September 1955 issue of SHORT WAVE

MAGAZINE. During preliminary under-run testing with 990 volts anode HT and 290 volts screen HT, the anode current dropped to 25 mA when drive was removed. Protection such as this not only obviates a separate bias pack and permits the use of an ordinary grid-leak, but it also makes it possible to key an early stage. The actual clamping action is that when drive is applied, voltage is developed across the grid-leak so that clamper and PA both become biased. In this condition the biased clamper makes only a light anode current demand on the common HT, and the PA screen is accordingly allowed to take its normal voltage with accompanying normal PA anode current. When drive is removed there is no voltage across the grid-leak and both valves become unbiased. The clamper at once makes a heavy anode current demand on the common HT, which in turn immediately robs voltage from the PA screen and thereby safely limits the PA anode current. The variable control designated "Input" on the front panel is a 50,000-ohm variable potentiometer placed. If its value is altered manually the clamper grid bias is altered the clamper grid bias is varied and this in turn varies the PA screen voltage and the anode output—a very simple but efficient way of setting the input to any desired value ; in the present case, between 150 and about 25 watts.

Besides input and output sockets, an additional coax socket is provided for a harmonic indicator. Shielded meters permanently indicate the grid, screen and anode currents, while an insulated socket on the front panel will accept the positive prod of any external voltmeter used to check screen voltage.

The 813 filament and 6L6 heater transformers are housed in one compartment ; the two filtered leads leaving the PA are heavy-duty flex for the AC mains supply to these



Front view of the 150-watt amplifier, discussed by G2NS, for which the drive unit (lower section) is a Panda Cub. Above the 813 band-switched PA, fully described in the text, is an aerial filter.

two transformers, and $\frac{3}{8}$ -in. diameter coax to carry the high-voltage positive (via the centre conductor) and negative (via the braiding) from an external power pack to the 813 and 6L6. While individual constructors may wish to incorporate a separate manual HT switch on the front panel, it has not been done in the present case as this facility is already available with the one-knob-control relay switching for the entire station.

Some method of switching the VFO quite independently of the rest of the station should already be in existence, and it should only re-

main necessary for intending constructors to decide whether clamper valve modulation is to be catered for when wiring-up. The input side of the PA needs little mention as it is of the normal switched type in which the "cold end" link coils and both ends of the band-coils not actually selected at the time are left floating; this will be more clearly seen by Fig. 3, which for simplification only gives one coil and link of the four actually in use.

The grid-current meter is mounted on the front panel, but, like those for the screen and anode, it is *fully shielded* from the back by total enclosure in a can, the positive terminal being earthed inside the can, while the negative lead is brought out in shielded cable through a small hole at the rear with the braiding earthed to the can at the point of exit.

On the output side a Pi-tank circuit is employed, because with reasonably correct values, feeding into a low-impedance coaxial cable

itself ensures an excellent degree of harmonic rejection. The blocking condenser keeping HT off the tank should have a rating equal at least to that of the anode voltage when CW is used. For telephony this rating should be doubled. Although it has no HT to withstand, the plate-side tuning condenser receives the full RF impact and should therefore also have a rating at least equal to that of the anode voltage for CW and double that for telephony. The variable loading condenser is let off lightly and receiver spacing of the plates is suitable in this position provided that it is only expected to load into low-impedance coaxial cable.

The popular type of tapped and switched anode inductance is employed because it is an excellent method of band-changing provided that the losses due to short-circuited turns are reduced by the use of an entirely separate 28 mc coil mounted at right angles to the main coil. This self-supporting coil, connected to,

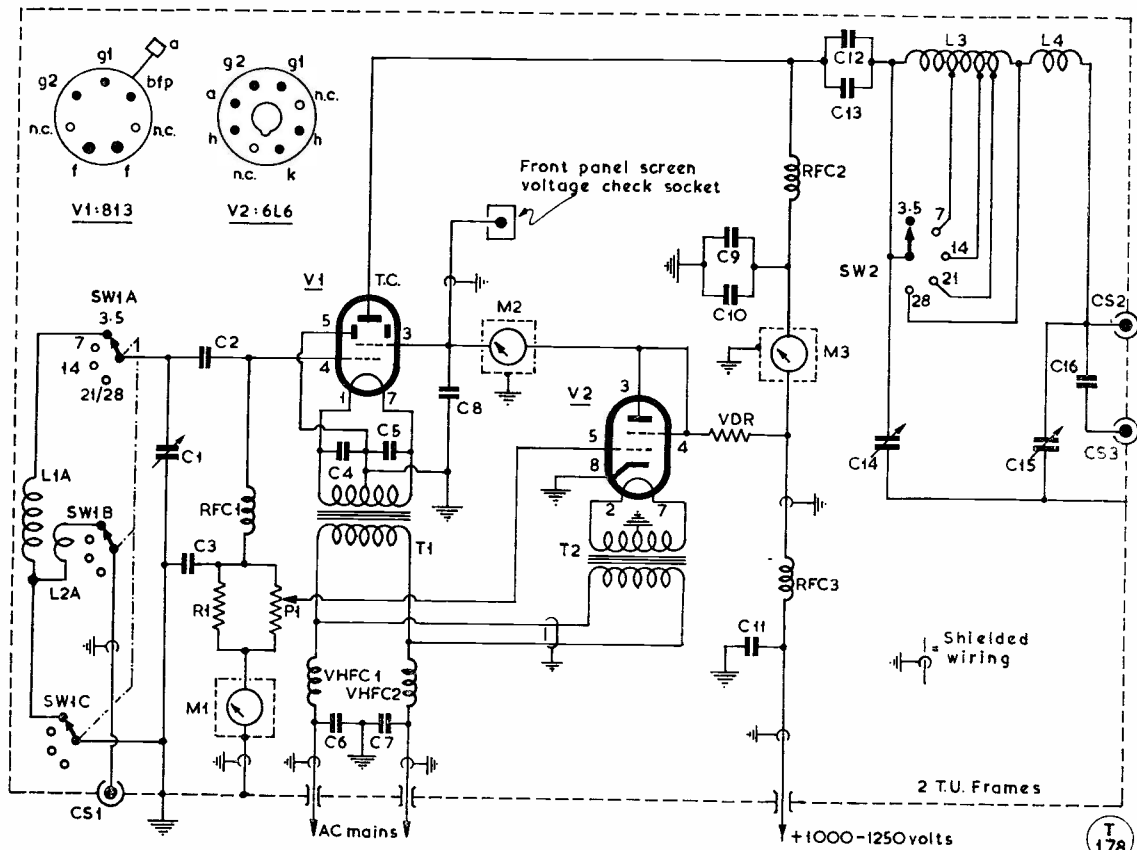

Fig. 1. Circuit of the band-switched 813 PA stage described by G2NS. It is built into a screening box, an ex-TU cabinet being adapted for the purpose, and the general design is such as to ensure full TVI-proofing. All feed leads are run in screened cable, the meters are enclosed, and at CS3 a harmonic check point is provided through the small capacity C16. L4 is the separate 10-metre coil, L3 being tapped for the other bands. On the grid side, the switch assembly SW1 selects the band, only one set of coils being shown, for simplicity.

Table of Values

Fig. 1. Circuit of the 813 PA.

C1 = TU 116 $\mu\mu\text{F}$ variable (TU6, 7, 9, 10B PA or TU7 MO), TU Vernier Knob	(or Labgear E5032 RFC)
C2 = 100 $\mu\mu\text{F}$ ceramic	RFC3 = Eddystone 1022
C3, 4, 5, 6, 7, 8 = TU .002 μF , 1200v.	VHFC1, 2 = 2in. winding of 18 SWG enam. on TU $\frac{1}{4}$ " ceramic RFC former
C9, 10 = TU 400 $\mu\mu\text{F}$, 2500v. in parallel	V1 = Surplus 813 (VT-144), PA.
C11 = TU 400 $\mu\mu\text{F}$, 2500v.	V2 = Surplus 6L6, Clamper
C12, 13 = TU 400 $\mu\mu\text{F}$, 2500v. in parallel	T1 = Fil. trans., 10v. 5 amp.
C14 = 250 $\mu\mu\text{F}$ variable, 2000v. (Surplus Johnson transmission), TU Vernier Knob	T2 = Heater trans., 6.3v. 1 amp.
C15 = 500 $\mu\mu\text{F}$, TU Vernier Knob (one section of ganged 500/500 $\mu\mu\text{F}$, ex-Philips BC receiver)	M1 = Grid, 0-25 mA m/c meter—
C16 = 5 $\mu\mu\text{F}$	M2 = Screen, 0-25 mA m/c meter—
R1 = 22,000 ohms, 2w.	M3 = Anode, 0-200 mA m/c meter—
P1 = 50,000 ohms pot. meter.	Each fully shielded, after mounting
VDR = 50,000 ohms, wirewound, 100w.	CS1 = Belling & Lee or Pye coax socket, Input
RFC1 = Eddystone 1010	CS2 = 80 ohm Output
RFC2 = 139 turns, ex-TU RFC windings approx. 2.7 D.C.C., on $\frac{1}{4}$ " ceramic pillar.	CS3 = Harmonic Check
	SW1A, B, C = Grid Band Selector, ganged paxolin 3-wafer, each single-pole 4-position
	SW2 = Anode Band Selector, Single-pole 5-position, TU ceramic 6-position aerial coupler switch
COIL DATA	
L1A = Grid, 3.5mc, 32 turns, 18 SWG enam., close wound on TU $1\frac{1}{4}$ " aerial coupling coil former, with 5-turn link coil L2A at "cold" end.	
L1B = 7mc, 18 turns ditto, 4-turn link L2B.	
L1C = 14mc, 9 turns ditto, 3-turn link L2C.	
L1D = 21/28mc, 4 turns ditto, spaced for minimum capacity setting of C1, 2-turn link L2D.	
L3 = Anode, 3.5-21mc, 18 turns, 16 SWG base, spaced 7 turns per inch on TU 2" ribbed ceramic former. Taps, from junction of L3-L4 = 21 mc, 1 turn; 14 mc, 5 turns; 7 mc, 13 turns	
L4 = 28 mc, 4 turns, 14 SWG enam., $1\frac{1}{4}$ " diam, self-supporting, mounted at right angles to L3.	

but not physically too close to, the main coil, gives quite good efficiency at 28 mc because it is not inter-coupled with the main coil shorted turns, as would be the case were all five bands to be wound on the one former. The fact, moreover, that this low-loss coil remains in circuit on 14 and 21 mc also helps materially in reducing losses on these two bands.

While the foregoing measures are all to the good, the most vital component in this or any Pi-tank circuit still remains the anode RF choke. Its great importance is rarely stressed and it is easy to forget that such a choke should be looked upon rather as a coil designed to have as much inductance as possible but as little distributed capacity as winding ingenuity can contrive. The small but unavoidable amount of distributed capacity invariably remaining is sufficient to resonate the choke, and if this happens on a frequency within an

amateur band, over-heating and burning-out will certainly result. Every home-wound RF choke should be tested at the time of winding in order to avoid resonances in any amateur band to which the transmitter will be tuned. The demands made by parallel anode feed together with the necessity for a high inductance spread over a wide frequency range are not easy to meet; when, during preliminary testing, the anode current meter refuses to dip on any band, even when not loaded, or if a neon passed over the RF choke windings is erratic in striking, then the RF choke should be immediately suspect and altered if possible.

Constructors who tire of attempts to get good home-wound choke performance on five bands might like to change to the E5032 Labgear RF choke, designed for just such a position in Pi-tank circuits. The one actually in use was wound on a ceramic former from details of an 813 circuit given in the 1954 *Radio Amateur's Handbook*, and while its performance is definitely better on some bands than on others, it was tested at the time of winding with a calibrated grid-dip oscillator and has been free from resonance troubles.

Framework and Construction

Two TU frames are used, one with a new panel and the other with its original front panel in which all unwanted holes are stopped up by bolts or masked by metal sheeting. Fig. 2 indicates the contents and disposition of the compartments that can be conveniently formed by bending TU top covers and base-plates to the required shape and masking unwanted perforations by sheet tin.

The grid band-switch is the normal paxolin type, each of the three ganged wafers having a single pole that selects four different positions. The grid tuning condenser mounted above the band-switch is a PA condenser taken from a TU6, 7, 9 or 10B which all have a maximum capacity of 116 $\mu\mu\text{F}$. Alternatively, it can be the 111 $\mu\mu\text{F}$ MO tuning condenser of a TU7B. The grid coils are first wound on the requisite lengths of TU $1\frac{1}{4}$ in. diameter former to be found with the TU aerial coupling coils; these are then mounted on square TU ceramic pillars, as originally used to hold fixed and variable condensers. The coverage of each coil should be determined approximately at the time of winding with a calibrated grid-dipper and the accuracy checked later under actual circuit conditions when the grid side and the filament circuit of the PA have been completed. No HT or wiring is needed on the anode side as the test simply consists of connecting the

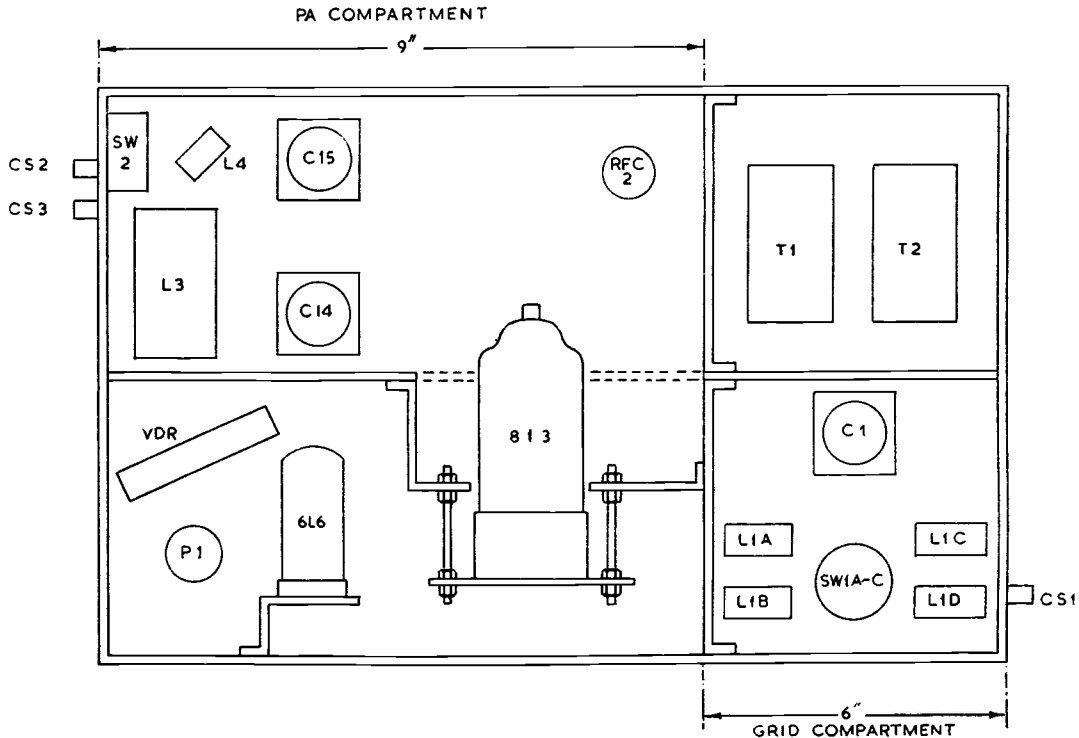

Fig. 2. Layout internally of the 813 PA unit, suggesting how the space available in a TU cabinet can be utilised. The grid assembly is lower right, and T1, T2 are the LT supply transformers — see Fig. 1. The resistor marked VDR is a heat dissipating element and must be mounted in such a way that it can run as cool as possible. P1 is the power control potentiometer.

output of the driver by coaxial cable to the grid input of the PA. With the 813 filament warmed up, drive is applied and the grid condenser is adjusted for maximum grid current meter readings on each band in turn; the VFO is then set to the limits of each band in turn to ascertain whether the grid coil windings give proper coverage and the links have the correct number of turns. Any alterations can then be effected at this stage in construction.

High-voltage TU fixed condensers are used wherever possible because they happen to be available, even if their individual ratings are unnecessarily high for many positions. As indicated by the circuit of Fig. 1, all wiring that does not carry RF is run in shielding while the actual method of mounting the 813 and 6L6 is given in greater detail by Fig. 4. The high-wattage 50,000-ohm VDR common to the clamper and the 813 screen may be safely suspended across the frame if a medicine-bottle cork is first pushed firmly into each open end; angle brackets can then be formed by bending two of the metal straps originally used on the cross-bars that support TU variable condensers; if a fixing hole is drilled through

each bracket at the end that is to be bolted to the frame, the undrilled end of the bracket being pushed into a knife-slit in its respective cork, the large resistor can be hung out of the way with its bare ends taped over to avoid any possible shorting against the frame.

Anode tuning is by a "surplus" transmitting type Johnson condenser, but any variable capacity of high rating with a maximum around 200 $\mu\mu\text{F}$ is suitable for this position. Anode band selection is by a TU aerial coupling switch and the tapped anode inductance is a TU 2in. diameter ceramic coil former originally wound with 35 turns of approximately 16 gauge wire (13 turns per inch); this is rewound to give 18 turns (about 7 turns per inch with double spacing). The total winding, which includes the 28 mc coil, and the tapping positions should be verified with a calibrated grid-dipper before being wired into circuit.

Testing and Operation

If the grid circuit has previously been tried out as already suggested, all wiring and connections on the anode side can now be checked

and the 813 and 6L6 allowed to warm up if all is well. The usual procedure and care taken when first "firing-up" a new PA stage must be exercised and in addition two tests need carrying out to ascertain whether de-coupling, bypassing and the isolation of input and output circuits is adequate. With drive applied but without any HT on the 813 anode or screen, the grid - current meter should remain steady without flicker or alteration when the anode tuning condenser is rotated through resonance on each band in turn. Then, with full HT on the anode and screen of the 813, but without any drive, the standing anode current of about 25 mA shown on the anode current meter should remain steady without flicker or alteration when, over each band in turn, the grid and anode tuning condensers are both fully rotated.

Working conditions will depend on the power supply available and the loading, but as a rough guide the PA as described was under-run with 990 volts anode HT, 288 volts screen HT and a screen current of 12.5 mA.

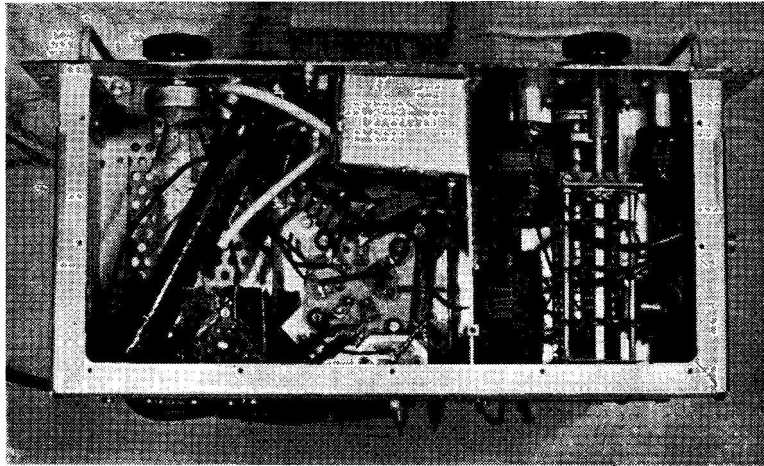

Under-chassis view of the 150-watt RF amplifier, in a TU case. The 813 valveholder is lower centre, with the 6L6 base to the left. The big resistor is VDR in Fig. 1. In the compartment on the right are coils L1A, L1B, L1C and L1D, and the switch assembly SW1A-C.

With an input of 150 watts, a drive of about 6 mA will be found ample, over-driving only resulting in lowered output. It should, of course, be emphasised that the VFO and frequency multiplying stages are expected to be already adequately shielded, filtered and suppressed if undisturbed operation at any hour is to be attempted.

The Panda "Cub" used by the writer as a driver provides far more drive than is required for the efficient operation of the 813; this will also hold true of many home-built drivers. Whether interested or not in the present PA, owners of a "Cub" may like to know of a small modification which improves tone on 21 and 28 mc by removing ripple and provides additional rejection of harmonics by a lessening of the drive when used with an auxiliary PA. It might therefore first be explained—for those unfamiliar with this all-band 40-watt CW/25-watt phone transmitter — that as the rectifier is not of the mercury vapour type the front panel on-off power switch has been connected in the AC primary side of the HT transformer, where it switches on heaters and HT together at the beginning of an operating session. Transmission is thereafter carried out by one-knob relay switching of the entire station, using the two auxiliary contacts provided for this purpose on the CW-Receive-Phone function switch found on the front panel. The action of the function switch is that, at the same time, it removes HT during "Receive" stand-by periods from the VFO and modulator screens, shorts the modulation transformer secondary, puts the key-jack out of circuit and keeps the keyed cathodes open.

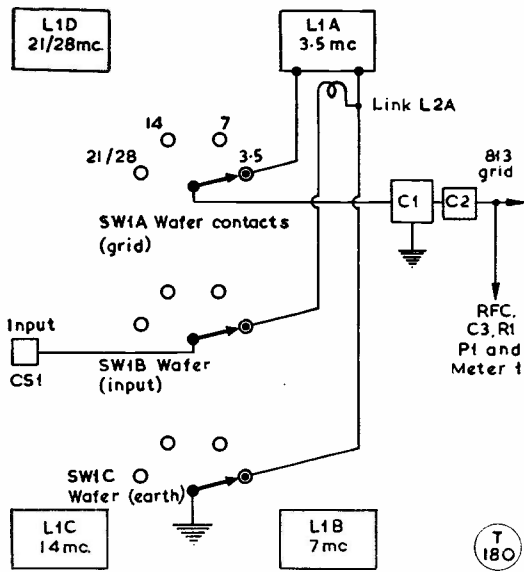

Note: Only one coil and link shown connected

Fig. 3. Wiring of the band selector switch on the grid side of the PA, showing how the three wafers are connected — read with main circuit Fig. 1.

This allows the transmitter to be operated with the speed of a push-to-talk or key system. One further point is that switching provides condenser input to the power pack on bands 3.5 to 28 mc and choke input on 1.8 mc, whereby the voltage is dropped and the input comes well within the ten-watt rating.

The suggested modification consists simply of disconnecting the on-off power switch from the primary side, joining and taping up the break and inserting the switch on the secondary side between the HT centre-tap and chassis. This, when desired, will allow a preliminary warm-up of the heaters alone, with a later application of the HT to all stages upon the commencement of transmission. It in no way alters the rapid change-over facility permanently provided by the function switch in the "Receive" position. It is suggested that the HT + line from the 5U4G rectifier filament should be broken before it branches to smoothing choke, high-low switch at rear of chassis (for condenser or choke input) and the first three smoothing condensers, and that in the break should be inserted a 5/25 Henry swinging choke which can conveniently stand just outside the cabinet for easy shorting when desired with a crocodile clip across its terminals.

It will be found that this modification removes ripple, improves regulation and tone and lessens drive for an auxiliary higher-powered PA like the present one. The simple procedure for making a contact is then first to switch on the driver HT and turn the function

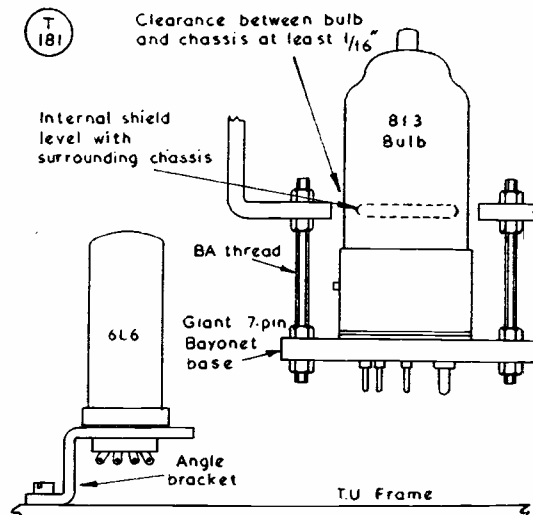
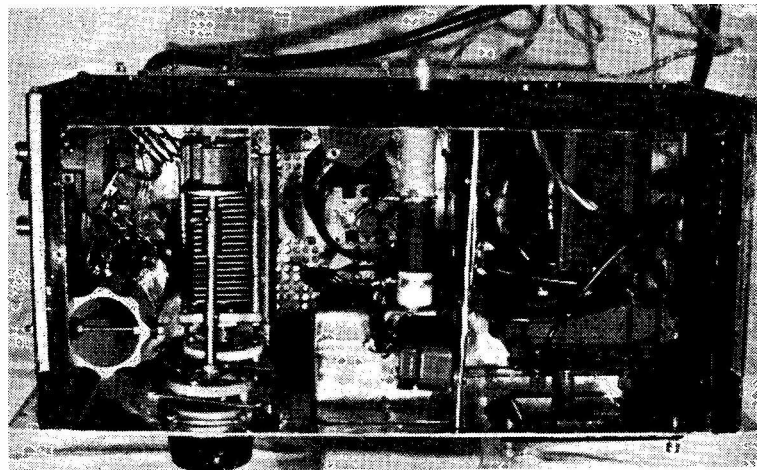

Fig. 4. Mechanical details for the mounting of the 813 PA and its 6L6 clamper valve. As explained in the text, it is essential to provide adequate clearance for the envelope of the 813.

switch to "CW" with the key plugged into its jack but left open. The VFO will be heard to come on alone, the rest of the driver and the 813 being dead; after the received signal has been heterodyned with the VFO, the VFO is switched off by returning the function switch to "Receive." The CW monitor (positioned where a comfortably strong signal from the transmitter can be heard in it and the beat from the monitor itself is nicely audible in the receiver), is then brought on by an over-ride manual switch placed across the monitor HT relay. After the monitor has been tuned until it beats with the received signal, it is switched off and both VFO and monitor are then ready for action close to the desired frequency when changing-over to call the distant station.

To avoid slowness in going over, relay switching should, in all amateur stations, control receiver (aerial-to-earth) protection, receiver HT, transmitter HT, monitor HT, aerial change-over and head-phone change-over (unless a one-to-one transformer is used in this latter position to avoid a separate relay). Override manual switches should be placed in parallel across the relays to control



The 813 PA unit, looking into the top deck of the chassis. The valve itself is upper centre, with the plate choke RFC2 on the long former immediately beside it. In the right-hand compartment are transformers T1, T2. The large variable condenser on the left is C14, and the close-spaced variable is C15. Lower left is L3, the tapped tank coil, and above it L4, the 10-metre inductance.

the application of HT to the VFO (for heterodyning the received signal), the monitor (for beating with the received signal or retrieving lost stations), the PA (for parasitic testing), the receiver and its protection (for use without the rest of the station) and the headphone change-over (for connection to receiver while heterodyning or beating with VFO and monitor).

If the 813 grid is left tuned, say, to the centre of the CW portion of any band, it will probably be found that only a slight touch on the anode tuning condenser is necessary for re-tuning after transmission is commenced on a new frequency in that particular portion. This may also apply to the driver.

As a concluding point of interest, acetone or amylacetate purchased from the local

chemist should help to soften TU "dope," and an Allan key of the correct size (borrowed, if necessary, from the trimming-tool kit of the nearest AR88 owner) will help to shift the TU grub-screws. Most good ironmongers, however, now stock several sizes of Allan key.

For future reference it might also be noted that all TU neutralising condensers have a maximum of about 25 $\mu\mu\text{F}$. The PA tuning condenser in the TU5B is 156 $\mu\mu\text{F}$, and that in the TU8B is 81 $\mu\mu\text{F}$. The MO tuning capacities in the TU6 and 9B are 77 $\mu\mu\text{F}$, the TU8B is 66 $\mu\mu\text{F}$, and in the TU10B is 66 $\mu\mu\text{F}$. And if dismantled for future use, label them with their original function and capacity—you'll never distinguish them once they get into that junk-box!

Ideas for DX Aerials

NOTES ON A MULTI-BAND SYSTEM, AND A SIMPLE BEAM

WHERE only one transmitting aerial can be erected, the amateur with limited ground space at his disposal is faced with a problem in making this aerial operate efficiently on all bands. The problem is complicated if the line of the aerial cannot be orientated in a direction favourable to propagation along the general DX paths.

The aerial described here has proved to be very satisfactory for multi-band operation, and its performance on DX has been outstanding. Local conditions of terrain, height and obstructions play a big part in aerial performance, and it is not suggested that this one is necessarily the best for a particular situation. But whatever the conditions, it might be worth trying, as the construction is simple. The height is about 30 ft. only. The mast end is on a halyard, so that the aerial can be raised and lowered easily.

Ability to bring the centre of the "flat-top" to within reach is an essential feature, as will be seen later.

Multi-Band Requirements

Use for Top Band dictates that the aerial be as long as possible, since the lengths of 50 to 100 ft. generally feasible in most situations only represent a fraction of the wavelength, and anything less is not of much use except for local contacts. Much the same considerations apply to the 80-metre band. No appreciable

control of directivity can be achieved on either of these bands, and the usual practice is employed of tying the feeder ends together at the transmitter end, and working the whole thing against ground. On 7 and 14 mc, however, dipole horizontal tops become practicable, and even the 66-ft. top requisite for a 7 mc dipole can be achieved at most locations.

Now, it is well known that a dipole exhibits marked broadside radiation characteristics, whilst the use of a top of length greater than a half-wavelength produces a series of lobes

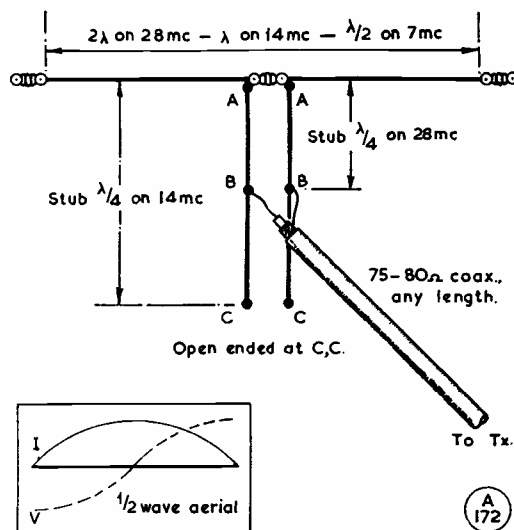

Fig. 1. The coupling system for the three-band single-wire aerial, which is stub-matched to give maximum current at the feed point on each band. On 7 mc, the coaxial feeder goes to the centre of the aerial, A-A, as for any centre-fed dipole. On 14 mc, the feeder goes across C-C, and on 28 mc across B-B. Thus, with a roof-length of about 66 feet, one obtains a matched three-band system fed by low impedance line, itself an important advantage. As explained in the text, the aerial must be slung in such a way that it can easily be lowered when changing the feed point.

in the horizontal plane, the axes of which lie closer to the axis of the aerial as the length is increased (see Fig. 3).

Unless a dipole can be erected approximately N-to-S it is, therefore, not the best form of aerial for the DX bands 14 and 28 mc. On the contrary, some form of long-wire aerial is desirable at these frequencies, in order to bring lobes to bear in the required directions.

As the LF section of 7 mc is likely to become useful again as a DX band a dipole cut for Forty will be worth having for general operation on it, irrespective of aerial direction.

Assuming, then, that a 66-ft. top is erected, its operation on 14 and 28 mc as a full-wave and two-full-wave aerial respectively will provide a more desirable lobe distribution, whilst operation on 1.7 and 3.5 mc with the feeders tied and operated against ground will give reasonable efficiency for local working.

The problem therefore resolves itself into one of feeding the aerial efficiently on the three HF bands.

Feeding and Matching

The use of tuned feeders has always been viewed with distaste because at HF it is difficult to avoid losses, and to maintain balance—particularly with end-fed aerials and aerial coupling coils and tuning condensers—becomes a nuisance for multi-band operation. Also, with the higher powers permitted to-day the tendency to condenser flash-over is prevalent, necessitating wide spacing, bulk and expense.

Current feed, using a simple untuned link to the PA tank and a co-axial feeder, connecting into a current loop point on the aerial, is modern, simple and efficient.

Consideration of the application of this method to an all-band system led to the conclusion that a compromise was necessary, either in respect of efficiency or convenience. It was decided to maintain efficiency, and the sacrifice lies in the fact that in order to change the working band it is necessary to go outside and shift the position of the aerial end of the co-ax feeder.

Design of the Feeder

Fig. 1 shows a 66-ft. 7 mc dipole and the current distribution along its length. A current loop at the centre enables the feeder to be attached at that point, using low-impedance (80-ohm) co-axial cable.

The same top used on 14 or 28 mc has a current distribution such that the centre becomes a current node (voltage loop) and the low-impedance feeder cannot be attached at

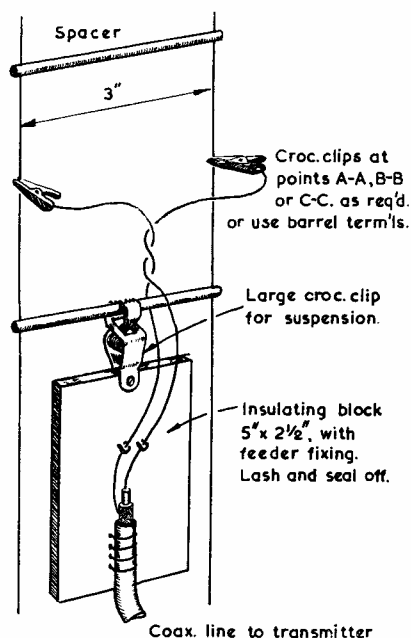

Fig. 2. Detail of a suggested method of making the feeder connection for the three-band aerial. The strain is taken off the coaxial cable and the spacers are placed to clear the feed points; when the latter are found, they could have pieces of thick copper wire soldered on to give a good "bite" for the clips or, better still, an anchorage for a barrel terminal.

this point. If it is, the PA refuses to load up, because of the violent mis-match. Obviously the co-ax can be applied if the point of feed can be moved a quarter-wavelength (at the frequency to be used) away from the centre.

This can be accomplished by inserting a stub a quarter-wavelength long at the centre of the aerial, connecting the feeder to the other end. The effect is the same as adding another half wave into the aerial, except that since it is

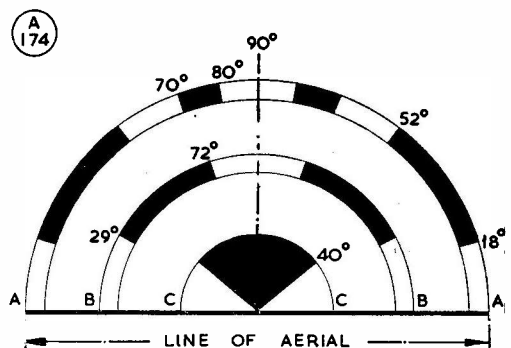

Fig. 3. Directivity of the three-band aerial system described in the article. The outer curve A-A is the lobe appearance, in plan, on the 28 mc band, B-B shows it for 14 mc, and C-C is the usual dipole behaviour on 7 mc. The directions are, of course, repeated in the two quadrants below the line of the aerial in this sketch.

folded, the added portion will be non-radiating. However, two different stub-lengths are necessary for the 14 and 28 mc bands, the length for the former being approximately twice that for the latter. This led to trying out the idea shown in Fig. 1, in which the open-ended stub is about a quarter-wavelength long on 14 mc and hangs vertically from the top portion.

For 7 mc operation the stub is not required, and the co-axial feeder is attached at points AA.

For 28 mc the point of attachment is BB (quarter-wave at 28 mc below the centre) whilst for 14 mc the whole stub length is required and the feeder connects at CC.

The presence of the unused portion of the open stub at 7 and 28 mc has no effect as far as can be ascertained. The stub comprises an open-wire twin-line of 16-gauge wire spaced 3 ins. apart.

The top or dipole section of the aerial was designed for 28,500 kc because it is best to cut the roof to the length necessary for the highest frequency band.

Since on 28 mc the top is two wavelengths long, the physical length is somewhat shorter than four times the length for a dipole at this frequency, owing to end effect.

The length may be calculated from the formula:

$$L \text{ (ft.)} = \frac{492 (N - 0.05)}{\text{Freq. (mc)}}$$

Where N = the number of half-waves in the top (4 for 28 mc). The stub length is given by:

$$L \text{ (ft.)} = \frac{234}{\text{Freq. (mc)}}$$

The stub length is actually made 17 ft., so that on 14 mc the feeder taps on a few inches above the bottom end.

Adjustment and Operation

Begin with 28 mc. Attach the co-axial feeder to a point roughly half-way down the stub, inserting an RF ammeter in series with one side of the co-ax at this point.

The clips are now moved above and below this position about 2 ins. at a time until maximum current is indicated. At each setting the coupling of the PA tank circuit link is adjusted for constant power input to the PA. The stub wires are marked when the correct position of attachment is found. The same process is employed to determine the position for 14 mc with the feeder clipped on near the bottom.

EDITORIAL NOTE: The system described above is from a design by the late GM6LS.

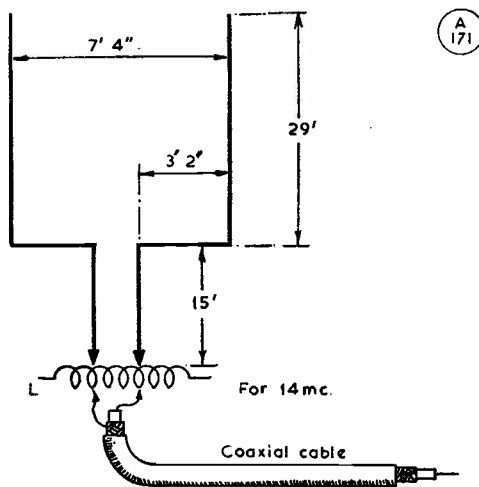

Fig. 4. Layout and dimensions, for 20 metres, of the horizontal "Pitchfork" suggested by VK2NO. When found, the tapping points on the coil are taped and sealed, the arrangement not being particularly frequency conscious within the band. It will give a 4 dB gain over a dipole, or about one S-point at the distant station.

THE 20-METRE PITCHFORK

A span of 30 ft., with two supports in the best line for bi-directional dipole coverage, will be needed. If the dimensions given are adopted, use for L eight turns of $\frac{1}{4}$ -in. copper tube 2 in. in diameter (14g. wire would do equally well). The system can then be resonated where you want it in the 14 mc band. The coil is arranged on a strip of good insulating material and placed at the end of a stub shortened from the usual 17 ft. quarter-wave length to about 15 ft. The stub wires are connected temporarily by clips to the coil, and the system excited either from another aerial or by linking the coaxial line via a two-turn loop around the centre of L. A thermo-couple meter can be connected *pro tem* in series with one side of the stub to indicate resonance, or the usual field strength meter placed adjacent, or a sensitive meter-indicating absorption wave-meter can be used.

Once the proper adjustment for resonance has been found, remove the clips and solder good solid leads permanently in position at those points. The next move is to adjust the coaxial line for correct match by clipping either side of the centre of L until standing waves are at the minimum, and when that process is finalised, permanently to solder those connections also. It will be found that the system is applicable to lines of impedance between 50 and 120 ohms, or of course, for 300-ohm twin-lead such as Telcon.

DX COMMENTARY

L. H. THOMAS, M.B.E. (G6QB)

THE same sunspots that are supposedly making things better for us are also responsible for a relatively poor month. The constantly-increasing number of spots leads us towards the peak of the eleven-year cycle and causes a *long-term* improvement in DX, raising of the MUF, and so on; but the irruption of one enormous solar flare, associated with one particularly large spot, can cause severe ionospheric storms which in their turn cause fade-outs and play havoc with communications in general. After one of these storms it is some time before conditions return to their previous level.

Thus it is our sad duty to report that the period April 15-May 15 was not nearly so good, from our point of view, as the previous thirty days or so. Even so, the HF bands are tremendously lively compared with a year ago, and there is really nothing to grumble about! We have a very large post-bag again, and will take the reports on the bands as they come, starting at the HF end.

Ten Metres

Despite the unfavourable conditions, *Ten* is still pretty well populated at times, and some nice pieces of DX have been extracted by those with the patience to scour the band frequently. G2CDI (Stokenchurch) added YS10, YN1HF and ZP5JE to his list, and also worked numerous ZS's, VQ2, 3 and 4, CR9, CX, PY, VS1 and the like.

G3GGS (Preston) raised MP4QAL for an all-time new one; new ones for this year were LU, OQ5 and VQ4. Others worked were ZS, CX, 5A and a W5 in Mississippi for a new State. A



ZCSCT

CALLS HEARD, WORKED and QSL'd

good contact was K6LCW, coming in at R5, S5-6 with a Collins transmitter running 3 watts! (All the above on phone.)

G5BZ (Croydon) had only one QSO on 10 metres—with OQ5BK on phone. G2DC (Bulford) finds the band has fallen off, but reports working JA3JM and 9BE, VK6FL, VS6CL, KP4CC and CN8GF. XE1A was heard but not worked.

GW3AHN (Cardiff) has booked in 32 countries on *Ten* this year, recent additions being HK3AB, HP1EH, PZ1AD, VE7MT and ZD8SC (all phone) with VS1GV, CR6 and W7 on CW. He says the band has deteriorated during the past few weeks, but there is usually something interesting to be found.

G6VC (Northfleet) spent two whole days on the band and only made three contacts — VQ2GW, ST2NG and KA2MA. G3JLB (Gravesend) also worked ST2NG, on CW. For G3HCU (Chiddingfold) interesting 10-metre contacts, among a cloud of ZS's, were with VK6GU, VQ5GC, ZD4BV and ZD8SC; he had a total of nearly 50 QSO's between April 15 and

May 13. But he agrees that conditions have been "not so good," even though 28 mc phone has given him 14 new countries in the month!

Fifteen-Metre DX

The former terrific population of 21 mc has thinned out slightly, and we rather imagine that this band will not be on top of its form again before the autumn. However, there is something going on all the time, and many of the 'chasers comment on the fact that DX from all parts of the world can sometimes be heard at the same time.

G2CDI raised his 21 mc score with VP8BT, ZD9AD, KW6CA, 9S4AL, HB9BX, VP9BO, 4S7GD and EAØAC; he also had a doubtful contact with BV1US (Formosa), who was not really readable; and worked VS1, ZL, KA, VP8, KR6, CR9, KH6, KL7, CR5, ZP and UQ2AN (who has QSL'd).

G3FXB (Southwick) found the band open *all night* on occasions, and with a path to KH6, W6 and 7, VE6 and KL7 sometimes in the

early mornings. Around 0100 GMT one day he heard MP4, OD5, VE7, VK, ZL, PY, LU and the whole of W. On phone he raised CR5, CX, DU, EL, HC, KG6, KR6, PJ, VP4, 7 and 9, VR2, VS1 and 2, YN, ZD2 and 9S—a nice bunch of varied DX—and on CW he collected FK8AO, HL1AB, W4IKC/KW6 and XZ2OM; EA0AC was heard on phone, and G3FXB also reports SV6FP as active.

New ones for G3GGS were VS1, 4S7 on phone, and KW6CA on CW. Others were VQ4, VE5, KA, VP6, Nevada and New Mexico—all phone. G8LG (Sunningdale) tells us that he was another who raised FS7RT 'way back in February. Since then he has worked VP1EE, 1EK and 1JH, PJ2AA, 2AB and 2AP, PZ1's, VP3YG, HR1LW, ZP5's, VQ6LQ, VP5RR (Turks) and FM7WN; G8LG runs an LG.300 with a separate dipole for each band.

G5BZ raised KW6CA at 1310 GMT on a dead band, and heard him four days running at about the same time—the first KW6 he has ever heard! Other DX was JA3BB, ZL3GU (2235), VK (2155), ZP6CR, FB8BX, ZD9AD and VS1GV (1945). 'BZ, like others,

comments on the "horrid lot of rude noises" filling the 15-metre band these days, and wonders whether the owners of these jammers can't measure their frequency, or what. (Our notion is that the band is used as a parking ground for the things, which are not switched off when out of use, but just shifted to another frequency. Unfortunately, we are the sufferers. But what use are jammers, anyway? The whole insane business of building a complicated piece of apparatus to radiate an objectionable noise is a sign of the times, one feels.)

New ones for G3KHE (Birmingham) were 4S7, KD2 and KG1; he is another sufferer from the nasty noises just mentioned. GM3JZK (Inverness) collected EL2FC/MM, off Brazil, VK's, OQ5 and the like on a 30-ft. wire. Gotaways were KX6AF, ZS7H and ZD8SC.

G2DC found this band fairly consistent and reports that May 11 was a good day, with signals from W6, VE7, VQ5 and VK all competing and all workable from G-land up to midnight. On such late sessions the signals from VE7ZM, VK2QL and VS1GV have been outstanding. The

Pacific Coast of U.S.A. has been good, and KH6AYG has been a regular S7 signal. Best contacts were VS1GV, 4S7GE, VQ5SC, VP8BT, ZP6CR, HP1EH, CE4AD, KH6AYG, VE5OC and 7ZM, and HL1AB, who appeared at 1000 on May 8 and seemed to be genuine, asking for QSL via W6NMJ.

GW3AHN has now worked over 150 countries on Fifteen (120 on phone). Since January 1 this year the score is 90. Among the best we note CR5, FB8, FS7, VP2, VP5 (Caicos), ZS7—all phone; FM7, I5, KH6, KL7, VE8, VQ6, VP8's, ZD9 and ZS7—all CW.

G3JLB comments on the late openings, and worked WN7AOZ and W5FT after 2330 GMT, leaving the band still open when he turned in; CE3AG was a new one for him. G3HCU worked HK2GO, TG9AZ and ZL2AGD among some others, but did not spend a great deal of time on 15 metres; however, the band gave him four new countries.

The DX on Twenty

We have actually reached the stage when Ten and Fifteen claim more attention than The Old Reliable, Twenty. This is possibly because so many 'chasers want to fill up the gaps in their Countries Worked lists on the other bands, having collected just about all that Twenty can offer. The band itself remains good, with plenty of activity of all kinds, including a particularly foul set of parasitics from Some Thing operating just below the low edge.

G3GGS has only been working the band around 2200 or later, when it is usually good for South America. His best was a phone QSO with ZP.

G3JKF (London, W.5), after being on Eighty for four years, has changed QTH and spent a month entirely on Twenty CW, with 100 watts to a long wire. He collected about 35 new countries, averaging at least one a day, and including ET2LB, FB8ZZ, HK3PC, KG1FR, KR6QW, OD5LJ, PJ2AW, PZ1AM, VK7CH and ZD2FNX. Other DX was CE, JA, KP4, VQ3 and 4, VP6 and 9, VS1, VK and all W call areas.

G8LG reports working M1B, HB1OP/HE, HP1CC and 1FL.

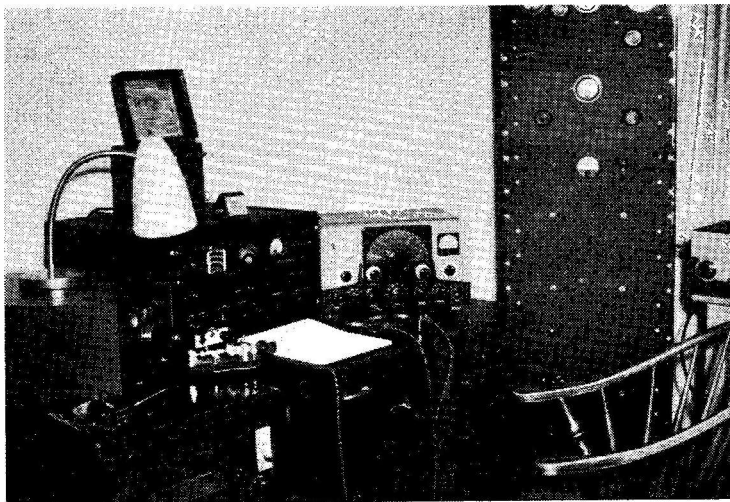

Station of VE2LI (ex-G5LI), now of Montreal. The transmitter on the right runs 500w, to a pair of 813's in push-pull. Beside the AR88, on the desk, is a 75-watt CW/phone all-band (160 to 10 metre) transmitter and to the left of the AR88 centre-piece is the VFO unit for the 500w. job. There is quite an array of aerials at VE2LI—ground-plane for 14 and 21 mc; a 135-ft. end-fed for all bands 160 to 10 metres; and a dipole for 28 mc. The low-pass filter in the aerial lead gives an attenuation of 75 dB on all frequencies above 45 mc, which takes care of the vulnerable channels in the Montreal TV area.

and VP5BE (Turks). G5BZ collected such nice ones as JZØPS (?), DU9JO, KH6, FB8BF, LU4ZV (Hope Bay, San Martin Land, wherever that is!), AP2RH, KG1FA, VP8BC and OH1RT/Ø (Aaland Is.).

GM3JZK worked OX3KW, VE8RR and PZ1BS; then, as G3JZK (Cambridge), he raised UA1KBB, who was having the time of his life working all and sundry. G2DC did not spend much time on 14 mc, but thought general conditions were good, with early mornings producing shoals

of W6, W7, VK and ZL. VR2CV has also been very consistent.

New ones for G6VC were ZD4 and HS1. G3JLB added CX5CO and CT3AB.

In a later note, G3JKF adds some more new ones on Twenty, mainly during evening sessions, and among calls he mentions are CO2BM, CR6AI, CT3AB, F9SF/FC, FF8BF and ST2NG, together with some ZL's; both "HV2AB" and UA1KBB came back to CQ's.

Forty and Eighty

These two bands are almost being left alone now by the DX fraternity, although they carry their fair share (or perhaps more than that?) of locals. But the attraction of the HF bands has pulled away even those who used to like getting their DX the hard way.

G2DC, however, says of *Forty*: "What a joy to be able to listen on this once famous DX band with a reasonable chance of hearing any DX that might appear. With Radio Pakistan, the last of the 'Tin Pan Alley Brigade' removed, the band might come into its own again." Nothing exceptional heard or worked, but normal W, VE, VK and ZL contacts during the early mornings.

G3JZK heard LA9PA/P (Spitzbergen) on *Forty*, but didn't raise him.

Sundry correspondents mention *Eighty*, but only to report odd European contacts, which we don't regard as DX any longer, so let us say that if anyone really is working DX up there still, they haven't told us.

Top Band Topics

G3GGS reports more activity than last month, and he raised Nairn, Ayr and Pembroke. G2DC kept up his reputation as an all-band station by having a fling up here with 0.2 watt, making several good G contacts.

G6VC has QSL's to hand from Wigtown and Peebles, and wants to thank the Expeditionaires for their efforts. G2HDR (Bristol) makes a similar report and adds that he now judges the state of the band from the strength of the Loran transmissions.

G3KOG (Ulceby) likewise has his "Easter-egg" cards; and so

has G2FTK (Coventry), who also worked Lanark, Banff, Ayr, Nairn, Midlothian and Pembroke.

Reference last month's remarks from GM3GZA (Lewis), 'FTK reports that he worked him, and it was a 100 per cent. contact, despite the Loran.

G3HEK (Oswestry) says he can be relied upon to keep the Salop flag flying, most evenings after dark around 1837 kc. He is looking for Suffolk to complete his G counties, together with many of the "rare" GM's and GC's; he has a QSL from HB1CM/HE, and has worked plenty of HB's and OK's. As it happens, G3IGW's "mystery trip" to Denbighshire was located only about eight miles from 'HEK, but as he didn't know anything about it at the time, they didn't meet.

G3HUB (Chelmsford) is toying with the idea of an expedition to the Scillies during his holiday (July 21-August 4). He will not be operating continuously, as it is intended to be a holiday, but will make skeds if they are desired, and would like to know the general opinion about the best frequency to operate on.

G3JHH (Hounslow) hoped the Whitsun expeditions would bring him Merioneth and Brecon, and is also surprised at the absence of signals from Berwick. He has found the GM's and GW's still coming through in good shape.

G3KEP (Bingley) collected Monmouth, Nairn and the G3IGW spots, but would like some activity from Brecknock, Carmarthen and Radnor—also a QSL from Montgomery!

G3IGW (Halifax) writes in with first-hand information about the Easter trip, and tells us that they chose Wigtown and Peebles "by popular demand," but could not decide on a third and eventually thought up the North Wales one at the last moment. They travelled in an Austin A.30, well laden, which stood up well to the rigours of the long journey, as did the gear and the weather. In Peebles, owing to a slip-up over accommodation, they eventually located rooms in a turret of a converted castle and were able to throw out a fine aerial 300 ft. long and 50 ft. high. In Denbigh they

TOP BAND COUNTIES LADDER

(Starting Jan. 1, 1952)

Station	Confirmed	Worked
G5JM	97	97
G2NJ	97	97
GM3EFS	96	96
G6VC	94	94
G3JEQ	94	94
G2AYG	88	89
G3HEK	86	89
G3GGS	86	88
G3JHH	84	85
G3BRL	83	83
G3KEP	79	81
G3ABG	75	79
G3DOQ	74	74
G3AKX	72	73
G3IXA	71	83
G3JJZ	71	76
G3HZM	70	71
G2FTK	66	83
G3FNV	65	74
G3KOG	65	69
G2CZU	63	67
G8KU	63	65
G3KKZ	60	64
G3JNX	60	61
G3EJF	57	64
G8CO	56	67
GM3JZK	54	55
G3KLP	48	52
G2HDR	39	54
G3HQT	39	44
G3ICH	32	51
G3KMQ	24	54
G3JZP	20	42
G3JME	16	25
G3JSN	13	27

also had 300 ft. out, but not very high and bent round the garden. By this stage they were so tired that one member went to sleep while keeping the log!

Final Note: The "mystery trip" in the autumn will probably be without radio, G3IGW admitting to having been "caught" at last! We hope that when the YL becomes an XYL she can be induced to see the point of DX-peditions.

Top Band DX

Next season's Trans-Atlantic tests will take the same form as the last series, with no organised dates but activity *ad lib* every Sunday morning. WIBB asks us to say that during the 1956-57 series he will send a handsome hand-coloured and appropriately-worded "Award" QSL to all DX stations working him on that band. Special lettering will note the event if it is a first QSO. This "king-size" QSL (10 by 14 ins.) will be practically another Certificate for the walls of the collectors. In addition, SWL's who report on WIBB's signals during seven or more tests in a given season will be sent one of these awards with due thanks for their reports.

Miscellany

G3FXB remarks that the Russians seem more or less unworkable still, apart from odd ones like UC2AA (who now says QSL *via* a Box No. in Sofia). UA1KBB has already been mentioned, and there is a UB5 working all and sundry on 21 mc. UA9CC has also been raised there without difficulty. On the other hand, recent press reports of "mass attempts to communicate with the U.S.A." on the part of Russian amateurs seem to have been grossly exaggerated. It is practically impossible to prevent the mass-circulation newspapers from putting out these sensation "stories," as they call them, usually based on the flimsiest evidence and forgotten in 24 hours.

G3KSU (Chelmsford) complains that a pirate is using his call, and probably *was*, even before it was allocated to him. He has received SP listener reports for transmissions of last year, and he didn't



W2APF of Albany, N.Y. (standing, right) is a roving reporter for the NBC of America. He was the W2 mentioned in our note on p. 161 of the May issue. Here he was visiting G3LB of Ripon, Yorks., who duly fed him "the genuine Yorkshire pudding" talked of in the BBC interview. The G3LB all-British equipment shown here consists of a Panda PR-120-V transmitter with a Radiovision Commander receiver.

get his ticket until this January. Since then he has been on Top Band and Two Metres only; on the former he gets around G-land very well, but can't yet raise the OK's.

We have an enquiry from SWL G. Boys (Woking) about the call

LJ3D, calling CQ and getting no replies. This is a regular one, and we can only repeat that LA, LB, LF, LH and LJ calls all belong to Norway and are allocated to amateur stations in different categories—Navy, Army, Air Force, Police reserve, Scouts

and so on—though we can never remember with accuracy which prefix is what! The point is that they are all ordinary Norwegian amateur stations.

Another SWL, R. V. Tapp (Penshurst) wonders who GB9IK might be—he was being worked by 5A1TZ on 14 mc phone. We would guess that it is a home-made call-sign.

News from Overseas

VE7AFP (Victoria, B.C.) runs 50 watts and an Eddystone 750, but says DX doesn't come easy to him! On 80 he has raised KH6 and XE; on 40, KH6, KJ6, KP4. On 20 he has heard KJ6BN, VR3B and VR1B, without raising them as yet. KB6BA is also very active. Now 'AFP has just started up on Fifteen and, despite quite a lot of DX, has not yet worked G-land, which he only left three years ago. So look out for him on that band.

VE2LI is, of course, ex-G5LI, now in Montreal. George sends 73 to all the old DX gang, along with news of doings on all bands. He strained his ears on the Top Band last winter, without result; however, he did work W9, WØ, KV4 and KP4 on One-Sixty. He raised plenty of G's on 80 and 40 during the season, and had five-band con-

tacts with G2DC, G4CP, G5R1 and G6ZO. Most of his DX is worked with 75 watts, but a QRO 500w. rig is available. One thing that is new is having to get up at unaccustomed hours to work DX! A 135-ft. wire serves for all-round DX, with a 20-metre ground-plane to fill the gaps, and plans for a beam are under way. Then there is a 10-metre dipole, too! In all, VE2LI seems to be keeping up the old tradition pretty well . . .

VS2CP (Selangor) has been back off leave for some time, but has not been able to do much radio. However, he says Europe is getting out there well on the short path now, but if a few more people would put their beams over South America between 0730 and 0900 GMT they would undoubtedly get long-path contacts.

ZB1HKO (Balzan) worked two G mobiles, both using CW on Ten—also OD5 and OY for new ones. KH6 was worked on Fifteen, using a 20-metre ground-plane. A half-wave for Top Band is going up, and ZB1HKO will be looking for G's again up there—spasmodically in the summer because of static, but certainly next winter.

JA1CR (Tokyo) joins the Five-Band Table and is chasing all the available certificates. He says the

MAGAZINE DX AWARDS

Will all readers, particularly overseas, please note that the conditions for the award of our various DX Certificates appeared in full on p.538 of the December 1955 issue, and a complete list of U.K. Counties on p.20 for March, 1956. Much needless correspondence is being occasioned by individual requests for details governing the issue of this-or-that Certificate, and the definition of Counties for the WBC Award.

hardest parts of the world to work from JA are ZD4 and the West Indies. On the other hand, "locals" who are active are CR10AA (14043, T8), KS6BA (14033), YJ1AA (14060), YJ1RF (14097), AC3SQ (14075) and VR1B (14080). JA1CR also tells us that the "WJDXRC" award is available to anyone sending five QSL's from members of their club, with five IRC's. Members are quite numerous—ask any JA contact whether he belongs. They issue a fortnightly club bulletin to members anywhere in the world.

MP4BBW (Awali) says things are more difficult there now because of static, but during the evenings and early mornings DX is quite good. The 21 mc band is alive between 0130 and 0500 GMT, and 28 mc has provided openings to CX, LU, PY and CE around 1700 GMT. South Americans and W's also appear on 14 mc around 0200, but the QRM is a bit much. New ones worked during the month on 21 and 28 mc were HA, GC, SVØ, DU, CR6, VE8, VP6 and PJ.

ZD6RM (Blantyre) has got up a Vee-beam to try to get into his home-land (GM) better, and it works; he runs 100 watts to 807's, all bands from 80 to 10. A new ZD6 has just been licensed—ZD6BR (c/o K.A.R., Zomba), but only has a B2 as yet, on 40 and 20. ZD6BX is active on 20 CW, sometimes also on 80, 40 and 10; ZD6RD is phone only on 15 and 10. Ten is very good down there, W's disappearing and VK's taking their place in the mornings.

**FIVE BAND DX TABLE
(POST-WAR)**

Station	Points	3.5 mc	7 mc	14 mc	21 mc	28 mc	Countries	Station	Points	3.5 mc	7 mc	14 mc	21 mc	28 mc	Countries
DL7AA	719	102	160	220	125	112	225	G3IGW	211	40	53	64	45	9	88
G5BZ	643	64	115	236	135	93	241	GM3EFS	209	25	39	97	27	21	107
W8KIA	617	61	145	255	51	105	255	G2DHV	175	19	25	112	7	12	113
G3FXB	587	67	124	190	143	63	201	MP4BBW (Phone)	172	1	5	47	63	56	90
G4ZU	534	12	45	215	138	124	222	G3JLB	162	31	28	49	32	22	74
W6AM	494	30	58	264	85	57	264	ZB1HKO	153	18	25	51	39	20	61
G3FPQ	456	52	64	145	124	71	169	G3IUW	143	30	32	32	35	14	72
W1VG	450	25	113	170	88	54	178	G3JWZ	140	41	44	41	10	4	69
G2YS	428	61	79	146	87	55	162	G3HSM	129	14	43	44	25	3	63
GM2DBX (Phone)	382	33	31	158	79	81	169	G3JJZ	109	21	31	48	7	2	58
G3ABG	364	45	83	157	49	30	165	G3JVJ	107	10	53	26	16	2	65
G8KU	364	23	52	161	53	75	170	G3GZJ	104	17	27	31	23	6	47
W6AM (Phone)	325	13	32	220	39	21	220	GM3DOD	71	10	15	36	9	1	40
JA1CR	280	15	49	151	55	10	152	G3HEV	47	8	19	16	3	1	28
G6VC	273	27	33	129	54	30	136	G3IDG	44	11	10	6	1	16	26
G3INR	265	43	51	101	50	20	114	G3JSN	29	13	8	5	2	1	17

SWL E. Elsley (s.t.s. *San Florentino*) reports this month on his voyage from Australia to Bahrein. On 21 mc he logged some KH6's and an LA early in the trip, followed by JA's, VK9 and more KH6's. Other DX coming up later on included FB8BZ and VS2DQ, with the G's breaking through as he neared the Persian Gulf.

DX Strays

The frequently-threatened trip of FB8BR to Comoro Is. is now expected to happen in June, but no date is fixed . . . VE7ASL/VR3 is said to be active on 28480 kc phone—South Pacific Airways. Christmas Island . . . VR1B has been heard many times in Southern England, both on phone and CW; he apparently uses phone on the same frequency (14080) as his CW . . .

ZE3JO tells us that he has been allotted VQ1JO for operation on Zanzibar, August 13 to September 4. He will be using a B2, CW on 14 mc only, and until he reaches the Island he doesn't know what aerial prospects he has; but Mal hopes for a wire at least 150 ft. long. Operating hours will depend upon local conditions and the ruling of the XYL; as many stations will be worked as possible—*quickly*—and all QSL's will be

answered *via* the RSSR QSL Bureau, which is ZE3JO himself.

ZB2Q (New Camp) says he was suspected of being a pirate when he first came on, so to make sure there's no repetition of this he notifies us that ZB2R and ZB2T are now also on the air, from RAF New Camp. All three of them operate ZB2A whenever possible.

SVØWO passes on the information, *via* G3KLC, that the address for all SV QSL's is now P.O. Box 564, Athens. All previous QTH's are unreliable.

VS5AT is a new one operating from Brunei; VS4NW is on 14 mc phone from Sarawak; XW8AB, after an illness, should now be active again.

Brand-new One

WØAIW and a group of other WØ's plan an expedition to Socorro Island, of the Revillagigodo Group, some 500 miles west of Mazatlan, Mexico. They will be sailing from the latter place on June 4 or 5, and will operate from the island for four or five days with the licensed call XE4A. It seems from ARRL correspondence that it is likely that this island will be granted "country status."

Aves (Birds) Island, YVØ, also appears a suitable candidate for country status, and an expedition to this one is planned for July 1-8.

The shortage of new and accessible islands is said to be causing more consternation than the absence of stations in Tibet . . . after all, if you have worked all the countries in the list, the only thing left is a longer list! (Incidentally, we hope to publish a full and up-to-the-minute List of Countries very shortly.)

More Strays

CR10AA seems genuine enough—around 14082 kc with a chirpy T7 note . . . Neville of VQ5GC hopes and plans to operate from VQ1 and VQ9. The latter expedition (Seychelles) will not be until towards the end of the year, and he expects to be there for about fourteen days, covering all bands on phone and CW.

FU8AC has been active on 14 mc, as well as FU8AA, reported

last month on 14, 21 and 28 mc . . . OY2A is around on 28 mc CW . . . FG7XB can often be found in the region of 14080, mornings; last time we heard him there was such a brouhaha over VR1B nearby that nobody would answer his CQ's.

VP2LH (St. Lucia, Windwards) has been heard and worked on 14020 kc (0130 GMT) . . . AC5PN does exist, but there is also a not-so-good one apparently in Europe . . . FD4BD is a nice one (14020, 2300) . . . AC3SQ now has a BC-610 and has been logged on phone, 14100 . . . KA7HH plans to go to Iwojima (KAØ) about the time of the next International DX Contest.

Cdr. Attilio Gatti is under way

**Short Wave Magazine
DX CERTIFICATES**

The following have been awarded since the publication of our last list, in the March 1956 issue:

WFE

No. 22 W2QHH (Hamilton, N.Y.)

FBA

No. 60 I1BPW (Ancona)

WNACA

No. 95 G4QD (Rainhill)
96 G8PL (London, N.W.3)
97 G3FXB (Southwick)
98 LA3DB (Bodo)

WABC

No. 122 GM3JFG (Invergordon)
123 G3IXA (Leamington)
124 G3KKZ (London, S.W.16)
125 G3KOG (Ulceby)
126 G3JVU (Gravesend)
127 G3JVR (Queenborough)
128 GM3AUD (Avoch)
129 G8FW (Epsworth)

WBC

No. 10 SM5AHK (Stockholm)
11 SM5CCE (Bromma)
12 VE3HB (Toronto)
13 W4THZ (Easley, S.C.)
14 W3OP (Slatington, Pa.)
15 W8YHO (Akron, Ohio)
16 W6GPB (San Rafael, Calif.)
17 SM6ID (Gothenburg)
18 LA2MA (Skien)
19 I1ER (Milan)
20 SM5WI (Vasteras)
21 SM5BRO (Stockholm)
22 SM6AMR (Gothenburg)
23 FBGB (Conflans)
24 W2QHH (Hamilton, N.Y.)
25 VU2JP (Munnar)
26 EA2CR (Pamplona)

Details of MAGAZINE DX AWARDS and CERTIFICATES, and the claims required for them, appeared in full on p. 538 of the December 1955 issue. A complete List of U.K. Counties was given on p. 20 of the March 1956 issue.

21-28mc MARATHON, 1956

Station	Total	21 mc	28 mc
G2CDI (Phone)	131	120	70
VQ4RF	113	47	80
G3HCU (Phone)	104	130	81
G5BZ	78	65	38
MP4BBW (Phone)	74	56	51
G2DC	69	57	33
G3KHE (Phone)	58	54	18
G3GGS	46	24	31
ZB1HKO	42	39	19
GM2DBX (Phone)	37	37	4
G3GZJ	20	14	6
G3JVJ	16	16	2
G3JWZ	14	10	4

with his thirteenth African expedition, making films for TV networks. Extensive radio gear is carried, and the chief op. is ZS6HG. They may show up in VQ3, 4 and 5, OQ5, OQ0, FQ8, ZD6, ZE and ZS7, among other places. Activity will be mainly on 14 mc SSB . . . Talking of SSB, KC4USA is using it on 14210 kc from Little America. The SSB exponents have some real rare-DX to choose from these days (remember FS7RT?)

F9RS reports that a station signing FE8AC will be on from Togoland shortly, so don't be misled by the prefix into thinking he's somewhere else . . . CE0AD on Easter Island is inactive—the officer at present stationed there is apparently not interested; his relief, next year, may be more enlightened . . . You only have another month or so to work Chagos; VQ8CB packs up by August and is possibly settling in ZL; he has been the sole representative of Chagos, as far as we know, and, when he leaves, the island will be off the air, except for possible expeditions.

FW8AB, according to VR2CG, is on every Sunday, 0600-0800 GMT, 14040 kc . . . W7FNK/FO8AI hopes to cover both Tokelau and Nauru this summer . . . JZ0PS works numerous W's, 14060 kc, but is apparently suspect still . . . HV1A no better than any of the other "HV's" that have shown up through the ages.

UPOL4 calls himself Victor and gives QTH as "USSR Expedition on Nord Golus." Now where do you suppose that might be?

VK9 is a prefix that needs watching, since it can cover four countries—Papua, New Guinea, Norfolk Island and (eventually) Nauru. At present VK9RH is on from Norfolk Island; VK9TW will be the call of Danny Weil (now VR1B) when he gets there.

ZS5YF is now G5YF yet again, and has apparently signed as radio officer on a new tanker . . . A new hazard down in ZS is "FSI" (Fire Service Interference). A ZS5 recently suffered from it while working on 7 mc—it was his 12th harmonic that caused the damage!

Thanks, for many of the above



“. . . And you can tell them I will QSL a hundred per cent . . .”

items, to W6YY, Northern Calif. DX Club, West Gulf DX Club, KV4AA, E. D. Riggle (Massillon, Ohio) and "Haywire News" (South Africa). Also, needless to say, to many individual correspondents who continue to include short notes of DX interest with their reports on their own doings. Keep it up, please!

Eleven-Year Itch

An effect of the coming sunspot maximum that has been apparent to many observers is the bringing

out of hibernation of quite a few Old Timers, who have been absent from the DX bands for five years or more. Perhaps they have been on Top Band or Two Metres, but they certainly have not been heard working DX—and now, there they are again.

Yet another effect is a profound change in the meaning of the expression "DX." A few years back it might have applied to a W6, a VK or a ZL—but not now. These estimable chaps have become the QRM that gets in the way of the DX, which is composed

of the likes of VR1, VR3, KX6, KJ6, KW6, ZM7 and all that.

This effect also works in the reverse direction—the stations that used to think we were DX now pass us over! A W station in one of the rarer States calls "CQ Europe," but what he's really after is an LZ, a UB5 who will answer him, an OY or an HE; possibly even a GC or a GD, but certainly not a G, GM or GW. We all have to readjust accordingly. Fortunately for those who like rag-chewing and don't devote their entire life to looking for new ones, there are still plenty of operators everywhere who are more satisfied with a good solid QSO than anything else.

Any Answers?

We should like *your* opinion on a question that is being hotly debated over the air and in amateur publications everywhere—to pay or not to pay for rare QSL's? More than one expedition at present out in the blue is only supplying QSL's at one dollar a time (or the equivalent). Is this right, and is it a good thing for Amateur Radio?

One point of view holds that these expeditions have to be paid for; another says "the bloke need not go there if he doesn't want to, and why should we be made to pay for working an amateur station anywhere?"

If a rare DX-pedition can claim, and get, a dollar per QSL—and works 2000 stations in a few days—we begin to feel that we are in the wrong trade! Possibly an even rarer one will announce beforehand that his price will be five dollars. Is this good or bad? What do *you* think?

And that ends the offering for this month. Please keep up the flow of news, which is increasing month by month, and let us have the next instalment by the deadline, **first post on Friday, June 15.** (For the benefit of overseas readers, the following one will be *July 13.*) Address everything to "DX Commentary," *Short Wave Magazine*, 55 Victoria Street, London, S.W.1.

THAT ORIGINAL MELBA BROADCAST

In 1920 VK2NO, as he is now, was 6XG at Birkdale in Lancashire. From there, on June 15 of that year, he heard the Melba broadcast from MZX, Chelmsford, referred to on p.29 of our March issue. The receiver was a massive "loose coupler" (tuning range unknown) with a carborundum-steel spring detector, followed by a three-stage "note magnifier" (as used in the trenches in the Kaiser's war) fitted with French R-valves; this assembly of equipment drove a speaker consisting of a horn fixed to a 4,000-ohm Brown's telephone earpiece. The aerial was a 6-wire cage 200 ft. long, with a fan counterpoise disposed symmetrically beneath it! The receiver was good enough to get spark signals from ICN in Italy, BYW in Malta and FL, the Eiffel Tower station, as well as ship-DX on the 600-metre international marine waveband. Great days!

ETHICS of QSL'ing

This is a perennial topic, and probably never will be solved to the complete satisfaction of everybody. To a lot of amateurs, especially if they have been in the game for many years, QSL cards are nothing but a nuisance; they just do not want them. Others are interested only in rare QSL's—and what may be of uncommon value to them might not be of any interest at all to somebody else. In other categories, there are those who ask for a card only when they really want it, or are looking for cards to complete the tally for some certificate award. Then there are the operators who, perhaps in the majority and nearly always the more recently licensed, gaily QSL anything and everything, regarding it as a courtesy as well as a duty to QSL all contacts; naturally, they expect cards back in the same ratio, and are generally disappointed.

It would seem that the golden rule for the average amateur is always to QSL immediately on receipt of the other man's card, irrespective of whether it has been asked for and even if it is not wanted—thus, courtesy is acknowledged and duty is done. For his

part, if wanting cards from particular stations, he should send his own first. The oft-repeated "Sure QSL, OM" should be honoured in the observance and not regarded simply as a form of words when signing off with a foreigner, entailing no particular responsibility. The procedure signal QSLL—"I will send a card in exchange for yours"—is not used as much as it should be these days, perhaps because its meaning has been lost among the newer generation of amateurs.

At many active stations, the burden of QSL'ing is very heavy; this is a fact to be borne in mind, particularly by SWL's, who must appreciate that, generally speaking, it is as much as the DX man can do to keep up with the QSL's for the stations he works, let alone from those who want his card merely because they hear him.

YOUNG OPERATORS' NET

Licensed amateurs under 19 who would like to meet others of the same age over the air are invited to join the G3KEP-G3KKZ-G3KLH 160-metre net on 1860 kc at 2330 clock time each Saturday evening.

INTERFERENCE SUPPRESSION

The G.P.O. has produced a hand-out leaflet, obtainable free at all main Post Offices, showing how domestic appliances can cause local TV and radio interference. The legal situation is clearly explained, with the obligations of the user of noise-creating appliances, the rights of the afflicted viewer or listener, and the action the G.P.O. itself is empowered to take if co-operation is not forthcoming. The object of the pamphlet is, however, not so much to lay stress on the sanctions as to encourage a "good neighbour" attitude on the part of all concerned.

MORSE TEST — INCREASED FEE

We are officially informed by the G.P.O. that the fee now charged for the Morse Test is 10s. Tests will be conducted by the Post Office on request at a number of convenient centres—see p.327, August 1955 issue, *SHORT WAVE MAGAZINE*.

THE RESONANT WHIP FOR MOBILE WORKING ON TOP BAND

RESULTS AND CONCLUSIONS FROM AN EXPERIMENTAL INVESTIGATION

THE writers approached this subject with a little basic theory and a few ideas—but no practical experience at all. In the first place, the object was simply to get mobile in the 160-metre band. It was felt that, as time went on, enough experience would be gained to settle on an effective system, it being realised from the beginning that in the aerial lay the clue to really successful results.

Indeed, some first rather hit-or-miss tests with a loaded whip—which can be defined as a rod aerial brought to resonance by means of a series loading coil, the whole mounted vertically and fed at the base—soon showed that unless the aerial *was* right, nothing much could be expected beyond local ranges of a few miles.

It was also found that, by means of a pi-section coupler, it is quite easy to load up on a vertical rod of, say, 8-10 feet in length, having a loading coil of some random dimension in series, such that the system as a whole can be made to draw power. Over short distances, up to five or seven miles, quite impressive results can be obtained with such an arrangement—anyway, good enough to impress a beginner in the mobile art.

But, as the writers will endeavour to show, there is much more in it than that. The radiating efficiency of a simple end-fed system, in this context, is, in fact, very poor; range falls off rapidly, and it becomes exceedingly difficult to keep the output tuning at resonance. This is in spite of the fact that RF and plate meter indications would suggest that the system is working quite well.

The Operating Mode

The reason why the arrangement is not really effective is because the aerial is working as a resonant end-on—that is, as an aerial very short in relation to the frequency and poked out, as it were, from the earthy mass of the vehicle. This is a very different thing from making the aerial a resonant quarter-wave, with the car body and its capacity to ground as the “other half” of the radiating system.

What it comes to is that, for really good results, one must aim for an effect akin to the ground-plane mode. In this, the whip-plus loading coil is one element in the system, and the car body with its own capacity to ground the other.

If this condition is achieved, the radiating efficiency goes up considerably and the whole aerial system, as a load on the transmitter, becomes much more docile and consistent. The problem is, therefore, to avoid tuning to the resonant end-on condition and to find the ground-plane mode.

In general, it can be stated that the ground-plane effect is present when the system is being fed at maximum current with a coil of reasonable dimensions in series with the whip. (At this stage, what is meant by “reasonable dimensions” is a coil which looks as if it should tune the 160-metre band.) It is easy to check on the mode, whether end-fed or ground-plane, by using an RF meter in the aerial feed lead: Assuming that we should be looking into an impedance of about 40 ohms for a quarter-wave GP system and knowing the RF output (taking 75% of PA input), $I^2R=W$ can be used to determine whether the aerial current is what it should be for that sort of impedance with the RF power available.

For example: With 4 watts PA input, the RF output into the aerial can be taken as 3 watts; if the feed impedance is 40 ohms, the current in the RF ammeter should be about 0.27 amps. If it is more than this, the feed impedance is less than 40 ohms (which it very well might be in some cases, as the figure can vary from 25 to 50 ohms). But if the ammeter reading obtainable is not greater than, say, 0.12 amps., it will be evident, from $I^2R=W$, that the feed impedance is much higher than 50 ohms, and the mode at which the system is operating is not ground-plane at all but resonant end-on—the one to avoid.

It is also possible to detect the ground-plane effect without an RF meter, by noting the behaviour of the variable condenser on the output, or “draw,” side of the pi-coupler. In the end-on condition, this will tune very sharply and will react strongly on the setting of the “resonating” capacity on the plate side of the coupler. On the other hand, when the low-impedance mode is found, the “draw” condenser will be quite flat in its adjustment, while the “resonate” capacity will not be much affected by changes in loading.

The First Results

That the ground-plane mode is the more effective is proved by the fact that on distance tests—working from the same point with the same transmitter at the same input, with constant conditions at the receiving end—the comparative S-meter readings with the GP system were some 25 dB up on the end-on aerial.

Having got thus far, the writers decided it could only be the first step in a comprehensive test programme. The next, and even more important, move was to determine the behaviour of different types of resonated whip aerial when operated in the true ground-plane mode.

Test Set-Up

This consisted of various lengths of copperised-steel whip section; a coil 13½-ins. long by 1½-ins. in diameter, wound full of 20g. DCC, with some 20 tapping points, including a selection of 5's and 1's, this being insulated at each end, with mounts to take the whip sections; a wide-range calibrated GDO and power supply; a tunable field-strength indicator having an 0-100 μ A scale; the car with which the tests were to be conducted, having the aerial mount on the offside of the rear bumper bar; and a receiver

with an S-meter calibrated to S9+50 dB.

The GDO, fitted with a 3-turn loop probe, was coupled into the base of the aerial by a few turns of wire, just enough to give an indication of resonance; one end of the coupling loop went to the insulated metal aerial mount, the other side to car chassis.

Throughout the tests, the same equipment was used, with constant coupling and the same relative positioning at a fixed distance of 50 feet from the receiver. It was found that adequate signal could be obtained off the test aerials, fed only by the GDO, with about 10 feet of wire on the receiver. It was this that greatly facilitated matters, since it was possible to sweep a wide range of frequencies at constant input, and to see from the receiver S-meter exactly how the aerial on test was behaving.

Interpretation of the Curves

The plottings in Fig. 1 show the results obtained with three different aerial arrangements. In (A), the length overall, including the coil, was 7'-9"; in (B), the 2'-6" top length was fitted on the coil like a T, with the horizontal section at 90° to the length of the car, giving an overall height of 5'-3"; in (C), the 5'-9" top projected above the coil in the conventional manner, height overall then being 11 feet.

In all three cases, the inductance value was kept constant, the point of resonance being found on the GDO and then measured on the receiver, which also gave the peak S-values. The resonance curve in each instance was plotted by moving the GDO in steps of 10-20 kc at a time, on each side of resonance.

There are several interesting points to notice about these curves. In the first place, they show very well how sharply a loaded whip resonates; in (A), (B) or (C) a move of only 10 kc off resonance results in a marked decrease in signal strength. Secondly, the shape of the curves is consistent (incidentally, this is a cross-check on the method of taking the readings, and therefore on the validity of the whole experiment). Thirdly, with aerial (A) the resonance point was moved 40 kc LF of (C); this by the mere shortening of the top section from 5'-9" to 2'-6"; by making this short top horizontal, the frequency went 10 kc HF.

Fourthly, the superiority of the (C) arrangement is very evident, not only in terms of higher peak signal level, but in the width of the curve above the S9-line; at the same time, the peak at resonance is just as sharp as with the others.

Explaining the apparent anomaly of a lower frequency with a shortened top (one might have expected the frequency to go HF), this would seem to be due to an increase in the capacity of the system *as a whole* with respect to the car; the longer top tends to distribute this capacity more. The result as between (A) and (B) supports this conclusion, since the (B) arrangement represented a decrease in capacity with respect to the car body.

The (A), (B) and (C) peak readings were also noted on the F/S meter, set up at a distance of 10 feet from the aerial; they followed the peaks shown in Fig. 1. All the readings were higher than those

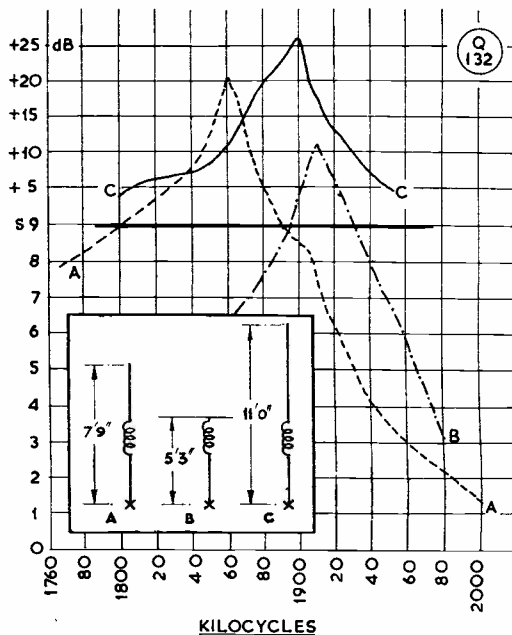

Fig. 1. Resonance curves obtained on the three different aerial arrangements shown, method being as described in the text. In each case, X is the feed point. The curves prove how sharply a loaded whip tunes when correctly set up. The inductance value was held constant, to see how the point of resonance moved with the different top sections. Though these curves were taken with a GDO and local receiver at a separation of 50 feet, it is important to note that the three aerials gave exactly the same relative results in a distant-test at a range of three miles.

obtained with the aerial in the original end-on resonance condition.

Results on the Air

So much for theory and paper-work. The next thing was to test Fig. 1 over a distance of miles instead of yards, to see how these aerials compared under actual radiating conditions—in the clear, and away from the possible local effects of a complex of radiating systems, involving feeder lines and stay wires which could conceivably be affecting the results as graphed in Fig. 1.

For the radiating tests, the transmitter was a CO-PA on 1896 kc, in a box about 7-ins. cube, running 5 watts from a vibrator pack giving 200v., with series heaters run from the 12v. accumulator feeding the HT unit. For the purpose of the tests, this transmitter was regarded merely as an RF generator, capable of a constant output at fixed frequency, to feed power into the test aerials.

The location for the distant tests could not confuse the issue in any way, because it was three miles away and right in the clear, with no local obstructions of any sort. It was selected as a convenient reference point from which all measurements could be taken.

Results obtained were exactly in accordance with those to be expected from Fig. 1. With constant

receiver settings, Aerial (C) gave $S9+22$ dB, Aerial (A) $S9+16$ dB, and Aerial (B) $S9+10$ dB. At the test site, readings on the F/S meter also corresponded to these results, *e.g.* with Aerial (C) the field-strength meter, at a distance of 10 feet, gave the highest reading.

While these results were as expected, they are yet of considerable experimental interest, because they prove that readings obtained using the GDO as the energising source, with a local receiver to compare radiating efficiency, can be taken as a reliable guide to what would happen under "real," or full-scale, conditions. This is a result worth bearing in mind by those who may be casting about for some certain method of setting up and resonating a whip aerial system on Top Band.

The Capacity Hat

It being by now evident that the critical factor was the length of top above the loading coil, a capacity hat was tried under a variety of conditions. The hat itself consisted of a 12-in. diameter stiff-wire ring, supported from the centre by four radial wires, mounting on the whip being by collar and grub screw, to allow the vertical positioning of the hat to be varied.

The first test was to determine the effect of the capacity hat on the resonant frequency. Results were surprising. With the 5'-9" top and resonance adjusted to 1900 kc, fixing the hat 2 ft. above the loading coil moved the point of resonance to 1750 kc; at 12 inches above the coil it was 1740 kc; and right on the coil, 1730 kc. In other words, the position of the hat above the coil was not critical, though at any setting it had a very marked effect on the resonant frequency as between hat and no-hat.

An even more surprising result was the effect of the capacity hat when tried with the short (2'-6") whip section above the loading coil. The resonant frequency was moved only a matter of 20 kc LF, to 1880 kc.

Resonance curves were then plotted, and are shown in Fig 2. From these, it is clear that the most effective arrangement is (F), even though (D) does give a higher peak. The reason for preferring (F) to (D) is because the curve is flatter, covering a greater area above the $S9$ datum-line than any other arrangement; thus, it is the most suitable for VFO operation, as it gives more latitude on tuning. Without the hat, even small changes of frequency would call for re-resonating the system. With the hat on, frequency changes of 15 kc or so *plus* to *minus* could be made without seriously affecting the radiating efficiency.

Indeed, it is clear that the effect of the capacity hat is always to flatten the curve by, so to speak, reducing the peak. In none of the tests would an aerial with a capacity hat give better peak signals than the same aerial without a hat.

Effect of Base Section

While all these tests were proceeding, the writers were beginning to reach the conclusion that the base section of the whip—that is, the 4 ft. length from the

bumper mount to the bottom of the loading coil, which it supported—was contributing nothing to radiating efficiency. This lower section seemed quite "dead to RF" in comparison with the "feel" of the system along the loading coil and in the whip section above it.

This was investigated by mounting the loading coil directly on the bumper bar, with results as shown in curves (E) and (G) in Fig. 2.

Since the S-meter readings in both Figs. 1 and 2 are directly comparable under all conditions, it is clear that the 4 ft. section below the loading coil was contributing next to nothing in terms of radiation. And its elimination reduced the overall length from 11 ft. to 7 ft., a factor of some importance from the mechanical point of view.

It was deduced that what drop there was in S-meter readings was probably due to the capacity of the car body on the loading coil and on the first few feet of the upper whip section, now brought down by the removal of the lower section. This assumption was thereupon tested by mounting the loading coil on the lower 4 ft. section in the mechanical sense, but cutting it out of the system electrically—in other words, it was arranged simply as a support for the coil. This was done by feeding the loading coil by a 4 ft. length of coaxial cable with the sheathing earthed to the car body; the layout was then somewhat as Fig. 3. The effect was to elevate the loading coil and top whip section to the original

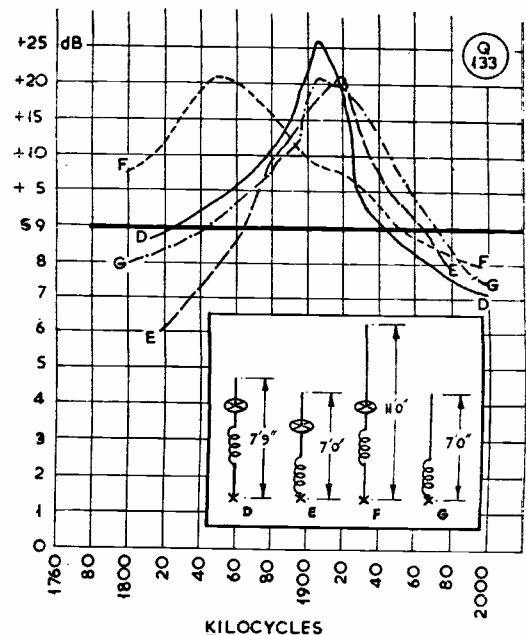

Fig. 2. Another set of curves, with aerial arrangements as shown inset, and feed point at X. As suggested in the text, Condition (F) appears to be the best choice of the four because the curve is flatter, thus giving more latitude for VFO operation, but even at that only to within 10-15 kc each side of resonance. The effect of the capacity hat is to lower the frequency, the actual position of the hat above the coil not being critical as regards radiation efficiency.

position, with the coil above the level of the car roof.

Earthing the 4 ft. lower section, or joining the earthy sheathing at the top of the length of coax to the upper end of the support (points X, Y in Fig. 3) made no difference whatever to the S-meter readings on the local test. All the radiation was taking place off the upper section, and the lower part was quite dead to RF.

The result on a distant-site test was a 5 dB improvement over the best previously obtained, Condition (C) in Fig. 1. This small increase is consistent with the drop noticed by lowering the loading coil and upper whip section into the "shadow" of the car body, and supports the validity of the argument.

Main Inference

From the foregoing, it would appear that the best radiating system for mobile working on Top Band is a base-loaded whip, with an upper section of at least 6 ft., fitted with a capacity hat about a foot above the coil, the whole mounted on the roof of the car.

If this is impracticable, then the bumper mounting or other support should be such as to push the loading coil above roof level, again with a capacity hat and a top section as long as practicable. The lower supporting section for the coil should be made dead to RF, by the method shown in Fig. 3.

Other Considerations

In most cases, the layout chosen will be dictated by æsthetic as much as by mechanical and electrical considerations. Nobody could pretend that a whip aerial with a loading coil and capacity hat is a pretty thing, no matter how it may be disguised. Of course, what to a radio man looks smart and efficient—a neat coil, with a small hat, the whole well made and cellulosed to tone in with the car finish—can still appear as a positive eyesore to anyone not much interested in its purpose. "Good gracious me, man," says she-who-must-be-obeyed, "what is that awful Thing you've got stuck on the back?"!

An easily detachable roof-mounting—so that the aerial can be taken down and put up quickly for strictly /M excursions—is one solution and is not difficult to arrange on most types of car; the few holes required can easily be camouflaged.

Results on the Road

Test runs signing G3HMO/M have been made in various directions with system (C) of Fig. 1 and the condition shown in Fig. 3, using the 5-watt RF generator already mentioned, working back to G6FO taking observations under constant receiving conditions.

It could be misleading to quote ranges and signal strength, since so much depends upon immediate location—and, in any case, so far as the writers are concerned, much remains to be done in finalising the general design of the mobile installation as a whole. What can be said is that S9+ signals can be relied upon up to about 20 miles. This is an S-meter figure

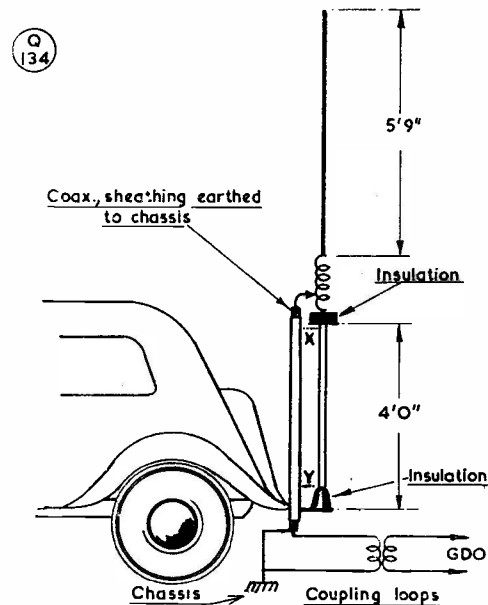

Fig. 3. The test arrangement to find out how much the lower section of the whip assembly, below the loading coil, was contributing to the effective radiation. With already a 5 dB improvement over Condition (G) of Fig. 2, it was found that connecting or disconnecting the lower 4 ft. section, or earthing the coax to it at points X or Y, made no difference whatever to the S-meter reading on local-test. This result was confirmed on distant-test, the layout as shown here being the best of those tried. From this, and Condition (F) of Fig. 2, the inference is that for VFO working with a swing of about 25 kc, a base-loaded whip with a capacity hat and upper section 6 ft. long, the whole mounted on the roof of the vehicle, should give the best results under practical conditions. There is certainly no electrical advantage in bumper mounting, though it is probably simpler mechanically than basing the whip on the roof.

on a receiver capable of producing comfortable speaker output with a carrier level down to S3, provided it is reasonably modulated.

Comparative tests against the 160-metre fixed stations of G3HMO and G6FO, having large radiating systems with the full 10 watts input and taken as reference signals, show that with most observers the signal from G3HMO/M with the 5-watt transmitter into the GP whip compares very favourably, in some directions being only a matter of a couple of S-points down.

An even more convincing result was obtained on the morning of May 1st, when G3HMO/M was en route Buckingham to Northampton, testing with G6FO. G3DOX/P was listening in a launch on the Thames near Oxford, using an 8 ft. whip with capacity hat; from a point beyond Towcester, he was able to give G3HMO/M RS-53, the distance being 33 miles; he it noted that this was whip to whip, on 1900 kc. At that moment, G3HMO/M was S9+5 with G6FO, at a distance of 12 miles; had the carrier level been only S3, it would still have been a full audio signal at G6FO.

In due course, further surveys will be made in different directions to establish the maximum distances at which R5 signals can be relied upon, in

daylight on the 160-metre band. After-dark results will always be worse, because of GDX interference and the high noise level.

Some General Notes

For the preliminary adjustment of the loading coil, whatever its position in the system, it will be found necessary to provide a large number of taps. As the adjustment approaches the optimum, a *single turn* one way or the other will make all the difference in getting resonance at the desired frequency. But once the correct inductance value is found, it will hold over large variations in loading, as given by the pi-coupler. This is consistent with normal ground-plane behaviour.

The inductance value is so critical that it is not possible to "give it a name" in terms of so-many turns on a such-and-such former with different whip lengths. It will always depend upon the length of the top section, the capacity of the GP element to the car, and the capacity of the car itself to ground. Obviously, this will not only vary with different makes of car, but also with the arrangement of the GP element with respect to the car. A whip length of so-many feet with a coil value of so-much may give the right result on a Hillman Husky with the base connection at the rear bumper, but these values could be wildly out for a Vanguard with the aerial on the roof, or an old Ford with the business lashed to a door handle.

In brief, what you have to do is to tune your system to your car, using the longest top section you can safely and conveniently manage.

Another vital factor is the proper weather-proofing of the loading coil—which, in the nature of things, is a very high-Q element. The coil as finally evolved must be absolutely impervious to weather effects. In the course of the tests discussed in these pages, at one stage it was found that the readings being obtained were no longer consistent with previous values; the coil was flat and appeared to have lost its "tune," while S-meter readings had gone down 15-20 dB. There was no apparent reason for this, except that it was late in the evening and the coil felt cold and damp. Forthwith, it was taken indoors and baked in a 300° oven for a quarter of an hour or so. (Judging by the smell, this was about 10 minutes too long and 100° too high.) Tried again, the coil had reverted to normal, with the familiar sharp-tuning effect and local S-meter readings back to the +20 dB mark. Really keen practitioners in the art of /M working must, figuratively speaking, take their loading coils to bed with them. The slightest variation in Q-value will throw the coil right off.

Conclusion

There are, no doubt, many 160-metre mobile operators who have found out all this for themselves. On the other hand, it is also clear that many others are not getting the results that they had been led to expect—indeed, the wide variation in signal levels recorded at the Northampton Mobile Rally on April 8 suggested that many a /M aerial was not radiating as well as it might.

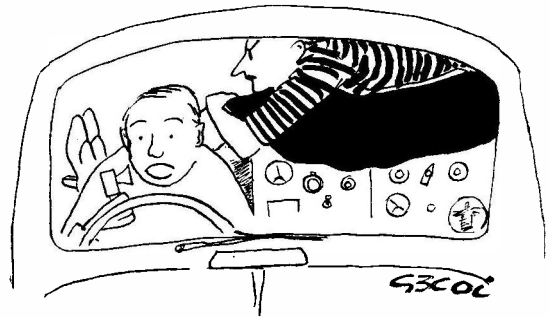

" But if I'm going on with this mobile lark, I'll have to miniaturise "

(No reflection is intended on those who use ZCI's in small cars!—Ed.)

This article is not offered as expert opinion and advice, but rather as guidance on some of the practical problems associated with the design of the aerial; in that respect, the data are not complete, in that there are several other possible arrangements that would be worth trying—such as a coil with a variable core adjustment; or variable transformer coupling, with the feed coil, linked to the transmitter, sliding over the resonating coil; or single-wire feed to a tap on the resonating coil, to give an auto-transformer effect. These and others will be investigated as opportunity offers.

However, it is hoped that, being based upon long hours of experiment under controlled conditions and giving repeatable results, the discussion here will be of interest to all engaged in getting going on Top Band mobile. Naturally, the findings are not thrown out simply as the outcome of a Saturday afternoon's work; in fact, the investigation alone absorbed something like 60 man-hours, to say nothing of the preparation of the apparatus. And had it not been a partnership undertaking, it would probably not have been possible at all.

Finally, it is of interest just to add that one Top Band operator, knowing the course the experiments were taking, has already improved considerably the 160-metre output from his *fixed* station by adapting Condition (G) of Fig. 2 to a vertical aerial of house-top height.

G3HMO/G6FO

DIRECT SUBSCRIPTIONS

Readers wishing to make sure of their copy of SHORT WAVE MAGAZINE by post on the publishing date each month are reminded that the direct subscription rate is 30s., post free, for a year of twelve issues. Orders, with remittance, to: The Circulation Manager, Short Wave Magazine, Ltd., 55 Victoria Street, London, S.W.1. We can also accept gift orders for overseas contacts at the same rate, for delivery anywhere in the world.

SSB Topics •

TECHNICALIA, ACTIVITY & OPERATING RESULTS

• Conducted by R. L. GLAISHER, G6LX

THIS is the first contribution for a new feature to appear every other month. It is being undertaken, at our request, by an operator already well known not only for his SSB activities but also as an occasional contributor to SHORT WAVE MAGAZINE on other subjects. We are sure that G6LX will have the support of all G/SSB's and that thereby he will succeed, through "SSB Topics," in introducing sideband working to a new and wider circle of Amateur Radio operators. It is intended to cover the technical side as well as the operating interest, and so to maintain a balance between the problems associated with the gear and activity on the air.—EDITOR.

One question that is often asked by the AM fraternity is "Does sideband help with TVI?"

There is no doubt that a correctly designed and adjusted sideband transmitter is much less of a potential danger in respect of harmonic radiation than the equivalent in A1 or A3 equipment. It is generally assumed that this happy state of affairs is due to the use of linear operation throughout the high-level amplifier chain. This is only partly true, as the use of Class-A, AB and B operating conditions will not stop harmonics being radiated if they are present in the earlier stages.

The drive requirements of a linear amplifier are so very much lower than those of a similar Class-C amplifier, and this, combined with a clean signal from a sideband exciter, usually produces the desired results.

To quote a practical example: At G6LX, two sideband equipments are in use, a 9 mc phasing exciter suitably heterodyned into 14, 21 and 28 mc, and a crystal filter unit on 470 kc mixed into 3.8 and 14 mc. Both exciters feed a common Class-AB1 linear amplifier running the full power now permissible under U.K. regulations. Although no special precautions have been taken and no low-pass aerial filter is used, harmonic-type TVI is completely absent.

Sideband operation does not, however, eliminate overload or cross-modulation effects, and these troubles must be tackled at the TV receiver in exactly the same way as would be adopted for AM or CW interference.

T-R Switches

During a recent visit to the States, the writer had a chance to examine most of the current T-R switches that are available on the American market. A common complaint from users of these switches

tends to confirm the experience of many of the sideband fraternity in Britain—that they generate harmonics which can cause TVI.

If anyone has a good design for a multi-band unit which does not exhibit this trouble G6LX, for one, would like to hear about it. After trying several of the designs that have appeared in the handbooks and magazines, the old faithful "TCS Antenna Relay" has been recalled to service.

News and Views

A recent newcomer to single-sideband working is G3GKG (Sheffield). Operating at present on 3.8 mc, he is using a phasing exciter running 8 watts peak and has been doing very well. A linear amplifier is under construction.

G3HRO (Bromley) sends along the information that he is mainly active on 14 mc with brief visits to Eighty; he has a very fine self-contained table-top transmitter with a pair of parallel 807's in the final. DL4SV (Munich) has recently moved house and is busy erecting a new aerial system. DL4YU (Kaiserlauten) has pensioned off his old phasing rig and is now the proud owner of a new KWS-1; active on the DX bands, he can be heard occasionally on Eighty.

During school holidays, G3KTU is operational from his home location in Esher, Surrey; using a phasing rig with two parallel connected 829B's in the final (yes, all four sections in parallel!), he puts out a very potent signal on 3.8 mc. G3KTU also works sideband under a /A call from Mill Hill School.

G3BFP (Shirley) is back on after a minor rebuild; he has a rather unusual filter arrangement, using a number of 85 kc IF transformers from the BC-453 Command receiver as the filter elements. (He also has a very fine triple-conversion receiver which is a real pleasure to use.) Another advocate of the Command transformer job is G3IRP (Morden), who is active on 1.8 and 3.8 mc and is planning operation on the DX bands when a balanced modulator and linear are completed; a sideband *mobile* rig is also under construction.

G3BXI (Chigwell) is new to Sideband, having recently obtained a Central Electronics Multiphase 10A exciter; he reports working plenty of DX on 14 and 21 mc during his first three weeks of sideband operation. Using a lash-up 100-watt linear and three-element beams on both bands, he was really going places when last heard on Twenty.

DL9PU (Munich) has also joined the Sideband ranks. With a phasing rig, running 40 watts peak, he made his first 80-metre contact on April 16. G3GWR (Sheffield) has been heard testing on 80 . . . his

signal sounded very good in Croydon.

Owing to QTH restrictions, G3GKF can only operate on a single band and has kept to 21 mc. With Sideband, he does not consider this to be a severe limitation! With a two-element beam and parallel 807's, he has pushed his score up to nearly 40 countries on Fifteen alone.

During the recent I.R.E. exhibition in New York City, the Sideband group held their annual dinner and get-together. It is reported to have been a great success, with nearly 400 active sidebanders present from all W call areas. Several overseas amateurs were also there.

Visitors from Overseas

Among the many amateurs who will be visiting Britain this summer are several well-known sidebanders. W2DPZ is due in London early in June and will be touring the British Isles. W2KG/W4VEC and W0DRD will be over for Bisley during July and will be spending a week or so in London. W2CFT arrived in Norway about mid-May and is touring Europe for 2-3 months, visiting amateurs in Scandinavia, France, Germany and Italy; he hopes to spend a few days in London prior to his return to the States from Southampton in August.

ZD4BF will be home on leave early in August and hopes to be able to visit many of his G friends. OA4CL is at present in the U.K. and was last reported in Cambridge.

DX Notes

With the general improvement in conditions, many new Sideband stations have appeared on Fifteen and Twenty. Both bands have provided interesting signals of excellent strength from all continents, numerous QSO's with Oceania, Africa and the America's having been reported.

The news of the month is undoubtedly the appearance of KC4USA in the Polar wastes of Little America. Using a Collins KWS-1, his signals have been reported on 14295 kc between 0700-0830 GMT for several mornings. At present most of the operating appears to be confined to phone-patch traffic with the States, as many British stations can testify. This is customary procedure with American expedition stations. However, at least one British sideband station and several Europeans have been lucky in breaking through the barrage of W's queuing up on the frequency. With the imminent opening of a second station, KC4USB, also with a KWS-1, the situation should be eased, and it is hoped that more time will be available for true amateur operation.

Several British stations were able to take part in the interesting aeronautical mobile sideband tests organised by the Collins Radio Co. During the long trip from Nebraska to Japan and back in a U.S.A.F. aircraft equipped with a KWS-1 transmitter and 75A-4 receiver, W0CXX/AM put a very consistent signal into Europe on both the 14 and 21 bands.

Mobile operation is again demonstrating how effective low-power sideband can be in getting through under the most trying band conditions. Night

after night W2ALK/M and W2UOX/M have pushed readable signals through the clutter of higher-powered AM stations on the high end of the 14 mc American phone band. Another consistent mobile sidebander is W8DLD/M, who is in the high-power class with a mean half-kilowatt.

With the increased evening activity on the HF bands, there are very few reports concerning Eighty. The usual Europeans have been on and several new ones have been worked. OH2OJ and SV0WA made brief appearances on the band before departing to Twenty. SV0WA will be remembered as DL4JX who was very active from Munich last year.

ZS6KD, reporting on 14 mc from South Africa, provides the news that Sideband activity is again on the increase. In Johannesburg alone at least *ten* stations are on and several new ones are almost ready to go. ZS6AIY is a new convert and is doing well with a "barefoot" phasing exciter. A linear amplifier is under construction. ZS3E is active most evenings (1630-1900 GMT). ZS3BC is rebuilding his beam and should be back within a week or so. Another relative newcomer to Sideband is ZS5CZ in Durban; using a filter rig and 100 watts peak power, he has a very clean-sounding signal.

ZD4BF in the Gold Coast is still very active and can be worked most evenings, sometimes as late as midnight GMT.

KX6BU in the Marshall Islands is on again and has been heard working W6 around 0830 GMT. No G QSO's have been reported during recent weeks.

Numerous contacts have been made with VK and ZL on the short and long paths. ZL3PJ has provided an S9 signal on several days around 1830-2000 GMT and has worked many G stations.

It is rumoured that a VK9 in Papua has obtained a Multiphase 20A, so perhaps this will mean yet another new country on Sideband.

From Asia, AP2BP and AP2CR have continued the good work. AP2BP has been worked as late as 1900 GMT (midnight Pakistan time).

From South America, YV5FL has been the mainstay during the past few months. CE2HV has obtained a KWS-1 and should be on shortly. HC2PP is working into the States, but no European QSO's have been reported.

G3GKF (Purley) mentions that the 1830 GMT weekday schedule on 21425 kc with W4NQN, W9RUK, W0DRD (Colorado) and KH6AR is now going very well, with satisfactory contacts most evenings. Other G's who have taken part in these tests include G2ALM, G3BFP, G3BXI, G3HJK and G6LX.

CX5AF is very active most evenings and is being hotly chased by those who still need South America for a Sideband WAC. CE2HV has been on and has been worked by DL4YU.

W4DGW/MM on the s.s. *Del Campo* has been worked several evenings while off the coast of South America.

Last month VS6DA made a brief appearance with a QRP phasing rig. Rumour has it that this is now back in the U.K. Let us hope he found Sideband to his liking and will take the trouble to buy, build,

beg, borrow or steal another one!

Little Sideband activity has been reported on Ten during the past few weeks. ZS6OY and several W stations have been raised, with W1CLS and W0CXX providing signals of workable strength when the band has been almost dead. Many DX stations are known to be building new VFO's and high-level mixers, so by the autumn the present dearth of active 28 mc sidebanders should be a thing of the past.

Finally—

This being the first offering with a new feature, it is necessarily somewhat attenuated and deals mainly with generalities. Since the intention is to discuss Sideband on the technical side as well as from the operating and DX angles—and mainly from the point of view of G/SSB's at that—*your* co-operation is invited. If you are on SSB, on any band, please let us have notes covering call, location, gear used, results to date, queries or problems, and any ideas

you may think worth passing on—photographs of SSB stations will also be welcomed for appearance in these pages.

Like any other regular feature—it is to appear every other month, by the way—"SSB Topics" depends for its success upon reader support. So we hope to hear from *you*, addressed "SSB Topics," *Short Wave Magazine*, 55 Victoria Street, London, S.W.1, by not later than **June 29** for the August issue.

And for those who are still finding their way with SSB in the technical sense, some useful references are given herewith.

"A Single-Sideband Exciter," SHORT WAVE MAGAZINE, October, 1955.
SINGLE SIDEBAND FOR THE RADIO AMATEUR — 175 pages, by ARRL.
RADIO AMATEUR'S HANDBOOK, 1956 Edn., Chapter XII.
THE RADIO HANDBOOK, 14th Edn., Chapter XIV.

(These can be obtained from stock as advertised by the Publication Dept., *Short Wave Magazine, Ltd.* in this issue).

EMERGENCY COMMUNICATIONS NETWORK

It is probably hardly realised that the greater part of the U.K. is now covered by a "private" emergency radio network operated exclusively by the AA (Automobile Association). They have no less than 17 control stations, centrally located and interconnected, stretching from Cardiff to Edinburgh, each working to its own group of mobile patrols equipped for two-way communication with the mother station. While the service, which is still expanding, is devised for the benefit of the motorist members of the A.A., it is evident that such a network—in being, covering the whole country and manned by trained operators—would be of immediate practical value in the event of any national disaster or emergency.

THE CALL-SIGN SEQUENCE

It will be noticed from "New QTH's" on p.216 that U.K. call-signs are now being issued in the G3L... sequence. It has taken just about two years to get through the available G3K's.

When amateur call-signs were first issued, before the 1914 war, they consisted simply of a group of three letters, e.g. DKX. After 1918, they came out with a numeral (2, 5 or 6) and two letters, roughly in alphabetical sequence, but with no prefix, e.g. 2DX, 5LS, 6XG. The prefix system followed in the mid-1920's, and for a time carried, unofficially, a letter to indicate the Continent, thus, EG6ZR, for a U.K. station (in Europe). At that period, British two-letter call-signs with the 2, 5 or 6 numeral were issued somewhat indiscriminately, depending rather upon the applicant's name or initials, e.g. G5FJ, G6DH, G6WY. In the early 1930's, the G8AA series commenced, followed, illogically enough, by the G3AA and then the G4AA. It was in the G4 two-letter sequence that calls were being issued up to the outbreak of war in September 1939. Also in the pre-war period, AA ("artificial aerial, non-radiating") licences were being granted to amateurs, these consisting of the numeral 2 and three letters, without the prefix,

e.g. 2AHK. On attaining full radiating status, the call-sign would be changed to a two-letter, with prefix, from the sequence then being issued. This was the system until September 1939.

With the resumption in 1946, all original calls were re-granted and AA call-holders as at the outbreak of war were given the privilege of converting to full radiating licences, simply by taking the G prefix with the old AA call-sign, e.g. G2BVW. All new call-signs issued since 1946 under the post-war regulations have been in the sequence G3AAA-G3ZZZ—bringing us down to the present time, with G3L... coming up.

As a footnote, it might be added that the system is not quite as smooth as this, because since the war the G.P.O. has re-issued to new applicants a certain number of the old two-letter calls, rendered void either by death, surrender or war casualty. Some, indeed, have been re-issued more than once.

ARTICLES AND PHOTOGRAPHS

We are always in the market for material suitable for publication in SHORT WAVE MAGAZINE. Articles, either long or short, good photographs and items of general interest are considered, and all those used are paid for immediately on appearance in print. Intending contributors are, however, specially asked to read, *and follow carefully*, the notes on the preparation of articles on p.432 of the October 1955 issue of SHORT WAVE MAGAZINE.

NEW QTH's

Readers becoming licensed, or changing address, are invited to send in details for "New QTH's." This will ensure publication in the *Radio Amateur Call Book*, which is the only directory to the radio amateurs of the world; as such, it has a world-wide circulation. When in the *Call Book*, which appears quarterly, you can use with confidence the procedure signal QTHR—"My address is correct in the latest Call Book."

Transmitter for Two Metres

MODERN DESIGN AND
CONSTRUCTION

W. F. COULSHED, B.Eng.(Hons.)

The very fine transmitter described in this article can be heard on the two-metre air under callsign G3GPT—as is well known, he has been most successful with it. The model as illustrated was designed and built for him by our contributor, who has produced an interesting and very well engineered piece of equipment, using modern circuit techniques and valve types. It is described here in sufficient detail for its construction to be undertaken with confidence by any experienced VHF operator.
—Editor.

THE transmitter to be described is the latest of a number that have been built for G3GPT during the past few years. For the first time an effort was made to produce a transmitter of a presentable physical appearance without compromising the electrical requirements. The result is believed to be acceptable from the first point of view, and in the second place, strangely enough, the layout is somewhat better than previous designs. A number of amateurs, during visits to G3GPT, have expressed the view that it would be of general interest to the VHF fraternity.

Circuit

The PA valve chosen is the Mullard QQV06-40A, preferred for a number of reasons now becoming apparent to constructors. The supply of surplus 829's is becoming exhausted, some of those obtainable are of doubtful quality, and they are no longer cheap. The QQV06-40A is perhaps a little expensive for the average amateur, but this is offset to a large extent by the generous guarantee terms offered by the manufacturers. Further advantages are that the valve has built-in neutralising condensers, the input and output capacities are smaller, and the drive requirements are easier to provide. It is in every way superior to the 829B, which was good enough when there was nothing else available.

The exciter portion of the transmitter consists of three valves only. A 12AU7 is used as an overtone oscillator/doubler from a 6 mc

crystal, providing 36 mc drive to a 5763 doubler to 72 mc, followed by another 5763 doubler driving the final. HT requirements in the exciter are 10 mA for each half of the 12AU7, at 255 volts stabilised, and 35 mA at 300 volts for each 5763.

The PA is operated at 500 volts, and the drive requirement of 3 mA through a 33,000-ohm grid resistor (for 'phone working) is obtained with 30 mA anode current in the final 5763, provided that the coupling circuits between 5763 anode and PA grid are adjusted with sufficient care.

The key jack for CW work is inserted in the HT supply to the final 5763, and the PA is protected by a somewhat unorthodox clamp circuit which has much to recommend it.

PA Protection

Since it is reasonable to expect that the clamp valve used shall be smaller than the PA valve itself, choice is limited to valves of the 6BW6 class. Attempts to use such a valve in the conventional way, *i.e.*, triode connected,

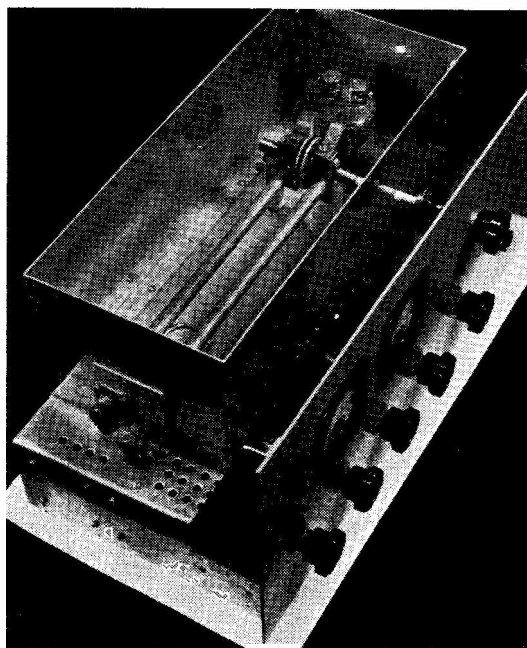

Two-metre transmitter (with cover removed) used by G3GPT, built for him by SWL Coulshed. The PA is a QQV06-40A, clamped by a tetrode-connected 6BW6, and driven by a CO-exciter chain, beneath the PA, consisting of 6-36 mc 12AU7, 72 mc 5763, 144 mc 5763, giving 3 mA against a 33,000-ohm grid resistor in the PA; this level of drive can be increased considerably. The disc condenser near the PA, upper right, is C18; part of L9, the pick-up loop, can just be seen at the rear end of the tank lines L8.

are useless, as the anode of such a triode (with the normal PA screen resistor as load) "bottoms" at about 100 volts. With this

Table of Values

Fig. 1. Circuit complete of the 90-watt Two-Metre Transmitter

- C1, C19 = 20 $\mu\mu\text{F}$ variable
- C5, C9 = 2-10 $\mu\mu\text{F}$ variable
- C13 = 47 $\mu\mu\text{F}$ silver mica
- C3, C4, C8, C10, C12, C14, C15, C16, C17, C21 = .001 μF Ceramic 500v.
- C6 = 22 $\mu\mu\text{F}$ ceramic
- C7, C11 = 68 $\mu\mu\text{F}$ ceramic
- C18 = Two circular metal discs, $1\frac{3}{8}$ " dia. screw thread adj.
- C20 = .001 μF 1500v. ceramic
- R1, R3, R4, R6, R10, R14, R16, R17 = 470 ohms, $\frac{1}{2}$ -w.
- R2, R5 = 100,000 ohms, $\frac{1}{2}$ -w
- R7, R12 = 180 ohms, $\frac{1}{2}$ -w.
- R8, R11 = 12,000 ohms, $\frac{1}{2}$ -w.
- R9, R13 = 75,000 ohms, $\frac{1}{2}$ -w.
- R15 = 33,000 ohms, $\frac{1}{2}$ -w.
- R18 = 20,000 ohms (two 10,000 ohm 10-watt in series)
- R19 = 60,000 ohms (four 15,000 ohm 1-watt in series)
- R20 = 22,000 ohms, 10 watt
- R21 = 33,000 ohms, 10 watt
- R22 = 12 ohms, $\frac{1}{2}$ -w.
- RFC = Approx 20 ins. 26 SWG enam., close wound $\frac{1}{8}$ " dia.
- L1 12 turns 20 SWG enam $\frac{1}{8}$ " dia. $\frac{3}{8}$ " long.
- L2 5 turns similar to L1 spaced approximately $\frac{1}{8}$ " from L1.
- L3 10 turns 20 SWG enam. $\frac{1}{8}$ " dia. $\frac{1}{2}$ " long.
- L4 4 turns 18 SWG silver plated, $\frac{1}{8}$ " dia. $\frac{1}{2}$ " long.
- L5 4 turns 16 SWG silver plated $\frac{3}{8}$ " dia. $\frac{1}{16}$ " long with 2 in. leads.
- L6 and L7 2 turns each, 16 SWG silver plated, wound in one piece with $\frac{3}{8}$ " gap; turn spacing approximately $\frac{1}{16}$ ".
- L8* Parallel line $7\frac{1}{2}$ " long, $\frac{3}{8}$ " dia. 1in. C-to-C spacing. Leads to PA anodes 2 in. long, $\frac{3}{8}$ " wide phosphor bronze strip.
- L9 Hairpin, $\frac{1}{8}$ " dia. wire, $\frac{3}{8}$ " C-to-C spacing, 2 ins. long.

voltage on the screen and zero bias (no drive) the PA greatly exceeds its rated plate dissipation. A glance at the tetrode-connected characteristics of the 6BW6 supplies the answer, as the "bottoming" potential in this case is 10 to 20 volts, which limits the PA anode dissipation to well within its rating. Further disadvantages of the triode mode are that the maximum screen voltage rating of the 6BW6 would be exceeded under plate-and-screen modulation conditions, and the PA operating bias of -100 volts may not be sufficient to ensure cut-off of the clamp valve at the peak positive modulation point, which would be very undesirable. Attempts to put a VR tube in series with the PA screen lead cure some of the faults of the triode clamp, but lead to further difficulties with modulation. The tetrode mode does not suffer from these dis-

- J1 = Insulated key jack, closed circuit
 - M1 = 0.5 mA meter
 - M2 = 0.250 mA meter
 - V1 = Brimar 12AU7
 - V2, V3 = Brimar 5763
 - V4 = Mullard QQV06-40A
 - V5 = Brimar 6BW6
- (*Obtained together with C18 from ex-Admiralty Oscillator Unit Patt. W6283)

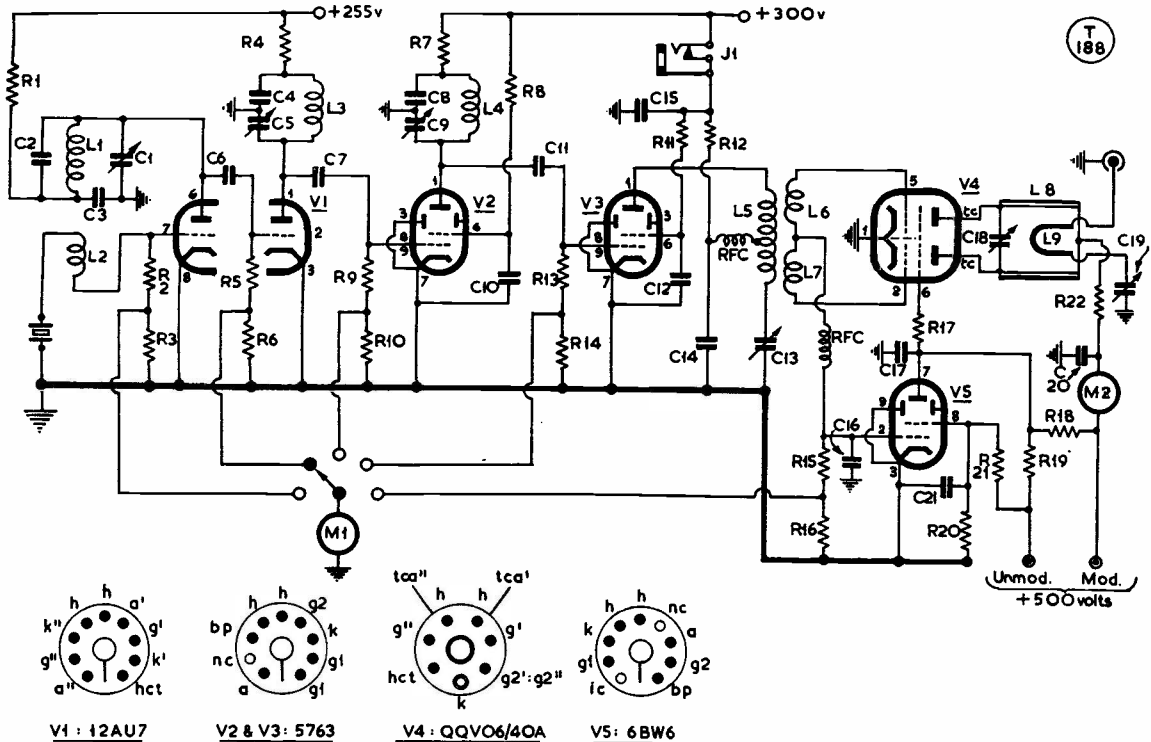

Fig. 1. Circuit complete of the Two-Metre Transmitter described and illustrated in the article. The exciter unit valves and the clamper are all Brimar types, with a Mullard QQV06-40A in the PA; it can be run at about 90w. input, V3 giving ample drive on 144 mc for this. It will be noted that while L5 is tuned, the split grid coil L6-L7 is adjusted to be self-resonant, as explained in the text. The 6BW6 in the clamper stage V5 gives full protection for the PA. Though not shown in the circuit, it should be noted that all heaters are by-passed with .001 μF ceramic condensers.

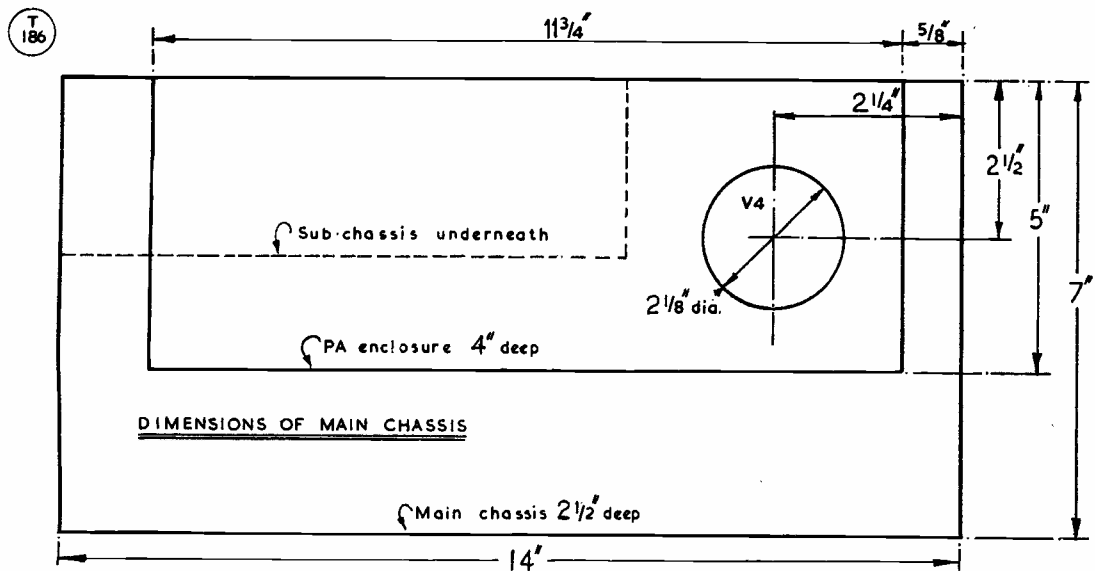

Fig. 2. The major dimensions for the main chassis, the general arrangement of which will be clear from the photographs. The material can be sheet aluminium, which is easy to work and will give sufficient rigidity for this application.

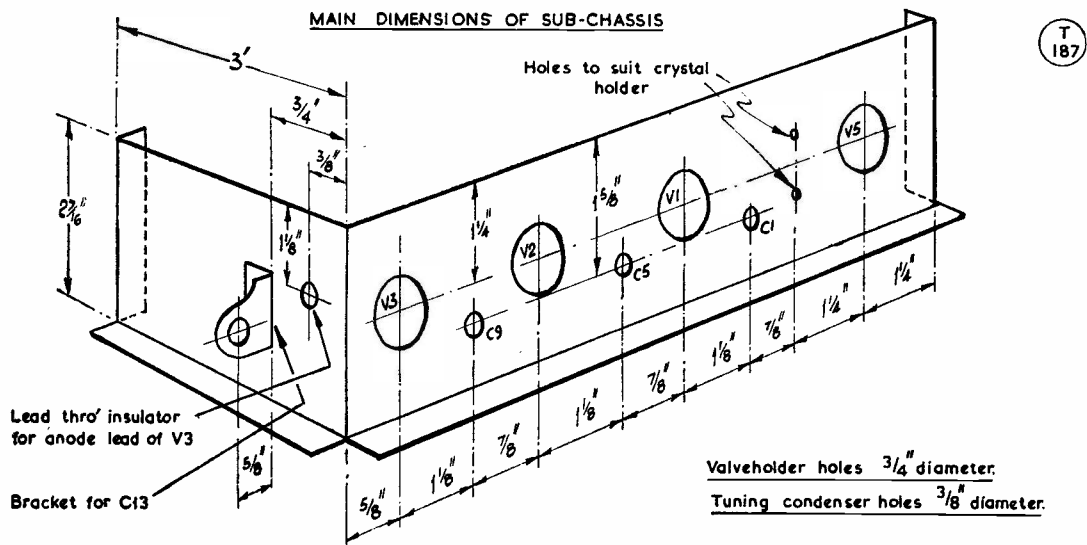
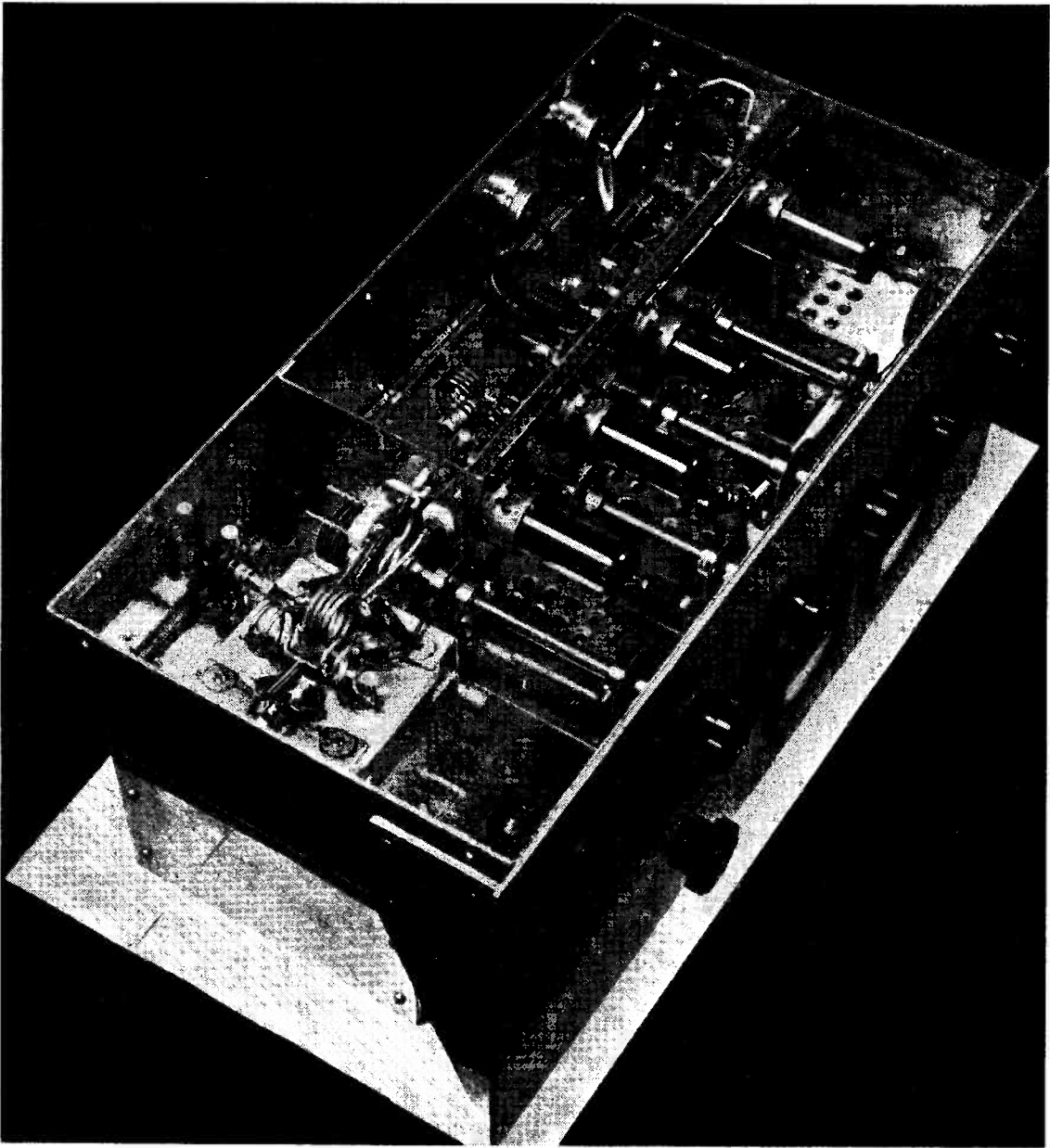

Fig. 3. The sub-chassis carries all the valves except the PA. If the mechanical layout of Fig. 2 is adopted, the construction underneath should follow these dimensions.

advantages. The clamper screen is fed from a potential divider across the unmodulated PA HT, designed so that the 6BW6 screen dissipation rating cannot be exceeded. A check on plate dissipation also proves satisfactory. Cut-off of the clamp valve is certain, even under modulation conditions, since its screen is fed from the unmodulated HT line. Attempts to run the 6BW6 screen from a separate supply

should be avoided, as failure of this supply would make the clamper inoperative.

Whilst complete protection is provided by the single 6BW6, a desirable modification to the present design would be to duplicate the 6BW6 and its screen resistors. No modification to the circuit values would be necessary and protection would then be assured, even if one 6BW6 or its screen resistors failed. (It



Driver section of the Two-Metre Transmitter, circuit of which is shown in Fig. 1. The oscillator-multiplier, second from right, is a 12AU7, followed by two 5763's in the third and fourth positions, to give drive output on 144 mc. The valve on the extreme right is V5, the 6BW6 clamper — see Fig. 3. The grid side of the QQV06-40A is to the left of the sub-chassis screen; note the layout of the L5, L6, L7 grid coil assembly, with C13 as the nearest panel control. The coils in the driver stages are mounted with their axes at right angles.

looks as though this rig isn't the final one after all !)

Two meters are used, one for PA anode current, the other being switched to read the various grid currents.

Construction

The main chassis size is 14ins. x 7ins. by 2½ins. An L-shaped sub-chassis 9½ins. by 3ins. by 2 7/16ins. is bolted inside the main chassis and the exciter valves, crystal and

clamp valve are mounted on this so that they lie horizontal inside the main chassis. Ventilation holes are drilled over and under each valve in the chassis and base cover.

The PA valve is mounted in the rear right hand corner, the holder being fitted under the chassis on spacers so that the internal shield is level with the chassis top. Ventilation holes are drilled in the base cover under the PA valve. If the transmitter is to stand on the base cover, feet should be bolted to the base to raise it half-an-inch or so above the table top. The PA and its tank circuit are screened to avoid radiation losses in an enclosure 11½ ins. by 5 ins. by 4 ins. high. The top cover for this also has a large number of ventilation holes above the PA valve. The extension spindle on the tank condenser is a ¼ in. diameter ceramic rod salvaged from a "surplus" VHF two-gang condenser. Use of a metal extension should be avoided as unbalance of the circuit would result. The clamp valve is furthest from the PA, and the layout of the rest of the circuit is fairly obvious from the photograph.

The front panel size is 15 ins. by 6½ ins. Controls in order left to right are grid meter switch, crystal oscillator tuning, 1st, 2nd and 3rd doubler tuning, with PA anode tuning above. Key jack is at extreme right.

One thing which may be a disadvantage to some operators is that the crystal is not easily changed, being inside the chassis. The crystal holder could be mounted on the front panel between meter switch and oscillator tuning knob if so desired.

Adjustment

No difficulty should be experienced in getting the driver stages going provided the coil sizes are duplicated fairly closely. The method of setting up overtone crystal oscillators has been described before and the doubler stages are conventional. It may, however, be helpful to describe the adjustment of the final 5763/PA grid circuit in detail, as this is perhaps the most critical part of the whole transmitter.

The 5763 anode coil should be made up and installed as shown in the photograph, *i.e.*, so that it is in a suitable position for coupling into the grid coil of the PA. Tests with a grid-dip meter or loosely coupled loop and lamp will allow adjustment of this coil so that resonance occurs at about mid-setting of C13. The PA grid coil should now be installed. The coil is made so that its ends pass easily into the holes in the holder tags which are bent vertical. This allows the coil to swing without distortion. For the first adjustments the coil should be as

TABLE OF OPERATING CONDITIONS

	Xtal Osc.	12AU7 Dblr.	1st 5763	2nd 5763	PA (500v. HT)
Ig1	0.5 mA	0.5 mA	1.5 mA	2.5 mA	3 mA
Ia	10 mA	10 mA	30 mA	30 mA	180 mA
Vg2	—	—	240v.	240v.	250v.
Ig2	—	—	5 mA	5 mA	16 mA

far *away* as possible from the driver coil and soldered in lightly. Then, with no anode or screen supply to the PA, adjust the grid coil turn spacing so that maximum grid current occurs, indicating that the coil is resonant with the valve input capacitance. An attempt should be made to make this adjustment in such a manner that when the coil is unsoldered in order to swing it over to increase the coupling, it does not spring out of shape. The coil should then be moved in small steps nearer to the driver coil until about 4.5 mA grid current flows through the 33,000-ohm grid leak. This point should be reached before any appreciable detuning of the driver anode becomes apparent.

HT may now be applied to the PA, taking the usual precaution of avoiding running without load, and checks made for stability (although no trouble should be experienced here) and correct operation of the clamp circuit. In the author's version, the key-up anode current is limited to 22 mA, well within the limits, and with no "spacer" audible at nearby monitor stations. (An external key click filter will be necessary, of course.) The grid current will drop on application of HT to the PA and the amount will vary from valve to valve and final adjustment of the grid circuit may be necessary to get the required 3 mA.

The makers recommend quite different bias and grid current figures for CW only, and the CW man may wish to modify the grid resistor to fit these figures, which are -80 volts at 7 mA. However, little or no difference results from this change and it is probably not worth considering.

Currents in the various stages under operating conditions are given in the Table herewith.

Some variation from the figures given would be expected using a different set of valves.

Other Points

The resistor network feeding the screen of the PA is somewhat unconventional and it is made necessary by the makers' recommendation that for 100% modulation the peak AC

screen volts should be 185v. The higher than normal power rating of these resistors is made necessary by the clamp circuit.

Some specimens of the QQV06-40A exhibit somewhat less than 16 mA screen current. In such a case the screen voltage would rise above the permitted 250 volts. The simplest way to deal with this (avoids computing new values for R18 and R19) is to shunt resistance from screen to earth, varying the value until the correct screen voltage is obtained with the transmitter operating normally.

The PA valve should be watched carefully for signs of overheating during the early stages of operating the rig at full ratings. If this does

occur, increase the ventilation. Forced air cooling has *not* been necessary in the author's version.

The crystal frequency of 6 mc was chosen to avoid TVI. Constructors wishing to use 8 mc crystals would be well advised to use a buffer stage (say an EL91) after the 12AU7, as it is doubtful if one half of a 12AU7 tripling from 24 mc will provide sufficient drive for a 5763 doubling to 144 mc.

An alternative suggestion is to use a single triode for a crystal overtone oscillator to 24 mc, making the first 5763 a tripler.

A word of thanks to G3GPT, who by his keen operating has proved the worth of the transmitter.

VHF BANDS

A BRIEF REPORT

WE very much regret that, owing to the indisposition of A. J. Devon, we are unable to present "VHF Bands" in its usual form this month. It is hoped—with sincerity but without much confidence!—that this short offering will be accepted by those who for so long have followed his feature.

Since the last appearance of "VHF Bands," there has been a marked improvement in conditions, while several events of much interest in the VHF world have taken place.

Happenings

The two-metre field day on May 6 (a bright, warm day, with a high glass) brought a good many stations on, under fair conditions. They were better in the north-south line than east to west. The more successful portables worked from 65 to 70 stations; G8SB/P was giving Rutland and thereby had a very busy time. PE1PL was on, working southerners around mid-day.

Earlier in the period, conditions started improving on May 3; on the 4th ON4BZ, with several Dutch stations, appeared in the London area, and the Lancashire call-signs were being worked from down the south. Other interesting signals were G5MR (Hythe, Kent) getting into the Midlands, GW8SU (Porthcawl, Glam.) heard in the London area, and G5MA on the air again from his new QTH, after a long absence.

On May 5, conditions were quite good. From 2200 BST onwards, plenty of Frenchmen—it was their "Coupe REF" contest—were being worked from London, and F8AA was a good signal in the South Midlands: an outstanding contact was G2FJR/F8AA, on that Saturday evening. Numerous F's were worked by South Coast stations. G5MR accounting for 22 of them.

A 25-Centimetre Result

On May 6, while out /P for the two-metre field

day, G3CGQ took the opportunity of running some tests on 25 cm with G3FUL. These were most successful. From Galley Hill, near Luton, G3CGQ/P was S9+ with G3FUL at Stewkley, Bucks., a stretch of about 16 miles. The frequency was 1248 mc, and the transmitter at the G3CGQ end a 703A modulated oscillator taking 5w. input, with modulation at high level by a keyed 400-cycle tone produced by an 807, the beam being a 10-element stack fed through about 6-ft. of air-spaced coaxial cable; the stack was backed by a sheet reflector spaced 0.2 wavelength from the dipoles. Receiver at the G3FUL end was as described by G3CGQ in the August 1955 issue of SHORT WAVE MAGAZINE, consisting essentially of a crystal mixer with harmonic oscillator, and the aerial was similar to that used for transmission; contact was one way only.

Effectively, therefore, this 16-mile link was established by a tone-modulated SEO producing an MCW signal for a wide-band superhet receiver using a low order of IF.

However this may be criticised or dissected by the pundits, the central fact remains that G3CGQ and G3FUL are producing results, and over a useful distance at that. Their success is largely due to their having been working together on the 25-centimetre band for the best part of two years.

Though it is hardly for your present correspondent to offer an opinion, it would seem that to get our 1250 mc band opened up, with some activity actually happening on it, a good line of approach is the simpler one adopted by G3CGQ and G3FUL. There are many theoretical objections to SEO working, and it should never be regarded as the ultimate or only way of getting on to the band. But the present state of suspended animation is clear proof of the axiom that "the best is the enemy of the good," in that while striving to overcome all the problems associated with CC transmitters and receivers, nothing is being done *over the air*. And nothing much will happen, even from the experts with the stream-lined answers, until more people are actually in communication, whatever methods they may be using.

lover

The Edinburgh Dinner

Held on May 4 last, this is reported as having been very successful, 30 VHF call-signs being recorded present. Visitors from across the Border were G2HCG, G3BA and G3BW. The first-named gave his always-interesting lecture on Slot Arrays, and it is said that the GM's were very much impressed. At any rate, several of them are going in for Slots, and GM3FGJ (with a 4/4 array) is already in action with his, showing a startling improvement over the 12-element stack previously used.

GM3DIQ will be on shortly with a 6/6 Slot array, fed by a pair of 4-125A's; he hopes that this will increase his E.R.P. somewhat—well, it certainly should!

UHF/VHF Convention

In London on May 26, an interesting and well-attended UHF/VHF one-day convention attracted a gathering of 91. Those present included EI2W, F3SK, F8MX, F8NH, F9CQ, K4BZH, PAØFB, W3RTM and VU2AT. The chair was taken by G2AIW, supported by G4KD; for the dinner with which the proceedings closed, the guest of the evening was Dr. R. L. Smith-Rose, of the Radio Research Board.

Talks and lectures included a representative of the U.S.A.F. on "Forward Scatter," and G5CD on the latest S.T.C. UHF valve types. Those to look out for are the DET23, 6AF4A, 6AM4 and the 6VY4 triode—this was the one G5CD kept in his pocket! W1HDQ of *QST* sent across a tape-recording on American VHF activity and results. G3EOH/G3HBW discussed the receiver problem on 25 centimetres, and F3SK exhibited his version of a very fine 1250 mc CC converter design. There was a good deal of discussion on band planning for 25 cm—there is at present a strong conflict of opinion as to what part of this wide band British and European stations should meet on—but no agreement was reached.

For the prize draw, after the dinner, there was a total of 75 donated items; this meant that practically everybody got something. Which is as it should be! As the only lady at the meeting, Margaret Mills, G3ACC, conducted the draw.

Among those present were a number of old-timers; from the point of view of your correspondent, it was interesting to find so many two-letter call-signs active on VHF, and enthusiastic enough to come in for the meeting.

The organisation for this convention reflects great credit on those responsible, and it may also be said that the choice of *venue* was a good one.

European VHF Contest

Rules for the SHORT WAVE MAGAZINE All-European VHF Contest appeared on pp.148-149 of the May issue, and have been circulated to everyone abroad likely to be interested. It is hoped that we shall have a really good entry—but, as ever, all depends upon Ole Man Condx.

We have already been informed that HB1RD will

be on, from his mountain QTH at Chasseral, specially for this Contest, and will be using a crystal for 145.01 mc. According to HB9RD, if conditions are good, the band will be full of S9 signals, and their problem will be local QRM; from this QTH, they get the DL and F stations very well. Anyhow, the HB1RD group will be looking specially for G's for the duration of the Contest.

In Conclusion

All correspondence, claims and VHFCC awards are being held for A.J.D. on his return to duty—he hopes (and so do we!) that this will be in time for the next issue, reports for which are due by **Monday, June 18**, certain, addressed A. J. Devon, "VHF Bands," Short Wave Magazine, 55 Victoria Street, London, S.W.1. All being well, this feature should bear its wonted appearance with the July issue.

"ELECTRIC WIRING by AMATEURS"

The recent official report by the Fire Research Board states that many fires started from electrical installations have been found to be due to "faulty wiring by amateurs"—not, of course, necessarily meaning *radio* amateurs, but rather the increasing numbers in the "do-it-yourself" category of householders no longer able to afford the services of a registered electrical contractor at the princely rates now demanded for labour charges.

So far as simple house-wiring is concerned, radio amateurs can regard themselves as "qualified electricians," since they do understand what they are doing, even if their own installation is a bit hay-wire. There are interesting possibilities here, since the standards required and the method of carrying out the work are clearly laid down by the Electricity Authority, from the local office of which all details can be obtained.

SUMMER HOLIDAY CONTACTS

This year, many readers will be going abroad for summer holidays, and perhaps hoping or intending to seek personal contacts with amateurs in the locations they visit. In most cases, they can be assured of a welcome, but remember that it is always better to write or telephone before calling—just as you would expect if a stranger was visiting you in your own home. We know that most G's going abroad would normally do this, and we only make the point at all because we have heard of several instances where these holiday encounters out of the blue have not turned out too happily.

BACK NUMBER SITUATION

We still receive many requests for issues of SHORT WAVE MAGAZINE unfortunately long out of print. Except for odd copies, in general we can no longer supply anything much earlier than Vol. X (to February, 1953). Copies of many issues later than this date are also out of print or very few in number. Readers particularly needing copies of early issues can, however, nearly always obtain them by a request through our Small Advertisement section.

Design for a Communications Receiver

CC FRONT END—CRYSTAL
FILTER DESIGN

PART II

B. A. M. HERBERT (G2WI)

The first part of this article appeared in our May issue, to which reference should be made for continuity with this concluding instalment.
—Editor.

The two rearmost wafers on the switch introduce the crystals into the grid-plate circuit of the first half of the 6J6, which functions as a simple Pierce oscillator. The only point of interest here is that for 80 metres it was necessary to introduce a capacity of about 100 $\mu\mu\text{F}$ across the grid leak to ensure that the oscillator started up with certainty.

Originally, the intention was to use the second half of the 6J6 as a buffer for the 80, 40 and 20 metre bands, and as a multiplier for 15 and 10 metres. The spare switch wafer would of course have been used to introduce the necessary coils into the anode circuit of the second portion of the 6J6. It was discovered, however, that sufficient third harmonic was generated, and amplified, with this half as a plain buffer to permit satisfactory mixing. So the odd wafer was left unconnected.

It was a simple matter to check that all the crystals were working, for although the oscillator section of the 6J6 has only 30 volts on the anode, the output is discernible in an adjacent receiver. Lest thought of TVI rears its head, it should be mentioned that a check by independent observers for radiation in the TV bands gave an entirely *nil* result!

The attention was next given to the RF and Mixer stages. Since the front-end was to be virtually fixed tune these only needed to be peaked on each band. To achieve this a twin-gang miniature variable of 75 $\mu\mu\text{F}$ per section (another "surplus" item) was mounted under the chassis on the side wall adjacent to the valves it was to serve. It can be seen alongside the wave-change switch in the underside view.

According to capacity/inductance/frequency Abacs, it was seen to be possible to resonate both 80 and 40 metres with one coil using this capacity swing. Accordingly, a pair of coils (one for RF, one for mixer) were fabricated on $\frac{3}{8}$ in. slug-tuned formers; each coil had 15 turns of 28 g. enamelled wire close-wound except for the last 3-4 turns, which were spaced out; this was the grid winding. At the upper end of the formers a coupling winding of 7 turns was secured in position. These coils were introduced to the RF and mixer stages *via* the appropriate switch contacts. It was found that 80 metres peaked as expected, near maximum capacity, and 40 metres near minimum. The coils were aligned by pushing the aforementioned spaced turns closer together and cementing when adjusted satisfactorily.

Further reference to the Abac gave assurance that the same process would apply for the

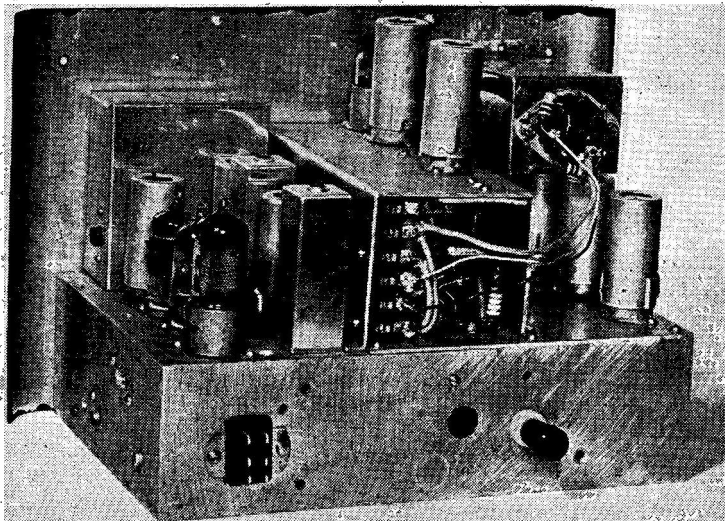

Upper-chassis view of the G2WI Tuned IF communications receiver, with the RF-mixer-CC oscillator front end on the right. The tunable oscillator is a 6AK5, just visible against the panel in the upper line of valves. The crystal filter is in the screened box on the left, fitted right up to the panel.

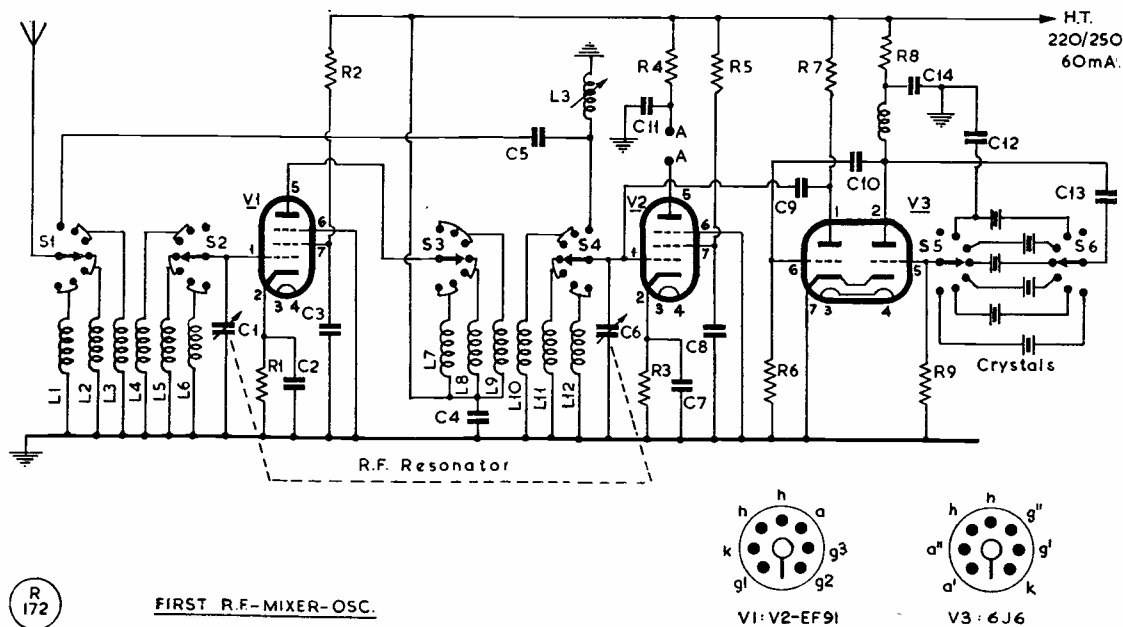

Fig. 5. The front end of the Amateur Band communications receiver, which consists of an RF stage, mixer and crystal oscillator, with switched crystals for the different bands — see Fig. 1 for frequencies, selected to give an IF of 1.8 mc all through. The 10-metre band is dealt with in two steps.

20, 15 and 10 metre bands. A pair of coils with 8 turns and 4 coupling turns was made and wired in. Alas! Stray capacities defeated the project, at least partially! The coils would resonate 20 and 15 metres, or, by removing some turns, 15 and 10 metres, but not all three! This was no real hardship, though, because it will be clear from the circuit that some of the switch contacts had to be jumpered in each case; therefore, these coils were used to resonate 20 and 15 and a third pair made solely for Ten.

This last pair had 6 turns with 4 coupling turns interwound; they were put on an ordinary lead pencil, doped with cement, and when dry installed. They resonated Ten nicely and peak performance was secured by slight stretching (or compressing) the last turn or so, though in fact the adjustment was very slight.

An operational check on the receiver was now made and signals came in exceedingly well on all bands; by pure chance this testing was done during December in a spell when Ten was well open, so that overall comparisons were easy.

Incidentally, *no* screening was found necessary between the coils, *but* it was very necessary to prevent the grid and anode sides of the RF stage from "seeing" each other across the valve holder. A small shield took care of this point. It should be noted that the RF

Table of Values

Fig. 5. First RF, Mixer, Crystal Oscillator Section

C1, C6 = Two-gang μF variable	R1, R3 = 100 ohm, $\frac{1}{2}$ watt
C2, 3, 7, 8, 11, 14, 4 = .01 μF tubular, 350v. wkg.	R2, 5, 6, 9 = 47,000 ohms, $\frac{1}{2}$ watt
C5 = 10 μF silver mica 350v. wkg.	R4 = 5,000 ohms, $\frac{1}{2}$ watt
C9 = 5 μF silver mica, 350v. wkg.	R7 = 100,000 ohms, $\frac{1}{2}$ watt
C10 = 50 μF silver mica 350v. wkg.	R8 = 25,000 ohms, $\frac{1}{2}$ watt
C12 = 100 μF approx. necessary value found by experiment)	RFC = 2.5 mh.
C13 = 500 μF silver mica, 350v. wkg.	S1, S6 = Six wafer (in use), Yaxley miniature type, each wafer one-pole, seven-way (see text)
	V1, V2 = EF91, Mullard
	V3 = 6J6

For all Coil Data, see text. For Crystal Frequencies, see Fig. 1, p. 154, May issue.

stage and mixer are operating well below maximum conditions; this was deliberately contrived and the values used were arrived at by experiment to get the best conversion and signal-noise ratio. The gain available in the second half of the receiver renders that aspect in the front end relatively unimportant.

The receiver was now fast taking shape and the front panel was fabricated, the curved ends visible in the illustrations being merely utilitarian in covering up some holes left in the cabinet! The switches for ANL, BFO and AVC were mounted (they are miniature push-on, push-again-off types as used in bedside

lights and similar applications) and the chassis mated with this panel.

The BFO uses another EF91 in a simple ECO circuit; the coil for this was wound by cut-and-try, and no direct coupling was made as the writer prefers a relatively weak injection. A tiny capacity feeding into the 465 kc diode detector would raise the BFO injection level if needed.

The RF gain control is dubbed "Sensitivity" on the front panel and controls the RF stage of the tunable IF and the second valve in the 465 kc IF; this arrangement has been found quite adequate and nicely progressive from the control point of view.

(4) *Crystal Filter*. Having met and solved all the problems up to this point preparations were made to tackle this one. Plenty of advice had been forthcoming during the planning and construction of the preceding stages, but there was a singular lack of it when this problem was mooted! Even the usual textbooks are not exactly voluble! The filter was to be quite conventional: Centre-tapped secondary of the first 465 kc IFT., crystal in one leg, phasing condenser in the other, common output fed *via* small capacity to grid of next stage which has separate grid coil, selectivity to be varied by introducing resistance in earthy end of this grid coil.

As a commencement the first 465 kc IFT was removed from the chassis, extracted from its can and the fixed condenser across the secondary removed. This was replaced by two others of twice the capacity joined in series, their junction forming the "centre-tap," and since the effective capacity across the secondary is the same its adjustment is not affected.

A small aluminium box 2½ins. x 2ins. x 1in. was made and into it the modified IFT was fitted as shown in sketch A, Fig. 6. Also mounted in the box were a small 50,000-ohm potentiometer (selectivity control), the phasing condenser (15 μ F miniature variable), the crystal and, in a well-shielded compartment, the next stage grid coil. This latter was wound on a ¼in. slug-tuned former and trimmed by

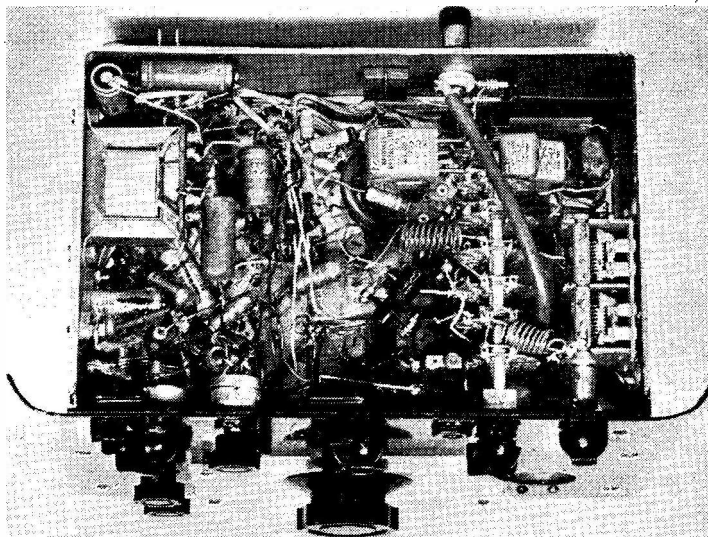

Underneath G2WT's Amateur Band receiver. This need not be as alarming as it looks because, as he explains, it can be assembled and tested section by section, with the first part (the AF end) underneath. The twin gang condenser on the extreme right is C1, C6 for RF resonance; alongside is the band-change switch, with the oscillator crystals mounted directly on the appropriate wafers.

experiment; it could, of course, be one "pie" from another IFT.

The whole assembly was wired up, and with some difficulty (purely on account of space) fitted into its appointed place. In the rear view of the receiver it will be readily identified as the box on the left up against the front panel. The coil head projecting at the side is the next stage grid coil.

Having "manufactured" it, now to try it! Well, there was a definite insertion loss, but no symptom of crystal action or anything like it! Everything was checked, but still no result. This was disappointing but not really unexpected — after all, one expects *some* snags! The filter was removed and opened up. All the components were OK and eventually it was decided to try another crystal. The only spare available was an "unknown" in a small bakelite case with pin spacing akin to the FT243 series; it was labelled 465 kc! This was soldered into circuit and all once again assembled. Switching on, a signal was found, and with considerable trepidation the crystal filter was introduced—it worked!

The familiar "twank" was immediately apparent; to get the best out of the filter the whole 465 kc IF section was carefully aligned

to the crystal and then results surpassed anything expected or hoped for.

In passing it should be mentioned that the switch for shorting out the crystal is achieved by bending the tip of one of the moving vanes of the phasing condenser so that in the fully meshed position it shorts.

Alignment

As will have been gathered, much of the individual lining up of circuits was done as work proceeded. In the accepted sense of the word, there is no complicated alignment to achieve! Once the relatively few individual coils have been adjusted the RF resonator control does the rest and the settings of this quickly become familiar in use.

General

This completed the plan as originally projected, and an enjoyable time was then spent in getting the feel of the receiver and controls. It handles nicely, stability is outstanding, it sorts out QRM with much less fuss than many of its more bulky brethren, and its other features all "measure up" as expected!

The power requirements are 200-250 volts DC at 60 mA, and 6.3 volts AC at 4 amps.

In the absence of a really miniature meter (one still hopes to discover one about the size of a halfpenny!) an EM34 magic eye has been built in as a means of assessing signal strengths.

Reference to the underneath view will reveal one or two points worth comment. It was found necessary to take the aerial feed in coax right to the switch wafer to reduce chances of break-through to the tunable IF; for a similar reason the feed to the tunable IF from the first mixer is also carried in a short length of the same cable.

Lest the complicated appearance of the underside should intimidate anyone we would say that, although it *appears* a little fearsome, if the steps taken are followed and everything made to work as it comes into being then there should be little fear of having to dig about in the assembly. The space apparently left empty below the EM34 has not been overlooked! A crystal check-unit is scheduled which will fit in there and give precise frequency measurement!

The whole of the constructional work involved in this project is well within the compass of most amateurs, having in this case been achieved almost entirely on the extending flap of a roll-top desk, with only a very ordinary selection of tools available. Only one tool is

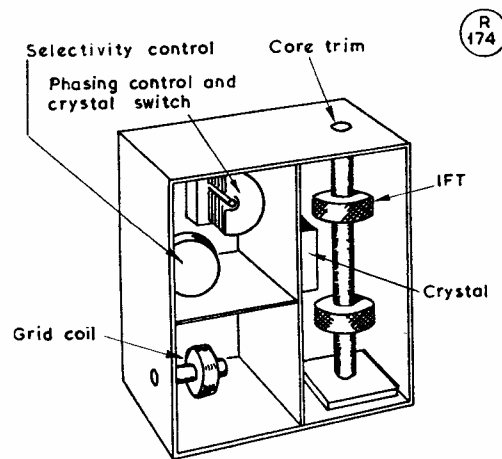

CRYSTAL FILTER LAYOUT—Sketch "A"

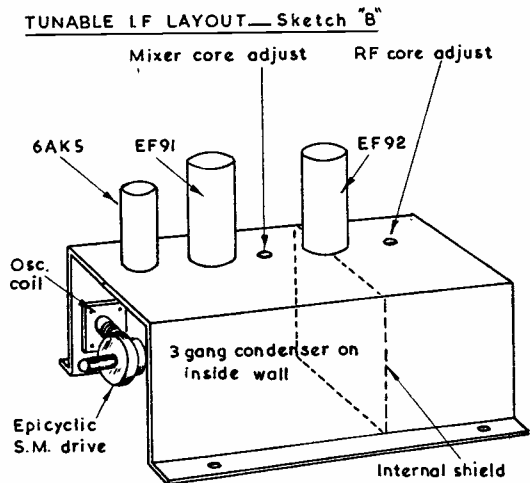

Fig. 6. Layout sketches showing the arrangement of the crystal filter and the Tunable IF section, the 6AK5 end of which is right up against the panel, and on its centre line. The circuit of this section is shown in Fig. 4, p. 157, May.

Table of Values

Resistor Values for Fig. 4, p. 157, May Issue

R4, R14,	R13, R16 = 150 ohms, $\frac{1}{2}$ -w.
R17 = 5,000 ohms, $\frac{1}{2}$ -w.	R12, R15 = 30,000 ohms, $\frac{1}{2}$ -w.
R11 = 100,000 ohms, $\frac{1}{2}$ -w.	R18 = 50,000 ohms, $\frac{1}{2}$ -w.

a *must* and that is a soldering iron with a long bit not more than $\frac{1}{8}$ in. in diameter.

In conclusion, it is hoped that this brief treatment will encourage others to try the experiment of building a real "Home-brewed special"—it's fun *and* well worth while!

(CONCLUDED)

WRITING SMALL ADVERTISEMENTS

When drafting your small advertisement, please write clearly, using the accepted abbreviations and conventions, and punctuate carefully. If printed in the form in which we actually receive them, many small advertisements would simply not make sense! In fact, in some instances, a good deal of detective work and a close knowledge of the "surplus" market has been called for to deduce what the advertiser really *does* mean! Remember that neither the typist who prepares the copy nor the printer who has to set it can be expected to write in the corrections. The best way of setting out the advertisement is first of all to make a rough draft, and from this a fair copy which states clearly what you want to say. A study of our Small Advertisement columns in any issue will show how it should be written.

THE E.M.I. COLLEGE OF ELECTRONICS

The department of E.M.I. Institutes, which provides full-time day courses giving comprehensive education in Radio and Electronic Engineering, will in future be known as the E.M.I. College of Electronics.

With the rapid and continuing expansion of the lecture rooms and laboratories of the College to meet the ever-growing national demand for highly-trained scientists and technologists, the need has become apparent for a definite title, descriptive of the activities of this important branch of E.M.I. Institutes. Over 200 students are attending the various full-time courses offered by the College and, in addition, a large number of qualified engineers and physicists are receiving part-time post-graduate training.

The standard courses in Electronic Engineering, Telecommunications, and Radio and Television Engineering are being augmented by special courses dealing with the advanced techniques of Automation, Electronic Process Control, and Digital and Analogue Computers.

The E.M.I. College therefore offers the fullest possible training in all branches of Electronic Science, including the latest developments in its application to industry and commerce, with the unique advantage for the student of a thorough practical grounding, as part of his course, in the laboratories and workshops of the vast E.M.I. Organisation.

Extension of Scholarship Scheme

The special scholarships for the 4-year course in Electronic Engineering have proved so successful that it has been decided to extend the scheme to include the 3-year course in Telecommunications. Eighteen scholarships are offered for the 4-year course starting on October 2, 1956, and two for the 3-year course starting on September 11.

The 4-year Electronic Engineering course is intended for suitable science sixth-formers capable of being trained as team leaders in scientific applications. Final qualifications are B.Sc. and the City and Guilds Full Technological Certificate in Telecommunications Engineering. The course is recognised by the I.E.E.

Entrance standard for the 3-year Telecommunications course is G.C.E. (ordinary level) or equivalent.

This is a course designed to train assistant development engineers to the level of the City and Guilds Full Technological Certificate in Telecommunications.

Full details of courses, scholarships schemes and so on are available from: The E.M.I. College of Electronics, 10 Pembridge Sq., London, W.2.

Re-ECHO from MACQUARIE

On p.44 of the March issue, we mentioned that the first radio station in Antarctic regions—though not, strictly speaking, within the Antarctic circle—was established on Macquarie Island (55° South) by Sir Douglas Mawson as far back as 1911. The interesting thing is that we now hear (from VK2NO) that one of Mawson's original operators, Wal Hannan, is VK2AXH, still going strong at the age of 74, and happily active on the 80, 40 and 20 metre phone bands. What a magnificent record! The KC4 boys of today have nothing on this, though Byrd did start in the Antarctic in 1929, with Amateur Radio as his sole link with the outside world.

ON THE COUNCIL

One of eight candidates in the list of four vacancies on the Buckingham Borough Council at the recent local government elections, Walter Krohn, G6KJ, was successful. An old timer of long standing—he was licensed more than 30 years ago—Councillor Krohn has been blind from birth. His affliction does not in any way prevent him from building most of his own gear, running a successful business and undertaking municipal duties for a third term. On the air, G6KJ is mainly active on Top Band and is a member of a regular Sunday morning net.

STILL THEY COME

The latest G.P.O. return shows that there are now nearly 6 million TV licences in issue throughout the country. Sound-only licences are still well in excess of this number, by about 2½ million.

CARDS IN THE BOX

We hold cards for the operators listed below, who are invited to send a large, stamped addressed envelope, with name and call-sign, to: BCM/QLS, London, W.C.1. This is the *only* address for our QSL Bureau; cards for G stations are cleared at fortnightly intervals. If publication of the call-sign/address is required, that should be mentioned at the same time. It will ensure appearance in our "New QTH" feature and in the *Radio Amateur Call Book*, the world-wide directory to radio amateurs, for which we are sole agents for Europe and the U.K.

G2ATX, 2FSB, 3BKP, 3IYN, 3JHJ,
3JZC, 3KJJ, 3KJM, 3KPI/A, 3KPU,
3KPV, 3KQU, 3KSG, 3KVC, 3RL,
3RPI, GM3SL, GW3KWB.

The Other Man's Station

G5FI

OUR description this month is of the station owned and operated by G. R. Scott-Farnie at 307 Grenville House, Dolphin Square, London, S.W.1. Now general manager of International Aeradio, Ltd., with world-wide interests in connection with civil aviation, he is one of the old timers, happily back with us after rather a long period of comparative inactivity.

Starting in South Wales with the AA ("artificial aerial") call 2AHK, he became licensed as G5FI in 1931; this was before stations in Wales took the GW prefix. Located in those days at Cefn Coed in Breconshire, there will be some reading these lines who will remember the first South Wales NFD, held in the field under the railway viaduct near his QTH; an argument as to what time it could be was settled by the passing of the "Brecon-Merthyr express."

As a result of changes occasioned by the war—during which G5FI served in the R.A.F. and specialising in Signals Intelligence, became a group-captain on the staff of the Air Command for D-Day,

1944—GW5FI as such disappeared. Post-war operation was spasmodic, and by 1952 all Amateur Radio activity had ceased. But the bug had bitten deep, and by 1955 the old urge to get on the air again became so strong that all difficulties had to be overcome.

The major of these was that, whereas previously there had been plenty of space available for shack and aerials, the new location was in a large block of flats, in London, with all the attendant aerial problems—and, of course, the menace of TVI. The first hurdle was the radiating system; fortunately, approaches made to the authorities concerned were sympathetically received and the result is shown in one of the photographs. This is a vertical mast aerial, half-wave on 14 mc, mounted about 125 ft. above street level but involving a coax feeder run of some 170 ft. into the station itself. Since multi-band operation was required, without the necessity of having to climb out on to the roof in a winter gale to change the system, a specially designed matching

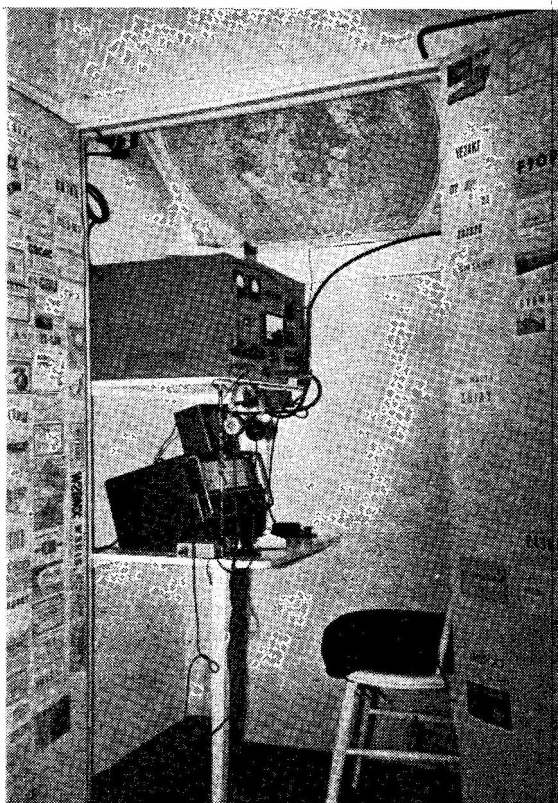

On the left — view as you enter the flat. On the right, the doors beside the telephone stand are opened, showing the station complete in its cupboard enclosure. The location is a block of flats in London, S.W.

unit was constructed. This is housed in a "dog kennel" placed at the foot of the mast, and by switched inductances and capacities gives coverage of the 3.5, 14 and 21 mc bands, selection of the system being by remote control. For the 10-metre band, a separate aerial is provided. At the operating position, a four-point switch selects the required aerial condition, the necessary control cable being run up in parallel with the coax feeder, cleated neatly to the face of the building.

It was imperative that in a small bachelor flat the station should be as tidily fitted and as inconspicuous as possible. Fortunately, the flat was well provided with cupboards, and the most suitable one, off the hall, was chosen. It measured 4 ft. wide by 2 ft. deep, with a roof height up to 10 feet. The layout can be seen in the photographs, the first showing a view of the hall with the station door closed, as it appears to unsuspecting visitors, and on the right with the "skeleton in the cupboard"; another shows G5FI in action on the air.

The transmitter consists of Minimitter units pre-fabricated into a form to fit the shelf space. Below

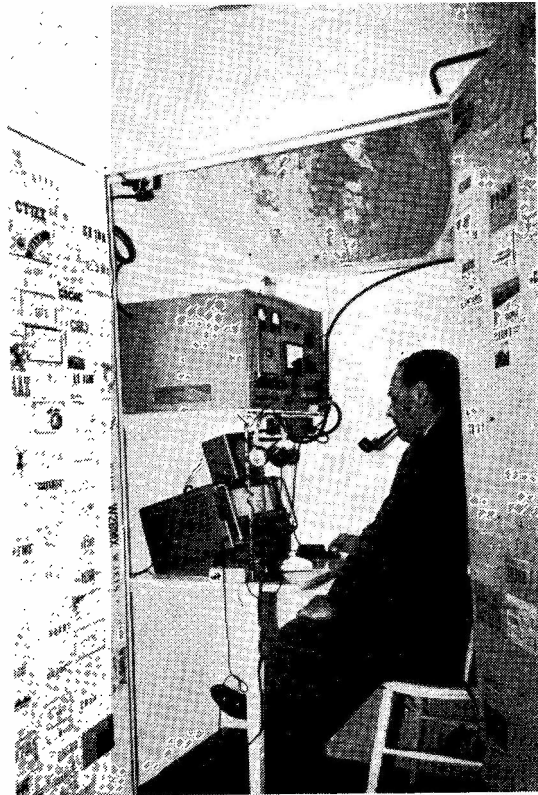

G5FI in action — if necessary, he can close those doors, and make himself completely "air tight and fire proof." In spite of the very long feeder run to the aerial on the roof of the block, good DX working is possible, with operation on four bands.

the transmitter is the Eddystone 680X receiver, speaker, microphone and key—the latter, by the way, a capture from Hitler's own signals station at Berchtesgaden! In front of the receiver is the small switch-box controlling the aerial change-over and band change, while mounted on the underside of the shelf supporting the transmitter is the aerial send-receive relay, actually a Type 78A as described by G2NS in the April issue of *SHORT WAVE MAGAZINE*. On the floor is the 24-volt DC power supply for the remote aerial switchgear and relay.

As to results: The station can be operated during TV hours at full power, CW or phone, on any band, without a trace of interference—in fact, the only interference experienced has been "the other way round," due to feed-back from the common-user TV aerial system, to which other residents are connected. On the air, the station has succeeded far beyond expectations, having regard to the aerial installation. Completed on Christmas Eve, G5FI as pictured here was WAC within a week, and by the middle of April 68 countries had been worked, CW and phone. In fact, G5FI is more satisfied with the "skeleton in the cupboard" than with any set-up previously operated anywhere. Rejuvenated by the renewal of old friendships and the making of new ones, he has great expectations for the future.

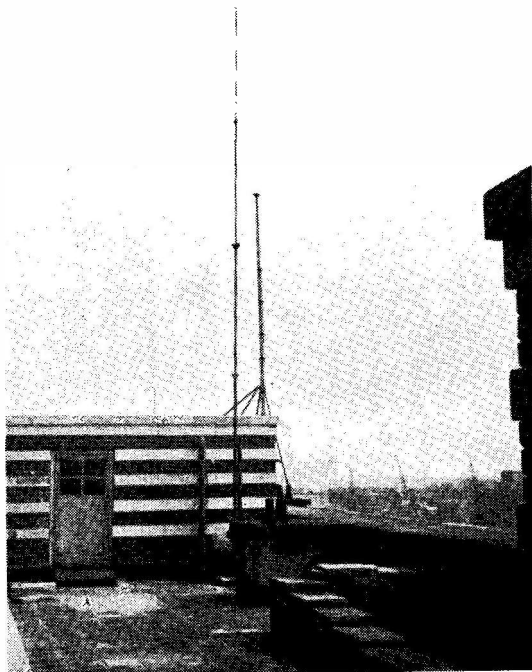

Looking over the roofs of London from the level of the three-band vertical mast aerial described in the text. The designed height of this is half-wave on 20 metres, with a remote-controlled matching unit to resonate it on 3.5 and 21 mc as well. From a "dog kennel" at the foot of the mast — housing the inductances, capacities and switchgear for changing over the aerial — a control cable is run down with the aerial feeder line to the operating position, involving a total length of about 170 feet. Very good results are being obtained on four bands, the aerial for 10 metres being a separate wire, also selected through the matching unit.

NEW QTH's

This space is available for the publication of the addresses of all holders of new U.K. call signs, as issued, or changes of address of transmitters already licensed. All addresses published here are reprinted in the quarterly issue of the "RADIO AMATEUR CALL BOOK" in preparation. QTH's are inserted as they are received, up to the limit of the space allowance each month. Please write clearly and address on a separate slip to QTH Section.

- EI2BD**, B. Bland, 66 Griffith Avenue, Clonmel, Co. Tipperary.
- EI3BD**, J. J. Drudy, 3 Alma Terrace, Finisklin, Sligo.
- GM2AH**, H. K. Bourne (*ex-G2KB*), 77 Newark Street, Greenock, Renfrewshire.
- G3BBR**, K. J. Wheatley, 28 Nutley Lane, Reigate, Surrey.
- G3GTI**, W/O H. R. Saunders, 6 Skeyton Road, Coltishall, Norwich, Norfolk.
- GM3HXF**, S. D. Morrison, 48 Rosemount Viaduct, Aberdeen.
- G3IUK**, C. M. Swift, 31 Charnwood Avenue, Belper, Derbyshire.
- G3JBA**, G. H. Maddox, 4 Pitt Crescent, Wimbledon Park, London, S.W.19.
- G3JDI**, K. Strellis, 119 Langley Crescent, Dagenham, Essex.
- G3JVB**, A. Brown, 43 Sharp Crescent, Gilesgate Moor, Durham City, Co. Durham. (*Tel.: Durham 2812*).
- G3JZR**, J. K. Curtis, 10 Albert Road, Portishead, Bristol, Somerset.
- G3KHB**, H. V. Prescott, 483 Durdar Road, Carlisle, Cumberland.
- G3KJN**, I. Winter, 667 Whitefield Road, Bury, Lancs.
- G3KMB**, K. Barnes, 49 Lyell Street, Scarborough, Yorkshire.
- G3KOR**, R. Halhead, 102 Waldgrave Road, Liverpool, 15.
- G3KPR**, I. R. Brookes, 64 Teignmouth Road, Cricklewood, London, N.W.2.
- G3KQC**, G. A. Piper, 46 St. Peter's Square, Hammersmith, London, W.6.
- G3KQY**, R. J. Disley, 35 Stanley Place, Fishergate Hill, Preston, Lancs.
- G3KRS**, H. Hinde, 97 Burton Road, Manchester, 20.
- G3KSO**, E. T. White, 137 Lewis Flats, London, W.14.
- GM3KTD**, W. K. Wylie, 2 Lovat Road, Kinlochleven, Argyll.
- G3KTF**, R. D. May, 46 Woodhall Road, Chelmsford, Essex.
- G3KTP**, E. E. West, 21 Westfield Avenue, Marlpool, Heanor, Derbyshire.
- G3KUF**, H. T. Falstein (*ex-MP4BBI*), 34 Richmond Terrace, Clifton, Bristol, 8.
- G3KUG**, H. Peabody, 182 Cavendish Road, Walsall, Staffs.
- G3KVG**, J. S. Charles, 87 Lees Hall Road, Sheffield, 8.
- G3KVI**, Cpl. C. Tebay, Stone Lea, Leece, nr. Ulverston, Lancs. (*QSL to Cpl. C. Tebay, R.A.F. Station, Digby, Lincs.*).
- G3KVV**, V. Bridport, 3 Matching Green, Basildon, Essex.
- GW3KWA**, J. Parry, Bangor, Caernarvonshire.
- G3KWC**, D. Page (*ex-VS6DF*), 1 New Cross Road, Stamford, Lincs.
- G3KWH**, J. F. Vaux, 7 Fearnley Road, Welwyn Garden City, Herts.
- GW3KWI**, Dr. R. W. G. Stewart, Mount Pleasant Hospital, Swansea, Glam. (*QSL to 73 Ashley Road, Aberdeen, Scotland*).
- G3KWJ**, N. B. Valentine (*ex-VP6NV*), Basement Flat, 109 Argyle Road, Ealing, London, W.13.
- G3KWK**, R. W. Nolan, 36 Church Street, Padstow, Cornwall.
- G3KWR**, M. Ward, Hut 358, "C" Sqdn., No. 1 Wing, R.A.F. Station, Locking, Weston-super-Mare, Somerset.
- G3KXA**, R. A. Swain, 8 Clinton Road, Shirley, Solihull, Warks.
- G3KXF**, D. S. Roden, 115 First Avenue, Gillingham, Kent.
- G3KXF/A**, A/A D. S. Roden, Hut 316, "C" Sqdn., No. 1 Wing (Apps), R.A.F. Station, Locking, Weston-super-Mare, Somerset.
- G3KXL**, C. V. Kempster, 1 Sack Street, Dukinfield, Cheshire.
- G3KXN**, B. M. Bonser, 54 Newport Road, Albrighton, nr. Wolverhampton, Staffs.
- G3KXN/A**, A/A B. M. Bonser, Hut 334, "A" Sqdn., No. 1 Wing (Apps), R.A.F. Station, Locking, Weston-super-Mare, Somerset.
- G3KXT**, R. I. Richardson, Knavesmire, Brookside Wav, Shirley, Croydon, Surrey.
- GW3KYA**, B. R. Davies, 19 Coronation Road, Blackwood, Mon.
- G3KYH**, J. A. Carter, 29 Newsoms Meadow, Lowestoft, Suffolk.
- G3KYN**, A. R. Daniel, 18b Tyn-dalls Park Road, Bristol, 8. (*Tel.: Bristol 3-3368*).
- G13KYP**, A. D. Patterson (*EI4BC*), Sharon, Cameronian Drive, Castlereagh, Belfast.
- G3KYQ**, A. J. Garcia, 203 Kenton Lane, Kenton, Harrow, Middlesex.
- G3KYT**, K. Schofield, 201 Upholland Road, Billinge, Orrell, nr. Wigan, Lancs.
- G3KYU**, J. Ashford, A.R.I.C.S., 119 Petersfield Road, Boscombe East, Bournemouth, Hants. (*Tel.: Southbourne 44569*).
- G3LAB**, No. 9F (Islington) Sqdn. A.T.C. Amateur Radio Club, 65 Parkhurst Road, Holloway, London, N.7.
- G6JF**, G. R. Wigg, Tabbacombe Farm, Kingsbridge, Devon.

CHANGE OF ADDRESS

EI4BC, A. D. Patterson (*G13KYP*), Trudder, Newtownmount-kennedy, Co. Wicklow. (*QSL to Sharon, Cameronian Drive, Castlereagh, Belfast, Northern Ireland*).

G3BPX, J. C. Menzies, 33 Polsted Road, Catford, London, S.E.6.

G3CDE, Dr. G. A. Jackson, 14 Normanhurst Avenue, Bournemouth, Hants.

G3ELG, H. N. Gubby, 50 Peveril Road, Sheffield, 11, Yorkshire.

G3KHT, Sgt. N. J. James, Sgts' Mess, R.A.F. Station, Honington, Bury St. Edmunds, Suffolk.

CORRECTION

G3KTV, A. G. Barnsley, 322 Willenhall Lane, Binley, Coventry, Warks.

THE MONTH WITH THE CLUBS

By "Club Secretary"

(Dead-line for July Issue : JUNE 15)

MAY we appeal once more to all Club Secretaries to take due note of the deadline (as quoted above) each month, and to make sure that their notes reach us on time? Month after month we receive reports two or three days too late for inclusion, and they then have to be held over until the following issue, when their contents are of considerably less interest than they would have been. The most urgent request to "squeeze us in although we are late" can never be met, because the deadline quoted is the *last* possible date on which we can accept copy. We really need it several days earlier, but we give you all the time we can.

Another perennial request of ours is for *good* photographs of Club events, equipment or personnel, but, please, they must be good. If they are of half-plate or larger size, and dead sharp, then (if the material is interesting enough) we can use them. But prints of 2½ by 2½, however sharp they may look, will not necessarily enlarge into good photographs. And pictures of a rather blurred face, fringed by headphones and showing a dim grey box in the background are not what we call a fair representation of "The Club's station at the local Follies Exhibition"! Club Groups and good pictures of meetings and outdoor events are always acceptable, bearing in mind the above limitations.

ACTIVITY REPORTS

Bournemouth signed G2HIF/P from Okeford Hill, Blandford, on May 6, and made 56 contacts during the day. The next meeting (before this is published) promises to be interesting, as all members are being asked to bring along what they consider the most useful tool, gadget or piece of equipment in their shack and to expound on its virtues. The summer outing (June 17) will be a tour of the Isle of Wight, calling at Niton Radio during the afternoon. Holiday visitors to Bournemouth will be welcomed to the meetings, on the first Friday at the Cricketers' Arms, Windham Road.

Clifton were represented at the recent Mobile Rally at Northampton by G3HSE, who made many /M contacts during the day. The Club station, G3GHN, operates on Top Band on alternate Friday evenings, and a transmitter is now being prepared for the HF bands. June 8 and 22 will be constructional evenings with ragchews, June 15 a Junk Sale, and June 17 the second D-F Contest. Normal meetings are on Fridays at 225 New Cross Road, London, S.E.14.

Coventry's forthcoming programme is : June 11,

Lecture by Mr. Dryburgh; June 25, Open Night; July 9, Lecture by G3IHX; July 23, Open Night.

Cray Valley recently celebrated its tenth anniversary and decided to open its ranks to non-transmitting members. Those interested in any aspect of Amateur Radio are therefore invited to meetings of the Club, 8 p.m. on the fourth Tuesday, at Station Hotel, Sidcup, Kent (next meeting, June 26). (See panel for secretary's QTH.)

Crystal Palace sent seven members, in two cars, to the Mobile Rally, and at one stage there were four mobile cars and an SWL with a deaf-aid Top-Band receiver on a motor-cycle, all in convoy! At the May meeting there was a talk on Transistors; the next event is the meeting on June 9 (at Windermere House, Westow Street, London, S.E.19), when



At a recent exhibition held at the Kodak Hall, Harrow, an amateur station signing GB3HAR was in action. The operators were : G3HBR, at the blackboard; G2TA with the microphone; and, nearest camera, G3KOE keeping the log. In all, some 28 countries were worked in the course of the single afternoon the station was on.

there will be a Junk Sale. Early arrivals will have a slow Morse session from 7.30 p.m.

Derby meets on Wednesdays, and members have recently had talks on Colour Photography and Pi-Networks. A recent visit was to the vibration testing laboratory of Rolls-Royce, Ltd., when thirty members saw the various electronic methods of studying engine transients. On June 20 there will be a Film Show. Membership as at March 31 totalled 80, and it is hoped to reach the 100 mark by the end of the year.

East Kent now meets every Tuesday in the basement of the Technical College, Longpost Street, Canterbury. Members are busy making benches, a group is at work on a temporary transmitter, and Morse classes are being given by G2BBT. The secretary also gives theory lectures most weeks, and the coming D-F season is causing some interest.

Edinburgh held their AGM in April and elected GM3FUU president, GM3KKG secretary, Mr. A. Henderson treasurer and a committee of three. Meetings will be held every Wednesday except between the first week in June and the autumn, when they will be only on the *first* Wednesday of the month. GM8FM was manned on June 2-3 from East Lothian, on 80 and 160 metres.

Harrow joined with local Model Engineering societies in an exhibition on May 12-13, the Club station being on the air with the special call of GB3HAR. Some 30 countries were worked, including quite a few DX contacts. The Mayor was among many visitors who showed great interest in the gear constructed by Club members. Meetings are held every Friday evening in the Science Lab., Roxeth Manor Secondary School, Eastcote Lane, South Harrow.

Isle of Man held their AGM on April 18, when they elected their officers, dined and held a Junk Sale. They have now closed for the summer months and will be opening again in September or October.

Lancaster had their AGM on May 2, and very good progress was reported, with an increase in membership. A weekly Club net has been formed, and it is hoped to acquire a permanent clubroom in which a transmitter can be built. Meetings are held on the first Wednesday at the George Hotel, Torrisholme. (Note new secretary's QTH, in panel.)

The **North-East Amateur Transmitting Society** announces that it will meet on June 5, July 3, August 7 and September 4, 7.45 p.m., at the Liberal Club, Pilgrim Street, Newcastle-upon-Tyne, 1.

Nottingham (Amateur Radio Club) held their first general meeting on May 8, and discussed club matters generally—in particular, the sale of surplus gear and components to swell the funds. A suitable transmitter is ready, a receiver will be provided, and then the club will be on the air once more. Several members sat for the RAE on May 4.

Nottingham (Amateur Radio Society) met at the end of April to hear G6MB on The Antennamatch and a new all-band coupling device. There were also a raffle and an exhibition of home-made and commercial gear, and this event attracted an attendance of 98. G3DJL was elected chairman and G2HIO secretary at the AGM, when it was agreed that future

meetings (next is on June 15) would be held at Basford Hall Miners' Welfare, Nuthall Road, Cinderhill, Nottingham.

Plymouth have found a new clubroom at The Virginia House Settlement, Barbican, where they meet on alternate Tuesdays at 7.30 p.m. (next meetings June 12 and 26). They hope to get a club station going there.

Purley held their AGM on May 18 and put up a proposal to raise the subscription rate slightly for members over 18 years of age. A general ragchew was held the same evening.

Sheffield meets on the fourth Wednesday of the month, 8 p.m., at the Dog and Partridge Hotel, Trippet Lane. During April they visited the BBC station at Moorside Edge, and hope to arrange a trip to Holme Moss in the near future.

Shefford get together every Friday evening in their HQ at Digs Well House. Recent attractions have included an amateur TV demonstration by G2DUS/T, a very active member. One-way TV with first-class pictures was transmitted over 13 miles, the return channel being on the Top Band. Visitors and new members are always welcome to the meetings, where refreshments are available.

Slade continues its meetings every fortnight, although the club station is available *daily* for the

NAMES AND ADDRESSES OF CLUB SECRETARIES REPORTING IN THIS ISSUE :

BOURNEMOUTH : J. Ashford, 119 Petersfield Road, Boscombe East, Bournemouth.
 BRADFORD GRAMMAR SCHOOL : D. M. Pratt, G3KEP, 27 Woodlands Grove, Cottingley, Bingley.
 CLIFTON : C. H. Bullivant, G3DIC, 25 St. Fillans Road, London, S.E.6.
 COVENTRY : J. H. Whitby, G3HDB, 24 Thornby Avenue, Kenilworth.
 CRAY VALLEY : S. W. Coursey, G3JJC, 49 Dulverton Road, London, S.E.9.
 CRYSTAL PALACE : G. M. C. Stone, G3FZL, 10 Liphook Crescent, London, S.E.23.
 DERBY : F. C. Ward, G2CVV, 5 Uplands Avenue, Littleover, Derby.
 EAST KENT : D. Williams, Llandogo, Bridge, nr. Canterbury.
 EDINBURGH : M. Darke, GM3KKG, 7 Joppa Gardens, Portobello, Midlothian.
 HARROW : S. C. J. Phillips, 131 Belmont Road, Harrow Weald.
 ISLE OF MAN : R. A. Davis, 2 Laureston View, Ballaquayle Road, Douglas, I.O.M.
 LANCASTER : B. Parker, G3KOQ, 125 Regent Road, Morecambe.
 LIVERPOOL : A. D. H. Looney, 81 Alstonfield Road, Knotty Ash, Liverpool 14.
 LOTHIANS : J. Good, GM3EWL, 24 Mansionhouse Road, Edinburgh 9.
 NORTH-EAST : L. G. Spencer, 16a Pilgrim Street, Newcastle-upon-Tyne 1.
 NOTTINGHAM (Amateur Radio Club) : J. Rayner, G3KTO, 28 Tottenbury Road, Basford, Nottingham.
 NOTTINGHAM (Amateur Radio Society) : A. Walmsley, G2HIO, Park House, Cinderhill Road, Cinderhill, Nottingham.
 PLYMOUTH : C. Teale, G3JYB, 3 Berron Park Road, Peverell, Plymouth.
 PURLEY : E. R. Honeywood, G3GKF, 105 Whytecliffe Road, Purley.
 SHEFFIELD : G. F. Lyon, G3GJF, 125 Rokeby Road, Sheffield 5.
 SHEFFORD : G. R. Cobb, G3IXG, 7 Hitchin Road, Shefford, Beds.
 SLADE : C. N. Smart, 110 Woolmore Road, Birmingham 23.
 SOUTH MANCHESTER : M. Barnsley, G3HZM, 17 Score Street, Bradford, Manchester 11.
 STOKE-ON-TRENT : A. Rowley, G3JWZ, 37 Leveson Road, Hanford, Stoke-on-Trent.
 SURREY (CROYDON) : S. A. Morley, G3FWR, 22 Old Farleigh Road, Selsdon, South Croydon.

use of members. On June 8 there will be a talk on Industrial Electronics, by Mr. D. W. Morris, and on June 22 one on Oscilloscope Design and Applications for Amateur Use, by a member of the Mullard organisation. All meetings begin at 7.45 p.m., Church House, High Street, Erdington, Birmingham, 23.

South Manchester meets on June 15 for Valves and How they Work (G3DQU), and on June 29 to hear about Interplanetary Travel (G2WS). The subject for the July 13 meeting is still to be announced.

Stoke-on-Trent continues its meetings as usual. Several members took the RAE examination, and are anxiously awaiting results. During the Whitsun holidays the society's annual field day was held.

Surrey (Croydon) turned out in force to hear G4ZU on his Minibeam, and decided to circulate a questionnaire among members to determine the kind of talk that would stimulate equally good attendances. So far it seems that SSB is most sought-after. At the June meeting there will be three short talks—on TVI harmonic-checking, converters for Ten and Fifteen, and a simple D-F receiver for Eighty.

Reports for this feature are welcomed from all active Clubs. For the July issue, they should reach us by **June 15**, addressed "Club Secretary," *Short Wave Magazine*, 55 Victoria Street, London, S.W.1. Closing date for August will be *July 13*.

Bradford Grammar School put five members in for the RAE, the result of which is awaited eagerly. Their transmitter G3KEP/A now operates on 80 and 160 metres during the lunch hour with a small ten-watt transmitter, but a 150-watt rig is on the way. Components are always required, and this Club would be most grateful for gifts of "junk" of any kind.

Lothians notify us that on June 10 they are running a Bus Tour—details and tickets from the secretary. June 14 is the date of their AGM—7.30 p.m. at 25 Charlotte Square.

We acknowledge receipt of broadsheets and news bulletins from South Africa (*South Coast QRM*) and Liverpool (*G3AHD News Sheet*).

COLOUR TELEVISION in the UNITED STATES

The Director of Engineering of the BBC, Sir Harold Bishop, spoke about colour television in the United States at a luncheon of the Radio Industries Club in London on April 24. Sir Harold Bishop has just returned from a visit to the United States.

He said that colour television had made a good start there, but he thought progress would be slow until the price of sets drops. The system which they had adopted—the National Television Standards Committee system—was capable of excellent results, and intensive work on the development of television sets was continuing.

So far, only about 25,000 colour television sets had been sold at a price of about 800 dollars (say £300) each. The service and maintenance charges on these sets averaged 100 dollars (£35) a year. The R.C.A. company was now making about 30,000 sets a month at a cost of 700 dollars each. Sir Harold had been told that, as manufacture developed, it was hoped that the price would come down to roughly double the cost of an ordinary black-and-white television set.

Of the three big networks in the United States, N.B.C. was radiating approximately 40 hours of colour television a month, which was to be increased to 80 hours at the end of the year. C.B.S. was doing 10 hours of colour television monthly, but had recently reduced this service. The other network—A.B.C.—was doing no colour transmissions. Sir Harold Bishop referred to the cost of the programmes, known as "spectaculars." They ran up to about a quarter of a million dollars (£90,000) for a half-hour programme!

About the prospects of colour television in Britain, Sir Harold Bishop said that the BBC had an open mind on what system should be adopted. It was the responsibility of the Television Advisory

Committee—on which the Post Office, the Trade and the BBC were represented—to recommend the most suitable system. The BBC had been accused in some quarters of spending public money in pushing a compatible colour television system on 405 lines. This was a misrepresentation of the facts. The BBC was exploring *all* aspects of colour television, and its experiments would cover all bands and standards other than 405 lines, in co-operation with the Industry. It would be a long time before a decision was reached. On black-and-white television in the United States, Sir Harold said that there were now 450 television stations and 35 million sets, still increasing at the rate of about six million a year. It was becoming usual for a household to have two television sets.

OBITUARY

We very much regret to have to record the death, on May 2, after a painful illness borne with great fortitude, of Charles Sullens, G3FQU, of Whitton, Middlesex, at the age of 65. He was a prominent member of the "Skylarks" early-morning 80-metre net, and he will be missed by a large number of radio friends, made over the air. Their sincere sympathy goes out to his widow and his mother.

* * * *

We also have to report the death, suddenly, of Claude Field, G3KBL, of Warley, Birmingham, who passed over on May 8 after a heart attack. Though at the age of 54 a newcomer to Amateur Radio, he was imbued with the true amateur spirit, and was looking forward to increased activity, especially on the VHF bands. He leaves a widow and son, who will have the deep sympathy of all who knew G3KBL.

LYONS RADIO LTD.

HIGH STABILITY RESISTORS. Miniaturised $\frac{1}{2}$ watt $\pm 10\%$ specially selected kit to give you a complete coverage of preferred values between 10 ohms and 3 megohms. Kit contains one each of 60 different values with resistance clearly marked on each resistor. PRICE per Kit, £1, post 9d. Values up to 10 megohms can also be supplied. Smaller quantities of your choice supplied at 5/6 dozen, post any qty. 1/-.

SPEAKER GRILLE. Woven metal, three sizes available. "A" $14\frac{1}{2} \times 13\frac{1}{2}$ in. "B" 15×12 in. "C" $16\frac{1}{2} \times 11\frac{1}{2}$ in., with smart gold sprayed finish. PRICE all sizes, 3/6 each, post paid.

ELECTROSTATIC SPEAKERS. Reproduce those missing frequencies beyond 8-10 Kc/s. and reproduce frequencies up to 20 Kc/s. By adding one of these speakers to an existing speaker system the remarkable quality of the VHF transmissions and the superb brilliance of modern long-playing recordings can be faithfully reproduced. Full instructions for incorporating these speakers supplied.

TYPE LSH 75 : $3 \times 3 \times \frac{1}{2}$ in., for handling up to 6 watts. PRICE 12/6.

TYPE LSH 518 : $7 \times 2 \times \frac{3}{8}$ in., for handling up to 12 watts. PRICE 17/6.

TYPE LSH 100 : $5 \times 4 \times \frac{1}{2}$ in., for handling up to 21 watts. PRICE 21/-.

(Dept: MS) **3, Goldhawk Road, Shepherds Bush, London W.12**

WAVEMETER TYPE W.1239. Frequency coverage 39-51 Mc/s. Rectifier type employing valves type VR92, 6J5, 6X5 and tuning indicator VI103. The tuning control is fitted with a Muirhead slow-motion drive, skirted type, with vernier scale. The instrument has its own built-in power pack for operation from 200/250v. A.C. mains, and are housed in copper-lined wooden instrument cases $16 \times 10 \times 9$ in. A really top grade job which would make a useful addition to any test room or laboratory, and at a price well below the value of the components alone. PRICE ONLY 59/6, carriage 7/6.

DYNAMOTORS TYPE DI01. Rotary converters, American made, rated for 27v. D.C. input at 1.4A and 225v. D.C. output at 60 mA. $4\frac{1}{2}$ in. long $\times 2\frac{3}{8}$ in. dia. In good condition. PRICE ONLY 10/6, post 2/-.

FOR CALLERS. AR88D, £55. Dictaphone with double recording head. In new condition, £30. Simon Sound Tape Recorder in good condition, £30.

THIS MONTH'S SPECIAL BARGAIN !

INDICATOR UNITS TYPE 182. Contain cathode ray tube type VCR517, 3-VR91's, 4-VR65's, 1-5U4, pots, resistors, condensers, and a wealth of other useful components. PRICE ONLY 55/-, or without 5U4, 45/- Carriage 7/6.

ALL THESE FINE BARGAINS ARE AT *The Walk-around Shop*

VIBRATOR PACKS

(Mallory). 12 volt input, 275 volt 80 mA. output. Size $5\frac{1}{2}$ in. W. \times $5\frac{1}{2}$ in. H. \times 3 in. D. New and Boxed, 25/- Post & Pkg. 2/6.

R.F. UNITS

R.F.24 20-30 Mc/s, switched tuning, valved, 9/6 ea.; R.F.25 40-50 Mc/s, switched tuning, valved, 9/6 ea.; R.F.26 50-65 Mc/s, variable tuning, valved (New), 25/- ea. Packing and postage 2/- ea

A.R.88

Ceramic wafered Range Switch Assembly. New and Boxed. Price 17/6, Post & Pkg., 2/-.

ADMIRALTY RESPONER UNIT. W.4790

This receiver tunes from 160-182 Mc/s. Valve line-up VR.136 R.F., VR.92 Mixer, VR.137 Osc., VR65's in 5 I.F. stages. Modification details available to cover approx. 80 to 100 Mc/s. Price 12/6. Each full valved. Post and Pkg., 7/6.

MINIATURE I.F. STRIPS

Size $10\frac{1}{2}$ in. \times $10\frac{1}{2}$ in. \times 3 in. Frequency 9.72 Mc/s. Line-up : 2 EF.92's and 1 EF91 I.F., Amps. EB.91 DET/AGC., EF.91 AGC Amp. and EF.91 limiter. Circuit supplied. Price, less valves, 8/- each, post paid.

TYPE "234" POWER UNITS. Double Smoothed 200-250 v. Input. 260 v. 100 mA. 6.3 at 6 amps. with voltmeter reading input and output voltages. Size : 19 in. \times 10 in. \times 6 in. Standard Rack Mounting. Price £4.10.0 each, plus 7/6 Post & Pkg.

BENDIX I.F. TRANSFORMERS

1.63 megs. Complete in cans set of 2. New and Boxed. Size 2 in. \times $1\frac{1}{2}$ in. \times $3\frac{1}{2}$ in. Price 5/- each, Post & Pkg. 1/6.

INSULATING TAPE. Perfect condition, $\frac{1}{2}$ in. wide, 25 yds reels. Foiled in tins. Price 1/3 each. Post & Pkg. 8d.

Make a Miniature POCKET RADIO. Complete KIT, £2.6.0. Send for full details.

NOTE : ORDERS AND ENQUIRIES TO DEPT. 'S'

PROOPS BROS. LTD. Telephone LANgham 0141
52 Tottenham Court Road, London, W.1.
Shop Hours : 9-6 p.m. Thursday : 9-1 p.m. Open all day Saturdays.

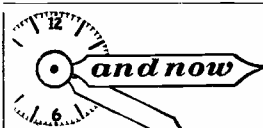

S.G. Brown

HEADPHONES FOR MARINE EQUIPMENT

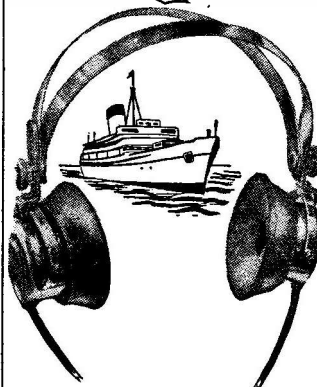

Every seagoing vessel in this electronic age relies on Marine Communication Equipment.

Our contribution is a specialised range of reliable Headphones which provide ships' operators with the clearest possible reception of all signals—Morse or speech.

S. G. Brown provide Headphones and associated equipment for all known purposes. Brochure "S" sent on request.

S.G. Brown, Ltd.

SHAKESPEARE STREET, WATFORD, HERTS

Telephone : Watford 7241

SMALL ADVERTISEMENTS

9d. per word, minimum charge 12/-. No series discount; all charges payable with order. Insertions of radio interest only accepted. Add 25% for Bold Face (Heavy Type). No responsibility accepted for errors. Replies to Box Numbers should be addressed to The Short Wave Magazine, 55 Victoria Street, S.W.1.

TRADE

G3CGD QSL's. — Fixed and mobile samples on request. Printing enquiries welcomed.—30 St. Luke's Road, Cheltenham.

QSL CARDS and LOG BOOKS. Approved G.P.O. Samples free.—Atkinson Bros., Printers, Elland, Yorks.

WANTED: BC-610 Hallicrafters, ET-4336 Transmitters and spare parts for same. Best prices.—P.C.A. Radio, Beavor Lane, Hammersmith, W.6.

TELEVISION INTERFERENCE: Receiver Filters —High-pass E.5037, 30/-; Low-pass E.5031, 30/-; Composite Band I/III, 49/6; Transmitter Filter E.5034, 80 dB, 1 kW., £6.—Labgear (Cambridge), Ltd., Willow Place, Cambridge.

QSL's and LOGS by MINERVA. The best there are.—Samples from Minerva Press, 46 Queen's Road, Brentwood, Essex.

READERS' ADVERTISEMENTS

3d. per word, min. charge 5/-. payable with order. Box Numbers 1/6 extra. Replies to Box Numbers should be addressed to The Short Wave Magazine, 55 Victoria Street, S.W.1.

FOR SALE: Receiver B36, 1-20 mc, unused, no valves; Receiver BC455-B, Mod. 14-28 mc; Receiver BC453-B, 190-550 kc; Receiver BC455-B, 6-9.1 mc, no valves; Receiver Rack for two Command Sets, Type CBY-46110; Control Box BC 450A, Indicator type 6C; Unit TU9B, no case; Unit TU5B, complete in case; £20.—Ring Ewell 5708, after 7 p.m.

FOR SALE: R-107, mint condition, with 20-metre preselector, £16; or exchange with cash for CR100 or Armstrong Chassis. — Albans, 17 Fern Road, Cropwell-Bishop, Notts.

GOING QRT: No. 12 Transmitter, 1.2-17.5 mc; GTCS-6 Rx, 1.2-12 mc; Class-C Wavemeter; Cossor Oscillator; TSC-6 Transmitter, stripped, various valves, etc.; £25 the lot.—Roots, Regina, Belmont Avenue, Wickford, Essex. (Phone (day) London Wall 2828, (evening) Wickford 2313).

FOR SALE: Panda PR120V; black cabinet; first-class condition; £85 (o.n.o.). — Box No. 1680, Short Wave Magazine, Ltd., 55 Victoria Street, London, S.W.1.

FOR SALE: HRO Senior, 500 kc-30 mc, in six coils; bandspread 20 and 40 metres; good, clean condition; manual; £18.—Tyrrell, 70 Middlesfield, Ormsgill, Barrow-in-Furness, Lancs.

FOR SALE: Eddystone S640, perfect, with S-meter. Loudspeaker, phones, £18 10s.—A. Preston, 31 Burnham Street, Bolton, Lancs.

This is Candler calling

- ALL ENTHUSIASTS
- wishing to learn or to
- improve their speed and
- accuracy in Morse Code.
- The Candler System of *home study* and practice embodies exclusive methods for quickly
- learning to read and send Morse Code. The Practice Equipment
- costs only a few shillings.

Thirty minutes of guided practice a day, the Candler way, is more beneficial than hours spent in hit and miss methods. This System is recognised throughout the World as the most efficient, simple and scientific method of Morse Code Training.

These are three Courses available :

(1) THE SPECIAL SHORT COURSE

For G.P.O. Morse Code test for securing Amateur Transmitting Licence, and for S.W.L.'s.

(2) THE JUNIOR COURSE

A Complete Course for the Beginner.

(3) THE ADVANCED COURSE

For all who desire to increase their accuracy and speeds up to 20 or more w.p.m.

For Terms and Full Details, write for the "BOOK OF FACTS" which is sent post free, without any obligation.

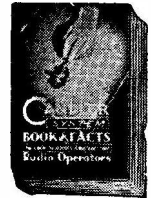
**CANDLER SYSTEM CO.**

(Dept. 55 S.W.) 55b ABINGDON ROAD, LONDON, W.8.

Candler System Company, Denver, Colorado, U.S.A.

HOME RADIO OF MITCHAM

for your

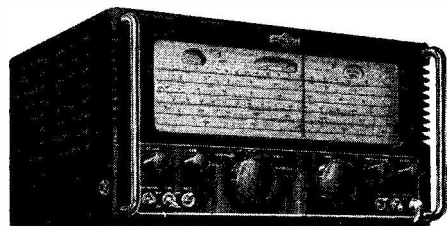
EDDYSTONE**Receivers and Short Wave Components**

We carry the full range of EDDYSTONE short wave components in stock. Fully illustrated catalogue, price 1/-.

SPECIAL OFFERS

New 16mfd. 375 volts can electrolytics. 1½" dia. 4½" high. Well known make 2/- each, plus 4d. post.

TR.1196. Ex-R.A.F. units comprising transmitter, receiver, and 12 (or 24) volt power unit. Range 4.3 to 6.7 mcs. Complete with valves and covers but less crystals. Circuit diagram available with each unit. Few only.

PRICE £3, plus 10/- carriage.

TR.1143. V.H.F. transmitter and receiver complete with valves and operating mechanism.

PRICE £4, plus 10/- carriage.

We have a range of Test Gear in stock including some second-hand units. Full details on request.

HOME RADIO

187, LONDON ROAD, MITCHAM, SURREY. MIT. 3282.

AERIAL EQUIPMENT

V.H.F. PARROT CAGE "H" DIPOLE ARRAYS. 24in. copper cage aerial elements on separate mountings with 45 ft. Co-ax lead in. A first class article, 17/6 (15/-*). **30-FOOT ROUND WOOD ONE-PIECE POLES.** 4in. dia. throughout. Hollow, light weight, perfectly round and smooth. Metal bound ends. Ideal for all aerial uses, 35/- (25/- 50 miles, 37/6 100 miles, 50/- 200 miles). **R.C.A. 5-ELEMENT V.H.F. YAGI ARRAY.** 420 mc/s on 16in. streamline metal mast, horizontal or vertical, 450 adjustment, 35/- (4/6). **AMERICAN ALUMINIUM TRIPOD BASE MASTS.** 20ft. high, 3 sections, 1½in. dia. with two folded dipoles, 150 mc/s. Occupies 10ft. ground circle, complete with stainless steel guys and all fittings and spares in canvas case. Weight 7 lbs., £12/10/- (20/-*). **AMERICAN 18-FOOT WHIP AERIALS,** six sections, tapered with plug, ferruled colour coded ends, 5/8in. to 1/8in., 30/- (2/6). **AMERICAN POLICE CAR WHIP AERIALS.** 9ft. long, solid, tapered one-piece with standard base, 10/- (2/6). **AMERICAN HEAVY INSULATED SPRING BASES** for whip aerials. Very solid, high quality. Roof type, 25/- (5/-); wall type, 30/- (5/-). **24-FOOT STEEL TUBULAR MASTS.** 2-section, 2in. diameter with guy attachments and ground pins, 40/- (10/-). **45-FOOT AMERICAN STEEL TUBULAR MASTS.** 9 sections, 1½in. diameter with hinged base and ground pins, 110/- (10/-).

Amount in brackets is carriage and packing. *Includes 10/- returnable case. Vast quantity Ham Gear. Lists available

Please cross remittance "Barclays Bank" Ltd.

P. HARRIS, ORGANFORD, DORSET

Southern Radio's Wireless Bargains

TRANSCEIVERS. Type "38" (Walkie-Talkie). Complete with 5-valves. In Metal Carrying Case. Ready for use. Less external attachments per set 30/-
ATTACHMENTS for use with "38" TRANSCEIVER :
HEADPHONES, 15/6 ; THROAT MICROPHONE with Lead and Plug, 4/6 ; **JUNCTION BOX, 2/6 ; AERIAL, 2/6 ; SPECIAL OFFER** of used "38" TRANSCEIVERS less Valves but complete with ALL COMPONENTS. Excellent for SPARES per set 11/6 P & P 2/-
TRANSCEIVERS. Type "18" Mark III. TWO UNITS (Receiver and Sender) contained in Metal Case. Complete with six valves, microammeter, etc. LESS EXTERNAL ATTACHMENTS £4/10/-
RECEIVERS. Type "109" 8-valve S.W. Receiver with VIBRATOR PACK for 6-volts. Built-in Speaker ; METAL CASE £5
BOMBSIGHT COMPUTERS. Ex R.A.F. BRAND NEW. A wealth of components. GYRO MOTORS ; REV COUNTERS ; GEAR WHEELS, etc., etc. Ideal for Model Makers, Experimenters, etc. £3
LUBBRA HOLE CUTTERS. Adjustable ¾" to 3¾". For Metal, wood, plastic, etc. 7/-
RESISTANCES. 100 ASSORTED USEFUL VALUES. Wire Ended per 100 12/6
CONDENSERS. 100 ASSORTED. Mica Metal Tubular, etc. per 100 15/-
PLASTIC CASES. 14" x 10½". Transparent. Ideal for Maps, Display, etc. 5/6
STAR IDENTIFIERS. Type I A-N covers both hemispheres. In case 5/6
CONTACTOR TIME SWITCHES. In sound-proof case. Clockwork movement ; two impulses per sec. Thermostatic control 11/6. REMOTE CONTACTORS for use with above 7/6
MORSE TAPPERS. Standard, 3/6. Midget 2/9
MORSE PRACTICE SET with buzzer on base 6/9
 Complete with battery 9/6
METERS AND AIRCRAFT INSTRUMENTS. Only need adjustment or with broken cases. TWELVE INSTRUMENTS including 3 brand new Aircraft Instruments 35/- for 12
CRYSTAL MONITORS. Type 2. New in transit case. Less valves 8/-

Postage or Carriage extra. Full List of Radio Books 2½d.

SOUTHERN RADIO SUPPLY LTD.
 11, LITTLE NEWPORT STREET, LONDON, W.C.2.
 GERrard 6653

SMALL ADVERTISEMENTS, READERS—continued

FOR SALE: HRO, P/Pack, coils, speaker ; professionally re-aligned/serviced, March '56 (£8) ; mint condition, £22 (o.n.o.)—Box No. 1681, Short Wave Magazine, Ltd., 55 Victoria Street, London, S.W.1.

TAYLOR 45A Valve Tester with Manuals, £10 ; "Record" Insulation Tester, 500v. hand generator, £6. Both excellent condition. Will exchange for S640 (the real one, not the Pirate!)—119 Crompton Avenue, Doncaster.

R.C.A. AR88 with Manual, etc.; also R.C.A. Tone Keyer, two U.S.A. Transceivers, £3 10s. each. All brand-new.—17 Kent Road, Atherstone, Manchester.

EDDYSTONE 680X for sale ; perfect condition ; little used ; £75 (o.n.o.)—Cave, 33 Sebastian Avenue, Shenfield, Essex. (Tel.: Brentwood 591).

EDDYSTONE 840A, mint condition, little used (going QRT), £45 (o.n.o.)—G5UQ, 1151 Alcester Road, Hollywood, Birmingham.

SALE: Nine R.C.A. 813's, new and boxed ; exchange Eddystone or similar, or sell 30/- each.—Clark, West Lodge, Dell Road, Grays, Essex.

EDDYSTONE Speaker, 40/- ; Brown's "A" Phones, 36/- ; 6V6GT (3), EF37A (1), 20/-—Box No. 1683, Short Wave Magazine, Ltd., 55 Victoria Street, London, S.W.1.

WANT McElroy de Luxe Bug, or similar. *Radio Craft* 28 mc Converter CC, Z77, 6J6, 1F 4-6 mc, Int. P/Pack ; as new. Offers.—G3BII, 42 Lakes Lane, Beaconsfield, Bucks.

JERSEY HOLIDAY.—Stay at "The Lincoln," 3 St. Saviours Road ; near sea/town centre. Ham shack ; photo dark-room.—S.a.e., please, brochure.

CR-100/7, nice appearance and first-class performance, £14 ; B29, 15 kc - 550 kc, in four bands, power pack, audio filter, noise limiter (similar appearance CR100), £7 ; AVO carrying case for Model 7, etc., £1 ; 832's and 5 mc crystals, 12/6 ; Spares for CR100, 358x and TCS-12 ; exchanges for Premier wide-angle television parts and CR100 manual.—Box No. 1684, Short Wave Magazine, Ltd., 55 Victoria Street, London, S.W.1.

21/28 mc CONVERTERS. RF 26/27 Units modified for 20/30 mc ; £4 10s. (carriage paid) ; s.a.e. for details.—G3FXB, 86 Cross Road, Southwick, Sussex.

AMATEUR clearing surplus components : Valves, including 813, PT-15's, condensers, meters, resistors, chokes, transformers including UM3. What offers? — Send your requirements, Box No. 1682, Short Wave Magazine, Ltd., 55 Victoria Street, London, S.W.1.

WANTED: All-band Phone Table-topper, 25 watts minimum ; TVI-proofed and first-class appearance. — James, 302 Carterknowle Road, Sheffield, 11. (Phone 50712).

FOR SALE: R1155A, good condition, internal power pack and output stage ; bargain, £8.—Apply Williamson, 9 Dywell Road, Cleadon, Co. Durham.

SMALL ADVERTISEMENTS, READERS—*continued*

VALVES: EBC33, EF50, 3/-; 6J5, 3/6; VT232 (E1148), 2/6; 6H6, 1/6; s.a.e., please. — S. Daniels, 18 Mill Street, Baxenden, Lancs.

EDDYSTONE 680, Radiocraft Preselector, BC221, Dulci RF-P/Pack chassis, all superb, for disposal. — Enquiries, please: Read, 24 Broughton Gifford, Melksham, Wilts.

G3FUP requires first-class Two-metre Converter, with or without P/Pack.—Details to: J. Moss, 88 Cornwallis Road, Dagenham, Essex.

WANTED: Eddystone 750, preferably with S-meter and speaker; also Transceiver or Tx for 6v. phone mobile on 28 mc.—Box No. 1685, Short Wave Magazine, Ltd., 55 Victoria Street, London, S.W.1.

WANTED: 12v. Vibrator Pack from lifeboat set, Type ET-344; also Command Tx and modulator complete, 160-metre band, 12v. input.—G5CP, Lynton, Nottingham Drive, Wingerworth, Chesterfield.

SALE: Trans. (20), Prim. 210/230/240, Sec. 525-0525 at 150 mA; 5v. at 3A; 6.3 at 1.5A; 50v. at 50 mA; complete with matching choke 10 Hy., 150 mA; £1. Smoothing Condensers: 4 μ F, 1000v. wkg.; 4 μ F, 600v., wkg.; and other values; 1/6 each. Selenium Rectifiers, 50v., 50 mA. 1/- each. Relays to suit above, 50v. winding, 2/- each. Toggle Switches, 1/- each; 832's (6), 8/- each; carriage extra.—Prior, 7 Gordon Road, Gosport, Hants.

WANTED: B2, complete, in good order; also B2 power pack.—Box No. 1686, Short Wave Magazine, Ltd., 55 Victoria Street, London, S.W.1.

WANTED: *Broadcaster Service Engineer* (1934-1936), *Radio Marketing Service Engineer* (1940-1945), and *Trader* (Radio Maintenance) (1933-1942) Service Sheets; also *Champion*, war-time edition, American Service Manual (Vol. 2).—Full details to: Watts, 62 Belmore Road, Thorpe, Norwich, Norfolk.

ZCI, Mk. II, modified 25w., 807 PA; screen modulator for crystal mike; extra IF stage and selectivity; speaker output; switched 500 μ A test meter; broadcast band incorporated; £15. Power unit and cables, £2 10s. 0d.; R103 modified, built-in speaker, P/Pack, £7 10s. 0d.; two 2½" Oscilloscopes with power supplies, £7 each; Wilcox Gay VFO, £2; 160/80m. 807 PA and P/Pack to match, £5; Midget AC/DC Superhet, no cabinet, £3; M/C Mike, £1; Eddystone Bug, £1; 829B, £1; 160m. Clapp VFO, £2; 14ft. telescopic whip aerial, 10/-; 8in. Smith's wall clock, £2 10s.; Woden UM2, £2 10s. All offers considered.—G3HBZ, 17 Lebanon Avenue, Hanworth, Feltham, Middlesex. (Feltham 2838).

EDDYSTONE 680, HARDLY USED; CONDITION AND PERFORMANCE AS NEW; IN ORIGINAL CARTON WITH INSTRUCTIONAL MANUAL; £70.—G3FMH, 87 HOLMFIELD ROAD, BLACKPOOL. (PHONE 52691 AFTER 6 p.m.).

HRO COILS: 80, 40, 20, B/S, 35/-; 7/14, 14/30 GC, 25/-. New Valves: 6V6M, 6AG7M, 6L6M, 7/6; 6NS7, 6K7M, 806, 6C6, 6D6, 3/6; 832, VCR 138, VCR 139A, 10/-; 6J5M, 6SH7, EF54, 2/6. Please add postage.—70, Northwood Gardens, Ilford, Essex. (CRE. 1127).

WANTED URGENTLY**Exceptional Prices Paid For****BC221****FREQUENCY METERS**

or CASES

Kindly advise price required.
NO REASONABLE FIGURE REFUSED
As we DO require these urgently.

UNIVERSAL ELECTRONICS

22, Lisle Street, Leicester Square, London, W.C.2.

**BRASS, COPPER, BRONZE,
ALUMINIUM, LIGHT ALLOYS**
IN ROD, BAR, SHEET, TUBE, STRIP, WIRE

3000 STANDARD STOCK SIZES**H. ROLLET & CO., LTD.**

6, CHESHAM PLACE, LONDON, S.W.1.

SLOane 3463

Works: 36 ROSEBERY AVENUE, LONDON, E.C.1.

Branches at LIVERPOOL, MANCHESTER, BIRMINGHAM, LEEDS

"No Quantity too Small"

G4GZ'S BARGAINS

VALVES: 6B8G, EL32, TT11, 6G6G, EF36, EF50, 12SC7M, 4/-, VS110A, 1A3, 1L4, 6J5GT, 15D2, 1LN5, 6AG5, EF39, 4/6, 3D6, 6C4, 6F8G, 6J6, 6K7G, W77, 6J5M, 6C5M, 5/-, 6AM6, EB91, EF91, 6AL5, Z77, EF50 (Syl), 6AC7M, OZ4A, 6/-, 3A4, 6AK5, 6CH6, 6SN7GT, 6SL7GT, 6SK7M, 6SG7M, EBC33, 5Y4G, 1A5GT, 1G6GT, 6F6M, 6N7M, 6/6, 807 (U.S.A.), X66, 6BE6, 6BS7, 6BW6, 6L7M, 6X4, 6X5GT, 6SJ7M, 6V6GT, 12A6M, 2A3, 1S5, 1T4, 354, 6A7M, 6Y7, 12C8M, VR150/30, VR105/30, 7/6, 1R5, 3V4, DK92, 6AT6, 6AU6, 6BA6, 12AU7, 12AT6, 12BE6, 6SQ7M, 6Q7GT, 6AQ5, EZ40, EZ90, UY41, 7Y4, 50L6GT, 7B7, 7C5, 7C6, 1C2, 5Z4G, 5U4G, 12K7GT, 12Q7GT, 12SQ7M, 8/6, 12AT7, 12J7GT, 12K8GT, 6AG7M, 12AU6, 80, 9/-, DAF96, DF96, DK96, DL96, EM80, 3Q5GT, 35Z4GT, 35L6GT, PY82, 6V6M, 6K8M, PL82, ECC83, ECH35, 5763, EF80, 9/6, PY80, PY81, EABC80, 10/-, ECH42, UCH42, ECC82, EL41, UL41, EAF42, UAF42, UF41, UBC41, EBC41, ECH81, EBF80, EL84, 20L1, ECL80, 83, EF41, 10/6, PL81, PL83, PCC84, EY51, 11/6, 12AH8, R19, 806A, EF86, PCF80, PCF82, 5R4GY, 6BQ7A, ECF82, ECC84, 12/6, 868, TZ40, HK24G, 25/-, 832, 805, 30/-, 813, 60/-.

MOULDED V/HLDRS. B9A, B7G, B8A. Int. Octal, 9d. each. B7G, B9A, with screen, 1/6 set.

MIDGET MAINS TRANS. (same size as Std. O/P.). 230/250v. input, 175v. 25m/A. 6.3v. 0.6A O/P., 10/6 (post 1/3).

M.C. METERS. 2in. sq. fl. mtg. 0-50 m/A, 0-150 m/A, 0-500 m/A (RF/T/C), 7/6 ea. 0-300v., 9/6. 50-0-50 amps., 10/6 ea. 2in. RD. fl. 0-30 m/A, 0-25v., 6/6 ea. 2in. RD. fl. plug-in type, 0-500 microamps (scaled 0-10v.), 17/6 ea. 0-350 m/A (RF T/C), 7/6 ea. 2½in. plug-in flush, 0-250 microamps, 22/6. 3½in. RD. fl. (2½in. dial), 0-500 m/A, 0-200 m/A, 0-2 amps., 0-30 m/A, 0-15v. A.C. (MI cal. at 50 cps.), 12/6 ea.

STILL AVAILABLE! POWER UNIT TYPE 247. 49/6 ea. cp. R.C.A. Amplifiers, MI-11220 (less valves), £9/19/6. As previously advertised.

SPECIAL VALVE OFFER! EL32, TT11, 3 for 9/6; 28/6 doz. EF39, EF50, 12SC7M, EF36, 3 for 11/-; 37/6 doz.

Post/packing under 10/- (9d.); 20/- (1/3); 40/- (2/-). Free over 40/-.

We regret we cannot accept overseas orders.

JOHN ANGLIN

385 CLEETHORPE ROAD, GRIMSBY, LINCS

Telephone 56315

SMALL ADVERTISEMENTS, READERS—continued

SALE: S640 Rx, excellent condition and appearance with speaker, phones and S-meter, £16 10s.; Grayshaw CR Bridge and Sig. Gen., both as new, £4 each; Class-D Wavemeter, phones, handbook, £4; Top Band Tx, metered, complete, £6 10s.; Xtal, 7/6; U.S.A. Multimeter, as new, £3 10s. All carriage extra; s.a.e. for list.—G3KKC, West Row, Nr. Bury St. Edmunds, Suffolk.

VALVES (100%): 829B and base, 40/-; 6C5GT (2), 2/6 lot; QS75/40, 4/-; 6SJ7M, 2/-; 6AC7M (3), 6/- lot; 6SK7GT (4), 7/6 lot; 6SH7GT, 2/-; 6SH7M (9), 10/- lot; 6J6 (2), 6/- lot; 6C8G, 2/-; U24, 2/6; VR105/30, 5/-; 12SK7M (2), 5/- lot; 6I7M (2), 5/- lot; DET 20 (10), 10/- lot; 955 (6), 10/- lot; 956 (2), 5/- lot; STV/280/40, 7/6; 12SR7M, 3/-. Meters: 10-0-10 mA, 2½", flush, 5/-; 0-30 mA, 2", panel, 3/-; 0-50 mA, 2", flush (4), 4/- each; 0-200 mA, 2", flush (2), 5/- each; 0-40 120 mA, 2", panel (2), 4/- each. Tx Condensers, Eddystone Type 137, split-stator, 60 µF per section, 2000v. RMS (2), 12/- each. Buyers to collect below. Rack, 6" 6" high, on castors; takes 7 standard panels and chassis; £2. VCR-140 and mask, 12/-. Chokes: 8 Hy. 250 mA (2), 5/- each; 20 Hy. 250 mA, 5/-.—Sephton, 16 Bloemfontein Avenue, Shepherds Bush, London, W.12.

HAMMARLUND Super Pro. and P/Pack, 1250 to 40 mc; good condition; £40 (o.n.o.). Buyer to collect.—Hilton, 27 Birch Road, Atherton, Manchester.

AMATEUR, moving QTH, has the following high-class gear for disposal: AR88LF, £45; HRO-9, coils untouched, even with a screwdriver, £30; American all-band Transmitter, made for the amateur, 150w. phone/CW, built-in 'scope and aerial tuner, only £65; Webster Wire Recorder, £15; 348R Receiver, fitted S-meter, £15; American UHF Signal Generators, 22/330 mc, with mod. and carrier level meters, £35; another, 15/230 mc, with one band TV wave-lengths, £15. — 82 Walsall Road, Aldridge, Staffs.

COMPLETE Amateur Station, 100w. CW, 50w. phone, comprising American Collins TCS Tx (pair 1625/807 PA, with pair 1625/807 modulator), aerial loading unit; separate TCS superhet Rx. All connecting cables with plug ends and suitable AC power unit, 250v. 100 mA, 500v. 200 mA, and 12v. DC for relays. Mike and full gen. book supplied. 160, 80 and 40m. (believe would modify to include 20m.). Operates full BK. Requires only 20ft. aerial, ground and key to complete. Condition as new. Nearest £50 secures.—G2OS, 27 Seafeld View, North Shields. (Phone 3600, evenings).

WANTED: Brand-new (or as new) recently released American Rx (i.e. NC-300, SX-100, etc). Fullest details, price, etc. Also brand-new (or as new) National Type "60TS" Speaker in cabinet. Also spare parts for AR88LF, S-meter, hole plate cover, RF-gain control, RCA Part-251402-2. Sell, brand-new, VHF 152A with manual; two complete Canadian 58 Sets, cheap to clear. DST-100; offers. Also want 50-ft. 8-way cable for outdoor use; screened preferred. — Box No. 1687, Short Wave Magazine, Ltd., 55 Victoria Street, London, S.W.1.

SMALL ADVERTISEMENTS, READERS—continued

R103 and MCRI, complete outfit, in new condition. Sell or exchange Hi-Fi equipment.—K. Whiteley, 5 Moor End Road, Sheffield, 10.

DST-100 MANUAL.—May I buy or borrow for copying?—Any offers to G3IMT, 2 Windmill Drive, Burgess Hill, Sussex.

Short Wave Magazine Advertising gives
World-Wide Coverage.

WANTED

VERY HIGH PRICES PAID FOR THE FOLLOWING :-

APN3	BC342	I-152
ARC1	BC611	TS13
ARC3	BC713A	TS35
ARN7	BC714A	TS45
ART13	BC721	TS148
BC221	BC788C	TS174
BC312	CPN2	TS175

Also Modulation Transformers Thermador No. CS2160 and Scanner (antenna) RC94 or parts.

ALTHAM RADIO CO.
JERSEY HOUSE - JERSEY STREET
MANCHESTER 4

Telephone: Central 7834/5/6

Largest stocks in Europe of Government surplus material.

STRESA I.A.R.U. CONVENTION

(Italy)

June 14-16

The Italian Hams have written to me saying how happy they will be to see so many G's and are arranging lots of entertainments. Why Not Join the Party?

8 Days (5 nights at hotel) from £20-10-6
15 Days (12 nights at hotel) from £28-9-6
(These arrangements can include a three-day trip to VENICE for £7-15-0 extra).

MOBILE ON A GONDOLA. 'Hi!'

Can I send you Particulars.

CLIFFE METCALFE, 3DQ, 12, Cliff Street, Bridlington, E. Yorks. Tel. 4872.

Can also quote you for all Holidays and Fares, etc.

RADIOCENTRE

(D. L. & H. DAVIES)

12 SHIRLEY ROAD, SOUTHAMPTON. Telephone: 20951.

Receiver Bargains.

CR100 Good Condition. Few only	£17 10 0
Eddystone 358X All Coils	£13 10 0
Labgear 2 Metre Converter (New)	£8 10 0
10" Loudspeakers in wooden case. All good Makers	£1 7 6
We can again supply a few power packs for the SCR522 TX, RX at		
		£7 10 0

Valves:

EF91, EF92, EL91, 6J6, 6AK5, 6AG5, EB91 at	5/6 each
6SL7, 6SN7, 6N7, 6AG7, 6G6, 6K7, 6SK7 at	5/6 each
EY51, ECL80, EZ40, PL81, PY81, EF80, PCC84, PCF80 at	8/- each

Ex Equipment.

6AC7, 6J5, 6SL7, 6N7G, KTW61, K78, PT15 at	3/6 each
--	--------	----------

Wanted AR88, S27 and S36 Receivers also BC221 Frequency Meters and Valves.

G2AK

QUALITY AND SERVICE

G2AK

THERE IS NO EXCUSE NOW for not being on phone or for not having a nice clear signal.

★
CRYSTAL HAND MICROPHONES

As illustrated, in silver hammer case with polished grille, handle and 4-feet of screened lead.

ONLY 21/-
Post paid.



COPPER WIRE. 14G, H/D 140ft., 17/-; 70ft., 8/6. Post and packing 2/-. Other lengths pro rata.

RACK MOUNTING PANELS. 19" x 5 1/2", 7", 8 1/2" or 10 1/2". black crackle finish. 5/9, 6/6, 7/6, 9/- respectively, postage and packing 2/-.

ABSORPTION WAVEMETERS. 3.00 to 35.00 Mc/s in 3 Switched Bands. 3.5, 7, 14, 21 and 28 Mc/s Ham Bands marked on scale. Complete with indicator bulb. A MUST for any Ham shack. Only 15/- each. Post and packing 1/-.

CERAMIC FORMERS. 2 1/2" x 1 1/2". Ideal for VFO or Turrets, 1/9 each or 17/6 doz.

CERAMIC SWITCHES. 2 bank, 2 pole, 4-way each bank, 5/-.. Post and packing 9d.

HEAVY DUTY POTS. 500 ohms only. Torodial type by: P.X. Fox, worth 15/-, OUR PRICE 3/6 each. Post and packing 1/-.

MINIATURE ROTARY TRANSFORMERS. 12v. input. Output 360/310v, 30 mA cont or 70 mA int. Only 4 1/2" x 2 1/2" overall. **ONLY 21/-** - P. & P., 1/6, or two for £2. Post 2/-.

CONDENSERS. TCC type III. 8 µF. 1000v. list over £3. Our price 10/6, Post 1/9. 8µF, 750v. 5/6 each, Post 1/6.

SHADED POLE MOTORS. Heavy duty type. Totally enclosed, made for professional tape deck. *Very limited quantity.* Only 35/-, P/P 2/-.

PARMEKO H/D Transformer, 230v. pri 620/620v. 200 mA. Tapped 550v. and 375v. 250 mA 5v. 3A., 5v. 3A. £3, carriage paid.

TRANSMITTER TUNING CONDENSERS. 500 pF, 1500v. rating, ceramic insulation, 15/- each. Ideal for PI couplers. Post free.

More Special Bargains

MINIATURE I.F. TRANSFORMERS

450/470 kc/s. Size: 2 3/8" high x 1 1/8" square. Litz wound. Slug tuned, **ONLY 7/6** per pair, P/P 9d.

FREE OFFER

AMERICAN. New boxed 807's, 7/6 each or 4 for 25/-.

CERAMIC 5-pin. holders for above, 1/- each 4 **HOLDERS FREE** with each 4 valves.

EDDYSTONE, WODEN, RAYMART, AVO, etc., COMPONENTS AND A GOOD RANGE OF COMMUNICATION RECEIVERS ALWAYS AVAILABLE.

No C.O.D. on Orders under £1

PLEASE PRINT YOUR NAME AND ADDRESS

CHAS. H. YOUNG Ltd

MAIL ORDERS TO :-Dept. "S"

102 Holloway Head, Birmingham

ALL CALLERS TO :- 110 Dale End, Birmingham

MIDLAND 3254

CENTRAL 1635

Quality Electronic Equipment All Guaranteed in Perfect Condition

Receivers

EDDYSTONE		
640 1.2 - 30 Mc/s	£22	10 0
740 550 - 30 Mc/s	£32	0 0
750 550kc/s - 32 Mc/s.....	£50	0 0
680	£65	0 0
680X	£85	0 0

R.C.A.		
AR88D-LF 550kc/s-32 Mc/s	from	£55 0 0
AR77E Completely reconditioned	£42	0 0

HALLICRAFTERS		
SX71 550kc/s - 32 Mc/s ...	£85	0 0
SX28	£45	0 0
SX24	£35	0 0
SX16	£30	0 0
Battery Mains Portable		
1955 model. 550kc/s-30 Mc/s	£40	0 0
Radiovision Commander		
Double superhet	£40	0 0
Hambander 1.2 - 30 Mc/s	£17	10 0
Central Electronics, Side-band slicer Kit		
	£25	0 0
NATIONAL HRO Jr. & Senior models. Complete		
From	£28	0 0

BRAND NEW
RADIO CITY PRODUCTS
VALVE TESTERS
230 V. A.C.
Complete with technical handbook

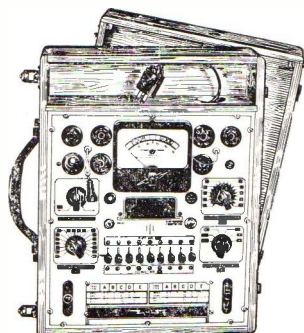

£10-10-0 each.
Post Paid.

WANTED URGENTLY !!!

Exceptional Prices Paid for

BC221

FREQUENCY METERS
or **CASES**

kindly advise price required
NO REASONABLE FIGURE REFUSED as we **DO** require these urgently

Also required :

RECEIVERS. ASB8, ASB4, ASB6, etc. Hallcrafters SX28, S27, S27C, S27CA, R.C.A., AR88, R1359, R1294 and any VHF equipment. APR4 and Units TN16, TN17, etc., etc.

U.S.A. MICROWAVE equipment including all TS prefix equipment, i.e.: TS12, TS13, TS47, TS174, TS175 and Manuals for any equipment.

Call, write or phone : GERRARD 8410
Shop hours 9.30 a.m.—6 p.m.
Thursday 9.30 a.m.—1 p.m.
OPEN ALL DAY SAT.

UNIVERSAL ELECTRONICS

22/27 LISLE STREET · LEICESTER SQUARE · LONDON · W.C.2

PIRANI HIGH VACUUM TEST EQUIPMENT
 Manufactured by 'Pye Radio Ltd.' for Atomic Research Station. Comprising: Pirani Control Unit, Pirani Bridge Unit, Gauge head with calibrator and Pye scale lampgalvanometer. All items brand new in original packing.

£33.10.0 COMPLETE.
 Spare Pirani Heads (Edwards M6) 15/-.

FERRANTI TESTVAC

High Speed Vacuum Tester, 200/250 A.C. ... £10/10/0

TRANSMITTER RECEIVERS

Special offer of above set, complete with 5 valves, 4-ARPI2 and ATP4, with circuit. Range 7.4 to 9 mc/s. These sets are not guaranteed but are serviceable. Junction box 2/6 extra.

"38" WALKIE-TALKIE SETS 25/-.

INDICATOR UNIT TYPE 182A

Unit Contains VCR517 Cathode Ray 6in. tube, complete with Mu-metal screen, 3 EF50, 4 SP61 and 1 5U4G valves, 9 wire-wound volume controls and quantity of resistors and condensers. Offered BRAND NEW (less relay) at 67/6 plus 7/6 carr. Radio Constructor 'scope circuit included.

PYE 45 MC/S STRIP TYPE 3583 UNITS

Complete with 45 Mc/s Pye Strip, 12 valves: 10 EF50, EB34 and EA50, volume controls, and hosts of resistors and condensers. New condition. Modification data supplied. Price 69/6, carriage paid.



QUARTZ CRYSTALS

Type FT243. Fundamental frequencies, 2-pin, 1/2in. spacing.
 200 types in the following frequencies: 5,675 Kc/s to 8,650 Kc/s in steps of 25 Kc/s. 5,706 Kc/s to 8,340 in steps of 33,333 Kc/s.
All Brand New 10/- each
Special price for complete sets of 80 or 120
 Above are ideal for re-grinding.



Type FT241A. 54th Harmonic. 2-pin 1/2in. spacing.
80 Types: 20 mc's to 27.9 mc's.
 (In steps of 100 kc's)
Brand New and Guaranteed. 7/6 each.
 (Complete sets of 80 available)

FT241A 200 Kc/s., 10/- 2-pin holders for all types, 1/3.

NEON INDICATOR

Striking at 80 volts, bayonet fitting ... 2/-

TRANSISTORS

JUNCTION TRANSISTOR (TYPE P.N.P.)

This Junction Transistor is designed for audio-frequency amplification although its frequency response makes it suitable for intermediate frequency and switching applications, together with many other uses. e.g. Local Station receiver, Transistor Voltmeter, Signal Tracer, Oscillators and Experimental work, etc.

Due to a large purchase we can offer these Transistors (a product of a well-known Manufacturer) at the very low price of

10/- EACH

Call and hear demonstration models working.

TRANSISTORS

WE HAVE OVER 50,000 B.V.A. AND AMERICAN VALVES IN STOCK AT VERY LOW PRICES SEND FOR LISTS.
LATEST TYPES NOW IN STOCK

EBC41	10/-	UCH42	12/6	PL82	10/-	I2AT7	9/-	EF86	10/-	DAF96	9/-
EY51	12/-	UBC41	10/-	PY81	10/-	I2AU6	9/-	EF89	10/-	DF96	9/-
EF41	11/-	DK40	10/-	EM80	10/-	I2BA6	9/-	ECF82	15/-	ECC84	12/6
EL41	11/-	EZ80	10/-	6X4	8/-	I2BE6	10/-	PABC80	15/-	6AQ5	10/-
EZ40	10/-	EABC80	10/-	PY82	10/-	I2AH8	12/6	6AU6	9/6	EF86	12/6
EM34	10/-	ECC85	10/-	PCC84	12/6	35W4	8/6	I17Z3	8/6	PCL82	12/6
UL41	11/-	EF80	10/-	PCF82	12/6	PCF80	15/-	I2AX7	10/-	832	35/-
UY41	11/-	ECL80	12/6	I2AU7	9/-	EBF80	11/6	DK96	9/-	884	12/6
UF41	11/-	PL81	12/6	I2AT6	8/-	EF85	10/6	DL96	9/-	EL42	12/6

SPECIAL REDUCTION FOR SETS OF VALVES

IA7GT, IN5GT, IH5GT, IA5GT (or IQ5GT or 3Q5GT) 37/6 Set
 10 EF50 (Ex-Brand New Units) 5/- each 45/- ..
 10 EF50 (Red Sylvania ex-new units) 6/- each 55/- ..

6K8G, 6K7G, 6Q7G, 5Z4G, 6V6G 35/- Set
 IR5, IS5, IT4, IS4 or (3S4 or 3V4) .. 27/6 ..
 DK96, DF96, DAF96, DL96 32/6 ..
 6K8G, 6K7G, 6Q7G, 25A6G, 25Z5 (or 25Z6G) 37/6 ..
 I2K8GT, I2K7GT, I2Q7GT, 35Z4GT, 35L6GT (or 50L6GT) .. 37/6 ..
 I2SA7GT, I2SK7GT, I2SQ7GT, 35Z4GT, 35L6GT or 50L6GT ... 35/- ..

CATHODE RAY TUBES

VCR138A (with screen) 35/-
 VCR139A. 2 1/2in. C/R Tube. Brand new in original cartons (carr.free) £1.15.0
 VCR97. Guaranteed full T/V picture (carr. 2/-) £2.0.0
 VCR517C. Guaranteed full T/V picture £1.15.0
MU-METAL SCREENS for VCR97 or 517. P.P. 1/6 10.0
 6in. ENLARGER for VCR97 or 517. P.P. 1/6 17.6
 VCR97. Slight cut-off. Carr 2/.. 15.0
 3BP1 Brand new £1.10.0

AN/APA-I CATHODE RAY INDICATOR AMPLIFIER UNIT. Complete, comprising 3BP1 C.R.T., 7-6SN7gts, 1-6H6, 1-6G6, 1-2X2, 1-6X5, valves. Brand new £4/19/6 plus carr. 7/6.

62A INDICATOR UNIT

Containing VCR97 with Mu-Metal Screen 21 valves:—12-EF50, 4-SP61, 3-EA50, 2-EB34, Plus Pots., Switches, H.V. Cond., Resistors, Muirhead S/M Dial, Double Deck Chassis and Crystal. BRAND NEW ORIGINAL CASES, 67/6. Carr. 7/6.

MINIATURE TRANSMITTING STRIP "TYPE 81"

Size 7 1/2in. x 6in. x 3in. Complete with Valves Type CV415, CV309, 2-6AM6, 2-7D9 and Quartz Crystal 4,860 kc/s. £4/10/- complete.

MINIATURE I.F. STRIP TYPE "373" 9-72 MEG.

Brand new miniature I.F. Strip size 10 1/2in. x 2 1/2in. x 3in. high. Valve line-up: 2-EF92; 3-EF91 and EB91. With circuit.
 Price (less valves) 7/6 p. & p. 1/6.
 This I.F. Strip is part of above equipment.

CRYSTAL MICROPHONE INSERTS

POST FREE

5/-

Ex-Units



POST FREE

8/6

Brand New & Boxed

Ideal for tape recording and amplifiers. No matching transformer required.

T/R 1196 RECEIVER

Complete with 6 valves 2 EF36, 2 EF39, 1 EK32, 1 EBC23, 465 I.F.T. ideal for conversion. In absolute new condition. 27/6 pp. 2/6, with circuit.

TR 1196 TRANSMITTER

Transmitter section comprising EL32, EF50, VT501, Relay etc., 12/6 p.p. 2/6.
COMPLETE TRANSMITTER RECEIVER with 24v. power-pack in original transit case, 57/6 p.p. 5/- 1196 RECEIVER, less valves, 7/6 plus 2/6 p.p.

U.S.A. INDICATOR UNIT BC929A

Complete with 3BP1 C/R tube and screen, 7 valves—2-6SN7GT, 2-6H6GT, 6G6, 2X2, 6X5G, volume controls, condensers, etc. Ideal for portable 'scope. In black crackle case size 1 1/2in. x 9in. x 9in. BRAND NEW. 65/- carr. FREE.

HENRY'S RADIO Ltd
5 HARROW ROAD, PADDINGTON, W.2
PADdington 1008/9 & 0410

SEND FOR 28 PAGE CATALOGUE, PRICE 3d.

Printed by The Courier Printing Co. Ltd., Tunbridge Wells, for the Proprietors and Publishers, The Short Wave Magazine, Ltd., 55 Victoria Street, London, S.W.1. The Short Wave Magazine is obtainable abroad through the following: Continental Publishers & Distributors, Ltd., William Dawson & Son, Ltd.; AUSTRALIA AND NEW ZEALAND—Gordon & Gotch, Ltd.; AMERICA—International News Company, 131 Varick Street, NEW YORK. Registered for transmission to Canada by Magazine Post. June, 1956.