

The

SHORT WAVE

Magazine

21-

VOL. XII

NOVEMBER, 1954

NUMBER 9



WORLD WIDE COMMUNICATION

H. WHITAKER G3SJ

10 YORKSHIRE STREET, BURNLEY Phone 4924

Manufacturers of precision Quartz Crystals in a wide variety of bases covering the complete range 50 Kc. to 18 Mc. in fundamental frequencies. All are made to extremely fine tolerances, and frequency adjustment can be given up to .005%. Plated electrodes of gold, silver or aluminium with wired in spot welded contacts are available. Quotations can be given for any type of cut or mode of oscillation including a complete range for filter circuits with zero temperature co-efficient over a sensibly wide temperature range. Our new works is equipped with up to the minute production technique methods, X-ray orientation ensuring accuracy of all cuts. Artificial aging by etching and plating by evaporation under vacuum ensure long term stability of the final calibration. Early delivery can be given of most types. Our regrind service is still available and in some cases we are prepared to quote for lowering the frequency of your existing crystals.

Special Offer :

200 kc. DT cut, zero temperature co-efficient over the range — 30° centigrade to + 55° centigrade. Frequency adjustment .005% or better. Mode : Face shear. Silver plated electrodes, wire mounted. Basing $\frac{1}{2}$ " pin spaced. Other bases to order, £1 each.

THE 2 METRE BAND IS ALIVE *not* DEAD!

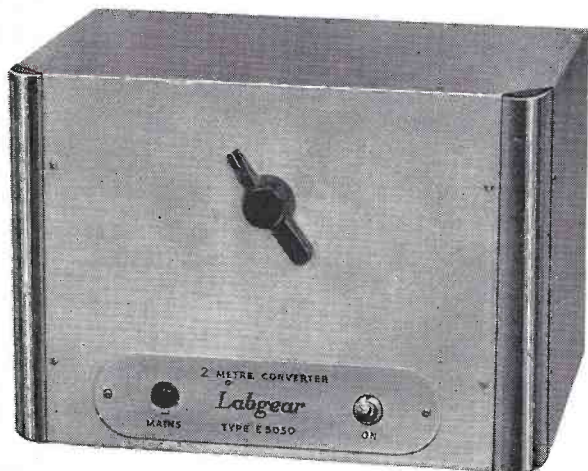

The World's finest commercial 2 metre Converter is only one of the outstanding new Amateur Radio products which will be on show at our stand at the Royal Hotel, London from 24th to 27th November.

Labgear (Cambridge) Ltd.
WILLOW PLACE, CAMBRIDGE

BROOKES *Crystals*

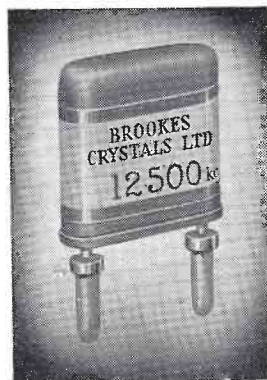

**mean
DEPENDABLE
frequency
control**

Illustrated left is a Type M Crystal Unit from a range covering 8 Mc/s to 17 Mc/s.

- Frequency 12,500 kc/s.
- Hermetically sealed metal can.
- Frequency tolerance $\pm 0.01\%$ of nominal at 20°C, or better for special applications.

ALL Brookess Crystals are made to exacting standards and close tolerances. They are available with a variety of bases and in a wide range of frequencies. There is a Brookess Crystal to suit your purpose—let us have your enquiry now.



Brookess Crystals Ltd.,

Suppliers to Ministry of Supply, Home Office, BBC, etc.
181/183 TRAFALGAR RD., GREENWICH, S.E.10

Telephone : GREENWICH 1828.

Grams: Xtals Green London. Cables: Xtals London

IN A CLASS *by itself...* THE NEW **NC-98**

No need to write a book about the new NC-98 receiver. One quick comparison proves it's in a class by itself—in performance and price! For only \$149.95, what other receiver offers you all these "high-priced" features?



- CRYSTAL FILTER
- S-METER
- 550 KCS. TO 40 MCS. RANGE
- CALIBRATED AMATEUR BANDSPREAD OR CALIBRATED SWL BANDSPREAD*
- NEW MINIATURE TUBES
- AN RF STAGE
- ACCESSORY SOCKET
- TWO IF STAGES
- EDGE-LIGHTED LUCITE DIALS
- NOISE LIMITER
- SEPARATE HF OSCILLATOR
- 3-POSITION SELECTIVITY
- ANTENNA TRIMMER
- PHASING CONTROL
- SENSITIVITY CONTROL

National



*Model NC-98SW (for shortwave listeners)

\$149⁹⁵
 List Price
 U. S. Dollars
 F.O.B. Factory

NATIONAL offers a full selection of receivers, from the world-famous HRO-Sixty at \$533.50 U. S. List, featuring dual-conversion, 12 permeability-tuned IF circuits, and the widest range (50-430 kc, 480 kc-35 mc, 50-54 mc) and the best sensitivity of any commercial receiver

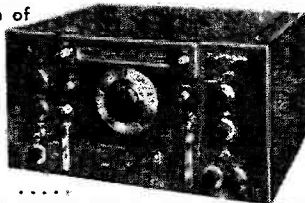

...to the low-cost "Mighty Midget" SW-54, at \$49.95, covering the entire frequency range from 540 kc to 30 mc, in 4 bands.

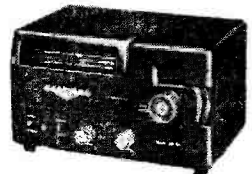

Ad. Auriema, Inc. Exclusive Export Representative
 89 BROAD ST., NEW YORK 4, N. Y. • Distributors' Inquiries Invited

LARGE QUANTITIES GUARANTEED UNUSED COMPONENTS STILL AVAILABLE

1,000 CERAMIC VARIABLE CONDENSERS split stator, plated vanes, spaced .035 ball bearings butterfly 15/15 P.F. extended spindle each **2/6**



2,500 CERAMIC TRIMMERS, air spaced silver-plated vanes, 22pF. Packed in 10's and singles, screwdriver adjustment, ... doz. **5/-**



5,000 STAND-OFF INSULATORS only miniature 1 inch. doz. **2/-**

2,500 VARIABLE CONDENSERS, 100 pF ceramic insulations, each **2/-**

2,000 VARIABLE CONDENSERS, 50 pF., in screening case, 3 1/2 x 1 1/2 x 2 1/2. Spacing .040in. each **1/-**
150 FERRANTI M. AMP METERS, **7/6**
 0-150 flush square, 2in. each
150 FERRANTI M. AMP. METERS, **9/-**
 0-5 mA. square, 2in. each
PAXOLIN RESISTOR PANELS with fixing brackets. Size 4in. x 3in. contains 1-10w. 5K, 2-5w 120k. 1-47k., 1-56k, 5w. Brand new ea. **1/9**

1,000 30-AMP. 1-WAY DOUBLE POLE Charging Switches on 1/2in. Ebonite Base, ex Admiralty **9d.**



250 TRANS-MITTER TANK CONDENSERS, split stator 250 pF. each section. Heavily silver-plated vanes rounded and polished, air gap .096, sealed cartons, **10/-** each ...

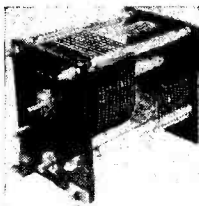

1,000 POTS 100K, 1/2 spindle each **1/-**
500 POTS, 1 meg. each **1/-**
1,000 POTS, 3 gang each, 70K, each **1/-**
1,000 HUNDINGER POTS, 100 ohm. Miniature wire wound each **2/-**
1,000 POTS COLVERN, 200 ohms 5 watts. Wire wound, N.P. case each **2/-**
1,000 WIRE WOUND POTS, 2,000 ohm 5-watts, E. case **1/6**
250 100K MINIATURE POTS, each **1/-**
10,000 ERIE RESISTORS, 47K, 2-watt, boxed in 50's and 5's. **ERIE RESISTORS**, 1,200 ohm, 1/2 watt. Boxed in 50's. Also 150K 1 watt 22K 1 watt. 70K 1-watt; price 2 watt, 3d.; 1 watt. 2d. 1/2 watt. 1d.
800 Wire-wound Vitreous 10-watt wire ends 500Ω each **9d.**

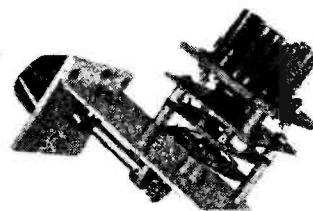

Switched Coil Units ex HF range of 1116 RX Covers 4.5-65 mcs. 4 coils switched through small geared drive. Ideal Unit for RX or with our 100 pf variable. Will make ideal absorption wave meter. Each **5/6**
5/6,000 gross yds. SLEEVING, various colours, 1 mm. and 1.5 mm. Permanoid, Minimum order 100 yds. Per 100 yds. **6/-**
5/6,000 COILS MICO FLEX SLEEVING, 1.5 mm. 2 gross yards Coils at per coil **18/-**
10,000 YAXLEY TYPE 1-pole 6-way Switches, complete, less screws, with knobs each **6d.**
1,500 WAVE CHANGE, 2-wafer 6-pole 3-way switches, each **1/3**
7,500 VALVEHOLDERS B9G, Paxolin doz. **4/-**
200 VOLTAGE REGULATORS, 3/6 VS. 110/30 mA., 4-pin. base each

Quantities listed still available minimum order 5/- postage extra.

WOOLLEYS RADIO & ELECTRICAL SUPPLIES LTD.

615 BORDESLEY GREEN, BIRMINGHAM, 9. Phone: VIC 2078

G2ACC offers you ...

No. 9 Catalogue

your buying guide for
RECEIVING
TRANSMITTING and
T.V. EQUIPMENT

58 pages illustrated on fine art paper
 Free price amendment sheet service
 All the best makes from one source
 3d. post free
 U.K., Forces & Eire only

Southern Radio & Electrical Supplies

SO-RAD WORKS, REDLYNCH, SALISBURY, WILTS.

Telephone: Downton 207.

LYONS RADIO

LIMITED

3, Goldhawk Rd., Shepherds Bush, London W.12

Dept. MS. Telephone: SHEPHERDS BUSH 1729

METERS. Flush panel mounting, moving coil types 3 1/2ins. dia. 0/200 micro-amps PRICE 45/- 50/0/50 milli-amps... PRICE 10/6
 0/1 milli-amps ... PRICE 25/- 0/100 milli-amps ... PRICE 15/-
 0/2 milli-amps ... PRICE 19/6 0/500 milli-amps ... PRICE 15/-
 Please add 1/- postage if less than £1

MAINS TRANSFORMERS. Ex. Gov. soundly constructed and fully impregnated. Primary: 200/250v. 50cps. Secondary: 300/0/300v. at 175 mA., 4v. at 3A. and 6.3v. at 4A. (Centre tapped). Size overall approx. 5 1/2 x 5 x 4ins. PRICE 25/-

SPECIAL BARGAIN IN VR91's. These are dirty and marked outside but are all tested and guaranteed electrically perfect. PRICE for 3, 10/6; 6 for 19/6; 12 for 35/-

POWER UNITS TYPE 87. Rotary converter units for 24v. D.C. input and having a twin D.C. output of 6.5v. at 2.5A and 250v. at 50mA. Can be operated in reverse from 6v. accumulator or D.C. mains. Totally enclosed in neat metal cases 8 1/2 x 6 1/2 x 4 1/2ins. In good condition and working order. PRICE 9/6, post 2/6. Alternatively the Rotary Converter only, less case, PRICE 5/-, post 2/-

RECEIVERS TYPE R.1155. One of the best known and most popular of ex Government communications receivers. Frequency range includes 20, 40 and 80 metre "Ham" bands, medium and long wave transmissions. Valve line-up: VR100-Sig. freq. amp., VR99-Freq. chng., VR100-st. I.F. amp., VR100-2nd I.F. amp., VR101-Det. A.F. amp., VR101-A.V.C. B.F.O., VR103-Tuning indicator. With 100-1 slow-motion drive, 5 switched bands etc. In tip top, new condition aerial tested before despatched and supplied in Makers transit case. PRICE £10/17/6, carriage 7/6.

A.C. MAINS POWER PACK/OUTPUT-STAGE UNITS for R.1155. Specially designed to operate these receivers direct from 200/250v. A.C. mains and to provide provide for a speaker output. Fitted with 5Z4 rectifier and 6V6 output valves and connector which plugs straight into receiver for immediate use. PRICE £3/19/6, carriage 3/6.

SPARE VALVES FOR R.1155. Types VR99, VR100, VR101. PRICE 8/6 each, post 6d.
TRADE ENQUIRIES INVITED for MAGNETRONS type 2J31.

EDDYSTONE

RADIO ENGINEERING OF SURPASSING EXCELLENCE



MODEL '680X' COMMUNICATION RECEIVER

30 Mc/s to 480 kc/s

USED PROFESSIONALLY IN ALL PARTS OF THE WORLD

Compare critically the Eddystone "680X" against world-wide production of similar equipment and you will find nothing to equal either the performance or the construction of this receiver at anywhere near its price level.

The solid diecast chassis ensures robust mechanical strength and rigidity and adds to the electrical screening. The large open dial is accurately calibrated and permits precise tuning and re-setting. The

flywheel-controlled, geared tuning mechanism is a masterpiece of light engineering; its perfection can only be judged by practical experience. The "680X" has a first-class electrical specification. Fifteen valves are used; two RF and two IF stages, separate oscillator and push-pull output. Figures for sensitivity, noise, selectivity and image ratio are excellent. Frequency drift is negligible on all ranges.

The "680X" receiver is handsomely finished in polychromatic grey and has an all-round performance of the highest order.

LIST PRICE £106 - 0 - 0 EX WORKS

Please write for full specification to the manufacturers:

STRATTON & CO. LTD., EDDYSTONE WORKS, BIRMINGHAM 31



S. G. Brown

HEADPHONES FOR MARINE EQUIPMENT



Every seagoing vessel in this electronic age relies on Marine Communication Equipment.

Our contribution is a specialised range of reliable Headphones which provide ships' operators with the clearest possible reception of all signals—Morse or speech.

S. G. Brown provide Headphones and associated equipment for all known purposes. Brochure "S" sent on request.

S. G. Brown, Ltd.

SHAKESPEARE STREET, WATFORD, HERTS

Telephone: Watford 7241

(1)

CALLING S.W. ENTHUSIASTS

COURSES FOR
RADIO AMATEURS EXAMS AND P.M.G. 1st & 2nd CLASS
CERTIFICATES (THEORY). ALSO GENERAL COURSES
FOR S.W. LISTENERS

Take our special postal courses which have been written by experts both in these subjects and in modern methods of postal instruction. E.M.I. INSTITUTES are part of a world-wide electronics organisation, and many former students testify that our tuition was invaluable in ensuring their success in examinations.

SPECIAL PRACTICAL KITS

are available as part of our Radio Courses. A typical Kit for beginners covers the design, construction and operation of a short wave 2 valve receiver. This Kit is supplied upon enrolment, and remains your property.

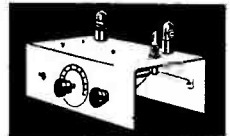

POST THIS COUPON TODAY

To E.M.I. Institutes, Dept. 14 R, 43, Grove Park Road, London, W.4.

Subject(s) of Interest

Name

Address

Nov

I.C.43

Osram 912

**a modern high quality amplifier &
reproducer for the home constructor**

BUILD THIS HIGH QUALITY AMPLIFIER

- Every part specified and readily obtainable from your Radio dealer.
- Every stage in construction clearly explained with step-by-step wiring, in instruction book.
- Rock-like stability in performance—no hum, no microphony, wide frequency response (9 octaves), low harmonic distortion at full power (12 watts) and ensured reliability, with Osram valves specified.
- Full control on frequency characteristic to introduce "art" into listening.
- Unparalleled clarity of both speech and music when used in conjunction with G.E.C. Metal Cone Loudspeaker in octagonal loaded-port cabinet.

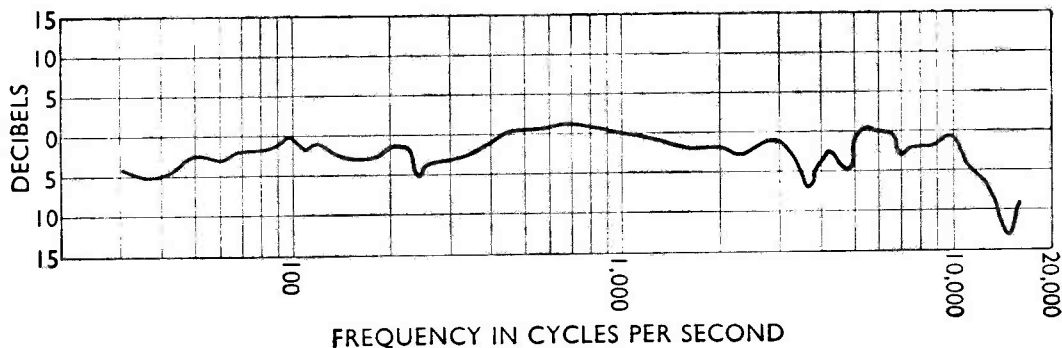

Overall frequency response of the complete equipment, comprising L.P. record, specified pick-up, Osram 912 amplifier and G.E.C. Metal Cone Loudspeaker in octagonal loaded-port cabinet.

How to build the Osram 912

A book giving full constructional details is obtainable from your dealer, or by post (3d. extra) from the The Osram Valve and Electronics Dept.

PRICE
3/6

INDEX TO
ADVERTISERS

| | PAGE |
|------------------------------------|-----------|
| Adcola | 528 |
| Ad. Auriema | 473 |
| Altham Radio | 527 |
| Anglin, J. T. | 528 |
| Brooks Crystals, Ltd. | cover ii |
| Brown, S. G. | 475 |
| Candler System | 525 |
| Clydesdale Supply Co., Ltd. | 522 |
| Clyne Radio | 526 |
| Electradix Radio | 523 |
| E.M.I. Institutes | 475 |
| Foyle | 525 |
| Fortiphone | 524 |
| G.E.C. | 476 |
| Henry's | cover iv |
| Home Radio | 523 |
| Labgear | cover ii |
| Lyons Radio | 474 |
| Miller's Radio | 525 |
| Proops | 524 |
| Reed & Ford | 528 |
| Rollet, H. | 528 |
| Salford | 478 |
| Samson's Surplus | 523 |
| Small Advertisements | 524-528 |
| Smith H. L. | 523 |
| Southern Radio & Elec. | 474 |
| Southern Radio | 522 |
| Stratton & Co., Ltd. | 475 |
| S.W.M. Publications Dept. | cover iii |
| Universal Electronics | 522 |
| Whitaker | cover ii |
| Woolley's Radio | 474 |
| World Radio Handbook | 523 |
| Young | cover iv |

SHORT WAVE MAGAZINE

VOL. XII

NOVEMBER 1954

No. 135

CONTENTS

| | Page |
|--|------|
| Editorial | 479 |
| Break-In Keying System , by A. K. Brookman, B.Sc., A.R.C.S. (G3FLP) | 480 |
| Boosting and Marking , by N. P. Spooner (G2NS) | 482 |
| The Carbon Microphone , by W. Farrar, B.Sc. (G3ESP) | 485 |
| Versatile Long-Wire Aerial , by G. A. Swinnerton (G6AS) | 486 |
| The Principles of Super-Regeneration , by K. E. V. Willis, B.Sc., A.R.C.S. (G8VR) | 487 |
| DX Commentary , by L. H. Thomas, M.B.E. (G6QB) | 490 |
| The Radio Amateurs' Examination — 1954 | 496 |
| Letters to The Editor | 497 |
| Transistor Topics | 499 |
| Speech Clipper Circuit , by F. E. Wyer (G8RY) | 504 |
| Noise in the Aerial , by K. W. Cranfield | 504 |
| VHF Bands , by A. J. Devon | 506 |
| VHF Weather Report , by A. H. Hooper (G3EGB) | 512 |
| Lines of Thought | 515 |
| Random Jottings , by The Old Timer | 517 |
| The Other Man's Station — G3JBR | 518 |
| The Month with the Clubs — From Reports | 519 |

Managing Editor : AUSTIN FORSYTH, O.B.E. (G6FO)

Advertisement Manager : P. H. FALKNER

Assistant Editor : L. H. THOMAS, M.B.E. (G6QB)

Published the Friday following the first Wednesday each month at 55 Victoria Street, London, S.W.1.
Telephone : Abbey 5341/2

Annual Subscription : Home and Overseas 24s. post paid.

Copyright Reserved throughout the World.

AUTHORS' MSS

Articles submitted for Editorial consideration must be typed double-spaced with wide margins on one side only of quarto or foolscap sheets, with diagrams shown separately. Photographs should be clearly identified on the back. Payment is made for all material used, and it is a condition of acceptance that full copyright passes to the Short Wave Magazine Ltd. on publication.

FOR STABILITY

to the 'nth degree

G.E.C.



QUARTZ CRYSTAL UNITS

*Please apply to the following address
for our latest publication.*

SALFORD ELECTRICAL INSTRUMENTS LTD
PEEL WORKS • SILK STREET • SALFORD 3 • LANC'S
A Subsidiary of **THE GENERAL ELECTRIC CO. LTD. OF ENGLAND**

FOR THE EXPERIMENTER AND THE RADIO ENGINEER

The SHORT-WAVE Magazine

E D I T O R I A L

Miniaturisation *This is one of those words, coined comparatively recently, which even if it is ugly and un-English, is very expressive and does not require to be explained to any radio man. Except perhaps in one particular sense.*

For it does not only mean equipment designs made physically small simply by bunching everything together, to a greater degree than has been accepted practice in the past. It means making full and proper use of modern parts, and especially valves, so that much less space is taken up without troubles such as interaction and over-heating. In the field of miniaturisation, we are well served for most components—not only an excellent range of valves, but also condensers, resistors, and mountings and fittings such as jacks, knobs, dials and switches. The only exception seems to be power supply components; it is still necessary to provide a good deal of space for even a modest HT unit if it is to be kept within its ratings.

However, in spite of the potentialities of miniaturisation, in Amateur Radio circles full advantage has not yet been taken of all the possibilities. One still sees a great deal of new equipment, larger and heavier by far than it need be, which could have been scaled down to something much neater, lighter and more compact with no loss of efficiency.

Some of the latest commercial designs, on the other hand, are excellent in these respects, and show what can be done by the proper use of modern components and constructional techniques.

While among radio amateurs there are some superb craftsmen, capable of turning out hand-built work up to the highest standards of electrical and mechanical design, the majority of us have not yet really got down to this business of miniaturisation in the way it should be tackled for our particular requirements.

Here, indeed, is food for thought and an interesting field for constructional activity during the months of semi-darkness now before us.

*Austin Fobyl
G6FO.*

Break-In Keying System

CLEAN AND CLICKLESS
OPERATION
WITH COMPLETE CUT-OFF

A. K. BROOKMAN, B.Sc., A.R.C.S.
(G3FLP)

EASE and convenience of operation has become, in the past few years, an increasingly important factor in the design of amateur transmitters, and break-in keying is now a highly desirable, if not essential, feature. The basic requirement for a perfect break-in keying system is that the transmitter output, under key-up conditions, should not be audible in the receiver; in practice, this means keying the master oscillator. It is, of course, possible to "listen through" a continuously running MO, provided it is very carefully screened, and operated at a very low level; the difficulties of this method are obvious, however, and it has not been generally adopted. Another possible solution is to shift the frequency of the MO slightly during the "space" period; but this again leads to practical difficulties which cannot be solved in a simple manner. In the days of universal crystal control, the problem was easily overcome, for a crystal oscillator can readily be keyed without introducing either clicks or chirp; a keyed VFO, however, shows serious switching transients, and it is instructive to examine the mechanism of these transients in some detail.

Oscillators in amateur transmitters are almost invariably operated in Class-B or C with grid leak bias; the gain of the valve varies according to the angle of flow of anode current, which is determined by the grid voltage and current. An increase in amplitude of oscillation leads to an increase in grid bias, hence to a reduction of anode conduction angle and average valve gain; a stable equilibrium amplitude is ultimately reached, in which the loop gain is precisely unity. The amplitude at which this equilibrium is reached depends largely on the amount of feedback, *i.e.*, the loop gain for very small amplitudes, and normally corresponds to a grid bias well beyond cut-off; the speed with which it is reached depends on the grid condenser-leak

time constant, and the rate at which the valve can deliver energy to the tuned circuit. For small amplitudes, the valve is operating in Class-A with little or no bias; the gain is therefore high, and the amplitude builds up very rapidly, limited only by the rate of energy delivery to the oscillatory circuit. In normal circuits, the time taken by this build-up is of the order of a few microseconds only, and is equivalent in effect to modulating a constant amplitude carrier wave with a sharp pulse, which, of course, constitutes a "click." As the build-up proceeds the grid bias increases, affecting the input and output capacities, and hence the frequency. This produces "chirp."

This argument applies for any sort of HT keying; if grid block or cathode keying is used, conditions are slightly different. On depressing the key, the bias is steadily reduced and oscillation commences as soon as the mutual conductance of the valve is sufficient to give unity loop gain; increasing amplitude now causes an increase of gain, however, since the positive grid excursions are into a region of increasing mutual conductance. The amplitude thus builds up very rapidly until grid current commences, when the bias starts to increase again towards an equilibrium level as described above. These processes are illustrated in Fig. 1.

A glance at the equivalent circuit of a crystal resonator will now make it clear why a crystal oscillator can be keyed satisfactorily. The "tapping down" effect of the holder

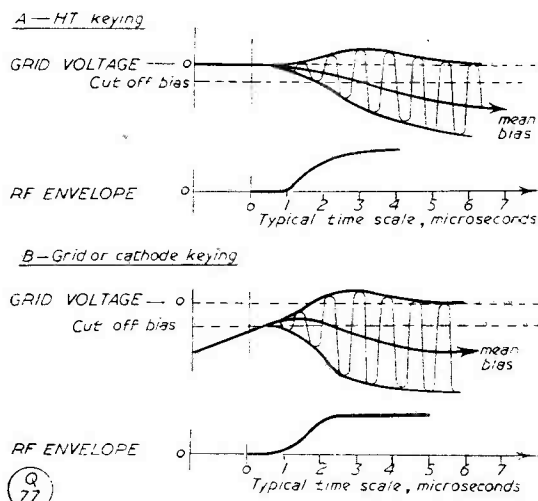

Fig. 1. Starting transient in a keyed oscillator, applying only at the initial build-up of oscillations. The rise in amplitude is controlled by the keying filter (if any); compare the time scale here with that of Fig. 3.

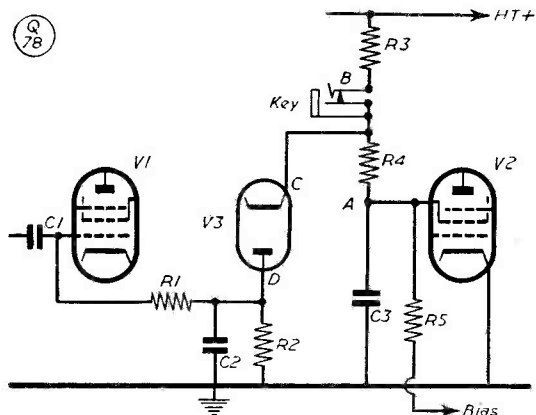

Fig. 2. The diode keying circuit discussed by G3FLP. If a "softer" keying characteristic is desired, an LF choke of about 1 henry at 5 mA can be connected in series with R5.

capacity severely limits the rate of energy delivery to the "tuned circuit" and hence the rate at which oscillations can build up; the build-up (and decay) times are typically of the order of milliseconds (listen to the "ring" of a single crystal IF filter if you do not believe this.) With such a large tapping down ratio, a very high "Q" is necessary to maintain oscillations at all; the various VFO circuits which have been designed in imitation of the crystal oscillator can evidently be successful only in so far as the "Q" (and hence the maximum permissible tap down) of their resonant circuits approaches that of a crystal. And the Q's obtainable from L - C circuits at present fall very far short of the minimum required for satisfactory keying characteristics.

Adjusting Time Constants

By making all the time constants associated with the VFO sufficiently short, the keying transient can be reduced to a duration of less than a millisecond; if a subsequent stage in the transmitter is simultaneously keyed so that it is switched on slightly after, and off slightly before, the VFO, the keying transient will not be radiated—a highly desirable state of affairs. This can be achieved by using a keying relay with suitably "adjusted" (!) contacts; the timing is somewhat uncertain, however, and a non-mechanical delay is obviously preferable.

A circuit which produces these delays electronically is shown in Fig. 2; it involves simultaneous grid blocking of the VFO V1 and screen keying of a subsequent stage. The operation of the circuit can be followed from

Table of Values

Fig. 2. Diode-controlled BK keying circuit.

| | |
|-------------------------|------------------------------------|
| C1 = 50 μ F | R3, R4 = 10,000 ohms, 1-w. |
| C2 = 500 μ F | R5 = 47,000 ohms, 1-w. |
| C3 = .02 μ F, 350v. | V1, V2 VFO, Buffer (see text) |
| R1 = 47,000 ohms, 1-w. | V3 = Keying diode, VR92 or similar |
| R2 = 100,000 ohms, 1-w. | |

the voltage waveforms at various points shown in Fig. 3. Under key-up conditions R2, R4, and R5 form a potential divider across the bias line (ignoring the voltage drop in the diode), and the earthy end D of the VFO grid leak is held sufficiently negative to prevent oscillation; V2 is cut off by the negative potential on its screen.

Action of the Circuit

When the key is depressed, points B and C (now connected) instantly assume a potential rather less than half the HT line voltage; the diode ceases to conduct, and C2 rapidly discharges through R2, removing the blocking bias from the VFO, which quickly reaches its equilibrium amplitude of oscillation. C3 in the meantime is charging up through R3 and R4, but V2 does not commence conducting until its screen has reached approximately earth potential; the rise continues until the

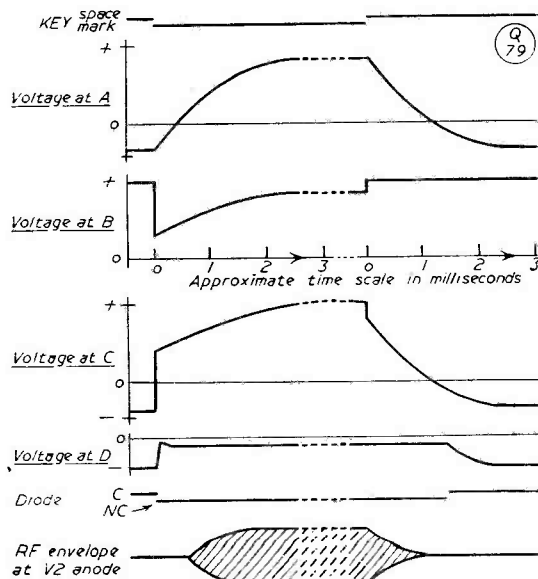

Fig. 3. Operation of the G3FLP diode keyer. The rise time constant is

$$(R3 + R4) R5.C3$$

$$R3 - R4 - R5$$

and the decay time constant is C3.R5 — though V2 screen current causes the end of the rise and the initial decay to be faster than the time constants indicate.

screen voltage reaches its operating level. On opening the key, C and A assume the same potential, since there is now no current through R4, and C3 commences discharging towards the bias line voltage through R5, assisted initially by the screen current drawn by V2. By the time the screen has reached earth potential, V2 is non-conducting, and no signal is radiated; the diode does not start to conduct, however, until C is more negative than D. The continued discharge of C3 now pulls D negative, and the VFO ceases to oscillate.

The actual time constants for each part of the sequence are indicated in Fig. 3: the essential requirement is that C2, R2 must be much less than C3, R5 (C1, R1 is normally negligibly small). This usually presents no difficulty, as C2 is only required as an RF bypass condenser, and need never exceed a few hundred picofarads. R3 and R4, together with R5, form a potentiometer feeding the screen of V2, and the values must be chosen to give the correct screen voltage under key-

down conditions; R4 and R5 must not be too large, however, or R2 will need to be excessively large to develop enough blocking bias on V1. (Since R2 forms part of the VFO grid leak, an upper limit to its value is imposed by the minimum acceptable grid current and output.) The component values shown are suitable for pentodes of the EF91 class, with bias and HT voltages of -45 and +300 respectively; if a valve with a long grid base, e.g., 6J5 or 6V6, is chosen for V1, a larger bias voltage may be required unless the VFO loop gain is fairly small.

The system has been tested in three transmitters, in which the valves used were: VFO, 6AK5, 9003, EF91; Buffer, EF91, 5763. Consistently good results were obtained, and no reports of click or chirp were received, even from very local stations.

The author wishes to acknowledge the help and advice given by G3FRV, particularly in carrying out much of the experimental work, and co-operating in tests.

Boosting and Marking

KEEPING UP MAINS VOLTAGE—AND A BAND-EDGE MARKER

N. P. SPOONER (G2NS)

IT is said that when a house-proud XYL was asked if the latest electrical labour-saving gadget in her kitchen was automatic she replied: "Oh no, you've got to switch it on yourself."

It is much the same, of course, with relays. But with them the tide of post-war surplus has at least bestowed real benefit upon countless amateur stations, now able to change over from Send-to-Receive and *vice versa* by single-knob control. However, there are unhappily many owner-operators who still prefer to agitate themselves with hurried journeyings to throw numerous switches, or to fix this and that with crocodile clips and pieces of flex, when the moment comes to Change Over. With them we are not concerned; our attention can be more profitably engaged by the question of relay energisation.

This is usually brought about by a suitable

AC mains transformer and a rectifier producing a DC supply of up to 24 volts or more. The set-up works excellently as long as the AC input remains fairly constant, but when this drops below a reasonable level the relays become starved, they start to grumble and eventually refuse to budge from their de-energised positions. We are then no better off than the owner of many switches, crocodile clips and pieces of flex. But in justice to all relays it should be mentioned that they are certainly not the only complainants. Well-bred mercury-vapour rectifiers have been known unashamedly to strip themselves and a VFO note, formerly as soothing as the vesper bell of San Felipe, will often crow or chirp suddenly in protest at being undernourished.

Complete power-cuts are quite beyond our control, but we can all definitely do something to bolster up sagging mains and shame the crocodile-clip manipulators. Do you remember the winter of 1947 when DX was still with us? For the writer, a shocking entry in his log startles him even now, thus: "Closed down. 135 volts trickling out of 230-volt AC mains." Perhaps, however, successive annual warnings in the national press that the approach of each winter may yet again bring fresh power cuts may have convinced many readers that all primary transformer tappings should be made variable.

A simple Mains Booster makes this possible. As the photograph shows, a 3-ply front panel will accommodate a "surplus" moving-iron 0-300 AC voltmeter calibrated at 50 cycles, an ex-Tuning Unit aerial coupling switch serving as a voltage selector, a DPDT toggle for unboosted Line and Load (boosted output) voltage readings, and an SPST for on-off switching. Behind the panel and enclosed in a metal cabinet (for protection against straying fingers and airborne screwdrivers) is the auto transformer that does all the work. This is a type AUT 673 50-cycle, 600-watt job wound and marketed by Gardner's Radio, of Somerford, Bournemouth — but any similar type will do, depending upon rating and station load.

Boosting and Dropping

Fig. 1 shows the simple wiring-up called for: the tapings chosen for all transformers in the station should be the same as the local nominal voltage advertised by the electricity supply authorities. Taking this to be 230 volts as an example, the selector switch is kept in the 230 position as long as the AC meter continues to read 230 volts. When this reading drops towards 210 volts the selector switch is moved into the "210" position, a simple action that at once boosts the output back to its original 230 volts for which the taps are set. Although most transformer manufacturers allow for a maximum input up to 250 volts, there are quite a number of specially wound or bought items that go no higher than 230, and this is also the case with some receiver packs (the SX28, for instance) imported from the U.S.A. One bright day in the not-too-distant future it is to be hoped that supply voltages will be standardised throughout the entire country and that

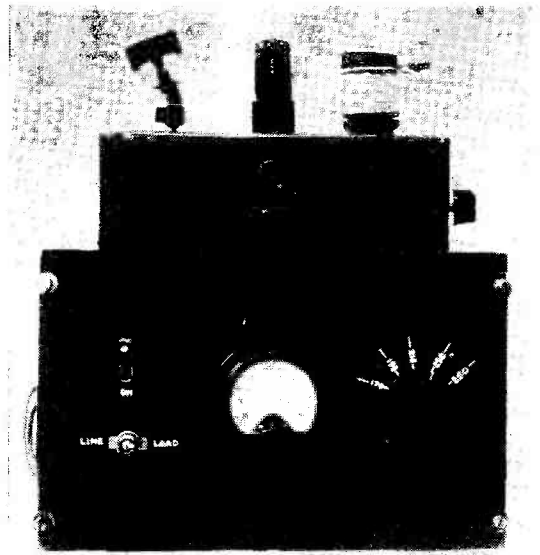

Below, the line-voltage booster described by G2NS, as constructed by him. Above is his version of the crystal oscillator marker unit shown as Fig. 2.

amateurs will no longer have to cope with the farcical nonsense of a different voltage at every QTH they move to—or even, as in some cases, if they change from one side of the same street to the other! In the meantime, owners of 230-volt transformers who move into 240-volt districts can, with a Mains Booster, also use it to *drop* the mains voltage by leaving the output from the auto transformer still wired to the 230-volt tap and by placing the selector switch in the 250 position. This cuts the output down by about 10 volts.

Marking

It is strange that, rather like the proverbial

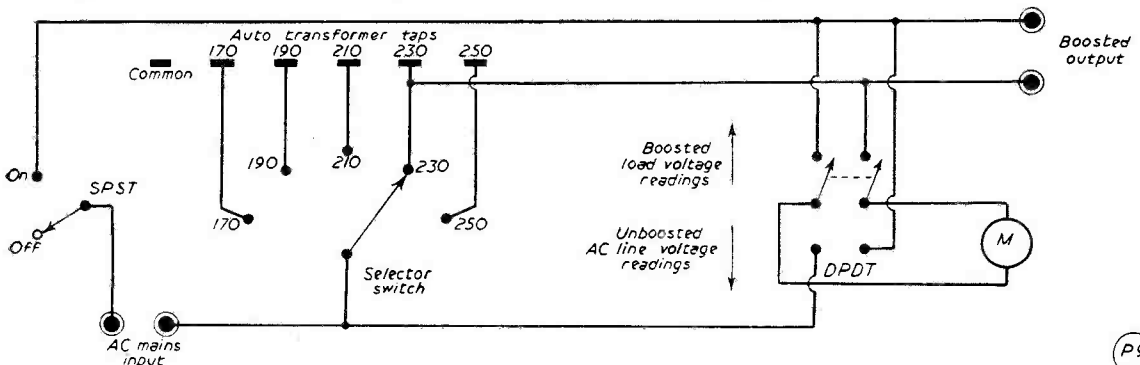

Fig. 1. Circuit of switching for the auto-transformer to give mains boosting, as described by G2NS. The auto-transformer itself should of course be rated at well over the full loading of the equipment it has to supply. The switch used should be of the type giving a clear break between adjacent taps so that sections of the winding are not short-circuited at the moment of switching; alternatively, the switch could be wired at every other pole.

The Carbon Microphone

HOW TO USE IT FOR BETTER SPEECH QUALITY

W. FARRAR, B.Sc. (G3ESP)

WHAT a despised thing a carbon microphone is in the eyes of the majority of radio men! How many times one hears on the amateur bands such statements as: "The mike here is only a carbon, but I hope to get something better soon"; or "It sounds as though you're using a carbon mike, old man." It is an established belief that good results can *not* be obtained from a carbon microphone. These notes are intended to disprove that opinion!

A carbon microphone is generally looked upon as having a comparatively high-level output, and consequently a small modulator can be used. Therein lies most of the trouble. The average user tries to get too much out of his equipment. To begin with, it seems to be the general impression that a carbon mike must be held close to the mouth to get any output from it at all. Well, it is certainly true that a greater output will be achieved by this

means, but at the expense of severe distortion and blasting, producing the accepted "carbon-mikeishness" of the instrument. The writer has experimented to some extent with these abhorred items of equipment, and excellent results have been achieved by following two rules:

- (1) Remove all forms of mouthpiece from the holder, and speak into the bare insert.
- (2) Let the mouth be 18 inches or 2 feet from the microphone and let speech be of a *normal conversational level*.

By following these two rules, all the roughness should disappear. Loss of output from the modulator due to speaking at a distance from the microphone must be made up by increasing the amplification in the modulator, but even so, fewer valves will be needed than for a low output microphone, such as a crystal or moving-coil.

If traces of roughness are still evident even with low modulation, the trouble will quite probably lie in the first stage of the modulator itself, and suggested cures are (i) To improve the decoupling in the HT supply; (ii) Put a bigger by-pass condenser (say 1 μ F) on the screen, and (iii) A very large cathode by-pass (at least 50 μ F).

Energising

Some will say that a carbon microphone is a nuisance because it needs an energising battery. Well, this is not essential. Apart from the standard battery connection (Fig. 1a), energising voltage may be obtained as shown in Figs. 1b and 1c with little cost.

Incidentally, the carbon microphones used in coming to the foregoing conclusions are not any superior models, but ordinary GPO telephone inserts, which are available for a few

Table of Values

Amplifier Stage for Carbon Microphone.

| | |
|---|--|
| C1 = at least 50 μ F, 12v. wkg electrolytic | R3, R4 = Voltage divider: values chosen to get about 3 volts across R4 |
| C2 = at least 100 μ F, 6v. wkg electrolytic | M = Carbon microphone |
| R1 = Normal cathode bias resistor | B = Energising battery (3-4½ volts) |
| R2 = 1000-5000 ohms, 1 watt (rather larger than R1) | T = Mic. transformer (1:80 or 1:100) |

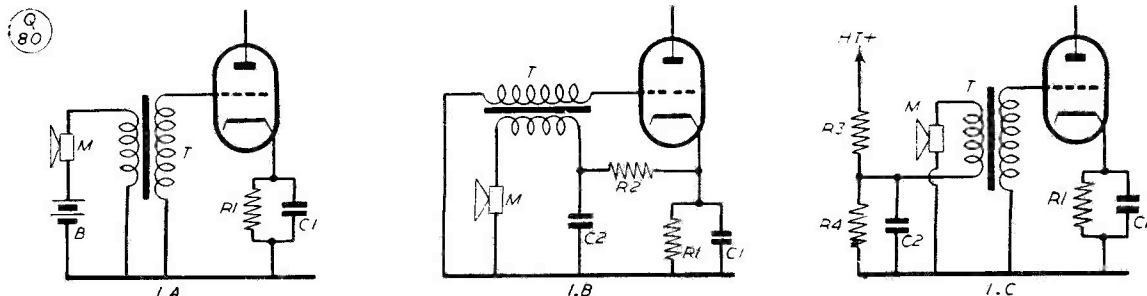

The carbon microphone should not be despised as automatically giving indifferent quality. As suggested in the text, if properly used it will give very good speech, with the advantage of an economical amplifier chain by reason of its high initial output. These circuits show different ways in which a carbon microphone can be energised.

pence on the surplus market. Some of these are fine as they stand, having perforations over most of the diaphragm shield. Others, however, have holes grouped only near the

centre, and in this case it is advantageous to remove the shield completely (it is only a tight push fit) and the oilskin material underneath it, and speak at the bare diaphragm.

Versatile Long-Wire Aerial

CENTRE-FED SYSTEM FOR
FOUR BANDS

G. A. SWINNERTON (G6AS)

The eyebrows of the purists may rise, for what our contributor describes is an aerial 118 feet long and fed at the centre with 150-ohm line. This will, as he shows in his article, give an "average result" as regards both resonant length and feed-point impedance, as well as output matching, on the four bands 80, 20, 14 and 10 metres. He himself points out that it is not an ideal arrangement. But it is a good practical answer for quick-change multi-band working in those locations where, because of the factor of space, it is not possible to put up the best aerial system for each band required.
—Editor.

WHILST there can be no question that an aerial system for each particular band is the most efficient arrangement, there are times when it is particularly useful to have one capable of working several frequencies. When good DX conditions return the need for a multi-band aerial will not be vital, but as things may not improve noticeably for another two years or more, the writer felt that in the meantime it was essential to have a system which could take advantage of conditions as they occur on several bands.

The particular circumstances dictated that at this station such an aerial should have a low impedance feed-line to match the Pi-section tank circuit in the band-switched transmitter. An aerial coupler unit was considered unnecessary with a modern table top transmitter.

Centre feeding was chosen because of the advantages of balance and because it was not physically inconvenient. In order to employ a low-impedance line, current feed was appropriate and for this the wire length had to be an odd number of half waves for the particular band in use.

Taking the four popular bands—28 to 3.5

mc, omitting 7 mc, then an arrangement had to be found to provide $7/2$ waves on 28 mc; $5/2$ waves on 21 mc; $3/2$ waves on 14 mc; and $1/2$ wave on 3.5 mc. At Table I the wire length required for particular frequencies in the four bands is shown, and it will be seen that a compromise is indicated. The actual length chosen was 118 feet for the aerial; this is a reasonable compromise for all bands except 14 mc, where the discrepancy amounts to a quarter-wave.

| Table I | Table II |
|-------------------------------------|-------------------------|
| $7/2$ waves — 28.2 mc = 119ft. 6in. | $7/2$ waves — 125 ohms. |
| $5/2$ „ — 21.1 mc = 115ft. 5in. | $5/2$ „ — 118 „ |
| $3/2$ „ — 14.2 mc = 102ft. | $3/2$ „ — 100 „ |
| $1/2$ „ — 3.8 mc = 123ft. | $1/2$ „ — 72 „ |

With regard to the impedance of the feed line, reference to Table II will show that if the aerial is at great height and is cut exactly to the number of half waves, it should vary between 72 and 125 ohms in the centre. In fact, a 150-ohm twin feeder was chosen in order to help matters out on 14 mc; 80-ohm feeder has also been used. Both provide a low standing-wave ratio on three bands and quite a tolerable SWR on 14 mc, according to a twin lamp indicator inserted in the feed line.

This system, in the short time it has been in operation, has proved successful on all the four bands. No difficulty is experienced in loading up to the desired degree, nor with TVI. It is certainly not claimed to be the best aerial for all bands, but a versatile system for use when it is necessary to change quickly from one band to another without the aid of an aerial coupler unit.

The writer will be pleased to hear from those who try this system and the results obtained.

WALK-ROUND RADIO STORE OPENS

We are glad to draw the attention of readers to a new establishment at 52 Tottenham Court Road, London, W.1, where Messrs. Proops Bros., Ltd., specialise in surplus equipment. A wide range of useful and interesting apparatus is offered, and their shop is well worth a visit. Proops Bros., Ltd., also have a store at 39 Cambridge Road, Kingston-on-Thames.

The Principles of Super-Regeneration

CONSIDERATIONS IN
DESIGN AND PRACTICE

K. E. V. WILLIS, A.R.C.S., B.Sc.
(G8VR)

It may come as a surprise to many readers to see an article on this subject in SHORT WAVE MAGAZINE, and it is true that super-regeneration has long since been discarded as a practicable receiving system in amateur band working. But the fact is that, like many other original ideas, the super-regenerator was doomed for damnation in its early days because the valves then available and the emphasis on simplicity brought out the inherent disadvantages of the system, while masking its virtues. Nor was the principle of operation clearly understood and since results of a sort could be obtained quite easily, little or no effort was made to improve on the circuitry. We now have far better VHF valve types and can obtain gain from tuned RF stages at VHF. There would appear, therefore, to be a case for a re-examination of the principle of super-regeneration, applying modern ideas and techniques. This article sets out the design factors involved and will suggest various lines of experiment. Given the extraordinary sensitivity of the super-regenerator, the lines along which it needs to be improved are as regards isolation of the detector from the aerial, selectivity, minimised noise effect, and capability for taking straight CW.—Editor.

IT is a fact that a well-designed super-regenerative receiver can produce outstanding results even above 500 mc, and many contacts over paths of up to 200 miles have been possible using such simple equipment. But the emphasis must be on the statement "well-designed," for a bad super-regenerative receiver is not only inefficient, but also a menace to the community! Since there appears to be a dearth of real information on the subject of super-regeneration, this article is intended to describe the fundamental action of such a system in order that potential designers may have some facts on which to build.

General Principles

In any type of receiver, one of the limitations

to sensitivity is to be found in the tuned-circuits. A signal voltage induced into the first tuned circuit is soon damped out by losses, and these losses increase very rapidly with signal frequency. The importance of high-Q tuned circuits cannot, therefore, be emphasised too strongly, but to achieve this at UHF is no simple matter. In a super-regenerative receiver, however, the circuit is operated on the verge of self-oscillation, and the anode voltage (or in some cases the grid voltage) is varied periodically to a peak value which exceeds the maximum stable voltage of the circuit. The frequency at which the voltage is varied is comparatively low, say, 200 kc. and the variations are produced by arranging for a separate source of oscillation at the appropriate frequency to be superimposed on the steady anode (or grid) voltage of the valve. This is the function of the "quench" oscillator. Some elementary circuits employ a single valve for both signal detection and quench generation, but this should be avoided for otherwise the individual adjustment of the two actions will be difficult. The operation of the super-regenerative detector is characterised by a loud "hissing" noise which disappears almost completely when a signal is received. The simplest form of receiver would be that shown in block form in Fig. 1.

Quench Action

The circuit normally employed as the first tuned-circuit of a receiver is a parallel arrangement of inductance and capacity, but some resistance is always associated with the inductance, and this tends to damp out the oscillations initiated by the incoming signals. By periodically raising the anode voltage to an unstable value by means of the applied "quench," the effect is to introduce an apparently *negative* resistance into the tuned grid circuit, and if the negative resistance is sufficient to cancel the loss resistance, then oscillations once started in the circuit will be maintained. This is

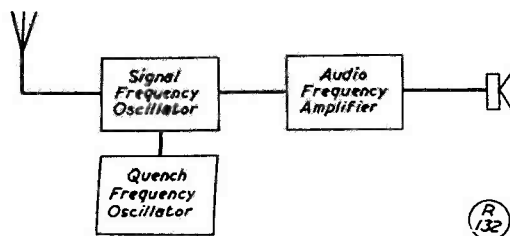

Fig. 1. Simplest form of super-regenerative receiver. The action is explained in the text.

normal "reactive-detector" practice, except that the valve only oscillates during a part of the quench cycle, as shown in Fig. 2. At some critical voltage V_q of the applied quench, the oscillator (that is, the detector stage) is triggered into the negative-resistance condition which prevails until the quench voltage falls to too low a value for the maintenance of the effect. The oscillatory voltage in the detector stage rises and falls as shown in the figure, its maximum amplitude being V_o . The frequency of these oscillations is governed by the natural frequency of the tuned circuit, and therefore is independent of the quench frequency.

Effect of Received Signal

When the tuned circuit is in resonance with an incoming signal, the following effects are observed :

- (1) There is a considerable reduction in the characteristic "hissing" noise.
- (2) The grid current in the detector valve increases
- (3) The anode current decreases.

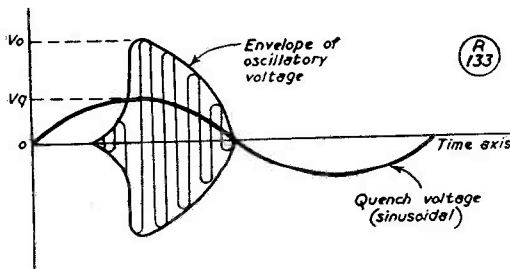

Fig. 2. Oscillation cycle of a super-regenerative stage. V_q being the quench frequency.

It is assumed that even when the quench has raised the anode voltage to a value above stability no oscillation occurs in the first tuned circuit until an RF voltage, however small, is introduced. When no signal is being received, the only voltages present for triggering purposes are stray ones, due to thermal and shot effects. Thus the oscillation will be spasmodic, and gives rise to the irregular noise so characteristic of the circuit. Many people seem to be under the mistaken impression that the "hiss" noise is due directly to the quench oscillation, but this is above audible frequency. On the arrival of a signal, which generally is of greater amplitude than the stray voltages, the oscillation is triggered by the signal—that is, synchronised to it — and the regular triggering reduces the noise. Thus for weak signals below the amplitude of the stray circuit voltages, no noise reduction can be hoped for,

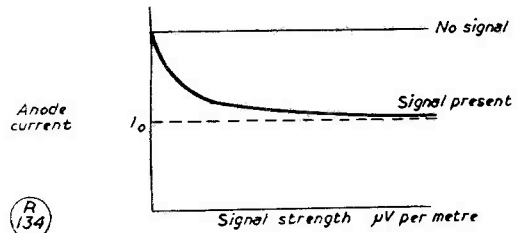

Fig. 3. Detector anode current falls as incoming signal strength increases, thus producing a self-limiting effect which prevents over-loading.

and a valve having a low noise-resistance should always be chosen for the detector stage.

The changes in anode and grid current due to the arrival of the signal permit the valve to be operated as a detector. Fig. 3 indicates the fall of anode current with increasing signal strength, and it will be observed that a saturation voltage is soon reached. This is highly desirable, for very strong signals will not overload the audio stages. Fig. 4 shows the variation in noise level, grid current and anode current as the first tuned circuit is tuned through the frequency of an incoming signal. The effective bandwidth of the signal, i.e., the width of tuning dial over which the effect is noticeable, generally is quite large, for super-regenerative receivers tend to be inherently unselective.

Sensitivity

The sensitivity is related to the change in anode current produced by a signal of given amplitude. The super-regenerative receiver is an amazingly sensitive device, and yet can be made even more so by attention to certain

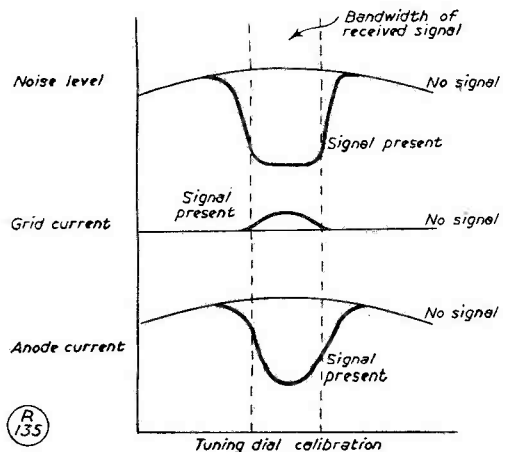

Fig. 4. Showing variation in noise level, grid current and anode current as an incoming signal is tuned.

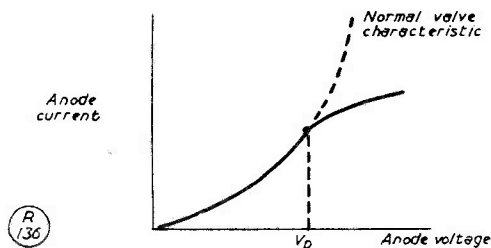

Fig. 5. Determining the correct anode voltage for the detector stage when in the unquenched condition. This is a critical value for most effective operation.

details. There are three main factors which influence sensitivity. These are anode voltage, quench voltage and quench frequency. It is virtually impossible to get all three at optimum values unless a separate quench oscillator be employed.

Anode Voltage

The valve should always be operated on the brink of self-oscillation in the absence of the quench. The correct operating potential may be determined by a simple experiment. With the quench out of action, a graph is plotted between anode current and anode voltage of the detector valve in its associated circuit. This is illustrated in Fig. 5, and at the point where the curve turns away from the smooth characteristic of the circuit, the corresponding voltage V_p is the critical anode voltage of the valve, and the circuit should be operated at this voltage. This experiment may be carried out on both self-quenched and external quench detectors.

The Quench Oscillator

Within certain limits, the higher the impressed quench voltage V_q the greater the sensitivity of the circuit. The quench frequency, contrary to the popular notion, is *extremely critical*, and has one definitely optimum value. When this is determined, a marked increase in sensitivity results. Fig. 6 shows the sensitivity plotted as a function of both quench frequency and quench voltage for a typical circuit. In general, the best results are obtained when the signal frequency is approximately 500 times greater than the quench frequency—say, 800 kc for a 400 mc signal—but wherever possible, a variable-frequency quench oscillator should be employed during the experimental work in order to fix the optimum value for the particular circuit. This could conveniently be a phase-shift or transitron oscillator, for these operate on resistance and capacity networks, and can be constructed to cover a wide range of frequencies without the necessity of a variable condenser of large "swing."

In using the super-regenerator because of its extreme simplicity, one has to face the fact that there are certain well-known disadvantages inherent in its design. For instance, its selectivity is poor, but this is not so serious on the VHF and UHF bands. It cannot be used, in its simplest form, for the reception of CW. Again, the characteristic circuit noise may mask a weak signal, although efficient pre-amplification and a low-noise detector valve can overcome a lot of this trouble. Finally, since the action of the circuit is really that of a pulsed oscillator, there will be considerable radiation from the aerial which will interfere on other receivers in the vicinity. Therefore some sort of RF or buffer stage between aerial and detector is practically essential.

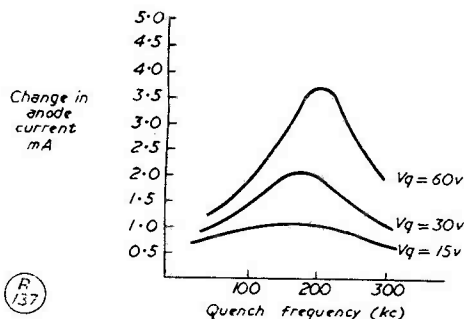

Fig. 6. Sensitivity as a function of both quench frequency and quench voltage in a typical circuit.

Some Suggestions

A super-regenerative receiver for 144 mc and above, using an earthed-grid triode as an RF amplifier buffer, should be a very interesting arrangement, and practically free from unwanted radiation. Another application which could be tried is to use the circuit in the second detector stage of a 144 mc superheterodyne, for the fact that the super-regenerator can handle strong signals without overloading makes it very useful in this position. This calls for an IF in the neighbourhood of 20 mc, and being so far removed from the aerial stage, no radiation should be encountered.

These notes have been drawn up in the hope that other enthusiasts will start experimental work in order to look at the possibility of making use of the super-regenerative principle under properly-controlled conditions, using modern valves and aiming to obtain low-noise action with proper separation of the quenched detector from the aerial and perhaps a tuned RF amplifier. Certainly, the results obtained on local signals will be found to be remarkable.

DX COMMENTARY

L. H. THOMAS, M.B.E. (G6QB)

JUST after the deadline there appeared to be a spectacular improvement in conditions. How long this was destined to last is a question that we must leave until next month, but it can definitely be said that October 16 and 17 marked the opening of the East-West path on the 21-mc band in a really big way.

On the Sunday afternoon (October 17) the band was jam-packed with W's, including plenty of 9's and 0's and even the occasional W6 and W7; the phone section was, if anything, more tightly crammed than the CW—a reminder of the 28-mc phone band during peak conditions.

During the same period 14 mc was full of just about everything one could imagine; incidentally, how nice it is to have the VK's and ZL's back with us once more—though not every day, by any means. What with WWV sending "N7," the HF bands showing their paces again, and the weather finer and warmer than for most of the summer, we can hardly bear to sit down at the desk to produce this Commentary!

Super DX on One-Sixty

Despite the foregoing, exciting enough, the big DX news is of the Top Band. G6GM (Hols-worthy), that old DX stalwart who worked ZL during October last year on 160 metres, in the persons of ZL1AH and ZL3RB, has done it again! On October 13 he had a 339/549 contact with ZL3RB at 0640; he, with G6CJ, had been hearing ZL signals for some days in the course of their privately-organised tests with ZL1AH; and



VK3ACD

CALLS HEARD, WORKED and QSL'd

on October 13 also. G6CJ (Stoke Poges) got 229 from ZL3RB.

These outstanding results are a magnificent opening for the 1954-'55 Top Band DX season. Those who may wish to emulate them should note, however, that the best period for G/ZL working has probably passed now until about March of next year, when the path should again be worth trying.

G6GM's success brings the first British 160-metre band WAC within sight, for he has only to work VP4LZ (they have already heard one another and may even have QSO'd ere this) to complete the round. And for the information of those who have queried it in the past, G6GM is still in a country location, has no local noise-level (he has no mains, either!), uses a battery-powered receiver, gets his HT from a 50-volt DC charging set (in connection with which a wind charger plays an important part) and—does know about aerials, for

which he has ample space. The 160-metre DX aerial at present in use at G6GM is a Zepp-fed half-wave wire running just off the N-S line.

Does anyone remember those pre-war jokes about a Top-Band WAC? They were well in the Flying Saucer category, and no one really took any part of them seriously. One or two W's have already achieved the "impossible," and we just can't wait to announce the first G station to join in . . . and it should be remembered that both geographical location and a 10-watt limit make it roughly 100 times harder for us.

Still on the 160-metre DX theme, a report from G5JU (Birmingham), who on the morning of October 17, 0600-0630, worked his first W's of the season—W1VDB, W3EIS, W3RGQ, all up to S7 on peaks, but fading away at 0630. Several other DX-men have been knocking about in the early mornings, looking for Trans-Atlantic contacts, and quite

a number of reports have been received of the reception of East Coast W stations.

Trans-Atlantic Tests

Here we can announce the *Short Wave Magazine* Top Band DX Tests for this season. They start on December 5, and in the panel herewith you will find full details as to times and frequencies.

Please observe carefully the calling and listening schedule until a QSO is effected. At all costs, *keep off* the DX channels. You will raise the wrath of multitudes if your *char-chip-char-chip char-chur-chip-char* is heard smearing W1BB or any of the DX stations! (There is nothing in your licence which says you must not do this—you are simply asked to cooperate in the general interest).

In spite of the good state of the other bands, the post-bag is overwhelmingly "Top-Band" in character again this month. There seems to have been a wholesale rush back to One-Sixty with the falling off of static and other summer troubles. So we will open the story at the lowest frequency this time.

Top-Band Topics

Lots of the ladder-climbers express their thanks to G3IGW (Halifax) for his portable efforts in Northern Ireland.

A comment by G16YW is worth quoting: "I had the pleasure of meeting G3IGW and G3JML when they were over here in GI, and I take off my hat to two lads who *carried* their gear round the country by train and bus. It was a very stout effort"—and all who were fortunate enough to work G3IGW will agree.

In a modest letter, claiming 78/80 on the Ladder, G3JML (the other half on this GI journey) says "I think the trip was a success, but conditions for the first few days were very poor." They had 314 contacts in all, found Fermanagh to be the best location, and for best DX worked GC2CNC (TTX), HB9T and OK1HI; this was from the house of SWL Taylor just outside Enniskillen; and they would also like to thank G13HXH for much help.

G3HQX (Mitcham) is among those who comment on the speed with which the G3IGW expedition have QSL'd.

GM3OM (Larbert) has reached the fantastic score of 95 worked, 93 confirmed, which includes a complete clean-up of all the GM and GI counties. 'OM wonders where he goes from there, and adds that OK and HB are coming in well in the early evenings. G2NJ has got to 91/91, and mentions OH2YV worked on October 11.

G3CO (London, S.E.14) has also jumped up, and quotes GW2FDF (Monmouthshire) as a useful one . . . but now for Anglesey and Merioneth. 'CO thinks the band is back on winter conditions already, with OH2YV putting a nice signal there, too.

G3HYJ (Norwich) had a QSO with EI8J, which made him wonder . . . but wait for the next paragraph! 'HYJ is still short of Oxford, which he wants to complete his English counties. G3HQX asks if there is a 1.8 mc station in Suffolk, and wonders if he is the only operator to have

worked Rutland from Rutland—G5PP/P.

EI8J (Dublin) writes and says "Very few EI stations are licensed for 160 metres, and fewer still active! Hence the interest I find when calling CQ on the band." He runs 9 watts of CW and 6 watts of phone to a 100-ft. wire, and has worked 32 countries to date—all QSL'd. OK1KTJ has also been worked. EI8J wishes that stations calling CQ would sign their *county* on the end of the call—he is looking for some of them at least as anxiously as they are looking for EI.

G3BRL (London, W.5) thanks G3IGW for Tyrone and Fermanagh—also for the necessary cards. G3JEQ (Great Bookham) is now up among the high scorers with 86 worked, thanks to all the DX-peditions. EI and OH have also been raised. G3JBK (Bexleyheath) has had some of the Continental DX and is yet another grateful to G3IGW/A and GM5RI/P.

G3JHH (Hounslow) collected the GI's, as well as GW2FDF (Monmouth) and GM3JIG (Ayr).

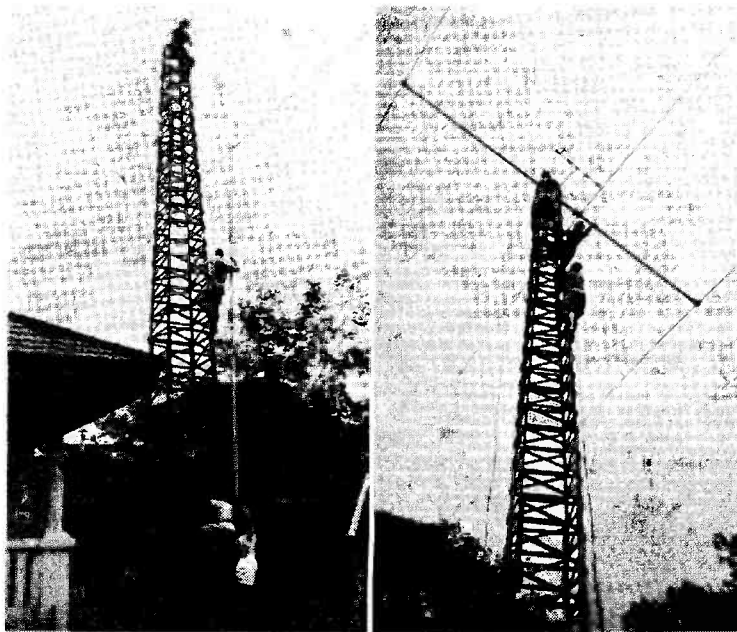

The VS2DQ (Kuala Ketil) 3-element beam for Twenty, with a 4-ele Yagi for 144 mc above it. On left—going up! On right—the array in position. The home-made wooden tower is 40ft. high, and the 20-metre beam is so constructed that it can easily be altered for either the 21 or 28 mc bands.

GM's are coming in well, and a very good signal emanates from

**TOP BAND COUNTIES
LADDER**
(Starting Jan. 1, 1952)

| Station | Confirmed | Worked |
|---------|-----------|--------|
| GM3OM | 93 | 95 |
| G2NJ | 91 | 91 |
| G5JM | 91 | 91 |
| G3HIS | 90 | 91 |
| G16YW | 88 | 89 |
| G6VC | 87 | 87 |
| G5LH | 87 | 87 |
| GM3EFS | 85 | 86 |
| G3HDQ | 84 | 85 |
| G3CO | 83 | 84 |
| G3JEQ | 81 | 86 |
| G3JEL | 81 | 85 |
| G3HIW | 79 | 86 |
| G3IVH | 79 | 83 |
| G3JML | 78 | 80 |
| G3BRL | 74 | 76 |
| G2AYG | 73 | 74 |
| G3EUK | 72 | 79 |
| G3HYJ | 71 | 77 |
| G3FTV | 69 | 79 |
| G3HQX | 68 | 63 |
| G3HTI | 66 | 70 |
| G3JHH | 65 | 67 |
| G3GYR | 64 | 66 |
| G3IOX | 63 | 74 |
| G3JKO | 63 | 69 |
| G3IGW | 62 | 76 |
| G3GSZ | 62 | 62 |
| G3GZB | 62 | 62 |
| G3DO | 61 | 64 |
| G2CZH | 60 | 62 |
| G3IND | 60 | 60 |
| G3ITY | 54 | 70 |
| G3HZM | 53 | 56 |
| G8VG | 50 | 60 |
| G2HKU | 48 | 50 |
| GM3JNW | 43 | 56 |
| G3JJZ | 43 | 52 |
| G3JBU | 39 | 43 |
| G2CZU | 39 | 41 |
| G3JZQ | 29 | 39 |
| G3JBK | 25 | 31 |
| G3JKM | 17 | 37 |
| G3HMF | 17 | 20 |
| G3IAD | 15 | 50 |
| G3FTV/A | 13 | 60 |
| E18J | 12 | 32 |

GM3JNW (Alloa), but 'JHH got his best report from GM3HXT (Moray), who gave him a 589.

G3JJZ (London, S.E.6) is rather despondent about his chances with an 80-ft. wire only 16-ft. high—yet he raised all three GI counties as well as G3JFF/MM in the middle of the Bay of Biscay, not to mention HB9T and OK1HI—and eight QSO's with OK1KTI. We wouldn't say that 'JJZ has much to be depressed about . . .

G3HZM (Manchester) worked Montgomery (GW3ESJ), who had only 30-ft. of wire pushed out of a window, and was pretty weak—but they made it. G3GYR (Stoke-on-Trent) raised GM3GZC (Argyll) and GD3UB for new ones; he has acquired WABC Certificate No. 73, and likes the number!

G2HKU (Sheerness) is going through the exciting process of changing over from DC to AC. After several years as an amateur, he will be building his first AC power-pack! On 160 he has worked OK1KTI many times, and has heard sundry stations calling VP4LZ—but no sign of the latter.

G3HIS (Ashbourne) is among the leaders on the Top Band ladder, with 91 worked and 90 confirmed. For the moment he is out of the race owing to the effects of dampness on a power pack, but he hopes to be back soon.

G3IGB (Londonderry) sends his regrets for only being able to come on the air a few times, over a period of some three weeks, but adds that G3CVH is now representing the county permanently. 'IGB hopes to be operating from Morayshire soon.

HB9T (Zurich) is on about 1830 kc most days at 1900 GMT for a short time, except when he is QRL and unable to make it.

G3JBI (Barking) wonders at the scarcity of stations working at the HF end of the band—above the Loran spread. Everyone seems to cluster around 1900 kc, he says, and the result is shocking, whereas you can find a clear spot at the HF end and call CQ until you're blue in the face Probably there are some VFO's that won't get there; and, among those that do, there is a dislike of re-tuning

throughout. But, as 'JBI reminds us, we lost a good chunk at the LF end last year; surely we should make use of the HF end to better effect?

G6VC (Northfleet) caught up with the three GI counties and is looking very anxiously for Anglesey. With his score of 87 worked and confirmed, he ties with G5LH on the ladder.

G3JZG (Willenhall) owns one of the latest call-signs to come on our books, and during his first two week-ends of operation he has worked 15 counties, including two GM's. He finds the OK's and HB's have signals as good as most GDx on the band, and looks forward to raising them.

DX on Twenty

Conditions have varied from excellent to very poor, but on the whole they could be labelled "Good" and left at that. From early October the VK's and ZL's began romping in during the mornings (but the poorest patch of all was during their own contest!) Afternoons have been filling up with W's, although the period 1200-1500 has often been very useful for the Far East. By October 17 the West Coast W's were in full cry around 1700-1800, and VK's have on rare occasions been heard very late in the even-

Short Wave Magazine DX CERTIFICATES

The following have been awarded since the publication of our last list, in the September issue:

WNACA
No. 75 G3FKM (Birmingham)

FBA
No. 40 SM7AKG (Eksjo)
41 OE1FF (Vienna)

WABC
No. 68 G3GQS (Helston)
69 G3DO (Sutton Coldfield)
70 G5PP (Coventry)
71 G5PP/P (Coventry)
72 G3JKO (Nottingham)
73 G3GYR (Stoke-on-Trent)
74 G3IND (London, E.7)
75 G2CZH (Morden)
76 G3GSZ (Castle Eden)
77 G3GZB (London, N.22)

Details of MAGAZINE DX AWARDS and CERTIFICATES, and the claims required for them, appeared in full on p. 323 of the August, 1954 issue.

ing. Yes, *Twenty* is most definitely warming up, but the short-skip troubles show no sign of abating just yet.

VQ6LQ (Box 11, Hargeisa) has been stirring things up around 14065, and will be out there for two months or so. The pack of W6's calling him on October 17 had to be heard to be believed, but he is usually fairly clear in the afternoons. He uses an old abbreviation with a new meaning: "QLF" used to mean "Send with your *Left* foot now," but on his key it seems to say "Call me on the LF side of my frequency."

VK4YP (Brisbane) is the old VK3YP from Melbourne, well known to many G's for his consistent signal and slick operating. HI8WA made a very brief appearance on CW, operated, we believe, by a W4. Normally one has to have a mike to raise an HI.

ZA1KAD showed up on the band last month, but was treated with such scepticism that there must have been many who didn't even bother to call him. (We still don't know whether he was genuine). ZD3BFC remains active, and his QSL's are beginning to arrive in this country.

G6VC reports three new ones—FL8AN, VK9AU and ZA1FA (the latter being treated with reserve). Otherwise most of the month's QSO's were with "dozens of W's." G2YS (Filey) heard and missed DU7SV, HS1D, FB8BE, ZD6BX.

G3IAD (Wakefield) is another who raised ZA1FA; two more new ones were KH6IJ and UC2KBA. He is troubled by TV receivers with 14 mc IF's, but his own gear has been cleared—and he is full of admiration for the way the GPO men have been doing their job.

G3HYJ raised EA8BH and VQ4EZ, but a lot of nice ones from FM8, F18, JA and the like were gotaways. A new one for GW3AHN (Cardiff), on one of his infrequent appearances on this band, was SVØWK/9.

DL2RO (BAOR 3) found the band patchy, but admits to one or two really good days. He quotes October 6, when he made a WAC in six consecutive QSO's between 1400 and 1700. (The stations were VQ6LQ, PY8MO, W8EGB/5.



The youthful "amateur wireless enthusiast" signing PZX in 1912 is now G3HT of Edgware. Items in this interesting old print include slider-tuned inductances (very advanced in those days), a coherer receiver, and somewhere was a spark transmitter. The wavelength would have been 1000 metres, plus or minus.

VK4SD, MP4BBL and ZB1BF). He passes on a note from VQ6LQ saying that he will always open up on Sundays, 1430 GMT around 14070 kc. Stations should call at least 15 kc below his frequency.

The 21-mc Band

We have already delivered a broad hint that this band is by no means dead. Others have found the same, although all readers' letters were written well before the real "official" opening on October 16-17. DL2RO, for instance, quotes the old regulars from ZS 1, 2 and 6, West African Coast MM stations, FY7YC, ZD4BQ and the like. He also mentions good phones from VU2EH and VQ3AV, and adds that HS1VR was heard on CW, but faded before a contact could be made. Kurt Carlsen,

W2ZXM/MM, in *Flying Enterprise II*, is running a kilowatt and is on a round-the-world trip.

GW3AHN has been as active as ever, and now scores 110 on this band, going to the top thereby. New ones have been MP4BBK, ZD6BX, ZS8D, XE1PJ and 4S7YL, some of these phones; other phone QSO's have included CO, TI, OQØ, EL, HC, HK, HP, YV, FF and lots of the more usual stuff. The only CW DX of note was FY7YC. GW3AHN remarks that the band has been alive as early as 0730 some mornings.

G3HCU (Chiddingfold), working entirely on phone, raised 4S7YL, TI2BX, VQ 2, 3 and 4, 4X, VP6, ZC4 and ZS's, plus quite a string of W's. He thinks fourteen is really looking up at last. VQ4EI was worked at 0800 one morning.

G2YS chased for ZS9I, but he

TRANS-ATLANTIC TESTS

1954-55 SEASON

Dates:

December 5 and 19, 1954
January 2, 16 and 30, 1955
February 13, 1955

Times:

0500-0800 GMT

DX stations call at 0500-0505, 0510-0515, 0520-0525, and so on. Europeans call 0505-0510, 0515-0520, 0525-0530, and so on. Clocks should be synchronized by WWV on 2500 kc.

Frequencies:

Europeans in band 1825-1875 kc, preferably keeping to 1830-1870 kc. W/VE stations, according to location, will be in bands 1800-1825 kc, 1875-1900 kc and 1975-2000 kc. They will know where to look for us, and contacts should be carried out cross-frequency to minimise interference. All Europeans are asked to keep clear of the DX channels.

was working W6's and eventually faded out. New ones for G3DO (Sutton Coldfield) were EAØAC and 5A2CO.

Other Bands

There is not much news of *Forty*, although G5DQ (Cambridge) tells us that he worked TI, YS, 4S and some ZL's up there from his new QTH. ZS2AT (East London) passes on the news that FB8BK (Tromelin Island) works *only* on *Forty*. His frequency is 7047 and he is pretty QRP, but he should be found there on Sundays at 0700.

An addition for G2YS was F8VQ/FC, and GW3AHN reports working CT2BO and several ZL's. G3JJZ had a listening session between 0430 and 0500 one morning, and logged two PY's, KP4SK and LU6FAD. And so much for *Forty*.

Turning to *Eighty*, we have an interesting one from G3HWF (Yatesbury), who has been knocking off some quite nice DX. In the list are ZD2DCP, T12BX, OD51M, OY5S, HE9LG, CN8's and FA's, ZB1's and ZB2A, SU1XZ and 5LS, ZL4IE, VE's, W's and VP4LZ. The interesting thing is that VP4LZ went on to One-Sixty, and G3HWF worked him cross-band from *Eighty*. Lots of G's were calling the VP4 on Top Band, and G3HWF relayed

their calls, but VP4LZ could not hear a trace of them; his own signals on 1833 kc were 559 with G3HWF.

G3HWF uses PT15's in push-pull, to an eighty-metre dipole 55 ft. up, and works on the band between 2300 and 0700 most week-ends, also week-days when possible. He says "Look out for HV1AB in late November; he will be active for about three days . . . that is all we know at present." Is this one going to be good?

G3HCU went portable while on holiday, and worked a lot of 80-metre phone from spots near Portmadoc, North Wales. The whole rig was self-contained in the boot of the car, and all kinds of aeriels were used, from wire fences to box kites 250 ft. high. The latter were always the best, but another nice one was run from a 70-ft. cliff down to the car, about 250 ft. away.

There is one solitary report on *Ten Metres*, from G3IDG (London, S.W.12). He passes on the news that G2YZ worked LU3AQ, PY1AGP and OQ5RU between October 6 and 10. Other stations heard on the band (by G2YZ, 5LB and 8SY) were CX4CS, CR6BX, CR7IV and ZS6BW. Distinct signs of something stirring down there . . . don't overlook them! G3IDG adds that he has the latest VK and ZL Call-Books, and if anyone wants an up-to-date QTH, he will send it along on receipt of a stamped addressed envelope.

ZD4BM (G2ATU) is just about back to Takoradi by now and will be on again very shortly, 20-metre CW and phone; he remarks that there is a "small bunch of active operators in ZD4 but very few ever work CW"—ZD4AB in Accra is an exception, and he has been on 3.5 mc at times. The ZD4 licence conditions are much as ours, but are for 25 watts phone and CW on all bands except 1.8 mc, which would not be much use to them anyway because of the static level out there. *Forty* is a very quiet band (!) in ZD4, and G's can be heard about midnight. ZD4BM hopes for more contacts with this country, preferably *not* of the rubber-stamp variety, and

reminds all who may be interested that nowadays it takes an operator with a DX call some time to keep up with the QSL's.

As an indication of how much better DX conditions and activity have been just recently, G5JU (Birmingham) reports that during the week-end October 16/17 he worked W's on all bands from 1.8 to 21 mc inclusive—he tried 28 mc, but apparently it did not open to the Midlands.

By the end of this month ZB1AH will be back in the U.K.; though he has QSL'd 100%, anyone who may not have had his card can write him to: 23 Hill Top Crescent, Wheatley Hills, Doncaster.

Contest Results

We have to hand (by courtesy of G3DOG) the results of last year's International DX Club Contest, as far as G, GM and GI prefixes are concerned. Space only permits us to quote the high

21 mc MARATHON

(Starting July 1, 1952)

| <u>STATION</u> | <u>COUNTRIES</u> |
|----------------|------------------|
| GW3AHN | 110 |
| VQ4RF | 108 |
| G4ZU | 105 |
| G5BZ | 103 |
| G4ZU (Phone) | 99 |
| G2WW | 98 |
| DL2RO | 93 |
| G2BW | 92 |
| G3HCU (Phone) | 89 |
| GW3AHN (Phone) | 81 |
| G2BJY | 81 |
| G2YS | 76 |
| G6QB | 75 |
| G3DO | 74 |
| ZS2AT | 70 |
| G3FXB | 65 |
| ZB1KQ | 64 |
| G3CMH | 64 |
| ZB1KQ (Phone) | 63 |
| G3CMH (Phone) | 62 |
| 5A2CA (Phone) | 60 |
| GM2DBX (Phone) | 42 |

scorers, but here are some of them.

CW Section: All Bands, G4CP (104483), G6PD (90630), G2VD (81480), **3.5 mc, G6PD** (5320), G8KP (4130), G3FXB (2607); **7 mc, G4CP** (9234), G2VD (9165), G4XC (5922), **14 mc, G2LB** (83096), G4PC (22936), G3DOG (21976), **21 mc, G2BW** (5782), G2VD (2178), G3FXB (1568).

Phone Section: All Bands, G3FXB (19758), **3.5 mc, G3FXB** (378), **7 mc, G3FXB** (36), **14 mc, G3FXB** (5289), **21 mc, G2WW** (5459).

In the multi-operator CW category, G2BOZ (20128) cleaned up the 7 mc band. A multi-operator phone award went to G3BTG (47424) for All Bands.

Other winners were GM3EOJ (21929) and G13FJX (37200), for all bands CW; and GI5HZ (8640) for 21 mc CW. There were no phone entries from Northern Ireland, but the Scottish results were GM3DHD (49152) and GM2DBX (28126) for all-band phone, and GM2DBX (429) headed the 7 mc phone.

The Ham Spirit

We really appreciated the kindly thought implied by a card received from PY2AJ, worded: "The 27 Sept. 54 was the 25th anniversary of our first QSO, as says my log and your QSL card. It was a long time ago but am happy to see that we are alive and QRV on the air yet. Congrats."

The AP Districts

G2YS passes on the following useful gen., from *Radio Rivista*, on the districts of Pakistan. They are as follows: AP2, Sind; AP3, Baluchistan; AP4, North-West Frontier; AP5, Punjab; AP6, Bhagalpur; AP7, Assam; AP8, Bengal. 'YS wonders how long it will be before a "WAAP" Certificate is announced!

Old-Timer Overseas

Further to previous remarks about G6UT, we now have news from him in his new QTH at Wynberg, Cape Province, where



"... Endurance behind many a CQ ..."

he is licensed as ZS1RG. He tells us that he has been made very welcome by the ZS1's, who have been of great help in getting him on the air. At least he has no European short-skip to worry about, but Table Mountain, only two miles north, is a bit of a hazard. G5VT (Bishops Stortford) also passes on the news that ZS1RG worked 30 countries in his first ten days on the air, using a Collins 32V1 and a 300-ft. aerial. He can be found on 7, 14 and 21 mc—mostly CW, but occasionally on phone as well.

DX Strays

Most of the odd DX plums (or peaches) have already been mentioned under various headings. Others will doubtless have shown up during the International DX Contest, the smoke from which will have died down by the time you read this. From KX4AA we learn that another Tokelau Island station should have been on the air, signing ZM7AL (ZM6AL on an expedition), that TT2FD (a station, not an aerial!) is on the

air in Tannu Tuva, and that the YN stations, banned from the air last April, are now back on again.

Otherwise there is little exciting DX news, and even the usual rumours about highly questionable ones are scarce this month...

Now that conditions are definitely on the up-grade, we hope to hear from more and more of the old clients. Many of them, we know, have been right off the air for quite long periods; but the smell of DX is extremely penetrating, and one by one they will be lured back. We look forward to hearing from them again.

Next deadline is first post on **Friday, November 12**. Make sure of catching that date, and address all your news and views to "DX Commentary," *Short Wave Magazine*, 55 Victoria Street, London, S.W.1. It will be *December 16* certain for the January issue; overseas readers are particularly requested to catch this, as we shall be involved in the Christmas rush and consequent delays. Until then, 73, Good Hunting, and BCNU.

Read Short Wave Magazine Regularly—It will keep you in touch with the Latest News

THE RADIO AMATEURS' EXAMINATION—1954

QUESTION PAPER

55.—RADIO AMATEURS' EXAMINATION

Friday, May 7, 1954, 6.30 to 9.30 p.m.

Eight questions in all are to be attempted, as under :

All four in Part 1 (which carry higher marks) and four others from Part 2.

Part 1.

All four questions to be attempted from this part.

1. (a) Explain why neutralisation is necessary when a triode valve is used in the R.F. power amplifier stage of a transmitter.
(b) With the aid of a diagram, show how neutralisation is effected. (15 marks.)
2. How can the following types of interference be minimised:—
(a) at the transmitter.
(i) over-modulation.
(ii) harmonics, interfering with television reception.
(iii) spurious oscillation?
(b) at the receiver.
(i) image response.
(ii) blocking? (15 marks.)
3. With the aid of a simple diagram, describe a heterodyne frequency meter and explain how it is used to measure the frequency of a transmitter. (15 marks.)
4. State what requirements have to be met under the frequency control and measurement conditions of the Postmaster General's licence to establish an Amateur Wireless Station, and say why these conditions are necessary. (15 marks.)

Part 2.

Four questions only to be attempted from this Part.

5. With the aid of a diagram indicate the magnetic field associated with an air-cored cylindrical coil through which direct current is flowing. How does the strength of the magnetic field depend upon:
(a) the magnitude of the current.
(b) the number of turns?
What is the effect of inserting an iron core in the coil and why are laminations used for the core when A.C. is used? (10 marks.)
6. What is meant by the term resonance?
If an inductance of 50 microhenrys is in series with a capacitance of 500 pico-farads, what is the resonant frequency?
 π^2 may be taken as 10. (10 marks.)
7. (a) State the relationship between the frequency and the wavelength of a radio wave.
(b) What are the frequencies corresponding to wavelengths of 150 m., 2 m. and 75 cm.? (10 marks.)
8. Define the following terms:—
(a) mutual inductance.
(b) amplification factor,
(c) A.C. resistance (anode slope resistance).
State the relationship between them. (10 marks.)
9. Describe with the aid of a block schematic diagram a super-heterodyne receiver suitable for continuous wave reception and state briefly the purpose of each stage of the receiver. (10 marks.)
10. Explain briefly why standing waves are undesirable in a feeder system connecting a transmitter to an aerial. How would you detect their presence and minimise them? (10 marks.)

THE RESULTS

| | 1954 | 1953 | 1952 |
|-----------------------|------------|------------|------------|
| Candidates : Home | 395 100.0% | 477 100.0% | 534 100.0% |
| Passed | 327 82.8% | 388 81.4% | 423 79.3% |
| Failed | 68 17.2% | 89 18.6% | 111 20.7% |
| Candidates : Overseas | 13 100.0% | 9 100.0% | 12 100.0% |
| Passed | 7 53.8% | 8 88.9% | 7 58.4% |
| Failed | 6 46.2% | 1 11.1% | 5 41.6% |

The number of entries for the 1954 Radio Amateurs' Examination was fewer than in the preceding year, but the general standard of the candidates' work was good. A report on each question follows:

Question 1. Part (a) was satisfactorily answered by practically all the candidates.

In part (b) about 20% of the candidates in

their diagrams of single-ended power amplifier stages incorrectly indicated the method of neutralisation by showing the neutralising capacitor connected directly between the anode end of the tank coil and the grid, and the high tension supply connected to the end of the tank coil.

Questions 2 and 3. Fairly well done by most candidates.

Questions 4, 5, 7, 9 and 10. Well done by nearly all the candidates.

Question 6. The first part of the question on resonance was well done. In the second part of the question about 20% of the candidates, although quoting the correct formula for resonance, were unable to complete the calculation.

Question 8. Satisfactorily answered by practically all the candidates. Most of them noted that part (a) of the question should have read "mutual conductance."

As usual, the paper set was fair and reasonable, calling mainly for just the sort of practical knowledge which ought to be possessed by anyone aspiring to the privilege of an amateur transmitting licence. The table shows that in the last three years 1,138 U.K. candidates have become qualified by examination. A large proportion of licensed amateurs are not required to take the examination at all, by

reason of holding professional or Service exemptions, of which there is a long list. The Radio Amateurs' Examination, Subject No. 55, is held by the Department of Technology, City and Guilds of London Institute, 31 Brechin Place London, S.W.7. All enquiries respecting the Examination should be made to that address. The next R.A.E. will be held in May, 1955, for which entries must be in by March 31.



Letters published are those which seem to us to be of general interest, but should not be read as necessarily being in accordance with our own views on the subject. We welcome readers' comments.

COMMENT ON THE "FOLDED GROUND PLANE"

SIR,—In the otherwise excellent article by G3FCS in your October issue, I must point out (for the sake of those who may encounter unexpectedly large readings on their SWR meters) that the terminal impedance of the assembly at Fig. 3, p.433, might not be 150 ohms. In his analysis, the author states, correctly, that the terminal impedance increases as the square of the total number of elements, and goes on to point out that this will be modified if the relative diameters of the elements differ.

This fact, of course, applies equally to the folded monopole he is discussing; hence, in the aerial illustrated the impedance will be modified by factors depending, among other things, upon the diameter of the 12 SWG primary wire radiator relative to the (unspecified) diameter of the secondary support radiator. The terminal impedance will only be 150 ohms if the diameters are equal.

G. Denby, G3FCW, 32 Queensway, Guiseley, Nr. Leeds, Yorks.

"THE CRYSTAL-MIXER VHF VFO"

SIR,—I read with very great interest the article "VFO for Two Metres" by G6XH in the September issue of the Magazine, and there is no doubt the VFO he describes would possess a very

high order of frequency stability; G6XH is to be congratulated on a most useful and instructive article. However, I suggest that his circuit has two main disadvantages:

(a) No matter how carefully designed and screened, there is always the possibility that the sum and difference frequencies present in the mixer circuits, and their associated harmonics, may get through to the PA, particularly if a number of multiplier stages follow the VFO, and

(b) The circuit is too complex for addition to the average two-metre transmitter, which is already somewhat complicated, requiring a number of stages, with the consequent drain on power supplies.

I am using VFO control on two metres, consisting of but a single stage with a KT61 in a Clapp oscillator; the valve is pentode-connected, with the grid side resonant on 6 mc, the anode doubling to 12 mc, and the screen as the grounded anode. The output circuit is a pi-network, feeding into low-impedance line to the first (24 mc) doubler stage in the VHF exciter. The VFO HT is stabilised, but drawn from the main power pack. I am assured over the air that the stability of this VFO is equal to crystal control; no appreciable degree of drift has been reported or is observable at my end. I have been persuaded that others may be

interested to know what can be accomplished on VHF with such simple equipment.

C. A. Bancroft, G3GBJ, 209 Plymouth Road, Redditch, Worcs.

OUR CONTRIBUTOR REPLIES:

"G3GBJ's letter rightly draws attention to the possibility of unwanted frequencies being present when using the Crystal-Mixer type of circuit. If the LF oscillator and crystal frequencies are chosen with care and a push-pull LFO and balanced mixer are used, unwanted frequencies should be at such a low level compared with the transmitter frequency that no trouble should be experienced.

G3GBJ's description of his use of a VFO on 6 mc is very interesting, and he is to be congratulated on having been so successful with it. There seems to be little quantitative data on the subject of oscillator drift, and it would therefore be very useful to know, as near as he can estimate, how much drift he does, in fact, experience on two metres when starting up from cold and how long it takes to achieve a steady condition."—G6XH.

NOVICE DIFFICULTIES

SIR,—Having been an SWL for about two years, with the intention of getting my ticket as soon as possible, I am surprised at the number of people who are opposed to the idea of a band for

the novice. Not all of us are fortunate enough to have a local radio club we can go to for exchanging views with other SWL's and gathering information from licensed amateurs. In a letter from VE3DDI in Canada, he says it is easy to get a novice licence out there, and I believe the same conditions apply in the States. Why, therefore, should the G-SWL have to struggle so hard?

W. Richards, 9 Church Lane, Padstow, Cornwall.

It is true that in the States and Canada what are known as Novice Licences are issued, for a period of 12 months only, on a minimum qualification standard; to remain on the air, the applicant must then pass the usual examinations. This has done a great deal to encourage and enthuse beginners. In this country, before the war, we used to have a somewhat similar form of licence known as the Artificial Aerial (or "three-letter call-sign"), issued without any qualifying standard at all beyond the ability to convince the GPO that serious radio experimental work was intended. When the applicant had been operating under non-radiating, i.e. "artificial aerial," conditions for a reasonable period and had then passed the usual Morse test, a full radiating two-letter call-sign was granted. It has always seemed to us a great pity—indeed, a retrograde step—that this procedure was not re-introduced after the war. What happened in 1946, on the resumption of Amateur Radio activity, was that all pre-war holders of AA licences were automatically granted full radiating permits, using the G prefix with their original call-signs; such licensees are now recognisable by the fact that their calls fall in the sequence G2AAA-G2HXX. Amateurs newly licensed under the post-war procedure have been allotted call-signs starting from G3AAA.—Editor.

QSL'S FOR SWL'S

SIR.—I beg to add my comments on the controversy regarding QSL's for SWL's. Surely we have not reached the stage when a non-transmitting amateur is to be

regarded as not one of the fraternity? I would venture to say that probably the majority of active amateurs today were themselves once SWL's; bearing that in mind, surely they can recall how they felt when an exotic DX station failed to QSL, perhaps despite an excellent and detailed report compiled over a period of days, or even weeks. By all means persuade our SWL's to send in useful reports, with details beyond those covered on the normal QSL card—but please do not let us seem to become "superior" to them, and cease to QSL because they are "inferior" in the amateur scale.

S. E. Aspinall, VS2DJ, c/o 4 Knutsford Road, Gorton, Manchester, 18.

The point at issue is stated by VS2DJ when he stresses the need for useful reports. Unfortunately, it is the mass of useless and unthinking SWL reports that has tended to depreciate the value of all listener cards. On the other hand, there are very few licensed operators who would not QSL any listener report really of use to them—and fewer still who would not agree that SWL's in general should be given all the advice and encouragement possible. It was probably a mistake in the first place for SWL's ever to have used a form of QSL card as a report; it would have been far better had they adopted a ruled sheet, on which a great deal more information can (and should) be given than there is space for on an ordinary QSL card.—Editor.

"CRYPTIC PHONES" AND "CRAZY CALL-SIGNS"

SIR.—Those writing on this subject in the September issue have, I feel, missed the whole point of "Old Timer's" original remarks. Surely these were aimed at the often unnecessary, and usually facetious, use of phonetics for carrying out a perfectly normal inter-G contact. One correspondent expresses his disregard for what the uninformed listener thinks about his transmission. This "couldn't care less" attitude

is as dangerous in Amateur Radio as in any other walk of life. Let us not forget that those who dictate licence policy probably do not know the meaning of "queen roger mary" and are not in the least interested in "S nine plus ten dog biscuits." Neither can a lot of what goes on in the 80-metre phone band convince the powers-that-be that we are making the best possible use of our frequencies. A little more dignity on the part of some operators might even encourage better SWL's, who in due course would become better amateurs. Just because we are not licensed as "experimenters" does not mean that our telephony transmissions should seek to emulate the Light Programme. The clamour for frequencies, coming from all quarters as it now does, should make the amateur ever watchful that his conduct on the air is beyond reproach.

E. G. Allen, G3DRN, 65A Melbury Gardens, Wimbledon, London, S.W.20.

POINT OF ETHICS

SIR.—I would like to appeal to newcomers to Amateur Radio, particularly the telephony operators, to observe the rules of precedence which have been traditional for many years. May I point out that the station which instigates a QSO—that is, the operator who first calls CQ on a clear channel—thereby takes precedence on that frequency so far as further QSO's are concerned. At the end of a contact, the instigating station remains in possession of the channel, and other stations which have been on the net should move off and find a clear spot for themselves. In no circumstances should two of them, wishing to work one another, proceed to make a full contact on the channel. To do so would be the height of bad manners, since it shuts out the instigating station. It is most necessary, in these days of crowded hands, that such elementary rules of operating courtesy be observed.

D. May, G2BB, Roza, Reading Road, Yateley, Nr. Camberley, Surrey.

TRANSISTOR TOPICS

Pocket Transistor Transmitter

Commercial Transistor Development

Notes on Home-Constructed Transistors

TTX Results and News

AFTER the Daylight Powered Transmitter described last month, the emphasis this month is on the heart of the transmitter—the home-made transistor. We start with the description of a small self-contained TTX using a home-made transistor and follow this with a discussion of the characteristics of the transistor used in the sun-powered transmitter.

The Self-Contained TTX

The two photographs of this transmitter are largely self-explanatory. The top view gives a good idea of the appearance and also, by comparison with the key and Q.C.C. crystal, of the size. The other photograph shows the disposition of the main components, including the centrally-mounted home-made transistor. A circuit diagram is given in Fig. 1 for easy reference to these components, but a glance will show that it is not new and follows closely the original circuit of Fig. 5b on page 15 of the March *Short Wave Magazine*.

The transmitter was developed by first incorporating all the components on the bread board hook-up, and then testing. This enabled several simplifications to be made by omitting some parts. Also, by finding the optimum setting of the potentiometers and variable resistors, substitution by small fixed resistors was possible. Only when the circuit had been completed and all the components tried was construction started. The complete layout was put on graph paper, which was then stuck to a sheet of 16 SWG aluminium sheet. (All cutting and drilling can then be done on the flat sheet, and subsequently the bending, using the original graph paper plan throughout.) The main point to watch is that, after all assembling and wiring, three wires to the transistor remain in a convenient position to support it well clear of anything which could foul the whiskers and hence ruin the transistor. Once the transistor is in place, an L-shaped lid, also made from the same gauge aluminium, can be slid under the flange of the

chassis and fixed near the battery compartment by a self-tapping screw.

Operating Notes. No meter is included, but initially the collector current can be checked by an external meter in the lead to the key. About 4 mA is drawn from the Ever-Ready 22½-volt battery, though this varies with aerial loading. The battery is a standard Ever-Ready type and fits snugly into the battery compartment without clips. No current can flow until the key is inserted and pressed, thus obviating the necessity of a switch. The crystal is plugged from the outside to enable the frequency to be changed easily. The tuning condensers are very small for the sake of miniaturisation, but once they have been "padded" into the band, give sufficient swing to cope with several different crystal frequencies. The Wearite P coil (PHF6) specified may give too close a coupling to the aerial, which may lead to difficulty in oscillation, a poor note, and even lack of hold by the crystal. The coupling can be reduced either by removing turns or by-passing the coupling coil with a small condenser. The aerial is brought to resonance by tuning for maximum reading on the field strength meter. The performance is unaffected by squeezing the lot into such a small space, and layout (of a single-stage job, anyhow) is not in any way critical.

As to results, with a total input of around 85 mW excellent local area CW coverage—up to about 15 miles or so—is obtained on the 160-metre

Table of Values

Fig. 1. Miniature Transistor Transmitter

- | | |
|--|---|
| C1, C3 = 100 μF | RFC = 2.5 mH RF choke |
| C4 = .01 μF | G = Germanium triode (home-made as illustrated) |
| C5 = 90 μF | |
| R1 = 70 ohms | |
| R2 = 5,000 ohms | L = Wearite Coil, PHF6 |
| K = Key jack (battery cut if open circuit type fitted) | |

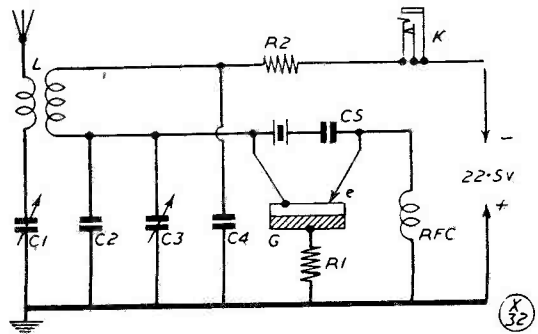

Fig. 1. Circuit of the transistor transmitter shown in the photographs. It follows the usual arrangement, with the tank in the collector circuit, with feed-back to emitter via the frequency-determining crystal. This circuit will go off with any active crystal in the 160-metre band.

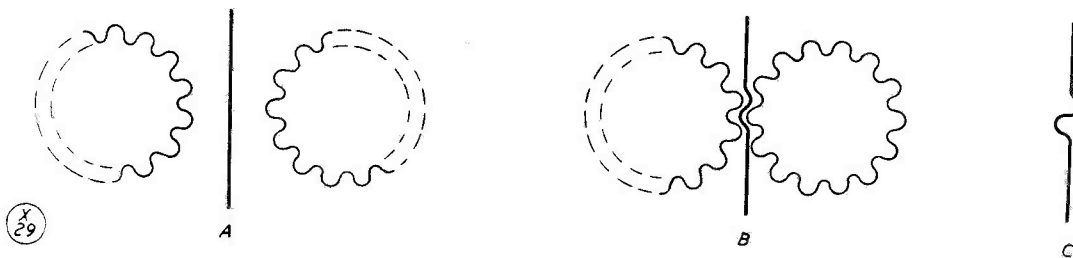

Fig. 2. Crimping whiskers for home-made transistors. With hard drawn phosphor-bronze wire this is a better method than bending the wire with tweezers. The gear wheels can be those from any small assembly having rounded teeth, and the crimp is obtained by pressing the wire between them.

band, reports varying from RST-599 to 569 from the more distant stations. For working over any distance it is, of course, essential to have an aerial which is inherently a good radiator on the Top Band.

Further Notes on Home-made Transistors

Whiskers. The phosphor bronze wire supplied by Messrs. Johnson, Matthey & Co., Ltd., is hard drawn and is less malleable than that previously used. This has two consequences: First, the electrolytically formed points are harder and do not blunt so easily; secondly, the wire is more brittle and may easily snap if it is bent through a right-angle while shaping the whiskers. A more satisfactory way of crimping the whiskers is shown in Fig. 2. The wire is placed between two small gear wheels (a), and the wheels are pressed together (b), so that a well-shaped whisker results (c). (The gear wheels were from a "surplus" bombsight computer). They were made of aluminium and had smooth, round teeth. Meccano or similar gears could be used, provided the teeth have no sharp edges.

Etching Germanium. The surface of the germanium, obtained from breaking open diodes, is clean and has been etched in the course of manufacture to provide a surface unworked by cutting tools. After experimenting with a home-made transistor for some time, the surface inevitably becomes contaminated.

A new surface can be prepared, by those who have the necessary facilities and experience, by re-etching the surface. The mounted crystal is suspended upside down by the lead wire and the crystal surface wetted with acid from underneath. This avoids the acid creeping into the soldered joint. The acid may be put on with a glass or polythene rod or by raising the acid container until the liquid just touches the germanium. After some hours the surface will be bright and clean.

This sounds easy, but unfortunately there is a snag. The acid mixtures recommended for etching germanium are highly dangerous, and no one who has not had previous experience with such chemicals should consider using them. They are so strong that they can *not* be stored in glass bottles. (After all, the price of a new diode is so small that it is not worth taking any risks). Only very small quantities of etching fluid are needed, and the writer stores his

acid in a polythene rod with a $\frac{1}{4}$ in. hole about half-an-inch deep drilled in it. This "bottle" is stoppered with another piece of polythene turned to fit the hole. Only the first recipe given below has been tried, but there seems no reason why the second, which is somewhat simpler, should not be used.

Etching Fluid (1)

| | |
|---------------------|--------------------------------|
| 5 Parts (by volume) | Fuming Nitric Acid |
| 3 " | Concentrated Hydrofluoric Acid |
| 3 " | Glacial Acetic |
| 1/10 " | Bromine |

Etching Fluid (2)

| | |
|---------------------|----------------------------------|
| 5 Parts (by volume) | Nitric Acid (70% strength) |
| 5 " | Hydrofluoric Acid (52% strength) |
| 1 " | Distilled Water |

Characteristics of Point-Contact Transistors

One possible advantage (though this is only a guess) from the use of a freshly etched surface is an improvement in the back-resistance of the collector. The family of collector curves of the home-made transistor used in the sun-powered transmitter is shown in Fig. 3, together with the same family taken for comparison on a GET-2. These curves were all obtained on the "Combined Processor and Test Set" described on p.80 of the April *Short Wave Magazine*.

The points to note are:

- The high Reverse Resistance: with V_c 10 volts and I_e at 0 mA, I_c is only 0.2 mA.
- The high Output Impedance. This is shown by the very steep rise of the curves. For example, this is 20,000 ohms when I_e is 1/4 mA and V_c is above 5 volts.
- The high Current Amplification (α). For the range I_c 0-1 mA and at V_c 10 volts, I_c changes by 5.3 mA. Hence over this range α is 5.3, an exceptionally good figure.
- The good Low-Voltage Characteristic. The curves start nearly horizontal and turn up to the near-vertical at low values of V_c .

Frequency Cut-Off. With the exception of (c), all these characteristics are better in a junction transistor. The failing of the junction transistor is its poor HF performance. This is measured by the α cut-off frequency. As the frequency rises, so the value of α falls until it is down to 0.7, i.e. fallen by 3 dB, of its low-frequency value. This frequency is called the cut-off, and may be as low as 500 kc for a junction transistor. At higher frequencies the performance falls off very rapidly indeed and α will probably drop by 8 dB at twice the cut-off frequency. Thus, a point-contact transis-

tor giving fair results on 1.8 mc may oscillate only feebly on 3.6 mc and have such a small output as to be of little use.

Spacing of the Whiskers. The main factor affecting the cut-off frequency of point-contact transistors, such as the home-made transistor, is the distance between the points of the whiskers on the surface of the germanium. As a rough guide, it may be taken that the cut-off frequency varies inversely as the cube of the spacing. Thus, typical results may be:

| | |
|----------------|---------------|
| 0.003" spacing | 1 mc cut-off |
| 0.002" spacing | 3 mc cut-off |
| 0.001" spacing | 20 mc cut-off |

These figures may be rather disconcerting to the hopeful constructor, but reference to Fig. 4 will show a simple way of *estimating* the spacing to ensure that the high-frequency performance is going to be adequate. An imaginary line produced down the side of a whisker intercepts the crystal surface at B. The point touches the surface at A. The distance from A to B is about equal to the radius of the whisker (0.0025in. in the case of 0.005in. phosphor bronze wire). Thus, if the other whisker touches the surface just at B, then the spacing is about

0.0025in. It is easy to see with a good magnifying glass whether the spacing is more or less than this and make a rough estimate of its actual value. It also shows the advantage of using 0.002in. or 0.001in. tungsten wire for the emitter and thus getting the emitter very close to the collector. When making the estimation it is, of course, important to be at right-angles to the line joining the two points.

From the Trade

The G.E.C. have recently announced the opening of a new laboratory at Wembley devoted entirely to semi-conductor research and development. In addition to fundamental research going on at present, development is progressing on both point- and junction-type transistors. Point-contact transistors oscillating up to 100 mc have been produced by reducing whisker spacing from 0.003 in. as in the GET-1, to 0.0005 in. For amplifier applications the point types reach a practical limit of 10 mc with a spacing of 0.00075 in.

Of particular interest are developmental junction transistors with a good HF performance up to 10 mc. To achieve this, the germanium wafer is reduced in thickness to 0.0005 in. by etching cavities electro-

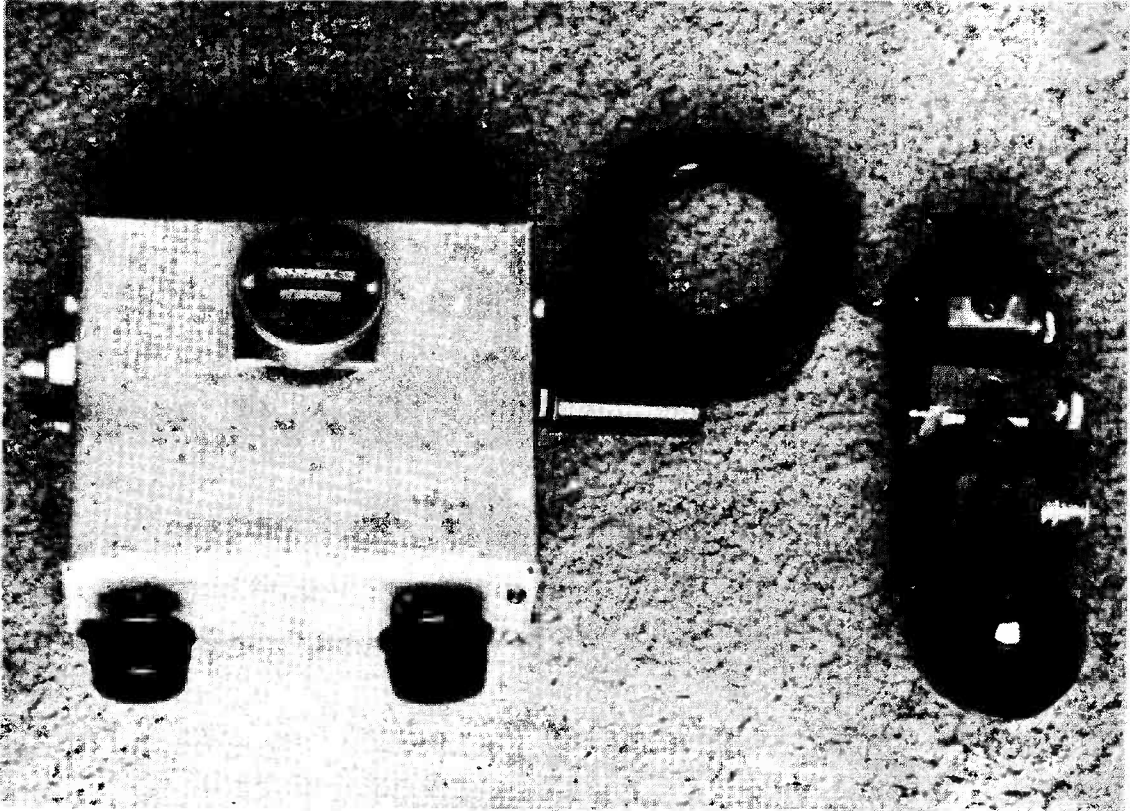

Complete 160-metre transmitter — the only additional connections called for are aerial and earth. This is a transistor oscillator, powered by a 22½-volt dead aid battery contained in the base. With a good radiating system on Top Band, it will collect R5 CW reports from distances of 10-15 miles. The circuit is shown in Fig. 1.

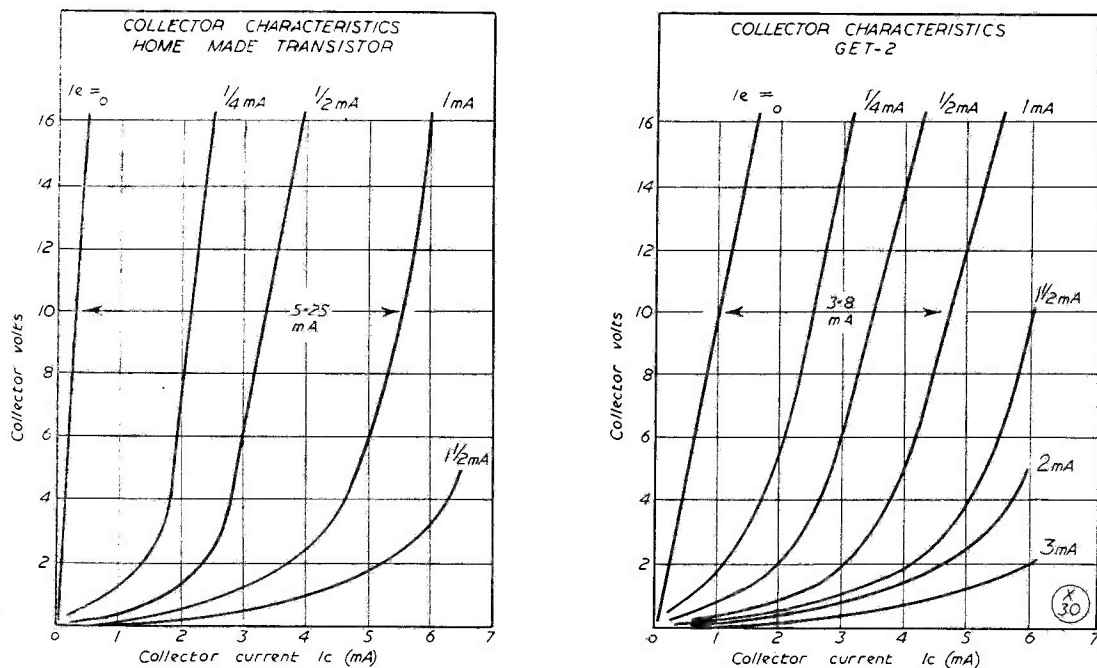

Fig. 3. Curves comparing the characteristics of (left) a home-made transistor with (right) a commercial transistor. It must be admitted that in this instance the home-made transistor (which is the one actually used for the sun-powered experiments discussed in our October issue) is a particularly good specimen! But it shows what can be done on the amateur work-bench, using the methods exactly as described in the April, 1954 issue of the Magazine. The curves at left give α as 5.25, and in general these figures might stand as a comparison for those making their own transistors, which could be better or worse.

lytically. Junctions are formed in the cavities, thus producing the junctions within "half a thou of each other," and so giving (with a short transit time) a high frequency α cut-off. Such transistors as these will be particularly interesting for sun power and other QRP uses, as they will function *efficiently* with only 2 or 3 volts HT.

It is very heartening to have news of such progress, as there is an increasing demand for a reasonably-priced transistor with specified properties up to 3.8 mc (or even better, 14 mc). At present there is *NO* commercially available transistor with a specification which guarantees its usefulness in *ANY* amateur band. The highest minimum cut-off frequency quoted is 1.5 mc. Although, of course, many specimens do function at much higher frequencies, it is something of a gamble buying a single transistor in the hope that it will perform satisfactorily on Top Band. One wonders how many amateurs, encouraged by reports of success from others, have invested in one or two commercial transistors, only to find that performance on 1.8 mc is very disappointing. Being, of course, their first excursion into Transistory, they do not know whether to blame themselves or the apparatus.

Last month "Transistor Topics" carried a photograph on p.445 of a transistor amplifier developed by Mullard, Ltd., for use with a noise-cancelling microphone over ordinary telephone circuits in

particularly noisy locations. Also shown by the same company at the Farnborough (S.B.A.C.) Air Show was a novel "Intercom" system using three junction transistors. It could be powered by either a 6-volt battery or the aircraft accumulator. Few people have yet realised the future of mobile transistor equipment. When one considers that transistors will operate direct from a 6- or 12-volt supply with negligible drain on the car accumulator

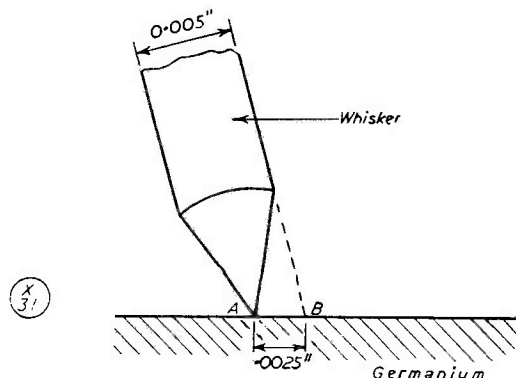

Fig. 4. This diagram suggests how the actual thickness of the phosphor-bronze wire, as seen through a magnifying glass, can be used to estimate whisker spacing in the home-made transistor — see text for discussion.

—no filament supply, no vibrators or convertors—the possibilities become apparent. As we have seen, 12 volts is really high tension for a good transistor! And, as Mullards have said, the power obtainable from junction transistors is increasing and will soon be in the region of several watts.

Constructional Activity

G3CSZ (Birkenhead), whose successes with home-made transistors were reported in last month's issue of *Short Wave Magazine*, continues to advance. He has now constructed, with a view to its possible use as a frequency changer, what he suggests might be termed a triode-tetrode. This is a transistor with four whiskers in a row. The alternate ones are formed as collectors, so we have, reading from left to right: Emitter, collector, emitter and collector. Labelling the whiskers E1, C1, E2 and C2, G3CSZ reports that triodes E1-C1, E2-C1 and E2-C2 all show an α of $2\frac{1}{2}$. Further, the triode E2-C1 has performed satisfactorily on Top Band. Each collector was processed to about 10,000 ohms.

Another transistor which goes off well on 7 mc. even without a base resistance, has been made. The G.E.C. red-spot diode has been largely instrumental in his obtaining such good results, according to G3CSZ. He also confirms his earlier statement that positive processing is more effective, although he admits that it is a very "hit or miss project." All his transistors are mounted on octal bases with standardised pin connections, which certainly facilitates both testing them and using them in equipment, and makes a neat job of the mounting.

Transistor Communication

Using home-made transistors, as mentioned above, G3CSZ is stirring up interest in Birkenhead and Liverpool with Top Band QSO's. Contacts have been made with G3FOO (Birkenhead), G3IQO, G3JMQ and G3JPJ (all in Liverpool). G3IHH has also reported.

The most outstanding results in transistor DX communication still continue to come in from GC2CNC (Jersey, C.I.). Among others he reports having worked recently are G2JF (Wye, Kent), G3ABU (Torquay) and G3JFF/MM (on voyage to Malta). GC2CNC also mentions having heard G3CCA working a GM at 2240 GMT on October 2;



Inside the TTX built by G3HMO, showing how a pocket-size transmitter can be constructed using a home-made transistor. C1 is upper right, and C3 variable upper left. Power is from the Ever-Ready 22½-volt battery in the lower compartment, and the loading is about 85 milliwatts. The transistor can be seen at the centre of the assembly.

GC2CNC was taking G3CCA at RST 499!

Work is still continuing on the calling circuit project and some progress has been made. A two-transistor receiver has been constructed which will close a relay in the output circuit when tuned to a strong carrier. The relay will close, for example, when tuned to Radio Luxembourg and will drop out when the aerial is disconnected. It is hoped to discuss a practical calling circuit for a 160-metre installation in the next issue.

The last date for reports to be included in the December issue is *November 12*. All reports of success with home-made transistors, news of TTX contacts and requests for phosphor bronze wire should be addressed to "Transistor Topics," c/o The Editor, *Short Wave Magazine*, 55 Victoria Street, London, S.W.1.

EIGHTH ANNUAL AMATEUR RADIO EXHIBITION

This important and interesting exhibition, sponsored by the Radio Society of Great Britain, will be held at the Royal Hotel, Woburn Place, London, W.C.1, during the period November 24-27. A number of commercial exhibitors are taking stand space, and there will also be a considerable display of amateur designed and built equipment. We shall be on Stand No. 9 and again look forward, as we have done in each of the past seven years, to meeting many of our readers; all who come to the *Short Wave Magazine* Stand are asked to sign the visitors'

book. The exhibition will be opened on Wednesday, November 24, at 12 noon, by H. Faulkner, Esq., C.M.G., Director of the Telecommunication Engineering and Manufacturing Association. The public is admitted from 11 a.m. to 9 p.m. daily, and the charge is 1s.

BCM/QSL, LONDON, W.C.1

This is a sufficient address for our QSL Bureau from any part of the world. Overseas readers who are direct subscribers are invited to make full use of BCM/QSL, London, W.C.1, for the quick delivery of their cards for all G stations.

SPEECH CLIPPER CIRCUIT

FOR QRO PHONE WORKING

F. E. WYER (G8RY)

THE drawing shows the arrangement—and the effect—of a clipper filter now in use at G8RY, the PA being an 813 on the 3.7 mc band, and the modulator a pair of 805's.

This clipper has been found most effective in practice; it enables the carrier to be heavily modulated without spill-over or splatter, the "sharpness" of the carrier being retained under full-modulation conditions.

For the circuit as shown, the values are: C1, C3, C4, C5, .002 μ F, 2500v, DC working, or as required; C2, .004 μ F, rated twice peak voltage; C3, value chosen to be less than that of the plate blocking condenser; T1, usual modulation transformer; T2, heater transformer for the 866 clipper valve; L1, L2, 0.4 Henry chokes.

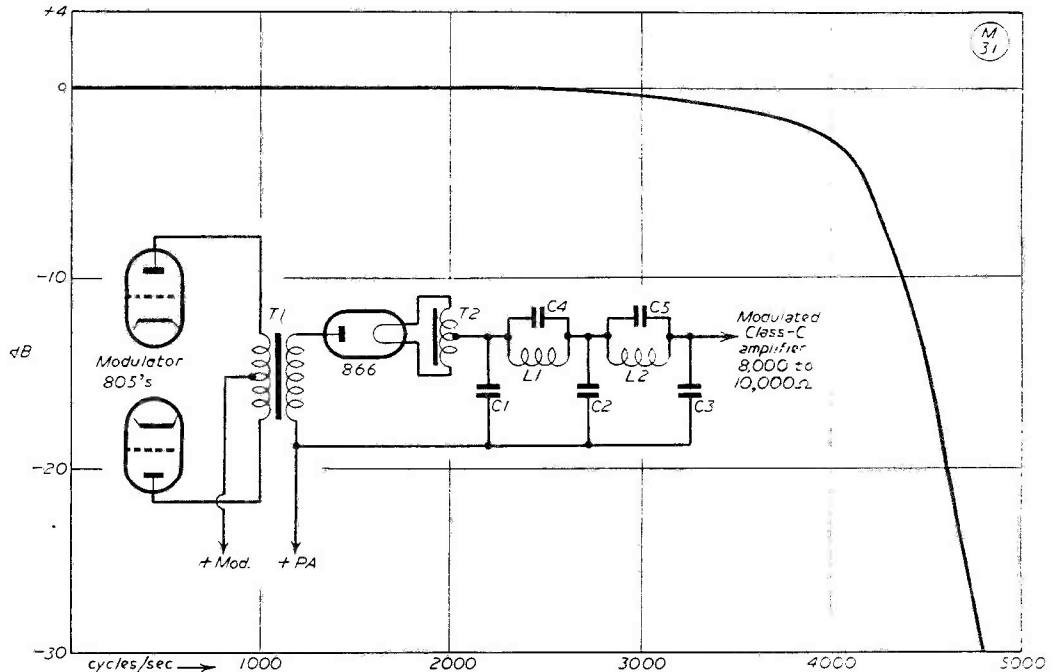

The speech clipper described by G8RY. The reference level is zero dB at 1,000 cycles, the insertion loss being neglected. The curve shows clearly, with its sharp cut-off at 4,000 cycles, the effectiveness of this clipper for the speech frequency range.

NOISE IN THE AERIAL

AN EXPLANATORY NOTE AND
THE EXPERIMENTAL PROOF

K. W. CRANFIELD

IN his "Random Jottings" in the September issue of *Short Wave Magazine*, Old Timer mentioned aerial noise under certain conditions, and queried the possible source. This is not due to precipitation static but is another phenomenon, known as "point discharge."

The mechanism by which this occurs can best be understood if we consider a cloud above the earth as one side of a two-plate condenser—the earth

forming the other side. Since the cloud can become charged (the reasons for which need not be gone into here), there will exist an electrostatic field which will set up a potential gradient in the space between the cloud and the ground. However, in this hypothetical condenser, the cloud which forms one of its plates is not homogeneous and can have differing intensities of charge upon its surface. These charges can be of either polarity and may vary in sign along the body of the cloud; these will induce in the ground directly beneath a charge of opposite sign.

In fair weather, when things are stable; the field thus set up is reasonably constant and the potential gradient is only of the order of a few hundred volts per metre. But during thundery weather the cloud can, of course, become very highly charged, causing the potential gradient to increase greatly; if this

continues, the break-down value of the air dielectric is reached. At this point, the "condenser" flashes over, producing the natural phenomenon of lightning. The flash neutralises the charge, and does not occur again until the potential gradient has once more built up to the critical value. All of which is well known.

The Crackle Effect

What we are interested in is the intermediate condition, before flash-over occurs. An aerial can be regarded as a point-collector, grounded at one end. When the earth becomes positively charged under the influence of a cloud overhead, the collector (aerial) attracts negative ions and the field in its own immediate vicinity tends to become intensified. When the potential gradient thus created exceeds some critical value (dependent on all sorts of local conditions) a sudden surge takes place between the collector and the atmosphere, as equilibrium is sought; the potential gradient is weakened, and the discharge ceases.

If the field from the cloud still exists in the neighbourhood, the process will be repeated again and again. The repetition rate can be as high as some thousands per second, depending on the size and shape of the aerial and the local conditions.

It is this effect which generates receiver noise; it has nothing to do with a lightning discharge and is independent of rain, though a shower can intensify the effect and may even start it off. The effect of rain is to lower the charge from the cloud to the ground, thus increasing the field strength. And the higher, the longer and the better insulated the aerial, the more pronounced the effect.

It is evident that all this happening some distance away may be heard on a sensitive receiver with a good aerial, even if there is no evidence of atmospheric electricity in the immediate neighbourhood. In the case of the directional effects mentioned by Old Timer, this could be due to the fact that one aerial is shielded by a tree or a building close to the unearthed end of the unaffected aerial. This would be quite sufficient to destroy or distort the electrostatic field and so prevent any voltage build-up.

Here it might be mentioned that some sharp projection on a tree or a building may exhibit local discharge, or the "seeking of equilibrium," in the form of a bluish glow round the projection, visible at night and known as corona effect (or "St. Elmo's Fire," as it was called in the days of the old sailing ships). It can often be seen round the insulators on high-voltage overhead power distribution systems, and is a prolific source of radio noise.

During a severe thunderstorm, a sizzling sound may be heard, with a loud click at the instant of the lightning stroke. The sizzle is due to a point-discharge somewhere, culminating in the dielectric failure producing the flash.

As to why all these effects seem to be more prevalent these days, the answer may lie in improved receiving installations—though, in fact, these phenomena have been noted since wireless aerials were first erected. It is also true to say that during

the last two or three years the incidence of thunderstorms has tended to increase; it might surprise many people to know that in any one year there are at least 100 days on which thunder is heard in the British Isles.

A Simple Test

Anyone doubtful about the validity of these arguments and wanting to carry out a little experiment to check the facts can do so quite easily. All that is necessary is a high-reading electrostatic voltmeter, say 2 kV, and a number of 5 megohm carbon resistors. The dozen or so resistors should be connected in series and hung by an insulator from the end of the aerial, with the bottom of the resistor chain earthed. The electrostatic voltmeter is then connected with one side to earth and the other pole, terminating in a crocodile clip and a well-insulated lead, tapped up and down the resistor chain till a reading on scale is obtained.

The thundery clouds are of the cumulo-nimbus type, and when one that is sufficiently charged approaches, it will be found that the voltmeter will read; it will, in fact, vary slowly up and down under the influence of the charge in the cloud, and may have to be tapped down the resistor chain if it tends to go over scale. Knowing E and R, I can be calculated, and will be found to be of the order of a few microamperes. It will also be noticed that if there should be a lightning flash while the meter is giving a reading, it will immediately kick to zero as the field collapses, showing the loss of charge from the aerial.

Naturally, any such experiments should be carried out with due regard to personal safety, with everything well insulated and "the apparatus" left severely to itself during a local thunderstorm.

"MCC" — MAGAZINE CLUB CONTEST

The attention of all 160-metre CW operators is drawn to the Club contest to take place on Saturdays/Sundays, November 20-21, and November 27-28, during the period 1430-1830 GMT only on each of those four days. Club stations will be signing "MCC" and, in addition to working one another for maximum points, will be looking for single-operator (non-Club) stations for the vital one-point contacts which in past years have decided the issue. For those interested, the rules for this Ninth Annual Club Contest appeared on p.463 of our October issue. It will be noted that non-Club stations can be worked once only to count during the whole period of the Contest.

AMATEUR TV LICENCE CHANGE

We are informed by the GPO that holders of the Amateur TV Licence "may now transmit messages by telephony or Morse without a separate licence, provided that these messages are concerned with the technical matter of the visual transmission." Those holding TV transmitting permits will no doubt know what this means.

THE conclusion this month is that during the period to October 17 conditions have been better, and for longer spells, than at almost any time this year. This has, of course, been directly related to the state of the weather, particularly in the first fortnight of October.

The data given in the "VHF Weather Report" this time will be found particularly interesting; the charts in Fig. 1 on p.512 show how the situation developed on the evening of October 9/10 for Continental working from the southern part of the country, and also the GDX possibilities a fortnight before that, on September 22/23.

The lower chart, though it is old news now, shows convincingly how it was that the HB1PQ expedition failed to get any positive results; the picture for August 2 is that for the most favourable situation during the week the HB1PQ party spent on the St. Gotthard—in other words, they never had a chance of working anything beyond locals. However, as HB9PQ himself points out, even this negative result is of value, in that it verifies the propagation conditions as affected by the weather. The expedition was primarily a meteorological investigation, and HB9PQ says that they have now found out all they wanted to know in that connection. Whether they try again next year depends on circumstances; a week's outing of the kind they undertook last August involves a good deal of organisation, as well as labour and expense, and in the ordinary way must be laid on with some definite object in view.

VHF Contest

Before dealing with the reports—of which once again we have a good many more than is usual at this time—there is a point to be mentioned in connection with the lamented European VHF Contest which this year, as last, never happened so far as we in the U.K. were concerned. The failure has been traced to its source.

All that need be said now is that if we do not receive, from somebody, some time during the

VHF BANDS

A. J. DEVON

Spell of Good Conditions—
October 7-9 Outstanding—
Station Reports and News—
Calls Heard and The Tables—

first fortnight in June next year, dates and rules for a properly organised Contest to take place in *September*, we shall ourselves lay on a Contest without reference to any other authority. The dates for this will be September 17-18, 1955, and we shall circulate rules and conditions to all European radio periodicals and societies, in their own languages, by the end of June 1955.

It is emphasised that this action will only be called for if a Contest organised by the I.A.R.U. fails to materialise, since it is their business, and not ours, to make the necessary arrangements, and to make sure that all concerned are informed in good time.

The Tabular Matter

This time we show the new Annual Counties table, with a good entry already, and Harold of G5YV well in the lead. Once again, your A.J.D. asks that all VHF operators eligible—which means everyone able to work 14-plus counties—should put in claims as they qualify, thereafter moving up the column as more counties accrue. This Table, even

though it may in some instances encourage "local Derbys," is not intended to be competitive so much as a record of progress. With 18 call-signs in the column after barely six weeks' working, we hope to see a much larger total entry this year than last.

The All-Time also appears again, corrected with all claims (a total of 31, incidentally) received up to October 18; here again, we see G5YV out in front, he having got a couple more Scots counties recently.

As regards the Activity Report, it has been suggested by more than one correspondent that calls *heard* are more useful than calls worked; this is true, and all who put in these lists are asked to make a particular point of including their calls heard. At the same time, your A.J.D. suggests that the worked lists have their own sort of usefulness, in that they give a good idea of the general level of activity, new calls coming on, stations workable in different parts of the country, and who is doing what when the openings do occur. In other words, we still want both sorts of list, and always the heard as well as the worked.

So with that, we are all set for the new season, and look forward to seeing progress and new entries in all departments.

The Station Reports

G2FJR (Sutton Bridge) notches up five more in the Annual, with G3IOE for Northumberland and GM6WL/A for Wigtownshire as particularly good ones. G2CZS (Chelmsford) found October 10 producing excellent signals from the southerly direction, with F8GH worked on phone for the first time; during that evening, G3ANB (Brightlingsea) raised GC3EBK.

G2XV (Cambridge) is now at 16C in the 70-centimetre Table, having worked G2DDD (Littlehampton), an excellent QSO in terms of both distance and direction. G3WW (Wimblington) found the two-metre band open on October 8/9 and had some good contacts, as did G5BD (Mablethorpe), who worked GM3EGW

and, in the other direction, several London stations.

In addition to new contacts on two metres, G3WW is now operational on 70 cm, the transmitter being the G3HAZ tripler and the receiver (temporarily) the G2DD converter for 430 mc, as described in our March 1953 issue; he has G2XV at a useful distance as a collaborator on the band.

North and North-West

GW3GWA (Wrexham, Denbs.) found several stations, including G4SA, coming in very well during the evenings of October 8 and 10, but failed to get a QSO, in spite of repeated calls; he puts this down to people tuning QLH and finding others answering before they get to Zone F. This is a point often touched upon before; of course, the only answer is that all operators should search QHL or QMH at least as frequently as the other way.

In his report, G5YV (Leeds) gives us an interesting statistic; it is that during last year he was able to work EDX on 36 different days for a total of 224 QSO's, whereas this year EDX has only been workable on 4 days, with 11 contacts; these figures *exclude* his ON4BZ and PE1PL schedules, both outstandingly successful, with PE1PL still workable every day (except Sunday) at lunch-time. His additions for the All-Time came from GM4LX/P, in Angus and Kincardine, towards the end of September.

GM6WL-EI2W on Seventycems

GM6WL (Glasgow) writes with full details of the 70-cm activity up there; between September 4 and 18, he and EI2W were trying hard for a 430 mc QSO over the 102-mile sea-water path, with partial success during the afternoon of September 15, when EI2W's carrier was S6 with the BFO on. But the weather was so bad, with everything on the move in a high and gusty wind, that it was difficult to read the signal. During the whole of this fortnight, GM6WL was sustained by being in constant touch with G13FWF, who was operating not only from the home QTH (Drumbo), but from various portable sites, over

distances up to 60 miles or so. One result of particular interest was that it was found that while the totally-blind path Drummore-Drumbo was workable at RST-569 when it was moderately wet, a heavy downpour reduced signal strength to S1, this being attributed to the screening effect of wet trees at the G13FWF end.

With GM3NG and GM3DDE available on 430 mc with a G3BKQ-converter, GM6WL has now got some very welcome co-operation on the band, and has worked GM3DDE at S9 both ways over 30 miles, from a portable site 1000 ft. a.s.l. at Tomtain. The GM6WL 430 mc transmitter is his two-metre portable rig driving a QV03/20 tripler, into another QV03/20 as PA.

GM3DIQ (Stevenston) says that "for the first time ever" he has succeeded in working I4C within a few weeks of the new Table opening; previously, it has taken him until about March to get to this figure. The evenings of September 30 and October 1st were good with him, G6XX being up to 579 instead of the more usual S3; on the 1st, Clarke had good contacts with a number of northerly stations, and was getting G8SB at S8 on phone.

South of the Border again—G3CCH (Scunthorpe) reports G2ADZ, in North Devon, worked, making his total now 257S.

In the Midlands

A clip of three reports from Rugby, G3BJQ, G3CKQ and G8VN all coming in this time. In his 12 months or so on two metres, G3CKQ has worked a total of 17C, and, like G8VN, he runs a 4-ele Yagi in the roof space; the transmitter takes 12w, and the converter is to the G2UJ design, modified, and with a push-pull RF stage in front. G3BJQ has also been getting round the counties, with seven recent additions, including G3EPW for Lancs. G8VN found the period October 7-9 particularly rewarding, and on the 9th was getting G2FTS (Hailsham, Sussex) very strongly, but could not raise him; there was a good deal of fading on the weaker of the more distant stations heard, so G8VN thinks

SEVENTY CENTIMETRES

ALL-TIME COUNTIES WORKED
Starting Figure, 4

| Worked | Station |
|--------|--------------|
| 23 | G3BKQ |
| 16 | G2XV |
| 15 | G4RO |
| 14 | G3HBW |
| 13 | G3IOO, G6NF |
| 11 | G2HDZ, G5YV |
| 7 | G2HDY |
| 6 | G3FAN, G3JMA |
| 5 | G3FUL, G3IRW |
| 4 | G2DDD, G3IGY |

On working four Counties or more on the 70-centimetre band, a list showing stations and counties should be sent in for this Table, and thereafter new counties worked notified as they accrue

that, with his indoor beam, the same thing might have applied on his own transmissions.

G3GHO (Roade, Northants.) had some good contacts during the period October 2-10, and on the 2nd F8GH and ON4BZ were strong signals. G3DO (Sutton Coldfield) worked F3WC and F8GH on phone on October 9, excellent QSO's for so late in the year and showing how good conditions were for a few days—and it is worth noting that both the F's answered G3DO on CQ's. Twenty counties are now in the bag here for the Annual.

G3DBP is the station of the University of Nottingham Radio Society, operating from Beeston; they have become increasingly active on VHF, running 70w, to a pair of HK24G's, with a Cascade into an AR88 on the receiving side; the beam is at present a fixed N-S 8-element stack, soon to be reinforced by a pair of slots to cover the E-W directions. It will interest a number of people to know that G3DBP/G5CP run a regular week-day schedule at 1315.

South-West and West

G3JGJ (Plympton) reports a contact with G2ADZ, S9 both ways across the Devon hills, also first-time QSO's with G8DA in Exeter and GW8UH; and it will

TWO METRES

ALL-TIME COUNTIES WORKED
LISTStarting Figure, 14
From Fixed QTH Only

| Worked | Station |
|--------|--|
| 71 | G5YV |
| 68 | G3BW |
| 64 | G6NB |
| 62 | EI2W (209), G3BLP (630) |
| 59 | G3EHY, G4SA |
| 58 | G8OU |
| 57 | G2OI (349), G8SB |
| 56 | G3CCH (257), G3GHO |
| 55 | G2FJR, G2HIF, G3WW, G5BM, GW5MQ |
| 54 | G3IUD (201) |
| 53 | G2AJ (519), G2HDZ (416), G3FAN, G4CI |
| 52 | G2NH, G3IOO, G5BD, G5DS (565), G6XX |
| 50 | G3ABA |
| 49 | G5MA |
| 47 | G5WP |
| 46 | G4HT (476), G5BY, G5ML (280), G6YU (205) |
| 45 | G2XC, G6XM (356) |
| 44 | G3BK, G3HAZ (262), G8DA |
| 43 | G2AHP (456), G3BA, G3COJ, G4RO, G5DF |
| 42 | G3GSE (424) |
| 41 | G2DVD, G2FQP, G3DMU, G3FIH, G6CI (184) |
| 40 | G3BNC, G3CGO, G3DO (260), G3HWJ, G5JU, G8KL |
| 39 | G2IQ, G3GBO (434), G3HBW, G3VM, G8IL (325) |
| 38 | G2FCL (234), G3APY, G3WS (183), G6TA (331) |
| 37 | G2DDD, G2FNW, G2FZU (180), G3DLU |
| 36 | G2DCI (155), G2HOP, G3CXD, G6CB (312), G8IP |
| 35 | G3IUQ, G3FZL, G3HCU (224) |
| 34 | G3BKQ, G5MR (230), G8IC |
| 32 | G2CZS (171), G2FVD, G3FYY (181), G8QY, G8VN (135), G8VR |
| 31 | G3HXO, G3IER (105), G5RP |
| 30 | G3FRY, G3GOP (208), G3GVF (129), G3IRA, G5NF, GM3DIQ, GM3EGW, GW8UH |
| 29 | G3AGS, G3AKU, G3FIJ (194) |
| 28 | G8DL, GM3BDA |
| 27 | G3DAH, G3ISA (160), G6GR- G13GQB |
| 26 | G3AEP, G3CFR (125), G3SM (211), G4LX, G4MR (189), |
| 25 | G3JMA, G5SK, G6PJ |
| 24 | G3FD, G3FXG, G3FXR |
| 23 | G3CWW (260), G5PY, GW3GWA |
| 22 | G3AGR (135), G3ASG (150), G3BPM, G3HIL |
| 21 | G2AOL (110), G3DVQ, G3IWJ, G6XY |
| 20 | G3EYV, G3HSD, G3YH |
| 19 | G3FEX (118), G3GCX, G5LQ (176) |
| 18 | G3DBP, G8NM, GC2CNC |
| 16 | G3FRE, G3IOE, G5AM |
| 15 | G2BRR, G3IWA |
| 14 | G2DHW, G3CYY |

probably interest G6TA to know that he was heard and called from Plympton.

Ted G4SA from Drayton, Berks., has duly raised G3IOE in Newcastle, with G6XM as intermediary; incidentally, Ted remarks that the latter is now as good a signal as he used to be from Farnborough, and is as strong, if not stronger, than G5YV.

G3DLU has been felling trees and generally preparing the ground for operation from Weston-s-Mare in due course; his new 8-ele stack weighs only 10 lbs. complete and has passed a windage test satisfactorily; constructional activity at G3DLU is now concentrated on portable equipment, to be ready for the spring.

G5BM (Cheltenham) also notes October 7-9 as outstanding, with the northerly stations coming in very well—unusual under the hills down there—and G3IOE was a most welcome QSO, again due to the good offices of G6XM. G8DA (Exeter) registers two more counties, with GC2FZC for a good QSO, and G2ADZ writes to report himself in action from Woolacombe in North Devon. The new QTH is 580 ft. a.s.l., clear to the SW and NW, but with rising ground in other directions; as this narrative shows, G2ADZ has already worked a number of GDX stations and as time goes on we shall look forward to hearing more of his activities on both bands.

G3FIH (Bath) had some very good contacts during the first fortnight of October, from G3EPW and G8SB in the north round to G2BAT and F9JY to the south. G3FIH draws attention to the fact that the improvement in conditions and activity has enabled him to work 23C in six weeks, whereas he managed only 29 counties in the previous six months! But a bother here is TVI; even though his own receiver within a yard or so of the transmitter is not

affected, complaints have come in from up to a quarter-mile away from viewers whose sets have the wrong sort of IF (in this case 19 mc), the channel interfered with being Wenvoe Sound on 63.25 mc; G3FIH does some figuring to show how his 145.5 mc Tx frequency can produce a 19 mc beat with the 2nd harmonic of the TV receiver's oscillator.

London and Home Counties

G3DVQ (Purley) goes up in the Tables, noting G6CW worked for Nottingham and G5CP for Derbyshire, both Old Timers, and John Curnow of G6CW we are glad to hear back on again after quite a long spell in the outer darkness. G3HWJ (Surbiton) hopes to be on much more regularly and as an earnest of this shows 20C worked in the first six weeks of the new season.

G3FYY (London, N.W.2) raises a point—what is meant by the County of London? Well, we mean (and always have meant) the area of London under the jurisdiction of the London County Council; this is the accepted definition according to the best authorities, though parts of the L.C.C. area do bite off parts of four geographical counties, and there is also the ambiguity introduced by the London Postal Districts arrangement, which is a different organisation again! Then there is the problem of Bristol-south-of-the-Avon, administratively Bristol and therefore Glos., but geographically Somerset; in this case, however, it is logical to say that G3GNJ (the station affected) scores for Somerset. And, for the last time, Bristol does *not* score as a county! If it did, so would every other city and most of the larger towns over the whole country! (For purely admin. purposes, cities and the big towns are given county or county borough status; it would be entirely illogical to accept this as a geographical definition, and for our purpose of county-working would lead to the most appalling confusion, with myriads of borderline cases).

G3FYY, who started all this, also draws attention to the stations signing G and GM in Berwick-on-

Note: Figures in brackets after call are number of different stations worked on Two Metres. Starting figure for this classification, 100 stations worked. QSL cards are not required to verify for entry into this Table. On working 14C or more, a list showing stations and counties should be sent, and thereafter added to as more counties are worked.

Tweed, and G and GW in Monmouthshire. Our understanding is, and always has been, that Monmouthshire is in England and Berwick in Scotland, and stations worked in these counties score accordingly.

While on the subject of "the rules" we might also answer here the point raised by another correspondent—does one have to start all over again in the Tables after a move of QTH to another town or district? The answer is Yes! The Counties scoring is strictly on the basis of "worked from the fixed QTH."

Some 70-cm Items

Back to London and the 430 mc band—G3HBW (Wembley) is almost entirely on 70 cm and irrespective of conditions has been having regular contacts along the South Coast with G2DDD (Littlehampton), G2DSP (Bognor) and G3JHM (Worthing). This is very good going; the distances are over 50 miles, across undulating country, yet G2DDD and G2DSP are workable at any time, with signals never less than RST-579; on September 15, G3HBW got a 430 mc signal from F8GH at a distance of 190 miles, 559 peaking S7; it would have been a both-ways QSO had it not been for QRM on G3HBW's frequency! F8GH is on 434.92 mc every Saturday and Sunday at 1400-1415, looking for G's from 1415-1430. Between 1900 and 1930 every evening, the following are calling and listening: G2BVW, Leicester, 434.38 mc; G2DDD, Littlehampton, 435.67 mc; G2DSP, Bognor, 434.97 mc; G3100, Oswestry, 432.8 mc; G5YV, Leeds, 432.7 mc; and G3HBW himself on 434.67 mc. Attempts to work N-S over these paths have so far given no definite results, but on September 26 G2XV was worked by G3HBW and G3GZM/P heard from Clew Hill in Shropshire.

On two metres, G5DS (Surbiton) reports for the Tables, and is now at 565S worked. G6TA (London, S.W.16) goes to 38C in the All-Time with G3CFK for Norfolk and 33IS worked; his standing in the current Table is 25C.

During the week-end October

TWO-METRE ACTIVITY REPORT

(Lists of stations heard and worked are requested for this section, set out in the form shown below, with call signs in alphabetical and numerical order).

G3IEX, Bexhill-on-Sea, Sussex
WORKED: G3BSU, 3CVO, 3DO, 3GGJ, 5JU, 5MR, 5RO, 8KW.

HEARD: F3LP, 8GH, G2BNC, 2CZS, 2FJR, 2FTS, 2HCG, 3ANB, 3BII, 3DOW, 3EGV, 3EPW, 3FQS, 3FZS, 3IOO, 3JMA, 3WW, 5RZ, 6AG, 6CH, 6NB, 6RH, 6XM, (October 5-12).

G8VN, Rugby, Works.

WORKED: G2AOK, 2ATK, 2BVW, 2FNW, 3AZT, 3BJQ, 3BKQ, 3CKQ, 3FCF/A, 3FUW, 3FW, 3GBJ, 3GHO, 4SA, 5BD, 5BM, 5JU, 5MA, 5MA/P, 5ML, 5SK, 5YK, 5YV, 6CW, 6NB, 6SN, 6YU/M, 8PX.

HEARD: G2AVQ, 2FTS, 2HOP, 2YB, 3APY, 3ENS, 3EPW, 3FIH, 3GHI, 3GNJ, 3GOP/P, 3HBW, 3HSD, 3IUU, 5CP, 5JO, 6AG, 6FK, 6RH, 6XM, (September 16 to October 17).

G3JGJ, Plympton, S. Devon.

WORKED: G2ADZ, 2BAT, 3EGW/P, 8DA, GW8UH.

HEARD: G3AGA, 3AUS, 3AVF, 3FAN, 3FIH, 5BM, 6TA, 6XM, (September 21 to October 17).

G2DHV, London, S.E.13.

WORKED: G3CGQ, 3ISA, 4GT, 5DS, 6NB.

HEARD: F8LO, 9CQ/P, G2AHP, 2HDZ, 3DVO, 3GHI, 5KW/M, 6CH, PA0FC.

G3ITF, Basingstoke, Hants.

WORKED: G2AHP, 2BAT, 2YB, 3BII, 3CLW, 3EGV, 3EJA, 3FIH, 3GVF, 3HXS, 3JFR, 6OU.

HEARD: G2CZS, 2HCG, 2IT, 3DBP, 3EGG, 3FAN, 3GHO, 3HVO, 3XC/A, 4SA, 5BD, 5RZ, 5TZ, 5YV, 6CW, 6TA, 6XM, GW3EJM, 8UH, (October 8-14).

GW3GWA, Wrexham,

Denbighs.

WORKED: G3CZU, 3FKY, 3FMI, 3GHO, 3GPT, 3IOO, 3IUD, 3IWI, 5YV, 8BP.

HEARD: G2ADZ, 2HCG, 3BKQ, 3WW, 4SA, 5BM, 5DS, 5HK, 5MA, 5MS, 6NB, 6WF, (September 25 to October 16).

G5MA/P, Nr. Oakham, Rutland.

WORKED: G2AHP, 2AIW, 2ANT, 2ATK, 2DVD, 2FJR, 2FNW, 2HCG, 3APY, 3BJQ, 3CGQ, 3DBP, 3DVO, 3EYV, 3FAN, 3FIH, 3FQS, 3FW, 3FYY, 3GHI, 3GHO, 3GXG, 3HWJ, 3IT, 3IUU, 3WW, 4CI, 5CP, 5DS, 5YV, 6NB, 6TA, 6XH, 6XM, 6XX, 8KW, 8OU, 8VN.

HEARD: F8GH, (October 16-17 only).

SWL, London, S.W.18.

HEARD: G2ADM, 2AHP, 2AIH, 2AMT, 2ATK/M, 2BPC, 2CZS, 2DDD, 2DGY, 2DUV, 2DVD, 2FNW, 2FWW, 2GG, 2HCG, 2MV, 2RD, 2TP, 3AEX, 3AGR, 3ANV, 3AUS, 3BDQ, 3BFP, 3BGV, 3BII, 3BRX, 3CLW, 3COW, 3DBP, 3DF, 3DGV/P, 3DO, 3DOV, 3DVO, 3DYY, 3EGV, 3EYV, 3FAN, 3FIH, 3FSG, 3FSG/P, 3FUH, 3FYY, 3GBC, 3GBR, 3GEV, 3GHI, 3GHO, 3GHQ, 3GSE, 3GSM, 3GVR, 3GVX, 3HWJ, 3HXJ, 3HYE, 3IAM, 3IEX, 3IFA, 3III, 3IPE, 3ISA, 3JEP, 3JFR, 3XC, 3XC/M, 3XT, 4CW, 4GT, 5DS, 5KW/M, 5MA, 5ML, 5RD, 5RZ, 5UM, 5US, 5YK, 5YV, 6AG, 6AG/P, 6CB, 6LL, 6NB, 6RH, 6SG, 6XH, 8GD, 8HY, 8RW, 8UQ, (September 14 to October 11).

G2CZS, Chelmsford, Essex.

WORKED: F8GH, G2BCB, 2FJR, 2HCG, 2WJ, 3ABA, 3AEX, 3ANB, 3BNC, 3BSU, 3CVO, 3DVO, 3FNL, 3FUL, 3GGJ, 3IJW, 3IOO, 3JMA, 3VI, 3WP, 4AC, 4KO, 4OT, 5AM, 5CP, 5DS, 5MA, 5YV, 6TA, 8KW, 8LN, 8RW, HEARD: G2BDP, 2DDD, 2FZU, 3BKQ, 3CCH, 3DIX, 3EGV, 3FAN, 3FYY, 3IEX, 5TZ, 5UM, 5US, 6LI, 8UQ, (September 18 to October 16).

G3FYY, London, N.W.2.

WORKED: G2ABD, 2ANT, 2BVW, 3BPC, 3CLW, 3DF, 3FQS, 3FW, 3GNJ, 3GXG, 3IJW, 3IPB, 3IRW, 5MA, 5TZ, 5UM, 5YV, 6CW, 6FO, 6TA, 8RW, (September 16 to October 12).

G3DBP, Beeston, Nottingham.

HEARD: G2BVW, 2CZS, 2FNW, 3ABA, 3BA, 3BII,

3FUW, 3HCG, 3HXS, 3IOE, 3ISU, 4MW, 5BM, 5JU, 5MA, 6NB, 8PX, 8RW, 8VN.

WORKED: G2ATK, 2DJM, 2DVD, 2FZU, 3AZT, 3BJQ, 3CCH, 3CLW, 3DVO, 3ENS, 3FAN, 3FW, 3GHO, 3GWB, 3FQS, 3HZF, 3IT, 3IUU, 3WW, 4SA, 5CP, 5DS, 5MA/P (Rutland), 5YV, 6CW, 6LL, 6RH, 6TA, 6XH, 6XM, 8RY, (October 4 to 16).

G4SA, Drayton, Berks.

WORKED: G2ATK, 2ATK/M, 2AIW, 2HCG, 2YB, 3ABA, 3A00, 3AMI, 3AZT, 3BII, 3BJQ, 3CKQ, 3CUZ, 3DBP, 3DO, 3EPW, 3FAN, 3FIH, 3FQS, 3FUM, 3GBJ, 3GHO, 3IRA, 3IOE, 3IWI, 4AU, 5BD, 5CP, 5ML, 5US, 5YV, 6CW, 6JK, 6NB, 6OU, 6XM, 8BP, 8PX, 8VN, 8VZ, (To October 17).

G3FIH, Bath, Somerset.

WORKED: F9JY, G2ATK, 2BAT, 2DCI, 2PU, 2UN, 3AGA, 3CCH, 3EGW/P, 3EPW, 3FAN, 3FKO, 3GHO, 3HSD, 3HZF, 3IER, 3IOO, 3ITF, 3IVF, 3IWA/A, 4SA, 5BM, 5MA/P, 5SK, 5YV, 6CW, 6OZ, 6TA, 6XM, 6Z, 8SB, GW8UH.

HEARD: F3LP, G2AHP, 2AIW, 2BMZ, 2DDD, 2FTS, 3AEX, 3AUS, 3CUZ, 3FMO, 3GNJ, 3GVC, 3IUD, 6NB, GW5BI, 3EJM, 8SU, (September 19 to October 17).

GM3DIQ, Stevenston, Ayr.

WORKED: EI2W, G3BW, 3EPW, 3FMI, 3GPT, 5YV, 6XX, G13AXD/P, 5AJ, GM2BUD, 3DDE, 3EGW, 3FYB/P, 3IBV, 4HX, 6KH, 6WL, 6WL/P, 6ZV.

HEARD: G5VM/A, 8SB, GM3FYB, 3INK, 3NG, 8AH, (September 5 to October 13; 82 hours operating).

G3CKQ, Rugby, Warwickshire.

WORKED: 2ATK, 2ATK/M, 2AOK, G2FJR, 3FW, 3ABA, 3ABA/A, 3AZT, 3BJQ, 3CRH, 3ENS, 3FUW, 3GHO, 4SA, 5ML, 6CW, 6YU, 8VN.

HEARD: 2FNW, 3BKQ, 3DBP, 3FIH, 3IOO, 3IUU, 3IVF, 5BM, 5RZ, 5SK, 5YK, 5YV, 6AG, 6SN, 6XM, 6YU/M, (September 1 to October 14).

16-17, Bob G5MA went again to his old site in Rutland, and worked 38 different stations, with G3FAN in the Isle of Wight as best DX. On the Sunday, G2HCG/M came over to see what went on, and for a little while there were two completely portable stations side-by-side, each able to work the other's contacts. This was Bob's

last portable outing until next year —he plans to spend the winter on constructional work. We shall all look forward to hearing the /P signal again from G5MA, when once more he is able to set out on his travels.

G5MR (Hythe, Kent) was there when the band opened on October 9, but though Vernon saw it

coming (in the weather sense) he could only be on during the early part of the evening, when G2ATK and G5ML were heard at good strength, with G3ENS worked. On the morning of the 10th the F's were good, but not nearly as loud as they had been during October 1-2, when they were at terrific strength; a new one worked by G5MR was F3GL (Auxerre), 85 miles south-east of Paris. Vernon is very interested to hear about the ON4BZ version, for two metres, of the G3BKQ 70-cm converter, and suggests that Guy might be persuaded to publish details of the concentric lines for this band. Incidentally, G5MR rightly points out that F8MX's recent G contacts have not been from his book-QTH in Paris, but from St. Valery-en-Caux, on the coast 16 miles west of Dieppe, which puts him about 100 miles nearer the G's. F8MX and F9CQ are brothers, operating the same station.

G3ITF (Basingstoke) was hearing, during October 8-16, Midlands signals like G3DBP and others, and G5BD in Mablethorpe, consistently at R5 and up to S9 on phone, but was unable to raise them; the same applied one lunch-hour with G3DBP, and

G3ITF comes to the same conclusion as GW3GWA—that perhaps too many stations are again not searching the whole band. G3ITF suggests that, as a result, the tendency may develop for people to QSY to the LF end in order to ensure contacts. This would be a great pity, and of course there is no need for it if everyone remembers to tune QMH.

G3IEX (Bexhill - on - Sea) is making steady progress, and G2DVD (Slinfold) remarks that most of his time has been spent in construction, with VHF portable/mobile equipment in view.

Some of the Comments

"It has been said that the Band Plan is a very good thing—for those who live in the right part of the country!" (G3ITF) . . . "Am busy on a new transmitter for the HF bands, hi!" (G2FJR) . . . "I scan stations—heard just in case some rare-DX bird may have received my QRP" (G3CKQ) . . . "Does G3IOE have to go QRT for supper?" (G3GHO) . . . "A word of praise for G4MW for his interesting article on VHF stacks" (G2CZS) . . . "G6FO was heard at RST-589, but as

TWO METRES COUNTIES WORKED SINCE

SEPTEMBER 1, 1954

Starting Figure, 14

From Home QTH only

| Worked | Station |
|--------|------------------------------|
| 40 | G5YV |
| 33 | G3GHO |
| 30 | G2FJR |
| 25 | G3WW, G6TA |
| 23 | G2DVD, G3FIH |
| 22 | G5DS |
| 21 | G3BJQ |
| 20 | G3DO, G3DVQ, G3FYY, G3HWJ |
| 19 | G5BM |
| 18 | G3DBP |
| 17 | G2CZS |
| 16 | G8VN |
| 14 | GM3DIQ |

Note: This Annual Counties Worked Table opened on September 1st, 1954 and will run for the twelve months to August 31, 1955. All operators who work 14 or more Counties on Two Metres are eligible for entry in the Table. The first list sent should give stations worked for the counties claimed; thereafter, additional claims need show only counties worked as they accrue. QSL cards are not required for entry in this table.

usual remained deaf to my calls!" (G5MR) . . . "There must be well over 100 TV sets within a radius of a ¼-mile; but I carry on, though I dare not go out in the dark alone!" (G3FIH) . . . "If stations would send in their calls-heard lists, it would interest everyone concerned; it would be nice to know who you *could* have worked if only you could have heard them" (G3BJQ).

VHF in the Med.

Arising from a QSO on 21 mc, G5JU reports that ZB1AJ, ZB1E and ZB1BZ are running regular schedules between themselves during 0730-0930 on Sunday mornings, frequencies near the LF end of the two-metre band. It will be remembered that considerable efforts were made to establish G/ZB1 contact some time ago, and it must be admitted that the path conditions are far from propitious, with the Alps forming a stubborn barrier. Indeed, accord-



Three well-known personalities: Left to right: EI2W, G5MA and G5ML. Between them, they have done a great deal to maintain VHF interest and activity.

ing to met. man G3EGB, it would only be by the merest chance that the right sort of conditions could develop to lift two-metre signals right over to Malta.

However, that is no reason why we should not again listen for the ZB1's, the advantage now being that they use 21150 kc as a contact channel, so that frequencies and listening times can be accurately correlated.

Nearer home, we have been looking through the VHF column in *Das DL-QTC*, conducted by DL3FM (who is well known in this country) and notice that the total of countries worked from DL

is now 17—they have Luxembourg, Poland and the Saarland accounted for, still to come into our list. Incidentally, it is interesting to see that the "first" between DL7FS and SP3PD was as recently as July 25; this is no great distance, but the point is that it proves the existence of a Polish station active on two metres. The high-scoring operator in countries-worked from Germany is DL3VJ with 12, and the distance record holder is DL1FF with 684 miles.

Concluding

And so we wind up once again.

with words of thanks to all our correspondents, the hope that we shall hear from them again for the next issue, and the reminder that this will have to be by **Monday, November 15, certain**, for December.

Address all your VHF news, views, claims and suggestions to: A. J. Devon, "VHF Bands," *Short Wave Magazine*, 55 Victoria Street, London, S.W.1. And check up on your "counties worked since September 1st" to see if you qualify for the new Table. All being well, we shall be resuming our discussions on December 3—so till then, 73.

BREAKING UP AERIAL GUY WIRES

In an interesting research paper (No. 2182) published by the National Bureau of Standards, Washington, D.C., U.S.A., it is shown that in the frequency range 1 to 25 mc it makes little difference to the radiation pattern of a delta vertical aerial whether (a) A metal or wooden mast is used, or (b) The guy wires are continuous or "broken by insulators," in the time-honoured fashion. Nor is the input impedance of the system affected unless the guy wires happen to be a half-wavelength long. While this is not conclusive proof that in a conventional system, intended to radiate strongly in the horizontal plane, the findings would be the same, it at least suggests that this might be so; and with near-vertical guy wires and a horizontal aerial, the input impedance might not be affected at all, even with guys near the half-wavelength.

NEW TREATISE ON TELEVISION

By Kerkhof and Werner of the Philips Laboratories at Eindhoven, Holland, *Television* has been written for technicians and engineers who have a good basic knowledge of radio theory. It makes clear the essential physical principles on which current practice and future advance must be based. The price of this book is 50s., of Cleaver-Hume Press, Ltd., 42A South Audley Street, London, W.1.

MINIATURE OUTPUT PENTODE—RF OR AF

Mullard Ltd. announce the EL85 AF and RF output pentode. This is a noval-based valve intended for AC mains operation. The heater rating is 6.3v., 0.2a., which is low in view of the maximum cathode current rating of 35 mA. The EL85, which has an anode dissipation of 6 watts, may be used as an AF output valve or as an RF amplifier up to 120 mc. As a Class-A audio amplifier it gives an output of 2.8 watts when operated with an HT supply of 225v., and an anode current of 26 mA. As an RF amplifier, it will deliver 2 watts at 100 mc.

The EL85 should be of great value for equipments requiring moderate power output and where low LT drain is important. It is particularly suitable for mobile transmitters and receivers, where it may be used as a driver, modulator, or audio output valve.

NEW TV TRANSMITTER AT ROWRIDGE

The BBC announces that it is hoped to bring Rowridge in the Isle of Wight into full TV programme service on November 12. Rowridge has been radiating during the normal morning trade test transmission period (10 a.m. to 1 p.m. daily except Sundays from all TV transmitters of the BBC) under the same conditions that will obtain when full programme service is commenced. Rowridge will use, at first, a temporary mast and aerial system; when the permanent installation is completed, with a 500-ft. mast, in about 12 months' time, the coverage should include Seaford in the east, Seaton to the west, and Lambourn in the north.

BONFIRE NIGHT

It is not often that our date of publication coincides with Guy Fawkes Day. While we know that there are those who would gladly consign *Short Wave Magazine* to the flames (and the effigy of its Editor with it), it is to be hoped that once again we shall avoid the fate that these gentle attentions are supposed to bring!

POSTAGE — PLEASE NOTE

Due to heavy postage charges, we must ask that all correspondence to which a reply is expected should be accompanied by a stamped addressed envelope. This need not, of course, apply to correspondents' reports for our various activity features, to which in the ordinary way no individual reply is given.

VHF WEATHER REPORT

PERIOD SEPTEMBER 18 TO
OCTOBER 15

NOTES BY HB9PQ
DIFFRACTION

A. H. HOOPER (G3EGB)

FOLLOWING the well-established pattern, assessments for this period will be found in Table I and the pressure graph in Fig. 2. Not brought out by the Table is the presence of good conditions for the GI/GM path on the evenings of September 22 and October 8, 9. For September 28 the opening is thought to have been limited to South Coast stations. Entries for October 1 arise from the approach of a strongly-marked layer which was still to the west of longitude 4°W two hours after midnight. Cornish stations and those in Ireland should have gained advantage, but for southern England improvement was delayed. This layer was over all southern counties by morning, however, and remained for that evening.

The HB9PQ Story

From HB9PQ comes conclusions based on this year's visit to St. Gotthard. At 8000 feet above sea level the surrounding mountain summits varied from one to five degrees elevation, and for all directions other than to the north-east the site was excellent. He says:

"The expected high pressure belt arrived, but only for a very short time. It extended from a small anticyclone situated to the east and covered the Alps from mid-day on August 2 for 24 hours. With strong cyclonic activity extending from the Azores to Scotland, pressure fell quickly on August 4 to between 1010 and 1000 millibars.

Fig. 1 for August 2 shows a promising situation for DX in the sector from North to West. The 1015 mb. isobar lay along the Channel and PE1PL received our signals between 1200 and 1300 GMT on schedule. Nevertheless, a QSO did not materialise.

During the night a warm front built up from the eastern Alps, crossing HB into France, bringing a few raindrops and nearby thunderstorms and disposing of all hopes of QSO's. At the same time, atmospherics occurred, and a strong, constant rushing noise began in our receivers which made it probably impossible to receive weak signals. This phenomenon

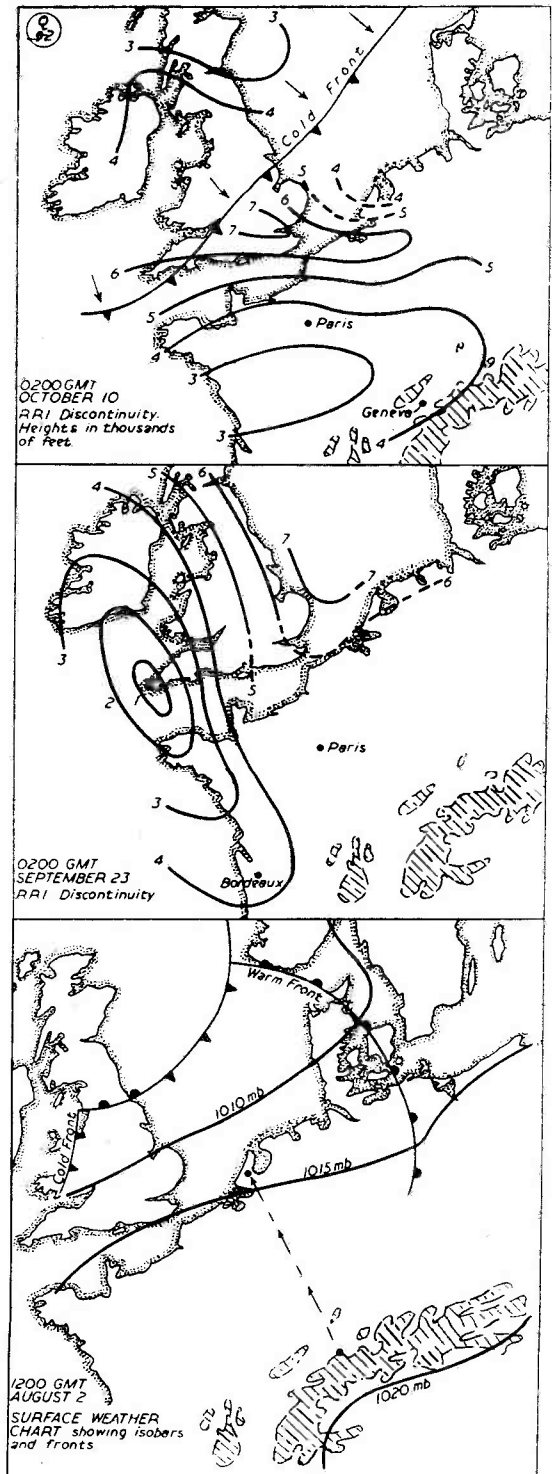

Fig. 1. Showing two of the layers capable of yielding VHF DX during the period September 16 to October 13, around September 23 and October 10 (for strictly DX conditions). The chart dated August 2 indicates the most favourable situation for the HB1PQ expedition, when the only DX achieved was a heard-report from PE1PL. In other words, the results obtained by the St. Gotthard party, which were almost entirely negative, tie up exactly with the known VHF propagation conditions.

| Date | SEPTEMBER | | | | | | | | | | OCTOBER | | | | | | | | | | | | | | | | | | | | | |
|---|-----------|----|----|----|----|----|----|----|-------|----|---------|----|-------|-------|----|-------|----|----|----|-------|----|---|----|----|-------|----|----|----|--|---|--|--|
| | 18 | 19 | 20 | 21 | 22 | 23 | 24 | 25 | 26 | 27 | 28 | 29 | 30 | 1 | 2 | 3 | 4 | 5 | 6 | 7 | 8 | 9 | 10 | 11 | 12 | 13 | 14 | 15 | | | | |
| Radiation over Bedfordshire | 06 | 06 | 06 | 02 | 02 | 06 | 22 | 03 | 24 | 24 | 24 | 24 | 24 | 05 | 03 | 24 | 03 | 24 | 23 | 02 | 24 | | | | | | | | | | | |
| | NE | | | | | | | | | | | | | | | | | | | | | | | | | | | | | | | |
| | E PA | | | | | | | | | PA | | | | | | PA PA | | | | PA DL | | | | | | | | | | | | |
| Discontinuities abt., from S.E. England to countries indicated. | SE | | | | | | | | ON ON | | | | | ON | | | | | | HB | | | | | | | | | | | | |
| | S | 45 | | 43 | | | | | 48 | 48 | | | 48 | 46 | | 48 | 45 | | | 43 | | | | | 48 | 43 | | | | | | |
| | SW | | GC | GC | | | | | GC GC | | | | GC GC | GC GC | | GC GC | | | | GC | | | | | GC GC | | | | | | | |
| | NW | I | | | | LM | | | | | | | I | L | | | | L | | | | | | | | | | | | M | | |

The possibilities for EDX and GD_X from September 18 to October 15. Country prefixes show approximate direction and distances from S.E. England to which good conditions are thought to have extended.

Table 1

- Notes:—(1) Conditions listed are for the evenings of the dates shown.
 (2) Figures in the first line are the times when inland super-refraction had reached its peak.
 (3) Country prefixes indicate the approximate limit of good conditions.
 (4) Sub-divisions of distance have been necessary, thus:
 ED eastern DL, WD western DL, L Lancashire, I — GI, and M — GM.
 (5) For the southern path degrees of latitude are given.
 (6) Paris is about 49 and Marseilles about 43.

also gave the same trouble on the communication bands. It seemed to be a constant static discharge, probably produced by a weak Foehn effect. This 'rushing' continued up to the arrival of a cold front in the night of August 6/7. Although the situation seemed hopeless after August 4, schedules were maintained during the whole test period. None were successful.

Even though this expedition was full of negative results, we established that the theories put forward in the April issue of *Short Wave Magazine* (valid for the Continent, mountainous country and partially for England and Ireland) were confirmed, since, in the absence of the conditions then alleged to be necessary for EDX, no results were obtained.

The reason for long-range QSO's at VHF is to be found in the inversions which give rise to reflection layers up to high altitudes. For operators wishing to carry out tests or to be aware of DX possibilities, it is easier to consult a weather chart than to ascertain reflection layers from radio-sounding results. In the hope that air pressure can be used as an indicator of such layers, attention has been directed to surface weather charts. Conclusions reported earlier in *Short Wave Magazine* still appear to be valid for the Continent, but not wholly so for island England, where weather events pass quicker and the temperature exchange of water and land are opposite. We see here a vast number of unsolved problems and influences."

Comment

Conclusions based upon selected occasions seldom stand up to everyday use. As has been admitted by one professional worker in this field, the striking incidents serve to brighten up dreary plodding through the much greater masses of routine results. In persisting in the face of negative results, HB9PQ and his companions have acquired further valuable data for their investigation.

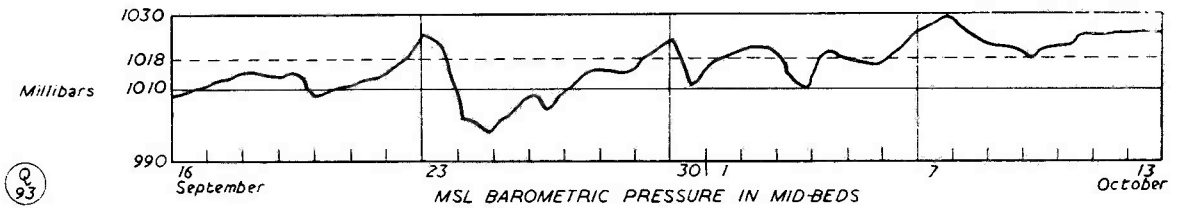

Fig. 2. The mean sea-level (MSL) pressure graph for the period under review, which should be compared with Table I. It will be seen that the better-than 1018 mb condition appears more frequently than in recent months.

Diffraction

At 70 cm, where reflections from atmospheric layers are rarer than on two metres, it has become increasingly apparent that hills and mountain ranges are not always the barriers that they at first sight appear. When strong signals were exchanged at the first attempt between Dublin and Oswestry, one might have at first regarded it as the result of the reflecting layer 5000 feet aloft at the time. However, it was found that signals were stronger on 70 cm than on 2 metres, whereas the beneficial effect of the layer would be very much greater at the longer wavelength. Fig. 3 shows the contours involved for this path, and one wonders what signal strength is involved in *diffraction* over such obstacles, and whether it could contribute noticeably to the result.

It is an experimental fact that if an obstruction with a sharp edge is placed partly within a parallel beam of light, the shadow cast by the object is not, in fact, clear-cut. Illumination is found to be present in the area of "shadow." It is possible to see, when viewing from the shadow, a bright line along the edge of the object. This line, then, is the source of illumination in the shadow zone. This *diffraction* of energy into shadow regions can occur also with radio waves, and, in the case of a diffracting mountain ridge within sight of the aerial system, both direct and ground-reflected paths from the ridge contribute to the received signal.

Using a formula suggested for this type of path, the field strength resulting from 50 watts of RF in a dipole has been calculated for several simple arrangements. These are set out in Table II.

Table II

| Path | Dublin-Oswestry | Payerne-Milano | Leeds-Brussels |
|--|-----------------|----------------|----------------|
| Aerial heights (metres) | 230 11 | 12 12 | 177 91 |
| Obstacle height (metres) | 580 | 3000 | (Sea) |
| Path length (Km) | 211 | 265 | 519 |
| Field Strengths (dB) referred to 1 μ V/m | 2 metres | +7 | -21 |
| | 70 cm | -15 | -16 |

These figures, of course, refer to obstacles in the simple form of brick walls of appropriate heights! Actual paths are far from such a simple shape, and so signal strengths may depart greatly from those given.

Comparing the first two paths, we note that, despite differing aerial heights—and in one case a vast piece of "brick-laying" extending up to 3000 metres—there is little difference in the strength resulting. Raising any one aerial from 11 to 22 metres improves strengths by 7 dB. Looking now at the GSYV - ON4BZ path, we find strengths are about 30 dB lower, although there is no brick wall. It has been claimed by some workers that, in diffracting round a smooth earth, strengths approximately follow an inverse fourth-power law. The above figures fit in with this.

Finally, it will be observed that 70 cm has about a 5 dB advantage in all cases over two metres—for

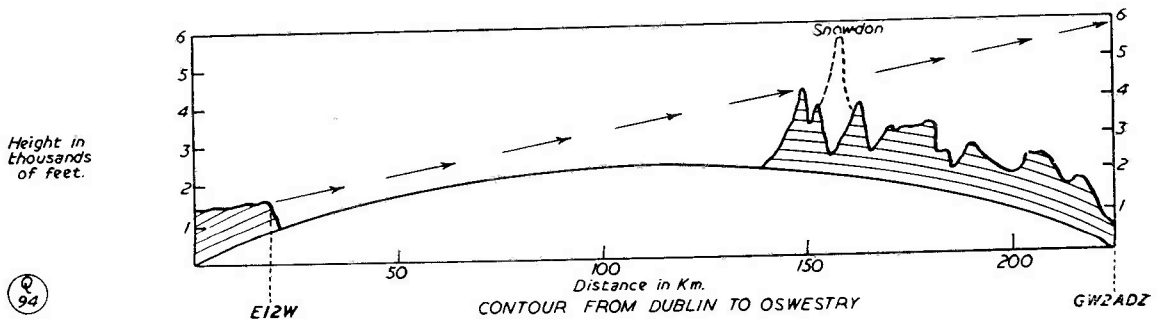

Fig. 3. This interesting sketch indicates the nature of the path between EI2W (Dublin) and GW2ADZ (Oswestry), showing that it is far from being optical. (The sketch makes allowance for normal refraction effects, enabling the radio rays to be shown as straight lines). GW2ADZ would need to have been at an elevation of nearly 6,000 feet for his beam to have "seen" EI2W — yet they were able to work quite comfortably on 70 centimetres. Snowdon lies just to the north of the line EI2W-GW2ADZ, otherwise it is doubtful whether the conditions discussed in the text would have obtained.

those with the equipment to use it. A measure of compensation for aerial scaling factors and circuit limitations! It was this superiority of 70 cm experienced on the Dublin-Oswestry link that made the writer wonder whether diffraction occurred. It is left to readers to decide whether this is likely and

whether to aim their beams occasionally over the local hilltops.

The writer is indebted to the Director, Meteorological Office, London, for permission to make use of information gained from official publications.

LINES OF THOUGHT

Ideas for the Constructor-Experimenter

A SURVEY of current amateur practice suggests that, perhaps, not enough attention is being given to new design and constructional methods and possibilities, for which the means are readily available. In a word, that we are becoming a bit too stereotyped in our outlook on what might be called the electro-mechanical side of Amateur Radio design and construction, particularly on the HF communication bands.

For years, we have been using valves like the 807 and 813 in the PA stage, in many cases preceded by types such as the 6V6 or 6L6 in the driver-multiplier stages. Of course, the thing works, and probably very well, and in any case (one may argue) it does not matter a great deal how the RF is generated, so long as it is under control and can be fed out to an aerial which is an effective radiator.

But how much neater would be a transmitter using types like the 6AQ5—a B7G-based miniature beam tetrode with characteristics similar to the 6V6, but only about 2 ins. long by less than an inch in diameter—in the early stages. For triode doubler service, there are the 12AT7 twin, the L77 and 6C4 miniature triodes. For the PA stage, why not the 829B (or 3E29) double tetrode? This valve, 3½-ins. long by 2 ins. in diameter, will give 80 watts RF output with but 500 volts on the plates for less than one watt of driving power. It makes for a much neater and more compact PA layout than a pair of 807's!

The 829 type can equally well be used as a modulator—in Class-B it will give 76 watts audio output and so here too could replace a pair of 807's.

Now take a look at the 832, another but smaller double-tetrode; it will produce 26 watts RF on CW with 500 volts on the plates for less than one-fifth of a watt driving power. In Class-B audio, with 425v. of HT, the 832 is rated to give 16 watts output. Its dimensions across the bulb are 2 ins. by 2 ins. in diameter!

These valves are well known to, and in general use by, the VHF fraternity. And they should be of equal interest to operators on the lower-frequency bands. The point is that by virtue of their small size, good sensitivity and relatively high power output, they are the right choice for that "compact table-top rig" which is in the mind of so many who are contemplating a rebuild.

Though American types are mentioned here, there are of course British-made valves of equivalent ratings in the Osram and Mullard ranges, while the receiving types with American classifications can be found either in the Brimar range as direct equivalents, or in the Osram or Mullard lists.

Low Power Transmitters

For those interested in QRP work—which we may take as operation with a DC input to the PA stage of less than 10 watts at 250-300 volts — the choice in the new, high-efficiency types is wide indeed. Valves like the L77 (6C4) make excellent oscillators—the L77 will give nearly 6 watts RF output—while the Z77 miniature RF pentode can be used perfectly well as a sensitive and efficient low-power doubler on any amateur band. For the RF output stage, there is the 6AQ5 or 5763, the latter on a B9A button-base and capable of taking 15 watts DC input at 300 volts.

For modulating in this power category, one notices the Brimar 13D3 twin triode; this valve (barely 2 ins. long and less than an inch in diameter) will, when connected in push-pull as a zero-bias Class-B amplifier, deliver 7 watts audio output for 32 volts across the grids with but 250v. on the plates.

Another interesting valve, about the size of your thumb, is the 6X4 full-wave rectifier, which will give 70 mA rectified at 400 volts DC output—thus, it is the right choice for the low-power, miniaturised transmitter.

These are all merely examples drawn from recent observation and a study of the extensive literature now published by the leading British valve manufacturers. All those mentioned are quite standard, readily available, and in the case of some of the receiving types may even be on the shelves of local radio dealers who have them in stock for receiver replacements.

Constructional Layouts

The panel-and-chassis (perhaps in-a-cabinet) is a standardised form of construction, and is probably one of the easiest for the amateur who has to do his building work "on the edge of the kitchen table." For transmitter assemblies, the shape of the finished job is usually the plain rectangular box chassis.

But there are other forms. For instance, for a small transmitter or modulator, it is only a matter of a little careful measuring and cutting of aluminium sheet to produce a chassis with a sloping front drop; if this is made about 3 ins. deep on a 45° slope, the neat 2-in. square-faced meters now to be had very reasonably can be mounted on it, at an angle easy to read and good to look at.

Then there is the stacked chassis: Two or three or four rectangular shells of the same size mounted above one another between aluminium angle pieces, upright at the four corners, with rest stops at the correct height for each chassis. Thus, one could have the power pack (as the heaviest unit) on the lower deck, the modulator next above, and the RF section on the upper deck; with the units interconnected by short cable-forms terminated in multi-way plugs, the result is a very neat assembly, with everything accessible for maintenance, and any of the chassis withdraw-able in a few minutes. For a 25-watt transmitter using miniature valves, the clearance between chassis need be no more than 2½ to 3 ins.

Another practical form of construction which is worth looking at as a departure from the usual is the vertical panel, considered as a sheet of aluminium of the required size for the job with a

right-angle bend along one edge for mounting purposes. On this, valves in succeeding stages that may have to be screened from one another have their holders fitted in such a way that the valves "look out of" the panel on opposite sides. With valves having top-cap grid or plate connections, matters can be so arranged that the feed from the plate of one valve into the grid of the succeeding stage can be obtained without having to take a single RF lead through a hole in the metal; in some circuits, a layout can be arrived at which dispenses with any additional inter-stage screening, the panel itself, with the different stages on either side of it, acting both as mount and screen. The panel is of course fixed edgewise on its bend, screwed to a horizontal baseboard (which could be of wood) carrying the power inlets, meter mountings and, in the case of a small transmitter, the power supply unit as well.

* * *

The notions put forward here are merely a few suggestions for possible new lines of approach for the interested constructor-experimenter who may be casting about for ideas. It may well be that readers have other, and better, ones of their own—or are already working along the lines suggested. If so, we would like to hear about them. *A.J.D.*

THE MODULATION CODE

For some quite inexplicable reason, the Region 1 IARU meeting at Lausanne last year produced what they called the M-code to report telephony signals, the range being M1-M5 to express modulation quality. This would have been quite all right had it not been forgotten by those responsible that many years ago the F-code was introduced for the very same purpose; the range is F9 (perfect high fidelity) to F1 (unintelligible faint gargle). Correctly, therefore, a telephony signal should be reported as RSF --- corresponding to the RST --- of CW working. The average amateur phone transmission would usually fall in the range F8-F5; anyone given F9 would know that he was taking up more ether space than that to which he is fairly entitled. In practice, of course, there is little point in having a modulation code at all, since communication being on telephony, the quality of the transmission can be discussed in plain language. If a code is required, the F9-F1 rating has always been available, and is entirely adequate for the purpose.

"WIRELESS WORLD" DIARY, 1954

We are glad to draw attention once again to this excellent pocket reference book and diary, now making its 37th annual appearance. The first 80 pages, devoted to factual information, contain such basic data as dimensions for receiving aerials for the commercial TV frequency band and the BBC's FM stations on VHF. The reference section includes useful formulæ, graphical design data, base connections for nearly 600 current valve types, and a mass of general information; in fact, the *Wireless World*

Diary provides in tabloid form the kind of practical technical data frequently required by the radio man but seldom readily available. Among the 43 subject headings are: BA Screws and Drill Sizes; Coil Winding Data; Decibel Equivalents; International Prefixes; Resistor Ratings; and Wire Tables.

Published by Iliffe & Sons, Ltd., Books Dept., Dorset House, Stamford Street, London, S.E.1, size 4½ ins. by 3½ ins., one week at an opening, price 6s. post free (in leather), and 4s. 3d. in rexine.

A NEW PERIODICAL

The Industrial Products Division of Philips Electrical Ltd., announce the introduction of their new monthly publication, *Philips Serving Science and Industry*. This journal, which is similar in approach to the well-known *Philips Technical Review*, will be devoted to new types of industrial equipment and industrial processes covering a wide field. Although emphasis will be on applied industrial electronics, resistance welding and filtration will also be included articles dealing with new developments in arc. from time to time.

Philips Serving Science and Industry is primarily directed to a technical audience, but many articles will be concerned with practical production problems of a widely differing nature which should prove of interest to industrial management. The publication is distributed free of charge, and though a substantial mailing list has already been built up, a limited number of applicants can still be accepted. Requests should be made to the Publication Department, Philips Electrical Ltd., Century House, Shaftesbury Avenue, London, W.C.2. on official notepaper, and the position of the applicant should be stated.

IT was delightful to note that the comments on "Cryptic Phones" and "Crazy Call-Signs." in the *August* issue, brought some very forceful replies into the Correspondence columns last month.irate replies are far better than no replies at all. There may be some who agreed with our comments, but they do not feel strongly enough on the subject to say so. Those who disagree have said so, in no uncertain terms, and we are very glad to meet them. Their defence of phonetics is quite impressive, but we did not condemn them out of hand in the first place; our own grouse (even if badly expressed) has always been the excessive and unnecessary use of phonetics. With the S9 signals so much in vogue these days, it still seems (to us) quite incredibly stupid to hear people talking about a "Six London Six" and "Queen Roger Norway." To drop the word "static" and call it "QRN" is quite businesslike, but "Queen Roger Norway" is either Marx Brothers or sheer lunacy.

PHONETIC OR PHONEY?

This column is all in favour of phonetics in call-signs (where the readability conditions make them desirable or necessary), but *not* the use of place names. That was the main groan in the paragraph headed "Crazy Call-Signs." As the call-sign itself is supposed to tell other people what country we reside in, the last thing that should be introduced, surely, is a string of names of other countries? DL4ABC is perfectly right in announcing himself as "Dog Love Four Able Baker Charlie," but he could hardly think of a worse combination than "Denmark London Four America Boston Canada." One still hears such things very frequently, and they could be tolerated if there were the slightest justification for them, but is there? If we introduced a general clean-up of phone procedure, we would certainly suggest the banning of place names; and probably the use of phonetics to "blow out" abbreviations, e.g. the Q signals, to a greater length



than the simple words that they are meant to replace. All clear, now?

ATOMIC STATIC

One very prompt and positive reply to September's query about the rain-static phenomenon contains this paragraph: "Imagine anyone even having a doubt on the subject! The answer is radioactive rain, and anyone with a sensitive detector knows by now that most of the rain which falls in any part of the world is radioactive to some degree. This is also undoubtedly the answer to the freak weather conditions. It only takes a small stone to start an eddy in a pond, and what the scientists have let loose at Bikini and elsewhere is only just *starting* to make its effects known. Those effects probably include our freak summer, North Atlantic hurricanes, China Sea typhoons and (who knows?) possibly Algerian earthquakes. So for goodness' sake don't worry about a little rushing noise when rain falls near your aerial." The gentleman who wrote all that, despite the infallible tone of his letter, is too modest to allow us to publish his name—but there is his opinion, for whatever you think it is worth.

NO GLAMOUR

We were reminiscing with another Old-Timer the other night (beard of roughly equal length!) and together we decided that some of the *glamour* has gone out of our hobby. Having both started

in the days when an outside aerial of any kind was something to make folk stop and stare, we remember the extraordinary thrill experienced when we saw a nice one, even from a fast-moving train. An aerial, in those days, looked like a piece of scientific apparatus, not a clothes-line, and one could really find some beauties even in the London suburbs. One keen transmitting type (still, fortunately, with us and active) had a couple of 70-footers, tubular steel and painted green, with scores of nicely insulated guys. And between the two masts, tightly strung and delightfully symmetrical, was a "twin," with six-foot spreaders. Although we should hate to be the owners of such a sky-wire every time the wind blew, we can't remember that one ever coming down. And the prestige it conferred upon its owner, in our youthful eyes, was quite incredible.

ELECTRONS OR MUSCLES?

One for the CW enthusiasts now. Electronic keys have become very popular in the last five years, and no one will deny that it is possible to build one which will send truly automatic-sounding Morse. So complicated have they become that one of the latest uses seven relays and has a memory. No matter how badly you send a character on the paddle, what comes out will be pure and perfect! But wait—is this a good thing, or is it? How about the thousands of good operators who can send perfect Morse on the old pump-handle, without the aid of relays, valves, potentiometers and myriads of electrons charging around . . . why, even they don't bother to do so, but alter it to suit their own requirements, and very nice some of them make it sound. So do we want perfect Morse, or are the Baghdad Bounce and Lake Erie Swing preferable to it? We are certain of one thing—if the energy spent on designing El-Bugs went into such things as improving the quality of the signal, there would be some very nice signals to be heard.

THE OTHER MAN'S STATION

G3JBR



OUR story this month is of the very attractive layout at G3JBR, owned and operated by D. P. Tipper, 23 Northstead Manor Drive, Scarborough, Yorks., who has been on the air since June 1953. Before that, he had been an enthusiastic SWL for a number of years. The station is shown as it is at present, and it is all home-constructed except the CR100 main receiver and the wide-band couplers.

The transmitter consists of a 9002 Clapp VFO, driving a 6AM6-6AC7 buffer amplifier, into four 6AQ5 wide-band coupled amplifiers, into the 807 PA. This has a pi-section tank circuit, band-switched from 80 to 10 metres, with 60 watts input on all bands. The receiver is mounted on a 2½-in. raised base carrying the circuit switching; in the centre of the front panel is the single change-over control, giving "Net," "Receive," "Transmit," the whole station being relay operated.

Immediately to the right of the receiver is the VFO and first buffer stage; above are the frequency meter and crystal calibrator; to the right of these is the PA, and above it the coax c/o relay for the aerial feeder. Behind the PA comes the switched wide-band coupler unit; on the wall is the mains

distribution panel. G3JBR runs a card-index system, which can be seen on the window-sill.

Beneath the operating table are the power supplies, a three-stage Top Band transmitter, grid dip meter and a small Clamp modulator "for the occasional trip on phone." Although CW is mainly used, more telephony working is envisaged when a high-level modulator has been completed.

As the QTH of G3JBR is in a TV fringe area. TVI precautions are essential; all units in the station are screened and filtered, with RF piped round in coaxial cable. A constant eye is kept on the harmonic level by the indicator visible in front of the PA. It can be said that—after considerable time, patience, testing and adjustment—G3JBR is TVI-proof on all bands, except 14 mc. on his own TV receiver; the necessary action is in hand to permit unrestricted operation on Twenty.

With aerial space rather restricted, many systems have been tried, and at present a 14 mc dipole is in use. Future plans include VHF activity and, possibly, SSB working. We might add that a by-line at G3JBR is amateur photography, the accompanying print being an example of his own work.

*Short Wave Magazine is an Independent Publication with
a World-Wide Circulation*

THE MONTH WITH THE CLUBS

By "Club Secretary"

(Dead-line for Next Issue : NOVEMBER 12)

HOW many active Clubs are there in this country ? And how shall we define "active," in order to answer the first question ? We have been checking over the card index, which gives details of all Clubs who have reported to us during the last five years, and are astonished to find that the total number of different organisations concerned is no less than 203 !

Of these, we consider 77 to be "active" from our own point of view, meaning that they report to us at least once in every three or four months. (A few of them, of course, do so regularly *every* month). Of the remainder, 126 in all, we do not know what to say. Some of them, after a year's absence from these columns, will suddenly spring to life again. But there are 48 Clubs whose secretaries have reported to us on just one single occasion and then vanished for ever ! We doubt whether these Clubs really exist — they probably made a start but were unable to keep going. This suggests that there are roughly 80 that may well be active, in addition to our regular 77. Let's settle for an estimated figure of 150 in all, and we should like to hear from some of them a great deal more often.

Magazine Club Contest

This year's MCC — the Ninth of the Series — takes place between the hours of 1430 and 1830 GMT on four days at the end of this month :— November 20, 21, 27 and 28. Full rules for the event were published in this feature last month (See p. 463, October) and many Clubs have already stated that they intend to enter. We are never able to gauge the number of entries until battle is actually joined, but we hope that last year's figure of 25 entries will be enlarged on this occasion. Will all participants please study the rules carefully, noting, in particular, that the word "Club" must be sent with their QRA, to distinguish them definitely from non-competing stations, or those only on to give MCC stations a point.

Thanet raise a query when they ask whether we require, with entries, a signed declaration by two Club officials to the effect that the rules were observed. In the interests of all concerned, we do think this desirable, and ask all Clubs to observe this point when submitting their logs.

Exhibitions and Displays

Bradford stage a display of members' gear on November 9. This has now become an annual event, and always produces a wide and interesting range.

Bradford Grammar School Radio Club ran a stand at the school Hobbies Exhibition on October 2, and their station G3HMY/A was operating on Top Band throughout the afternoon, with great success. *Grafton* are again putting on a stand, with G3AFT in operation, at the Handicrafts Exhibition at Islington Town Hall from November 15-19.

Harrow joins forces with the local Society of Model Engineers, at a public exhibition to be held on November 20 at the Wesley Hall, High Street, Wembley. G3EFX/A will be operating, and members' gear will be on show. There will be no Club meeting on November 19, because of this extra activity. *Isle of Man* will be taking part in a Trades Exhibition to be held in Douglas.

Outings and Field Days

Just a final echo of the summer season before settling down to winter routine ! *Sutton and Cheam* went to Brighton on September 5, and they plan a mass visit to an Ice Pantomime in January (*brrr* !)

Bradford visited the Tinsill TV relay station on October 12. And, arising out of *Chester's* recent outing, we are asked to state that the accident to their Hon. Secretary, as reported last month, followed an earlier injury to his knee, for which he was already receiving treatment.

Clifton held their final D-F Contest on September 5, and Messrs. E. Strong and D. Reed won the event. The D-F Shield for the year, however, was gained by G3HZI.

Two new members for the *British Two-Call Club* are G2AMX/VE3BUU and VQ4EG/MI3TM, bringing the membership up to 141. Recent events at *Grafton* have been a lecture on Portable Equipment (G8TL) and another on Transmitter Design (G3AFC). At the AGM, recently held, G2AAN was elected President, G8PL Chairman, and G2CJN Secretary and Treasurer.

Newcomer

A welcome addition to the ranks is announced from Hayes, Middlesex, where the *Hayes* Amateur Transmitters' Club has just been formed. Local amateurs are invited to apply to G2OF (*see* panel for QTH) for particulars.

Isle of Man have decided that monthly meetings are not frequent enough, and will get together, in future, on the first and third Wednesdays, with an agreement that there should be no official business on the third Wednesday, unless it is of a very urgent nature.

Medway announce their intention of taking part in MCC, adding that if the weather is at all good, they will be operating portable.

Midland are moving to new Headquarters, and on Tuesday, November 16, they will hold their inaugural meeting at the Birmingham Midland Institute, Paradise Street, Birmingham 1. It is hoped that this meeting will be addressed by a very well-known personality in the radio sphere; the time is 6.45 for 7.15 p.m.

The **QRP Society** Journal celebrated its fifth birthday in September, the first issue having been dated September, 1949. The Society is proud of having embarked on its sixth year of existence, and the recent exhibition organised by them was a worthy send-off.

Reading were fortunate in securing the services of G6CJ, who gave a talk and demonstration on Aerials at their Annual Hamfest. On October 30 Mr. Edwards, of A.E.I., lectured on Radiating from Lightning Discharge.

Southend heard a very interesting talk by G3AXN on Radio in the Antarctic, illustrated by about 100 photographs taken on the tour from which he had only recently returned. Another recent talk of great interest was on Crystal Oscillators.

Surrey (Croydon) had a good turn-out of VHF types to hear G3BLP's talk on Two-Metre Aerials and Converters. Their next meeting is fixed for November 9, at the Blacksmith's Arms, South End, Croydon.

TVI Topic

It will be remembered that some months ago (June, p. 239) we mentioned the formation, by **Torbay**, of a committee for the express purpose of liaising between the local GPO interference department and members afflicted with TVI. This committee is now in action under G3AVF, and has recently functioned successfully in the interests of a member who was involved. We feel sure that this suggests a line of activity which could usefully be followed by many other Clubs.

At **Northampton** G3ITW is again chairman, with G2HCG (the well-known VHF operator) on the committee; although in the past the Club has concentrated on VHF, and has been very successful on the two-metre band with G3GWB, a much wider sphere of activity

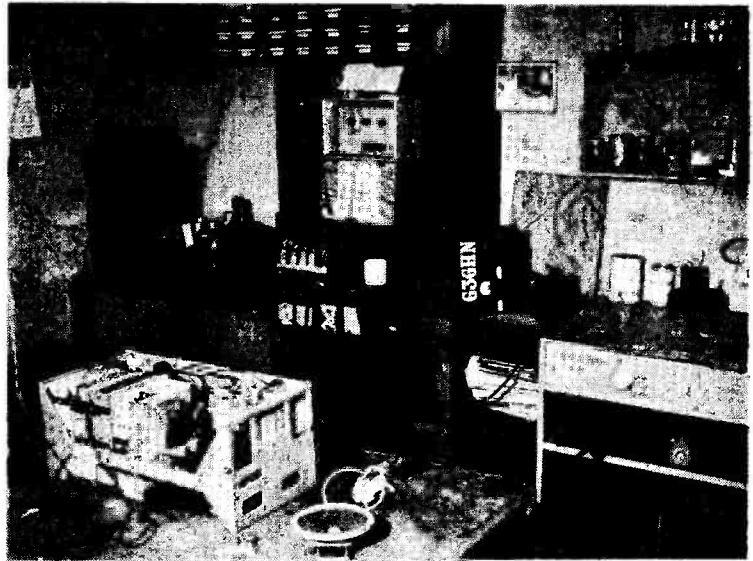

The Clifton (London S.E.14) Amateur Radio Society provides excellent workshop facilities for members at headquarters at New Cross Gate. With a good collection of tools, an assembly of test equipment, and a supply of "bits 'n pieces," they not only take care of Club station G3GHN, but members are also able to do their own test and constructional work. Clifton are rightly proud of an activity centre which is much appreciated by their members.

is planned for the future. Meetings are on Fridays, 7.0 p.m., at 8 Duke Street.

What should be a particularly interesting talk scheduled for **Cambridge** on December 3 is to be on Colour TV, by G5IG. On November 22 the Mullard film show will be given at Milton Road Primary School; normally, meetings are at the "Jolly Waterman," in Chesterton Road.

Purley have been discussing FM and the reception of VHF FM transmissions, both from the BBC and on the amateur bands. At a recent very successful junk sale, G4ZU undertook the onerous duty of auctioneer.

Coming Events

BRADFORD: November 9, Display of Members' Gear; November 23, The Human Ear (J. H. Otty, F.R.C.S.).

CLIFTON: November 5, Quiz; November 12 and 26, Constructional; November 19, Metropolitan Police Radio (G2YG). All at 7.30 p.m., at 225 New Cross Road, London, S.E. 14.

GRAFTON: November 5, Metropolitan Police Radio; November 12, "Avo" Talk; November 15-19, G3AFT Stand at Islington Town Hall.

HASTINGS: November 16 and 30, at Saxon Cafe, Hastings.

LEEDS: November 10, Transmitting Evening; November 17, Talk on Test Gear; November 24, Junk Sale; December 1, Home-Constructor exhibition; all meetings at Swarthmore Educational Centre, Woodhouse Square.

NEWARK: November 7, Film Show at the Northern

Deadline for next month's reports is :

First post on Friday, November 12,
addressed "Club Secretary,"

Short Wave Magazine

55 Victoria Street, London, S.W.1.

Hotel; November 18, Meeting at Northgate House, 7 p.m., with demonstration of commercial trans-receiver.
RAVENSBOURNE: Wednesdays, 8 p.m., at Durham Hill School, Downham, Kent.
ROMFORD: Tuesdays, 8.15 p.m., at RAFA House, 18 Carlton Road, Romford. Film shows, lectures, discussions. "On the Air" evenings and monthly Junk Sales.
SLADE: November 12, Television Aerials (A. P. Hale); November 26, AGM. Church House, High Street, Erdington.
SOUTH MANCHESTER: November 19, Communication Receivers; December 3, Tape Recorded Lecture by G2IG on Receivers.
SPEN VALLEY: November 17, Oscilloscopes (G. F. Craven); December 1, TRF Receivers (for Juniors) — G2BMC.
SUTTON AND CHEAM: November 16, An Aerial Matching Unit (G6MB), at the Harrow Inn, Cheam, 7.30 p.m.
TORBAY: November 20, at YMCA, Torquay.

CHANGE OF ADDRESS

We are asked to state that the Glasgow District Office of the Edison Swan Electric Co., Ltd., has moved to 167 St. Vincent Street, Glasgow (Tel.: Central 0687).

UNIVERSAL ELECTRONICS — NEW PREMISES

This well-known Lisle Street firm has taken additional premises at No. 22, and the establishment has been considerably enlarged. Universal Electronics do a big business in clean "surplus" and good second-hand equipment of every kind; those of our readers who may come up to Town should not lose an opportunity of visiting them.

CAUTIONARY CANTATA No. 2

*When the thunder clouds are looming
 And the Rx is full of static,
 You may start to hear a booming
 From the basement to the attic.*

*But before the lightning flashes,
 E'en before you hear the thunder,
 Your aerial can give bashes
 Which may tear the gear asunder.*

*As the static charges build up,
 Your aerial may start sparking,
 But this needn't cause you wind up
 If the point at which it's arcing*

*.....
 Can be taken down to earth
 By a lead of weight and girth!*

F.J.A.

NAMES AND ADDRESSES OF CLUB SECRETARIES REPORTING IN THIS ISSUE:

BRADFORD: F. J. Davies, 39 Pullan Avenue, Bradford 2.
BRADFORD GRAMMAR SCHOOL: D. M. Pratt, 27 Woodlands Grove, Cottingley, Bingley.
BRITISH TWO-CALL CLUB: G. V. Haylock, G2DHV, 63 Lewisham Hill, London, S.E. 13.
CAMBRIDGE: F. A. E. Porter, 38 Montague Road, Cambridge.
CHESTER: N. Richardson, 23 St. Mary's Road, Dodleston, Chester.
CLIFTON: C. H. Bullivant, G3DIC, 25 St. Fillans Road, London, S.E.6.
GRAFTON: A. W. H. Wennell, G2CJN, 145 Uxendon Hill, Wembley Park, Middlesex.
HARROW: S. C. J. Phillips, 131 Belmont Road, Harrow Weald, Middlesex.
HASTINGS: W. E. Thompson, 8 Coventry Road, St. Leonards-on-Sea.
HAYES: W. G. D'Arcy, G2OF, 29 Adelphi Crescent, Hayes, Middlesex.
ISLE OF MAN: R. S. Trickey, GD3DRB, 35 Sunningdale Drive, Onchan, I.O.M.
LEEDS: B. A. Payne, 454 Kirkstall Road, Leeds 4.
MEDWAY: D. H. Brett, 14 Connaught Road, Luton, Chatham.
MIDLAND: D. Hall, 144 Hill Village Road, Sutton Coldfield.
NEWARK: J. R. Clayton, 160 Wolsey Road, Newark.
NORTHAMPTON: A. J. Kightley, B.Sc., 23 Garrick Road, Northampton.
PURLEY: G. Honeywood, 105 Whytecliffe Road, Purley, Surrey.
QRP SOCIETY: J. Whitehead, 92 Ryden's Avenue, Walton-on-Thames.
RAVENSBOURNE: J. H. F. Wilshaw, 4 Station Road, Bromley, Kent.
READING: L. Hensford, G2BHS, 30 Boston Avenue, Reading.
ROMFORD: N. Miller, 18 Mascalls Gardens, Brentwood.
SOUTHEND: J. H. Barrance, M.B.E., G3BUJ, 49 Swanage Road, Southend.
SOUTH MANCHESTER: M. Barnsley, G3HZM, 17 Cross Street, Bradford, Manchester 11.
SPEN VALLEY: N. Pride, 100 Raikes Lane, Birstall, nr. Leeds.
SURREY (CROYDON): S. A. Morley, G3FWR, 22 Old Farleigh Road, Selsdon, South Croydon.
SUTTON AND CHEAM: F. J. Harris, 143 Collingwood Road, Sutton.
TORBAY: L. D. Webber, G3GDW, 43 Lime Tree Walk, Newton Abbot.

WORK IT OUT YOURSELF

It is reported by *ERT* that a Gloucester newspaper says that if TV viewers buy a receiver with an IF which is not 35 mc, the GPO will take no action in the case of amateur interference. A spokesman for BREMA deplors this advice, saying that the IF for TV is still a matter of choice by manufacturers. *ERT* understands that BREMA will shortly announce a recommended standard IF for television receivers—the laugh here is that BREMA promised this last March. It is said, by *ERT*, that "this will follow long deliberations and co-operation with the GPO with data provided by manufacturers' television engineers and the GPO engineers"—that is exactly how they say it. *ERT* also says that the GPO will allow amateurs to continue transmission during TV hours if the TVI they cause is due to the choice of the receiver's IF, stating the conditions that the signal interfered with should be a high-level one, and that there will be a month's respite so that the set owner (or manufacturer) can "take steps to prevent the trouble." (You can see this happening, can't you, in a case where the TV set is one of the cheap no-front-end types hired on the never-ever!). Your clue is that *ERT* stands for a publication called *Electrical and Radio Trading*, from the issue dated September 18 of which the foregoing is taken.

UNIVERSAL ELECTRONICS

Additional Large Premises at **22 LISLE STREET, W.C.2.**

(3 minutes from Leicester Square Tube Station)

Our Radio Amateur friends are cordially invited to inspect our large increased range of communication receivers, these include many British and U.S.A. types. We have also a wide selection of new and secondhand

**TEST INSTRUMENTS
TAPE RECORDERS AND
QUALITY AUDIO EQUIPMENT
ETC.**

NOW OPEN

**Showroom Floor Space
500 square feet**

Where we also display a fine selection of
V.H.F. and Microwave apparatus, including :—
RECEIVERS — TRANSMITTERS — SIGNAL
GENERATORS — SPECTRUM ANALYSERS
AND ALL ASSOCIATED EQUIPMENT.

When in Town pay us a visit
OPEN ALL DAY SATURDAYS
We close at 1 p.m. Thursdays
Shop hours 9 a.m. to 6 p.m. 9 a.m. to 1 p.m. Thursdays

UNIVERSAL ELECTRONICS
22 LISLE STREET, LEICESTER SQUARE, LONDON, W.C.2
Telephones: GERrard 4447 and 8410 (Day) MEAdway 3145 (Night)

Prices slashed at Clydesdale

T1154B TRANSMITTER UNIT

Medium/High powered for C.V.-M.C.W. R/T 3 ranges, 10-5.5 mcs. 5.5-3 mcs. 500-200 kcs. Complete with 4 valves, etc., in metal case 14" x 16½" x 8½". External Power Supply required.

ASK FOR SMJESA. **39/6** Each PLUS 7/6 CARRIAGE

Circuit 2/3. Ref.: 100/2.

VISUAL INDICATOR TYPE 1. Dual reading left/right D.F. meter for R1155, 2½". Scale overall Dim.: 3½" x 2¼", in used condition.

ASK FOR SMJH862A. **12/6** Each POST PAID

S.440-B V.H.F. TRANSMITTER CHASSIS

Part of the Stratton P40 Equipment. Partly stripped by the M.O.S., less valves, inductances and Crystal, but otherwise a good basis for reconstruction, compact size 14" x 8" x 7". Original frequencies 85-95 Mc/s.

ASK FOR SMJH517. **15/-** Each CARRIAGE PAID

WS-18 RECEIVER CHASSIS

Complete with valves, 3/ARP12 (VP23), AR8 (HL23DA), I.F. 465 kcs. Range 9-9 mcs. (battery operated). Chassis 8½" x 5" x 1". Front panel 9½" x 5¾".

ASK FOR SMJH22. **25/-** Each POST PAID

Circuit and Data 2/3. Ref.: 10P/1L.

RECEIVER UNIT TYPE 25. Part of TR1196 Range 4.3-6.7 mcs. with valves 21VR53 (EF39), 2VR56 (EF36), VR55 (EBC33), VR57 (EK32), 21J.F.T. 460 kcs. etc., in metal case 8½" x 6½" x 6½".

ASK FOR SMJH299. **35/-** Each POST PAID

Conversion Data 1/6. In Transit Case.

POWER UNIT TYPE 266. Input 80V. 1.5 K/cps. A.C. Output H.T. 120V. D.C. bias 3 and 9V. L.T. 2V. Smoothed and stabilized. Complete with 5U4G valves, VC110 stabilizer, 12V. 1A. metal rectifiers, etc., etc. In attractive metal case with handles.

Dim.: 11" x 9½" x 7½".

ASK FOR SMJES70. **22/6** Each CARRIAGE PAID

PLEASE NOTE. Carriage and Postal Charges refer to the U.K. only. Overseas freight, etc., extra.

Order direct from

Tel.: South 270619

CLYDESDALE SUPPLY CO., LTD.

2 BRIDGE STREET, GLASGOW, C.5

Southern Radio's Wireless Bargains

TRANSRECEIVERS. Type "38" Mark II (Walkie-Talkie). With 5 valves and ready for use. Metal carrying case. Less external attachments. **30/-** per set

TRANSRECEIVERS. Type "18" Mark III. Comprising Superhet Receiver and Transmitter. Two units contained in metal carrying case. Complete with 6 valves **£4/10/-** per complete set

RECEIVERS. Type "109." Built-in speaker. 8 Valves with VIBRATOR PACK for 6 volts. Contained in metal case. Perfect **£5** each to clear

TELESONIC 4-valve Battery Portable. Complete with Hivac valves in metal carrying case. Simply converted to Personal Portable **£2** per set including Conversion Sheet

BOMBSIGHT COMPUTERS. BRAND NEW ex-R.A.F. Contains gyro, motors, rev. counters, gear wheels, etc., etc. Ideal for model makers, experimenters, etc. **£3/5/-** each plus 10/- carr.

CRYSTAL MONITORS. Type 2. New in transit case. Less crystals **7/6** each

LUFBRA HOLE CUTTERS. Adjustable ¼ to 3½ in. For metal, wood, plastic, etc. **6/6**

RESISTANCES. 100 Assorted, all useful values, etc. Wire end **12/6** per 100

CONDENSERS. 100 Assorted. Mica, Metal, Tub., etc. 15/- per 100

PLASTIC CASES. 14in. by 10½in. Transparent. Ideal for maps display, etc. **5/6**

STAR IDENTIFIERS. Type I A-N. Covers both Hemispheres, in case **5/6**

CONTACTOR TIME SWITCHES. In soundproof case, 2 impulses per second. Thermostatic control. Clockwork movement **11/6** each

REMOTE CONTACTORS for use with above **7/6** each

DIMMERS. Wire wound in bakelite case **1/3** each ; **12/-** doz.

TRANSMITTERS. Type 1154. Brand new. Complete with meters and valves in transit case **37/6** each

CONVERSION KITS for 1154 Transmitters. New **10/-** each

METERS. 12 Instruments. May need adjustment or with broken cases **35/-** for 12

Postage or carriage extra. Full List of Radio Books, 2½d.

SOUTHERN RADIO SUPPLY LTD.
11, LITTLE NEWPORT STREET, LONDON, W.C.2.
GERrard 6653

HOME RADIO OF MITCHAM

FOR

EDDYSTONE

RECEIVERS AND COMPONENTS

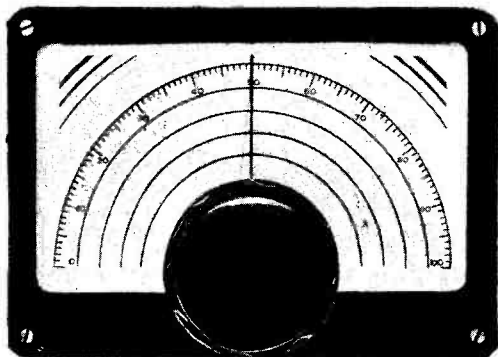

FULL VISION DIAL No. 598. The epicyclic ball bearing drive mechanism is smooth and free from backlash and has a reduction ratio of approximately 10 to 1. Escutcheon measures 6" x 4½", in ripple black finish. Scale 0-100 over 180. Spare scales included. PRICE 24/6.

Available direct from :

HOME RADIO

187, LONDON ROAD, MITCHAM, SURREY. MIT. 3282.
Fully illustrated EDDYSTONE Catalogue, 1/3 post paid.

Smith's

of

EDGWARE ROAD

for High Stability Resistors by Welwyn,
E.M.I., Dubilier

| | | | |
|---------|------|------|-----|
| | 5% | 2% | 1% |
| ¼ watt. | 7½d | 10½d | 1/3 |
| ½ watt. | 9d | 1/- | 1/6 |
| 1 watt. | 10½d | 1/3 | 1/9 |
| 2 watt. | 1/- | 1/6 | 2/- |

Send for List of over 300.

H. L. SMITH & CO. LTD.

287/9 Edgware Road, London, W.2.

Tel. Paddington 5891. Hours 9 till 6 (Thursday 1 o'clock).

Near Edgware Road Stations, Metropolitan and Bakerloo.

SAMSONS

SURPLUS STORES

30ft. **AERIAL MAST.** Type 55. Comprising of 9 Ashwood sections, and 1 metal mast top section with aerial clamp attachment. Complete with base plate, guys and rings. Dia. of first section 1½", dia. of top section ½". Supplied New in Makers Transit cases with instructions 65/-, carr. 5/-.

12in. **Copper Plated AERIAL RODS.** Push-in sleeve joint, 8/6 per half gross, 15/- per gross. P.P. 1/6. Special Price for larger quantities; very useful to gardeners. **AMAZING OFFER!** First Time on Surplus Market, **MINIATURE ACCUMULATORS**, made by Willard & Co., 36v. 0.2 AH. size 3¾" x 1¾" x ¾", weight 5½oz., 5/-, P.P. 6d. 6v. 1.2AH., size 3¾" x 1¾" x ¾", weight 4½oz., 7/6, P.P. 6d. or set of three, 36v. and one 6v. in sealed container £1, P.P. 1/3. Brand new and uncharged, easily filled with hypodermic syringe. Brand New Ex.-Govt. Hypodermic Syringes, 2cc. complete with 1 needle, 4/9, P.P. 6d. Extra Needles, Box of 6, 2/6. 10cc. Syringes with 1 Needle, 7/6 P.P. 6d. **STORAGE BATTERIES**, New and Uncharged. Pritchett and Gold. 12v. 75AH. Built in teak cases, £4/10/6, Carr. 7/6. 6v. 100-125AH, £4/19/6, carr. 7/6. Exide 10v. 5AH. **GLASS ACCUMULATORS.** Suitable for model work or HT unit construction, 8/6, P.P. 1/6. **FIELD TELEPHONES**, Type D5. Complete with hand set and batteries, buzzer calling. Built-in strong metal containers, £5 per pair. Telephone Cable D.3 single. 1 mile drums, 55/-, carr., 5/-.

Commando Assault Telephone Cable P.V.C., very useful for the garden, 15/-, per 1000 yard drum, P.P. 2/6. Admiralty Sound Powered Telephone Hand Sets, No Batteries required, 35/- per pair, P.P. 2/-.

169/171 EDGWARE ROAD

LONDON, W.2. Tel : PAD. 7851

125 Tottenham Court Road, W.1. Tel : EUS. 4982
All orders and enquiries to our Edgware Rd. branch please.
Open All Day Saturday at the Edgware Road Branch.

ELECTRADIX BARGAINS

TRANSFORMERS double wound 230 volts input 12 volts 8 amps output, 30/-, post 2/6. 440 volts 50 cy. input 220 volts 2.2 K.W. output tapped every 25 volts, £9/15/-, carr. extra. 200/240 volts input 270-0-270 volts 6.3 volts 2 amps 5 volts 2 amp., 14/-, post 2/-.

VARIABLE WIRE WOUND RESISTANCES. 5.3 ohms 8 amp. geared movement 45/- other sizes not exceeding 350 watts with geared movement 45/- 30 ohms 3 amps., 30/-.

MOTOR ALTERNATORS 28 volts D.C. input 150 volts 3-phase 400 cycles output, as new and unused. 24 volts input 115 volts 7 amps. 800 cycles 5.P. output 110 volt D.C. input 68/125 volts 1½ K.W. 500 cycles output. 220 volts 9 amps. input 68/125 volts 500 cycles 1½ K.W. output. Prices on application.

FLEXIBLE SHAFT. 7ft. long; new surplus, 5/6, post 1/-.

ROTARY CONVERTERS 24 volts D.C. input 230 volt 200 watts A.C. 50 cycles output, £10, carr. 10/-.

110 volts D.C. input 230 volts 200 watt A.C. 50 cycles output, £12/10/-.

24 volts input 230 volts 100 watts A.C. 50 cy. output, 90/-, carr. 5/-.

TERRY ANGLEPOISE LAMPS for drawing board or workshop will stay in position; for wall or machine mounting; S.B.C. Lampholder, shade and flex, 35/-, post 2/6.

Telephone : MACaulay 2159

Dept. B. 214 Queenstown Road, Battersea, London, S.W.8.

WORLD RADIO HANDBOOK

A extended and improved edition—the eighth—is now ready. In its preface highly recommended by the UNITED NATIONS and UNESCO.

The new edition of WRH is the best ever published, containing a lot of new short wave stations, with all medium-wave and television stations.

WRH opens a new world for you and is the only complete guide to the short wave services of the world.

LISTEN TO THE WORLD WITH THE NEW EDITION OF WORLD RADIO HANDBOOK

Extended and Improved

Published by O. Lund-Johansen

Price : 9s.

136 pages.

EARN A PROFIT FROM YOUR HOBBY AT HOME

Fortiphone Ltd. need a few good radio amateurs who will undertake fault-finding and modifications at home, to sub-miniature amplifier chassis, such as are used in hearing aids.

Generous piece rates and instruction are offered, and men with experience have earned as much as a pound an hour.

Please telephone Rodney 6166, or write to the :—

Senior Engineer,
FORTIPHONE, LTD.,
27, ADDINGTON SQUARE,
LONDON, S.E.5.

In full swing !!!

Those on the look-out for full value for their money are getting it at

The Walk-around Shop

which we recently opened at

52, TOTTENHAM COURT ROAD, LONDON, W.1.

(A few minutes from Lyons Corner House)

If you have not yet paid us a visit, come along as soon as possible and inspect the wide range of surplus lines displayed, including :—

RADIO EQUIPMENT — RECEIVERS — TRANSMITTERS — COMPONENTS ETC. — LABORATORY INSTRUMENTS — ELECTRICAL ACCESSORIES — AIRCRAFT SUNDRIES, ETC.

RECEIVER UNIT Ex 1143A

Suitable for conversion to 2 metres or F.M. Wrotham transmissions.

Valve line-up: (4) EF50. (1) EL32. (2) EF39. (1) EBC33. (1) EA50. Supplied with circuit diagrams.

PRICE 9/- Post Paid
(less valves)

It will pay you to pay us a visit

PROOPS BROS., LTD. LAngham :
52 Tottenham Court Road, W.1. 0141
OPEN ALL DAY SATURDAY Shop Hours : 9 a.m.-6 p.m.

SMALL ADVERTISEMENTS

9d. per word, minimum charge 12/-. No series discount; all charges payable with order. Insertions of radio interest only accepted. Add 25% for Bold Face (Heavy Type). No responsibility accepted for errors. Replies to Box Numbers should be addressed to The Short Wave Magazine, 55 Victoria Street, S.W.1.

OFFICIAL APPOINTMENTS

TECHNICIANS, GRADE I (RADIO) required by **EAST AFRICAN POSTS AND TELECOMMUNICATIONS ADMINISTRATION** on probation for pensionable employment. Salary scale (including present temporary allowance of 35% of salary) £742, rising to £1,134 a year. Outfit allowance £30. Free passages. Liberal leave on full salary. Normal tour 4 years. Candidates should possess a thorough practical knowledge of the working and maintenance of modern HF radio telegraph equipment and VHF multi-channel radio-telephone equipment. G.P.O. staff should apply through departmental channels.—Write to the Crown Agents, 4 Millbank, London, S.W.1. State age, name (in block letters), full qualifications and experience, and quote M2C/32424/SQ.

WIRELESS STATION SUPERINTENDENTS required by the **NIGERIA Posts and Telegraphs Department** for one tour of 18 to 24 months in the first instance. Option of appointment (a) on temporary terms with salary scale (including Expatriation pay) £864, rising to £1,392 a year. Gratuity at the rate of £100/£150 a year; or (b) with prospect of pensionable employment with salary scale (including Expatriation pay) £750, rising to £1,175 a year. Outfit allowance £60. Free passages for officer and wife. Assistance towards cost of children's passages or grant up to £150 annually for maintenance in U.K. Liberal leave on full salary. Candidates must have had wide practical experience of modern radio techniques and equipment, in particular V.H.F. equipment, and preferable also V.H.F. multi-channel equipment.—Write to the Crown Agents, 4 Millbank, London, S.W.1. State age, name (in block letters), full qualifications and experience, and quote M2C/30086/SQ.

TRADE

QSL's and LOGS by **MINERVA**. The best there are.—Samples from Minerva Press, 48 Queen's Road, Brentwood, Essex.

WANTED: TUNING UNITS TN17, TN18, TN19, and R54/APR4; £50 each offered.—Box 1383, Short Wave Magazine, Ltd., 55 Victoria Street, London, S.W.1.

WANTED: BC610 Hallicrafters, ET4336 Transmitters, AR88D's and LF's, receivers and spare parts for above; also BC221 Frequency Meters. Best prices.—P.C.A. Radio, Beavor Lane, Hammersmith, W.6.

WANTED: RCA Speech Amplifiers, type M1-11220 J or K, and aerial tuning units BC939A.—Offers, stating quantity and price, to P.C.A. Radio, Beavor Lane, Hammersmith, W.6.

QSL CARDS AND LOG BOOKS. APPROVED G.P.O. SAMPLES FREE.—ATKINSON BROS., PRINTERS, ELLAND, YORKS.

HRO COILS wanted for 3.5, 7, 14, 21, 28 mc bandspread. Your price paid. "Urgent."—GW5TJ, 6 Fairview Terrace, Merthyr Tydfil, Glam.

SMALL ADVERTISEMENTS, TRADE—*continued*

VALVES (over 3,000 in stock): 6AM6, EF92, 6AL5, EAC91, 1L4, 5/-; 12AT7, 12AX7, 6CH6, 6AK5, 6BW6, 6J6, 6F33, 6BR7, EC91, EL91, CV284, CV286, 85A1, 85A2, 7/6; 12AU7, 12E1, 6SN7, 6SL7, 6SJ7M, R10, 9/-.—Skillman, Franchise Street, Weymouth.

READERS' ADVERTISEMENTS

3d. per word, min. charge 5/-. payable with order. Box Numbers 1/6 extra. Replies to Box Numbers should be addressed to The Short Wave Magazine, 55 Victoria Street, S.W.1.

SALE, cheap: De Luxe Top Band Transmitter; S Phone/CW; complete. Double Superhet (85 kc. 2nd IF), 31 mc-50 kc. Many Valves: 813, TZ40, 35T, 931, etc.—Enquiries, Box 1496, Short Wave Magazine, Ltd., 55 Victoria Street, S.W.1.

HRO STANDARD, in magnificent condition, as new; 9 coils bandspread in National fitted container; AC and battery power-packs; variable noise limiter; handbook; 9 spare valves. Not a gift, but a superlative outfit unmodified and in perfect alignment. £45, delivered. — G2AC, Sleepy Hollow, Headley, Bordon, Hants.

DX PHONE Tx. Three-band, Rx and all equipment: Dual 3-Element Rotary Beam (35-foot pole and ladder if required). Over 130 countries worked. £30 for quick sale (buyer collects).—Kings Langley 2804.

WANTED: Tx 40/100-watts Table Model for 7, 14, 21, 28 mc; VFO and crystal; Phone/CW, P/Pack complete.—Write details to VQ5DM, 114 Cygnet Avenue, Feltham, Middlesex.

EDDYSTONE 750 for sale; brand-new condition; complete with S-meter, L/S and a number of spare valves. Delivered London area. £45 (o.n.o.).—G3INC, 72 Torrington Road, Ruislip Manor, Middx.

SALE: AR77E, with book; excellent working order, nice condition; price £25 (buyer collects). Also *Wireless Worlds* for sale.—R. W. Hewetson, 20 Terront Road, Tottenham, N.15.

VF0 80, 40, 20, 15, 10 metres; professionally built; 9" flywheel dial; complete with power-pack, black wrinkle cabinet; in perfect condition; £10. **W**ANTED: Six TZ40's, new, and 100-yard coil Talcon RU29 100-ohm twisted feeder. Sample supplied.—G3HLS, 21 Park Avenue, Farnborough Park, Kent.

TX 80/40/20/15 metres; 1625 PA and switched turret, modulator, batt. bias; all in black crackle cabinet. Commercial appearance; £6 10s. 0d. (o.n.o.).—Hinton, 11 Wellington Road, Bulford Camp, Wilts.

AR 88 LF for sale; superior condition; internal S-meter, manual; recently overhauled, but exchange arrangement for AR88D or Eddystone 680 preferred by MW listener.—Write any time, Read, 24 Broughton Gifford, Melksham, Wilts.

FOR SALE: Hammerlund Super Pro, 210LX, rack mounting; separate power unit; first-class condition; £27 10s. 0d. Also other ham-gear for sale. — F. G. Hamshere, 55 Maclean Road, West Howe, Bournemouth, Hants.

VALVES: 6J4, S130, 6/-; 35T, 10/-. Xtals: 1917 kc, 5257 kc, 9/6.—Hill, 5 Sussex Road, North Heath, Erith, Kent.

"Go to it" —
To become a speedy and highly efficient W/T Operator there is no better way than **—the CANDLER way**

The Candler system of Morse Code Training was devised for those who desire to enter or have entered the commercial side of telegraphy, the Services or who take a real interest in Amateur Radio work.

Read this extract from a letter sent us by a student taking the Junior Course.

"I am pleased to inform you that my progress is most satisfactory, even at this early stage I am quite certain this course will give me the standard required for radio operating. With only one month of work, or should I say interesting pleasure, I have been taught more than I ever learned in my A.T.C. and R.A.F. days" J.V.R.

Special Course covers Code training for Amateur Transmitting Licence.

The Junior Course is a complete Code Course for the Beginner.

The Advanced Course is for those with sending and receiving speed of not less than 15 w.p.m. who desire to improve their speed and accuracy in code work.

Courses supplied on Cash or low Monthly Payment Terms.

Send for the **CANDLER "BOOK OF FACTS"** It gives full details of the above training.

THE CANDLER SYSTEM CO.

(55SW) 52b. ABINGDON ROAD, LONDON, W.8.

Candler System Company, Denver, Colorado, U.S.A.

**Wanted for Cash**

All types of American Equipment. Communication Rxs. A.R.88s S.X.28s. Hallicrafters, B.C.221s, B.C.348s. Test Gear. Sig. Gens. Oscilloscopes. Valve Testers. Tape Recorders. Portable radiograms. 3-speed players, etc., etc. Highest price in the trade paid, call, send or write, every letter or enquiry answered, all goods forwarded will receive personal attention, cash forwarded by Telegraphed money order as soon as offer is accepted. Send to Dept. "S"

Miller's Radio

38a Newport Court, Charing Cross Road.

Close Leicester Square Tube Station, London W.C.2. Established 20 years
Phone Ger 4638. Ham 0713.

THE WORLD'S GREATEST BOOKSHOP**FOYLES**
FOR BOOKS

Huge stock of new, secondhand and rare Books on Radio and Allied subjects.

Foyles have departments for Music, Records, Handicraft Tools and Materials and Stationery.

Subscriptions taken for British, American and Continental radio magazines.

119-125 CHARING CROSS RD., LONDON, W.C.2

Gerrard 5660 (16 lines) ▼ Open 9-6 (inc. Sats.)

Nearest Station: Tottenham Court Road

F.M. !! (Frequency Modulation)

We are pleased to announce our complete Kit for the "Denco" F.M. Feeder Unit. This unit provides an A.F. output suitable for feeding into the audio section of a standard broadcast receiver where triode type output are available. Within an average of 30 miles from a V.H.F. transmitter one I.F. stage should be adequate, but our complete Kit supplied includes all components and valves for an extra I.F. stage if necessary, or if the unit is used at greater distances. Full Constructional details, theoretical circuit, and point-to-point wiring diagram can be supplied for 1/4 post free, or the complete Kit right down to the last nut and bolt, at only £6/7/6, plus 2/6 packing and postage. This unit can be supplied, if desired, ready assembled, aligned and tested, at £8/10/-, plus 2/6 p. and p. If required we shall be pleased to align this unit for constructors not possessing the necessary equipment for a charge of 7/6. N.B.—Valve line-up is 6AM6, 12AH6, 2-6BA6 and 6AL5. Chassis measures only 6 1/2 in. x 5 1/2 in. x 1 1/2 in. Demonstrations at 18, Tottenham Court Road !!

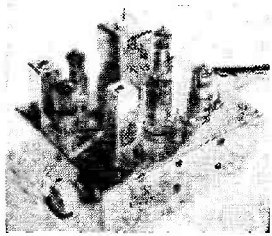

METERS

| F.S.D. | Size | Type | Fitting | Price |
|--------------|---------------|--------|-------------------------------|-------|
| 50 microamp | D.C. 2in. | M.C. | R.P. | 50/- |
| 250 microamp | D.C. 2 1/2in. | M.C. | F.R. | 40/- |
| 500 microamp | D.C. 2in. | M.C. | R.P. | 13/6 |
| 500 microamp | D.C. 2in. | M.C. | F.R. | 18/6 |
| 500 microamp | D.C. 2 1/2in. | M.C. | F.R. | 35/- |
| 1 mA. | D.C. 2in. | M.C. | F. Sq. | 17/6 |
| 1 mA. | D.C. 2in. | M.C. | F. Sq. (scale calib. 1.5 kV.) | 15/- |
| 1 mA. | D.C. 2 1/2in. | M.C. | F.R. | 22/6 |
| 1 mA. | D.C. 2 1/2in. | M.C. | Desk Type | 27/6 |
| 5 mA. | D.C. 2in. | M.C. | F. Sq. | 7/6 |
| 10 mA. | D.C. 2in. | M.C. | R.P. | 7/6 |
| 10 mA. | D.C. 2 1/2in. | M.C. | F.R. | 10/- |
| 15 mA. | D.C. 2in. | M.C. | F.R. | 7/6 |
| 20 mA. | D.C. 2in. | M.C. | F.R. | 7/6 |
| 50 mA. | D.C. 2in. | M.C. | F. Sq. | 8/6 |
| 150 mA. | D.C. 2in. | M.C. | F. Sq. | 7/6 |
| 200 mA. | D.C. 2in. | M.C. | R.P. | 10/- |
| 500 mA. | D.C. 2in. | M.C. | R.P. | 6/6 |
| 500 mA. | D.C. 2 1/2in. | M.C. | F.R. | 8/6 |
| 0.5 amp. | R.F. 2in. | Thermo | F. Sq. | 4/6 |
| 1 amp. | R.F. 2 1/2in. | Thermo | R.P. | 10/- |
| 3 amp. | R.F. 2in. | Thermo | F. Sq. | 6/- |
| 5 amp. | D.C. 2in. | M.C. | F. Sq. | 13/6 |
| 6 amp. | R.F. 2 1/2in. | Thermo | F.R. | 7/6 |
| 20 amp. | D.C. 2in. | — | R.P. (with shunt) | 10/6 |
| 50-0-50 amp. | D.C. | M.C. | F. Sq. | 7/6 |
| 15 volt | D.C. 2 1/2in. | M.C. | F. Sq. | 10/6 |
| 20 volt | D.C. 2in. | M.C. | F. Sq. | 7/6 |
| 15-0-15 volt | D.C. 2 1/2in. | M.C. | F.R. | 17/6 |
| 150 volt | D.C. 2in. | M.C. | F.R. | 15/- |
| 300 volt | D.C. 2in. | M.C. | F. Sq. | 8/6 |

R.P. = Round projection
F. Sq. = Flush Square
F.R. = Flush Round

Thermo = Thermo-couple
M.C. = Moving Coil

RI155A RECEIVERS guaranteed serviceable in original packing cases, £7/19/6. Fully assembled Power Pack and output stage, to plug straight into RI155 for A.C. 200/250 volts, at 79/6. We have a few brand new RI155A at £11/19/6, also in original packing cases—Deduct 10/- if purchasing either receiver together with power pack. Plus 10/- packing and cage.

TI154 TRANSMITTER UNIT. Medium/highpowered for C.W.-M.C.W./R.T. 3 ranges, 10-5.5 Mc/s, 5-3.3 Mc/s, 500-200 Kc/s. Absolutely complete; 4 valves, 2 meters, hundreds of resistors, condensers, etc., in wooden transit case. Price 39/6, plus 7/6 carriage and packing.

R.F. UNITS. All new condition and complete. Case size, 9 1/2 in. x 7 1/2 in. x 5 in.
Type 24—20-30 Mc/s, 15/-
 Switched Tuning. Type 25—30 Mc/s, 19/6
 Switched Tuning. Type 27—65-85 Mc/s, 45/-
 Variable Tuning.
 We have a limited supply of RF27 new condition and complete, but tuning dial damaged. Price 39/6 each only. ALL these units Post Free !!

METER SPECIAL! We have a limited quantity of aircraft electrical thermometers. Brand new, by Weston. 2in. moving coil meter, flush square fitting. These meters have a luminous scale graduated 40-140 degrees centigrade, but the full scale deflection is approximately 150 microamps! Price 12/6 each only, plus 1/- P. & P.

LIGHTWEIGHT CRYSTAL HEADPHONES. Brand new, by Roethermel. List price 70/-. Our Price 25/- 1 Limited supply.

HEADPHONES. Brand new, ex-Govt., by S. G. Brown. Type CLR. Low resistance, 7/6 per pair. Type CHR, high resistance, 12/6 per pair. We can also supply very good light weight high resistance phones by Trimm, at 15/- per pair.

L.T. TRANSFORMER — AD-MIRALTY. Heavy duty type, 180/230v. input, 4.2v. plus 4.2v. at 10 amp. 25/- only plus 1/6 P. & P.

Staff Call Sign:
LIONEL E. HOWES, G3AYA

Please add postage under £1. C.O.D. or Cash with order. C.O.D. charge extra. Open 9 a.m.-6 p.m., Monday to Friday. Sorry, but we close at 1.0 p.m. on Saturday.

CLYNE RADIO LTD

18, TOTTENHAM COURT ROAD, LONDON, W.1.
 MUS. 5929/0095.

SMALL ADVERTISEMENTS, READERS—continued

FOR SALE: BC312M. Hallicrafter S38B. Sky Buddy, RA-10-DB, Canadian No. 9, Tran-Rec 58. Canadian R193. National 1-10. R1155. CR100. R.C.A. Amplifier, MI-11220, with mike. BC221 p-pack. BC906. "Editor" Tape Recorder. Beam Motor, Car Radio. AVO 40; s.a.e.—R. Wright, 18 Kent Road, Atherton, Nr. Manchester. Lancs.

SN TRF Rx. Stand-by/Portable; covers up to 30 mc with spread; works batteries or baby pwr.-pk.; £3; s.a.e. partics.—Box 1497, Short Wave Magazine, Ltd., 55 Victoria Street, London, S.W.1.

FOR SALE: SCR 522 Tx; mint condition. Two 2kW Variacs, good condition; 1kW Variac slightly damaged but O.K. Hallicrafters HT7 Frequency Standard, with power supply; Type A. Mark III, Transceiver. AC or 6 volts, complete; also Type A Mark III Transceiver, AC but less vibrator pack; Receiver R2/ARR3 with 28-volt rotary supply; Type 18 Walkie-Talkie, complete, less batts.—Offers for any of the above to: GM4PW, Sunnybank, Ayr Road, Prestwick, Scotland.

R1155, good condition; separate power-pack/output stage; modified for wide/narrow band; £11 (carriage paid).—B. J. Fowler, 10 Priory Close, Bebbington, Cheshire.

CR100, no modifications. £26; 15 6V6GT, £3; 4 new KT66, £2.—Box 1498, Short Wave Magazine, Ltd., 55 Victoria Street, S.W.1.

COMPLETE STATION for sale: Rx CR100, mint condition; S-meter; Tx, CW/Phone; VFO and Xtals; 140-watt band switched with power supply. AC mains.—Offers to: GM3DGD, Dickie, 6 Dunedin Terrace, Clydebank, Glasgow.

AVO 40, good condition. £8; RF25, 10/-; 5Y3G (U50), 6SA7, 6SG7 (2), 5/- each, post free.—Atkinson, 29 Plains Lane, Elland, Yorks.

WANTED by Amateur: Good-class American Communications Receiver, Transmitter; freq. meter, 809, TZ40, 6SQ7 valve.—Box 1499, Short Wave Magazine, Ltd., 55 Victoria Street, London, S.W.1.

HALLICRAFTERS SX71 Communications Receiver (one of America's latest); two HF signal generators, type 804 and 1/222A. Lampkin Laboratories freq. meter. All American.—Offers each, or lot: Box 1500, Short Wave Magazine, Ltd., 55 Victoria Street, London, S.W.1.

BC342 RECEIVER with auto transformer; usual modifications; any trial; in continuous use; £14.—Further details, G3IDW, 136 Beech Avenue, Swindon.

HRO FOR SALE; table model; nine coils, 697 packs; speaker reasonable condition. Offers?—Wallace, Hillside, Derby Road, Worksworth, Derbyshire.

DELCO (U.S.A.) Petrol Electric Set, 12v., 200 watts, self-starting; Hallicrafters SX24. Rx 1131 PA power deck; Marconi B21A Rx; Packard Bell K1 audio amplr.; BC453 Q5'er for BC348; TUSB VFO TU5B, as per QST (2); power-pack type S451B. 175v., 60 mA, 12v.; SCR-522, less choke and mod. transformer; EMI GDO Model 407, 1.5 to 30 mc. Offers or exchanges considered.—G3DMO, 3 Queen Street, Great Harwood, Blackburn, Lancs.

WANTED: Communications Receiver, general coverage, 540 kc-30 mc; must be good appearance and good order; £15-£20 offered.—Tyrrell, 70 Middlefield, Ormsgill, Barrow-in-Furness, Lancs.

SMALL ADVERTISEMENTS, READERS—*continued*

BELLING TV MULTI-ROD. S.C., 35/-; 3-805. £1 each; American D104 mike. 70A. high-gain mod. unit, 10 watts, all valves and mod. trans., £5; Eddystone Ham Two, all mains, with coils and power-pack. £5. WANTED: T17 Carbon Mike.—Box 1501, Short Wave Magazine, Ltd., 55 Victoria Street, London, S.W.1.

SX 24, £15; Oscillator 37, £5 with manuals; Woden 60-watt Amplifier, £6. Offers (or exchange Tape Recorder).—Edwards, 89 Victoria Road, Birkenhead.

WANTED: *Bulletin*, July 1926; *CQ*, January, March, June, November, December 1945, May 1946; *Radio* before 1936; *R/9* before April 1935; *QST* before 1924; *Radio Ref.*, April 1935; any *QTC. Ham Chatter. Radio ZS.* many *Amateur Radio. Break-in. Xtal. I.R.T.S. News. QRV. QMF. Hints/Kinks*, Vols. 1-2; *Calling CQ* (de-Soto); *R.S.G.B. Guide*, 1934.—G3IDG, 95 Ramsden Road, London, S.W.12.

FOR SALE: BC342N, £15 (o.n.o.); buyer collects. WANTED: T.C.S. Tx.—G3IRP, 25 Love Lane, Morden, Surrey.

ARM Y 12 Transmitter, £20; first-class condition, perfect working order; buyer inspects and collects.—Lawn, 20 Croft Road, Godalming, Surrey.

WANTED: Cabinet for R1155 receiver, any condition; reasonable offer.—Pegler, 2 Shaftesbury Villas, Mutley, Plymouth.

TWO-METRE Rx, AC, 12 valves; also 3-element Yagi with 18/20 coax; carriage paid, £14.—Box 1503, Short Wave Magazine, Ltd., 55 Victoria Street, London, S.W.1.

SALE OR EXCHANGE: Wavemeter, Class D, No. 1 MK11, 6.3v. AC input; manual. Eddystone 640, matching speaker, manual; R.208, 10-60 mc. manual. Cash offers, or willing exchange all or part for CR100 in first-class condition. Cash adjustments if necessary.—Box 1502, Short Wave Magazine, Ltd., 55 Victoria Street, London, S.W.1.

HALLICRAFTER Sky Champion S20, perfect condition and appearance, £15; £2 deposit secures free personal delivery, 100 miles radius.—Shacklock, 22 Westgate Road, Rugby. (Tel. Rugby 4957).

HRO JUNIOR; factory re-engineered to use latest Mullard miniature valves; chrome panel, power-pack and four band-spread coils for amateur bands; superb performance. First £20.—90 Maesycoed Road, Cardiff.

EDDYSTONE 740, complete with speaker and phones, all perfect condition; carrying case; £30, delivered.—Lytleton, 20 Dartmouth Street, Burslem, Staffs.

HRO Rx Jnr., with valves (no coils), £4; HRO Power-Pack and Speaker, complete, £2 10s. 0d.; Power-Pack for 1132, £2 10s. 0d.; Rx1132, £2; VFO, 3 to 4 mc, £3, complete with power-pack; Tx completely encased, 4 decks with modulator, oscilloscope, detachable sides, 75 watts (needs attention), £15 or £25 the lot. Callers only (buyer collects).—G3AMN, 47 Essex Park, West Finchley, N.3.

HRO Power-Pack, Speaker, complete in rack; 11 coils (4 bandspread); perfect. Offers? Marconi CR100, noise limiter, stabilizer, tuning meter, excellent condition and performance, £20; 1224A, unmodified, as new, less batteries, £3 (buyer collects).—74, St. Augustine Road, Southsea, Hants. (After 6 p.m. or week-ends).

WE PAY TOP PRICES

FOR
AMERICAN SURPLUS
ELECTRONIC EQUIPMENT

LOOK AT THESE EXAMPLES

For equipment in good condition

| | | | | |
|-----------------------------|-----|-----|-----|------|
| Receiver R54/APR4, complete | ... | ... | ... | £200 |
| Transmitter ET4336 | ... | ... | ... | £110 |
| Test Set TS13 | ... | ... | ... | £100 |
| Frequency Meter TS175/U | ... | ... | ... | £80 |
| Frequency Meter BC221 | ... | ... | ... | £28 |
| Receiver BC348R | ... | ... | ... | £25 |

We pay similar remarkable prices for

Receivers. R111/APR5, R5/ARN7, AR88D, BC348, ARN5, CR91.

Transceivers. ARCI, TCS, BC800, RT1/APN2.

Transmitters. T11/APN3, ART13.

Indicators. ID17/APN3, BC1151, BC1152.

Test Sets. Any unit with prefix "TS" also IE19, I-208, BC713A/BC714.

Modulators. BC1091, BC1142.

Synchroniser. BC1148.

Power Units. RA34, RA42, RA62, RA88, RA90, MG149, PE158, DM28.

Tuning Units. TN17, TN18, TN19, TN54, TU57, TU58, TU59.

Control Gear. BC1150, BC1145, JB91, JB95, JB98, JB102, C45-ARCI.

And almost every American made unit even if not mentioned above.

Phone us immediately, transfer charge.

TO HAMS WHO PURCHASED BC348, BC342, BC312 etc. Post to us all the bits and pieces which you removed, i.e. plugs, sockets, dynamotors, etc. We will pay you several pounds for this junk. You need not write; just send it.

TO OVERSEAS BUYERS

We have the largest stock in Europe of American Government surplus electronic equipment and we would be pleased to quote by return of post against your enquiries. The following are a few examples only of the equipment which we can supply from stock.

| | |
|---------|------------------------|
| ET4336 | Transmitter |
| SCR720C | Search Radar, complete |
| BC348 | Receiver |
| ART13 | Transmitter |

Deal with the firm that has been established for twenty-five years.

ALTHAM RADIO CO.

JERSEY HOUSE, JERSEY STREET

MANCHESTER 4

Telephone: Central 7834/5/6

SMALL ADVERTISEMENTS, READERS—continued

PIONEER GENERATOR SET. Small portable. 110v., 50 cps., 600 watt. Complete with 600-watt auto transformer and 12-volt starting battery. All in excellent condition. Will run transmitters or TV receivers without mains. £30 (or exchange for best communications receiver.—Blake, Two Chimneys, Prah Sands, Penzance.

REASONABLE OFFERS. please, for newly-overhauled HRO in table rack with coil cabinet; AC mains unit, LS and nine coils; Type 53 Tx; 250 watts output, CW or Phone, 1.2-17.5 mc. Beam Rotator, very heavy duty, with outdoor multicore cable, magslips, etc. Set SCR522 Chokes and Transformers. 128 issues *QST*, November '35 to July '49; *Wireless World*, January '46 to July '54; *Electronics*, Feb. '46 to May '54. Delivery arranged. Seen S.W. London.—Box 1504, Short Wave Magazine, Ltd., 55 Victoria Street, London, S.W.1.

WANTED: Hallicrafter H.T.11; can be without valves and power supply.—Hocking, Sandycroft, Taplow, Bucks.

WANTED: Screening Can for AR88 RF section, £1 each offered. Output Transformers, No. K901666, 15/- offered. **WANTED:** BC221. Would exchange HRO, complete, for good specimen. **FOR SALE:** AR88 Handbooks, D and LF, 15/- each.—Box 1503, Short Wave Magazine, Ltd., 55 Victoria Street, London, S.W.1.

WANTED: S27 Receiver, BC221 frequency meter. **FOR SALE:** DST100 and HRO Receivers. Exchanges for above, cash adjustment either way. Also need: Q-Max Grid-Dip Meter.—Box 1506, Short Wave Magazine, Ltd., 55 Victoria Street, London, S.W.1.

FOR SALE: Four Hallicrafter Power-Packs, No. CHL2018L, for radio telephone; also one Hallicrafter radio telephone, fair condition; £40 the lot.—Box 1507, Short Wave Magazine, Ltd., 55 Victoria Street, London, S.W.1.

FOUR-VALVE Elprag Personal Radio, Eddystone S640, speaker and S-meter. Type 6 Amplifier with valves; 5ft. 6ins. standard rack. BC453 and 454. 350-volt. 50 mA, metered power unit; RF-26, EF-54, pre-amp; 33 yards 80-ohm coax. Various new valves. Reasonable prices.—G. W. Newton, 20 Ormesby Bank, Ormesby, Middlesbrough.

UHF VALVE TYPES wanted (or information locating source of supply): 2C36, 2C43, 2C37, CV178 (equiv. 3C27 or Marconi E.1458), 703A, GL446A, 6F4, 5648, 5675, 5764, 5765, 5766, 5767.—Write: Box 1509, Short Wave Magazine, Ltd., 55 Victoria Street, London, S.W.1.

BRAND-NEW Enclosed Rack Cabinet, four 10½" panels; depth 16"; £5 (buyer collects). 813's, 50/-; 35T's, 17/6 (post extra).—Surman, Lyncote, Coltsfoot Drive, Guildford.

WANTED: Handbook, etc, for 19 Set transmitter-receiver. Your price paid. Also accessories for the above.—D. Townsend, Paxford, Holly Road, Wilmslow, Cheshire.

FOR SALE: Std. Rack Transmitter, 6ft. high; 40 transmitter valves, weight 7 cwt. 1 qr., 813; best part CR100 with valves; large box miscellaneous equipment; £44. Must be sold. Will sell separately.—W. G. Penrice, 105 Mandeville Road, Aylesbury, Bucks. (Tel. 1032. After 7 p.m.)

TWO perfect Eddystone Receivers for sale: S504 at £23, and S640 at £17. Both checked and aligned. Money refunded if not satisfied. Going QRT.—Box 1508, Short Wave Magazine, Ltd., 55 Victoria Street, London, S.W.1.

BRAND NEW EX-GOVERNMENT AND SURPLUS VALVES

"A" Indicates original makers cartons. "B" indicates plain or Services Cartons.

| 2C26 | A | B | 617G | A | B | 7V7 | A | B | EC31 | A | B |
|-------|------|------|-------|------|-----|------|------|------|--------|------|------|
| 6AC7 | 4/9 | 4/3 | 6K7 | 7/6 | 6/6 | 9D6 | 7/9 | 7/9 | ECC31 | 7/9 | 7/9 |
| 6AG5 | 10/6 | 10/6 | 6K7G | 5/6 | 4/6 | 8D3 | 6/9 | 6/9 | ECC33 | 12/9 | 12/9 |
| 6AK5 | 8/6 | 8/6 | 6K7GT | 5/6 | 4/6 | 12C8 | 9/6 | 9/6 | ECC91 | 14/6 | 14/6 |
| 6F6G | 7/6 | 7/6 | 6Q7GT | 10/6 | 8/9 | 12H6 | 2/9 | 2/9 | ECH42 | 10/6 | 10/6 |
| 6H6 | 3/6 | 3/6 | 6SH7 | 5/6 | 5/6 | 80 | 8/9 | 8/9 | ECL80 | 10/6 | 10/6 |
| 6I5 | 6/6 | 6/6 | 6SK7 | 6/9 | 5/9 | 5654 | 10/6 | 10/6 | EF50 | 6/6 | 6/6 |
| 6I5GT | 5/6 | 5/6 | 6SK7 | 6/9 | 5/9 | 7193 | 2/6 | 2/6 | EF80 | 10/6 | 10/6 |
| 6I6 | 10/6 | 10/6 | 6V6G | 6/9 | 5/9 | EB34 | 2/6 | 2/6 | EF92 | 7/9 | 7/9 |
| 6J7 | 7/6 | 7/6 | 6X5GT | 8/6 | 8/6 | EB91 | 7/3 | 7/3 | IKT263 | 6/6 | 6/6 |
| | | | VU111 | 3/6 | 3/6 | | | | IRK34 | 2/3 | 1/9 |

Carbon Potentiometers 2M, 3M, 1/6 each; 100K, 6K & 5K, 1/3 each. **Wire-wound Potentiometers** 3K, 3W, 1/3 each 6Ω, 8W 2/- each. Coaxial cable, 80Ω, 6d. a yard. 6μF 2000 test. 1000 v.w. metal black condensers, 3/9 plus 1/- postage. **Electrolytics**, 2000 μF, 15v., 4/9; 50 μF, 50v., 2/6; 40 μF, 450v., 4/6; 32 μF 350v. 5/3; 32 μF 450v. 6/6; 32 μF 6/6; 32 μF 350v., 4/9; 16 μF, 450v., 2/9; 25μF 25v., 1/9; 32 μF, 450v. (large size, 2" diameter), 1/6. Best Quality **Sleeving**, black 1mm., yellow 1mm., red and blue 2mm., 2d. a yard. Green 1mm., 1/3d. yard. Send 3d. for full bargain list.

Please add postage to orders less than £1.

2a, BURNLEY ROAD

REED & FORD

AINSDALE SOUTHPORT

ADCOLA (Regd. Trade Mark) SOLDERING INSTRUMENTS



Reg. Design No. 860302

British, U.S. and Foreign Patents

Supplied for all volt ranges from 67v-230/250v. Meets every requirement for radio assembly, maintenance, telecommunications, etc. High Temperature. Quick Heating, Low Consumption, Light Weight.

| | | |
|---------|------|---------------------|
| 3/16in. | Dia. | Bit Standard Model |
| 1/4in. | Dia. | Bit Standard Model |
| 3/16in. | Dia. | Detachable Bit Type |

Sole Manufacturers: **ADCOLA PRODUCTS LTD.**

Head Office and Sales: **Gauden Road, Clapham High Street, London, S.W.4.** (MACaulay 4272).

G4GZ'S BARGAINS

VALVES: XH, XP, 2X2, VU120, VU111, 3/6 each, 3D6, 6AG5, 6C4, 6AL5, 6AM6, 6I6, 6I7G, 6K7G, 6F8, V5110A, 954, 955, 956, 15D2, AC6Pen, EF50, EF54, EC52, EF91, EF92, EB91, W77, Z77, 5/-, 6AC7M, KTW73, KTZ73, 6U5G, OZ4, 6Z4, 6/-, 6F6G, 6K7M, 6K7GT, 6G6G, EL32, 6K6G, 6CH6, 6/6, 12BE6, 12A6, 7C5, 6F7, 6I7M, 6V6G/GT, EF50(Syl.), X66, 6AK5, VR150/30, VR105/30, 35A, 1T4, 1R5, 15T, 6AT6, 6B16, 6B5T, 6B/W6, 6XSGT, 6SG7M, 6BA6, 6BE6, 6X4, 6SN7GT, 6SL7GT, 7/6, EL35(6L6G), 6Q7G/GT, U22, 12AT7, 12AX7, 5U4G, 5Z4G, 5Y3GT, 6K8G, 8/6, 807, 757, 1W4/350, 50L6GT, 9/-, 5763, 6SQ7M, CBL1, ECH35, 10/-, 6AG7M, 866A, ECH42, 12/6, 4304CA(834), 20/-, 35T, TZ40, HK24G, 808, 30/-, 805, 811, 832, 35/-, 813, 70/-, 829, 50/-, 829B, 70/-, 250TH, 120/-, GEC Germanium diodes 2/- each, 18/- doz. High note buzzers 6-12v. 3/9. Mica bypass .002mfd 5Kv wkg. 2/6 each. 5 for 10/-, TCC Can elects. 100mfd 450v. pk. wkg. type CE37PE, 5/6 each. Nylon loaded B9A V/HI/drs. with screens 2/6 set, 27/6 doz. 12v. lamp FW bridge rects. 8/- All goods despatched by return. Please add post/packing.

J. T. ANGLIN

160, CLEETHORPE ROAD, GRIMSBY, Lincs. Tel. 56315

BRASS, COPPER, BRONZE, ALUMINIUM, LIGHT ALLOYS
IN ROD, BAR, SHEET, TUBE, STRIP, WIRE

3000 STANDARD STOCK SIZES

H. ROLLET & CO., LTD.

6, CHESHAM PLACE, LONDON S.W.1.

StOane 3463

Works: 36 ROSEBERY AVENUE, LONDON, E.C.1.

Branches at LIVERPOOL, MANCHESTER, BIRMINGHAM, LEEDS

"No Quantity too Small"

USEFUL BOOKS

"Transistors Theory & Practise"

Price 16s. 6d.
post free

"Hints & Kinks"

A collection of ideas, circuits, workshop tips, short cuts, adaptations and suggestions — all tried and tested in practice — for the radio experimenter.

Vol. 5. Price 11s. 5d.
post free

"Mobile Handbook"

Probably the most comprehensive guide to practical /M operation yet published. All bands 160 metres to 10 metres are fully covered.

Price 17s. 6d.
post free

"How to Listen to The World"

For the SWL interested in short wave broadcast reception.

Price 1s. 11d.
post free

"Radio Amateur Call Book"

Foreign Edition excludes only American amateur stations. Otherwise complete with latest callsign-address listings for all countries, and including much DX data. In its 32nd year of publication.

Latest Edition 10s.
post free
27s. post free

COMPLETE EDITION

OTHER PUBLICATIONS FOR IMMEDIATE DELIVERY

| | Post Free | | Post Free |
|---|-----------|---|-----------|
| RADIO HANDBOOK 13th Edition | 49/6 | SURPLUS CONVERSION MANUAL Vol. 1 | 21/5 |
| ANTENNA HANDBOOK | 14/6 | Vol. 2 | 21/5 |
| ANTENNA MANUAL | 28/- | THE RADIO AMATEUR'S LICENCE MANUAL | 4/10 |
| HINTS AND KINKS Vol. 5 | 11/5 | HOW TO BECOME A RADIO AMATEUR | 4/10 |
| Vol. 4 | 7/6 | LEARNING THE RADIO TELEGRAPH CODE | 2/8 |
| HOW TO LISTEN TO THE WORLD | 1/11 | WORLD RADIO VALVE HANDBOOK | 11/10 |
| HAM'S INTERPRETER | 5/- | RADIO TUBE FUNDAMENTALS.. | 8/4 |
| POST-WAR COMMUNICATION RECEIVER MANUAL Vol. 1 | 28/6 | RADIO AND TV HINTS | 8/5 |
| Vol. 2 | 28/6 | RADIO AMATEUR CALL BOOK (Complete Edition) | 27/- |
| A COURSE IN RADIO FUNDAMENTALS | 4/10 | (Foreign Section)..... | 10/- |
| WORLD RADIO HANDBOOK 1954 Edition..... | 9/- | RADIO AMATEURS' MOBILE HANDBOOK | 17/6 |
| RADIO AMATEUR'S HANDBOOK 31st Edition, 1954 | 31/- | | |

MAGAZINES BY SUBSCRIPTION

| | One Year |
|---|--------------|
| Radio Electronics | 33/- |
| Popular Mechanics | 32/- |
| Radio Electronic Engineering Service | 56/- 24/- |
| F.M. and Television | 32/- |
| Electronics | 160/- |
| Popular Science | 32/- |
| Proc. I.R.E. | 152/- |
| RCA Review | 20/- |
| Tele-Tech | 80/- |
| Television | 48/- |
| Television Engineering | 32/- |
| CQ..... | 29/- |
| Audio | 29/- |
| Radio and Television News.. | 36/- |
| QST..... | 36/- |
| Transistor Research Bulletin | 40/- |

SHORT WAVE MAGAZINE

(PUBLICATIONS DEPARTMENT)

55 VICTORIA STREET • LONDON • S.W.1 • ABBEY 5341

HENRY'S

(RADIO LTD.)

We have over 20,000 American and B.V.A. valves in stock.

| SETS OF VALVES | |
|--|----------|
| Ten EF50 (Ex-Brand New Units) ... 5/- each ... | 45/- Set |
| 6K8G, 6K7G, 6Q7G, 5Z4G, 6V6G ... | 37/6 " |
| 1R5, 1S5, 1T4, S4, or (3S4 or 3V4) ... | 27/6 " |
| TP25, HL23/DD, VP23, PEN25 (or QP25) ... | 25/- " |
| 6K8G, 6K7G, 6Q7G, 25A6G, 25Z5 or 25Z6G ... | 37/6 " |
| 12K8GT, 12K7GT, 12Q7GT, 35Z4GT, 35L6GT or 50L6GT ... | 37/6 " |
| 12A7GT, 12S7GT, 12S9GT, 35Z4GT, 35L6GT or 50L6GT ... | 37/6 " |

CRYSTAL MICROPHONE INSERTS

8/6

POST FREE



8/6

POST FREE

Ideal for tape recording and amplifiers. No matching transformer required.

BRAND NEW R.F. UNITS

| | |
|-----------------|----------------|
| RF24 20-30 mc/s | 15/- post free |
| RF25 40-50 mc s | 19/6 post free |
| RF26 50-6_ mc/s | 35/- post free |

ALL VALVES NEW AND GUARANTEED

| | |
|--|------------------------------|
| 1A5GT 10/- 6AK5 9/- 35Z4GT 8/6 | TDD2A 8/6 D1 ... 2/- |
| 1A7GT 12/6 6I7G 6/6 35Z5GT 8/6 | DK40 ... 11/- AC6PEN 6/6 |
| 1NSGT 11/- 6K7G 6/6 25A6 ... 8/6 | UL41 ... 11/- PEN25 ... 6/6 |
| 1LD5 7/6 6K8G 9/- 35L6GT 8/6 | UY41 ... 11/- PEN46 ... 7/6 |
| 1R5 ... 7/6 6L6G 10/- 50L6GT 8/6 | D41 ... 5/- QP25 ... 6/6 |
| 1S5 ... 7/6 6U5 7/6 42 ... 8/6 | KT2 ... 5/- SP61 ... 4/- |
| 1T4 ... 7/6 6N7GT 7/6 43 ... 8/6 | U52 ... 8/6 SP41 ... 4/- |
| 1C5 ... 8/- 6S7GT 8/6 80 ... 8/6 | Y63 ... 8/6 HL23/DD ... 6/6 |
| 3A4 ... 9/- 6X5G ... 8/6 866A ... 15/- | MU14 ... 8/6 VP23 ... 6/6 |
| 3V4 ... 7/6 6SA7GT 8/6 TZ40 ... 37/6 | PCCB4 12/6 U22 ... 8/6 |
| 354 ... 7/6 6SQ7GT 8/6 931A ... 50/- | PCF82 12/6 ATP4 4/- |
| 5Z3G 8/6 6S7 7/6 EA50 ... 2/- | PL81 ... 11/- TP22 ... 8/6 |
| 5U4G 8/6 6SK7GT 7/6 ECH35 12/- | PL82 ... 10/- TH233 ... 10/- |
| 5Z4G 8/6 6SL7GT 9/- EF54 ... 6/6 | PX25 ... 12/6 41MP ... 7/6 |
| 6A7G 8/6 6SN7GT 9/- EB34 ... 3/6 | PY81 ... 10/- 42SP2 ... 6/- |
| 6AC7 6/6 6SC7 ... 10/- EBC33 8/6 | PY82 ... 8/6 2155G ... 4/- |
| 6ABG 8/6 6V6GT 7/6 EF36 ... 6/6 | KT33C 10/- MS/PEN 7/6 |
| 6AM6 9/- 6AC7 12/6 EF39 ... 6/6 | KU50 ... 12/6 MS/PENB 7/6 |
| 688 ... 7/6 12K7GT 8/6 EY51 ... 12/6 | GU50 ... 12/6 VT501 ... 7/6 |
| 6C5GT 5/- 12K8GT 8/6 EK32 ... 6/6 | XP2V ... 4/- AC/PEN(7) 10/- |
| 6C6 ... 6/6 12Q7GT 8/6 EF91 ... 9/- | XH (1.5) 4/- |
| 6D6 ... 6/6 12SA7GT 8/6 EL33 ... 10/- | VU111 4/- PENDD4020 12/6 |
| 6F6G 8/6 12SQ7GT 8/6 EL32 ... 7/6 | VU133 4/- |
| 6G6G 6/6 12S17 ... 8/6 EF50 7/6 | VU120A 4/- FC13C ... 10/- |
| 6H6GT 5/- 12S7 ... 8/6 Red Syl. 10/- | QP230 8/- VP4(7) ... 8/6 |
| 615GT 5/- 12SR7 ... 7/6 EF50 5/- | VR105/30 8/6 ID5 ... 8/6 |
| 616 ... 9/- 25Z6GT 8/6 SP2 ... 8/6 | VR150/30 8/6 EF80 ... 10/6 |
| 6L7 ... 7/6 25Z5 ... 8/6 VP2 ... 8/6 | CK510AX 5/- ECL80 ... 10/6 |

MORSE PRACTICE BUZZER

Complete with tapper and 4-volt buzzer on base board, 6/-, brand new. Post paid.

R.F. OSCILLATOR COIL UNIT

6-18 kv., including EY51 valve, 37/-

CRYSTALS

| | |
|---------------------------|----------|
| 200 kc/s, 2-pin (U.S.A.) | ... 10/- |
| 465 kc/s, 2-pin (U.S.A.) | ... 10/- |
| 500 kc/s, 2-pin (British) | ... 15/- |

T.C.C. 1 5/7,000 v. wkg. Type CP58QO, Bakelite Case, 7/6 each.

28-page Catalogue, 3d.

Open Mon.-Sat. 9-6. Thurs. 1 p.m.

5 HARROW ROAD, PADDINGTON, LONDON, W.2

TEL: PADDINGTON 1008/9, 0401.

INDICATOR UNIT TYPE 182A

This unit contains VCR517 Cathode Ray 6in. tube, complete with Mu-metal screen, 3 EF50, 4 5P61 and 1 5U4G valves, W/W volume controls, resistors and condensers. Suitable either for basis of T/V or Oscilloscope. "Radio Constructor" Scope constructional circ uit included. 67/6 (plus 7/6 carr.)

CATHODE RAY TUBES

| Brand New | |
|--|------|
| VCR97 (slight cut-off) ... | 15/- |
| VCR97, guaranteed full T/V picture ... | 40/- |
| VCR517C, guaranteed full T/V Picture ... | 35/- |
| VCR139A, guaranteed full T/V Picture ... | 35/- |
| 3BP1, guaranteed full T/V Picture ... | 30/- |
| Carr. and packing on all tubes, 2/- | |

DENCO F.M. FEEDER UNIT

Finest Audio available. Complete kit of parts, including drilled chassis. 5 valves: types 6AM6, 12AH8, EB91 and 2 6AB6. Also complete circuit and wiring diagram. £6/10/-. Or assembled and aligned, £8/10/-. Alignment only, 7/6. Demonstration daily.

G2AK

THIS MONTH'S BARGAINS

G2AK

Aids for Aerial Efficiency

COPPER WIRE. 14G. H/D. 140 feet. 15/-, 70ft. 7/6. Post and Packing 2/-. Other lengths pro-rata.

TWIN FEEDER. Special offer, 300 ohm flat twin, 150 watt rating. (Minimum 20 yards), 6d. yard, post free. Similar K25. K35B tubular 300 ohm 1/6 yard.

V.H.F. FANS THE BUY OF THE YEAR. Air spaced 150 ohm. Coaxial Cable, 20 yard coils, £1 each (Normal price 3/11 per ft.). VERY LIMITED QUANTITY.

STANDARD 1/70 ohm coax 9d. yard or in 25 yards or over 6d. yard. P. and P. 1/6.

GLASS INSULATORS 3" long 1/6, 8" long 3/-.

POCKET VOLTMETERS. Dual range. 0-15 and 0-250v. 345. O.P.V. M.C. worth 50/-, our price 17/6, post free.

PANL. HOME CRACKLE FINISH. Brown, black or green, 3/- per tin, packing and postage 8d.

PHILIPS CONCENTRIC AIR TRIMMERS. 8pf max 9d. each or 6/- doz. 30pf max 1/- each or 10/- doz.

STREAMLINED BUG KEYS by famous manufacturer. Listed over £4. OUR PRICE 45/- only.

RACK SIZE CHASSIS in 16 SWG. ALI. All 17" long, all 2 1/2" deep x 12", 16/6, x 10", 15/- and x 8", 14/6, P. and P. 1/-.

METERS. 0-9A Hot Wire, 2" Flush 0-4A Thermo, 20/0/20 amps, 5/-, 0-350 mA Thermo, 7/6, 0-100, mA and 0-10 mA 2 1/2" Flush, 12/6 each. 0-1 mA 2" square, 20/-, 2" square 0-10A D.C., 7/6. 0-50 mA 7/6 each 0-5A Thermo 2" round Flush, 7/6.

RACK MOUNTING PANELS. Black crackle finish, 19" x 5 1/2", 7", 8 1/2" or 10 1/2" at 5/9, 6/6, 7/6, 9/- respectively. Postage and packing 1/6.

GERMANIUM DIODES, 2/-, or 6 for 9/-.

HEADPHONES. Low resistance type CLR No. 3 9/6, DLR No. 2 13/6, high resistance CHR Mark 2 17/6 and the most sensitive of all DHR No. 5B 18/6 per pair. P. and P. 1/- per pair.

HIGH NOTE BUZZERS for practice, 5/-, Straight Keys, brand new, all metal, crackle finish, 5/-, Small round Buzzers, 2/-.

AR88 SPARES. Cabinets complete with side channels and base, £4/15/-, p. and p. 7/6. Complete valve kit (14), £5/10/-, RCA matching speaker, £3/5/-. Panel escutcheons, 22/6. "D" I.F.S. 12/6. Spare coils for some ranges only, 7/6 each. Output transformers to Government specification, 37/6.

SHADED POLE MOTORS. For Tape Recorders or Gram. Units, with voltage tapping plate 200/250 volts. 3-hole fixing. Our price 12/6 each or 21/- pair. Post and packing on either, 1/6.

SPECIAL VALVE OFFER. 1.4v. Midgrets. B7G base. IS4, IS5, IT4, IR5, 3V4, 354 all at 7/6 each or four for 27/6.

SPECIAL VALVE OFFER. 8012, 12/6 each. 6L6G, 10/6, 813, 70/-, 829, 60/-, 866a, 17/6 each or 30/- a pair. 807 10/- each or 17/6 a pair. 931A, 45/-, 832, 25/-.

FISK SOLARISCOPEs. Complete with charts. Give World time, light and dark paths, invaluable to the DX Man. List 21/-. Our Price 7/6, Post free.

THIS MONTH'S SPECIAL

GLASS CASED METERS

Hermetically sealed, NEW in original cartons. 0-1MA F.S.D. Scaled 0-1000v. or 0-3000v. Worth £4 each, our price

20/- Each
Post Free

CHAS. H. YOUNG, G2AK

MAIL ORDERS TO :- Dept. 'S' Please Print Your Name and Address.
102 Holloway Head, Birmingham MIDLAND 3254
ALL CALLERS TO :- 110 Dale End, Birmingham. CENTRAL 1635