

2/6

*The*  
**SHORT WAVE**  
*Magazine*

VOL. X

FEBRUARY, 1953

NUMBER 12

*Carte*

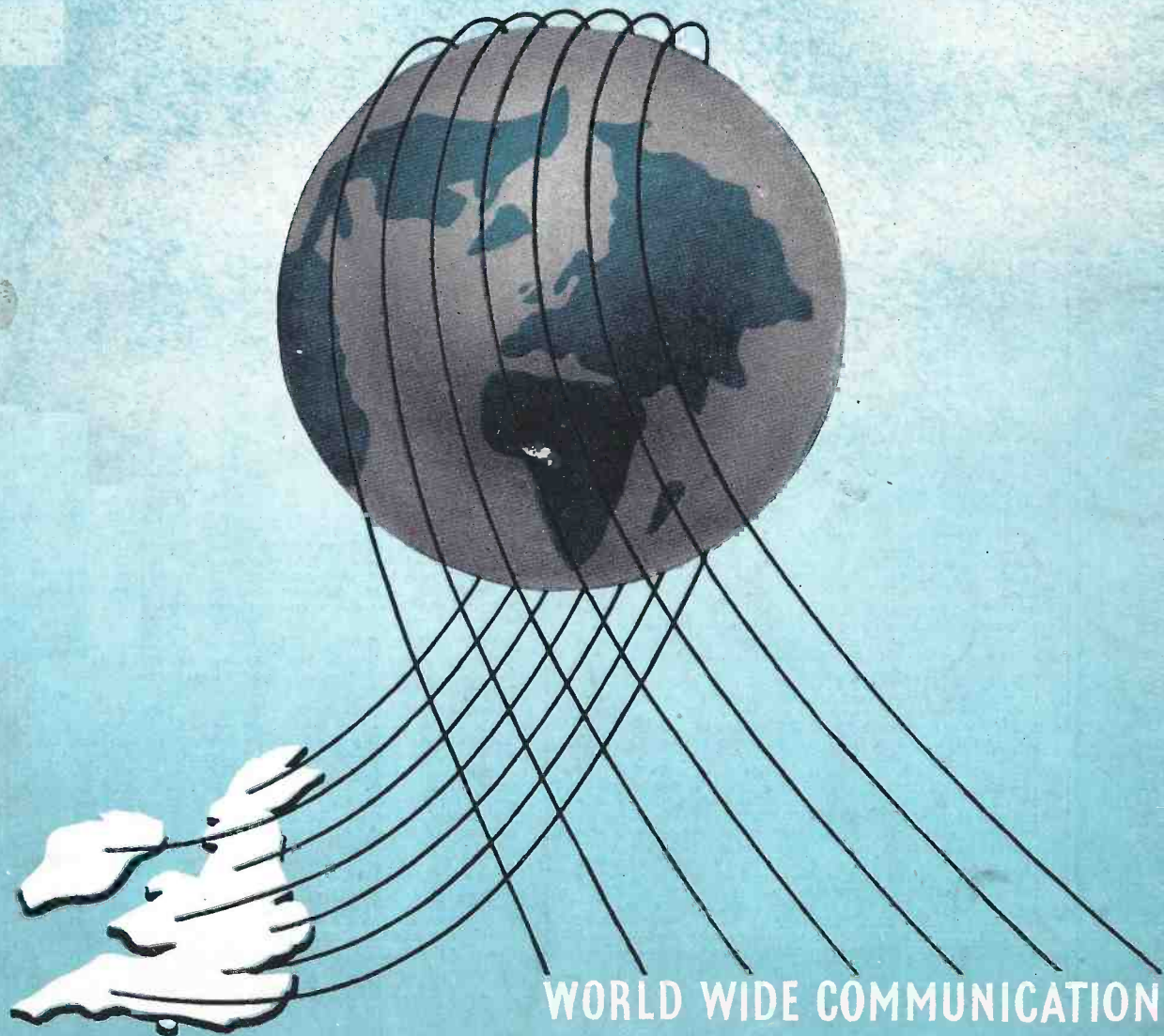

WORLD WIDE COMMUNICATION

# H. WHITAKER G3SJ

## 10 YORKSHIRE STREET, BURNLEY Phone 4924

**WAVEMETER CLASS C NRL. CRYSTAL UNIT Z.A. 2959.** Each unit contains 1000 Kc crystal in 10x holder, with a guaranteed accuracy of .005%. Offered at the bargain price of 18/- post free.

**THIS MONTH'S BARGAIN.** Collaro, A.C.37 Gram motor complete with turntable. Variable speed motor through 33½ to 100 revs. per minute. 110/230v. 50cy. Exceptional offer of 50/- each Carr. paid.

**PLESSEY.** Auto record changers. 3 speed, dual sapphire switched stylus, Mixed 10 and 12in. at 78 revs., mixed ditto at 33½ or 45 revs. List £23 13s., Offered at £16 Carr. paid.

**CONNOISSIEUR** Standard light weight Pickups. Complete with input transformer, Brand new and boxed, List £4/10/5, inc. tax. Post free £16/10. Available in quantity for export less tax.

**VALVES.** IW4/350 9/-, 6X5 7/6, 6L7 8/-, VMS4 7 pin 5/-, 6K7 6/-, 6SG7 7/6, 7Q7 5/-, VS 110 voltage regulator 5/-, VU111 2/6, 24/- doz. VT 25 5/-, CV 187 High voltage rectifier 4v. 3a. 2500v. at 200 mills. 10/-, CV 235 Similar. 4v. 3a. 1750v. at 250 mills. 10/-, RG3/1250 4v. 7a. 4600v. at 2500 mills. 30/-, 807 U.S.A. sealed cartons, 12/6, £5 Doz. Taylor T200 £4.

**TELEPHONE OR MIKE JACKS.** Standard P.O. type. Contacts for open or closed circuit, Panel mounting. 1/3, 12/- doz.

**1155 Rx.** Brand new and unused, in perfect condition, Carr. Paid £12/10/-. 1154 Tx Brand new in original transit cases, complete with all valves £5.

**WEYMOUTH COIL PACKS.** CP.A.I. or Atkins. Super Het. Coil packs, complete with circuits. List 38/6. To clear 17/6 Post free. I.F. Transformers for the above. 465 Kc, Atkins 4/- each. Weymouth Miniature P2 5/-, Wearite type 552 6/-, Wearite. P coils, A.F., R.F., BFO, PA4, 5, 6 and 7. PHF4, 5, 6 and 7, PO4, 5 and 6. Weymouth DA1, DA3, DO 1, 3 and 6. DH3, DH6, KA1, KA2, KH1, KO1, KO2, HO1, HO4, HA4. Q1 I.F. filter. All at 2/- each.

**MUIRHEAD.** Heavy brass Wavemeter dials. 3½in. diameter. Calibrated 0/100 degrees, fast/slow release button, Slow motion 50 complete revolutions for full 100 deg. ½in. spindle. A precision dial ideal for V.F.O. etc. Brand new and boxed at the nominal price of 8/6 each.

**RESISTORS.** 100 Brand new assorted, Erie, Dubilier, etc. as follows: 15 ½w, 30 ½w, 20 1w. insulated, 20 1w. standard. 10 2w., 5 5w. with a range of at least 30 different values 100 ohm to 5.6 Meg. at 16/- per 100, post free.

**WIRE WOUND AND SMALL VITREOUS.** 15 ohm to 25k. 5/10 watt, well assorted at 6/- doz. Heavy duty vitreous, Mixed British and U.S.A. 350 ohms to 75K, 40/120 watt. 6/12ins. at 24/- per doz. Nearest values to your own specified can be sent.

**RESISTORS VARIABLE.** 5k 2 watt 1/-, 100k + 10k 3 watt 1/6, 10k + 10k 5 watt 2/-, ½ meg Tropicalised 1/-, All normal ½in. spindles. Assorted normal spindles at 12/- doz., Assorted short spindles 8/- doz., both include U.S.A. J types etc.

**TRANSFORMERS AND CHOKES.** Immediate delivery from stock at Pre-increase prices of Woden: UMI 54/-, UM2 72/6, UM3 (sold out, new stock at 110/-), UM4 215/-, Mains DTM11 39/-, DTM12 48/6, RMS11 30/-, RMS12 40/-, DTM15 75/-, DTM17 109/6, Drivers DTF (sold out new stock at 40/-), DT2 39/6, DT3 34/-, Filament DTF12 2½v. 10a. 38/6, DTF14 5v 4a. 31/6, DTF17 7½v 5a. 37/6, DTF18 5v 3a. 63v 4a. 38/6, DTF20 10v 10a. 59/6, Chokes: DCS14 12hy 350 mills 102/-, DCS20 20hy 350 mills 140/-, DCS17 20hy 60 mills 28/8, DCS18 20hy 150 mills 41/6, PCS135/25hy 350/50 mills 58/6. The following are by Parmeko or Gresham Transformer Co. All are post war production not Ex-Gov., they represent the highest standard of British production, and are brand new and unused, offered at a fraction of original cost. Primaries all 200/250v 50cy. Plate 2000/0/2000 at 200 mills 9½ x 9½ x 8 weight 70lb. at 75/-, 2000/0/2000 at 500 mills 13 x 10 x 7½ weight 100lb. at £6. 5800v at 800 mills tapped 2000/3000/3500/4000 16½ x 13 x 12 weight 180lb. at £6. L.T. Chokes for the above 10hy at 800 mills 8½ x 6 x 7 weight 50lb. 70/-, 15hy at 400 mills D.C. res. 90 ohms 6 x 7 x 9

weight 40lb. 35/-, 3.5hy at 500 mills weight 45lb. 30/-, Swinging 13/23hy at 180/500 mills weight 45lb. at 40/-, Plate 19500/0/19500 at 6.1 KVa. Oil filled, built in rollers, 6in. stand-offs, weight 6 cwt. For collection only £12. Plate 5850v at 445 mills 13 x 10½ x 7½ tapped 4450/3560/2660v. weight 85lb. at £5. Thermador 2000/0/2000 at 800 mills £7/10/-. Swing choke suitable for the above 23/10hy at 100/800 mills weight 50lb. at 70/-, Auto, 230/115v 350 watts 35/-, 500 watts 50/-, 5KV a £6. 6½KV a at £8. L.T. Filament and L.T. heavy duty. 2½v at 10 amp for 866s at 20/-, 10v c.t. at 10amp at 20/-, 22v c.t. at 30 amp 7 x 7 x 7 weight 35lb. at £2. 22v. c.t. at 15 amp 30/-, 21v at 17 amp 30/-, 11v 15 amp twice 30/-, 50v tapped at 5v at 36 amp size 10 x 10 x 10 weight 50lb. at £3. 4v at 14½ amp 4 times, 13 Kv test, 10½ x 11 x 8½ 70/-, 4v 4½a. 4v 11½a. 4v 29a. 11 x 11 x 8½ weight 35lb at £3. Most of the above heavy duty LT are also available in 360/440v primaries at similar prices, as also are the high voltage plate transformers. In addition we have large stocks of High voltage plate transformers 440v3 phase working. Parmeko driver transformers, single 6L6 to 805 grids split secondary, ditto PP 6V6s to split secondary 805 grids both 12/6 each, completely screened. Parmeko Modulation 450 watts, P.P. 805s to pair of 813s with additional winding for plate and/or screen modulation at 50/-. Woden driver P.P. 6L6s to 500 ohm line at 22/6. The following are Ex-Gov. mostly by Philips, all are 230v primaries with earthed screen 275/0/275 100 mills 4v 2½a. 4v 5a 15/-, 265/0/265 120 mills 6.3v 7a. 4v 2½a. 20/-, 445/0/445 at 200 mills 25/-, 265/0/265 at 30 mills, 3,300v at 50 mills, 4v 10a. 2½v 4a 4v 1a. 10 x 10 x 10 in die cast aluminium cases at 35/-, 365/0/365 120 mills, 4v 2½a. 6.3v 42a. 20/-, 1540v at 1.75 mills 4v 1a. 2.05v. 2a. 15/-, Fil. 4v 3½a. 4v 7a. 14/-, Chokes. 10hy 200 mills in pott case cast 3½ x 3½ x 4½ DC res. 150 ohms 12/6. Chokes Speaker field replacement, 15hy 150 mills, 1500, 1800 or 2000 ohm 12/6. G.E.C. Fil. 4v at 5a. 8/-, ditto 4v 5a. twice 12/6. Thermador Driver, 500 ohm line to P.P. 805 grids with split secondary 20/-, Thermador Microphone. High or Low impedance to 50,000 Secondary, for m/c or carbon mike 15/-, Both the above completely screened and potted. Miniature Screened and potted Mike transformer. Single or double button carbon mike, to single of P.P. grids 3/-, Output Potted 6SN7 anodes to 45 ohm or high impedance phones 3/-, Stancor miniature smoothing chokes 8hy 40 mills 3/-, U.S.A. Rola, potted 8hy 100 mills 7/6, Modulation, single 1625 to parallel 1625s potted, 456 Modulator Command spares, 7/6.

**CRYSTALS.** 1,000 kc. Valpey, Biley or Somerset, standard ½in. pin spacing, 20/-, B.C.221 Octal based 1,000 Kc. G.E.C. Biley etc. 30/-, Full range of Western I.F. freqs. 450, 465 kc, etc., 12/6 each. Amateur and Commercial bands. G3 SJ Xtals are precision lapped, and acid etched to final freq. Are available in either Ft 243 holders, ½in. British, ½in. U.S.A. or ¾in. P.5 holders. Your own choice of frequency 2 Mc to 10 Mc inclusive. We will despatch to within 1 Kc of your chosen frequency at 15/- each, accurately calibrated with freq. clearly marked. Slight extra charges for decimal point freqs. We also undertake the calibration or re-grinding of your own crystals at extremely reasonable and nominal charges.

**STATION LOG BOOKS.** A quality production. 300 pages cream laid paper, section sewn, opens completely flat like a ledger. Stout heavy cover. 18/- post free. Sample leaves on request.

**CONDENSERS.** Silver Mica 100 assorted 9pf/6000 pf. 350/1000v wkg at 16/- post free. Mica and Tubular 100 assorted 350/1000v wkg 15/- post free. Ceramicons 100pf 500pf 2000v. wkg 1/- each. High voltage Mica, Muirhead .001 2½ Kv 2/6, .002 4 Kv 4/-, U.S.A. 5angamo etc 1250/2500 wkg 12/- doz. assorted. ditto .005 K3 v 2/6, .005 5 Kv 3/-, Quotations by return for any type smoothing condensers, British and U.S.A. 1mf to 10mf 1,000v. to 3,000v. wkg. U.S.A. Oil filled metal case 5 x 4 x 2½, 8 + 8 + 4mf 500v. wkg. 7/6.

**DYNAMOTORS.** U.S.A. Completely enclosed and suppressed. Input 12v. Output 250v. 150 mills 25/-, Ditto Input 12v., Output 500v. at 450 mills, with fan. 35/-, U.S.A. Blower motors Totally enclosed, 27v. input, 3,000 revs. By Oster Mfg. Co. 111. U.S.A. Black Gunmetal finish, Exceptionally fine 8/- each, ditto but completed with Blower and fan housing 12/6, ditto, dual blower assembly 15/-.

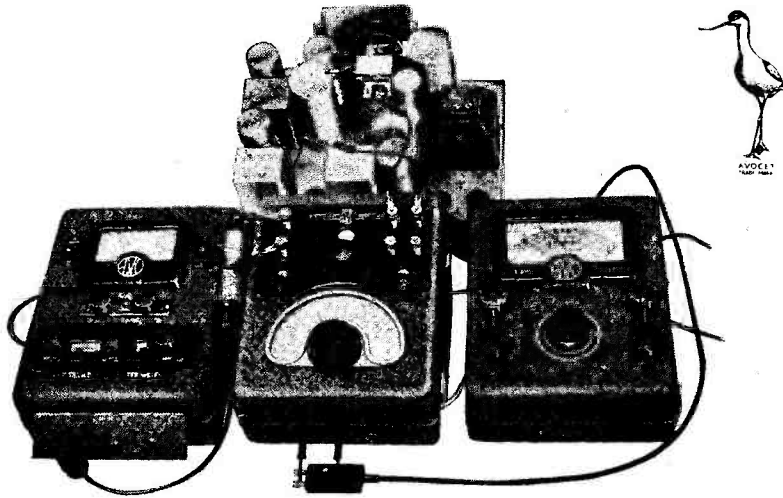

## The PERFECT TEST TEAM

The illustration depicts a set of modern "AVO" testgear being used to measure the "Q" of the secondary winding of the second I.F. transformer on a chassis of unknown characteristics — just one of many tests which can be performed by this combination of instruments.

A signal of predetermined frequency from the "AVO" Wide Range Signal Generator is being fed into the Electronic Test Unit, where it is amplified and fed

to the secondary winding of the transformer. The Electronic Testmeter is connected across the tuned circuit under test and, from the readings obtained and the controls of the Electronic Test Unit, the "Q" of the circuit can be determined. The three instruments, shown as a team, cover a very wide field in measurement and form between them a complete set of laboratory testgear, ruggedly constructed to withstand hard usage.



### ELECTRONIC TESTMETER

A 56-range instrument combining the sensitivity of a delicate galvanometer with the robustness and ease of handling of an ordinary multi-range meter. Consists basically of a highly stable D.C. Valve Millivoltmeter, free from mains variations and presenting negligible load on circuit under test.

Switched to measure: —

D.C. Volts: 5mV to 10,000V.

D.C. Current: .5μA to 1 Amp.

A.C. Volts: .1V to 2,500V R.M.S. up to 2 Mc/s.

.1V to 250V R.M.S. up to 200 Mc/s.

A.C. Power Output: 5mW to 5 Watts.

Decibels: -10db to +20db.

Capacitance: .0001μF to 50μF.

Resistance: .2ohm to 10 Megohms



### ELECTRONIC TEST UNIT

For measuring small values of A.C. voltage, inductance, capacity and "Q" at radio frequencies. Although designed primarily for use with "AVO" instruments, it can be used with any suitable Signal Generator/Valve Voltmeter combination.

As a Wide Range Amplifier, it is capable of an amplification factor of  $40 \pm 2$ —3db between 30c/s and 20Mc/s.

As a Capacity Meter, it covers measurements at radio frequency from .5pF. to 900pF. in two distinctly calibrated ranges.

As an Inductance Meter, it gives direct measurements from .5μH. to 50mH. in six ranges.

As a "Q" Meter, it indicates R.F. coil and condenser losses at frequencies up to 20 Mc/s.



### WIDE RANGE

#### SIGNAL GENERATOR

An instrument of wide range and accuracy for use with modern radio and television circuits. Turret coil switching provides six frequency ranges covering 50Kc/s to 80Mc/s.

Range 1.	50 Kc/s.—150 Kc/s.
" 2.	150 Kc/s.—500 Kc/s.
" 3.	500 Kc/s.—1.5 Mc/s.
" 4.	1.5 Mc/s.—5.5 Mc/s.
" 5.	5.5 Mc/s.—20 Mc/s.
" 6.	20 Mc/s.—80 Mc/s.

Accuracy to within 1% of scale marking. Gives sensibly constant signal of good wave-form, modulated or unmodulated, over entire range. Minimum signal less than 1μV at 20 Mc/s. and less than 3μV between 20 and 80 Mc/s. Gives calibrated output from 1μV to 50mV.

Fully descriptive leaflets available from the Sole Proprietors and Manufacturers

THE AUTOMATIC COIL WINDER & ELECTRICAL EQUIPMENT CO. LTD.  
WINDER HOUSE DOUGLAS STREET LONDON S.W.1 Telephone VICTORIA 3404-9



# NATIONAL H.R.O. POWER UNITS

The ideal power supply for practically any Communication Receiver or to drive an independent Crystal Oscillator or V.F.O. Unit. Complete with Rectifying Valve, Operating Manual, Circuit Diagram.

65/- each, plus 3/- postage.



230 Volt/115 Volt 50-60 cycles, very fully smoothed. Output 230 Volts D.C. at 75 MA., 6.3 Volts at 3.5 Amps.

## BC.614E SPEECH AMPLIFIER

Complete with all Tubes, energised input for Carbon Microphone and additional input for Dynamic Microphone. 500 Ohms Output, £32 each. Carriage Paid.

## RELAYS

Replacement Relays for RY200. Used in SCR-399-A (BC.610 Transmitter) 12 volt D.C., 10/- each including postage.

## CONDENSERS, OIL FILLED

15 mfd., 2000 volts, 15 Amps. 12/6 each including postage.

## MIDGET RELAY

REL.21953. RAF.110FB/242. S.P. D.T. 115 volt A.C. 60 Cycle, 10/- each including postage.

Also :

OVERLOAD RELAYS.

KEYING RELAYS.

ANTENNA SHORTING RELAYS.

All at 10/- each including postage.

## McELROY - ADAMS Manufacturing Group Ltd.

(Sole concessionaires U.K. for Hallicrafter Communication Equipment)

46 GREYHOUND ROAD, LONDON, W.6.

Cables : Hallicrafter, London.

Phone : Fulham 1138/9.

## HAM'S INTERPRETER

Published by PENTTI AARNIO, Helsinki, Finland

"Any Radio Amateur with the slightest interest in affairs outside his own immediate family circle must at some time, have felt a desire to know a few phrases of one or more foreign languages for use over the air.

"A language learnt at school may not be readily applicable to Amateur Radio, and it is for this reason that Mr. Pentti Aarnio, OH2SQ, has produced the 'Ham's Interpreter.' In this book, sentences and expressions commonly used in Amateur parlance are given in English, French, Spanish, Italian, German, Swedish and Finnish.

"Pronunciation of the letters of the alphabet, and numerals, is covered fully in all the above languages. The main body of the book is divided into sections covering all subjects from 'CQ' to '73 and good DX OM' A model QSO is given in all languages, together with a large selection of technical terms.

"The book has been extremely well written by OH2SQ in conjunction with Amateurs in other countries to which the languages pertain. In its 37 well-printed pages is condensed more information than one would probably acquire from a lifetime at evening classes."

Price 5s. post free

## 1953 Edition

# "THE RADIO AMATEUR'S HANDBOOK"

We are now taking orders for the above Handbook which will be ready for distribution early in March.

Price 31/- post free

## SHORT WAVE MAGAZINE

(PUBLICATIONS DEPARTMENT)

55 VICTORIA STREET, LONDON, S.W.1. ABBEY 5341

# ROYAL NAVAL VOLUNTEER WIRELESS RESERVE

Two reasons why  
**YOU**  
should join now

Added  
Attractions

- 1 To ensure doing your **National Service** in the Royal Navy
- 2 If **Ex-Service**, to get a first class **wireless transmitter and receiver** for use in your own home
  - a Cruises to **France, Norway, Holland** etc., with **Pay**
  - b All travel expenses paid. Training allowances
  - c Free uniform
  - d Tax free bounty of up to **£12**

**DETACH THIS**  
coupon and send it to :—  
**The Staff**  
**Communications Officer**  
**Queen Anne's Mansions,**  
**London S.W.1.**

NAME \_\_\_\_\_  
ADDRESS \_\_\_\_\_

AGE \_\_\_\_\_

Please send me details of the Royal Naval Volunteer (Wireless) Reserve.

## CLYDESDALE

Bargains in Ex-Services Radio and Electronic Equipment

### THE R1155 AS A COMMUNICATIONS RECEIVER

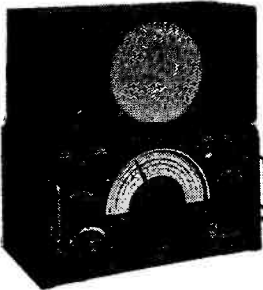

With 9 valves, for 200-250 V a.c. mains. Comprises Receiver Unit R1155 with 5 switched bands. 18-7.5 Mc/s=17-40 metres, 7.5-3 Mc/s=40-100 metres, 1,500-600 kc/s=200-500 metres, 500-200 kc/s=600-1,500 metres, 200-75 kc/s=1,500-4,000 metres. 7 valves: VR99 (X65), 3/VR100 (KTVW61), 2/YR101 (DH63), VII03 (Y63), ME, D.F. valves left out. Simple controls. Slow-motion 2-speed tuning, manual volume control, wave-change switch. Also optional B.F.O., A.V.C. Magic Eye tuning indicator. In black metal case, 16½ x 9 x 9 in.

**PLUS COMBINED OUTPUT/POWER PACK**  
With 2 valves, pentode output and rectifier, 8-in. speaker, mains and output transformers, tone control, on/off switch. In black crackle metal case, 16½ x 9 x 9 in.

Ask for No. SM/E6 AC.

**£21**

Carriage Paid.

APPEARANCE GOOD

Ask for No. SM/H916 AC.

**£20**

Carriage Paid.

APPEARANCE ROUGH

Ask for No. SM/H898 AC.

**£18/10/0**

Carriage Paid.

Both Units in Each Case.

#### RECEIVER UNIT ONLY

Grade 1. APPEARANCE AS NEW.

Ask for No. SM/E6. **£10/19/6**

Carriage Paid.

Grade 2. APPEARANCE GOOD.

Ask for No. SM/H916 **£9/19/6**

Carriage Paid.

Grade 3. APPEARANCE ROUGH.

Ask for No. SM/H898. **£7/19/6**

Carriage Paid.

#### AMMETER RANGE 0-20

2-in. round clip mounting with ext. shunt Res. .00375 ohms.

Ask for No. SM/H892 **12/6** Each

Post Paid

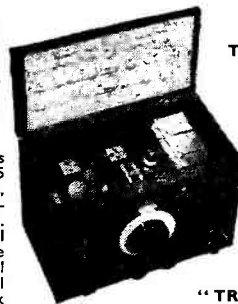

**BATTERY POWERED COMMUNICATIONS RECEIVER R1224A**

Ref. 10D/13074

Covering the "TRAWLER BAND"

A 5 Valve 2/VP23s, 210LF, FC2A, 220PA, 3 wave-bands 30-300 metres. 1F 470Kc/s. SM tuned. Superhet Receiver, headphone outputs.

Complete (less batteries) in wooden cabinet with calibrated chart on hinged lid. Dim.: 14½ x 10 x 9½ in., finish grey.

ASK FOR No. SM/H355

**£7/19/6**

CARRIAGE PAID Each

IN ORIGINAL TRANSIT CASE

#### R1224A RECEIVER

As above, but less valves. Used, reconditioned and tested.

ASK FOR No. SM/H355A

**£3/19/6**

CARRIAGE PAID Each

Batteries required: H.T. 120V., G.B. 9V. L.T. 2.V. Circuit of R1224A available price 1/3.

New Catalogue No. 8D now in the press Price 1/6 (Credited on first purchase of 10/-)

Order Direct from :—

Phone: SOUTH 2706/9

**CLYDESDALE SUPPLY 2 BRIDGE ST. Co. Ltd. GLASGOW C.5**

BRANCHES IN SCOTLAND, ENGLAND AND NORTHERN IRELAND



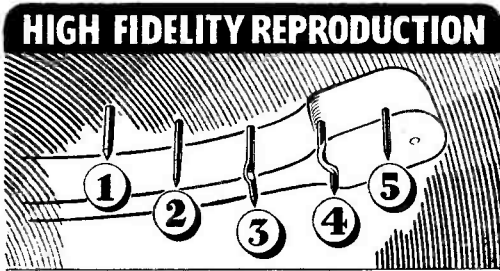

**HIGH FIDELITY REPRODUCTION**

**WITH A MINIMUM OF WEAR**

Calls for the use of **S. G. BROWN PRECISION SAPPHIRE NEEDLES**

- No. 1 "Miniature" jewel-tipped needle for light-weight pick-ups.
- No. 2 "Straight" jewel-tipped needle for crystal pick-ups.
- No. 3 "Trailer" jewel-tipped needle for medium-weight pick-ups.
- No. 4 "Knee Bend Trailer" jewel-tipped needle for older heavy-weight pick-ups.
- No. 5 "Miniature Solid Sapphire" needle for light-weight pick-ups.

**PRICES.** Nos. 1-4, 7/-, plus 3/1 P.T. Post 6d.  
No. 5, 9/3, plus 4/1 P.T. Post 6d.

There's an **S. G. BROWN PRECISION SAPPHIRE NEEDLE** for every type of pick-up.

All S. G. Brown Precision Sapphire Needles are protectively mounted on a useful double-sided stroboscope (78 and 33 1/2 r.p.m.). An instructive and interesting Brochure with many useful hints on obtaining better reproduction, gladly sent on request. Write to Dept. S.

**S. G. Brown Ltd.** SHAKESPEARE ST., WATFORD, HERTS.  
Telephone: Watford 7241



**POTTED AND COMPOUND FILLED TRANSFORMERS AND CHOKES**

made by Woden are the answer when the call is for transformers to operate under exacting industrial conditions, coupled with adverse climatic conditions.

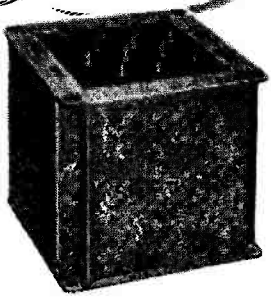

Every transformer leaving our factory is subjected to a rigid inspection, and is fully impregnated with moisture proof filling compound by the latest vacuum and pressure process. The fact that "WODEN" are the choice of many leading radio and television manufacturers is proof enough of the quality of our products.

Please send for latest Catalogue.

**WODEN TRANSFORMER CO LTD**  
**MOXLEY ROAD, BILSTON, STAFFS.**  
TELEPHONE: BILSTON 41959

The **RONETTE**  
World Famous  
**BI10 CRYSTAL REPORTER MICROPHONE**  
FOR AMATEUR-RADIO AND P.A. COMMUNICATION SERVICE

- ★ Rugged construction.
- ★ High grade finished ivory or black Polopas moulding.
- ★ Effective output level 1.1 MV/ $\mu$ BAR at 1,000 c/s in 5 megohms.
- ★ Frequency response 30-13,000 c/s.
- ★ Output impedance 2200 pfd.
- ★ Semi directional Characteristic.
- ★ Vacuum sealed, precision ground crystal with annealed corrosion resistive aluminium diaphragm.
- ★ Decreasing the load resistance from 5 megohms to 220,000 ohms, decreases bass response and gives that "DX" quality wanted by amateurs.
- ★ Supplied complete with shielded plug and fits any regular microphone stand.

MICROPHONE STANDS AVAILABLE—17/6

Only **52/-** List Price

ALL RONETTE MICROPHONES ARE FULLY GUARANTEED AND A FULL RANGE OF DIFFERENT TYPES ARE AVAILABLE FROM STOCK  
**RONETTE**—The House of Aristocratic Microphones



**MAIL ORDER SUPPLY CO.**  
The Radio Centre  
33 Tottenham Court Road,  
London, W.1. Tel.: MUSeum 6667

**PULLIN SERIES 100**  
**MULTI-RANGE TEST SET**

The universal testing set for Service Engineers. Sensitivity-10,000 ohms per volt. Strong metal case with carrying handle, complete with leads having detachable bulldog clips and test prods. Size 9 x 5 1/2 x 4ins.

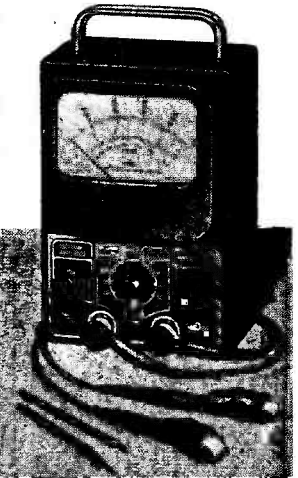

**RANGES**  
AC/DC Volts: 10, 25, 100, 250, 500, 1,000.  
D.C. Millamps: 2.5, 10, 25, 100, 500.  
AC/DC Microamps: 100 Microamps 10v. range.  
Resistance ranges: 0/1 Meg (13,500 ohms mid-scale), 0/10,000 ohms (135 ohms mid-scale).

**MEASURING INSTRUMENTS (PULLIN) LTD**  
Electrin Works, Winchester Street, London, W.3  
Tel.: ACOrn 4651/3 & 4995.

# SOLONS FOR ESSENTIAL JOBS!

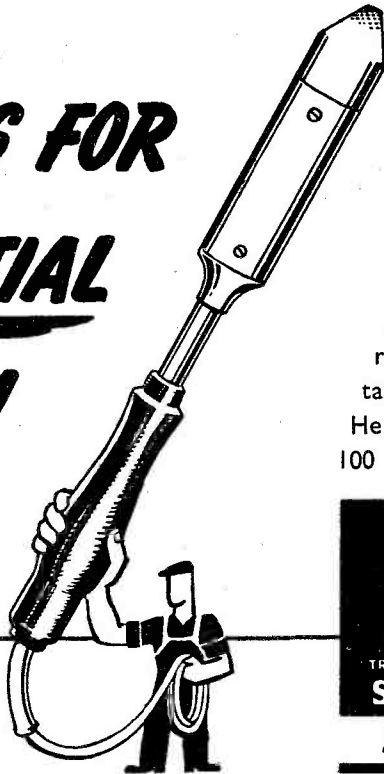

W. T. HENLEY'S TELEGRAPH  
WORKS CO. LTD.,  
51-53, Hatton Garden,  
London, E.C.1

Use SOLONS for the jobs that matter — this modern precision tool makes soldering speedier, simpler and more reliable. 5 models: 65 watt with oval tapered and round pencil bit; 125 watt with oval tapered and round pencil bit; 240 watt with oval tapered bit; each with 6 feet 3-core Henley flexible. Voltage ranges from 100 to 250. Write for folder Y.10.



G2AK

## This Month's Bargains

G2AK

### THIS MONTH'S SPECIALS :-

**CERAMIC FORMERS** 2 $\frac{3}{8}$ in. x 1 $\frac{1}{2}$ in. Ideal for VFO or Turrets 1/9 each or 17/6 per Doz.

**CRYSTAL MICROPHONE INSERTS.** Type DAL. By Rothermel, 12/6 each.

**GENUINE R.C.A. AR88 MATCHING SPEAKERS,** fitted with louvered back, rubber feet and lead. Worth £5. Our price 65/-.

**BUG KEYS.** Brand new boxed by famous manufacturer, streamlined and unrepeatable, list over £4. Our price 45/-. Limited quantity only.

**METERS.** 2 $\frac{1}{2}$ in. Flush Mounting M.C. 0-100mA., 0-15 Volt 12/6 each. 2in. Flush 0-4A Thermo 5/-, 0-350A., Thermo 7/6, 2 $\frac{1}{2}$ in. Flush 0-2A Thermo 7/6, 2in. Flush 0-20v. 7/6, 2in. Flush 20-0-20 Amos 5/-.

**4,800v. MULTIPLIERS** for Model 40 AVO 5/-.

**TAPE RECORDING EQUIPMENT.** Decks by Bradmatic, Tamsa, Lane and Qualtape. Ex. stock. Heads, Oscillator Coils, Tape and Reels always available.

**MORSE PRACTICE SETS,** with double-action buzzer, output for phones, excellent key, requires only 4 $\frac{1}{2}$  v. battery. As new, 7/6, postage and packing 1/-.

**AERIAL PULLEYS.** Heavy galv., 6d. ea. or 5/- per doz.

Carriage paid on all orders over £1 except where stated. Please include small amount for orders under £1.

Please Print Your Name Name & Address.

# CHAS. H. YOUNG, G2AK

ALL CALLERS TO

110 Dale End, Birmingham · Central 1635

MAIL ORDERS TO 102 Holloway Head, Birmingham Midland 3254

**SHORT WAVE PLUG-IN COILS.** 6 pin standard. 2 ranges only. 3.9/1.8 Mc/s., 21.4/33.3 Mc/s. 2 for 3/-. Formers alone are listed at 6/-.

**COMPLETE NOISE LIMITERS.** Wired on a small sub-chassis with 6H6 type valve, boxed, with circuit and instructions. Only 5/-, post free.

**TWIN FEEDER.** 300 ohm Heavy Twin Ribbon Feeder, 5d. per yard. K24, 150 ohm, 9d. per yard. Co-ax. Cable,  $\frac{1}{8}$ in. dia., 50 ohm, 8d. per yard;  $\frac{1}{4}$ in. dia., 1/3 per yard. Post on above feeder and cable 1/6, any length. K35B (Round), 1/6 yd.

**POTENTIOMETERS,** Carbon, 50 k., 25 k., and 2 meg., 1/6 each. 500 ohm H.D. torodial, 3/6 each. 50 K.V.V.V. Pre-Set Type 2/- each. 20K.V.V.V. Pre-Set, 1/- each.

**R.F. CHOKES.** Pie wound. 2.5 mH., 100 mA., receiver type, 9d. each, or 7/6 per doz.; 250 mA., transmitter type, 1/- each, 10/- per doz.

**KNOB AND DIAL** with engraved scale, 2in. dia. New and boxed, black finished, 1/9 ea.; complete with index.

**LOG BOOKS,** 100 pages with heavy bound cover, 10/6 ea. Postage and packing 1/- ea.

**SPECIAL VALVE OFFER.** Kit of 4 midget 1.4 v. valves 1 each IS5, IR5, IT4 and IS4, 35/- or 9/6 each, separately.

**SPECIAL VALVE OFFER.** To transmitting hams only. Not more than 2 of any type to any one person. 813 70/-, 829 80/-, 866a 17/6, 807 15/- each or 4 for 50/-.



**INDEX TO  
ADVERTISERS**

	PAGE
Adcola .....	766
Altham Radio .....	766
Anglin, J. T. ....	765
Ashworth, H. ....	762
Automatic Coil .....	705
Bensons .....	764
Brookes Crystals. Ltd. ....	708
Brown, S. G. ....	709
Burn Engineering .....	768
Candler System .....	765
Clydesdale Supply Co., Ltd. ....	707
Electrad Radio .....	768
Electradix Radios .....	763
Elm Electric .....	708
E.M.I. ....	767
Foyle .....	766
Henley's .....	710
Henry's .....	cover iv
Hoile .....	767
H.P. Radio Services. Ltd....	763
Johnson's .....	767
Labgear .....	708
Lyons, Claude .....	763
Lyons Radio .....	764
Magnetic Coatings .....	708
Mail Order Supply Co. ....	709
McElroy Adams .....	706
Miller's Radio....	768
Pullin (M.I.) .....	709
Radio Servicing Co....	762
Rollett, H. ....	768
Royal Navy .....	707
Salford .....	712
Samson's Surplus Stores .....	763
S.W.M. Publications Dept. cover iii	706
Small Advertisements .....	765-768
Smith, H. L. ....	762
Southern Radio .....	762
Universal Elec. ....	764
Venner's .....	712
Walton's Wireless Stores .....	764
Whitaker .....	cover ii
Woden .....	709
Young .....	710

# SHORT WAVE MAGAZINE

VOL. X

FEBRUARY 1953

No. 114

## CONTENTS

	Page
<b>Editorial</b> .....	713
<b>QRP Portable Transceiver for 160-Metre Band, by L. Knight, Grad.I.E.E. (G2DXK)</b> .....	714
<b>Switched Multi-Band Exciter Unit, Part II, by W. N. Stevens (G3AKA)</b> .....	717
<b>The Design of HF Receivers, by P. Short, M.Sc., A.M.I.E.E. (G3CWX)</b> .....	722
<b>Multi-Band DX Aerial, by S. G. Mercer (G2DPY)</b> .....	726
<b>Notes on the 815 Double Tetrode</b> .....	728
<b>DX Commentary, by L. H. Thomas, M.B.E. (G6QB)</b> .....	730
<b>Keying without Annoying, by I. E. Hill (G6HL)</b> .....	736
<b>Wax Impregnating, by Rev. F. Ness, M.A. (G3ESV)</b> .....	738
<b>Predicting VHF Conditions, by A. H. Hooper (G3EGB)</b> .....	741
<b>VHF Bands, by A. J. Devon</b> .....	747
<b>Receiver Remote Control Unit, by G. Whitby</b> .....	752
<b>The Working of QSL Bureaux</b> .....	753
<b>New QTH's</b> .....	756
<b>The Other Man's Station — YU1AD</b> .....	757
<b>The Month with the Clubs — From Reports</b> .....	758

*Managing Editor* : AUSTIN FORSYTH, O.B.E. (G6FO)

*Advertisement Manager* : P. H. FALKNER

*Assistant Editor* : L. H. THOMAS, M.B.E. (G6QB)

*Published the Friday following the first Wednesday each month at 55 Victoria Street, London, S.W.1.* Telephone : Abbey 5341/2

*Annual Subscription : Inland 30s. Abroad 30s. post paid.*

**Copyright Reserved throughout the World.**

### AUTHORS' MSS

*Articles submitted for Editorial consideration must be typed double-spaced with wide margins on one side only of quarto or foolscap sheets, with diagrams shown separately. Photographs should be clearly identified on the back. Payment is made for all material used, and it is a condition of acceptance that full copyright passes to the Short Wave Magazine Ltd. on publication.*

**THE SHORT WAVE LISTENER ASSOCIATED WITH THIS  
MAGAZINE IS SPECIALLY FOR THE RECEIVING ENTHUSIAST**

# Watt/hour efficiency

## - UP TO 90%

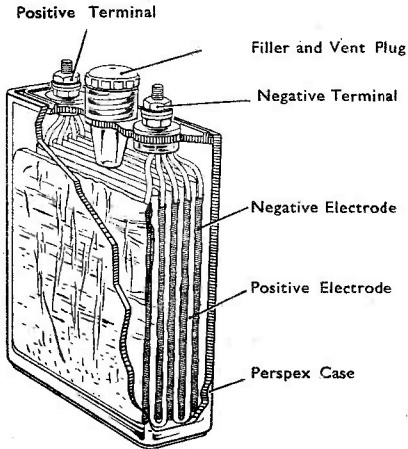

**This MUST mean something to you**

Savings of up to 4/5ths of the size and 5/6ths of the weight can be achieved in comparison to other storage batteries of similar capacities. Owing to their unique characteristics there are many occasions when a smaller capacity Venner cell can satisfactorily replace higher capacity *lead-acid* or *nickel-iron* types.

Write for brochure giving full details on the Venner silver-zinc accumulator.

# VENNER

LIGHTWEIGHT ACCUMULATORS

**VENNER ACCUMULATORS LTD.**

Kingston By-pass, New Malden, Surrey.

Telephone: MALDEN 2442



Weight and space saving by Venner Accumulators is **VITAL** in many projects to-day.



Communication  
assured with  
**G.E.C.**  
QUARTZ CRYSTAL  
UNITS

From take-off to touch-down, the safety of the aircraft is dependent on trouble-free radio contact being maintained. The components used in the radio equipment must be the best obtainable.

For reliable communications under all conditions, use G.E.C. Quartz Crystal Units.

Write today for list Q.C. 5012(R)

**SALFORD ELECTRICAL INSTRUMENTS LTD**

A Subsidiary of THE GENERAL ELECTRIC CO. LTD. OF ENGLAND  
PEEL WORKS · SILK STREET · SALFORD 3 · LANCs.

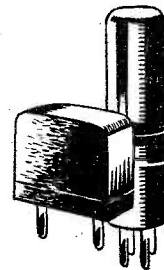

FOR THE EXPERIMENTER AND THE RADIO ENGINEER

# The SHORT WAVE Magazine

E D I T O R I A L

**Readjustment**      *This time last year, in this space, we had to announce an increase in cover price. Now, twelve months later, we are happy to inform readers that by reason of lower production costs and an expanding circulation — particularly overseas — we are able to reduce the cover price of SHORT WAVE MAGAZINE to Two Shillings.*

*This will be effective with the next issue, which is also the first of the new Volume XI. With the reduced price, all readers who are direct subscribers at the old rate will automatically have their subscriptions extended to give them three extra issues before renewal, at 24s. only, becomes due. (And it might be added here that we have always covered direct subscribers for price changes: their subscriptions were carried over when the price went up, and now we are in effect giving them the immediate benefit of the reduced rate.)*

*The price reduction does not herald any other changes in SHORT WAVE MAGAZINE, in any department or section. Though a number of readers have written us to argue to the contrary, the bigger page area is not (repeat not) offset by the larger type we use when compared with the old size. A direct comparison between any three issues of 1951 with the corresponding months of 1952 will prove that in the present format there is fully 10% more actual text matter than we gave in the old pre-1952 size—and you can be sure we checked it pretty thoroughly before starting to write this!*

*Hence, SHORT WAVE MAGAZINE at its reduced price of two shillings is better value than ever before, being not only bigger, but giving even more reading and a wider range of subjects than at any previous period.*

*Austin Fobler  
G.F.O.*

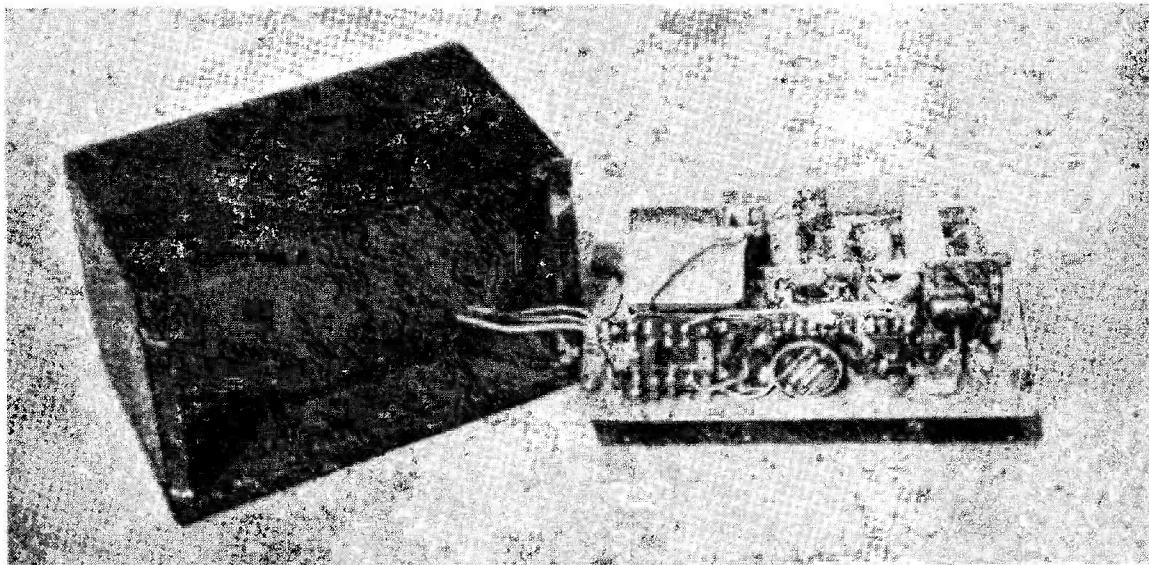

The 160-metre transmitter/receiver unit, as designed and built by G2DXK and described in the article, removed from its case. The batteries are accommodated in the lower compartment.

## QRP Portable Transreceiver for the 160-Metre Band

DESIGN AND CONSTRUCTION

L. KNIGHT, G.I.E.E. (G2DXK)

*This article, describing an effective low-power transmitter/receiver unit intended for local work on the Top Band, will be of great interest to those many readers who have similar ideas about compact, truly portable apparatus. Though simple and easy to build and adjust, such a rig can be very effective not only as a transportable station, but also as a short-range talking link.—Editor.*

WITHIN a mile of the writer's home there are several amateurs active on 160-metre phone. Consequently, it was decided to build the midget portable rig described below, confident that G2DXK would be able to contact at least three or four stations with it. The results have been most gratifying. With  $\frac{1}{2}$ -watt input, an eight foot vertical aerial and the transmitter standing on the ground, 100% contacts have been made over distances up to 8 miles.

The receiver is a straightforward superhet. The IF transformers are midget iron-cored, of 465 kc. Small capacities (C7, C8), consisting of two insulated wires twisted together for about  $\frac{1}{2}$  inch, was added to each transformer to increase the gain and widen the bandwidth. Since the receiver is only used for listening to local stations the increased bandwidth is not detrimental. In fact, it is something of an advantage as it makes it possible to tune over the band quite comfortably with a small pointer knob.

The transmitter PA inductance is used as the aerial coil on "Receive." Unless listening to a very weak station on a frequency well away from that of the transmitter, there is no need to readjust the aerial tuning.

The transmitter uses a 3V4 in the PA, driven from a crystal oscillator. The latter is a 1R5 strapped as a triode, this being found to give more RF output than any other valve of the same filament current.

At first sight, the aerial circuit may appear a little unusual, but it must be remembered that at 1.9 mc an eight-foot aerial has the electrical characteristics of something like 10  $\mu\mu\text{F}$  to earth. Consequently, to make the aerial draw any appreciable current it must be connected to a very high impedance tuned circuit. The 3V4 anode and the tuning condenser are tapped into the PA coil to give this high impedance

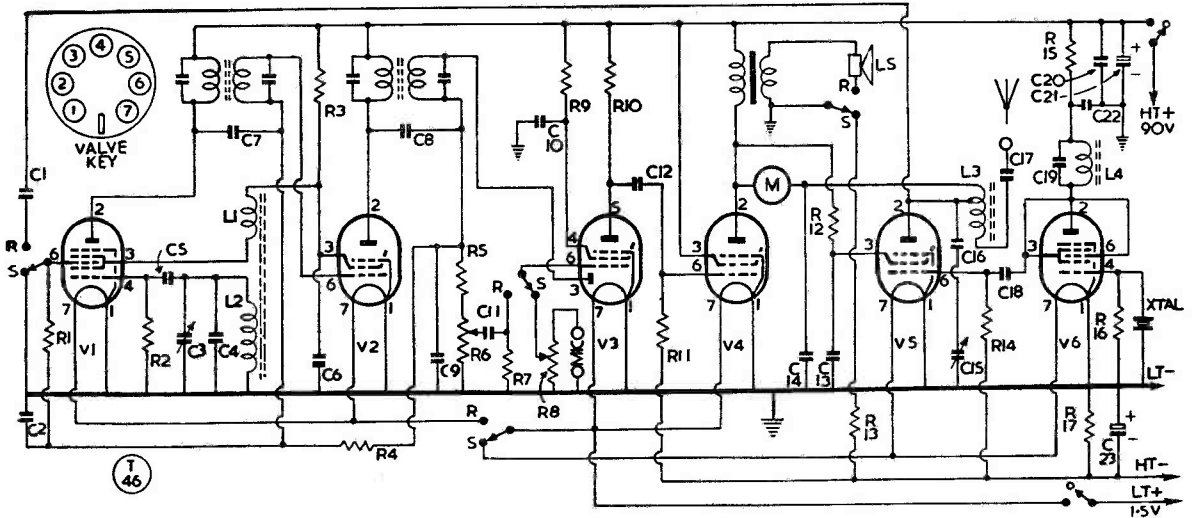

Circuit of the G2DXK 1.7 mc Tx/Rx unit, in which certain valves function in both sections. See text for details.

at the "hot" end, and the aerial is taken direct to the coil through a blocking condenser. Some experimenting with the PA coil was necessary to make it tune to the correct frequency and to give maximum aerial current. The meter now gives just a small dip when the PA is on tune.

**AF Modulator**

The AF section of the receiver is used as the modulator, the primary of the output transformer acting as a modulation choke. The HT current on "Send" is heavier than on "Receive"

**Table of Values**

The Top-Band Transceiver Unit

C1, C18,	R7, R11 = 3.3 Megohms
C19 = 50 $\mu$ F	R8 = 2 Megohms, variable
C2, C6,	R10 = 470,000 ohms
C10, C14,	R12 = 4,700 ohms
C3 = 0.01 $\mu$ F	R13 = 1,000 ohms
C3 = 50 $\mu$ F, variable	R15 = 10,000 ohms
C4, C5, C9 = 100 $\mu$ F	R16 = 2.2 Megohms
C7, C8 = see text	R17 = 390 ohms
C11, C12,	V1, V6 1R5
C17 = 0.001 $\mu$ F	V2 1T4
C13, C16 = 0.002 $\mu$ F	V3 1S5
C15 = 100 $\mu$ F, variable	V4, V5 3V4
C20 = 0.1 $\mu$ F	
C21 = 8.0 $\mu$ F, 175v. wkg.	
C23 = 50.0 $\mu$ F, 12v. wkg.	
R1, R5 = 47,000 ohms	L1 } See Coil Table
R2, R14 = 100,000 ohms	L2 }
R3 = 22,000 ohms	L3 }
R4, R9 = 1 Megohm	L4 }
R6 = 1 Megohm, variable	LS = 3in. loudspeaker
	M = 0-10 mA 2in. meter

**Coil Data**

Receiver Oscillator Coil

*Coupling Winding:* 20 turns 36 SWG enamelled copper wire, wound at the base of the former.

*Main Winding:* 65 turns 36 enam. wire wound next to the coupling winding. Finish of coupling winding to HT. Start of main winding to chassis.

PA Coil

Pile wound with Litz wire salvaged from an old IF transformer. Length of winding  $\frac{1}{4}$  inch. Start taken to meter. 40 turns wound and tap taken out for PA anode. 120 more turns wound and finish taken to aerial blocking condenser.

Crystal Oscillator Anode Coil

85 turns Litz wire pile wound. Length of winding  $\frac{1}{4}$  inch.

All coils wound on Aladdin F804 formers with iron-dust cores.

and therefore a 1000-ohm resistor is switched across the bias resistor to maintain the correct bias voltage. A small deaf-aid type microphone is used, and its output is just sufficient to modulate the transmitter fully.

On tune the PA anode current is just under 6 mA at 90 volts, that is to say, there is about  $\frac{1}{2}$  watt input. The total HT current is 16 mA on "Send" and 12 mA on "Receive." LT current is 0.3A and 0.25A respectively. The HT battery is a Drydex 517 and the LT an Ever-ready Alldry 4. Both have had over 50 hours' use and are still giving current.

**Layout and Construction**

There would appear to be nothing very critical in the physical layout, except that the

1S5 valve holder must be rubber mounted to prevent microphony. All the "works" are arranged on the 8 in. x 6 in. top panel. It needed a little persuasion to get every part in and even then the meter had to be fitted on top of the panel as there was no room underneath. The depth of the set below the panel is  $2\frac{1}{2}$  inches, leaving the rest of the depth of the box (about 4 inches) for the batteries. There is a wooden partition between the set and the batteries and the latter are accessible *via* a removable bottom.

The only two components which are not fixtures are the aerial and the microphone. The former consists of a number of 12 inch long tubes which plug one in the other, the bottom one plugging into a home-made socket on the panel. The microphone has a short coaxial lead terminating in a Pye socket which plugs into the panel.

The whole rig is very easy to carry about. It has been transported many miles around the byroads of Hertfordshire and Bedfordshire in the front basket of a dilapidated bicycle and operated from a variety of sites. It has even solved the age-old problem of how to carry on a QSO and yet not offend the XYL by being late for tea. The writer merely brings the rig

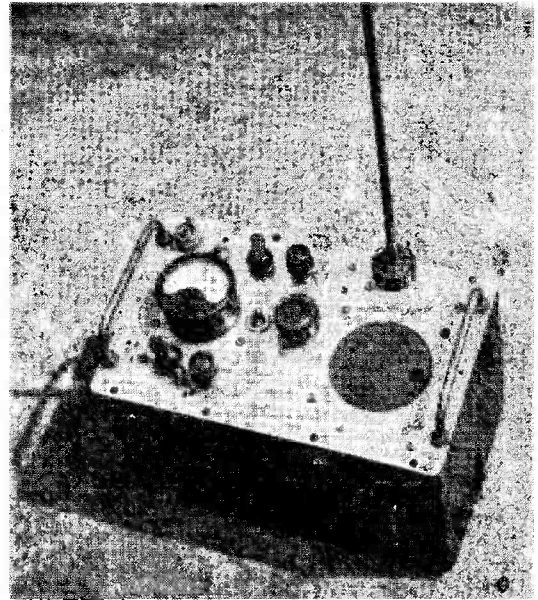

Showing the transportable 1.7 mc Tx/Rx unit complete and ready for operation.

indoors, stands it beside the dining table, changes the call-sign from G2DXK/P to G2DXK, and carries on !

### VALE G6YR

It is with deep regret that we record the passing of R. W. Rogers (G6YR), of Southport, Lancs., who died on December 21, 1952, after many years' struggle against heart disease. He was bedfast and in and out of hospital from shortly after the war, during which he served in the Royal Air Force. Though often near collapse at the end of a QSO from sheer physical exhaustion, he was always heard over the air as a fine, steady operator with an easy, faultless fist. He will be remembered by his Southport friends and associates as a keen amateur, and by many readers as a contributor to *Short Wave Magazine* of several very competent articles. In every sense of the term, "His note was always T9x." He leaves a widow and two children, to whom we offer our sincere sympathy.

### HF CONVERTER FOR THE HRO

Unless it has been very specially attended to, the HRO is not so hot at the HF end of the tuning range, and on 28 mc most specimens are nearly dead. Assuming satisfactory performance on the 14 mc band, it would seem that for the higher frequencies the best way to use an HRO is with a converter. The February issue of our *Short Wave Listener* carries a constructional article on the design of such

a converter for the 21 mc band, for operation specifically with the HRO. A fixed-frequency oscillator is used, so that the incomparable tuning mechanism of the HRO can be retained. The converter itself is three-stage, with valves in the 9000 series; it can thus be made small and compact, and once set up need not be touched. Copies of the February *Short Wave Listener* are available at 1s. 6d. post free, of The Circulation Manager, Short Wave Magazine, Ltd., 55 Victoria Street, London, S.W.1.

### CARDS IN THE BOX

Operators named here are asked to let us have a large s.a.e., with name and call-sign, for the delivery of cards held for them in our QSL Bureau. Address to: BCM/QSL, London, W.C.1. If publication of the QTH in the *Radio Amateur Call Book* is required, that can be mentioned at the same time, as we are *Call Book* agents for Europe and the U.K.

G2MS, 3BQD, 3EMG, 3HFG, 3HLT,  
3HWB, 3ICM, 3IIH, 3IMC, 3IPG,  
3ISI, 3ITT, 3IUD, GD6OR, G13IEK,  
GM3HLU, GW2CYB, 3HXX.

# Switched Multi-Band Exciter Unit

## PART II

### VFO STABILITY, GENERAL CONSTRUCTION AND SETTING UP

W. N. STEVENS (G3AKA)

*The first part of this article, discussing the circuitry and electrical arrangement of the unit in detail, appeared in our January issue. The notes following complete the description of the Exciter.—Editor.*

IT should be stressed that test figures given need not be taken *too* literally. For instance, there are bound to be slight variations due to component tolerances and the *mu* of the valves (which can differ surprisingly on test). Also, the sensitivity of the test instrument must be taken into account. Therefore, the figures are quoted merely as a guide and any variations should not be taken too seriously unless there is some obviously widely different reading.

The V1 readings marked "non-oscillating" were taken with the signal grid shorted to chassis. In the "oscillating" readings the VFO is not coupled to the buffer stage, *i.e.*, S2 is switched to the crystal position. Likewise, the readings for V2 are taken with the 1.7 mc switch S3 at the "Off" position. The doublers were loaded to their following stages for the purposes of test readings, but no actual load was imposed on the RF output terminals.

#### Factors Affecting Stability

In a unit of this type, flimsy construction is worse than useless. Aluminium may be easy to work and quite suitable for a good proportion of equipment, but in the case of a unit where stability is of the utmost importance—both mechanically and electrically—such as an Exciter, there is no doubt that all-steel construction is much more satisfactory. In the model being described the panel and chassis are of 16 gauge steel, and, in fact, forms one "shelf" of a three-tier all-enclosed steel rack cabinet which houses the complete transmitter. The finished job is well worth the extra effort.

Although the complete unit is screened by virtue of its metal cabinet, a certain amount of internal screening is necessary. The VFO, for instance, should be carefully enclosed. In

the photograph the VFO casing can be seen in the centre of the chassis and this encloses all the components associated with the oscillator, except for the band-change switches. The valve itself is mounted externally so that there is no heating of components inside the compartment—essential to minimise frequency drift. The main condenser C is mounted at the front of the case with the coil L1 immediately above. The HF setters Cp5-Cp8 are seen with their spindles projecting at the back of the case and the other variables Cp1-Cp4 are to the right and below the oscillator valve. These have short spindles and may not be seen clearly in the photograph. It may seem to be a rather inconvenient position for adjustment, but the 2C34 can be removed whilst doing the initial setting up, as the doublers do not affect the trimming and padding.

The rest of the VFO parts are disposed round the valveholder and a long mounting strip. To obtain the best results from this (or any other VFO) extreme care should be taken in construction to avoid frequency drift or frequency shift.

Mechanical changes are often to blame. Make sure that the metal housing will not bend or "give" under normal pressures; see that the coil is firmly cemented or "doped" to avoid any possibility of loose or wandering turns—as there is a very large capacity across the grid circuit a slight change in inductance can give substantial frequency change; note that the variable condensers do not have loose vanes or vanes which can vibrate readily—and that the bearings are good and positive. Take special care over the main variable C which, incidentally, should preferably be of straight-line characteristics to simplify calibration. There must be no suspicion of side or end play in the bearings.

Frequency changes with variations in temperature are common. As the temperature increases so does the inductance and capacity of the affected components. This can be reduced to quite small proportions by the use of a box such as described, and another help is the use of temperature compensating condensers; the two factors usually counteract any frequency change due to temperature effects except for the small initial warm-up drift.

Many amateurs fail to understand that it is not just a matter of fitting a negative temperature co-efficient condenser; the actual value is quite important. Like many things, one cannot give hard and fast rules and the exact value can only be found by experiment in individual

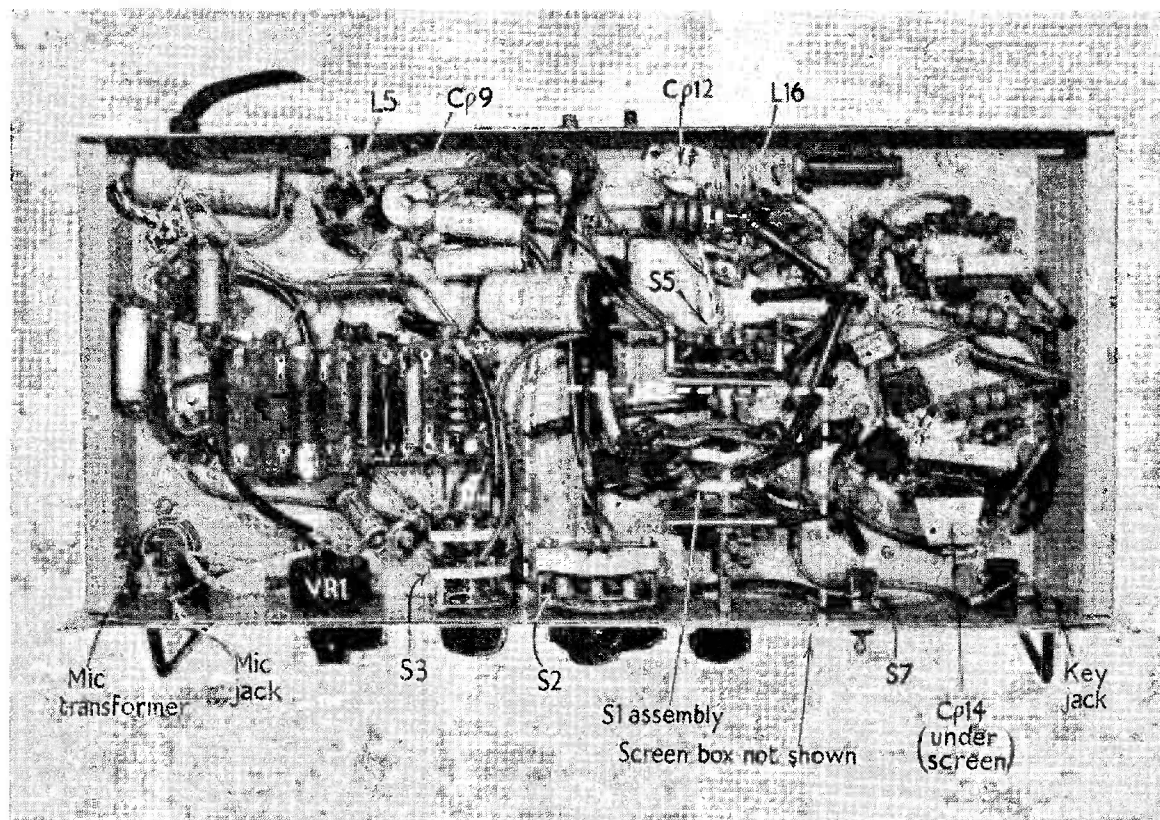

Under-chassis construction of the VFO-Exciter Unit, showing general layout and arrangement, with main parts identified.

cases. However, it is normally the case that by making the compensating condenser of a value equal to one-tenth of the total grid circuit capacity the thermal drift will be checked sufficiently for general purposes. Those wishing to cut down the drift to an absolute minimum should use trial-and-error by substitution—starting off with a value about 10% of the total capacity across the grid and gradually increasing the proportion.

The most vulnerable component is the tank coil and for this reason it is a good scheme to mount the temperature compensating condenser *inside* the coil former so that it will heat and cool in sympathy with the coil. The circuit of Fig. 4 shows that the buffer is keyed, but some prefer to key the VFO. This is a mistake because there is considerable heating due to anode dissipation—even though the heaters are running all the time—so that by stopping and starting the HT supply there will be frequency creep during the transmission and a “relapse” during receiving periods. This,

of course, is of great importance where the Exciter is used as a frequency determining circuit for multiplying to the HF bands.

The large total grid capacity helps in reducing the effect of valve heating, and it should always be remembered that thermal drift depends on the actual capacity in circuit and *not* on the L/C ratio of the tank circuit.

Most readers will realise that changes in humidity can, and certainly do, affect the frequency of the oscillator. The effect of humidity changes is to alter the dielectric constant of air comprising the dielectric of the “air-spaced” variables, between the turns on the coil, and between the remainder of the wiring. The result is a change in circuit capacity. Users of frequency meters will be familiar with this and the consequent need to determine a daily “correction” for the calibration of the instrument.

Humidity changes can, however, be reduced considerably if the constructor wishes to go to a little extra trouble. As regards the coil,



this can be baked in the domestic oven after which it can be given a thorough coating of polystyrene dope or impregnated with a suitable waterproof wax. Of the two, the wax is the more effective.

Frequency instability can also be caused by voltage variation and variation of loading. The use of a good stabilised supply voltage helps to overcome these problems, as does the use of a higher-than-normal grid leak. By keeping the grid leak high, 2.2 megohms, there will be considerably lighter grid loading. (Normally the grid imposes greater loading than the anode circuit.)

The values given in the Table for the VFO pre-set condensers can be built up in some cases by using a mixture of fixed and variable components. For instance, in the original model all the pre-sets are 70  $\mu\mu\text{F}$ , any extra capacity being made up by shunting fixed condensers across the variables. This, in itself, is no disadvantage because the aim in any VFO should be to get most of the fixed capacity in ceramic or mica dielectric components—the less air-spaced capacity in circuit the smaller will be the effect of humidity on frequency stability.

The oscillator is a 6AC7 triode connected, but a metal 6J5 would be a suitable alternative. If similar constructional lines are followed, the valveholder should be so arranged that pins 2 and 7 (heaters) are in the vertical plane.

### General Construction

The buffer is mounted at the back of the chassis behind the oscillator box, with the tank circuit bolted below chassis. Condenser Cp9 is adjusted by screwdriver from above chassis. The Top Band section is located to the right of the screening box and the various bits and pieces will be clearly seen from the photograph. A can is fitted to the 807 in the usual way and a well-screened top cap connector is provided for the buffer to avoid any TPTG tendencies. It was not found necessary to screen the modulator valve V5 but this may be advisable in some cases.

The rest of the above-deck assembly to the left of the box consists of the multipliers. Here a T-shaped metal screen serves two purposes; it provides three convenient screened partitions and enables some of the tank components to be mounted on its walls. In the small partition, below the oscillator valve, is the tripler and the S4 switch assembly. The spindle of the 21 mc tank condenser also appears through the chassis at this point—the actual components being below deck.

Incidentally, it will be noted that Pye plugs are used for the output terminals. Owing to observable losses, the insulating washers as fitted were replaced by similar ones fabricated from small pieces of polystyrene.

The other compartments contain (a) The 3.5 and 7 mc tank and decoupling components and V6; (b) The 14 and 28 mc tank components with V8. All "hot" leads are, naturally, taken through the chassis by ceramic or polystyrene feed-throughs.

Below chassis there is quite a lot to accommodate! Most of the V3/V4 and some of the V5 components are carried on a wide mounting panel over the 807 valveholder. The leads from the microphone transformer to the signal grid

#### Test Measurements

##### OSCILLATOR (V1)—Unloaded

Anode Voltage	240 V
Anode Current	7 mA
Anode Current	15 mA (non-oscillating)

##### BUFFER AMPLIFIER (V2)—Driven, unloaded

Anode Voltage	240 V
G2 Voltage	120 V
G1 Voltage	-1.5 V
Anode Current	10 mA (off resonance)
Anode Current	5 mA (at resonance)
G2 Current	2 mA (off resonance)
G2 Current	1.5 mA (at resonance)

##### 1.7 MC PA (V3)

Anode Voltage	300 V
G2 Voltage	100 V (undriven)
G2 Voltage	250 V (with drive)
Anode Current	20 mA (undriven)
Anode Current	35 mA (driven, off resonance)
Anode Current	5 mA (driven, at resonance)
Cathode Voltage	20 V

##### DOUBLER STAGES (V6, V8)—Each section

Anode Voltage	300 V
Cathode Voltage	30 V
Anode Current	30 mA (off resonance)
Anode Current	15 mA (at resonance)

(NB:—Doublers driven and coupled to following stage but unloaded).

##### TRIPLER STAGE (V7)—Driven

Anode Voltage	300 V
G2 Voltage	230 V
Cathode Voltage	20 V
Anode Current	40 mA (off resonance)
Anode Current	25 mA (at resonance)
G2 Current	2 mA (off resonance)
G2 Current	15 mA (at resonance)

##### MODULATOR (V5)

Anode Voltage V5A	100 V
Anode Voltage V5B	50 V
G1 Voltage V5A	-4 V
G1 Voltage V5B	-5 V
Anode Current V5A	0.8 mA
Anode Current V5B	4 mA

and from the anode of the second triode to S3 are by means of coaxial cable ; no other screening was found necessary in this section.

The biggest problem was the S1 switching assembly. This was made up of a four-pole four-way ceramic rotary with S5 ganged behind it—both being secured to the chassis by means of stout metal brackets. Do not attempt to “get away” with omitting one of the banks (S1a or S1b) ; both are necessary because *both* sides of the pre-sets Cp1 to Cp4 are *above ground* so far as RF is concerned. By using only one set of switching here (leaving one end of each condenser inter-connected) there would be considerable interaction—varying the setting of one condenser would affect the setting of all the others.

Since the actual condensers are in the box above chassis the connecting leads are taken through the chassis to the switch by means of five-way *screened* cable. (The fifth lead, of course, is needed in two cases for the wiper contacts.) Although not shown in the under-chassis photograph for reasons of clarity, a screened casing suitably cut and shaped is used in practice. This entirely encloses the S1 assembly, the S2 switch and the VFO feed connection going to that switch. This cuts off the entire circuit right up to the grid of the buffer ; necessary due to the radiation of RF from the grid leads. The writer began setting up the finished unit with some trepidation but the interaction between the various pre-set condensers was so small as to be practically indiscernible, certainly of no practical consequence whatsoever. Considering the rather long connecting leads from the condensers to the switch (dictated by circumstances which could probably be avoided by prospective builders) this was a very agreeable discovery !

The remainder of the construction needs little comment. Components are, in the main, mounted for shortest possible leads with only one or two small mounting strips placed at strategic points. The 21 mc coil and condenser and the 28 mc tank variable are both mounted below chassis as a matter of convenience.

Leads from the anodes of the doublers are taken to the S1d contacts *via* short lengths of coaxial cable ; the coupling condensers are large (0.001  $\mu$ F) to minimise cable losses and are soldered to the nearest anode point. Also connected by cable is the lead from S3b to the grid of V6.

Details of all the inductances are given in a separate table. So far as the tank coils are concerned there may be need for slight adjustment on assembly owing to differences in stray

capacities and so forth. Spreading out or squeezing the turns of the 21 and 28 mc coils should enable any necessary variation to be obtained. The oscillator coil is especially critical. Before finally impregnating or doping it should be so adjusted that 1750 kc is tuned when C is at maximum capacity, Cp1 (75  $\mu$  $\mu$ F variable, 225  $\mu$  $\mu$ F fixed) is at near maximum and Cp5 is about three-quarters in circuit.

### Setting Up

Setting up the pre-set condensers is a job not to be rushed ; it is, perhaps, tedious but necessary. As a general guide, Cp1 should be set about three-quarters in, Cp2 about half-in, Cp3 about the same and Cp4 similar. Of the HF limit setters, Cp5 should be about three-quarters in, Cp6 about half in, Cp7 about the same, and Cp8 near maximum. This assumes that the variables are all of 70  $\mu$  $\mu$ F.

Then tune the station receiver to 30 mc (checking with an accurate frequency meter if necessary) and set C to *minimum* capacity with the switch S1 in position 4. Adjust Cp8 until a beat is heard. Then rotate C to *maximum* capacity. If this setting corresponds to more than 28 mc, increase Cp4 ; if it is less, decrease Cp4. With Cp4 adjusted to give a beat on 28 mc, re-adjust the main variable C for minimum capacity again and tune the receiver back to 30 mc. If, as is likely, the beat is *not* still on 30 mc, adjust Cp8 until it is.

This process is repeated until C gives a beat at 28 mc with maximum capacity and on 30 mc at minimum capacity.

When the 28 mc band has been lined-up, switch to position 3 and line up the band 14000-14350 kc in the same manner. Then 7000-7150 on switch position 2, and finally 3500-3800 kc on position 1.

When the whole series of bands has been aligned it is well to check that lining up one band has not affected the calibration of the others. It should not do so, but it is a recommended precaution. Incidentally, the exciter should be run with just the oscillator and buffer valves in operation, when carrying out the lining up.

With the alignment job finished the VFO will be in itself a fairly accurate frequency meter. The 180-degree rotation will give the following average kilocycles-per-degree calibration: 1.7 mc-0.8 ; 3.5 mc-1.7 ; 7 mc-0.8 ; 14 mc-1.9 ; 21 mc-2.5 ; 28 mc-11. Thus, it is possible to read to the nearest kilocycle on most of the bands. When lining up and calibrating the unit, remember the “gap” in the 80-metre band (3635-3685 kc). The dial drive shown in

the photograph is one that was on hand; a better proposition would be one of the large full vision dials with blank scales—each band could then be individually calibrated, obviating the need for calibration graphs.

In setting up the buffer and multiplier pre-set tank condensers a certain degree of stagger tuning will be advisable. Fig. 6 is a graphical representation of the various banks reduced to the fundamental range. The buffer tank Cp9 should be adjusted around mid-band, and the 3.5 mc doubler tank Cp10 can also be set around this point. The 7 and 14 mc condensers Cp11 and Cp13 can be adjusted to a position near the HF band-edges. The 28 mc Cp14 can be set to mid-band, as can the 21 mc condenser Cp12.

The RF output will not be so constant as that obtained under some systems, but a reasonably even output will be available. Under construction by the writer to go with this Exciter is a multi-band PA unit which will include a buffer stage to act as a power leveller—having wide-band characteristics.

The construction of a unit of this type may not be everyone's meat, but the writer has no regrets. It has simply been the logical development from a series of VFO's built over the last six years. Apart from other considerations, it is nice to know that the "... not less than  $\pm 0.1\%$  ..." specified in the license conditions can be measured on all bands directly from the VFO calibration.

#### "HOWARD THOMAS AT THE ORGAN"

This is, of course, our own G6QB, of "DX Commentary," who now broadcasts frequently on the BBC's mighty theatre organ. His next audio appearance is on February 17 at 3.30 p.m. in the Light Programme. On this occasion, G2YS will be turning the music.

#### ARMY WIRELESS RESERVE SQUADRON

On p.482 of our issue for October, 1952, reference was made to the formation of this Unit, with an invitation to suitably qualified amateurs to join. A number have now enlisted, and we are informed by G3ADZ (Major D. W. J. Haylock, Royal Signals, who is the C.O.) that the 1953 training camp will be near Chester, for the 15 days June 13-27. Training equipment in Camp will be 250-watt Service transmitters, high-speed high-power sets, and UHF/VHF gear. Voluntary training transmissions, for procedure practice, are being radiated from Chester and Southsea, and are on Service frequencies already allocated to the Squadron. Licensed members who can operate their own stations in the 3.0-4.0 mc range will also be encouraged to join a training net—of course, using Army call-signs and procedure.

Voluntary training, evenings or week-ends, can be arranged by attachment to Regular or T.A. units on request to Major Haylock.

Applications to join this important Reserve are invited from licensed amateurs; from ex-Royal Signals Z Reserve tradesmen; and from radio amateurs who, though not licensed, either (a) Can read and send Morse at 12's, or (b) Have sound radio maintenance experience.

Enlistment in the A.W.R.S. involves an annual training commitment of 15 days in Camp, with pay and full allowances of the rank. It is intended to have G3ADZ/A installed for amateur operation at Chester, and licensed members of the Squadron, already enlisted, are free to bring their own gear should they so wish, as there will be plenty of opportunity for amateur activity during off-duty periods.

All enquiries regarding the Army Wireless Reserve Squadron should be addressed to the Commanding Officer: Major D. W. J. Haylock, R.Sigs. (G3ADZ), 230 Devonshire Avenue, Southsea, Hants.

#### NOTICE OF PRICE REDUCTION

We are very glad to be able to announce that with effect from the next issue of **SHORT WAVE MAGAZINE**—March, 1953, No. 1 of Vol. XI and No. 115 in the series—our cover price is to be reduced to two shillings.

All direct subscribers in our current lists will automatically have their subscriptions extended by three months, so that they will obtain the full benefit of the reduced selling price.

New subscriptions at the rate of 24s. post free for a year of twelve issues will be accepted immediately. This guarantees posting of a copy by direct mail on the day of publication each month, and also entitles the subscriber to full use of our QSL Bureau.

Subscription orders, with remittance, should be addressed to:

The Circulation Manager,  
Short Wave Magazine, Ltd.,  
55 Victoria Street,  
London, S.W.1.

# The Design of HF Receivers

REQUIREMENTS FOR THE  
AMATEUR BANDS AND THE  
COMPROMISES INVOLVED

P. SHORT, M.Sc., A.M.I.E.E. (G3CWX)

*Our contributor's approach to the problem of better receivers for amateur band working is provocative but sound, and he has prepared a design to support the principles he puts forward. While our receivers are in general a good deal better than they were 20 years ago, they could be better still if they were designed for the purpose for which they are intended, rather than for general coverage over a wide band of unnecessary frequencies. It is this which imposes the design compromises resulting in an "average performance" on a particular band, rather than peak performance on the bands in which we are interested. And if we had better receivers with more stable transmitters, the QRM factor on the HF communication bands would be correspondingly less troublesome.—*

*Editor.*

THOSE who spend more time in listening than in calling CQ certainly hear some strange things for their trouble nowadays. The reasons why people do come on the air at all are various, but one and all presumably have as their aim what may be called "a 100% QSO," where there has been an exchange of information without misunderstandings and above all without losing the other station and having to search for him all over again. Unfortunately, though, only a fraction of the amateur population seems really happy in its QSO's. The rest are suffering from what they call bad QRM, weak signals, noise, QSB, and so on, and seem always to be straining on the edge, missing words, missing names (a terrible thing, this!) or losing contact altogether.

In Amateur Radio, as in any other pursuit, we will always have a percentage of the lads, the clots, the dimwits. The writer's feeling is, however, that much of the present-day QSO troubles cannot be laid at the door of old Bert (Jean, Paolo or Heinrich) along the road—who was never very bright anyway—but arise more from the shortcomings of the average receiver in use.

One is so accustomed to the special difficulties of amateur HF reception that it is worth while sitting back and trying to consider the situation from the outside. QRM is everywhere. Weak, fading signals are to be dealt with successfully. Phone QSO's are bad enough, but CW—with a mass of signals, some drifting frequency, some from well-used bug keys and sounding all the same, others chirping so that the crystal filter is almost useless—is surely the limit. To outsiders the idea that anybody should cheerfully put up with a second-rate receiver must be quite inexplicable. Small wonder that most people who have the situation sized up increase power as far as they can, or dare to, so that even the second-rate or common receiver can pick them out from the crowd. Small wonder also that the general level of QRM steadily rises.

It is therefore worth while to see what is to be desired in an ideal Amateur Band receiver and to find how far that ideal can be approached in practice. First, then, what qualities do we want?

## The Requirements

*Stability* is the first essential. When tuned to a particular frequency the receiver should of course stay tuned to that frequency till further orders. Such freedom from drift should be allied with good logging facilities, preferably direct frequency calibration, and bandspread. Bandspread tuning in the amateur receiver should mean that the whole sweep of the tuning dial is used for covering the wanted band, so that the dial is not, as so often, cluttered up with unwanted frequencies. In addition we need the ability to cope with unwanted strong signals and QRM of all sorts without blocking or modulating the wanted signal by the unwanted one.

*Selectivity* is the next essential. In CW work and to some extent on phone the mental ability, acquired by the practised operator, to concentrate on the wanted signal and ignore the unwanted takes one a long way; but the act of doing so is tiring and the performance of any particular operator will obviously be improved if he can use the maximum selectivity which is profitable in a given situation. Very often this implies a narrow acceptance bandwidth unattainable in the average receiver actually used and the rejection of signals outside the pass band to a degree which even some highly-priced receivers fail to provide.

*Sensitivity* nowadays implies not only high gain but also a low internal noise level. Especially on the highest frequency ranges

many fall short in this respect, and if the receiver is all right these properties are easily wasted by the use of a poor receiving aerial; though remembering how difficulties can arise even in S7 and S8 QSO's, one sees that sensitivity alone is not very much use.

*Ease of Operation* is generally assured, as far as any modern receiver goes, provided that stability as defined above is all right. Those who have to run round the station when they switch from "receive" to "transmit" do sometimes find, though, that during that time the other station tunes away from the right spot when trying to find their missing signal. Transmit-receive switching and BK working are, however, not our concern at the moment.

Having run over these points, one can ask two questions:

- (1) How is it that most amateurs use such poor receivers?
- (2) What in practice sets the limit of performance of the best ones?

### The Difficulties

The first question is easily answered. First-class new receivers, when they can be bought, are very expensive. Those which are available in this country—they are not many—are of the general-purpose wide coverage type not designed especially for amateur use. One pays for facilities one does not need without getting exactly what one does want. It should be remembered that the market for specialised *amateur band* receivers is very small, comparatively speaking. Ten thousand would probably keep us going for twenty years. Also development costs are high. The construction of first-class HF receivers is nearly a lost art as far as the amateur himself is concerned, mainly because first-rank designers are not nowadays employed to design models intended for home construction. At present, many of us are using ex-Service receivers, few of which are altogether suitable, together with the remaining pre-war imports from the U.S.A. and a very few modern purchases of communication receivers. Neither as individuals nor, apparently, as a nation can we afford to pay for a large ready-made supply of something better. Most of amateur Europe—the place where the QRM comes from—is in the same boat.

The receiver problem then resolves itself into one which the VHF fraternity have already faced, namely, the construction or part construction by hook or by crook of a first-class receiver at a price in hard work and £.s.d. which the average amateur can afford to pay.

With this in mind we can get on with the second question by considering from the practical angle the design of efficient HF receivers.

### Design Considerations

Our receivers are intended for use on the six HF amateur bands. We need not provide general coverage of frequencies far outside the bands and thus worsen their performance where it is wanted. Six tuning ranges are therefore required. (A seventh one for the 200 kc Light Programme is very useful for setting 100 kc crystal oscillators and providing Greenwich time signals!) Only superhet circuits need be considered. Of these there are two very useful kinds, one with tunable first oscillator and fixed IF, and another with first oscillator frequency fixed (generally crystal-controlled) and variable IF feeding a variable-tune receiver of one waverange only. In the second case the use of broad-band, fixed tune signal-frequency circuits is preferred and the IF is high — 1600 kc upwards — to improve second channel suppression.

Neither of these circuits are ideal. In one the first oscillator, operating near the signal frequency, has to be tuned by the variable gang condenser and its frequency stability is essentially poor. In the other the oscillator may be crystal controlled but the selectivity before the frequency changer is poorer and trouble may arise from the presence of large unwanted signals, duly amplified by the HF stages, at the frequency-changer input.

In the present case it seems better to use the first and more conventional type of circuit. In this instance the intermediate frequency may be so low that simple crystal-bridge filter circuits will provide most of the IF selectivity. The question of stability, less easy to attain in this type of circuit, needs consideration. We want short-term stability, so that chasing a signal round the dial during a QSO is minimised, and preferably long-term stability, so that dial calibrations stay put. The requirements of CW reception will be dealt with first and the less exacting but different case of phone reception later.

Stability in this receiver depends chiefly on the first oscillator. This oscillator generally operates above the signal frequency—*above*, not below, to facilitate tracking in general-coverage receivers. Our oscillator need cover only the width of one band on each of the tuning ranges and only on the lowest range, (1710 kc + IF) to (2000 kc + IF), will tracking need much consideration. Common receiver tuning condensers of 200-500  $\mu\text{F}$  maximum

are no doubt value for money but their stability leaves much to be desired. It is better to use, as we can, a small well-made three or four gang condenser of say 50  $\mu\mu\text{F}$  maximum and to have relatively large shunt trimmer capacities, of high stability, for each band. According to the best traditions the oscillator coils should be wound in tension on ceramic formers to keep their co-efficient of expansion down to that of the former and to avoid unexpected, permanent changes in inductance. On the highest frequency ranges, however, a fair proportion of the inductance will reside in the wiring and the range switch; thus very careful consideration must be given to the mechanical design of the tuning assembly. Unfortunately the result of increasing the oscillator tuning capacity, to increase the stability, is that of decreasing the total inductance and thus increasing the proportion of it which does not reside on the ceramic former of low temperature co-efficient. The capacities across the tuned circuits hence need further scrutiny.

A little consideration will show that there is no reason why the tuning capacity of the oscillator should be nearly the same as that of a signal-frequency circuit. If the oscillator section of the variable condenser has say twice the capacity (max-to-min) swing of a signal frequency circuit then the total oscillator capacity can be doubled and its tuning inductance halved. There is an idea, by the way, that in signal frequency circuits one wants low capacity and high inductance to provide the maximum resonant impedance and hence maximum gain. Whether this idea fits in with modern low-noise HF amplifier pentodes of high mutual conductance is rather doubtful as far as HF receivers are concerned. In the present case it seems best to use such valves and to increase selectivity by working as if at the low frequency end of a wave-range of a commercial general coverage receiver, by using signal frequency circuits of relatively high capacitance. Even with only one RF stage it is not difficult to get at 30 mc the modest degree of gain—10 times or so—which is all that is really necessary.

A further refinement in oscillator stability may be obtained by the use of negative temperature co-efficient condensers as part of the shunt capacity. The initial frequency drift while the receiver warms up and the valve capacities settle to their working values will probably have to be accepted by most people, though various cunning devices such as trimmers fitted with their own heater coils are available to the enthusiastic. The oscillator

anode supply voltage must be, and readily is, stabilised, but compensation for changes in heater voltage will not be easy and the amateur's receiver may well be no better than the average commercial specimen in this respect.

To sum up, care must be taken over oscillator stability but the problem can be tackled with confidence by anyone who has built his own VFO.

### Band Changing

In the above it has been assumed that wave change is to be by the ordinary ceramic-wafer type of switch. These have the advantage of being ready made, the precision work involved being the maker's worry, but they do impose some restrictions in the mechanical layout of the circuit. The alternatives are a turret-type coil change, or plug-in coil assemblies. One would prefer to be excused from tackling the former at low cost or with simple tools: the latter, plug-in coil assemblies, strikes some people as too much trouble, though every HRO user is hardened to it. It is just a matter of taste.

The next point, *Selectivity*, is not so easy. The bandwidth available from simple crystal bridge filters at 465 kc is sufficiently narrow, except that the suppression obtained well away from the pass band is often found insufficient and the sharpest of the sharply peaked responses is put in, making slight drifts in frequency at transmitter or at receiver oscillator distressingly evident. It is usual to fit such filters (which, let it be emphasised, are not really difficult to construct and adjust) immediately after the frequency changer in order to restrict interference voltages to as few stages as possible. Increased suppression away from the pass band can be gained by redesigning the crystal filter in accordance with the principles laid down by M. T. Mason, of the U.S. Bell System, long ago; but this brings with it far greater difficulty in construction and adjustment. The alternative is to increase the selectivity provided by the IF transformers, which is often done by subsequent frequency changing from the crystal-bridge frequency to a lower IF at which narrow transformer bandwidths are easier to get. The ready-made surplus Q-Fiver, or BC453 receiver, has been successfully adapted for this purpose as it receives in the band 200-500 kc and has a sharply tuned 85 kc IF system. When properly used the BC453 is very handy, but some people do not realise that it is in its own right a sensitive receiver (needing only to be fed from the frequency

changer *via* the crystal filter) and try to run it from the last IF valve of the main receiver with the wick turned up, often for some obscure reason switching on the beat oscillator there and switching off that in the BC453. The resulting manifestation of excessive noise is not surprising!

However one may assort the selective devices, there is no getting away from the distressing phenomenon of "ringing," to be heard with all narrow-band-pass filter systems. Impulses occurring outside the pass band of the filter, as well as within it, will both give rise to "ringing." For this reason the usable selectivity is very limited under conditions of heavy QRM.

The traditional methods outlined make available enough selectivity for most amateur needs. As far as receivers which the amateur can afford or construct are concerned, no advance on the performance of the present double-super arrangements with crystal bridge and Q-5'er or the equivalent seems likely; but the point is that the vast majority of receivers actually in amateur use now have a very long way to go before they reach this attainable standard.

*Sensitivity* and signal-to-noise ratio are topics which one would surely think have been fully explored after years of VHF receiver building by the enthusiasts. The necessary techniques do not seem to have filtered down to the HF field very thoroughly, probably because most people are afraid of building HF receivers. The principle is however the same: To start off with a low noise HF valve—a pentode will do — and follow it by enough signal-frequency gain to render innocuous the higher level of noise inherent in the frequency changer valve, without being too liberal with gain so that the frequency changer overloads easily. After the frequency changer, gain as desired up to 80 dB or so is readily obtained by IF amplifier stages. The last IF amplifier stage is easily overloaded, especially if there is much voltage lost in the IF transformer feeding the final detector. The effects of high signal level on a second changer are generally not so troublesome, as the selectivity ahead of it can cut down all but a small band of signals to a low level.

*Phone Reception*—The design of receivers for AM telephony is less exacting than that for CW. The signal bandwidths used are of necessity greater and in consequence oscillator drift is not so troublesome. On the other hand, variable selectivity—here down to a nominal 1 kc bandwidth—is still desirable and care must be taken not to increase unduly in the

receiver the distortion which is almost certain to be present in the signal. This is orthodox superhet design. The phone receiver should also have AGC facilities and an efficient noise-silencer circuit for maximum performance. The question of what noise silencers really are and why they are not used in CW work need not trouble us here. The standard circuits are simple and well known: a very good commercial sample is that in the AR88, using a double diode. It can fairly be said that no good phone receiver is without one.

The various points outlined above do not of course comprise a complete guide to receiver design, but will it is hoped cast some light on the design of the specialised amateur receiver, and start some practical thinking. It is hoped that it has been made clear that the limits of performance of HF receivers are no mystery and that receivers very near to these limits may be built with ordinary amateur facilities, without an expensive laboratory, *provided* that coverage of the amateur bands *only* is required. A general improvement in the average receiver, as distinct from an extra polish on a few outstandingly good ones, will help conditions on the amateur bands considerably; but it looks as if this improvement can only come about if the building of receivers again becomes an active amateur interest.

An efficient receiver for the 14 mc band, simply constructed on the lines laid down above, will form the subject of a later article.

---

#### GPO's RADIO AMATEUR EXAMINATION

We are informed that for the Radio Amateurs' Examination held by the G.P.O. in London and Leith in October last, there was a total of 66 entrants (London 57, Leith 9), of whom 48 passed (London 41, Leith 7). The eight questions set were fair and reasonable and (with one possible exception) well within what should be the range of theoretical knowledge of the prospective amateur. The Post Office is proposing to hold another such Examination in October of this year—in London, Edinburgh and Cardiff—provided the total number of applications to sit is not less than 60. The fee for this will be 25s., and it is specially arranged to supplement the R.A.E., always held in May each year, by the City and Guilds of London Institute, and for which the majority of candidates enter. Further information as to how and where to apply for the G.P.O. sitting will be given in due course.

#### IS THIS YOU?

From a Despairing XYL: "How can I cure my hobby-happy hubby? Every night when he comes home he gulps down his tea, and then buries himself in his radio. I might be the other side of the Iron Curtain for all the notice he takes of me."

# Multi-Band DX Aerial

THE EXTENDED  
DOUBLE-ZEPP

S. G. MERCER (G2DPY)

*The aerial described in this article is not new—it was used very successfully by some of the leading DX men in the pre-war era—but of recent years the Centre-Fed Zepp has been largely neglected. Easy to erect and tune, it is well worth a trial in locations at which other systems appear to be failing. The author shows how his own results were improved by adopting the Double Zepp, and gives all the necessary information for the construction and adjustment of a suitable aerial tuning unit.—Editor.*

CONTRARY to usual procedure, the writer will describe results obtained with this aerial before going into the constructional details. In June, 1952, there was dismay at G2DPY over never having QSO'd W7, only scratching through with one or two W6's, and possessing an almost blank score card for Africa. Fingering through the tattered remnants of a 1937 *ARRL Handbook* it was decided to try the "Extended Double Zepp" which found so much favour with pre-war amateurs, although it is rarely encountered these days. Twenty was decided upon as the target band.

It was seen that if this aerial could be erected in the 90 ft. available, running NE/SW approximately, that — radiation being maximum at right angles—one lobe would cover the more interesting parts of Africa and the other would take in W6, W7, WØ, VE4-VE8, and other interesting areas. Power available was 25-75 watts, averaging 50 watts most days, the variation being due to badly overloaded local mains. In practice there was little difference in reports, using 25 or 75 watts! The writer must ashamedly confess to not possessing at that time either a field strength meter or yet even an RF meter for feeder current measurements! In fact, the only indication used has been a neon and a couple of flash bulbs, the bulbs being paralleled in one leg of the feeder. If low current at this point, one bulb is unscrewed, whilst in the case of heavier current, the bulbs are shunted and a neon used as an RF indicator. Parallel tuning

is used on all bands, 3.5, 7, 14 and 21 mc. Ten has not been tried as a local radar noise blots out all reception around this frequency. Band changing only involved altering the disposition of (crocodile) clips in the tuning unit.

## Areas Covered

Results on all four bands were comparable, DX being worked on all. For an all-band effort the aerial even performed remarkably well on 21 mc.

Here, briefly, are the results obtained during 5 months' exclusive use of this system, which show how the aim to work W6, 7, Africa and other distant parts was duly fulfilled. Contacts were made with CR6-7, ET, FB8, FB8 (Amsterdam Is.), FF8, FQ8, EA8-9 (and Ifni!), HZ, MI, OQ5, ST, SU, VK1, (Heard Is.), VQ2-VQ6, VQ8, ZD2-4-6, Z9D, ZE, ZS1-6, ZS3, ZS9, 3V8 and others. In addition, a schedule was maintained for more than 100 contacts with ZS5AM in Natal, for good solid QSO's. In the American direction, QSO's were made with W6 and W7 prolifically; more than 100 W6 and W7 stations were worked. VE1-VE8 and NWT, VO and VO6, KL7, KH6, FP8 were also brought in, whilst "off the beam" came such tit-bits as KG6, OA, JA, TI, VP8, VK and ZL. East Coast W's were always workable when conditions were open for them, especially on 40 and 14 metres. Directivity, in a "beam-width" of approximately 40 degrees for the loss of one S-point, seemed most marked on 20 metres. On other bands, there seemed little to choose.

## Putting It Up

The writer is a very busy man and rather slap-dash with constructional efforts, so the fact that the aerial was measured and functioning in a couple of hours should be convincing enough to tempt the discontented owners of "end feds" to yank them down and sling up this easily built member of the DX family of skywires.

You will find your short skip stuff unaffected or even improved. Mast height at 2DPY is 35 ft. and location sea level, near enough. CW operation is used exclusively. Whether right or wrong in theory, it has always been found that to make the feeders just long enough to drop away from the top at right angles to within a distance of 7 feet or so from the ground, and then straight to the radio room, gave the best results; the writer has never fiddled around with quarter wave multiples.



Spacers were made from a shilling's worth of  $\frac{1}{4}$  inch dowelling (curtain rod) from the local ironmonger's. This was cut into  $4\frac{1}{2}$ -inch lengths, holed with a  $\frac{1}{16}$ -inch drill at each end and then the lot boiled in paraffin wax for half-an-hour or so. (Make sure that the XYL is out when you do this!) The approximate length of feeder required was then estimated and two lengths of 16 SWG cut and stretched down the garden. At intervals of two feet, a small piece of insulation tape was wrapped and the spacers then bound to the feeder with 20 SWG copper wire, the tape providing a "non-skid" joint;  $87\frac{1}{2}$ -feet of 16 SWG was then stretched likewise and insulators fitted to each end; this was then split at dead-centre, and a 4-inch insulator inserted. The feeder was attached across this centre insulator (Yes!—the joints were twisted!)

The whole job was then pulled up by the halcyards and a 7-foot post located under the centre, to the top of which, on two insulators, was strained the feeder. From this anchoring point the feeder was stretched tautly across to the station window. Total length of feeder in the writer's case was 50 feet.

### Coupling

At the business end is a link-coupled aerial tuning unit, as shown in the sketch. This was originally built when a full wave Zepp was in use and needed no modifications, being fairly versatile by reason of wander leads and crocodile clips. Only on 80 metres is it found necessary to retune the coupler slightly, if jumping large spans on the band; even this is not necessary unless striving to get the last milliamp for some choice DX! Possibly, series tuning might have been better on some

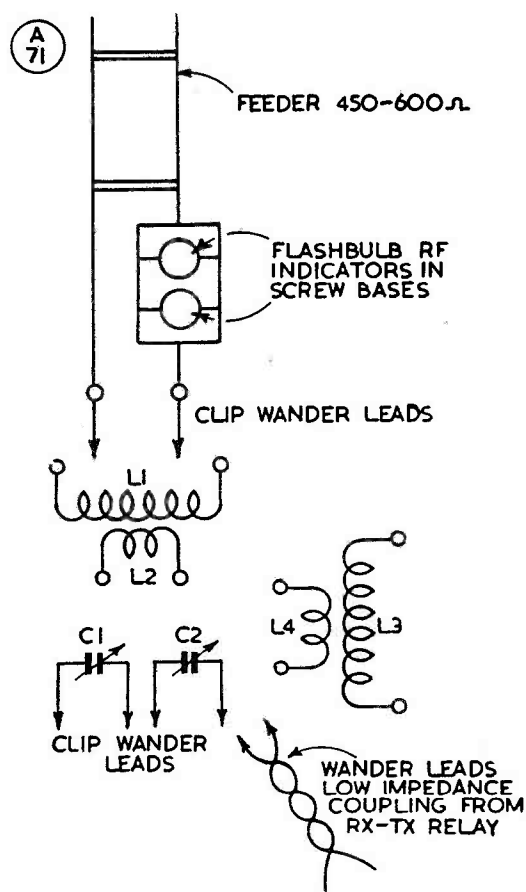

Electrical layout of the aerial tuning unit used by G2DPY with his Extended Double Zepp. The coil assembly L3/L4 is interchangeable with L1/L2, according to the bands required, and each accommodates two bands. See tables for values and tuning procedure for the various bands.

### Coil Data

#### AERIAL TUNING UNIT

##### 3.5 and 7 mc Bands

L1 — 24 turns,  $2\frac{1}{2}$ -in. diam., winding length  $4\frac{1}{2}$ -in., 16 SWG.

L2 — 6 turns insulated wire over L1.

##### 14 and 21 mc Bands

L3 — 8 turns,  $2\frac{1}{2}$ -in. diam., winding length 2-in., 12 SWG.

L4 — 4 turns heavy insulated wire, self-supporting, to slide in L3 for variable coupling.

##### Tuning Condensers—All Bands

C1, C2 — 300  $\mu\mu\text{F}$  transmitting type variable.

##### Indicators

0.3 amp. flash-lamp bulbs, connected as described.

bands, but being a great believer in parallel tuning wherever possible, and because current indication was available on every band with this method, it was left at that, especially as the one tuning system made for easy band changing. A swinging link of 5 close-wound turns of flex-type rubber covered wire was made up for the PA, and this coupling is used on all bands quite satisfactorily.

In all cases, the tuning procedure is to set the tuner capacity at minimum, reduce PA coupling to a minimum, tune the PA for dip and then increase capacity in the tuner until a rise is indicated on the PA meter. The tuner is left set at the point of maximum rise. Coupling to PA is then increased until maximum brilliance is shown in the feeder bulbs. Slight retuning of the PA for dip may be

necessary, but due to good fortune in the matching it is found that this is rarely required. You may not be so lucky !

Before the theorists tear G2DPY apart, he would point out that the proof of the pudding is in the eating and that "I am doing quite nicely, thank you !" without ever even switching the bulbs to the other leg to check the balance !

The system as described here has given many thrills at G2DPY. After trying carefully prepared Half, Full and 3/2 Zepps, folded dipoles, Ground Planes, Windoms and what-not, it can honestly be said that better results have been obtained from this Zepp than any other. Certainly, the writer is not questioning that better results could be obtained by a more "purist" approach—but the aim of this article has been simply to dispel the doubts that many "end-feeders" seem to have about any transmission-line-fed system. Being symmetrical, the layout described lends itself admirably to TVI suppression. At G2DPY a simple cut-off at 18 mc is used on 80 and 40 in the low impedance coupling between tuner and PA, and at least enables one to work the two LF bands during TV hours. As an aside to some of our newer constructors the writer would say

### Tuning Procedure

#### 21 mc Band

Feeder to L3 ; Rx/Tx link to L4 ; C2 across 4-5 turns L3. Half couple L3/L4, resonate on C2, increase coupling for maximum glow in indicator lamp. (One bulb in circuit).

#### 14 mc Band

As for 21 mc, but C2 across L3 and feeder line tapped inwards for optimum loading indication. (Both RF bulbs in circuit).

#### 7 mc Band

C2 across whole of L1 ; Rx/Tx link to L2. Feeder tapped in towards centre of L1 until sufficient loading obtained. (Both bulbs in circuit).

#### 3.5 mc Band

With unit set up as for 7 mc, parallel C1, C2, short out bulbs, and resonate to full PA loading by neon indication at L1.

(Note : Transmitter at G2DPY is run with 50-ft. feeder line and 50 watts input. Other feeder lengths and different PA inputs will affect tuning procedure and RF indications).

that arranging some kind of easily-adjusted variable coupling in either PA or tuner, or both, will give a reward in efficiency and ease of adjustment beyond all relation to the trouble involved.

## Notes on the 815 Double Tetrode

### OPERATION ON THE HF BANDS

THE circuit and photograph herewith are offered following a number of enquiries from readers who noticed from p.543 of the November, 1952, *Short Wave Magazine* that an 815 PA is in use at G6TJ, on the 20-metre band.

Apart from the obvious suitability of the 815 for VHF push-pull circuits, those who may have acquired one more or less accidentally when buying "surplus" would perhaps be interested to know that it also provides an easy-to-drive RF power amplifier on the lower frequencies.

The 815 is a double-tetrode with top cap anode connections, and at G6TJ is used as a single valve with the two sections in parallel (see circuit diagram). Under these conditions, it can be driven to a comfortable 50 watts by a single 6V6 or 6L6. With sufficient drive,

the 815 can actually be run at 75 watts DC input with 500 volts on the plate, the anode dissipation being 25 watts.

For those who may not have the operating data handy, these are : Heater, 6.3v., 1.6 amp.; max. plate voltage 500v.; max. screen, 200v.; max. plate current, 150 mA ; screen current, 17 mA ; grid current, 2.5 mA ; grid bias,

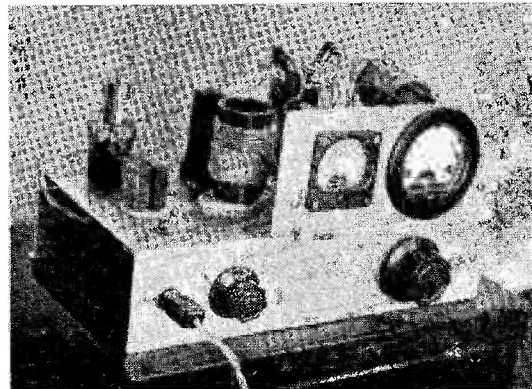

Neat constructional layout of G6TJ's 14 mc CO-PA transmitter, using an 815 in the output stage. All necessary values are given with the circuit diagram.

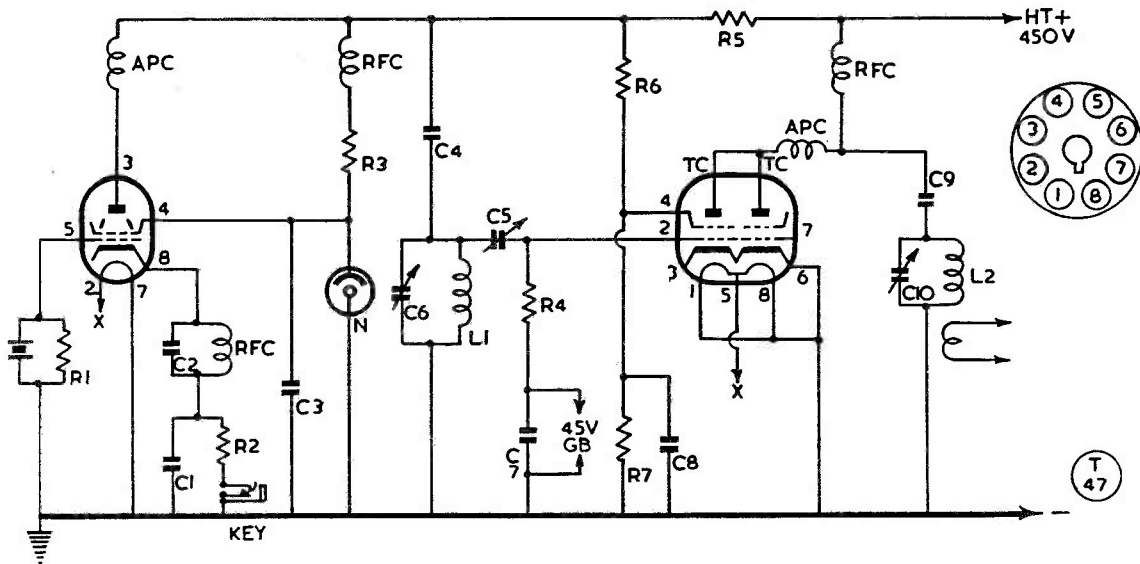

Circuit of the 20-metre CO-PA transmitter designed by G6TJ, using a paralleled 815 in the output stage. As shown, the transmitter can be run at an easy 50 watts. Values are given in the accompanying table. Coil L1, L2, should be as normally used for 14 mc.

**Table of Values**

Circuit of Two-Stage Transmitter, using 815 PA.

C1,	C8 = .01 $\mu$ F.	R5 = 500 ohms, 10 watt.
C2,	C7 = 75 $\mu$ F.	R6 = 7,500 ohms, 20 watt.
C3,	C6 = .002 $\mu$ F.	R7 = 20,000 ohms, 20 watt.
C4,	C9 = .001 $\mu$ F.	V1 = 6V6G.
C5,	C5 = 10 $\mu$ F variable.	V2 = 815.
C6,	C10 = 100 $\mu$ F variable.	N = VR150.
	R1 = 150,000 ohms.	APC = 15 turns.
	R2 = 150 ohms.	
	R3 = 30,000 ohms.	
	R4 = 400 ohms, 20 watt.	

- 45v.: grid driving power for full output, 0.13 watts : max. RF output, 56 watts.

Base connections for the 815 are given inset in the circuit diagram, and the values used at G6TJ for his simplified but very effective transmitter for the 14 mc band appear in the table.

**ACTIVE OLD TIMERS**

By the same post, we recently had letters, on quite different subjects, from G2HQ (Sheffield) and G2NU of Staines, but who both mentioned that they started in Amateur Radio as long ago as 1912. G2HQ is active on all bands, including two metres, from a difficult QTH in a deep valley. G2NU speaks of how in 1912 the possessor of what was then known as a "three-slide tuner" was treated with the respectful awe due to the owner of a Rolls-Royce, and remarks on a spark QSO with G2KT more than 40 years ago. It was a memorable contact because G2KT at Snarebrook had just succeeded in working a St. Albans station at a range of no less than *eight miles!* To these and all the other fine

**XTAL XCHANGE**

Notices for this space are free, but can be accepted in respect of exchanges of crystals only. Offers should be set out in the form shown here, on a separate slip headed "Xtal Xchange - Free Insertion." and all negotiations conducted direct.

- G2FCA, 26 Northolme Gardens, Edware, Middlesex.  
Has QCC Type P5 crystals 7069, 7185 and 7278 kc, certificated ; also Brookes Type S, 7009 kc. Wants frequencies in 3.5 mc band, similar makes.
- G3CXD, 9 Kingsway East, Newcastle, Staffs.  
Has several 7 mc crystals, and 100 kc bar. Wants Type V, FT-241 for channels 59 and 325.
- G3DXJ, 7b M.S.O., Aborfield, Reading, Berks.  
Has 3510, 3555 kc crystals,  $\frac{1}{2}$ in. mounting ; 7006 kc, and frequencies 6.0-7.5 mc,  $\frac{1}{2}$ in. mounting ; also RCA 200 kc bar, octal mounted. Wants 14 mc crystals for CW section.
- G3HJG, 23 Link Avenue, Urmston, Manchester.  
Has GEC 3505 and 3561 kc crystals, certificated ; also ex-U.S. 3513 kc. Wants 100 kc bar.
- G3IDW, 136 Beech Avenue, Swindon, Wilts.  
Has ex-U.S. 8284 kc crystal. Wants any frequency in CW section 3.5 or 7 mc band.
- G3IKT, 79 Smith House Lane, Brighouse, Yorks.  
Has RCA 100 kc bar, 3-pin base. Wants crystal in 3520-3550 kc band,  $\frac{1}{2}$ in. mounting.
- G3IOZ, 1 Hillington Road, Edgeley, Stockport, Cheshire.  
Has crystals 7062, 7075, 7150, 7175 and 7775 kc, Type FT-243 ; also 6547.9 and 6522.9 kc,  $\frac{1}{2}$ in. mounting. Wants 7 mc crystals for CW working, preferably FT-243 mounting, also 6.0 and 8.0 mc frequencies for multiplying into Zone E (144.4-144.65 mc)

Old Timers still active, with all their early interest and enthusiasm for Amateur Radio still undimmed, we say "Hail!" and respectfully offer them our good wishes for many more years of health, happiness and activity on the air.

# DX COMMENTARY

L. H. THOMAS, M.B.E. (G6QB)

DISREGARDING the suggestion of a correspondent that we should just call this column "Commentary" (or print the *DX* in extremely small letters), we embark on yet another chronicle of the monthly happenings. Labour under Difficulties, or the Triumph of Virtue over Vice—call it what you will, but the going is certainly pretty hard these days.

Nevertheless, amateurs being what they are, some of them have found a way of beating the odds, and the one redeeming feature of this winter of 1952-53 has been the wonderful behaviour of our Top Band.

Though everything else seems to have touched a new Low, the first two legs of the Trans-Atlantic Tests have shown that conditions on 160 metres are better for DX than they have been, at any rate during the last three years.

It only remains for us to keep on plugging away at these tests, winter after winter, right through an eleven-year cycle. We shall then know, for the first time, whether the peak year on the 1.7 mc band really does correspond with the worst year on the HF bands, or whether the whole lot go round together.

At the moment it certainly seems that the lowest trough on the DX bands has fallen into step with the highest peak on the LF band, for never, in one single month, has there been such an absence of DX below about 40 metres, coupled with such a profusion thereof on the 160-metre band.

Time alone will tell; meanwhile some of us would willingly sacri-



VQ4AA

## CALLS HEARD, WORKED AND QSL'd

fice just a little of that Top-Band DX in order to make some of the others start working again!

### Top-Band Achievements

Activity on One-Sixty now falls under two headings—the working of real DX in the early mornings (particularly on the Sundays of the Trans-Atlantic Tests) and the striving after WABC in the evenings. A surprising number of erstwhile DX types have settled down to WABC as a self-imposed task, and they report that they are finding it interesting and amusing. In fact, one such writes and says "Don't know how I should keep up any interest in radio these days if it were not for your various devices of torture and particularly WABC"!

But first, the DX, which has been quite outstanding this year compared with the two previous series of Tests. December 28 saw a fine assortment of W's and VE's coming over, with nearly everyone hearing WØNWX for their best

DX so far. Stations known to have worked (or to have been called by) the DX include G3PU, 5JU, 5RI, 6GF, 6GM, 6GO, 8KP, G12ARS, G15UR. W's heard included 1's, 2's and 3's too numerous to mention, as well as W4JBF, 4LRN, 4POB, 4VFL, 4VUA, 8NJC, 9NH, ØNWX, and W2HCW on phone. VE1EA, 1HJ and 3AAZ were batting for Canada and got across well.

On the following Sunday (not an organised test) the conditions were even better. G6GM (Hols-worthy) on this day, January 4, worked W1BB, 2EQS, 3EIS, 8BKH, 9FIM, 9MFV, 9NH, ØNWX and VE1EA—just like that! G5JU (Birmingham) worked twelve stations, including W9MFV, 9NH, ØNWX and 5ENE in Dallas, Texas, this almost certainly being the first G/W5 contact ever made on the band. And he has the card to prove it!

Then came the second Sunday of the tests (January 11) with conditions right on top of their form

again. This time several more G's got across, with the old reliables doing even better than before. G5JU worked thirteen this time, including W9CZT, 9MFV and ØNWX. G3ATU (Roker) opened up the path, as far as he was concerned, with VE1HJ and W1TCR.

G6GM did well again, with thirteen QSO's (W9PNE and 9NH among them). G6LB (Chelmsford) worked W1DWO, as the result, he says, of 95 hours of early-morning operating! GM3EHI (Bellshill) raised W2HCW, whom he also heard on phone at R3, S5. G8KP (Wakefield) worked K2ANR, W2EQS and 3EIS.

GW3ESP (Skewen) raised four of them, and spent a long time replying to W4JBF, who was on 1900 kc, but didn't manage it. G3BKF (Chelmsford) connected with K2ANR and W1EFN. G5TN (Weston - super - Mare) worked W1LYV and had a doubtful one (due to QRM) with WØNWX.

Much to the delight of the W's, E19J (Cavan) showed up on the band, having managed to acquire a special licence for the Tests. He celebrated this in a big way by working no fewer than 19 W/VE stations, the best being W4LRN, 9F1M, 9PNE and ØNWX. He also worked W2QHH on sked, giving the latter a new country on the band and achieving a *six-band* QSO for both of them. Paddy had no special gear for 160 metres and had to adapt his 80-metre exciter, using his 137-ft. Zepp. What happened left him amazed, and he will, of course, now be gunning for them every week-end.



An interesting personality photograph. MP4KAB (right) and W2KEZ on board the tanker "Gulfpass" at Kuwait. The latter operates /MM on this ship.

### A QRP Feat

Perhaps the most outstanding piece of work was achieved by G6ZN (Horbury), who says: "I parked my *three watts* among the Top Band giants and heard K2ANR come back and give me RST 549. We had a solid QSO, his RST being 579. The Tx here was a Hartley (solo) with dry batteries, and a half-wave end-fed ant." This strikes us as pretty terrific, and we can hardly wait to hear of W9 and WØ contacts with this QRP rig!

Receiving logs are acknowledged, with thanks, from G2YS (Chester), G3ICX (Sutton Coldfield), G5MP (Hythe), GW4CG/A (Port Talbot) and several prominent SWL's. By next month we shall have two more Test week-ends to report on, and we only hope that conditions continue to play as well as they have done up to now.

And so to the equally interesting, if less spectacular, work being done on the band at other times. G2YS mentions that further "rare ones" for WABC, working from his part of the world, are GW3HEU and 3IWH (Denbigh) and GW3BNK (Flint).

G3ICX reports as a newcomer on the transmitting side. On the first night of the tests his aerial was only 50 feet long and 25 feet high, so he didn't expect any results. Reading our comments last month urged him to parley with neighbours, so he will be trying with greater expectations and a better aerial from now on.

G8KP (Wakefield) must have broken a record of some sort, having worked his 60 counties on the band in 31 days. His present score is 67, but the confirmations are 'way down and he is still chasing the paper-work. (One more to go!) He was one of those lucky enough to raise MF2AG (they had a 50-minute QSO at S8 both ways), and also has cards from HB9HT and HA5BT. Many contacts with OH3NY, with OK's, and SWL reports from SP and DL have been keeping KP happy on the band. Recent additions have been GM2FNF (Bute), GM3GUJ/A (Ayr) and G6VQ (Westmorland).

OH3NY, by the way, makes a special request that stations work-

### TOP-BAND COUNTIES LADDER

(Starting Jan. 1, 1952)

Station	Confirmed	Worked
GM3IGW	66	68
G16YW	66	67
GM3OM	62	66
GM3JDR	61	66
G5LH	60	61
G8KP	59	67
G2NJ	59	61
G6VC	58	68
G3EIZ	58	64
GM3EFS	56	67
G6ZN	55	70
G3AFL	48	53
G4XC	31	53
G3BDS	30	50
G3HTI	28	45
G2YS	24	53
G3NA	11	27
G3HWH	6	31

ing him should send his card *via* BCM/QSL; they are then forwarded to him direct. For some reason, those that go to the OH QSL Bureau never seem to reach him.

G2NJ (Peterborough) tells us that HB9HT is ex-G3EIO (formerly of West Barming, Kent), who uses an 80-metre dipole and 10 watts. NJ also reports working YU6TL on January 9. G6VC (Northfleet) is hot on the trail of WABC, but thinks the Top-Band crowd are pretty tight on their QSL's. A recent one for him was G3ART (Cumberland), and he now needs only Rutland and Shropshire for *all* English counties.

G16YW (Belfast) lost his mast in a storm and is now using a "clothes-line aerial," but finds that reports have hardly changed although the far end is only 7ft. high.

G4XC (Grimsby) says that the way activity has increased owing to WABC is remarkable, but, even so, he finds that there are very few rubber-stamp QSO's. But he suggests that a condition of the award should be an undertaking

to QSL to anyone who sends a card and a request for QSL.

GM3EFS (Alexandria) disagrees, and says that if the DX bands are worse than 160 is under the county-chasers' regime, they must be pretty bad. He also presses for more use of the 1715-1800 kc region and suggests that we shall lose it if we don't use it. We heartily agree, but no one seems interested, except for several of the Sunday morning nets, which can be heard right up to the LF edge.

GM3OM (Larbert) reports that he has now worked 66 counties, with 62 confirmed, and sends the two extra cards to prove it! (Please note, by the way, that we don't require the cards for staking positions on the ladder—only for the actual WABC award).

G3NA (Hereford) asks us to remind readers that he is there—in a rather rare spot—as well as G3ESY, who appeared in the panel last month. G3NA uses only a 6V6 CO on 1890 kc, with 5 watts and a 136-ft. Marconi.

And for Rutland and WABC 'chasers, G5PP informs us that he will be /P in that county on February 21-22, 1200-0200 clock time (and perhaps later for the DX Test), accompanied by G2HBG. One scheduled QSO will be with OH3NY, to help the latter with his WABC—frequency will be around 1860 kc, but is VFO'able for any necessary shifting. Short QSO's are requested, and a card will be sent only on receipt of a QSL, with s.a.e. if it is wanted direct; G5PP says that he is *still* awaiting *most* of the QSL's for the 84 cards he sent out on his trips last year! The expenses of these expeditions, plus the cost of QSL's, makes it unreasonable to expect him to go on QSL'ing *ad lib.* with no appreciable return. G5PP adds that during the Easter holiday he expects to be GW5PP/P around the rarer Welsh counties—so he is certainly doing his stuff for the WABC clan.

GM3IGW (Alloa) mentions a few rare ones—GM6RI (Angus), GM3CCK (Orkney), GM4JQ (Stirling), GM3DUS (Renfrew), G13CDH, 3CVF and 3GXU (Armagh).

So there you have a summary

of the doings on a strictly "non-DX" band (or so we should once have said). With conditions as they are to-day, what *should* we do without it? Top Band seems to be the only slice of ether that keeps us alive, especially after dark.

#### Activity on Eighty

The particular conditions prevailing at the moment seem to have made work on the 3.5 mc band very difficult. Either there has been a terrific influx of Service and commercial stations at the LF end, or else skip (particularly late at night) favours all these transmissions, wherever they come from. They don't appear to be British, at all events, and probably most of them hail from the Continent, judging by the relative strengths of European and British stations after the early hours of the evening.

At all events, they seem to have driven a lot of erstwhile DX-chasers clean off the band. Early mornings are not too bad, with ZL's and similar DX there nearly all the time. But, curiously enough, the G stations most successful at working this DX seem to be those who keep extremely quiet about it, so we have little news of their activity except what we have heard with our own receiver.

G5JU, after a very successful early-morning session on the Top

Band, worked W7GHU (Arizona) on 3.5 mc. The time was as late as 0825, on January 11.

G3BKF was up the following morning and reports QSO's with FF8AG and W6ZAT. G5TN worked EA9CR, ZC4IP, CT3AV and sundry W's and VE's (all on CW), as well as TA3AA and W1ATE on phone.

Two new ones for W2QHH have been VR2CG and OE13RN; he is still gunning for an EA6 and an EA9 on Eighty. G5BZ (Croydon) collected a new one with 5A3TZ.

#### Forty-Metre Doings

Even Forty can almost be classed as one of the HF bands, judging by its recent behaviour. But we note, by referring back, that last winter was much the same. In spite of the reasonable behaviour of Forty in the autumn and spring, we had no good words to say for it in January or February, 1952.

So no further comments, but let the devotees speak for themselves. G2YS worked IT1AGA and a mysterious "MM2D," who said he was "a G3 100 miles W. of Gibraltar."

G3FPQ (Bordon) raised TF5TP and Y12AM, and new ones for G8KP were EL2AC, Y12AM, CT3AA, FF8AG and OQ5CP—mostly back in December. G5FA (London, N.11), also in a report carried over from last month,

FOUR BAND DX TABLE  
POST WAR

Station	Points	3.5 m c	7 m c	14 m c	28 m c	Countries	Station	Points	3.5 m c	7 m c	14 m c	28 m c	Countries
DL7AA	515	74	131	210	100	217	G6YR	310	19	43	147	101	166
W2QHH	510	95	96	213	106	213	G3ABG	286	35	79	142	30	149
G6QB	502	52	100	215	135	231	G2BW	268	24	57	144	43	151
G5BZ	436	56	99	216	65	220	G8VG	259	34	76	123	26	140
G2AJ	433	42	81	192	118	211	G2YS	251	42	45	124	40	142
G2VD	413	46	84	175	108	184	GM2DBX	234	5	31	117	81	137
G6LX	392	58	56	172	106	194	G3GUM	218	31	38	148	1	159
G2WW	370	21	62	182	105	190	G6TC	213	17	59	100	27	119
G5FA	367	33	112	149	73	164	G3FPQ	197	45	24	116	12	119
G3FXB	361	53	101	168	39	174	GM3EDU	197	37	41	96	23	116
G6QX	332	48	85	142	57	161	G3FXA	193	22	46	117	8	124

quotes CT2AE, LX1AP, TA3MP and CN2AQ. He heard VK1RG and EA6AU, and says the W7 path was fine for a while. But this, too, was back in December, and everything now seems much poorer.

### The DX on Twenty

G3TR (Southampton), working exclusively on phone, raised HP1AP, KA2JM, HK4FV, VP5AK and 7NB, EL2P, VK6DX, ZS6ZU, PJ2CA and "the usual crop." TR says that he was stung into this activity by our remarks last month about the 'phone types; if we had made them earlier in the year, he says, he would probably have finished up with a much higher score! It is worth noting that G3TR has scored 101 Countries on Phone in 18 months' operation from his present QTH—prior to that he was GC3TR (Jersey), and in the pre-war days GM3TR (Orkney). We note with particular interest that everything in the shack is home-built.

G8FC (Locking) was running 25 watts into a 600-ft. aerial through the Christmas period, and found results up to the standard of the normal 150 watts. The best DX pieces were VK1JC (1630), HH2FL (1130) and Y13BU (1545).

G3GUM (Formby) says that when he listened on Twenty it was full of "Hellschreiber creepy-crawlies and rude noises from Central Europe," so he stuck to his favourite 21 mc band.

GW3FSP had an interesting contact with VQ4NZK, who was a W6 on safari in Kenya. Another, with CR7LU, gave him his first CR7 YL! G3FPQ managed to raise OD5AD for a new one, as well as KP4JE, ZD2HAH and ZS4FF.

Last month's remark about the possibility of G2ALO's phone contact with ZS6ZU being the first of the kind with Marion Island has brought forth a prior claim from G3DO (Sutton Coldfield), who worked the same station on phone on December 1 at 1900 GMT. DO found conditions on the South African path quite good, and on phone he raised three CR6's, two CR7's, FB8BA, ZS3N and ZS9G.



G2QX, Luton, Beds., is one of the active Old Timers. He was 2BJG/AA in 1925, becoming fully licensed a year later — and he has been at it ever since. G2QX is equipped for all bands 1.7-28 mc, averages two contacts a day all the year round, and possesses a QSL collection of well over 4,000 cards.

G3GIQ (London, W.5) worked HP1CC, VP6FO and VP6WR on phone, as well as VK9GW, W7's, CR7 and ZD2 on CW. G3FOT (Shildon) found DX pretty scarce, but bagged SU, YK and OX for new ones. Gotaways were EA9, FM, FF and HR.

G5BZ says his only contacts of interest were VQ5CL, VK1JC and VK1PN, the band having been "pretty grim" at the only times he could get on.

### The DX on 21 mc

Surprisingly, this band does not seem to have been in quite such a poor state as Twenty. It has suffered from lack of activity, except at week-ends, but there seems to have been plenty to keep the troops amused.

G5BZ pulled a new one out by

working PJ2AD on CW; other contacts were OD and Y1 on phone. G3GIQ stuck to phone and collected AP2L, OD5AN, VP6SD, ZD9AA and ZE2JV.

G6GN reports again from Bristol and puts his score up to 61. He found the VK/ZL opening on January 11 very interesting and had "quite a field day" on the band that morning. He also tried to put ZL4GA through to ZS1FD, for the purpose of a WAC, but they couldn't hear each other, although both were rolling in at G6GN. He has now worked all U.S. districts, having had a contact with K7FAH. The aerial used, by the way, is a vertical dipole, and G6GN would like to hear more about other people's aerial systems for this band.

G2BW (Walton-on-Thames) is now on 21 mc and has raised ZD9AA as well as VK, ZL, ZE, ZS and the others. G3DO is another new entry for the Marathon, with 30 countries worked on the band.

G3FPQ worked KP4KD, who told him that he would be on the Top Band (1810 kc) with 100 watts. (W's have been heard calling him, but he has not been logged over here as yet.) GW3FSP found Fourteen erratic, but worked VK7, FF, TA, HZ, ZL and the like on CW, as well as VK2AWU, 3EG, 4HR and ZL4BO on phone.

G3GUM is as keen as ever on 21 mc, and had a good time with the VK/ZL opening on January 10/11. At this same week-end he found the band open for most paths in the Northern Hemisphere, with S9 signals from W and VE but very little from South Africa or South America.

In half an hour on the 11th, G3GUM worked FF8AG, VK2AWU and 2SA, ZL4BO and

## 21 MC MARATHON

(Starting July 1, 1952)

STATION	COUNTRIES
W4COK	64
G6GN	61
G3GUM	60
G2BJY	55
DL7AA	53
G2VD	51
G8KP	50
G6QB	49
G5BZ	44
G3FXB	38
G2YS	38
G8OJ	32
G3DO	30
G6QX	28
G5FA	20
G3ABG	17
G2BW	15
G8VG	9
G2DHV	6

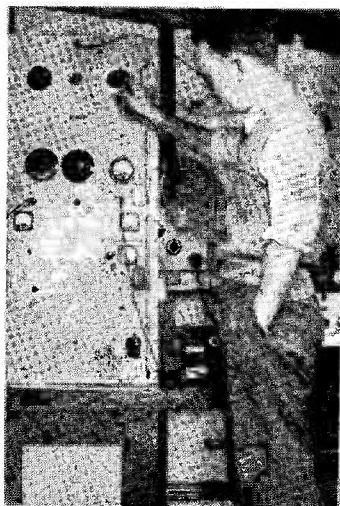

G3DOP, Coventry, is one of the careful chaps who keeps one hand in his pocket when tuning up the rig with power on. His main interest is Forty.

4GA, and heard VR2CG, apparently answering a CQ but blotted out by an OH. Other contacts have been TF3SG, CE3AG, KP4KD, OA4C and TI2RG, to mention the best. Everything points, as 'GUM says, to Fourteen being wide open by about March. By the way (still from 'GUM), an unusual QSO was with W3K1F/2, on a tug in New York Harbour. He was worked from somewhere up the Hudson right round Battery Point to Brooklyn, at 589 each way.

W4COK has left his QTH in Florida and will be starting up shortly as a W2 in New Jersey. He has been busy up to the last minute chasing rare Europeans (9S, HE, IS and the like) to improve his total still further. 'COK laments the fact that a lot of nice people who were on the band for the CQ Contest apparently deserted it afterwards and haven't been heard since. Among them were ZK2AA, FY7YC, 9S4AX and other exotic ones.

He has worked a pack of KH6's and two KL7's—seldom if ever heard over here. Final note—CPIBX is said to be active, Sunday mornings only, around 21010. And just before going to press we heard VU2CQ on the band (1130).

## Short Wave Magazine DX CERTIFICATES

The following have been issued since the publication of the last list, in the November, 1952, issue of the Magazine:

### WNACA

- No. 24. GC4LI (Jersey)
- 25. VK3XO (Melbourne)
- 26. GM2DBX (Methilhill)
- 27. SM3ARE (Ostersund)
- 28. G8FF (Cheltenham)
- 29. OK1HI (Prague)

### FBA

- No. 7. G6QX (Hornchurch)
- 8. W2QHH (Hamilton, N.Y.)
- 9. G2YS (Chester)

### WABC

- No. 1. G13HFT (Belfast)
- 2. GM3IGW (Alloa)
- 3. G16YW (Belfast)
- 4. G6AB (Holland on Sea)
- 5. G5LH (Horbury)
- 6. GM3OM (Larbert)
- 7. G3US (Pontefract)
- 8. G2BOF (Sutton)
- 9. GM3JDR (Wick)

## Six-Band Contacts

We are glad to record two Six-Band QSO's. One already mentioned in the Top-Band notes is that between EI9J and W2QHH. The other is between GW3FSP and ZC4XP. Nice work on all sides. Please let us hear of any more, because any Six-Bander between two different continents is surely worth recording?

Another, but equally interesting, claim to fame comes from DL7AA (Berlin), who has achieved a Five-Band WAC. The stations concerned were VK5KO, CE3AG, KP4KD, VQ4HJP, 4X4RE and ZB1BJ—all worked, of course, on

## TRANS-ATLANTIC TESTS

Next dates are Sundays, February 8 and 22, 0500-0800 GMT. The DX will be mainly in the 1800-1825 kc area, with some stations near 1900 kc, and in the 1975-2000 kc band. All G stations should remain in the 1750-1800 kc area. The test procedure is by now well established, and the W/VE's search only where they expect to find G's. Calls by G stations in the DX areas will merely QRM the W/VE stations, without being heard by them.



all five bands. Rudy presses strongly for us to turn the Four-Band Table into a Five-Band affair, by bringing in 21 mc.

This we are rather inclined to do, not starting with next month, but with the April issue, to give you all a chance to make a starting score on 21 mc. So please note—*A Five-Band DX Table will start in the April issue.*

### Strays

Various complaints continue to come through about non-*QSL*'ing stations, particularly on the Top Band. G6ZN says that two of the stations who have collected their WABC certificates have failed to *QSL* to G8KP and himself, who want their cards for their own awards. We feel that the answer in many of these cases is delay in the bureaux (lack of envelopes is sometimes the reason!) or just plain delay in sending off the cards. There will always be these complaints (the VHF clan have been suffering in the same way for years), and it's not a thing that we can take any kind of action on.

G2NU (Staines) suggests that our Top-Band DX seekers should get further away from Scheveningen on 1800 kc. who is shown in the Berne list as having an aerial input of 2 kW on telephony and naturally has a tremendous range.

G3CHN (m.s. *Benedick*) expects to be around the West or East coast of Arabia some time during the Top Band tests, and will be listening keenly. He had an interesting time at Kuwait with MP4KAB and W2KEZ, operator on the *Gulfpass*, who runs 400 watts of phone on ten metres.

G5PS (Kings Langley) passes on the sad news that Roger Harrison, his nephew, known to many of us as EL2R, died in hospital

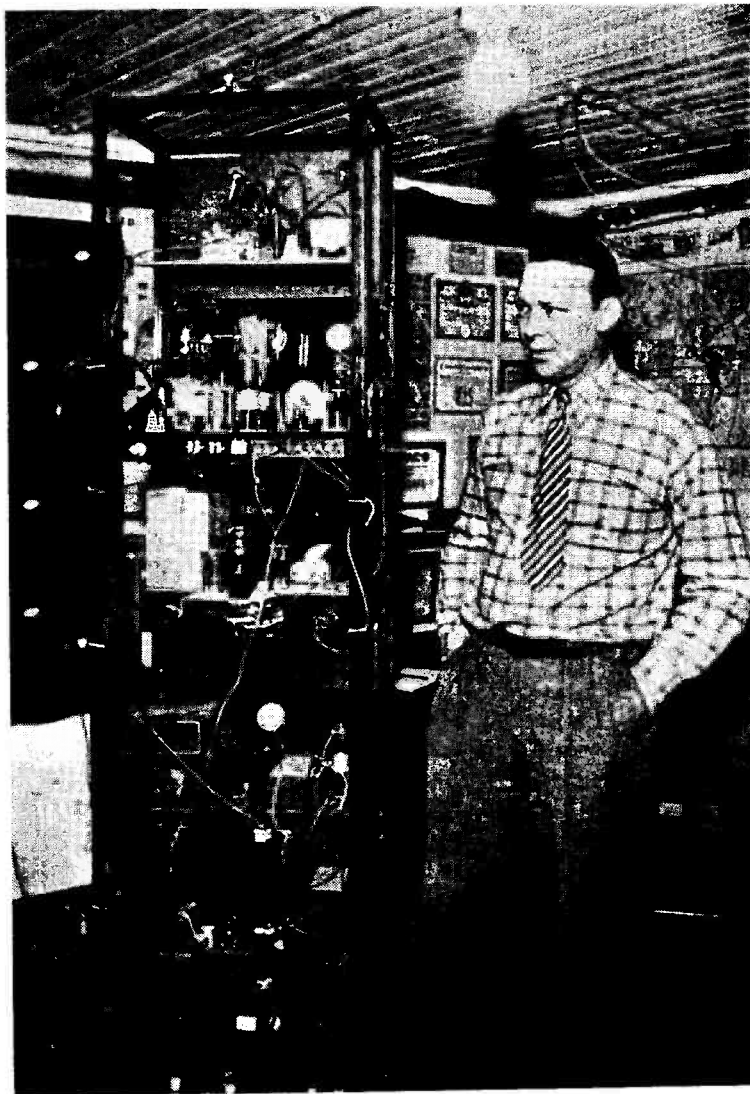

The transmitter at SM5WI, Eskilstuna, Sweden, who recently gained our WNACA Certificate No. 23.

after a bout of malaria coupled with jaundice. He had visited most parts of the world since the war, but had never taken out a British licence.

G3DOG (Brentford) is moving to Walton-on-Thames, so naturally will not be active for some few months. But he will continue as an interested reader-cum-spectator and we shall be hearing from him again.

G3HDL (Liverpool) has started up on the Top Band with a hastily-built 0-V-1 and a little

table-top Tx—still with an indoor aerial. He is looking for a place with a garden 275ft. by 6in.!

### Contests and Ladders

Congratulations to the leaders in the 1952 Marathon, shown in a box of their own. Considering the general level of conditions, anyone who managed to work 120 countries or thereabouts during the year might justifiably be fairly proud of himself. And to top the century on Phone, as GM2DBX just managed to do, was an outstanding achievement for such a

### WAZ MARAHON, 1952

#### Final Placings

	Station	Zones	Countries
1.	G5BZ	36	154
2.	G8FC	36	118
3.	G3FXB	35	134
<b>Phone</b>			
1.	GM2DBX	31	101
2.	G3TR	28	89

year as 1952. Any pre-war year in which one managed to work 100 countries (whether on CW or Phone) would have been considered terrific . . . which just shows how our receiving, transmitting and operating techniques must have advanced since that time. There, perhaps, is an answer to those who say that the competitive spirit is ruining Amateur Radio?

Note, also, the supplementary list of those to whom our various Certificates have been sent. The WFE award seems to be hanging fire, based, as it is, on past achievements rather than present possibilities. With the arrival,

however, of the VS5ELA cards for last summer's contacts, there should be a few more claims before long—and *when* conditions start to improve . . .

Please not the regrettably early deadlines for the next two issues. First post on **February 11** and **March 11** will be positively the latest for receiving your notes, news and claims. Make a note of the dates now and please try to get in on time—otherwise you will surely be left out! Address everything, as always, to "DX Commentary," *Short Wave Magazine*, 55 Victoria Street, London, S.W.1. So, for now, 73 and Good Hunting—if you can find anything!

#### TRANS-ATLANTIC TESTS

Next dates are **Sundays, February 8 and 22, 0500-0800 GMT.** The DX will be mainly in the 1800-1825 kc area, with some stations near 1900 kc, and in the 1975-2000 kc band. All G stations should remain in the 1750-1800 kc area. The test procedure is by now well established, and the W/VE's search only where they expect to find G's. Calls by G stations in the DX areas will merely QRM the W/VE stations, without being heard by them.

## Keying Without Annoying

### CONTROL VALVE CIRCUIT

I. E. HILL (G6HL)

S/Ldr., R.A.F.

*It should be the aim of every CW operator to radiate clean, sharp, clickless signals which produce no more than "AVC breathing" on neighbouring receivers in the same band—and nothing at all off the fundamental frequency. Our contributor has made a practical study of this problem and his notes will be found helpful and interesting.—Editor.*

IN an article contributed to *Short Wave Magazine* several years ago (June, 1950) the writer advocated the use of a valve keyer as the most effective means of keying a transmitter without causing annoyance to listeners on amateur or even other frequencies. Half-an-hour's listening on any band will convince one that some further discussion on this topic would be profitable.

#### Keying Requirements

To transmit intelligible Morse the requirement from any keying system is that power output from the transmitter should reach full normal value and then break down to zero quickly and cleanly. Unfortunately, a very sudden change of conditions in any electrical circuit encounters opposition which in the case

of a keyed transmitter results eventually in key clicks at the receiver. In designing a keyed stage it is therefore necessary first to select a keying system which gives rapid rise and fall of output and then to slow the process down until the key clicks are minimised or eliminated.

#### Bias Keying

By arranging that a high bias is applied to the grid of the keyed valve in the key-up position and that the bias is removed (shorted) when the key is down, effective keying can be obtained. By the incorporation of suitable values of resistance and capacity in the keyed grid circuit it is possible to slow up the keying action and obtain effectively clickless keying. Bias keying applies to any variation of potential on control electrodes in the valve (grid, screen or suppressor).

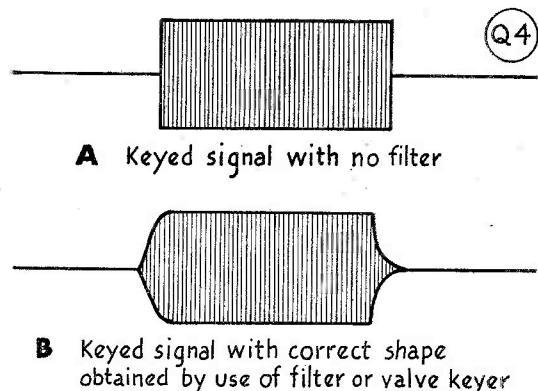

Fig. 1. The shape of keyed signals—the B shape is the desired condition.

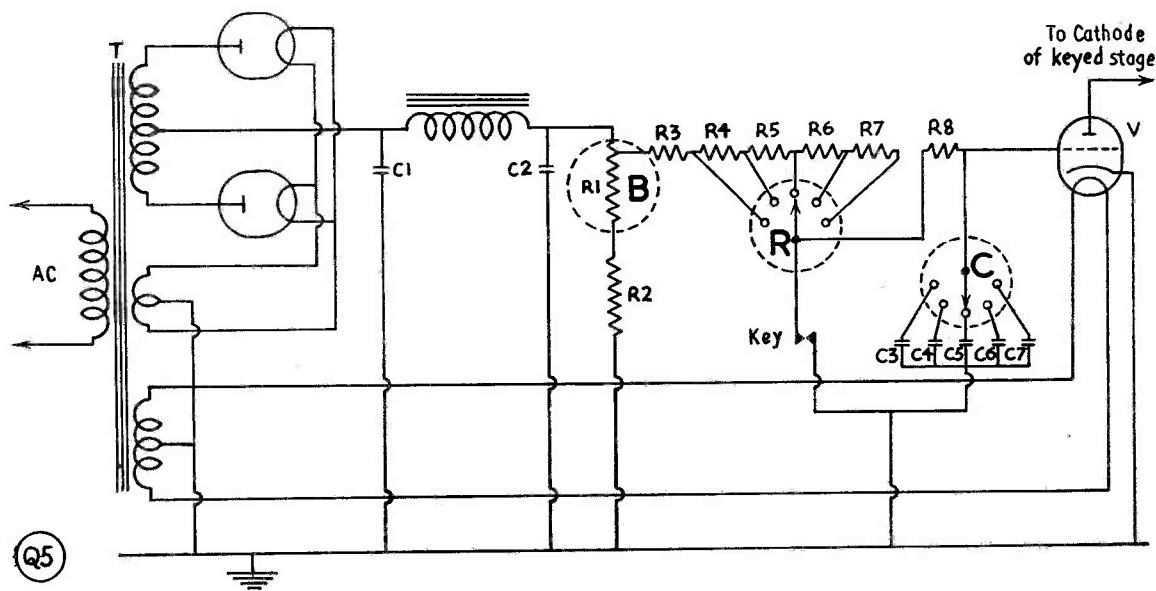

Fig. 2. The G6HL valve keyer circuit. The desired characteristic is obtained by adjustment of the variables R and C, as described in the text. If a condenser is put across the actual key contacts, it must not exceed .001  $\mu$ F.

The objection to bias keying is that relatively high voltages must be used to obtain cut-off, and also that careful filtering is necessary to keep RF from the actual key circuit.

### Cathode Keying

When the cathode circuit of a keyed stage is broken the grid automatically acquires a high negative potential by virtue of connection to HT negative. Valve action is therefore cut off very rapidly. Similarly, when the key is made the grid very rapidly becomes less negative with respect to cathode and the valve conducts, quickly building to normal peak value.

This method of keying is probably the most effective, but unfortunately, in the raw state, it is very prone to give clicks.

The keying action can be slowed up by the use of an LCR filter, but the filter once correctly adjusted is effective only for one set of input conditions. When checked on an oscilloscope it is surprising how few amateurs using this type of filter do succeed in achieving correct adjustment.

### Valve Keyer

Undoubtedly the optimum keying system is one which combines the advantages of the two systems referred above but obviates the disadvantages. A valve keyer will do all this.

### Table of Values

Fig. 2. Practical Valve Keyer circuit, by G6HL.

C1, C2 = 2 $\mu$ F	R6, R7 = 5 megohm, $\frac{1}{2}$ -watt
C3 = .002 $\mu$ F	R8 = 470,000 ohms, $\frac{1}{2}$ -watt
C4 = .003 $\mu$ F	T = 150.0-150 volt x-former
C5 = .004 $\mu$ F	V = Any low-impedance triode, or pentode with screens strapped to plate. Valves can be paralleled to increase current rating.
C6 = .006 $\mu$ F	
C7 = .008 $\mu$ F	
R1 = 50,000 ohms, variable	
R2 = 50,000 ohms, 2-watt	
R3 = 50,000 ohms, 1-watt	
R4, R5 = 2 megohm, $\frac{1}{2}$ -watt	

The cathode is the best circuit to key, and the adjustment of C and R in a bias circuit is the easiest way to correct the rate of signal build up and decay. By using a low impedance valve or valves as a keyer the bias to be keyed is kept to a low value. Additionally, the value of cathode current in the keyed stage will not materially affect the time constant of the keyed stage. Here then is a keyer unit which can be plugged into the cathode circuit of any low power stage (except, please, the oscillator, which should never be keyed) and will give clean well-formed keying.

### Circuit

The circuit of Fig. 2 is self-explanatory, but the following additional notes may be helpful.

The keyer valves may be any low impedance triodes or pentodes with screens and plates strapped. The writer has used 2A3, 6B4, and

6L6 at various times. Valves can be installed in parallel in order to provide sufficient current capacity for the keyed stage. Allowance must be made for voltage drop across the keyer valve which will result in some loss of plate voltage at the keyed stage.

It is convenient to have a variable control of the bias available to cut off the keyer valve. A value should be chosen just in excess of that necessary to give cut-off. In this way maximum control is available from C and R.

The "live" lead to the key must have a high order of insulation. A relay can be used for keying but it is not at all necessary.

The values of C and R can be predetermined and fixed, but for reasons explained later there is advantage in having some flexibility of control.

### Adjustment of the Keyer

Switch on the transmitter only as far as the keyed stage. Adjust B (the keyer valve bias control) until it is at a value just in excess of that necessary to cut off the keyer. Sending continuous dots adjust C and R until the keyed signal is clean and resembles Fig. 1B in shape. There is of course only one satisfactory way of determining shape and that is by the use of an oscilloscope. A coil and condenser resonated to the operating frequency and connected directly to the Y-plates of the oscilloscope will give adequate deflection if a short length of pick-up wire is also coupled to the coil. The X-base should be adjusted to a slow running speed in step with the keying. Correct adjustment of C and R in the keyer is then simple.

The later stages of the transmitter should next be switched on and the shape of the keyed

signal rechecked. Owing to the characteristics of the later stages, the signal shape may have changed slightly. This can be rectified by over or under doing the adjustment of C and R in the keyer. However, this is a fine point as also is a similar check when changing bands. In general, if the keyer is adjusted once for correct shape the radiated signal will be free from adverse keying criticism when used on other frequencies, or under different operating conditions.

### Other Considerations

There are a few pitfalls which must be avoided if a transmitter is to give of its best. Correct keying will not obviate unwanted LF or HF harmonics. Other normal means must be adopted to eradicate these faults. The writer recently rebuilt an amplifier stage using a pair of pentodes in push pull. On completion the keying was checked and adjusted by use of the 'scope and all appeared well. Several days later a local amateur asked was it necessary to operate G6HL on three channels simultaneously! Investigation showed that transient clicks were being radiated *plus* and *minus* 55 kc from the fundamental in the 3.5 mc band. These were LF oscillations and occurred only during keying; key-down the transient rapidly fell to zero. A lot of changes were made to plate, grid, and screen feed chokes before a lesson supposedly learnt years ago was remembered. *Don't* put an RF choke in the suppressor lead! Its removal cleared the unwanted transients but did not affect the fundamental signal which on the oscilloscope looked perfect both with and without the LF parasitic.

---

## Wax Impregnating

THE REASON, THE METHOD  
AND THE RESULTS

REV. F. NESS, M.A. (G3ESV)

*For those who make or adapt some of their own components, or who wish to be sure that damp will not ruin their labour, this article will be of particular interest.—Editor.*

**I**T is generally conceded to-day that receiver building is fast becoming a lost art, and at least from the States one hears complaints of

the increasing number of amateurs who even purchase factory-built transmitters and auxiliary equipment. On the other hand, one does contact folk over the air who are not only the proud owners of home-built single signal receivers and band-switched transmitters, but who think nothing of winding an occasional transformer as and when required. If the fast-dwindling supplies of war-surplus and the sharp rise in price of new equipment forces more of us to make or adapt things for ourselves, so much the better. And even if a transformer sounds too big a job to tackle on the kitchen table, there is still that old burnt-out output transformer which can be re-wound as a smoothing choke; or those 28 volt relays which

can be rewound to work off six volts ; or that unused bell-transformer which can have a new secondary wound on, to provide a heater supply for some special piece of equipment. And if the finished article is then wax-impregnated, it will stand comparison with any factory product and will be a source of satisfaction and pride as well as giving long and useful service.

Whether you incline to the opinion that impregnation is "just a bit of swank" on the part of manufacturers which no honest ham could be guilty of ; or whether you think it needs expensive vacuum equipment, you will be interested in the practical notes given here. The technique is simple and easily mastered.

### Advantages

The big benefit from wax-impregnating is that it makes the finished product absolutely solid and silent. Every one of the tiny spaces and gaps (which occur even with expensive layer-winding methods) becomes filled with hard wax, and movement or vibration is impossible. It is a fact that, however hard one tightens up the laminations of an iron core, and however tightly the wire is tensioned in the winding process, there is always a certain amount of hum from a home-constructed article. This is especially true of chokes, for they are naturally subjected to a fairly high ripple voltage which it is their job to suppress. Likewise, relay coils which work on rectified but unsmoothed DC will buzz if the windings have any slack in them at all. Now it is not just that the audible hum or buzz is unpleasant to listen to, but rather that where wires can vibrate the insulation is in danger and breakdown can occur.

The very first impregnation job tackled by the writer was the cheap-and-nasty mains transformer in the VFO power supply, which put out an S4 buzz the whole time it was on. It is anybody's guess how long it would have taken for the insulation to break down, but after impregnation it was utterly silent and has been in constant use for over two years. What is more, it is moisture-proof, and would give perfectly good service in a damp location. Lastly (though this may only be imagination) the transformer appears to run cooler, possibly due to the heat from the windings being conducted away more readily through the wax.

### Equipment

The equipment required is simple: Just one aluminium saucepan of sufficient depth to accommodate the largest article to be "cooked"

—say, the 2 pint size. Since the writer's living quarters comprise two rooms, the wax of necessity must be heated over the electric fire in the sitting room (the vacant space in the bedroom is reserved for photography!). There need be no risk of fire provided that normal precautions are taken to avoid spilling molten wax on to the fire element. Needless to say, one would never leave the pan of wax unattended while it was being heated. And probably the kitchen stove would be a better place, anyway. As for the wax, let it be said at the outset that ordinary candles are definitely *not* a source of supply. For one thing, they are not made of wax but of stearine (oleic acid). In addition, they contain far too high a proportion of impurities calculated to attack the enamel insulation on wires, and to corrode metal. A number of firms manufacture special types of waxes for impregnating purposes. These consist usually of resin mixed with paraffin waxes of various sorts, the proportions being adjusted to suit the purpose for which the work is intended. Needless to say, these preparations are highly purified and have a very low acid content.

The writer uses Okerin Wax, no. 193, which is a medium priced wax of general utility, made by Astor Boisselier Lawrence, Ltd. It is pale yellow in colour, sets very hard, and has good adhesion to metals. Its melting point has been found to be 80° Centigrade approximately. The price used to be in the region of 2s. per lb. for small quantities. Incidentally, there are coil winding firms in most of the larger towns, and if tactfully approached they would probably be willing to supply the small quantity required. (That is how the writer got his.) Two pounds of wax will more than half-fill a 2-pint saucepan, so that if a total of four pounds is purchased, the supply will last for several years. A few ounces only are required even for the biggest transformer, and the pan will need only occasional replenishment.

### Method

The object to be impregnated, whether transformer, choke, relay coil or what-have-you, should be thoroughly dry. If you can possibly spare the time, leave it in a warm dry place for several days. Put it in a warm oven, or leave it propped up near the fire, and let it get quite warm to the touch before you heat up the wax. The temperature of the latter should be about 120° Centigrade ; if you have no thermometer, it is sufficient to heat the wax above the melting point, but not so strongly that it begins to smoke. After all, you are not

frying the job! Apart from the risk of excessive heat damaging the enamel insulation, too high a temperature may affect the properties of the wax. Lower the object slowly into the wax, holding it by means of a length of wire (*not* the lead-out wires of the actual windings) looped through any convenient hole. Be careful not to splash hot wax: even if it does not catch fire, it is a nuisance to clean up. The impregnation time will vary with every article, but fortunately there is a simple way of determining it. Almost at once bubbles of air will begin to stream to the surface: this is the air which is being displaced from all the internal nooks and crannies by the hot wax. It may take 20 minutes for all the air to be driven out of the windings of a big transformer, but that is about the limit in the writer's experience. When the stream of bubbles dies away, turn off the heat and allow the wax to cool somewhat. Then withdraw the job and suspend it by the wire loop over the pan to drain. Even after the wax has set, it will take an hour or more to reach room temperature, and should not be disturbed meanwhile. If the article impregnated is to be installed in a very damp situation, it is worth while keeping the wax in the pan hot for a while. Then, when the article is almost cold, a quick dip, straight in and out, will leave a thick coating of wax over the whole of it. This procedure is wasteful of wax and is only needed in exceptional circumstances—*e.g.*, for the mains transformer of a battery charger which has to be installed in a damp garage.

The slight extra trouble involved in wax-impregnating is more than off-set by the feeling that the job has been properly finished off, and its reliability greatly increased. Many of the cheaper grades of transformers and chokes on

the market to-day are neither varnished nor impregnated during manufacture, and they too will benefit by the treatment. In the last three years the writer has treated a variety of articles, and no snags have been encountered.

### Finally

As a postscript, it may be added that experiments are proceeding on the subject of salvaging leaky tubular paper condensers. The majority of those taken from war-surplus equipment are now definitely faulty, and an insulation resistance of a megohm or two is common. The writer's private theory is that their low insulation resistance is due to moisture having penetrated to the paper foil separating the electrodes. It seemed reasonable to assume that if these condensers were placed in wax heated to 120° Centigrade, the moisture would boil off as steam, and the insulation would then return to normal. In addition the fresh wax coating would protect the condenser from further deterioration. So far, results have been inconclusive. A dozen condensers, all considered useless, were treated. Of these, four were completely restored to normal, the measured leakage being over 800 megohms (the limit of the home-made measuring gear used). Six others were ruined, showing resistances varying from a dead short to a few thousand ohms. The remaining two were apparently unaffected. The critical factors are the time and the temperature of the wax. If the time of treatment is too short, there is no improvement. But a minute or two too much spells failure. So the treatment is very much of a kill-or-cure nature so far—but is well worth trying on condensers which would otherwise be discarded as useless.

### ANOTHER MULLARD HIGH PERFORMANCE STABILISER

A new high performance 90-volt stabiliser, type 90C1, has recently been introduced by the Communications and Industrial Valve Department of Mullard Ltd. This new tube, which is a miniature all-glass type constructed on the B7G base, is designed to operate in the very wide current range of 1 to 40 mA. This means that it is possible to employ a single tube of this type in a simple stabiliser circuit and obtain either: A stable output voltage at any given burning current; or, a highly predictable output voltage, even when the output current fluctuates within very wide limits.

As in the 85A1 and 85A2 Voltage Reference Tubes and the stabiliser Type 150B2, described in our January issue, this high degree of stability is made possible by employing the Mullard sputtered metal technique.

The principal characteristics of the 90C1 stabiliser are as follows:—

Ignition voltage	...	125V
Burning voltage (variation from tube to tube)	...	86 to 94V ±
Burning Current	...	1 - 30mA
Incremental Resistance (approx.)	...	350ohms ±
Temperature co-efficient of Burning Voltage (approx.)	...	- 2.7mV°C ±
Ambient Temperature Limits	...	- 55 to + 90°C
Maximum burning voltage variation over 1000 hours	...	1% ±
		± Measured at 20mA

Further technical data can be obtained on request, from the Communications and Industrial Valve Department, Mullard Ltd.

# Predicting VHF Conditions

THE WEATHER AND  
PROPAGATION EFFECTS  
ON TWO METRES

A. H. HOOPER (G3EGB)

*The title of this article is a bold one, but if it is carefully studied, present theory on the mechanism of VHF propagation can be related to weather effects, enabling predictions to be made which could be tested by results. With the steadily increasing population of the VHF bands, more attention will come to be directed towards establishing the distances over which reliable communication is possible. A working knowledge of current VHF propagation theory—which is what this article covers—then becomes essential if the conclusions drawn from a study of results are to be of any value.*

—Editor.

THE spread of amateur activity in the 144 mc and 432 mc allocations throughout the European area, together with the development of efficient equipment, has made evident the fact that in this part of the radio spectrum extended propagation over many hundred miles can occur at times. That such propagation is related to weather conditions is readily apparent. The incidence of propagation beyond visual range at metric and centimetric wavelengths has been the subject of considerable investigation during recent years, and as a result, the meteorological conditions necessary for such propagation are fairly well established. These conditions are usually observed at intervals of six hours, but are available at the time only in the indirect form of weather forecasts. From an understanding of the meteorological processes involved, however, and from simple local observations, it is often possible to decide upon the prospects of anomalous propagation. Like the author, most amateurs, no doubt, have only a limited amount of time for the several phases of their hobby, and have to strike a balance between operating and constructional activity. It is hoped that the following account will assist amateurs in making the best possible division of their spare time.

## Refraction in the Atmosphere

For the longer wavelengths employed by radio amateurs the ionosphere is the controlling factor of extended propagation, but for wavelengths of two metres and less it can be said to have little or no effect. For propagation over the curved surface of the earth we must look for reflection or refraction within the lower atmosphere, and as with light waves, it is vertical changes of refractive index that are significant. Although at radio wavelengths the refractive index varies very little with frequency, the longer wavelengths can respond to the average change of index only over a very great height, and such changes are not in fact sufficient for anomalous propagation to occur. Thus it is only the shorter wavelengths (actually of two metres and less) that can utilise the larger changes of index with height which occur from time to time in shallow layers in the lower atmosphere.

The radio refractive index of the atmosphere depends directly upon air pressure and upon the amount of water vapour present, and inversely upon the absolute temperature. The distribution of air pressure arises from the effect of gravity and is a decrease with height. All water vapour in the atmosphere originates at the earth's surface, being carried aloft by air currents, and tends to decrease in amount with height. Heat in the atmosphere originates to a large extent at the surface of the earth and so temperature, too, tends to decrease with height. In the troposphere, which in these latitudes extends from the earth to between 20,000 and 40,000 feet, the net effect is for a decrease of refractive index with height. The resulting downward curvature of radio waves is insufficient for return to earth. For a greater decrease of refractive index with height and curvature downward again to earth, a sufficiently rapid decrease of water vapour or increase of temperature—a temperature inversion—with height is necessary. The rates of change required are large and it is more usual for lesser rates of change to occur simultaneously in both factors.

When tracing a wave, the important feature is its path relative to the earth's surface, and for this purpose it is convenient to consider the earth as flat. This can be done by suitably modifying the refractive index. When the modified refractive index (usually abbreviated as MRI) increases with height all affected waves bend upwards away from the "flat" earth. Variations in the degree of bending result in

small changes in range achieved. When the MRI is unchanged with height then the radiation paths trace straight lines with respect to the flat earth, and any horizontal radiation continues along the surface of the earth. When the MRI decreases with height, downward bending of low angle radiation towards the earth takes place.

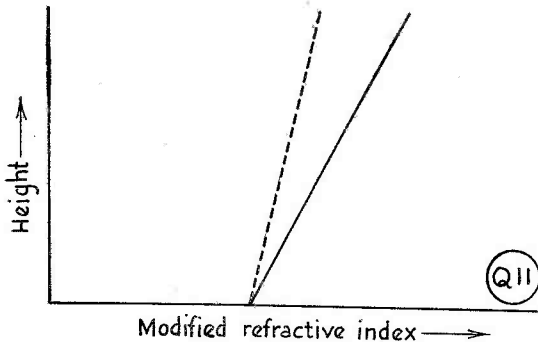

Fig. 1. The Modified Refractive Index (MRI) normally increases with height and, considering the earth as flat, radio waves bend upwards away from it. This concept is necessary to show that for a slower increase of MRI with height, upward bending is reduced and greater ranges result.

In Fig. 1 are two plots of MRI against height. Both full and pecked lines represent "normal" conditions, but in the latter case the range would be somewhat greater than in the former. Fig. 2 shows a decrease of MRI with height in the lowest layer. Such a layer or "duct" will greatly improve the propagation of wavelengths less than a value related to its vertical extent, and will improve to a lesser extent the propagation of longer wavelengths. In Fig. 3, the refracting layer occurs some way above the surface of the earth, but the duct "width" is still measured downwards to the surface, and in this case longer wavelengths can be accepted. The extension of this condition in Fig. 4 illustrates the fact that the lower limit of a duct is that level at which the minimum value of MRI for the layer is regained. In such cases the full benefit is gained only when both transmitter and receiver aerials lie within the duct. Radiation from an aerial placed below the duct will, however, benefit to some extent.

For wavelengths of two metres and seventy centimetres duct widths of 700 feet and 250 feet or more, respectively, are necessary. Such widths have never been observed in the European area and the full benefits of ducting are not obtained at these wavelengths. The shallower ducts which form from time to time permit amateur communication over increased

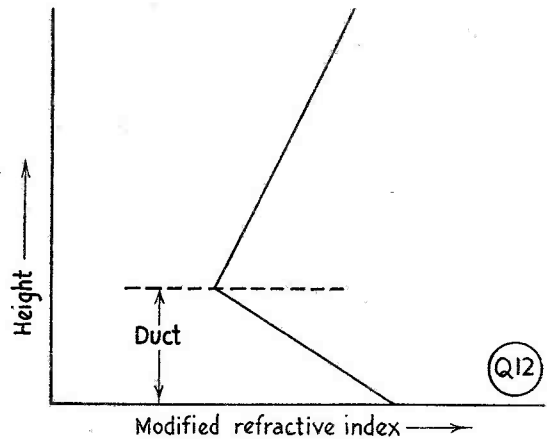

Fig. 2. In a shallow layer, the MRI can decrease with height, and radio waves sufficiently short in wavelength travel for great distances as though in a waveguide or duct. Longer wavelengths can be similarly affected, but only partial guiding occurs, with considerable leakage from the top of the duct.

ranges, but with considerable leakage of radio energy from their upper surfaces. When a duct of the type depicted in Fig. 4 occurs at a higher level in the atmosphere, say, at 2,000 feet or more, it is possible for reflection to occur. Recent investigation suggests that in such cases metric wavelengths are more favoured than centimetric wavelengths, a result directly opposite to that of refraction effects at or near the ground. In such conditions the increase of MRI with height below the reflecting layer will bend radio waves upwards thereby increasing the angle of attack. The higher the layer the greater the angle, until the critical angle is exceeded and reflection ceases. Obviously, then, the layer must not be too high. Owing to the limited effects of ducts upon metre wavelengths it is usually the reflection phenomenon that produces striking instances of anomalous propagation. In cases of reflection from extreme heights, with a distribution below of MRI unfavourable for refraction, a skip effect can sometimes be observed.

### Surface Ducts Over Land

The flow of air over the rough surface generally presented by land masses is confused and turbulent. Irregularities in the average flow occur not only in the horizontal but also in the vertical plane, and extend at times as much as 1,500 feet upwards. This thorough mixing, together with pressure changes arising from the vertical motion, results in a steady decrease of temperature with height. The



same mixing results in an even distribution of water vapour with height. The net effect of this normal atmospheric condition is for a gradual increase of MRI with height, and for a small downward bending of radio waves towards the curved surface of the earth. It will be met whenever there is appreciable surface wind. The depth of the turbulent layer varies with the roughness of the earth's surface and with wind speed, being less for a sea area and for lower wind speeds.

The earth is always losing heat by radiation into space. During daylight hours incoming radiation from the sun more than balances this. The quantity of radiation from the sun increases with its elevation above the horizon and reaches a maximum value at noon. As a result, the temperature of the earth's surface undergoes a daily (and seasonal) variation. The temperature depends, too, upon the specific heat of that surface. Heat spreads upwards through the atmosphere from the earth's surface and results in a decrease of air temperature with height, the maximum value at any level being reached at about two hours after noon. At sunset radiation from the earth into space takes control, and its surface cools. This cooling spreads upwards into the lower layers of the atmosphere and results in the formation of a temperature inversion. The vertical extent of the inversion increases rapidly until about midnight and then slowly until dawn. The presence of clouds results in a reduced temperature rise during the day and a reduced temperature fall at night, their effect varying with their amount, thickness and height above surface.

All water vapour in the lower atmosphere originates at the earth's surface. The amount capable of being taken up by air varies with air temperature, and any surplus condenses out as water droplets. In the circumstances considered above, water vapour spreads aloft from the earth during the day, and sets up a decrease with height. With the formation of a temperature inversion after sunset, Fig. 2 represents the change of MRI with height, and anomalous propagation can be expected over the area involved. As cooling continues a temperature will be reached at which the lowest layer of air is saturated. Further cooling results in the excess vapour condensing out, usually as dew. The result is an increase of water vapour content with height over a layer which, as the process continues, becomes deeper and deeper. Fig. 3 illustrates the result. Prolonged cooling will result finally in the less favourable condition represented by Fig. 4. Sunrise reverses the process. With a low water vapour content

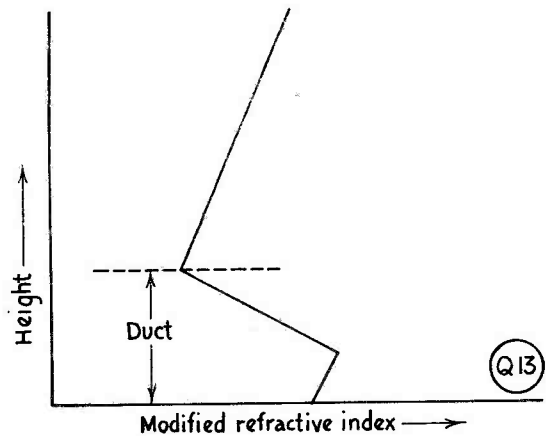

Fig. 3. When the layer of decreasing MRI lifts, the duct will still extend down to the ground providing the value of MRI there is greater than the minimum in the layer. The greater duct "width" improves the propagation of partially guided waves of any given length.

the saturation temperature is lower, and it will take longer for the surface air temperature to cool down to that value, in fact dew may not be deposited until just before sunrise. On such occasions anomalous propagation can continue to improve throughout most of the night.

Owing to the greater specific heat of water, there is little daily change in temperature of the sea and radiation inversions do not develop, being confined therefore to land areas.

For anomalous propagation by this means we need a cloudless night, and under the right conditions there will be little or no wind. The effect will be more marked if there has been little afternoon cloud to impede the daytime temperature rise. The onset of dew, easily detected, indicates the start of a process which leads ultimately to a lifting of the duct beyond aerial height and less favourable propagation conditions. Such propagation is restricted to nighttime over land areas, within the settled conditions of high pressure necessary for cloudless night skies. High pressure circulations are slow moving and extend at times for several hundred miles. The right conditions can also develop in the small areas of fine weather travelling along between bad weather areas (depressions). These small areas can give rise to anomalous propagation over restricted paths from a given point for a few hours before the next depression arrives. They are referred to as ridges of high pressure. In Europe, the size of continuous land areas and of high pressure systems is less than in North America, and there is little prospect of European records

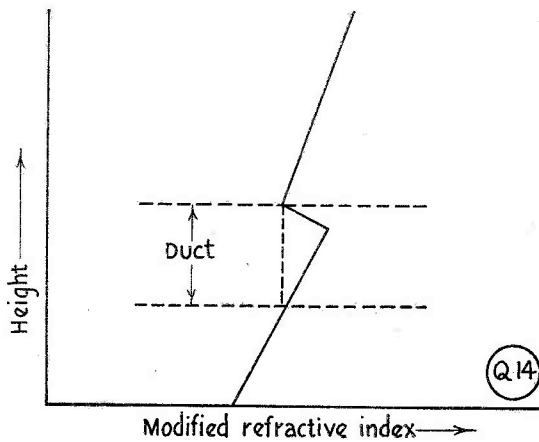

Fig. 4. Lifting of the layer of decreasing MRI often continues until the ground value is less than the layer minimum. In such cases the duct extends downwards only to the level at which the layer minimum is regained. In this case, transmitter and receiver aerials must both lie within the duct for maximum advantage.

equalling those achieved across the Atlantic.

With the aid of two thermometers it is a simple matter to derive the amount of water vapour present. The thermometers should be set up well away from buildings, exposed to the air, but shielded from the direct rays of the sun. The bulb of one is covered with a piece of muslin which is kept moist by placing its free end in a container of distilled water. This thermometer will give a lower reading than the other. The extent of its depression below the normal thermometer is some indication of the amount of water vapour present, the precise quantity being obtained from tables if desired. During night-time cooling it will be found that the dry-bulb thermometer reading decreases more rapidly than that of the wet-bulb thermometer, and that they give approximately the same reading when dew is forming.

### Surface Ducts Over the Sea

In passing over the earth's surface a stream of air tends to acquire in the lowest layers the temperature of that surface. The process takes time and changes occur in the lowest layer first, then spreading upwards. When the surface temperature is from warm to cool then an inversion forms in the air stream. For the effect on radio propagation to be appreciable the temperature change must be considerable and the two areas extensive. Only then will the air have time to acquire first the one characteristic and then the other. In European latitudes conditions are favourable in summer-time when the temperature of land areas can

become much higher in daytime than that of adjacent sea areas, although usually lower than the temperature of adjacent sea areas at night and during the cooler seasons.

If a stream of day-time heated air sweeps from land out over the sea it is cooled from below and a temperature inversion forms. Additionally, water vapour is then freely available with the result that the air becomes nearly saturated at the surface and has a decrease of water vapour content with height. This condition arises from the horizontal motion of the air and is described as an advection inversion. An area or ridge of high pressure is usually necessary over land for the initial land heating, but winds tend to be light or nil in the centres of high pressure areas and it is towards the edges of such systems and in ridges that the wind will flow strongly enough to spread over appreciable sea areas. It is a day-time phenomenon, and for amateur exploitation must extend across the whole of the sea path considered. Anomalous propagation by this method is limited, therefore, to little more than coast to coast paths during day-time, and then only in the summer months.

### Elevated Ducts

At levels higher than those we have been considering the atmosphere is very much colder than near the surface and can contain only a much-reduced quantity of water vapour. It is a feature of high pressure systems that air from high levels sinks slowly towards the surface. In so doing, it undergoes compression and becomes warmer, its temperature eventually exceeding that of the air beneath. The latter is supplied with water vapour from the earth below and is much moister. Once again the desirable features of temperature inversion and decrease of water vapour content with height exist. It is known as a subsidence inversion, and is independent of surface or day and night effects. It can occur over the full extent of a high pressure system. Recent work suggests that the thickness of the layer through which the inversion occurs often favours particularly the reflection of metric wavelengths. In Europe with its broken masses of land and sea, the seekers after long distance VHF communication must rely on this phenomenon. Again, the smaller high pressure systems make it unlikely that distances can equal those achieved in North America.

For anomalous propagation, the subsidence inversion must first develop and then sink sufficiently low, having regard for the MRI structure beneath, for the radio waves to reach

it at less than the critical angle. As it continues to sink it will eventually reach a height insufficient for the ray theory of radio waves to apply. The situation is then as in Fig 4, or even as in Fig. 3, and propagation will be greatly reduced although still somewhat better than normal. It has been estimated that less than one quarter of all subsidence inversions sink below 3,000 feet, and less than one in fifteen below 1,500 feet above the earth. Not all high pressure areas, moreover, remain in existence long enough to develop the subsidence effect. Anomalous propagation by this means then, is an infrequent, although impressive, occurrence.

The existence and sinking of subsidence inversions is readily observed only by means of soundings of the atmosphere, but the amateur can often deduce their arrival below the 3,000 feet level for himself. Within high pressure areas, day-time heating of the earth results in rising currents of air. As they rise they become cooler, the process often being enough for water vapour borne aloft to condense out, as cloud. The resulting blobs of cumulus (or heaped) cloud are easily recognised. It is a feature of temperature inversions of much magnitude that rising air currents, and hence cloud, cannot extend upwards through them. As an inversion sinks, any cloud extending upwards to its level is progressively reduced in height. One studies the fine-weather clouds during the afternoon. If their tops are flattish or have a tendency to "mushroom" out horizontally then they are being limited by an inversion. A reduction in their height indicates a sinking of the inversion. Complete absence of cloud in mid-afternoon suggests the existence of a very low inversion, unless the air be very dry. It sometimes happens that the cloud develops during the morning, only to disappear during the afternoon instead of the more usual time of early evening. This is the extreme example of the effect of a sinking inversion upon cloud, and suggests that anomalous propagation is likely to occur during the coming night.

In the conditions existing within a high pressure area an indication of the height of the base of the cloud is given by the depression of a wet-bulb thermometer reading below that of a dry-bulb or ordinary thermometer. The cloud base will be roughly 1,000 feet up for every 2.7 degrees Fahrenheit of difference. Suppose that dry-bulb and wet-bulb thermometer readings are respectively 68.7 and 62.0 degrees Fahrenheit. The wet-bulb depression is 6.7 degrees and the cloud base will be

roughly 2,500 feet above the earth. Using a figure obtained in this way and comparing the vertical extent of the cloud with the gap beneath it is possible to estimate the height of the cloud tops, a useful facility when they are being limited by inversion. In the moist air streams that usually cover the British Isles the absence of cloud in mid-afternoon suggests the existence of an inversion aloft, but below the height value deduced from thermometer readings. It should, perhaps, be mentioned that although the exposure of thermometers requires considerable care in order to yield accurate results, readings obtained in locations other than ideal will, nevertheless, form a useful guide.

The writer is unable to suggest the order of height below which a subsidence inversion must sink for reflection to occur and would be glad to receive reports of communication suspected of being by this means. It is an interesting point that although a subsidence inversion may not be low enough to affect propagation directly by means of reflection, it can, by limiting cloud development, assist in the development of a large radiation inversion the same evening, with beneficial results.

### Other Conditions

There are several other processes leading to the formation of temperature inversions in the atmosphere, but they usually occur in conjunction with an increasing water vapour content with height. The controlling factors are then in opposition and little modification of the normal MRI distribution occurs. For example, in the phenomenon known as the warm front, warm and moist air can be imagined as sliding up the inclined edge of cold and relatively dry air. It is usually first visible as a high thin sheet of cloud (cirro-stratus) which gradually thickens and lowers until obscured, finally, by rain. A vertical sounding through this frontal surface reveals the unfavourable combination of temperature inversion and increase in water vapour with height. However, the writer has occasionally noticed an inversion of the subsidence type just below the frontal inversion. As the latter sinks over a given spot, the subsidence inversion is, apparently, forced downwards beneath it. This may well be the explanation of reflections observed by some operators for a brief time apparently from the warm front.

### Conclusion

In order to assess the chances of anomalous propagation on a given occasion, one has to

form a mental picture of the high and low pressure systems and their movement within the area. The weather maps shown by the television service and the weather forecasts distributed by the B.B.C. are the best sources of material, while the maps printed in certain of the daily papers are helpful, although not wholly up to the minute.

Those amateurs lying within high pressure areas and finding rapidly clearing or clear skies together with decreasing wind in the early evening, can expect a radiation inversion to develop, and anomalous propagation to extend over inland paths. Those amateurs operating coastal stations in the warmer months of the year and lying towards the edge of a high pressure area with a fresh wind blowing out to sea can expect a daylight sea path to be possible. All amateurs lying within a high pressure area and noting that fine-weather cloud is rapidly disappearing or non-existent during the early afternoon can hold themselves ready to exploit the long-distance "opening" likely to develop.

Those interested in investigating cases of anomalous propagation after the event, perhaps with view to improving their own predictions, can always obtain weather maps and the results of vertical soundings of the atmosphere from official publications.

At wavelengths greater than about ten metres reliable long range predictions of radio propagation are available to all. Only temporary disturbance occurs — during periods of abnormal sunspot activity. At metric and centimetric wavelengths, radio propagation is closely related to the weather and predictions of propagation conditions, even if issued, could not be for longer periods than are possible for weather forecasts. For the enthusiast whose main concern is the exploitation of long range openings at two metres and less, an understanding of the relevant weather processes can be very rewarding. It is hoped that this article will help operators to formulate their own predictions of VHF radio propagation and at least to avoid the pinprick of being under reconstruction when openings develop.

#### HONOURS AND PROMOTIONS

Her Majesty's first New Year Honours List included, in the radio and electronics field, a C.B.E. for Mr. H. A. Cruse, of Westinghouse; an O.B.E. for Mr. A. A. Dyson, of Erie Resistor; and the M.B.E. for Mr. A. H. Farman, chief radio operator of the liner *Queen Elizabeth*.

In the Royal Navy's half-yearly promotion list, Lt./Cdr. A. J. R. Pegler (G3ENI), known to many readers as a contributor to *Short Wave Magazine* on VHF subjects, is promoted to Commander (E); he has since been posted to the Joint Services Staff College.

#### COMING — THE ERA OF TRANSISTORS

Transistors are semi-conductors, at present made from the crystals silicon or, more often, germanium, which have remarkable physical properties. The coherers and crystal detectors of 40 years ago can be thought of as the remote ancestors of the modern transistor. In brief, the difference is that a germanium crystal can amplify. This is indeed a huge step forward in electronics, the full potentialities of which are only just beginning to be realised. Germanium crystals are actually made artificially, by "rendering down" germanium oxide, the resulting powder being fused in a high-temperature (1200°C) vacuum furnace to produce the crystals by gradual cooling.

It is widely held that the coming developments in the application of transistors will revolutionise the science of electronics, particularly in the field of computer design and in Service equipments where light weight, minimum power requirements, expendability, and simplified construction are of prime importance.

The November 1952 issue of *Proc. I.R.E.*, the well-known monthly publication of the American Institute of Radio Engineers, is a Transistor Issue and contains a mass of detail on transistors—their physics, the construction of transistors, operating characteristics and applications (as so far developed), and the peculiarities of transistor circuitry. Broadly, the immediate need in the research field is the study and evolution of an entirely new circuitry to make proper use of transistors. In this connection, it is interesting to note that about two years ago the General Electric Co., Ltd., of Kingsway, actually produced an experimental model of a working three-stage TRF type of receiver using germanium triodes throughout, and capable of good local-station reception. The design and construction of this model was widely publicised at the time, and was discussed in the November 1951 issue of our *Short Wave Listener*.

#### "THE OTHER MAN'S STATION"

For years, this has been a regular and popular feature in *Short Wave Magazine*—and every station description published has been unsolicited. Active operators with a good clear picture of their existing layouts are invited to send it in for appearance as "The Other Man's Station," accompanied by notes covering the equipment in use, the results achieved, particular interests in Amateur Radio, and such personal details as the writer may care to give for publication. The writing of the story based on these notes is a staff job, but payment at full rates is made to the operator concerned for each station description we publish under this heading.

WERE you there on the evenings of January 12 and 13? If not, you missed something, for we had one of those excellent winter openings which come with a sudden change in the weather—with the result that good, stable paths developed all over the southern half of the country and right up into the North Midlands area. Though these were ordinary week-day evenings, more than 70 different stations were on and contacts were being made quite comfortably over 150-200 mile distances. The F's and ON4BZ were getting through to the South Coast and into the London district, and altogether it was another astonishing example of how stations manage to come on when conditions are right—or perhaps they are really there most of the time, ready to come up when the GDX starts appearing.

Going back a bit further in the period, January 4 and 8 were good days in the South, and again these openings can be related to the weather conditions then generally prevailing in the affected areas. Incidentally, this issue contains an interesting article discussing meteorological effects in relation to VHF propagation, and the conclusions will enable the average operator to form his own opinion as to when conditions *should* be right. But it is also true to say that there is a lot more to be learnt—and proved by observation and experiment—on this subject. And that is why we return again to the point that one of the ways to find out is by regular schedule operating over long-haul paths. We can all of us assume that our signals should be getting out to the 100-mile distances under almost any conditions, and that it is only some peculiar local effect—connected perhaps with topography, or aerial effectiveness, or local screening (or something!)—which prevents us working all stations within a radius of 100 miles or so at almost any time. (But even this needs proving; the statement made here is based upon experience and the study of a great many reports over a long period).

#### The Schedule-Keepers

Louis G3EHY and Bill G13GQB keep steadily at it, and for the

# VHF BANDS

A. J. DEVON

---

New Year Opens Well—  
EDX/GDX Conditions in  
January—  
Discussing the Activity Index—  
More Progress on Seventycems—  
News From Round the Country—

---

month of December registered eight hits and 16 near-misses—not quite as well as they had been doing, but very creditable and satisfactory none the less, particularly in view of the conditions during December. And the distance is still 268 miles! In addition to G2CYN and G13GQB, G3EHY has now opened another regular schedule: With G5RW, Ilkeston, Derbyshire, 135 miles, 2300-2305 clock time nightly. So far, they have not had a single miss, and most evenings it is possible to work S8 phone both ways. Louis would like G2BAT to note this, as the G5RW beam is aimed south-west, and on the good nights there should be a chance of a QSO G2BAT-G5RW—which no doubt would please them both.

And for those who may be interested, and who would like a word with G13GQB over the air, he will be with G3EHY on one or two of the three nights February 20-22; Louis hopes that numerous beams will be turned his way, so that G13GQB can meet as many stations as possible and get a good

idea of activity and the distances being covered.

#### Thursday QSO Parties

This scheme is certainly producing regular activity—in the sense that every Thursday evening from about 2000 onwards there is always someone on the band to work—and we very much hope that support for it will be continued. It should be remembered by those really interested in VHF activity that new stations are coming on all the time; the best way to help and encourage them is to give them contacts; and the easiest way to do that is to arrange to be on when you know there should be somebody there to work.

For our part, it would be very helpful if correspondents who come on for the Thursday evening sessions would be good enough to let us have *separate* calls heard/ worked lists for these periods—see the G2HIF listings in this issue.

#### The Activity Index

It has for long been your A.J.D.'s wish (a secret ambition, almost) to be able to devise some method of arriving at a true estimate of VHF activity and interest. The figures we have always maintained in connection with this feature help a great deal, of course, but they only go part of the way, and can be used only to indicate trends. In other words, while they have some statistical significance, it is really possible to draw certain broad conclusions only.

Our first would be that though not less than 200 new stations came on VHF during the year 1952, the nett increase is barely half of this, at some 80-90 operators appear to have abandoned VHF altogether (or to be so inactive that their occurrences do not count). The general tendency during the year 1952 was for the established stations, with a good GDX record already in hand, to come on only when conditions seemed good—it is probable that many of them put in a lot of time listening, and can smell out the good evenings with the unerring instinct borne of long experience. The not-so-experienced adopted much the same tactic, arguing that

"If old G-so-and-so is on, the band must be open"—then proceeding to let out a CQ.

Our second conclusion is, therefore, that these factors working together resulted in a generally lower level of two-metre activity than in 1951. The more obvious result was that all contests were worse supported than in 1951, particularly (again) by the more experienced operators, who had mostly done it all before. Also, of course, towards the end of 1952 there was increasing practical interest in the 430 mc band, and though there is not yet in any sense a "migration to 70 cm," as has been suggested, many more stations—say, 20% of the total VHF population—are either on Seventycems or contemplating serious operations on that band.

Taking 1951 in comparison with 1950, the conclusions are quite different. There was a large net gain in active stations over 1950, and naturally enough this led to more operators being on oftener, with the general impression that there was always more to work. It is interesting to note that every correspondent in the last two months who has mentioned the matter at all has given it as his opinion that activity was better in 1951 than in 1952, though the Tables show that the general level of achievement in 1952 is quite the highest yet.

On this general topic, some figures from the log of G3WW—one of our most consistent VHF operators—are worth quoting: During the first six months of 1952, he had 467 QSO's; over the second half-year to December 31, 1952, the log shows 552 contacts with 218 different stations. This makes more than 1,000 two-metre contacts for the year, or an average of about three QSO's a day, allowing for absences. A very fine record indeed, which we wish could be emulated (or even approached) by a few more operators, since it is appearance on the band that makes activity; on the other hand, there are plenty of others who, as we have seen, lie doggo waiting for the GDX to come through, and it can be said that "They also serve, who only watch and wait."

## TWO-METRE ACTIVITY REPORT

(Lists of stations heard and worked are particularly requested for this section, set out in the form shown below.)

G2AHP, Perivale, Middlesex.  
NGR 51/168830.

WORKED: G2AIH, 2ANT, 2AVR, 2DUV, 2HCG, 2KF, 2LW, 2MV, 2NM, 2MQ, 3BPM, 3CAT, 3CVO, 3CWV, 3FUH, 3FUM, 3FQS, 3GBO, 3GDR, 3GHE, 3GHI, 3HBW, 3HVO/A, 3HWJ, 3HXS, 3ICI, 3ISA, 3SM, 4DC, 4GT, 4KD, 5BC, 5QL, 5NF, 6RH, 6TA, 6XM, 6YP, 8AO/MM. (All worked during December 1952).

G5DS, Surbiton, Surrey.

WORKED: F8AA, 8JR, 8KF, 8NW, G2AVR, 2BMZ, 3AUS, 3DLU, 3IAI, 8IL.  
HEARD: F8GH, G2AHP, 2AIW, 2ANT, 2BRR, 2DTP, 2DUV, 2FFG, 2FVD, 2MV, 2TP, 2UN, 2WJ, 2XV, 2YB, 3ANB, 3BLP, 3EGV, 3EHY, 3EYV, 3FOU, 3FUH, 3FUM, 3GDR, 3GHO, 3GOP, 3GSE, 3GZD, 3HBW, 3HCU, 3HXO, 3IEI, 3IOO, 3MI, 3SM, 3WW, 4AU, 5BC, 5LK, 5NF, 5QB, 5SK, 5UM, 6LR, 6QN, 6RH, 6TA, 6UH, 6YU, 8DV/A, 8OU. (January 12 and 13 Only).

G2HIF, Wantage, Berks.

WORKED: G2MV, 4SA, 6RH.  
HEARD: G2AHP, 3DIV, 3FRY, 3FUM, 3IEI, 3WW, 4AP, 6TA, 8ML. (Thursday, December 18, 2000-2230 Only).  
WORKED: G3GOP, 3IOO, 3NL, 8SC.  
HEARD: G2BUJ, 3DKZ, 3FRY, 3FUM, 4AP, 6RH. (Thursday, January 8, 2000-2230 Only).

G3DLU, Weston-Super-Mare, Somerset.

WORKED: G3YH, 5DS, 6VX.

HEARD: G3BLP, 3CGE, 4AP, 8IL, F8NW. (December 12 to January 13).

G3IBY/A, Worthing, Sussex.  
NGR 51/125047.

WORKED: F8GH, G2NM, 2UN, 3EBW, 3FEX, 3FRG, 3GEG, 5MA, 5NF.

HEARD: F8AA, 8NW, G2AHP, 2ANT, 2AVR, 2BUJ, 2DDD, 2DSP, 2DSW, 2FVD, 2HCG, 2JU, 2MC, 2TP, 2YB, 3ARL, 3AUS, 3BEX, 3BK, 3BNC, 3BPM, 3BUN, 3DKM, 3FAN, 3FSD, 3GBO, 3GOP, 3HBW, 3HCU, 3HWJ, 3WW, 4SA, 5BC, 5DS, 6WU, 8DV/A, 8IL. (November 1 to January 15).

G3YH, Bristol.

WORKED: G3DLU, 3EHY, 3FUM, 3ION, 5HB, 5ML, 6VX, 8DA.

HEARD: F8NW, G2AHP, 2BUJ, 2HCG, 2MV, 2PU, 2WJ, 2XV, 2YB, 3ANB, 3AUS, 3BLP, 3BUV, 3CGE, 3DKZ, 3GOP, 3HWF, 3HXO, 3IAI, 3IEI, 3IRA, 3WW, 4GR, 4SA, 5DS, 8DM, 8IL, GW8UH. (December 12 to January 13).

G3HBW, Wembley, Middlesex.

WORKED: G2AHP, 2DDD, 2UQ, 3AEP, 3BPM, 3CCP, 3CVO, 3EGV, 3GBO, 3HGR, 3HVO/A, 3HXO, 3HZK, 3IAI, 3IEI, 3IEX, 3WW, 4DC, 5UM, 6BO, 6EX, 6PG, 6TA, 6XM, ON4BZ.

HEARD: G2AVR, 2FFG, 2FZU, 2HCG, 2NM, 2XV, 3AUS, 3BKQ, 3FAN, 3GHO, 3GJZ, 3IOO, 3IUK, 4MW, 4SA, 5RW, 8IL. (December 20 to January 14).

G6RH, Bexley, Kent.

WORKED: G2AHP, 2ANT, 2AVR, 2BM, 2BRR, 2DTP, 2DUV, 2FFG, 2FZU, 2HIF, 2HCG, 2KF, 2MQ, 2PU, 2YB, 2ZI, 3AEX, 3BK, 3BRQ, 3BYI, 3CNF, 3CVO, 3DIV, 3EBW, 3EGV, 3FAN, 3FUH, 3FUM, 3GBO, 3GHO, 3GOP, 3HCK, 3HSC, 3HZK, 3IOO, 3ISA, 3SM, 3WW, 4DC, 4GT, 4MW, 4SA, 5BC, 5DS, 5NF, 5QL, 6LL, 6WU, 8AO/MM, 8DV/A, 8LN.

HEARD: F8GH, G2FNW, 2MV, 2UN, 3BLP, 3BPM, 3EYH, 3EOH, 3GHI, 3GHU, 3GZD, 3HBW, 3HWJ, 3IAI, 4KD, 5UM, 6TA, 6PG, 6YP, 8IL. (December 2 to January 11).

G3HXO, Shefford, Beds.

WORKED: G2AHP, 2FFG, 2FNW, 2HCG, 2YB, 2XV, 3ANB, 3BUN, 3FUL, 3GDR, 3GHU, 3HBW, 3IAI, 3IIT, 3IOO, 3WW, 4AU, 4MW, 5IG, 5UM, 5RW, 6RH, ON4BZ.

HEARD: F8AA, G2BRR, 2HOP, 2MV, 2PU, 3BRQ, 3BLP, 3DIX, 3EHY, 3FAN, 3FUM, 3GHI, 3GJZ, 3GOP, 3GSE, 4RO, 5DS, 5ML, 5QL, 6CW, 6PG, 8MW, 8VZ. (December 11 to January 14).

G3EHY, Banwell, Somerset.

WORKED: G2CYN, 2FZU, 2HQ/P, 2YB, 3ELT, 3FUM, 3GNP, 3GZM, 3HAZ, 3IEI, 3IER, 3ION, 3IOO, 3MA, 3YH, 5BC, 5DS, 5ML, 5RW, 5YV, 6TA, 6VX, 6YU, 8DA, 8VR, G3GQB, GW8UH. (December 13 to January 14).

Anyway, so much for the Activity Index—for what our researches on this subject may be worth. The right way to tackle the problem, and arrive at some firm conclusions, would be for all operators who have maintained more or less regular activity on Two during the last three years to tot up their logs for (a) Total QSO's, and (b) Different stations worked, in each of the three years. Even this would require a certain amount of adjustment for factors like hours available and location—but it would be extremely interesting, and very helpful.

### The VHF Century Club

We are glad to announce the election of G6RH, Bexley, Kent (No. 138), as the latest member of the VHF Century Club; he gains his certificate after twelve months' two-metre activity, and is, of

course, well known as one of the leading DX men on the HF communication bands.

### GM's on 70 Cm

A budget of news from GM6WL (Glasgow), from whom we are very glad to hear again. He reports most encouraging activity and progress on 430 mc. Stations up there actually firing on Seventycems are GM's, 3BA, 3ENJ, 3FOW, 3IBV, 5VG, 6KH, 6WL and 6ZV, with GM3EGW coming on. One of the most successful pairs is GM3ENJ/3IBV, who have worked ground-to-ground over about 30 miles. GM3IBV (Larkhall) is 18 miles from Glasgow, but puts in a very strong 70-centimetre signal and has been able to do duplex phone with GM3FOW over that path. GM's 3FOW, 6KH and 6WL are in reliable contact over 13 miles or

so "with plenty to spare," and GM3BA is also a strong signal with the Glasgow group. GM5VG is building himself a complete VHF (two-metre and 70-centimetre) station, remote-controlled from the operating position by relays, which sounds a very interesting layout.

Not previously reported (as far as we know) was a cross-band QSO back in September between GM6WL and GI3GQB, when the former was /P in Galloway and receiving on 430 mc from '3GQB, this being the first GI/GM contact on that band, and the distance about 30 miles.

Another to report progress on 430 mc, "which has been well worth all the trouble taken," is G3BKQ (Blaby, Leics.). He has improved the Rx with a new germanium crystal mixer and two 446A concentric-line RF stages, with more effective oscillator-mixer coupling, all resulting in better signal-to-noise ratio. The transmitter PA is now an 8012A built into a concentric tank assembly which, though working as a tripler, is proving very efficient; it can be run at 26 watts input, with an anode-current dip to 30 mA from 95 mA, the grid drive being 12 mA into a 40,000 ohm resistor. Aerial is a 16-ele

stack, which is shortly to be replaced by a 48-element array for the 430 mc band. And now for G3BKQ's results with this equipment: G3HAZ (Birmingham, 40 miles) is a certain phone QSO, varying from S9 to S6, depending upon whether the path is wet or dry; G5SK and G6YU (Coventry, 18-22 miles) are S9 on phone both ways; so is G2FNW (Melton Mowbray) at 17 miles; G3APY of Kirkby, Notts. at about 30 miles, receives G3BKQ at S8, and an SWL in Birmingham at 35 miles gets him consistently at S8-9 on phone. For general coverage and reliable working over useful distances, this is one of the best 430 mc reports we have yet seen. G3BKQ himself feels that—having had experience of both bands—70 cm would be quite as good as Two if we had more activity and higher station efficiency, particularly in the PA.

From this, and the 430 mc results reported last month, it looks as if a hook-up Birmingham-Coventry - Leicester - Cambridge-London should be possible. In any event, we look forward to hearing that G2XV/G3BKQ have been able to QSO on 430 mc over their 60-mile path, as they are both getting out so well.

#### THURSDAY VHF SESSION

Come on every Thursday evening for the QSO Party, held between 2000 and 2230 GMT. There is activity on both bands, Two and Seventy Centimetres. Make it A Date! There is always somebody to work. Calls lists would be appreciated.

#### Two Metres Up North

G4LX (Newcastle) writes to claim his rightful place in All-Time Counties, and from the same neighbourhood G3IOE reports his first results on Two; on January 10 he worked G4LX and then GM3EGW, the latter being a fine QSO over very heavy country from a badly-screened location (at the Newcastle end). Two nights' activity gave G3IOE 4 stations in two counties and two countries; on January 10, G3WW was copied on phone, but as yet the latter has not worked any of the Newcastle stations.

G3GED, Blackpool, draws our attention to the fact that none of the local VHF activity has yet been mentioned in these pages—stations on Two in the Blackpool-Fylde area are: G3GED, G3GEF, G3GFT, G3GVY, G5VN and G6MI, all looking for contacts.

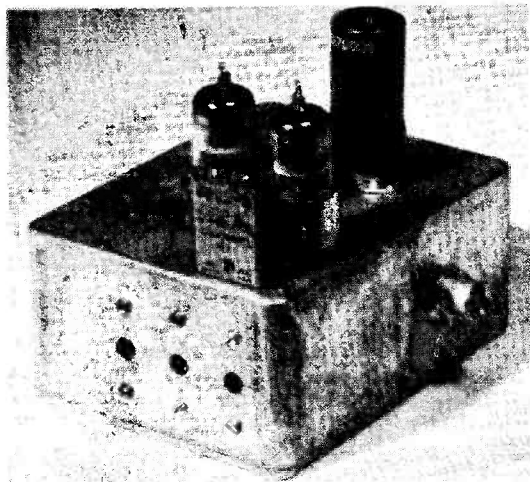

General appearance of a simplified 70-centimetre converter designed and constructed by G2DD, of which it is hoped to give full details in a forthcoming issue. Main features of this design are that it involves no plumbing and no frequency chasing if the CO side is working properly, while the IF is 17 mc, which is within the tuning range of any receiver likely to be used with it.

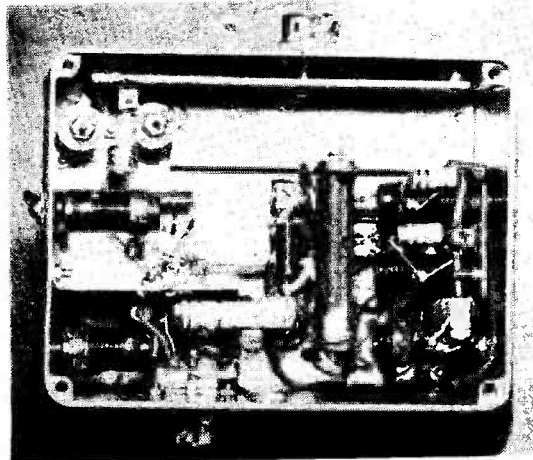

Under chassis view of the 70-centimetre converter; the two trimmers at top left tune the lines, which are brass strips. Features of this design are ease of construction and high stability, and good results have been obtained on the several models made by G2DD. It has been tested at various locations, is easy to reproduce, and will help in solving the 430 mc Rx problem.

Round to Manchester, where G3AGS has got his beam up again outside and is able to claim two new counties; he hopes to do some /P work in the summer and supports the suggestion by G4JJ that stations operating /P should be eligible for the 40C Certificate. G3IOO, of Oswestry, had worked 69 different stations, in the period October 11 to January 12, and heard F8NW at 2110 on the 12th—this is an excellent piece of EDX for the season of the year; incidentally, he will QSL all outstandings as soon as the cards are along from the printers.

G2HOP (Stamford, Lincs.) shows up again, and is hoping to find himself a permanent QTH in Rutland; he is running 30 watts to an 832, with a G2IQ converter and a 5-over-5, his most consistent DX signal being G3GZM, Tenbury (about 100 miles and usually S9 on phone!).

Up near Shipley, G2FCL is rebuilding to a pair of 826's to run at the full 150w, and is also trying a Cascode against the push-pull RF stage job; though the beam is indoors at the moment, G2FCL intends to get a 12-ele stack up to 50-ft. outside as soon as may be. In the meantime, he is on most evenings, testing and listening round.

#### Midlands and East

G6CI (Kenilworth) has been somewhat inactive, but noticed the openings to the South during the period; he asks for stickers on the VHFCC certificate to show on what bands the qualifying contacts were made. At this stage, it would be a tall order, as VHFCC goes back several years and nearly 140 certificates have now been issued. The theme here has always been "stations worked two-way above 50 mc" and we rather feel it should be kept like that.

After the spell of dull conditions and rather low activity, G3HXO (Shefford, Beds.) was very glad to be there on January 11-13, when he was able to work ON4BZ on phone, and hear F8AA for the first time. Nice going on both counts, from a location well inland.

If you are in need of Suffolk, look for G3GJZ, of Newmarket,

who is a recent arrival on Two and wishes to thank G2XV for the help he has given in getting him there; the G3GJZ transmitter runs 18w. to an 832, on 144.522 mc, and several London-area stations have been worked. An unexpected QSO was with an American bomber airborne over Oxfordshire—no card and no county! Not far away in Bassingbourne, G3AVO/A is still in his QRO re-build, and here again Jerry G2XV is very active—urging G3AVO/A on so that they can get cracking on 70 cm, for which band the G3AVO receiver is taking shape.

G3WW, or "Dickie Wimblington," as they call him now, sends through a fine comprehensive report; he overheard G3GJZ's contact with the American aircraft, and also tried to QSO, but as the airborne Rx was spot-frequency, it involved crystal changes which were impracticable. On Christmas Eve, G3WW worked five counties with five contacts, and since the New Year has found G3FAN (Isle of Wight) and G6RH (Bexley, Kent) very consistent signals. From January 10 onwards, several new stations were raised, and on the 13th F8AA was heard, with ON4BZ and ON4HC worked; through G2XV, it is reported from ON4BZ that LX1AS will shortly be on Two.

#### London & Home Counties

G2AHP (Perivale) thought conditions poor—until the good spell from January 4 onwards—but activity higher than during the early part of December; even at that, for that month he worked 40 different stations, twelve being "greeted" on Christmas Day, with several new ones, and one or two others showing up on phone after the probationary CW period.

G5DS (Surbiton), another very consistent operator, who can be relied on for his regular appearances, draws attention to the fact that for the two evenings of January 12 and 13 only, he heard or worked a total of 61 different stations—which is two-thirds of the number h/w during the whole of the previous month!

From Wootton, I.o.W., G3DEP writes that he hopes soon to be back on the band after 18 months'

## TWO METRES

### ALL-TIME COUNTIES WORKED LIST

Starting Figure, 14  
From Fixed QTH Only

Worked	Station
60	G3BW
58	G3BLP
57	G2OI (349)
56	G3EHY (365), G8SB
55	GW5MQ
54	G6NB
53	G2AJ (519), G5YV (364)
51	G3WW, G4CI
50	G2HIF (195)
48	G3ABA (282)
47	G2NH, G2HDZ, (331), G4SA, G5DS (405), G5WP
46	G4HT (476), G5BY, G5MA
45	EI2W (132) G2XC, G3FAN (315), G5BM, G6XM (356), G6YU (195)
43	G3BK, G3COJ, G5DF
42	G5BD
41	G2FQP, G3BA, G3DMU, G3CGQ, G3HAZ, G4RO (256), G5JU, G8KL, G8OU
39	G2IQ, G3VM
38	G3APY, G8IL (300)
37	G2FNW
36	G3CXD, G3GHO (170), G3HBW, G6CB (312), G8IP
35	G2FZU (118)
34	G2AHP (321)
33	G2FCL (117), G3FZL, G6CI (134)
32	G2FVD, G5ML (131), G8IC, G8QY
31	G2FJR (103), G3HXO, G5RP
30	G2HOP, G3BKQ, G5NE, G6TA (206)
29	G3AGS, G3AKU, G3BJQ
28	G3FIJ (143), GM3BDA, G8VR
27	G3BNC, G3DAH, G3GSE, G3HCU (152), G6GR
26	G3CFR (125), G3FIH, G3GBO (289), G4MR (189)
25	G5SK
24	G3FD, G3FXG
23	G3CWW (260), G4LX, G5PY
22	G3AEP, G3ASG (150), G3BPM, G3FRY, G3GOP (122), G3EIL, G5MR (128), GM3EGW
21	G6XY
20	G3EYV, G6PJ
19	G3SM, G5LQ (176)
18	GM3DIQ
17	G3DLU
16	G2AOL, G3FEX, G3FRE, GC2CNC
15	G2DVD, G3IWA, G3YH
14	G2DHV, G3GY, G3ISA

Note: Figures in brackets after call are number of different stations worked on Two Metres. Starting figure for this classification, 100 stations worked. QSL cards are not required to verify for entry into this Table. On working 14C or more, a list showing stations and counties should be sent, and thereafter added to as more counties are worked.



absence, as he is now established at his own QTH. G4SA (Drayton, Berks.) found January 4 "exceptional," with G3FAN pushing the needle right against the stop; his log analysis shows 670 two-metre contacts during 1952—and G4SA would like to help in any way possible to get GC2CNC back on to the band. (We have not heard from GC2CNC lately, but understand that he intends to be on any time now).

G2HIF (Wantage) discusses the Thursday QSO Session, and says that for his part the number of stations heard or worked from there on Thursdays is "most unusual for the time of year." For him, interesting contacts have been made with G6RH and G3GOP (Southampton); the latter in particular was most unexpected, as G2HIF is on the reverse slope of the Berkshire Downs, so that South Coast stations are not usually workable unless conditions are very good. G2HIF was lucky enough to have a personal QSO with G5YV early in January, and it is gathered that he will be on for the Thursday VHF Nights.

G3IBY/A (Worthing) reports as active locals G2DDD (Littlehampton, and a well-known SWL on the old five-metre band before the war), G2DSP (Bognor), G2MC (Brighton, one of the OT's) and G3FRG (Worthing). They are all looking for contacts to the North. On January 8, stations heard for DX were G3AUS, G3BK (S5 on phone), and F8GH; on the 14th, F8AA, F8GH, F8NW and G2BMZ (Torquay) came up.

G3HBW (Wembley) also was in on the good stuff; on January 4, G2UQ, G3IAI and G6CW were worked for GDX. On the 10th, G3IUK (Derby) was heard; during the 13th/14th, G3AEP and ON4BZ were worked, and interesting stations heard include G2FZU (Ilkeston), G3AUS (Torquay), G3BKQ (Leicester), G3GJZ (Newmarket) and G5RW (Ilkeston). As an indication of how things were, G3HBW remarks that the signal from ON4BZ at 220 miles was S7-8 on the 13th.

As already mentioned, G6RH (Bexley) has been on for about a year, starting with a 25-watt 832 transmitter; this has now become 120w. with a QQV06/40 in the

PA, anode-and-screen controlled by a pair of 807's, the actual valve sequence being 12 mc EF91 CO, tripling into an EL91 doubler, another EL91 doubler, a QVO4-7 buffer, into the QQVO6/40, on 144.9 mc. The receiver is a three-stage job, 6AK5-6AK5-9002 osc. tuning 51.3-52.0 mc with a 6AK5 tripler; the IF at 10 mc is fed to a 6BA6, a 6BE6 second mixer with separate 6J4 CO, into a 6BA6 2nd IF at 465 kc, 6AL5 detector-AVC, 6H6 NL, 6J5 1st audio, 6V6 output, and 6BA6 VFO. The beam at present in use is a 4-ele Yagi at 35 ft., and the height a.s.l. is 150 ft. with a 450-ft. hill to the north-west. Apart from qualifying for VHFCC, during the year contacts were made with F, ON, OZ, and PA, with OZ2FR as best EDX. The distant G's are now being sought, and G6RH would particularly like to open regular schedules with stations more than 150 miles away. G6RH also remarks that he has done "No inconsiderable amount of experimental work to get the equipment ship-shape"—and is fortunate enough to have a young harmonic who can do the constructional work for him!

#### The West Country

From down in Bristol, G3YH reports that he is now running a standing schedule with G5ML (Coventry); this is Monday, Tuesday, Friday, Saturday at 1830. His receiver is an interesting departure: An S27 modified by the removal of the RF section, which is replaced by a 6AK5-6J6 Cascade and 6J6-9002 mixer-oscillator, with a Cascade RF amplifier ahead of the receiver; the aerial is a 3-over-3 at 40 ft. G3YH was getting good signals from "the more distant stations" on December 21, 28, 29 and January 2, 4, 9-13; on January 12 and 13, F8NW was heard, and the Cambridge and Northampton stations were also coming in well.

G3FRY (Cheltenham) was pleased to raise G3BLP for a new county, after much trying, and reports local activity as "very good" with the following on almost every evening: G3FRY, G3IER, G5BM, G6VX (Maurice testing out the new QTH, we guess!) and G8ML in Cheltenham; G3FSL, G3MA and G8DA

### TWO METRES COUNTIES WORKED SINCE SEPTEMBER 1, 1952 Starting Figure, 14

Worked	Station
42	G3WW
30	G4SA, G5DS
28	G3FAN
27	G5YV
26	G3GHO
25	G2HDZ, G3HXO, G3IOO
23	G8JL
22	G3HBW
21	G4RO, G6TA
20	G2AHP,
18	G6YU, G8DA
14	G2FCL

*Note: This Annual Counties Worked Table opened on September 1st, 1952, and will run until August 31st, 1953. All operators who work 14 or more Counties during this period are eligible for entry in the Table. The first list sent should give stations worked for the counties claimed; thereafter, additions claimed need show only stations worked in each county as they accrue. A certificate is given for all VHF operators who work 40C or more in the year, for which QSL cards must be shown. Cards are not, however, required for entry into the Table.*

in Gloucester; G3NL and G8SC in Malvern. G3IOO (Oswestry) is almost a local, as he is worked most evenings.

For G3EHY (Banwell) the New Year opened well, and for the first fortnight of January stations at up to 150 miles or so were consistently workable, with an encouraging level of activity from all quarters. New stations raised included G2HQ/P for an interesting contact on January 11, who was S8 on phone though away up near Sheffield. G3DLU of Weston-s-Mare was considerably heartened to receive F8NW on January 12, S8-9 on CW and quite steady for an hour or more; and at the moment F8NW came back to G3DLU, the latter's Rx went dead on him—but he is at least happy about the new Yagi.

#### Calls Heard & The Tables

As always, the calls lists appearing in this piece are very interesting and, we hope, useful. All correspondents are asked to send

in a list of stations heard/worked whenever they write, as it keeps everybody up-to-date with what is happening and who is on.

The Counties Tables are corrected to January 14 for all reports and claims received, and we look forward to seeing Annual Counties moving a bit during the next couple of months, with more of the newer operators on the band staking their claims. All necessary information about Counties procedure is given in the foot-notes to the Tables.

And so for this month, that

about winds it up again, and the thanks of your A.J.D. for the volume of reports received—always interesting and encouraging.

#### Final Note

Closing date for the next issue is **Friday, February 13**, certainly—a bit tight, but February is a short month, and we are calendar-bound in these matters. And for the issue following it is *Friday, March 13*, for the same reason. Address all your VHF news, views, claims, ideas, complaints and suggestions to: A J. Devon, "VHF Bands," 55

Victoria Street, London, S.W.1. Please hit the dates With you again on March 6—and what about fixing a few regular schedules?

#### THURSDAY VHF SESSION

Come on every Thursday evening for the QSO Party, held between 2000 and 2230 GMT. There is activity on both bands, Two and Seventy Centimetres. Make it A Date! There is always somebody to work. Calls lists would be appreciated.

## Receiver Remote Control Unit

AN ADAPTABLE CIRCUIT

G. WHITBY

WHEN an extension speaker is run in conjunction with a radio receiver it is sometimes inconvenient to return to the receiver to switch it off. If the extension speaker is used in a sickroom or by an invalid it is frequently impossible for the listener to control the receiver unless alternative mains switching is employed. This is often undesirable, even if the danger of having mains voltage lying around is not considered.

The writer has designed an inexpensive unit which provides the necessary on-off control of the receiver from any number of different points. Thin bellwire may be used for the extension control, because the actual switching—at the extension point—controls very little power. Alternatively, a two-pair cable (four way) could provide control and also carry the audio output to the extension loudspeaker.

This particular unit has been mounted inside the cabinet of the writer's receiver and functions quite satisfactorily. (But of course the position of the unit itself is immaterial.)

#### Circuitry

The operation of the circuit is quite simple. Closing the isolator switch S1 will apply mains voltage to the unit transformer and also to contacts B1 and B2 of the relay. When the receiver is switched off by this unit the latter will consume a negligible amount of power and this only due to mains transformer losses. As

will be seen from the diagram, there is no current path through the unit until switch S2—or one of the extension control switches in parallel with S2—is closed. Switch S2 in the writer's unit is the normal receiver on-off switch. It has been disconnected from the receiver circuit and placed in the position shown because, when the unit is installed, it is simpler if there is no independent control fitted to the receiver. As many other switches as are necessary may be connected in parallel across S2 and placed at various points where the extension speakers are situated, or likely to be situated, and where control is required.

#### Action

If S2, or any associated switch, is closed then current passes through the relay and operates it, closing contacts B1 and B2, so applying mains voltage to the receiver. Opening the

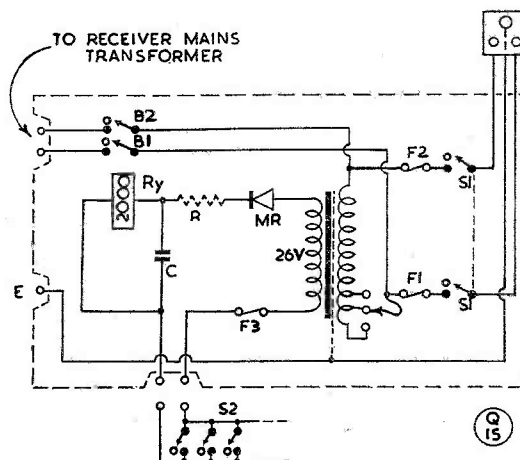

Circuit diagram of a receiver remote control unit, which can be adapted for various purposes. Values are: MR, LT56; C, 2 $\mu$ F, 350v.; R, as may be required—see text.

switch will open the circuit of the relay winding and the contacts will open, switching the receiver off.

The three fuses are an essential safety measure if the unit is to be left connected to the mains for a long period without attention. F1 and F2 should be rated according to the power consumption of the receiver; a reasonable value would be 500 mA, while F3 should be about 75 mA. For the same reason the unit mains transformer should be reasonably robust and the 2  $\mu$ F condenser should be of the paper type. The contacts B1 and B2 of the relay should be heavy enough to carry the mains current to the receiver.

The writer has used a relay with a winding

resistance of 2000 ohms, but of course any suitable relay may be employed, so long as the winding is not appreciably greater than 2000 ohms. If the winding has a low resistance it is preferable to insert a dropper resistance (shown dotted in the diagram) to reduce the operating voltage. The transformer secondary voltage of 26 volts, applied to a Westinghouse metal rectifier type LT56, gives an approximate operating voltage of 24 volts. The current through the rectifier is about 13 mA when the unit is in operation.

Although this unit has been built for remote control of a receiver it will be appreciated that it is quite suitable for any other purpose where remote control of power is required.

---

## THE WORKING OF QSL BUREAUX

WITH PARTICULAR REFERENCE TO BCM/QSL

**W**E frequently receive inquiries from readers wishing to know what they should do to make use of our QSL Bureau, and how the QSL system works generally.

Most organisations active in the field of Amateur Radio operate a QSL Bureau, which is essentially a clearing house for members' or readers' cards, working in conjunction with similar bureaux, or clearing houses, in all other countries—including even Soviet Russia. (Recently, however, the QSL traffic between Moscow and countries on this side of the Iron Curtain has been stopped by the Russians.)

The medium of exchange is the QSL card, sent by two transmitters exchanging cards between themselves to confirm a contact.

### Some of the Figures

It is only a matter of a moment's calculation to realise that the traffic, world-wide, in QSL cards is of enormous proportions. The world total of regularly active transmitters and SWL's, together, is probably now not less than 100,000. (The casually interested, and those not regularly active, would increase this figure to at least 150,000.)

Taking it that our 100,000 regularly-active enthusiasts send out on the average 100 cards a year each—by no means an outside figure; we know of operators who use 1,000 QSL cards in a twelvemonth—we arrive at the staggering total of *ten million* cards, at the lowest estimate, finding their way about the world each year! From this, it would be safe to assume that the gross throughput cannot be much less than *one million* cards in circulation *every month*.

Obviously, it is a great financial advantage to the keen QSL'er to be able to bulk his cards (especially

if he is sending out more than 100 a year) through a bureau which, in turn, handles in bulk for him through other bureaux. Were it not for this arrangement, postal charges on each card sent individually would close down this side of Amateur Radio activity for a great many operators.

In the main, therefore, this colossal bulk of cards is circulated between the various QSL bureaux, which also sort out and despatch at the country of destination.

### Working of the System

Arrived at the accepting bureau, how is final delivery effected? Some bureaux can only deliver cards to individuals who are members of their own organisations; others rely upon membership schemes whereby individuals entitled to use the bureau keep stamped addressed envelopes on deposit for cards received for them. These envelopes are held by the bureau until the number of cards approaches the stamped weight of the package. Hence, the user of any such bureau sends his cards in to the bureau in bulk and (in theory, at least) should get his cards back in bulk by the same route.

### What Often Happens

Now, there are certain practical difficulties and drawbacks about this apparently perfect scheme. Suppose you, Transmitter A, send a QSL card to Transmitter B in Uruguay. If B is not a member of his national society (which these days is not unusual) he will possibly never receive your card, which may or may not come back to you eventually as undeliverable. And even if he is a member, he will only get your card if he keeps stamped addressed envelopes at his own bureau. He may not be a very active operator, nor particularly keen about QSL's. So even if he is a member of his national society, and keeps envelopes at the bureau, it may be some time (perhaps several months) before enough cards come in for him to justify the posting off of his envelope.

Thus, it can be anything from three weeks (in the case of a very active operator who observes all the rules of a well-run bureau) to nine months (in the case

of one who is a bit off-hand about it all) before your QSL is finally delivered to the intended recipient. If it is several months, then from his point of view your card is an "old one," and of no particular interest to him. In any case, you may wait months—and in many well-authenticated cases, years—before you get the acknowledgment QSL, for which you so enthusiastically sent off your card so long ago.

You in your turn may only be receiving cards comparatively slowly at your own bureau, so that time will elapse before enough cards are in to justify sending off your envelope. So there is a further delay! You may have decided to expedite matters by short-cutting your own bureau for outwards cards, sending them in bulk to the countries in which you are interested. This only helps a little, as you are still in the hands of the ultimate recipients of your cards—who may or may not have envelopes at their bureaux when your cards arrive.

In spite of the foregoing, it is fair to say that in general the QSL bureaux system works very well and, as we have seen, enormous quantities of cards are handled by them every year. But it will also explain why so many operators are finding that sending QSL's *via* these bureaux seems at times like dropping good cards into a bottomless pit—nothing seems to happen in return.

#### Operation of BCM/QSL

While BCM/QSL, the Bureau we operate, must fit into the broad pattern of the QSL system, we do expedite matters considerably in a large number of cases by despatching cards to the addressee by *direct post*. That is to say, cards through our Bureau would reach Transmitter B in Uruguay by mail from us, and not months later through his own bureau. At first sight, this looks as if we pay postal charges on individual cards. In fact, that happens but rarely, because it is a safe assumption that whenever we have to post to Transmitter B there would be not

one but several cards for him. He will have worked one or two G stations, and a few listeners will be reporting to him as well.

Not only does Transmitter B get his packet of cards from us through his letter-box, but he also gets a man-sized print-addressed return envelope (which he has only to stamp) into which he can put *all* his QSL cards in reply to those he received in our packet—and any others he cares to squeeze in as well! Thus, *under our system it is of no consequence if Transmitter B is not a user of his local bureau, or even a member of his national society.*

Transmitter B's packet duly arrives at BCM/QSL, the cards are sorted with hundreds of others received in the same way, and we are left with varying quantities of cards, from one to 20 or 30, for each of a number of different addressees. These packets are then cleared to their owners in accordance with Bureau rules.

What it all amounts to is that if you want quicker action on QSL's (and do not want to QSL direct, which is much the better alternative if you can afford the postage) you should use BCM/QSL—if you are entitled to do so. Naturally, the operation of a Bureau on the lines we have chosen to adopt is an extremely expensive business (in effect, we are posting free of charge all over the world by direct mail). Hence, its full use both ways, *i.e.* for cards outwards (those you send) and inwards (cards received for you), is strictly confined to readers who are direct subscribers to *Short Wave Magazine*, or members of the British Short Wave League.

Even if you are also a member of some other organisation, your cards inwards can be delivered through BCM/QSL provided your call-sign appears on the cards for you. Nor is there any risk of cards becoming "lost," for the simple reason that in self-defence and in the interests of their own members, all bureaux interchange cards which happen to come in for those who are not members of their own organisation.

---

## NOTES ON MAGNETIC RECORDING TAPE

During the last nine months *Short Wave Magazine* has published series of articles dealing with magnetic tape recording. One of these gives details of the construction of an equipment, while the other includes the subject under the general heading of Sound Recording. As little has been said so far about the tape itself, the following short description of this important link in the recording chain will probably be of interest.

Magnetic tape can be prepared in the form of a homogeneous film or as a coating on either a paper or plastic base. Homogeneous tape has rarely been used in this country and is, in fact, generally declining in popularity everywhere. The choice therefore lies between paper or plastic-based tape. Paper tape is cheaper and may occasionally be more robust, but even with the best quality papers noise is always some 10 dB higher. Of the plastic bases, the most popular is cellulose acetate, since it can provide a

mirror-like surface for coating and is reasonably strong and stable. Another plastic favoured on the Continent is P.V.C.

#### Coatings

Of the three varieties of magnetic coating—low, medium, and high coercivity—medium coercivity is generally preferred these days, as it provides a better top response for the same tape speed than low coercivity, while the recording and erasing power demanded is less than that needed for high coercivity. The magnetic material employed is almost universally one specific iron oxide, but variation in processing results in a final value of coercivity which can lie anywhere within what is generally considered the medium-coercivity range, 200-280 oersts.

The characteristics which make or mar a magnetic tape are as much mechanical as magnetic. A plastic-based tape with a high signal/noise ratio—impossible

to specify quantitatively, since there are as yet no standards—a uniformity within  $\pm 0.5$  dB with full-track working, and a smooth-surface coating not thicker than 0.0007 in. to ensure a good top response, is magnetically sound by present-day standards. Sensitivity is unlikely to be an important factor except when used with inexpensive recorders of low gain. Transfer, or “print-through” from one layer to the next, is much the same for all types, although here again medium-coercivity tapes have a slight advantage over low. The time has probably not yet come when the output capacity for a given percentage distortion—and this can vary from tape to tape—is of major importance except in professional circles. So much, then, for electrical and magnetic qualities.

### Mechanical Factors

In practice, good mechanical properties are quite as important and quite as difficult to achieve. Curl, bias, and cupping make clean winding and rewinding

uncertain and are liable to cause sudden speed changes (particularly with weak drives), breaking of the tape, or loss of top. Blocking, or sticking, and overwidth give rise to much the same faults. Minute particles or impurities protruding from the surface of the tape will cause jumps and drop-outs. Occasional “pin-holes” in the coating, surprisingly enough, appear to be of minor importance except when the tape is used for multi-track work. Poor adhesion of the coating to the base will lead eventually to shedding, an effect which not only spoils the tape but also results in accumulations of oxide particles on the equipment.

It need hardly be pointed out that the above notes do not delve deeply into the magnetic phenomena occurring in the tape. They do attempt, however, to indicate the qualities to be expected of the finished product when used with well-designed equipment and to assess the relative importance of these qualities.

## CALL-BOOK — WINTER EDITION

The latest (Winter 1952-53) edition of *Radio Amateurs of the World* is the *Radio Amateur Call Book* less only the American section. Of more than 150 pages, it gives the call-sign, name and address of all known amateurs outside the United States, listed alphabetically by prefix. There are 190 separate country-headings, ranging from remote islands with only one or two operators, to the new, enlarged G section, covering nearly 20 pages, set in three closely-printed columns to a page, with all the latest amendments. Both the Zone area and the QSL Bureau address are given for each country, so that all-in-all the winter edition of *Radio Amateurs of the World*, in its smart new *Call Book* cover, is again an indispensable publication for every keen DX operator. The price is but 10s., post free, of the Publications Dept., Short Wave Magazine, Ltd., 55 Victoria Street, London, S.W.1, and delivery is immediate.

### TO APPEAR IN FORTHCOMING ISSUES

A self-contained two-metre portable station, for /P. mobile or /A operation. Also, a 25-watt 10-metre CW/Phone transmitter with built-in power supply, intended for either local or DX work on Ten, as conditions serve. Both these will be fully detailed and illustrated constructional articles.

### SLIGHT CORRECTIONS

In the Table of Values on p.588 of the December issue, include C14 as 60  $\mu$ F variable. In the circuit diagram on p.655, January *Short Wave Magazine*, the resistor R1 should be from the grid side of C2 to earth, and not as shown.

### AN AERIAL FARM

We have all heard of “aerial farms”—meaning an assemblage of various transmitting systems of different types and sizes for directional working or

multi-band coverage—but few amateurs possess or could install an aerial system as ambitious or as elaborate as that owned by W6AM, Rolling Hills, California. On a 120-acre site, on a hill 1,200ft. high, he has no less than ten rhombics, a Vee-beam and a bi-directional curtain. Between them, these systems give world-wide coverage with high-gain directional aeriels, selected from the operating position, and energised by an 800-watt CW/Phone transmitter. His is probably the most comprehensive amateur aerial layout in the world.

### NEW QTH's

Readers are reminded that under this heading each month we publish the addresses of newly-licensed operators, and changes of address of amateurs already on the air. Any licensed amateur is entitled to appearance in “New QTH's,” and it should be noted that call-sign/addresses sent to us appear also in both sections of the *Radio Amateur Call Book*, the American publication which for nearly 30 years has been the only directory to the amateur stations of the whole world, and for which we are sole agents for Europe and the United Kingdom.

### GERMAN AMATEUR POPULATION

It is reported that there are now well over 6,000 licensed DJ-DL stations in the Western Zone of Germany, many of whom were pre-war operators. Having regard to all the circumstances, this is a remarkable recovery. G8KW played a large part in this, as during his service with the Control Commission, he was instrumental in persuading the three Occupying Powers—and it took two years—to remove the war-time restrictions on German nationals. In recognition of this, G8KW has been made the first honorary member of the D.A.R.C. He is now a senior development engineer with Burndept, Ltd., of Erith, Kent, one of the oldest research and manufacturing firms in the radio industry.

# NEW QTH'S

This space is available for the publication of the addresses of all holders of new U.K. call signs, as issued, or changes of address of transmitters already licensed. All addresses published here are reprinted in the quarterly issue of the "RADIO AMATEUR CALL BOOK" in preparation. QTH's are inserted as they are received, up to the limit of the space allowance each month. Please write clearly and address on a separate slip to QTH Section.

- G2HR/A**, E. Johnson, 19a Burnham Road, South Chingford, London, E.4.
- GM3EWM**, P. Green, 13 Knowes Road, Haddington, East Lothian.
- G3GQY**, G. C. Mowat (*ex-ZLIQX*), 36 Bassingham Road, Wandsworth, London, S.W.18.
- G3IEJ**, B. A. Watson, 5 Nether Avenue, Grenoside, Sheffield, Yorkshire.
- G3IGR**, J. Britton, 2 Chatterton Square, Redcliffe, Bristol, 1.
- G3IHA**, A. E. Parker, 4 Ridgeway Road, Warsop, nr. Mansfield, Notts.
- G3IHS**, R. Hutton, 7 Burcott Road, Wells, Somerset.
- G3IID**, D. J. Warford, 89 Highridge Road, Bishopsworth, Bristol. (*Tel.: Bristol 64259*).
- G3IKE**, D. J. Raitt, 84 Victoria Avenue, Ore, Hastings, Sussex.
- G3IKF**, A. B. Chadburn, Cassacawn, Blisland, Bodmin, Cornwall.
- G3ILE**, E. Marsh, 24 Darkwood Crescent, Chaburn, Clitheroe, Lancs.
- G3ILF**, F. E. G. Hubbocks, 62 Arkley Road, Hall Green, Birmingham, 28.
- G3ILX**, D. H. Wheeler, 44 Rakesmoor Lane, Barrow-in-Furness, Lancs.
- G3IMS**, A. Scott, 2 Greendale View, Grindleton, nr. Clitheroe, Lancs.
- GM3IMY**, J. McComb, Lydgate, Haddington, East Lothian.
- GM3INH**, J. Paterson, 9 West Road, Haddington, East Lothian.
- G3IOG**, The Royal Signals Boys' Radio Club, 6 (Boys) Training Regiment, Royal Signals, Normandy Camp, Beverley, East Yorkshire.
- G3IOO**, A. H. Brown, 21 The Terrace, Morda, Oswestry, Shropshire.
- G3IOZ**, R. A. Stringer, 1 Hillington Road, Edgeley, Stockport, Cheshire.
- G3IPD**, C. W. Oakley, Ramsden Cottage, Varley Road, Slaithwaite, Huddersfield, Yorkshire.
- G3IPR**, F. W. Lloyd, 31 Pound Street, Newbury, Berks.
- G3IQG**, G. S. Austin, 75 Haslemere Road, Bexleyheath, Kent.
- GM3IQJ**, J. Abernethy, 54 Blalowan Park, Cupar, Fife.
- G3IQO**, J. E. Taylor, 20 Asbridge Street, Liverpool, 8.
- G3IQT**, E. S. Sabberton, 91 Hotblack Road, Norwich, Norfolk.
- G3IQU**, B. E. Buckingham, 88 Rydal Crescent, Perivale, Greenford, Middlesex. (*Tel.: PER 1981*).
- G3IQX**, E. W. Popplewell, 238 Iford Lane, Southbourne, Bournemouth, Hants.
- G3IRD**, A. D. Willett, 23 Main Street, Bagworth, Leics.
- G3ISB**, C. J. Brock, 138 Wrexham Road, Whitchurch, Shropshire.
- GW3ISJ**, J. J. Caulfield, 20 Castle Road, Tongwynlais, Cardiff, Glam.
- G3ISY**, L. F. P. Hollis, 156 Bexley Road, Erith, Kent.
- GM3ITC**, P. M. Cleland, Parkview, Newhouse, Motherwell, Lanarks.
- GW3ITD**, M. R. Davies, Rhoslynw, Llanybyther, Carms.
- G3ITF**, B. S. Freeman, 18 Bounty Road, Basingstoke, Hants.
- G3ITK**, P. Haddock, 19 Aldersyde Street, Lever Edge Lane, Bolton, Lancs.
- GM3ITN**, L. Hamilton, Hall's Land, Hardgate, Clydebank.
- GM3JDR**, D. Robertson, Aukengill, Wick, Caithness.
- G3JOW**, O. D. Wyles, 5 Kingsbridge Road, Newbury, Berks.
- G3ADP**, H. Waddington, c/o 98 Woodhouse Road, Keighley, Yorkshire.
- G3AEN**, A. G. Witham, St. Davids, Elm Park Road, Church End, London, N.3.
- G3AST**, J. A. Plowman, 59 Lewsey Road, Luton, Beds.
- G3BDQ**, J. D. Heys, 201 London Road, St. Leonards-on-Sea, Sussex.
- G3BNE**, G. W. Alderman, 34 Harlington Road, Bexleyheath, Kent.
- G3CDG**, D. H. Bearcroft (*ex-VSIFA*), 30 Newton Road, Arle, Cheltenham, Glos.
- G3CFZ**, R. Aird, 153 Tebay Drive, Newcastle-upon-Tyne, 5.
- GM3CIG**, J. E. Priddy, 6 Dunlop Terrace, Inverkeithing, Fife.
- G3EAP**, C. Sellars, 92 Churchfield, Harlow New Town, Essex.
- GW3GSJ**, E. E. Hewins, 77 High Street, Barry, Glam.
- G3GUU**, C. H. Hall, 23 Swainson Street, Lytham, Lancs.
- G3HCL**, F/Lt. D. E. C. Lockyer, Officers' Mess, R.A.F. Station, Debden, Saffron Walden, Essex.
- GW3HPN**, E. B. Nunn, Lleiandy, Ashford Close, Croesyceiliog, Mon.
- G3IES**, B. S. Sutherland, 7 Beech House, Hampstead, London, N.W.3.
- G3IEX**, Sgt. D. J. Roper, 31 M.Q. Grays Road, R.A.F. Station, Uxbridge, Middlesex.
- G3WQ**, P. B. Jackson, 5 Hull Road, Barlby, nr. Selby, Yorkshire.

## CORRECTION

- EISB**, R. J. Toby, Ewell, Mount Anville Road, Dundrum, Co. Dublin.
- G2BSN**, R. E. Sedgwick, 8 St. Margaret's Road, Chelmsford, Essex.

## CHANGE OF ADDRESS

- GM3AAU**, R. C. Kenny, c/o J. S. Martin, Kirkhill Cottage, Dalton, Lockerbie.

## YUIAD

## The Other Man's Station

VERY few workers on the DX bands can have missed hearing the call YUIAD—located in Belgrade, Yugo-Slavia—at some time or other, usually with an outstanding signal and driven by an El-Bug. Mirko Vosnjak, the operator, first came on the air in February, 1950, with the call YUICAB; this was changed to 1AD in 1951. In less than three years he has worked 191 countries on CW and 92 on phone, and several of the well-known DX awards have been achieved on five bands. Photographs appearing herewith were taken as recently as two months ago.

The rig consists of a Clapp VFO, buffer and doublers using wide-band couplers, and a PA which is the German equivalent of an 813. Mirko claims that his excellent note is due to the use of a German valve, type LS50 (40 watts dissipation) in the VFO,

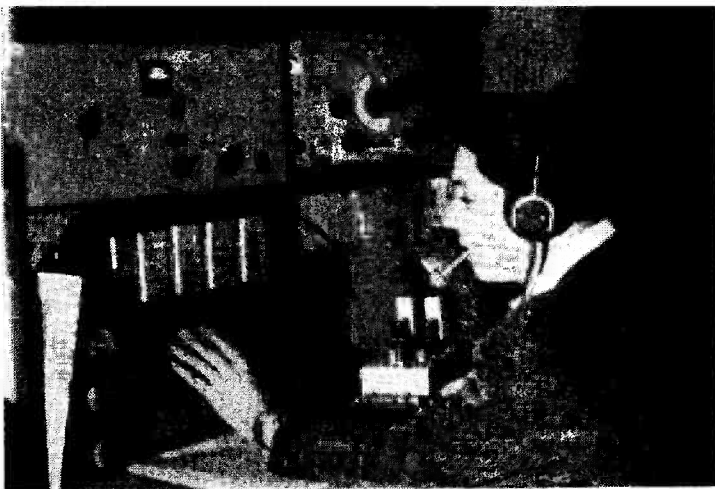

which operates with an input of only 3 watts. Similar valves are used for the buffer and doublers, running at 7-8 watts only.

Quite an aerial-farm assists in putting out the signals. For 3.5 and 7 mc there are separate dipoles, the 7 mc aerial also being used for 21 mc. For 14 mc and 28 mc there are separate ground-planes.

The receiver is a well-modernised HRO-5, with a separate all-triode converter for 21 and 28 mc. A crystal-controlled frequency-standard oscillator is built into the receiver, and also a CW limiter with adjustable limiting level.

In the photographs the VFO-buffer unit can be seen on the extreme right, above the HRO, with the FD band-pass unit adjacent to it. The big rack houses the PA and power supplies. To the right of the receiver is the El-Bug, the most modern type as designed by W6DPU. The photograph above shows Mirko at work, doubtless chasing another new one.

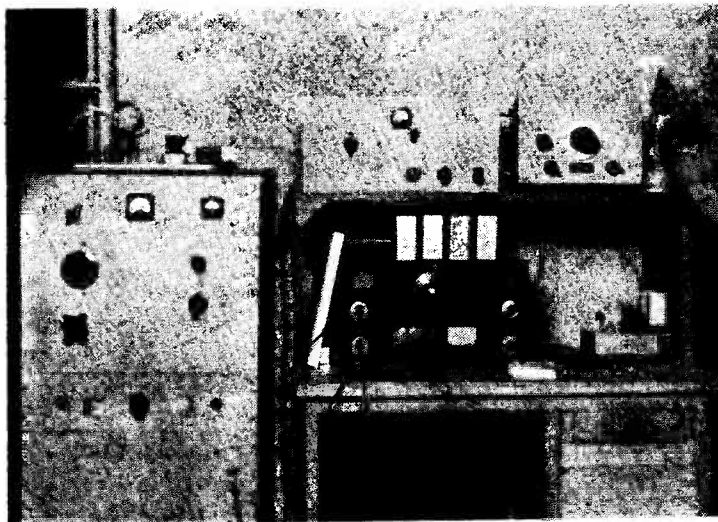

*Short Wave Magazine is an Independent Publication with  
a World-Wide Circulation*

# The Month With the Clubs

## Barnsley & District Amateur Radio Club

Recent lectures have covered the following subjects: Fault finding in TV Receivers (Messrs. H. Green and C. Smith); VFO's (G3FLQ); and Introduction to Two-Metre Working (G4JJ).

## Brighton & District Radio Club

The January lectures were on Sub-Miniature Equipment (Multi-tone Electric) and Fluorescent Lighting (Thorn Electrical Industries). On February 17 there is a talk on Tape and Disc Recording, by Mr. G. Austin, and on March 3 "Radio Autobiography" by Mr. R. T. Parsons.

## Chester & District Amateur Radio Society

The Club transmitter is not quite ready for the air yet, but should be very shortly. Morse classes and basic lectures continue on Monday nights at 7.30, with the main meetings on Tuesdays at the same time. Two or three members have recently obtained their calls, and more hopefuls are on the way.

## Clacton Radio Club

This Club should, by now, be installed in new Headquarters and will open with a lecture on the Design and Construction of High-Quality Sound Reproducers by Mr. R. Cook, of the R.E.M.E. Telecommunications Department. Recent talks have been on a Home-Built Oscilloscope and the Development of Cable and Wireless through the years.

*The excitement of "MCC" having subsided in those quarters where the most keenness on the operating side is shown, the Clubs participating have settled down to normal routine. Many of them have suggested that two such Contests a year would not be overdoing things, but for the moment we have "no statement to make" on this subject!*

*For the rest, reports have not been too numerous, no doubt on account of the somewhat earlier date-line, which always affects us at this time of year. They have been received from 26 Clubs, and, in addition, we should like to acknowledge receipt of the following Club publications: "Newsletter" (CLIFTON), "Monthly News" (S.R.C.C.), "Radio Rag" (STOKE-ON-TRENT), "News Bulletin" (STOCKPORT), "News-Sheet" (PURLEY).*

*Where such publications contain details of meetings ahead of publication date, we extract them; when, however, everything in the News Letter refers to the past, we do not endeavour to make a Club Report out of the contents. Honorary Secretaries will be well advised to forward a concise programme of forthcoming events (ahead of the next publication date) if they wish such a report to appear.*

*Please note that the deadlines for the next two issues are February 11 and March 11. Notes for these issues should be addressed to "Club Secretary," Short Wave Magazine, 55 Victoria Street, London, S.W.1.*

## Coventry Amateur Radio Society

A mixed bag of lectures, a Night on the Air, a Junk Sale and a Supper saw the old year out—not forgetting the Children's Party on December 15. On January 5 G5GR lectured on "DX on a Landline." February 27 is the date for the 21st Anniversary Dinner—tickets available from the Hon. Sec.

## Edinburgh Amateur Radio Club

Meetings continue every Wednesday evening in Unity House, Hillside Crescent. Recent subjects have been Aerials, the Club Tx, and Amplifiers.

## Hastings & District Amateur Radio Club

The Annual Dinner in December was a great success, and the regular lectures covered such varied subjects as Radar, 3000-ohm Relays, Aerials, VHF Aerials and Tape Recorders. February meetings are on the 10th and 24th, at the Saxon Cafe.

## Manchester & District Radio Society

Meetings are held on the first Monday of the month at the

Brunswick Hotel, Piccadilly—7.30 p.m. See panel for QTH of new Secretary.

## Medway Amateur Receiving and Transmitting Society

Note the appointment of a new Secretary, the former holder of the office being about to leave the country. See panel for QTH.

## Slade Radio Society

At the AGM a new President was elected, together with other officers. At a recent meeting the subject was "The Basic Equipment for an Amateur Station." and on January 9 the subject was RF Heating. Meetings are at the Church House, Erdington, on alternate Fridays—visitors always welcome.

## Southend & District Radio Society

The January meetings consisted of a talk on D-F Receivers (Mr. Seabrook) and the AGM. The maintenance of the General Hospital wireless installation is carried out by a local GPO engineer, who has approached the society for some co-operation. A meeting is being arranged to settle the details.



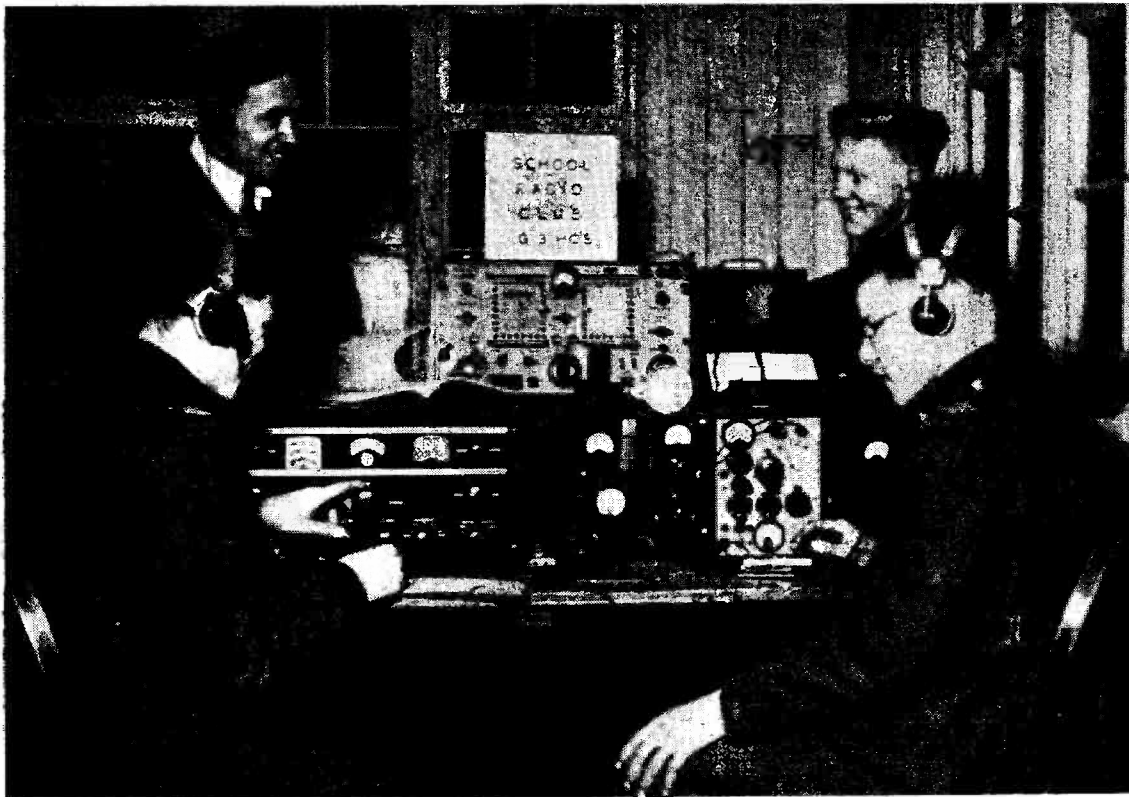

The Army Apprentices School Radio Club, Arborfield, put G3HOS on the air for MCC in November last, with G3HBU (standing left) as operator-in-charge. The station was otherwise handled by the boys themselves (who are training for the telecommunications branches of the Army) and they acquitted themselves admirably, gaining 9th place in a field of 28.

#### **West Lanes. Radio Society**

New club premises have been taken over, and meetings are now held every Thursday (8 p.m.) at the Scouts' Hall, East Street, off South Road, Waterloo. Recent events have included lectures on Production and Manufacture of Wire, and Japanese Morse. There have also been visits to the automatic telephone exchange and to Seaforth Radio. The Christmas party was held on December 17 and was enjoyed by over 40 members.

#### **Acton, Brentford & Chiswick Radio Club.**

Meetings continue every Tuesday at 7 p.m. in the A.E.U. Rooms, 66 High Road, Chiswick, W.4. The plan for 1953 is for this routine to remain unchanged. The Club Tx is G3IUU, and evenings

are spent on constructional work, Morse practice, general discussion and operating the Tx. Out of 32 members, 17 are licensed — and still more will be welcomed, particularly some of the Old Timers known to be in the area.

#### **Army Apprentices' School Radio Club**

This Club, as one of the "youngsters" in the MCC, did well to achieve ninth place and is duly pleased at the result. To accompany the successful Top Band aerial (275-ft.) a Tx is now being built in a small rack assembly. We are asked to say that G3HOS is very grateful to those who reply to some of the rather faltering CQ's emanating from learner-operators on the Club key!

#### **Bradford Amateur Radio Society**

The main attraction for

February is a lecture on Fidelity Reproduction, to be given on the 17th at 7.30 p.m. This will be preceded by the usual Morse class at 7 p.m.

#### **Cambridge & District Amateur Radio Club**

The February meeting will be held at the Jolly Waterman, Cambridge, at 8 p.m. on the 13th. This evening will be given over to a Junk Sale, and we are told that only those who have attended similar events in the past know what bargains are usually offered.

#### **Dartmouth & District Amateur Radio Society**

The winter programme is in full swing, and talks have been given by G3FHI, together with an interesting lecture by G3AVF on Two Metres. Mrs. Elton, a patroness of the Club, has given

two fine silver cups, suitably inscribed, for competition purposes.

#### **Isle of Man Radio Society**

During January the usual monthly meetings were held, the first being a Junk Sale and the second a Hot Pot supper at the Ridgeway Hotel, Douglas. Normal meetings are on the first Wednesday of the month at Broadway House, Douglas, by the kindness of GD3FBS, the president. A new member of the Society will shortly be GD4IA—at present G4IA of Bolton.

#### **Purley & District Radio Club**

At the next meeting, which is on Thursday, February 26, G3CKH will give a talk on Aerials and Feeders. The Annual Dinner will be held on February 28, 7.30 for 8 p.m., at the Railway Hotel, Purley. Tickets are available from the Secretary at 10s. 6d. each.

#### **Surrey Radio Contact Club**

January saw the Annual Dinner (on the 16th) and the normal monthly meeting, at which G3BCM gave an "Introduction to D-F for Amateurs." On February 10 there will be a talk, with demonstration, on Radio-activity. This will be given by a member who works in the bio-chemistry department of a hospital medical school. The Wardman Cup for this year was won by Andrew Smith, G3IAS.

#### **Grafton Radio Society**

Little news from the Club, except that the transmitter is on 1.7, 3.5, 7 and 14 mc most Club evenings (Mondays and Fridays each week). All meetings are at 7.30 p.m., with regular Morse classes.

#### **Ixworth Radio Club**

The working station G3GZY/A, at a recent Bury St. Edmunds exhi-

bitation, proved a great attraction and received good support from the press. Contacts were not numerous owing to QRM and the lack of a good aerial, but many personal contacts were made with prospective Club members. During the next three months there will be an intensive series of Technical and Morse classes—new members always welcome.

#### **Portsmouth & District Radio Society**

Meetings are held every Tuesday at 7.30 p.m. in The Signal School, Royal Marine Barracks, Eastney, to which new members will always be welcomed. Last month there was a talk and demonstration on Microwaves and Wave Guides by G3DBV, and the AGM was also held. G6NZ is Chairman and Life Vice-President.

#### **Liverpool & District Short Wave Club**

The end of a very successful year was marked by a Hamfest,

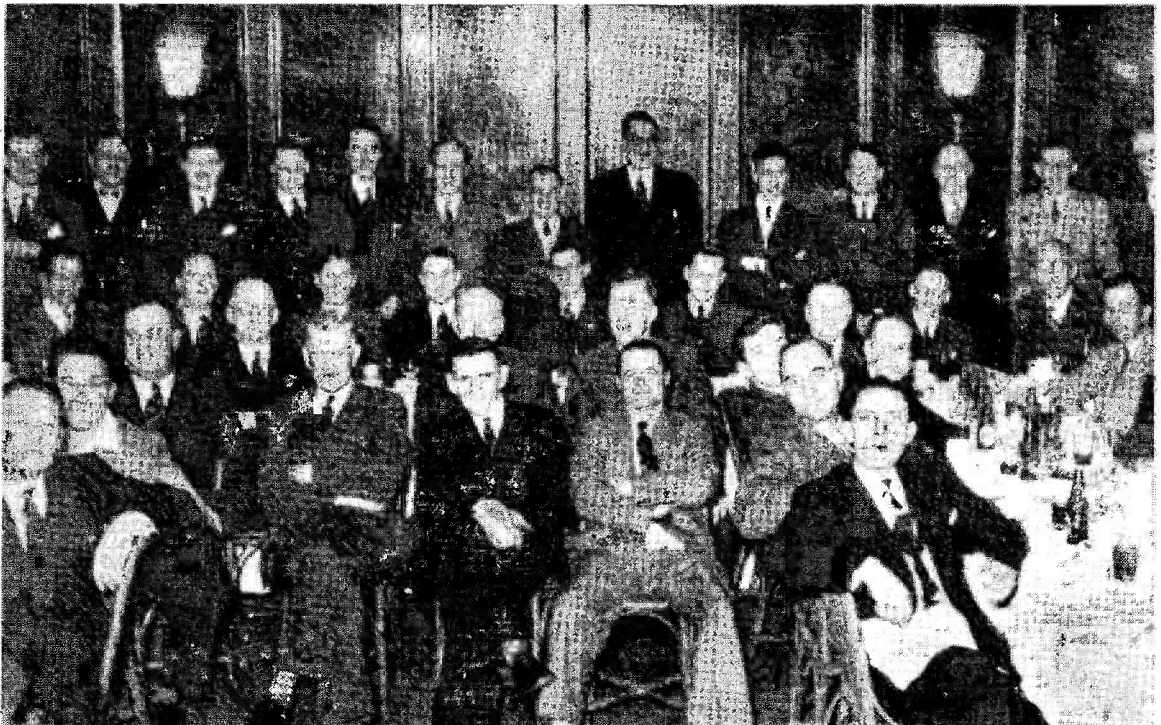

The gathering at the Liverpool and District Short Wave Club's hamfest on November 7, which was attended by representatives from other societies in the area. The total for the dinner was 48, and the menu included "good old Lancashire hot-pot."

at which 48 sat down to supper. Guests of honour were there from Wirral, Chester, Merseyside and West Lancs., and a representative from the new American Club at Burtonwood was also present. The event was reported in the local press—"Radio Hams Take a Night Off."

#### Salisbury & District Short Wave Club

To help the local Scouts to establish a 2.5-metre Scout Net, a demonstration took place at the Club House, operating a two-metre net with stations in the Salisbury and Southampton areas. The Scouts are determined to press matters further, and practical help has been promised by the Club Secretary. Later, Amateur Radio on the LF bands was demonstrated with a tape recorder. Club nights are Tuesdays—7.30 p.m.

#### South-West Essex Radio Club

The AGM was held on December 30, and proposals for the new

### NAMES AND ADDRESSES OF SECRETARIES REPORTING IN THIS ISSUE

ACTON, BRENTFORD AND CHISWICK : R. G. Hinds, 51 Rusthall Avenue, Bedford Park, London, W.4.  
ARMY APPRENTICES' SCHOOL : F. A. Hall, G3GBU, Tels. Dept., A.A.S., Arborfield, Reading.  
BARNSELY : P. Carbutt, 33 Woodstock Road, Barnsley.  
BRADFORD : A. R. Bailey, G3IBN, Scarr Croft, Parkside, Bingley.  
BRIGHTON : R. T. Parsons, 14 Carlyle Avenue, Brighton 7.  
CAMBRIDGE : T. A. T. Davies, G2ALL, Meadow Side, Comberton, Cambs.  
CHESTER : N. Richardson, 1 Victory Villas, Upton Lane, Chester.  
CLAENTON : R. F. E. Bliss, 67 Salisbury Road, Holland on Sea, Essex.  
COVENTRY : K. Lines, G3FOH, 142 Shorncliffe Road, Coventry.  
DARTMOUTH : B. Farleigh, G4RJ, Montpelier, Lower Contour Road, Kingswear, Devon.  
EDINBURGH : D. B. R. Black, 16 Edina Place, Edinburgh.  
GRAFTON : A. W. H. Wennell, G2CJN, 145 Uxendon Hill, Wembly Park, Middx.  
HASTINGS : W. E. Thompson, 8 Coventry Road, St. Leonards on Sea.  
ISLE OF MAN : R. S. Trickey, Aigburth, Sunningdale Drive, Onchan, I.O.M.  
LXWORTH : P. G. Wright, Thurston Road, Great Barton, Bury-St.-Edmunds.  
LIVERPOOL : A. D. H. Looney, 81 Alstonfield Road, Knotty Ash, Liverpool 14.  
MANCHESTER : K. Brockbank, 17 Burleigh Road, Stretford.  
MEDWAY : D. H. Brett, 14 Connaught Road, Luton, Chatham.  
PORTSMOUTH : L. Rooms, G8BU, 51 Locksway Road, Milton, Portsmouth.  
PURLEY : A. Frost, G3FTQ, 18 Beechwood Avenue, Thornton Heath, Surrey.  
SALISBURY : V. G. Page, G3IVP, 32 Feversham Road, Salisbury.  
SLADE : C. N. Smart, 110 Woolmore Road, Birmingham 23.  
SOUTHEND : G. Chapman, B.E.M., 20 Leigh Hill, Leigh on Sea.  
SOUTH WEST ESSEX : B. W. Le Grys, G3GOT, 75 Shaftesbury Road, Romford.  
SURREY (CROYDON) : S. A. Morley, G3FWR, 22 Old Farleigh Road, Selsdon, South Croydon.  
WEST LANCs. : B. J. Whitty, G3HWX, 46 Argo Road, Waterloo, Liverpool 22.

season put forward. Construction of gear for portable operation is to commence forthwith. Morse classes are also to start at an early

date. All interested persons will be welcomed to the regular meetings—Tuesdays at 8 p.m., at 367 Rush Green Road, Romford.

#### FOR THOSE WHO WOULD DARE

The use of FM phone is now permitted on all bands 1.7 mc up, with a maximum deviation of 2.5 kc; the maximum effective modulating frequency is to be 4000 c/s, with any audio frequencies above this attenuated by not less than 26 dB. These particular restrictions only apply in the bands 1.7-21 mc inclusive; from 28 mc up, the deviation and AF limits are not officially defined. Though a 2.5 kc deviation is not very menacing, and as FM techniques are of great practical value in dealing with TVI, this new concession—obtained by the RSGB after prolonged negotiation with the Post Office—is of considerable interest. On the other hand, having regard to the general operating conditions on our HF communications bands, it would seem that FM should properly be restricted, *in practice*, to low-power local working in daylight on the 1.7 mc band only. A useful article on practical FM working appeared in the November 1951 issue of *Short Wave Magazine*; though intended for a ten-metre transmitter, the modulator and FM systems there described are equally applicable to any other band.

#### TELCON TELECOMMUNICATIONS LTD.

Mr. R. R. C. Rankin, O.B.E., A.M.I.E.E., A.R.T.C., a director of Mullard Equipment Ltd., has been appointed a director of Telcon Telecommunications Ltd. (owned jointly by Mullard Ltd. and The Telegraph Construction & Maintenance Co. Ltd.). He succeeds Dr. C. F. Bareford, who has resigned

from the board following his appointment as Chief Superintendent of the Long Range Weapons Establishment at Salisbury and Woomera, South Australia.

#### OBITUARY — W. T. GIBSON

The untimely death occurred at Bridgewater on December 27 of William Thomas Gibson, O.B.E., M.A., B.Sc., M.I.E.E., of Ivy House, Chard, Chief Valve Engineer of Standard Telephones and Cables, Ltd., and Manager of their Ilminster laboratories and factory.

Born in 1899 at Northampton, W. T. Gibson went to Northampton Grammar School, from which he gained an open scholarship in mathematics and physics to Trinity College, Cambridge, in 1917. He took first-class honours in Natural Science in 1921, and after a year of research in the Cavendish Laboratory under Professors J. J. Thomson and Rutherford, he joined the staff of the Western Electric Company (later Standard Telephones and Cables Limited) in 1922 for the purpose of initiating and building up the manufacture of radio valves. He had an intimate knowledge of the history and design of every one of the many hundreds of different types of valve made by the Company since the earliest days. He also set up the valve laboratory of Le Matériel Téléphonique in Paris in 1928, and the Newark, New Jersey Valve Laboratory of Federal Telephone Laboratories in 1932. Mr. Gibson was internationally known for his technical knowledge of radio valves, and throughout the world he was regarded as an outstanding authority in this field.

# "AMATEUR OSCILLOSCOPE"

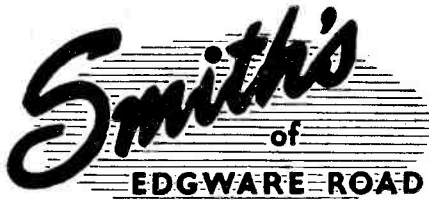

**Can Supply ALL the parts for this self-contained CRO unit**

as described in the November issue of The Short Wave Magazine

Send for List

**H. L. SMITH & CO. LTD.**  
287/9 Edgware Road, London, W.2.

Tel. Paddington 5891. Hours 9 till 6 (Thursday 1 o'clock).  
Near Edgware Road Stations, Metropolitan and Bakerloo

**YOU CAN RELY ON US FOR BRAND NEW CLEAN COMPETITIVE COMPONENTS.**

**VALVE MANUALS.**

**BRIMAR, OSRAM, MULLARD, 5/- each**

**CHASSIS.** 4 Sided, all 2 1/2 in. Deep. 12 in. x 8 in., 9/3; 10 in. x 7 in., 8/3; 8 in. x 6 in., 7/3; 6 in. x 4 in., 5/6. Polished Aluminium, 18 SWG. Prices include post and packing.

**BRIMAR METAL RECTIFIERS.** RMI, 125v. 60m/a., 4/9; RM2, 100m/a., 5/3; RM3, 120m/a., 6/3. Two in Series for 250v. Working. K3/100, 14/8. RM4, 18/-.

**FILAMENT TRANSFORMERS.** 200/240v. to 6.3v. 1.5a., small dimensions, 8/6; 3v. to 30v. at 2a, tapped 3, 4, 5, 6, 8, 9, 10, 12, 18, 20, 24, 30 volts, 24/-; 200/240v. to 6.3v. 3a, 12/6.

**RF EHT COIL 61KV.** Wavewound accurately on Polystyrene former, will operate with EY51 or U25, 39/-; with U25 assembled and wired with anti-corona wire, 67/6. Coil unit for 10-14kv., complete with U25 valve, £3/15/-.

**4Ba BOX SPANNERS,** box of five, 2/-; Terrys 2/4/6Ba Flat, 1/- set.

**NEW T.C.C. CONDENSERS.** 100mfd., 25v., 4/-; 1,000mfd., 6v., 5/6; 3,500mfd., 3v., 6/9; .1mfd., 350v., Metalmite, 2/3; .05mfd., 500v., Metalmite, 2/-; 100mfd., 350v., 13/6; 20mfd., 12v., Picopack, 2/6; 1mfd., 350v., Picopack, 2/6.

**METAL RECTIFIERS.** 1m/a Bridge Westinghouse, 12/6; Half Wave Surplus, 1/-.

**VOLUME CONTROLS.** With switch, 4/3, less, 2/9. Standard long spindles. Midget, 5/6 and 3/6.

**QMAX CHASSIS CUTTERS AND KEYS.** 3/4 in., 12/4; 1/2 in., 13/4; 1/4 in., 13/4; 1/8 in., 16/-; 1/16 in., 16/-; 1/32 in., 17/9; 1/64 in., 17/9; 1/128 in., 19/6; 1/256 in., 36/9. 1 in. square 24/3.

**10in. LOUDSPEAKERS.** Standard 3 Ohm, New, 25/-, 8in., 17/6.

**VALVE CANS.** Three piece for octal valves, 1/6.

**MAINS TRANSFORMERS.** 350-0-350v., 250m/a., 6.3v. at 8a., 5v. at 3a., 6.3v. tapped 2v. at 2a. Standard Primary 50 cycles, 200-240v. 67/6, post 2/6.

**RADIO SERVICING CO.**

Dept. M/O 444 Wandsworth Road, London, S.W.8.  
MACaulay 4155

## SOUTHERN RADIO'S WIRELESS BARGAINS

**TRANSMITTER-RECEIVERS.** No. 18. Mark III. Brand new, complete in original packing cases. Complete with all attachments. Headphones, aeriols, microphones, tappers, etc., and complete set of spares, including duplicate set of valves, £18.

**TRANSRECEIVER No. 18, Mark III.** As above, less attachments. Complete with valves. Guaranteed perfect, £7/10/-, plus 7/6 carriage.

**TRANSMITTER-RECEIVERS (Walkie-Talkie).** Type 38, Mark II. With 5 valves, microphone, headphones, aerial. Less batteries. Fully guaranteed, £4/15/-, post paid.

**RECEIVERS.** Telesonic 4-valve battery portable. Complete with 4 Hivac valves. Contained in metal carrying case. Easily convertible to personal portable. Brand new, £2, including conversion sheet.

**RECEIVERS RI09.** Complete with 8 valves. Vibrator pack for 6 volts. Contained in metal case with built-in speaker, 1.8 to 8.5 megs. Guaranteed, £7/15/-, plus 7/6.

**INDUCTION MOTORS,** shaded pole A.C. 120/240 volts, 2,800 r.p.m. Ideal for recorders, models, etc., 23/-.

**GRAMOPHONE MOTORS.** Garrard induction 100/250 volts A.C., 78 r.p.m. Brand new with turntable, £4/17/6.

**LUBBRA HOLE CUTTERS.** Adjustable 1/2 to 3 1/2 in. .... 5/9

**THROAT MICROPHONES,** with lead and plug ..... 4/6

**PLASTIC MAP CASES,** 14 by 10 1/2 in. .... 5/6

**STAR IDENTIFIERS,** A-N type, in case ..... 5/6

**WESTECTORS,** W x 6, W112 ..... 1/-

**MARCONI aerial filter units** ..... 4/6

**CONTACTOR** Time Switches in case ..... 11/6

**REMOTE CONTACTORS** for use with above ..... 7/6

**RESISTANCES,** 100 assorted values, wire ended ..... 12/6

**CONDENSERS.** 100 assorted tubular and mica ..... 15/-

Full list of Radio Books 2 1/2d.

HUNDREDS OF FURTHER LINES FOR CALLERS

## SOUTHERN RADIO SUPPLY LTD.,

11, LITTLE NEWPORT STREET, LONDON, W.C.2.

GERrard 6653.

### MAINS, TRANSFORMERS, SCREENED, FULLY INTERLEAVED AND IMPREGNATED

Half Shrouded—	
H.S.63. Input 200/250v. Output 250/0/250v. 60 m/a 6.3v. 3 amps, 5v. 2 amps	18/6
H.S.40. Windings as above, 4v. 4 amps, 4v. 2 amps	18/6
H.S.2. Input 200/250v. Output 250/0/250v. 80 m/a	21/-
H.S.30. Input 200/250v. Output 300/0/300v. 80 m/a	21/-
H.S.3. Input 200/250v. Output 350/0/350v. 80 m/a	21/-
H.S.2X. Input 200/250v. Output 250/0/250v. 100 m/a	23/-
H.S.30X. Input 200/250v. Output 300/0/300v. 100 m/a	23/-
Fully Shrouded—	
F.S.2. Input 200/250v. Output 250/0/250v. 80 m/a	23/-
F.S.30. Input 200/250v. Output 300/0/300v. 80 m/a	23/-
F.S.3. Input 200/250v. Output 350/0/350v. 80 m/a	23/-
F.S.2X. Input 200/250v. Output 250/0/250v. 100 m/a	25/9
F.S.30X. Input 200/250v. Output 300/0/300v. 100 m/a	25/9
F.S.3X. Input 200/250v. Output 350/0/350v. 100 m/a	25/9
All above have 6.3-4-0v at 4 amps. 5-4-0v at 2 amps.	
F.S.43. Input 200/250v. Output 425/0/425v. 200 m/a 6.3v. 4 amps C.T. 6.3v. 4 amps C.T. 5v. 3 amps	51/-
H.S.6. Input 200/250v. Output 250/0/250v. 80 m/a 6.3v. 6 amps C.T. 5v. 3 amps. Half-shrouded	29/3
For Receiver R1355.	
Framed, Flying Leads—	
F.30X. Input 200/250v. Output 300/0/300v. 80 m/a, 6.3v. 7 amps 5v. 2 amps	31/9
H.S.150. Input 200/250v. Output 350/0/350v. 150 m/a, 6.3v. 3 amps C.T. 5v. 3 amps. Half-shrouded	30/9
F.S.120. Input 200/250v. Output 350/0/350v. 120 m/a, 6.3v. 2 amps C.T. 6.3v. 2 amps C.T. 5v. 3 amps. Fully shrouded	33/-
F.S.150X. Input 200/250v. Output 350/0/350v. 150 m/a, 6.3v. 2 amps C.T. 6.3v. 2 amps C.T. 5v. 3 amps. Fully shrouded	34/9
<b>FILAMENT TRANSFORMERS</b>	
F5. Input 200/250v. 6.3v. at 10 amps or 5v. 10 amp or 10v. at 5 amp or 12.6v. at 5 amp. Framed Flying Leads	37/9
F.U.6. Input 200/250v. 0-2-4-5-6.3v. at 2 amps	11/-
F.29. Input 200/250v. 0-2-4-5-6.3v. at 4 amps	20/9
Clamped flying leads	
F.6. Input 200/250v. 6.3v. 2 amps	9/-
F.12. Input 200/250v. 12.6v. Tapped at 6.3v. 3 amps	18/6
F.24. Input 200/250v. 24v. Tapped at 12v. 3 amps	26/-
C.W.O. (add 1/3 in the £ for carriage).	

**H. ASHWORTH (Dept. S.W.)**  
676 Great Horton Road, Bradford, Yorks.

## Motor Car Radio Bargains

Latest Ferranti AR15 High Power Car Radio, 12 volt only. Medium and Long Wave. Guaranteed Brand New Condition. Complete with Control Head and leads. Unfortunately we are without the flexible drives for these sets which we have purchased from the estate of a late dealer. List Price is no less than £37/10. Five only on offer at the amazingly low price of £15 each. Guaranteed absolutely perfect.

Current model Ekco CR32. Six pre-selected stations, 12 volt. A compact and superlative car radio. List price approximately £24. Complete in every respect. Condition indistinguishable from Brand New. Three only. A gift at 14 gns. each

PHILCO KS26T, 12 volt. Brand New and unused in original carton. List Price approximately £28. First £20 secures.

SATISFACTION GUARANTEED

## H.P. RADIO SERVICES LTD

Britain's Leading Radio Mail Order House

55 County Road, Walton, Liverpool 4

Tel.: Aintree 1445.

Established 1935

## SAMSONS

### SURPLUS STORES

**NIFE BATTERIES**, crates of 5 cells, giving 6 volts at 58 A.H., size of wood crate, 15in. x 5½in. x 1½in., in perfect condition, £6/17/6, carriage 7/6. Limited number only.  
Single cells, 2.4v., 18/20 A.H. Size, 4½in. x 6in. x 3½in., 17/6, post and packing, 1/6.

**34FT. AMERICAN SURPLUS TELESCOPIC STEEL AERIAL MASTS**, length closed 6ft. 6in., dia. of first section, 1½in., dia. of top section, ¾in., complete with base, guys, insulated assembly and metal pegs, £6/10/0., carriage 7/6.  
As above, but 20ft. long, £4/15/0., carriage 7/6.

**S.T.C. FIELD HAND TELEPHONE SET**. Complete Unit, built in metal container which can be easily held in one hand, operates from 4½ volt flat battery. Buzzer calling device, will work efficiently up to 15 miles, on twin cable or 10 miles earth return. Suitable for Offices, Farms, Building sites, Estates, etc., 65/- each instrument. P.P. 2/-.

**TELEPHONE CABLE D.3 SINGLE**. 1 mile drums, 55/-, carr. 5/-.

**TELEPHONE CABLE TWIN D.3 TWISTED**. 500 yard drums. Brand New, 65/-, carr. 5/-.

**PAINTON ATTENUATORS**. 5000 ohm in 75 ohm steps. ½in. spindle, 10/6, P.P. 1/-.

**HEAVY DUTY TRANSFORMERS**. Prim 200/230, Sec. 10 volts, 15 amps, 32/6. P.P. 2/6. Prim 200/240 volts, Sec. 6.3 volts, 15 amps, 25/-, P.P. 2/-.

169/171 EDGWARE ROAD

LONDON, W.2. Tel: PAD. 7851

125 Tottenham Court Road, W.1. Tel: EUS. 4982

All orders and enquiries to our Edgware Rd branch please. Open All Day Saturday at the Edgware Road Branch.

## FIXED CONDENSERS OF ALL TYPES

Both Paper and Mica

Large stocks available for immediate delivery. Your specific enquiries, giving full details, will receive immediate attention. Our prices show substantial savings.

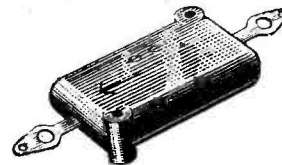
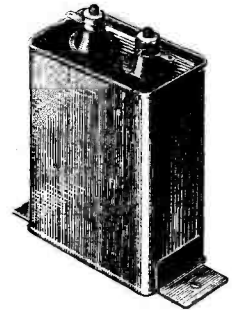

## CLAUDE LYONS LTD.

ELECTRICAL & RADIO LABORATORY APPARATUS

180 Tottenham Court Rd., London, W.1. Tel: MUS 3025

## Good Investments

**VARIABLE WIRE WOUND RESISTANCES**. 60 ohms, 1 amp, 12/6. 5 ohms, 10 amps., 35/-.

370 ohms, 1 amp., double with geared movement, 37/6. 300 ohms, ½ amp., 15/-.

1.2 ohms, 15 amps., 12/6.  
**NIFE BATTERIES**. 1.2 volts, 45 amp. hr. cells, in first-class condition, 25/- per cell; or crate of 10 cells, £10/10/-; crate of 9 cells, £9/9/-, carr. extra 2/- per cell or 10/- per crate.

**WAVEMETERS**. R.C.A. crystal calibrated T.E. 149 accuracy, 0.005 per cent, 200 Kc/s to 30 Mc/s, new, complete with spares, £20 each. Few complete, less spares, £18, carr. extra.

**HEADPHONES**, ex W.D., as new with headband, cord and plug, 10/- per pair, post 9d. Single L.R. phone with cord and plug, 3/6, post 6d.

**D.C. DYNAMOS** for battery charging or lighting, 14/32 volts, 9 amps., by leading Makers. 2,500 r.p.m., shunt wound, 70/-, carr. 5/-.

**MORSE KEYS**. A.M. type, precision made on bakelite base, heavy insulated knob, 3/6, post 9d.

**BUZZERS**. The tiny Townsend Wavemeter Buzzer, Plat. contacts, sweet high note, used on Govt. Wavemeters, 5/-, post 6d.

**ROTARY CONVERTERS**. D.C./A.C. 24 volts input 230 volts A.C. 5v. cy. S.P. 100 watts output, £6/10/0. 110 volts D.C. to 230 volts A.C. 50 cy. S.P. 200 watts, £12/10/0. Starter 40/- extra. Several sizes in stock, write for list.

**CONDENSERS**. 2 mfd., fixed, new surplus, sealed type, 250 volts, 7/6 dozen, post 9d. 1 -+ 1 mfd., 6/- dozen, post 9d. 4-gang variable ceramic insulation, .0005 mfd., 4/6, post 9d. Variable Short Wave air spaced 16m. mfd., trolitul insulation, ball bearings, 5/-, post 6d.

**B.C.221 Frequency Meters**, Battery Model 120 K.C. to 20 mc/s, accuracy 0.005%. Complete with all charts and crystal, £35.

## ELECTRADIX RADIOS

Dept. B.

214 Queenstown Road, Battersea, London, S.W.8

Telephone: MACaulay 2159

## CLEARANCE OFFER!

Of special interest to Experimenters, Service Engineers, Dealers, and all Radio Constructors.



**100 RADIO CONDENSERS**, all brand new Ex-Govt. Stock and comprising Electrolytic, Paper, Mica, and Ceramic types.

Capacities 2.P.F. to 8 mfd (at least 18 + 8 + 8 mfd at 500 volt working included in each selection).

**NOTE**—We cannot guarantee any one particular type of condenser to be included, but we do guarantee that the normal retail price for the parcel to be not less than **£3.10.0d.**

Our special price for the 100 Condensers

**15/-** (Post and Packing 1/6d.)

**WALTON'S WIRELESS STORES**  
48, Stafford Street - Wolverhampton

Send S.A.E. and 3d. in stamps for our latest list.

## LYONS RADIO

LIMITED

3, Goldhawk Rd., Shepherds Bush, London W.12

Telephone: SHEPHERDS BUSH 1729

**AMERICAN HEADSETS.** Complete with adjustable double head-band and cord. Weight only 10 ozs., type HS16A (Low resist.). Brand new and unused, PRICE, 14/6.

**WAVEMETERS, TYPE W.1239.** Frequency range, 39-51 Mc/s. Rectifier type, employing 4 valves (VR92, 6J5, V1103, 6X5). The tuning control is fitted with a Muirhead slow-motion drive, and all components and construction are of the highest quality. A built-in power pack enables the wavemeter to be operated direct from 200/250v., 50 cps. A.C. Mains. Assembled in copper lined, wooden instrument cases, 15½ in. x 10½ in. x 9 in. Condition is as new and unused, supplied in makers transit case. These wavemeters are a really top grade job and will make a useful addition to any test room or laboratory at a price much less than the original cost of the components alone. PRICE £3/19/6, carriage, 6/6.

**CERAMIC ROTARY SWITCHES.** 3 wafer, each wafer, single pole 5 way, single hole fixing. PRICE, 4/3 each, or 3 for 11/9, post free.

**SUPPLY UNITS LP. 1.** These units are fitted with wire-wound resistors, smoothing condensers, a rotary converter unit for 12v. D.C. input, and 230v. D.C. output at 30 mA., and other useful components. Built on a neat two deck chassis and fitting into a case, overall size, 11 x 8½ x 4½ ins. Circuit diagram is provided. Might be slightly damaged externally, but internal condition is good and rotary converter tested before despatch. PRICE, 10/-, carriage, 3/6.

**SPECIAL CLEARANCE LINES.** Electrolytics 2 mfd., 400v. wkg., wire ends, 3 for 4/-. Selenium Rectifiers, ½ wave 30v., 30 mA., 3 for 5/-. Voltage Regulators, CV71, S.B.C. fitting, Strk. V, 230. Optrg., V. 160, Reg. V. 12, Optrg., 1, 2-4 mA., 3 for 5/6. Valves, VU111, 3 for 10/6. Valves, 6F8, 7/6 each. All these items as new and unused.

**FLUXMETERS No. 1.** Designed to calibrate the fields of magnets and to determine polarity. Range, 500 to 4,000 Gauss. The meter, together with probe unit, are housed in a polished, wooden instrument case, with hinged lid containing instructions. Size, 12½ x 9 x 6 ins. Condition is as new and unused. PRICE, £6/10/0, post paid, U.K.

**MOTOR GENERATORS, TYPE 7.** Air Min. ref., 5U/3286. Input, 22-29v. D.C. Output, 80v. A.C. at 1,600 cycles, 240 VA. at unity power factor. Complete with carbon pile, voltage regulator, and filter unit mounted on the same base plate. Overall size approx. 9½ x 8½ x 5 ins., and weighs 15½ lbs. In new, unused condition. PRICE, £5/10/0.

## UNIVERSAL ELECTRONICS

We wish to buy

### ★ TEST EQUIPMENT

By:—AVO, MARCONI, E.M.I. SIGNAL GENERATORS. TF517. TF144G. TF390G, etc.

### ★ AMERICAN TEST SETS

TS3. TS33. TS45. TS69. TS148. TSX-4SE. TS174/U. TS175. TS47AP. TS34AP. IE19. TS13. BC221. LM10.

### ★ RECEIVERS

RCA AR88-LF or D. Hallicrafters SX28. S27. S27C. S27CA. U.S.A. R.34. APR4 or APR5 receivers or tuning units. TN16, 17, 18, 19, complete or any parts. BC348. BC312. BC342. HT11A. TCS12-6. Collins 75A or 35V4TX, and any other good communication receivers.

### ★ TRANSMITTERS

BC610. ET4336. Speech Amplifiers. Tuning units VFO, etc.

### ★ ANY VHF GEAR

Klystrons 723/AB and 707B and CV129. Magnetrons 2K33. 1B24 and any 1 and 3 cm equipment.

At Your Price

(provided it is a fair one), we guarantee to pay you

Cash by Return

Shop hours: 9.30 a.m. to 6 p.m. Thursday to 1 p.m.

Write, Call or Phone: GERrard 8410 (Day)  
OUR ONLY ADDRESS (Dept. S). MEAdway 3145 (Night)

**27 LISLE STREET,**  
LEICESTER SQUARE, LONDON. WC2

Close to Leicester Square tube station

## BENSON'S BETTER BARGAINS

**EDDYSTONE** Inductances Tx., types "P" and "Q", ceramic, on 5 pin base, 3/6. **TEST SETS:** Admly. types:—S.E.2, 160/230mcs. 230v. 50c. input and hi-ci, also Valves: 2/6J5, 2/EA50, 1/EC52, 1/6X5, 1/CV172. 500 micro A meter. A precision job, new, with leads and fittings, in metal-lined case, 60/- (carr. 8/6). **Rxs. P60.** 530/600mcs. Valves:—4/EF54, 1/6J5, 1/6Q7, 2/EA50, 2/NR88, on plated brass chassis, in met. case. IFT's wound on poly. formers, 60/- (carr. 8/6). **OSC. UNITS.** 98/152mcs. Valves:—1/6J5, 1/P61, in small grey metal case, with bat. compartments, 50/- (carr. 5/-). **10B2** with 5 bat. valves and 2 Muirhead diodes, 25/- (carr. 3/6). **R122A.** Bat. s'het, 3 w'bands. Less valves, store soiled, 25/- (carr. 5/-). **Coils** wound with ¼ in. dia. copper tube, size 7 in. x 5½ in. dia., 17 turns, tapped, 7/6; smaller dia. 4/-. **Trans.** Admly. rating, 275/0/275v., 120ma., 6.3v. twice, and 5v., 230v., 50c. input, 17/6. **AC37** Collaro Gram. motors, 110/250v., A.C. ½ in. dia. spindle, 30/-. **OSC. UNIT,** 12A Modulated, 700, 1150, 1700c. 30/41mcs. Valves, 1/RK34, 1/CV51, 2/6J5 and 8 xtals, 12v. D.C. input (to dynamotor), £4 (carr. 10/-). **L.U.51.** 8-way turret coil assy., S.V., 3½ in. dia. plated case, 5/6; **MONITOR R.F.** with 2/EF50, 1/EA50, 4½ in. cube, 15/-; **INDICATORS T.233** with VCR97, 3 each EF50, SP61, EB34, 2/EA50, ex. cond., 65/- (carr. 5/-); **Power Unit 599,** 100/250v. 50c. input. Outputs: **D.C.** 300v. 40ma. and 12v. 3A., in met. case, with fuse, indicator and input socket, 50/- (carr. 5/-); **IND. 186,** with 3/EF50, 1/5Z4G, 1/EA50, 1/Y63 and 350v. D.C. power pack, 50c. input, 50/- (carr. 5/-); **WAVEFORM GENERATORS,** with 2/ECC33, 1/EF50, 1/EA50, 25/-; **R161.** VHF chassis with 2/EF54, 1/CV66, 1/EC52, 22/6; **R159, R61,** with one each, EF50, SP61, CV66, EA50, 16/6; **RF UNITS,** type 24, 22/6, 25 25/-, 27 47/6; **R1355,** 35/- (carr. 6/-); **AUTO-TRANS.,** 50c. 0-104-230v., 312VA. new, 17/6; **IFT's,** canned, new, 10/13mcs., 1/6, 7mcs. (R1355), 1/6, Diode type 2/-; 10mcs. for G21G WB Couplers, 2/-. Coilformers 2in. x ½ in., 4 for 1/-; **5,000 Meters,** from 500UA to 50A, 20v. to 2,500v. Full range of BVA and Surplus valves.

List and enquiries, S.A.E., please.

Terms: C.W.O. CARR. PAID U.K., over 25/-

**W. A. BENSON**

308 Rathbone Rd., Liverpool, 13. STO 1604

**We will pay £250/0/0 each for Receiver R54-APR4 complete with 5 Tuning Units. Box Number 1187**  
 SHORT WAVE MAGAZINE LTD.  
 55 VICTORIA STREET, S.W.I.

**SMALL ADVERTISEMENTS**

9d. per word, minimum charge 12/-. No series discount; all charges payable with order. Insertions of radio interest only accepted. Add 25% for Bold Face (Heavy Type). No responsibility accepted for errors. Replies to Box Numbers should be addressed to The Short Wave Magazine, 55 Victoria Street, S.W.I.

**TRADE**

**METAL WORK:** All types cabinets, chassis, racks, etc., to your own specifications.—Philpott's Metal Works, Ltd. (G4Bl), Chapman Street, Loughborough, Leics.

**QSL's and LOGS by MINERVA.** The best there are.—Samples from Minerva Press, 46 Queen's Road, Brentwood, Essex.

**WANTED: RCA 4331 Transmitters.** — P.C.A. Radio, Cambridge Grove, Hammersmith, W.6. (Telephone: *Riverside 3279*).

**QSL CARDS & LOG BOOKS. APPROVED G.P.O. SAMPLES FREE.** — ATKINSON BROS., PRINTERS, ELLAND, YORKS.

**WANTED: NEW VALVES — 6K8, 6V6, 5Z4, FW4/500, KT33C, KT61, 6Q7, etc., etc. PROMPT CASH.**—Wm. CARVIS, 103 NORTH STREET, LEEDS, 7.

**SCR 536 Handie Talkie** (also known as BC-611 Transmitter Receiver) spare parts wanted, including cases, top and bottom lids, microphones, ear-phones, crystals and coils.—Details to Box 1176. *Short Wave Magazine*, 55 Victoria Street, London, S.W.I.

**WANTED: Two B2 Receivers.** State price and condition. — Reply P.O. Box 184, KITWE, Northern Rhodesia.

**FIVE-YEAR** accumulation of clean Amer. and Brit. resistance/condenser boards offered at clearance price: 2lb. parcel 2/6, post 1/-. Other parcels as free list (S.A.E.). VALVES: 931A, 35/-; 725A, 25/-; 836, 10/-; 6K7G, LH63, H63, 4/6; VR65, VR91, 3/6; VR92, 6H6, 2/-; 954, 1/6. Post 4d.—THE RADIO SERVICES, LR. BULLINGHAM, HEREFORD.

**VALVES WANTED: TYPES 805, 807, 813, 832, 100TH, 250TH, 723A/B, 2K33, 2J36, ETC. HIGHEST PRICES PAID INSTANTLY.—DETAILS TO: MESSRS. PYPE-HAYES RADIO, 606 KINGSBURY ROAD, BIRMINGHAM 24. (PHONE: ERDINGTON 942).**

**WANTED: R.C.A. Speech Amplifiers,** type MI-11220 J or K, and aerial tuning units BC939A coils and tuning units for BC610 transmitters.—Offers stating quantity and price to P.C.A. Radio, The Arches, Cambridge Grove, W.6.

**WANTED: BC610 Hallicrafters, ET4336 transmitters, SX28's, AR88's,** receivers and spare parts for above. Best prices.—P.C.A. Radio. The Arches, Cambridge Grove, W.6.

**45% EACH** paid for new boxed 813's; 20/- for new boxed TZ40's.—Box 1206, *Short Wave Magazine*, 55 Victoria Street, London, S.W.I.

**45% EACH** paid for valves, Type 813; 25/- each 832; 20/- each 931A, etc. Also wanted urgently: BC610 Transmitters, etc. Highest prices paid.—Details to Box 1202, *Short Wave Magazine*, 55 Victoria Street, London, S.W.I.

**“Go to it”**  
 To become a speedy and highly efficient W/T Operator there is no better way than **—the CANDLER way**

The Candler system of Morse Code Training was devised for those who desire to enter or have entered the commercial side of telegraphy, the Services or who take a real interest in Amateur Radio work.

The Special Course covers all the Code training necessary to pass the G.P.O. test for an Amateur Transmitting Licence.

The Junior Course is a complete Code Course for the Beginner who desires to secure the G.P.O. Certificate in which he is interested.

The Advanced Course is for those with a consistent sending and receiving speed of not less than 15 w.p.m. who desire to improve their speed and accuracy in code work.



Touch-Typing Course. A series of interesting and easily followed lessons which enable one to record messages at high speeds.

Courses supplied on Cash or Monthly Payment Terms.

You are invited to send for a copy of the CANDLER "BOOK OF FACTS," it gives full details of the above training.

**THE CANDLER SYSTEM CO.**

(55SW) 52b, ABINGDON ROAD, LONDON, W.8.

Candler System Company, Denver, Colorado, U.S.A.

**G4GZ's BARGAINS**

**SPECIAL VALVE OFFER!** 6SH7 Metal tubes, slightly soiled ex equipment, 4 for 9/6, 27/6 doz., all guaranteed.

OZ4 ... 4/-	6C4 ... 6/6	6Q7GT 11/6	15D2 6/6
1G6GT 6/6	6C5GT 6/6	6R7GT 8/-	866A 17/6
1LN5GT 6/-	6F7 ... 10/6	6S7M 8/6	8012 12/6
1LD5GT 6/-	6F8G 7/6	6SN7GT 10/6	9002 6/6
1R5 ... 8/6	6F6G 8/6	6SQ7M 10/6	9003 5/6
1S5 ... 8/6	6F6M 9/6	6U5G 8/6	VS110A 6/6
1T4 ... 8/6	6K8B 12/6	6V6G ... 9/6	W77 ... 7/6
2A3 ... 8/6	6K8M 15/-	6X5GT 8/6	MU12/14 9/6
3A4 ... 8/6	6J5GT 6/6	7A3 (Pen) 12/6	DL510 9/6
3V4 ... 9/6	6J5M 7/6	A4 12/6	25L6GT 9/6
3D6 ... 3/6	6J6 ... 10/6	12A7 9/6	6Y7G ... 7/6
5Z4M 9/6	6J7M 8/6	12AU7 9/6	6Z4G ... 7/6
5Z4G 9/6	6J7G ... 6/6	12AX7 9/6	6SC7M 12/6
6AG5 6/6	6N7GT 6/6	12SQ7GT 12/6	808 45/-
6BG6G 12/6	6N7M 7/6	7C5 ... 9/-	100th 75/-

**NEW BOXED MC METERS.** 3 1/2 in. rd. fl. mtg. (2 1/2 in. dial) 0-500m/a., 17/6. 0-15v. A.C. (MI cal. at 50 cps.), 12/6. 2 in. rd. 0-500 microamps (scaled 0-10v.), 17/6. 2 in. sq. fl. mtg., 0-200m/a. 17/6. 0-300v., 12/6. 0-.5amps. RF T/C. 8/6. 0-3amps. RF T/C. 8/6.

**MISCELLANEOUS.** Double circ. jack pl. and sock., 2/6 pr. 24/- doz. Mica Bypass .002 mfd. 5Kv. wkg., 4/- ea. Mains Trans. Input, 230v. 220, 260, 300v., 80 m/a (HWV), 5v. 5amps output. 8/6.

**INTERESTED IN TAPE RECORDING?** THE NEW, 3 Motor Lane Deck, £16/10/0. THE NEW, Qual. tape, £16/16/0. Truvox, 22 Gns. Wearite, £35. Simon TR2B, with xtal mike and tape, £60. Grundig, with cond. mike and tape, 75 Gns. Tape-master Heads, 3,000 ohm at I K. R/P, 45/-, Erase, 39/6. Senior ditto, 5,000 ohm R/P, 45/-, Erase, 45/-, Lane, 45Kcs. osc. coils, 10/-, Tapemaster, 45 Kc/s. osc. units with 6V6, 45/-, Scotch Boy, MCI-111, Emitape H60/A, 35/-, 1200ft. reel, 21/- 600ft. Spare reels, 4/6, plastic, 4/-, G.E.C. jointing fluid, 4/9 bottle. Acos, Rothermel, Lustraphone mikes in stock. BSR, FP.10 motors, clock or anticlock, 38/- ea.

IT'S WORTH REMEMBERING THAT

ALL GOODS ARE DESPATCHED BY RETURN OF POST

Please add post/packing.

**J. T. ANGLIN**

160 CLEETHORPE ROAD, GRIMSBY, Lincs. Tel. 56315.

## WE PAY TOP PRICES

FOR

### American Surplus Electronic Equipment

Any quantity or condition

### LOOK at THESE EXAMPLES

For equipment in good condition

Receiver R54/APR4 with tuning units TN16, 17, 18, 19, 54 (or bought separately) ...	£125
Receiver AR88D ... ..	£55
Frequency Meter TS 175 ... ..	£80
TX/RX RT18/ARCI ... ..	£50
Test Set I-100 ... ..	£50

### We pay similar Remarkable Prices for

Receivers APR1, APR4, APR5, R5/ARN7, BC348, BC342, BC312, R78/APS15, APN9

Frequency Meters BC221, TS174/U

Test Sets TS3, TS13, TS14, TS17, TS19, TS33, TS34, TS45, TS47, TS59, TS69, TS102, TS118, IE19, TS148

Transmitters ART13, SCR522, TRCI, TCS6-12-13.

Synchronisers BC1148 Modulators BC1142

Phone us immediately, transfer charge

★ NOTE OUR NEW ADDRESS

## ALTHAM RADIO CO.

JERSEY HOUSE, JERSEY STREET, MANCHESTER 4  
TELEPHONE: CENTRAL 7834/5/6

## ADCOLA (Regd. Trade Mark) SOLDERING INSTRUMENTS



Reg. Design No. 860302

British, U.S. and Foreign Patents

Supplied for all volt ranges from 6/7v-230/250v. Meets every requirement for radio assembly, maintenance, telecommunications, etc. High Temperature. Quick Heating, Low Consumption, Light Weight

3/16in.	Dia.	Bit Standard Model
1/4in.	Dia.	Bit Standard Model
3/16in.	Dia.	Detachable Bit Type

Sole Manufacturers: ADCOLA PRODUCTS LTD.

Sales Offices and Works: Cranmer Court, Clapham High Street,  
London, S.W.4. (MACaulay 4272)

### THE WORLDS GREATEST BOOKSHOP

# FOYLES

★ ★ FOR BOOKS ★ ★

All new Books available on day of publication.  
Secondhand and rare Books on every subject.  
Large Technical dept.Subscriptions taken for British, American and  
Continental radio magazines.

119-125 CHARING CROSS RD., LONDON, W.C.2

Gerard 5660 (16 lines) ▼ Open 9-6 (inc. Sats.)

Nearest Station: Tottenham Court Road.

### SITUATIONS WANTED

EXPERIENCED RADIO ENGINEER, City & Guilds and other certs. Fully equipped with test gear and facilities at home, being now disabled, desires experimental or development work in radio or allied fields. Intricate assembly work undertaken. Open to suggestions.—Jim Slater (G3EKF), 79 Newhouse Road, Blackpool. (Tel.: Marton 794).

### SITUATIONS VACANT

£50 A YEAR TAX FREE BOUNTY is paid to electronic artificers joining special section of the Army Emergency Reserve. Men with City & Guilds Final Certificate in Telecommunications and Radio and up-to-date experience in current electronic engineering practice will be needed to maintain electronic instruments controlling fire of anti-aircraft guns which protect vital centres of Great Britain should war break out. By joining the AER a man will not only be playing a vital part in the defence of this country, but will also know his exact role in the event of war. Minimum rank Staff Sergeant. Minimum of 15 days' training per year with Regular Army rates of pay in addition to bounty.—Further details from DDME, Anti-Aircraft Command, Glenthorn, Stanmore, Middlesex, or the War Office (AG.10/EA9), London, S.W.1.

### READERS' ADVERTISEMENTS

3d. per word, min. charge 5/-, payable with order. Box Numbers 1/6 extra. Replies to Box Numbers should be addressed to The Short Wave Magazine, 55 Victoria Street, S.W.1.

NEW RCA5527 Iconoscope Tube wanted.—G4GZ, 233 Welholme Road, Grimsby.

FOR SALE: Army 12 set, £12; HRO coils, all ranges, 30/- each. WANTED: 813's, 808's, also AR88, S27, BC221. Exchanges or cash adjustment. Will collect.—Box 1165, *Short Wave Magazine*, 55 Victoria Street, London, S.W.1.

G.E.C. BRT-400 Receiver, 150 kc - 33 mc; perfect condition; £85 or consider part exchange AR88D similar condition. Type 1131 Tx, modified Amateur bands, details on request. Wilcox Gay M/O unmodified, AVO valve tester in carrying case, Rx-BC733D, complete unmodified. Offers, please.—Box 1195, *Short Wave Magazine*, 55 Victoria Street, London, S.W.1.

WANTED: Marconi Magnetic Detector; D.E. and Multiple Tuners; 101, 106, 107 and 112 Receivers; Fleming Valves; Coherers; and other early wireless gear, valves and literature.—FRANKLIN WINGARD, Rock Island, Illinois, U.S.A.

SALE: 30 *R.S.G.B. Bulletin*, 1950 onwards; 26 *Short Wave Magazine*, 1950 onwards; £2. *ARRL Handbook*, unused, 12/6. Ship's c/s book with supplements, 15/-, plus postage. 150 feet new 300 ohm twin feeder cable, 15/- (buyer collects).—17 Park View, Morden, Surrey.

WANTED: T.C.S. TXM, unmodified preferred; will pay good price, plus carriage and packing, for unit in good condition. — Nelson, Sherwood, Douglas, Lo.MAN.

EDDYSTONE "750" (unwanted), latest model just delivered; guaranteed under 10 hours' use; £60, plus carriage.—110 Church Lane, Handsworth, Birmingham.

BC221 FOR SALE, with manual; frequency meter and dial index perfect; battery box slightly soiled; £12 or offer. Demonstration, evenings.—Nash, 193 Sudbury Heights Avenue, Greenford, Middlesex.



**SMALL ADVERTISEMENTS, READERS—continued**

**EXCHANGE:** Advance Audio Generator H1 and Connoisseur Two-Speed Motor, with coil pick-up, generator and motor as new, for Amateur Equipment, or sell £14 each.—Thompson, 29 Sandringham Avenue, Benton, Newcastle-on-Tyne.

**A TRANSMITTER** with Sonar VFO, either xtal or VFO; designed to cover 80, 40, 20, 15, 10 metres; CW and phone monitor incorporated. Valves: 6SK7 oscillator, 6SL7 speech amplifier, 6AK6FM modulator, 6V6 buffer-amp., 6AG7 1st multiplier, 6L6 2nd multiplier; VR150 voltage regulator for VFO; 573 rectifier; 6E5 deviation and RF indicator, with 813 final. Output of final 10 and 20 metres. Matches National 183D Receiver, 2 power supplies and xtal mic.; £50 or offer. **WANTED:** UHF frequency meter APN4 or 9 indicator. Also complete SCR522 and TS148.—Box No. 1194, *Short Wave Magazine*, 55 Victoria Street, London, S.W.1 (or Phone: HAM 3627).

**EDDYSTONE** S.640, £18; RF25, £1; RF27, £42/-; Viewmaster Filament Trf., £1; Line Trf., 12/6. **WANTED:** BC221, AR88, 12in. Viewmaster, AV07.—Box 1193, *Short Wave Magazine*, 55 Victoria Street, London, S.W.1.

**£25** ONO. B2 Tx/Rx; all coils, crystal, aerial, phones, key, instruction manual; A1 condition.—Box No. 1196, *Short Wave Magazine*, 55 Victoria Street, London, S.W.1.

**AR 77**, complete with handbook. Needs realigning, otherwise OK. Best offer over £20 secures. Buyer collects.—Lyll, 73 Montague Road, Cambridge.

**FOR SALE:** Tx 150w. phone or Cw, for 10/20 metres; PT15's in final, for 20/40/80/160 mtrs.; pair of 807's in final, VFO and relay controlled, relay power pack supplied, aerial coupler, D104 crystal mike and key. Modulator 6J5, 6J7, 6L6's driving 807's in Class B. Complete in 5 chassis (19in. x 10in. x 6in.) over 3ft. in all; also spare valves free. The lot, £20. Also another Tx, HK54's for 10/15/20 mtrs.; 150w. phone or CW; with modulator; £20. BC453 (Q'fiver) with AC power pack, £4. DuMont Double Beam 'scope, £15 o.n.o.?—G3CSN, 4 Lowden Road, Herne Hill, London, S.E.24.

**AR 77E**, good condition, with maker's manual, £30. —G3GUF, 117 Erith Road, Upper Belvedere, Kent (or phone ERITH 2606, after 6 p.m.)

**SALE:** *Short Wave Magazine*, June 1949-August 1950 incl., October 1950 and February 1951-December 1952 incl. All as new; 25/- or offer.—Goddard, Dovedale, Birmingham Road, Warwick.

**EDDYSTONE** 750 for sale; latest model. This Rx has been little used and is guaranteed in first-class condition. £42 10s. 0d.—Mortimer, 51 Townhead Road, Dore, Sheffield. (TEL: 70210).

**EXCHANGE** Williamson Amplifier (Premier), unused, for AV0 7. **WANTED:** Home-constructed 'scope; must be cheap. Letters answered.—Box No. 1198, *Short Wave Magazine*, 55 Victoria Street, London, S.W.1.

**HAM** going QRT. For disposal: BC348 230v., as new; wavemeter, meters, oscilloscope, valves, transmitter (807PA). S.A.E. for details.—Box 1197, *Short Wave Magazine*, 55 Victoria Street, London, S.W.1.

**SCR 522** Transmitter, metered, with AC. P/Pack, both mounted standard rack panels; £7 10s. 0d. Wanted for AR77: Bandsread dial and flywheel, S-meter and cabinet.—Ingram, 49 Lime Tree Avenue, Broadway, Worcestershire.

**FREE THIS VALUABLE BOOK**

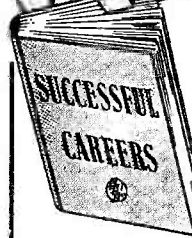

which details the wide range of Engineering and Commercial courses of modern training offered by E.M.I. Institutes—the only Postal College which is part of a world-wide Industrial Organisation.

Over 150 Courses including training for :-

P.M.G. Certificates, City and Guilds Grouped Certificates in Telecommunications; A.M.Brit.I.R.E. Examination, Radio Amateur's Licence, Radio & Television Servicing Certificates, General Radio and Television Courses, Radar, Sound Recording, etc. Also Courses in all other branches of Engineering.

**E.M.I.**

Institutes associated with MARCONIPHONE COLUMBIA

**H.M.V.**

(His Master's Voice) ETC.

COURSES FROM

**£1**

PER MONTH

**NEW! HOME EXPERIMENTAL KITS NOW AVAILABLE**

**POST NOW**

Please send, without obligation, FREE book. E.M.I. Institutes, Dept. 14K, 43 Grove Park Road, Chiswick, London, W.4.

Subject(s) of interest

Name .....

Address .....

IC. 10EK

**RADIO G200 ANNOUNCES**

**VALVES** at 2/9: RK34/2C34, DI, EA50, 7193, 954, 2X2/879; at 4/6: 6H6, 12H6; at 5/6: 12SH7, 4D1; at 6/9: SP41, SP61, 6J7gtg, 6SG7, 6U5g, 12SC7, 12SK7, EC52, EF50, EF54, U78, 12SL7; at 7/9: 7C5, 7H7, 7R7, 7S7, 7Y4, 1619; at 8/6: IS4, IRS, IT4, N18, DH77, W77, 6AC7, KT44, KT61, 6K7gtg, 25L6gt, 6AG5, 50L6gt, D77, 6V6g, 6V6gt, 6K6gt, KL35, 6C6, 6D6, 6X5gt; at 9/6: 6BG6g, 6CH6, X78, 6N7gt, 6B8gtm, 12AX7, KT61, 6G6G, KT81, 2A3, 6B4g; at 10/6: 6K8gt, 6K8g, 12K8gt, 5U4g, 5Z4g; at 12/6: 5R4gy, CV2, 8012, 801, 5Z3; at 3/6: NGT1, GDT4c.

**ARTHUR HOILE**

55 UNION STREET, MAIDSTONE, KENT.

Phone 2812

★ ACCLAIMED BY SHORT-WAVE LISTENERS THROUGHOUT THE WORLD — Write today for free catalogue and literature. Enclose stamp for postage. Kits complete or assembled receiver.

THE INCOMPARABLE

**“GLOBE-KING”**

**SINGLE VALVE S.W. RECEIVER**

WORLD-WIDE RANGE 11-100 metres with absolute NOISE-FREE BACKGROUND.

Sole Distributors. Home and Overseas Sales

**JOHNSONS (RADIO)**

**46 FRIAR STREET, WORCESTER**

## SMALL ADVERTISEMENTS. READERS—continued

**WANTED:** Power supply unit for Hammarlund Super Pro Rx. — G3AHU, 14 Angell Road, Brixton, London, S.W.9.

**FOR SALE:** Ham Gear; TVI-proof Tx, HRO Mod. Valves, components. Reasonable prices. S.A.E. for list.—42 Derwent Road, Flixton, Manchester.

**“CR 100 CHASSIS** and case with dial and selectivity switch.” Will Totton phone again regarding above?—27 Highbury Avenue, Salisbury 4305.

**HRO SENIOR** for sale; just overhauled; good condition. Coils: 0.9-2.05 mc; 1.7-4 and 3.7-7.3 mc, band-spread. Carriage paid. £21.—G3ESV, Upholland College, Wigan, Lancs.

**BC 1147A** American 13-valve commun. Rx 1-30 mc; new in 1950. Built-in Power pack and speaker; spare set new valves. Repair Handbook. Perfect condition; very little used; £20 or offer.—17 Holders Hill Drive, Hendon, N.W.4. (Phone: HENDON 2592 after 6 p.m.).

**SALE:** Mains Transformers, suitable rewinding. Modified W1191 with stabilised power pack, £4 10s. 0d. S.A.E. complete list. **WANTED:** R1294 Receivers and Bush TV22.—G3EJR, 40 The Oval, Mirehouse, Whitehaven.

**Q MAX, Q510X, 180°** Bandsread only on 160/80/40/20/15/10 metres with Panadaptor, £80. TCS12 with 12v. rotary Power Pack, £20. or near offers? Inspection/delivery near London. **WANTED:** 680X.—Box 1199, *Short Wave Magazine*, 55 Victoria Street, London, S.W.1.

**SALE:** R107 Receiver, good condition, £12; W1191 wavemeter with spare valves, £5. No. 48 Set built into wooden case, with spare valves, £7 10s. 0d. Also quantity of other parts. — 43 Richmond Hill, Luton, Beds.

**TRANSMITTER ART/13** with cables, converter, spare valves, book, £50; or exchange AR88D, SX28A or similar. — G3AWY, 293 Milton Road, Southsea.

**SALE:** BC221, AC Power Pack, wooden case, £20, s.o.o.?—Richard, 20 New Church Road, Hove, Sussex.

**BC 348** will exchange for two Wilcox Gay VFO, unmodified. BC221 (new) exchange for commercial tape recorder, or sell.—Box 1200, *Short Wave Magazine*, 55 Victoria Street, London, S.W.1.

**BC 348** p/p, £12; CNY1, £12; 1154, 25/-; Sky Challenger, £7; 6-watt amplifier, £6; 5-metre Tx p/p, £5; 5-metre Rx, £5; Scope, £5; Q5'er, 25/-; Morse Oscillator, 20/-. Speakers, meters, chargers, etc.; buyer collects. — G3HR, Balmoral Chapel Lane, New Longton, Preston. (Phone: Longton 2357).

**CR 100, S-meter**, grey crackle finish, mint condition, £20. B2 Tx, orig. p/p, perfect, £10.—17 Barrowby Lane, Austhorpe, Leeds.

**I-130-A VHF Signal Generator**, Taylor 45B Valve Tester wanted; state condition and price. 829B's, guaranteed, 58/- each. Supreme U.S.A. 504-A Tube Tester, combined multi-range meter, as new, £13. — Box 1201, *Short Wave Magazine*, 55 Victoria Street, London, S.W.1.

**HRO SENIOR** for sale, in excellent condition; complete with S-meter, xtal, metered power pack, 9 coils, 50 kc-30 mc, including B.S. 10, 20, 40 metres; spare set valves; £30. **WANTED:** First-class Converter for 2 metres, preferably with power pack.—Box 1203, *Short Wave Magazine*, 55 Victoria Street, London, S.W.1.

Presenting one of our range of

**CABINETS**

**BLACK RIPPLE FINISH. MILD STEEL CONSTRUCTION. 16 SWG ALUMINIUM FRONT PANEL. FOUR RUBBER MOUNTING FEET.**

Length 9½ in. Width 7 in. Depth 7 in.

**18 SWG ALUMINIUM CHASSIS, 8 in. x 6 in. x 2½ in.**  
(Folded, Fitted, and Rivetted Ends)

**27/- COMPLETE** : Less Chassis 18/6 P/Packing 1/-  
Trade Supplied. Latest Catalogue on application

**BURN ENGINEERING**

Produce Exchange Buildings, 8 Victoria Street, Liverpool 2

**Urgently Required**

**COMMUNICATIONS RXs. HALLICRAFTERS SX. 28s A.R.88s, A.R.77s, EDDYSTONE 640s, 740, 750s**, all types purchased.

**TEST EQUIPMENT.** AVO 8s, Model 7s, Valve Testers, Sig Gens, Bridges, etc. MC. R.l.s. Tape Recorders, Transmitters. We can arrange part exchange for any equipment we have in stock. Established 15 years. Call, write or send, phone Ger. 4638. Hours of business 10 a.m. to 6 p.m., open all day Saturdays. One min. from Leicester Square Tube Station.

**MILLER'S RADIO 38A NEWPORT COURT LONDON, W.C.2.**

**BRASS, COPPER, BRONZE, ALUMINIUM, LIGHT ALLOYS**  
IN ROD, BAR, SHEET, TUBE, STRIP, WIRE

3000 STANDARD STOCK SIZES

**H. ROLLET & CO., LTD.**

6, CHESHAM PLACE, LONDON S.W.1.

SLOane 3463

**Works: 36 ROSEBERY AVENUE, LONDON, E.C.1.**  
BRANCHES AT LIVERPOOL, MANCHESTER, BIRMINGHAM

"No Quantity too Small"

**VALVE BARGAINS**

**GUARANTEED:** 6AK5, 9/6 each, 3 for 27/-; 6KB, 9/6 each, 3 for 26/-; 6AG5, 6/6 each, 3 for 16/6; 807, 8/6 each, 3 for 24/6; 807 (American) 9/6; 6L7M, 6/6 each, 3 for 16/6; 6N7M, 6/6 each, 3 for 16/6; 6SF5, 7/6 each, 3 for 21/-; EA50, 2/- each, 3 for 5/-; 6J5G, 6/6 each, 813, 55/-; 829, 75/-; 801, 4/-; 2050, 2051, 8/6; 3A4, 4/-; 6BR7, 12/6; 1B5BT, 12/6; CV286, CV287, (B7G Stabilisers) 12/6; EC91, 9/6; EAC91, 7/6; GS16, GS46, (P.E. Cells), 22/6; IT4, 7/6; 1L4, 6/6; 3Q4, 8/6; S130, 6/6; 6SA7, 8/6; 12SG7, 4/-; 100TH, 45/-; 6J6, 12AT7, 10/6. Minimum Postage 9d. Orders over £2 post free. Send for full valve list.

**ELECTROLYTICS**, can type 8 + 8 mfd. 450v., 8 + 16 mfd. 450v., 32 mfd. 350v., Standard, and 16 + 16 mfd., 500v., 32 mfd. 450v., large, all types 3/9 each, minimum postage 1/3, or 6 for £1 post free.

**ELECTRAD RADIO**

69, HIGH STREET, BELFAST, N.1

# RADIO AMATEUR CALL BOOK

## FOREIGN SECTION

Now Available, the WINTER EDITION (Foreign Section) of the Radio Amateur Call Book — that is, the Call Book proper, less only the American station listings, containing the latest and most up-to-date lists of the World's Amateur Transmitters, exclusive of the U.S.A. Shown alphabetically by prefix, country, call sign, name and address.

Zone location and QSL Bureau addresses are also given.

PRICE **10/-** Post Free

IMMEDIATE DELIVERY

### OTHER PUBLICATIONS FOR IMMEDIATE DELIVERY

	<i>Post free.</i>		<i>Post free.</i>		<i>Post free.</i>
RADIO HANDBOOK		A COURSE IN RADIO		HANDY KINKS AND SHORT	
12th Edition .....	25/11	FUNDAMENTALS .....	4/10	CUTS .....	4/3
13th Edition .....	49/6	THE RADIO AMATEUR'S		UNUSUAL PATENTED	
ANTENNA MANUAL .....	27/11	LICENCE MANUAL .....	4/10	CIRCUITS .....	4/3
ANTENNA HANDBOOK .....	11/7	HOW TO BECOME A RADIO		RADIO QUESTIONS AND	
HINTS AND KINKS .....	11/5	AMATEUR .....	4/10	ANSWERS .....	4/3
HOW TO LISTEN TO THE		LEARNING THE RADIOTELE-		ADVANCED SERVICE	
WORLD .....	1/11	GRAPH CODE .....	2/8	TECHNIQUE .....	4/3
HAM'S INTERPRETER .....	5/-	SGR PLUS CONVERSION		AMPLIFIERS BUILDERS	
POST-WAR COMMUNICATION		MANUAL		GUIDE .....	4/3
RECEIVER MANUAL .....	28/5	In two vols. Vol. I 21/5		PRACTICAL DISC RECORDING	6/4
WORLD RADIO HANDBOOK,		Vol. II 21/5		THE CATHODE RAY	
1953 Edition .....	9/-	WORLD RADIO VALVE		OSCILLOSCOPE .....	6/5
RADIO AMATEUR CALL		HANDBOOK .....	11/10	PUBLIC ADDRESS GUIDE .....	6/4
BOOK		VADE MECUM .....	27/11	HIGH FIDELITY TECHNIQUES	8/5
Complete Edition .....	25/-			MODEL CONTROL BY RADIO	8/5
				BASIC RADIO COURSE .....	18/7
				RADIO TUBE FUNDAMENTALS	8/4

### MAGAZINES BY SUBSCRIPTION

	One Year
Radio Electronics .....	33/-
Popular Mechanics .....	32/-
Radio Electronic	
Engineering .....	56/-
Service .....	24/-
F.M. and Television .....	32/-
Electronics .....	160/-
Popular Science .....	32/-
Proc. I.R.E. ....	152/-
RCA Review .....	20/-
Tele-Tech .....	40/-
Television .....	48/-
Television Engineering .....	32/-
CQ .....	29/-
Audio Engineering .....	29/-
Radio and Television News	36/-
QST .....	36/-

## SHORT WAVE MAGAZINE

(PUBLICATIONS DEPARTMENT)

55 VICTORIA STREET, LONDON, S.W.1. ABBEY 5341

# HENRY'S

5 Harrow Road  
Paddington : W.2

PADddington 1008/9 and 0401

OPEN MONDAY to SATURDAY 9-5.30 THURS. 10'clock SAT. 6p.m.

## INDICATOR UNIT TYPE 182A.

This unit contains VCR517 Cathode Ray 6in. Tube, complete with Mumetal screen, 3 EF50, 4 SP61 and 1 5U4G valves, 9 wire-wound volume controls and quantity of Resistors and Condensers. Suitable either for basis of Television (full picture guaranteed) or Oscilloscope. Offered BRAND NEW (less relay) in original packing case at 79/6. Plus 7/6 carriage.

SPECIAL NOTE.—The VCR 517 Tube has proved to be far superior to the VCR 97 Tube (call for demonstration).

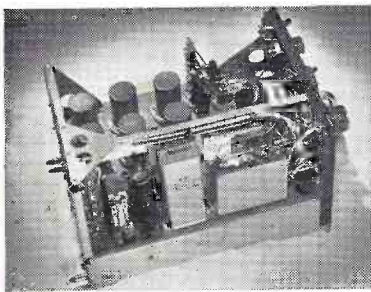
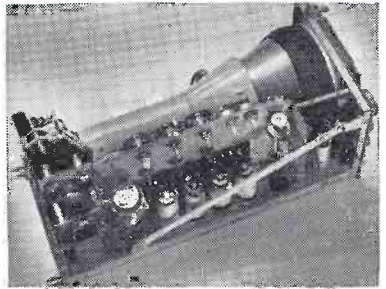

**STROBE UNITS.** Brand New, in sealed cartons, these contain 6 EF50s, 5 EA50s, 1 SP61, a host of condensers, resistors, transformers, chokes, relays, switches, 7 pots and 5 smoothing condensers. Size 18in. x 8 1/2in. x 7 1/2in. Only 67/6, plus 5/- carriage.

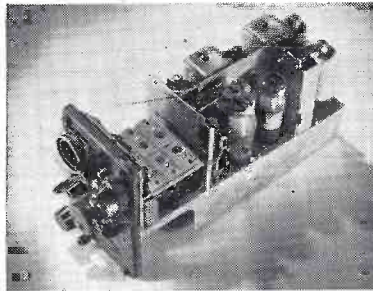

**WALKIE-TALKIE TYPE "46"** (case removed) complete with 6 valves, 2VP23, HL23, DD, QP25, TP25 and ATP4, aerial rods, I.F. trans., 1.6 mc/s. mike trans. in new condition, but less transmitting components and coils removed by M.O.S., 35/-, carr. paid. (Less valves, 12/6).

### — A COMBINED SIGNAL TRACER AND AUDIO OSCILLATOR —

An easy-to-build unit that can be used for I.F. and Audio signal tracing, without any switching or tuning, including variable output oscillator, for amplifier checking. Highly sensitive, responds to signals picked up from an ordinary receiving aerial. The circuit is that of a high-gain 2-stage, resistance-coupled audio frequency amplifier, employing 3 miniature 1.4 valves, with a 3in. speaker in the output of the Power Amplifier Stage. An added advantage being that this Unit is "All-Dry" it can be used with safety on A.C. or A.C./D.C. mains and Battery sets. The complete Kit with portable cabinet (size 6in. x 7in. x 6in.) and battery weighs only 4 lbs. We shall be pleased to supply a complete Kit for the construction of the above, right down to the last nut and bolt, including 2-IT4 and 1-S4 Valves, 3in. Speaker and Portable case and All-Dry Battery for 44/19/6. Concise instructions and circuits supplied. If preferred, circuit and instructions only can be supplied for 1/6. If required this Unit will be assembled and tested for an extra charge of 15/-. This is a highly efficient instrument and a MUST for every radio man.

**BOWTHORPE CONTINUITY METER.** Dual scale 0-500 ohms and 100-200,000 ohms moving coil operated from 4 1/2-volt internal battery. Size 6in. x 3in. x 4in. Original price £8 19s. Our price, brand new, £4 4s.

H.T. RECTIFIERS	
S.T.C. 125 v. 60 mA.	4 6
S.T.C. 125 v. 100 mA.	5 0
S.T.C. 125 v. 125 mA.	6 0
S.T.C. 250 v. 250 mA.	18 0

### ELECTROLYTIC CONDENSERS

MIDGET TYPE WIRE-ENDED WITH SLEEVE	METAL TUBULAR WITH SLEEVES
8 mfd. 450 v. wkg.	2/6
16 mfd. 450 v. wkg.	3/6
8 x 8 mfd. 450 v. wkg.	4/-
16 x 8 mfd. 450 v. wkg.	5/-
16 x 16 mfd. 450 v. wkg.	5/-

SMALL STANDARD METAL CASED	
16 x 8 mfd. 350 v. wkg.	3/6
32 x 32 mfd. 275 v. wkg.	5/-
32 x 32 mfd. 450 v. wkg.	7/6
60 x 40 mfd. 350 v. wkg.	5/-
8 mfd. 500 v. wkg. B.I. Block	2/6

**MOVING COIL METERS** (Brand New) —  
0.5 mA, square panel mounting, 2in. scale 7 6  
0.50 mA, square panel mounting, 2in. scale 7 6  
0.40 v. square panel mounting, 2in. scale 7 6  
0.20 amps round panel mounting, 2in. scale 7 6  
0.300 v. square panel mounting, 2 1/2in. scale 12 6  
0.40/120 mA double reading round 2in. scale 12 6  
2 1/2in. round flush mfg., drilled flange —  
Range 0/750 v. 200 ohms per v. each £1 2 6  
Range 0/1500 v. 250 ohms per v. each £1 2 6  
Range 0/3000 v. 200 ohms per v. each £1 5 0  
0-1 m/a desk type, 2 1/2in. scale, £1 12 6

**WESTINGHOUSE 14D/972, 250 v. 25 mA** 6 6

**RECEIVER UNIT TYPE 159.** Size 8in. x 6 1/2in. x 4 1/2in., containing VR91, VR92, CV66, VR65 and 24 v. selector switch. New condition, 15/-.

**G.E.C. METER RECTIFIER, 1 mA.** 11 6

**RECEIVER RI355.** As specified for "inexpensive Television." Complete with 8 valves VR65 and 1 each 5U4G, VU120, VR92. Only 55/-, carriage 7/6. Brand new in original packing case. Slightly soiled, 35/-, carr. 7/6.  
RF24, 25/-; RF25, 25/-; RF26, 59/6; RF27, 59/6.

L.T. RECTIFIERS	
6 v. 1 amp. G.E.C.	4 0
12 v. 2 1/2 amp. Westinghouse	12 6
12 v. 4 amp. S.T.C.	17 6
12 v. 8 amp. S.T.C.	£1 12 6

S.T.C. RECTIFIERS E.H.T.	
K3/25 650 v. 1 mA.	4 7
K3/40 1,000 v. 1 mA.	6 0
K3/100 8,500 v. 1 mA	14 8
K3/200 10,500 v. 1 mA.	£1 6 0

**WEARITE.** 705 coil pack, 3 wave-band, £1/17/10.

**PYE 45 Mc/s STRIP.** Special purchase of M.O.S. Type 35B3 Units. Size 15in. x 8in. x 2in. Complete with 45 mc/s Pye Strip, 12 valves, 10 EF50, EB34 and EA50, volume controls and hosts of Resistors and Condensers. Sound and vision can be incorporated on this chassis with minimum space. New condition. Modification data supplied. Price £5, carriage paid.

**No. 38 "WALKIE - TALKIE" TRANS. RECEIVER,** complete with throat mike, phones, Junction Box and aerial rods in canvas bag. Freq. range 7.4 to 9 Mc/s. All units are as new and tested before dispatch. As supplied to Overseas police forces. £4/19/6, carr. 2/6.

**PUSH-PULL OUTPUT TRANSFORMER,** U.S.A. potted type primary, 10,000 ohms sec., 2 ohms, 8 ohm, 15 watts, 12/6.

**ACRIO (VCR139A),** Brand New and Boxed, 35/-, Base 2/-, postage and Packing 3/-  
**BLUE CRACKLE CABINET.** Size, 8 1/2in. x 6 1/2in. x 1 1/2in. Suitable for the above or 3BP1. Complete with drilled chassis. Suitable for scope or midget T.V. Set., 25/-.

VCR97 Guaranteed Full Picture	40/-	carr. 5/-
VCR517	40/-	5/-
3BP1	25/-	3/-
VCR139A (ACRIO) Guar. Full Picture	35/-	3/-

**TRUVOX TAPE DECK, MARK III.** Now available from stock. £23 2/0, plus 10/- carriage. Send for descriptive leaflet.

**WEARITE MAINS TRANSFORMER.** Input, 110/250 volts. Output 325 0-325 80 M/A., 6v., 2.5 amp., 5v., 2 amp., 2 1/2 amp., 1 1/2 amp.

**PLESSEY MIDGET TYPE 200/250 volts.** Output, 230-0-230, 50 M/A., 6v., 2.6 amps, 12/6, p/p, 1/-.

**WEARITE I.F.T. 501A and 502.** 465 kc/s, 10/- pair, p/p, 1/-.

**PLESSEY I.F.T. 465 kc/s,** permeability, 8/6 pair, p/p, 1/-.

2 Gang .0005 Condensers Midget	5/-
2 Gang .0005 Condensers Midget with Trimmers	6/6
2 Gang .0005 Condensers with 4 way Push Button Assembly	8/6
Postage and Packing 1/- extra.	

P.M. SPEAKERS (Inc. Tax)	
Plessey 2 1/2" with Trans.	15/-
Celestion 5" Less Trans.	16/-
Rola 5" "	12/6
Plessey 5" "	12/6
Rola 10" with Trans.	30/-
Goodmans 10" "	30/-
Electrona 10" "	25/-
Plessey 6 1/2" Less Trans.	15/-
Postage & Packing 1/- extra.	

**EXCEPTIONAL VALVE OFFER**  
Ten EF50 Brand New (Ex-Units) 55/- Set  
6K8G, 6K7G, 6Q7G, 5Z4G, 6V6G, (or KT61) 42/6 ..  
1R5, 1S5, 1T4, 1S4, or (3S4 or 3V4) 32/6 ..  
TP25, HL23/DD, VP23, PEN25 (or QP25) 27/6 ..  
6K8G, 6K7G, 6Q7G, 25A6G, 25Z5 or 25Z6 42/6 ..  
12K8GT, 12K7GT, 12Q7GT, 35Z4GT 35L6GT or 50L6GT 42/6 ..  
12SA7GT, 12SK7GT, 12SQ7GT, 35Z-4GT, 35L6GT, or 50L6GT 42/6 ..  
We have over 10,000 New Valves in Stock, B.V.A. and Ex-Government. Let us have your requirements.