

2/6

The
SHORT WAVE
Magazine

VOL. X

OCTOBER, 1952

NUMBER 8

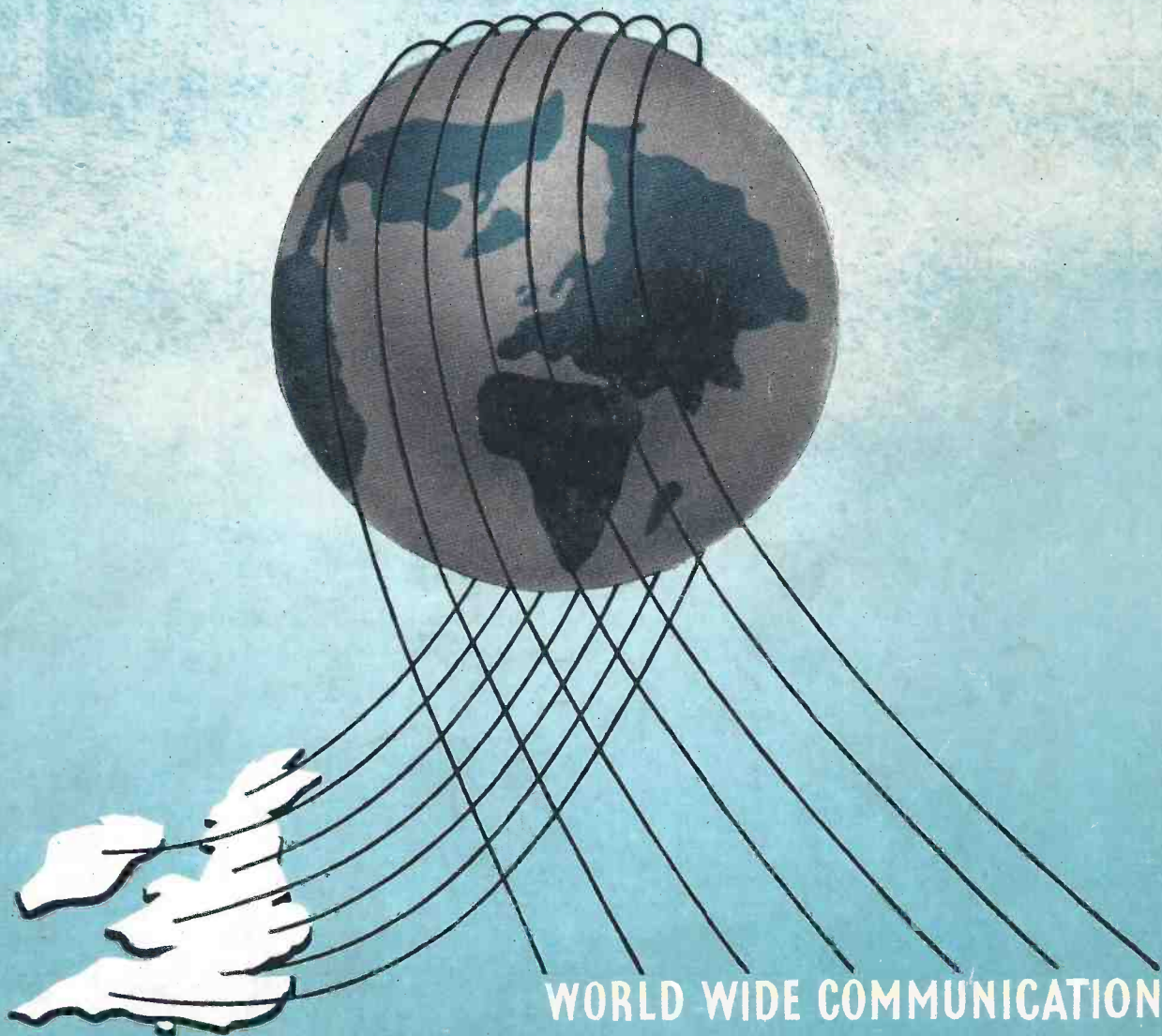

WORLD WIDE COMMUNICATION

H. WHITAKER G3SJ

10 YORKSHIRE STREET, BURNLEY Phone 4924

BARGAIN PARCELS: We have a vast accumulation of component parts, held in too small a quantity to advertise, which we are once again making up into 20/- parcels. They are of primary interest to the transmitting ham, and those who have taken advantage of our previous offers, need no reminding of the outstanding value.

WODEN, POWER AMPLIFIERS. Standard 5ft. rack and panel, completely enclosed with hinged back. Two models, 30 watt and 60 watt of audio. Switched 3 band radio, mike, gram. 30 watt has monitor speaker. Recessed gram. desk, but less motor. Mike input for 15 ohm m/c mike. Ideal for music while you work, or large public address amplifiers for up to a dozen speakers. Brand new and unused, offered at a fraction of original cost, complete in every detail with all valves, 230 v. input, 60 watt, £75, 30 watt £60. Carr. forward or collect Burnley. 10in. speakers suitable for the above, 17/6. Plessey record changers, 3 speed dual switched stylus, mixed 10in. and 12in. at 78 revs., mixed ditto at 33½ revs. or 45 revs. List £23 13s., offered at £16.

CONNOISSEUR LIGHT WEIGHT PICK-UP. Connoisseur standard light weight pick-up complete with input transformer, brand new and boxed. List price £4/10/5 inc. tax. To clear £1/6/10 each. Available in quantity for export.

TRANSFORMERS AND CHOKES. Immediate delivery from stock at pre-increase prices. UMI 54/-, UM2 73/6 (UM3 sold out, new stock at 110/-), UM4 215/-, Mains, DTM 11 39/-, DTM12 48/6, RMS11 30/-, RMS12 40/-, DTM15 75/-, DTM 17 109/6, Drivers (DT1 sold out, new price 40/-), DT2 39/6, DT3 34/-, Filament DTF12 2.5v 10 amp, 38/6, DTF14 5v 4amp, 31/6, DTF17 7½v 5amp 37/6, DTF18 5v 3amp 6.3v 4 amp 38/6, DTF20 10v 10amp 59/6, Chokes, DCS14 12hy 350 mills 102/-, DCS20 20hy 350 mills DCS17 20hy 60 mills 28/8, DCS18 20hy 150 mills 41/6, PCS13 5/25hy 350/50 mills 58/6. All the above Woden are pre-increase prices except where stated. New Ex-Govt. Primaries, all 230v, 2,000/0/2,000 at 450 mills, porcelain stand offs, 9 x 9 x 9, 5in. core, carr. paid, £6. Chokes suitable for the above, 15 h_y at 400 mills, DC res. 90 ohms, 6 x 7 x 9, 2½in. core, 35/-. Carr. paid. G.E.C. swinging 5/15hy 400 mills, 20/-. Potted cast cases 10hy at 200 mills, DC res. 150 ohms, 3½ x 3½ x 4½, 12/6. G.E.C. Filament 4v. at 5 amp., 8/-. Ditto 4v. 5 amp., 4v. 5 amp., 4v. 5 amp., at 17/6. The following range are all completely screened and potted in cast metal cases, primary 230v. 275/0/275 30 mills 4v. 2½a., 4v. 5a., 15/-, 265/0/265, 120 mills, 6.3v. 7 amp., 4v. 2½ amp., 20/-, 445/0/445 at 200 mills, 25/-. 265/0/265 30 mills, 3,300 v. at 5 mills, 4v. 10a., 4v. 2½a., 4v. 1a., at 20/-. 365/0/365 120 mills 4v. 2½a., 6.3v., 42a., 20/-. 1,540v. at 1.75 mills, 4v. 1a., 2.05v., 2a., 15/-. Filament 4v. 3½a., 4v. 6.9a., 14/-. Heavy duty 50v. tapped at 5v. 36 amp, at £3. Modulation. Parmeko. 450 watt. PP805s to pair 8/3s, 50/-. The following are by Parmeko or Gresham Transformer Co., and represent the highest standard of British production, all are brand new and offered at a fraction of to-day's cost. Primaries of transformers are all 200/250v. 50cy. 2,000/0/2,000 at 200 mills, or 4,000 tapped at 3,500/3,000/2,500/2,000, 9½ x 9½ x 8, weight 70lb. at 75/-, 2,000/0/2,000 at 500 mills or 4,000 tapped at 3,000/2,000, 13 x 10 x 7½, weight 100lb. £6. 5,800v. at 800 mills tapped 2,000/3,000/3,500/4,000, 16½ x 13 x 12, weight 180lb., £6. L.F. choke for the above 10hy at 800 mills, 8½ x 6 x 7, weight 50lb. 70/-. 19,500/0/19,500 at 6.1 KV_a., oil filled, 6in. stand offs, 230v. single phase. On built-in rollers.

Weight 6 cwt. For collection only, £12. Also a good selection of 440v. 3 phase similar to the above from 3,000/0/3,000/0/3,000, with filament windings. Full details on request. Auto, 200 to 250v./115v. 5KV_a. in external metal cases, 20 x 16 x 11, £6. Weight 180lb. Ditto 230/110 400 watt, 35/-. Plate 5,850v. at 445 mills, c/t. 13 x 10½ x 7½, weight 85lb., £5. L.T. and Filament, all 200/250v. primaries, Output 22v. at 30 amp., 7 x 7 x 7, weight 35lb., £2, ditto 22v. at 15 amp., c/t., 30/-. Ditto 4v. at 14.5 amp., 4 times. 13Kv. test. 10½ x 11 x 8½, 70/-. Ditto 4v. 4.5a., 4v. 11.5a., 4v. 29a., 11 x 11 x 8½, weight 35lb., £3. Ditto 8v. 10a., 4v. 10a., 2v. 10a., 1v. 10a., 5v. 10a. twice, 6½ x 5½ x 5½, weight 15lb, 30/-. Primary current limiting chokes. A.C. amps., 1.6. Tapped to produce voltage drops of 80, 120 and 150, 4 x 4 x 3½, weight 4lb., 10/- each. Similar to the above for 400v. primaries, 10/-.

CRYSTALS. 1,000 kc. Valpey, Biley or Somerset, standard ¾in. pin spacing, 20/-. R.C.A. 100kc sub-standards 20/-. Full range of Western I.F. freqs. 450, 465 kc, etc., 12/6 each. Amateur and Commercial bands. G3 SJ Xtals are precision lapped, and acid etched to final freq. Are available in either Ft 243 holders, ¾in. British, ¾in. U.S.A. or ¾in. P.5 holders. Your own choice of frequency 2 Mc to 10 Mc inclusive. We will despatch to within 1 Kc of your chosen frequency at 15/- each, accurately calibrated with freq. clearly marked. Slight extra charges for decimal point freqs. We also undertake the calibration or re-grinding of your own crystals at extremely reasonable and nominal charges.

ZENITH: Variac transformer. Input 230v, for voltage stabilization 200/240v at 7½ amp., £3, carriage paid.

B.C. 453. Q. FIVER. Brand new in perfect condition, £4.

1155 RX. Brand new and unused in perfect condition, £12 10s.

POWER UNITS TYPE 45 and 46. The complete power supply for the 1,154 Tx, £10 per pair. Carr. paid.

VALVE HOLDERS. Ceramic octal with flanges, 1/-, 10/- doz., ditto 807, 1/3, 12/- doz. British 5 and 7 pin ceramic, 4/- doz. to clear. Amphenol B7G, 7d., 6/- doz. Clix B7G complete with screen and valve retaining spring, 2/-. B8G amphenol, 6d.

STATION LOG BOOKS. A quality production. 300 pages cream laid paper, section sewn, opens completely flat like a ledger. Stout heavy cover. 18/- post free. Sample leaves on request.

RESISTORS. New and unused Erie and Dubilier, Sample 100 Assorted as follows, 20 ½-watt, 25 ½-watt, 20 1-watt insulated, 20 1-watt Standard, 10 2-watt, 5 5-watt, with a range of at least 30 standard values between 100 ohm and 6.8 Meg. 14/- post free.

SPEAKERS. Take advantage of our Tax free stocks whilst they last, P.M. Types, 6½in. 12/6, 8in. 15/-, 10in. 18/6.

FEEDERS. Henley 80 ohm twin line, 6d. per yard. 80 ohm ½in. co-ax. 1/2 yard. Telcon 300 ohm line 9d. per yard, RG52 1/- yard. Ex-Air Ministry 10in. insulators 6/- per doz. Johnson conical feed through insulators 4in. for windows, etc., 9d. each. Large U.S.A. egg type insulator for up to ¾in. cable, 4/6 each. Telcon K35b circular 300 ohm at 1/6 per yard.

ANTENNA RELAYS. Price Bros., Maryland, Double double throw, suitable for 600 ohm line. 28v. DC. Piston cylinder action, with self-centring contacts. On heavy ceramic stand-offs. Will handle up to 1 Kw. of R.F., 25/- each.

BLEEDERS. 1K to 75K, 85/120 Watts, most values available at 2/- each. All the above are standard vicreous 8 to 12in.



Produced in response to a demand for a high sensitivity version of the world-famous Universal AvoMeter, this model incorporates the traditional design features of its predecessors, so highly valued for simplicity of operation and compact portability.

It has a sensitivity of 20,000 ohms per volt on all D.C. voltage ranges and 1,000 ohms per volt on A.C. ranges from 100 V. upwards. A decibel scale is provided for audio frequency tests. In addition, a press button has been incorporated which reverses the direction of current through the moving coil, and thus obviates the inconvenience of changing over test leads when the current direction reverses. It also simplifies the testing of potentials both positive and negative about a common reference point.

A wide range of resistance measurements can be made using internal batteries, separate zero adjustment being provided for each range.

It is of importance to note that this model incorporates the "AVO" automatic cutout for protection against inadvertent overloads.

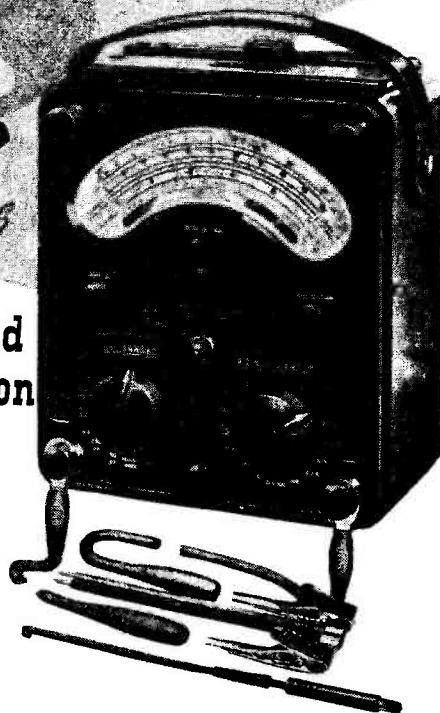

Size : 8½ in. x 7½ in. x 4½ in.
Weight : 6½ lbs. (including leads)

£23 : 10 : 0

The following accessories are available to widen still further the ranges of the instrument:- A Resistance Range Extension Unit to extend the limits of measurement from 0.025 ohm to 200 MΩ, a 10kV D.C. multiplier and a number of A.C. current transformers.

D.C. Voltage	D.C. Current	A.C. Voltage	A.C. Current	RESISTANCE
2.5V.	50μA.	2.5V.	100mA.	First indication 0.5Ω
10V.	250μA.	10V.	1A.	Maximum indication 20MΩ.
25V.	1mA.	25V.	2.5A.	0-2,000Ω } using internal batteries.
100V.	10mA.	100V.	10A.	0-200,000Ω } using external batteries.
250V.	100mA.	250V.	—	0-20MΩ } using external batteries.
1,000V.	1A.	1,000V.	—	
2,500V.	10A.	2,500V.	—	0-200MΩ }

The efficiency of your
equipment depends on
the solder that you use

Just a single faulty connection may interfere seriously with reception or transmission. Make sure that every joint is sound by using Ersin Multicore—the 3-core solder that ensures complete freedom from “dry” or H.R. joints.



This is the Handyman (Size 2) Carton, specially made for use in the home. Contains enough solder for 200 average joints. Price 6d.



Illustrated above is the Size 1 carton for Service Engineers and maintenance use. Price 5/-. Both sizes are obtainable at most radio and electrical shops.

**MULTICORE SOLDERS LTD., MULTICORE WORKS, MAYLANDS AVENUE,
HEMEL HEMPSTEAD, HERTS. Telephone: BOXMOOR 3636 (3 lines)**

Lyons Radio Ltd.

3 GOLDHAWK ROAD (Dept. MS),
SHEPHERDS BUSH, LONDON, W.12

Telephone: Shepherds Bush 1729

POWER UNITS TYPE 138. This is a rotary converter unit for 6v. DC. input and having a fully smoothed and filtered DC. output of 300v. at 100mA. Originally designed to operate the Receivers types R.1132 and R.1392. The whole is housed in a metal cabinet for rack mounting 19 x 10½ x 10½ ins., with instrument handles each side of front panel and small removable cover giving access to input and output fuses. The rotary converter itself (Type 57) occupies a space of only 8½ x 5 x 5 ins., so that if required the power unit could be made up very much reduced in size. Condition, apart from internal metal work, which might be slightly store soiled, is new and unused and in good working order. PRICE 55/-. carriage 6/6.

L.T. TRANSFORMERS. Primary 230v. 50 cps. Secondary 4v. at 10A. twice. 5½ x 5½ x 3½ ins. PRICE 19/6, post 2/-.

SUB-STANDARD VARIABLE CONDENSERS. Fitted in glass containers with heavy brass frame. Calibrated 0.05 jars to 0.95 jars. Approx. size 7 x 7 x 6 ins. Front panel fitted with brass terminals and shorting switch. In good condition, PRICE 25/- or less glass container 15/-. Carriage 3/6.

FLUXMETERS No. 1. Designed to calibrate the fields of magnets and to determine polarity. The complete range of the meter is divided into three which cover 500/1,000; 1,000/2,000; 2,000/4,000 Gauss. A probe unit is included with the meter. This is in a bakelite case with polarity gauge mounted at the top. Concentric circles on side of probe provide a guide to the parallel insertion. Resetting is effected by means of a wire-wound pot with control knob mounted on panel and press button control on probe case. The fluxmeter and probe are housed in a polished wooden instrument case with hinged lid containing instructions. Size 12½ x 9 x 6 ins. Condition is new and unused. PRICE £6 10s. 0d., post paid U.K.

R.F. UNITS TYPE 26 and 27. Complete with valves and in brand new unused condition. PRICE either type, 52/6, post 2/-.

R.F. UNITS TYPE 24 and 25. Complete with all valves, new but soiled externally. PRICE, either type, 30/-. post 2/-.

RECTIFIER UNITS TYPE 46. These units incorporating metal rectifiers were originally designed to provide H.T. and L.T. for the R.1155 and L.T. for relays and valves of the T.1154. Input 200/250v. AC. mains 50 cps. Output 220v. smoothed DC. at 110mA. and 6.3v. smoothed DC. at 13A. Totally enclosed in metal cases 17 ins. high x 19 x 12 ins. and weighs about 100 lbs. Fuse holders on outside of cases may be broken but can easily be replaced, otherwise the units are in first-class order. PRICE £8 7s. 6d., carriage 12/6.

VALVE SPECIALS. All brand new and retested before despatch. CV173 (EF55), 12/6; VR91 (EF50), 6/6, EC52, 6/-; VR136 (EF54), 6/6; CV66 (RL37), 6/6; 6SG7, 7/6. Postage 9d. up to three and over free.

THIS MONTH'S BARGAIN OFFERS

INDICATOR UNITS TYPE 6. To free storage space we are offering these brand new and unused units at a clearance price. They are fitted with a cathode ray tube type VCR97 suitable for scope or TV. (Tested to ensure freedom from cut-off), 4-VR91's and 3-VR54's, mu-metal screen, pots and many other useful components. We can supply data for scope conversion for 9d. and "Inexpensive TV." which gives the TV. data for 2/6. PRICE 65/-. carriage 6/6 (data only add 3d. postage).

R.1155 RECEIVERS. These popular receivers in "Used" condition, complete with seven valves. They are in working order although this might not be perfect. "WW" data leaflet supplied (separately 1/3). PRICE £6 17s. 6d., carriage 7/6 plus £1 for transit case which we refund when this is returned.

SOLONS FOR ESSENTIAL JOBS!

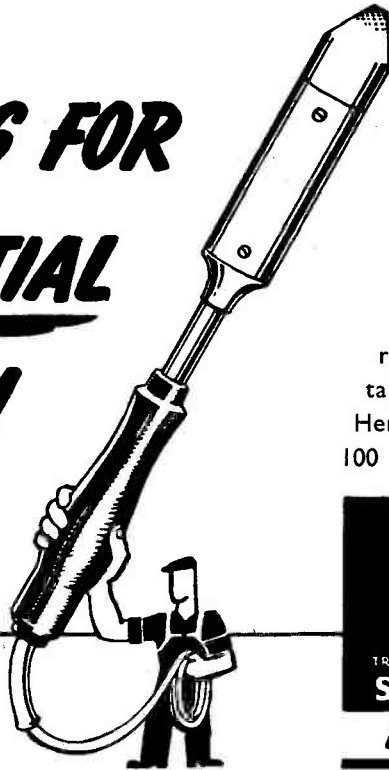

Use SOLONS for the jobs that matter — this modern precision tool makes soldering speedier, simpler and more reliable. 5 models: 65 watt with oval tapered and round pencil bit; 125 watt with oval tapered and round pencil bit; 240 watt with oval tapered bit; each with 6 feet 3-core Henley flexible. Voltage ranges from 100 to 250. Write for folder Y.10.

W. T. HENLEY'S TELEGRAPH
WORKS CO. LTD.,
51-53, Hatton Garden,
London, E.C.1



Benson's Better Bargains

VALVES: EA50, 7193, 12H6, EB34, at 2/6; VR65, VR66, 7V7, 9004, 9006, VR21, CV6, VU120, CV54, 6H6, at 3/6; 12SK7, 954, 955, 956B, 9D2, EF39, EF50, ARP12, 6SH7, 9001, ML6, 77, 78, RK34, NT37, VS70, 6C4, 12SH7, 717A, VR116 at 5/6; 6AG5, 6B8M, 6J7M, 6J5M, (GT), 6N7M, 12SJ7, 12SR7, 12A6, EF54, EC52, CV66, AC6/Pen, SG215. Pen 46, 1625, ATP4, 9002, 6K7, SP4, KT2, 3Q5, 6L7M, 12SC7, EK32, PM256, 721A, VS110A, NGT1, 6AC7 at 7/6; 524M, 210VPT, IC5, VR150/30 at 8/6; 6V6GT, UF41, UCH42, UY41, ECL80, EZ40, EF41, PM240, 6SN7, 6A6G, EBC41, UAF42, UBC41, 35LGT, EBC33, MU12/14, 6Q7G, 6F6G, 354, 6L6G, ECC33 at 10/-; 12AT7, 6AK5, PT15, at 12/6. **SPECIAL Valve offer:** at 5/6, 41MP, 42SPT, 41MPT, MS/Pen/T, 41MHL, 41MTL, 45HA, 4TSP, 4TPB, DDL4, MSPen. **METERS:** 40/120ma 2in. 6/6. 1FTS, canned, new 10/13 mcs, 2/-, 10mcs for G21G WB Couplers, 2/9. Coilformers 2in. x 1/2in., 4 for 1/-, R1355. New 45/-, Good, used 35/- (carr. 7/6). Chassis only, 15/-, plus carr. **RF UNITS,** type 24, 22/6. R3132 Store soiled, with 7/VR91, EA50, 2/VR136, VU39, VU134, VR137, 65/- (carr. 7/6). Chassis only, 15/-, plus carr. **VHF Rx,** Ex-Police, 10 x 8 x 7ins. Grey enamel case, with 10 valves, 40/- (carr. 5/-). Chassis only, 10/-, plus carr. (less xtal and power supplies). **IF AMP,** No. 178, Rebecca, with 5/IFTS, 7/VR65, EA50, 32/6. **TX/RX NO. 38,** Mk. 2, with 4/ARP12, ATP4, complete, less outside spares, 32/6. **R-3/ARR-2X,** 234/258 mcs. Valves: 3/6AK5, 7/9001, 12A6, new condition, £4, less valves, 21/6. **R161A,** VHF converter, with 2/VR136, CV66, VR137, 22/-. **R159 ETC.** VHF converter, with VR91, VR92, CV66, VR65, 24v. selector, 16/6. **R155A-5** wavebands, 10 valves. New, in original cases, £9 (carr. 11/5). **CAY,** 47151A, .8/1.5 mcs. **TX** tuning units, 12/6 (carr. 2/-), less case. **CRT's** 3BP1, 25/-, SCPI, 25/- **NEW TRANSFORMERS:** 250-0-250v. 60ma. 6v. and 5v., 11/6; at 80ma., 18/6; 350v. similar, 19/-; fully shrouded (Woden, Varley) 350v. 21/-. Output trans. potted, UX-7489-A, 2-1 ratio, pri. 3.6k, sec 720u., 9/6. Combined choke, 80ma and o.p. trans. 60-1, 5/6. Ferranti Mod. trans. 2-1 ratio, 30w. 11/6. **VITREOUS Resistors:** 21k 15w, 3k 30w, 30k 25w, 400u 25w, 500u 5w, tapped, 27K., 10w, 7k tap 2k 25w, 15k 25w,

2.7k 10w, 30u, 30u 30w, 50u 20w, 2.5k 25w, 20k 50w, 350u 60w, 16+2-2u 100w. at 1/-, lk. 100w, 20k, 120w at 2/-, Precision 1% 1 meg. 1/6. Var. wirewound 8u 50w, 500u 15w, 100u 5w, 1.850u 10w, 20k 6w at 3/6, lk 30w, 6/6. **METAL RECTIFIERS:** HW 270v 80ma, 6/-, 560v. 100ma, 7/6; 600v. 30ma., 5/-; meter type bridge, 5/6. **FW.** 120v. 80ma., 5/-, 30v 60ma, 3/-, 30vAC to 15v5a, 17/6. 48v 2 1/2a, 15/6. **GENERATORS,** hand-driven, geared, 300v. and 28v. outputs, 9/-. **DYNAMOTORS:** 9v. DC to 450v. 8/6, 28v DC to 285v. small 8/6, TR1196 Rx-type 24v. 7/6, 6v. DC to 200v., 10/-. **Vibrapacks:** 21v DC to 150v 30ma, 12/6, 12 or 24v. DC to 110v 60ma DC smoothed, stabilised, 15/-. **CERAMICONS** at 5/- doz., 2.2, 3, 5.6, 6.8, 10, 12, 15, 22, 27, 33, 39, 40, 47 and 100pfs. Ceramic trimmers and padders, 9d. each. **YAXLEYS:** 3P3W2B, 2P4W4B, 1P6W2B, at 2/9; 3P4W ceramic, 3/6; 2P2W, 4P2W, at 1/3. **ACCUMULATORS,** Midget, celluloid, 4 A.H., 6/-; 7 A.H., 7/6. **CHOKES,** RF 4 pie, Bulgin 9d.; RF 1.5mH 250ma (Eddystone type), 1/3. **CONDENSERS (Variable),** 75pf. Twin Ceramic (as RF26), 4/-; 75pf. Double spindle (as RF26), 2/-; or long spindle, 1/6; 500pf. 4 gang, 8/6; 25pf 3-gang Ceramic, 3/6; 500pf. twin, 5/6. Panel Lampholders, ruby metal (Bulgin) for MES, 1/6, ruby moulded 1/-; **WAVEMETERS,** Admiralty GS6, 2 valves, 11 wavebands 15kcs - 24mcs. Precision SM drive, 500uA, 3in. meter. Less chart and power pack, 50/- (carr. 7/6). **W.F. GEN.,** Case 8 x 6 x 4ins. containing 2/CV18 (6SN7 types), 1/VR91, 1/VR92, components, 25/-, **POWER PACK,** Hi-ci. Case 18 x 8 x 8ins., containing 1/6V6G, 1/5U4G, 1/5U120, 2/02 8kV. conds., etc., 25/- (carr. 5/-). **R1124,** with 6 13v. valves, 25/-; **R1125,** with 2/8D2, 10/-. **AUTO-TRANS.,** Admty 0-104-230v., 3A, 20/-. **STROBE UNITS,** with 9/VR91, 1/5Z4G; 600v met. rec., 200ma choke, and a wealth of components, 60/- (carr. 7/6). **W.F. GENs.** with 7/VR65, 3/VR56, 2/VR54, 1/VR55, many resistors, condensers, etc. 35/- (Carr. 5/-). **RELAYS G.P.O. types.** Multi-contact, 120, 765, lk ohms, each 3/6. **POTENTIO-METERS** Carbon, less switch, 1/9, w/w 2w, 2/6, most values. Ganged, 500k twice, 3/6.

LISTS AVAILABLE 1d. S.A.E.

Terms: C.W.O. CARR. PAID OVER 15/6. S.A.E. enquiries please

W. A. BENSON, 308 Rathbone Rd., Liverpool, 13 STONEYCROFT 1604

ABOVE ALL OTHERS

WODEN
TRANSFORMER CO. LTD.

POTTED COMPOUND FILLED TRANSFORMERS AND CHOKES

have been designed to fulfil such a purpose, and for this reason they have been standardized by many leading Radio, Television and Electronic manufacturers and also Government Research Departments. Their choice is only made after exhaustive tests for accuracy and reliability. To merit this confidence, there is a constant need to provide components of the highest quality and our ample research and testing facilities ensure continued progress in this direction.

Send for our fully
Illustrated
Catalogue.

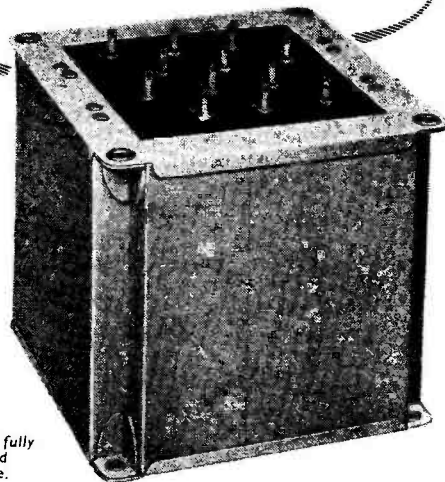

WODEN TRANSFORMER CO. LTD.

MOXLEY ROAD
TELEPHONE

BILSTON
BILSTON

STAFFS.
41959

OUR 17th YEAR **Money Saving Offers**

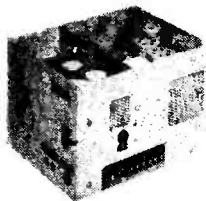

SPECIAL OFFER OF G.E.C. VHF RECEIVERS. (Illustrated). The receiver complete with 10 valves as follows. HF and 1st det stages ZA2, 954 or EF50's Local Oscillator Det 19. Three IF stages KTW63's. Det and AVC D63, LF H63, noise suppressor D63. Available in two frequency ranges, crystal controlled

(crystal not supplied). (State one required), "B" 95-5-100 mcs., "C" 78.5-82 mcs. Power requirements, 6 v. LT. 270 v. H.T. Grey enamel steel case 10 x 8 x 7 in., weight 22lbs. In first-class condition. Your chance to get going on VHF. Amazingly low price due to huge purchase, 49/6, plus carriage 5/-.

1155 POWER PACK AND OUTPUT STAGE, complete with U50 and KT61 valves (not surplus). Black crackle case 12 x 8 x 5in., built-in 5in. P.M. speaker and phone jack. Operates on 200/250 v. A.C. Connections terminate in Jones plug which enables instant operation of receiver without any modification whatsoever. Made to "Wireless World" specification. Matches in appearance with receiver. Price £7/10/-, plus carriage 3/6.

NOTE OUR PRICES. OUTSTANDING VALUE FOR MONEY

H.P. RADIO SERVICES LTD.

Britain's Leading Radio Mail Order House

55 COUNTY ROAD, LIVERPOOL 4

Est. 1935

Tel.: Aintree 1445

Smiths of Edgware Road The Component People

Can now supply from Stock all **VIEWMASTER TELEVISOR** Parts, for London, Midlands, Holme Moss, Kirk o'Shotts, and Wenvoe.

including :-

W.B. Frame Transformer 106, 25/6; Smoothing Choke 104, 15/6; Heater Transformer 103, 42/-; Heater Transformer 103A, 52/6; Scanning Coils 108, 33/3; Focus Ring 109/1-2, 22/6; Line Transformer 107, 32/6; Width Control 110, 10/-; Speaker 105 32/6; 9in. Tube Support 112, 21/-; 12in. Tube Support 112, 21/6; Boost Choke 111, 5/9; Sound-Vision Chassis 200, 18/6; Power-T.B. Chassis 102, 18/6; Support Bracket 101, 6/-.

T.C.C. Condenser Kit, 7 gns. (London, £7) (separate Condensers supplied at current prices). **Morganite** Resistors Kit, 35/3 (London, 36/3) Separate Resistors:—Type T, 6d. ea. Type R, 9d. ea. **Westinghouse** Rectifiers (5), 68/9 or supplied separately:—MR1, 3/9; MR2, 11/6; MR3, 29/5; MR4, 20/4; MRS, 3/9. **Wearite** Coils, 28/- set (London, 20/-). **Wearite** R.F. Choke, 2/-. **Colvern** Variable Resistors, Type CLR901, 3/2 ea., Type CLR4089/22, 6/7 ea. **Morganite** Variable Resistors, Type Q, 5/- ea. **Belling-Lee** Connecting Unit L707, 8/9 ea. **G.E.C.** Neon Lamp, 3/6.

Bulgin On-off Switch, 4/3. **Valves:** Mullard EF50, 17/6 plus 7/7 P/Tax. Ex-Govt. EF50 (new), 10/6 ea. Mullard EB91, 9/- plus 3/11 P/Tax; EL33, 13/- plus 5/8 P/Tax; EBC33, 12/- plus 5/3 P/Tax; Mazda 6P28, 17/6 plus 7/7 P/Tax; 6P25, 13/- plus 5/8 P/Tax; 6K25, 10/6 plus 4/7 P/Tax. 12in. Tallon Cabinet (Kit of Parts) Table, £7 14s. 0d. 12in. Tallon Cabinet (Kit of Parts) Console, £13 15s. 0d. 9in. W.B. Cabinet Table (Finished), £7 15s. 0d. 12in. W.B. Cabinet Table (Finished), £10 10s. 0d. Components for increased E.H.T. and Pre-amplifier, Aerials, Feeder Cable, Wiring-up wire, sleeving, solder, nuts and bolts, clips, etc. Constructor Envelope, 7/6.

Send for complete list.

C.O.D. or C.W.O. Carriage paid on all orders over £1.

Note.—We have had much experience with this set, which we can thoroughly recommend, and are ready to help you if in any difficulty. We will be pleased to supply a single part, all the parts, or stage by stage.

H. L. SMITH & CO. LTD.

287/9 Edgware Road, London, W.2.

Tel. Paddington 5891. Hours 9 till 6 (Thursday 1 o'clock).
Near Edgware Road Stations, Metropolitan and Bakerloo

YOU CAN RELY ON US FOR BRAND NEW
CLEAN COMPETITIVE COMPONENTS.

VALVE MANUALS.

BRIMAR, OSRAM, MULLARD, 5/- each

VALVES: R3.4V Rect., 8/6; 6AT6, 8/6; 6BE6, 8/-; 6B; V6, 10/6; 6AG5, 8/6; 12A6, 7/-; EL35, 8/6; 5Z4G, 9/6; S130 Stabilisor, 6/-; KT66, 10/-; 154, 9/-; KT61, 10/-; 6G6, 7/6; UL44, 15/-; 12SL7, 8/-.

BRIMAR METAL RECTIFIERS. RM1 125v 60m/a., 4/9; RM2, 100m/a., 5/3; RM3, 120m/a., 6/3. Two in Series for 250v Working.

FILAMENT TRANSFORMERS. 200/240v to 6.3V, 1.5a., small dimensions, 8/6; 3v to 30v at 2a, tapped 3, 4, 5, 6, 8, 9, 10, 12, 18, 20, 24, 30 volts, 24/-.

RF EHT COIL 6-11KV. Wavewound accurately on Polyester former will operate with EY51 or U24, 39/-; with U24 assembled and wired with anti-corona wire, 67/6.

4Ba BOX SPANNERS, box of five, 2/-; Terrys 2/4/6Ba Flat, 1/- set.

SPECIAL OFFER, this month only:—

Twin Triode 12SC7, octal base, 6/-.

HF Pentode EF36, octal base, 6/-.

METER RECTIFIERS. 1m/a Bridge Westinghouse, 12/6; Half Wave Surplus, 1/-.

VOLUME CONTROLS. With switch, 4/3, less, 2/9. Standard long spindles.

QMAX CHASSIS CUTTERS AND KEYS. $\frac{5}{8}$ in., 12/4; $\frac{3}{4}$ in., 13/4; $\frac{7}{8}$ in., 13/4; 1in., 16/-; $1\frac{1}{8}$ in., 16/-; $1\frac{1}{4}$ in., 17/9; $1\frac{3}{8}$ in., 17/9; $1\frac{1}{2}$ in., 19/6; $2\frac{1}{8}$ in., 36/9. 1in. square, 24/3.

10in. LOUDSPEAKERS. Standard 3 Ohm, New, 21/- · 8in., 17/6.

VALVE CANS. Three piece for octal valves, 1/6.

STOCKISTS of:—HUNTS, T.C.C., WEYMOUTH, HAYNES, ELSTONE, WEARITE, COLVERN, BULGIN, OSMOR, W.B. JACKSON, MORGANITE, LAB, AMPLION, ETC.

CATALOGUE No. 11. Price 6d.

RADIO SERVICING CO.

Dept. M/O 444 Wandsworth Road, London, S.W.8.

MACaulay 4155

BROOKES FOR CRYSTALS

with a World-Wide
Reputation for Quality

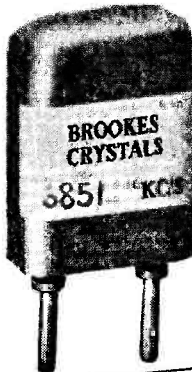

TYPE "SM"

Range 3 to 17 mc/s

Hermetically sealed metal can 1.125" high under pins, 0.825" wide, 0.457" thick, with 3/32" diameter pins at 0.490" centres

**BROOKES CRYSTALS
LIMITED**

10 Stockwell St., Greenwich, London, S.E.10

Phone: Greenwich 1828.

Grams: Xtals Green, London Cables: Xtals. London

R.C.A. TRANSMITTER ET4336.

UNUSED AND RECONDITIONED

THIS MAGNIFICENT TRANSMITTER IS COMPLETE IN ONE TOTALLY ENCLOSED RACK AND INCLUDES AERIAL TUNING PANEL.

TUBE LINE UP: 807 C.O./Buffer. Two 813 P.A. Two 805 P.P. Class B Modulator. Four 866A Rectifiers. **CONTROLS:** Manual or Remote. **POWER OUTPUT:** Normal 350 watts. **FREQUENCY COVERAGE:** Normal 2 to 20 mcs continuous. **FREQUENCY CONTROL** THE TRANSMITTER HAS A DETACHABLE FRONT PANEL FOR INSERTION OF WILCOX GAY V.F.O. OR CRYSTAL MULTIPLIER.

20 page manual and circuit diagram with each equipment. Every Instrument is Air Tested and Guaranteed perfect.

WILCOX GAY Crystal Multiplier for use with above transmitter.

WILCOX GAY VFO for use with above transmitter. **SPEECH AMPLIFIER** British made with 500 ohm output, suitable for use with EF4336B.

R.C.A. ET4336 SPARES. Very large stocks of essential maintenance spares available.

ET4336.K. Brand New in original packing cases and in absolute mint and Factory condition. Limited quantity only. The above transmitters are available for Export only.

McELROY - ADAMS Manufacturing Group Ltd.

(Sole concessionaries U.K. for Hallicrafter Communication Equipment)

Phone Fulham 1138/9. 46 GREYHOUND ROAD, LONDON, W.6. Cables Hallicrafter London.

TELCON LOW-LOSS TRANSMISSION LINES

K.24.B 150-ohms nominal impedance, figure-8 section twin; capacitance 10.6 mmf/ft; Attenuation at 50 Mc/s, 2.1 db/100 ft; power rating at 100 Mc s, 300 watts.

K.25.B 300-ohms nominal impedance, flat ribbon-type twin; capacitance 4.6 mmf/ft; attenuation at 50 Mc/s, 1.0 db/100ft; power rating at 100 Mc/s 500 watts.

K.35.B 300-ohm tubular twin feeder with stable characteristics in varying weather conditions. Capacitance 4.0 mmf/ft; attenuation at 50 Mc.s 0.92 db/100 ft; power rating at 100 Mc s, 550 watts.

THE TELEGRAPH CONSTRUCTION & MAINTENANCE CO LTD

Head Office: 22, Old Broad Street, London, E.C.2
Enquiries to: Telcon Works, Greenwich, S.E.10

Telephone: LONDON Wall 7104
Telephone: GREENWICH 3291



G2AK

This Month's Bargains

G2AK

TAPE RECORDING EQUIPMENT. Decks by Bradmatic, Tamsa, Lane and Qualtape. Ex. stock. Heads, Oscillator Coils, Tape and Reels always available.

SPLIT STATOR transmitting condensers, 60 pF. per section. 0.068 gap, 2,000 v. R.M.S. Beautiful job. Few only, £1 2s. 6d. ea.

145 MC/S. Tuning assembly, silver-plated loop inductance, tuned by 8X8PF. Butterfly type condenser, 10s. 6d. ea.

KNOB AND DIAL with engraved scale, 2in. dia. New and boxed, black finished, 1/9 ea.; silver finished, 2/- ea.; complete with index.

SHORT WAVE PLUG-IN COILS. 6 pin standard. 4 ranges only. 500/1,000 mtrs. 7.3/3.2 Mc/s., 3.9/1.8 Mc/s., 21.4/33.3 Mc/s. Set of 4 for 6/-. Formers alone are listed at 12/.

PLUG-IN VHF COILS, silver-plated wire on Ceramic base. 3 turn and 4 turn set of 3 (2-3 turn and 1-4 turn), 2/-.

AERIAL PULLEYS. Heavy galv., 6d. ea. or 5/- per doz.

COMPLETE NOISE LIMITERS: Wired on a small sub-chassis with 6H6 type valve, boxed, with circuit and instructions. Only 5/- post free.

SPECIAL VALVE OFFER: To transmitting hams only. Not more than 2 of any type to any one person. 813 70/-, 829 80/-, 832 30/-, 866a 17/6, 807 15/- ea. or 4 for 50/-.

COMPLETE SET (14) TUBES, for AR88 Receivers. £5 10s.

Carriage paid on all orders over £1 except where stated. Please include small amount for orders under £1. Please Print Your Name & Address

CHAS. H. YOUNG, G2AK

MORSE PRACTICE SETS, with double-action buzzer, output for phones, excellent key, requires only 4½ v. battery. As new, 7/6, postage and packing 1/-.

TWIN FEEDER: 300 ohm Heavy Twin Ribbon Feeder, 5d. per yard. K24, 150 ohm, 9d. per yard. Co-ax. Cable, ¼in. dia., 50 ohm, 8d. per yard; ½in. dia., 1/3 per yard. Post on above feeder and cable 1/6, any length. K35B (Round), 1/6 yd.

POTENTIOMETERS, Carbon, 50 k., 25 k., and 2 meg., 1/6 each, 500 ohm H.D. toroidal, 3/6 each. 50 K.W.V. Pre-Set Type, 2/- each. 20 K. W.V. Pre-Set, 1/- each.

R.F. CHOKES: Pie wound, 2.5 mH., 100 mA., receiver type, 9d. each, or 7/6 per doz.; 250 mA., transmitter type, 1/- each, 10/- per doz.

PARMEKO H.D. SHROUDED CHOKES. 8H at 250 mA., weight 11lb. Beautiful job. Only 16/6 each, postage and packing 1/6.

METERS: 2½in. Flush Mounting M.C. 100 mA., 12/6 each. 2in. Flush M.C.; 5 mA., 7/6; and 0.5 A. Thermo, 5/-; 4 A. Thermo, 5/-.

JUST IN! LOG BOOKS, 100 pages with heavy bound cover, 10/6 ea. Postage and packing 1/- ea.

EDDYSTONE 740 & 750 Receivers and components from stock.

SPECIAL VALVE OFFER. Kit of 4 midget 1.4 v. valves, 1 each IS5, IR5, IT4 and IS4, 35/- or 9/6 each, separately.

ALL CALLERS TO

110 Dale End, Birmingham • Central 1635

MAIL ORDERS TO 102 Holloway Head, Birmingham Midland 3254

INDEX TO
ADVERTISERS

	PAGE
Adcola	512
Alpha Radio Service	508
Altham Radio... ..	508
Anglin, J. T.	509
Ashworth, H.	507
Automatic Coil	449
Bensons	451
Brookes Crystals, Ltd.	453
Brown, S. G.	507
Burn Engineering	510
Candler System	509
Chase Products	506
Clydesdale Supply Co., Ltd.	505
Electrad Radio	510
Electradix Radios	506
Elm Electric	506
E.M.I.	511
Field, N.H.	507
Foyle	511
Henley's	451
Henry's	cover iv.
Hoile	510
H.P. Radio Services, Ltd.	452
Johnson's	511
Labgear	508
Lyons, Claude	505
Lyons Radio	450
McElroy Adams	453
Minett, E.	512
Multicore	450
Pullin (M.I.)	505
Radio Servicing Co.	453
Rollett, H.	512
Salford	456
Samsons Surplus Stores	507
S.W.M. Publications Dept.	cover iii
Small Advertisements	509-512
Smith, H. L.	452
Southern Radio	506
T.C.M.	454
Universal Elec.	510
Walton's Wireless Stores	508
Whitaker	cover ii.
Woden	452
Young	454

SHORT WAVE MAGAZINE

VOL X

OCTOBER 1952

No. 110

CONTENTS

	Page
Editorial	457
The Cure of TVI, Part I , by R. L. Glaiser (G6LX)	458
Improving the SX-28 , by A. H. Dormer (G3DAH)	463
Two-Band Radiating System , by J. G. Hobbs (G2QG)	469
Volume Compression in the Modulator , by E. A. Rule (G2QG)	473
Useful Workshop Tool , by J. W. Hobley (G2VU)	476
DX Commentary , by L. H. Thomas, M.B.E. (G6QB)	477
DX for G3AKZ	483
New Radio Propagation Disturbance Warnings , by R. H. <i>Greenland, B.Sc.</i>	484
VHF Beam at PE1PL , by C. D. de Leeuw (PAØBL)	485
VHF Bands , by A. J. Devon	488
Marathon VHF Contest Results	489
Paddle for the Electronic Key , by C. Henry (GM3HLD)	497
Random Jottings , by <i>The Old Timer</i>	498
New QTH's	499
The Other Man's Station — GM2DBX	500
The Month with the Clubs — From Reports	501

Managing Editor : AUSTIN FORSYTH, O.B.E. (G6FO)

Advertisement Manager : P. H. FALKNER

Assistant Editor : L. H. THOMAS, M.B.E. (G6QB)

Published the Friday following the first Wednesday each month at 55 Victoria Street, London, S.W.1.
Telephone : Abbey 2384

Annual Subscription : Inland 30s. Abroad 30s. post paid.

Copyright Reserved throughout the World.

AUTHORS' MSS

Articles submitted for Editorial consideration must be typed double-spaced with wide margins on one side only of quarto or foolscap sheets, with diagrams shown separately. Photographs should be clearly identified on the back. Payment is made for all material used, and it is a condition of acceptance that full copyright passes to the Short Wave Magazine Ltd. on publication.

**THE SHORT WAVE LISTENER ASSOCIATED WITH THIS
MAGAZINE IS SPECIALLY FOR THE RECEIVING ENTHUSIAST**



from aircraft to aircraft

Efficient contact between high-speed aircraft depends on instantaneous radio communication. Aircraft radio equipment is used under arduous conditions both in peace and war and must be available instantly throughout the 24 hours of a day.

It is not surprising, therefore, that more and more G.E.C. Quartz Crystal Units are being used, for this is the most critical component and only the best is safe and good enough.

Write for list QC 5012 (R)

SALFORD ELECTRICAL INSTRUMENTS LTD · SALFORD 3 · LANCS
A SUBSIDIARY OF THE GENERAL ELECTRIC CO. LTD. OF ENGLAND

The
SHORT-WAVE
Magazine

E D I T O R I A L

Occupancy From having discussed the Pressure on our bands, it is logical to survey their Occupancy, in the sense of how the loading is distributed. Broadly, the picture is that we are carrying far too much short-haul traffic on the two LF bands—particularly 80 metres. After dark, that band is a babel of unnecessary interference, mainly short-range contacts which could be carried out, at that time, on the Top Band. It would surprise many post-war operators to know that before 1939, Eighty at about this time of year was very comfortable for European phone working and was only used for G contacts in daylight.

By the same token, in most populated districts the Top Band is now becoming uncomfortably crowded for the many Sunday morning sessions that take place on it. Again, for the winter season, 1.7 mc is a band on which good long-haul G QSO's are possible in daylight (interference permitting), which would help to relieve much of the congestion on Eighty.

Where, then, are we to take our local net, and have our regular short-haul chats with friends outside easy travelling radius?

The answer is Ten Metres, now almost unpopulated, an ideal band for close-range phone and CW contacts, involving no difficulty with gear, not liable after dark to cause interference with distant stations, almost unaffected by conditions at short ranges, capable of giving super-DX in daylight when conditions serve, a relatively easy problem from the point of view of TVI, no trouble as far as the aerial is concerned, and giving ample scope for interesting experimental work with directive radiating systems—for instance, a pair of crossed dipoles connected into a goniometer will enable the lobes to be swung electrically, eliminating the need for any mechanical contrivance.

A ten-metre 25-watt CW/Phone transmitter available at all the stations now operating on Eighty and the Top Band would open these bands for more effective working over greater ranges than are at present possible, due solely to the factor of unnecessary short-range interference. Try it, and see!

Austin Fobell
G6FO.

The Cure of TVI

APPROACHING THE PROBLEM—FREQUENCY RELATIONSHIPS —HARMONIC CHECKING—SUITABLE DETECTION EQUIPMENT

PART I

R. L. GLAISHER (G6LX)

(Component Division, Mullard, Ltd.)

This important article, the first of a short series devoted to the pressing problem of TVI, is intended to guide, by practical experience and treatment of particular cases, those who wish to tackle the TVI on their own doorsteps in the same way. While it is agreed that many cases of TVI are largely due to the inadequate design of certain makes of TV receivers (not always the cheapest, by any means) the fact remains that as in the case of BCI the amateur transmitter must try to find the cure if he is to be able to operate during TV hours with an easy mind and safe in the knowledge that he is not causing interference. This goes some way beyond what is required by the Post Office, which takes a very reasonable view of the problem and, where the amateur concerned is co-operative, will treat each case on its merits. On the other hand, amateurs should not allow themselves to be brow-beaten by TV-owning neighbours, whose sets are in most instances wide open to every sort of interference other than amateur. In fact, many TV receivers themselves radiate strong interference on normal broadcast frequencies, so that the whole matter resolves itself into one of mutual co-operation.—Editor.

TELEVISION interference is by far the most serious problem facing the present-day radio amateur. One has only to listen around 7.55 p.m. any evening on the HF bands to realize how many operators are suffering from this difficult and challenging problem.

Some eight months ago, several South London amateurs, including the writer, were having a late-night local QSO on 14 mc phone after the evening TV programme had finished, and the subject under discussion was TVI. It was decided that the only way to tackle the problem was by a determined attack, and since then considerable work has been carried out with a view to sifting, and checking, the wealth of information that has appeared in British and American publications.

In attempting to collate the results of this work, a number of salient points have emerged, the most important being the established fact that TVI can be and has been eliminated in every case so far tackled by the South London Group.

Before giving detailed consideration to the measures necessary to reduce and cure TVI, it is worth while examining the types and causes of the interference.

General Considerations

By its very nature, television is considerably more susceptible to interference than the

normal AM broadcast and commercial speech services. Even the ideally designed TV receiver is, relatively speaking, wide open to interference when compared with broadcast and communications receivers.

Up to the time of the re-opening after the war of the London Television Service and the expansion of Television to other parts of the country, little attention was paid by amateurs to the amount of harmonic radiation emitted by their transmitters, as it was only in rare cases that such spurious signals caused interference to other services.

Television marks the first broadcasting service enjoying widespread popularity that uses frequencies *higher* than the LF and HF amateur bands, and moreover the television frequency channels at present in use all fall in harmonic relationship to one or more of these amateur bands.

In Table 1 the harmonic frequencies of each of the amateur bands between 3.5 mc and 28 mc are presented, together with details of the service likely to be affected by a harmonic.

The causes of interference to television reception encountered when an amateur station is transmitting can be divided into three general classifications:

- (1) Harmonic and spurious radiation from the transmitter.
- (2) Incomplete rejection of the amateur funda-

Table 1

BAND KC	2	3	4	5	6	7	8	9	10	11	12
3500-3800	7.0-7.6 Part only in amateur band	10.5-11.4 Fixed and aircraft services	14.0-15.2 Part only in amateur band	17.5-19.0 Fixed broadcast and aircraft services	21.0-22.8 Part only in amateur band	24.5-26.6 Mobile and fixed services	28.0-30.4 Part only in amateur band	31.5-34.2 Nav-aids, fixed and mobile services	35.0-38.0 Fixed and mobile services	38.5-41.8 London sound	42.0-45.6 London vision
7000-7300	14.0-14.6 Part only in amateur band	21.0-21.9 Part only in amateur band	28.0-29.2 Amateur band	35.0-36.5 Fixed and mobile services	42.0-43.8 Lower sideband of London vision (Channel 1)	49.0-51.1 Channel 2 vision (North)	56.0-58.4 Channel 3 vision (Scotland) Channel 4 sound	63.0-65.7 Channel 5 sound and vision (West)	70.0-73.0 Fixed and mobile services	77.0-80.3 Fixed and mobile services Nav-aids	84.0-87.6 Fixed and mobile services Nav-aids
14000-14350	28.0-28.7 Amateur band	42.0-43.05 Lower sideband of London vision (Channel 1)	56.0-57.4 Channel 3 vision (Scotland)	70.0-71.75 Fixed and mobile services	84.0-86.1 Fixed and mobile services Nav-aids	98.0-100.45 Fixed and mobile services	112.0-114.8 Aircraft band	126.0-129.15 Aircraft band	140.0-143.5 Aircraft and fixed band		
21000-21450	42.0-42.9 Lower sideband of London vision (Channel 1)	63.0-64.35 Channel 5 sound and vision (West)	84.0-85.8 Land mobile services band	105.0-107.25 Fixed and mobile services	126.0-128.7 Aircraft band	147.0-150.15 Fixed and mobile services					
28000-29700	56.0-59.4 Channel 3 vision (Scotland) Channel 4 sound and vision (Midland)	84.0-89.1 Land mobile services band	112.0-118.8 Aircraft band	140.0-148.5 Fixed and mobile services							

mental signal by the television receiver.
 (3) Generation and radiation of harmonics by an external rectifying source excited by the amateur signal.

The most common form of television interference from amateur transmitters is that due to harmonic radiation; and the amateur's first problem is to restrict the emission of spurious signals in the television channels to a sufficiently low value, so as to permit reception in his neighbourhood without interference.

Once the spurious harmonic interference has been reduced to a minimum TVI complaints are likely to be somewhat similar to those normally experienced due to BCI with AM broadcast receivers.

Receiver cross-modulation, blocking, inadequate receiver shielding, poor image rejection, are all faults likely to be met, in addition to the more usual direct reception of the fundamental signal through the IF amplifier!

Harmonic Interference

A signal generated by a transmitter operating in one of the LF or HF amateur bands, can, and nearly always does, have a VHF component whose frequency falls in the television channels. In some cases the level of this signal is sufficient to cause interference to local television receivers.

The VHF component can be a harmonic of the operating frequency, or of the frequency of one

of the multiplier stages in the transmitter, or even of the VFO or crystal oscillator. It can be a parasitic oscillation in a stage of the transmitter, or it can be produced by modulation.

Another source of harmonic interference may be due to an incorrectly adjusted CW transmitter giving rise to spurious emissions or hash caused by the rapid and large frequency shift in a stage or stages of the transmitter as the key is opened and closed.

The existence of harmonics in the output of the average oscillator, multiplier or RF power amplifier can easily be verified, because the frequencies are known. Interfering signals from the transmitter that fall within a TV channel, but whose frequencies are not harmonically related to the fundamental signal, are usually generated by parasitic oscillations.

VHF parasitics can be as troublesome as VHF harmonics and in most cases the damaging results are the same. In spite of careful design and construction, VHF parasitic oscillations may be generated in an amateur transmitter without the operator being aware of the fact. Quite often the first indication that parasitics are present in a transmitter show up when a TVI complaint is being investigated.

The elimination of parasitics has been treated very thoroughly in the amateur handbooks and other publications, and need not be enlarged upon here, except to say that they must be eliminated as a first step.

Interference Due to Receiver Inadequacies

At first sight it would appear that interference caused by receiver blocking, sound breakthrough, rectification, heterodyning and direct reception of the fundamental amateur frequency are due to poor engineering design by the television set manufacturer. It must be borne in mind, however, that if it were not for the presence of an amateur transmitter, the set would provide acceptable performance, so it is the amateur's responsibility to do all he can to permit the owner to enjoy his television reception despite local amateur activities. Point out the inadequacies of the design, if you like—but you must still clear the QRM.

Television receivers vary in ability to reject low frequency signals. In many instances, the set manufacturer has provided circuits which greatly attenuate signals outside the normal pass-band of the receiver. Until quite recently, however, this practice has been the exception rather than the rule.

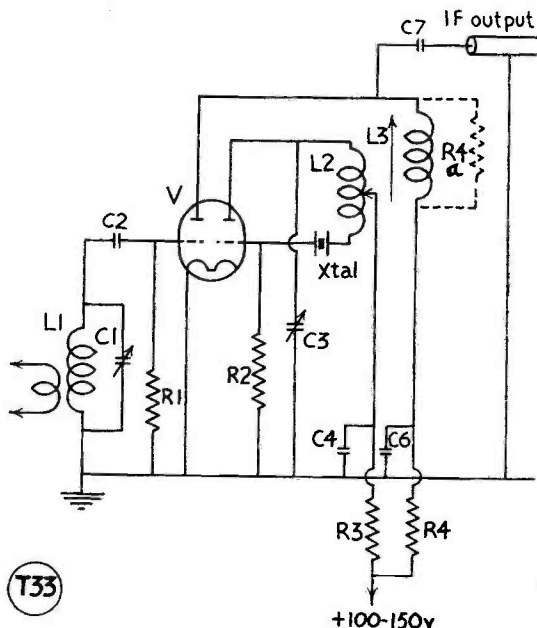

Fig. 1. Circuit of a Field Intensity Checker, suitable for investigating interference where TV signal levels are low. See Range Table, page 461, for coverage data.

Blocking occurs when a strong extraneous signal reduces the gain of the receiver by driving the control grid of an amplifier or mixer stage to a positive potential, thereby producing grid current, which biases the stage to a potential at which little or no amplification can take place.

Rectification occurs in the grid/cathode circuit of an amplifier stage when an extraneous signal swings the grid beyond the linear portion of the characteristic curve of the valve.

Table of Values

Fig. 1. Circuit for suitable Field Intensity Checker

C1, C7 = 50 μ F	R4a = Loading resistor if needed for broad banding: 1,000 ohms
C2 = 100 μ F	V1 = 6J6 or ECC91
C3 = 60 μ F	L3 = Slug-tuned to suit IF
C4, C6 = .005 μ F	
R1 = 1 megohm	
R2 = 3,300 ohms	
R3, R4 = 1,000 ohms	

Coil Data

- L1 *Loc. Freq. Channels* = 8 turns 22 enamel, $\frac{1}{8}$ in. dia., $\frac{1}{2}$ in. long.
High Freq. Channels = 6 turns 22 enamel, $\frac{1}{8}$ in. dia., $\frac{1}{2}$ in. long.
 Link = 3 turns 22 enamel close wound at cold end of grid winding.
- L2 *Multiplication $\times 3$* = 10 turns No. 20 S.W.G. tinned, tapped $\frac{3}{4}$ turns from xtal end, $\frac{1}{8}$ in. dia. x $\frac{1}{2}$ in. long.
Multiplication $\times 5$ = 10 turns No. 20 S.W.G. tinned, tapped $\frac{3}{4}$ turns from xtal end, $\frac{1}{8}$ in. dia. x $\frac{1}{2}$ in. long.

Table 2

	OUTPUT FRE- QUENCY	MEASURED FREQUENCY	LEVELS	
			DUMMY LOAD	OPEN AERIAL
London Vision Carrier	45 mc	Fundamental	Reference	Level S9
150 watt transmitter	14 mc	Fundamental	S9 - 30dB	Not measured
150 watt transmitter	14 mc	2nd harmonic	S6	S9 - 35dB
150 watt transmitter	14 mc	3rd harmonic	S4	S9 - 27dB
150 watt transmitter *1	14 mc	4th harmonic	S3	S9 - 15dB
6 watt exciter feeding into PA (PA off)	14 mc	3rd harmonic	Unreadable	S3
6 watt exciter fed into aerial	14 mc	3rd harmonic	Not measured	S6
VFO unit fed into exciter (exciter off)	3.5 mc	12th harmonic	Not measured	Unreadable
VFO unit fed into aerial *2	3.5 mc	12th harmonic	Not measured	S1.5

* 1 A signal was recorded on 46.8 mc which was traced to a parasitic in the 807 buffer amplifier.

* 2 Measurements were also made on the 13th, 14th and 15th harmonics and levels were recorded between S1 and S1.5.

Heterodyning occurs when an amateur signal and a second extraneous signal enter the receiver. For example, a 14 mc amateur signal can heterodyne another local 29 mc amateur signal into the London vision channel, so causing cross-hatching and the usual troubles associated with harmonic interference. Another common form of heterodyne interference is caused by the mixing of amateur signals and VHF business or police radio services.

Several makes of television receivers use an IF amplifier working either in, or adjacent to, an amateur band, or in some cases the local oscillator frequency has been selected so that the second-channel frequency falls in an amateur band. These receivers will quite often accept a fundamental amateur signal by direct reception.

The effects of heterodyning, rectification, blocking, and so on may be encountered in-

Range Table

RANGE	XTAL RANGE	MULTIPLI- CATION	INJECTION FREQ.	IF RANGE
41.5 - 45 mc	6-9 mc	3	18-27 mc	6 mc Xtal 23.5 - 27 mc
				9 mc Xtal 14.5 - 18 mc
48.25 - 51.75 mc	6-8 mc	5	30-40 mc	6 mc Xtal 18.25 - 21.75 mc
				8 mc Xtal 8.25 - 11.75 mc
53.25 - 56.75 mc	6-9 mc	5	30-45 mc	6 mc Xtal 23.25 - 26.75 mc
				9 mc Xtal 8.25 - 11.75 mc
58.25 - 61.75 mc	7-9 mc	5	35-45 mc	7 mc Xtal 23.25 - 26.75 mc
				9 mc Xtal 13.25 - 16.75 mc
63.25 - 66.75 mc	8-9 mc	5	40-45 mc	8 mc Xtal 23.25 - 26.75 mc
				9 mc Xtal 18.25 - 21.75 mc

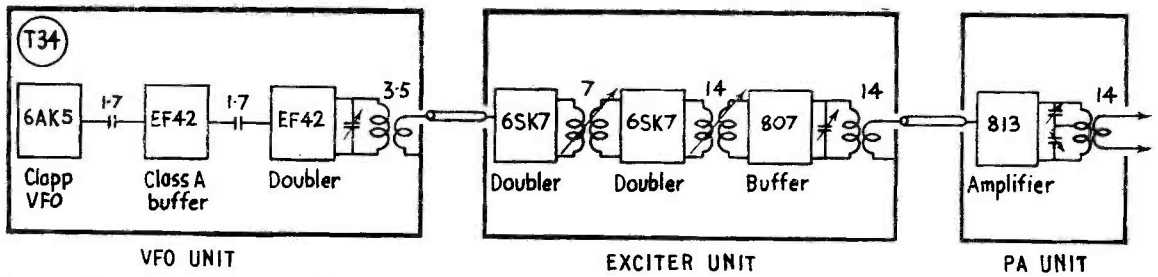

Fig. 2. Block schematic of a typical 14 mc 150-watt transmitter. The object must be to eliminate harmonic radiation at all stages.

dividually or in combinations, but all are evidence that the TV receiver has inadequate low-frequency rejection.

External Causes of Harmonic Interference

Non-linear devices, such as rectifiers, when excited by a strong local signal, can generate and radiate harmonics of the signal. The offending rectifier can be of the normal valve or oxide type connected to electrical conductors, or it can be water, gas or drain pipe joints, corroded earth connections, radio receivers, dirty telephone connections, and numerous other types of joint giving rectifier action.

One such case was recently traced to a corroded stay-joint on a tube mast supporting a television receiving aerial. In this instance, the amateur transmitter had been suppressed for harmonic radiation, yet on one particular receiver severe harmonic interference was being experienced, though other receivers much nearer to the transmitter were completely free of such interference. A further similar case, reported from the States, was found to be due to a rusty metal window frame, which only gave trouble when the window was closed! Luckily such causes of trouble are very few and far between, and are only worth considering if every other cure fails.

Initial Checks and Measurement of Levels

It cannot be sufficiently emphasized that the clearing of television interference is a painstaking process that requires much patience and work. In many cases merely trying one of the suggested procedures may not prove effective, and a combination of several may have to be employed.

The first step in the tackling of a television interference problem is to determine the type of interference being experienced, *i.e.*, whether harmonic cross-hatching, sound break-through, receiver blocking, direct reception of the fundamental through the IF channel, or whatever it may be.

It is worth while at this stage making a few simple checks to determine whether the TVI is caused by fundamental or harmonic radiation from the gear. To do this, transmit an unmodulated carrier and examine the TV tube screen while a TV signal is being received. If a herring-bone pattern appears, the trouble is most likely due to harmonic or parasitic troubles. With modulation, dark coloured bars will appear superimposed on the herring-bone pattern. A very high level of harmonic can over-ride the sync signal and cause the picture to slip or in some cases "wash-out" completely. Fundamental radiation troubles from an unmodulated carrier can also cause the picture to "wash-out," shimmer, slip, or produce shadows. In some cases the picture may only lose brilliance or contrast. Modulation may cause sound break-through, but this will depend on the discrimination of the sound circuits in the receiver.

If harmonic radiation is found to be the main cause of the interference, it is necessary to have some form of signal or field-strength measuring device so as to compare the relative levels of television signal and harmonic interference. Such an indicator also gives an accurate indication of how much effect each method of harmonic attenuation attempted will produce. Of course, the real indication of a complete remedy depends on the results actually obtained at the television receiver, but the field intensity meter is indispensable when making accurate adjustments to TVI corrective devices by showing if they are being applied in the correct direction.

An improvement in harmonic attenuation may not greatly show itself in the television receiver at first, but the measuring instrument will show the attenuation of each measure attempted so that the total cumulative effectiveness of all the steps taken can be accurately judged.

It has been the experience of the writer that the so-called "Harmonic Indicator" described

in other publications is not sufficiently sensitive for use in weak TV signal areas, and furthermore lacks the facility of a direct comparison between the level of the harmonic and the television signal. A simple crystal-controlled converter using the two halves of a 6J6 (ECC91) as mixer-oscillator has been found very useful for these checks. A circuit diagram is shown in Fig. 1.

The converter should be installed well away from the transmitter, but adjacent to the transmitting aerial. It can be fed to the main station receiver at the IF by a length of coaxial cable. The tunable IF should be chosen well away from the transmitter fundamental or sub-harmonic frequencies, for obvious reasons.

Once a satisfactory harmonic indicating device has been installed, the transmitter can be switched on as normal and the amount of harmonic radiation checked. The aerial should then be removed from the transmitter and replaced with a shielded dummy load. If the harmonic level drops to zero, it is obvious that the interference is being transmitted *via* the aerial. If the level still remains high the harmonic is being radiated directly from the transmitter or through its associated power leads.

In some instances the harmonic level will drop by a few dB, and this usually indicates that harmonics are being radiated both directly from the transmitter and through the aerial.

This test procedure can be carried one step further by isolating each stage of the transmitter and noting the harmonic level. Table 2 shows typical levels obtained from an un-suppressed 150 watt 14 mc transmitter located 15 miles from the London television transmitter in the Croydon area. A block diagram of the transmitter is shown in Fig. 2.

From the table it will be noted that all the stages in the transmitter are generating or amplifying spurious components and these were being radiated both directly from the transmitter or its associated wiring and *via* the aerial system. It was also found that the spurious signal recorded on 46.8 mc was due to a parasitic oscillation generated in the 807 buffer stage and amplified by the PA stage.

Once these checks have been carried out and any parasitic oscillations eliminated, it is possible to start taking remedial measures to reduce or eliminate the harmonics to a level where satisfactory television reception is possible.

(To be continued)

Improving the SX-28

VALVE CHANGES, CIRCUIT MODIFICATIONS, AND RE-ALIGNMENT

A. H. DORMER (G3DAH)

S/Ldr., R.A.F.

This article shows how a good receiver can be made better by carrying out a series of modifications and adjustments, all described in careful detail. But our contributor rightly utters the usual warning—do NOT attempt to interfere with a complicated assembly like the SX-28 unless you are confident that you know what you are doing, and can follow the instructions.—Editor.

AFTER having used three other makes of modern American-made communication receivers and two British types, it was finally

decided that the SX-28 had certain advantages for all-band operation which, for one reason or another, were not possessed by the other sets. Put another way, the SX-28 as now modified and operated is, in the writer's opinion, superior to any other commercial receiver he has yet handled. It does, however, need some modification and very careful adjustment before this result can be claimed. It is the purpose of this article to detail the modifications found necessary and to discuss a lining-up procedure which, while not being easy, has definitely paid dividends in improved performance.

The modifications and adjustments required were:—

- (1). Better performance on Ten Metres.
- (2). Lower noise level.
- (3). Better noise limiting.
- (4). Better smoothing of the HT supplies.
- (5). Re-alignment.
- (6). Increased output and better quality on the broadcast bands.
- (7). Improved selectivity for CW working.
- (8). Ability to monitor signals on a CRO.

Before going into detail on the above it is emphasised that the SX-28 is no beginner's set

to modify, and without a circuit diagram and a fair amount of "know how" it is *not* recommended that all the proposed modifications should be attempted.

Mods. 1 and 2.

These objects were achieved by simple valve changes which did not necessitate any changes to the set wiring. Replace the 2nd RF valve (V2-6SK7) with a 6AB7 (1853). Replace the 2nd IF valve (V6-6SK7) with a 6AC7 (1852). No AVC is applied to this stage and circuit constants are such that the substitution has no deleterious effect.

Mod. 6.

The 6V6 output valves have a common bias resistor of 220 ohms, two-watt rating. Replace this common resistor by two one-watt resistors of 200 ohms each, one in each cathode, and decouple each by a 50 μ F 25 volt working capacitor. As an additional check, balance the cathode currents of each valve by slight adjustments to these cathode resistors.

Mod. 7.

The ubiquitous BC-453 was pressed into service for this purpose. Wrap the inner,

insulated, centre wire of a piece of screened wire round pins 4 and 5 of the 6B8 (V7—2nd Det.) and replace the valve in its socket. Earth the screening by fastening it under one of the terminals on the top of the coil and condenser housing and bring it out through the louvres at the side of the set. Connect the inner to the input terminal of the BC-453, earthing the screening again to the case. Take a twin lead to the output terminal of the BC-453 and earth and thence to an ordinary phone jack, which is then plugged into the audio socket at the back of the SX-28, making sure that the "hot" lead goes to the tip. Tune in a strong carrier on the main set and adjust the BC-453 tuning for maximum response. The rods in the tops of the IF cans in the BC-453 should be pulled right out for maximum selectivity. All the facilities of the SX-28—noise limiting, tone control and so on—are still available, and it is now possible to work Twenty CW at weekends with a reasonable degree of ease and certainty.

This addition can be made without re-aligning the main set, but it is recommended that the 2nd IF be "touched up" if the major re-alignment (dealt with in the remainder of this article) is not carried out. Further, it will be found that the tuning of the BC-453 requires

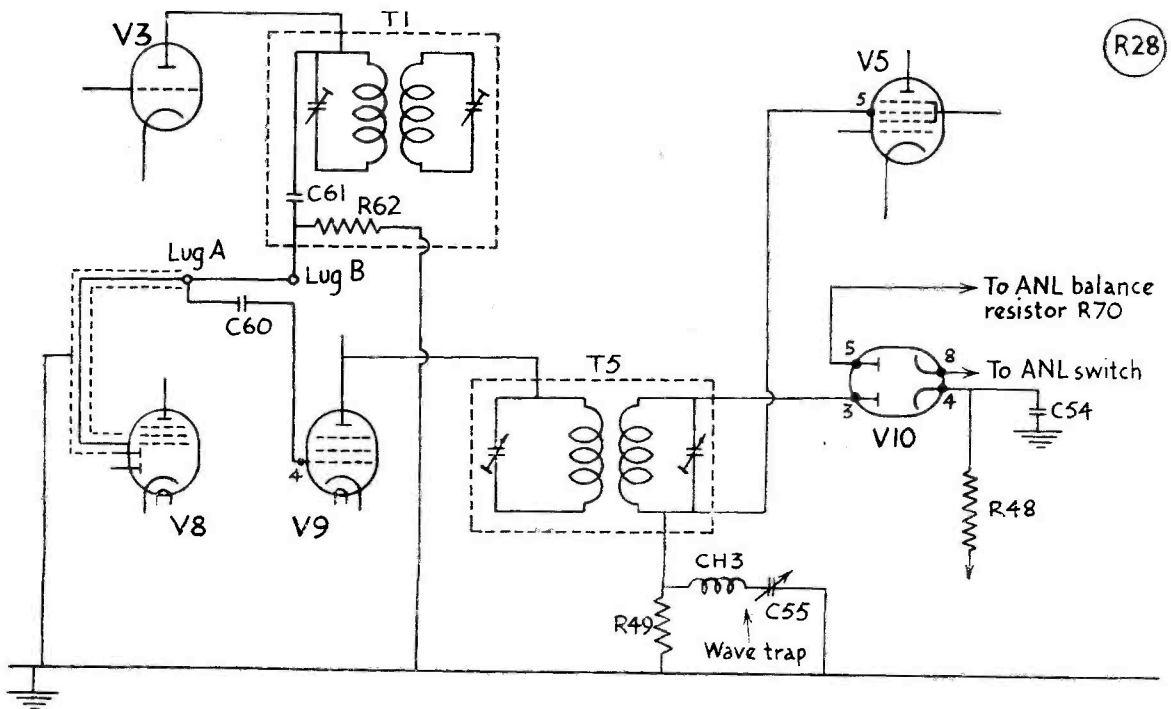

Fig. 1. The part of the SX-28 to be approached for the suggested modifications, as described by G3DAH.

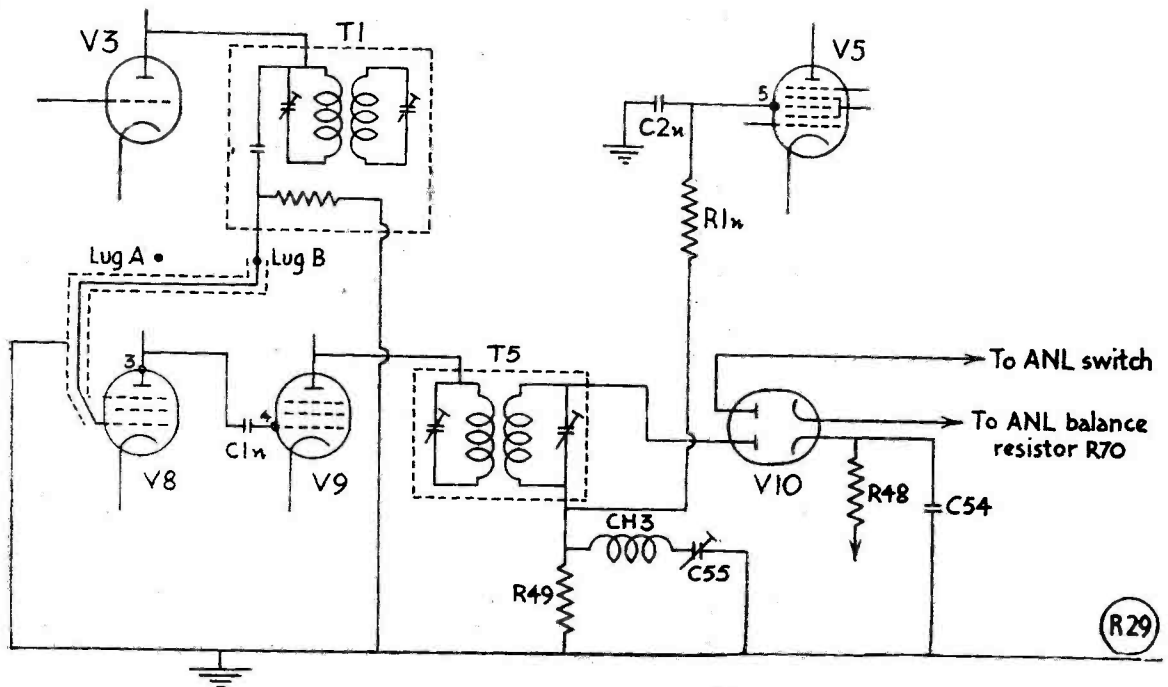

Fig. 2. The circuit of Fig. 1 with the modifications applied. New components are: $C1n$, $5 \mu\mu F$; $C2n$, $27 \mu\mu F$; $R1n$, $100,000$ ohms.

slight adjustment on passing from one position to another on the IF selectivity switch on the SX-28.

Mod. 8.

Mod. 7 above facilitates the monitoring of incoming signals on a CRO. By connecting a jumper from the input terminal of the BC-453 to the input of the CRO amplifier, a picture of the incoming modulated carrier of a phone signal, or the envelope of a keyed CW signal, can be observed. For general checks on modulated signals the CRO time base should run at about 500 c.p.s.

Mod. 3.

The weak point about the noise silencer in the SX-28 is the lack of noise amplification before rectification and insertion in the IF chain as a negative going pulse at the grid of the 6L7. The 6H6 noise rectifier and limiter also functions more satisfactorily if the input transformer leads and the plate and cathode leads of the limiter section are both reversed. Circuit changes necessary to effect this modification are as follows:

- (a) On the socket of the 6H6(V10) unsolder the leads connected to pins 5 and 8. reverse them and re-solder.
- (b) Unsolder the lead to pin 3 of V10 and also the black tracer coded lead on the tie lug under the 500 ohm S-meter shunt on the rear apron of the chassis. These leads are from the secondary of the transformer feeding the 6H6 (T5). Reverse these leads and re-solder.
- (c) Remove condenser, circuit reference C60 ($50 \mu\mu F$), connected between the grid of V9 (6AB7) and the plate of V3 (6SA7). (See Lug "A" in Fig. 1).
- (d) Connect a ceramic condenser of value $5 \mu\mu F$ between pin 3 of V8 and pin 4 of V9. Keep the leads as short as possible.
- (e) Unsolder and remove the blue coded jumper between the two lugs adjacent to the mixer and 2nd RF compartments respectively (Lugs A and B). This lead connects the anode of V3 with the $50 \mu\mu F$ condenser already removed.
- (f) Remove the screened lead from Lug "A" and re-solder it to Lug "B." It will be necessary to unsolder the grounding point for the screening and to bend the lead into a U-shape. After making the lead connection to Lug "B." re-solder the screening to the same point as before.
- (g) Unsolder the lead with the blue tracer connected to pin 5 of V5 and connect it to the "hot" end of the wavetrap at

the junction of the coil and the one megohm resistor.

- (h) Remove the jumper between pin 5 of V5 and the wavetrap and replace it with a 100,000 ohm carbon resistor of $\frac{1}{2}$ -watt rating.
- (i) Connect a 27 μF mica or ceramic condenser between pin 5 of V5 and ground, using the same earth point as for the 1 megohm resistor in (g) above.

The result of these changes can be seen from Figs. 1 and 2. As modified, the circuitry of T5 secondary appears identical with that shown in Fig. 1, but, in fact, the secondary leads have been reversed.

Having completed these changes, the truth of the earlier statement that the SX-28 is no easy set to modify will have become quite apparent! However, at this point, switch on the receiver and ensure that it is still functioning as a check on the accuracy of the work so far carried out.

Mod. 5

After all these modifications the receiver is going to need re-alignment. It will still work, and the results will not be greatly inferior to what they were, but after all the blood, sweat, toil, tears and strong language, an improved performance becomes your just due.

In the writer's opinion, there is only one way to line up a receiver of this type at all accurately, and that is with a CRO and a wobulator. True, results of a sort *can* be achieved by the use of a meter across the output terminals, a modulated signal generator and a vast amount of time and patience, but the SX-28 is worthy of better treatment.

Many amateurs will have access to, or

possess, a CRO, but a wobulator is a different matter, and the circuit shown in Fig. 3 was therefore made up and is reproduced here for the benefit of those who do not already possess one.

The wobulator shown is triggered by an output from the CRO time base, but if this voltage is not available externally on the oscilloscope to be used, 10 volts AC from the mains will do the trick. The set-up actually used is shown in Fig. 4.

Setting Up Test Equipment

While the lining-up procedure as laid down in the SX-28 manual was followed generally, there are several points which need elaboration and certain changes in procedure necessitated by the modifications described which need further explanation.

First, then, the setting up of the wobulator, the oscillator section of which operates on a frequency of about one megacycle. Connect up the power supplies, take the output lead to *near* the aerial terminals of the SX-28 and

Table of Values

Fig. 3. The Wobulator used for the SX-28 modifications

C1 = 0.25 μF	R6 = 30,000 ohms
C2 = 3/30 μF	R8, R9 = 25,000 ohms
C3 = .002 μF	V1 = 6S17
C4 = .01 μF	V2 = 6R8
C5 = 10 μF	
C6, C11 = .005 μF	L1 = 150 turns 28g.
C12 = .005 μF	enamelled, on $1\frac{1}{2}$ -
C7 = 50 μF	in dia. former
C8 = 250 μF	
C9 = 0.1 μF	L2 = 20 turns 28g.
C10 = 25 μF	enam., on L1 for
R1 = 0.5 megohm	mer spaced 3in.
R2, R4 = 50,000 ohms	from L1. Check
R3 = 5,000 ohms	L2 connections
R5, R7 = 100,000 ohms	for correct sense
	for oscillation.

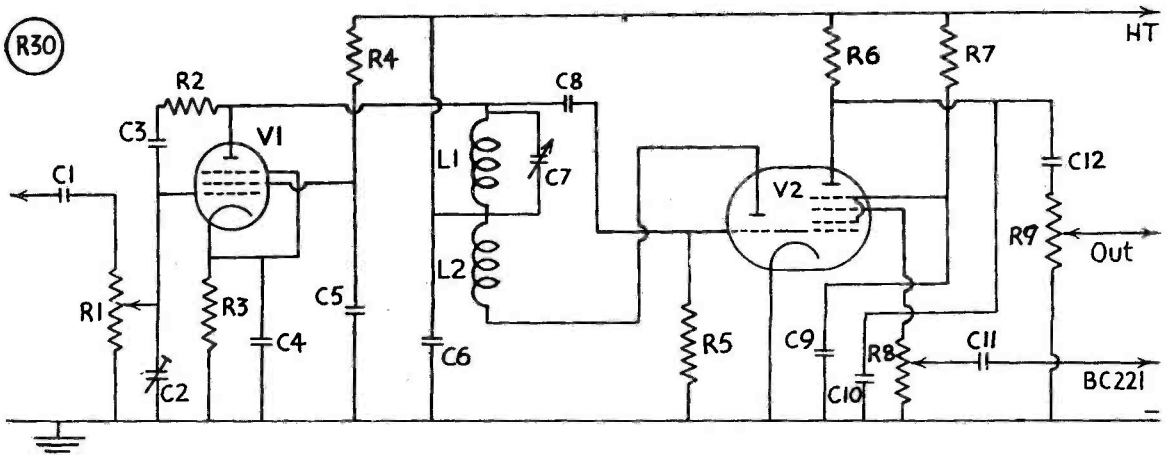

Fig. 3. A wobulator for carrying out the tests and making the adjustments on the SX-28 suggested by G3DAH. It is important to check that the windings L1, L2 are in the right sense.

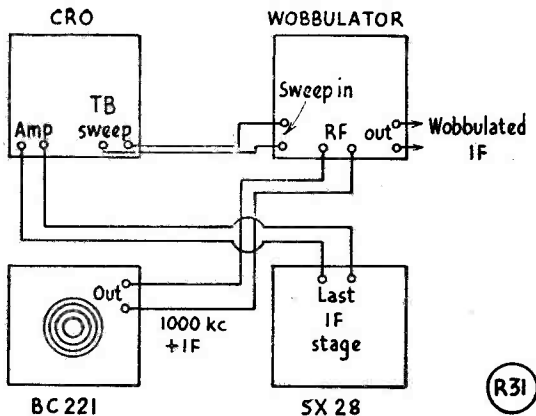

Fig. 4. Test set up as explained by G3DAH in his article on improving SX-28 performance.

tune in the oscillator signal on the main dial of the set. Note the frequency and add to it the value of the IF of the receiver—about 455 kc—and set up this new frequency on the signal generator, connecting its output to the “RF IN” terminals of the wobbulator. The sum frequency, mixed in the wobbulator, may now be checked on the SX-28. Now connect the 50 c.p.s. sweep voltage and hear the horrid rattle all over the tuning range. No matter, as long as it is there at the moment. At this point, pause. You are about to line up the receiver on the wrong frequency. First, you do not know how good the calibration now is on the SX-28, and therefore you do not know accurately the frequency of the wobbulator; and secondly, you do not know the IF of the SX-28 accurately. Oh yes, the book says that it is 455 kc, but you are going to line up on the crystal for the best selectivity and you do not know the exact frequency of the crystal. However, as far as you have gone you have

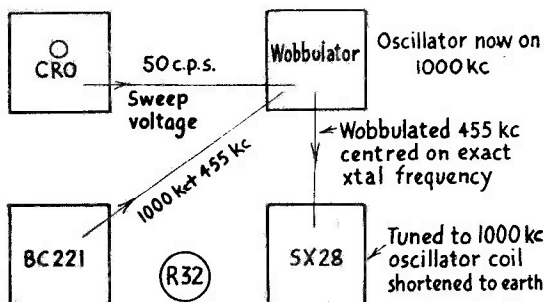

Fig. 5. See text for explanation of this test layout on the SX-28.

at least checked that the test gear is all working satisfactorily.

Now switch off the wobbulator, set up the BC-221 to about 455 kc and connect its output to pin 8 on the mixer (V3). Switch off the set while you do this as pin 8 is in a very awkward place and there are several hundred volts around your fingers! Switch to “Xtal Broad” and rock the BC-221 dial until you pick up the signal as shown by maximum deflection on the S-meter. That is your crystal frequency which for the purpose of this article we will assume to be 455 kc. Make a note of it, add 1,000 kc to it, and transfer the output of the BC-221 to the wobbulator. Set the SX-28 tuning dial to around 1,000 kc and vary the wobbulator tuning until the raw AC note is audible again. Having located it, connect the wobbulator output to pin 8 of V3 again. Connect a jumper from the oscillator coil in the SX-28 to ground. The set-up now looks like Fig. 5.

Now go away and have lunch (or some other suitable refreshment) leaving everything switched on and warming up to stable operation. Re-check to Fig. 5 on your return.

The CRO should now be connected by taking a lead from the diode load resistor of V7 to the vertical amplifier input of the CRO.

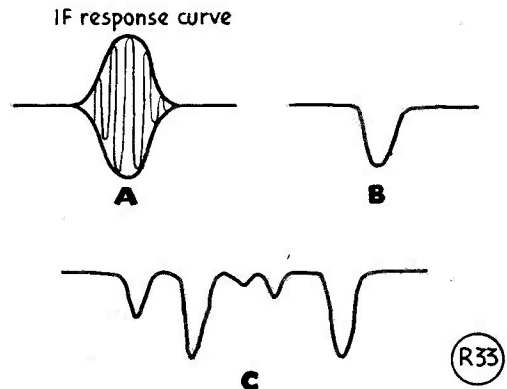

Fig. 6.

There are several convenient points at which this lead can be connected and depending on the gain of the CRO amplifier, one will be easier to use than another. The junction of R24 and R25, or of R24 and R70, gives a convenient picture. If you connect the lead directly to the diode a picture like Fig. 6 (A) will result. But at the junction of R24 and R25 you will get Fig. 6 (B) which is much easier to handle and was the one used in the

author's case. Incidentally, if you do not short the oscillator coil, you may get a picture like Fig. 6 (C), and where do you go from there ?

With the switch in the "Xtal Broad" position, adjust T1, the lower trimmer on T2, and C31 and T3 for maximum response. Switch to "Xtal sharp" and retune the trimmers as above except that for C31 read C30. Switch to "Xtal medium" and adjust as above but for C30 read C29. The top trimmer on T2 will affect all crystal positions of the selectivity switch and, rather than adhere strictly to the makers' instructions at this point and vary the signal generator frequency to check the shape of the IF response curves, it is recommended that the trimmers be altered slightly after the initial adjustment until the waveforms given in Fig. 7 are shown on the CRO: D, Xtal broad ; E, Xtal medium ; F, Xtal sharp.

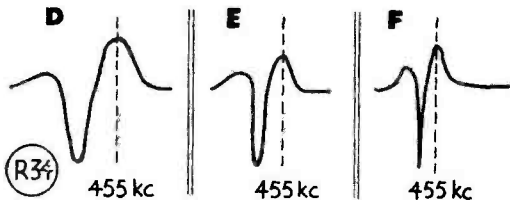

Fig. 7.

Avoid like the plague anything which looks like G in Fig. 8, which is crystal ringing, because however sharp the peak appears, you are *not* on the crystal frequency.

Now switch to "IF sharp," "IF medium" and "IF broad" in turn. The waveforms should look like H, J, and K respectively in Fig. 9.

To get the correct "Rabbit's ears" shape in the "IF broad" position, use the trimmers on T3 rather than T2. The latter should not be varied once the crystal selectivity waveforms have been set up. After all, you are hotting up the receiver for the amateur bands, and the writer has yet to find a band on which the "IF broad" position could be used with comfort ! Improved performance on the HF bands is considered preferable to a perfect IF

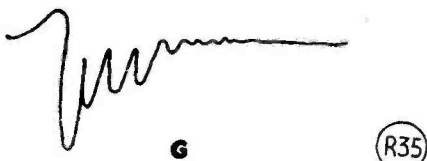

Fig. 8.

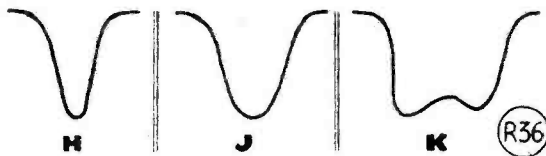

Fig. 9.

response in the "IF broad" position at the expense of selectivity on the other bands.

Now for the noise filter and the wavetrapp alignment. Controls should be set as follows:

- AVC switch on: Tone control maximum high frequency: BFO at zero: Bass switch "in":
- AF gain at 9: RF gain at 9: Band switch at .55 to 1.6 mc: Noise limiter at 9.

Connect a high resistance voltmeter across R49 at the wavetrapp. Connect a 50,000 ohm resistor across the primary of T5 (red and blue leads). Set the BC-221 to the IF frequency as determined above (without sweep) and connect to the grid of the 6AB7 (pin 4). Adjust the trimmers on T5 for maximum deflection on the meter. In the writer's case, this was approximately 0.6 volts. Now connect the BC-221 to the mixer grid of the 6SA7 (pin 8) and remove the 50,000 ohm resistor from the primary of T5. Adjust the wavetrapp trimmer for minimum voltage on the meter.

Remove the grid clip from the grid cap of the 6B8 (V8) and connect the BC-221 to the grid of the 6B8. (BC-221 still at IF.) Tune the trimmers on T6 for maximum indication on the voltmeter. Re-check the alignment of T1 as above. And that concludes the IF adjustments.

In the writer's experience the best method of adjusting the RF circuits is to use the BC-221, fed through a 400-ohm resistor with 200 μ F in parallel, to the aerial terminal of the set, and to rely on the S-meter readings as an indication of maximum response. One point about this adjustment: On Band 5 (11 to 21 mc) it is possible to adjust at 12 mc and 16 mc instead of the 11 mc and 20 mc recommended. This improves the response and the calibration over the 14 mc band, but it is inadvisable to go any closer than this as instability may result. On Band 6 it is possible to set up on 24 and 32 mc with similar results, but once again it is not advisable to go nearer than this.

Well, there is your SX-28, and it is hoped that your results will show the same *measured* increase of gain as at G3DAH where signals on 14 mc, for example, were three S-points up and the signal/noise ratio showed an improvement of some 4 dB.

Two-Band Radiating System

INGENIOUS AND PRACTICAL

J. G. HOBBS (G2QG)

The search for the multi-band aerial, like the perfect VFO, still goes on. This article describes in some detail a new approach to the old problem, and will be of interest to all who experiment with aerials, or think about the design of true multi-band systems. — Editor.

MUCH time has been expended on the development of aerial systems capable of working on at least two bands with high efficiency. Several such systems are available which will work with varying degrees of success, but none is really satisfactory; it is thought that the aerial described here more nearly approaches the ideal than any other system hitherto available.

It is not claimed that any new principle has been evolved, but merely that known engineering techniques have been applied to finding the solution to a particular problem. The author is convinced that this problem would have been solved many years ago by his professional colleagues (probably in a similar manner) had the need arisen. But the professional usually has ample space available, and should an aerial of another frequency be required, a new one is constructed and placed into position. If space is available and the siting and layout of the two aerials similar, this is still probably the better method. The majority of amateurs, however, lack the space for a multiplicity of aerial systems, and theirs becomes a special

problem, which it is thought may now be answered.

Basically, the two-band system which is described is a half-wave dipole centre fed by an 80-ohm feeder on the fundamental mode. The only difference which may be observed between this aerial and the conventional dipole is in the inclusion of the series blocking condensers (of negligible impedance) inserted between the feed and the aerial proper, which are included for control purposes only (See Fig. 1).

The second operational band is pre-selected, and if of higher frequency than the fundamental, the aerial functions as a conventional system, the type depending on the frequency. If, however, the selected frequency band is lower, the aerial is made to operate with reduced efficiency as a compressed dipole. The aerial described here operates on a 20-metre fundamental and a 10-metre harmonic. In this latter mode the dipole becomes two "in phase" half-wave elements, transformer coupled to the 80-ohm feeder, with an expected power gain of 3 dB over a single dipole (See Fig. 2).

It is emphasized that on any band the system is coupled to the transmitter or receiver by an 80-ohm matched impedance feeder of any length.

Some Practical Considerations

It is well-known that the actual length of a half-wave antenna is not exactly equal to a half wavelength in free space, but is shorter by about 5%. This figure rises slightly with large increases of frequency and is due to what are termed "end effects." When, however, more than one half wave appears on an aerial element these "end effects" become less apparent and the factor is modified. Considering the system under discussion, it will be seen that in neither case does more than one half-wave appear on any element, and *in this particular instance* the modification does not apply. This means that

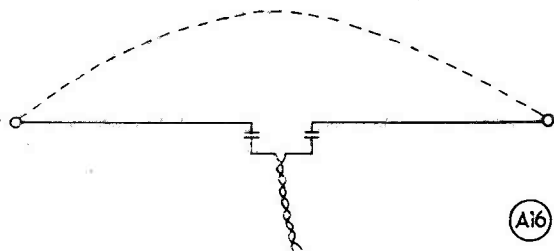

Fig. 1. The familiar diagram to show the current distribution on a half-wave dipole.

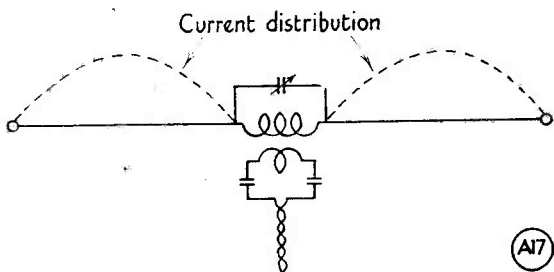

Fig. 2. Current distribution on the two-half-wave system discussed by G2QG.

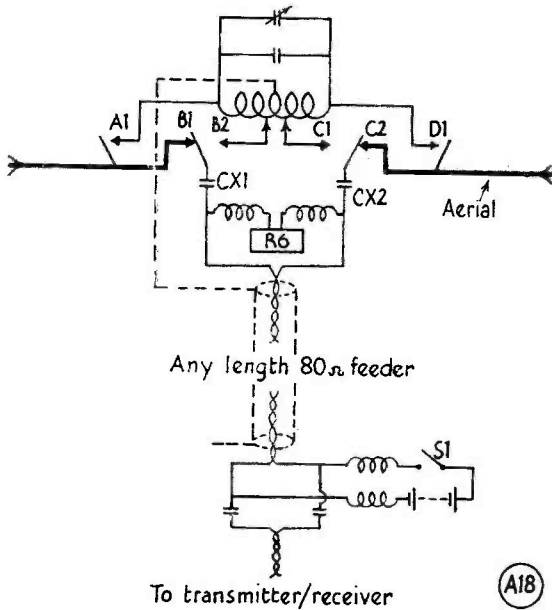

Fig. 3. Detail of the switching and relay layout in the G2QG system.

if the aerial is cut to the correct length on the fundamental it will automatically be correct on the harmonic. The actual length is given by

$$L \text{ (feet)} = \frac{492 \times 0.95}{f \text{ (megacycles)}} = \frac{468}{f \text{ mc}} \quad (1)$$

In the case where the selected band of harmonic operation has a multiple of half waves along its elements, e.g., 80-metre fundamental, 10-metre harmonic, the correct length of a single element is given by

$$L \text{ (feet)} = \frac{492 (m - 0.05)}{f \text{ mc}} \quad (2)$$

Thus from (1) and (2) the length difference is given by

$$\Delta \text{ feet} = 2 \left(\frac{492 m - 0.05}{f_1} \right) - \frac{468}{f_2} \quad (3)$$

Where m = number of half waves along one element (half the aerial).

f₁ = harmonic frequency in megacycles
f₂ = fundamental frequency in megacycles

$\frac{\Delta}{2}$ is then the length which must be added to each element to make correction.

Example: A two-band aerial is required to work on 80 and 10 metres and the fundamental frequency is 3580 kc.

The harmonic frequency = 3580 × 8 = 28,640 kc. By inspection, four half waves lie on each element, thus "m" = 4. Substituting in (3)

$$\Delta \text{ feet} = 2 \left(\frac{492 (4 - 0.05)}{28,640} \right) - \frac{468}{3,580} = 5 \text{ ft.}$$

∴ the equivalent length to be added to each element
= $\frac{5 \text{ ft}}{2} = 2 \text{ ft. } 6 \text{ in.}$

This change in elemental length is not serious as far as the aerial itself is concerned, but it does have the effect of mismatching the feeder, and in the case of the end-fed Zepp alters the phase distribution along it with consequent loss of power to the aerial. For all practical purposes in the present system this change in length can be accommodated.

Method of Control

The band change is effected by the use of a relay located at the aerial centre, and remotely controlled from the transmitter. The method is shown clearly in Fig. 3. This relay is of a simple type, having two "change-over" and two "make" contacts, preferably of low capacitance, although the actual relay used in the prototype was a war surplus telephone type which at its face value appeared quite unsuitable, but actually performed quite well. It may be thought that in order to carry appreciable power the relay contacts must be comparatively large. This would be true if it were necessary to break or make the circuit whilst current was flowing, but it will be realised that change over is made under static conditions, power being applied only after contact has been made. It should, however, be ascertained that the contacts will carry the desired current, as any heat generated might well be transferred to the springs, affecting their temper, which would in time upset the efficient functioning of the relay.

In its non-operate condition RF energy on the fundamental mode is transferred via the 80-ohm feeder, CX1, B1 on one side, and CX2, C2 on the other, making the whole a half-wave centre fed dipole. When the switch S1 is closed DC is supplied from a suitable source to the energising coil of the relay R6 via the feeder and RF chokes; the relay then throws, coupling the feeder to the low imped-

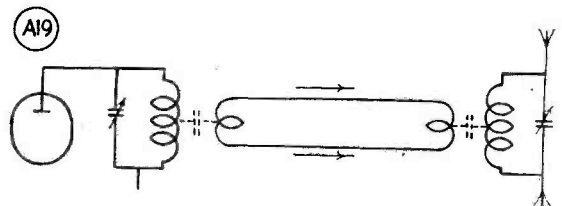

Fig. 4. Representation of the coupling effect between RF source (PA) and tuned load (aerial).

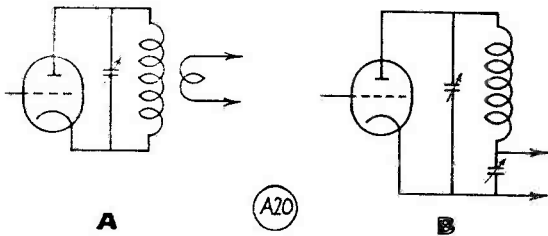

Fig. 5. Output coupling methods discussed by G2QG in his article.

ance winding of the transformer, the tuned secondary of which is at the same time connected to the aerial elements. The RF chokes are effectively in parallel with the 80-ohm feeder, but as their impedance is of the order of several thousand ohms the effect on the performance of the feeder will be negligible. Similarly, the series condensers will have negligible effect. The reactance of a 0.01 μ F condenser at 14 mc is of the order of 1 ohm, and any mismatch occurring would be less than the manufacturing tolerance of the cable, and the effects of objects in the vicinity of the aerial.

Matching the Feeder

In order to maintain correct matching due to change in aerial length with change of frequency, reference to which has already been made, the connections between the tuned circuit and A1, and the other side of the tuned circuit and D1 (Fig. 3) are each made equal to $\frac{\Delta}{2}$

In practice this may be best accomplished by using two or three inches of wire in the form of a slow loop, the small inductance thus formed being adjusted so that with the transformer on tune, maximum energy is transferred to the aerial with minimum standing wave ratio.

The aerial, however, will operate quite satisfactorily even if the above be dispensed with, as the action of tuning has a compensating action of its own over small limits, and a surprisingly high standing wave ratio can be tolerated without great loss of power. For instance, if the mismatch ratio is as high as 3/1 the loss over a perfectly terminated feeder is only of the order of 1 dB.

Details of the transformers used for the various bands are given in the Table.

Band (Wavelength)	No. of turns Tuned secondary. Spacing = Wire Diameter	Approx. Tuning C Including strays	Primary tapped across Turns	Int. dia. of L in inches	Wire Gauge
10	6	30 μ F	1.5	1.25	1/2" copper
20	10	60 μ F	2	1.25	14 SWG.
40	14	120 μ F	2.5	1.25	14 SWG.

Reference to Fig. 3 will show that an optional centre-tap is provided at the aerial termination on the high frequency mode when a screened and balanced feeder is used; this is to assist in obtaining a more symmetrical system as a whole, and the suppression of TVI. Higher order harmonics may be fed to an aerial by capacity currents as shown in Fig. 4, where "in phase" TVI currents flow up both feeders into the aerial via the capacities shown dotted. This may be overcome by centre tapping the primary of the transformer when the currents will produce equal and opposite fields in each half of the primary. Since the fields are equal and opposite the net inductance and therefore the effective impedance is zero, unwanted

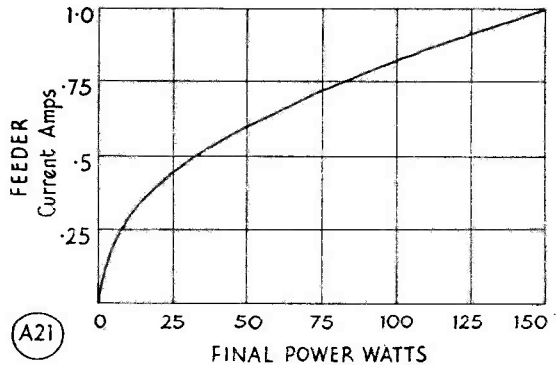

Fig. 6. Curve showing relationship between PA Input Watts and Feeder Current Amps. in the system suggested by G2QG.

currents being returned to earth via the short circuit so formed.

The above will not assist if interference is radiated when the aerial is operating on its fundamental mode, and other means of suppression must be found. It may be advantageous where the output stage of the transmitter is single ended, to modify the plate tank circuit and feed the aerial asymmetrically. The performance of circuits (a) and (b) in Fig. 5 are similar. In the case of (a), correct matching is found by altering the coupling between the tank circuit and the coupling coil, and approximately the same percentage of harmonic voltage exists in the output as is across the plate

circuit itself. In (b) correct matching is obtained by altering the ratio of the two condensers with respect to each other whilst keeping the circuit on tune; this circuit reduces the harmonic percentage by a factor $1/m^2$, where "m" is the order of harmonic.

Radiation Pattern

Little need be said concerning polar diagrams as these follow standard patterns. It is perhaps wise, however, to mention a disconcerting effect which can be traced to the effect of the polar diagram. It will be found in practice that if on receiving a station whose direction is such that the incoming wave is coincident with, or approaching, a null in the polar diagram, when the aerial is switched to the other mode the signal strength will increase. This is because the feeder becomes miterminated and unbalanced, and in consequence picks up signal voltages which may be greater than those picked up by the aerial itself. Similarly, when transmitting, if change over is made, the feeder current may rise considerably, indicating large standing waves as a consequence of the mismatch. The curve Fig. 6 indicates the order of current in the feeders which may be expected with a transmitter operating at 50% efficiency, and with no standing waves on the feeders—which, incidentally, is an extremely unlikely condition using *any* aerial system.

Multi-Band Operation

It is suggested by the writer that the system can be expanded to triple or multi-band working by the use of an additional relay or relays. The principle is indicated in Fig. 7.

The operating coils and contacts of the relays are shown without the RF portion, for the sake of clarity. Two identical relays are used (though two special relays could be used, dispensing with the series resistance in the R2 circuit) in which in the operating coil circuit of one (R2) is a series dropping resistance. DC power is applied to the feeder and R1 operates, giving one set of conditions. Owing to the voltage drop across X1, R2 does not operate until the applied volts are increased sufficiently to overcome this series resistance. When this critical value is reached R2 operates, cutting off R1, giving a second set of conditions. The principle may be expanded to any reasonable number of circuits.

In conclusion, the author wishes to acknowledge the help of many friends who have assisted in the preparation of the above, by criticising, standing-by for tests, and giving

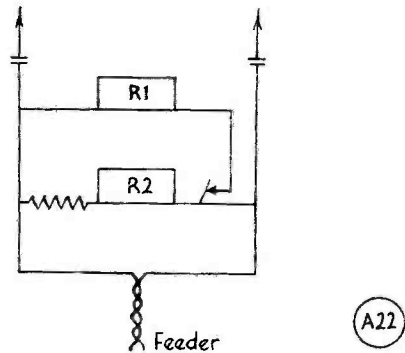

Fig. 7. Details of the relay connections.

reports. Special thanks are due to G3GFN, who unstintingly gave of his time, carrying out quite elaborate tests between the aerial described, a dipole, and a three-element beam on 10 metres, under as nearly as possible identical conditions. The author offers no comment upon the results, but merely quotes the analysis of reports given by many brother amateurs who unwittingly took part in the tests:

Half-wave dipole. G2QG. Three-element beam.
Reference. + 8 dB + 9 dB.

MODEL ENGINEERING EXHIBITION

The annual exhibition organised by our well-known contemporary THE MODEL ENGINEER is to be opened on October 20 at the New Royal Horticultural Hall, Westminster, S.W.1. by H.R.H. The Duke of Edinburgh, K.G., F.R.S. Radio-controlled models, both ships and aircraft, will again be a feature of an interesting display covering the art and science of model engineering. The exhibition will be open for the week to October 25, and is well worth a visit.

XTAL XCHANGE

Following are this month's offerings. Notices for insertion in this space, which are free for crystal exchanges *only*, should be set out in the form shown below, on a separate slip headed "Xtal Xchange—Free Insertion." All negotiations should be conducted direct.

G2ATJ, 5 Kiln Hill, Tweedmouth, Berwick-on-Tweed, Northumberland.

Has 7000, 7075, 7100, 7125 kc crystals, FT-243 fitting, no certificates. Wants any frequencies 7010-7045 kc, any type mounting.

G3EGH, 4 Gainsborough Avenue, Withington, Manchester, 20.

Has 4000, 7040, 7240, 8001.43, 8007.69 kc crystals, 3/4-in. pin spacing. Wants 3.5 and 7 mc frequencies, and 100/1000 kc bars.

G3WR, 6 Green Ridge, Brighton, 5, Sussex.

Has variety of crystals in 4, 5, 6, 7 and 8 mc ranges. Wants 6994 or 9325 kc crystal.

G4QW, 38 Chatsworth Avenue, Merton Park, London, S.W.20.

Has Brookes 3510 and 3520 kc crystals, certificated. Wants QCC octal-mounted 100 kc bar.

Volume Compression in the Modulator

PRACTICAL CIRCUIT AND VALUES

E. A. RULE (G3FEW)

Our contributor shows how the well-known principle of Volume Compression can be applied to a modulator unit, permitting a much higher degree of true modulation to be obtained without spill-over or splatter due to over-control. Preliminary tests on a modulator incorporating these principles could most conveniently be carried out on the LF bands.
—Editor.

IT is not generally realized that a modulation level of exactly 100% is unobtainable over the whole range of audio frequencies using conventional equipment, since the amplitude at any particular frequency varies over the entire audio range. In addition, the harmonic content and phase distortion through the amplifier all contribute to excess of spurious signals, often greatly removed from the normal sidebands, especially with a very fully modulated signal. Also, there is the tendency for the operator to accentuate or otherwise vary the syllabic intensity, particularly when talking close to a microphone, under which conditions slight movements of the head cause a change in the modulation level.

For 100% modulation, the amplitude of the RF carrier on positive going audio will rise

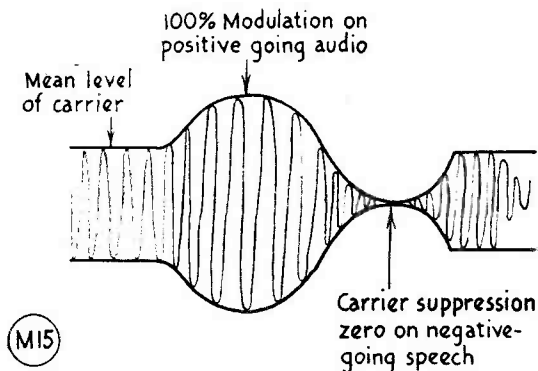

Fig. 1. Shape of the modulation envelope.

twice its normal value, and for negative going audio will fall to zero, as in the familiar diagram of Fig. 1.

If the level of modulation is greater than 100%, then on negative going speech the carrier may be cut off, resulting in bad distortion, and the occupation of a very wide RF channel.

This will occur if the level of modulation is not constant, e.g., if the power from the modulator is rising above that required for 100% modulation, which is brought about by the varying level of speech voltage to the grids of the modulator valves, or to the preceding low frequency amplifiers.

Volume Compression provides an automatic control of signal voltage to the grids of one or more of the early stages of the speech amplifier. The principle of operation is very similar to the automatic gain control on a superhet receiver, inasmuch that the amplifying stages preceding the second detector are controlled by bias produced by rectification of the incoming signal voltage. This allows the RF and IF amplifier valves to develop their full amplification for a weak signal and limits the gain on a very strong signal which would otherwise overload the detector and/or speech amplifier. To some extent control over varying signal strength (fading) is achieved by this method.

Theory of Transmitter Operation

With proper adjustment, an average increase in modulation level of about 7 dB (audio power gain) can be secured without exceeding 100% modulation on peaks. If an audio input of one volt, at say 1,000 cps, is producing an output from the amplifier of ten watts, assume this to modulate the RF carrier to 100%. Now, if the audio input were reduced to 0.5 volts, and as the result of this, the amplifier output falls, to say, five watts, then the modulation level would be lowered accordingly. On the other hand, if the audio input to the grid of the first stage is raised to two volts, then, providing the amplifier is capable of handling this amount, the output will exceed that required for the 100% modulation level. As

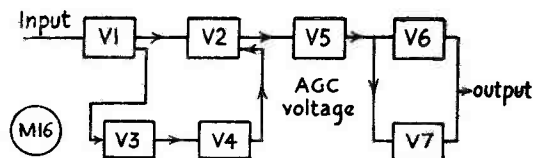

Fig. 2. Block diagram of an amplifier incorporating Volume Compression.

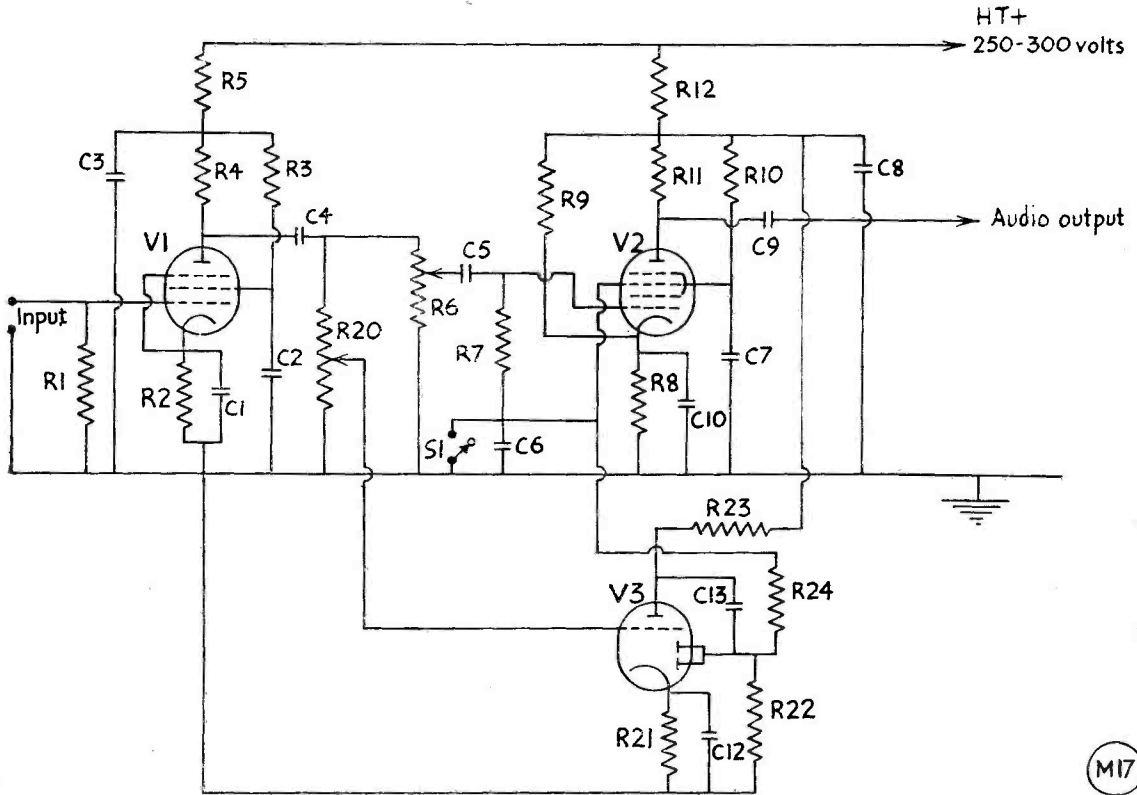

Fig. 3. Circuit diagram complete of a modulator using Volume Compression, as suggested by G3FEW.

already mentioned, the action of volume compression will either limit the higher input voltage to one volt, or allow the first amplifier stage or stages to maintain amplification sufficient to raise the lower input of 0.5 volt to a level capable of producing the audio output required for a 100% modulation.

Fig. 2 is a block diagram of an amplifier with volume compression and the circuit operates as follows:

The first valve in the circuit (V1) is a normal preamplifier stage into which is fed the microphone in the usual way. The anode circuit is divided, and the voltage developed is fed to two potentiometers, one of which is the grid load of V2, the other controlling the audio voltage to the grid of V3, which is a triode, and operates as an amplifier, its output being fed to a diode, (V4), which rectifies the audio voltage. This is used as bias to control the gain of V2, a pentagrid, the gain of which is varied in inverse proportion to the audio voltage from the first stage. Then follows V5.

which may be a phase inverter driving V6 and V7 as the audio output stage.

The circuit of V1, V2, V3 and V4 may be used in front of any normal transformer or resistance coupled amplifier, in turn used to drive a push-pull or single ended output stage.

Practical Circuit

A practical circuit is shown in Fig. 3, which used a 6J7 as the first amplifier, a 6L7 as the

Table of Values

Fig. 3. Circuit of Modulator unit incorporating Volume Compression.

C1, C10	= 50 μ F, 50-volt	R9	= 220,000 ohms, 1 watt
C2, C4		R10, R11	
C5, C6		R23	= 100,000 ohms
C9, C13	= 0.1 μ F, 500-volt	R12	= 10,000 ohms, 1-watt
C3, C8	= 8 μ F, 500-volt	R20	= 0.5 megohm, linear
C7	= 0.5 μ F, 500-volt	V1	= 6J7 or EF37
R1, R21	= 4.7 megohm	V2	= 6L7
R2, R8	= 1,200 ohms	V3	= 6SQ7 or 6Q7
R3, R7	= 2.2 megohm		
R4, R22			
R24	= 470,000 ohms		
R5	= 47,000 ohms		
R6	= 0.5 megohm, log. law.		

(All resistors 1/2-watt rating except as stated)



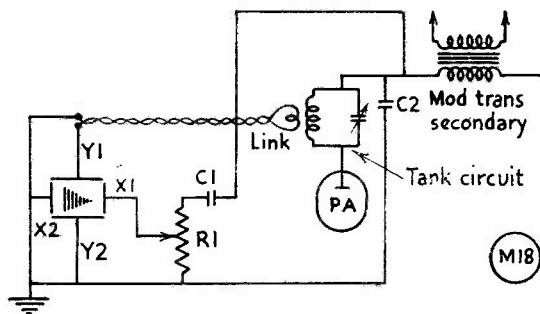

Fig. 4. Electrical layout at G3FEW for adjustment of the modulator using an oscilloscope. C1 is a $0.1 \mu\text{F}$ DC blocking condenser, suitably rated; C2 is the usual RF by-pass capacity; and R1 is one megohm.

pentagrid control valve, and a 6SQ7 compression amplifier and rectifier combined. The operation of the circuit is similar to that already given for the block diagram.

R1, the grid load to the first valve, may be substituted for a variable control as desired, but must be included in the circuit, particularly if a crystal microphone is used. The switch S1 is provided to short circuit the AGCV line from the junction of R24, R7, C6, when compression is not required. The system then operates as a normal amplifier.

The audio output is taken from C9, and may be used to drive a phase inverter, or other type of LF amplifier as desired. For normal operation of the circuit a voltage of between 250 and 300 volts is required. This may be taken from an existing power supply which is capable of supplying the extra current.

Setting Up

The adjustment of the compressor control, R20, is rather critical. First set this control to zero, slider to the earthed end of the potentiometer, and adjust the gain control, R6, for full modulation with the particular microphone in use. The switch, S1, must be open during these adjustments.

Advance the compressor control (R20) until the amplifier just "cuts off" (output decreasing to a low level) on peaks. When this point is reached, back off the compressor control until the cut-off effect has gone, but an obvious decrease in gain follows each peak.

Because of the necessity of filtering out the audio frequency component in the rectifier output there will be a slight delay (amounting to a fraction of a second) before the decrease in gain "catches up" with the peak. This is caused by the time constant of the circuit and

is unavoidable. When a satisfactory setting is secured, as indicated by good speech quality with a definite reduction in gain on peaks, the gain control R6 should be advanced to give full output with normal operation. Too much volume compression, indicated by the cut-off effect following each peak, is definitely undesirable, and the object of adjustment of the compressor control should be to use as much compression as possible without danger of over compression.

Adjustment by Oscilloscope

The use of an oscilloscope makes for much easier adjustment, the writer having done it by the following method :

A CRT with a suitable power supply for the EHT, together with the necessary brilliance and focus controls, is used with the X-plates connected for horizontal deflection. The voltage developed across the modulator transformer secondary is fed via a suitable DC blocking condenser to one X-plate, the other being grounded.

The Y-plates are connected through a twin lead to a link coil, consisting of sufficient turns to pick up enough RF from the tank coil, to produce a trapezium waveform of sufficient amplitude with full modulation. Fig. 4 will

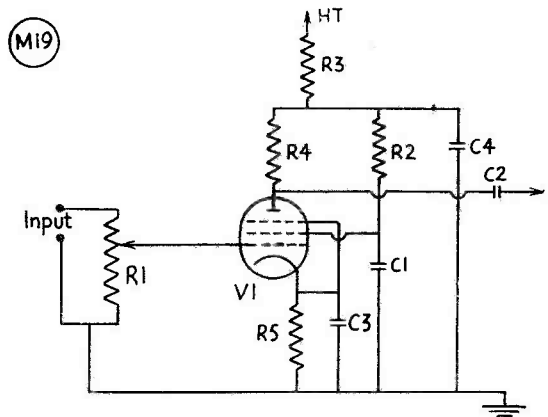

Fig. 5. Circuit of the pre-amplifier used by G3FEW. It can be near the microphone and connected into the speech amplifier proper by screened lead.

Table of Values

Fig. 5. Circuit of suitable pre-amplifier

C1 = .01 μF , 500-volt	R2 = 390,000 ohms
C2 = 0.1 μF , 500-volt	R3 = 10,000 ohms
C3 = 25 μF , 50-volt	R4 = 220,000 ohms
C4 = 4 μF , 500-volt	R5 = 3,300 ohms
R1 = 2.5 megohm	V1 = EF37, or EF37A.

illustrate more clearly the arrangement as used.

Conclusion

It was found from experiment that an improvement in the operation of the compressor was obtained by using .01 μ F coupling condensers throughout.

An almost non-existent hum level was evident when using an EF37 high gain amplifier valve as in Fig. 5 (this valve is specially designed, and useful for its low microphonic properties). A by-pass condenser across the cathode resistor (R8) of the 6L7 resulted in a considerable increase in gain, and a further

reduction in hum, probably due to heater/cathode leakage on the particular valve in use.

The system has proved its usefulness, and on tests an approximate gain of 6-7 dB was obtained, when compared with signals from the same transmitter, modulated without compression. On 160 metres over long distances the advantages of Volume Compression were such that a high average level of modulation could be maintained without causing interference and splatter to local stations. In the writer's opinion, the simplicity of the circuit and advantages obtained by the high modulation level that can be gained most certainly warranted the few components required for its construction.

Useful Workshop Tool

STRIPPERS AND GRIPPERS

J. W. HOBLEY (G2VU)

THESE tools are made from door lock springs, or they could be fabricated from suitable strip spring steel.

The larger one, Fig. 1, is mainly for stripping covered wire or flex, and if used properly does so without cutting the strands. It is also very suitable for cleaning the pins of electric light plugs and similar light fittings.

Take a spring 7/16in. wide and make it red-hot all over in a gas flame or bunsen burner. Bend and cut both ends to the same length. Bring both ends to a bright red heat and shape them as Fig. 1, so that they overlap closely when brought together. Bring the outside end to a bright red, cool slowly, and file a V-slot 3/32in. deep half-way in that end. Then file the inside edge to form a cutting tool.

The smaller tool, Fig. 2, is for the difficult operation of cleaning all round the pins of miniature all-glass valves, multi-pinned valves and similar small jobs which cannot be done properly in any other way.

In this case, use a spring 3/16in. wide and treat as before. Cut to the same length and bend slightly inwards, but do *not* overlap the ends. Bring one end to a bright red, cool

slowly, and with a small round file cut an inside groove in a central and lengthwise position to act as a guide. Then file the other end square to match.

Application

When cleaning off the pins of valves, place the cleaner at the bottom of the pin and draw upwards with a slight pressure. In the case of miniature valves, particularly, the process

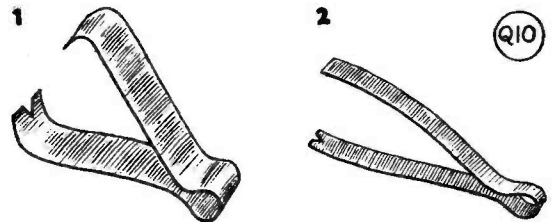

The shapes made up and described by G2VU.

should be regarded as burnishing rather than scraping. The slight oxide-film which sometimes forms on these pins tends to be non-conductive and is easily cleaned off with this simple tool.

To use the larger tool, place thumb and first finger partly over the ends so as firmly to grip the wire to be stripped. If leads coated with plastic material are slightly warmed, they will strip easily and cleanly.

DX COMMENTARY

L. H. THOMAS, M.B.E. (G6QB)

ALTHOUGH the bands, at the time of writing, seem to be in a deplorable state, we have hopes that it is only a temporary lull. The latter half of August and the first few days of September appeared to be quite good, but since then we have gone right into the doldrums. Maybe next month's Commentary will be able to record another spectacular burst of conditions, but at the moment we don't feel very hopeful, and have been having a nice quiet time on 80-metre phone!

One of the bright spots during August was undoubtedly the 21-mc band, and we will, once more, open the proceedings with a chronicle of its doings.

The DX on 21 mc

The big surprise occurred on August 24, when the band suddenly opened wide for the whole of the States, even including the West Coast. We will let W6DFY (Los Angeles) speak for himself. "At about 1630 I noticed that OLU and FTC were coming in nicely, but nothing was heard from you fellows. At about 1645 I worked ZD9AA and ZS1FD, followed by VS2CR, who surprised me by breaking through. Then, at 1723, I heard G2PL calling me. Thereafter I worked G6QB, G5DQ, PAØUN, GM8MJ, G3GUM, G3FPQ, G5UX, LU1EP, VQ4HJP, FA9RZ, G6UT, PAØIF, ON4HC, G3AJP and G6GN—the latter at 2110. The band seemed to be riding on the threshold of an opening to Europe for several hours, as it would open for a few minutes and then fold up again." On August 26 the same thing



VK3ASD

CALLS HEARD, WORKED AND QSL'd

happened, and 'DFY worked some more.

He adds: "I believe last Sunday's opening was the biggest thrill I have had in DX Amateur Radio since I began the hobby some 25 years ago." (George is running a kilowatt to his 7-mc ground-plane!)

VK9GW is another station who has given the G's a lot of joy. G2YS (Chester) worked him on August 28 and collected his WAC on the band in the process. G3GUM (Formby) got him on the 26th, and they both thought it was the first VK-G Contact, but, of course, we recorded an earlier one (G6GN-VK2AWU) last month. 'GUM has been going great guns—note his score in the ladder!—and thinks it is a wonderful band. The Clots can have 14 mc now, he says. DX includes all W districts except 7, VE2, KV4, VP9 and most of the more usual stuff. VS7XG is being enticed on the band and should show up soon. G3GUM is con-

vinced that 21 mc suffers more from inactivity than poor conditions, and says we should give a big hand to stalwarts like FF8AG, who is willing to give everybody a new one on the band. CQ calls on a "dead" band produce dividends, too—VK9GW replied to one.

G3FXB (Hove) thinks activity has been lower than last month, and has not much DX to report, but he has worked Trieste, TA, W4, 8 and 9, and ZS. G2DHV (London, S.E.13) has heard KH6, LU, PY, ZS, VQ4 and W's and is now active on the band himself, hoping for plenty of contacts.

G3FPQ (Bordon) has got going and worked KG4AF, KV4AA, KP4CC, FA, ZC4 and ZS. G2BJY (West Bromwich) didn't think much of conditions, but his list shows QSO's with CE3AG, VS2CR, W6DFY and 6VX. TA3AA and all the usuals, and his total is 36—so it can't have been *that* bad!

GC3EML (Jersey) finds the new

WWV signals a good check (they now indicate conditions with a figure from 1 to 9 at 20 and 50 minutes past the hour). He enjoys the band very much and has worked FF8, ZB1, ZS and W's, having also heard VK4HR and a UA.

Some of the Contests this autumn are obviously going to increase the activity on the band, and then, maybe, we shall see what it is really capable of. It wouldn't surprise us if someone scored a 21-mc Century this year.

G5CP (Sale, Ches.) recently back from a three-months' trip to W/VE, "hastily erected a vertical 21 mc aerial using 300-ohm ribbon throughout," and by September 11 had worked 24 countries, with TA3AA, for WAC on the band.

Doings on 14 mc

Nothing very exciting has emerged from the 14-mc scrum. On *that* band there has been no lack of activity, but conditions have been very much up and down. Last month's remark about W5AGB/FM on Fletcher's Ice Island has brought a comment from G2SA (Burnham-on-Crouch), who worked him on July 17.

G6QX has kept up his usual midnight watches and has collected FM7WF, TG9RB (who QSL's by air mail), VP5BH (Caymans), G3AAT/OX, three FP8's, VP1AA, HP1BR, VP6 and 7, and W6KIP, who chewed the rag for thirty minutes. G3TR (Southampton) thinks that early September has been the worst patch he can remember. Once or twice he found Pacific stations coming in, but his only new ones were VP9 and CS3.

G5BZ (Croydon) has been on holiday, but managed to push his scores up a little. G8OJ (Manchester) went on Phone and worked EA6AT, VS7WA, HB1JJ/HE, OD5A and LX1BU; CW brought in KA2KW (KA is the new prefix for U.S. Forces in Japan).

G2HKU (Sheerness) raised MF2AG, who is ex-VQ4ALF, and VEREM. During his holiday, HKU and family took over G6AB's QTH, complete with rig—quite an idea worth following up!

GM2DBX (Methilhill) has

worked 296 DL4's on phone, and in recognition of this has been made the "first Honorary Member of the German-American Amateur Radio Club." DBX says that since he has collected his DXCC on phone he has been surprised how many he has met who have worked just as much DX but never bothered to claim the awards. An interesting survey of his time on the air gives the following estimates: Working DX, 1 per cent.; looking for and calling DX, 5 to 10 per cent.; making new friends in Europe or USA, 20 per cent.; chewing the rag with old friends, 70 per cent. The rest of his time seems to be spent on sending reminders to non-QSL'ers, writing reports for this Commentary and reading technical literature! Finally, he tells us that AP5B (D. T. Boffin, 4 Race Course Road, Lahore) will look after AP cards, although there is no official Bureau, as we said last month.

Talking of AP, the new station 4U-AG is located in Karachi, and was worked on 14 mc by G3ABG (Cannock).

G3FPQ (Bordon) has been doing well with his 24 watts, and says the best of a large bunch were FP8AJ, FM7WF, FB8BB, ST2HK, TI2PZ, VQ5CL, VS6CG and VR2AS. These were the results of two weeks' operating, after which a holiday was indulged

in! G3GUM says he was brooding over Poor Old Twenty when "it suddenly sat bolt upright in its winding sheet and threw KG6AB1 and HB91L/HE at me for two new ones."

G3FXB has been mostly on phone, which has brought him in KL7, OX, OD, VE8, VK6 and 7, VP9, VQ2 and VS7. On CW he raised HZ, KG6 and KH6, as well as W5AGB/FM. G3HZL (Isleworth) pushed up his score with FF8, FP8, KV4, OQ, TF, VP9, VS7 and the like; Gotaways were ET3R, FB8BB, TG9RB, YS10, ZP9RH and 4U-AJ — as nice a bunch as ever we saw.

G3CMH (Yeovil) worked two FP8's, but doesn't mention anything else . . . G3DOG (London, W.3) bumped up his score a little and then departed for F, 3A and HB . . . G8VG (Dartford) reports no change, but is all ready for 21 mc. . . . G3HDL (Liverpool) still uses his indoor aerial, but has now had to rebuild throughout because of the unfavourable behaviour of the ceiling of the room below the shack. (No, not with RF—with avoidupois!) He hopes to build a table-topper and instal it in another room eventually.

G3BDQ (Hastings) has treated himself to a new QTH and new aerial system which has made DX-chasing much easier. Selected QSO's on Twenty were with VS7,

FOUR BAND DX TABLE
POST WAR

Station	Points	3.5 mc	7 mc	14 mc	28 mc	Countries	Station	Points	3.5 mc	7 mc	14 mc	28 mc	Countries
DL7AA	508	72	128	208	100	215	G6YR	310	19	43	147	101	166
W2QHH	501	93	92	210	106	210	G3ABG	286	35	79	142	30	149
G6QB	491	51	94	211	135	227	G2BW	262	24	57	144	37	150
G2AJ	433	42	81	192	118	211	G8VG	259	34	76	123	26	140
G5BZ	422	54	90	214	64	217	G2YS	249	40	45	124	40	138
G2VD	405	42	80	175	108	183	GM2DBX	234	5	31	117	81	137
G6LX	392	58	56	172	106	194	G3GUM	218	31	38	148	1	159
G2WW	370	21	62	182	105	190	G6TC	213	17	59	100	27	119
G5FA	365	33	111	148	73	163	GM3EDU	197	37	41	96	23	116
G3FXB	345	48	95	163	39	170	G3FXA	193	22	46	117	8	124
G6QX	326	47	82	141	56	160	G3FPQ	185	43	20	111	11	114

DU, OX, VS6, FP8, AP, CO, YS, EQ, HZ and a mystery-guy called VSSAP. This latter one sounded right and came in at the right time, but how is it that we have never heard a whisper about him? Any gen. will be welcomed.

The Other Bands

Only one letter about *Ten* reaches us this month. It is from G2BW (Walton-on-Thames), who has been concentrating on his TVI-proof rig and has therefore only been on the air with some 30 watts on Ten. He insists that the band is *not dead* if only people would use it; during the last four months he has worked 23 countries thereon, and says that at least 37 have been heard. With a good receiver and aerial (and lots of patience) it should be possible to work 50 or 60 countries on Ten even this year, and if more countries were using it the score would be even higher. It's the same old tale—Nothing Succeeds like Success—and its converse is just what's troubling Ten Metres now.

A few small snippets about *Forty*: G3HZL worked 9S4AX and Y13BZL, but heard plenty more DX without working it. G3FXB raised KZ5BE, LU3DD and TI2PZ one night, and heard ZD2DCP on another occasion. He says that CT1CL and others are working ZL's and South Americans on phone.

G3FPQ found ZB1AQ on Forty and ZB2I on Eighty for new ones. G3GVY (Buxton) runs 10 watts on both these bands and says that a new country is always a Big Occasion, although it's all done strictly for fun . . . he was terrified that his new score might shift him from the bottom of the ladder, but G2BP, the rival contestant, has also jumped up a bit, so 'GVY is quite safe!

Top Band

This band is coming back into good shape, and we should have more activity to report next month. G2NJ (Peterborough) says static has been bad, although the DX (mostly OH, HA and OK) has been there. On August 30 there was an OK Contest and half-a-dozen of them were heard.



DL3XH operating G3GBS, Moseley, Birmingham, during a recent visit. He took back with him to Germany a tape recording of greetings to the DL's from the Birmingham group, and DL3XH also asks us to record his thanks for the great kindness and hospitality shown him during his stay in England.

GM3IGW (Alloa) has found it open for these same three countries and tells us that OH3NY is running flat out for WABC—he has already worked 31 Counties towards it! G3IDG (London, S.W.12) has heard 21 *countries* on this band, plus another seven doubtful ones; he wonders whether there is any hope of the DL's coming back on Top Band again.

The Trans-Atlantic Tests for this season have now been arranged—see the end of this Commentary for dates. Further details next month.

News from Overseas

ZE3JJ (Salisbury) tells us that he was awarded the first 21-mc WAC Certificate on July 24, which strikes us as pretty quick work. Although the ZE's have had the band for years, it was not until July 1 that a WAC became possible. ZE3JJ worked G, W, PY, VK, OD and OQ for his six continents.

VS9AW (Aden Command) writes in person to confirm that his QTH is in Oman (*not* the Trucial Oman), although he comes

under Aden for licensing. He has been active on 14 mc, but hopes to be on 21 and 28 mc very soon. By August 24 he had had over 250 QSO's, and worked more than 60 countries, and he promises to hand out as many contacts as possible; he will *not* listen within 10 kc of his own frequency. VS9AW (who is also G3GUK) tells us that HZ1MY, in his first 30 days on the air, worked 1200 stations in over 100 countries!

YU1AD (Belgrade), well known among all the DX types, writes to tell us something of his rig. Mirko runs 260 watts to an 813 at the end of a five-stage transmitter, which starts off with a 1.7 mc Clapp VFO. His aerial farm includes a 136-ft. Windom, 14 and 21 mc ground-planes, and a vertical dipole for 28 mc. On 21 mc, YU1AD made his WAC within two days of starting up. VK2AWU giving him the Oceania contact on July 20; probably the first VK-Europe QSO. Mirko tells us that when the Russians call "WSEM," they mean UA, OK, SP, YO and LZ but *not* YU; and that LZ stations will not work YU; also, in his own words,

"Never was there any stations in ZA-land. Those guys which signed from time to time ZA1AA, ZA2AA, ZA1A, etc., are phoneys and not located in ZA-land. There is a very heavy political terror and no chance to getting any activity from Albania."

HB9EU (Cham) claims, and gets, his FBA and WNACA Certificates. One more card, from VS5ELA, will give him the WFE as well; if this comes through quickly he will be the first to hold all three awards. A fine all-round performance indeed. Rudy says that every DX-man needs a much better receiver than a few years ago, and remarks that any station can work good DX if he has a good and selective receiver. To prove this, he quotes some of the DX stations that have recently appeared; if they have had weak signals it has been quite easy to work them, whereas the strong ones have produced terrific QRM at once from everybody calling them. To quote, again: "Many same examples give us the sureness that we can do far more with our Rx than going stronger and stronger with our power." Quite a few people could benefit by this advice.

ST2HK (Khartoum) tells us that he is active on 14020 and 14030 CW, with 22 watts to a dipole. Because of poor QSL results when he was VQ4HK (2000 cards only brought back something under a 50 per cent. return) he will only

21 MC MARATHON

(Starting July 1, 1952)

STATION	COUNTRIES
G3GUM	41
G2VD	38
G6GN	36
G2BJY	36
G8KP	33
G8OJ	31
G6QB	28
G5BZ	26
GC3EML	26
G3FXB	21
G3ABG	16
G5FA	10
G2DHW	6

QSL actual cards received. 'HK hopes to be in a position to put ST back on the map again, since ST2AM at the RAF Station has closed down.

It seems that VS5ELA, who made 450 contacts during five nights of operation, had a pretty hard time of it. The case containing all the transmitting gear was lost *en route* from Japan and has not yet been found, so a transmitter built during his trip to Japan last year was pressed into service, together with a Japanese "bug." The stay in Brunei was cut short by plane trouble, and Clyde had a fourteen-hour foodless boat trip back to Labuan, in terrific heat. He arrived in a state of exhaustion and fourteen pounds lighter! (Sounds to us like the modern version of being butchered to make a Roman holiday). Thanks to KV4AA for the above information.

SU1XZ says he was active on 21 mc for a while, and thinks that G2UX made the first SU-G contact with him. He is home on leave, but will be in SU again by October and hopes there will be some activity from those parts once more. DL2SU pushed up his score by some nine countries, but says that DX still means, to him, anything outside Europe on Twenty, or anything he hasn't already worked, on Forty! He mentions VK's coming in on Forty at 2000 GMT.

Y13BZL reports that his own activities have now ceased, but the station will carry on as a club effort signing Y12AM. All Y13BZL contacts and SWL reports received up to May last have been duly QSL'd, amounting in all to some *eight thousand* cards—which will give some idea of the burden of QSL'ing on a sought-after DX station! Stations now operating out there are Y12AM, Y12FD and Y13WH.

Writing from Santiago de Chile, CE3QC says that he has just been licensed, and during this coming winter will be on Eighty with a crystal-controlled 25 watts, on the look-out for G contacts.

This month the Four-Band Award has gone to two more Overseas claimants—HB9EU and 4X4BX. Congratulations to them

both. DX Certificates issued now total 15 WNACA, five FBA and as yet only one Worked Far East.

The Debate Continues

Last month's paragraphs about Contests and Clottery have produced some telling shots from both sides. We cannot do full justice to most of the letters merely by quoting fragments, but you can take it from us that some strong views are being expressed, with the honours about equal.

Here are some of the things they say. G3GUM: "If there

WAZ MARATHON, 1952

Station	Zones	Countries
G5BZ	36	149
G8FC	36	111
G3FXB	35	122
G6QB	34	118
G2VD	34	116
G3FXA	34	96
G2DPY	33	109
G6YR	33	103
G3GUM	32	99
G6QX	32	93
G3DOG	32	93
G3FPQ	30	79
GM2DBX (Phone)	29	94
G3BDQ	27	98
G3CMN	27	55
G2BW	25	85
G3TR (Phone)	25	76
G3ABG	24	86
G5FA	22	68
G3HDL	21	60
G5GK	17	24
G3HZL	18	56
G3IGZ	15	49
G2BAM	13	46
G2CMQ (Phone)	13	34
G6TC	12	37
G3FPK	11	31
G2BJN	10	37
G2VJ (Phone)	8	12
G3IHI	7	29
G4QK	4	7
DL2SU	3	26
G2BP	2	14
G3GVY	2	11

NOTE: New entries in this table must not include QSO's dating back more than two months from the time of entry. Regular reporters should send in their score month by month — three months' failure to do so will be taken to indicate loss of interest and the score will be deleted.

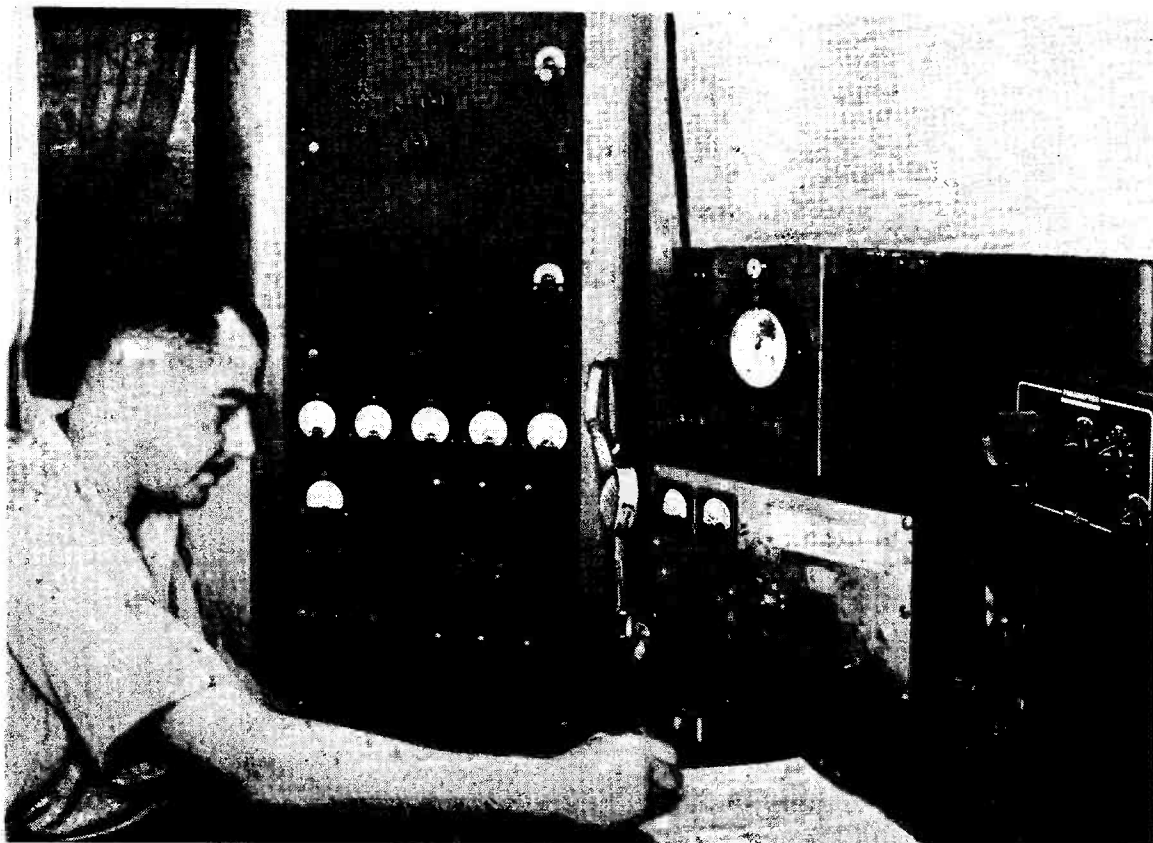

ZS6BW, Johannesburg, knocks it out on Ten, Fourteen and Twenty, with separate PA stages for each band. His aerials are rotary beams for 14 and 28 mc (note the remote direction indicator above the VFO), with a ground-plane on 21 mc. The receiver is an AR88 with a panadapter.

were no ladders, certificates or DXCC there would be no wolf-packs, no brawls over across-the-Yemen-border portables, and no rubber-stamp QSO's just to get cards. *But* the contests are here, so let's make the best of them. DXCC is something to aim at, and the ladders give one an idea of how efficient one's rig and operating are, compared with other stations. And that is thanks as much to the very sporting types who enter an absolutely hopeless score at the bottom of the ladder as the big shots at the top. We can get a lot of enjoyment out of the ladders without spoiling anyone else's, and even, in the course of it, give the other bloke some enjoyment—so carry on; help the occasional lid and jump with both feet on the real Clot."

From G2SA: "I endorse the remarks made by my old friend

G6LB. The philosophy of contests is the philosophy of the jungle—every man for himself and the devil take the hindmost—and they breed Clottery of every description."

From G6QX: "About rubber-stamp QSO's, just you try any one of the FP8's, tell him about the weather, the beautiful scenery and the colour of your girl-friend's eyes; you will probably find that he has worked about 10 other stations while you were spiling stuff about which he couldn't care less. It's all a question of two communicators communicating; if one wants a '569 QSL 73 QRZ?' contact, then the other is a sucker if he doesn't take the hint, no matter what his personal ideas about ethics. If I were a rare one and I knew others were waiting, I would pass on quickly. I have the greatest admiration for

the men at the top of the ladders; I have never believed that they had P/P 813's as buffers to a water-cooled job in the attic; in fact, they generally have P/P 807's and a dipole, but *they know what they are doing.*"

From GC2CNC: "I gave up DX'ing in 1949 and have never regretted it. If I hear DX and call it, and miss it, well, who cares? If I get it, that's FB, but still I don't get any feelings of intense jubilation. Contests give chaps a chance to have snappy QSO's, but long natters give them a chance to improve their operating. (I know one well-known Contest chap who just can't follow a normal CW chat, although he can read call-signs, QTH and RST at tremendous speed.)"

Finally, G3DRN: "Surely it is time all this Contest nonsense was

forgotten? Pre-war stations were in contact with all parts of the world on 10 or 25 watts; so is it clever for a chap with a 60-ft. beam and an 813 (CW rating 360 watts) to work, say, VU? And yet the impression is given that DX work is the be-all and end-all of Amateur Radio, and that if you don't appear in the tables you're just a lid. Is it a coincidence that so many DX men are impatient with local SWL's and newly-licensed amateurs? Co-operation, rather than competition, should be the feature of a hobby."

So draw your own conclusions from these views. But we still think that much of this argument can be left to cancel itself out if everyone will remember just three words: "Take it Easy." We know plenty who have never exceeded their licensed power, never burst any blood-vessels, and never (knowingly) been ill-mannered on the air—but their walls show that the DX has come in just the same.

General Notes

G3IDC (operating G8FC, Locking) has not been very active, but made some nice personal QSO's on the RAF Stand at the National Radio Show, including VK's, VS7, VQ8 and an SM5. He will be more active next month, and will also operate "A" from the beach at Weston-super-Mare during Battle of Britain week.

G3ATU (Roker) tells us that when ZC2MAC arrived in Ceylon, where he is, of course, VS7MC, he found his Cocos Is. licence waiting for him, with the call ZC2AB! So Mac's face is slightly red, and his QSL's (under way) will show the two calls.

We don't often have to chronicle the writing-off of a complete station, but it is our sad duty to do just that in the case of G3GRL (Hucknall). GRL turned

VK/ZL Contest:

CW: October 4, 1200
—October 5, 1200
Phone: October 11, 1200
—October 12, 1200

CQ DX Contest:

Phone: October 25, 0200
—October 27, 0200
CW: November 1, 0200
—November 3, 0200

All-European DX Contest:

CW: December 6, 0001
—December 7, 2359
Phone: December 13, 0001
—December 14, 2359

MCC (Clubs Only):

November 15 — November
22, 1830-2230 daily.

Top Band Transatlantics:

December 28, January 11
and 25,
February 8 & 22, 0500-0800
All the times quoted above
are GMT.

in one night and was awakened at 0330 to find the shack well and truly on fire. The Brigade came to the rescue, but nothing was salvaged from the debris. This is most mysterious, as the gear had been switched off for four hours and there was no juice of any kind turned on. (As a possible clue, we did once have the top tag-board of a transformer smouldering long after the big switch had been pulled, and if we hadn't noticed it at the time there might have been a big rebuild shortly afterwards!) But all sympathy to GRL, and we hope to hear a new signal from him before long.

G6QX would like to hear from anyone using a Type 145 Oscillator, in order to get the exact dial reading for the 5.2 mc range. He has been trundling up and down the dial but has not yet found it!

Contest Diary

The Contest season is with us in a big way, and here are the dates for some of the events, for which you can either lay in your stock of benzedrine or arrange to have a good week-end in the garden.

On the theme of Contests and Awards, we frequently receive letters asking for full particulars of this and that Contest (giving the rules in detail) or for information about the "Worked All Italian Provinces" Award, or the WACE, or the WASM, or what have you

Reluctantly, we must ask readers to note that there are now so many of these affairs that we cannot possibly keep ourselves in stock with full details of each and every one. Much as we would like to be able to send a leaflet by return of post in answer to all these queries, it is quite impossible to keep track of them all, especially as the details concerning some of these awards are sufficiently involved to necessitate three or four closely-printed sheets of paper!

Details should therefore be sought from the organising body in the country issuing the award, or organising the Contest. If you are not sure of the address of that body, the QSL Bureau for that country (as given in the *Radio Amateur Call Book*) is usually the correct address, and even if it is not, enquiries will be forwarded.

This concludes this month's session, so please note these future dates. Next month's deadline is **first post on October 15**, and the following one first post on *November 12*. Send all your news, views and claims to "DX Commentary," *Short Wave Magazine*, 55 Victoria Street, London, S.W.1. 73 and Good Hunting.

ARMY WIRELESS RESERVE SQUADRON

Some time ago, the possibility of establishing an Amateur Wireless Reserve was mentioned in *Short Wave Magazine* ("Here & There," August-September, 1949). The formation of the Army Wireless Reserve Squadron, Royal Signals (SR), is the outcome of discussions that have taken place. This unit is commanded by Major D. W. J. Haylock, G3ADZ.

Those who originally wrote in signifying interest in the project will shortly be notified of further details. Briefly, the unit will be part of the new Army Emergency Reserve, with a training liability of 15 days annually. Others interested are invited to write, without obligation, to the Officer Commanding, at 230 Devonshire Avenue, Southsea, Hants.

DX for G3AKZ

Attempting a Channel Swim



G3AKZ being de-greased after his 12-hour swim. The dope coming off is olive oil and lanoline, put on thick to keep out the cold. In the white sweater is the official observer of the Channel Swimming Association.

IT will probably surprise, and interest, many readers to know that among the aspirants for this year's Channel-swimming honours there was one holder of a British amateur call-sign—G3AKZ, R. T. Glynn, of Cheltenham, Glos.

G3AKZ is not only an amateur in the radio sense, but also as a swimmer, as he was entirely self-backed. And as the following account will show, it costs quite a lot of money to lay on a Channel-swimming attempt. You do not simply enter the water and strike out—you must have an accompanying hired boat, an official observer (certain stringent rules must be followed before a successful crossing can be confirmed), and arrange your transport to and from the scene of action.

Having learnt to swim in 1931 while still at school in Cheltenham, G3AKZ then started practising long-distance swimming and keeping in the water for prolonged periods. In 1949, he did 10½ hours non-stop in the Cheltenham Baths, followed by a

seven-hour night swim in the River Avon at Tewkesbury. Then came sea practice, including Southsea to Ryde, Isle of Wight—a matter of four hours—and finally a seven-hour non-stop swim backwards and forwards over this stretch.

The Attempt

On the evening of August 28 this year, G3AKZ left Folkestone in a fishing boat, accompanied by a pilot, the official observer (Mr. E. Thomas, of the Channel Swimming Association) and Mr. G. Swanson, of Cheltenham, who took the photographs. They reached Cap Gris Nez at about 0200 hrs. on August 29; G3AKZ was then sheathed in olive

oil and 5 lbs. of lanoline grease. He entered the sea at 2.45 a.m. to attempt what he calls "The long-distance swimmer's DX from any part of the world."

During the trip, he was fed on chocolate, tea and Bovril, with the fishing boat on one side of him and the dinghy on the other. The rules preclude touching the boats or anyone in them, and the only assistance permitted is a change of sea-goggles if that should be necessary.

Twelve Hours Later

Alas! the tides were running in such a way that after a 12-hours' swim, it became obvious that it would be impossible for G3AKZ to make landfall on the English side, and so, though feeling quite fresh, he had to leave the water 7 miles off Folkestone, having completed two-thirds of the crossing.

Thus ended a gallant attempt, self-backed, made after long and painstaking training. However, G3AKZ hopes to try again (if he can afford it), and in this he will have the good wishes of all readers. Incidentally, he is a man of parts. Not only an amateur active on the Top Band and Twenty with simple gear, he is a member of the British Astronomical Association and chairman of the Cheltenham Astronomical Society. He is also a bee breeder and a broadcaster on Midland Regional.

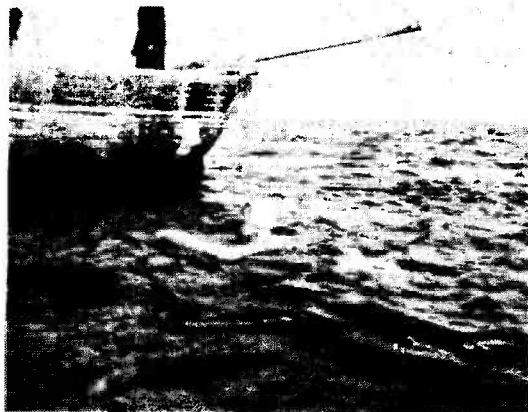

G3AKZ in the lee of the escorting fishing boat when attempting to swim the English Channel on August 29.

New Radio Propagation Disturbance Warnings

R. H. GREENLAND, B.Sc.

A Digest of the Technical Report issued by the National Bureau of Standards, U.S. Department of Commerce, Washington 25, D.C.

ON July 1, 1952, the National Bureau of Standards, Washington, D.C., commenced broadcasting new short wave radio disturbance forecasts via the NBS standard frequency broadcasting station WWV. This new service replaces the radio disturbance warning notices that have been transmitted by WWV since 1946.

The purpose of the new broadcasts is to inform users of radio transmission paths over the North Atlantic of the condition of the ionosphere at the time of the announcement, and to indicate how good or how bad communication conditions are expected to be for the next twelve hours.

The NBS radio disturbance forecasts, prepared four times daily, are transmitted in Morse twice each hour—19½ and 49½ minutes past the hour—on WWV standard frequencies of 2.5, 5, 10, 15, 20, and 25 mc, as was done prior to July 1. As in the past, the notices as transmitted include a letter indicating present radio reception conditions. However, the new notices also contain a digit indicating the expected quality of future reception. As before, the letters used are "N," "U," and "W," signifying that radio propagation conditions are Normal, Unsettled, or Disturbed, respectively. The digit is the forecast of expected quality of transmitting conditions on the scale of 1 (impossible) to 9 (excellent).

If, for example, propagation conditions at the time the forecast is made are normal, but are expected to be "Fair to Poor" within the next twelve hours, the forecast statement is broadcast as N4 in Morse, repeated five times, i.e., "N4, N4, N4, N4, N4."

The forecasts are issued by NBS regularly each day at 0500, 1130, 1700 and 2300 GMT. Each forecast statement is broadcast by WWV for a period of about six hours, until the next forecast is issued. Thus the forecast prepared at 1700 is first broadcast at 1719½ and then at half-hourly intervals, including 2249½. The broadcast at 2319½ then carries the next disturbance forecast issued at 2300.

Validity of Forecasts

The letter portion of the forecast statement, describing the quality of radio propagation conditions, is valid only for the North Atlantic transmission path at the time the forecast is issued from NBS. The digit portion is a forecast of the average quality of communication conditions along these paths in the 12-hour period beginning at 0001, 0600, 1200, or 1800—about an hour after the time at which the letter describes the condition. For example, a forecast statement of "W5" issued at 0500 means that at 0500 the conditions across the North Atlantic path were disturbed and that in the period 0600-1800 the average of conditions is expected to improve to quality 5 (Fair).

The new NBS radio disturbance forecasts refer only to North Atlantic paths, such as Washington to London or New York to Berlin. The forecasters assume that the most suitable radio frequencies for communication are available and in use along these paths. Because of this assumption, their notices must be interpreted on a relative scale in terms of experience on each radio circuit in use. It is impossible to rate conditions on an absolute scale because the varied effects of transmitter power, type of traffic and procedure, aerials, and receivers prevent an evaluation that will be valid for all systems and all circuits. One purpose of broadcasting both a description and a forecast is to show more clearly whether propagation conditions are expected to deteriorate or improve in the twelve-hour period, and this will be their chief value to users of the service.

STILL THEY COME

The Post Office announces that as at the end of July, 1952, there were 1,564,253 television licences current in Great Britain and Northern Ireland.

Digit (Forecast)	Propagation Condition	Letter (Current)
1	Impossible	W
2	Very Poor	W
3	Poor	W
4	Fair to Poor	W
5	Fair	U
6	Fair to Good	N
7	Good	N
8	Very Good	N
9	Excellent	N

VHF Beam at PEIPL

DESIGN AND PERFORMANCE

C. D. DE LEEUW (PAØBL)

THE aerial consists of a reflector screen mounted vertically on a rotary platform. The screen is guyed and reinforced against buckling.

On one side of this screen 10 half-wave radiators are mounted at a distance of 0.2 wavelength (15 ins.) from the screen. The radiators are arranged in two stacked rows of five each. The radiators are closely one half-wave long, fed in-phase and connected through 72-ohm coaxial cable via a balance-to-unbalance transformer (balun), a watertight matching box, a variable stub and a quarter-wave matching transformer (see Fig. 3). The overall cable-length from balun to transmitter is about 31 feet. A rotating joint in the feeder cable allows the aerial to be rotated through 360°. This joint is located in the transmitting room.

Aerial Layout

The screen measures 8ft. 5ins. horizontally by 14ft. 9ins. vertically. The frame is made of 19 mm. o.d. steel tubing with the same size tubing running across, spaced as shown in the drawing, see Fig. 1. Behind every radiator is a concentration of three of these tubes in order to get maximum reflection. The space between the cross tubing is filled up with straight horizontal copper wires spaced about 2ins. The radiators are 37½ins. long with a dia. of 12

Readers will be interested in this description of the successful two-metre beam assembly at the well-known Dutch station sited at the Experimental Physics Laboratory of the National Defence Research Council, The Hague, Netherlands. It will be noted that the chief feature of this design is the reflecting screen, and that the system is connected through 72-ohm line matched in by a balun transformer.—Editor.

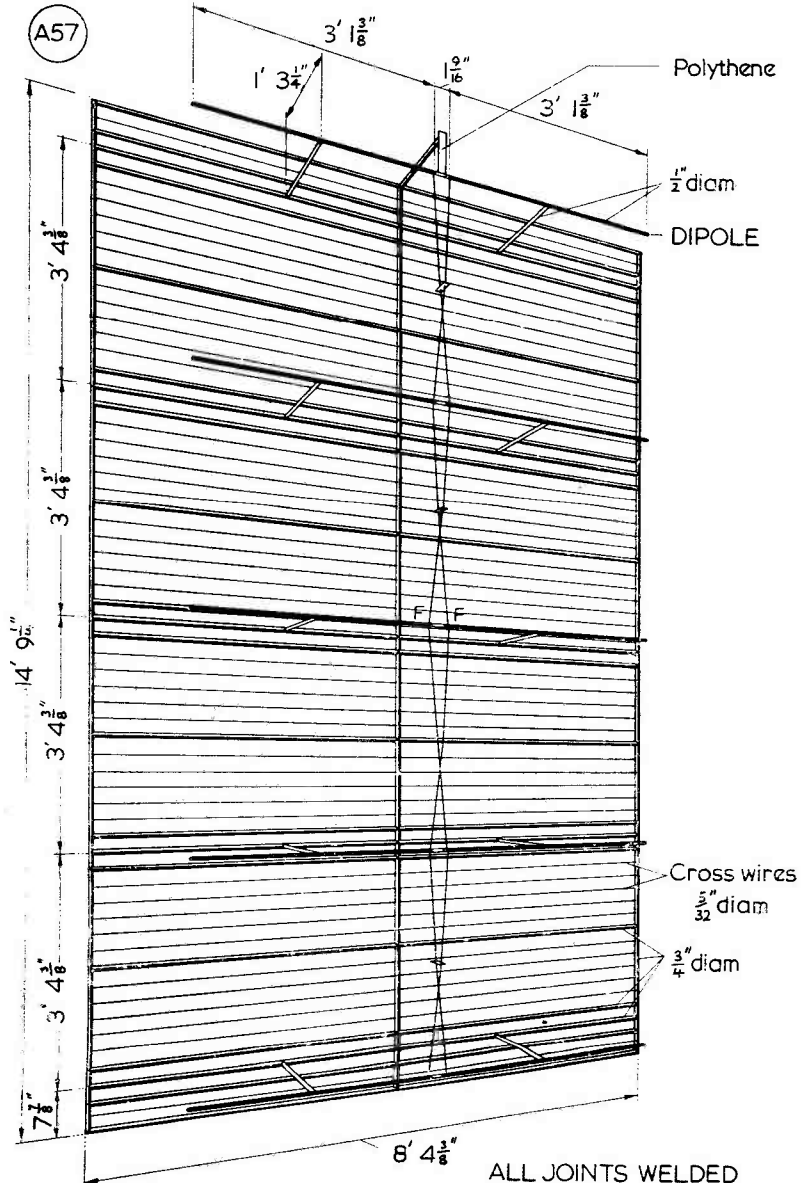

Fig. 1. Detail of layout and dimensions of beam assembly, PEIPL. It would be enough to work to the nearest inch on the main dimensions given.

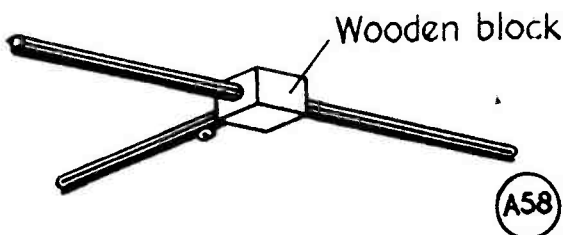

Fig. 2. The mounting block for each set of elements.

mm, and are centrally mounted on metal rods attached to the middle one of three cross-tubes. The short metal supporting rods carry a small wooden block with the radiators running through this block; the radiators are therefore insulated from the metal supports. (See Fig. 2.)

The inner ends of the radiators, separated by small polythene rods, are cross-connected by means of a transposed two-wire feeder line with polythene spreaders, while a matching quarter-wave line, made of brass tubing (FF-EE) is connected to FF. This line FF-EE is connected at the end EE to the variable condensers C1 and C2, and the adjustable stub S. (See Fig. 3.)

Matching Box, Stub and Balun

The first consists of a watertight compartment made of plexiglass or perspex, containing the variable condensers C1 and C2 of about 50 $\mu\mu$ F each and the balun transformer terminals DD.

The condensers can be adjusted by means of a screw driver through small holes in the plexiglass, which are normally sealed.

Stub. The stub is made of 10 mm o.d. brass tubing spaced 1-1/5th ins. centre-to-centre, and adjustable by means of the movable shorting bar A.

Balun. The balun consists of copper tubing with an o.d. of 14 mm formed as depicted in Fig. 3, the length being approximately $\frac{1}{4}$ -wave plus 4ins. The coaxial cable is connected to the balun in the conventional way.

Tuning and Adjustment

With dimensions as specified the tuning procedure should be carried out as follows:

The output of a standard signal generator at 145 mc (or any other suitable RF source) is taken to the feeder cable via a standing wave indicator or a reflecto-meter. The SWR or reflection coefficient is adjusted to a minimum by means of the variable stub(s) and the tuning condensers, which should finally be at equal

capacity setting. The balun remains fixed at about a quarter wavelength. If necessary, any reactance appearing across the terminals DD can be "tuned out" by means of the movable shorting bar B of the balun. The resulting SWR over the whole band (144-146 mc) is less than 1.5.

Performance

A front-to-back ratio of about 25:1 in amplitude, or 28 dB, is obtained with a forward gain of around 15 dB over that of an isotropic dipole. Fig. 4 shows the horizontal radiation pattern obtained with the assembly as described and pictured here.

Gear at PEIPL

As at the end of August, the PEIPL receiver consisted of two 6J6's as balanced RF amplifiers, 6J6 balanced mixer, crystal con-

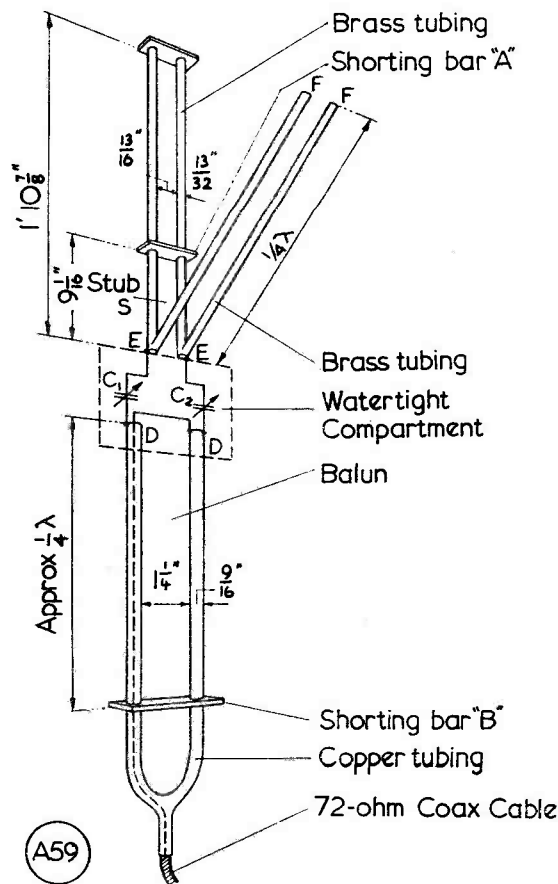

Fig. 3. The matching unit in detail for the PEIPL beam design, which allows the use of 72-ohm coax.

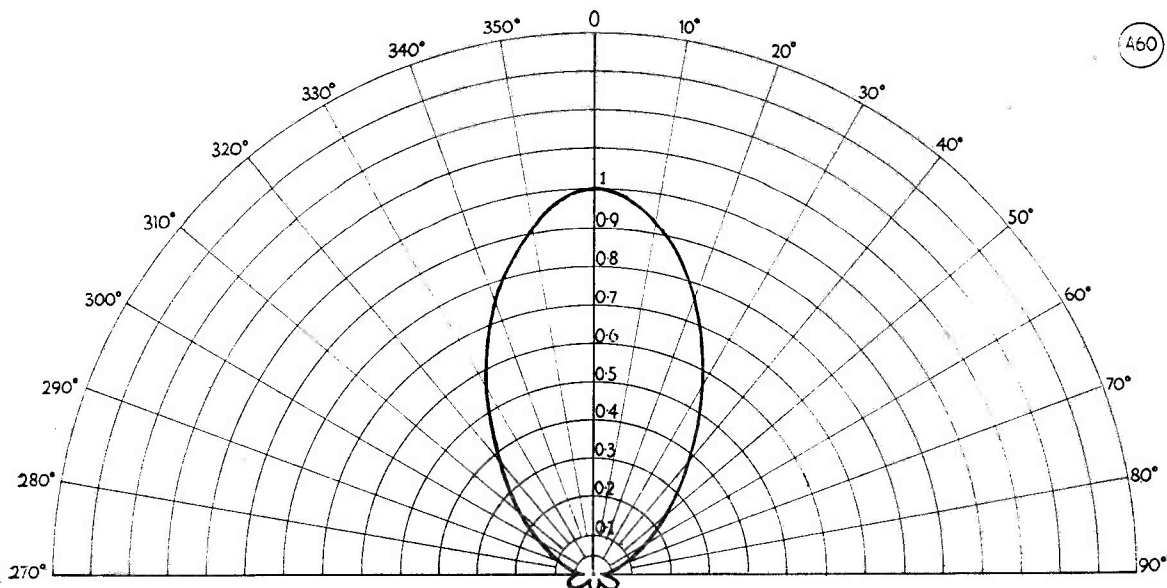

Fig. 4. Measured horizontal radiation pattern of the PE1PL array, as described and illustrated. The front-to-back ratio is about 25:1, or 28 dB in amplitude, and the forward gain approximately 15 dB.

trolled oscillator, into a communications receiver, forming a double superhet with a noise-factor of 3. The transmitter is crystal-controlled from 8 mc. followed by four multiplier stages, into a PA which is a Philips QQE-06/40 (similar to the Amperex AX-9903), giving 60 watts RF output, and modulated plate-and-screen for phone. If required, this PA can be used to drive a QRO final consisting of four Eimac 150A's, capable of an RF

output of 180 watts at the operating frequency of 144.000 mc.

Operators at PE1PL are PAØBL, PAØCW and PAØGQ, with Ing. S. Gratama in charge as chief operator. Some very good two-metre DX has been raised from PE1PL—a recent QSO was with DL6RL at 400 miles—and the station has often been heard and worked from this country.

OLD TIMER — NEW CALL

In sending us his newly acquired call-sign for appearance in "New QTH's," G3IWR remarks that he started in the Willesden Wireless Society in 1919, in association with G2UV. Joining the BBC in 1935, he is now senior television engineer at the Lime Grove establishment. During the war he was a radar and wireless officer, R.N., in the Mediterranean theatre, and was also engaged in radar research. And after all that, he is now finding time to come on the air as amateur G3IWR.



DUTCH QSL ARRANGEMENTS

There are now two QSL bureaux operating for the Netherlands—that of VERON, Box 400, Rotterdam, and VRZA, Box 190, Groningen. It seems that the PA membership is still predominantly VERON, which operates the IARU bureau. Our own Bureau accepts cards from either. In the case

of operators in this country who like to QSL directly through foreign bureaux, our suggestion is that when in QSO with PA's they ask the Dutch operator concerned through which bureau he wants his card, VERON or VRZA. In most cases, it will be the former.



CORRECTION — VHF PORTABLE

The circuit diagram of the Receiver Section of G3MY's excellent article in our September issue (p.424) contained two slight drawing errors on his original draft. The junction of R7, C12 should go to the C11 connection on coil L5—so as to get some HT on the oscillator—and in V1, there should be no other-side-of-the-cathode going down to earth; the cathode tap goes only to L1, as shown. C5 is, of course, taken direct to earth. No doubt, these slips were noticed by those interested, but we apologise for them just the same.

MUCH of the talk this time is about the sudden wide-opening on August 29, when DL6EP (Linz, Rhineland) was working G's as hard as he could go and succeeded in penetrating into the Midlands—he was there until about 0200 on August 30, and many operators stayed on for the chance of a QSO. Another EDX station showing up at the time was DL3NQ, who was not so successful in hearing the stations calling him.

On this evening of August 29, EI2W worked DL3VJ/P at 2322 BST, for a distance of 655 miles—thereby obtaining the EI/DL "first" and what at the time appeared to be the European ground record. But it is not, of course, the point-to-point record (still held by G5YV-F8MG at 620 miles) because DL3VJ was /P and therefore not working from his home location. All this was explained last month in connection with the F8II-FA9RZ QSO over 696 miles, for which F8II was working portable from a high spot (Mt. Ventoux) about 30 miles north-east of Avignon.

There has been some chuntering about this, both as regards the facts and the distance. The answers are that the facts remain as stated last time, and the R.E.F. have recorded the F8II-FA9RZ distance as 1,120 km. (which we naturally accept; anyway, it checks with our calculations). If there is a point at issue, it is whether a contact Europe-North Africa, supposing it had been made under normal conditions, would count as a European record? Having regard to the geography, and because one station was in Europe, we would say that it should. But this QSO, like the EI2W-DL3VJ/P contact, was *not* made under normal conditions.

So, while we hand it to F8II-FA9RZ and EI2W-DL3VJ/P for covering these considerable new distances on Two Metres, we wish that in both cases both stations had been operating from their usual home locations, and not with one end up on a mountain! It is for this reason that, under the rulings accepted by the VHF fraternity for the last six years,

VHF BANDS

A. J. DEVON

Continental Openings—

The Meaning of Records—

Development of VHF Activity—

Marathon Contest Progress—

G3BW Heads Annual Counties—

Station Reports and News—

the ground record still remains with G5YV-F8MG. And with this we feel that all will agree.

To elaborate the point—We all knew four years ago that a G on Snowdon could work an HB on Mt. Blanc on 145 mc almost any evening during the summer months. But the objective of all our efforts on VHF must be to make contacts over such distances possible between a G in, say, an attic shack in Acacia Grove, Coalville, and an HB living on the edge of the lake of Geneva. This *would* be communication.

It may well be said that this is difficult, if not impossible. To which the quick answer is that when we lost the five-metre band it was widely believed that only line-of-sight contacts would be possible on Two. It was your old A.J.D. who, in this space, confidently prophesied (June 1947) that 168 mc—as we then expected the new band might be—would be as good as Five Metres, if not better, for GDY and occasional

EDX working. And within a few months of the opening of the two-metre band that prophecy had been more than amply fulfilled. Now, the leading operators expect to be able to work all round the country at almost any time. This would never have been achieved if everybody had accepted the line-of-sight theory and had been content to leave GDY to the occasional /P effort. It might even be said with complete justification that it was through this column, pre-war, that the line-of-sight notion on *five* metres was finally broken down, after some years of expeditions to hill-tops to work into the next town. (The record is there for those who might want to check this).

Of course, on two metres there are limits, and it is obvious that the governing factor is still, and probably always will remain, Conditions. But, again, the point here is that when the VHF bands become more densely populated in this country and in Europe—as assuredly they will—and more operators understand better the mechanism of VHF propagation, what we now call EDX working will become common-place. This will be because people will come on when they know conditions are right, and they will find the EDX rolling in. Mark these words—you will be reminded of them in about three years from now!

In the meantime, let the effort continue to be to find and work the stuff from the home pitch, where nearly all of us are for most of our time. This is not to disparage /P working as such, whether on VHF or any other band, since it has its place in the scheme of things, and calls for much patience, skill and ingenuity in the getting of results. But, as most will agree, the taste and flavour of /P operation is something quite different from working GDY from the home location.

The Marathon Contest

As expected, this gets much more interesting. The aggregated scores for the first two legs appear in the Table, and straight away one sees a considerable change in nearly all the positions; the two leaders, G5YV and G3EHY, are still well out in front, G5YV

MARATHON VHF CONTEST

Aggregate Scores
FIRST AND SECOND LEGS
(July 19-20, August 23-24)

Station	Location	Score			Aerial	Input	Converter	Zone
		1st	2nd	Aggr.				
G5YV	Leeds, Yorks.	543	805	1,348	4/4 Stack	60	6J6/S.640	C
G3EHY	Banwell, Somerset	633	603	1,236	8-ele Stack	120	4RF-M-Osc	I
G4RO	St. Albans, Herts.	230	401	631	5-ele Yagi	25	4RF-M-Osc/BC-348	G
G2BAT	Edmouthe, Cornwall	125	405	530	16-ele Stack	100	G2IQ/AR77	I
G3HVO	Parkstone, Dorset	196	283	479	10-ele Colinear	20	3-stage HRO	H
G5DS	Surbiton, Surrey	130	324	454	16-ele Stack	65	6J6	J
G3GDR	Watford, Herts.	99	328	427	16-ele Stack	20	2RF-M-Osc	G
G3VM	Norwich, Norfolk	392	—	392	4/4 Yagi	90	3RF/TCS	G
G3BW	Whitehaven, Cumb.	387	—	387	16-ele Stack	60	6J6/AR88	C
G8IL	Salisbury, Wilts.	—	381	381	4/4 Yagi	100	4-stage RME-69	H
G3GHO	Roads, Northants.	139	236	375	12-ele Turnstile	30	RF-M-Osc 1155	G
G2FCL	Shipley, Yorks.	—	352	352	3-ele Yagi	60	2RF-M-Osc	C
G8DA	Gloucester	109	227	336	5-ele Yagi	25	2RF-M-Osc S.640	H
G3WW	Wimblington, Cambs.	335	—	335	5/5 Yagi	140	G2IQ/BC-348	G
G2XC	Portsmouth, Hants.	—	314	314	4/4 Yagi	25	6AK5 Converter	H
G6LI	Grimsby, Lines.	—	240	240	4 st'd fld d'pl	150	Cascode	E
G3CQC	Newton Abbot, Devon	—	210	210	4/4 Yagi	25	6J6-954-9002	I
G4GR	Marshfield, Mon	205	—	205	16-ele Stack	100	3RF-M-Osc AR88	I
G2DSW	Southampton, Hants.	—	171	171	4/4 Yagi	55	6J6/SX-28	H
G5MR	Hythe, Kent	—	171	171	3/3 Yagi	95	2RF-M-Osc/SX-16	J
G3DVK	Rawmarsh, Yorks.	—	161	161	4/4 Yagi	22	Cascode CR100	C
G5HN	Caversham, Berks.	—	155	155	16-ele Stack	35	5-stage HRO	H
G2FJR	Sutton Bridge, Lines.	—	133	133	6-ele Stack/R'ftr	45	2-stage AR88	E
G6PJ	Sheffield, Yorks.	20	108	128	3/3 Yagi	60	G2IQ	C
G4MR	Slough, Bucks.	—	94	94	4-ele Yagi	20	6J6/BC800A, RF24 R107	G
G2DHV	London	37	—	37	4-ele Yagi	18	5-stage/FBXA	J

having taken the stick from G3EHY. The scores lower down are running fairly close (among those who have played in both legs) and there will be a good many changes in this part of the Table before we get round to final placings.

The analysis shows that the scoring for the second leg, August 23/24, was in general much higher than the first leg. Conditions were a little better, though not much, than for the July weekend, but there was a great deal more activity—hence the higher scoring. Curiously, though, Louis G3EHY is the only operator to

make a lower score in the second leg than in the first, and yet he put in more time on the second session. All entrants worked many more stations, and the notes following are based upon a study of the logs, individually and together.

G5YV, for his magnificent 2nd leg total of 805 points, worked 41 different stations, with one 25-point contact only (G3BEX/P) and twenty-six 20-pointers, the remainder being 10's and locals, plus 100 points for 20C worked. His total operating time was 10 hours, giving an average rate of scoring of 80 points an hour;

with 51 log entries, he was working stations at the rate of about five an hour, and only ten of his 41 stations were raised for second-time points. It will be noticed that since the first leg, G5YV has changed the beam head to a 4-over-4.

G3EHY (Banwell) had 42 contacts to score, for 37 different stations in 21 counties. Calls were heard from 28 counties, but nothing from EI, GI or GM, nor did Louis have any 25-point QSO's this time. An interesting contact was with GW6NB/P, Whitton, Brecc., at 1915 on the Saturday evening; Bill apparently

flashed back to Aylesbury the next morning, as there was a QSO G3EHY-G6NB on Sunday evening.

G4RO (St. Albans) is one whose 2nd leg score is a marked improvement over his first—he managed 22C. and had a good 25-point QSO with G2BAT (Falmouth), but only got three 20-pointers, the rest being 10's, 5's and singles; in fact, the G4RO log shows no less than 16 local QSO's, and he had a total of 44 scoring contacts in 11½ hours' operating.

The big increase in G2BAT's 2nd leg score is largely attributable to six excellent 25-point QSO's—with G3ABA, G3GOP, G3WW, G4RO, G5MA and G8OU. Eight 20-point contacts, with some 10's, and 11C worked, add up to the third best score in the second leg. And it may interest G2AHP, G2XC, G3EHY, G5MR and G5UD to know that they rank as gotaways; they were heard and called, but no joy. As for the July week-end, G2BAT had no locals at all (Devon or Cornwall) in the log.

Using CW only, G3HVO (Parkstone) worked 28 stations in 17 counties and had 31 contacts to score. G5DS (Surbiton) made seven 20-point QSO's and had 32 contacts in 21C. Comparatively, with almost the same total in the 2nd leg, G3GDR (Walford) worked 24C. with F8GH (Beauvais) at 1800 on the Saturday scoring as a "county"; he had four 20-pointers with F8GH and G5YV both worked twice, and 13 locals.

A number of operators made their first entry on the second leg, the leader here being G8IL (Salisbury) with 19C and 34 QSO's to score, three of which were with F8BY (25), F8GH (25) and F9RL. G3MY/P was worked for Derbyshire, and of all the entries for the second leg, G8IL's log is the only one in which he appears. For those who would like to know, the QSO was at 1715 on August 23; most people were not on till after six p.m., by which time G3MY had evidently folded his tent.

G3GHO (Rode, Northants.) cut himself 100 points in adding up his score! We put that right for him, and found he had worked

TWO-METRE ACTIVITY REPORT

G62DRD, Forfar, Angus.

WORKED: G3BW, G12FH, GM3BDA, 3D1Q, 3EGW, 3FVX, 3IBV, 8FM, GW5MQ.
HEARD: E12W, G5YV, G13GQB, GM2BLP, 3BRW, 3ENJ, 3FGJ, 3FYB, 5VG, 6LS, 6SR, 6XW, 6ZV.

G5MA/P, Near Oakham, Rutland.

G2AIW, 2DUS, 2FCL, 2FNW, 2FO, 2FQP, 2FVD, 2FZU, 2HIF, 3AVO/A, 3BW, 3CGO, 3DVK, 3DVP, 3FAN, 3FEM, 3FVW, 3HAZ, 3HEW, 3HMH, 3HZF, 4CI, 4RO, 5ML, 5RW, 5UM, 5WP, 5YC, 6QN, 6XX, 6YU, 8HK, 8IC, 8OU (August 16 and 17).

GW5MA/P, 4 miles N.N.W. Brynmawr, Brecknock.

G2HDZ, 2HIF, 2NH, 2YB, 3BLP, 3EHY, 3FD, 3FRY, 3GHO, 3HBW, 3HCK, 3IEA, 3MA, 3WW, 4CI, 4DC, 4SA, 5BM, 5DS, 6JK, 8DA, 8ML, 8OU, 8VZ (September 6 and 7).

G3HAZ, Birmingham, Warwicks. NGR 42/023790.

WORKED: E12W, G2FNW, 3ABA, 3AMM, 3AUS, 3CFR, 3DJQ, 3EHY, 3FAN, 3FUW, 3GWB, 3GZM, 3HEN, 3HWF, 3HXO, 4CR, 4SA, 5MA/P, 5ML, 6XX, 6YU, 8DA, 8MZ, 8SY, GW2ADZ.

HEARD: DL6EP, G2AOK/A, 2ATK, 2BAT, 2COP, 2FJR, 2FTS, 2HCG, 2HIF, 2HOJ, 2XC, 2XV, 3AZT, 3BJQ, 3BLP, 3CVK, 3DUP/P, 3FGT, 3HWF, 3HZF, 3IS, 3NL, 4RK, 6CI, 6NB, 8KL, 8OU, 8SC, GW6NB/P, 8UH (August 10 to September 10).

G6PJ, Sheffield, 8.

WORKED: G2AJ, 2DRA, 2FCL, 2FO, 2FZU, 2XS, 3AGS, 3AMM, 3APY, 3ANT, 3BLP, 3CCH, 3CHY, 3DVK, 3EHY, 3FFG, 3GCG, 3HWC, 4DC, 4JJ, 4JJ/P, 5GX, 5RW, 5UD, 5YV, 6NB, 6XX, 8GL, 8IC, GM3BDA, GW2ADZ.

HEARD: G2CPT, 2FOP, 2HCG, 2OI, 2PU, 3A0O, 3BPD, 3BPJ, 3BW, 3CYJ, 3DHC, 3ENS, 3GGJ, 3GHO, 3GWB, 4CI, 4SA, 6LI, 6YU, 8AO, 8AOMM, 8AX, GW3ENY, 5MQ (During July and August).

G3HXO, Sheffield, Beds.

WORKED: G2BM, 2DSW, 2FFG, 2FJR, 2FNW, 2FVD, 3AVO/A, 3E0H, 3FAN, 3HAZ, 3HBW, 3HNS, 3HZF, 3IEX, 3IIT, 3WW, 5DS, 5GX, 6IU, 8DA, 8IL, PAONL.

HEARD: 2HIF, 2YB, 3BEX/P, 3GHO, 3HVO/A, 3HNJ, 3VM, 5UM (August 3 to September 6).

G2XC, Portsmouth, Hants.

WORKED: F8JR, G2AHP, 2AIW, 2ANT, 2DSW, 2DIO, 2FNW, 2FVD, 2OI, 2UN, 2YB, 3AVO/A, 3BEX/P, 3BK, 3BKE, 3BPM, 3CGE, 3CGQ, 3CTM, 3DEP, 3DKZ, 3FAN, 3FD, 3FII, 3FII, 3FGB, 3FRG, 3GAO, 3GDR, 3GHO, 3GSE, 3HSC, 3HVO, 3HNS, 3IBY, 3IIT, 3WW, 4MR, 4RO, 5DS, 5HN, 5MR, 5RO, 6CI, 6GR/P, 6QN, 6YU, 8IL, 8KL, 8OU, 8PX, GW6NB/P, ON4HN.

HEARD: DL3NQ, 6EP, G2FTS, 2IQ, 2XV, 3AUS, 3BLP, 3BNC, 3CFK, 3CFR, 3CNE, 3CQC, 3EHY, 3FMI, 3GHI, 3GZM, 3HAZ, 3HCK, 3HCU, 3HWF, 4DC, 4SA, 5UD, 5YV, 6AG, 6NB, 8DM/A, 8HK, 8SY, GW8UH, PAOFC (August 14 to September).

G8IL, Salisbury, Wilts. NGR41/129.307.

WORKED: DL6EP, F8BY, 8GH, 9JY, 9RL, G2AHP, 2AIW, 2BAT, 2BCB, 2BUV, 2DSF, 2DIO, 2FFG, 2FNW, 2FTS, 2HDZ, 2HIF, 2NQ, 2PU, 2XC, 2YB, 3AGA, 3ASG, 3ATV, 3BHS, 3BHS/A, 3BJQ, 3BKF, 3CFR, 3CGE, 3CGQ, 3CFN, 3CQC, 3CTM, 3DFP, 3DIX, 3FAN, 3FD, 3FFG, 3FGB, 3FII, 3FKF, 3FUM, 3GHO, 3GOP, 3GOP/P, 3HRW, 3HXO, 3HNS, 3HWF, 3HZF, 3WW, 4GR, 4RO, 4SA, 5BM, 5DF, 5DS, 5HN, 5GN, 5MA, 5MR, 5RO, 5SR, 5YV, 6AG, 6NB, 6YU, 8AO, 8MM, 8HK, 8KL, 8SY, GW4JJ/P, ON4HN.

HEARD: F8JR, G2FJR, 2OI, 2XS, 3VM, 8NM, GW3BNO, 8UH, 8SU (July 25 to August 31).

G8DA, Gloucester. NGR 32/834167.

WORKED: E12W, G2AHP, 2BAT, 2FJR, 2FNW, 2HCG, 2XS, 2XV, 3AUS, 3CQC, 3DLU, 3EHY, 3FRY, 3FSL, 3GHO, 3HAZ, 3HSD, 3HNS, 3IER, 3MA, 3YH, 4GR, 4RO, 5GX, 5ML, 5YV, 6XX, 8DM, 8GL, 8KL, 8ML, 8OU, GW2ADZ, 4JJ/P, 5MA/P, 6NB/P.

HEARD: G2AJ, 2AOK/A, 2DRA, 2FCL, 2FFG, 2FTS, 2HDZ, 2HIF, 2OI, 2YB, 3AGA, 3AVF, 3BEX/P, 3BGR, 3BJQ, 3BLP, 3CGQ, 3CVK, 3DVK, 3FAN, 3GFD, 3FGT, 3FII, 3FUW, 3GDR, 3GWB, 3GZM, 3HWC, 3HWF, 3HNO, 3IAI, 3NL, 3VM, 3WW, 4DC, 4SA, 5BM, 5DS, 5UD, 6LI, 6NB, 6YU, 8DA, 8IL, 8VZ, G13GQB, GW3BNO, 3ENY, 8UH, ON4BZ (August 12 to September 8).

G6LI, Grimsby, Lincs.

G2HIF, 2IQ, 2XC, 3AVO/A, 3GHO, 3HNS, 4DC, 5HN, 5YV (heard only, August 23 to 24).

G2HIF, Wantage, Berks. NGR 41/404855.

WORKED: DL6EP, E12W, G2AOK/A, 2BAT, 2FO, 2HCG, 2IQ, 3AZT, 3BVU, 3DKZ, 3EHY, 3ELI, 3FMI, 3FUM, 3GHO, 3ML, 3WW, 4DC, 4G4SA, 5MA/P, 6MR, 5YV, 6AG, 8IL, 8SC, 8YV, 8VZ, G13GQB, GW8UH (August 1 to 31).

G3MY, Sheffield.

WORKED: G2AJ, 2ANT/A, 2BAT, 2FCL, 2FNW, 2FOP, 2HCG/P, 2HQ, 2IQ, 2RI, 3ABA/P, 3AGA, 3A0O, 3AIU/P, 3BEX/P, 3BLP, 3BPM/P, 3CC, 3DA, 3CCH/P, 3CGQ, 3CYJ, 3DMU, 3DJQ, 3EHY, 3ERD/P, 3FAN, 3GCG, 3FFV, 3MA, 3MI, 3WW, 4JJ/P, 5BD, 5DF, 5DS, 5YU, 5ML, 5ML/P, 5RW, 5YV, 6CI, 6LI, 6NB, 6PJ, 6XM, 6XX, 8DA, 8GL, 8IC, 8IL, 8PX, 8OY/P, 8SI/P, GW3ATZ/P, 5MQ, 8UH (worked since May when P).

17C in the 2nd leg, but had no QSO's worth more than 10 points, with 28 scoring contacts. G2FCL (Shipley, Yorks.) made a very creditable 352 at his first attempt, with 15C. G8DA (Gloucester) more than doubles his first leg score, being now one point ahead of G3WW; the latter did not enter for the 2nd leg, though many of the logs show that he was on for short periods.

G2XC (Portsmouth) worked 19C and was among the very few who managed GW6NB/P. "a

colossal signal with his 4 watts." Ted also encountered one station, of his 43 contacts, who blankly refused to give him a number—the only such instance so far reported. As this station was only a 5-pointer, and it does not affect the placings above or below G2XC, we reluctantly allowed him the points! His own best QSO was with G2OI for 20.

From further down the list, stations to work out of the country were G2DSW (Southampton) and G5MR (Hythe), who

gained points with F8BY, F8GH and F9JY. G5MR is, of course, rather badly located, by reason both of screening and geography, and his best QSO north was with G2HIF (Wantage).

As always, we are grateful to the tail-enders for being sporting enough to send in entries (usually with some remark like "This will help to hold up the bottom") and, having regard to all the circumstances, the movements at the foot of the Table are just as interesting as those further up. So please come in on the next two legs, too.

Some Contest Comments

"Conditions were fair only with DX ranges never more than 180 miles, and became very poor on Sunday evening. Activity was high and well spread over the whole of the country" (G3EHY) "A future contest should be on one evening of the week, on a Wednesday or Thursday, 1800-2300, with scoring as for the Marathon; nobody would have to lose any sleep, and it would wake up the band" (G2FJR) "I feel that the rules appeared too complicated (which is not the same as saying that they were, in fact, so) and it was rather a lengthy job to explain them to Continental stations" (G5MR) "Conditions were reasonably good; among those who escaped me were G3CFK and G5UD (for Norfolk), G8IL (only 40 miles distant and S9+ all the time), G5YV (who would have been worth 30 points), and G3EHY (who must have a wave-trap in his feeders tuned to 145.3 mc!); it is unfortunate that when I beam north I look up the main road to London, and week-end ignition QRM must be heard to be believed" (G2XC) "In spite of good conditions, my total is very poor; much time was spent in vain calling northern stations" (G4MR).

And so we leave the Second Leg of the Marathon VHF Contest. The third leg will have been played off by the time you read this, but there is an opportunity to remind you that we want the logs by October 8. The last session is the week-end October

one will be on, calling "CQ MVC" and piling up the points for the Final Table.

For the information of those who may be coming up against the Marathon for the first time in this issue, the rules and all necessary information covering it appeared on pp.296-297 of the July issue.

New VHFCC Members

The QSL position must be improving rapidly, for this month we are very glad to welcome no less than seven new members who have succeeded in making VHFCC—still no mean feat, and a good target for all who are taking a serious interest in the VHF bands. VHF Century Club Certificates, Nos. 124-130 in the order given, have been issued to: G6YU, Coventry; G3DJQ, Colehill, Warks.; G3HAZ, Birmingham; G3GHO, Roade, Northants.; G3AKU, St. Ives, Hunts.; G2DSW, Southampton; and DL3FM, Mulheim-Ruhr.

Karl of DL3FM is, of course, our very first DL member, and, being remotely located, he has had to work very hard for his contacts (and the cards!) as most of his QSO's are DX. To support his claim, DL3FM put in 24 DL cards, two F's, 23 G's, ten ON's and 41 PA's. He is the holder of the DL/ON and DL/PA "firsts" on Two, and has actually worked 135 different stations—well done, Karl.

The Counties Tables

A glance at Counties Worked shows G3BW (Whitehaven, Cumb.) sitting comfortably at the top of both—with a remarkable 56C in Annual Counties, five ahead of his nearest pursuers, and three up in the All-Time list. This is a magnificent performance from every point of view, and all the VHF fraternity will want to congratulate him on it. Two years ago, the odds were all against any northerner getting into the first ten, let alone leading the field.

The stations listed in this year's Annual Counties total 47, compared with 56 entered for the 1950-51 event. Barely half the operators in that table appear in this year's listing, but nearly all of them periodically report movements in All-Time Counties. Most

TWO METRES

ALL-TIME COUNTIES WORKED LIST

Starting Figure 14
From Fixed QTH Only

Worked	Station
60	G3BW
57	G2OI (349)
56	G3BLP (567), G3EHY (365), G8SB
55	GW5MQ (188)
54	G6NB
53	G2AJ (519), G5YV (364)
49	G3WW, G4CI
47	G2HIF (187), G2NH, G5WP
46	G3ABA (274), G4HT (476), G5BY, G5DS (387), G5MA
45	E12W (132), G2XC, G5BM, G6XM (356), G6YU (183)
44	G2HDZ (307)
43	G3BK, G3COJ, G5DF
42	G4SA, G5BD
41	G2FQP, G3BA, G3DMU, G3FAN (295)
40	G3CGQ, G3HAZ (166), G8OU
39	G2IQ, G3VM, G4RO (236)
38	G3APY, G8IL
37	G2FNW
36	G3CND, G6CB (312), G8IP
35	G2FZU (118)
34	G2AHP (295), G3AVO.A, G3GHO, G5JU
33	G3FZL, G3HBW, G6CI
32	G2FCL (102), G2FVD, G5ML (131), G8IC, G8QY
31	G2FJR (103), G5RP
30	G5NF
29	G3AKU, G3BJQ, G6FA (181)
28	G3FIJ (143), G3BDA
27	G3AGS, G3BNC, G3DAH, G3GSE, G3HCU (152), G6GR
26	G3CPR (125), G3FIH, G3GBO (289), G4MR (189)
25	G5SK, G8VR
24	G3FD, G3FNG, G8KL
23	G3CWW (260), G5PY
22	G3AEP, G3BPM, G3GOP (100), G3HJ, G3EGW
21	G5MR (115), G6XY
20	G2HOP, G3EYV, G4LX
19	G3SM, G5LQ (176)
18	G6PI
17	GM3DIQ
16	G2AOL, G3FEX, G3FRE, GC2CNC
15	G2DVD, G3IWA
14	G2DHV, G3CYY, G3ISA

Note: Figures in brackets after call are number of different stations worked on Two Metres. Starting figure for this classification, 100 stations worked.

TWO METRES**COUNTRIES WORKED**

Starting Figure, 8

- 12 G3BLP (DL, EI, F, G, GC, GD, GI, GM, GW, ON, OZ, PA),
G5YV (DL, EI, F, G, GD, GI, GM, GW, ON, OZ, PA, SM),
- 11 G2AJ, G6NB.
- 10 G2FQP, G2HDZ, G2HIF, G3WW, G5DS, G6LI, GW5MQ.
- 9 EI2W, G3ABA, G5BD, G6XM, G8IC.
- 8 G2AHP, G2XC, G3BK, G3EHY, G3GH1, G3HAZ, G3VM, G5BY, G5MA, G5UD, G8SB.

operators who were in the chase this year and last worked a good many more counties in the 1951-52 list—which is what one would have expected.

Annual Counties, 1952-53, is now open, and some lists have already been received for it. However, it is proposed to start this Table again next month, and we would be glad to have all qualifying claims—14 or more worked since 1/9/52, and thereafter a note (date, station and county) each month for the additions. In particular, we very much hope that the newer stations on the band will come in for this Table, as it a measure of general progress.

While on Counties Worked—there is general approval for the idea of a 40C Certificate (see this space last month), but several correspondents have raised what seems to them to be the difficulty of getting second QSL cards to verify out of certain operators from whom they are still waiting for the first! But, surely, there are now enough regularly-active stations on in many more than 40 counties not to make it necessary to need a card from the same operator again! With new stations coming on steadily, and most interested in QSL'ing and keeping up with the scoring, it seems to your A.J.D. that in practice the difficulty should not arise. Anyway, let us see how things go, and remember that a Certificate for 40 Counties Worked 1/9/52-31/8/53 is there for those who care to claim it, with QSL cards to verify.

Station Reports — North

G3MY (Sheffield) writes that

his VHF Portable, as described last month, has been in use since May of this year, with 7½ watts into the final from a vibrator; the aerial is a collapsible 6-element Yagi, which can be cleared for action in 10 minutes, and from his "usual portable site, 1,400 ft. a.s.l." a number of stations have been worked at 150-200 mile ranges. During the latter part of July, G3MY was /P in the very south of Cornwall, with a 3-ele. beam only 6 ft. above ground; a number of local contacts were made and, though GW8UH (Cardiff) was worked several times at a distance of about 140 miles, nothing could be heard from the London or south-east coast areas. G3MY considers this to have been due to the screening effect of Bodmin Moor, rising to some 1,500 feet in that general direction. Incidentally, he hopes shortly to be able to come on *without* having to sign /P, as suitable mast supports have been obtained for the home location.

Writing from the hot seat, G3BW says (and he should know) that conditions have been patchy, with GM easier to work than stations South. He is very pleased with his 16-element stack, to which all the credit must go for his 56C in one year. G2OI (Eccles) confirms G3BW on conditions, and goes on to say that it is surprising to find from his log that during the August-September period last year conditions were generally much better than during the same period this year; as equipment has been improved and activity is much higher, it can only be that conditions have been letting us down. G2OI is only 67 ft. a.s.l. and he finds that, by taking the Rx a couple of miles up the hill, he can hear GM's with a 3-element beam on the car—but at home they are only audible under really good conditions with the beam head at 48 ft. G2OI offers himself as a regular schedule-keeper — he says he "takes a turn on Two every night"—and is already testing the 90-mile mountain path to GW3ENY.

G2FCL (Shipley) has worked 102 stations in 32C since Easter, and feels he has a fair chance of making VHFCC by the end of the

year. G6PJ (Sheffield) has begun to make progress, and is putting in plenty of time on the band, with a 3-over-3 instead of the 16-ele. used at first, which would not stand up to the wind.

GM2DRD (Forfar) found conditions poor and activity low, but with his 10 watts has nevertheless worked GW5MQ at 250 miles; testing with 6 watts, he managed several 100-mile contacts with

TWO METRES**FINAL PLACINGS, ANNUAL COUNTIES WORKED TABLE**

(Sept. 1st, 1951 to August 31st, 1952)

Worked	Station
56	G3BW
51	G3EHY, G5YV
50	GW5MQ
47	G3WW
46	G2OI
45	G2HIF
43	G3FAN, G6YU
42	G3BK, G5DS, G5MA
41	G2HDZ
37	G4RO, G4SA
36	G2XC, G4HT
35	G2FQP
34	G8IL
33	G3GHO
32	G2FCL, G2NH, G3VM
31	G2FJR, G2FVD
30	G5ML
29	G2AHP, G6TA
28	G3BJQ
27	G2FNW
26	G3AVOFA
24	G6CI
22	G3FHL, GM3EGW
21	G3BNC, G3FIJ, G3HIF, G6CB
20	G4MR
19	G3CWW, G3HCU
18	G8VR
15	G3GOP, G3IWA
14	G2DHY, G3ISA, GM3DIQ

Note: This Table re-opened with effect from September 1st, 1952 for which claims can be made as soon as 14 or more counties have been worked. The first list will appear in the next issue.

GM's and also GI2FHN at 190 miles—all of which shows that QRP can give results, even from a poor location, if the beam is right. EI2W and G5YV can be heard with good signals at GM2DRD, and the most consistent G is G3BW.

Round the South

On September 4, GC2CNC (Jersey) came up on Two "for the first time in months": he is now on 145.13 mc every evening about 7.15 p.m. and looking for contacts with the mainland. G5MR (Hythe) worked his first DL in DL6EP on the August 29 evening, and it was actually the first time he had even heard DL.

G2XC (Portsmouth) found conditions "poor to very poor" from the beginning of September, but worked GW6NB/P for Radnorshire; when Bob 5MA was /P in Brecks., however, he just could not be heard down there. Ted reports a fair level of regular activity along the south coast, and mentions the following: G2DSP, G2FTS, G2UN, G3BEX, G3FRG, G3IBY and G5RO for Sussex; G3DEP, G3FAN and G6GR/P for the Isle of Wight; G3BHS, G3BNC, G3CFR, G3CGE, G3CTM, G3DTT and G3GOP for the Hampshire mainland; and G3HVO for Dorset. He feels that this represents activity which may be above the average for the country as a whole. Incidentally, readers will be glad to hear that the medicos have now given Ted a clean bill.

G8IL (Salisbury) is another who offers regular schedules, and agrees in general with the ideas and suggestions put forward on this topic last month. But he feels that the newer stations will be interested in the shorter distances, 75-100 miles, since anything like regular working over a 250-mile path does call for good gear and a very good location, at least at one end. He suggests a more "quantitative" survey of the merits of each location (on the lines of the article by G3AUS in our last) with plots of the topography in different directions. To quote him: "Let every station prepare a contour map for his location, showing the above-horizon angles subtended around

the compass by local projections. It is surprising how 'small' a 500-ft. hill a few miles away and how 'big' a 25-ft. bump up the road are when considered in this way." G8IL wants data on active stations and frequencies along the path due south of him, through F and into FA. (In the general interest, we are looking into this, but if anyone already has reliable information, it would be appreciated). G8IL reports his two-metre results during August as excellent, with the extra beam height helping a lot to the north—first contacts were made with G5GX (Leven, E. Yorks.—210 miles) and G5YV, with easier QSO's into the Midlands.

Down in the West

A first report from G3DLU (Weston-s-Mare), who is on 145.360 mc and whose usual operating period is 7.00 - 8.00 p.m. daily; he is also making short CQ calls, beaming east, every week-day morning during October at the hour of 0630 clock time, and would welcome short QSO's with anyone who may be up and about at that time. The gear at G3DLU consists of a CV66-6AK5-6J6-6J6 receiver, and the transmitter runs 25 watts to an 832. Aerials are a 6-element beam fixed to fire south-west, and a fixed 16-element stack aimed east; this is bringing in the Londoners, so, with 8C worked so far, G3DLU hopes soon to be reaching for the bottom rung of Counties Worked. Incidentally, he would like to hear from anyone using the *inductively* neutralised Cascade, all same ARRL *Handbook*.

G3EHY (Banwell) reports conditions as moderate only, except for the period August 29-31, when they were exceptionally good. Then, from the beginning of September, they deteriorated with the change in the weather. For the period as a whole, working ranges from G3EHY were limited to 150-200 miles. On the other hand, the 268-mile schedule G3EHY/GI3GQB has proved most interesting. Between August 6 and September 6, it was kept on 29 occasions; on 22 evenings, contact was possible with signal levels ranging from S8 to S3, but always solid; on two further

MARATHON VHF CONTEST

FINAL LEG

Week End October 25-26

See Rules pp. 296-297 July Issue

Logs by November 5 for Fourth Table in December Issue

occasions GI3GQB was heard but could not be raised; and only on five evenings did the contact fail completely. Which, as G3EHY says, is interesting because on many of the successful evenings no other stations *at all* could be heard on the band. During the month, G3DUP from Northampton was visiting, and they went /P locally with interesting results and some GDX worked. G3EHY is interested in the suggestion (*see* last month) about mounting the gear in the eye of the beam, and quotes the station we know where it has already been done successfully; Louis himself intends to apply the idea to his 70-centimetre gear, when time serves.

Midlands and East

Freddy at G5ML (Coventry) has also found conditions patchy, and he and SWL Bastin can hear a lot of stations they cannot raise—samples being G2BAT, G3FAN, G4GR, G5UD and GW8UH, representing four counties badly wanted. However, the score went up one with G5MA/P when in Rutland—Bob certainly gets about on these /P jaunts, and always chooses a rare spot!—and new stations worked include G3DVP, G4RO and G4SA. G5ML also is all for the regular schedule idea, and can keep daily dates during the period 6.30 - 8.00 p.m. During the month, the 16-element stack was found to have too high a back-to-front ratio (it being desired to know what is happening in other directions as well), so it has been replaced by the 3-element Yagi, which will eventually be up at about 70-ft. This has a much poorer back-to-front ratio, but, being considerably higher than the stack, gives better results.

It was nice to hear from G3AKU again, now /A at Corby, Northants., who is only back at

St. Ives for the occasional week-end and not well placed for working from Corby—with a '522 and dipole in his bedroom! However, plans are in hand to remedy this, and in the meantime he just reads about the doings on the band. Brian of G6CI (Kenilworth) goes up again in the Tables, and has now installed a 3-ele. job with 300-ohm delta match; this has produced contacts with G3AUS (Torquay) and G3BW, with some choice pieces heard, so some interesting results are expected. And it also looks as if OT G6CI is going to burst out on 70 centimetres, too—well, we can remember talking to him on 45-metre phone, but that was a very long time ago, and nothing to do with our present theme, except to show what happens to a really keen amateur in the course of time.

G3HXO (Shefford, Beds.) reports himself on 144.97 mc most evenings, with 27C in the bag in just nine months on the band. An exciting QSO recently was with PA0NL, and G3HXO remarks that his most consistent signals from the south are G3FAN and G8IL, with G5YV always there from the north. G3GHO (Roade, Northants.) heard DL6EP and EI2W during the wide-opening on August 29, and was very pleased to work GW5MA/P for Breconshire on September 6. Otherwise, conditions have not been too good, and even G5YV faded to inaudibility during the four days September 4-7.

G3HAZ (Birmingham) is on again regularly, and by raising EI2W has "managed to get into the bottom right-hand corner of Countries Worked." This QSO was snaked-in on August 30, when everyone else appeared to be busily hunting the EDX. GDX heard and badly wanted includes G2BAT and GW8UH, and G3HAZ would also be pleased to try for GC2CNC whenever the latter likes.

G3BKQ (Blaby, Leics.) has had to be off the air for a long time due to illness, but is back again on both bands with completely re-built gear. On Two, the Rx is a CC Cascade, with an 829B in the transmitter; the aerial is a 16-element stack at 45-ft., and with this equipment G3BKQ is now set

to work all comers. In Rugby, G3BJQ spent the last couple of months experimenting with converters; this was done by building a 6C4 SEO and cathode-follower output stage on to a chassis with a 5in. by 3in. hole in it, into which could be dropped all manner of RF-and-mixer combinations, from the Cascade to G2IQ's 6J6 design. New contacts at G3BJQ during the last month included G4GR for Monmouthshire and G8IL for Wiltshire, with some local counties also worked for the first time. G3FIJ (Colchester) has only had a few hours on the band this month, but hopes to improve his scores from now on.

London and Home Counties

G2AHP (Perivale) having taken the necessary steps, is now able to work during TV hours. The new Tx runs Z77(8-24) into N78(72 mc) into N78(144), giving 12-15 mA drive into an 829B, which is screen modulated. The whole job is boxed up in a TU5 case and the PA runs at 30 watts, into a 12-element stack. Some 50 stations have been worked, including GDX on CW and phone, and now G2AHP would like to hear from one or two stations about 50 miles away who would help him carry out some aerial tests during TV hours.

Very recently on Two is G3FGB (Wembley), who is running 25w. to an 832, a G2IQ converter and a 3-ele. Yagi at 150-ft. a.s.l., but screened to the north. In a fortnight, this brought him contacts with 24S in 9C, with G2XC and G8IL as best GDX, and F8GH, G2BAT (Falmouth) and G3CQC (Newton Abbot) heard. G3FGB finds that he can receive the 50-100 mile stations at good strength when they are on, but feels that because they have probably worked so many London stations already they are not interested in him. Well, the majority are certainly only too pleased to QSO newcomers on the band, if only to push up their stations-worked score.

G4RO (St. Albans) was there for August 29, and worked DL6EP and ON4MI—he then spent one hour and a quarter answering EI2W's CQ calls, but no dice.

Another successful station during that session was G2HDZ (Pinner), who knocked off DL3VJ/P and DL6EP, and later on in the month G5MA/P was caught for another interesting QSO.

Bob of G5MA (Ashted) reports two /P expeditions during August and September. For the August 16/17 week-end he went into Rutland, and from the highest point in that county, about 1½ miles west of Oakham, worked a total of 34 different stations, for many of which it was a new county; best QSO's in terms of distance were G2FO, 135m; G3BW, 175m.; and G3FAN, 135m. For September 6/7, he was four miles from Brynmawr, Breconshire, looking right down the lovely Usk valley, and by previous experience a good spot from which to put signals into the London area; the results were 24 different stations worked, several being in Surrey and Middlesex. These two trips involved Bob in round journeys of 216 and 320 miles respectively, and once again he earns the thanks of the VHF fraternity for his enterprise and enthusiasm; and his XYL must not be forgotten, either, for not only does she put up with all this travelling, but she also assists with the gear and keeps Bob fed and contented.

G3CWW (Hendon) thinks he must hold some sort of a record, by reason of having the largest number of stations worked for the smallest number of counties—260S in 23C. G3GHI (Purley) writes to claim a footing in Countries worked, and G2FVD (Morden) reports new counties with Rutland and G6LI for Lincs.

VALE G2BN

We very much regret to have to report the death, on August 23, of G2BN, Kingston-on-Thames, Surrey. Colonel Stephens was an active VHF operator, and a member of our Fiveband Club. He was on the air until just before his final collapse. All FBC members will wish us to send condolences to his family and friends.

G4MR (Slough) spent a long time calling the DL's on August 29. Having checked up on his QSL cards, he finds he holds 154 for contacts made on the old 5-metre band, the foreigners including F, I and OZ! It is probable that there are other potential VHFCC claimants, particularly among those who started up on VHF immediately on the resumption after the war.

G2HIF (Wantage) is not sure whether his lack of contacts recently has been due to poor conditions or low activity, but was made very happy by good DX QSO's with DL6EP, G2FO, G13GQB and ON4BZ; as EI2W was also worked on the same evening, it was five countries for five calls in one session—and what could be more satisfying. G2HIF runs 20 watts only, with a 5-over-5 and a Cascade, and says that he would need a lot of convincing before he changed to anything else.

Though G3GBO (Denham, Bucks.) has added more than 20 new stations worked since last writing, he says he "seems to be firmly anchored at 26 counties" and cannot find another one. However, with the beam raised to 41-ft. and now looking over the house, he hopes to get out to the DX distances, as results are showing a great improvement.

EI2W Activity Report

Thanks to the unremitting efforts of EI2W, the VHF Research Society of Ireland—of which he has been elected first president—is making excellent progress. Membership now totals no less than 70, and on August 23 a meeting held in Clonmel, Tipperary, was attended by 32 of them, one of the largest amateur gatherings in Eire for many years. It is hoped that about 20 EI/GI stations will shortly be active on VHF, and particular stress is being laid upon the desirability of adhering to the Zone Plan—thank you, EI2W! It is planned to republish, in the society's own journal, the 6J6 converter design by G2IQ which appeared originally in *Short Wave Magazine* (August 1949).

All this work, and preoccupations with business, have kept

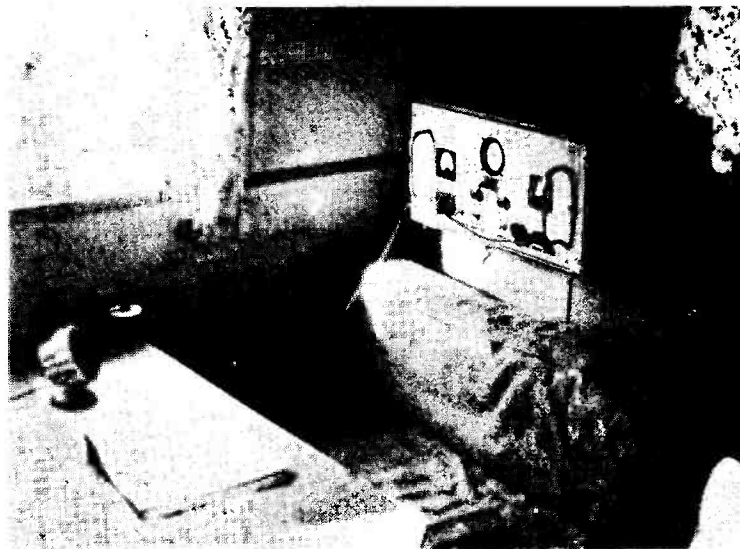

If you hear or work G3EDD, Little Abington, Carms., this is what the station looks like—it is operated from a caravan. The Tx runs 40 watts to an 815, the converter is a CC job into a BC-454, and the aerial is an 18-element array consisting of six 3-element beams in two stacks of three side-by-side, at a height of 60 feet. The VHF totals at G3EDD add up to 153S in 39C, with six countries also worked.

EI2W somewhat less active on the air than usual. Nevertheless, during August, and apart from his fine telephony contact with DL3YJ/P, he worked G2FCV, G3HAZ, G4RK, G5TH and GM3FVX for new stations.

Some Seventycem Items

G3HAZ reports increasing 70 cm activity and interest around Birmingham, with G3GZM and G3HTY cross-banding almost nightly, and G3HHY (Solihull) due on at any moment. G3HAZ himself has been testing a new aerial with G2FNW (Melton Mowbray), G3GZM (Tenbury) and GW2ADZ. Activity is also promised from over Leicester way.

The 430 mc gear at G3BKQ (Blaby) consists of a 16-ele. stack at 48 feet, with a CC receiver incorporating a coaxial RF stage and mixer. The CC transmitter has a CV82 coaxial PA, giving about 3 watts RF out. Up in Rhosesmor, GW5MQ does his share towards keeping the 70-centimetre band warm, and has recently cross-banded with a new station, G3HWC of Preston. G2OI is also active, and once again raises the question of a defined one-megacycle band in the

430 mc region. This was thrashed out at one of our VHF meetings early last year—April 14, 1951—and it was then decided that all 70-centimetre stations should aim for a transmitting frequency in the range 434-436 mc. (See p.251, June 1951 *Short Wave Magazine*). There are good reasons why a band like this should be agreed upon, as it prevents what would otherwise be unnecessary spreading—as things are at the moment—and preserves the principle of harmonic relationship with the 144-146 mc band.

Just as this issue was going to press, we were officially notified that the 25-watt embargo on the 430 mc band is to be raised with effect from November 1st next, when operators licensed for full power will be permitted to use up to the 150 watts maximum. Actually, it will not be too easy to take full advantage of this, as there are not many valves, generally available, which can be run at this input on 430 mc. The 15E is an exception, and a diligent search through the lists will probably disclose some others.

Thoughts on QSL'ing

"Have done remarkably well

for QSL's; about 95% returns so far. I QSL direct—perhaps that is the secret" (G6PJ) "Total of two-metre stations worked is now 295, with a very high percentage of QSL's—240 odd" (G3FAN) "I want 52 cards outstanding; who doesn't QSL? Nearly always the old hands!" (G2FJR) "I shall only QSL if requested; after all, no good me sending a second card to a chap if he is not interested" (G3GHO) "I cannot really complain about the receipt of QSL cards; I have received 107 cards for 143 contacts" (G3FIJ) "With 189 stations worked, 131 have sent QSL's, but cards are still wanted from a number of DX stations" (G4MR) "QSL's are a curse; the only way to get cards back is to QSL direct immediately after a contact. If cards are sent *via* the bureaux, they arrive in batches and, unless the chap has some sort of system, they get filed away and you won't get yours" (G4RO).

Calls Heard

Will all correspondents please remember that Calls Heard lists are still of great value and interest—what we would like to see would be one from every operator reporting each month; they might not all be published, but it would enable your A.J.D. to make a selection of interest to nearly everybody. The reasons why we like calls lists are: (a) They are a valuable cross-check on activity and call-signs; (b) They keep us informed as to what stations are active, and how they are getting out; (c) They give new stations on the band some idea of what can be worked, either locally or in terms of DX; (d) They let others

know what individuals are doing, and where they have been heard; and (e) They help to form the general picture of activity and results. To every reader, at least one of these reasons is a good one; to us, they are all important—so more calls lists, please!

But *do* set them out on separate sheets and in the form in which you see them in print—in alphabetical and numerical order, prefixes repeated once only, name and address at the top, period referred to at the foot, with the call-signs in block capitals. Calls Heard is one of the most difficult sections to get into print accurately—far more so than text matter.

The Form of Reports

It would perhaps astonish most of those who may be with us thus far that it has taken your devoted A.J.D. four whole days and three long evenings of concentrated work to get this offering of "VHF Bands" into print. Though the Editor merely remarks "That is what you're there for," it *would* be a great help (and perhaps enable us to get even more out of the great mass of material which now reaches us every month) if all correspondents would be good enough to consider setting out their reports under the following heads, in the order given:

(1) Dates active; (2) Best dates for conditions—very good, good, average, or poor; (3) New stations heard or worked, with QTH if possible; (4) Claims for the Tables; (5) Notes on equipment; and (6) General chat.

The advantages of receiving all reports in this general form are obvious. We are anxious to get

as much factual information about the VHF bands—and this includes Seventycems—as we possibly can, especially during what has come to be regarded as the off-season (the winter months). That can best be done by careful analysis of as many reports as possible; if these reports are in some standardised form, it makes the job that much easier, more accurate and the result more interesting for all concerned.

Attention to the rather tedious points covered under the last two heads would be more than gratefully regarded by your A.J.D.

Concluding

Once again, it was a very heavy mail, and the machine was running hot (and thirsty) long before we got round to this stage. But that is as it should be, and how we like it. This feature aims consistently to cover the whole ground, as it always has done, and for that we need a story from every active VHF operator.

Reports for the next issue of "VHF Bands" should be in by **October 17** certain, at the office, addressed to: A. J. Devon, "VHF Bands," *Short Wave Magazine*, 55 Victoria Street, London, S.W.1. With you again on November 7, and don't forget the Marathon.

MARATHON VHF CONTEST

FINAL LEG

Week End October 25-26

See Rules pp. 296-297 July Issue

Logs by November 5 for Fourth Table in December Issue

OVERSEAS SUBSCRIPTION RATES

For the information of readers overseas, and those in this country who are in "exchange relations" with foreign amateurs, the cost of a year's subscription to *Short Wave Magazine*, at the rate of 30s, and including bank collection charges, is as follows for the countries named: America, \$4.50; Canada, \$4.25; France, Fr.1545; Belgium, Fr.221; Sweden, Kr.22.85; Switzerland, Fr.19.15; Holland, f 16.76; Portugal, Es.126.80. Remittances can be accepted in any of these currencies, and guarantee the delivery

of a copy of *Short Wave Magazine* by direct mail each month.

ONE-SIDED SPEECH

G3BH, Birkenhead, is right up against it. Using a simple Top Band transmitter, his problem is that all stations report 100% modulation on one side of his carrier, 60% through the carrier, and nothing on the HF side. The answer to this one could be—Reverse the modulator output connections. If that doesn't work, then it looks like a rebuild. Any other suggestions?

Paddle for the Electronic Key

HOME-MADE KEYING UNIT

C. HENRY (GM3HLD)

FROM time to time one comes across circuits for electronic keys, but so far the writer has not seen any constructional details of an actual knob or control paddle. The key described in this article works perfectly, has been universally admired and in appearance is a slick, compact job. The base is a piece of Tuftnol or Polystyrene $4\frac{1}{4}$ ins. x $3\frac{1}{4}$ ins. x $\frac{1}{2}$ in. thick, which was an odd cutting left over from a commercial switch gear panel. The casing, which is really the basis of the design, was a sample of "Holoplast" building board: it is a hard resin composition of a dark brown colour.

The key beam is a 3 in. length of brass $\frac{1}{2}$ in. x $\frac{3}{8}$ in. channel section. A small bearing plate is checked into and sweated to the flanges of the channel for the pivot, the flanges at the other end being slotted an easy fit on 2 BA rod. The pivot is a sleeved extension bolt which is used for binding certain types of loose leaf catalogues, files and photograph albums.

For the following, see drawings: One $2\frac{1}{2}$ in. length of 2 BA tapped rod, the thread removed except at the ends so as not to bind the movement of the centring springs, and having two washers and two nuts. Two suitable terminal screws with lock-nuts to form contacts and limit stops. One piece of $\frac{1}{4}$ in. material (the writer used ebonite) to form finger grip. One countersunk bolt to connect upper portion to base, three cap-nut terminals and two com-

pression springs about $\frac{1}{4}$ in. dia. x $1\frac{1}{4}$ ins. The tension of the springs is most important; unfortunately specification data cannot be given, but from a small selection of light springs, by trial and error a nice movement can be achieved. Washers should be fitted between the ends of the springs and the key-beam, otherwise the wire of the springs is inclined to grip the slot.

If a piece of "Holoplast" material cannot be obtained, a similar box section could be built up from sheet perspex cemented with

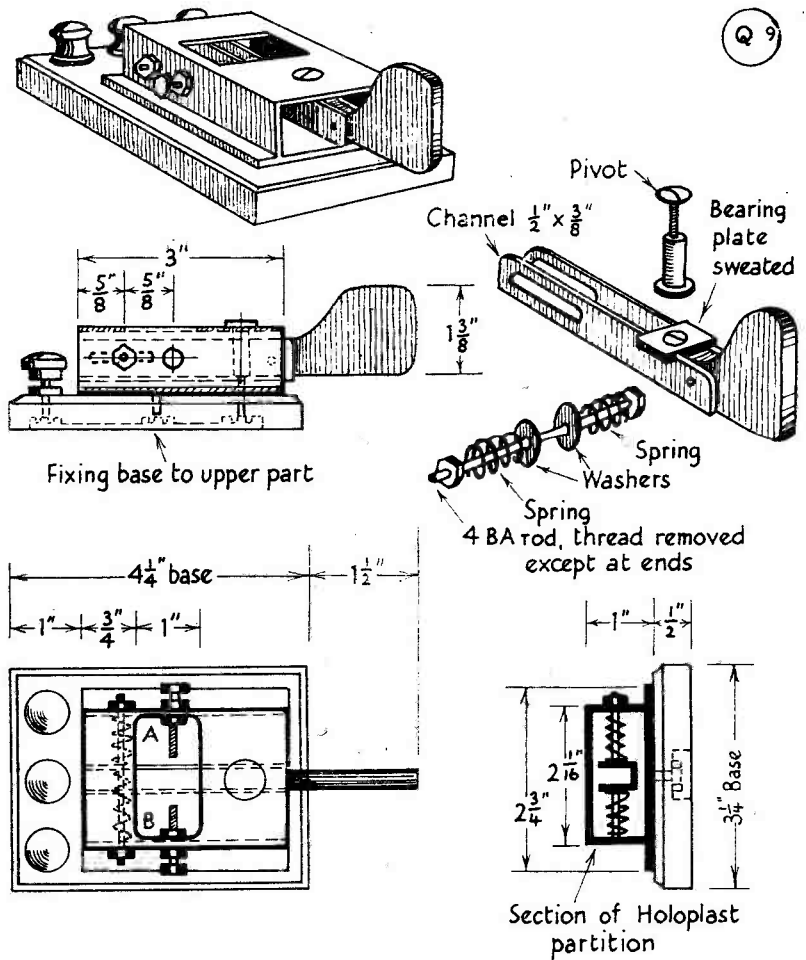

Mechanical details and construction of the paddle assembly designed by GM3HLD.

celluloid shavings dissolved in amyl acetone.

The pivot is wired to the centre terminal and the side contacts to the side terminals, the wire from the side contacts being brought down through holes in the base.

MY recent note about the rarity of holiday visits to resident amateurs has brought in several remarks from inhabitants of "holiday towns." They all agree that a surprisingly small number of visitors make themselves known, either to the local Club or to individual amateurs. One Club suggests that here is a chance for some good publicity work by Club committees. Small advertisements in the local papers are hardly good enough, but preliminary notices in our own Club Section ought to bear fruit. The theme of all the comments received is this: When you visit a strange town, don't assume that you will be treated as an interloper; rather, assume that just because you come from distant parts, your presence will be welcomed. And the local Club is the first place to visit, because there you will meet the individuals who will be only too glad to entertain you privately at their various shacks.

DOTS AND DASHES

Has it ever struck you what an admirably flexible system the Morse code is? Only one amateur in fifty is ever heard sending perfect code, and yet 48 of the other 49 can be copied, and copied with ease. (The odd man out sounds like a random collection of bangs and crashes, and is not worth wasting any time over!) But what with straight keys of the pump-handle variety, side-swipers (yes, they are still in use), ordinary bugs and all the different sorts of electronic bugs, one certainly hears an extraordinary variety of rhythms on the air these days. Personally, I find perfect Morse much easier to copy at high speeds than any of the stuff with so-called "personality" in it, and I find that an EI-bug, handled at 25 w.p.m., only appears to be going about 20. Many others have confirmed this impression. Unfortunately, it seems that it is easier to make mistakes on an EI-Bug than on any other form of key, and this factor rather cancels out the advantage. Those few operators who really have got the EI-Bug sewn up, and never



make a mistake (how few they are!) are the only exponents of Perfect Code.

MORE PIONEERING

Another flash-back, this time to a previous remark that the only people doing any real pioneer work are the VHF enthusiasts. Many of the others disagree violently, pointing out that many minor improvements in transmitting technique can be attributed to the keen DX worker and the "communicator." Before the war a really stable VFO was a comparative rarity; nowadays it is an absolute necessity and is so frequently met with as to be hardly worth comment. New systems of modulation are also quoted, although, admittedly, most of them are capable of nothing better than "commercial" quality. However, they may well have their bearing on small field sets of the future. Aerial research, again contributed to largely by the DX men, has increased the general knowledge among amateurs on this very tricky subject. Before the war, as many Service instructors will tell you, the average amateur's knowledge of aerial theory was lamentably small. Now, even if not profound, it is at least much more comprehensive.

SHARED BANDS

The Editorial remarks in the September issue drew attention to the fact that not one of our bands from 28 mc downwards is

exclusively amateur. This, unfortunately, is only too true, although at least the 14 mc band *should* be. Certain irresponsible organisations, however, have not been slow to discover that although we ourselves complain about interference within our bands, they are a peaceful oasis compared with the packed masses of commercial stations on either side of them. Hence the unwelcome arrival of facsimile transmissions on any frequency from 14000 to 14100 kc. Only the arrival of a band full of Kilowatts from U.S.A. could possibly cause enough QRM to move them off the pitch. And then the strange noises that invade the 80-metre band from time to time! I have noted repeatedly that when two Service stations want to start a CW net, they choose a frequency on which an amateur phone conversation is going on, even if open space surrounds it on both sides. The purpose of these tactics eludes me.

TOP BAND OCCUPANTS

In an altogether different category are the sharers of the Top Band, whose use of the band is of paramount importance compared with our own. A ten-watt amateur in a coastal town could easily cause serious interference on a lightship channel or another frequency on which a message of life-and-death character might be passing. Fortunately, the Top-Band crowd appear to realise this and to act accordingly. In passing, though, it might be admitted that some of the "babble" from other users sounds pretty pointless on occasions; no less so, doubtless, than some of the amateur babble that these fellows must hear from time to time. The question is not "Where is this going to end?"—because it just *isn't* going to end. We are, eventually, going to be squeezed out of the normal communication bands, and if that happens before the amateurs have surmounted their next great problem—how to establish worldwide communication on VHF—then those whose only interest is DX work are going to have a thin time of it.

NEW QTH'S

This space is available for the publication of the addresses of all holders of new U.K. call signs, as issued, or changes of address of transmitters already licensed. All addresses published here are reprinted in the quarterly issue of the "RADIO AMATEUR CALL BOOK" in preparation. QTH's are inserted as they are received, up to the limit of the space allowance each month. Please write clearly and address on a separate slip to QTH Section.

E15H, W. P. Kennedy, B.Comm.,
7 Morley Terrace, Waterford.

G3BTU, H. White, 39 Trent
Street, Retford, Notts.

G3HXJ, H. du Fresne, Byways,
Gover Road, Redbridge, South-
ampton, Hants. (Tel.: *Totton*
2332).

G3IDQ, J. D. Booth, 15 Gordon
Crescent, Sneyd Green, Hanley,
Stoke-on-Trent, Staffs.

G3IEG, R. Stringer, 10 Allington
Place, Handbridge, Chester.

GW3IEQ, F/Sgt. P. Hudson,
Silhill, Dinas Dinille, Llandwrog,
nr. Caernarvon.

G3IHZ, A. S. Burden, Martin
Cottage, Silver Hill Road,
Willesborough Lees, Ashford,
Kent.

G3IKM, S. J. Slater, 90 Beverley
Road, Hessle, E. Yorkshire.

G3IKO, D. W. E. Butterworth,
15 Waverley Road, Chingford,
London, E.4.

G3IKQ, R. H. Chilton, 15 Norton
Avenue, Lipson, Plymouth,
Devon.

G3IKR, J. P. Moore, 16 Silver-
birch Road, Solihull, Warks.

G3IKT, W. R. Midgley, 79 Smith
House Lane, Brighouse, York-
shire.

G3IKU, E. Howarth, 4 Cobham
Street, Gravesend, Kent.

G3ILI, B. J. Rogers, 108 Wood-
vale, Forest Hill, London,
S.E.23. (Tel.: *FOR 3304*).

G3ILK, H. C. Manning, 3
Magheralave Road, Lisburn,
Co. Antrim.

G3ILO, T. G. Spencer, c/o Peak
Villa, Upper Cam, Glos.

G3ILR, H. A. Trimmer, 49
Houblon Road, Richmond,
Surrey.

G3ILV, J. Thompson, 1 Westland
Road, Portadown, Co. Armagh.

G3IPS, P. Sterrett, 1 Pye Corner,
Kennford, Exeter, Devon.
(Tel.: *Kennford 424*).

G3IRT, A. J. B. Roberts, 25 Beta
Close, New Ferry, Bebington,
Cheshire.

G3ITP, J. T. Parker, 34 Glebe
Road, Letchworth, Herts.

G3IWR, A. Wright, 108 Old Oak
Road, Acton, London, W.3.
(Tel.: *SHE 3955*).

G3JGM, G. Millington, 17 Tetten-
hall Road, Wolverhampton,
Staffs.

G3JRS, J. R. Simpson, 240
Blagreaves Lane, Littleover,
Derby. (Tel.: *Derby 2684*).

G4WJ, A. L. Donaldson, 16
Givens Street, Roker, Sunder-
land, Co. Durham. (Tel.:
Sunderland 58422).

CHANGE OF ADDRESS

G2CYN, M. D. Hely, 22 Wellin-
gton Road, Oxton, Birkenhead,
Cheshire.

G2NS, N. P. Spooner, 7 Foxholes
Road, Southbourne, Bourn-
mouth, Hants.

G3AET, J. N. Watson, 24 St.
John's Terrace, Devoran, nr.
Truro, Cornwall. (Tel.: *Perran-
ar-Worthal 147*).

G3BHT, B. G. Meaden, Hove To,
Sandy Lane, Hightown, Lancs.

G3BUZ, W. G. Crundall, Rosen-
dale, Hackhurst Lane, Lower
Dicker, nr. Hailsham, Sussex.

G3CAT, A. F. Ward, 60 Calder
Gardens, Edgware, Middlesex.

G3CFG, R. S. Lancaster, 9 Cross-
way, Harpenden, Herts. (Tel.:
Harpenden 4241).

G3CYY, I. Paul, 146 Brighton
Grove, Newcastle-on-Tyne, 4.

G3EAX, Sgt. A. Weatherley,
M.M., Flat 2, Territorial House,
Bramley Road, London, W.10.

GW3FEJ, E. J. Wright, 31 Terrace
Road, Mount Pleasant, Swan-
sea, Glam.

G3GGL, A. W. Graeme Wormald,
30 Moorland Drive, Thornbury,
Bradford, Yorkshire.

G3HAX, M. K. Hare, 26 Calver-
ton Road, Stony Stratford,
Wolverton, Bucks.

G13HCG, R. J. Johnston, Royal
Ulster Constabulary, Carrick-
fergus, Co. Antrim.

G13HJA, P. J. Flanagan, Gortin,
Omagh, Co. Tyrone.

G3HZE, R. Macdonald Cobb, 57
The Avenues, Norwich, Norfolk.

G3JD, W. H. Baker, 46 Dower
Road, Torquay, Devon.

G4SA, E. J. W. Ahier, 20 Hilliat
Fields, Drayton, Berks.

G5BL, A. E. Vick, A.L.C.M.,
Splatfylde, The Ridge, Bossing-
ton Lane, Porlock, nr. Mine-
head, Somerset. (Tel.: *Porlock*
58).

G6DV, C. Noke, 74 Stockport
Road, Ashton - under - Lyne,
Lancs.

CARDS IN THE BOX

Please send a large stamped addressed envelope to BCM/QSL, London, W.C.1, with name and call-sign, and the card(s) will be forwarded. If appearance in "New QTH's" in *Short Wave Magazine*, and in the *Radio Amateur Call Book*, is also desired, that should also be mentioned.

G2ALW, 2APM, 2FOM,
2FQX, 2HFY, 2HWF, 2ND,
3ETV, 3FFD, 3FGS, 3HHE,
3IGC, 3IHF, 4PV, 6BQ, 6CD,
GM3CGI, 3DHO, 3FTE,
GW3IHL, 3IKK.

GM2DBX

The Other Man's Station

THE well-known DX-working phone station—owned and operated by J. Taylor, M.P.S., Main Street, Methilhill, Leven, Fife—now signing GM2DBX, was first licensed AA in 1939, the full permit being obtained in March, 1946, right at the resumption.

From the outset, GM2DBX has been exclusively phone, mainly on Twenty and Ten, with occasional appearances on Forty. Over the last few years, the results have been shown in our various Achievement Tables, in which GM2DBX has consistently been standing high for Scotland. With a total of 137 countries now worked, he has about 110 confirmed, and holds a Phone DXCC; in March, 1950, he made WAC on telephony in the space of 8 hours.

Apart from the receivers and the BC-221, all equipment is home constructed. The gear stacked in the photograph includes a Radio-voice "Commander" and an Eddystone S.504 for the receiving side, and in the centre section we see the 6L6-807 exciter unit for the 813 PA in the top panel but one; above this is the aerial coupling unit, and in the lower deck the modulator. The VFO and speech clipper stand above the "Commander," the VFO being EF50-6L6 in a modified TU5B unit. The speech chain is D104 into a 6L7- $\frac{1}{2}$ /6N7-6H6- $\frac{1}{2}$ /6N7 head amplifier, followed by 6C5-p/p 6L6 into a pair of 807's in Class-B zero bias, modulating the 813 running at 120 watts input.

On the aerial side, GM2DBX has a close-spaced three-element beam for Ten, a folded dipole

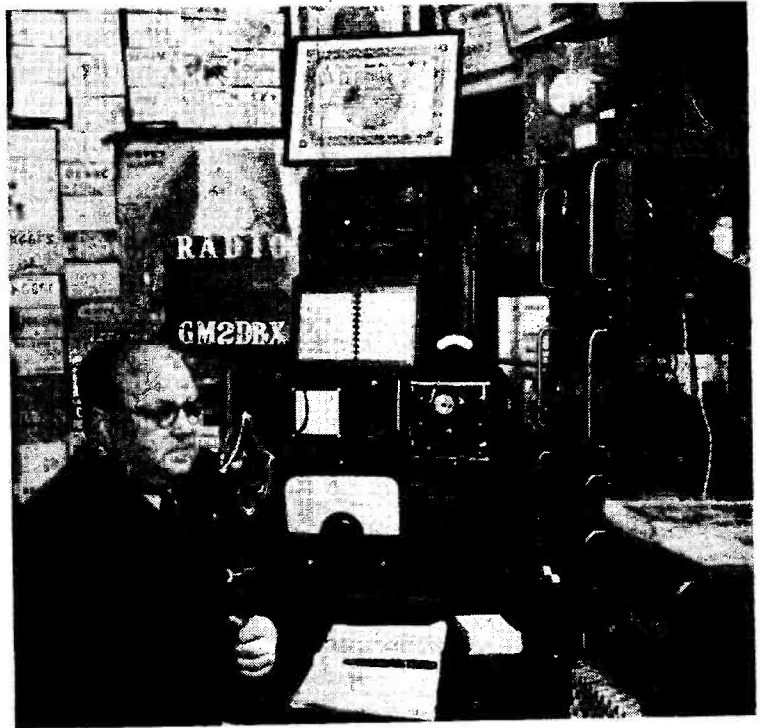

made of 300-ohm Telcon ribbon for Twenty, and a 66-ft. Zepp for Forty. Auxiliary equipment in the station includes a monitoring oscilloscope and a phone output checker.

The station is operated from the back room of what Jimmy calls his "little chemist shop in Main Street"—and we daresay he is thus able to get on during some of those periods when the bands are fairly quiet and the DX is coming through. He is secretary/treasurer of the Kirkcaldy Amateur Radio Society, and is a keen QSL collector, keeping his

cards and station records in indexed files which enable him to check back on any QSO in a matter of seconds. Apart from DX, he is interested in the study of skip and propagation conditions, and regards DX working as a means of making new friends—and brushing up his geography!

From all of which readers will deduce that GM2DBX is operated in the best traditions of Amateur Radio—and that Jimmy, while making the most of his opportunities, runs his station in the way that gives him the most pleasure, interest and satisfaction.

PHOTOGRAPHS

Remember that we are always interested in seeing clear, sharp photographs of Amateur Radio interest—whether stations, equipment or personalities. Pay-

ment is made for all prints used, but in the nature of things it is not always possible to publish photographs immediately they are received.

*Always mention Short Wave Magazine when writing to Advertisers—
It Helps You, Helps Them and Helps Us*

The Month With the Clubs

Spen Valley & District Radio & Television Society

An attractive programme has been arranged for the coming season, starting with a Social Evening at the end of September. On October 8 there is a talk on The Optics of Projection Television; on October 15-16, a visit to Holme Moss. On October 22 there is a visit to the works of Kershaw, Ltd., Optical Manufacturers, in Leeds. November 5 will be an open meeting.

Portsmouth & District Radio Society

After the holiday break, meetings have recommenced—every Tuesday at the R.M. Barracks, Eastney. Two Club transmitters are to be built, one of low power and the other a 150-watt. Any-one in the district who is interested is asked to get into touch with the Hon. Sec. (See panel for QTH).

Dorking & District Radio Society

Meetings are held every Tuesday evening at 5 London Road, Dorking, 7.30-10.30 p.m. The next is on October 7, when Mr. A. Carrington will talk on "How I got Started."

Purley & District Radio Club

Arrangements have been made for two visits to the BBC Receiving Station at Tatsfield, on October 12 and 19. The Secretary should be contacted for details. On October 11 there is a concert and social, and on October 23 there will be a Junk Sale.

This month we present the reports from 28 Clubs, all of whom are intent' on providing an interesting bill of fare for the winter session which is just opening. On the whole, the Clubs still present a picture of healthy activity, although some seem to be able to carry on a regular weekly meeting while others cannot manage to fill more than one evening a month with their programme. Fortunately, there is no need for any kind of "standardisation," and local gatherings are arranged to suit the needs of the extremely varied types of membership.

Coming nearer now is MCC, the Seventh Annual 1.7 mc Club Transmitting Contest, which takes place during the week November 15-22. Circularisation of the Rules to all Clubs and active groups should be completed by October 10. If at that date any honorary secretary has not had his copy, a request by card to the Office will be met immediately. A second copy of the Rules can also be supplied to those who may particularly want one, but we cannot do this as a general rule, as the print is limited to the required total plus a small supply of spare copies. It is hoped that this year we shall have a bigger entry for MCC than ever before.

Next month's deadline will be FIRST POST ON OCTOBER 15, and the following month's, November 12. Address your notes to Club Secretary, SHORT WAVE MAGAZINE, 55 Victoria Street, London, S.W.1.

Coventry Amateur Radio Society

Attendances at the fortnightly meetings have been good throughout the holidays, and the winter programme is now being prepared. The Society will be taking part in a Low-Power Field Day and a Two-Metre Field Day during September, and the AGM is also held during the month.

Brighton & District Radio Club

On October 14 Dr. Alexander, of the BBC, talks on Studio Acoustics, Mikes and related problems, and on October 28 there will be a talk by Thermionic Products on Tape Recorders. The intermediate Tuesday evenings will be informal.

Clacton Radio Club

New premises have been acquired at the Queen's Arms, Magdalen Green, and meetings are now held on alternate Fridays. Regular Morse lessons are given, and at a recent meeting the Club went on the air with a portable licence and gear supplied by G6AB.

Edgware & District Radio Society

Club membership already exceeds last year's total, and finances

are in a healthy state. Work is about to begin on a new Club station for phone and CW operation, fully TVI-proof. A reconstituted beginners' class is running under the guidance of G2IM. The Club ran a stand at the recent Hendon Show, but few contacts were made on account of unreliable mains voltage; all contacts were on 144 mc.

Gravesend Amateur Radio Society

Formal meetings have begun again, and working parties on the Club station have been organised. Another course for the RAE is beginning in October, and the season's programme includes talks on Aerials (G3DCV), Time Bases (G3EJK) and Pi-Couplers (G3HLF). The usual auction sales will also take their place in the proceedings.

W.F.S.R.A. (Bedfast Club)

The Club's chief concern is the building up of a fund on which it can draw for the assistance of those who are bed-ridden. Anyone who feels that he would like to help with a donation, however small, is asked to send it to G3AAU at 30 Churchbury Road, Enfield, Middx. Reading matter is another pressing need, and this—books, magazines and periodicals of any kind—should be sent to



The Edgware and District Radio Society's fine stand at the Hendon Borough Show, 1952. The Club station G3ASR/A was laid on and some contacts made on Two Metres.

John Gill, 30 Sholebroke View, Leeds, 7. Much good work is being done, and it is hoped that all readers will help the Bedfast Club in any way possible.

Bournemouth Radio & Television Society

The recent golf tournament was much enjoyed by members and wives. Forthcoming events include: October 3, General Meeting; October 17, Junk Sale; October 30, Visit to the Trunk Telephone Exchange. November 21 is the closing date for entries in the Home-Constructed Gear Competition. New members and visitors will be welcomed to the meetings on the first and third Fridays, 7.45 p.m., at the Cricketers' Arms, Windham Road.

Cambridge & District Amateur Radio Club

The October meeting will be held on the 24th, at the Jolly Waterman, and the evening will be given over to a Junk Sale.

Members are also asked to remember to take along any suitable photographs for inclusion in the Club album.

British Two-Call Club

Although this is not a corporate body that holds meetings, 104 members have enrolled. It is open to any British amateur who has held call-signs in two countries. A news letter is circulated, and full details are available from G2DHV, the Hon. Secretary.

Grafton Radio Society

G2AHB, Secretary of Grafton for so long, has had to resign owing to pressure of business, and has been honoured with a Vice-Presidency. G2CJN, who has been Chairman for the past six years, has taken over the job of Secretary and Treasurer. Full activity has now been resumed, with the usual three meetings a week. There is always a welcome for new members and visitors.

Ixworth Radio Club

Meetings are now held on the first Saturday, for Constructional and Elementary Lectures, and the third Saturday, for the main lectures, at the Reading Room, Ixworth. The Club is putting on a show at the Handicrafts Exhibition in Bury St. Edmunds on November 17-22, and will be pleased to meet anyone interested on that occasion.

Liverpool & District Short Wave Club

A very successful year ends on the first Tuesday in October, and it is hoped that the new season's programme will be equally interesting. All members are looking forward to the "Hot-Pot" at the Mecca Cafe, Cotton Exchange, on November 7. Any unattached SWL or "Ham" is invited to turn up on Tuesday evenings at 8 p.m.; reports on G3AHD (Top Band at 2115 on meeting nights) would also be welcomed.

Ravensbourne Amateur Radio Club

After an interesting year, the members have returned to further classes on practical and theoretical matters. G3HEV, the Club Tx, is in operation, and RAE and Morse classes are also organised if required. Informal meetings are held every Wednesday evening, 8 p.m., at Durham Hill School, Downham.

Stockport Radio Society

This Club reports for the first time, having been re-formed last February. Membership is now 60, with some 35 transmitting members. Forthcoming events include a social on October 15, at 7.30 p.m. Meetings are held on alternate Tuesdays at Blossoms Hotel, Buxton Road, Stockport, at 8 p.m.

Wanstead & Woodford Radio Society

Activities continue on a rather reduced scale, and at the AGM, on October 28, important decisions must be taken if the Club is to continue to function. All members are asked to make a special effort to attend. There will be a junk sale on October 14, and the usual alternate weeks of practical work will continue during the month.

West Kent Radio Society

The winter session has now opened, and a good programme for future meetings has been arranged. Lectures on Transmitter and Receiver Design will be included. Meetings are at Culverden House, on October 15 and 29, November 12 and 26, at 7.45 p.m. All interested persons will be welcomed.

Yeovil Amateur Radio Club

Wednesday meetings have continued, and members have built a six-foot metal rack to house G3CMH, at present under overhaul for TVI-proofing. The Secretary recently gave a talk on Amateur Radio to the local Rotary Club, which was reported in the local newspapers.

Swanton Morley Amateur Radio Club

A recent demonstration by this Club increased the membership to 70, and a competition is being run over the winter session covering construction, operating and lecturing. Club Nights are Mondays at 8 p.m., and although it is a "closed shop," visitors are most welcome. Some 100 contacts a month are made from G3GIJ on 80, 40 and 20 metres. CW and Phone.

Chester & District Amateur Radio Society

Past meetings, which have included a lecture on Propagation and a Junk Sale, have had the usual good attendances. A special meeting will be held on October 20, with a lecture from Messrs. Goodmans; all "audio fans" and interested traders are invited to attend—7.30 at the Tarran Hut, Y.M.C.A., Chester. Meetings are held every Tuesday.

Southend & District Radio Society

At the International Boy Scouts' Jamboree, held at Belchamps, Hawkwell, Essex, the Society had G5QK/A in action for the whole of the week, and the station proved to be a great centre of interest for the boys. Contacts were obtained with countries from which many of the Scouts had come, and a particularly effective piece of work on the part of the operators of G5QK/A was the relaying by loud-speaker of greetings sent to the Jamboree by the Australian Broadcasting Commission.

Romford & District Amateur Radio Society

The honorary secretary, having done his Z call-up, is back again with an excellent programme for the next few months. There are weekly meetings on Tuesdays, starting on October 7, and the lectures scheduled include Time Bases and Electric Circuitry, with additional talks by various members. There are also junk sales and rag-chew evenings. Full details from G3BNI.

South Manchester Radio Club

Activity is well maintained and the following items are offered for the immediate future: October 10, Annual General Meeting; October 24, Valves and their Manufacture (Mullard Film Strip); November 7, Single Side-Band Working, by G2ALN.

Barnsley & District Amateur Radio Club

This Club was established as long ago as 1913, and on September 12 last the A.G.M. was held, at which arrangements were made for the winter session.

NAMES AND ADDRESSES OF SECRETARIES REPORTING IN THIS ISSUE

BARNESLEY: G. W. Wigglesworth, G2BH, 90 Blenheim Road, Barnsley, Yorks.
BOURNEMOUTH: J. Ashford, 3 Stevenson Court, 57 Alum Chine Road, Bournemouth.
BRIGHTON: R. T. Parsons, 14 Carlyle Avenue, Brighton 7.
CAMBRIDGE: T. A. T. Davies, G2ALL, Meadow Side, Comberton, Cambs.
CHESTER: W. Lloyd, 124 Farvin Road, Chester.
CLACTON: R. F. E. Bliss, 67 Salisbury Road, Holland-on-Sea, Essex.
CLIFTON (London): T. Arch, 11 Boyson Road, Walworth, S.E.17.
COVENTRY: K. Lines, G3FOH, 142 Shorncliffe Road, Coventry.
DORKING: J. Greenwell, G3AEZ, 7 Sondes Place Drive, Dorking.
EDGWARE: R. H. Newland, G3VW, 10 Holmstall Avenue, Edgware.
GRAFTON: A. W. H. Wennell, G2CJN, 145 Uxendon Hill, Wembley Park, Middx.
GRAVESEND: R. Appleton, 23 Laurel Avenue, Gravesend.
IXWORTH: P. G. Wright, Thurston Road, Great Barton, Bury-St.-Edmunds.
LIVERPOOL: A. D. H. Looney, 81 Alstonfield Road, Knotty Ash, Liverpool 14.
PORTSMOUTH: L. V. Shaw, 8 Belmont Street, Southsea.
PURLEY: A. Frost, G3FTQ, 18 Beechwood Avenue, Thornton Heath, Surrey.
RAVENSBORNE: J. H. F. Wilshaw, 4 Station Road, Bromley, Kent.
ROMFORD: D. L. Coppendale, G3BNI, 9 Morden Road, Chadwell Heath, Romford.
SOUTH MANCHESTER: F. H. Hudson, 21 Ashbourne Road, Stretford, Manchester.
SOUTHEND: G. Chapman, B.E.M., Bell Hotel, 20 Leigh Hill, Leigh-on-Sea, Essex.
SPEN VALLEY: N. Pride, 100 Raikes Lane, Birstall, nr. Leeds.
STOCKPORT: G. Phillips, G3FYE, 7 Germans Buildings, Buxton Road, Stockport.
SWANTON MORLEY: F/L. A. E. White, G3FNX, SMARC, RAF Swanton Morley, East Dereham, Norfolk.
WANSTEAD: C. Stevenson, 45 Dacre Road, London, E.13.
WEST KENT: F. R. Freeman, 1b Queen's Road, Tunbridge Wells.
W.F.S.R.A. (Bedfast Club): J. Beavan, G3GBL, 296 Fore Street, London, N.9.
YEovil: D. L. McLean, 9 Cedar Grove, Yeovil.



From August 9 to 16, Southend and District Radio Society provided a station, signing G5QK/A, for the International Boy Scouts Jamboree held at Hawkwell. In the middle background is the Top Band transmitter, with a T.1154 on the right for Twenty, Forty and Eighty. The aerial was a 264-footer, stung on two 32-foot masts. In this picture (plain clothes) are, left to right, G3BCJ, G6MH and G2BHA. During the week, the activities of the station aroused considerable interest, and they had a special QSL card for the occasion.

Clifton Amateur Radio Society

On September 7, they held their annual D/F Field Day at Orpington, with some 20 members par-

ticipating; the test was won by J. Lambert. At the annual general meeting on the 12th, four new officials were elected, and the honorary secretary is now as in the panel. The next full meeting

is on October 10, with a Quiz Evening on October 17. Visitors and prospective members will always be welcome at the Club Room, New Cross Gate, S.E.14, on Fridays at 7.30 p.m.

CALL BOOK — FOREIGN SECTION

We are glad to be able to say that once again it has been possible to arrange for the publication, separately, of the Foreign Section of the *Radio Amateur Call Book*—that is, the *Call Book* proper, less only the American amateur station listings. The new edition of the Foreign Section will be the autumn issue, containing the latest and most up-to-date lists of the world's amateur transmitters, exclusive of the U.S.A., shown alphabetically by prefix, country, call-sign, name and address. Zone locations and QSL bureaux addresses are also given. The price of the Foreign Section is 10s. post free, and the edition is limited. Order on: Publications

Dept., Short Wave Magazine, Ltd., 55 Victoria Street, London, S.W.1.

MALAYAN RADIO SOCIETY

We are informed that the Federation of Malaya Radio Society is in process of formation, with VS2CR as the guiding light and leading spirit. Among other things, it is proposed to run a regular breakfast-hour net on 7050 kc at 0230 GMT on Sunday mornings—which will be 10.0 a.m. in Malaya. This is thought to be the best way of holding the group together, having regard to the distances involved and the dangers of travelling to meetings through bandit country!

CLYDESDALE

Burgains in Ex-Services Radio and Electronic Equipment

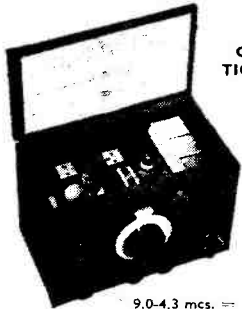

BATTERY POWERED COMMUNICATIONS RECEIVER RI224A

Ref. 10D-13074

Covering the "Trawler Band" 3-wave ranges.

9.0-4.3 mcs. = 30-70 metres.
4.3-2.1 mcs. = 70-140 metres.
2.1-1.0 mcs. = 140-300 metres.

Valves : VP23, R.F. Stage. FC2A, Mixer. VP23, I.F. Stage. 210LF, Det. 220PA, Output. I.F. of 470 kcs.

250 pf. 3-gang tuning condenser. Sensitivity control reaction control for C.W. Aerial Trimmer. High Impedance and 600 ohm. line outputs.

A very F.B. receiver for portable "160," "80 and "40" metre use, or for a station without mains supply. Exceptionally sensitive and selective. Complete (less batteries) in wooden cabinet with calibrated chart or hinged lid. Dim.: 14½ x 10 x 9½ in., finish grey.

ASK FOR No. SM/H355 **£7.19.6** Each CARRIAGE PAID

IN ORIGINAL TRANSIT CASE
Batteries required : HT 120 volts. GB 9 volts LT 2 volts. Circuit and data for RI224A available at 1/3 each, post paid.

FOR INEXPENSIVE TELEVISION

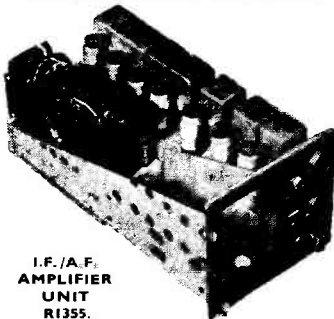

I.F./A.F. AMPLIFIER UNIT RI355.

The popular T.V. Sound and/or Vision Unit. 5 i.f. stages. 10 valves 8/VR65 (SP61), 5U4G, VU120A, etc., etc. In metal case 18 in. x 8½ in. x 7½ in. Used, good condition.

IN ORIGINAL CASE **67/6** CARRIAGE PAID
ASK FOR No. SM/E770

2nd Grade in Transit Case, **59/6**, Carr. Paid.
3rd Grade, loose stored, **42/6**, Carr. Paid.
Circuit available at 1/3

BC625-A TRANSMITTER CHASSIS

Less Valves. Partly built by the B.O.T., but contains many useful parts. R.F. section in good order, less valves, crystal switch and crystals.

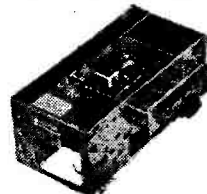

Dim.: 15½ in. x 7½ in. x 6 in. Separate modulation transformer and choke supplied.
ASK FOR NO. **29/6** CARRIAGE PAID
SM/E752

192 PAGE CATALOGUE, NEW LIST NO. 8C
Giving details and illustrations of ex-services items and cancelling all previous lists and supplements. Now Ready—Price 1/6. Price credited on first purchase of 10/- or over

MODULATOR 169

Brand new, in original wooden case. Contains : 5U4C, EF50, CV7 Klystron and CV85 Valves. Repeater motor, 3 Neon Bulbs with holders, 2 Metal Rectifiers, High Cycle Transformer, 2 oil filled high voltage Condensers. Oil filled choke, 4 1 mfd. 500v. 2 W.V. Pots. Plus fixed condensers and resistance, etc. Built-in chassis 18 x 8½ x 7½ ins., with black case.
ASK FOR No. **£2.19.6** CARRIAGE PAID
SM/H713

CARBON POWER MICROPHONE
In original carton

With transformer and leads (made by Tannoy). Requires only a loudspeaker and 12-volt acc. to make a portable P.A. equipment. Power consumption approx. 2 amps., output 4.5 watts.
ASK FOR No. **45/-** Each POST PAID
SM/E894

Order Direct from :—

Phone : SOUTH 2706/9

CLYDESDALE SUPPLY 2 BRIDGE ST. Co. Ltd. GLASGOW C.5

BRANCHES IN SCOTLAND, ENGLAND AND NORTHERN IRELAND

FIXED CONDENSERS OF ALL TYPES

Both Paper and Mica

Large stocks available for immediate delivery. Your specific enquiries, giving full details, will receive immediate attention. Our prices show substantial savings.

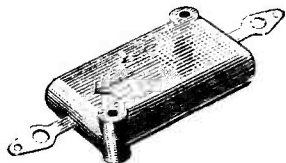
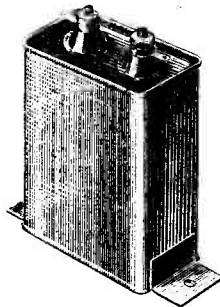

CLAUDE LYONS LTD

ELECTRICAL & RADIO LABORATORY APPARATUS

180 Tottenham Court Rd., London, W.1. Tel: MUS 3025

PULLIN SERIES 100 MULTI-RANGE TEST SET

The universal testing set for Service Engineers. Sensitivity-10,000 ohms per volt. Strong metal case with carrying handle, complete with leads having detachable bulldog clips and test prods. Size 9 x 5½ x 4 ins.

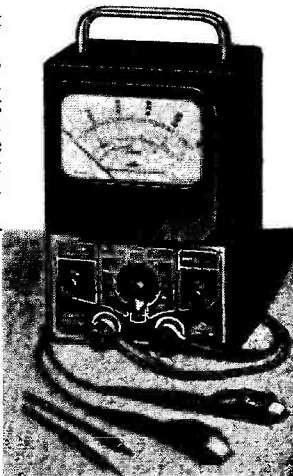

RANGES

AC/DC Volts : 10, 25, 100, 250, 500, 1,000.
D.C. Milliamps : 2.5, 10, 25, 100, 500.
AC/DC Microamps : 100 Microamps 10v. range.
Resistance ranges : 0/1 Meg (13,500 ohms mid-scale), 0/10,000 ohms (135 ohms mid-scale).



MEASURING INSTRUMENTS (PULLIN) LTD

Electrin Works, Winchester Street, London, W.3

Tel. : ACORn 4651/3 & 4995.

Manufacturers of all types of
**SCIENTIFIC INSTRUMENT
 CASES and CHASSIS**
 IN METAL

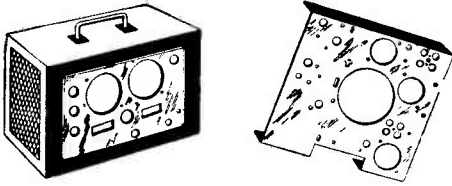

GENERAL SHEET METAL WORK
 for the Trade

CHASE PRODUCTS
(Engineering) LTD

27 PACKINGTON RD., SOUTH ACTON, W.3
 Acorn 1153-4. and at LEEDS.

URGENTLY REQUIRED

THE FOLLOWING EQUIPMENT
 IN ANY CONDITION:—

FREQUENCY METERS Type BC.221, BC.221AK, TS.174/U, TS.175, TS.69/AP, Also LR2 (Naval Version) by General Radio Co., and other types.

AMERICAN TEST SETS, Type TS.3A/AP, TS.17, TS.19, TS.33, TS.34/AP, TS.62, TS.120, LE-19-A and BC.1277.

AMERICAN SIGNAL GENERATORS, TS.13/AP, TS.14/AP, TS.47/AP, L.A.D., L.A.E., Ferris 18 B or C, Measurements 65B, General Radio Corp 605B and 804.

RECEIVERS, Type APRI, APR4 and APR5, also Tuning Units, types TN16/APR4, TN17/APR4, TN18/APR4, TN19/APR4, TN54/APR4 and others.

RECEIVERS, Type R78/APS15, with or without valves, or any parts for the APS-15 Unit.

ALSO:— ANY CENTIMETRIC EQUIPMENT 10 cm OR 3 cm SUCH AS WAVE GUIDES, ANTENNAS, FREQUENCY METERS, SIGNAL GENERATORS, KLYSTRONS, MAGNETRONS ETC.

Please write, call or phone, giving price, condition, etc.

ELM ELECTRIC CO.
 175, UXBRIDGE RD., HANWELL, W.7
 EALing 0779

This Month's Offers

DYNAMOS. Shunt wound D.C. 14/32 volts, 9 amps., 2,500 r.p.m. for charging 12-18 or 24 volt batteries, £3 10s. 0d. As new and guaranteed. Carr. 5/- extra.

ALTERNATORS, 500 watt, 1,300/2,600 c/s., need 12 volt excitation, spline shaft, 45/-, carr. 2/6.

TRANSFORMERS, double wound, 230 volt. 50 c/s. input, 12 volts, 8 amps., 30/-, post 2/-; 105/230 volts, input 12 volts, 3 amps., output, 21/-, post 1/9; 230 volt, 50 c/s. input 12 volts, 30 amp. output, £3, carr. 5/-.

NIFE BATTERIES, type F4H 45 A.H. 8.4 volts, steel cells—seven in wood crate. £8 10s., carr. extra.

CHOKES, 125 watt Osira chokes, 15/-, post 2/-.

ROTARY CONVERTERS, 24 volt D.C., input 230 volts, 100 watts A.C. 50 c/s. output, £6 10s., carr. 5/-.

MORSE PRACTICE SETS, A.M., precision Key and twin coil buzzer on base with space for battery, 6/6, post 1/-.

MAGNETS, D.C. Electro magnets, 6 volts, twin coil, lift 4 lbs., 5/-, post 6d.

THERMOSTATS, fit small test tube operate 0 degrees cent. Easily altered, suitable for fish tanks. New, in maker's boxes, 6/6, post 6d.

ELECTRADIX RADIOS

Dept. B. 214 Queenstown Road, Battersea, London, S.W.8.

Telephone: MACaulay 2159

SOUTHERN RADIO'S WIRELESS BARGAINS

TRANSMITTER-RECEIVERS. (WALKIE-TALKIE) Type 38, Mark II. Complete with 5 Valves, Microphone, Phones, Aerial, etc. Guaranteed Ready for the Air. Less Batteries, £6 12s. 6d. plus 2/6 post.

TRANSMITTER-RECEIVERS Type 38, Mark III. Later Model. Complete. CRYSTAL CHECK £8 10s. 0d.

TRANSMITTER-RECEIVERS. Type "18" 6-9 Mcs. Perfect. £7 10s. 0d.

RECEIVERS R.109 COMPLETE WITH ENCLOSED SPEAKER and Vibrator Pack for 6-Volts, 1.8 to 8.5 mcs. Complete with 8 Valves in Metal Case, £7 15s. 0d. plus 7/6 carriage.

MINISCOPIES G.E.C. Type M861b. MINIATURE CATHODE RAY OSCILLOSCOPES. 1½ inch Tube. Time Base, etc., etc. BRAND NEW IN MAKER'S SEALED CARTONS. WITH LEATHERETTE CARRYING CASE, £15 10s. 0d. plus 5/- carriage. LUBRA HOLE CUTTERS. For use on Wood, Metal, etc., etc. Adjustable from 3/16 in. to 3/8 in., 5/9.

THROAT MICROPHONES. Complete with long lead and plug. Magnetic. 4/6.

PLASTIC TRANSPARENT MAP CASES. 14in. by 10½in. Ideal for Charts, Photos, Display, etc., etc., 5/6.

STAR IDENTIFIERS. With Hydrographic Office Mods. A-N Type. New in cases, 5/6.

WESTECTORS. Wx6 and W112, 1/- each, 11/- per doz.

MARCONI AERIAL FILTER UNITS. Type "916" in conformity with P.O. Specifications. Full fixing instructions, 4/6.

CONTACTOR TIME SWITCHES. 10-hour movements. 2 impulses per second. Thermostatic Control. In Soundproof Case, 11/6. Remote Controls for above, 7/6.

VISUAL INDICATORS. Type 3 (10Q4). Contains two Moving Coil Microamp Meter Movements, Neons, etc. Easily convertible to efficient M.C. Meters, 11/-. Conversion fully described in "W.W." Sept. 1951.

RESISTANCES. 100 Assorted Values. Wire ended ¼ to 2 watts, 12/6 per 100.

CONDENSERS. 100 Assorted Tubular and Mica Condensers. All useful values, 15/- per 100.

CONTROL CABLES for Command Receivers B.C. 453/4/5, 14 feet with adaptors at either end, 10/-. Full List of Radio Books 2/6. Hundreds of more Lines or Callers.

SOUTHERN RADIO SUPPLY LTD.
 11, LITTLE NEWPORT STREET, LONDON, W.C.2.
 GERrard 6653.

NORMAN H. FIELD

68 HURST STREET, BIRMINGHAM 5

Mail Order Dept.

64-65 Church Lane, Wolverhampton

CRYSTAL MONITORS (Less valves and Crystal), 7/6. Ideal for Ham use. Can be easily modified to Mains use with our simple circuit. 1/- extra.

AI368 BATTERY AMPLIFIERS. Complete with VR35 and VR21 valves for use as intercom or with slight alteration as Gram amplifier, in metal case 7in. x 4½in. x 4½in. 15/-, circuit 1/- extra. Carrying case 1/6 extra.

TRANSFORMERS, MAINS. Input 230v. A.C., output 18v, 26v-44v at 2 amps 12/6

METERS. Marked Air/Oil. Moving Coil basic 200 micro-amps. Very sensitive. 2½in. square 7/6

LOOP AERIAL. 1155. D.F. 8/6

ROTARY CONVERTORS. Approx. 6v input and 220v at 80 m/a output 12/6

CRYSTALS. 500 Kcs. 7/6

CONDENSERS. 270 pfs., 3 gang 5/-

MAINS TRANSFORMERS, 350-0-350, 100m/a, 6.3v., 3.5 amps., 5v., 2 amps 26/6

As above but 250-0-250 26/6

FILAMENT TRANSFORMER, 6.3v. at 1.5 amp. 7/6

"AMPLION" MULTI-RANGE TEST METER, volts to 500 (can be increased to 5,000 with special test prods). Current to .5 amp. D.C./A.C., ohms to 200,000, meter sensitivity 500 micro-amps. Tested and guaranteed £5

SPECIAL OFFER

Pre-Amplifiers, Ultra S.W., uses EF54 with Coax input and output sockets, also plug and socket for power supply. Broad band slug tuned for use on T.V. frequencies or 10 metres, 5/- (valves to suit available).

Please include something for postage.

MAINS, TRANSFORMERS, SCREENED, FULLY INTERLEAVED AND IMPREGNATED

Half Shrouded—			
H.S.63.	Input 200/250v. Output 250/0/250v.	60 m/a	18/6
	6.3v 3 amps, 5v 2 amps
H.S.40.	Windings as above, 4v 4 amps, 4v 2 amps	...	18/6
H.S.2.	Input 200/250v. Output 250/0/250v.	80 m/a	21/-
H.S.30.	Input 200/250v. Output 300/0/300v.	80 m/a	21/-
H.S.3.	Input 200/250v. Output 350/0/350v.	80 m/a	21/-
H.S.2X.	Input 200/250v. Output 250/0/250v.	100 m/a	23/-
H.S.30X.	Input 200/250v. Output 300/0/300v.	100 m/a	23/-
Fully Shrouded—			
F.S.2.	Input 200/250v. Output 250/0/250v.	80 m/a	23/-
F.S.30	Input 200/250v. Output 300/0/300v.	80 m/a	23/-
F.S.3.	Input 200/250v. Output 350/0/350v.	80 m/a	23/-
F.S.2X.	Input 200/250v. Output 250/0/250v.	100 m/a	25/9
F.S.30X.	Input 200/250v. Output 300/0/300v.	100 m/a	25/9
F.S.3X.	Input 200/250v. Output 350/0/350v.	100 m/a	25/9
All above have 6.3-4-0v at 4 amps, 5-4-0v at 2 amps.			
F.S.43.	Input 200/250v. Output 425/0/425v	200 m/a	6.3v
	4 amps C.T. 6.3v 4 amps C.T. 5v 3 amps	...	51/-
H.S.6.	Input 200/250v. Output 250/0/250v.	80 m/a	6.3v
	6 amps C.T. 5v 3 amps. Half-shrouded	...	29/3
For Receiver R1355.			
Framed, Flying Leads—			
F.30X.	Input 200/250v. Output 300/0/300v.	80 m/a, 6.3v	31/9
	7 amps, 5v 2 amps
HS150.	Input 200/250v. Output 350/0/350v.	150 m/a, 6.3v	30/9
	3 amps C.T. 5v 3 amps. Half-shrouded
FS120.	Input 200/250v. Output 350/0/350v.	120 m/a, 6.3v	33/-
	2 amps C.T. 6.3v 2 amps C.T. 5v 3 amps Fully shrouded
FS150X.	Input 200/250v. Output 350/0/350v.	150 m/a, 6.3v	34/9
	2 amps C.T. 6.3v 2 amps C.T. 5v 3 amps Fully shrouded
FILAMENT TRANSFORMERS			
F5.	Input 200/250v. 6.3v at 10 amps or 5v 10 amp or 10v at 5 amp or 12.6v at 5 amp.	Framed Flying Leads	37/9
F.U.6.	Input 200/250v. 0-2-4-5-6.3v at } 2 amps	Clamped flying leads	11/-
F.29.	Input 200/250v. 0-2-4-5-6.3v at } 4 amps		
F.6.	Input 200/250v. 6.3v 2 amps	...	9/-
F.12.	Input 200/250v. 12.6v. Tapped at 6.3v 3 amps	...	18/6
F.24.	Input 200/250v. 24v. tapped at 12v. 3 amps	...	26/-
C.V.O.	(add 1/3 in the £ for carriage).		

H. ASHWORTH (Dept. S. W.)
676 Great Horton Road, Bradford Yorks.

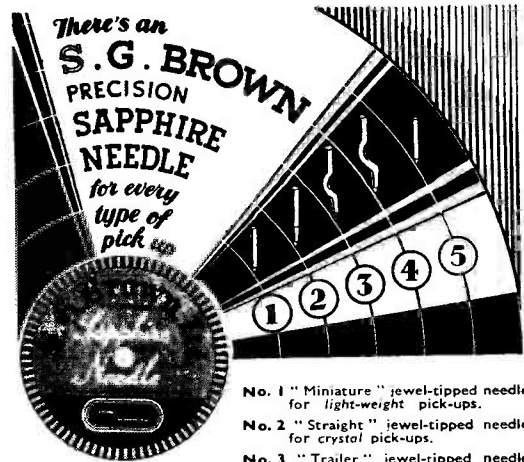

- PRICES**
 Nos. 1-4 7/- plus 3/1 P.T. post 6d.
 No. 5 9/3 plus 4/1 P.T. post 6d.
- No. 1 "Miniature" jewel-tipped needle for light-weight pick-ups.
 - No. 2 "Straight" jewel-tipped needle for crystal pick-ups.
 - No. 3 "Trailer" jewel-tipped needle for medium-weight pick-ups.
 - No. 4 "Knee Bend Trailer" jewel-tipped needle for older heavy-weight pick-ups.
 - No. 5 "Miniature Solid Sapphire" needle for light-weight pick ups.

All S. G. Brown Precision Sapphire Needles are protectively mounted on a useful double-sided stroboscope (78 and 33½ r.p.m.). An instructive and interesting Brochure with many useful hints on obtaining better reproduction, gladly sent on request. Write to Dept. 5.

S. G. Brown Ltd. SHAKESPEARE ST. WATFORD, HERTS.
Telephone: Watford 7241

14.

SAMSONS

SURPLUS STORES

Special offer of ALKALINE CELLS BY BRITANNIA BATTERIES, LTD. 2.4v 18/20 AH. Size 6in. x 4in. x 2½in., 17/6, p.p. 1/6. Banks of 3 cells 1.4v each, 10 AH. Size 1½in. x 1½in. x 7in., 19/6, p.p. 1/6. Separate cells, 7/6 ea., p.p. 9d. 2.5v, 10 AH, 6½in. x 2½in. x 2in., 15/-, p.p. 1/6. 2.5v 21 AH, 9in. x 3in. x 2½in., p.p. 2/-.

DELCO 24v. 11 AH BATTERIES. Size 8in. x 7½in. x 7½in. Brand New, 47/6, carr. 4/- DELCO 6v 90 AH, 23 PLATES. Size 13in. x 7in. x 9in. BRAND NEW, £5 5s. 0d., carr. 5/-.

PRITCHETT AND GOLD 6v 100-125 AH. Size 16in. x 11in. x 8in. in teak cases, brand new, £6 10s. 0d. Callers only.

AMERICAN LIGHT-WEIGHT PHONES, LOW RES., 10/6, p.p. 1/-.

30ft. lengths Coils CO-AXIAL CABLE with Pye Sockets on each end, 8/6, p.p. 1/6.

MASTER VOLT METERS, 0-20v AC MOVING IRON, 6in. scale. MADE BY METRO VICKERS, 27/6, p.p. 1/6.

E.D.C. ROTARY CONVERTORS, D.C. INPUT 200-240v., A.C. OUTPUT 230v., 150 watts. Completely shrouded in metal case, £12 10s. 0d., carr. 5/-.

BRAND NEW RECEPTION SET R103A 6-VALVE RECEIVERS with built-in power pack for 100-250v. A.C. or 6v. D.C. Freq. range 1.7 mc/s-7.5 mc/s. Output is matched for L.R. phones. Complete with manual, £10 10s. 0d., carr. 5/-.

169/171 EDGWARE ROAD
LONDON, W.2. Tel : PAD. 7851

125 Tottenham Court Road, W.1. Tel : EUS. 4982

All orders and enquiries to our Edgware Rd. branch please Open All Day Saturday at the Edgware Road Branch.

T/V RECEIVER 'ANTI-SWAMP' FILTER

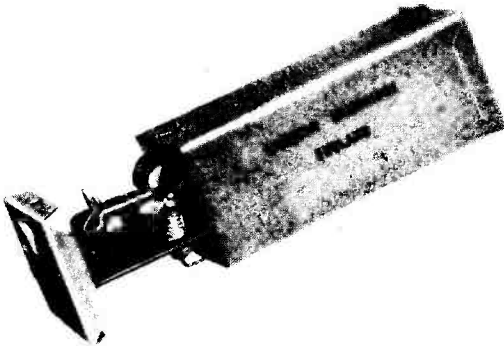

Can be fitted instantly to the aerial feeder of any T/V receiver and effects a complete cure of "front-end" overload due to amateur transmitter fundamentals; for all bands 30Mc/s and down. No adjustments necessary.

Price 10/6 direct from:

Labgear (Cambridge) Ltd.
WILLOW PLACE, CAMBRIDGE.
Tel. 2494—2 lines.

WALTON'S of WOLVERHAMPTON

INSULATION TAPE, To clear 18/- dozen, 1/2 in. x 1/2 lb. Ex. A.M. Each ... £7 10s. 0d. per gross, Cellophane wrapped. ... Carriage paid.

RELAYS. Super Sensitive High Speed, 7/6 each, postage 6d.

MAP CASES, Plastic, 14in. x 10 1/2 in., 3/6 each, postage 1/-.

10in. ROLA P.M. EXTENSION SPEAKERS, 25/- each, postage 1/-.

SPECIAL 8 + 8 - 8 mfd. ELECTROLYTIC, 550v. D.C. working, 1/6 each (only supplied with other goods).

Boxes of NUTS, BOLTS & WASHERS, mainly B.A. sizes, each box contains approx. 1,000 items. 3/6 each, postage 1/-.

SPECIAL VALVE OFFER. 6 brand new U.S.A. Valves (in original boxes) comprising:—2 off VU111

High Voltage Rectifiers, 2 off RK.34 V.H.F. Low Power Transmitters, 2 off 954 V.H.F. acorn Pentodes. 12/6 the 6, post paid Great Britain.

Send s.a.e. and 3d. in stamps for our latest list.

WALTON'S WIRELESS STORES
48, STAFFORD ST., WOLVERHAMPTON

WE PAY TOP PRICES

FOR

American Surplus Electronic Equipment

Any quantity or condition

LOOK at THESE EXAMPLES

For equipment in good condition

- Receiver R54/APR4 with tuning units TN16, 17, 18, 19 (or bought separately) ... **£110**
- Receiver AR88D **£55**
- Frequency Meter TS 175 **£80**
- TX/RX RT18/ARCI **£50**

We pay similar Remarkable Prices for

- Receivers APR1, APR4, APR5, R5/ARN7, BC348, BC342, BC312, R78/APS15, R28/ARC5
- Frequency Meters BC221, TS174/U
- Test Sets TS3, TS13, TS14, TS17, TS19, TS33, TS34, TS45, TS47, TS59, TS69, TS102, TS118, IE19
- Transmitters ART13, SCR522, TRCI, TCS6-12-13, SCR300, BC1000
- Synchronisers BC1148 Modulators BC1142

Phone us immediately, transfer charge

ALTHAM RADIO CO.
BRAZENNOSE STREET, MANCHESTER 2
Tel. DEAnsgate 5387

ALPHA OFFERS

VALVES

GUARANTEED NEW AND BOXED, SOME GOVERNMENT SURPLUS

8018	10/-	MS/PEN	5/-	684	8/6	65N7	11/6
VU508	10/-	35L6G	9/6	6C6	7/6	6SL7	9/6
VT52	10/-	KT66	11/6	6D6	7/6	80	9/6
866A	10/-	1R5	8/9	6F6	9/-	9001	6/6
VU72	9/-	1S5	8/9	50L6GT	10/-	9002	6/6
VS110A	8/-	1S4	8/9	MH4	8/-	9003	6/6
KT44	8/-	1T4	8/9	6J5	5/6	9004	6/6
RL37	10/-	354	10/6	6V6G	9/-	35Z4GT	9/6
YGT128	10/-	5R4	9/-	6K7G	6/6	NT40	11/6
5U3G	9/-	5U4G	9/-	6K8G	12/6	U19	10/-
5Y4G	9/-	5Z4G	9/6	6Q7G	10/6	5W4	9/-

MAINS TRANSFORMERS. The following are all ex-equip n steel cases, with all connections to terminals on top.

- T1, 220 v. A.C., 320-0-320 v. 95 m/a., 6.3 v. 3.1 a., 4 v. 2.5 a. Weight 24 lb., 27/6.
- T2, 220 v. A.C., 445-0-445 v. Weight 24 lb., 27/6.
- T3, 220 v. A.C., 265-0-265 v. 4v. 2.5 a., 6.7 v. 7 a. Weight 24 lb., 27/6.
- T4, 220 v. A.C., 365-0-365 v. 4 v. 2.5 a., 6.9 v. 4.2 a. Weight 14lb., 25/6.
- T5, 220 v. A.C., 275-0-275 v. 30 m/a., 4 v. 5 a., 4 v. 2.5 a. Weight 14lb., 25/6.
- T6, 220 v. A.C., 700 v. H.T., 4 v., 2 a. C.T., 4 v. 1 a. Weight 14lb., 21/- each.
- T7, 220 v. A.C., 1,540 v. 1.75 m/a., 2 v. 2 a., 4 v., 8 a. Weight 14lb., 22/6.

FILAMENT TRANSFORMERS (as above). F.T.1., 220 v. A.C., 4 v. 2 amp. Weight 6lb., 8/6 each. F.T.2., 220 v. A.C., 4 v. 3.75 a., 4 v. 6.9 a. Weight 16lb., 10/6 each.

Carriage on T1 to T7, 3/- each.
COLLARO MOTOR. Type 4-pole, shaded pole, variable speed A.C. 100/125 v. 200/250 v... 32/6 each.

THIS MONTH'S OUTSTANDING BARGAINS
8 mfd. 350 v. CONDENSERS, 1/3 each.
32 mfd. 350 v. CONDENSERS, 1/6 each.
WIRE-WOUND VOL. CONTROLS, 5k Ω , 20k Ω , 25k Ω , 50k Ω , 2/- ea.
CARBON VOL. CONTROLS, 5k Ω , 10k Ω , 20k Ω , 25k Ω , 200k Ω , 50k Ω , 1/2 meg., 1 meg., 2 meg., 1/- each.
MORGANITE VOL. CONTROLS, 1/2, 1/3 and 1 meg., with S.P.S., 3/9 each.

BIAS CONDENSERS, 25 mfd., 25 v. D.C., 1/4 each.
METAL RECTIFIER, 12 v., 1/2 amp., 1/6 each, 12 v. 1A 4/6 each.
CAR HEADLAMP BULBS, 6 volt, 18 watt, 1/6 each.
PUSH BACK WIRE, 7/0076, various colours, 2d. per yard.
30 amp. ROTARY SWITCH, 4 position, 4/- each.

TERMS—Cash with order, C.O.D., MAIL ORDER ONLY. Postage 6d. to 10/-, 1/- to 20/-, 1/6 to £5. Full list available, send 3d. in stamps.

ALPHA RADIO SUPPLY CO.

5/6, VINCE'S CHAMBERS, VICTORIA SQUARE, LEEDS 1.

SMALL ADVERTISEMENTS

9d. per word, minimum charge 12/-. No series discount; all charges payable with order. Insertions of radio interest only accepted. Add 25% for Bold Face (Heavy Type). No responsibility accepted for errors. Replies to Box Numbers should be addressed to The Short Wave Magazine, 55 Victoria Street, S.W.1.

TRADE

METAL WORK: All types cabinets, chassis racks, etc., to your own specifications.—Philpott's Metal Works, Ltd. (G4BI), Chapman Street, Loughborough, Leics.

QSL's and LOGS by MINERVA. The best there are.—Samples from Minerva Press, 46 Queen's Road, Brentwood, Essex.

VALVES WANTED: Types 805, 807, 813, 829B, 832, 866A, 931A, 100TH, 250TH, TZ40, 723A/B, 2K33, 2C43, CV129, CV323. Quantity and price, please, to: Pipe-Hayes Radio, 606 Kingsbury Road, Birmingham, 24. (Phone: Erdington 4942).

WANTED: RCA Speech Amplifiers, Type MI-11220, J or K, and Aerial Tuning Units, BC939A. Coils and tuning units for BC610 transmitters.—Offers, stating quantity and price, to PCA Radio, The Arches, Cambridge Grove, W.6.

WANTED: BC-610 Hallicrafters, ET-4336 Transmitters; SX28's, AR88's. Receivers and spare parts for above; best prices.—Write Box 864, c/o Spiers Service, 82 Centurion Road, Brighton, Sussex.

QSL CARDS AND LOG BOOKS. APPROVED G.P.O. SAMPLES FREE.—ATKINSON BROS., PRINTERS, ELLAND YORKS.

TRANSMITTERS: BC610, ET4336. Receivers: AR88, BC348, SX24, etc. Frequency meters, test sets, etc., wanted urgently. We pay high prices instantly.—Write/Phone: Pipe-Hayes Radio, 606 Kingsbury Road, Erdington, Birmingham, 24. (Erdington 4942).

WANTED, NEW VALVES: 6K8, 6V6, 5Z4, FW4/500, KT33C, KT61, 6Q7, etc., etc. PROMPT CASH.—WM. CARVIS, 103 NORTH STREET, LEEDS, 7.

SHORT WAVE Radio or Television components; Service aids, valves, speakers, etc. Send for free list.—The Radio Equipment Company (S.W. Dept.), Castor Road, Brixham, Devon.

QSL CARDS: Neat, attractive; reasonable prices. Samples.—Lovedee, BRS.15643, Mill Street, Barwell, Leicester.

VALVES: 6J6, 12AT7, 10/-; EF91, 6AM6, 7/6; 6C4, EF92, EAC91, 6AL5, D77, 6/6.—Skillman, Franchise Street, Weymouth.

READERS' ADVERTISEMENTS

3d. per word, min. charge 5/-, payable with order. Box Numbers 1/6 extra. Replies to Box Numbers should be addressed to The Short Wave Magazine, 55 Victoria Street, S.W.1.

1155 RECEIVER with nearly built-in power pack and output stage; spare set valves; circuit diagrams; T1083 aerial tuner. Perfect working order; £15 o.n.o.—Stevens, 45 Homestead Court, Welwyn Garden City.

ATTENTION! R.A.F. and ex-R.A.F. bods. Are you a member of the R.A.F. Amateur Radio Society? No? Then please write the Secretary, R.A.F.A.R.S., R.A.F., Locking Somerset, for full details of membership, and for copy of the official magazine *QRV*, price 2/-.

WANTED

1st Class W/T Operators

There is an urgent call for W/T Operators to fill hundreds of vacancies in the Marine, Land and Air Services.

Why not bring your present w.p.m. in Morse code up to the required standard of 20—30 w.p.m. Expert operating is the important factor.

If you can consistently send and receive at 15 w.p.m., the **Candler Advanced Code Course** will enable you to apply for a good well-paid position.

A Candler Student says: **Re ADVANCED COURSE:** "With regard to code work, I can send at a comfortable 30 w.p.m. and can read quite long sentences at a speed just under that... I have a smoother sending action, and get off 'reversals' at a fairly high speed with good spacing and accuracy."—J.C.B.

Send now for the **CANDLER "BOOK OF FACTS."** Sent Free on receipt of a postcard request quoting Ref. W/T. S.W.

THE CANDLER SYSTEM COMPANY

52b, ABINGDON ROAD,
LONDON, W.8

The Candler System Co., Denver, Colorado, U.S.A.

G4GZ's BARGAINS

		VALVES					
OZ4	6/6	6AQ5	11/6	6L7M	8/-	12AT7	10/6
1A5GT	7/6	6BG6	12/6	6N7GT	6/6	12AX7	10/6
1G6GT	7/-	6BB8	7/6	6N7M	8/6	12A6M	7/6
1LN5GT	7/6	6BBM	7/6	6Q7GT	11/6	125Q7GT	12/6
1LD5GT	6/6	6C4	6/6	6R7GT	8/-	6Y7G	9/-
1R5	10/6	6C5GT	6/6	6SA7M	9/6	6Z4	9/-
1S5	9/6	6F7	10/6	6SC7M	12/6	15D2	5/-
1T4	9/6	6F8G	7/6	6SG7M	8/6	25L6GT	9/-
2A3	7/6	6G6G	7/6	6SH7M	6/6	38	9/6
2X2	5/-	6H6M	5/6	6SL7GT	10/6	76	10/6
3A4	8/6	6K6GT	8/6	6SN7GT	10/6	884	12/6
3D6	3/6	6K7GT	6/6	6SQ7M	10/6	866A	17/6
3V4	8/6	6K8G	12/6	6SJ7M	12/6	9002	6/6
5Z4M	9/6	6K8M	15/-	6SJ7Y	15/-	9003	5/6
5Z4G	9/6	6J5GT	6/6	6U5G	7/6	VS110A	6/6
6AC7M	6/6	6J5M	7/6	6V6G	9/6	AC6Pen	7/6
6AG5	7/6	6J6	10/6	6V6M	10/6	DL510	10/6
6AK6	11/6	6J7G	6/6	6X5GT	7/6	ECL80	13/-
6AM6	10/6	6J7M	8/6	7A3	11/6	VU39	9/6

NEW BOXED MC METERS. 3 1/2 in. rd. fl. mtg. 0-10m/a., 17/6. 0-30m/a., 15/-. 0-500m/a., 17/6. 0-15v AC (MI Cal at 50 cps), 15/- (All 2 1/2 in. dials).

Also few only 0-100 microamps, 45/- ea. 2in. sq. fl. mtg., 0-200m/a., 17/6. 0-300v., 12/6. 2in. rd. 0-500 microamps (scaled 0-10v.), 17/6 ea. 2 1/2 in. rd. proj. 0-1 amp T/C, 12/6 ea. 2 1/2 in. sq. fl. mtg. scaled 40-140 FSD approx. 2 1/2 m/a. pointer zeroed to right; ideal for conversion to "S" meters, 6/6 ea.

SPECIAL OFFER!! 65H7M's (soiled ex Equip.) 4 for 9/6 All Guaranteed.

4 Bank wafer switches each bank 2 pole 4 way (Total 8P 4W), 4/6 ea., 45/- doz.

INTERESTED IN TAPE RECORDING? The NEW 3 Motor Lane Tape Tables are in stock, £16 10s. 0d. (car. 7/6), 1,200ft. reels Scotch Boy MC1-111 Tape, 35/- Spare reels, 4/6. Lane 45K/cs. osc. coils, 10/-. GEC Tape joining fluid, 4/9 bottle. Acos. Mic-30 mikes, £4 4s. 0d. Lustraphone High Z Dynamic, £5 15s. 6d.

All goods despatched per return post. Please add post/packing.

J. T. ANGLIN

160, CLEETHORPE ROAD, GRIMSBY, LINCS. Tel. 56315.

RADIO G200 ANNOUNCES

VALVES at: 1/9: EA50, DI, CV6, RK34/2C34; at 2/6: 954, 956, 2X2; at 3/6: SP61, P61; at 4/6: 6K7g, 615g, 6H6, 12H6, 12SH7, 6SH7; at 5/-: 6K7g, 6AC7, 617g, 6SS7, 6S37; at 6/9: KT61, 6SK7g, 6SK7, 12C8, 12SC7, EF22, EC52, EF36, 12SK7, 12SL7; at 7/6: 12SN7, B36, 7B7, 7C5, 7C6, 7C7, 7H7, 7R7, 7S7, 7Y4, EF54, DH77; at 8/6: 1R5, IS4, IS5, IT4, 354, 3A4, 3Q4, 3V4, W77, U73, 6X5gt, 35L6gt, 25L6gt, 50L6gt, 6V6gt, 6V6g, 6F6g, 6C6, 6D6, DF92; at 9/6: Z77, D77, 12AT7, 12AX7, X79, X78, 6L6g, 6SL7, 6SN7, 6L7; at 10/6: 6V6, 6F6, 6N7, 6SQ7, 6SA7, 6K3g, X61, 6Q7gt.

ARTHUR HOILE

55 UNION STREET, MAIDSTONE, KENT.

Phone 2812

WHY HESITATE?

—when the introduction of our Precision Component and Alignment Service has removed the main obstacle to Single Sideband working, universally recognized as the most efficient and economical method of radio-telephony. It eliminates costly high-level modulators with their heavy-duty power supplies, and pushes your signal into areas where ordinary A.M. signals would be smothered by Q.R.M. If you are not familiar with the advantages of this system, send 6d. for leaflet, "Comparison of Modern Methods of Modulation," and don't fail to secure a copy of our booklet, "SINGLE SIDEBAND SUPPRESSED CARRIER TRANSMISSION FOR THE AMATEUR," price 2/6, post free.

VALVE BARGAINS: 807, 6V6, 8/6; 6K8, 1616, 9/-; 6AK5, FV4/500, 10/-; 6L6G, KT66, 6E5, 9/6; OA2, OB2, 185BT, ECH35, 12/6; 6K7G, EF36, 5/6; EL32, EF92, 6SF5, 7/6; 7C5, VR150/30, 8/6; U37, 16/-, TH22C, 15/-; Also a few QVO4/7, 446B, 829B, 813, 100TH. Please add 9d. Postage on orders under £2.

ELECTRAD RADIO

69, HIGH STREET, BELFAST, N.I

We wish to buy . . .

- **TEST EQUIPMENT.** AVO, ADVANCE, MARCONI, E.M.I. etc. Signals Generators, Valve Testers, Bridges, etc. BC221's.
- **AMERICAN TEST SETS.** TS3, TS12, TS69, TS174, TS175/U, TS34 AP, TS47 AP, etc.
- **COMMUNICATIONS RECEIVERS.** AR88, LF, AR88.D., S27, S27CA, APR4, APR5 and any TN 16, 17, 18, 19 Units.
- **TRANSMITTERS.** ET4336, BC610 ANY Klystrons 723/AB., Magnetrans 2K33., 1B24's, etc. ANY 3 cm. equipment or microwave gear, waveguides, etc.

Please write, phone, call or send to Dept. "S":

**HIGHEST
PRICES GIVEN
CASH BY RETURN**

UNIVERSAL ELECTRONICS

27 LISLE ST. Leicester Sq., London, W.C.2
Phone: GERrard 8410

ALUMINIUM CHASSIS 18 S.W.G. with Folded Fitted and rivetted ends.

8 x 6 x 2 1/2"	7/5	each
10 x 6 x 2 1/2"	8/3	"
12 x 6 x 2 1/2"	8/7	"
12 x 8 x 2 1/2"	9/5	"
14 x 8 x 2 1/2"	10/4	"
14 x 10 x 2 1/2"	11/1	"
17 x 10 x 2 1/2"	12/5	"

STEEL CHASSIS Stove Enamelled Finish

8 x 6 x 2 1/2"	6/8	each
10 x 6 x 2 1/2"	7/7	"
12 x 6 x 2 1/2"	7/11	"
12 x 8 x 2 1/2"	8/10	"
14 x 8 x 2 1/2"	9/8	"
14 x 10 x 2 1/2"	10/3	"
17 x 10 x 2 1/2"	11/8	"

Post and Packing 1/- Metalwork to order. Trade supplied

BURN ENGINEERING

Produce Exchange Buildings, 8 Victoria Street, Liverpool 2

SMALL ADVERTISEMENTS. READERS—continued

WANTED by Ham: AR88 or HRO; also S27 and BC221. Or would consider complete station. Will collect.—Box No. 1116.

TU5B and **TU8B** tuning units, both as new, unused, with outer cases. Offers?—Sargent, 12 Stokes Avenue, Watton, Thetford, Norfolk.

S 640, 1949 model, perfect order. £18 (carriage paid).—G3BWX, 76 Monkton Road, Minster, Ramsgate, Kent.

T TRANSMITTED FOR SALE. late G21X: 150 watts, Phone/CW; 100TH final; Class-B807 modulator; 6ft. rack-and-panel construction. What offers?—G5MY, 111 Queen's Road, Leicester.

S SALE: Set 10 new boxed valves for AR77, 50/-; QVO4/7, 12/6; 717A (2), 7/6; KT66, 8/6; 6KM7 (3), 6/-; 5U4G, 7/-; new unboxed, 2/- each: 12SG7M (6), 12H6M (2), 12AH7GT (2), 12J5GT (2), 12C8M (2), 12SQ7M, 1LH4, 6C5G, EF36; RF27 unit, good condition, 25/-. Offers *Short Wave Magazine*, Vols. 5-8, bound cloth. Vol. 9 unbound. SAE, please.—G3AAV, 166 Otley Road, Leeds, 6. (Tel.: 51277).

AR 88D (one owner since new); makers' original alignment and valves; very good condition in and out; little used; £45 (no offers).—Box 1139.

R X's: ASB8 converted to 70 centimetres, £10; National 1-10, £10; RME 5-10, £20.—G5LJ, Butler, 32 Pilkington Avenue, Sutton Coldfield, Warwick.

F OR SALE: Super-Pro. (BC.779); rack mounting; with Power Pack and Auto-Trans.; £30 (buyer collects).—White, 85 Springwell Road, Heston, Middlesex. (HOU. 9157).

R ME 70, little used, excellent condition, complete with 8in. RME speaker on 2ft. sq. baffle and Ericsson earphones; £24.—Box No. 1140.

W ANTED: HRO Senior—with or without coils—any condition, but must be cheap.—Box 1141.

N ATIONAL Senior HRO with HRO Power Unit and four GC/BS coils 30 mc to 1.7 mc, guaranteed. £19; UM2, £2; D104 with telescopic stand and coax, £3; new boxed 866/A (2), 15/- each; new boxed RCA 807 (6), 5/- each; Woden potted swinging chokes 10H, 250 mA (2), £1 each.—R. H. Low, Moulin, Balmoral Road, Blairgowrie, Perth.

R ADIOVISION Commander, as new; manual, spare valves; £30. U.S.A. CR Oscilloscope. £18. Pre-selector, 10 mc to 30 mc, brand new, £3.—H. J. Balsam, 38 Wantage Road, Didcot, Berks.

N ATIONAL 1-10 with p/pack, £12 10s. 0d.; Triplet multi-range test meter, mint condition, £9 10s. 0d.; *Radio Handbook*, 13th edition, new, 35/-. Various valves and components. SAE list. WANTED: American test equipment, also signal generator; prefer Advance.—31c Upper Addison Gardens, W.14.

S SALE: 30-watt modulator P/P 6L6's, with 350v. 150 mA P/P, on one 19in. panel. Contains new Woden UM2 multi-ratio mod. and multi-ratio driver transformers, perfect working order. Bargain, £5.—233 Chelmsford Road, Shenfield, Essex.

R 107 with handbook and spares, £12; RCA TE149 Xtal wavemeter, £6; Taylor 65B signal generator, £8. Also other items. Buyer collects.—Phone: Ewell 3936.

W ANTED: Unconverted BC458A command Tx. —Box 1151.

SMALL ADVERTISEMENTS. READERS—continued

SX 28 HANDBOOK or Circuit wanted, to purchase or hire; R107 with S-meter for sale. £10.—Baker, 1 Mossdale Road, Nottingham.

BC 342. AUTO-TRANSFORMER. £17; R107, mint condition, unmodified. £15; R1155N, power/output stage. £8 (offers?) Buyer must collect.—Barron, 20 Second Avenue, Halifax.

G OING VHF. Recently reconditioned by Webb's, a BC348 Rx for sale. What offers?—Box 1142.

R. 1155A p/p output; DCR19; both very good condition. Offers, or exchange Eddystone 750; must be immaculate. Also, data wanted on BC-AR-430.—Wotton, 15a Langdale Road, Wallasey, Wirral.

AR 88LF, mint condition. S-meter, alignment recently checked by professional communication engineers; thoroughly sound in all respects; £60.—Box No. 1143.

M ODEL 40 AVO. electrically perfect; condition as new; £10.—G3BNV. 7 New Road, Minster, Sheerness, Kent.

1131 VHF TRANSMITTER PA stage with two new 834's.—Offers to Meeks, 37 Pevensey Road, Eastbourne.

E XCHANGE: 12in. TV Holme Moss; professionally-built chassis with tube used less than two months; excellent condition, with four spare valves and essential spares. Exchange for Radiovision Commander receiver, unmodified. — 17 Tudor Avenue, Bebington, Cheshire.

W ANTED—to buy or borrow: Manual for CR100.—G3EGH. 4 Gainsborough Avenue, Withington, Manchester. 20.

TR 1143A, complete with all valves, less crystals: new condition.—Offers to A. F. Watton, 80 Bedminster Down Road, Bedminster, Bristol, 3.

F OR SALE: R.107, excellent condition. £12; prefer buyer collects.—Bagnall, 12 The Crescent, Donnington, Nr. Wellington, Salop.

N ATIONAL NC81X. AC-DC; perfect; instruction manual; £20. Weston industrial circuit tester. Model 785, 20,000 o.p.v., cost 125 dollars. £10.—Offers, details, G2HKU, 4a, Clyde Avenue, Sheerness.

A MATEUR SURPLUS: QCC crystals, 15/-; UMI Mod. Transformer, £2; Parmeko choke, 8H 150 mA, 5/-; Wearite "P" coils, 1/6; Eddystone condensers.—Box No. 1144.

A MATEUR selling up: Bargains; must clear. QRO Transmitter. Power Packs, Coils, Type 48 Tx/Rx and hand Generator, FB QRP Job. SAE for lists.—G3ANK, 135 Station Road, Sidcup, Kent.

E DDYSTONE 750 Receiver; one owner; very little used; condition indistinguishable from brand-new; genuine bargain. £45.—Webster, Oakburn, Blackwell, Darlington.

R. 1224A FOR SALE; modified full vision scale; R. direct reading; £5 o.n.o.—J. Haggart, 10 St. Johnstoun's Bds., Charles Street, Perth.

AR 77, £22; seven-valve, four waveband Rx, designed relay monitoring, £10. Exchange either Zeiss folding camera. Spragues, 6/- doz. Quantity valves, mostly octals.—Box 1152.

D. S.T.100 MK. III, 50 kc-30 mc, 13-valve, D/Superhet, perfect; nearest £20 buyer collects. AR88D fitted S-meter, mint, £60.—Call or write, 31c Upper Addison Gardens, W.14.

FREE

THIS VALUABLE BOOK

which details the wide range of Engineering and Commercial courses of modern training offered by E.M.I. Institutes—the only Postal College which is part of a world-wide Industrial Organisation.

Courses include training for:

- P.M.G. Certificates, City and Guilds Grouped
- Certificates in Telecommunications:
- A.M.Brit.I.R.E. Examination, Radio Amateur's Licence, Radio & Television Servicing Certificates, General Radio and Television Courses, Radar, Sound Recording, etc. Also Courses in all other branches of Engineering



E.M.I.

Institutes

associated with

MARCONIPHONE
COLUMBIA
H.M.V.
(His Master's Voice)
ETC.

COURSES FROM

£1

PER MONTH

POST NOW

Please send, without obligation FREE book, E.M.I. Institutes, Dept. 14, 43 Grove Park Road, Chiswick, London, W.4.

Name _____

Address _____

T.C. TOP

★ SHORT-WAVE LISTENERS,
AMATEURS, ENTHUSIASTS!

If you doubt the ability of this miniature O-V-O, read what users claim. Send today for free literature, Catalogue and Testimonials, enclose stamp for postage.

THE INCOMPARABLE

GLOBE-KING

SINGLE VALVE S.W. RECEIVER

WORLD-WIDE RANGE. 11-100 metres with absolute NOISE-FREE BACKGROUND.

Sole Distributors. Home and Overseas Sales

JOHNSONS (RADIO)

46 FRIAR STREET, WORCESTER

THE WORLDS GREATEST BOOKSHOP

FOYLES

★ ★ FOR BOOKS ★ ★

All new Books available on day of publication. Secondhand and rare Books on every subject. Large Technical dept.

Subscriptions taken for British, American and Continental radio magazines.

119-125 CHARING CROSS RD., LONDON, W.C.2

Gerrard 5660 (16 lines) ▼ Open 9-6 (inc. Sats.)

Nearest Station: Tottenham Court Road.

SMALL ADVERTISEMENTS, READERS—continued

TRANSMITTER: 150 watts Phone/CW. P/P 35T in final. Bandswitched exciter with VFO. Class-B. TZ40 modulator; professionally built in two four-foot racks; nearest £50 secures (incl. carriage). Type 37 Oscillator Tx for 28 mc, 807 final. £5. Hallicrafter HT11. Tx-Rx needs attention, £5; covers Top Band 807 final P/P 6V6 Mod. Table-top Transmitter, completely bandswitched 80, 40, 20, 15, 10 metres; parallel 807 final, 120 watts input, Clamp tube mod., built-in VFO, not yet completed; measures only 17in. x 10in.; professional appearance; complete with separate power supplies; £25. Type 145 VFO. £5. Power supply for Type 145, 50/-; BC458A Tx. 25/-; BC454B Rx. 25/-; ACR5 Mod. and Dynamo-motor. 25/-; 2000-0-2000 500 mA plate transformer. £3; sundry Woden and Gardner 350-0-350 transformers at 20/- each; brand-new grid dip oscillator. 1 to 150 mc. 10 gns.; large Webb's Tx rack. 30/-.

WANTED: Hallicrafter S.72 Portable Rx and Mobile Tx for 28 mc Phone.—G3AME. Rowley Farm, Lowfield Heath, Nr. Crawley, Sussex. (Tel.: Crawley 875).

I HAVE LOADS OF GOOD GEAR that I shall never find time to use: Transmitters, Receivers, etc., British and American. Stamped addressed envelope for list at low price.—G2CVO, 13 Mount Echo Drive, E.4.

SALE: Complete station; transmitter P/P 813. All bands, and smaller rigs. AR88LF, BC221. Test gear. Large quantity components, meters, valves, etc.—Write for details, Box 1145.

RCA AR88D, with genuine RCA S-meter, overhauled. £52; MI-11220J, RCA speech amplifier, as new. £15; LM-10 frequency meter, unused. £10; Wilcox-Gay VFO, £5; Type 145 VFO with power pack, £5; Heavy Duty 1500v. power supplies. 600/350 ditto, all standard rack-mounted; dozens of Valves, cheap.—Please state wants: S.A.E. to G2FSR, 2 Parkhill Road, Chingford, E.4.

WANTED URGENTLY: QST, January 1947; also Cable Socket and Instructional Manual for BC348R. State price.—White, 279 Neasham Road, Darlington.

TS 69 FREQUENCY METER, 347-1000 mc, absolutely brand-new, mint condition, unused, complete in transit case with spare crystal diodes, etc.; highest offer secures. R15/APN3 (similar BC788) mixer, osc., and IF strip, plug-in type units like TN16's, etc.; covers 400-470 mc; precision slow-motion tuned lines; in good condition but less valves; £3 each. TCS6 Rx, as new, in mint and original condition, unmodified, complete with circuit diagrams, etc., £10 (with P/P £12). DFS1A Frequency sub-standard 100 kc-50 mc, brand-new, £8. RF26 Unit, brand-new, modified to 2 metres, excellent working order, 35/- (All items plus carriage). **WANTED:** 8025 Valves.—Box No. 1146.

WANTED: BC342 or BC312; preferably unconverted.—Box 1150.

£20 OFFERED for AR77 in reasonable condition.—Details to Ingram, 49 Lime Tree Avenue, Broadway, Worcestershire.

WANTED: Post-war medium-price American communications receiver in good condition, or Eddystone 750 or 680.—Box 1149.

MCR1 MINIATURE Superhet Communications Receiver. AC/DC or battery. 19/2000 metres, perfect, with power pack and complete coils; £7 or over.—Box 1147.

HAM requires ET4336. ET4332, ART13, HT9 or similar CW/Phone transmitter. All letters, giving full details and price, answered promptly.—Box 1148.

VALVE VALUE

IG6	4/6	6G6GT	9/-	12A6	7/-	QP25	7/6
IG8GT	5/-	6H6	5/-	12J5	5/6	RK34	3/-
ILD5	6/6	6J5GT	5/6	12SG7	5/-	RL37	4/-
ILN5	6/6	6J6	10/-	12SH7	5/6	RR72	2/6
IR5	9/-	6J7G	7/6	12SL7	7/6	SP4	7/6
IS4	9/-	6K6	8/6	A915	5/6	SP61	3/6
IS5	9/-	6K7G	6/6	ARPI2	5/-	TP25	8/-
IT4	9/-	6N7	8/-	CV6	2/6	U21	10/6
1625	5/-	6SC7	7/6	DI	2/6	U404	9/-
2155G	4/-	6SG7	8/-	E148	2/6	VR21	3/6
25A6	9/-	6SH7	5/6	EAS0	2/6	VR53	6/6
28D7	2/6	6SQ7	9/6	EF36	6/-	VR54	2/6
2C34	3/-	6SN7	10/6	EF50	4/6	VR65A	3/-
35L6	11/6	6SS7	7/6	EF54	4/6	VR78	2/6
3D6	5/-	6U7	6/6	EF91	10/-	VT62	5/-
354	10/-	6V6G	9/-	EK32	6/6	VU110	7/6
50Y6GT	7/6	6X5GT	7/6	EL32	7/6	VU111	3/6
5U4G	9/-	7193	3/6	EL91	10/-	VU102A	3/6
5Y3/SZ4	8/6	77	7/6	KT61	10/-	VU133	3/6
6AC7	7/6	786	6/6	KT63	7/6		
6B8	7/-	7R7	7/6	KT66	10/-		
6F6	8/6	954	2/6	OZ4	7/6		
6F8	5/-	9D2	3/6	PEN46	7/6		

All the above are Boxed and Tested and carry my guarantee. Money back if dissatisfied.

Please include a small amount for postage.

MAIL ORDER ONLY

E. MINETT — VALVE SPECIALIST —
(S.W.M.) 54, RETREAT STREET,
WOLVERHAMPTON

ADCOLA (Regd. Trade Mark) SOLDERING INSTRUMENTS



Reg. Design No. 860302
British, U.S. and Foreign Patents

Supplied for all volt ranges from 6/7v-230/250v. Meets every requirement for radio assembly, maintenance, telecommunications, etc. High Temperature. Quick Heating. Low Consumption. Light Weight.

3/16in. Dia. Bit Standard Model
1/4in. Dia. Bit Standard Model
3/16in. Dia. Detachable Bit Type

Sole Manufacturers: **ADCOLA PRODUCTS LTD.**

Sales Offices and Works: **Cranmer Court, Clapham High Street, London, S.W.4.** (MACaulay 4272)

**BRASS, COPPER, BRONZE,
ALUMINIUM, LIGHT ALLOYS**
IN ROD, BAR, SHEET, TUBE, STRIP, WIRE

3000 STANDARD STOCK SIZES

H. ROLLET & CO., LTD.

6, CHESHAM PLACE, LONDON S.W.1.
SLOane 3463

Works: 36 ROSEBURY AVENUE, LONDON, E.C.1.
BRANCHES AT LIVERPOOL, MANCHESTER, BIRMINGHAM
"No Quantity too Small"

Radio Amateur Call Book

FOREIGN SECTION

We are glad to be able to announce that it has again been possible to arrange for the Foreign Section of the RADIO AMATEUR CALL BOOK—complete less only the American amateur listings—to be made available at the price of

TEN SHILLINGS

This brings you the world directory of Amateur Radio stations, less the W section, in more than 120 pages in the same style and format as the *Radio Amateur Call Book* proper. It will include all regular CALL BOOK sections outside the United States, and is the latest and most up-to-date listing of its kind.

By arrangement with the American publishers of the *Call Book*, the new FOREIGN SECTION offered at Ten Shillings will be the Autumn issue, and will be available about the second week of October.

This is a Limited Edition—Order Now

Radio Handbook	A Course in Radio	One Year
11th Edition26/3	Fundamentals4/10	Radio Electronics.....33/-
12th Edition25/11	The Radio Amateur's Licence	Popular Mechanics32/-
13th Edition49/6	Manual4/10	Radio Electronic
Antenna Manual27/11	How to Become a Radio	Engineering56/-
Antenna Handbook11/7	Amateur4/10	Service24/-
Hints and Kinks11/5	Learning the Radiotelegraph	F.M. and Television.....32/-
How to Listen to the World 1/11	Code2/8	Electronics160/-
Ham's Interpreter5/-	Surplus Conversion Manual.	Popular Science32/-
Post-War Communication	In two vols. Vol. I 21/5	Proc. I.R.E.152/-
Receiver Manual.....28/5	Vol. II 21/5	RCA Review20/-
World Radio Handbook9/-	World Radio Valve	Tele-Tech40/-
	Handbook11/10	Television48/-
	ARRL Radio Amateur Hand-	Television Engineering32/-
	book, 1952 Edition30/-	CQ29/-
		Audio Engineering29/-
		Radio and Television News 36/-
		QST36/-

Short Wave Magazine (Publications Department)

55 VICTORIA STREET, LONDON, S.W.1

Suppliers of Technical Books and Publications to Schools,
Universities, British and Colonial Government Departments.

ABBEY 5034

HENRY'S

5 Harrow Road
Paddington : W.2

PADddington 1008/9 and 0401

OPEN MONDAY to SATURDAY 9-5.30 THURS. 1 o'clock SAT 6p.m

INDICATOR UNIT TYPE 182A.

This unit contains VCR517 Cathode Ray 6in. Tube, complete with Mu-metal screen, 3 EF50, 4 SP61 and 1 5U4G valves, 9 wire-wound volume controls and quantity of Resistors and Condensers. Suitable either for basis of Television (full picture guaranteed) or Oscilloscope. Offered BRAND NEW (less relay) in original packing case at 79/6. Plus 7/6 carriage.

SPECIAL NOTE.—The VCR 517 Tube has proved to be far superior to the VCR 97 Tube (call for demonstration).

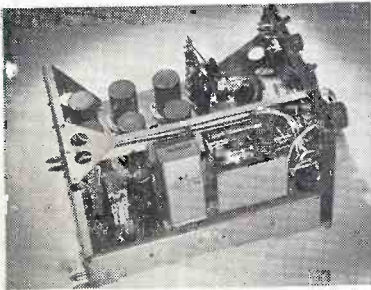
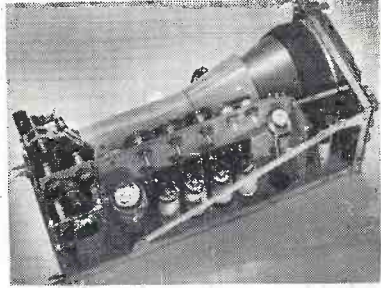

STROBE UNITS. Brand New, in sealed cartons, these contain 6 EF50s, 5 EA50s, 1 SP61, a host of condensers, resistors, transformers, chokes, relays, switches, 7 pots and 5 smoothing condensers. Size 18in. x 8 3/4in. x 7 1/2in. Only 67/6, plus 5/- carriage.

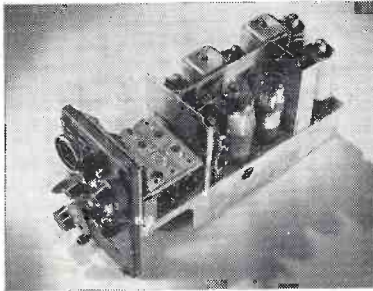

WALKIE-TALKIE TYPE "46" (case removed) complete with 6 valves. 2VP23, HL23, DD, CP25, TP25 and ATP4, aerial rods, i.f. trans., 1.6 mc/s. mike trans. in new condition, but less transmitting components and coils removed by M.O.S., 35/-, carr. paid. (Less valves, 14/-).

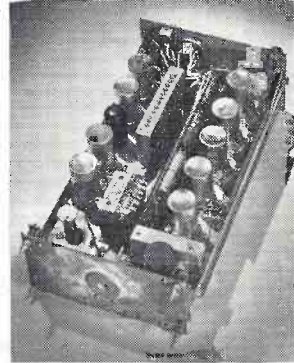

PYE 45 Mc/s STRIP. Special purchase of M.O.S. Type 3583 Units. Size 15in. x 8in. x 2in. Complete with 45 mc/s Pye Strip, 12 valves, 10 EF50, EB34 and EA50, volume controls and hosts of Resistors and Condensers. Sound and vision can be incorporated on this chassis with minimum space. New condition. Modification data supplied. Price £5, carriage paid.

— A COMBINED SIGNAL TRACER AND AUDIO OSCILLATOR —

An easy-to-build unit that can be used for I.F. and Audio signal tracing, without any switching or tuning, including variable output oscillator, for amplifier checking. Highly sensitive, responds to signals picked up from an ordinary receiving aerial. The circuit is that of a high-gain 2-stage, resistance-coupled audio frequency amplifier, employing 3 miniature 1.4 valves, with a 3in. speaker in the output of the Power Amplifier Stage. An added advantage being that as this Unit is "All-Dry" it can be used with safety on A.C. or A.C./D.C. mains and Battery sets. The complete Kit with portable cabinet (size 6in. x 7in. x 6in.) and battery weighs only 4 lbs. We shall be pleased to supply a complete Kit for the construction of the above, right down to the last nut and bolt, including 2-IT4 and 1-1/54 Valves, 3in. Speaker and Portable case and All-Dry Battery for £4/19/6. Concise instructions and circuits supplied. If preferred, circuit and instructions only can be supplied for 1/6. If required this Unit will be assembled and tested for an extra charge of 15/-. This is a highly efficient instrument and a MUST for every radio man.

BOWTHORPE CONTINUITY METER. Dual scale 0-500 ohms and 100-200,000 ohms moving coil operated from 4 1/2-volt internal battery. Size 6in. x 3in. x 4in. Original price £8 19s. Our price, brand new, £4 4s.

CONDENSERS. 1 mfd. 2,500 v. metal or bakelite, 2,000 v. Electrolytic 8 mfd. 450 v. w. 2/6; 8 x 8 mfd., 4/-; 16 mfd. 450 v. w. 3/6; 16 x 16 mfd., 450 v. w. 5/-. All midget tubular cans, carbide sleeves, 60 mfd. x 40 mfd. 350 v. size 4 1/4in. x 1in., 5/-. Bias condensers 25 x 25 mfd., 50 x 12, 12 x 50, 1/6; 50 x 50, 2/-. All new stocks. NOT surplus.

TRANSFORMERS-FILAMENT. All inputs 200/250 v. A.C.
Output 6.3 v. 1.5 amps. 7 6
Output 6.3 v. 2.5 amps. 10 0
Output 6 and 12 v. 3 amps. £1 0 0
Output 6.3 v. 12 amps. £1 5 0
N.B.—Above voltages are when "on load."

MOVING COIL METERS. (Brand New) —
0-5 mA, square panel mounting, 2in. scale 7 6
0-50 mA, square panel mounting, 2in. scale 7 6
0-40 v. square panel mounting, 2in. scale 7 6
0-20 amps square panel mounting, 2in. scale 7 6
0-300 v. square panel mounting, 2in. scale 12 6
0-40/120 mA double reading round scale 12 6
2 1/2in. round flush mtg., drilled flange —
Range 0/75 v. 200 ohms per v. each £1 2 6
Range 0/1500 v. 250 ohms per v. each £1 2 6
Range 0/3000 v. 200 ohms per v. each £1 5 0
0-1 mA desk type, 2 1/2in. scale, £1 12 6

L.T. RECTIFIERS
6 v. 1 amp. G.E.C. 6 0
12 v. 2 1/2 amp. Westinghouse 12 6
12 v. 4 amp. S.T.C. 17 6
12 v. 8 amp. S.T.C. £1 12 6

S.T.C. RECTIFIERS E.H.T.
K3/25 650 v. 1 mA. 4 7
K3/40 1,000 v. 1 mA. 6 0
K3/100 8,500 v. 1 mA. 14 8
K3/200 10,500 v. 1 mA. £1 6 0

H.T. RECTIFIERS
S.T.C. 125 v. 60 mA. 4 6
S.T.C. 125 v. 100 mA. 5 0
S.T.C. 125 v. 125 mA. 6 0
S.T.C. 250 v. 250 mA. 18 0
S.T.C. 300 v. 75 mA. 6 0

WESTINGHOUSE 14D/972, 250 v. 25 mA 6 6

G.E.C. METER RECTIFIER, 1 mA... 11 6

WEARITE
705 Coil Pack 3 wave band £1 17 10
400B Min. I.F.T. 465 kc. pair 15 0
501 and 502, 465 kc. pair 14 0
800's pair 15 0

RECEIVER R1355. As specified for "Inexpensive Television." Complete with 8 valves VR65 and 1 each 5U4G, VU120, VR92. Only 55/-, carriage 7/6. Brand new in original packing case. Slightly soiled. 35/-, carr. 7/6.
RF24, 25/-; RF25, 25/-; RF26, 59/6; RF27, 59/6. Owing to limited quantities, these units supplied only with R1355's.

CATHODE RAY TUBES:
VCR97. Guaranteed full picture. 40/-, carr. 5/-.
VCR517. Guaranteed full picture. 40/-, carr. 5/-.
3BP1. Suitable for scopes. 25/-, carr. 3/-.

RECEIVER UNIT TYPE 159. Size 8in. x 6 1/2in. x 4 1/4in., containing VR91, VR92, CV66, VR65 and 24 v. selector switch. New condition, 15/-.
9in. ESCUTCHEON. Brown bakelite. Suitable plate glass and mask for 9in. tube. Price 7/6 each.

No. 38 "WALKIE-TALKIE" TRANS. RECEIVER, complete with throat mike, 'phones, Junction Box and aerial rods in canvas bag. Freq. range 7.4 to 9 Mc/s. All units are as new and tested before dispatch. As supplied to Overseas police forces. £4/19/6, carr. 2/6.

TUNING CONDENSERS
2 gang .0005 standard 1/2 spindle, with trimmers 7 6
3 gang .0005 with ceramic insulation 1/2 spindle 7 6
Midget two gang .000375, with trimmers. 6 6
Size 2in. x 1 1/2in. x 1 1/2in. 6 6
Midget .0005 mfd. 2 gang tuning condenser. 6 6
Size only 2 1/2in. x 1 1/2in. x 1 1/2in. 7 6
Or with built-in trimmers 7 6
Two-gang Midget. .0005 with 4-way push-button assembly. Suitable for car radio, etc. 8 6

PUSH-PULL OUTPUT TRANSFORMER, U.S.A. potted type primary, 10,000 ohms sec., 2 ohms, 8 ohm, 15 watts, 21/-.

E.H.T. TRANSFORMER FOR VCR97. Input 230 v., output 2,500 v. 4v. 2-0-2. 45/-.

E.H.T. TRANSFORMER FOR SCPI. Input 230 v., output 3,250 v. at 0.6 afm., 2-0-2 v. 45/-.

MAINS TRANSFORMERS. 250-0-250, 90 mA, 6.3 v. 3 amp, 5 v. 2 amp. Input 110 v./250 v. £1, post 9d.

EX-MANUFACTURERS. 350-0-350, 100 mA, 6.3 v. 4 amp, 5 v. 2 amp. Input 200/250. 25/-.

REPLACEMENT TYPE. 350-0-350, 90 mA, 4 v. 6 amps, 4 v. 3 amps, input 200/250. 18/6

DUAL PURPOSE TYPE. 350-0-350, 80 mA, 6.3 v. tapped 4 v. at 3 amps, 5 v. tapped at 2 amps, 4 v. 20/-, post 9d.

VR91 (EF50). Red Sylvanian. Brand new original boxes U.S.A., 10/-; Silver, brand new original boxes, British, 8/6; red or silver ex-units guaranteed, 6/-; 6A7, 43, 12/6; VU11, VU120, VU120A, at 5/-; IS4, IT4 at 9/-; 3S4, 3V4, 1R5, 1S5, 10/-; U19, 10/6.

Over 10,000 B.V.A. valves in stock. Send in your enquiries.