

*The*

6<sup>D</sup>

# SHORT-WAVE MAGAZINE

Exclusively for the  
Short-Wave Listener,  
Experimenter and  
Transmitting Amateur

**JULY**

1939

—  
*Volume III*

*Number 5*

# Better Results with SOLON Electric SOLDERING



NO DIRT	CONSTANT HEAT	PERMANENT RESULTS	ECONOMICAL IN USE	WEARING PARTS REPLACEABLE
Heating element clamped inside bit. No flame hence no dirt.	Switch on — ready in four minutes. Heat maintained while current is on.	Solon resin-cored solder needs no other flux.	15 hours' continuous use requires only 1 unit of electricity.	These can be supplied and fitted without trouble.

Supplied complete with resin-cored solder, flux and lamp adaptor 8/6  
Solon resin-cored solder 6d. per reel

*It's Easier with a*

**SOLON** *Electric SOLDERING IRON*

TRADE MARK

W. T. HENLEY'S TELEGRAPH WORKS CO., Ltd. (Dept. 4 BB), Holborn Viaduct, London, E.C.1

## Mullard Transmitting Pentode PV06-20



**27'6**  
NETT

The PV06-20 is a screened pentode designed for use down to 5 metres as a doubler, RF amplifier or oscillator.

It can replace American Valves of the 807 or RK39 types with very little modification to the circuit.

### TECHNICAL DATA

CATHODE	LIMITS
Heater - - - 6.3V 1.3A	Max. Anode Voltage - - 600V
<b>CHARACTERISTICS</b>	Max. Anode Dissipation - 25W
Mutual Conductance - 4mA/V	Max. Screen Voltage - 300V
Amplification Factor ( $G_1G_2$ ) - 6	Min. Wavelength - - 5m
Anode-Grid Capacity - 0.1pF	Output as CW Amplifier - 42W
Base - - - British 7 pin	

*A copy of our list of low-power transmitting valves will be supplied free on request.*

**The Mullard Wireless Service Co. Ltd.** Transmitting Division  
Century House, Shaftesbury Avenue, London, W.C.2  
Telephone: Gerrard 7777

# BETTER RESULTS ACCRUE FROM USING EDDYSTONE SHORT WAVE COMPONENTS. ASK YOUR DEALER FOR EDDYSTONE

*-It pays to buy the best*

In your continual aim for Radio progress, the highest efficiency of your working components is of major importance. You will find you have moved a step forward if you specify EDDYSTONE. EDDYSTONE Components are specially designed to occupy a high position in the Short Wave World. To get full satisfaction from Short Wave experiments you want the BEST . . . Eddystone will give it you. See your Dealer NOW.



**Flexible Coupler.** Free from back-lash but very flexible, this coupler banishes alignment troubles, DL-9 HF insulation. For  $\frac{1}{4}$ " spindles. No. 1009. 1/6.

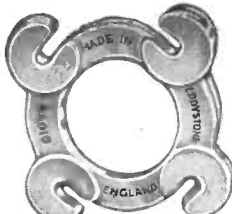

**Featherweight Cross-eder Blocks.** Made of transparent thermo plastic material, impervious to moisture, practically unbreakable and possessing remarkable HF insulating properties. No. 1041 4/6 doz.

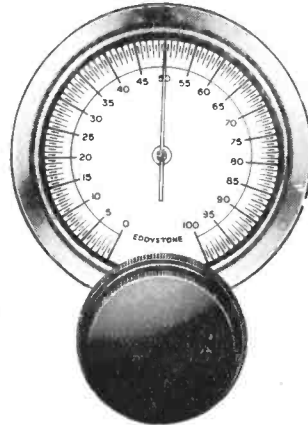

**Full vision dual speed dial.** Cat. No. 1070. A full vision dual speed dial with 20:1 and 100:1 speeds. Well graduated scale, reading increasing as frequency increases. For  $\frac{1}{4}$ " panel and  $\frac{1}{4}$ " spindles. Ideal for H.F. tuning. 10/6.



**Slow Motion Driving Head.** Cat. No. 1017. Very useful for transceivers and ultra short wave receivers. With 9-1 reduction ratio: pointer moving through 180 degrees. 3-



**Air Dielectric Trimmer.** DL-9 insulation. 3 to 65 mmfd. For all preset and trimming purposes and particularly for use with IF transformers. Cat. No. 978. 3/6

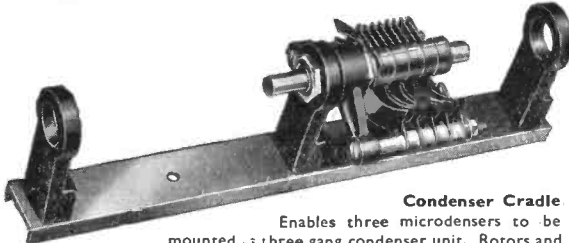
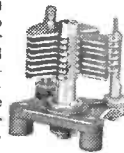

**Condenser Cradle**  
Enables three microden- sers to be mounted as three gang condenser unit. Rotors and stators completely isolated. Brass division plates available for screening condenser units. No. 1114. 3/6. Metal screens. No. 1125. 8d. pair.

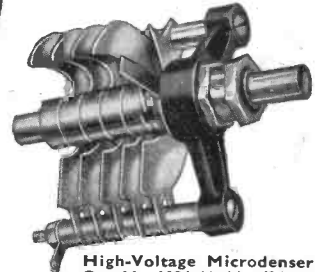

**High-Voltage Microdenser** Cat. No. 1094. Highly efficient. Soldered brass vanes. Constantly maintained capacity; very low minimum 3 mmfd. DL9 insulation.  $\frac{1}{4}$ " spindle extended for ganging. Peak flashover voltage 3,500 volts. Easy to gang—capacity matched within 1 per cent. 18 mmfd. 3/9



**Midget Insulator.** Made from Frequentite for high frequency work, with N.P. metal parts. 1" overall height. No.1019. 4/6doz.

**Neutralising Condenser.** Cat. No. 1088. For HF circuits using low-capacity triodes. Maximum voltage 2000 volts D.C. Capacity variation 1-8 mmfd. Frequentite pillar insulator mounting, insulated adjusting knob. 6/6.

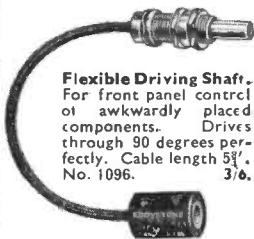

**Flexible Driving Shaft.** For front panel control of awkwardly placed components. Drives through 90 degrees perfectly. Cable length 5 1/2'. No. 1096. 3/6.

Post this coupon for catalogue of

## EDDYSTONE SHORT WAVE RADIO

Sole Manufacturers:

Stratton & Co., Ltd., Eddystone Works, Bromsgrove St., Birmingham

LONDON SERVICE: WEBB'S, 14 SOHO STREET, W.1

### COUPON

To Stratton & Co. Ltd,  
Eddystone Works,  
Bromsgrove St.,  
Birmingham.

Please send me  
Eddystone Catalogue  
and address of nearest  
stockist.

Name .....

Address .....

# BEST SELLERS!

ALL BRITISH LOW-PRICE TROPHY RANGE ADDITIONS

## PRESELECTOR

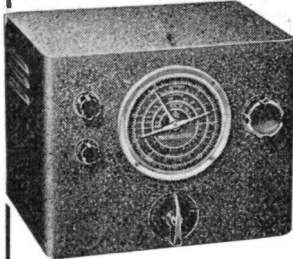

Useful for any receiver . . . .

- 2-stages using EF8 valves.
- 5 Bands—7 to 550 metres.
- S/M tuning—800° in 1° steps.
- Frequency calibrated scale.
- Self-powered for AC 200/250 volts.

We have no hesitation in recommending this HF amplifier for use in front of any mains or battery operated superhet or straight instrument. Two low-noise RF pentodes are employed giving increased range, selectivity, signal strength and considerable image suppression. Controls comprise combined RF Gain and On-Off Switch, Band Switch, Stand-by Switch and Tuning. Black crackle finish steel cabinet size 12½x9½x9½ ins. Guaranteed 12 months including valves. **TERMS:** 11/6 deposit and 12 monthly payments of 11/7.

**£6:15s.**

- The TROPHY range also includes an 8-valve AC communications-type receiver, price 12 gns. and the popular TROPHY 3-valvers for battery and AC mains listed at £5 15s. and 6 gns. respectively.

## TROPHY 6



A real Amateur junior Communication Receiver with a performance rivalling many higher-priced models. Four bands, 6.5—545 metres. Scale calibrated directly in frequencies. Separate dial electrical bandspread. 6 international octal-type valves comprising 6TH8, 6K7, 6Q7, 6V6, 6C5 and 5Z4. All essential refinements including AVC and BFO switches, Send/Receive switch, Pitch control, provision for doublet input, built-in speaker and 'phone jack. Pleasing cabinet measures 17½" wide, 10" high, 9" deep. Usual TROPHY Guarantee. **TERMS:** 12/6 deposit and 18 monthly payments of 12/3.

**9 ½ GNS.**

SEND NOW FOR COMPLETE LISTS

**PETO-SCOTT CO., LTD.** 77 (SM16) CITY RD., LONDON, E.C.1. Tel. CLIsold 9875  
41 HIGH HOLBORN, LONDON, W.C.1. Tel. HOLborn 3248



for Accurate Testing  
you need an

## AVOMINOR

ELECTRICAL MEASURING INSTRUMENT

Highly efficient testing facilities are provided by either of these models of the AvoMinor. Whilst moderate in price, they are precision instruments, made by the makers of the famous Avometer—the world's foremost combination testing instrument.

BRITISH MADE

### The D.C. AVOMINOR

Electrical Measuring Instrument

13 precision meters in one. This accurate moving-coil instrument has 13 ranges . . . voltage ranges sufficient for measuring H.T., L.T., Grid Bias, Mains and Eliminator voltages: milli-amp ranges for testing all receiving valves and radio apparatus: resistance ranges for all resistance tests. In case, complete with instruction booklet, leads and interchangeable testing prods and crocodile clips **45/-**

All "Avo" Instruments are available on Deferred Terms if desired.

- Write for fully descriptive pamphlets.

Sole Proprietors and Manufacturers:—

**THE AUTOMATIC COIL WINDER & ELECTRICAL EQUIPMENT CO., LTD.,**  
Winder House, Douglas Street, London, S.W.1. Telephone: Victoria 3404-7.

### The UNIVERSAL AVOMINOR

Electrical Measuring Instrument

This compact precision moving-coil instrument covers all A.C. and D.C. testing. It has 22 ranges for measuring A.C. voltage, D.C. voltage, current and resistance. All readings are direct. No calculations. The high total resistance of the instrument—200,000 ohms—ensures accurate readings. Complete with instruction booklet, leads and interchangeable testing prods and crocodile clips . . . **£5 10s.**

(Leather carrying case, 10/-)

The word "AVO" is our Registered Trade Mark.

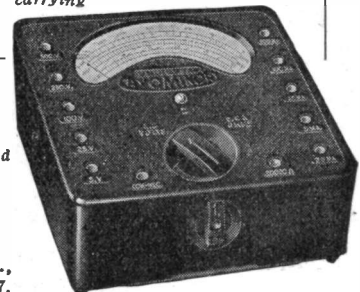

---

---

The  
**Short-Wave Magazine**

No. 5, Vol. III.

JULY, 1939

---

---

## Features

	PAGE
Editorial - - - - -	5
56 Mc News. <i>A. J. Devon</i> - - - - -	6
The Modern Two Transmitter. Part II. <i>The Editor</i> - - - - -	9
The Other Man's Station—G6IH - - - - -	11
The Cathode-Ray Tube—VI. <i>A. F. Hollins</i> - - - - -	12
Conditions—The Month's Survey - - - - -	14
On the Amateur Bands. <i>Old Timer</i> - - - - -	15
"Have You Heard . . . ?" <i>F. A. Beane</i> - - - - -	16
Three Useful Circuits. <i>Tester</i> - - - - -	18
Danger—High Voltage. <i>F. L. Postlethwaite, G5KA</i> - - - - -	20
"Here and There" - - - - -	21
DX Commentary. <i>The DX Scribe</i> - - - - -	22
Calls Heard - - - - -	- 27 and 29
A QRP Contest Analysed. <i>A. C. Gee, G2UK</i> - - - - -	28
Letters to the Editor - - - - -	30
The Month's Club News. <i>2AMW</i> - - - - -	31
Readers' Bargain Page - - - - -	36
List of Broadcast Stations—13 to 31 Metres - - - - -	- iii of Cover

---

---

Editor - AUSTIN FORSYTH, G6FO  
Assistant Editor - S. W. CLARK, 2AMW  
Business Manager - C. T. MILDENHALL  
Advertisement Manager - A. W. MARRIOTT

Published on the first Wednesday in each month at 84-88  
Tabernacle Street, London, E.C.2. Telephone: Clerkenwell  
8230. Annual subscription: Inland 8s.; Abroad 10s., post paid.

### AUTHORS' MSS.

Articles submitted for Editorial consideration must be typed  
double-spaced with wide margins, on one side only of quarto  
sheets, with diagrams shown separately. Photographs should  
be clearly identified on the back. Payment is made for all  
material used, and a figure quoted in the letter of acceptance.  
A large stamped addressed envelope should be enclosed  
for the return of MSS. not found suitable for publication.

---

---

RF 1851; FC 6J8; RF Oscillator 6F6; 1st IF 6K7; 2nd IF 6K7; 2nd Det. 6H6; 1st LF 6F5; 2LF 6L6; Main Rec. 5Z4; AVC Neg. Rec. 6H6; AVC DC Amp. 6C5; Meter Amp. 6C5; BFO 6J7; Wave Range 9-600 metres continuous in 5 Bands; Electrical band-spread on all amateur bands; RF stage all bands; Separate FC and Osc.; Variable delayed AVC; Undelayed amplified "R" meter; Differential Xtal gate; RF Gain control; BFO Variable pitch; 2 phone jacks; Switched AVC; TR Switch; Dipole and Marconi inputs; High and Low Imped. output.

**At last! A British made Communications Receiver far superior to many higher priced models of American origin. Priced only at £27 10 0**

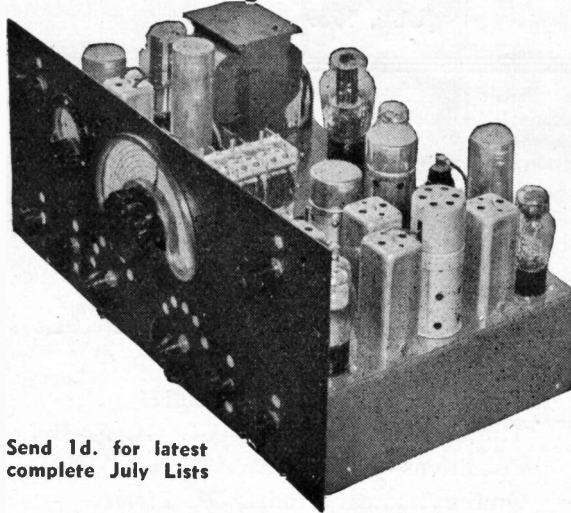

**LOOK! Your Technical Editor says:** "I think this design has all the desirable features required in an amateur band receiver, and at its price, should be a very popular model." Ken Jowers, G5ZJ, of "Television & Short Wave World," says: "This new Hamrad 140 Receiver has a better specification than any other at anywhere near the price. The "R" meter works well on both CW and 'Phone. Noise level is low whilst the BFO does not bring up any background."

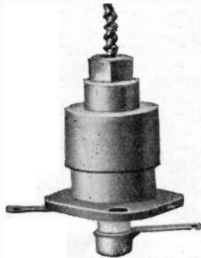

**Concentric Air Spaced Trimmers**, once set they remain constant, ceramic insulation, illustration actual size. 3-40 Mmf. each 1/-

**Bakelite Air Spaced Trimmers**, tubular type, 5-40 Mmf. each 1/-

Send 1d. for latest complete July Lists

**KENYON TRANSFORMERS**

We are now in the happy position to supply KENYON transformers from stock at reasonable prices.

**HT types**, 230 volts Pri., T655, T656, T664; **HT & Fil. Types**, 230 volts Pri., T213, T214, T246, C808, C809, C817; **Filaments only**, 230 volt Primary, C810, C812, C813, C814; **Ken-o-tap Modulation Transformers**, T493, T494, T495; **Plate & Screen Mod. Trans.**, T497; **Ken-o-dyne Universal Output Trans.**, T108, T109; **Class AB & B Input Trans.**, T251, T253, T254, T255, T256, T257, T271; **Class A Input Trans.**, T58; **Ken-o-Drive Universal Driver Trans.**, T263, T264.

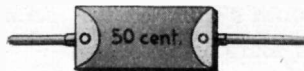

**Aluminium Can Type ELECTROLYTICS**

500—550 volts working  
 1 x 8 Mfd. each 2/-  
 1 x 12 " ... each 2/3  
 1 x 16 " ... each 2/6  
 2 x 8 " ... each 2/6  
 2 x 12 " ... each 3/6  
 2 x 16 " ... each 4/-

**4 Wire Type**  
 2 x 8 Mfd. each 3/-  
 2 x 12 " ... each 3/7  
 2 x 16 " ... each 4/3

**MICA CONDENSERS**  
 50 Mmf. ... each 4d.  
 150 " ... each 4d.  
 500 " ... each 4½d.  
 001 Mfd. ... each 6d.  
 003 " ... each 10d.

**EMINENT RESISTORS**

250 to 3000 ohms only in the 67 watt range 1/9  
 8 watt  
 50 to 10,000 ohms 11d.  
 Up to 20,000 ohms 1/1  
 Up to 50,000 ohms 1/4

15 watt  
 1000 to 10,000 oh. 1/1  
 Up to 20,000 ohms 1/4  
 Up to 50,000 ohms 1/6

25 watt  
 1000 to 10,000 oh. 1/6  
 Up to 20,000 ohms 1/9  
 Up to 30,000 ohms 1/11  
 Up to 40,000 ohms 2/1  
 Up to 50,000 ohms 2/3

**Taylor Tubes**, 866 JR, 7/-; TZ20, 17/6; Send us your enquiries for other Taylor Transmitting types. All Tungram TX Valves obtainable. We carry a comprehensive stock of Raytheon RK Tubes. RK-1851, 1852, 1853 ..... 17/6  
 RK-11 ..... 17/6  
 RK-18 ..... 55/-  
 RK-20A ..... 88/-  
 RK-23 ..... 27/6  
 RK-25 ..... 27/6  
 RK-32 ..... 55/-  
 RK-34 ..... 22/6  
 RK-38 ..... 95/-  
 RK-41 ..... 22/6  
 RK-49 ..... 16/6  
 866 ..... 12/-  
 866A ..... 27/6



**HAMRAD WHOLESALE LTD.**

32, St. LAWRENCE TERRACE, W.10

LADbroke 1166-7

## Six Months' Probation

Editorial

THERE IS IN OUR VIEW a strong case for the suggestion, made from time to time in the past, that the granting of a new licence to radiate should be conditional on the holder refraining from the use of telephony on any band for a period of six months from the issue of the permit.

Reasons for this contention are (1) that the British amateur would lead in maintaining a high standard of telegraphy operation; (2) there would be far less abuse of the terms of the licence than is at present evident; (3) the general condition of the bands would be improved; and (4) the idea of being a competent CW operator first is more in keeping with the spirit and tradition of Amateur Radio.

Objections which could immediately be raised are that many people would wait for the probationary period to expire before commencing transmission in earnest with 'phone and (the old one) that there is as much experimental work to be done on telephony as there is on the key. The answer to the first point is that the system of issuing licences could be still further improved by requiring a check Morse Test every twelve months; and as to the second, we know of very few telephony experiments which cannot be carried out on an artificial load circuit.

These remarks may suggest that we do not favour the use of telephony on the amateur bands. Such is not the case, for there is as much scope for it as for CW, while there is no doubt that amateur 'phone working is in an advanced state and has come to stay. But in the interests of the art, what we should like to see are reasonable regulations to ensure that all holders of transmitting permits are competent telegraphists, as this would have the important secondary effect of discouraging the type of operator who does not add anything to the good name of Amateur Radio.

In this country, we already have the useful and important first-stage licence known as the AA Permit which, at least in the past, did much to place British operating and technique in the forefront of the Amateur Radio world. Further to qualify the existing licence regulations by imposing a telephony graduation period and re-examination in Morse would merely be a step towards general improvement in operating conditions, to the ultimate benefit of all concerned.

*Austin Foster  
G6FO.*

# Five Metres

By  
A. J. Devon

## European DX Again—New G/I Contacts— Inter-G Records — Increased Activity

ON JUNE 1, I1IRA hears G5MP, G5MQ and G6DH, 1800-1900 BST. . . June 13, G6CW and G8JV obtain two-way contact with I1FA and I1SS, R8 both ways at 2115-2130 BST. . . June 24, I1FA works G8KD at 2005, G2MV at 2020 and G6XM shortly after; G6XM receives F8AA, I1BE, I1SS and English voice with American accent calling "CQ five"; G2MV gets R6 harmonic from Addis Abbaba commercial transmitter and G6YL logs 'phone from F8VC and I1IRA, all on that same evening of June 24. . . G2MR works I1TKM on the 25th, and G2MV hears I1RS at 1150 that morning. . . Also on June 25, R. J. Lee at Heathfield receives I1BE and I1TKM, 1600-1700 BST. . . The Italians and some unidentified European 'phones severally heard by G2XC, G3FA, G3HW, GW6AA, G6IH, G8NM and others. . . G2ZV-G6CW establish new inter-G record (150 miles) and R. J. Lee brings in G2WS at 156 miles. . . In eight days, G6CW puts down thirteen contacts over 100 miles with six different G's.

Such, in brief, are the highlights of the month's happenings on 56 Mc. The stations regularly active have all had a share of the DX and contacts have been made with low power—G2MR only uses 10 watts—while on the receiving side simple 0-v-1 and 1-v-1 circuits brought in what was going.

### ● Comment

These results are not only a tribute to the tenacity of the 56 Mc operators concerned but also the fulfilment of the prophecies of those who were convinced that it was merely a matter of time before conditions broke for European DX; further than this, the potentialities of the 56 Mc band are proved to be very similar to those observed in the States for the last three years, our American friends having had the advantage of a much greater degree of activity and more convenient placing of stations.

At the same time, it is worth remarking that indirectly these Italian contacts have been made possible by the ban placed on Amateur Radio in that country; you can't keep a good man down, as they say, and so the Italian operators have risked much to become active on the one frequency which gives them their best chance of under-cover work. It certainly is an ill wind that blows nobody good!

It is greatly to be hoped that now these results have been obtained, there will be more regular activity on 56 Mc all over Europe by an increasing number of stations. There is some interest in 5-metre working in practically every country in the world, and as it becomes known that DX is possible, so we shall see new records being made.

There is, however, no doubt that conditions will be very variable and quite unpredictable, while the "flashes" of DX will only last for comparatively short periods of not more than a few hours and may only occur on isolated occasions. It is therefore steady activity which will find DX and day-to-

day listening and calling at odd times is most likely to produce results; early evening working is the need of the moment.

### ● Weather

As to the possible effect of local weather on conditions, we see again that DX has been obtained during what amounted to a heat-wave in the early part of June, with many good G contacts as well as the European QSOs, but the change to much cooler weather round about June 17-18 did *not* mean a cessation of DX, nor of G contacts over 100 miles.

Comparing conditions on other bands over the period June 1-15, we find that they were steady and good June 1-12, with a pronounced change on June 13-14, bad QSB being evident on the lower frequencies, apparently due to the influence of a small sunspot (see "Conditions — The Month's Survey", this issue.)

So far as can be ascertained from the many reports which have come in, fading was the outstanding characteristic on all the DX heard or worked, but a close study of this material suggests no connection between conditions on 56 Mc and results on other frequencies—except that, as always, the reception of DX harmonics up to 50 Mc and above is a sure indication that the 5-metre band is open or opening.

G6YL, who draws attention to the way in which the opening of the band this year again coincides with the June full moon (June 2 and 12), thoughtfully adds the local weather conditions to her report on the reception of F8VC and I1IRA on June 24; it was cold, with a falling barometer, cloudy and raining heavily—all this applied throughout the country on that day. Yet June 13, when the Nottingham stations worked the Italians, was extremely hot.

This would seem to be further proof that weather plays no part in 56 Mc DX—though a warm day followed by a cool evening might help in working distances around the 200-mile mark—while the condition of the other bands for long-distance working is likewise no guide to what can be expected on 5 metres. These cannot of course be final conclusions—they are only suggestions based on the available evidence. It may in time be possible to trace a closer connection between weather and 56 Mc, and between results on that band with, say, conditions on 14 Mc.

### ● Tests and Schedules

Last month's Test Period was arranged for June 14-18 and some of the results are shown in the form of the calls lists on p. 29 of this issue; these are useful and of interest as indicating the degree of activity on the band and listeners should note that all the stations named are glad to have detailed



reports. Similarly, stations given as "heard" can obtain reception data on request to the receiving operator concerned.

The next Test Period is a most important one; the dates, given last month, are July 5-9, or during the time you will be reading this. GW6AA is on Snowdon and many stations are working portable. Full details of schedules, etc., where known, were included in these Notes in our June issue, to which reference should be made. Here are some more:

July 9, G2QY portable on 56200 or 58300 kc, CC, using CW only, commencing about 1000 BST. He suggests that operators quote their normal frequency when reporting, to assist in getting the band pegged out.

SM7UC (56300) and OZ7T (57100) are on every Sunday, while over the period July 8-10, G2MF will be working portable from the "Sir William Hill" in Derbyshire, using a horizontal beam, with G3FA, G3OH and G4DO co-operating. G5UI (Ryde, I. of W.) is on every night from 2200 BST onwards and wants reports and schedules. G3HW (Teignmouth) will be there for the Test Period; he is also active most Sundays and on Wednesdays and Fridays 2030-2200 BST. G5AX (Preston) is keeping watch on 56 Mc and will be transmitting as soon as the licence comes through; so far, he has heard locals only. G6LY and G8NM maintain their schedule as given last month, R. J. Lee of Heathfield is an outstandingly successful listener and 2AAH of Chichester spends a great deal of time on 56 Mc. Another efficient receiving operator to report again is R. H. Holmes (Painswick), who suggests that the persistent carriers heard at the HF end of the band may be from the Bristol Channel telephone link transmitters; he has proved that the radiation is horizontally polarised, as it is R9 *plus* on a horizontal aerial but only R1 with the same aerial placed vertically.

### ● Inter-G Working

Over the period May 30-June 9, G6CW swept the board so far as G DX is concerned; John Curnow deserves all the success he gets, as he has been on 56 Mc consistently not for months, but for years, and is at last beginning to see something for it. Apart from the Italian working already mentioned, eight operating days produced no less than *thirteen contacts over 100 miles* with six different stations—G2MC, G2MV, G2ZV, G5MA, G5RD, G6OT—of whom G2MV was worked six times at 125 miles! In addition, G2MR (107) and G6DH (130) were heard and G6IH (74) worked. G6DH and G6CW hear one another but have not yet contacted; G2BI (Calne) received the latter on June 7.

### 56 Mc CALLS HEARD

Interesting 56 Mc activity lists, the most comprehensive yet published in this country, appear on page 29. To make these logs more useful and to save office time, we should be glad if in future correspondents would set out their lists in the manner shown, deleting all calls heard or worked under 50 miles distant. Notes and comments for A. J. Devon's columns should be written separately, and we should also like to see more reports from the North.

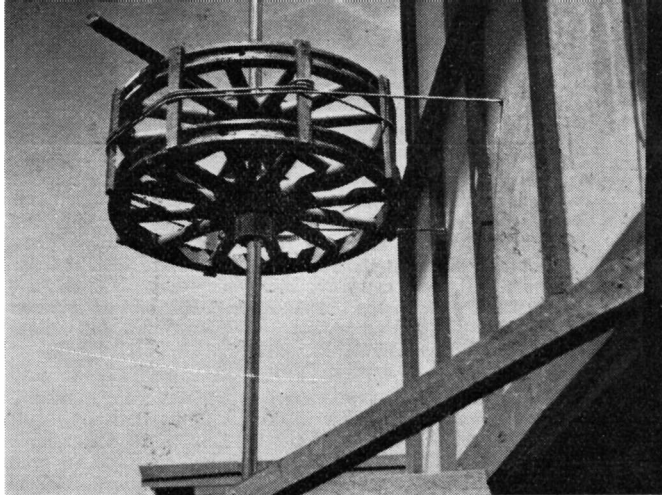

Rotating gear for the vertical two-section W8JK 56 Mc beam aerial at VK2NO, Sydney, whose 5-metre equipment is very similar to that used by G5BY.

Some extraordinary QSOs are reported by G3YY—he can work G2XC (42) and G2ZV (20) with an "aerial" consisting of 25 sq. ft. of flat lead roofing tapped to a 10-watt FD stage by a wire 12-ins. long. With a more normal aerial (this and the transmitter are to be improved shortly) he has done well to medium distances.

On June 7, G6DH heard G2XC (116 miles) and the latter mentions reception of numerous Italian commercials, including the broadcaster 2RO and IBT, on June 1 and 13 at strengths varying from R6 to R9. On June 22, G8KD began to hear Italian amateurs working 'phone amongst themselves, the calls being difficult to identify owing to QSB and because they were speaking at great speed—also, like many of our own stations, they were making quick "overs" without signing. This is a practice which cannot be deprecated too strongly on any band, but particularly on 56 Mc.

Denis Heightman, G6DH, sends in a most comprehensive report covering observations over the two-month period May and June. These showed that there were good days prior to May 31, but as G6DH says, the usual complaints have to be made—in-sufficient and inconsistent activity on the part of most people and the use of insensitive receivers and poor aerials. Simple beams can easily be erected for 56 Mc and make a great difference in extended ground-wave working. Denis Heightman also makes two further observations of particular interest: That the weather prior to June 10 may have affected results, as things went off after this date, and he also draws attention to the fact that though we are well past the period for maximum sun-spot activity we are still getting short-skip conditions, which would suggest that the higher frequencies do not follow the course taken by 28 Mc, i.e., the falling-off in conditions on the lower frequencies is not an indication of what is going to happen on 56 Mc. We fully agree with the latter point, but the former would appear to be disproved by events subsequent to June 10 and right down to June 25.

A word from G6FO who, due to an unfortunate combination of circumstances, was not able to join in making hay while the sun shone during the first three weeks of June. However, on the 20th, a brief period on the band brought a good contact with G2MV (Coulsdon, 124 miles), and R. J. Lee reported reception (146 miles) on June 22.

This does not complete the tale of active or reporting stations. G5MA (Ashted) who does a great

deal of portable work, not only co-operates in our various Test Periods but also takes G5MAP out independently, the location being usually on the South Downs, about a mile south of Storrington, Sussex. His log shows some 15 stations QSO'd from there on two occasions this year—best DX G5RD, 56 miles—but from the Ashtead QRA he has worked G6CW (130 miles), with G8KD (Sheffield, 160 miles) and G6QZ (115 miles) heard.

The contact G2MR-I1TKM on June 25, already mentioned, was preceded on the Saturday evening by reception of I1FA at about 2000 BST by both G2NH and G2MR. When I1TKM came through to G2MR at 1545 on the 25th, the Italian's 'phone was R7-0; a call brought him back immediately, G2MR also getting R7-0 and I1TKM was audible till 1600 BST. G2MR's equipment consists of a  $\frac{1}{2}$ -wave rotatable dipole, a National FBXA receiver adapted for 56 Mc operation, and a simple 6L6 tritet-6N7 push-push doubler, made slightly regenerative and feeding directly into the aerial, the input being about 10 watts. G2NH says that seven of these little transmitters have been made up in the New Malden district with complete success every time, in spite of variations of layout. An interesting point is that G2NH, G5MA, G6LK and G6SC have modified their HRO's for 5 metres by using the second harmonic of the 28 Mc oscillator and a home-made 56 Mc detector coil, preceded by an RF stage in the case of G2NH (EF12) and G5MA (acorn). As G2NH suggests, this scheme is effective and entirely practicable for such receivers as the FBXA, HRO, NC-100 and NC-101X.

Up in the North, the two Southport stations G2IN and G5ZI plough a lonely furrow, as there do not seem to be many stations in regular operation within ground-wave range. The former has 100 watts to a 35T in the final, and G5ZI runs 10 watts to an 809. They are anxious for transmitter and listener schedules after 2000 BST or on Tuesday afternoons.

There is a dearth of information from GM, GI and EI as regards 56 Mc working and, as mentioned editorially elsewhere, we should very much like to have news of what our Scots and Irish readers are doing about it. The GM stations are well situated for semi-DX contacts—giving distances up to 400 miles or so—with the large group of 5-metre operators from the Midlands to the South, and the present inter-G record of 150 miles two-way should be easy to break. Similarly, contacts from the Midlands and South to Northern Ireland ought to be made if the co-operation is forthcoming.

### ● Summer Forecast

There is not the least doubt that this summer is going to give us a wonderful chance of showing progress in 56 Mc working and, while it is most pleasing to hear of so much activity and interest after the comparatively barren months of last year, there is room for plenty more yet. The band is 4000 kc wide and even in congested areas of amateur population will accommodate a large number of stations; furthermore, with new licences being granted only for the HF section from 58.5 Mc up, there is more spreading through the available territory and stations are no longer exclusively to be heard at the LF end. At the same time, it is true that in the same way that 28 Mc was first opened, most people get as near the LF sides of their respective licensed sections as they reasonably

can. At present, the band is populated from 56 to 59 Mc, with the majority of operators using 56-57.5 Mc.

Another point which is of great importance from our side—speaking for the MAGAZINE—is the question of reporting. We cannot make news, and so the co-operation of every reader interested in 56 Mc is particularly requested. Let us have, not later than the 20th of each month and earlier if possible, any information no matter how trivial it may appear, with details of contacts, equipment, conditions, etc., also where possible good photographs of 5-metre apparatus and aerial systems.



Portable on 7 Mc with GW8NPP, near Cardiff. In front, left to right, are GW's 4FW, 8AM, 8WU, 8UH, 5BI, 4KQ, 8NP and 3VL. Above are the masts raised for the occasion, with a doublet aimed NW-SE between the right-hand pair, a 66-ft. end-on aerial sloping down from the third one.

### USEFUL PUBLICATIONS

The Mullard Technical Bulletins are extremely well produced—in fact, they are what may be called art productions. No. 6 of the series deals with various design points in connection with the superhet oscillator circuit and also describes the Mullard measuring bridge Type GM.4140, while No. 7 discusses a volume expansion circuit using the EL3 or EF6 output valve. Enquiries regarding these Bulletins, which are primarily for engineers, should be directed to the Mullard Wireless Service Co., Ltd., Century House, Shaftesbury Avenue, London, W.C.2.

# The Modern Two

By

Austin Forsyth, G6FO

(Editor)

## General Points and Operation

### PART II.

LAST MONTH we described the circuit and covered most of the constructional details of this two-stage transmitter, and it only remains now to discuss general points and operation.

First, however, a word for those who have been writing us to inquire about changes in layout, different components and other forms of construction. The answers are briefly as follows: This transmitter can, of course, be built up rack-and-panel, and even in three units, since it is link-coupled. We adopted a single chassis design because it is easier for the man without much experience to get at chassis-built apparatus for alterations and adjustment. If rack and-panel is preferred, or a suitable three-tier assembly is available, the transmitter will work quite as well in it as does the model shown in last month's heading photograph. As to substituting components, this is a different matter. It is not entirely a question of values—even some of these are not of vital importance and could be altered by the man who knows what he is doing without there being any noticeable difference in performance—but the point is that the parts have been chosen to fit in on the chassis in the same way that the values are calculated to work with the valves at the frequencies involved.

Therefore, substitution will only upset the balance of the design and for this reason alone it is at least advisable to keep to what we find is the most suitable apparatus for this particular rig.

### ● General Details

The keyed circuit and list of parts, with values, are shown herewith and there is little to add to what was said last month. There are, however, several further points to mention in connection with construction. The layout of the parts can easily be seen from the photograph in the June issue.

The various jacks must be insulated from the chassis with Bulgin spacing washers and the wires passed through to the sub-space should go through holes protected by rubber grommets. Wiring can be in "push-back," systoflex-sleeved tinned copper or enamelled wire protected with sleeving, in No. 18 gauge; the only exceptions to this are the output tank connections, which should be in copper strip, and the heater supply leads, for which heavy flex is suitable.

Everything not visible in the June photograph is in the sub-space, i.e., most of the RF wiring is above chassis level, all resistors, by-pass condensers, chokes, etc., being carried in the run of the wiring

underneath. This makes for stability, a neater appearance and easy construction. In this connection, remember that the cathode circuit L1/C1 is also in the sub-space, and L1 could be wound on a piece of plain paxolin the same diameter as a plug-in coil former if the transmitter is to be operated only on the bands 7-28 Mc. In the model, L1 is made pluggable in view of possible operation on the lower frequencies.

### ● Operation

Briefly, the transmitter is tuned CO-PA on 7 Mc, Tritet-PA with a very loose link coupling on 14 Mc, and Tritet-FD with a tighter link, or 4th Harmonic Tritet-PA, on 28 Mc. That is, 28 Mc output can be obtained in two ways—frequency doubling in the PA with the drive side on 14 Mc, or by tuning the 6L6 CO to give 4th harmonic (28 Mc) output from a 7 Mc crystal, thus driving the PV06-20 as a straight amplifier on 28 Mc. For those who may doubt, let it be said that this is entirely possible, because the PV06-20 will give high output with very low driving power, hence the necessity of keeping the link very loose (one turn, spaced away from the windings) on both 7 and 14 Mc.

Adjustment follows the usual lines in any two or three stage transmitter: Cut HT off the PA side by opening S2; with the 7 Mc cathode coil and 14 Mc inductances at L2, L3 and L4, first get the driver side working. Swinging C1 should drop plate current indicated at J2 to a low value; then adjust C5 till a further variation is obtained on the meter, and check that it is 14 Mc output with an absorption wavemeter. Then, with the links loose, plug the meter to J3 and resonate on C6, which will produce a grid current reading; by variation of the links, get this to about 5 mA. Move C10 through its range and notice if there is a flicker on the grid meter; a kick will show that neutralisation is required, the circuit connections for which are given. The capacity involved will be less than 3 mmF and can be formed by means of well-insulated leads twisted together or with two aluminium plates, the aim in either case being to set this capacity till no flickering is apparent on the meter needle at J3.

The meter can be transferred to J4 and HT applied to the PV06-20; unless you are lucky enough to have found the resonance tune setting while checking for neutralisation, the needle will probably hit the back-stop. Swing C10 till PA plate current is a minimum—and you now have the transmitter on 14 Mc.

On 7 Mc; L1 is shorted out, and the 6L6 adjusted as a straight CO, PA tuning being as before.

For 28 Mc, the 6L6 should give the required 6 mA of grid current for driving the PA; less output will be obtained with lower drive, but the other method is to make the PA double, in which case some 10 mA of grid drive should be applied to the PV06-20, its tank side being tuned to 28 Mc with the circuit L3/C6 on 14 Mc.

The main operating points to remember are: Get 4 mA PA grid drive on 7 Mc (this will be obtainable with very little coupling from the CO), 5 mA on 14 Mc, 6 mA on 28 Mc, and 10 mA when doubling the final stage. These figures are for maximum efficient PA input on load, which would be about 35-40 watts with the HT supply available. Actually, inputs of 20 watts are obtainable with lower grid drive, hence it can be seen that this is a most economical design for 25-watt working. On the other hand, do not run grid current too high, as anything over the figures given will merely reduce output and damage the

valve, which in any case must not be operated at more than 50 watts input, and that under efficient load conditions.

COIL DATA

	7 Mc.	14 Mc.	28 Mc.
L1	10 turns close spaced.	—	—
L2	15 turns	7 turns.	4 turns.
L3	17 turns.	8 turns.	5 turns.
L4	15 turns 3¼-ins. diam., spaced.	8 turns.	5 turns 2-ins. diam., spaced ¼-in.

L1 is in use for 14 and 28 Mc only and is shorted out for 7 Mc. L1, L2, L3, are on standard plug-in formers wound with No. 18 enamelled, spaced to follow grooves. L4 is wound with No. 14 enamelled, well spaced, to a diameter of 3¼-ins., using strips of polystyrene to secure the turns.

THE MODERN TWO—VALUES AND PARTS

- C1—100 mmF, Eddystone.
- C2—.006 mF, Dubilier.
- C3, C4—.002 mF, Dubilier.
- C5—100 mmF, Eddystone.

- C7, C8, C9—.002 mF, Dubilier.
- C6—60mmF, Eddystone.
- C10—35 x 35 mmF, Polar C.603
- C11, C12—.01 mF, Dubilier.

- C13—2mF, Dubilier.
- C14—4 mF, Dubilier.
- R1—350 ohms, 3 watt.
- R2—25,000 ohms, 1 watt.
- R3—30,000 ohms, 2 watt.
- R4, R9—10,000 ohms, 3 watt.
- R5—10,000 ohms, 5 watt.
- R6—20,000 ohms, 3 watt.
- R7—500 ohms, 5 watts.
- R8—40,000 ohms, 2 watts.
- (All above Dubilier).
- T1—6.3, 6.3, 5.0 volts, centre-tapped, Short Wave Radio.
- T2—450-0-450 volts, 150 mA, Short Wave Radio.
- Ch—200 mA, 20-henry, Short Wave Radio.
- J1-J5—Bulgin close circuit.
- S1-S2—Bulgin toggle on-off.
- S3—Bulgin DPST mains.
- RFC—Bulgin mains chokes.

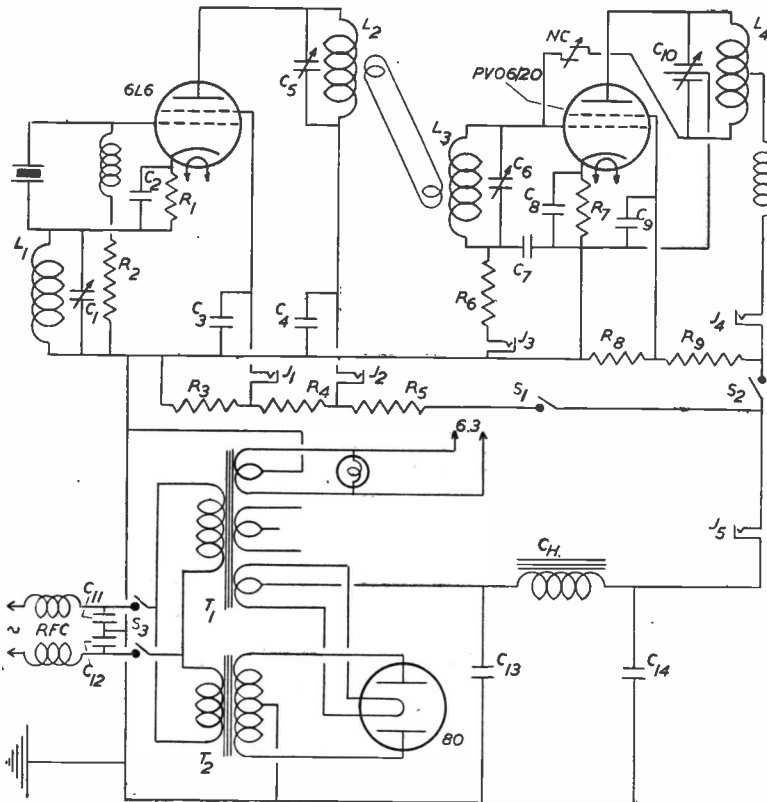

Chassis, Peto-Scott, 20 by 12 by 4-ins.; Eddystone small mounting brackets, s/o insulators, extension controls, knobs, Denco RF chokes; Q.C.C. crystal and holder; Bulgin rubber grommets, insulating washers, pilot light, mains plug and socket; Hamrad valve and coil holders, insulating pillars, distance pieces; Raymart coil formers; 6L6 and type 80 valves, Tungram or Hamrad; PV06-20, Mullard.

# The Other Man's Station

## G6IH

THIS MONTH we feature G6IH—L. H. Mansell, M.I.R.E., A.M.I.W.T., Woodfield, Madresfield Rd., Malvern—a station now devoted almost entirely to 56 Mc work and a good example of up-to-date design for that band.

Five-metre activity started just three years ago, using self-excited gear and a super-regenerative receiver, with which many interesting local tests were conducted and useful field-strength data obtained up to distances of six or seven miles. It is worth mentioning here that subsequent observations, made with much more elaborate equipment, checked very closely with these early results.

### ● Aerials

In February, 1937, G6IH began the construction of a most ambitious aerial system, an impression of it being shown in our issue of May last (see "56 Mc News"). The mast was 65-ft. high and took eleven weeks' hard work to build; it carried two aerials, one a  $\frac{1}{2}$ -wave VF with reflector and the other a Franklin type in three  $\frac{1}{4}$ -wave form, the 450-ohm feeder line being matched in at the lower stub arm. This aerial has never been beaten for consistent results, operated with a transmitter running at 25-watts input. On the receiving side, the gain was superior to anything which has been tried since—and G6IH has had experience with most types, including the multi-wave long-wire fed voltage, matched impedance, centre and, as he says, "fed up," but the Franklin was better than any of them.

All this is in the past tense because early in January, 1938, disaster overtook the mast; it was wrecked in a freak gale, though the lower 24-ft. steel section remained standing. This now supports a rotatable 47-ft. pole carrying a single  $\frac{1}{2}$ -wave wire centre-fed with coaxial cable and a full-wave arrangement with reflectors. Though both these aerials are good, G6IH remarks that they do not seem to have the same heart for the job as the much grieved-for Franklin.

### ● Station Equipment

The present transmitter is excited from a 6A6 CO with the crystal automatically temperature-controlled, keeping the output frequency very close to 56,344 kc at all times. Two 6L6's follow for doubling and power for driving the final amplifier on either 28 or 56 Mc is obtained by a quick-change linking system. The PA is a pair of Eimac 35T's in push-pull, taking a normal 50 watts input and

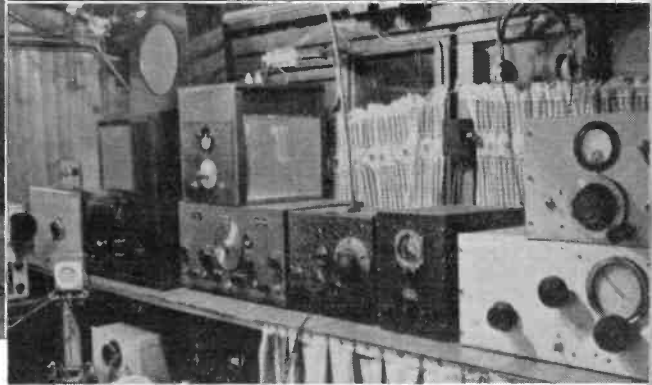
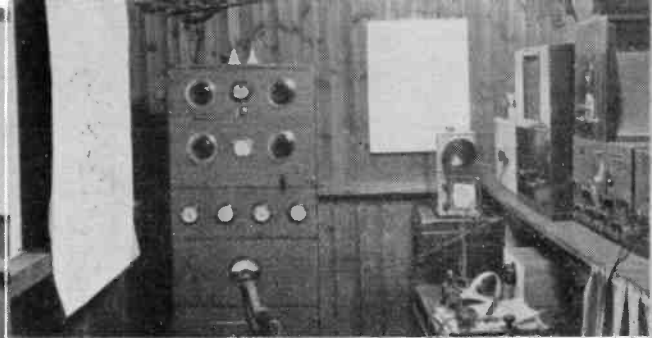
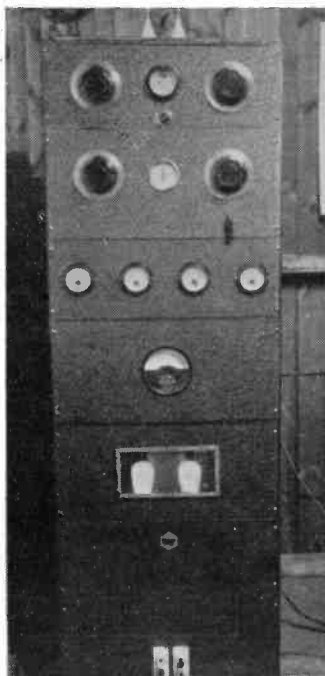

capable of putting 23 watts of RF into the aerial. Modulation is by Osram KT.66's in Class-AB1, themselves driven by two 6C5's, the whole giving a good 45 watts of audio on full gain; this 6C5-KT.66 modulator is preceded by a small two-stage speech amplifier, which can be used as a modulator on its own for a QRP 6A6 TPTG transmitter kept as stand-by. With an input of 5 watts, the latter will push a good 'phone signal over to Cheltenham, 21 miles away.

For reception—a Hallicrafters "Sky Challenger," a National "1-10," a Hallicrafters "Skyrider 5-10" and a mains-operated straight using a Mazda SP.41 in the tuned RF stage, which gives real gain on 56 Mc. A common loud-speaker takes the output from either of them and they can be switched in together if necessary, making multi-way cross-talk or watching on more than one band at once an easy matter.

The station switching is done from a small control box at the back of the operating table, with the exciter-transmitter-modulator-receiver HT's and the aerial change-over all on the one knob. Bypassing switches are provided to bring in any unit separately as desired.

On the experimental side, G6IH is working on a variable-frequency drive unit which is capable of giving from 9 to 12 watts RF output for controlling the main transmitter when on the HF end of the band, or this exciter can be used alone, plate modulator, for low-power operation.

### ● Results

The 56 Mc log for the last twelve months shows that reports have been received from 27 towns, seven being over 100 miles distant; two-way contact with 18 towns, five being more than 70 miles away, with Liverpool as best DX; and the greatest distance covered on CW to date 161 miles.

The photographs which supplement this description show a neat and well laid-out station with everything accessible and all the equipment necessary for careful investigation on the band to which so many experimentally-inclined operators are now turning their attention.

# The Cathode-Ray Tube—VI.

By *A. F. Hollins*

(The Mullard Wireless Service Co., Ltd.)

## Conclusion

SUFFICIENT HAS BEEN SAID in previous articles to indicate the general principles underlying the design and operation of cathode-ray tubes and cathode-ray oscillographs, and with this information the experimenter should be in a position to apply the cathode-ray tube to the investigation of numerous problems associated with the maintenance and satisfactory operation of transmitting and receiving apparatus.

Apart from the ultimate usefulness of a complete cathode-ray oscilloscope, the experimenter may derive very considerable interest and experience from designing and building the various units which go to make up the complete equipment.

The Mullard Cathode-Ray Tube Unit Type B.100 has been especially designed to form the nucleus round which a complete oscilloscope may be built, and by itself still has a wide range of application. The various unretouched photographs reproduced in the following have been selected from a large number as being fairly representative of the more general type of information to be obtained by the use of quite simple apparatus.

### ● Applications not requiring a Time Base

Apart from the obvious use of a cathode-ray tube as a meter for indicating and measuring voltage and current, there is a wide range of applications in Radio Engineering not requiring the use of either an amplifier or time base. Some of these applications are listed hereunder.

#### Condensers

Measurement of capacity and resistance, and the determination of the power factor of a condenser.

#### Valves

Measurement of slope, amplification factor and internal resistance. Investigation of the dynamic characteristics.

#### Amplifiers

Determination of amplifier characteristics, checking linearity, gain, phase displacement, etc.

#### Loudspeakers

Measurement of response, determination of voltage-current characteristics, measurement of acoustic energy at different frequencies, etc.

#### Transmitters

Measurement of modulation depth. Testing of frequency and phase modulation. Checking of decoupling efficiency and smoothing. Phase angle measurements in capacitative and inductive circuits. Frequency comparison and synchronising. Fault finding, monitoring, etc.

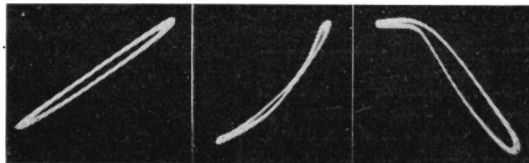

Fig. 25—An amplifier operating under conditions free from distortion.

Fig. 26—Distortion is indicated by the curvature of this diagram.

Fig. 27—Note the sudden bend due to the valve running into grid current.

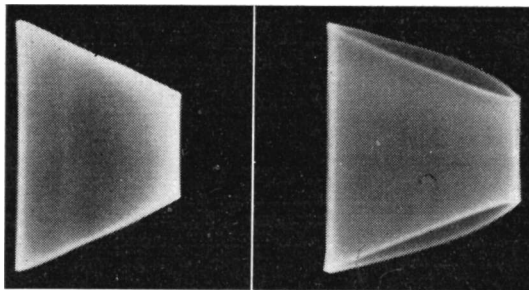

Fig. 28—Oscillogram of a signal with 38 per cent. modulation recorded without a time base.

Fig. 29—This figure is similar to Fig. 28 but shows phase distortion.

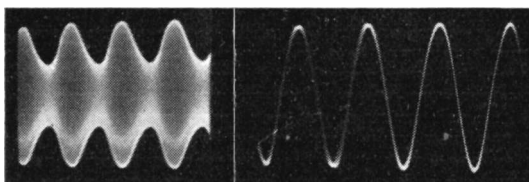

Fig. 30—Similar signal to Figs. 28 and 29 recorded with a time base.

Fig. 31—Oscillogram taken from the diode stage of a receiver against a linear time base.

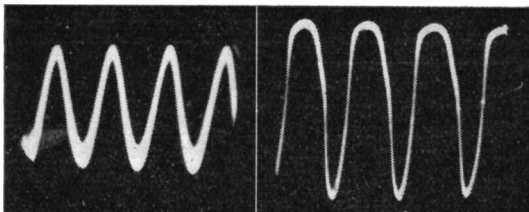

Fig. 32—This is the same signal as that recorded in Fig. 31 but with superimposed HF.

Fig. 33—Oscillogram obtained from a receiver operating under incorrect conditions.

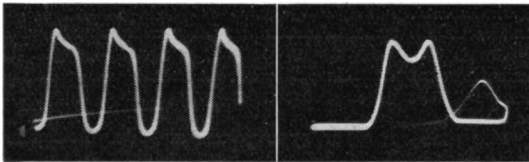

Fig. 34—The output waveform from a severely overloaded amplifier.

Fig. 35—IF circuit rectified image of symmetrical double peak response curve.

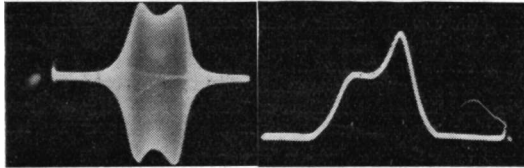

Fig. 36—This oscillogram shows the unrectified image corresponding to Fig. 35.

Fig. 37—Oscillogram showing asymmetrical resonance due to misalignment of tuned circuits, taken from diode load.

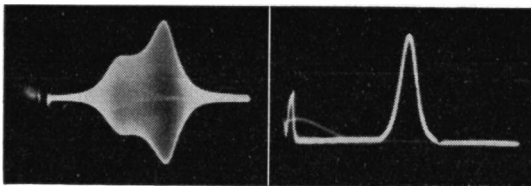

Fig. 38—Similar conditions to Fig. 37 showing full HF envelope.

Fig. 39—Sharply peaked resonance curve.

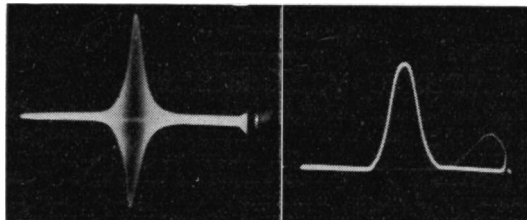

Fig. 40—Full-wave image of Fig. 39.

Fig. 41—A resonance curve with somewhat wider band width than Fig. 40.

### ● Distortion and Stage Gain

The photographs shown as Figs. 25 to 27 were taken to illustrate the use of a cathode-ray tube without a time base for measuring either the stage gain or detecting distortion in an amplifying valve. The calculations necessary to arrive at the stage gain were given in an earlier article. Fig. 25 shows an oscillogram free from distortion, whilst Fig. 26 shows distortion produced by incorrect operating conditions, and Fig. 27 is of the same valve showing the effect of running into grid current. Providing no distortion is present the input and output voltages will be proportional and therefore the image produced, whether it be a line or an ellipse, will be symmetrical about a given axis.

### ● Modulation Measurements

There are several different methods of producing images from which modulation measurements may

be made, and information may be obtained from these images as to the percentage modulation, harmonic distortion and phase distortion.

Fig. 28 shows an image produced by applying the modulated carrier to the vertical plates, and the modulating voltage to the horizontal plates. Providing no phase change takes place between the modulator and the carrier output stage the sides of the trapezium will be straight as shown.

The percentage modulation is:—

$$M = \frac{E_{\max} + E_{\min}}{E_{\max} - E_{\min}} \times 100$$

so that for 100 per cent. modulation the figure becomes a solid triangle.

It is necessary, of course, when carrying out this test, that the modulation amplitude should remain constant.

Fig. 29 shows a modulation envelope indicating a phase shift between the modulator and the carrier output stage, the trapezoid in this case having looped edges.

Such a figure might also be obtained if the modulating voltage applied to the cathode-ray tube were obtained from some part of the audio amplifier other than the output from the modulator valve.

Fig. 30 shows another and perhaps a more familiar form of modulated HF carrier.

To obtain this figure the modulated signal is applied to the vertical plates and a linear time-base voltage to the horizontal plates, the percentage modulation being calculated as before. In this case the time-base must be synchronised to the modulation frequency in order to obtain a stationary figure. Over-modulation will result in the "troughs" of successive waves decreasing to form a line at the point of contact. The signal shown is a 100 kc carrier modulated by a 500-cycle note to a depth of 38 per cent.

As has been stated, other patterns are obtainable from which the modulation may be checked and with a little experience the operator soon becomes familiar with the various patterns.

### ● Examination of Sine Waves

Fig. 31 shows a rectified signal taken from the diode stage of a receiver. Between the diode lead and the cathode-ray tube a filter circuit is arranged to filter out the radio frequency. In the absence of the filter circuit the signal appears as shown in Fig. 32, the presence of RF being indicated by the broadness of the trace.

Fig. 33 shows the distorted waveform obtained from the output stage of a receiver under incorrect operating conditions. It was actually obtained by injecting a fairly heavy modulated signal into a receiver and cutting out the AVC control.

Fig. 34 shows harmonic distortion introduced by severely overloading an amplifier.

### ● Tuning Circuit Alignment

Rather more elaborate apparatus is necessary for the delineation of resonance curves. The curve required is a graph of the voltage output obtained across a tuned circuit, when the input voltage is varied over a given frequency range. The voltage developed across the tuned circuit is applied to the vertical plates of the cathode-ray tube, and a voltage corresponding to a given frequency variation is applied across the horizontal axis.

One method of producing the necessary frequency sweep is to attach a small variable condenser to the

shaft of a rotating motor and to connect this across an oscillator circuit tuned to the mean frequency of the circuit under test. The motor-driven condenser then varies the output frequency over a predetermined band, say 10 kc each side of the resonant frequency, and the voltage developed is applied to the circuit under test, the actual band width covered being a function of the LC values of the oscillator circuit.

If, now, a potentiometer is coupled to the same shaft as the rotating condenser, and connected in such a manner that an output voltage is developed across it proportional to the frequency sweep, then, in principle, there is available a device for drawing out a resonance curve on the screen of a cathode-ray tube.

Actually the modern commercial type of frequency-modulated oscillator or "wobulator" as it is sometimes called, is a good deal more complicated in design than would appear from the brief information given above, and moreover the mechanically-operated type of apparatus has now generally given place to the electrically-operated unit in which all

the necessary capacity and voltage changes are produced by special circuit arrangements.

There are two types of image available in the examination of response curves, one the rectified image taken after demodulation, and secondly, the full HF envelope.

The more familiar type is the single-line rectified image, and in order to obtain the full HF envelope of a circuit response in the normal receiver, it is necessary to employ an amplifier having a high gain at the mean frequency of the circuit under examination. Fig. 35 shows the single-line image of the familiar double peak wide-band circuit, and Fig. 36 is the unrectified envelope of the same response curve. It is possible to detect distortion in the detector stage by a comparison of such curves.

Figs. 37 and 38 are two companion curves showing the asymmetrical resonance produced by misalignment of the circuit under test.

Figs. 39 and 40 show the two corresponding images produced by a sharply-peaked circuit, and finally Fig. 41 is of a tuned circuit having a somewhat wider band-width.

## Conditions—The Month's Survey — Big Improvement

SHORT-WAVE conditions were very much better during the period May 15 to June 15 than for some time previous, and no very severe ionosphere disturbance occurred. Solar activity remained relatively high, and, though the F layer critical frequency was much lower than in winter during the mid-day period, the increased daylight in the northern hemisphere led to relatively high critical frequencies during the evening and for the night. Thus, though the maximum usable frequencies for *daytime* working was generally in the region of 21 Mc, it was often about the same value at midnight.

Conditions remained quite stable from May 15 to May 23, except for a slight deterioration of frequencies above 11 Mc on May 21. Early on May 24 a large sunspot group crossed the central meridian, its area on May 23 being 615-millionths of the disc. In the evening of May 24 conditions deteriorated considerably, the disturbance, while not being a major one, causing poor reception on all frequencies. On May 25, while 14 Mc U.S.A. stations were coming in at fair strength in the evening, conditions were still a bit "under the weather." They were again good on May 26.

### ● Stable Conditions

Apart from a slight deterioration of the higher frequencies on May 31, conditions then remained uniformly good until June 12. A relatively small sunspot crossed the meridian about June 12 and in the evening of June 13 conditions became rather poor. The disturbance manifested itself on this occasion in the form of flutter fading, which was particularly noticeable on frequencies above 14 Mc. This flutter was again present during the evening

June 14, but by June 15 reception was back to normal.

The present *type* of conditions should continue till the end of July, apart, of course, from any severe ionosphere disturbances which may take place. The "probable" periods for these are:—

July 20—23.

July 28—31.

### ANNOUNCE YOUR FREQUENCY

A correspondent draws our attention to the difficulty of getting individual amateur frequencies, and has even suggested a "frequency code" in order to overcome the supposed dislike of enunciating cumbersome figures. But the real solution is that operators should announce their own frequencies during transmission. The great majority of stations are crystal-controlled to a reasonable degree of accuracy on known frequencies, and it is only a matter of saying "This is G9BF testing on seven-o-three-one kc" when using 'phone, or sending the frequency at the end of a CW transmission.

### BIBLIOGRAPHICAL EXTRACTS

Two papers which will interest many readers are "Comparison between Theory and Experimental Data for UHF Propagation" (Smith-Rose and Stickland, *THE WIRELESS ENGINEER*, Vol. 16, No. 186) and "Design and Construction of Short-Wave Field Strength Measuring Set" (Colebrook and Gordon-Smith, *JOURNAL I.E.E.*, Vol. 84, No. 507).

These authors are officers of the National Physical Laboratory, and the papers named can either be consulted in progressive public libraries or obtained through booksellers or from the publishers.

---

*"The Short-Wave Magazine" circulates throughout the World*

---



# On the Amateur Bands

A BAND that has caused more disappointments to newcomers than any other is "Twenty." Consider how it has gone through a series of changes during the past thirteen years. Prior to 1928, we used to descend to 23 metres with trepidation, wondering if our final oscillators were working at more than 10 per cent. efficiency, and frequently only heard a few stations to call. QRM was almost non-existent and everyone prophesied the end of DX when the Washington International Radio Convention of 1927 put us all together in our present 400 kc.

We know now that DX did not die. In fact, we have no hesitation in saying that DX working is the main interest among present-day amateurs and therefore a little discussion on our 14 Mc band as it now is will not be out of place.

## ● Telephony

All was well until 1933, although it must be remembered that 1930-31-32 had been lean years owing to the influence of the solar cycle. With the arrival once more of good conditions and the advancement in transmitting technique, particularly frequency stabilization, DX telephony came into the picture for the first time and, of course, these stations worked in amongst the preponderance of CW signals, managing very well. This state of affairs lasted until 1937, with an ever-increasing number of telephony stations coming on the air, and it was at this time that CW/'phone QSOs came to an end. Obviously, as the original DX 'phone people were in the minority they had to listen for CW replies, which they invariably received; equally obviously, when the army of 'phones increased they were able to rely on themselves for congenial company and the camp thus became split into the two factions of code and speech operators.

Things had now reached such a pitch that the Americans realised the necessity of reserving a 100 kc portion, near the middle of the 400 kc bandwidth, for all W telephony operation. If they had not done this, the band would undoubtedly have been in a dreadful condition by now—some will say it is already in this state, but more of that later.

The CW/'phone allocation at once split the band into three separate channels, though for a time one listened over the whole of it after calling "Test" or "CQ," receiving replies from the HF portion after calling on the LF side, and *vice versa*. The natural growth of Amateur Radio prevented a continuance of this practice as it became impossible to search more than 150 kc after a call owing to the large number of active stations.

## ● LF End 'Phone

For some reason which will never be explained, the DX 'phone fraternity began to assemble more and more towards the low-frequency side, i.e., 14050 to 14150 kc, leaving the 50 kc at the edge free for telegraphy operation; this condition worked very

## The Development of 14 Mc : Operation under Present Conditions - OLD TIMER

well for about a year, with an equal number of CW stations to be heard on both sides of the American 'phone channel, but the "'phone brigade" increased and, by gradual penetration, have now pushed the CW stations over to the other side.

## ● Telegraphy

Having been driven from the LF end, the CW lads proceeded to insinuate themselves in the form of a wedge between 14350 and 14400 kc *plus*, with the result that the QRM situation became extremely severe. This peculiar congregation was prompted primarily by the desire of the DX-minded to be the first to raise the rare DX operators, who by now invariably listened from the HF end, with the inevitable result that this section became overcrowded. A temporary alleviation was obtained when the practice of working at the other end of the HF portion started, i.e., 14250 to 14300 kc, but then occurred the most unfortunate thing that has so far happened in the history of the 14 Mc band. All the wanted DX operators bought crystals or tuned their ECOs to the limit of the HF edge, and well beyond, and listened from that end.

This therefore is the picture that we see to-day: DX calling "CQ" from 14400 to 14450, and replies being received between 14450 and 14350 kc—in other words, 75 per cent. of the CW people are working in 50 kc, or one-eighth of the whole band, not to mention the large and growing body that is persistently and purposely outside. Although the 'phones have captured 14000 to 14150 kc, they do spread themselves out—they have to.

## ● Advice

If you work telephony, we accordingly suggest you use two frequencies between 14005 and 14145 kc; if CW is preferred, then four spot frequencies between 14250-14395 will give you the best chance of working most things, as to avoid this edge-band menace, many stations are now listening right on their own spot and nowhere else.

Most newcomers wonder how to set about successful 14 Mc DX working. Our advice is that all thought of 'phone be abandoned until it is known, from exclusive use of CW, in what directions the aerial is radiating. "Test" calls will usually raise USA (all districts call G's), but if you wish to augment your country totals the "lying in wait" policy will repay you, especially if you note the station to which the DX replies and mark his frequency so that you can then choose a nearby one for your next call. Endless "Test" calls only create unnecessary QRM and rarely bring replies from countries other than USA. Avoid 14380-14395 kc like the plague if you use low power, and always call "Test" well *inside* the band.

# HAVE YOU HEARD . . . ?

CONGRATULATIONS to the follower of my colleague "The DX Scribe" who shattered my HAC record claim by hearing all continents in 45 seconds! A most amazing effort and one which is likely to remain unbeaten. I do not know whether the time includes the writing down of the calls, frequencies, signal strengths, etc., as in my own case; however I had the advantage of knowing exactly where to listen, the critical time and programme to expect, whereas on the amateur bands one has no advance knowledge. I raise my hat to you, Mr. Huxley!

## ● Conditions!

North American reception has proved comparatively poor but I am glad to note, at the time of writing, that stronger signals are available—particularly in the early morning around 0500 or so. Nothing has yet been observed of W6XBE on either frequency although I see it has been reported in a contemporary. W2XE, by its desertion of the 13 m channel, has left the 21 Mc band devoid of worthwhile programmes, but has compensated by radiating a strong signal in the 19 Mc band. Reception from the East has been but fair, while excellent South American transmissions may be secured by listening well after midnight, especially from 0300 onwards.

## ● European Notes

*Albania.* What appears to be ZAA, Tirana, is occasionally heard at weak strength on 49.3 m in the evening, much of the speech being in Italian.

*Bulgaria.* "Radio Sofia" is again active, this time near 32.6 m where it is heard regularly until 0645, also on Sundays around 1315.

*Germany.* A programme in Arabic was heard once via an unidentified station on 29.16 m, closing at 1900 with the Zeesen interval signal (the opening bars of the "Horst Wessel" song) but no German announcement. No mention of this is made in the official programme booklet but a DIQ operated on the same channel many years ago, though the present call is believed to be DZC. DJZ, Vienna, 25.42 m, is now operating daily 2250-0450.

*Hungary.* HAAQ2, Budapest, heard on 11,850 kc at 2130 with announcements in English and a request for reports to be sent to "Radio Labor, Budapest" (as for HAS3 and HAT4). Also reported on 21,680, 9,625 and 7,221 kc.

*Poland.* SP48 and SP31 on 48.86 and 31.49 m respectively, are now operating from 1935 instead of 2000, signing off at 2230.

*Portugal.* CSW8, Lisbon, is now heard on 41.32 m, 7,260 kc, Tuesdays, Thursdays and Saturdays from 2205 to 2300, programmes consisting of folk music. Reports should be addressed to "Emissora Nacional de Radiodifusao, rua do Quelhas, Lisbon." CS2WA, 31.09 m, appears to have discontinued its broadcasts.

*Roumania.* Bucharest, 24.6 m, 12,160 kc, heard at 1900 with "Marching along together" and the English announcement "This is the short-wave of the Polytechnic School in Bucharest, Roumania," request for reports, national anthem and close down.

*Spain.* EAQ, Madrid, 30.43 m, is again broadcasting normal programmes of pre-civil war type

and the original identification announcement "Aquí estación EAQ, Transradio Espanola, Madrid, Espana" is used frequently between 2230 and 0030, or later. Heard once at 2345 with same programme as CSW7, 30.8 m, and other stations in the 40 m band.

*Switzerland.* Test transmissions are shortly to be made by the new Schwarzenburg transmitter on 11.70, 13.94, 16.87, 19.60, 25.28, 31.46, 48.66 and 49.55 m. Programme of Swiss music, announcements in Italian and French, "God Save the King" at 1510, lady announcer at 1520 and close at 1523, heard one Sunday on 26.3 m and taken for HBO until mention was made of Schwarzenburg. The programme apparently emanated from the National Exhibition at Zurich.

## ● From the Americas

*Bahamas.* ZNF (or ZNS), Nassau, heard on 49.3 m at 0220 with a programme of recordings, including a BBC feature, strength being R7. At 0229 the following announcement was made: "The time is almost exactly 8.30 p.m. and you are tuned to ZNS, Nassau," together with a weather forecast and news of the King and Queen. Broadcasts are concluded at 0300 with the national anthem. Reports addressed to "Radio Station ZNS, Nassau, Bahamas, West Indies" would undoubtedly reach their intended destination.

*Newfoundland.* VONG, St. John's, relay of VONF, heard frequently from 0030 to 0215 (or later) on an estimated frequency of 5,965 m, 10 kc lower than the present channel of HH2S. Programmes consist of recordings, BBC features (such as the "Kentucky Minstrels"), speeches, the call being given as "Station VONF and short-wave VONG, the Broadcasting Corporation of Newfoundland," while NBC-type chimes are occasionally employed at the quarter-hour. Address reports to "Short-wave station VONG, c/o VONF, St. John's, Newfoundland."

*U.S.A.* W1XAL, Boston, 49.67 m, heard closing at 0600, off schedule. W2XE, New York, used 6,120 kc 0500-0600 during June and until further notice will alternate with 6,170 kc monthly.

## ● Central and South

*Chile.* CB960, Santiago, 31.25 m, 9,600 kc, occasionally heard around 2330, peaking at R6, with slogan "Radio Americana." Schedule is said to be 0200-0530, however.

*Costa Rica.* TIPG, San Jose, now on 30.94 m, 9,697 kc, where it settled for a brief period a summer or two ago. Slogan "La Voz de la Victor," schedule 1300-1530, 1800-2000 and 0200-0530 with a tourist programme in English 0330-0515. Heard once at 0100 with anthem, chimes and English announcement. TIEP, "La Voz del Tropica," 44.48 m, strongly received at 0525 with announcements interspersed by varying number of chimes.

*Colombia.* A recent signal of unusual interest was the 2nd harmonic of HJ1ABB on 31.36 m between 0650 and 0740, at a strength of R3-4, the fundamental being inaudible. HJ1ABP, Cartagena, formerly on 31.21 m, is on 4,925 kc, signing off at 0330 (Roger Legge, USA).

*Cuba.* COCE, Havana, 24.53 m, 12,230 kc, the new relay of CMC, has remained inaudible, and, according to the Cuban "Radio Guia," is inactive due to a change to new studios. COBC, Havana, 9,980 kc, announces as "CMBC del Progreso Cubano y los grandes Almacenes El Gallo en 690 kc y COBC de las cigarras Trinidad y Hno en 9,980 kc ambas en el Habana, Republica de Cuba," with a cock crow every fifteen minutes (Ricardo R. Rubio, Havana).

*Ecuador.* HC2ET, Guayaquil, now on 9,200 kc, double their old frequency of 4,600 kc, leaving the air at 0330 (Roger Legge).

*Guadeloupe.* "Radio Guadeloupe" sends attractive QSL bearing diagonal tri-colour, hemisphere, and the details:—power 50 watts, identification march "Marche Lorraine," wavelength 40.29 m, but no call-sign or schedule; however, it is still well received 0000-0115. A photograph of a native girl accompanies each verification.

*Guatemala.* TGWA, 30.95 m, 9,685 kc, heard closing at 0531 after a marimba solo and mention of TGW, TGWA, TGWB, and TGWC in English. Heard on 19.78 m one Monday at 0030 apparently with football commentary. TGWB, 46.22 m, 6,490 kc, with news bulletin, mention of "La Voz de Guatemala," TGWB and TGWC, marimba solo and

age is appreciated. Address correspondence to "Correspondence Dept., Radio Ankara, Ankara, Turkey" (Roger Legge).

*Saigon, French Indo-China.* "Radio Saigon," 6,116 kc, operates from 1200 to 1515 with English at times and a lady announcer. It has been reported in Gt. Britain.

### ● Programme Notes

Those readers who are lovers of dance music and feel that they cannot await the 11 p.m. BBC session, should make a point of tuning to the powerful TAP, Ankara, which gives a first-class programme of modern rhythm, rumbas and beautiful Argentine tangos between 2210 and 2245. Reception is generally excellent throughout and a fine prelude to slumber!

The NBC wish me to bring to readers' notice "The English Hours," a programme dedicated to the British Empire and English-speaking people throughout the world and broadcast over W3XL, 17,780 kc, and W8XK, 15,210 kc, every day 1700-1900. Letters commenting on reception and those of general interest are acknowledged over the air in the "Mail Bag" at 1830 on Mondays, Thursdays and Fridays, while on Sundays; at the same time, the programme is styled "Calling All Stamp Collectors."

---

## *Causerie of Short-Wave Broadcast News for the Listener - - By F. A. Beane*

---

close at 0621. Special DX programmes are broadcast over TGWA and TGWB on the first and third Sundays of each month 0700-0930 and reports requested. TGWC operates on 2,320 kc, relays IGW 1400-1500, 1845-2145 and 0130-0615, but is not likely to be audible in Europe. Power 1 kW.

*Martinique.* "Radio Martinique," Fort-de-France, 30.93 m, 9,700 kc, now signs on at 2330 with the "Marseillaise," six chimes, call "Ici Radio Martinique" and mention of "Paris-Mondial" from whence programmes are sometimes derived.

*Nicaragua.* YN3DG, Leon, heard on 13.90 Mc at 0700 (Roger Legge).

*Venezuela.* The Caracas station signs YV5RM and relays YV5RV with an input of 10 kw. Receivable around 0330 on 5010 kc.

### ● From the East

*China.* XPSA, Kweiyang, 6,970 kc, 10 kW, sends letter verification. Schedule 1730-2300 Chungking Time (one hour behind Shanghai) and QRA "Kweichow Broadcasting Station, Kweiyang, Kweichow, China." XGOY, Chungking, 25.21 m, 11,900 kc, well heard 2230-0020 with news in English at 2300. Reports are requested.

*Dutch East Indies.* YDC, Bandoeng, 19.8 m, heard peaking at R9 just after midnight when many excellent recordings are radiated. PMN, 29.24 m, heard with the same programme, is generally two R points weaker.

*Turkey.* TAP, Ankara, 31.69 m, 9,465 kc, verifies by letter in which they state QSLs are being prepared and in future will be sent to confirm reception. Back reports are being caught up with and henceforth all will be answered by return but post-

An outstanding feature of General Electric's international broadcasters 2XAD and 2XAF is "The Cabinet Series" radiated every Tuesday at 2030. President Roosevelt opened the first programme and members of his Cabinet will be heard during the succeeding weeks, explaining the day-by-day activities of the various United States Governmental Departments.

\* \* \* \*

A reader (D. Simpson, Bristol) asks whether ZIK2 uses languages other than English and for their schedule. As far as we know only English and Spanish are used, the station has been reported from Gt. Britain and the schedule is believed to be as published in our station list, although it has been stated that a ZIK3 (5.3 Mc) has now replaced the 10.6 Mc channel.

### COMMENT

Apart from the projected occupation of the HF end of the 7 Mc amateur band by new commercial broadcasting stations from September on, we shall probably see an intensification of international radio propaganda during this summer; this will be carried on in all European languages from transmitters using more and more power.

While it is doubtful whether the obvious intention to impress one particular point of view on the listener always has the mass-effect hoped for, there is an unmistakable result in another direction: QSLs become very easy to obtain from station managements which, maintaining a staff for the purpose, are only too glad to send them!

# Three Useful Circuits

Selected by  
"Tester"

## Improved Tuning Network—56 Mc Receiver—Neon RF Indicator

THE FIRST of this month's selections from the case-book is worth trying by all who use the Collins aerial-matching system—whether direct, capacity, or link-coupled—for feeding an end-on aerial of the single-wire type.

Fig. 1 shows the usual arrangement L1, C1, C2, linked to the PA output tank, with an additional tuned circuit L2, C3, in the earth lead. Briefly, having adjusted the coupler in the ordinary way with C3 at minimum capacity, the latter is then moved towards maximum till a further resonance effect is obtained, the result being an increased reading on the aerial ammeter A and a corresponding improvement in signal strength.

There are, however, several points to bear in mind when contemplating a test along the lines suggested:

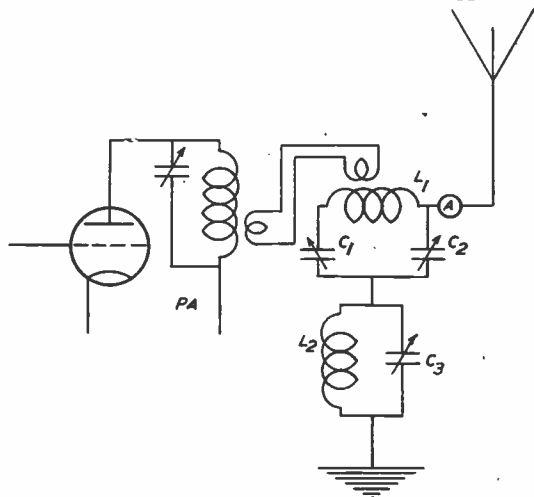

FIG. 1.

Suggested circuit for improving the Collins coupler with end-fed aeri-als. C3 can be 150 mmF for the HF bands and from 250 to 300 mmF for 3.5 and 1.7 Mc; L2 must be found by experiment. Other adjustments and values as usual.

The idea is due to J. H. Caldwell, G8US.

First, it is not possible to apply the idea to twin-fed aerial systems or even to those involving the use of single-wire feeders; secondly, the size of L2 will be dependent on the length of the earth lead, and thirdly, the coupling between L1 and the PA tank must be kept loose enough to avoid too great an increase in plate current when C3 is resonated, though it should be explained here that if the coupler is being correctly operated in the first place, there will be no excessive rise in PA plate mA when L2, C3, is in tune.

The reason why twin-feeder systems cannot be adapted is self-evident—the coupling circuit is already in balance and working independently of a

direct earth connection. The difficulty with single-wire feeder systems is interesting: Using either a Windom, off-centre multi-band, or any similar arrangement, the first essential is that the feeder must not radiate, i.e., it must not carry any standing waves. To use the circuit of Fig. 1 on such an aerial is simply asking for trouble, since the system as a whole will tend to operate as a Marconi, so throwing the roof section of the aerial out of action as a Hertz. The thus mis-tuned Windom, or whatever it happens to be, will undoubtedly go on working—and probably quite well—but not as a Windom, since the feeder line will be radiating instead of acting as a matching transformer.

Therefore, it follows that this modified Collins coupler—if we may dare call it that—is going to be most effective when used with the ordinary end-on aerial which radiates all the way from the meter A to the insulator at the far end, and it is only with such an aerial that the circuit of Fig. 1 should be tried since, for the reasons already given, it is not likely to do much good with other types—except perhaps to convert a poor Windom into a good Marconi! Analysing the operation of this circuit, it is clear that the action of the portion L2, C3, is such as to produce from the earth connection to the far end of the aerial a very accurately matched and tuned Marconi; in other words, a system applicable to any band and, with more than 100-ft. of wire in the aerial itself, practically omni-directional at the HF end of the amateur frequency range.

### ● 56 Mc Receiver

There is a great deal of scope for experimental work on 5-metre receiving circuits and Fig. 2 is a good example for those interested in mains-operated equipment. The first valve is a tuned RF stage, direct coupled to a detector with cathode-tap regeneration controlled by a potentiometer R6, the resistor at R1 being for variation of RF gain. The LF end is not shown, since this can be of the conventional type, or the detector output can be fed into the station LF amplifier.

The RF and detector stages are screened from one another and it is of course important that all leads should be as short and direct as possible and that a very well smoothed and absolutely hum-free HT supply should be available. On 56 Mc, hum effects occur which are quite unnoticeable even on 28 Mc; getting a quiet background with mains apparatus is a problem in itself on five metres.

Note that the aerial is coupled loosely to L1 by tapping down the coil—the position of the tap depends on the type of aerial being used and its loading effect on the grid of the SP.41 in the RF stage; this valve, used in conjunction with the EF.6 in the detector position, is definitely suggested as an essential part of the combination, though it should be noted that the SP.41 has a 4-volt heater and the EF.6 requires six volts.

FIG. 2.

The RF and detector portion of the 56 Mc straight receiver used by L. H. Mansell, G6IH. Details and values are discussed in the text.

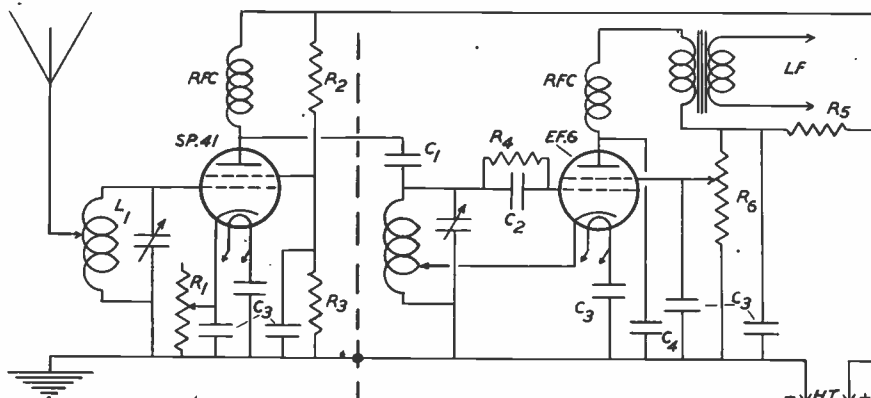

Values and coil data are as follows: L1-L2, 5 turns No. 14, 1/2-in. diameter, with the detector cathode tap one turn up from the earthy end; R1, 3,000 ohms; R2, 8,000 ohms; R3, 100,000 ohms; R4, 1 megohm; R5, 25,000 ohms; R6, 50,000 ohms 3-watt; C1, 50 mmF ceramic; C2, 100 mmF ceramic; all condensers marked C3, .002 mF mica; C4, 100 mmF mica, and the two tuning condensers 25 mmF each. Varley or Bulgin variable resistors should be used, Dubilier fixed resistors and condensers, and Eddystone variable capacities for tuning. The coils can of course be home-made and though a metal chassis probably improves stability, good efficiency is obtainable with wood; in either case, all earthy connections should be taken to one point by the shortest route, and the heater leads run in shielded cable, while tests should be made to ascertain what effect earthing the centre-tap of the heater transformer windings has on the hum-level. Some combination of earthing or by-passing will eliminate hum almost entirely.

Another point to watch carefully is the RF chokes; these should be dissimilar if of the commercial type, which means that bought UHF chokes of different make should be used. And they must be designed for UHF, as the distributed capacity of the ordinary short-wave choke is usually enough to by-pass RF altogether on 56 Mc. It is quite an easy matter to make up one's own chokes by filling a 1/2-in. diam. by 1 1/2-in. length of polystyrene (Troli-tul) full of No. 28 enamelled with the turns spaced so as just not to touch.

### ● Neon RF Indicator

This may suggest that "Tester" is about to put over the old one where you are said to "see RF" by holding a neon tube near the tank coil. Not so. Fig. 3 is the circuit of an indicating device which should be most useful to all transmitters and doubly so to the AA man who is working into an artificial load all the time.

The device consists merely of the usual tuned pick-up L, C1, with a neon tube and milliammeter in series. HT is applied across the condenser C2 in order to bring the neon near its normal striking voltage, supposing a low-power (10 watt or less) transmitter is being used. On tuning to resonance the neon lights up and current in terms of DC mA is shown on the meter, which for this purpose can be of any type, though preferably dead-beat, i.e., needle goes to its position and stays there without wagging about for an interminable period. It is

actually better to use a cheap moving-iron instrument as then there is less chance of damage due to excessive RF across the meter.

The things to remember when getting this unit into operation are: Use an "Osglim" beehive-type neon, as no other works as well; if the DC meter reads too high or off-scale, reduce the voltage across C2; if the meter reads reverse, change the HT leads over; if it reads too low, try reversing the "Osglim" neon tube in its socket before increasing coupling or the HT voltage. This HT voltage, by the way, can be taken from the odd battery to be found in every station. The current drain is no more than may be indicated on the milliammeter.

The uses of this simple little indicator are legion—finding dead resonance tune on the output stage, noting the effect of transmitter adjustments, watching modulation (the meter needle should kick up)

FIG. 3.

Alvin Pryor, 2FTR, puts forward this AA load circuit, applications of which are explained in the accompanying notes. L, C1, are as normally used to resonate at the transmitter frequency and C2 is not critical around 0.02 mF.

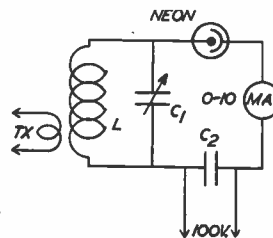

and making comparative tests on drive circuits such as different types of CO's—are some which occur to one without thinking very deeply as to possible applications.

Constructional points are few. Build the unit on a small panel, keep leads short (this is always essential with RF apparatus, however simple it may be) and make L, C1 a replica of the transmitter output stage. The link should be adjusted so that the meter reading does not run too high—not because of the meter itself, as an 0-50 mA instrument could be used if the scale range 0-15 mA or so were not exceeded—but because higher current will only de-activate the neon. As is well known, neon tubes will not stand too much RF and deteriorate if overloaded.

Incidentally, a South African reader, A. E. Rowcroft of Johannesburg, suggest another application for the always-useful and never-at-hand neon. Put it near the tank coil, and wire a pair of 'phones across the contacts with a couple of RF chokes in series. You can then hear your speech and watch the neon blinking at the same time.

# Danger—High Voltage

By

F. L. Postlethwaite, G5KA

Even if you are QRP, read this!

SIX MONTHS AGO, it was my good fortune to miss death by electrocution by a few minutes. This did not happen playing about with 10,000 volts at a sub-station, but at home, where the power supply to the transmitter does not exceed 600 volts. It was never my intention to write about my experience because for one thing, I have never liked to think too much about what happened! However, I think it about time the whole thing came to light, as during my recent visits to a number of amateur stations, I have been amazed at the risks some of the fellows are running with "hay wire" gear. It is a common thing to have HT lines trailing all over the floor, and some of the operators even seem to enjoy sitting at the receiver with the high-voltage leads across the chair.

I have in the past always prided myself upon the way I could take "packets" and not turn a hair; I never worried if I got occasional shocks when throwing the send/receive switch. In my case, I might mention that a piece of low-impedance line came from the tank coil of a push-pull stage down to the operating table, where it connected to the send/receive switch, the other connections going to receiver and aerial. I was using an aerial tuning unit, link coupled, to prevent heavy voltages getting on to the aerial, but I had never used link coupling at the tank coil, but always direct tapping. Not much thought is required to see that when the transmitter was on, there was a nice voltage at that send/receive switch. I had one or two bites from this from time to time; so did one or two other people who occasionally operated the gear, but as they all thought it a joke, I never worried about replacing the direct tapped tank coil by link coupling. Sheer laziness was the only reason I didn't, and where electricity is concerned, laziness should not be encouraged!

## ● The Final Packet

Now for the gruesome part of the story. One morning recently I decided to get up early to try and work some VK's on 'phone. I slipped on the telephones (which had a nice metal headband), put the 'phone jack in the overmodulation indicator-cum-field strength meter-cum-carrier shift indicator-cum-'phone monitor, and switched on the transmitter. Grabbing hold of the microphone (it is one of the push to talk crystal variety, with metal casing earthed), I put out a few whistles, just to warn the VK's I was on the way. Having decided things were up to standard I took the telephones off and let them dangle round my head. Things then started happening in a big way. I suddenly found myself in a real electric chair! I was sitting there quite unable to move. My hand grasping the microphone felt as though it was being held by giants.

I was powerless even to move my free hand. This is not surprising when it is remembered that I had 600-odd volts on the vital nerve centre of the body. Before losing consciousness, I had managed to let out a few yells. After the yells had brought my father from bed and he saw the plight I was in, he was lucky enough to find the right switch straight away. This was the one at the door, which put everything out of operation.

(Note: Tell everyone in your house which is the master switch!)

I came to a few moments later, feeling very much like a cat that had nearly lost all his nine lives at one try. I had a nasty shaking up, as can be imagined, and there was a burn in the back of my head the size of a penny, which kept me from business for two months. Not much of a holiday when this had to be dressed every four hours!

## ● How It Happened

What had happened was that the overmodulation indicator-cum-the-et ceteras-cum-'phone monitor was coupled to the "send" position of the send/receive switch through a large condenser. That condenser had not been tested, and there might have been an internal short in it from the day it was first put in. So the HT was flowing merrily through the condenser, along the flex linking up with the 'phone monitor, and had got into the 'phones through breaking down the resistance of the flex which was wound loosely round the coil in the monitoring unit. The HT went through that coil on to the 'phones, so when I grabbed the earthed microphone the circuit was complete.

## ● Moral

All the "hay-wire" has gone from the station now. Everything is link-coupled where it should be, and link-coupled in an effective way. No wrapping flex (and rotten flex at that) round a coil in future! I am not even taking any more chances with that microphone—a cheap rubber tobacco-pouch was purchased and this fixed round the "push to talk" department to form an effective barrier. Judging from the remarks of others on the air using "hand" microphones, a lot more could follow this tip with advantage!

My accident might have been one in a thousand, but with the risks run in some amateur stations I am decidedly surprised that more of our fellows don't get a listing under the "Silent Keys" section. If this narrative sends some of you rushing to your stations to remove that "hay-wire" the unpleasantness of writing it will have been amply repaid. Amateur Radio is a fine hobby—take all precautions to see you live to enjoy it!

---

*Mention the Magazine when writing to Advertisers. It helps you, helps them and helps us*

---

## ... HERE AND THERE ...

### NEW EQUIPMENT

In addition to the new Howard model 460 Receiver, which we shall be dealing with more fully in a subsequent issue, Raymart have available another piece of apparatus of particular interest.

This is the HX.56 Transmitter, designed for both 'phone and CW operation over the range 7-120 Mc at inputs up to 78 watts in the RK.35 final. The preceding stages are 6J5-6L6-P/P RK.25's and there are only four tuned circuits, while the input is variable from 15 to 78 watts at practically level efficiency. Five separate power packs run the various stages and sections of the transmitter, including bias and the modulator. The latter is designed for high-fidelity audio output and uses 6J7-6C5-6C5-P/P 6C5-P/P 6L6, giving enough modulating power to control the full carrier input 100 per cent. when using a crystal microphone. The transmitter is housed in a black ripple-finish cabinet matching the popular communication receivers, and measures 42½-ins. by 19½-ins. by 11-ins. deep, the units being easily removable and inter-connected with multi-way non-reversible plugs and sockets.

This transmitter, all-in with coils for any one band 7-56 Mc, valves, microphone and key complete, costs 51 guineas. Specifically designed for the UHF ranges, it is the first of its kind to be produced in this country for the Amateur market. Write Radiomart, 44 Holloway Head, Birmingham, 1 for fuller details of this and other new equipment.

### CRACKLE FINISHES

To get that professional finish is the object of many amateurs who take a pride in the appearance of their gear. As is well known, it is now possible to buy various lacquers and enamels which dry off in a hard crackle surface and we have recently seen samples of work produced by two different makes.

That offered by C. Overland, 86 Dibdin House, Maida Vale, London, W.9 is a proprietary product known as "Crystene" and gives a well-marked bluish effect on any surface, such as wood, metal, glass, etc. With the exception of metal surfaces, a sealer must first be used; it is easy to apply and dries off naturally, the price being 1s. a tin.

Gedge & Co., 88 St. John Street, London, E.C.1 market a black crackle paint at prices varying from 1s. 9d. for ½-pint tins to 6s. a quart which brings up an excellent crackle pattern and finishes very hard. This also is easy to apply and a short baking process—which can be carried out in the kitchen oven—is necessary for the best results.

### NEW QRA

Having acquired extensive new premises adjacent to their Tottenham factory, all departments of the Tungram organisation have been transferred there from the old address in Theobalds Road.

We are asked to inform readers of this by The British Tungram Radio Works, Ltd., West Road, Tottenham, London N.17, 'phone Tottenham 4884-6.

### MAGAZINE GEAR

The Amateur Three receiver and Battery Three-Stage transmitter as set up for recent outdoor tests on 1.7 Mc. Between them are two "Drydex" 120v. HT blocks which ran the whole station for 24 hours

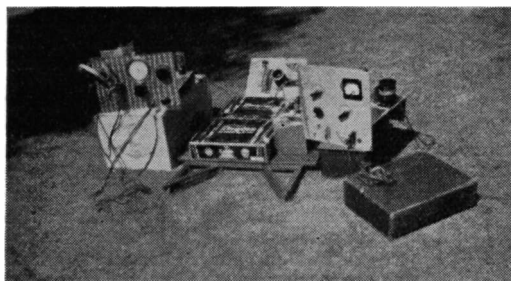

continuously without losing voltage, and behind is the aerial tuning panel linked to the transmitter output stage. The aerial was a ¼-wave Marconi and contacts were obtained all over the Kingdom with 8 watts input.

### SENSELESS CHATTER

Anent "Old Timer's" remarks in our June issue, G2NS has designed a badge for those 'phone operators who qualify. The motto is "Vox et praeterea nihil," but you can apply only if you are A Voice and Nothing Else!

### ELECTROLYTIC CONDENSERS

This is the title of a very useful book on the subject, now in its second edition, by Philip R. Coursey, B.Sc., M.I.E.E., F.Inst.P., the well known engineer and technical director of the Dubilier Condenser Co., Ltd.

Dealing first with the properties of the electrolytic condenser and its origin and development, separate chapters are devoted to the three main types—wet, non-aqueous and dry—and their production is fully discussed. The applications of the electrolytic condenser are treated quite comprehensively and it will be something of a revelation to many readers to hear of the large number of non-radio uses there are for them. Another interesting point brought out by the author is the fact that there is as yet no theory which fully accounts for all the phenomena observed in connection with their operation.

"Electrolytic Condensers" is in nine chapters of 190 pages including the index, extremely well illustrated with plates and diagrammatic drawings, and costs 10s. 6d. from Chapman and Hall, 11 Henrietta Street, Covent Garden, London, W.C.2.

2HBC, Fredric Webb, 8 Cambridge Gardens, Folkestone is newly-arrived in that district and wishes to make contact with Folkestone amateurs and SWLs.

# DX

## Commentary on Calls Heard, Worked and QSL'd

By The DX Scribe

OWING TO numerous requests, we are giving a few hints on the type of report that is more likely to bring dividends in the form of grateful QSL cards from transmitters than the useless reports that are too frequently sent. We have covered this ground before, as many of you will remember, but we hope the following will not be considered a waste of space.

### ● How to Report

Wherever possible, the report should cover several days' listening to the same station, with full details of everything heard working or calling him. Particular attention should be given to fading throughout the observations, especially when phase distortion is present on telephony signals. The time (in GMT) when signal strength is maximum should be noted and it is generally at this period that fading is least. The calls of all interfering transmissions should be mentioned, this being most helpful as an indication of the amount of interference that may be expected in future, and from whom. Weather conditions are of interest, though not always important, but the aerial employed and its direction must be included. You will not of course forget to mention your type of receiver and *do not* exaggerate signal strength by turning all the volume controls full on—signal strength can only be judged in comparison with background noise; almost any signal can be made S9 on the average communication receiver and it is well to compare the transmissions of the station reported with others heard from the same locality.

Finally, *never* send the "your signals S6 FB" type of report. A stamp or coupon should be enclosed to ensure that the recipient is not out of pocket, even though he may be pleased with your details—we have heard of many cases where coupons have been returned owing to the value of the report, but it must not be forgotten that amateurs very rarely have more money than SWLs, or more time. Where it is believed that a transmitter receives hundreds of requests for QSLs owing to the rarity of his country, or the outstanding strength of his signals, it is as well to enclose a stamped addressed envelope to save his time; take note of this fact too—CW stations do not receive the abundance of SWL cards that bless the post box of the telephony station and are therefore more likely to come back with the much-sought card.

### ● Cross-Band 'Phone

D. R. Gilmore, 19 Ormiston Drive, Knock, Belfast, N.I., heard TI2FR on the HF end of 7 Mc calling "CQ 75 metre 'phone." This is not unusual and is generally due to the fact that certain Central American countries are not permitted to operate 'phone on 3.5 Mc, while USA stations are similarly debarred from using 7 Mc for this purpose, so their only possible solution is to attempt cross-band contacts. Mr. Gilmore has now heard 84 countries on telephony.

### ● May 28 Mc DX

As was expected, 2AOU's 28 Mc tests between May 8 and 14 were not so fruitful, but a good log resulted in spite of summer conditions. He was ably helped by BSWL 819 in Midlothian, Scotland, and the log is therefore representative of reception at 600 miles separation. K4EZR, ZS1AX, 5T, SU1DM, 1MW, 1GP, VP6YB, VU7BR, CR7AK and FB8AA were heard, showing the DX potentialities for a so-called "dead" month. Although Martin Bourke has not set any further listening periods owing to lack of support, we shall welcome logs during the next few months from serious observers on this band.

### ● News from America

From M. W. Soplop, 54 Chestnut St., Allegany, N.Y. comes some interesting news. TG5 and TG9BA are both friendly with the President of Guatemala, but the former is now using TG5JG—still unlicensed. Much gnashing of teeth was heard from a USA station the other day because this TG was relaying a local football game on the 14 Mc amateur band, an action on which no true amateur would look with approval, especially following the recent agitation in the States over "Paris Mondial" broadcasting in our 7 Mc band. This led to the French Government closing the offending station, but we expect he will show up again after September 1 when broadcasting will be permitted in Europe between 7200-7300 kc.

Roger Legge, 20 Beethoven St., Binghamton, N.Y., has heard 135 countries on 'phone with verifications from 122. 1180 foreign cards have been received, including 68 from Asia, 102 from Oceania, and 100 from Africa. Incidentally, he wishes to congratulate British stations on their promptitude in QSL'ing—of 30 GW, GM, GI's to whom he has sent reports, only 5 have failed to respond. Jack Wells, 1000-14th St., Phenix City, Alabama, asks for some QRAs, which have been given him, and tells us that acknowledgments of reception of PK6XX (Archbold Expedition to Dutch Guinea), may be obtained by writing to F. E. Handy, Communications Manager, ARRL, 38 La Salle Rd., West Hartford, Conn., USA. The actual station PK6XX does not issue cards at all.

### ● American QSL Bureau

Realizing that many SWLs do not possess an up-to-date Call Book, and that frequently they desire to send a report to a station whose address is unknown, M. F. Williams, 119 S. 8th St., Newark, N.J., USA, has formed a free service for all who wish to take advantage of his generosity. He feels that a card should bear the postmark of the country of origin to be really authentic, therefore address your cards to the station heard c/o his address, and he will forward them to their destination without fail. Do not send cards in packets; each should



be mailed separately and will be sent on with a short letter explaining the service to the recipient. The following countries only are covered: CE, CM, CO, CP, CX, EA (all countries), HC, HH, HI, HK, HP, HR, K4, KB4, K5, K6, KA, KB6, KC6, KD6, KE6, KF6, KG6, KH6, K7, LU, NY, OA, PY, TG, TI, VE, VO, W, XE, YN, YS, YV, and ZP. Take careful note of these prefixes. We have not previously heard of a more friendly and helpful gesture to the cause of Amateur Radio and we know all our readers will join us in thanking Mr. Williams for his Bureau. Obviously, where a listener has a new Call Book he should not bother Mr. Williams.

A few additional items of interest mentioned by him are: XU6TL, 14095 kc, T. L. Shen, P.O. Box 132, Canton, QSLs 100 per cent. and is a most consistent signal; VS6AB welcomes reports from SWLs and should be QSL'd to J. W. M. Brown, c/o Import and Export Office, Kowloon, Hong Kong. PK6CI in Moluccas on 14158 kc is the only 'phone in that locality and cards should be sent to E. R. Illing, Ambon, Moluccas, D.E.I. The only active



A few cards at the station of G. J. Rawlinson, "Cresta," Chase Side, Southgate, London, N.14.

'phone in New Hebrides is FU8AA on 14010 kc, who verifies all genuine reports; he would represent an amazing catch if heard in G. ZD2H and CR7AG are both said to be using telephony.

### ● QSLs Received

L. J. Miller, Fern Cotts., Five Oaks, Billingshurst, W. Sussex, from VK2AGU, VE5VP, ZS5Q, SU1AM and VP3CO; D. W. H. Ffennell, c/o R. T. Assheton, Eton College, Windsor, from OK1SZ, PK4KS, VK2EO, VS2AL, W6AM, 6GVM, VO3X and CM7AC (7 CW); Norman Stevens, BSWL 1039, 59 College Rd., Kensal Rise, London, N.W.10, from VS7MB, ZS5B, VK4JP, ZC6HS, VQ2WP, for 'phone and for CW, ZS5BM, 1CJ, VP6TR, ZC6RL, VS1AL, U1BP, ZB2B, PK4FS, VU7BR, and LX1RB. Ian A. Bates, 85 Jeanfield Rd., Perth, Scotland, from XE2IK, CN1AF for 'phone and VE4OX, ZS5CX for CW; Conrad Tilley, Bristol, from W5GEU (who wants G reports), 6DIY, EK1AA, XE1GK, PK4HW, VK3DG, PY5BL, FA3QV (3.5 Mc), PY2IT, CO8RQ; Bob Everard, St. Margarets-at-Cliffe, Kent, from WIITX, 2IXY, 3IDT, 8JRQ, for 1.7 Mc, W2, 3, 4, 8, and W9IVW

(Neb.), for 3.5 Mc, and VP3CO, VS6AF, LU7BK for 28 Mc. He also had confirmation of reception of a police car in New Orleans using 15 watts! D. J. Mathers, BSWL 1012, Ranelagh, Dublin, Eire, from FT4AO, K4FCV, TF5C, VE5AAD, VP2AT, 4TO, VU2FO, 7BR (Bahrein), ZB1X for CW reception; and PK4JD, VS7RA, VU2CO, 2FA, ZS1CH for 'phone; Martin Bourke of Jersey from CR6AI; Roger Legge, New York, from ZL2BN (3.5 Mc), ZL1MR (28 Mc), KF6DHW, VK3BM, LA1Y, SU1WM, 1RD, FA3JY, PK3WI, CN8MB, NY1AA, CT2BP, CE2BX, KA1FH and CE3AT—all 'phones; G. C. Lidstone, 2FDN, 18 Chalton Drive, London, N.2, from K6OQE, VQ3HJP, TI5JJ, YV4AE, OA4R, VE3XQ; Eddy H. Trowell, BSWL1148, 27 Unity St., Sheerness, Kent, from W3, 4, 8 (for 3.9 Mc), CO7VP, KAILB, CX2CO; and R. J. Lee, Heathfield, Sussex, from VP4TO and VP6YB.

We have received several letters commenting on GM3TR's remarks regarding QSL's from listeners (see last month's MAGAZINE) in view of a letter from him printed some months ago.

### ● Queries

Leslie Morgan, 45 Parkwood Rd., Bournemouth has now heard 103 countries, the latest being VU7BR, VQ3TOM, EA8AE and HP1X. Cards for the latter can only be sent c/o ARRL, as we have already explained that he is operating under cover; XI1AA is merely an Italian portable; OXVC is the S/S "Geir," a Danish salvage steamer that does not count as a new country although he is permanently harboured at Gibraltar. Eddy Trowell of Sheerness heard "HU1CB" and requests details, but we feel that this was incorrectly received, similarly "VU2SU" should read VU2FU and "VP6IT" is probably also misread. We suggest that cards for all EA stations should be sent c/o M. F. Williams until the reappearance of their addresses in the Call Book. Cards for UK3AH should go via the Russian Bureau, 1 Samotechny Per. 17, Moscow. Eddy would like to correspond with overseas SWLs. Ken Bunston, Gable Cottage, Broad Hinton, nr. Swindon, Wilts, has some queries for us; OQ5TR is believed to be a ship on the River Congo and probably has some connection with OQ5HR (queried by VU2EU last month). The latter is S/S "Kindu," a survey ship sailing from the port of Kindu on the Congo; the operator is ex-ON4HR and cards should be mailed to the ship's captain at Kindu. YY1X gives as QRA "south east Europe," more than that we cannot say except that QSLs go via SU1TM; ONC is possibly the call used by a Belgian ship.\* In answer to Ken and others, we do not intend to duplicate the current Call Book, but will always publish QRAs of stations (where known or reported) which do not appear therein. L. C. B. Blanchard, Montcalm, 122 St. Andrews Rd., Coulsdon, Surrey, informs Ken Bunston that KFR3 was the call used by a boat near Sarawak, so we were apparently wrong in suggesting it originated from Panama. Mr. Blanchard appeals for greater listening on 28 Mc during the summer, even though it may be "tough going." We entirely agree and will always publish logs for this band.

G. C. Lidstone heard TA1AA and TA2AC. TA1XR has also been received but, of course, no TA has so far proved genuine. SX2C was another mystery, probably in Greece.

\* (Three-letter calls are, officially, always land stations.—Ed.)

## ● VR6AB

Last month, VU2EU said that VU2FX had received a card from "VR6AB" confirming a contact and signed by Andrew Young, the operator of VR6AY. Cecil Martin, Lynton, Pound Rd., Bursledon, Southampton, also received a card from Andrew Young following his report on VR6AB's CW signals, so either VR6AB was no pirate or Andrew is handing cards out indiscriminately without bothering to read the reports! Note that W2IXY has said that VR6AB was "phoney," and she should know.

## ● 1.7 Mc

Cecil Martin continues to send lists of calls heard on 1.7 Mc, which are very welcome. He suggests that this band (and 56 Mc) should be kept more populated, as this would be the best insurance against the possibility of commercial interests taking a slice from us at Rome in 1943. He remarks on the rising occupancy figures and stresses how easily contacts may be obtained compared with 7 Mc. Once again we say "Why try and fight the QRM on 7 Mc when you have 1.7?"

Roger Legge of N.Y. heard some interesting DX, although he complains of poor conditions during May. Telephony was logged from VP2SA 7108, VP4ZD 14200, OQ5ZZ 14318, VK9VG 14120, PK6XX 7000, KA1CW 14130, NY4AB 14255, and PY9AB. Another query is presented by Frank Jones, 6 Sutherland St., Fenton, Stoke-on-Trent, Staffs, who heard PJ5EE. We also heard this station but can only presume he is in Curacao; cards should be sent either *via* NVIR or ARRL. KB6ILT is signing K6ILT/KB6 on occasion and we presume that he will do this until permission to change his prefix has arrived from the licensing authorities. His home address is in Hawaii and we believe he used "K6ILT/KD6" when passing through Midway I. Box 47, Agana, Guam will find him.

## ● A Record

In 7 days' listening, from June 4 to 11 inclusive, comprising 12 hours 47 minutes actual listening time, Martin Bourke of Jersey received 94 counting

## DX FORECAST FOR JULY, 1939

North America. (All times GMT)		14 Mc.
Eastern States of U.S.A., VE1, 2, 3, VO, K4 and West Indies	...	2100-0800
Western States of U.S.A., K7, VE4, 5, XE...	...	1700-1800 0400-0700
<b>outh America.</b>		
All	...	2100-0800
<b>Africa.</b>		
ZS, CR7, VO8, FR	...	1700-1900
VQ2, 3, 4, 5, OQ, ZE, ZD, FB, CR4	...	1700-2100
FA, FT, CN, SU, ST, tc.	...	All Day
<b>Asia.</b>		
J, XU, MX, VS1, 2, 3, 6, 7, FI, etc.	...	1500-2200
YI, ZC6, VU (North), U8, 9	...	1200-2300 (or later)
<b>Oceania.</b>		
VK2, 3, 4, 5, 7	...	0300-0900 1900-2000
VK6, 9, VK4 (Papua)	...	0600-0700 1400-2000
ZL, VR, and Pacific Is.	...	0400-0700 1700-1900
PK, KA, KB6, etc.	...	1500-2200

Note.—Signals may only be heard from South and Central America on some evenings with U.S.A. entirely absent.

countries. These were: CE, CM, CN, CR4, CR6, CR7, CT1, CT2, CT3, CX, D, EI, ES, F, FA, FT, G, GI, GM, GW, G (C.I.) HA, HB, HI, HK, HR, I, J, K4, K5, K6, K7, KA, KB6, LA, LU, LX, LY, OA, OH, ON, OQ, OZ, PA, PK1, PK4, PK6, PY, SM, SP, ST, SU, SV, TF, TG, TI, U3, U5, U9, VE, VK (Aust.), VK7, VO, VP1, VP2, VP3, VP4, VP5, VP6, VP7, VP9, VQ2, VQ3, VQ4, VS6, VS7, VU, W, XE, XU, XZ, YI, YM, YR, YU, YV, ZB1, ZB2, ZC6, ZE, ZL, ZS, FM, PJ. We should imagine that this is a record, but would be interested to know if anyone can hear 100 in a week; we have already suggested that it should be possible to get 75 in a 24-hour period. Other unusual DX received by Martin included MX1A, TA1AA and LZIAK, rightly considered as doubtfuls; I7B on 'phone, claiming to be in Eritrea is another mystery.

A new C.I. station in G4LI (Jersey) is to be heard on 7080 kc 'phone, while G3GS is still active on three different 7 Mc frequencies. A new Virgin Is. station has been heard on CW by your DX Scribe—KB4FCS 14400, while KC5C claims to be near the Black Sea (QSL *via* W8LCN).

## ● The Aether Patrol Club

This is a new SWL club which pools results and the honorary secretary, E. C. Cooper, has given us some news (see Club Notes). A list of calls heard has also been sent, comprising much of the telephony DX receivable on 7 and 14 Mc.

Len Wright, 6 Hughstead Grove, Liverpool 19, is another who logged I7B, saying he was a "radio pirate in Italian Somaliland." But as he claims to be in Eritrea as well, it is probably wise to discountenance him. Len also reports W6USA on Treasure Island in San Francisco Bay, at the Golden Gate Exhibition. Incidentally, while listening round the other morning, your Scribe listened to W6USA calling "CQ" on CW 30-kc *outside* the HF end of 14 Mc, but before he finished it was obvious he realised his mistake as no more was heard. YA2UR has been causing some excitement and he gives the following as an address—Peter Henin, Box 22, Kabul, Afghanistan. But we are anxiously waiting for some verification before accepting it as authentic.

## ● Sounds Bad

Donald A. Goodchild, 35 Duckworth Grove, Bradford, Yorks, writes as follows, "Plenty has been written about 7 Mc, but what seems worse is the action of a group of Yorkshire stations using 25-50 watts for local 14 Mc 'rag-chewing' for hours on end when the band is open for DX, two of them wiping out 50-100 kc on my receiver." We will not continue with his opinion of them or what he would have done to them, but we hope that certain transmitters not a thousand miles from Leeds will inwardly digest these remarks and see if the cap fits.

## ● Country Counting

Bob Everard queries the fact that we have only included Windward and Leeward Is. as two separate countries instead of splitting them up into the various small islands comprising the two groups! We have endeavoured to keep island groups (where they bear one name) as a single "country." If we were to split up the Windward Is., we should have so to treat the Hawaiian Is., and so on *ad inf.* The American lists deal with the matter in the same way as we have done.

### ● Set Listening Periods—July

SLP1 July 9 22.30 — 23.30 BST 1.7 Mc

SLP2 July 16 06.00 — 08.00 BST 14 Mc

SLP3 July 23 22.00 — 24.00 BST 14 Mc

General reception logs for 28 and 56 Mc will be appreciated in addition.

Conrad Tilley and others have reported CP1AA on 14300 kc 'phone. We are reproducing the card herewith as he represents a rare country for telephony enthusiasts. NY4AD is said to be a naval vessel operating in Guatemala Bay, Cuba, while VN1LB is a newcomer in Managua on 14330 kc. LU2BAF is the call of the Yacht "Cuperang"—at least that's what it sounded like to Conrad—while other unusual DX for him included LU4DJ, PK6XX, PY9AF, 9AE, PK1OG (a new one), CE4AC, OA3A, VS2AK, TG5JG, VP5PZ and YV6AM. V. K. Coles, 13 Mervyn Rd., Tremorfa, Cardiff, had a shot at "50 countries in a day" on 'phone and just missed with 48. These were: CO, CE, CP, CN, CT1, CT2, ES, EK, F, FA, G, GW, HA, HR, HI, HB, HH, I, KA, K4, LA, LU, OH, OZ, ON, PY, PK1, PK4, PA, SM, SU, SV, SP, TI, TG, VP4, VP7, VP9, VO, VQ2, VE, VU, W, YV, ZB1. He uses a 12-valve super with a rotating half-wave doublet.

BOLIVIA		QSO #1246-C
<b>C P 1 A A</b>		
To Radio.....		
Confirming our QSO of <u>Oct 9</u> 19 <u>38</u> on <u>14</u> MC		
CW phone—ur signals were RST <u>5.5</u> : <u>9</u> on my		
NC100 Receiver here. General Conditions were <u>heavy</u>		
Transmitter HR is 89-6L6-RK20		HENRY E. J. SMITH
80 watts CW		Casilla 669 - La Paz
30 " Phone.		Bolivia

Ian Bates, 85 Jeanfield Rd., Perth, reports J3RD, KA7EC, KB6ILT, MX3C (genuine, ex-MX2C), OA4D, and XU9UX. The QRA of ZC6JW is Box 300, Haifa, but we have no details yet of VQ4JWW, frequently coming out as "VQ4JRW" owing to his poor fist. Harold Owen, 2 Campion Av., Basford Park, Newcastle, Staffs, feels that the I. of Man should count separately, although not shown as such in our Country List. To be in line with the Channel Is., we agree, as I.O.M. has its own government.

As the only Isle of Man station is G6IA, who loathes and abominates the thought of being separate and does not QSL listener reports, we felt there was little point in including it. Norman Stevens gives the QRA of ZC6RL as follows: R. Lyall, c/o 8 Divn, Sigs., Palestine. D. W. H. Fennell of Eton College, requests the QRA of VQ4RHL—Box 103, Nairobi will find him. We have no details of MX1A, but XX2B was apparently the call used by a certain G operating on a yacht cruising to the West Indies.

### Transmitters' Section

We expect there will be a good entry for our QRP 120 v. contest between July 9 and July 15 inclusive, and many amateurs have already indicated their intention of participating. The full rules will be found in the June issue, and those who are sceptical of low-power work are urged to see what 1-2 watts can raise.

### ● CQ DX from Danzig

From YM4AZ of Zoppot we have a most interesting letter on matters amateur in Danzig. First, he tells us that YM4R is definitely bogus as no telephony is permitted in that State. The following 20 stations are the only genuine YM's: 4AA, 4AD, 4AM, 4AO, 4AS, 4A1, 4AU, 4AW, 4AZ, 4BA, 4BG, 4BD, 4BE, 4BF (these are always on), 4AB, 4AI, 4AL, 4AY, 4BB and 4BG (rarely active).

YM4AZ rightly complains about the lack of understanding on the part of certain G's in replying to a YM who calls "CQ DX." To clear up this point, we take sides with him and say that if *any* European station is heard sending "CQ DX", a reply is not wanted from the other European countries. It is fair to presume that anything outside our continent would constitute DX. There are quite a few YM's who are willing and anxious to work their G friends, including YM4AZ, who will QSL all SWL reports as well. The Scribe's own experience is that Danzig is a 100 per cent. QSL country.

All YMs work with home constructed apparatus, and the leading station is considered to be YM4AA, who is WAC many times over. Those who enter for DX contests will always hear this station "knocking 'em off." YM4AZ has made more than 70 contacts with Europe, using only 2-5 watts input into a V-beam.

### ● Lichtenstein

We understand that this small principality is to be represented in Amateur Radio for the first time during the early part of August, when HB9CE takes a portable there for his summer holiday. He intends to use the call HBICE on 14400 kc and will also work in the 3.5 Mc band. All contacts will be QSL'd, so don't start your holidays till the second week!

We have just learnt that a genuine telephony station in Zanzibar, with a VQ1 call, is shortly to commence transmission on 14 Mc. He is a friend of VQ3HJP, who is helping him build the equipment.

For Honduras, HR4CX is a newcomer on CW on the HF end of 14 Mc; he supplements the existing list which includes HR4AF, 7WC and 5C. All stations are very much unlicensed and great care should be taken in sending cards—usually, it is safer to QSL *via* the ARRL.

It is worth turning out for early morning DX on 7 Mc these days, when that band is often well populated with CW stations of the kind which are rapidly becoming almost impossible to work on 14 Mc, if only because of the QRM. HR4AF at 0605 BST is only one example. We shall be particularly interested to hear what readers are able to do in the way of 7 Mc DX this summer.

*When writing the Trade, identify yourself with this Magazine*

## Notes and News from the East

On May 3 there was a total lunar eclipse which lasted from 1858 to 2225 Indian Standard Time. It was noticed that conditions were normal both before and after the eclipse, but while the moon was obscured a definite effect on radio signals was evident.

All 14 Mc signals came up in strength, QRK increasing with the eclipse. During the total eclipse, 2010 to 2113 IST, signals from five continents were heard, all at S9 and no fading. Among the stations received by VU2FO were VP4DM, never previously logged, and W7ALO, also at S9. After the total eclipse signal strength gradually reverted to normal and only European signals were recorded for the remainder of the night.

### ● VU2FA

Major Atkinson, who is a newcomer to Amateur Radio, obtained his Indian operator's licence in 1938 and VU2EU was the first station he heard on the air. Since commencing operation world-wide contacts have been made on 'phone, and VU2FA only awaits a QSO with South America in order to claim his 'phone WAC.

The parts for the rig were supplied by E. Read, G6US of Oswestry, the technical details for the transmitter and aeriels being planned by G6DT, G2IS and G5BG. Owing to the Indian licence restriction to ten watts the original design was not used and the line-up now consists of a 6L6 tritot CO driving an 804 PA, suppressor-grid modulated. The modulator consists of MH4-ML4-PX4 and the present frequency is 14092 kc ('phone only); VU2FA has solved the aerial problem by having a W8JK, rhombic, and two full-waves in phase from which to pick!

Major Atkinson has received numerous reports from G, K6, VK, VE, ZL, and ZS; those from England generally remark that his is the strongest VU 'phone yet heard on the 14 Mc band. His position is an ideal one and may account for the excellent reports received, but the efficiency of the rig is also very high. He hopes to be on 28 Mc very shortly and additional rotating beam aeriels are being erected.

### ● SP Contest

A number of complaints have been received from places as far apart as K6, ZL and VU, about the poor notes of the Polish stations during the SP contest. The 14 Mc band sounded worse than a 40-metre Sunday morning in England! The great improvement in conditions for European contacts between 1400 and 1900 GMT has been at the expense of a corresponding falling off with the rest of the DX world. Very few W's can be heard although South Africans are beginning to come in. One very reliable DX station is K6ILT in Guam, who can be worked most nights on about 14380 kc.

VU2EU recently logged a station on 46.3 Mc broadcasting what appeared to be dance music followed by an announcement after which Big Ben could be heard striking 6 o'clock. The latter item was the only one which could be identified and your Correspondent is wondering if this transmission was from Alexandra Palace or a harmonic of one of the Empire stations. A reply from the BBC is now awaited.

### ● Some Calls Pegged

XG5SV has been heard by NZ16W and VU2EU and is supposed to be located in or off Singapore. W9AM is operating in the Atlantic Ocean under the call of ZX9AM; QRP 'phone is used on 14050 and 14300 kc. YX8A, reported by NZ16W, is definitely a pirate, likewise YA5RC. VR4HR is active (QRAR), VR4BA is also in the Call Book. This station operates on 14 Mc with a single CO and 12-watts input. PK5HL, who sent NZ164 an air mail QSL, says that he seldom uses CW and has not yet WAC; he is on 7160 kc with 30 watts input.

\* \* \* \*

Below is a photograph of the station of our Far East correspondent, W. H. G. Metcalfe, VU2EU. The input is never more than 20.25 watts from 200v. DC mains, and the receiver a TRF 1-v-1 with built-in monitor; the transmitter is 43-25L6-P/P 25L6, with a 67-ft. single-wire multi-band aerial. Modulation is by grid control with another 25L6, and all heaters are wired in series.

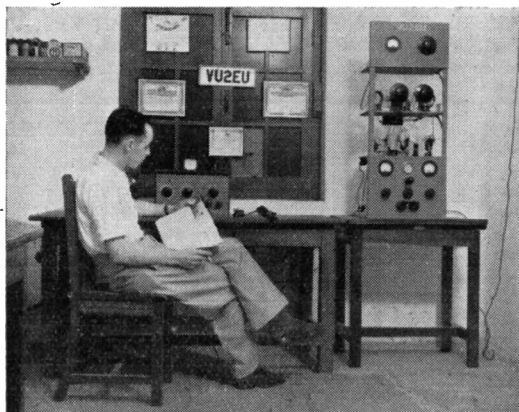

Readers in India, Burma, Malaya and Ceylon should note that he has recently been appointed official representative for the Call Book, so that all new calls and changes of address should be notified to him direct—W. H. G. Metcalfe, c/o Peshawar District Signals, N.W.F.P., India.

### WANTED

—News of DX worked from amateur stations throughout the world.

—Photographs, with brief details, of apparatus of unusual interest or application.

—Station descriptions from GM and EI, in the form of notes on the gear, results, experimental work, etc., with good clear photographs, any size. We write the story you see in "The Other Man's Station" series from all the detail you can give.

—Information on reception of the Alexandra Palace television sound signal at distances of over 100 miles.

# CALLS HEARD SECTION

## SET LISTENING PERIOD 1, 1.7 Mc May 6, 2230-2400 BST.

**J. G. WARDHAUGH**, 2DTT, 20, Hall-gates, Hexham, Northumberland. 1-v-2 battery; 66-ft. Marconi NW-SE. CW—G2DF, HW, QM, YY, 30A, PL, ZH, ZL, 4CF, HD, 5BX, GT, XH, 6VC, WH, 8NF, SG. CW2BG, 3AJ, 8TP, NW, WU.  
\*Phone—G2LD, 5GJ, 6GU.

**H. OWEN**, 2, Campion Ave., Basford Park, Newcastle, Staffs. "All World Two," 33-ft. ENE-WSW. CW—G2HW, MN, 30A, 4CF, 5XH 6KR, ZR, 8GI, NF, QZ, SG, US, VN. CW2BG, 8WU; OZ2GM.  
\*Phone—G2DQ, 4DD, 5ZQ, 6AB. CW2BG.

## SET LISTENING PERIOD 2, 14 Mc May 14, 1600-1800 BST.

**K. BUNSTON**, "Gable Cottage," Broad Hinton, Wilts. 0-v-1(triodes); two aerials, N-S and E-W, long-wire. \*Phone & CW—CR7AD, AU, FA3JY, RY, PKIMF, BX, RI, 3AJ, JK, 4DG, FS, JD, SUIWM, UIBO, 3BX, VU2FX, HB, JG, VS2AL, 7MB, WIBEV, DQ, 2A0A, APW, ICV, 7AYO, ZC6RL, ZE1N.

**F. JONES**, 6, Sutherland Street, Fenton, Stoke-on-Trent. Electron-coupled 0-v-1; 28-ft. high, 22-ft. long, W-S-W, 65° elevation. CW—HA4K, 5Z, HB9BD, KB6IL.T. LA7R, OH2NB, 3NK, 5OD, ON4PZ. PKIBX, 4FS, SM3MT, 5UW, SPIHA, WI, WO, UIBL, 9BC, ML, UE3LT. V5MZ, VU2HB, JG, WIBEV, 7AYO, 8RFJ, YL2AC.  
\*Phone—CT1FI, VM, F3QR, 8LT, HB9CZ, DQ, KA1AF, HS, OH2QM, SM5JH, 7MU, VQ2CM, W1DQ.

**BSWL319**, Bristol, 6. "Improved Every-man Four," 1S; Indoor "Vee" beam, N-S-E.  
\*Phone—CT1FI, ES5C, F3HV, FT4AI, AR, HA7L, JIMX, UR, KA1HS, LA5H, P, OH2QM, PKIOE, 4DG, JD, SM4JG, 5JH, NZ, SI, 6WE, 7MU, SPIAT, W1DQ, 2JEH, 3CHE.

**I. A. BATES**, 85, Jeanfield Road, Perth. 5-v SH, \*phones; 22-ft. inverted "I," pointing E-SE.  
\*Phone—F3BU.  
CW—CT1JU, F8XP, GM8HM, HA4K, 5Z, HB9BD, CP, KA1SP, OH5OD, SM5LB, SPIAR, DP, EB, HA, WI, WO, YX, 2GW, UIBL, 3QD, 9ML, W2A0A, YM4AU, YU7LX, TE.

## GENERAL LOGS 1.7 Mc

**CECIL T. H. MARTIN**, "Lynnton," Pound Road, Bursledon, Southampton. 1(regen)-v-1; end-on, NE-SW. 8.5-39-46.39.  
\*Phone and CW—F3HD, 8BO, G13ML, 8LP, GM2LQ, 5UT, 6JJ, RI, 8CN, TT, CW2BG, 3YR, 4FW, 5OD, TC, 6KY, 8CT, NP, WU, G2IT, XQ, SC, OU, BF, XS, KT, CF, QM, AT, WA, FI, RC, AF, IX, YT, YY, RI, KC, GG, UJ, DQ, NJ, JM, JL, MN, NY, XG, QV, SU, MI, 3UJ, UB, XR, ZL, SB, LP, GH, GW, HA, JO, VX, SI, FN, ZY, WI, JW, FM, OA, KX, PL, ST, PH, SD, HN, VA, MV, TP, OJ, BY, MB, HS, XS, VG, 4GJ, CW, AU, DD, HH, BP, HZ, DC,

FH, CG, AK, ZZ(!), 5GJ, ZQ, BK, RY, MM, ZT, QG, OB, CU, FN, RD, LO, HS, IL, AK, RI, AA, QY, BX, GN, KG, RP, GT, TN, UY, JU, IU, RX, UC, FO, UQ, DY, LX, FY, XR, 6AB, GO, KR, YV, LL, UT, SS, YI, GH, ZR, QA, GN, NB, TR, CI, PO, FV, MK, OI, SQ, WY, YU, ST, GR, 8BA, NC, FU, NF, GI, GF, SR, MW, GN, LZ, UJ, IC, DA, OK, PR, GG, AX, PM, SG, SK, DS, GQ, PI, HK, JM, MU, AF, PD, ML, DT, PX, NL.

Portable CW—GM2LQP, 20XP, 6RIP. G13MLP, CW3AJ, 6AAP, G2FIP, OIP, UJP, 3KSP, ZJP, 5RIP, JHP, XLP, PAP, AKP, UMP, 6VDP, SNP, UTP, KRP, RWP, 8MUP.

## 3.5 Mc

**BOB EVERARD**, "Belle Vue," Nelson Park, St. Margarets-at-Cliffe, near Dover, Kent. "Sky Champion," 9.5-39 to 24-5-39.

W1DQA, ABY, AW, FOF, AAH, FLP, WL, 2HNR, JEG, ASI, JDG, IRC, ACB, DKX, HXQ, HB, 3JC, AHS, CRO, CKS, AHQ, CNY, BTM, UO, EVK, BEI, EMM, CEI, COJ, EOP, ZD, 4CZC, BPD, CJD, DCQ, OJ, LU, EQZ, CDG, IS, BZX, 5DNV, 8DK, PGL, BOZ, KDX, GPS, NWO, 8ZHQ, VE1LR, IGR, ICR, CK, ILR, 3IZ.

## 14 Mc

**BSWL319**, details as SLP2. 10.5-39 to 10.6-39.

\*Phone—CE1AC, AH, AM, AO, AS, 3AA, AC, AT, BK, CO, CG, DW, FE, EP, CO2AM, HS, JJ, JV, LA, LL, MA, KG, RH, SV, WI, WM, WW, 6OM, 7AS, CX, 8AR, EC, JK, RO, CP1AA, CT2BP, CX1AA, AG, CW, FA, 2AU, AW, CO, CV, EA7BA, FT4AI, AR, HC1FG, HH2HF, H13N, 7G, HK1AG, 3CL, CK, CO, 4DF, 5EE, HPLA, KA1CS, HS, K4DSE, FAY, 6NYD, OQE, LUIJ, QA, 2AW, BAF (yacht on River Platte), BG, FI, HF, LH, 3AJ, AT, DF, HA, HK, 4AW, BH, DH, PB, 5CK, CZ, 6MB, 7AG, H1H, 8AB, 9WA, OA3A, OH2OI, OM, OQ5AA, ZZ, NY4AB (at C08), PKIOE, OG, 2AY, 4AX, DG, JD, 6XX, PY1CK, FX, FZ, GJ, GO, GR, HJ, IM, MH, 2AC, BA, BH, BM, DA, FF, GC, HV, IT, KX, KT, MI, NO, 3DZ, EN, FA, 4BI, CT, EJ, FT, 5AJ, AQ, BL, BW, OT, OR, 6AG, 7AG, AT, 9AE, AF, SUIAF, AM, AX, DM, JM, MW, RH, RO, SG, WM, 2JR, 5BO, TG5JG, 9BA, T12AV, KC, 5JJ, U8BX, VE3EO, HJ, XQ, 4IF, 9AT, VK2AHA, 3BM, VP1BA, WB, 2AT, 3CO, LF, 5PZ, 6FO, MR, MY; YB, 7NS, 9G, L, R, VQ2CM, 4CRE, VS2AK, VU2CQ, L, FA, W5AKZ, CXU, DUK, HDK, 6BUY, USA, 7BVO, DX, YL2CD, YN1LB, BX, YU7U, YV1AF, AO, 4AE, 5ABE, ABF, ABQ, ACA, ACE, AK, 6AM, ZB1E, L, 2B, ZC6HS, ZE1JA, JH, JN, JS, ZS1BM, T, 2AQ, BJ, 5BZ, Q.

**J. J. BURCHELL**, 4, Kangley Bridge Road, Lower Sydenham, S.E.26. Battery 1-v-2, with eliminator; 20-ft. long, 20-ft. high, E-W. 20.5-39 to 30.5-39.

CE2AG, 3AJ, BF, CM2AO, CN8AY, MV, CR4HU, MM, HT, 6AI, 7AF, BC, CX1CB, 2AJ, EA8AA, EK1AA, FA3JY, RY, WW, 8DA, ZZ, ZA, FB8AD, FM8AD, HH2CM, 3L, J4CP, KA7EC, KB6IL.T, K4ESH, EVD, FC, FCV, FTD, KD, UG, 5AC, AD, AF, 6CGK, LUICA, BC, JA, 2EV, 3AM, 4BH, 4DQ, AG, NB, 5LA, 6DG, JB, 7CH, 8DJ, 9AX, FC, LX1PP, SI (\*phone), LY1AH, AT, KK, OA4D, OK3DK, OQ5AV, Pj3CO, 5EE, PKIMF, RI, 4FS, KS, PY1AZ, DA, DH,

FM, GJ, HQ, HX, 2AL, BA, CD, 2EG, EU, MI, 3ES, SP, 4AP, KV, 5AG, QJ, QK, 7AO, SUIAS, AX, DM, GT, MS, TM, 5KW, TF3F, 5M, UIBL, 2AE, NE, 3AM, AV, CY, DQ, 4AM, 5KA, YH, 8ID, 9ML, MP, UE3LT, UKICC, AA, 3AH, AQ, AU, RCV, FW, 5KA, KI, VE4AED, RO, VK2AMC, IG, KD, 3LP, XG, 5JU, KM, LL, 5LZ, 7BM, GJ, VO1Y, O, 2CK, VP2AT, 4TO, 5PZ, 7NX, VQ2BI, GW, CJ, MI, 3HJP, 4AHL, CHS, CRI, JWW, VS6AF, VU2AN, FX, JG, W4ZZ, 5HIP, KC, 9CYT, CM, WJV, XU8MI, YM4AA, AO, AS, YU7LX, TE, XU, YV5AD, YY1X, ZB1X, ZC6JW, RI, ZS1AC, AW, CG, 2X, Y, 4AA, I, 6BZ, DM, 6EZ, OM, ZL2GW, 4GS.

## PORTABLE STATIONS Heard June 3-4

**J. C. HARVEY**, 2CQT, St. Margaret's, Oak Hill Park, Hampstead, N.W.3. 1-v-1; 20m. doublet and 66-ft. Hertz. 1900-0200, 0400-1000, 1300-1700 BST. (Figures in brackets indicate average signal strength).

## 1.7 Mc

G2OIP(6), F1P(7), UJP(4), 3ZJP(6), KSP(5), GM3TDP(5), NDP(4), 5JHP(5), PAP(3), RIP(4), 6SNP(4), KRP(4), VDP(5), GW6AAP(7), G6UTP(5), RWP(6), GM6RIP(4), G8MUP(3).  
Also heard: G8PD(9), 5HZ(3), DC(7), 3XS(6), 2MI(8), 5HY(5), 8PX(4), 2RX(7), 3LA(7).

## 3.5 Mc

G2INP(7), JLP(6), CXP(8), IZP(7), KOP(7), 5HKP(5), QOP(6), VMP(7), VUP(8), JOP(6), WWP(6), VBP(1), WZE(4), G15JP(5), GM5ZXP(7), FTP(1), G6RBF(8), GMP(5), GSP(4), GW6OK(3), GM6IZP(5), E16JP(5), G8ABF(5), FCP(7).  
Also heard: G2UP(5), 8LG(7), CW5FI(7), G5CC(4), CG(3).

## BRITISH CALLS HEARD OVERSEAS

## 14 Mc

**JACK WELLS**, 1000, 14th Street, Phoenix City, Alabama, U.S.A. Hallicrafter S14, plus 1851 preselector; 1/4w vertical, single wire fed.  
\*Phone—G2AV, IW, KG, PU, 3BM, IC, II, 4AS, DC, 5BJ, JO, ML, VT, 6BY, 8CL, IG, IK, TD, GM3OI, 6WD, GW3KY, UO, G12CC, 5OY.

## 28 Mc

**M. F. WILLIAMS**, 119, South Eighth Street, Newark, New Jersey, U.S.A.  
\*Phone—GM6RG, GW5KJ, G2CG, MF, 3DM, 5GI, 6AG, 8MA, SH.

## 7 Mc

CW—G2LC, 3KT, SS, 4BM, 5ND.

## ACKNOWLEDGMENT

S. Ashworth, Darwen; BSWL1139, Churwell, Leeds; D. A. Goodchild, Bradford; R. Hall, New Waltham, Lincs.; F. Jones, Stoke-on-Trent; G. C. Lidstone, 2FDN, London, N.2; Cecil T. H. Martin, Bursledon; Roy McCondvich, Glasgow; P. Oliver, G3NT, Northallerton; B. Pashley, G6PJ, Sheffield; F. H. Pickard, Leeds, 6; P. Sawyer, Croydon; Len, Wright, Liver-pool, 19.

# A QRP Contest—Analysed

By Arthur C. Gee, G2UK

IT HAS BEEN the custom in the East Essex district to hold an annual Local Test. This has always been an unofficial affair and its character varies from year to year, but an endeavour is always made to devise some form of test which will yield results of experimental value. Last year the event took the form of a Great Circle Route DX Contest, competitors having to work as many stations on a given Great Circle route as possible, the object being to encourage experimental work with directional aerials.

This year, in view of the interest shown in real low-power work, a QRP Contest was held. It took place from 0000 BST on May 22 to 2400 BST May 28, and its chief feature was that the HT supply for all stages of the transmitter had to consist of *one* standard HT battery (receiving type) not exceeding 120 volts. The filament supply was optional (DC or AC) and the circuit and aerial arrangements were left to the preference of individual competitors, but 7 Mc and 14 Mc only were to be used. Scoring was one point per contact, with the total number of contacts to be multiplied by the number of countries worked on each band.

The log sheets sent in were accompanied by a statement of circuit and power used, aerial arrangements, receiver, and any other interesting information which might result during the Contest. On analysis, the results brought some extremely interesting facts to light, and in order to show just what can be done with simple battery-operated gear, a summary of the results and findings appears herewith.

## ● The Competitors

There were seven competitors, the winner being G2FO, who worked 62 stations in nine countries, and thus scored a total of 558 points. G2LC was a good second with 44 stations, eight countries and 352 points. The order of merit, score, number of contacts, etc., can be seen from Table 1.

## ● Gear Used

Each competitor's gear is shown in tabulated form in Table 2. It will be seen that four of them, including the winner, used a simple one-valve transmitter—a crystal oscillator only; G2LC had an ECO and FD and G5XI a CO and PA. G5VQ tried a

TPTG but had very little success with it, running into a series of mishaps which prevented him getting going properly. The power drawn by three of the competitors was in the region of three watts, but only half this was used by G2LC (who came second), G8RT and G6IF.

The receivers are also given in Table 2 and it will be seen that they are a fairly representative collection, both commercial and home-built types being employed.

As regards aerials, these also varied from competitor to competitor. Details can be seen in Table 2.

## ● Stations Worked

As Table 1 indicates, contacts were not limited to G stations, in spite of the low power used. The majority of competitors worked half-a-dozen countries at least. The best DX worked was SM5NM (850 miles) by G2SO. Not a bad effort for 4 watts. Next was LA6U at 700 miles worked by 6IF with one watt and then HB1AW by G5XI. In all, the following twelve countries were contacted:—G, GI, GM, GW, D4, F, EI, LA, HB, ON, OZ and SM.

An interesting point was that whilst the contest was open for 7 Mc and 14 Mc, all competitors preferred to remain on 7 Mc and no contacts on 14 Mc are recorded.

## ● In Conclusion

Viewing the Contest as a whole, one cannot but be impressed with the results obtained under ordinary everyday conditions, with the really QRP gear employed. In these days, when one hears so much about the necessity of having plenty of power to "cut the QRM," as they say, it is refreshing to find several low-power stations working on 7 Mc—the worst of all bands for QRM—and succeeding in contacting a total of twelve countries amongst them. QSOs apparently came quite easily; G8RT reported that "on the whole operation was very good, quite reasonable QSOs resulting, although most people reported QRM at some time or another." Who wouldn't complain of QRM on 7 Mc, with that band as it is at the moment! Due to lack of time G8RT's operating was limited to the last day—a Saturday. (continued at foot of next page.)

TABLE 1.

Order of Merit	Call	Score	Number of Contacts	Number of Countries
1	G2SO	558	62	9
2	G2LC	352	44	8
3	G5XI	147	21	7
4	G6IF	144	24	6
5	G2KH	65	13	5
6	G8RT	36	12	3
7	G5VQ	1	1	1

TABLE 2.

Call	Transmitter	Input	Aerial	Receiver	Rx Aerial
G2SO	CO (P650)	3-4	Windom	Sky Budd3	Vert 16ft
G2LC	ECO/FD	1.5	66ft Zepp	1-v-1 (AC)	Indoor
G5XI	CO-PA	3.5	Windom	0-v-1	Indoor
G6IF	CO (P220)	1	C.F. Hertz	Sky Chief	A.O.G.
G2KH	CO	3	66ft Zepp	1-v-1	Indoor
G8RT	CO (6L6)	1.5	66ft End on	1-v-1 (AC)	Vert. 30ft
G5VQ	TPTG	-	-	-	-

## 56 Mc CALLS HEARD

(Distances in brackets; asterisked calls denote two-way contacts.)

**JOHN CURNOW**, G6CW, St. Anns, Bramcote Lane, Wollaton, Notts. May 30 to June 9, 'phone and CW.  
G2HQ(40)\*, MC(105)\*, MR(107), MV(125)\*, ZV(150)\*, 5MA(130)\*, RD(93)\*, 6DH(130), IH(74)\*, OT(110)\*.

**R. HOLMES**, Camp Bungalow, Cheltenham Road, Painswick, Glos. May 10-June 9, 'phone and CW; 0-v-Pen., hor. and vert. dipoles.  
G2BI(26), MV(94), NV(49), 3QO(55), YZ(10), 4GN(6), 5TX(92), 6FO(37), IH(24), QO(131), XM(71), 8LB(9), 1.Y(58), ML(9).

**K. A. SLY**, 2FAU, 16, Buckland Avenue, Slough, Bucks. 0-v-1, ¼w CF vertical, 10-ft. high. 18.5.39 to 9.6.39.  
CW—G2DP(22), MC(11), MV(23), QY(18), 5BY(23), MA(17), NF(22), NG(5), RD(13), 6XM(17).  
'Phone—G2MV(23), 5RD(13), 8WH-P.

**DENIS HEIGHTMAN**, G6DH, 231, Burrs Road, Clacton, Essex. Between May 1 and June 20.  
G2AO(80)\*, DN(64), HC(58), LW(52)\*, MR(68)\*, MV(64)\*, XC(116), ZV(100)\*, 5BY(60), MA(72)\*, TX(128), UK(26)\*.

6CW(128), OH(72), OT(58)\*, 6PG(42)\*, QC(38)\*, QZ(58)\*, 8MU(18), SK(54), SS(32)\*.

**R. J. LEE**, 9, Theobalds Green, Heathfield, Sussex. May 7-31, 'phone and CW; 0-v-1.

G2AO(14), AW(28), GG(75), HG(34), LW(34), MC(51), MV(29), NH(38), UJ(12), XC(59), ZV(34), 3OO(35), YY(20), 5BY(32), CM(34), MP(37), NF(48), OJ(32), OX(30), TX(70), UK(44), 6CW(152), DH(68), FO(146), OT(48), WL(47), XM(48), 8OS(30), SK(50).

**C. T. FAIRCHILD**, G3YY, la Dover Road, Brighton, 6. 'Phone and CW; 0-v-1.

G2OA(22), MV(37), OD(48)\*, XC(42)\*, ZV(20)\*, 5CM(30)\*, JZ(20), RD(75)\*, TP(60), TX(50)\*, 6GR(50), LK(35), XM(43), 8IZ(40), OS(20)\*.

Harmonics heard: G2RU, 3WR, 4HS, 8AC.

**G6FO**, Newport, Mon. Transmitter, 4-stage 50-watt; aerial, 10 ¼-wave bent end-on; 0-v-1 and Hallicrafters "5-10" receivers. Since Jan. 1, 1939.

G2BI(45)\*, JL(local)\*, MV(124)\*, 5BY(126)\*, JU(21)\*, WU(13)\*, 6GN(19)\*, 1H(45), LQ(16)\*, VA(124)\*, VF(20)\*, XM(98)\*, 8WU(11)\*.

### During MAGAZINE Test Period June 14-18

**E. J. WILLIAMS**, B.Sc., G2XC, 34, London Road, Widley, Portsmouth.

G2MV(44), 3YY(43)\*, 5MA(45)\*, TX(14), UI(10), 6LK(35)\*, XM(34)\*, 8LY(25)\*.

**W. JAMES**, G6XM, 36, Elm Grove, Farnborough, Hants.

G2BI(55), GC(26)\*, MR(21)\*, NH(24)\*, XC(34)\*, 5CD(30), CM(17)\*, RD(33)\*, 6IH(88), LK(9)\*, OH(18)\*, VX(40), 8LY(20)\*.

**R. J. LEE**, 9, Theobalds Green, Heathfield, Sussex.

G2AO(14), MV(29), QY(45), UJ(12), WS(156), XC(59), 5CM(34), IB(45), MA(35), TX(70), UK(44), 6IH(140), LK(35), OT(48), WL(47), XM(48), 8AA(60).

**W. F. MILLER**, 2AAH, 60, Spitalfield Lane, Chichester, Sussex. Acorn TRF-v-1, full-wave aerial.

G2MV(42), OD(40), XC(14), ZV(12), 3SU(12), YY(28), 5MA(37), TX(25), U(19), 6LK(24), VX(58), 1-1SS.

### A QRP CONTEST—ANALYSED

(continued from previous page.)

He worked twelve stations in three countries—with one-and-a-half watts! Surely this should be encouraging for the man who is contemplating QRP work. Quite considerable interest was shown in the Contest by stations contacted and it is hoped that this short account of the results actually obtained with simple apparatus will encourage those who have hitherto thought it not worth while to get going with very low power and will also show that the QRP man has just as much a place as the QRO merchant.

In conclusion, the writer would like to thank those who took part in the Contest, for the information collected, and the reports sent in. Also the organisers—G6CT and G2LC—for putting at his disposal the logs of the competitors, and G2SO and G8RT for helping in sorting out the number of stations worked, distances, gear used, and other details.

### 7 Mc—NEW ANGLE

It seems it may happen that when broadcasting starts in the HF portion of our 7 Mc band, American amateurs will make a concerted effort to blanket reception of these stations in the United States. It is even suggested that the American authorities will not look with official disfavour on the proposed attempt to make the existence of a broadcaster not worth having on 7 Mc. While we are naturally in no sympathy with the invasion of our frequencies, we cannot think that starting a war *via ether* will improve the situation in the slightest degree.

### NEW AMATEUR CALLS

Home and Overseas readers are invited to send in new Calls as issued for inclusion under this heading.

G4FD—J. Irwin, 85, Stansfeld Street, Blackburn, Lancs.

G4GC—C. D. S. Wintle, 5, "Westridge," 3, Prince Arthur Road, Hampstead, London, N.W.3.

G4GI—S. M. Gambles, 1, Lindum Terrace, Lincoln.

G4KO—H. Staff, 59, Charles Avenue, Thunder Lane, Thorpe, Norwich, Norfolk.

GW4KQ—H. Phillips, 132, Clare Road, Grangetown, Cardiff.

G4KV—Reginald Lansley, 27, Bascott Road, Wallisdown, Bournemouth, Hants.

G4KW—G. Jones, 46, Robart Street, Sheffield.

G4LA—J. G. Wardhaugh, 20, Hallgates, Hexham, Northumberland.

GW4LK—R. Foster, 15, Park Drive, Cardiff Road, Newport, Mon.

GW4LN—J. Manning, 16, Riversdale Road, West Cross, Swansea.

G4LO—C. W. Fish, Lancaster Cottages, Northwold, Thetford, Norfolk.

G5LT—J. W. Goodlad, The Doreys, Medstead, near Alton, Hants.

HB9DO—Fritz Frey, Box 644, Lucerne.

HC2CC—Wally Grosskreuz, Apartado 1293, Guayaquil, Ecuador.

HK3CW—Edward Noguera, Radio Dept., Ministry of Communications, Bogota.

I, U8AG—Elias Grinberg, Cordoba 1807, Buenos Aires.

LY1CC—Frank Drukteinis, Seimu G-ve-9, Kaunas, Lithuania.

PK1DG—Malabar Radio Station, Bardoen, Western Java, Netherland Indies.

SUIRH—R. Hooten, c/o Sir Henry Baker, Alexandria.

VU2FA—Major J. N. Atkinson, R.A.M.C. Military Food Laboratory, Kasauli, Simla Hills, Punjab.

ZC6RI—R. Lyall, c/o 8th Divisional Signals, Palestine.

For more enjoyment of your hobby—read "The Short-Wave Magazine" regularly

## LETTERS TO THE EDITOR

### Aerial for Awkward Location!

I have moved into a bungalow where estate restrictions do not allow an outside aerial, which is very unfortunate from a transmitter's point of view. About the only thing I can use are two posts 9ft. high and 40-ft. apart, which I have disguised as washing-line supports. Could you please help me with a 7 and 14 Mc aerial design to suit these circumstances.—S. DEVON.

*[For obvious reasons, we have suppressed our correspondent's name and full QRA, and his query has been answered direct. We regard these aerial bans, becoming more and more frequent, as an unjustifiable imposition against which strong protest should be made.—Ed.]*

### 1.7 Mc Comment

Many thanks for the April issue of the MAGAZINE and I read the 160 meter DX story with great interest. Please let me know next year when you plan to get things started and I shall be pleased to co-operate in every possible way. For your information I am now on 5 meters with my Johnson "Q" and looking for European contacts with 250-375 watts input on 58.6 Mc 'phone.—STEWART S. PERRY, WIBB, 36 Pleasant Street, Winthrop, Mass, U.S.A.

I would like to add my opinion to yours with regard to 1.7 Mc as compared with 7 Mc. It certainly is a treat to go on 1.7 at night and have a QSO without a struggle with QRM. Activity on this band is greatly on the increase.—R. MOFFITT, G5KX, 1 Balmoral Drive, Southport, Lancs.

### Radio in Emergency

In emphasising the case for wired communication in emergency, the Postmaster-General seems to have overlooked the lessons of the last war. It was shown repeatedly that in bombed and shelled areas wired communication was subject to continued interruption and if, as has been frequently stated, large areas are vulnerable from the air, then wired communication may fail and the radio link becomes vital for the maintenance of contact. The Postmaster-General appears to have ignored the importance of radio as a means of maintaining emergency communication, although it appears to be fully recognised by the Services.—A. JOHN DANNHORN, The Radio Manufacturers' Association, 59 Russell Square, London, W.C.1.

### 28 Mc Reception

As a regular reader of the MAGAZINE I am forced to the conclusion that the scarcity of 28 Mc reports mentioned in the DX Commentary is due to many other people being in the same position as myself—no adequate data available for building a reasonably priced receiver for this band. The communication jobs, with one exception, are unsatisfactory. What I suggest for home construction is a good Pen-Pen, AC or battery; if the former, use American valves. Such a receiver would not be expensive and should be as good as a superhet for headphone working, with low noise-level. I have been combing all magazines, English and American, for over a year now, but so far I have found no circuit designed to cover the range 7-40 Mc. Incidentally, I should like to congratulate G6IO!—W. LARDNER, 14 Hamilton Avenue, Tolworth, Surrey.

### 60 Mc Signals

I see in your 56 Mc Notes several references to unidentified carriers, and I suggest that some that may be heard in this locality are due to me. I have eight transceiver type sets, signing EC1-EC8, depending on which one is in operation, and as it is difficult to arrange protracted tests, I often leave a signal on for tuning purposes. I may therefore be responsible for some of the unmodulated carriers and would be glad if readers who identify these signals would send a report either to the address below, or c/o The Orderly Room, Eton College O.T.C. The most-used frequency is in the region of 64 Mc and it is unlikely that these transmitters will ever be heard below 60 Mc, as we try and avoid creating QRM in the amateur band.—M. C. STANLEY, Cpl., ECOTC, i/c Wireless Section, c/o J. M. Peterson, Esq., Eton College, Windsor.

### Disappointed

On looking through the June MAGAZINE I was very surprised and disappointed to see that you had omitted F. A. Beane's fine article "Have You Heard?". I can only say that I hope its absence is only temporary as my friends and I consider this feature among the best and most interesting you print.—V. SMYTHEMAN, 23a Augusta Road, Birmingham, 13.

*[It is sometimes necessary to hold articles over when considerations of space demand it. A note to this effect appeared on p. 31 of our June issue—Ed.]*

*When writing the Trade, identify yourself with this Magazine*



# The Month's Club News

By S. W. CLARK, 2AMW (Assistant Editor)

REMEMBER HOW we paired Kilmarnock with BROMLEY recently, suggesting that the Southerners could make as good a showing with a new club? Here is the outcome: Bromley and District SW Society have 25 members with G2NK (A.C.S. Radio) as president. G8KV is conducting the Morse class, which is finding many followers. 2FWV has described and demonstrated his TRF receiver and weekly meetings for discussion are augmented by the business bi-monthlies. Still more members are required, and as Kilmarnock's initial figure was also 25 we must await next month's news from both to name the winner.

At long last LIVERPOOL boast a SW Club. A strong committee has set about the task of preparation in so able a manner that on the 20th of this month the highly-situated clubroom will be thrown open, when it is hoped that local readers will turn up in such numbers that the founders will feel their efforts have been worth while. Here are a few brief notes—Hq.: Tower Room, St. Barnabas Hall, Penny Lane; Thursdays at 7.30; 6d. is the entrance fee and 6d. is also payable at each attendance. A superhet and a 56 Mc receiver (by 2FZM) are to be installed. VU2EU promises support when he returns to G.

The trio of newcomers is completed by news of the WOODFORD and District Radio Society. We cannot do better than quote 2ABC, who is doing duty as secretary: "The aim is to foster interest in short-wave radio, and to provide members with an opportunity of meeting and discussion, special attention being paid to Morse. It is also hoped to build a receiver and transmitter, and to organise listening contests."

## ● Birthdays and an Invitation

A few days ago the PECKHAM District SW Club celebrated its first birthday in optimistic style. Earlier in the year the Dulwich Club joined with them to mutual advantage, and although there is now no local competition they are going ahead in all directions. Members are looking forward to the Contest and hope that the result of the second event will be more favourable to them; at the same time they are expecting more entries from Clubs. Their own weekly competition has helped to choose and polish up the team and Morse reporting at 20 w.p.m. solid by several members points to a much stronger effort this time. Eight members have calls, the most active of whom seems to be G3ZF.

This month sees the completion of two years in the life of SOUTHPORT Amateur Transmitters' Association. As the membership here is limited to holders of calls the total of 14 is good; now, however, the rules have been altered to cater for "District Members," who are admitted at an entry fee of 2s. 6d. and 1s. for each meeting attended. The annual meeting also heartily endorsed G5KX's suggestion that a hamfest be held in September when open invitation should be given to all sections of amateurs to come to what will be primarily a social function having the object of a "get-together"; suggestions as to the day are asked for

and any other points will be welcomed by the organisers, who hope thereby to make the event an outstanding affair for members and strangers alike. At this A.G.M. G2LM lectured on crystals used in early experiments in RF control, followed by G3JR's talk on DX working with low power. There has been no 56 Mc activity, as field days and 20-metre DX has claimed full attention during the past month; some individual reports are that G6YR has at last commenced building a superhet but is retaining his trusty 1-v-1; G2IN is erecting a 10-metre W8JK rotatable beam aerial; and a new QRA claims all G5ZI's time.

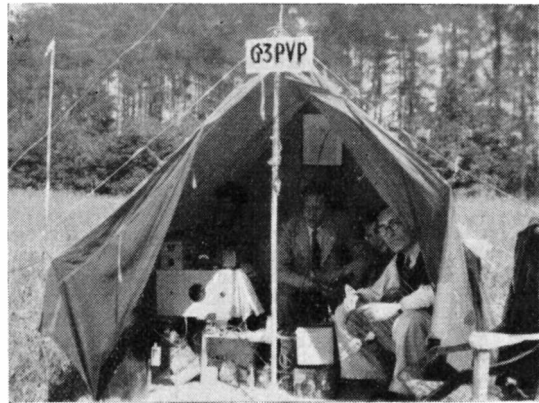

A group of West Herts G's encamped at Berkhamsted.

## ● Local SLPs

"Set Listening Periods" are now a regular feature at SLOUGH, where eight members have signed on for correlating meteorological conditions in connection with radio waves. On June 8 2DDG invited members to his home for an informal meeting, and his hospitality was much appreciated. Among the visitors were G3FJ and 2FWG. G3GZ has helped forward Morse practice by advice and demonstration.

To make sure no prospective member looks upon the WILLESDEN Society as catering only for the call-holder 2FTD tells us that E. Strowbridge (BSWL 1144) has organised a series of listening times similar to those of the "DX" section; they are for the purpose of receiver comparisons, etc., and at the same time the SWL is made to feel that his interest is equal to that of the transmitter. G3XL puts out slow Morse on Thursday evenings (7052 kc).

## ● "Portable G..."

Some thirteen members of the ALDERSHOT Society enjoyed themselves with G6XMP on June 11, working SM and ON. The transmitter, built by G6XM, was CO-FD-PA, two car batteries driving a generator for the PA and a vibrator for the exciter. The aerial was 132 ft. end-on for transmitting, while the 1-v-2 receiver was coupled to two half-waves in phase.

BRISTOL Experimental Radio Club had their first taste of field days, also on the 11th, and report good all-round results while working from the Somerset hills of Penpole Point and Dundry. Recent



Bristol Experimental Radio Club members on Dundry Hill, Som.

meetings have covered demonstrations of several commercial receivers for the amateur and the next meeting is reserved for G3YT, who will describe and operate his transmitter on the 11th of this month.

Westerham drew a fair proportion of DEPTFORD Men's Institute SW Club on June 25, when a 7 Mc station was operated on CW and telephony. Two CO-PA transmitters were used in turn, though not at full efficiency during the early stages through difficulty with the power supply. However, by using lead-pencil refills as brushes in the generator some useful contacts were made. All went home happy and this coming week-end will find the Club continuing tests from the same point. The last meeting of the session was held on July 27; a recommencement in September will be announced in these pages.

The DOLLIS HILL Society also close down until September, winding up the summer with a 14 Mc day in the open. Telephony and CW are the only certain facts about this event at the time of writing, but nevertheless details will be available if application is made quickly, for G6SKP is due to call "Test" next Sunday.

Three outings make the news from EDGWARE, this society favouring the 56 Mc band. G2QYP, with ten receiving entries competing, was scheduled for July 2 and another 5-metre camp is to be set up on the 9th. At an earlier field day (not 56 Mc!) all continents, except VK were contacted and a crowd of over 50 visitors gathered.

At the risk of copying another MAGAZINE feature we quote the HEATHFIELD Society's DX worked from portable G5JZ at Brightling Needle early last month: VU (port.), SU (port.), VK, PY, VP4, W, ZS; the not-so-DX stations were LA, UK, SM, CT, SP; HB1 (port.). The transmitter was 42-CO/42-FD/809-PA on 14 Mc, using a generator and HT accumulators loaned by Exide; aerials a W8JK beam and Windom. Two receivers were in commission—0-v-1 and 1-v-1. A drawing of the 45 ft. masts is awaiting the first application. Thank you, Heathfield.

We also thank the HODDESDON Society for similar information, but regret that much as we should like to we cannot find room for the details of their masts. As reported last month, the Society carried out their 160-metre field day with good results, using a PM22A CO (batteries), driving a suppressor-modulated RK25 powered by a rotary

converter and car battery, the modulator being a Class-B battery unit with moving-coil microphone. The aerial was a 132 ft. Marconi with twin counterpoise. A similar day is anticipated this month and co-operation is desired. G5HO and 2FUU experimented with kite aerials while in the Isle of Wight.

There has been much activity in direction finding by ROMFORD. The first joint field day, organised by Southend, resulted in the following placing: Southend, Ilford, Brentwood. The second event, planned this time by Romford, was started from Shenfield with 39 entrants, of whom only 2CWF (Romford) discovered the transmitter, hidden at Aveley. The Society now has the call G4KF. G2HK of the Peto-Scott Co. has demonstrated a Trophy.

Although able to report only a fair number of QSOs the SURREY Radio Contact Club's 1.7 Mc "do" provided much fun. All went well with erection of tents and gear on the first day and as the hour for sleep arrived the first disturbance came in the form of a photographer using a flashlight. Contacts were made during the night and tea (made with paraffin!) was offered at 3 a.m. More photographs were taken at six and tea was again forthcoming, but this time made with water. The second day was less fruitful in the matter of QSOs, as conditions fell off. Nevertheless all agreed the week-end was worth while.

Several members of the WEST HERTS Society went native last month for a week-end while operating on 7 Mc near Berkhamsted. The photograph on page 31 shows G3MI, G3NR, G4GG (now QRA's at Hampstead) and G3PV.

Attendance figures for the WOLVERHAMPTON SW Radio Society's past four lectures have not been up to expectation; perhaps the result of their 5-metre field day in May will help to arouse more enthusiasm. First impressions were that the gear would have to be transported miles before land was sighted; however, the floods were safely negotiated and from a high spot near Bridgnorth four 20-mile QSOs were made, followed by 35- and 50-mile



Brentwood, Ilford, Romford and Southend combine for DF Contest. The winner, 2CWF, is on the extreme left.

SWL reports. There is to be a similar event on July 16, when co-operation from four local 5-metre stations should enable us to record even better distances.

### ● New Headquarters

The move to Baidon by the BRADFORD Short-Wave Club has proved well worth while in many respects; best of all, the receiving section is working in almost ideal circumstances. The transmitter is also in operation and though the second aerial had to be corked to warn pigeons, the

task was undertaken cheerfully in the knowledge that the birds were part of the Militia.

The BRIGHTON Branch of the World Friendship Society of Radio Amateurs now hold their meetings at 35 Brading Road, where it is hoped that better conditions will aid testing. Morse is a regular feature.

Temporary headquarters at the Slake Terrace Inn, provided by a member, has overcome one of COXHOE's difficulties, though absence of Mr. Ayton has meant that Morse instruction is slowed down. Mr. Bates is proceeding with the construction of a mains receiver for members' use, using two pentodes as det/LF. Meetings are held fortnightly on alternate Mondays and Tuesdays.

**● Generalities**

BRENTWOOD's G8VH has been consistently active on 160, 40 and 20 metres, mostly in connection with aerial tests. Credit is due to 2CIH and 2DWQ for upholding the Society's prestige in DF events, they having attended every local joint effort. Rothermels have provided a lecture, which was followed with much interest. We have had an opportunity of reading the "HV Bulletin," which is up to a good club magazine standard.

G2PA recently gave a lecture to the EAST-BOURNE Radio Society on "Television Transmission and Reception," dealing in turn with the discovery of selenium, scanning systems, the cathode-ray tube, cameras, receivers, film transmissions, aerial systems, and finishing off the extensive survey with some time-base circuits.

All members of the Aether Patrol Club (EAST GRINSTEAD) have put their shoulders to the

wheel with good effect. They are disappointed at the response received from an offer to report any 1.7 or 3.5 Mc signals, and now extend this invitation to cover 7 and 14 Mc transmissions. Arrangements can be made for listening at any hour of the day and comprehensive reports are promised. Some useful lists of QSLs received and Calls Heard have been passed to the "DX Scribe."

Two holders of full licences and several AAs are among the members of the SALE and District Radio Society, which holds meetings every Thursday evening at St. Mary's Schools, Barker Lane. An interesting programme of lectures and discussions on problems connected with amateur transmission has been arranged to cover the next few weeks, with Morse tuition at each meeting. Some Local Authorities having enlisted the aid of Amateur Radio for A.R.P. communications the Society offered the services of members to the Borough Council for any local activity in which the use of radio for civil defence could be authorised. Meetings commence at 7.30 p.m. and new members will be welcomed.

As the recent THORNTON HEATH 56 Mc field day was a success it has been decided to hold a similar event on July 9. An interesting visit was paid to the studios at Broadcasting House last month. Any reader will receive a cordial welcome at the weekly meetings at St. Paul's Hall, Norfolk Road on Tuesday evenings at 8.15 p.m.

The TONYREFAIL and District Radio Society has now entered an era of settled prosperity, for which it is felt the basic work of GW3GO and

*(Continued on next page.)*

**Spot Signals Scientifically !**

with the NEW

**HOWARD 460**  
COMMUNICATION RECEIVER

*with built-in*  
FREQUENCY MONITOR AND  
NOISE LIMITER

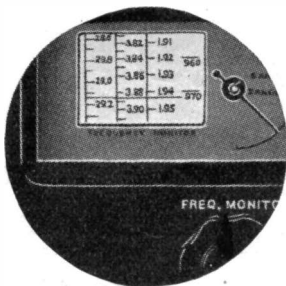

The NEW  
BUILT-IN MONITOR

*Here's what it means to you!*

- A self-contained frequency meter is built into this receiver which allows the exact frequency measurement of your own transmitter.
- It allows checking of the exact frequency of an incoming signal.
- It makes possible the location of the amateur bands with absolute accuracy.
- It makes it possible to re-set the dial to an exact pre-determined frequency so that you may be positive to return to any station which you have already worked.
- Allows you to set the dial on the exact frequency of a station which you wish to work.
- Accuracy is controlled by beating against an expensive broadcast station frequency equipment.

Other features—: Ten tubes, noise limiter, moving coil "R" meter, 340 degrees of electrical band-spread, ceramic coil forms on high frequency bands, high frequency insulation on both tuning condensers, pre-selection on all bands from 43 mc to 540 k/c, iron-cored I.F.'s, crystal filter, with iron-cored coupling transformer.

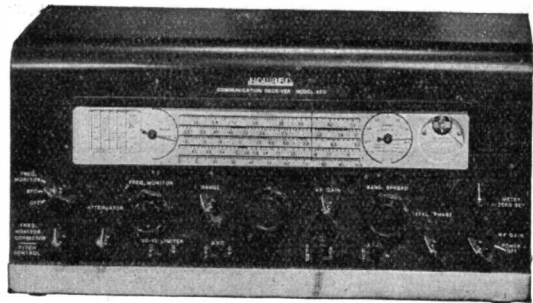

- MODEL 460, with Frequency Monitor and 8-inch Dynamic Speaker in cabinet to match receiver ... .. £23 - 10 - 0
- MODEL 460, with Frequency Monitor, but with Crystal Filter and 8" Dynamic Speaker in cabinet to match Receiver £25 - 10 - 0

Model available has universal transformer.

Send for details of other Howard Models from 9½ gns.

**RADIOMART**  
G 5 N I (9HAM) LTD.

SHORT  
WAVE  
SPECIALISTS

Directors: W. H. D. Nightingale, L. Nightingale

**44, HOLLOWAY HEAD, BIRMINGHAM, 1.**

MIDLAND 3245

GW3QB has laid a sure foundation. Presentations were made to these two members at the A.G.M., when a successful year was reviewed, confirmed by re-election of officers. On the 23rd of this month members' 40-metre preparations for the field day will have to stand trial; as a start was made early last month everything should go with a swing.

Further information regarding any of these societies may be had from the officials concerned, whose addresses appear below.

- ALDESHOT—Miss G. Bird, Dormans Cottage, Mavins Road, Farnham, Surrey (temporary).  
 BRADFORD—G. Walker, 2AWK, 33 Napier Road, Thornbury, Bradford.  
 BRENTWOOD—J. R. Deane Sainsbury, 2CYW, "Brunook," Crossways, Shenfield, Essex.  
 BRIGHTON—F. R. Jupp, 2FAD, 35 Brading Road, Brighton, Sussex.  
 BRISTOL—D. James, 40, Robertson Road, Bristol, 5.  
 BROMLEY—H. N. Holbrook, 191, High Street, Bromley, Kent.  
 COXHOE—D. F. Chatt, 23, North View, Sherburn Hill; or R. Bowes, 2DTA, 10, Blackgate, Coxhoe.  
 DEPTFORD—G. Edwards, G2UX, 14a, Louisville Road, Upper Tooting, S.W.17.  
 DOLLIS HILL—E. Eldridge, 79 Oxgate Gardens, N.W.2. Phone: Gladstone 2315.  
 EASTBOURNE—T. G. R. Dowsett, 48 Grove Road, Eastbourne, Sussex.  
 EAST GRINSTEAD—E. G. Cooper, "The Alders," Hackendon, East Grinstead, Sussex.  
 EDGWARE—F. Bell, G4JU, 118, Colin Crescent, Edgware, Middlesex.  
 GRAVESEND—R. S. Martin, G2IZ, 41 Mayfield Road, Gravesend.  
 HEATHFIELD—R. J. Lee, 9, Theobalds Green, Heathfield, Sussex.  
 HODDESDON—T. Knight, Junr., 2FUU, Caxton House, High Street, Hoddesdon.  
 LIVERPOOL—L. Frank, 2F10, 4, West Albert Park, Liverpool.  
 PECKHAM—L. J. Orange, 11 Grenards Road, Peckham, S.E.15.  
 ROMFORD—R. Beardow, G3FT, 3, Geneva Gardens, Chadwell Heath. Phone Seven Kings 5393.  
 SALE—S. C. O. Allen, 2FCQ, 31, Ennerdale Drive, Sale.  
 SHEFFIELD—D. H. Tomlin, 32 Moorsyde Avenue, Walkley, Sheffield, 10.  
 SLOUGH—K. A. Sly, 16, Buckland Avenue, Slough.  
 SOUTHPORT—R. W. Rogers, G6YR, 21, Chester Avenue, Southport.  
 SURREY—S. A. Morley, 22, Old Farleigh Road, Selsdon, Surrey.  
 THORNTON HEATH—R. E. Dabbs, G2RD, 4, Nutfield Road, Thornton Heath.  
 TONYREFAIL—E. Powell, GW3QB, 44, Pritchard Street, Tonyrefail, Glam.  
 WEST HERTS—A. W. Birt, G3NR, 6, Hempstead Road, Kings Langley, Herts.  
 WILLESDEN—G. H. Talbot, 2FTD, 46, Snaresbrook Drive, Stanmore, Edgware 3746.  
 WOLVERHAMPTON—W. H. Hill, G8PB, Newin House, Uplands Avenue, Wolverhampton.  
 WOODFORD—R. A. I. edgerton, 2ABC, 64, High Road, Woodford Bridge, Essex.

**Send for New 1939 List of SWR Specialities. Just issued.**

EVERYTHING FOR THE TRANSMITTER  
 ALL EDDYSTONE COMPONENTS IN STOCK

Authorised Stockists of: All Hallicrafter Sets.  
**Sky Champion 15 gns. New Skyrider 23 £33 10.**  
 Howard Models in Stock: Model 430, 9½ gns.;  
 Model 438, £15 10; Model 450A, 30 gns.  
 complete with Xtal and Speaker.

Hire Purchase Terms Available

**SHORT WAVE RADIO LTD.,**  
 97, PARK LANE, LEEDS, 1. Tel. 24689

**CANDLER CAN HELP YOU!**

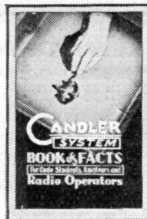

All desiring to become proficient in Code work should fill in the Coupon below.

**CANDLER CODE COURSES** have helped thousands to pass their full tests for securing licences, and have also helped numerous operators to greatly increase the w.p.m. speeds.

**Three Famous Courses**

**Junior Scientific Code Course** for beginners. Teaches all the necessary code fundamentals scientifically.

**Advanced High Speed Telegraphing** for operators who want to increase their w.p.m. speed and improve their technique.

**Telegraph Touch-type Writing** for those who want to become expert in the use of the typewriter.

Terms: Cash or monthly payments

Fill in Coupon for Free Copy of the "BOOK OF FACTS"

**COUPON**

NAME .....

ADDRESS .....

Post coupon in ¼d. unsealed envelope to London Manager  
 (Room 55C) 121, KINGSWAY, LONDON, W.C.1  
**CANDLER SYSTEM CO.**  
 Candler System Co., Ashville, North Carolina, U.S.A.



**HURRY!**

In addition to our range of new Communication Receivers we have a very fine selection of shop-soiled and second-hand receivers and transmitters. We fully guarantee every item and we make a point of checking carefully the alignment, sensitivity and controls of every piece of apparatus before sale. We list below a small selection of receivers and transmitters but suggest that you send for our free catalogue giving technical data on the entire range.

- National NC-44, 10-550 m., complete with speaker, perfect **£14 0 0**
- Sargeant Streamliner 39, 10-550 metres, built-in speaker **£8 0 0**
- Hallicrafters Super Skyrider, SX-16, 5-550 m., crystal **£24 0 0**
- RME-69, standard model, 10-550 metres, crystal, perfect **£25 0 0**
- National NC-100, 10-550 metres, complete with speaker **£25 0 0**
- Harvey UHX-10 Transmitter, 5-160 metres, 3 crystals, AC pack ... **£19 10 0**
- Scott Fifteen, 15 tubes, 13-600 metres, 20 watts output ... **£15 10 0**
- Hammarlund Super-Pro, SP-120-X, 7½-240m., 12" speaker **£55 0 0**
- American Presto Recording Outfit, in carrying case with special motor, cutting and play-back heads, amplifier, speaker and crystal microphone on floor stand ... **£40 0 0**
- Temco 100 Transmitter, for 10, 20, 40 and 80 metres, complete with all coils, tubes and antenna matching network, 125 watts phone and 175 watts CW. A really super outfit ... **£75 0 0**

ALL EDDYSTONE AND HAMRAD COMPONENTS, BROWN'S HEADPHONES, HYTRON TUBES, ETC.

Send for free list to:

**A.C.S. RADIO** TECHNICAL MANAGER **G2NK**  
 16 GRAYS INN ROAD, LONDON, W.C.1  
 Telephone: HOLBORN 9894-5

# CLASSIFIED ADVERTISEMENTS

## RECEIVERS, TRANSMITTERS AND COMPONENTS

PAREX CHASSIS, PANELS, RACKS as supplied to Government Departments. Moderate Terms—Let us quote you.—E. PAROUSSI, 10, Featherstone Buildings, W.C.1.

SHORT WAVE VARIABLE DIRECTIONAL AERIALS. 500° rotating beam system for transmission and reception. 1½d. stamp for details.—A. W. MANN, 62, Costa Street, Middlesbrough.

HALLICRAFTER "New Skyrider 23" with Speaker in original packing. Cost £37 10 0—what offer?—E. MARCHAL, 143, Whitfield Street, London, W.1.

NEW ROTARY CONVERTER 220v DC to 230v AC, output 200 watts, with filter and sound-proof cabinet. Cost £21 0 0—what offer?—E. MARCHAL, 143, Whitfield St., London, W.1.

THE BEST IS CHEAPEST Write for Component Catalogue to—2ATV, 86, Dibdin House, Maida Vale, W.9.

## BOOKS, CATALOGUES, ETC.

ALL WIRELESS AND RADIO ENGINEERING books available on new terms as low as 2/6 monthly. Write a card for details from PHOENIX, Chandos Place, W.C.2.

SPECIAL IMPORTED AMERICAN BOOKS, MAGAZINES Radio, Short Wave, everything. Samples and Catalogues 2/6. A. V. FINAL, 15, Nashleigh Hill, Chesham.

2d. per word, minimum 3s. All advertisements must be prepaid. Cheques and postal orders to be made payable to "The Short-Wave Magazine, Ltd."

## QSL CARDS, PRINT, ETC.

QSL's FROM 4s. 6d. 250. Samples Free. Satisfaction guaranteed.—ATKINSON BROS., Printers, ELLAND.

## MISCELLANEOUS

HOLIDAYS.—Mrs. G8JC has rooms vacant during next two months. Vy FB part of Severn Valley. Stamp to 1, School Road, Coalbrookdale, Shrops.

NOW! JOIN AN AMERICAN Radio Club. 4s. year, including monthly bulletin, full of DX tips, etc.—Write INTERNATIONAL LISTENERS' ASSOCIATION, Box 808, Dryden, Washington, U.S.A.

**FOYLES FOR RADIO BOOKS**  
and books on every other subject, new or secondhand.  
Catalogues free.  
JOIN THE SCIENTIFIC BOOK CLUB  
**FOYLES**  
113-125, CHARING CROSS ROAD, LONDON, W.C.2  
Telephone: Gerrard 5660 (16 lines)

*When writing the Trade, identify yourself with this Magazine*

## TECHNICAL BOOKS

English and Foreign Scientific and Technical Books supplied from stock or obtained promptly to order.

Catalogue of books on Radio and Electrical Engineering post free on application.

### LENDING LIBRARY

Annual Subscription from One Guinea Detailed prospectus free on request

**H. K. LEWIS & CO. LTD.**  
136 Gower St., London, W.C.1

Telephone: EUston 4282 (5 lines)

## Surplus Stock to Clear, everything First Grade and worth more than double.

Five-Range Test Meters AC/DC, 0-30 and 30 0 mA. 0-8, 16 and 240 volts. Guaranteed accurate—8" complete. Microphone Insets, latest P.O. type—2/-, genuine P.O. mikes with transformer—3/6, larger model, spring mounted—5/6. Transverse current mikes—3/6. 350-0-350 volt mains transformers, 4 volt filaments—7/6. Racheon type 53 tubes—2/6, Europa and Yale type 80 and 81—2/6, Hi-test type 10—3/-, Hi-test 6L6<sub>J</sub>—4/-, Morse Keys—3/0 and 8/6. Headphones 1/11 pr. Celestion/Moving Coil speakers 6/11.

Money back guarantee, prompt personal attention.

COMPLETE CATALOGUE SENT ON REQUEST.

**GW8WU, Wholesale Radio Supplies**  
32, CITY ROAD, CARDIFF.

EDDYSTONE, HYTRON AND HAMRAD AGENT



## Make certain that your QSL and SWL Cards are correctly mailed.

The RADIO AMATEUR CALL BOOK is essential to "hams" and to owners of all-wave sets. It is the only radio callbook published that lists all radio amateur stations throughout the entire world. Also contains a World map showing International radio prefixes, High frequency press, time and weather schedules, etc., the "Q" and "RST" codes.

**JUNE ISSUE NOW ON SALE**  
Price 6/- per copy post free. List of other books on "ham" radio free on request.

GSKA (Dept. SM.6.) 41 Kinfauns Road, Goodmayes, Ilford, Essex.

H  
•  
A  
•  
G

The "H.A.C." one-valve Short-Wave receiver, famous for over 5 years and used by many ham transmitters for their sole receiver, — has now been brought completely up-to-date and can be purchased in kit form. No soldering or other experience is necessary, and the completed receiver provides powerful world-wide reception with a really silent background. The complete kit of quality precision S.W. components, accessories, and full instructions  
★ COSTS ONLY 12/6. (post 6d.) ★  
Descriptive folder giving full information, logs, testimonials, etc., gladly SENT FREE ON REQUEST. Sole distributors:—F. L. Bacchus, 109, Hartington Rd., London, S.W.8.

H  
•  
A  
•  
G

# READERS' SMALL ADVERTISEMENTS

FOR SALE.—Q C.C. Power-type crystal (1768kc) in type UB holder, with calibration certificate, as new, 15s.—G3JS, 10, Holly Road, Handsworth, Bir'm, 20.

WANTED.—TX, 10-15 watts, 7 and 14 Mc, CC, CW and 'phone or CW, AC.—Knight, 13, Malwood Road, Balham, S.W.12.

FEW SW component bargains still left. Specified ST800, Stentorian Spkr, coils, Call Book, etc. Stamp for list —2DZZ, Fivehead, Taunton.

SALE.—Eddystone "All World Two," complete, cabinet, valves, coils, £2.—Hamp, 83b, High Road, London, S.W.16.

REMAINS of AA's station for sale.—1 Webb's mains transf., 400-0-100, 150 mA, two 6.3 2a, 210, 230, 250 input, 15s.—See below.

EDDYSTONE components.—1 B'spread tuning unit comp, 6s.; reac. cond. 3s.; two No. 1027 dials, 9d. ea; 25mMF vari-cond., 2s.—See below.

4 5-pin Eddystone ceramic v. holders. 9d. ea; T.C.C. 8 mF 550v, surge-proof cond. 2s. 6d.; Hunts 450v. 8 mF ditto, 2s.; Hunt's 8 mF 500v, 2s.—See below.

HUNT'S 8x8 mF 450v surge-proof cond. in cardboard case, 2s.; 3 Igranite jack sockets, 3d. ea; 4 Q.C.C. beehives, 6d. ea; Indigraph dial, 2s.—See below.

COMPLETE power supply, 250v 90mA, with extra 4v 4a LT supply, rect., 10s.; Ferranti AF10 transf., 2s. 6d.; Ferranti AF3 transf., 2s.—See below.

60mA, 30hy choke, 2s.; 2 ceramic octal v. holders, 9d. each; 2 compo octal VHS 6d. ea; Hammarlund 6-pin ceramic VH, 9d.; 6 WB VHS, 2d. ea.—See below.

RAYTHEON 83, 1s. 6d.; 2 Raytheon 6L6, 2s. ea.—All in good condition. Best offer taken.—G6CU, 5, St. Luke's Road, Maidenhead.

WHAT offers? "All World Two," good cond., metal case; also Eddystone Battery SH5, home constructed, good cond.—2CUB, Ridgewell, Halstead, Essex.

WANTED, commercial TX, 'phone/CW 10-15 watt; also S meter for Sky Champion; and aerial meter.—Hill, Robin Hood, Catsfield, Battle, Sussex.

EXCHANGE 150v. 25mA Eliminator with trickle charger, almost new, cost £3, for Preselector.—Sutton, 32, Windsor Street, Glasgow.

- 1 Advertisements must be accompanied by 6d. in stamps or P.O. made payable to "The Short-Wave Magazine, Ltd." and crossed.
- 2 A maximum of four lines only will be allowed, including name and address.
- 3 Trade and Box Number advertisements cannot be accepted.
- 4 We reserve the right to refuse any advertisement.
- 5 We cannot act as an intermediary for an advertiser in this section.
- 6 Advertisements must reach this office not later than the 15th of the month preceding the month of issue.

RACK, standard, steel, 31½ in. high, 15s.; panels 10½ in 3s., 3¼ in. 1s. 3d.; chassis 3s. 6d. Gift.—G4HH, 22, Darbshire Road, Fleetwood.

1939 all-wave 9v Crossley, 190-225v AC, cost £17, as new, £8 10s., or exch. for comm. RX.—71, Sudbourne Road, Brixton, S.W.2.

80-metre Crystal Osc. complete with crystal and 6L6, 10-15w input. Offers? S. H. Watts, 73, Leckhampton Road, Cheltenham.

WANTED.—Belling & Lee "Sky-Rod" aerial, also mains filter.—42, Woodland Road, Heywood, Manchester.

300v Power Pack, 12s. 6d.; Atlas Elim, 7s. 6d.; Ferranti AF5, 5s. 6d.; 0-15/400, 354V, PX4, lot 7s.—G5UJ, 80, E. Bawtry Road, Rotherham.

LATEST Hallicrafter S21 5-10m receiver, 230v, as new, £15, cost £20.—Lownds, The Cottage, Old Lenton, Nottingham.

FOR sale.—Rotary Converter, 21v DC to 230v AC, 80w, first-class cond., £3.—Hill, Robin Hood, Catsfield, Battle, Sussex.

LISSEN Bandsread 3, 12s. 6d.; mains eliminator, 7s. AF4, 2s. 6d.—Stocks, 10, Bywater Street, Leeds, 11.

3 BARGAINS! Hi-Q Superhet, 5-175m, £5. Lissen 3v I&M wave, £2; SW adaptor, £1, or offers. All perf.—Hawkins, Farm Lodge, Edenbridge, Kent.

SALE.—Pye 5v battery super, 50s.; Ekeo chassis and cabinet, 17s. 6d. Other bargains, send for lists.—Barnett, 2, Church Street, Evesham.

SALE.—3 TXs, 2 modulators, 2 transv. mikes, several MC meters. Call or write, 2DQZ, 11, Hill Crescent, Bexley, Kent.

WESTON Analyzer E665, Raycraft cell and relay, eng. MC and WB duplex, other gear. Offers cash or exch. comm RX.—Hurren, 46, Saltoun Road, S.W.2.

SALE.—£1, Fkco eliminator with 2, 4, 6v trickle charger.—D. Shagsby, 46, Bath Road, Southport.

FERRANTI AF4 Exch. for meter or SW 4-pin coils.—Hodkinson, 17, Coronation Street, Barnoldswick, Lancs.

EDDYSTONE "Ham Bands Two" (lab. built), with coils and new valves, 35s.—GM3IW, 86, Woodlands Terrace, Dundee.

TRIODE hexode TX4, used 1 hour, cost 15s. 6d. Exch. for 20m Xtal or large 4v triode.—F. Smith, 60, Northbrook Road, Watford.

SHORT-wave AC receiver wanted really cheap, must reach out, preferably down to 7 metres.—44, Parkgate Road, Watford.

WANTED for cash, DC Avominor or similar, must be good condition. Particulars to GRPH, 33, St. Lukes Road, Totterdown, Bristol, 3.

SELL, B'spread 0-v-PEN, coils 9-94m; 35s.; 2 'phones (2000 ea. piece), 6s.; 1/2 prints, 7s. 6d.; or lot 44s. 6d.—T. D., 65, Gaer Park Avenue, Newport, Mon.

SALE.—G.E.C. Home Broadcaster, 7s. 6d. Call Book wanted, price to Brown, 1, Church Road, Penmaenmawr, N. Wales.

SALE or exch. "W.W." 1935-8, Eddy-stone 6G. Wanted, 6W and 6-pin base, SM reac, chassis, panel.—Whitman, 2, Lynwood Road, Manchester, 19.

SALE.—Components including Xtals, transf, cond, resistors, coils, etc., main-valves. Call or write—2DQZ, 11, Hill Crescent, Bexley, Kent.

SWL going QRT, must clear 4RXs for cash. Stamp to BSWL1016, 70, Scotch Street, Armagh, N. Ireland.

WANTED.—Eddystone batt. SH, 13-90m coils, less valves, cabinet opt. For cash. J. Ellard, 4, Bowes Well Road, Ilkeston, Derbyshire.

PREMIER 1939 5-v-5 Comm. receiver, 3 Morse records, Lissen B'spl 3. Sell or exch.—J. Harper, 78, Grove Road, Finchley, N.12

WANTED.—Comm RX, 10-550m, 6 valves or upwards, battery or AC. Exchange, or? Approval desired.—Barnett, 2, Church Street, Evesham.

SELL 3-stage TX in perf. order: 6L6, 6L6, T40, first grade components, 6 gns. or near.—Details: Brierley, Deganwy, N. Wales.

MAGAZINES.—18 "Radio News," 1937-39, 3s. 9d.; 14 "A.W. Radio," 1937-8, 3s. 9d.—M. K., 112, Deacon Road, Kingston, Surrey.

WANTED.—6.3 LT transf. with other winding if poss, 230 inrut. cheap for cash or?—G8JC, 1, School Road, Coalbrookdale, Shrops.

E.D.C. car-radio type rotary conv., 12 v inp, 200v 40mA out, complete smoothing, case, 45s. or ex. compts.—G6LH, Eastville Vicarage, Boston.

HMV all-wave serial type 73, 5-2000m, 36ft. screened lead. One week's use only, 21s.—2FUV, 82, Mill Lane, Hampstead, London, N.W.6.

EXCHANGE 7 Mc Xtal (unmounted) for Hi-Q rotary coil unit.—Burgess, 119, Mudford Road, Yeovil, Som.

EDDYSTONE 6-pin coils, 9-14m, 26"-510m, 1000-2000m, 2s. ea; Weston 0-300 mA, 14s.—S. Long, 19, Hyde Road, Kenilworth, Warwicks.

NEW Valves, components kit sets for sale; Varley coils, IFs; Polar dials. Appro. against cash.—Barnett, 2, Church Street, Evesham.



### QUERY COUPON

S:—W.M. 7/39

# SHORT-WAVE BROADCASTING STATIONS

Abbreviations: S—Sunday; M—Monday; T—Tuesday; W—Wednesday; Th—Thursday; F—Friday; Sa—Saturday.

M.	KC.	Call-Sign, Location, Schedule.	M.	KC.	Call-Sign, Location, Schedule.	M.	KC.	Call-Sign, Location, Schedule.
5.00	59980	56 Mc AMATEUR BAND, with new licenses granted 58.5-59.98 Mc only	19.74	15200	DAJ, Zeezen, 0605-1700, 2250-0450	25.47	11780	HP5C, Panama City, 1800-1900, 0600-0400, S 1300-1400
5.36	56920	Mc only	19.75	15190	OAL, Aankara, 1130-1300	25.47	11780	0133, Lahti, 0705-1805
10.00	29990	28 Mc AMATEUR BAND, with American amateur 'phone sub-band 28500-30000 kc	19.76	15180	GLO, Daventry, 0020-0230, 2200-0000	25.49	11770	DJL, Zeezen, 0605-0830, 1530-1700, 2250-0450
13.87	21630	W3XAI, Roundbrook, 1400-2400	19.76	15180	KV96, Moscow	25.53	11750	GSD, Daventry, 0020-0230, 0320-0630, 0600-0830, 1820-2400
13.93	21510	W8NK, Pittsburgh, 1200-1400	19.78	15170	TCVWA, Guatemala, 1845-1945, occasionally after	25.55	11740	COCX, Havana, 1300-0500
13.95	21500	G5J, Daventry, 1145-1300	19.78	15170	LNV, Oslo, 1240-1600	25.55	11740	CRKC, Loandri, T between 2045 and 2130
13.95	21500	W2XAD, Schenectady, 1200-1500	19.79	15170	S 1555-2300	25.55	11740	SP25, Warsaw, 0000-0300
13.97	21470	G8H, Daventry, 1145-1300	19.79	15170	JZK, Tokyo, 2030-2200	25.55	11740	HVJ, Vatican, T at 1430
13.99	21450	G5I, Zeezen, 0605-1350	19.80	15150	W2XAD, Schenectady, 1200-1500	25.56	11730	LKQ, Oslo, 0600-1240, 1600-2100
13.99	21460	W1XAL, Boston, S, T, Th, 1500-1600, or later	19.80	15150	VCTD3, Delhi, 0300-0400, 0900-1000	25.58	11730	W1XAK, Boston, S 2100-2400, T, Th, Sa 0630-0940 (occasionally on this schedule in place of W1XAL, 49.6 m)
14.23	21080	P5A, Rio de Janeiro, F 1850-2000, 1st Th of month, 1715-1800	19.81	15130	W1XAL, Paris-Mondial, 1700-2300, S 1555-2300	25.59	11720	ZPH, Villa Rica, 2330-0155
15.77	19023	H8GJF, Bangkok, M 1400-1600	19.82	15110	0000	25.63	11700	CRKH, Wunipeg, 2300-0900
16.81	17845	D1H, Zeezen, 0605-1350, 1400-1500	19.84	15120	SP19, Warsaw, 0000-0300	25.69	11720	CR7BH, Lourenco Marques, between 1800 and 2500
16.82	17840	Athlone, Eire, 1430-1600, 1830-2230	19.84	15120	HVJ, Vatican City, S 1800, w days 1630-1645	25.69	11720	TPA4, Paris-Mondial, 0000-0115, 0230-0500
16.83	17830	W2XF, New York, Sa, S 1900-2300, other days 1230-2300	19.85	15110	DJL, Zeezen, 0605-0800, 1400-1500, 1630-2255	25.69	11720	SPB, Motala, 0720-0800 1700-2215
16.83	17820	12K48, Rome, 1100-1325, 1330-1445, 0000-0125	19.85	15110	CSVA4, Moscow, afternoons 1500, 1630-2255	25.63	11700	JLC3, Tokyo, 2030-2200, 2230-2330
16.84	17810	TPB3, Paris-Mondial, 1430-1600	19.87	15100	RKJ, Moscow, unknowns	25.64	11700	HP5A, Panama City, 1300-1430, 1600-1900, 2300-0400
16.84	17810	G5V, Daventry, 1145-1300	19.87	15100	CSVA4, Moscow, unknowns	25.64	11700	CB10, Santiago, Chile, 1600-1900, 2300-0400
16.85	17800	XGAV, Chungking, 0600-0400	19.88	15080	PSE, Rio de Janeiro, W 2300-2510, Th (ex. 1st of month)	25.70	11673	IOY, Rome, 1120-1140 ex. S, 2100-2130, Sa 2100-2130, 23rd of month 2500-2230
16.85	17800	O1H, Chungking, 1000-1500	20.08	14935	210, Th (ex. 1st of month)	26.01	11530	SPD, Warsaw, 0000-0300
16.87	17790	G5S, Daventry, 1145-1300, 1820-2200	20.83	14935	14 Mc AMATEUR BAND, with American amateur 'phone sub-band 14150-14250 kc.	26.31	11400	HBC, Radio Nations, Switzerland, S 1345-1430, M 0830-0945
16.87	17780	JZJ, Tokyo, 2230-2330, 0240-0230	21.43	14005	14 Mc AMATEUR BAND, with American amateur 'phone sub-band 14150-14250 kc.	27.17	11040	CSW6, Lisbon, 1700-2230, S 1600-2230
16.87	17780	W3XU, Roundbrook, 1400-2200	22.00	13635	SPW, Warsaw, 0000-0300	27.27	11000	PIJ, Bandoeng, see YDC, 19.8 m.
16.88	17770	PHI, Hinzten, S 1210-1535, Th 1510-1630, other days 1310-1415	24.08	12460	HCJB, Quito, ex. M 1800-1400, 0100-0430	28.30	10600	ZIK2, Belize, Br. Honduras, S, W, F 0245-0300
16.89	17760	DJ15, Zeezen, 0605-1150, 1400-1700	24.52	12230	TFJ, Kykjavik, S 1940-2030	28.48	10535	JIB, Taihoku, Formosa, 1500-1600
16.90	17755	LKW, Oslo, unknown	25.00	12000	RNE, Moscow	28.55	10400	YSP, San Salvador, occasionally
16.92	17580	ZEB3, Dribouti, 1400-1430	25.08	11962	CB150, Santiago, 0000-0400	28.93	10370	EJ4J, Tencriffe, between 2035 and 0200
16.92	17570	HAS3, Budapest, S 1500-1600	25.08	11962	HTX2, Trujillo, W, Sa 0110-0510, S 1240-1440	29.04	10360	ORK, Ruysselede, 1530-2000
16.94	17530	DJK, Zeezen, 2250-0450	25.08	11962	HTX2, Trujillo, W, Sa 0110-0510, S 1240-1440	29.24	10350	PAN, Bandoeng, as YDC 19.8 m.
16.94	17530	W2XAD, Schenectady, 1515-2200	25.21	11920	T5XND, San Jose, 1300-1800, 2300-0400	29.35	10220	PSH, Rio de Janeiro, 0000-0100, T 0200-0230
16.94	17530	W2XBE, Treasure Island, 2330-0300	25.21	11900	CD1190, Valdivia, 1600-1900, 2100-0600, 0100-0400	29.85	10050	TIEM, San Jose, 2230-0200
16.95	17520	GZHZ, Skamlebaek, S 1400-1930	25.21	11900	NGOY, Chungking, 1130-1730, 2230-0030	29.85	10050	COBC, Havana, 1255-0615
16.95	17510	YDB, Sourabaya, 0130-0800	25.21	11900	PR013, Rome, testing (0230-0500)	30.12	9980	JDV, Deuren, 1300-1400
16.96	15310	G5T, Daventry, 1915-2200, 2200-0000	25.21	11885	TPB1, Paris-Mondial, 0000-0215	30.22	9925	FAO, Madrid, 2200-2400 (or later)
16.96	15310	G5T, Daventry, 1915-2200, 2200-0000	25.21	11885	TPB2, Paris-Mondial, 0000-0215	30.43	9840	COCLM, Havana, S 1400-0300 (M), w days 1400-0300
16.96	15310	G5T, Daventry, 1915-2200, 2200-0000	25.21	11880	TPB3, Paris-Mondial, 0000-0215	30.52	9833	COCLM, Havana, S 1400-0300 (M), w days 1400-0300
16.96	15310	G5T, Daventry, 1915-2200, 2200-0000	25.21	11880	TPB4, Paris-Mondial, 0000-0215	30.52	9833	COCLM, Havana, S 1400-0300 (M), w days 1400-0300
16.96	15310	G5T, Daventry, 1915-2200, 2200-0000	25.21	11880	TPB5, Paris-Mondial, 0000-0215	30.52	9833	COCLM, Havana, S 1400-0300 (M), w days 1400-0300
16.96	15310	G5T, Daventry, 1915-2200, 2200-0000	25.21	11880	TPB6, Paris-Mondial, 0000-0215	30.52	9833	COCLM, Havana, S 1400-0300 (M), w days 1400-0300
16.96	15310	G5T, Daventry, 1915-2200, 2200-0000	25.21	11880	TPB7, Paris-Mondial, 0000-0215	30.52	9833	COCLM, Havana, S 1400-0300 (M), w days 1400-0300
16.96	15310	G5T, Daventry, 1915-2200, 2200-0000	25.21	11880	TPB8, Paris-Mondial, 0000-0215	30.52	9833	COCLM, Havana, S 1400-0300 (M), w days 1400-0300
16.96	15310	G5T, Daventry, 1915-2200, 2200-0000	25.21	11880	TPB9, Paris-Mondial, 0000-0215	30.52	9833	COCLM, Havana, S 1400-0300 (M), w days 1400-0300
16.96	15310	G5T, Daventry, 1915-2200, 2200-0000	25.21	11880	TPB10, Paris-Mondial, 0000-0215	30.52	9833	COCLM, Havana, S 1400-0300 (M), w days 1400-0300
16.96	15310	G5T, Daventry, 1915-2200, 2200-0000	25.21	11880	TPB11, Paris-Mondial, 0000-0215	30.52	9833	COCLM, Havana, S 1400-0300 (M), w days 1400-0300
16.96	15310	G5T, Daventry, 1915-2200, 2200-0000	25.21	11880	TPB12, Paris-Mondial, 0000-0215	30.52	9833	COCLM, Havana, S 1400-0300 (M), w days 1400-0300
16.96	15310	G5T, Daventry, 1915-2200, 2200-0000	25.21	11880	TPB13, Paris-Mondial, 0000-0215	30.52	9833	COCLM, Havana, S 1400-0300 (M), w days 1400-0300
16.96	15310	G5T, Daventry, 1915-2200, 2200-0000	25.21	11880	TPB14, Paris-Mondial, 0000-0215	30.52	9833	COCLM, Havana, S 1400-0300 (M), w days 1400-0300
16.96	15310	G5T, Daventry, 1915-2200, 2200-0000	25.21	11880	TPB15, Paris-Mondial, 0000-0215	30.52	9833	COCLM, Havana, S 1400-0300 (M), w days 1400-0300
16.96	15310	G5T, Daventry, 1915-2200, 2200-0000	25.21	11880	TPB16, Paris-Mondial, 0000-0215	30.52	9833	COCLM, Havana, S 1400-0300 (M), w days 1400-0300
16.96	15310	G5T, Daventry, 1915-2200, 2200-0000	25.21	11880	TPB17, Paris-Mondial, 0000-0215	30.52	9833	COCLM, Havana, S 1400-0300 (M), w days 1400-0300
16.96	15310	G5T, Daventry, 1915-2200, 2200-0000	25.21	11880	TPB18, Paris-Mondial, 0000-0215	30.52	9833	COCLM, Havana, S 1400-0300 (M), w days 1400-0300
16.96	15310	G5T, Daventry, 1915-2200, 2200-0000	25.21	11880	TPB19, Paris-Mondial, 0000-0215	30.52	9833	COCLM, Havana, S 1400-0300 (M), w days 1400-0300
16.96	15310	G5T, Daventry, 1915-2200, 2200-0000	25.21	11880	TPB20, Paris-Mondial, 0000-0215	30.52	9833	COCLM, Havana, S 1400-0300 (M), w days 1400-0300
16.96	15310	G5T, Daventry, 1915-2200, 2200-0000	25.21	11880	TPB21, Paris-Mondial, 0000-0215	30.52	9833	COCLM, Havana, S 1400-0300 (M), w days 1400-0300
16.96	15310	G5T, Daventry, 1915-2200, 2200-0000	25.21	11880	TPB22, Paris-Mondial, 0000-0215	30.52	9833	COCLM, Havana, S 1400-0300 (M), w days 1400-0300
16.96	15310	G5T, Daventry, 1915-2200, 2200-0000	25.21	11880	TPB23, Paris-Mondial, 0000-0215	30.52	9833	COCLM, Havana, S 1400-0300 (M), w days 1400-0300
16.96	15310	G5T, Daventry, 1915-2200, 2200-0000	25.21	11880	TPB24, Paris-Mondial, 0000-0215	30.52	9833	COCLM, Havana, S 1400-0300 (M), w days 1400-0300
16.96	15310	G5T, Daventry, 1915-2200, 2200-0000	25.21	11880	TPB25, Paris-Mondial, 0000-0215	30.52	9833	COCLM, Havana, S 1400-0300 (M), w days 1400-0300
16.96	15310	G5T, Daventry, 1915-2200, 2200-0000	25.21	11880	TPB26, Paris-Mondial, 0000-0215	30.52	9833	COCLM, Havana, S 1400-0300 (M), w days 1400-0300
16.96	15310	G5T, Daventry, 1915-2200, 2200-0000	25.21	11880	TPB27, Paris-Mondial, 0000-0215	30.52	9833	COCLM, Havana, S 1400-0300 (M), w days 1400-0300
16.96	15310	G5T, Daventry, 1915-2200, 2200-0000	25.21	11880	TPB28, Paris-Mondial, 0000-0215	30.52	9833	COCLM, Havana, S 1400-0300 (M), w days 1400-0300
16.96	15310	G5T, Daventry, 1915-2200, 2200-0000	25.21	11880	TPB29, Paris-Mondial, 0000-0215	30.52	9833	COCLM, Havana, S 1400-0300 (M), w days 1400-0300
16.96	15310	G5T, Daventry, 1915-2200, 2200-0000	25.21	11880	TPB30, Paris-Mondial, 0000-0215	30.52	9833	COCLM, Havana, S 1400-0300 (M), w days 1400-0300
16.96	15310	G5T, Daventry, 1915-2200, 2200-0000	25.21	11880	TPB31, Paris-Mondial, 0000-0215	30.52	9833	COCLM, Havana, S 1400-0300 (M), w days 1400-0300
16.96	15310	G5T, Daventry, 1915-2200, 2200-0000	25.21	11880	TPB32, Paris-Mondial, 0000-0215	30.52	9833	COCLM, Havana, S 1400-0300 (M), w days 1400-0300
16.96	15310	G5T, Daventry, 1915-2200, 2200-0000	25.21	11880	TPB33, Paris-Mondial, 0000-0215	30.52	9833	COCLM, Havana, S 1400-0300 (M), w days 1400-0300
16.96	15310	G5T, Daventry, 1915-2200, 2200-0000	25.21	11880	TPB34, Paris-Mondial, 0000-0215	30.52	9833	COCLM, Havana, S 1400-0300 (M), w days 1400-0300
16.96	15310	G5T, Daventry, 1915-2200, 2200-0000	25.21	11880	TPB35, Paris-Mondial, 0000-0215	30.52	9833	COCLM, Havana, S 1400-0300 (M), w days 1400-0300
16.96	15310	G5T, Daventry, 1915-2200, 2200-0000	25.21	11880	TPB36, Paris-Mondial, 0000-0215	30.52	9833	COCLM, Havana, S 1400-0300 (M), w days 1400-0300
16.96	15310	G5T, Daventry, 1915-2200, 2200-0000	25.21	11880	TPB37, Paris-Mondial, 0000-0215	30.52	9833	COCLM, Havana, S 1400-0300 (M), w days 1400-0300
16.96	15310	G5T, Daventry, 1915-2200, 2200-0000	25.21	11880	TPB38, Paris-Mondial, 0000-0215	30.52	9833	COCLM, Havana, S 1400-0300 (M), w days 1400-0300
16.96	15310	G5T, Daventry, 1915-2200, 2200-0000	25.21	11880	TPB39, Paris-Mondial, 0000-0215	30.52	9833	COCLM, Havana, S 1400-0300 (M), w days 1400-0300
16.96	15310	G5T, Daventry, 1915-2200, 2200-0000	25.21	11880	TPB40, Paris-Mondial, 0000-0215	30.52	9833	COCLM, Havana, S 1400-0300 (M), w days 1400-0300
16.96	15310	G5T, Daventry, 1915-2200, 2200-0000	25.21	11880	TPB41, Paris-Mondial, 0000-0215	30.52	9833	COCLM, Havana, S 1400-0300 (M), w days 1400-0300
16.								

# THE NEW HALLICRAFTER SKYRIDER DEFIANT

MODEL SX24

WITH FREQUENCY  
METER TUNING

NINE VALVES

COMPLETE INSTRUMENT

**£21 0 0**

HIRE PURCHASE FACILITIES AVAILABLE



The Sky Rider DEFIANT offers performance that can be favourably compared to any receiver regardless of price. It has new features, like **BUILT-IN FREQUENCY METER TUNING**, that are absolutely new. And in addition it has all the desirable features and qualities that are needed for outstanding amateur reception.

**FREQUENCY METER TUNING.** The Band Spread Dial is accurately calibrated throughout the amateur bands, and, when once set, maintains a high degree of accuracy throughout the band, bringing in signals on their frequencies as indicated by the dial.

**BUILT-IN NOISE LIMITER.** The noise-limiting circuit is of recent development, highly efficient in reducing noise level on the ultra high frequencies. All leads are short and close to the noise-limiter tube for greater efficiency.

**VARIABLE SELECTIVITY.** A six position Variable Selectivity Switch is provided, offering a degree of variability suitable to all practical requirements for CW and phone. Selectivity positions are as follows: AVC off—Sharp Crystal, AVC off—Broad Crystal, AVC off—Sharp IF, AVC on—Broad Crystal, AVC on—Sharp IF, AVC on—Broad IF.

**FREQUENCY STABILITY.** By means of an especially developed circuit, variations in line voltage cause only a barely discernible change in oscillator frequency.

**BATTERY OPERATION.** In addition to the AC Power Supply, a power plug is provided at the rear of the chassis for connection of a source of filament and high tension DC voltage supply for mobile or emergency operations.

**BREAK-IN RELAY OPERATION.** Terminals are provided on the rear panel for stand-by relay operation.

**CRYSTAL FILTER.** A Bliley Resonator Crystal in a new Hallicrafter low capacity crystal holder with a double balance bridge circuit allows a high degree of rejection of unwanted signal even when interfering signal is closely adjacent.

**GENERAL COVERAGE—43.5 to .54 MC**

**4 BAND POSITIONS**

Band 1— .54 to 1.73 MC	Band 3— 5.0 to 15.7 MC
Band 2— 1.7 to 5.1 MC	Band 4—15.2 to 43.5 MC

**BAND SPREAD CALIBRATION**

80 Metre Amateur Band	20 Metre Amateur Band
40 Metre Amateur Band	10 Metre Amateur Band

**9 TUBES**

6SK7 RF amplifier	6F6G power amplifier
6K8 first det. and osc.	76 beat frequency oscillator
6SK7 first IF amplifier	80 rectifier
6SK7 second IF amplifier	6H6 noise limiter
6SQ7 diode detector, AVC and first AF amplifier	

**S METER** calibrated in S units and DB.

**CONTROLS**

1—RF Gain	8—Bandspread Tuning Control
2—Band Switch	9—Tone Control Switch
3—Selectivity Switch	10—Automatic Noise Limiter Switch
4—Crystal Phasing	11—Send-Receive Switch
5—Audio-Gain	12—BFO Switch
6—Pitch Control	
7—Main Tuning Control	

**MAIN TUNING DIAL.** Directly Calibrated, Translucent Illuminated Dial.

**ELECTRICAL BAND SPREAD.** Directly Calibrated, Translucent Illuminated.

**CABINET DIMENSIONS.**

19½ ins. wide, 9½ ins. high, 10½ ins. deep.

**WEBB'S RADIO, 14, Soho Street, London, W.1**

Sole Distributors for British Isles of Hallicrafter Equipment

'PHONE: GERRARD 2089