

*The*

6<sup>p</sup>

# SHORT-WAVE MAGAZINE

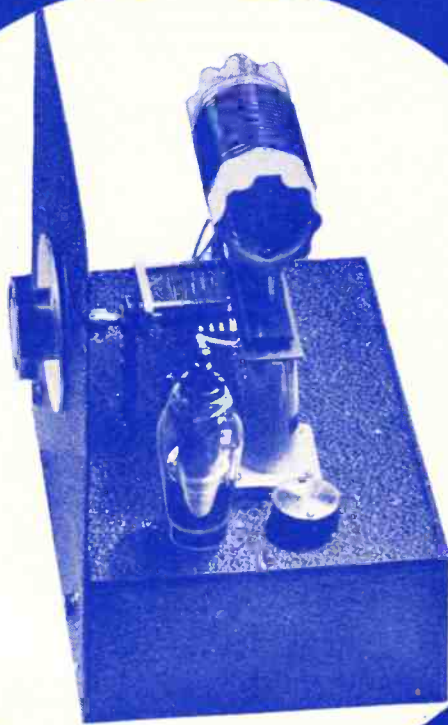

**No. 10**  
DECEMBER,  
1937

Pages 5 and 6 give full information concerning the construction of a unique one-valve transmitter, illustrated above.



## THE SIGN OF A GOOD VALVE

**VP 215** Variable-Mu H.F. Pentode.  
**D 210** Non-Microphonic Detector.  
**Y 220** Hivac-Harries Medium Power Tetrode.  
**PX 41** Three-watt Output Triode.  
**MIDGETS** A range of Hivac 2-volt "Midgets."

**AC/HL** Medium Impedance Triode.  
**AC/Y** Hivac-Harries Medium Slope Tetrode.  
**AC/Z** Hivac-Harries Steep Slope Tetrode.  
**AC/Q** Hivac-Harries Beam Power Tetrode.

### A SPECIAL RANGE OF 2 VOLT SHORT-WAVE VALVES

Non-Microphonic Detector. High Gain Screen Grid. Super Power. Class B.

### ALL THESE VALVES DESERVE YOUR SPECIAL ATTENTION

There are over 50 types of HIVAC valves. 2-volt Battery types. 4-volt A.C. Mains valves (indirectly heated). 4-volt A.C. Mains (directly heated). 13-volt Universal A.C./D.C. valves (indirectly heated). 2-volt "Midget" Battery valves and 2-volt Short-Wave Battery valves. Full details will be sent FREE to all asking for LIST, and Chart "S.M."

*British Made by*

**HIGH VACUUM VALVE CO., LTD., 111-117, FARRINGTON ROAD, LONDON, E.C.1.**

TERminus 2567

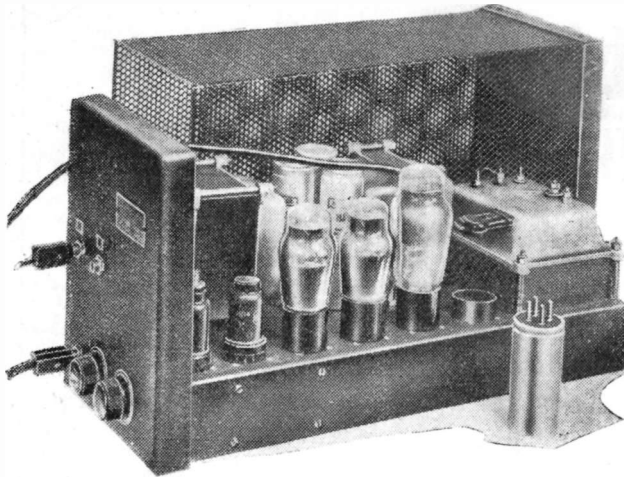

## VORTEXION

15 watt high gain, high quality amplifier within 3DB 30—17,000 cycles. Outputs in stock for 4, 7.5, and 15 ohm speakers or to any impedance to order. .04 volt input required, separate mike and gram inputs with mixing faders.

PRICE 8½ gns.

Gauze case, 12/6 extra.

Microphones, Piezo pick-ups, G.12 Rolas and Collaro motors. Trade supplied.

**VORTEXION LTD.,**

**182 THE BROADWAY,  
WIMBLEDON, S.W.19.**

Telephone : Liberty 2814.

## DX!

Every Short Wave Fan should join the B.S.W.L.—the leading British organisation for the DX enthusiast. We produce our own "Review": run our own QSL Distributing Bureau; issue "Heard all Continents" Certificates and can honestly boast of running one of the friendliest DX societies in the World. There are many advantages of joining such a society. For further particulars write to:—The Secretary, British Short Wave League, Ridgewell, H.stead, Essex, or get a copy of our publication "Short Wave Review" through your newsagent—price 6d. This magazine is also the official organ of the British Section of the World Friendship Society of Radio Amateurs.

**"DX FOR DXers BY DXers"**

## ELECTRADIX BARGAINS

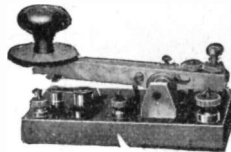

**A Guinea 7/6  
Key for**

**TRANSMITTERS, MORSE AND SIGNAL KEYS, Royal Air Force model, balanced action, solid brass bar, tungsil contacts, indicator lamp, Type KBSL, a guinea key for 7/6. Other keys from 4/6 to 30/-. Learner's outfit complete, 4/9. Ask for special illustrated Key List "S.W."**

**HEADPHONES. Light weight, 2,000 ohms, 4/6. Single high res. earpieces, 2/8. Sullivan 120 ohm W.D. model. Aluminium body and headbands. Maker's price to-day, 15/-. Our price 2/9 per pair. 3d. postage.**

## ELECTRADIX RADIOS

**218, Upper Thames Street, London, E.C.4.**

Telephone : Central 4611

## CLASSIFIED ADVERTISEMENTS

are charged at 2d. per word, minimum 2s. All advertisements must be prepaid.

Cheques and postal orders should be made payable to "The Short-Wave Magazine."

**WE BUY FOR CASH Short-Wave Parts, Sets, Test Meters, etc. Bring or send.—UNIVERSITY RADIO, LTD., 82, Hampstead Road, Euston, N.W.1.**

**REPAIRS AND RE-ALIGNMENT** by the old-established City Repair Service. Radio repairs only. All-Wave and Standard Sets and Amplifiers "hotted up," rebuilt, repaired, etc. Estimates free.—**DISTAVOX SERVICE CO., 119, Bunhill Row, E.C.1. National 8589.**

**HERE'S YOUR CHANCE TO SAVE MONEY.** The following new and unused radio snips offered by G5KA: Two TAYLOR T50's, 35s. each. M.R. Reisz type mike, with ring stand (all chromium) and input transformer, 32s. 6d. Raytheon RK23, 17s. 6d.. 5-meter trans-receiver (two tube), professional built; fitted in magnificent cabinet holding batteries, fones, etc.; complete with latest pattern hand-mike combination and vertical rod antenna; this cost well over £15—best offer takes. 3-tube, 5-meter receiver (superregen); Eddystone components throughout; a terrific bargain at £4.—G5KA, 41, Kinfauns Road, Goodmayes, Ilford, Essex. Phone: Seven Kings 2888.

**AMERICAN ALL-WAVE DOUBLET AERIALS.** complete with Variable Transformer, 15s. Also all types of American Valves at low prices.—**C. J. SCATES, 5, Church Street, N.W.8.**

**CONDENSERS.—Fixed Paper. In Metal Containers.** 1,000 volt. Wkg. 8 mfd. 10s. 6d.; 4 mfd. 7s. 6d.; 2 mfd. 4s. 9d.; 1 mfd. 2s. 6d. **TUBULARS** in Bakelite cases, 1,000 volt. Wkg. 1 mfd. 2s. 6d.; 0.5 mfd. 2s.; 0.25 mfd. 1s. 9d.; 0.1 mfd. 1s. 3d.;

**"ENGINEER'S GUIDE TO SUCCESS"** shows how to qualify in Television, Sound Recording, Radio Engineering and Servicing, Wireless Communications, etc., by studying at home with The T.I.G.B. Write to-day for this Great Guide—FREE—which contains the world's widest choice of engineering courses—and alone gives the Regulations for Qualifications such as A.M.I.E.E., A.M.I.R.E., A.M.I.T.E., A.M.I.W.T., C. and G., etc. The T.I.G.B. Guarantees Training until Successful.—**THE TECHNOLOGICAL INSTITUTE OF GREAT BRITAIN, 105, Temple Bar House, London, E.C.4. (Founded 1917. 20,000 Successes).**

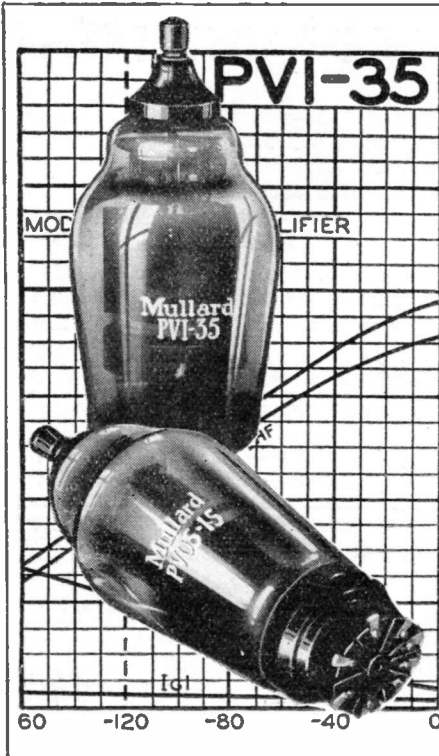

# Mullard TRANSMITTING PENTODES for AMATEUR RADIO

The PVO5-15 and PVI-35 are fully screened pentodes with indirectly heated cathodes.

They set a new standard of operating efficiency on short wavelengths.

★

For technical data, send a postcard to —

**TRANSMITTING DIVISION**  
**The Mullard Wireless Service Co. Ltd.**  
**225 TOTTENHAM COURT ROAD**  
**LONDON, W.1**

# 'AVO' TESTING INSTRUMENTS

WORLD FAMOUS FOR ACCURACY

Regd.  
Trade  
Mark.

British  
Made.

## The Universal AVOMINOR

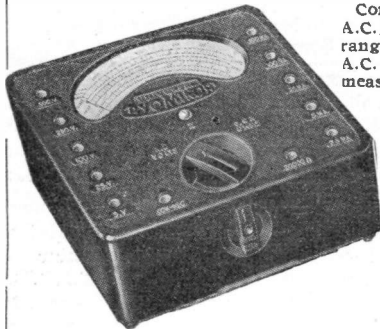

Compact multi-range A.C./D.C. meter, 22 ranges. Provides for A.C. and D.C. voltage measurements up to 500 volts; Current measurements up to 500 milliamps; Resistance measurements from 0-10 megohms. Highly accurate. Total resistance 200,000 ohms. Complete with leads, testing prods, crocodile clips, and instruction booklet.

Price £5 10 0 Leather Case 10/-  
Also, the 13-range D.C. Avomator, 45/-

## The 46-range Universal AVOMETER Model 7

World's foremost multi-range meter. Has 46 ranges. Provides for all A.C. and D.C. voltage and current measurements; Resistance measurements; Capacity tests; audio-frequency power output measurements; and Decibel tests. No external shunts or series resistances. B.S. 1st grade accuracy. Protected by automatic cut-out against damage through over-load.

16 Gns.

Resistance Range Extension Unit (for measurements down to 1/100th ohm). 10/-

36-range Universal Avometer, 13 gns.  
22-range D.C. Avometer, 9 gns.

Leather Carrying Cases, 25/-

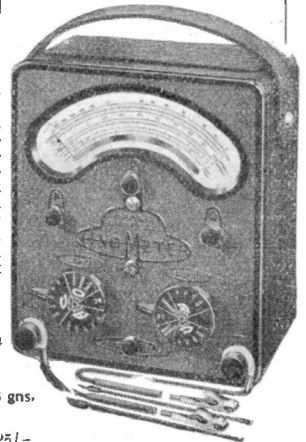

Write for list of "AVO" Instruments—

**THE AUTOMATIC COIL WINDER & ELECTRICAL EQUIPMENT CO., LTD.**  
WINDER HOUSE, DOUGLAS STREET, LONDON, S.W.1.

Telephone: Victoria 3404/7.

# THE SHORT-WAVE MAGAZINE

Vol. I

DECEMBER 1937

No. 10

Editor: BASIL WARDMAN (G5GQ)

Editorial Asst.: S. W. CLARK (2AMW)

Advertisement Manager: C. T. MILDENHALL

A GREAT DEAL has been said and written about the home constructor. Well-known authorities have informed the world at large that home construction is dead, killed by mass produced receivers.

We humble remnants of this extinct race should not presume to dispute the statements of the wise men, but somehow our correspondence, our contact with dealers and radio clubs, seems to indicate a large interest in home construction, particularly in short-wave apparatus.

Deep in the ditch of mass produced broadcast sets it is probably impossible to see the vast fields of short-wave home construction "over the top." From a distance they are clearly visible; from three

they would enrich themselves, satisfy the public, and keep our money at home.

Short-wave construction is eternally new. It is a creative hobby conquering time and distance, not to be stifled by pessimists. If our own people ignore our wants, we must turn to those who will satisfy them.

The amateur motor mechanic was once treated in the same manner. It was thought that mass produced cars would eliminate him. He still tinkers in his garage, his semi-technical knowledge is a vital factor in the "new car a year" market.

The idea of regarding a car as a sealed mystery to be left severely alone has long been abandoned.

---

## KILLING THE GOOSE

---

thousand miles away our American cousins have espied these fair pastures, and every month sell us many thousands of pounds worth of short-wave components and receivers. Hit by the slump they realised the necessity of creating a demand for their products, of nursing small markets until they became remunerative. They studied the needs of, instead of despising, the short-wave "fan" and "ham," and now they are reaping their reward.

What a pity so many of our manufacturers persist in remaining at the bottom of the ditch. If instead of sitting there, screaming for tariffs (although they declare there is no market), they would climb out, foster and cater for the demand,

The owner is treated as an intelligent being, able to appreciate the minor technicalities of his vehicle, encouraged to do his own repairs, to tinker in his garage, and the success of the motor industry proves the logic of this policy.

The 6,000,000 radio users in this country are not fools, and are tired of being treated as such. The "hush-hush" policy of keeping a wireless set a secret box of tricks is played out. The semi-technical man does not like mysteries, he likes to tinker as does his car-owning brother.

The home construction market can be developed to greater peaks than it has ever touched. Let us hope our own people will do it.

---

Contributions for publication in our editorial pages will be given consideration and payment will be made for matter used. Only manuscript accompanied by a stamped, addressed envelope will be returned. Whilst we are willing to advise on suggested articles no guarantee of acceptance can be given.

The publisher does not necessarily agree with the views expressed by all correspondents and contributors, the aim being to open the columns to every phase of opinion.

Annual subscription—Inland, 8s.; Abroad, 10s. Post paid. Published on the first Wednesday of each month at 84/86 Tabernacle Street, London, E.C.2. Phone: Clerkenwell 6230.

# HAVE YOU HEARD . . . ?

An abstract of the past month's conditions, as compiled and presented by

F. A. BEANE (2CUB)

YES! HAVE YOU HEARD? And *what* can't we hear? Everything is at our finger-tips, whether war ridden Spain, marital Japan, romantic Cuba, diminutive Dominicana, jazz dissipating America, coffee producing Colombia, its rival claimant to world supremacy Guatemala, or sunny Australia; we control all! And the winter has increased our scope, for no longer is it necessary to sit up half the night to hear the fascinating Latin Americans or to ensure wonderful reception from North America.

Just before writing this I took a spin at the dial before partaking of a final meal and bed, and to my amazement I found W8XK (48.86 m.), Pittsburgh, the popular broadcaster, romping in long before 22.00, a truly astounding signal. VP3MR (49.42 m.), of Georgetown, was quite good at 21.45 just as we used to hear it when it made its etheric debut in the 40-metre amateur band some time ago. The Cubans COCH, COBC, COCQ, COCM and COBX were brilliant long before midnight, while at 23.24 I was surprised to find OKG on a new wavelength of 33.7 m. At 24.00 they obliged with an English announcement "Short-Wave Station COKG in Santiago, Cuba, P.O. Box 137," and followed with announcements in Spanish, given by a lady announcer and interrupted frequently by chimes, sometimes one or three, but generally two. Yes; winter conditions are here again, and so be prepared for dx and many new Cubans—and Dominicans!

## ● News from the East

Japan has made changes in view of these conditions and so their transmissions for Europe are now carried by JZI and JZK, on 31.46 and 25.42 metres respectively, between 20.00 and 21.00. Siam, too, has made alterations with the result that HS8PJ is now heard on 31.54 m. each Thursday from 13.00 until close down at 15.00, but whether this is a wise move or not I cannot say since the band is already overcrowded, particularly at night.

I have often been asked whether KZRM will verify; my answer is in the affirmative for I have their QSL card before me. Lucky? Oh, no, it isn't mine I regret to say; it belongs to H.T. (Bridgend), and is particularly interesting. The card itself is buff and bears large call-letters and the title "Radio Manila," also the following details:—power 1 kw.; wavelength 31.35 m., 9,570 kcs., or 25.33 m., 11,850 kcs.; schedule Monday-Friday inclusive 10.00-14.00 and 21.30-23.00 G.M.T.; Saturdays 10.00-15.00 and 21.30-23.00; Sundays 09.00-15.00 G.M.T. Broadcasts are carried out simultaneously on "long" and short waves, in English, Spanish and Filipino dialects "from four studios atop the Insular Life Building," the owners being Erlanger and Galinger, Inc. Actually KZRM is heard near 31.33 m. and not on exactly 31.35 m. Incidentally H.T.'s reception was in July whereas mine occurred in September and so I expect I shall have to wait a little longer before I receive a card! And I hope that they *don't* address mine to "England, Australia"—T.T.'s is addressed, "Wales, Australia!" And

that reminds me of a veri from SR1, Poland, which was sent to "Essex, U.S.A.!"

## ● News from Latin America

Much of interest is now available in the evenings; generally, when good conditions prevail, I find the North Americans monopolising the 31 m. band from about 21.00, shortly after, or sometimes even much earlier, follow the Cubans, then the Dominicans from about 22.30 and the HJ's and YV's from 23.30 or so. There is nothing really new to report from the "Pearl of the Antilles" except that a new station, employing the call-sign COCU, will shortly appear on 45.52 m., 6,590 kcs., and will relay CMCU, "de Garcia Serra," with 400 watts power. The schedule is to be 12.00-05.00 on weekdays and 12.00-24.00 on Sundays, and the address, to which reports should be sent, is "Estrada Palma No. 25, Vibora, Havana, Cuba."

The Dominican Republic furnishes a newcomer in HIIL of Santiago de los Caballeros, operating in the region of 46.2 m.; that is very slightly higher in wavelength than the popular and powerful YV4RB of Valencia. I have heard it quite well from 22.30 or so, and the station call is given clearly in Spanish and English at the hour, i.e., at 22.40, 23.40, 00.40 G.M.T., and so on, as Dominican time is 4 hours 40 minutes *behind* G.M.T. 4 chimes precede the identification announcement, the latter being usually "HIIL, Emisora Nacional el Diario, Santiago de los Caballeros, Republica Dominicana" followed by the English call "Short-Wave station HIIL at Santiago City, Dominican Republic, West Indies." Incidentally these announcements are often given at fifteen-minute intervals, that is at 22.40, 22.55, 23.10, 23.25 G.M.T. and so on.

On a slightly higher wavelength of about 46.27 m. will be found yet another of these fascinating "mushroom" transmitters; this time HI4V, of San Francisco de Macoris (very good for refreshing one's geographical knowledge!) and this has been heard at good strength from midnight until close down at 02.00, or 9.20 p.m. Dominican Time. Unlike its compatriot HIIL, however, it does not appear to make use of English, at least it did not during the two hours in which I listened to its almost incessant rumbas, boleros and tipica music, characteristic of all Latin-American broadcasters, but despite this, identification is a matter of the utmost simplicity as a four-chime signal, with the last note hardly discernible, is used at each hour—don't forget the difference in Dominican time—together with the announcement in Spanish "Broadcasting SI4V, La Voz de la Marina, en San Francisco de Macoris, capital de Provincia Duarte, Republica Dominicana." At other times the call is given briefly as "Emisora HI4V." While on the subject I should like to mention HI5N, a low-powered broadcaster on 48.8 m. This, too, is well heard over here from about 23.00 and favours us with English announcements. 4 chimes herald the announcement "Short-Wave station HI5N, in Moca City, Dominican

Republic"; a similar number of chimes intersperse the following announcements and advertisements, while the call is repeated in Spanish several times and the station styled "La Voz de Moca." Broadcasts are concluded at 00.40, or a few minutes later, with the call, "Buenos Noches" and the National Anthem. HI5N was well heard here just two years ago, but was then in Santiago de los Caballeros and known as "La Voz del Almacén," while their verification, which I was fortunate enough to secure at that time, is particularly attractive. I know that many dx'ers are often in a quandary as to where to address reports to new stations, but I can assure them that letters addressed thus (for example) "Radioemisora HI5N, La Voz de Moca, Ciudad Moca, Dominican Republic," invariably reach their destination without much bother on the part of the postal authorities!

### ● Canadian verification

Last month I inadvertently stated, or rather suggested that the newcomer on 49.9 m. was CJCG, whereas it is, of course, CJCX a relay of medium wave CJCB, Sydney, Nova Scotia. Their QSL card, of not too attractive appearance, gives the wavelength as stated above and power 1,000 watts, but fails to give their schedule or other interesting details—in fact the covering envelope is more attractive—it bears several photos—and is indeed more informative!

Writing of QSL's reminds me of the speculation in the short-wave sphere concerning the fate of CB615, or "Radio Service," the broadcaster that made such a sensational debut on 12,300 kcs. some time ago, and thanks to a verification I am able to state that this station is off the air and has been replaced by CB1170 on 11,700 kcs., or perhaps a little nearer to 11,695 kcs., although officially the former. The card from CB1170 is a little unusual in design and bears a type-written message of verification, being accompanied by a circular from the owner, Otto Becker, in which it is stated that CB615 has been taken over by him and that CB1170 has an output of 1,000 watts, which certainly makes it appear—since CB615 had the same power—that CB1170 and CB615 are one and the same. The letter continues to explain that the "Anglo-American Hour" is broadcast thrice weekly, on Tuesdays, Thursdays and Saturdays, from 23.00 to 23.45, and that the full operating hours are daily 16.00-20.00 and 22.00-05.00. The full title of CB1170, as announced, is "CB89 y CB1170, Radios Otto Becker, Santiago de Chile" and the address "Radio Otto Becker, Casilla 706, Santiago, Chile."

Latin America still predominates the 49-metre band at night and early morning, but it is amazing the way in which many of the stations desert this band in favour of the 31 m. channels. Latest addition is HJ7ABD of Bucaramanga, already introduced to you in these pages, which is without much doubt HJ2ABD, "Radio Bucaramanga," operating with a new call, and I understand that others may shortly follow suit.

"Radio Belgrano" on 31.1 m. approx., has, as I partly prophesied, turned out to be a Uruguayan relaying a Buenos Aires medium-wave broadcaster, namely LR3, whose title is that heard so frequently from the relay—CXAS, for that is its call-sign and the location is Montevideo. The address I do not know, but have been told that reports should be addressed to LR3, "Radio Belgrano," Buenos Aires, although when I have the time and inclination I

shall send mine to "Radiodifusora CXAS, Montevideo, Uruguay" and then hope for the best!

### ● Spanish vociferations

The Spanish war stations, although causing chaos in the already too over-crowded 40 m. amateur band, still hold a certain amount of interest for the listener, and, as I write this, I am listening to station EAIDD, the operator of which made an appeal to members of the B.S.W.L. for "control cards." This station is operated by the 26th Division, on the Aragon Front, and generally announces itself thus: "Halo, here is station EAIDD of the 26th Division of the Spanish Republican Army, operating in the Aragon Front, at the service of the Spanish Popular Front Government," the wavelength being, according to the operators, 40.5 m. In reply to "control cards" they send a letter and also answer, or acknowledge reports during the course of their English broadcasts, which take place—war conditions permitting!—from 21.30-21.45 and 00.30-00.45. Other interesting stations are the Government "Radio Norte," Madrid, on approximately 42 m.; RR6, "Radio Requete de Vitoria," Vitoria; FE11, "Emisora Falange FE11," Valladolid; EAJ8, "Radio Espana," San Sebastian, 41.65 m.; EAQ4, "Radio Madrid," Madrid, 42.58 m.; and EAJ28, Bilbao, 41.4 m.

Other European news comes from Portugal, whence we learn of CTIAA's new call, CS2WA; Venezuela with YV6RC; "Radio Bolivar," Bolivar, on 46.73 m., where it is often well heard from 22.45, or so, using Westminster chimes each quarter-hour coupled to the call "Radio Bolivar (phon. Bo-lee-va), Estacion YV6RC en ciudad Bolivar, Venezuela, America del Sud," and numerous chimes and gong notes between announcements; Colombia, where HJ4ABE, "La Voz de Antioquia," Medellin, appears to have wandered from its original wavelength in four of 48.83 m.; Martinique with its sole representative FZF6, "Radio Martinique," Fort-de-France, continuing to put in a good signal on 30.98 m. between 23.45 and 00.45, and finally the tidings that yet another Venezuelan is to make its etheric bow with the call-sign YV5RR on 51.43 m. ere long.

In conclusion I am very grateful to R.M.L. (Reigate) for pointing out the error in the Canadian's call-sign, and for his most encouraging remarks concerning my last article, and to G.W.P. (Alfreton) for similar information.

### ATTENTION!—A NOTE FROM "AVO"

We should esteem it a favour if you would kindly give publicity to the fact that the following instruments were stolen from a representative's car in Islington on November 2.

Universal "Avometer" No. 66-5454.

D.C. "Avometer" No. 6594.

Universal "Avominor" No. U.23257-16.

D.C. "Avominor" No. 41931-46.

"Avo" Oscillator No. 9150.

"Avodapter," "Avocapler." No record of serial number.

"Avo" Exposure Meter No. 14015-107.

Smethurst High-Light Meter No. H.1012-67.

"Avo" light Meter, for measuring candle power No. H.1020-37.

1—"P" Type Zeva Iron No. H.16.

1—"P.O." Type Zeva Iron No. G.109.

We are sure you will appreciate that with the tens of thousands of instruments we have supplied to the trade, many are stolen from time to time, and we have a black list upon which we record the serial numbers of such instruments, most of which are returned to us for repair in due course. Upon receipt of such instruments we advise the original purchasers, and in most cases are able to return same to the rightful owners. We are sure your readers will recognise that our system may be of great help to them in the event of their losing any "Avo" products.—THE AUTOMATIC COIL WINDER AND ELECTRICAL INSTRUMENT CO., LTD., Winder House, Douglas Street, London, S.W.1.

# THE SIMPLEST TRANSMITTER

With Direct Modulation—  
One Valve—No Neutralising

Designed by G5GQ

THE SIMPLEST 40-metre 'phone/cw transmitter possible. That's what we set out to design, and the little rig shown on our cover is the result. No neutralising, one coil, one tuning condenser, one valve. *The valve is modulated direct from the microphone, no modulating valve or speech amplifier being necessary with a sensitive microphone.* Plug the key into the right hand jack, and you are on c.w.; plug the mike in the left hand jack, and you are ready for 'phone. Change coil and crystal, and you are on another band. In fact a single control transmitter! Can anything simpler be imagined?

The circuit is our friend the regenerative pentode crystal oscillator, using one of the new Mullard PVO5/15 r.f. pentodes, with suppressor modulation. 20 watts output on c.w., 5 on 'phone.

In choosing the circuit crystal control was thought to be an absolute necessity. We didn't want to use more than one valve in the transmitter proper, but what valve should it be? A triode would have given somewhat less output with considerably more crystal heating; a tetrode (beam tube) would have given equal output, but with both these types modulation presents difficulties. It would have to be either Heising, needing a fairly large modulator, or grid modulation involving difficult adjustments.

A pentode can be suppressor modulated. It is about the simplest form of modulation to use. Adjustments are not critical, the bias can be varied over a wide range, quality is excellent, and modulation power required is less than a watt.

A well-shielded r.f. pentode as a straight crystal oscillator is not a very satisfactory arrangement, a beam tube is far better. But when regeneration is applied the r.f. pentode gives more output with minimum crystal heating than any other type.

Regeneration may sound complicated, but all that is required is the .0002 mfd. condenser, and the r.f. choke in the cathode circuit. Note how the use of an indirectly-heated valve saves trouble. A directly-heated one may be used, but then filament chokes are essential, a bothersome procedure.

## ● Layout

A departure from the usual regenerative pentode circuit is the addition of a minute capacity between grid and anode. This is necessary because the PVO5/15 is a *shielded* r.f. pentode, designed to work as low as 5 metres as a straight amplifier, and some external capacity between grid and anode is necessary for satisfactory oscillation. This condenser is made by connecting a wire to the grid (on the valve base for the crystal); running it through the chassis and wrapping it round the insulated lead from the valve anode to the coil. The length of "wrap" necessary is about two inches.

The transmitter is built on a 12-in. x 8-in. x 4-in. aluminium chassis, fitted with a 12-in. x 12-in. front panel, by Scott-Sessions. On top is mounted the valve, crystal, coil, and tuning condenser. The Raymart coil may appear ambitious for use in a

simple c.o. circuit, but it must be remembered that it is being used as a final stage, not as a driver unit, so maximum efficiency must be obtained. The particular coil used was chosen because it is efficient, and also because when a larger transmitter is built, it can still be used, so on the score of economy the extra shilling or two spent, is a worthwhile investment.

For those who prefer to make their own coils, the winding consists of 16 turns of 14 s.w.g. wound on a 2½-in. outside diameter former. Although the commercial type coil is centre tapped this is unnecessary for this particular circuit, but it is useful in that the coil may be used for a neutralised p.a. should one be used at a future date.

Three turns are wound on the h.t. end to provide a "link" for coupling to a low impedance feeder. The base may be drilled to take these two extra leads, but this is a matter of choice for the individual constructor. In the photo it will be seen that this winding is taken to two terminals mounted directly on the coil former.

## ● Construction

The only point to be watched in the construction is the mounting of the tuning condenser (Raymart TC40). This is mounted on an Eddystone condenser bracket, but it will be seen that the condenser has two nuts on the fixing shaft. These are not the same thickness, so they are removed and the thinner one is placed nearest the condenser, the thicker one being used to secure to the bracket. The extension rod consists of a length of ¼-in. ebonite rod.

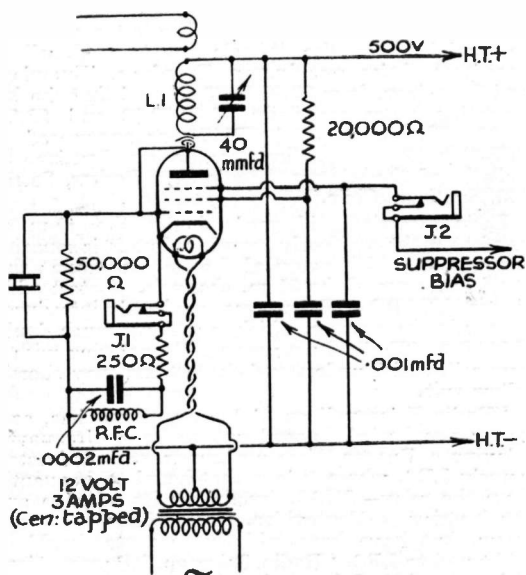



The crystal, a Valpey (Webb's Radio) is supplied complete with holder, and this fits into an American 5-pin valve holder. As many amateurs do not have a 12-volt filament supply available from their usual transformers, a separate filament supply is incorporated, and this can be seen mounted in the centre, under the chassis.

The 'phone/c.w. jacks are of the Igranic closed circuit type, and are insulated. Care must be taken if deviation from this pattern is contemplated.

The power is brought in to a five-pin valve socket at the rear of the chassis. The anode pin is for positive h.t., the filament pins for minus h.t. and positive bias (suppressor) and the centre pin for negative suppressor bias. The grid pin is left free.

### ● C.W.

When the set has been completed, and the power switched on, the total h.t. should not exceed 85 milliamps, non-oscillating. As the tuning condenser is rotated, the valve will start oscillating, and the h.t. milliamps will drop, the average figure being 25 milliamps, this including both the anode and the screen current. The screen alone consumes between 12 and 18 milliamps.

For c.w. operation no suppressor bias need be used, and the centre pin of the rear socket can be connected to one of the filaments. This should be done when tuning up. When the transmitter oscillates, as shown by a neon bulb or by a meter connected in the h.t. circuit, the aerial may be connected, and the key inserted in the right hand jack. Keying takes place in the cathode return, so the transmitter can be used for "break-in" work.

For c.w. use, a small positive bias may be put on the suppressor (say 30 volts), but this is only necessary when maximum power output is required. Whenever alterations are made to the tuning it is always wise to keep the suppressor either at earth potential, or negative. It helps prevent the anode current "running away" when out of resonance.

Removal of the key keeps the carrier on. For 'phone the secondary of the mike transformer is connected to the left hand jack, and if a sensitive microphone is used, there will be ample power to fully modulate the carrier. Under test a B.T.S. carbon mike was used, and with six volts on it gave excellent results. If an insensitive mike is used, such as a Reisz, an amplifier will be needed, and the one recently described in these pages will be found to give more than sufficient audio. In fact the trouble is to keep the modulation down, so sensitive is the valve.

The modulation being arranged, the correct bias should be put on the suppressor, a voltage of about forty volts negative being sufficient.

### ● Results

The aerial used for 7 mc. was a doublet, centre fed with 75-ohm feeders, connected to the link on the coil. With 350 volts h.t. continental stations were easily raised, signal strengths of R6-8 being obtained. This h.t. voltage was found quite enough for all ordinary purposes, but can be increased to 500 volts if additional

power is required. With 350 volts the input to the anode was about 14 watts.

This little transmitter is one of the most pleasant outfits we have ever handled. It is absolutely fool-proof, puts out as strong a signal as can be desired for ranges up to 1,000 miles, and when we do want to scrap it every part can be used in the construction of another larger transmitter. Reports will be anticipated and in this connection the transmitter is available for loan purposes to clubs, and will be sent complete with filament supply. An h.t. voltage of 500 will be necessary, and owing to the weight clubs are expected to provide it.

### PARTS REQUIRED

- Chassis—Scott Sessions.
- Coil (7 mc. ready wound)—Raymart.
- Coil base—Raymart.
- 2 stand-off insulators (type SX)—Raymart.
- 1 40 mmfd. cond. Raymart—(TC40).
- Tuning dial—Eddystone (1077).
- Bush and ebonite rod—Bulgin.
- Crystal and holder (7 mc.)—Webb's Radio.
- 1 5-pin American valve base (chassis type)—Clix.
- 1 5-pin valve base (chassis type)—Clix.
- 1 5-pin connector—Bulgin (P3).
- 1 8-pin side contact valve base—Bulgin (VH24).
- 1 50,000 ohm resistor (1 watt)—Erie.
- 1 20,000 20-watt resistor—Bulgin (PR38).
- 1 250 20-watt resistor—Bulgin (AR250).
- 1 r.f. choke—Eddystone (1022).
- 3 .001 fixed condensers—Dubilier.
- 2 insulated closed-circuit jacks—Webbs.
- 1 12-volt, centre-tapped fil. transformer—All-Power.
- 1 PVO5/15 transmitting pentode—Mullard.

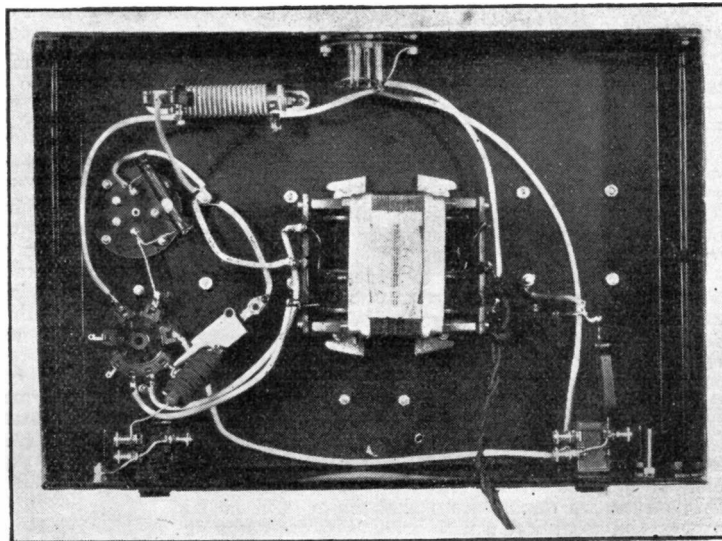

# “RADIOQUEST”

## Armchair Understanding of Radio Riddles

Conducted by RAY CORTON

FULLY HALF the queries that have been raised by Radioquest have been concerning receiving aerials, so it will be as well at this stage, even at the expense of retarding what I had hoped to cover this month, to deal with elementary aerial design. I have stressed that an ordinary broadcast aerial can be used with considerable success for short-wave listening. That is all very well up to a point, but as already explained, the greater the amount of signal picked up by the aerial the less the amplification required in the receiver, and the less the amplification the less the internal noise in the receiver. What is lost by an inefficient aerial cannot be put back by the set, at least not with the same freedom of background noise, so for logging dx we cannot over-estimate the importance of a good aerial.

### ● The chief requirements

The two most important characteristics an aerial should possess are, of course, a good pick-up and a high signal-to-noise ratio. The first is easily obtained by the employment of an efficient conductor such as copper wire erected in a high position where losses are at a minimum, that is, well away from buildings, trees and other “screening,” especially metal objects such as drainpipes, guttering, telephone wires, etc.

As the amount of energy picked up by the aerial is directly proportional to its height, this is a very important factor and the maximum height permitted by local conditions should be used to full advantage. When we speak of the height of an aerial we really mean its *effective* height, that is, not merely the height above ground level but the height above surrounding obstacles.

### ● Marconi and Hertz aerials

Aerials may be roughly divided into two classes: (a) the untuned or non-resonant and (b) the tuned or resonant. The Marconi, as used for normal broadcast reception is of the former type and consists of a wire of indefinite length used in conjunction with an earth or counterpoise. It usually takes a form of a T or inverted L (names which describe its shape) and is brought into tune with the frequency used by tuning adjustment of the receiver's aerial circuit.

The tuned aerial, or Hertz type, is designed to work on a certain band. As we saw last month, the wavelength to which a wire will tune is directly dependent upon its length, thus it can be cut to resonate at a given frequency and no earth or counterpoise is necessary. The most popular form this aerial takes is the half-wave, which, as its name suggests, has physical dimensions of half the wavelength it is intended to work on. At the wavelength for which a doublet is designed, say 30 metres, it gives over twice the strength but this falls off as we depart from that figure and at 25 metres the reception would be merely the same as with a normal aerial of the same dimensions. A

30-metre doublet would have a top span of roughly 48 feet, somewhat less than the average broadcast aerial.

A doublet or ordinary half-wave aerial is impossible for most of us for medium or long-wave reception (even if the G.P.O. permitted it) owing to the enormous length required, so we have to use the less efficient Marconi type, but on short-waves we can take full advantage of the great increase given over a narrow band and with the doublet, if we are limited to one aerial only, we can use it as a Marconi T for wavebands other than for which it was designed. I will return to this a little later.

Aerials erected horizontally are directional, that is they receive better from certain directions than from others. With the T type there is little pick-up from the directions in which the ends of the top span point, but if we erect it vertically it will receive from every point other than immediately above or below it.

A signal from a short-wave station does not travel along the earth's surface, but, as we saw in the first Radioquest article, in a series of hops—refracted (or reflected in the case of certain wavelengths) by the ionized layers above the earth and reflected by the ground. The signal thus reaches the aerial at a definite angle. Not infrequently it happens that a well-designed and otherwise successful aerial simply will not pick up signals from a certain country, due to local conditions. This can often be overcome by varying the height, when they come in at full strength—a tip worth bearing in mind if you find some particular country elusive.

### ● Feeders

To the beginner, the term feeder probably suggests transmitting aerials, so it will be as well at this point to make it clear that transmitting aerials are just as suitable for receiving as they are for transmitting, their particular properties remaining unchanged. The customary method used by transmitters to test their aerial is by trying it for reception. It is the aim of a transmitter to transfer all the energy into the aerial itself. Obviously the ideal means of doing this would be to position the transmitting apparatus up beside the aerial. This being impossible, the next best thing must be done. The energy is fed through a feeder system which of itself is unable to radiate, usually transposed cable or separate wires held in position by transposition blocks.

We shall continue next month with a study of feeder systems for the receiver.

---

TURN TO PAGE 31  
FOR  
READERS' BARGAINS

# MR. EVERYMAN TRIES A COMMUNICATION RECEIVER

MANY PEOPLE, even keen short-wave listeners, seem still rather puzzled as to the exact position in the realm of radio held by communication-type receivers. Possibly the terms "single-signal" and "communication" suggesting one class of reception only is responsible for the impression that these receivers are unsuited to general use—an idea supported by their severely practical appearance. They certainly look to be more at home in a receiving station or laboratory than a drawing-room, and yet their severe lines cannot be said to be completely out of harmony with modern furnishing schemes. The almost exclusive use of them by transmitters has rather given the impression that they are unsuitable for short-wave broadcast reception, so it was decided to try out some of them purely from the point of view of the novice, as opposed to the expert.

## ● The R.M.E. 69

One of the best known receivers of this type, an RME69, was supplied for test purposes by Messrs. Webbs Radio, 14, Soho Square, W.1, and it was felt a review of this receiver's performance under everyday conditions would be of greater interest than a laboratory report consisting of facts and figures which even to those fully understanding them, are difficult to appreciate if unfamiliar with receivers of this description.

This receiver goes up to 550 metres and so it may very well be adapted to ordinary domestic listening. "What about long waves?" you may ask. I too, might well ask the same question "What about long waves?" High-power long-wave stations were thought to be necessary to give a wide service area in days long gone by, but we know better now, and for a number of years they have been superfluous for listeners with even fairly modern sets. Although it has often been rumoured that the B.B.C. would like to do away with the long-wave National there is always a protest from someone that someone else would be hard hit by it. Yet a manufacturer would be thought to be completely mad if he decided to cut provision for long-wave listening out of his receivers although the listener does not really want it—which merely shows how irrational we humans are—so for all practical purposes a communication-type receiver can be considered as a serious competitor to an all-waver in choosing a receiver for general listening.

## ● Deceptive appearance

Many all-wavers unfortunately have the short-wave part stuck on as an afterthought and leave great gaps in the tuning range so actually they should be called 3 or 4 wave-band receivers as the case may be, which gives the communication type an enormous advantage in this respect. This is a much greater advantage than it appears at first sight. Many of these "in-between range" stations are really good "entertainment value" and thus one obtains a much greater effective listening band.

Now for the frightening appearance of communication receivers—they look difficult to operate and the

RME69 in common with others has 11 knobs. It is utterly impossible without having every part of the set under control to bring a weak distant station through a half-a-dozen locals and the adjustment of these extra controls gives that flexibility needed for this purpose. But for broadcast listening only two knobs need be used once the others are set. To prove this beyond doubt this receiver was installed in a household of the least technical listeners possible and their normal receiver rendered inoperable so they would have to resort to the RME69 for medium-wave programmes. High fidelity reproduction was obtained by them from scores of broadcast stations without difficulty once they were told that the needle of the carrier level indicator had to be "tuned" to the maximum reading irrespective of volume. Yes, Mr. O-v-1, even when they tried the short-waves they found it much easier to handle than they would your three knob affair which works wonders in your hands only. In fact these BCL's expressed disappointment when it was taken away from them "just as they were getting interested" as they were receiving stations they had never heard free of interference before.

To an intelligent person half-an-hour is quite enough to learn how to use to full advantage the flexibility afforded by these extra controls, and after an evening's practice the veriest tyro should be able to receive distant amateur stations free of interference. For simple broadcast use it will do everything asked of it; high selectivity, quality reproduction and a bigger output than most listeners can ever use, with a much greater variety of entertaining listening that the best of so-called all-wave receivers can offer.

## ● Specification

Now for a few facts about the RME69 for those who are interested in communication receivers for their special virtues. The main tuning dial is calibrated in megacycles and wide band-spreading is continuous over the whole range, adjusting all r.f. circuits and not merely the oscillator. The built-in coils cover 9 to 550 metres in six steps, .55 to 1.5, 1.5 to 3.1, 3.1 to 6.8, 6.8 to 13, 13 to 20, 20 to 32 mc. with a generous overlap between each. The crystal filter ensures high selectivity which is variable and can be switched either in series or parallel. A built-in audio-frequency monitor is operated by pulling out the volume control knob which also serves as a send/receive switch, leaving the heater volts on and removing the plate voltage from the r.f. and i.f. valves. Other features are, cast aluminium chassis frame, tone control, 'phone jack automatically disconnecting speaker, 6-volt standard valves, built-in power supply and very complete screening in every stage.

It is housed in an attractive, well-ventilated "furniture" steel cabinet with crackle finish, and is obviously capable of standing up to real work and rough handling.

In addition to being a receiver for reliable communication work the RME69 can truly be described as a delight to handle for daily all-useful-wave listening.



● **Components**

A Bulgin C5F 465 kc. i.f. transformer was used, as this has the extra reaction winding included at one end. The condenser should be a sturdy slow-motion job of .0005 mfd. capacity.

Decoupling condensers in the h.f. portion of the set are of an unusual value. The capacity of .003 mfd. has been found to be the best, and greater capacities will only result in an increase of noise. Where both i.f. and r.f. currents are handled a .003 and .01 mfd. are placed in parallel as shown.

The hexode section of the f.c. has been left untuned; the extra coil and condenser make no difference, and would only increase cost and ganging difficulties.

● **Layout**

The intending constructor may have various practical designs in mind, but the drawing shows the layout as used by the author. Certainly no instability or electrical deficiency was noticed, yet no special claims are made for the plan.

All wiring should be rigid, especially in the oscilla-

tor section, or signal wobble will result. Valves and coils were all screened, in addition to this the h.f. portion was completely boxed in with aluminium.

**I.S.W.C. BIRTHDAY BROADCASTS**

Mr. GEO. W. KING, official programme arranger of the I.S.W.C., 116, Sheil Road, Fairfield, Liverpool, forwards the following information:

This Club celebrates its ninth birthday in December, and the following programmes will take place to mark the occasion:

1. From OLR, Praha, Czechoslovakia on 31.41 metres, from 21.05 to 21.35 G.M.T. on Saturday, December 4.
2. From 2RO, Rome, Italy on 31.15 metres from 00.40 to 01.50 G.M.T. on December 9.
3. From Radio-Coloniale, TPA4 on 25.6 metres, from 4.45 to 5.45 a.m. G.M.T. on December 24.

A prize of a world globe is offered to the member who sends in to headquarters the best report on the reception of 2RO, provided he resides over 600 miles from this station.

# Short Wave Masterpieces-

**Ultra Short Wave Interchangeable Coil.** Cat. No. 1050. Price 1/8d.

**Split Stator Transmitting Condenser,** 50 x 50 mmfd. Cat. No. 1081. Price 17/6.

**Microdenser for High Frequency tuning,** Calit insulation. Cat. No. 900/20. Price 3/9d.

**Short Wave H.F. Choke,** 5-180 metres. Cat. No. 1010. Price 2/-.

*By* **EDDYSTONE**

## Foremost of Short Wave Craftsmen

1938  
ILLUSTRATED CATALOGUE  
Free on Request.

STRATTON & CO. LTD.,  
EDDYSTONE WORKS,  
Bromsgrove St., BIRMINGHAM

London Service,  
Webb's Radio Stores,  
14 Soho St., Oxford St., W.1.

# Hi! Hi!

"A little nonsense now and then  
Is relished by the wisest men."

W. S. Gilbert.

## (A Festive Effort by "Centre Tap")

DESPITE THE high demand for Humour, there is still a vast, untapped source in this radio world of ours, although the demand for it is not so great as the less specialised sort which is more easily marketable. Just look round for yourselves. How about that fellow a few doors down from you who makes the craziest short-wavers imaginable? Why, you have to laugh every time you think about him and his comic hay-wiring!

### ● "Things to come"

I have always considered that Ambrose Fandermere is the world's best example of this type and I have already attempted to persuade the Editor to let me write him up in the "Round the Ham Shacks" series. After all, there is no reason why it should be limited to hams—why not listeners and constructors? Ambrose Fandermere *has* got a shack—quite a modest affair it is true, but he built it himself out of practically nothing so to speak, which must be considered all the more to his credit. I specially interviewed him for the purpose and it seems a shame that such good material should be wasted.

Ambrose is a real enthusiast. So much so that instead of sticking to ordinary design he has always tried to strike a new note. He first took an interest in radio during 1924 when he exchanged a buck rabbit and a parrot cage for a crystal set with a valve amplifier (less valve) and an h.t. battery which had given more or less trouble-free service for over eighteen months. He regularly dismantled and re-assembled this outfit with minor alterations, alternate Tuesdays and Fridays until the ebonite panel was so completely smothered in holes that it crumbled away in his hands.

### ● Forethought

By that time, fortunately, simpler home-construction had become the vogue. Anyone, so the advertisement said, could construct the "Roof-Raiser" Three in a half-an-hour with the aid of a screwdriver and a penknife. This appealed most strongly to Ambrose, he felt that after all even if he did want to alter or re-build it twice a week it would only take him half-an-hour a time, and it would give him more opportunity to listen, especially as he was very keen on getting foreign stations like one of the fellows at his office claimed to. Also the part about the penknife and screwdriver attracted him as he already possessed them.

He bought a kit of parts (less the bits he felt usable from his previous receiver) from a little shop down a back street in the East End and because the proprietor cut one-and-ninety off the price, Ambrose said he would go back there when he wanted to buy anything else—which he hoped he wouldn't. So the proprietor said he would make it one-and-elevenpence discount instead, which pleased Ambrose immensely and he told the proprietor he would also recommend his friends to go there. How-

ever, the proprietor made a mistake with the change which Ambrose didn't find out until he got home!

After he had built up all the circuits he could find—most of them enabled him to get the Regional on the loudspeaker and some the National as well, although not quite so well as the advertisement and published details led him to believe, but that, he was told upon enquiry, was because he was living in a blind spot—he hit upon a new idea. That was to take a bit of one circuit and a bit of another and blend them into one receiver. The results were about the same and he had the added satisfaction of feeling that at last he was a designer.

Then, all of a sudden, like a bolt from the blue, came the metal chassis. Ambrose still maintains to this day that he, and he alone, was the first constructor to think of using an inverted biscuit box for a chassis. Hundreds of others copied him but it was his idea first.

### ● Ingenuity

He still uses biscuit boxes both for his short-wavers and broadcast receivers, but it meant adding a hammer and a nail to his collection of tools. He points out that it is much easier to punch a hole through and if you do it from alternate ways, that is, one from the outside and then one from the inside, very little disfigurement results. With a large size biscuit box there is an enormous area available to add components after the set has been built, inside, on the top and on all the sides, the one snag being that it is difficult to get the nuts on the component-holding-bolts after the first few parts have been placed inside the box. However, with characteristic ingenuity he has devised a method of securing them with pieces of bootlace threaded through with the aid of a football-lacer.

Ambrose has not yet applied for his A.A. licence. He is much too busy at the moment designing a multi-purpose receiver. In its final stage, he hopes to embody an egg-boiler, bacon-slicer, radio-gram and a swivel-mirror (for shaving purposes) as well as a number of other useful sundries. He has found it impossible to house all this equipment in one biscuit box so he is using three which are placed on top of one another in rack form. By getting boxes of slightly varying sizes and mounting all the components on the outside of the top one and the inside of the bottom one, he hopes to make it collapsible and thus add the further advantage of portability. As it will be too heavy to carry about, pram-wheels will be fitted to the base and an oil-can included in the kit. A de luxe model is to be built later with a caterpillar chain around the wheels so that it can be taken upstairs when required.

Ambrose has approached many leading manufacturers with this outfit, and has pointed out it can be marketed profitably if only enough models are produced to ensure a low retail price. He says that even if they don't sell in the normal way they can easily be disposed of really cheaply in junk shops so they will all be sold in any case.

# On the Amateur Bands

"Ham" News by G5GQ

"DUPLEX 'PHONE should be stopped." "Tell us how duplex 'phone is worked." So which ever way I turn I am going to be caught by someone. Best thing is for me to fall from my fence and bounce from one side to the other!

Duplex 'phone has the very obvious advantage of saving repetitions due to QRM; the ham at the other end can stop until it is clear. Against this other hams complain that stations stick on the air and take up space unnecessarily.

Well, it is annoying to switch on and find a station working duplex dead on your frequency, but you do know he is there. If he were working send-receive he would probably land on you when you had just got a contact, which I always think is worse than having to keep off because duplex is being used on your frequency.

When the carrier is on continuously you know that QRM will be bad at that spot, so the best thing to do is shift your own frequency. Only got one crystal? Then put a piece of cigarette card between the top plate and the crystal, it will move your frequency just the few kc. necessary to clear.

The use of duplex has every advantage, the abuse of it is the cause of the outcry against it. Hams come on 7 mc. with 100 watts or so, put R99 signals all over the place, leave their carriers running for a couple of hours at a time, and then wonder why others complain. If duplex were used with 10 watts, and QSO's limited to half an hour maximum, most of the complaints would cease. The funny part about it is that duplex is supposed to save time on the air, yet hams who with send-receive can only spare ten minutes carry on for ages when they get on duplex.

The trick in using it is to use only a few feet of wire for aerial, and no earth. A.V.C. should be switched off, and manual control used. With a decent superhet I can work within 20 kc. of my own frequency, but with a t.r.f. job there has to be 100 kc. between the two frequencies.

Years ago I used to work 5IN with duplex 'phone on 200 metres. He was about six miles away, and we had R9 signals each way with 15 volts on the p.a. Never had a spot of bother with broadcast either.

## ● Licences

Was tackled at the local club on the subject of licences. One lad told me that he used to look upon licensed hams as little tin gods, but after meeting them he decided their knowledge of radio was inferior to his. He thought there was some sort of formula for getting a ticket, and asked me to say something about it in these notes.

The best thing in applying for a licence is to be honest. Ask for the A.A. permit by saying that you want to get experience in handling transmitting gear. Then, when you get it, experiment with simple transmitters, keep notes, and when you apply for your full ticket you can tell G.P.O. what you have been doing. A well-designed, home-made transmitter is better evidence (especially when supported by notes on the snags met) than any

reference or involved excuse. It shows you have made good use of your A.A. permit, and proves that you are capable of building and using transmitters.

Experiments warranting the use of a full aerial worry many would-be hams. Two things I have often wanted to try, but never seem to have the time for, are tests with aerials. Directional aerials are beyond the scope of most of us owing to the room required. But there is no reason why small ones, suitable for the average ham, should not be developed.

The signal strength of a station depends on the current in the transmitting aerial. In a dipole this current reaches its maximum in the centre, dying away towards each end. How much of a dipole need be used for radiation purposes? Its length can be reduced by coiling up each end, making room for more dipoles in the same space.

Little work has been done on these lines, and the amount of aerial that can be coiled has not been settled.

The other scheme is to vary the angle of propagation by means of a reflector under the aerial. Either its distance from the aerial can be altered, or else some "tune" phasing scheme can be tried.

Two don'ts—don't show a radiating aerial attached to the transmitter when submitting the sketch for A.A., and don't ask for a full ticket because you want to try some modulation system, it can be tried on A.A. just as well.

## ● Lightning

Correspondence with G2PC raises the old question of lightning risk. Are we to protect against a direct strike, or only to provide some means of discharging the aerial? I remember seeing some photos of a direct strike on a church steeple. It was lead covered, and as the lightning approached gaseous lead rose from the steeple to meet it! A million-odd amps would not worry much about our 7/22 earthing cable, so it seems that if lightning is going to strike the best thing is to be out!

Charged aerials are an easier job, a simple aerial/earth switch sees to them, and the sight of the spark when the aerial is earthed always amuses visitors.

## ● Personalities

Calling in Webb's to see G2NO, I ran into Jack Paddon, G2IS. He seems to be a world-wide ham. Over in New York they asked me whether I knew him, another ham back from a job in Paris had run into him there. I missed him for a time and found he was in Africa, assisting in making the film "Sanders of the River."

He has been cursed with home-brewed mains, 50 volts d.c., but has just had a.c. put on, and says that he intends to come on the air with enough power to work through the terrific QRM prevailing.

He regards radio as pure engineering, draws scale plans of everything he intends to build, and when it is built it makes professional gear look amateur,

(Continued on page 38.)

# "HOW CAN I MODULATE THE BATTERY TRANSMITTER?"

AND SIMILAR QUERIES ANSWERED BY G5GQ

I HAVE HAD SO MANY transmitter questions shot at me recently that I think it worth while dealing with some of them in the pages of this magazine.

The most persistent question is that of adding modulation to the battery transmitter described in the May issue. This transmitter consists of a class B valve, one half used as c.o., and the other as doubler when required. The p.a. was a two-volt power valve, a Hivac PP220.

The output of this little rig is between three and five watts, depending on how hard the valve is driven. With a couple of hundred volts h.t. the consumption of the p.a. valve is between 20 and 30 mils., a pretty tall order for h.t. batteries. But this transmitter was only intended for c.w., and so although the valve takes 20 or 30 mils. with the key down, its average consumption is much less. When allowance is made for the time the key is "up," for spaces between words, and for waits while the operator thinks of what to say next, the actual key "down" time is only about a quarter of the actual time the transmitter is in use.

When the consumption is worked out on this basis it will be found to be one quarter of the apparent consumption, and the drain on batteries will be only between 5 and 6 mils., taken on the same basis as a receiver in constant use. Hence battery life will not be a troublesome item.

When we try to use 'phone the load on batteries is constant, and is the full 20 or 30 mils., plus the mils. taken by the modulator valve.

## ● Grid Modulation

The first thought is to use grid modulation. The modulator valve will take, say, 9 mils. The drain is high but not high enough to prevent us trying.

But what about the output? Instead of putting out three watts, we only get 25% of that with grid modulation. Our aerial power has dropped from 3 watts to  $\frac{3}{4}$  watt.

Now we must consider signal strength. A signal must be above the prevailing background noise to be readable. That's obvious to us all, but what is the minimum power required on 7 mc. to effect contacts with reasonable certainty? In practice all the British Isles can be worked fairly reliably with 3 watts, but below this figure the background noise is comparable with the signal strength. I do not mean to suggest that  $\frac{3}{4}$  watt will not reach over the country, but it would mean calling time and time again before raising a station, whereas 3 watts does result in a 75% answer to calls.

## ● Heising Modulation

The answer to the problem is Heising modulation. With this system the output on 'phone and c.w. is approximately the same, but the battery drain is appalling. To fully modulate our three-watt carrier we must have  $1\frac{1}{2}$  watts of audio. Even by using a class B modulator the efficiency will not exceed 50%, which means that the class B stage alone will take 3 watts, or another 20 mils. To this has to be added the driver valve consumption, which will bring the total up to nearly 30 mils.

Thus the drain of the p.a. stage, plus the modulator will be a constant one of nearly 50 mils., far beyond the economic limit of batteries. For these reasons the use of 'phone with this transmitter is not to be recommended; it was designed for c.w. use only.

## ● Tank Circuit Design

Tank circuits cause a lot of confusion. In the battery transmitter the circuit of *fig. 1* was used. This uses a standard type of variable condenser, and because the circuit is series fed this condenser has to be insulated from the chassis.

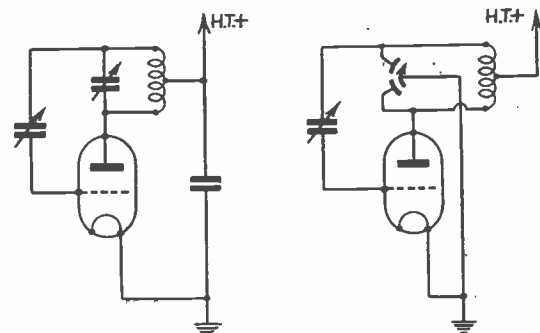

FIG. 1.

FIG. 2.

The use of a split-stator condenser (*fig. 2*) permits the condenser to be connected to the chassis. It also makes neutralisation more or less constant when the transmitter is changed from band to band. The only objection to it is cost, as the price of a split-stator condenser is far above that of the more normal type. If cost is no object, use a split-stator tank circuit; you will find it far more convenient.

On a high-power transmitter the reverse is the case, the split-stator system is cheaper. The reason is that no fixed anode bypass condenser is necessary, and on high power this item alone will cost a couple of pounds—as much as the split-stator condenser. On top of this a normal type variable condenser has to be bought; so if you work out the cost of the two systems—using 1,500 volts upwards—you will find the split-stator more economical.

## ● Experiments

Many amateurs are anxious to experiment but find most research work beyond their pockets, so we will discuss a pet theory of ours which can be played with by any transmitter.

The problem of using 'phone has been stated above, but there is one solution—CONTROLLED CARRIER. The normally used form of controlled carrier varies the carrier strength with the modulation strength. It is complex and not worth installing in a battery transmitter. There is no need to vary the carrier strength with modulation, all we have to do is cut the power from both p.a. and modulator during intervals in speaking.

(Continued on page 38.)



# I. C. S.

## International Correspondence Schools

offer comprehensive and thorough instruction in Radio theory and practice for those wishing to qualify for progressive posts in the Wireless Industry. The matter dealing with SHORT WAVE work has recently been revised and amplified to cover this increasingly important subject. 40-page "Radio" booklet—sent free and without obligation—describes in detail the following Courses of instruction:

Radio Engineering	I.E.E. Grad. Exam.
Complete Radio	I.W.T. Exam.
Radio Serviceman's	C. & G. in Radio Com.
Radio Service & Sales	Exam.
Television	P.M.C. Certificate
	Air Ministry Prov. Certif.

Write for this booklet to-day, and, if you wish, ask for our free advice regarding your career.

### Advisory Department,

International Correspondence Schools, Ltd.,  
90 International Buildings,  
Kingsway, London, W.C.2.

## All Power Transformers Ltd.

Specialists in the  
manufacture of all  
**MAINS EQUIPMENT and  
IRON CORED COMPONENTS**

Your enquiries are invited. Prompt attention for Power Transformers, Chokes, Input and Output Transformers, Modulation and Coupling Transformers.

Reliability and Quality  
the acknowledged best

**ALL POWER TRANSFORMERS LTD.,**  
8a GLADSTONE ROAD, WIMBLEDON, S.W.19  
Telephone: Liberty 3303.

## RADIO AMATEUR'S HANDBOOK 1938 EDITION

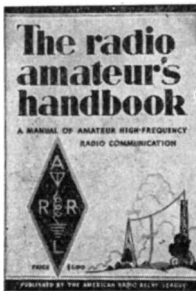

Send now for your copy of the 15th edition of this very famous Handbook. 20 chapters and over 500 pages dealing with every aspect of amateur radio communication.

**RADIO AMATEUR CALLBOOK.**  
Orders now being taken for the December issue, for delivery middle of month. A necessity to every ham and all who own short wave sets. 6/- per copy post free anywhere. G5KA, 41 KINFAUNS ROAD, GOODMAYES, ILFORD, ESSEX. Dept. M.

**Transatlantic All-wave Tuning Pack,** as reviewed in this issue, page 35. Four wave-lengths, 12 - 33, 30 - 80, 195 - 550, 800 - 2,000 metres. With all coils, Yaxley-type switching, 3-gang J.B. Bar-type condenser, Station and metre marked moving pointer full-vision dial. Iron-cored I.F. transformers and valveholders on chassis, grey cellulose finished. Completely wired, aligned and tested, ready to use. 3-gang model, HF, FC and IF, 69/6. 2-gang model, FC and IF, 49/6, carriage paid.

Sole distributors:

**MAINS RADIO DEVELOPMENT COY.,**  
4-6 MUSWELL HILL ROAD, LONDON, N.6.  
Tudor 4046 (Mornings)

## "PAREX" PRODUCTS PAR-EXCELLENCE. OUR FREE OFFER

Have you ever tried to wire a set? After going to endless trouble to collect all the specified components, sometimes after long waiting, you then discover that one or more of the parts are of the wrong type, or unobtainable.

### A GENUINE OFFER

**YOUR SET IS WIRED BY  
EXPERTS FREE**

We charge only for the Components Cabinet as shown here with chassis and lid 13/6 (postage 6d.) "PAREX" Cabinet for "IDEAL" Receiver (described in this Mag.) including chassis and 4 boxes £2. Chassis, panel and boxes alone 30/-

"IDEAL RECEIVER" ready wired 18 gns.

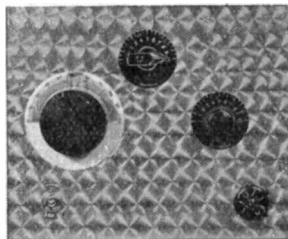

**CLASS "B" ONE VALVER** as described in March No. completely wired and housed in a "PAREX" cabinet (as supplied to B.B.C., Admiralty, etc.)

**EACH SET TESTED AND GUARANTEED.** Components are as specified and include EDDYSTONE condensers, coils, etc. Price £3 (postage 6d.) With valve £3 9s. 6d Coils 2 9 each extra.

Any Set supplied **READY WIRED.**

Let us quote you for "PAREX" CABINETS CHASSIS, PANELS, Etc.

**E. PAROUSSI, 10 Featherstone Buildings, High Holborn, W.C.1** Phone: Chancery 7010

# From S.W.L. to Full Licence—3.

By CHARLES WHEELER

BEFORE GETTING DOWN to the p.a. I decided to re-wire and make a neat job of the oscillator-doubler, and try out another valve. When finished I pressed the key and expected to get a reading somewhere between 10 and 20 ma. in the meter, so you can imagine my surprise when the needle flicked across and the valve glowed in a very pretty but even more disconcerting fashion. Well, I didn't leave it like that long, but checked over my connections, and, believe it or not, those of the valve were reversed, despite the fact that I warned you about that very thing last month, which just goes to show . . . !

## ● Valve trouble

That, however, was by no means the end of the trouble, for when the connections were put right the meter read just under two ma. This time no amount of checking revealed anything wrong, and at last it was decided to give the valve a thorough test. That test showed quite a lot was wrong: it was in fact a wolf in sheep's envelope. The emission of one side, with 100 volts h.t. was 1 mil., and the total emission of both sides, with 220 volts—7. The reason for putting a lot of h.t. on was that some valves have unusually steep curves, and the extra voltage might have resulted in a sudden rise in output.

Like most of the stages of our transmitter the name of the power amplifier gives a good explanation of itself. The p.a. is an amplifier, to which is applied a drive from the c.o. or doubler, and functions simply to give greater output from the transmitter.

In a p.a. valve there is feed-back from the anode to the grid, and unless this is neutralised oscillation will occur; consequently we need a secondary neutralising circuit in the amplifier, and a means of determining when it is neutralised. As there is much to say on this subject I will leave it for a few moments and outline the circuit.

The plate circuit consists of a coil made by winding eight turns of 12 s.w.g. wire on a two-inch former, and a 50 + 50 split stator condenser. The coil is coupled by a small variable condenser to the grid, forming the neutralising circuit (*fig. 2*). H.T. is applied to the plate through an h.f. choke, while h.t. negative goes to g.b. positive and g.b. negative through an h.f. choke to grid. A meter is inserted in place of the bias battery to determine when the circuit is neutralised.

## ● Neutralisation

Now I think I can explain the neutralising operation. The oscillator-doubler was tuned for maximum output and connected through a small fixed condenser to p.a. grid, no bias or h.t. being applied to that stage. The next part of the work is usually described as "juggling" the tank and neutralising condensers, and consists of tuning the n.c. until its capacity is equal to the anode-to-grid capacity, but

the voltage feed-back is in opposite phase, and the two cancel out. This was shown by tuning the tank condenser, and seeing that no variation took place in the meter reading of 9 mils.: it was, however, necessary to readjust the doubler condenser to get the full nine mils.

By the way, negative of meter goes to grid; if current flows in the opposite direction the meter will tend to give a negative reading.

The stage has now been neutralised, and we can get on and bias the valve, replacing the meter by the C battery, and removing the h.t. from the first two stages. I then put 150 volts on the plate of the p.a. valve, which was the PX230SW brought back into service to do good work in yet another capacity. The bias required to reduce anode current to zero was 18 volts, and then remembering a tip: "Never be afraid of using plenty of bias," I put another 9 volts on.

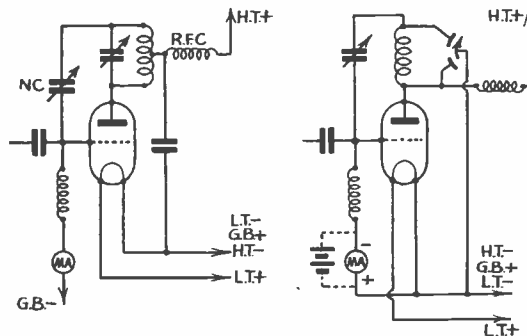

FIG. 1.

FIG. 2.

## ● Three stages working

I replaced h.t. on the first two stages so that all three were working together. Before tuning, the p.a. was taking about 35 mils., but when in resonance, this dropped to 6. When the circuit is in resonance, we are getting a bigger output, which is of course our aim and so for that reading—the smaller the better.

If you have not a split-stator condenser handy—they are rather expensive—there is another quite good circuit (*fig. 1*) which employs an h.t. by-pass condenser. This time h.t. is applied direct to the centre of the plate coil, and a by-pass condenser to earth takes the place of the earthing connection from the condenser. After that, procedure is the same.

By now I hope you have learnt with me how to handle all three stages of a simple c.w. transmitter, and even if you have heard the horrible gurgle which arises from and unneutralised p.a. or worried over a doubler which didn't double, I feel sure you have had some interesting times. Next month I hope to deal with modulation experiments, carrying on with our method of grasping the fundamentals first.

# THE MAINS "S.-W.M."

## "IDEAL" STRAIGHT RECEIVER

### Preliminary Notes by the Designer

IN NEXT MONTH'S issue we shall be dealing with the Mains Version of this receiver, as it is certain that the majority of readers are more interested in this than the battery set, though the latter has proved both popular and successful.

The "Ideal" Mains Receiver will embody all the main features of the battery model—which was fully described in September, October and November—with the addition of a built-in power pack for mains working. This will be accommodated on a chassis very similar to that used for the battery "Ideal," so that the only external connections will be for the power line, speaker, aerial and earth, and 'phones. A monitor-beat oscillator will be incorporated, as before, together with r.f. regeneration and tapped band-spreading, so that the five amateur bands covered are each tuned over 80 degrees of the 0-100 degree main tuning dial.

Hivac valves will be used, as in the case of the battery receiver, as the results obtainable with these highly efficient valves make their inclusion well worth while. In fact, in common with all mains sets when compared with similar battery-operated receivers, the performance of the Mains Version of the "Ideal" is noticeably better than that of the battery model, which is only to be expected.

#### ● Hum

The chief difficulty in any mains short-wave receiver is the elimination of hum on the higher frequencies, and in this receiver we have aimed at nothing less than a completely silent background with headphones on ten metres. This is something of a problem, as all those who have tried to get similar results will agree, and has involved much experiment, as the lay-out and stray coupling effects are the deciding factors in the total elimination of hum. To this end, the grouping of the various stages has been altered somewhat from that adopted for the battery receiver, the ultimate result being that our effort to ensure absolutely silent headphone reception on the higher frequencies has been achieved.

It is interesting to note here that while it was found comparatively easy to obtain a quiet background under ordinary conditions of reception at the h.f. end of the tuning range, the hum came up strongly when using the r.f. regeneration control in its most sensitive setting. In other words, with this control turned down and the receiver working as a t.r.f. receiver of the "straight" type, the background on ten metres was no worse than when using battery supply. But as soon as the r.f. regeneration control was brought up, up came the hum—and what a hum!

While this showed that the tuned regenerative r.f. stage was doing its stuff, it also proved that extra

special precautions must be taken to prevent the slightest trace of a.c. reaching the grid of the r.f. valve. It was this that gave us the headaches. Some will say that the problem should not have presented any serious difficulties if American multi-stage a.c. operated sets can be made to give a quiet background under similar conditions, but actually the problem is a little different, because it is possible, in the first place, to cut down the gain on the high frequencies in such a receiver without affecting sensitivity to any serious extent, while secondly—and even more important—a factory-built mass-production receiver can be screened and boxed up in a manner which is not possible in a design intended for general consumption and reproduction by home-constructors of varying grades of proficiency and experience.

The design must therefore be kept as simple as possible, at the same time obtaining the utmost from every valve in the circuit, and it is really on this point that the main problem hinges.

We mention all this because it may be of interest to those who are trying r.f. regeneration in a short-wave receiver, and in the individual case it may be possible to go even further than we can do in the matter of screening and lay-out, since we must always keep in mind the fact that the set has to be designed for easy reproduction by the average reader.

At one time, we thought of dropping r.f. regeneration in the Mains Version, but when we remembered how striking is the improvement in performance that it gives on the high frequencies, we decided that it must at all costs be used in the receiver under discussion.

#### ● Components

As before, the choice of components has been given very careful consideration, and readers may take it that the parts specified are not only essential for reproducing the model exactly, but that they are the best obtainable for the job. This is not to say that we consider all other similar components inferior, but rather that the ones we have chosen work better together, which is the only reason for using them.

All designers are haunted by the fear that their readers will attempt to build up their set using either components they may have by them, or parts different from those specified. Usually, the receiver turns out a failure, and a black mark is registered against both the paper and designer concerned. This does not prevent readers who have so deviated from the specification writing in to complain, very often giving their oath at the same time that the set has been built exactly as described!

# Spanish Nationalist Short-Wave Stations

By W. L. CARTER

JUDGING BY what has so far been written in regard to Spanish short-wave reception, considerable confusion exists in the minds of British listeners. When one reads of "Insurgent" stations alleged to be relaying programmes from Valencia one is tempted to "say things."

For months past the writer has concentrated upon a careful reception of stations operated by the Spanish Nationalists, and some most interesting broadcasts have been received here (Midlands) since the Iberian conflict flared up. Almost every leader of note has been heard including the late General Mola, Generals Franco, Moscardó of Toledo Alcazar fame, the one-armed, one-eyed Millan d'Astray, veteran founder of the Spanish Foreign Legion in Morocco, and a good speaker. That says nothing of the nightly peroration relayed by every Spanish Nationalist short-wave transmitter from Seville at 10 p.m. G.M.T. The voice of General Quiépo de Llano can thus be heard booming every night at many points on the 40-metre band.

## ● An Authentic Nationalist Roll

The list given below has been officially confirmed and may be taken as being absolutely correct.

Station Call.	Location	Freq (mc)	Metres	Power
Radio Espana (EAJ28)	Bilbao	7.246	41.40	200 watts.
F.E.T.5	Burgos	14.200	21.12	300 "
EA7BA	Cadiz	14.284	40	40 "
EA7BA	Cadiz	7.142	42.00	49 "
F.E.T.5	Burgos	7.100	42.25	300 "
F.E.T.21	Ceuta	7.134	42.00	100 "
EA2BL	Ejea de Los Caballeros	7.000	42.85	50 "
EA2BA	Jaca	14.031	21.38	200 "
EA2BA	Jaca	7.177	41.80	200 "
F.E.T.8	Melilla	7.202	41.65	85 "
EA8AE	Melilla	7.200	41.66	20 "
EA8AE	Las Palmas	14.080	21.30	100 "
EA8AE	Las Palmas	7.200	41.66	100 "
F.E.T.	Las Palmas	7.003	42.33	40 "
F.E.T.	Las Palmas	7.117	41.97	40 "
F.E.T.6	Palma de Mallorca	7.125	42.10	145 "
F.E.T.6	Palma de Mallorca	7.168	41.85	145 "
EA1BL	Pontevedra	7.212	41.59	75 "
EA1BL	Pontevedra	7.200	41.66	75 "
EA1BH	Pontevedra	7.500	40.00	60 "
Radio Espana (EAJ8)	San Sebastian	7.203	41.65	1 kw.
Radio Pizarralcs	Salamanca	10.630	28.22	1.5 kw.
EA1BO	Salamanca	7.070	42.43	74 watts.
EA1AV	Salas	15.000	21.12	60 "
EA1AV	Salas	7.000	42.85	60 "
Radio Tenerife (EAJ43)	Tenerife "El Tablero"	10.373	28.92	23 kw.
F.E.T.7	Tenerife	7.474	40.14	100 watts.
EA9AH	Tetuan	6.996	43.50	500 "
EA9AH	Tetuan	3.992	75.15	500 "
EA9AH	Tetuan	14.030	21.40	Not stated.
F.E.T.1	Valladolid	7.006	42.82	400 watts.
F.E.T.10	Vitoria	7.027	42.69	160 "
R.R.6	Vitoria	7.265		Not stated.
EA2AA	Zaragoza (Saragossa)	7.002	42.82	150 watts.

Keen listeners may have recognised there are certain omissions, e.g., Santander and the famous mystery station "Radio Espana en el Frente de Madrid," which operates on two frequencies simultaneously on the 40-metre band. It uses a secondary identification of "Radio AZ," but invariably announces itself by its full name as well. One or two people have written to the press about this station, giving the impression of its being a real capture and difficult to receive. I can only say that it has been received here three times daily over a period of months. Those who send in a control report to Spain and ask for a QSL acknowledgment will get this, but there will be no indication of the transmitter's location. The reason for the omission is obvious, but I can assure listeners that it is a genuine Madrid Front station.

## ● News from the Front

I have had some really exciting times with a short-wave receiver during the war in Spain, and it is possible to beat completely the Press in up-to-date information. A particularly notable example of this was my reception of the little radio station at Durango near Bilbao in pre-Iron Belt days. This was only a field transmitter but it sent out quite a respectable service, although its musical programmes were at times sadly deficient in quality. This station, which styled itself Radio Requeté en Durango, worked a regular schedule until shortly before the occupation of Bilbao. I was officially informed that I was the only person outside Spain who had reported reception of it. The night before Bilbao fell, the Durango transmitter suddenly announced at about 6 p.m. that it was closing down for good and moving on to Bilbao. Its short life had ended. Then even more recently in connection with the Asturian campaign I used to listen every evening, as well as in the daytime, to Radio Requeté en el Frente de Asturias. (Call letters R.R.7). That, too, had a short life but a fast one while it lasted. Then, one morning recently, I heard Radio Gijon change its tone completely. It called up Radio Espana de Bilbao (EAJ28) and exchanged hearty greetings. Congratulations were returned amid much "Viva Franco" and "Arriba Espana." Other stations followed suit, San Sebastian being the first of a series, and then I knew Gijon had changed hands. I had practically listened in to the end of the war in Northern Spain.

## ● English Programmes

The language difficulty at once arises in connection with listening to these stations, but it need not cause much trouble. Indeed, it is possible to pick up a smattering of Spanish from these transmissions as some of the stations read the official Salamanca bulletin in English. They give also a reading in

French, German, Italian, Portuguese, and in one or two special transmissions a reading in Arabic. As all these are a literal translation from the original Spanish, it is quite simple to follow the Spanish from the English and so polish up one's knowledge of that pleasant-sounding language. Useful stations of this type are Radio Nacional which is relayed by Tenerife. This broadcast is often put out by F.E.I. of Valladolid, Radio Espana of Bilbao (EAJ28), Vitoria which announces itself as Radio Requeté R.R.6, "Madrid Front," as well as EAJ8 better known as Radio Espana of San Sebastian, which is one of the very best stations for English reception. The English programme, which has been designed specially for British listeners, is broadcast twice daily at 1.20 p.m. and at 9.20 p.m. G.M.T., Sundays excepted. The evening broadcast is a good one, lasting half-an-hour, and delivered in perfect English by a competent announcer. This station has recently greatly increased its strength in Britain by reason of a topographical adjustment of the transmitter. I understand that reports of consistent reception at good strength have been received from as far distant as New Zealand, which is as satisfactory as any European station might hope for.

### ● Verification Hints

Without exception, all Spanish Nationalist stations from 11.15 p.m. onwards relay Salamanca, ending at 11.45 with the military News Bulletin in a variety of languages including English. At the moment my interest is concentrated on EA2BA, the small 200-watt transmitter at Jaca just south of the Spanish side of the Pyrenes. This station transmits in English as early as 3.40 p.m. G.M.T., including Sundays, and the announcer asks for reception reports. When sending these, and the same applies to any other station on the list, I find it certainly pays to enclose a 6d. International Reply Coupon, which has never yet failed to produce a courteous reply. Reports to be of any value at the other end are best detailed over a period—I always report covering an entire week—and I invariably give full details regarding aerial used, type or make of receiver, weather during reception, altitude of residence above sea level, and so forth. Trivial reports are worse than useless to their recipients. Many of these stations will almost certainly cease to operate after the Spanish war is ended, so listeners should "get busy" before their opportunities pass for ever.

In conclusion, it may be mentioned that R.R., or Radio Requeté, and F.E., or more simply Falange Espanola, are explained thus. The Requetés are the Carlists; the Falange are the Spanish Fascists. Both have been amalgamated in the organisation now styled F.E.T. or, to give it its full title, "Falange Espanola Tradicionalista y de las Jons." General Franco has assumed leadership of this organisation, according to many of the broadcasts.

Some of the transmitters still operated by them still preserve their original names as a kind of historical interest. Bilbao, San Sebastian, and Madrid Front were all formerly Requeté stations, but within the past few months they have changed their style to Radio Espana.

It is hoped these few notes may be of assistance. Their accuracy is guaranteed correct after a very long period of annotation and exceedingly careful checking. The information given agrees in every respect with that supplied by official Spanish Nationalist sources.

### "S.-W.M." Class B Receiver Test

The first striking feature about the class B receiver is its neat and tidy appearance. Whilst the components are not crowded together the wiring is direct and short. The metal cabinet not only shields it but gives it a professional appearance. Tuning is made very easy for the operator by the bandspread and good slow-motion dial. When the reaction control is advanced very smooth oscillation is obtained, and this, together with the complete absence of hand capacity and background noise, probably account for the success of his little receiver. Although one or two blind spots were noticeable these could be eliminated by adjusting the aerial series condenser.

Good loudspeaker entertainment was obtained on the strong signals, aircraft stations, especially, coming in very well. The aerial used during these tests was a sixty-foot doublet, only one side being connected. It was found that American signals could still be received at good strength on nine feet of wire placed on the floor.

Some of the best 20-metre fone signals were, October 14: W1JFQ, BBS, KKP, FLH, W2JMC, HYT, ZC, GIZ, MRX, FBA, W3EQU, AFG, FTI, W4DLH, OC, W8GKC, HAF, MAT, FNN, MJT, NEX, OKU, NXQ, VE1FQ, VO2Z, SU1WM, FA8GT, SV1CA. October 15: W1JRO, QM, ZB1L, SU1SG, WM, CN8AM, SV1CA, KE, ES5D, F8PU. October 16: W1BLO, JGX, JG, W2IVW, ZC, IUP, W3DFH, VO1I, VO2Z, VO6L, SU1RO, CO6JQ, HB1S, LA1G, LA6N, HA4A, ES5D, IIM1, F3KN, F8PU. October 17: KA1BH, W1ADM, APA, W2BIF, W4OC, DXP.

—A. D. GREEN, Brentwood Amateur Radio Society.

#### *Recently Published.*

## SHORT-WAVE RADIO

By J. H. Reyner, B.Sc., A.C.G.I., D.I.C., etc.

This book is a thoroughly up-to-date guide to modern developments in the use of the short, ultra-short, and micro-waves. It gives a comprehensive survey of the available data concerning them, and of the practical methods by which they have been harnessed for radio and television transmissions. It shows the tremendous progress which has been made in short-wave radio telegraphy during the last few years. "Accurate and up-to-date."—*Electrical Review*. 162 pages. 8/6 net (by post 8/10).

Order from a bookseller or direct from

**PITMAN**

Parker St., Kingsway, London, W.C.2.

# CORRESPONDENCE

## THANKS, MR. SPOONER

Your editorial, October number of the "S.W.M." on "Value"—those who suggest your modernity can be nothing but Americanism may be classified as insular-minded Britishers! It is a brand of mentality that sends out to Portuguese-speaking Brazil instructions printed in Spanish (how they love each other!) and consistently loses valuable Colonial markets because it doesn't care a hang whether goods suited for home consumption and use are not necessarily suited for other climes. No attempt need be made to learn another tongue—"English is good enough for me," so let the blighters learn a "Q" code. This same insular-mindedness cost us in unpreparedness some £9,500,000,000 twenty years ago!

Go ahead with your progressive policy "S.W.M.," and if anything new originates in a black, brown, yellow or other shirted country let's have it!

## Translation Bureau

If in pursuing your policy you decide to run a bureau for the translation of readers' QSL, correspondence or technical dope, you can count on me for:—

FRENCH (F and colonies; ON, etc.).

PORTUGUESE (CT and colonies; PY).

I have been doing this for R.S.G.B. for the past four years and my "fee" is a stamped addressed envelope.—N. P. SPOONER (G2NS), "Roselea," 17, Swanmore Road, Boscombe, Bournemouth.

## ADVICE FOR 1.7 USERS

The article by my old and very good friend, 2NS, in October, prompts me to go a little deeper into the matter of b.c.l.'s and 160 m., especially as I hope to go on this band in the near future. Rightly or wrongly I think that the majority of b.c.l. interference is caused in either or both of two ways, namely, local ground wave swamp, and harmonics. If this is so what can the transmitting amateur do in order that he may work at any time on this band without causing trouble?

Take harmonics first. They can be due to a variety of reasons which need not be gone into now, but some remarks can be made concerning their care. Obviously the first thing to do is to discover their existence. It is the duty of every transmitting amateur to ensure that the transmitter does not radiate any spurious harmonics.

The easiest way by far to track down harmonics in the case of 160 metres is to build a simple det.-21.f. b.c. receiver (if made with plug-in coils it will also serve as a monitor), then listen for them when the transmitter is radiating. This can be achieved by a loud-ticking clock or some similar device whilst the transmitter is coupled with the normal coupling to an artificial aerial, which is made as near as possible with the same characteristics as the normal radiating aerial. First tests can be carried out by listening in a near-by room with different lengths of antenna attached to the checking receiver to ensure that the detector is not being swamped. Should harmonics be found then various cures can be attempted until a successful one has been found. These can consist of looser coupling; make certain the transmitter is correctly neutralised; that the coupling between xtal oscillator and p.a. is right, different types of aerial coupler, the use of a Faraday shield, etc.

Having found a cure, tests can now be made with the normal radiating aerial coupled, as near as possible to the conditions which existed when using an artificial aerial; p.a. drawing same m.a., etc. Using the same checking receiver, get a friend to run around various parts of the immediate neighbourhood, or better still loan the receiver to different people in order to once more check harmonic radiations under actual working conditions. These checks should, if possible, be made as near as possible to the complainants' homes, the results showing how much interference was due to harmonics and how much to swamp effect.

What can be done about swamp? I think it safe to say that the majority of straight sets to-day use a first detector of the variable mu or h.f. pentode type, and in the case of these interference might possibly be caused—due to cross-modulation. The first valve of our checking receiver can be adapted to these requirements.

A cure in the case of local swamp can sometimes be effected by the use of a resistance of a few ohms in either the aerial or earth lead of the affected receiver; again our checking receiver comes in useful. In addition to a resistance in the aerial lead an old-type plug-in coil can be tried; or an h.f. choke of the b.c.l. type.

In extremely bad cases, next-door neighbour, etc., a trap would seem to be the best thing, and should be fitted as near the aerial terminal as possible. Too much trouble, you think? Careful attention to the foregoing enabled the writer to operate local fone (using a single valve Hartley, plate modulated) on 7 mc. for a number of months, at any time of the day or night. Complaints? None.—F. J. R. TAYLOR (G6YD), Portland Hotel, King's Street, Weymouth.

## "EX-OP THREE" ON LEARNING MORSE

May a third "Ex-op" give his experience of teaching Morse. I have always found that anyone who has first learned by "opposites" has to re-learn in the ordinary way. It is a longer job, in the first instance, to memorise each letter separately, I admit, but when it is done there never is that doubt in one's mind as a "P" or "X" comes along—that extra second needed to decide which to write invariably means the loss of the remainder of the word. This is a disaster if a P.O. examiner is to check the copy.

To conclude, let me agree with the original "Ex-op" no matter where the code is learned—the best way is undoubtedly with a valve oscillator and 'phones. The sound of a letter in Morse is far removed from its appearance on paper, and let us not gull would-be telegraphists—a good operator takes a long time, and a great deal of practice, to become efficient.—J. A. KAYE, (2BTK), 63, Allerton Grange Way, Leeds, 7.

## "EX-OP TWO" WARMS UP!

Your contributor, C. A. Rigby, in his reply to my comment seems to think that uttering Morse sounds aloud must necessarily mean shouting them. I think the majority understand that it is only necessary to make these sounds sufficiently audible to enable one to become accustomed to the Morse equivalents, in a convenient manner. Learning in this way is no more annoying to others in the home than someone learning to play the piano, violin, etc. Moreover, it is a very poor household whose members cannot bear and forbear!

Referring to the statement "the majority of learners combine both sight and sound methods," surely there's no such thing as sight method in a system which essentially depends upon sound. Your contributor must be getting confused with the Morse lamp as used in the Services and the Merchant Service.

I cannot agree that nine out of ten would-be operators will discard the sound method for a grouping of letters so as to memorise quickly, and for the following reason. Take the Morse equivalent of any letter you like. That particular sound is peculiar to that letter only. Now does it seem feasible that one should first think of the *opposite* of this sound before writing down the appropriate letter? I think not.

Regarding the last paragraph, if Mr. Rigby is friendly with his neighbour he can do him a good turn by pointing out that he will never make a good telegraphist while he uses a key as if he were sending with a hammer. The poor fellow is evidently misguided—he is using a gap that is much too large and no wrist work.—"EX-OP," Westcliff-on-Sea.

## A "SUPER" FOR £5

I read with interest Bob Everard's few words on receivers on page 17 of this month's "S.W.M." I quite agree with him that receivers of the type he mentions are too expensive to buy. My advice is—build a set to suit your tastes and pocket. For two years I ran an a.c. receiver—untuned h.f., det., i.f. and pentode. I'm one of those funny people who will not have batteries or 'phones at any price—the starting up of a local ham about a quarter of a mile from here made a superhet necessary.

Now I'm not a No. 9 hat, just a very ordinary constructor and my only test gear is an old Pifco all-in-one meter, but with the aid of last year's Osram valve book and a little common sense I have built a s.w. superhet which I think will be hard to beat in performance.

The set consists of f.c. (X41), h.f. pen. (i.f.), d.d.t. and AC2 Pen—i.f.'s are 465 kc.; energised speaker; switched coils, tuning from just below 13 metres to 250 metres in three steps with no gaps (another of my dislikes is plug-in coils) and the lot has cost round about £5, the only secondhand parts are speaker and smoothing condensers (8 mfd.'s). The drive is two-speed—8-1 and 6-1—the coils are the new Wearite P type. I am using a tuned r.f. stage with regeneration in front of the set and very shortly I'm going to put the r.f. stage on the one chassis as soon as I can get the



# GUIDE TO THE WORLD'S SHORT-WAVE BROADCASTERS

(listed by Continent)

Compiled for "The Short-Wave Magazine" by F. A. BEANE (2CUB)

All times are given in G.M.T. for convenience.

## LATIN AMERICA

### HJ4ABB, MANIZALES (Colombia)

Metres: 49.10. Kilocycles: 6,110.  
Power: Believed to be 1,000 watts.

**Operating schedule:** 23.00—04.00 irregular.

**Standard time:** G.M.T. less 5 hours.

**Distance from London:** Approximately 4,780 miles.

**Postal address:** "Radiodifusora HJ4ABB, Apartado 175, Manizales, Colombia."

**Identification characteristics:** Announces as "Radio Manizales, Estacion HJ4ABB en Manizales, Caldas, Colombia" and often in English as "Radio Manizales in Manizales, Caldas, Colombia, South America." At other times the call is abbreviated to "Radio Manizales."

**Verification of reception reports:** Confirms with large card bearing red call-letters; difficult to obtain, however.

### HJ4ABD, MEDELLIN (Colombia)

Metres: 51.90 or 48.88.  
Kilocycles: 5,780 or 6,138.  
Power: 1,000 watts.

**Operating schedule:** 15.00—19.00 and 21.00—04.00 daily.

**Standard time:** G.M.T. less 5 hours.

**Distance from London:** Approximately 4,650 miles.

**Postal address:** "Radioemisora HJ4ABD, La Voz Catia, Palacio Municipal, Medellin, Colombia."

**Identification characteristics:** Employs the slogan "La Voz Catia" often.

**Verification of reception reports:** Sends letter-veri.

### HJ4ABC, IBAGUE (Colombia)

Metres: 49.26. Kilocycles: 6,090. Power: 1,000 w.

**Operating schedule:** Believed to be 23.00—04.00; irregular.

**Standard time:** G.M.T. less 5 hours.

**Distance from London:** Approximately 4,700 miles.

**Postal address:** "Radiodifusora HJ4ABC, Apartado 39, Ibague, Colombia."

**Identification characteristics:** Reference to the slogan "Ecos del Combeima"; five or six chimes and occasionally the call in English as "HJ4ABC, Echoes of the Combeima, in Ibague, Colombia, South America."

**Verification of reception reports:** Confirms with QSL card.

### HJ4ABE, MEDELLIN (Colombia)

Metres: 49.20. Kilocycles: 6,097. Power: 1,000 w.

**Operating schedule:** 14.30—18.00 and 22.00—04.30 daily.

**Standard time:** G.M.T. less 5 hours.

**Distance from London:** Approximately 4,650 miles.

**Postal address:** "Radiodifusora HJ4ABE, Cia. Radiodifusora de Medellin, Medellin, Colombia."

**Identification characteristics:** 4 chimes at fifteen minute intervals; slogan "La Voz de Antioquia"; relays HJ4ABK and uses English often.

**Verification of reception reports:** Confirms with QSL card.



### HJ4ABH, ARMENIA (Colombia)

Metres: 31.51. Kilocycles: 9,520. Power: 1,000 w.

**Operating schedule:** 13.00—16.00 and 23.00—03.00 daily.

**Standard time:** G.M.T. less 5 hours.

**Distance from London:** Approximately 4,780 miles.

**Postal address:** "Radiodifusora HJ4ABH, Aristizabal Hogos y Gutierrez, Armenia, Caldas, Colombia."

**Identification characteristics:** Two chimes between announcements; four at fifteen minute intervals; call in Spanish, and in English as "You are listening to HJ4ABH, the Voice of Armenia, located in Armenia, Caldas, Colombia," or sometimes as "Short-wave station HJ4ABH and long-wave HJ4ABN, in the City of Armenia, Caldas, Colombia, South America." Closes with one-step—"The Spanish Soldiers."

**Verification of reception reports:** Confirms by QSL card.

### HJ5ABD, CALI (Colombia)

Metres: 49.3. Kilocycles: 6,085.

Power: Believed to be 1,000 watts.

**Operating schedule:** 00.00—04.00 daily, except Monday.

**Standard time:** G.M.T. less 5 hours.

**Distance from London:** Approximately 4,980 miles.

**Postal address:** "Radiodifusora HJ5ABD, Miguel Rivas, Cali, Colombia."

**Identification characteristics:** Employs three chimes, similar to N.B.C., at fifteen minute intervals coupled to the slogan "La Voz del Valle."

**Verification of reception reports:** Confirms with QSL card, but difficult to secure.

### HJ4ABP, MEDELLIN (Colombia)

Metres: 49.75. Kilocycles: 6,110. Power: 1,000 w.

**Operating schedule:** 13.00—04.00 daily.

**Standard time:** G.M.T. less 5 hours.

**Distance from London:** Approximately 4,650 miles.

**Postal address:** "Radiodifusora HJ4ABP, Medellin, Colombia."

**Identification characteristics:** Relay HJ4ABQ; English concert Sundays at 04.00; slogan "Emisora Philco"; sometimes uses single chime between announcements and generally three each quarter-hour.

**Verification of reception reports:** Confirms with QSL card.

### HJ7ABD, BUCARAMANGA (Colombia)

Metres: 31.15. Kilocycles: 9,630.

Power: 1,000 watts.

**Operating schedule:** not definitely known, but heard from 23.00.

**Standard time:** G.M.T. less 5 hours.

**Distance from London:** Approximately 4,600 miles.

**Postal address:** "Radiodifusora HJ7ABD, Radio Bucaramanga, Bucaramanga, Colombia."

**Identification characteristics:** Announces in Spanish as "Radio Bucaramanga, Estacion HJ7ABD en Bucaramanga, Colombia, America del Sud", sometimes as "Radio Bucaramanga." English used infrequently, the name Bucaramanga being spelt out distinctly; bugle fanfare at the hour; news bulletin at 00.30; sometimes employs female announcer.

**Verification of reception reports:** Will, no doubt, verify as reports are requested.

**N.B.**—This may be HJ2ABD, Radio Bucaramanga, of the same city, employing a new call-sign for the 31 m. band.

### HJ4ABU, PEREIRA (Colombia)

Metres: 48.78. Kilocycles: 6,150.

Power: Believed to be 1,000 watts.

**Operating schedule:** 14.30—17.00 and 23.30—03.00 daily.

**Standard time:** G.M.T. less 5 hours.

**Distance from London:** Approximately 4,780 miles.

**Postal address:** "Radiodifusora HJ4ABU, La Voz de Pereira, Cesar y Mario Arango M., Pereira, Caldas, Colombia."

**Identification characteristics:** Announces often as "La Voz de Pereira, en Pereira, Caldas" and mentions "General Electric" often; does not appear to employ English.

**Verification of reception reports:** Confirms with QSL card.

### HJN, BOGOTA (Colombia)

Power: Believed to be 5 kw.

Metres: 50.42. Kilocycles: 5,953.

**Operating schedule:** Thought to be 01.00—04.00 daily.

**Standard time:** G.M.T. less 5 hours.

**Distance from London:** Approximately 4,780 miles.

**Postal address:** "Radiodifusora HJN, Ministerio de Educacion Nacional, Teatro de Colon No. 5—28, Bogota, Colombia."

**Identification characteristics:** Announces in Spanish as "Radio Nacional" and occasionally in English as "This is HJN, the National Broadcasting Station in Bogota."

**Verification of reception reports:** Will not verify.

# OPERATION ON 1.7 mc.

## Announcing Some Proposed dx Tests

By G6FO

THAT THE 1.7 mc. amateur band is being sadly neglected by the majority of transmitters goes without saying; but this has been the fate of the low-frequency bands ever since 1926, when the rush to get lower and still lower in wavelength first started.

It is, however, noteworthy that the larger proportion of those amateurs who are at present operating on 1.7 mc. fairly regularly are "old timers" who, while they do their share on the dx bands, use 1.7 mc. for local working in daylight and medium-distance contacts after dark. In other words, experienced transmitters realise to the full the value of our 160-metre band, but it is safe to say that the great majority of the younger generation of amateurs—those who have been licensed during the last three or four years—rushed straight to 7 mc. for their initial efforts on the air, with the results which we all deplore to-day. A great many of these newcomers are not even licensed for 1.7 mc. simply because they made no request for it, and so one of the most useful and interesting of our bands is closed to them—which may be just as well!

### ● Retrospection

Recent articles in this magazine by G5GQ and G2NS have effectively disproved some of the accepted objections to a wider use of 1.7 mc.—limited range and b.c.l. interference troubles. But the fact that here it is also being suggested that even dx is possible needs some further explanation. So let us delve briefly into history, here recorded for the first time.

In the winter season 1931-32, it was noticed by many, in common with the writer, that those European amateurs who did appear on 1.7 mc. could be worked quite as easily on that band as on, say, 7 mc. The outstanding example was the famous OK3SK who, using only 3 watts, worked on one particular evening all the G stations who happened to be on the band. This success encouraged a small group of keen 1.7 mc. enthusiasts, one of whom was your present scribe, to set about organising some Trans-Atlantic tests. At the time, the idea of this was so ludicrous that it was kept a close secret from all but the chosen few, and the test was duly staged in December, 1932, in co-operation with several American stations, the G's being, of course, tied down to ten watts input—and it was a genuine 10 watts in all cases. So far as any of our signals getting over to the States was concerned, the test was a failure, but we did hear consistently two or three W's, of whom W1DBM will always be remembered. He came over every morning at anything from R5 to R7, being readable right up till 08.00 G.M.T., or broad daylight on this side. We found afterwards that this was scarcely to be wondered at, as he was using 460 watts input and a directional aerial 560 feet long! Moreover, his QRA was Cape Cod, about as near this country as he could reasonably get.

### ● Discovery

However, another and more important fact which emerged—and it should be explained here that the schedule ran from midnight till breakfast-time daily—was that the peak time for Trans-Atlantic signals on 1.7 mc. was from 05.30 to 07.30 G.M.T., while it also became evident for other reasons that the season was not well enough advanced for two-way working with low power.

Accordingly, a further test on the same lines was organised in February, 1933, the same group of stations taking part. The writer had the good fortune to be first across, working W1DBM one very chilly morning for over an hour between 06.00 and 07.15 G.M.T., with solid copies both ways. This was with 9-watts input to a push-pull transmitter from 230 v. d.c. mains, the radiating system being a simple type of aerial-counterpoise system with two 66-foot arms, such as could be erected almost anywhere. G5WU was also heard on this occasion, his transmitting arrangement being almost identical with that described.

The following year, several other low-power G stations repeated the feat, and since then a total of about six British stations have worked the States or Canada on 1.7 mc. Of these, G5WU, G2II, G6YQ and G2PL should be mentioned, and there are probably others of whom the writer has not heard.

### ● Future tests

Coming back to the present time, we are now approaching the 1938 season, and once again the question has been raised about organising similar tests. There are several operators who have already indicated their desire to take part; both in the States and on this side, and the present suggestion is that the tests be arranged for the first or second week in February. Whether any *organised* effort is made, however, depends on the response to this article, so that readers interested are asked to get in touch with the writer through this paper. As much correspondence is involved, those wishing to join should write immediately, since we must all know the call-signs and frequencies which are to be listened for. Only those who write in answer to this article will receive the necessary details, while the results (if any!) will be duly published in these columns.

For those who may be new either to the 1.7 mc. band or amateur transmission, we would say that success depends on efficiency—even a small radiating system can be made to perform well—while a QSO with the States on 1.7 mc. can be marked down as a really outstanding achievement.

Finally, it is hoped that there will be in the near future an opportunity to augment this article with some details regarding suitable apparatus and small aerial systems for 1.7 mc. working.

# SEND TO SCOTT-SESSIONS

FOR

Kits or complete instruments as described in "S.-W.M." Lowest charges for first class work. 15 years' experience. U.S.W. Equipment. Transmitters of all powers. Special receivers and instruments built to your own specification. Service Department for overhauling, repairing all U.S. and British sets. Completely equipped works. Prompt Service. Free quotations—no obligation. We have helped many thousands of amateurs throughout the world. Let us be of service to you. Send us details of your requirements **to-day**. (Tropical finish on all apparatus, if desired)

Phone :  
TUDOR  
4101

**G. SCOTT-SESSIONS & CO.,**  
Radio Engineers  
(Contractors to H.M. Government Departments, etc.)  
**MUSWELL HILL, LONDON, N.10.**

## NEW YEAR RESOLUTIONS!

If by some chance you have been ploughing a lonely furrow in your experimental work why not make a New Year's Resolution to join the Radio Society of Great Britain?

The annual subscription is moderate (London 21/-, Provinces 15/-).

The Society, founded in 1913, to-day has a membership well in excess of 3,000. Each month the T. & R. Bulletin is sent post free to members. This Journal contains on an average 60 pages of up-to-date technical and topical information—written by and for radio amateurs.

The November issue includes important contributions dealing with such widely different subjects as Third Harmonic Suppression, a low power battery operated transmitter, The Month on the Air, 28 and 56 Mc. activities, International and local Contests, Bright Ideas, and a full length article on the construction of Transmitters, the latter being Part VIII of the popular "Helping Hand" feature.

In addition, "Uncle Tom" commences a new series of monthly contributions under the title "Twelve Years Back."

Resolve to-day to write for a copy of this issue (price 1/- post free) and ask for full details of membership.

All communications to

The Secretary:

**RADIO SOCIETY OF GREAT BRITAIN**  
53 VICTORIA ST., LONDON, S.W.1



**HAVE YOU HAD** a copy of our latest Catalogue of Short-wave Components? Full of **1 1/2 d.** good lines for short-wave enthusiasts. **1 1/2 d.** post free

**Q.C.C. H.F. CHOKES**  
specified for the  
"IDEAL" RECEIVER.

Type A. Three required 2/3 each  
Type B. Three required 1/3 each

**THE QUARTZ CRYSTAL CO., LTD.,**

63 & 71 Kingston Rd., New Malden, Surrey, Eng.  
Telephone No.: MALDEN 0334.

**SPEAK TO THE WORLD**  
WITH AN

**R.F.P.15 Transmitting  
PENTODE**

Price - - 30/-

Filament Volts	4 v	Anode Load	10,000 ohms
Anode Volts	500 v	Screen Volts	300 v
Max. Anode Input	25 watts	Speech Input	1 watt

**362** **RADIO VALVE Co. Ltd.,**  
324/6 LIVERPOOL ROAD,  
LONDON, N.7. North 1853

# Practical Ultra-Short-Wave Reception

Some Notes on  
Apparatus and Technique

By A. J. DEVON

THE INTERESTING ARTICLES which have appeared recently in this magazine on short-wave reception in general, and results on ten metres in particular, will probably encourage many readers to explore the 7-10-metre range. There are several commercial receivers which tune down to below seven metres, but it is certain that the majority of listeners will use home-constructed apparatus, as the commercial sets mentioned—being designed primarily for television reception—will necessarily be in the hands of comparatively few people, who happen to be within range of Alexandra Palace.

The purpose of this article is therefore to discuss, for the benefit of the more technically-minded home-constructor who wishes to get away from the ordinary type of short-wave listening, some of the practical points in connection with the design and operation of receivers covering the range 5-10 metres.

## ● Compromise unsatisfactory

First, as regards 10 metres—an existing short-wave receiver can very often be adapted to give satisfactory results on this band, but they will never be as good as with a set designed for the purpose. The reason for this is that practically every published design for home-constructed short-wave receivers assumes their use over a waveband of about 15 to 70 metres, as it is within this range that the more regular and reliable transmissions fall, and even if the set will tune down to 7 metres, its

efficiency at these frequencies will be low, because the values of capacity and inductance must be chosen to be the best compromise over the more normal tuning range. Putting this another way, for reception on 40 metres, by-pass and de-coupling condensers should have a value of .001 mfd., but on 10 metres the corresponding optimum capacities are not more than .0003 mfd., and on 5 metres, .0001 mfd. or less. In other words, it is at present a practical impossibility to design a short-wave receiver which will give level performance over a wave-range 10-200 metres, or even 20-100 metres, though in the latter case the discrepancies at each end of the range will naturally not be so great.

That this question of values is very important is shown by considering the frequencies involved. The frequency at 40 metres is 7,500 kc., at 10 metres it is 30,000 kc., and at 5 metres 60,000 kc. That is, dropping the wavelength 30 metres from 40 to 10 metres corresponds to a frequency change of 22,500 kc. But the change in frequency when tuning from 10 to 5 metres only is 30,000 kc. Obviously, therefore, when working on the range 5-10 metres, we are not only dealing with a part of the radio spectrum where frequencies are very high, but the rate of change of frequency for small differences in wavelength is also extremely rapid. Further, the question of design must also be a compromise, for inductance-capacity ratios suitable for 10 metres are not the best for 5, though here the discrepancy is not nearly so marked as when trying to use on the

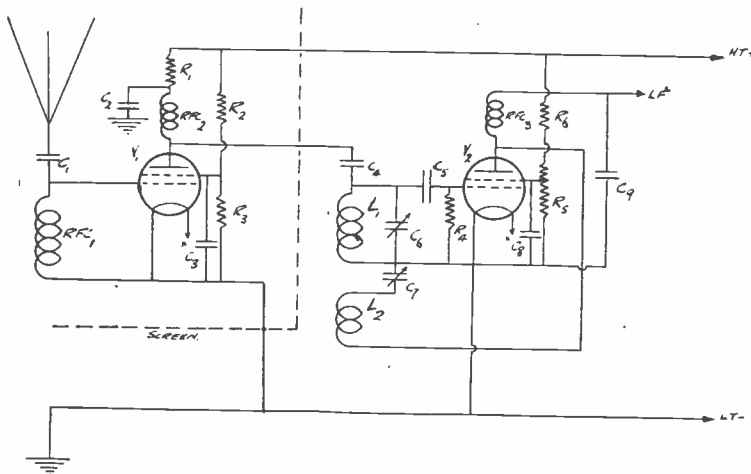

FIG. 1.

C1-4-5, .00005 mfd. C2-C3-C9, .0002 mfd., C6- .000025 mfd. (Eddystone 900/20), C7- .0001 mfd. (Eddystone 900/100). R1-R6, 10,000 ohm 1-watt. R2, 40,000 ohm 1-watt. R3, 50,000 ohm 1-watt. R4, 4 megohm ½-watt. R5, 50,000 ohm 3-watt potentiometer. V1-2, Hivac SG220SW. Fixed condensers should be mica. See table for RFC and L1-L2. X goes to LT pos. Variable condensers should be mounted on adjustable brackets, using Eddystone extension controls, slow-motion drives and flexible couplers.

latter band a short-wave receiver intended for optimum performance on the medium short-wave range.

In practice, the best thing to do if serious experimental work is contemplated between 5 and 10 metres is to build a separate receiver for this range, using it as a radio-frequency stage for an existing l.f. amplifier, which may be the audio side of the ordinary set. While there is a lot of interesting work to be done on s.w. superhets, any ultra short-wave signals which are reaching the aerial will be heard on headphones quite as easily as on a bigger receiver operating a speaker, so that the listener on the highest frequencies need never feel himself at a disadvantage because he is only using a straight circuit.

### ● Design considerations

It scarcely need be said that everything must be kept as low-loss as possible when designing such a receiver, a suitable circuit for the radio frequency end of which (h.f. stage and detector) is given at fig. 1, and a good practical lay-out in fig. 2. Either the usual type of l.f. amplifier can be built on to the receiver, or the output stage of any existing set used, as suggested previously.

The circuit itself is quite conventional, points to notice being the use of an h.f. stage and a screen-grid detector valve. The former is merely to isolate the detector from the aerial, obviating the effects of aerial damping and "blind spotting" as well as allowing any end-on type of aerial to be used. The values are important, and as regards valves, the Hivac SG220SW are strongly recommended. These have the grid connection at the top, which results in greatly improved efficiency on the high frequencies and facilitates a low-loss lay-out with short leads. The three r.f. chokes and the coils are very easily home-made, the necessary data being given in the table. The variable condensers must be on extension controls, and the Eddystone catalogue will suggest suitable parts and slow-motion drives, those actually recommended being shown in the circuit caption. Existing components can of course be used provided they are of good low-loss design and of the correct values, but the general lay-out indicated in fig. 2 will probably have to be altered to suit them.

As shown in the sketch, a wooden baseboard and panel should be employed, as on the very high frequencies metal chassis are not satisfactory. Losses and coupling effects are introduced, and very often a receiver which is quite stable and easily handled when assembled on a wooden baseboard with an ebonite or wood panel, becomes almost uncontrollable when built on an identical metal chassis.

The coils L1 and L2 are all made self-supporting and are mounted directly on the condensers. They are wound up on  $\frac{3}{8}$ -inch diam. formers and then, slipped off, have their turns slightly spaced. Enough wire should be left to allow the coils to mount with their axes horizontal—the Eddystone variable condensers have their rotor and stator terminals at different levels—and the ends of the supporting leads should be looped to go under these terminals. This form of mounting admittedly makes coil-changing not the simple matter it is with plug-in formers, but this is more than counter-balanced by the gain in efficiency, as all unnecessary leads are cut out. It should be noted that while L1 is mounted directly across the terminals of C6, L2 is

across the rotor terminals of C6 and C7, i.e., the rotor of C6 has two coil ends brought to it, so that there are three terminals to be unscrewed when changing coils. The stator of C7 goes straight to the plate of the valve. The supporting arms of the coils should be bent so that the two coils are in the same line and about  $\frac{3}{8}$ -inch apart, making sure that their turns are in the same direction.

The operation of the receiver is quite simple. With C6 set near full capacity and C7 about half-mesh, the potentiometer R5 is adjusted till oscillation occurs. The control of reaction now takes place on C7, R5 only being touched when changing bands, as re-setting will be necessary with different tuning-ranges.

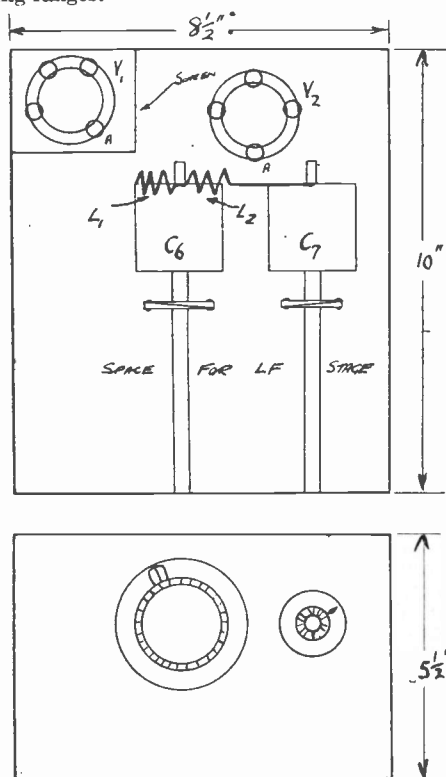

FIG. 2.

As this is suggested as an experimental receiver for general exploration of the ultra short-waves, band-spread is not included, though it is a simple matter to incorporate a three-plate midget variable in parallel with C6 in order to get it. Tuning is, of course, quite sharp, but not unduly so as C6 is kept small on purpose.

### ● Locating the Bands

The 10-metre band will readily be found by listening almost any afternoon, when many American amateur 'phone and c.w. stations will be heard at good strength. For reasons connected with the harmonic relation of the amateur bands and the convenience of using lower frequency crystals which give transmitting points on several of them, only about half the 10-metre band is populated. That is to say, though the band of frequencies reserved for amateur transmission is 2,000 kc. wide, from

28,000 to 30,000 kc., the bulk of the signals will be heard between 28,000 and 29,000 kc., so that bearing this in mind, a rough calibration can be obtained.

As regards 5 metres, it is not possible to say for certain when or if signals will be heard, unless the listener has an amateur transmitter living within 10 or 15 miles of him who operates on 5 metres. The difficulty with this band is to find it, as even with careful specification and exact reproduction of coils, etc., it is always a matter of chance if the band is located at the first attempt.

However, there are two ways in which the receiver can be calibrated for 5 metres. Cut a length of wire to 8½ feet and loop one end loosely near to, but not touching, L1; the other end is left free and hung up to the picture-rail or any other convenient point. Now tune with the receiver oscillating. If a setting is found on C6 at which the detector tends to go out of oscillation, or cuts off completely, the receiver is then very near 5 metres, as eight feet of wire is resonant at that wavelength, i.e., it tunes to 5 metres approximately by virtue of its physical dimensions. The exact resonance point depends on the capacity of this wire to ground and other similar factors, so that it is only an indication and no more, but if the cut-off effect comes near the middle of the tuning range, it can safely be assumed that part at least of the 5-metre band is being covered. Conversely, the spacing of the turns of L1 should be adjusted so that the "hole" in the oscillation is brought to the mid-way setting of C6.

The second method is to bend 17 inches of No. 12 bare copper wire into a loop and connect the ends across a .000025 mfd. variable condenser, fitted with a scale, preferably slow-motion. The whole thing forms an absorption wavemeter, which will bring the middle of the 5-metre band somewhere near 60 degrees of an 0-100 degree dial. It is used in much the same way as the length of resonant wire—the loop of the wavemeter is held near L1 with its dial set to 60 degrees, and C6 is then varied with the detector oscillating till a "pop" is heard, indicating that the two circuits are in tune. If signals of known frequency are eventually heard on 5 metres, the wavemeter can be accurately calibrated by the reverse process, and a graph drawn. Note that when using such a wavemeter, it should be mounted on a piece of wood to minimise body-capacity effects. In many parts of the country there is considerable amateur activity on this band, so that there is no reason why something should not be received. The co-operation of listeners is gratefully acknowledged by amateur transmitters, and there is much useful and interesting work to be done, in which listeners can play an important part.

#### COIL TABLE

	L1.	L2.
7-10.5 m. ... ..	8	5
4.5-7.5 m. ... ..	4	3

All coils ¼-inch diam., self-supporting, using No. 16 bare copper wire with turns slightly spaced. Wavelength can be adjusted by squeezing in or opening out turns.

#### CHOKE TABLE

RFC1	30 turns No. 24 enamelled on ¼-inch wood or ebonite former, turns slightly spaced.
RFC2	20 turns as above.
RFC3	40 turns as above.

## GUERNSEY BRANCH I.S.W.C. VISIT FORT GEORGE

Members of the Guernsey Chapter of the International Short-Wave Club were permitted, by permission of the engineer-in-chief, to visit the Post Office ultra short-wave radio-telephone station at Fort George, Guernsey.

Telephone communication between Guernsey and the mainland is given by one submarine cable and four radio circuits. The radio circuits are provided by the use of two sets of carrier equipment operating on two radio links working on approximately 5- and 8-metre wavelengths respectively. By this means two simultaneous conversations may be transmitted from each radio transmitter and received on each radio receiver.

The transmitters are provided with quartz crystal control to ensure stability and to eliminate the necessity for retuning frequently. The actual power radiated from the aerial system is of the order of 100 watts in each case. The two speech circuits which are to be combined in each transmitter pass from the landlines through what is termed the duplex equipment. Here the two bands of speech frequencies are combined and "scrambled" to provide secrecy and the resulting band of frequencies is then applied to the transmitter in the normal way.

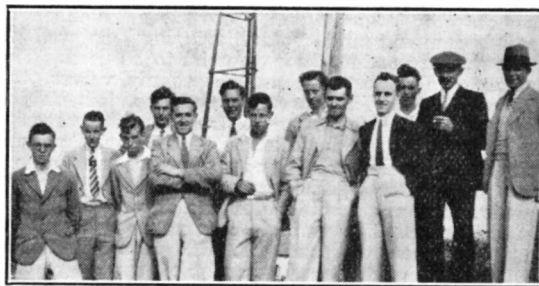

This procedure is adopted in order to render the messages unintelligible to persons who may try to intercept them by "tuning in" to the radio transmitter.

Superheterodyne type receivers are employed, having crystal control to ensure stability of tune, as in the case of the transmitters. The output from the receivers is passed through an equipment of filters and demodulators which separate the two conversations and restores the frequencies of which they are comprised to the positions they occupied before being "scrambled" at the radio transmitter. They are then passed out over the landline circuits to the terminal trunk exchanges. The aerial systems used consist of arrays designed to have strongly directional characteristics to and from the distant radio station.

The radio station in Guernsey is situated at Fort George, while that on the mainland is on the cliffs near Chaldon, some few miles west of Lulworth Cove. The landline terminations of the circuits are in St. Peter-Port and London respectively. To facilitate the routing of calls two of the circuits are normally extended over a submarine cable link to Jersey, providing two direct London-Jersey trunks.

The accompanying photograph shows the members of the Guernsey Club at the foot of one of the 100-foot masts supporting the imposing array of 5-metre aerials.

## AROUND THE HAM SHACKS

### 3—G2UK

#### A. C. Gee tells the story of a transmitter that won for him two trophies

MY FIRST experience of amateur radio came when, during the winter of 1934, I built a short-wave receiver and started to hear the telephone transmissions of some of the local amateurs. It was not long before I began to wish I could participate in experimental work, so application was made for a transmitting licence and after the usual delays, my amateur call was issued in February, 1936.

Since then the station G2UK has undergone a gradual and progressive change. Experimental work has always appealed to the writer so it is not surprising that a number of transmitters have been built and subsequently pulled to bits again, during the short time I have been licensed.

Most station descriptions seem to be written by an outsider: a fellow ham who comes into the shack one fine day when dx is good, takes a fancy to the gear and "writes it up." The result is a faithful—we hope—description of the gear, but it gives no indication of what really makes an amateur station: the failures and minor troubles which have ultimately been overcome and resulted in the construction of gear which is reliable and can be depended on to make the best of conditions on the air.

#### ● First Effort Failure

The first tx at G2UK was one of these failures. Looking back I always feel glad it was a failure, as the lessons learned in getting it to work have stood me in good stead ever since. The chief trouble was that most of the components had come out of the junk box and were not suitable for short-wave work. That tx was a simple c.o.-p.a., built bread-board fashion, with the power pack located rather artistically but very inconveniently beneath. The tuning condensers were from an old b.c.l. set, the coils were wound on formers of a very doubtful material, and what h.f. was not lost by it was effectively by-passed via some h.f. "chokes" which, though reputed to be for short-wave work, must have been designed for long-wave sets!

The combined efforts of the "local gang" did get it working eventually, but the results were nothing to be proud of. However, it provided the first thrill of being on the air, and the excitement of receiving the first batch of QSL's over, attention was turned to building something more worthy of the traditions of amateur radio.

#### ● A Special Endeavour

The next tx was built rack and panel fashion. The rack was built of wood and was forty inches high, taking panels twelve inches wide. The power pack was located at the bottom and was quite accessible for replacing blown fuses, etc. The c.o.

occupied the next shelf, the p.a. the next and the antenna tuning gear the top. Good quality short-wave components were used this time. The tx was operated c.o.-p.a. on 7 mc. and c.o.-f.d. on 14 mc. Many pleasant QSO's were had and some dx worked.

Though this tx worked very well several weak points soon showed up. Rack and panel construction is all right if the rig is to be more or less permanent, but where minor changes are constantly being made, either the panel gets shot full of holes or it has to be constantly replaced, which becomes expensive. Also the shelves were found to be too small and coupling arrangements between different stages were longer than desirable. The power pack was too small and it was

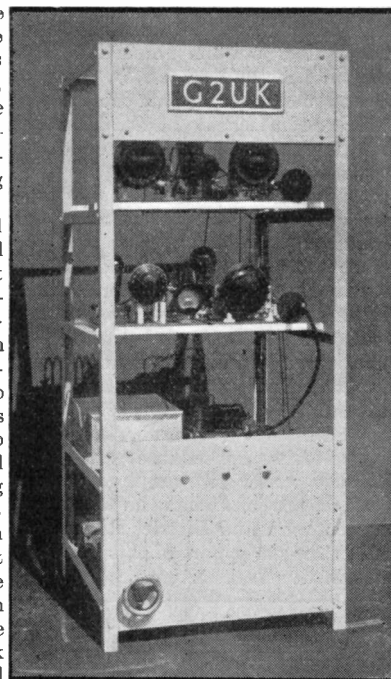

obvious that two packs giving different voltages would be much more convenient than only one where the voltages for the c.o. and f.d. had to be obtained via dropping resistance.

So with these points in mind a scheme for a new tx was got out. The design was also somewhat influenced by the fact that the local radio society's exhibition was in the offing.

So in this manner the present tx at G2UK came into being. The frame is of one-inch angle iron and takes the form of an open rack. It is three feet, six inches high and eighteen inches wide and deep. A series of holes were drilled up either side so that struts to carry the rack can be fixed where required. Similarly, these struts are drilled to accommodate racks of differing widths. The base contains two power packs, each giving 500 volts at 250 ma., from type 83 mercury vapour rectifiers. There are also several filament transformers giving various voltages. The only switch provided is an ironclad mains switchboard type. This is operated by the hand-wheel on the front of the transmitter, and turns on the power to the whole transmitter. The h.t. is remote controlled by a relay situated on the first shelf, this unit also accommodates the keying relay.

Both these relays are operated by a metal rectifier included in the unit. A small aluminium cabinet is also on this rack in which the bias batteries are housed. Above this is the c.o., stage coupled to the f.d. stage via a .0005 fixed condenser.

### ● The Present Line-up

A built-in meter is wired permanently in the anode circuit of the c.o., so that one can see at a glance how the crystal is behaving itself. Both these circuits are the usual triode type of oscillator and doubler circuits respectively, the valves used being a LS5 and an LS5B. The p.a. stage is on the top rack and is link coupled to the f.d. stage. Closed circuit jacks in anode circuits of f.d. and p.a. allow currents in these circuits to be read with a multi-range test meter. Keying is in the f.d. anode circuit, a plug from the keying relay being inserted in the jack in the anode circuit. A T25D is used as p.a.

The units are built on oiled oak baseboards which fit into polished aluminium racks, and all condensers and components are mounted on stand-off insulators. H.T. is fed through from below via busbars of  $\frac{1}{2}$ -inch copper rod and "feed-through" insulators, one power pack supplying the c.o. and f.d. and the other feeding the p.a. The frame was sprayed B.B.C. grey and when finished presented a very pleasing appearance. It need hardly be said that the writer felt amply rewarded for the time spent on the job, when the transmitter was awarded the Southend and District Radio Society's Challenge Cup in the early part of this summer as well as first prize in the Transmitter Section.

### ● H.Q. activities

All Southern services are suspended temporarily. Please note the South telephone service is inoperative, but that of the North is continuing as before. Details have appeared in earlier issues of this magazine.

I.F.S. meetings are held at 18, St. David's Terrace, N.C.R., Dublin every Wednesday as 8 p.m. Morse classes are held. Mr. J. C. White, the I.F.S. Representative, will be pleased to supply theoretical circuit diagrams of straight receivers to members on receipt of a stamped address envelope—please note that Irish Free State stamps will be accepted—but do not fix to envelope. The Irish postal rate is 2d.

### ● News Sheet Services

There are two services at the moment: Lancs. Branch, Mr. A. Park, 14, Fairfax Road, Prestwich, Manchester, a very interesting one indeed, and can be had post paid for 12 months by sending 1s. P.O. to Mr. Parks; and the second, Essex Branch, Mr. R. S. Stevens, 43, Pettits Lane, Romford, Essex, which by the way is for Essex members only; this is also an interesting News Sheet.

The competition is suspended pending the decision of the Committee, as also is the Magazine Service.

Finally, I would ask your indulgence this month for the necessary scrappy notes, and next month I hope to be in a position to tell you the outcome of committee deliberations, then we can get down to a settled period of development.

Please address your H.Q. enquiries to C. F. Biggs, 87, Lordship Lane, Tottenham, N.17.

## NATIONAL RADIO SOCIETY

### Reorganisation Commenced

By F. C. BIGGS (Hon. Sec. pro tem)

I have been invited to act as temporary secretary owing to the resignation of Mr. Leslie W. Orton, who, since the formation of this Society has held the position of honorary secretary and treasurer. I have accepted and already plans are being made to provide for reorganisation, in which you, as a member, are invited to co-operate.

You will agree it is impossible for me to give much detail here, consequently I append a copy of the letter sent to all County Representatives during the week-end November 27. This letter will explain the immediate plans. A notification of an Executive Meeting to be held on November 29 has also been sent, and by the time these notes appear the first Executive Meeting will have settled our temporary policy. Here is the letter sent to Representatives:

"DEAR SIR,

"Mr. Leslie W. Orton has resigned the duties of Honorary Secretary and Treasurer of the above Society—I understand he has informed you of this fact. In view of this development I was invited to act as Honorary Secretary until such time as the members have had an opportunity of expressing their wishes. I have pleasure in accepting this trust and shall endeavour to carry out the duty in a manner acceptable to all with a view to re-organisation of the Society.

"A temporary Committee has been formed and consists of the following County Representatives residing in or near London: Messrs. S. G. Berry, F. Chapman, E. W. J. Field, G. J. Goldsworthy (Treasurer, pro tem), R. Pearce, E. J. Sprange, R. S. Stevens, F. Stringer and R. C. Taylor. This Committee will form the machinery for receiving and acting upon your proposals with regard to the calling of an extraordinary general meeting to appoint Officers and an Executive Committee.

"Your suggestions regarding the future policy of N.R.S., proposed Rules, and any other relevant matters will receive the attention of this temporary Committee, which will then hand its report to the elected Secretary for submission to the elected Committee.

"To further assist, will you please forward to me a nominal roll of District Representatives and Members you are in touch with, giving name, address and joining date, also whether they are Honorary or Full Members.

"Assuring you of my close co-operation, I am,  
Yours sincerely, C. F. Biggs, Hon. Sec., pro tem."

### ● Suggestions will be appreciated

I welcome suggestions towards a method of giving members the opportunity of expressing their opinions, and suggest they get in touch with their nearest County Representative, who will forward the collected information to the Executive Committee. The next step will be a ballot of members for the election of officers and an Executive Committee. Please assist in this direction by at least sending your membership card in—you will receive a new one as soon as design, etc., has been fully gone into. Membership remains as before—1s.

(Continued at foot of previous column.)



# PRIVATE ADVERTISEMENTS

2d. per word.  
Minimum 2s.

*Readers replying to private advertisements are requested to enclose stamped addressed envelope for return of remittance or notice of disposal. Replies to box number advertisements should be addressed to Box....., "The Short-Wave Magazine," 84, Tabernacle Street, London, E.C.2.*

*Box number advertisements are subject to an additional charge of sixpence.*

*The Advertising Department is willing to assist in the exchange of goods against cash where invited and agreed to by both parties.*

RAYTHEON 6D6's. Practically unused. Only three, 3s. 6d. each. G.P.O. Morse key, 5s.—Box 1.

TRICKLE CHARGER (Westinghouse rectifier), 6 volt 1 amp. and complete in case with ammeter, £2. Hivac QP240, unused, 8s.—14, Carolina Road, Thornton Heath, Surrey.

## READERS' BARGAINS

This new feature is introduced at the request of a number of readers. Watch the column carefully and use it to buy and sell your gear.

WANTED.—Moving coil voltmeter, range 0-2,500.—Box 2.

BATTERY or A.C. CONVERTER, 13 to 70 metres (New), sell for 35s., list 63s.—Box 3.

FOR SALE.—Eddystone 1935 Kilodyne Four, Short-Wave Battery Model in cabinet, with six coils covering 12½-500 metres without a break. Less batteries and loudspeaker. Valves probably 25% off emission. What offers?—M.A.W., 98, Wellington Avenue, Westcliff-on-Sea.

CRYSTALS—1.7 and 3.5—for Sale, 5s. each.—Radio G6MY, Morley, Leeds.

AC12 EKCO ELIMINATOR. Exchange for anything Radio.—Box 4.

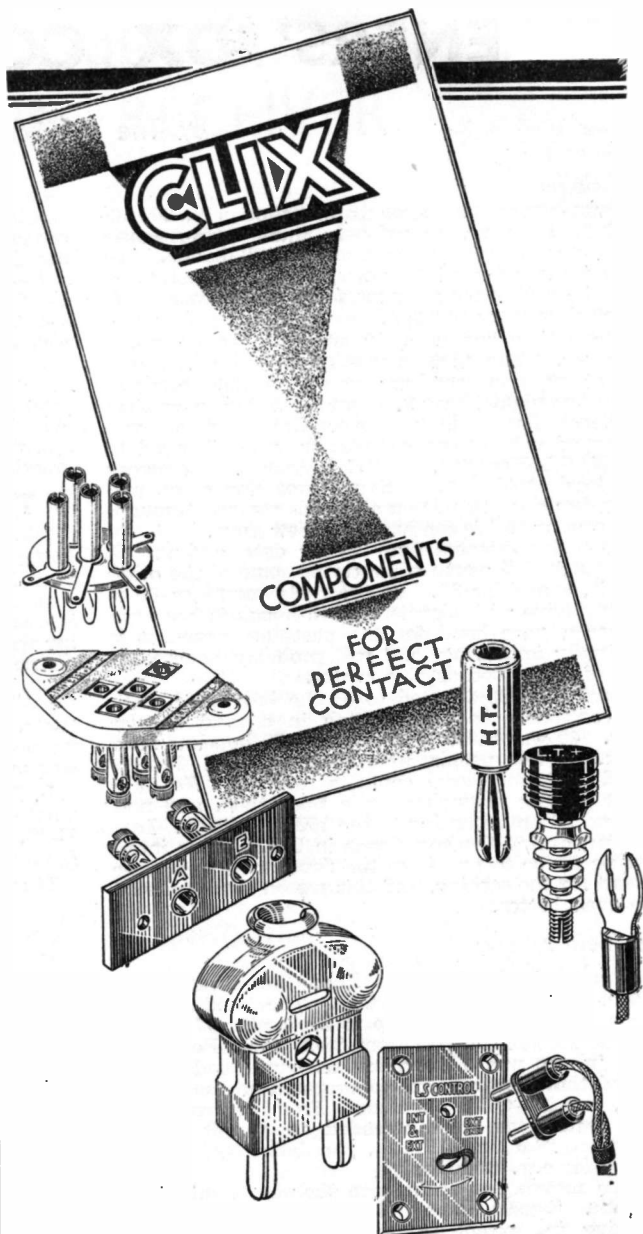

## CONTACTS FOR CHRISTMAS

Don't be short of a spare 5 amp Plug, a Loudspeaker Control, Panel Strips, Fuse Plugs, Terminals, Plugs, Sockets, or even a Valveholder, you are almost sure to want one or more during the Festive Season.

**ALL GOOD DEALERS STOCK CLIX**

*Descriptive Folders "S.M" Free.*

**BRITISH MECHANICAL PRODUCTIONS LTD.**

79a, ROCHESTER ROW  
LONDON - S.W.1

# CLIX

# LISTENERS' DX CORNER

By The DX Scribe

AN ALL-ROUND MONTH of dx this time. 10, 20, 40, and 80 all alive, so we only want trans-Atlantic signals on 5 and 160 to complete all bands. 160 may wake up any time now, so it is worth looking on this band in the early mornings just in case something does come through.

Some time ago both 10 and 160 came through together. The first intimation I had of unusual conditions was searching round on the broadcast band one night about 9.30, and listening to Scottish National for a little while. Gradually he was swamped out by another station, which proved to be WITC, Hartford, Conn.! Almost as strong as the local at 10 p.m. This was one November, and for a few days signals on all bands romped through, ten coming to life for just those few days.

So many listeners find twenty dead and switch off. It is well worth while trying some of the other bands, especially 80. In the early mornings 80 is simply alive with signals, and although it has been rather a poor band for the past few years, it is gradually improving, and will probably be productive of some good dx this winter.

Back in 1926 80 used to be the best band, with all continents coming through in a most regular way. 40 was rather inferior, and 20 hopeless after dark. A few people were using the old 8-metre band, but only local contacts resulted. We have been passing through a cycle since then, and now 40 and 80 are returning to the 1926 condition. Last winter, during the vast floods in U.S.A. some interesting traffic to and from the flood areas was to be heard for the seeking, and this season signals should be even better.

## ● Ten metres

Changes in the American 'Phone Regulations have confused many ten-metre fans. The band extends from 28 to 30 mc., and up to September 17 'phone operation was allowed from 28-29 mc. Both c.w. and 'phone was allowed in this band, and it was found that most stations congregated on the 28 mc. end, making QRM appalling. From September 17 the regulations were amended to permit 'phone between 28.5 and 30 mc., the band 28-28.5 mc. being for c.w. exclusively.

Ten metres has again been the star band of the month. Signals from all continents have been rocking in, except from VK. VK's have been coming through, but few of them are using 'phone, so are overlooked by many of us.

K6 is a newcomer this month, K6MBT being reported by L. Levitt. Maybe more K6's will be heard from now onwards.

Fog has been plentiful this month, so we have had plenty of chances of noticing its effect on signals. Personally I cannot decide whether it improves or spoils them. Some days the gradual appearance of fog has resulted in fade-cut, other days it has changed bad conditions to good. But one thing I am certain about is that it increases the racket from cars, always bad at this QRA. Rain also seems to have the same effect.

Another thing about ten is the aerial. Some people swear by long aerials, others will use nothing but doublets. I've got several aerials up, including a 40-metre and a 20-metre doublet, but I thought I'd try some indoor aerials. The shack is only about twelve feet square, so I ran lengths of 30 s.w.g. in various directions across the room. On South Africans especially a noticeable improvement resulted, and six feet of wire in the correct direction gave better signals than any of the big outside ones. With such a small aerial you can grab the free end and walk round the room until the best direction is found. Crude, but effective.

## ● Twenty

Pacific Coast Americans have again been the main feature of this band. It must have been a record year for them. Not only have they been coming through in the early mornings, but also through the late afternoons and early evenings. Conditions during the afternoon have been most peculiar, every W district coming through. Listening the other afternoon, the first station heard was a VE4, followed by W5, VE3, W6, W7, and the rest of the W districts. From 20.00 onwards things have been variable, sometimes very good, often complete fade-out.

L. LEVITT (LEEDS), starts the ball rolling this month with his comments on the periods October 17-18, and November 2-3.

October 17—

- |        |       |   |
|--------|-------|---|
| 14 mc. | 10.20 | ES5D, LY1CC, LA1G, and many F8's R9.      |
|        | 10.45 | G's began to come in.                     |
|        | 11.00 | OZ5BW, TF3P, W2 and 3.                    |
|        | 11.30 | W8, VE1.                                  |
|        | 12.00 | VK2APO, VK3AL at R3 to R4 with W6's R4-5. |
| 28 mc. | 14.00 | W2's and 4's, VU2ON.                      |
|        | 16.30 | W1, 2, 4, 6, 8, VE2, FA3JY.               |

October 18—

- |        |       |                                    |
|--------|-------|------------------------------------|
| 14 mc. | 09.30 | All locals.                        |
|        | 11.30 | W8's, few G's.                     |
| 28 mc. | Good, | but usual dx on 14 mc. from 07.00; |
|        |       | 10.00 missing.                     |

November 2—

- |        |       |             |
|--------|-------|-------------|
| 14 mc. | 07.10 | W6, W8, VK. |
|--------|-------|-------------|

November 3—

- |        |             |                                   |
|--------|-------------|-----------------------------------|
| 14 mc. | 12.00       | W1, 2, 3, 8, YV4AF, CO7HF.        |
|        | 12.30       | W4, 5, CO7AT, 7PA, 7CX&           |
| 28 mc. | 18.00-19.30 | All W except 7, VE1 and 2, ZE1JR. |

Many thanks for this very fb report, om. Nothing-unusual seems to have occurred save for early morning fade out, and the presence of the Central Americans around midday. Of course W5 is rare at this time of day, so probably there is some relationship between the two sets of stations. W5 is more usual around midnight and early morning, and I have never heard them between 11.00 and 15.00 G.M.T.

First report from W. PETERS gives fine log on 3.5, 14 and 28 mc. Pity he has missed W7 for all districts on ten, but he makes up for this with his 80-metre log.

Commenting on conditions he says: "On 20 conditions have been average, although I have not noticed any outstanding days. On Sunday, October 31, between 09.30 and sunset, remarkably short skip prevailed on 20 metres, G, GW, GM, GI, EI, F and PA signals coming in more like 40. No dx at all was heard during this period. Another feature has been the return of W's on the 80-metre band. In the early hours of Monday, November 8, I logged 8, and would have logged more but my detector filament gave out (perhaps it felt my excitement!)."

A rare "catch" was VEIEE working portable at the Montreal Radio Exhibition.

N. J. RUTTER, SWINDON, apart from an "All-Continent" log sends an account of his receiver arrangements. Unfortunately there is not room this month to show the diagram, so I will just say that he uses a two-valve receiver for s.w. headphone work, but for speaker reception he switches the output to the l.f. amplifier of a b.c. set. However, I will show this scheme in full next month, so don't inundate him with letters asking for details! He

prefers speaker reception to headphones, and as he can use either at will, is in a position to judge.

H. SUGDEN, BRADFORD, has also noticed the "group" effect. "I find that conditions favour one district perhaps for a day or two, and another district the next. W5, 6, 7 and 9 do not come in together, but generally have their own special conditions. On September 14 K7FBE was received about 07.40, up to that time the band was dead. On September 27 he was heard at 07.35, preceded by K6NSQ at 07.23, K6OQE at 07.25, K6GCT at 07.30, and followed by K6BNR."

Thanks for the dope, om. It seems that this "group" effect is fairly general. Perhaps we shall be able to notice some regular cycle, and predict dx a few days in advance from it.

Lastly, from BOB EVERARD, our most consistent dx'er, comes a list of W6 'phone veri's received. 100 of them, all real dx.

Bob has very kindly taken the trouble to compile a list of them together with notes on their frequencies, cards, etc., so that the rest of us will know where to look for them. Many thanks to you from us all for your trouble, om.

Here is the list:

### BOB EVERARD'S 100 W6's

NEVADA		CIF, 14mc, 300w. A real comic QSL.	ITH, 14mc, 300w. Famous Reg Tib-
BIC, 14mc, 130w.		CIN, 14mc. "Radio Bug" QSL.	betts. FB double photo QSL.
FUO, 14,224kc, 65w. Fine QSL. in black and orange on white.		CUR, 14mc, 250w.	IXJ, 14mc, 50w. FB QSL, red and white on black.
UTAH		CLS, 14,152kc, 500w. Fine QSL., silver, blue, red, etc.	JP, 14mc, 475w.
GBO, 28mc, 75w. His first G report.		CNA, 14mc.	JPW, 14mc.
IZD, 14mc, 25w.		COG, 14mc.	JXI, 14mc, 300w.
ARIZONA		COK, 14,158kc, 200w. First G report.	JZE, 14mc, 40w. First G report.
OIF, 28mc, 55w. A beautiful coloured view QSL.		CZ, 14mc. "Aeroplane Contact" QSL.	IZH, 14mc, 1kw.
DKU, 14mc, 130w.		DEP, 14mc, 1kw.	KMO, 14mc, 180w. First G report.
GZU, 14mc, 180w.		DL, 14mc.	KQO, 14mc, 500w—1kw. FB playing card and photo type.
KSO, 14mc, 700w. FB photo QSL.		DMN, 14mc, 150w. Comic "Dentist" QSL.	KW, 14mc, 365w.
CALIFORNIA		DTE, 14mc.	L.A.J, 14mc, 250w. Comic QSL. photo QSL.
CKR, 28mc, 250w. FB Eagle, etc., QSL.		DWE, 14mc, 150w. FB ship QSL.	I.D.B, 14mc, 700w. First G report.
ERT, 28mc. FB photo, etc., QSL.		DYH, 14mc, 500w.	I.F.U, 14mc, 300w.
LWN, 28mc, 200w. First G report.		DZH, 14mc. Californian station of WICCCZ.	L.H.F, 14mc, 500w. First G report. FB LP 14,174kc, 208w.
MAF, 28mc, 75w.		EIP, 14mc, 250w. Unique comic "Globe" QSL.	I.K.Q, 14mc.
MOV, 28mc.		ELR, 14mc, 120w.	LLQ, 14mc, 1kw.
MWK, 28mc, 150w. FB photo QSL.		FQA, 14mc. Home-made QSL.	I.L.U, 14mc, 165w. FB photo QSL.
NLS, 28,800kc, 425w.		ESX, 14mc, 300w.	I.R, 14mc, 800w. FB blue and silver QSL.
NWQ, 28mc. FB "Mission" type QSL.		FGU, 14mc, 400w. FB photo QSL.	I.Y, 14mc, 275w. "Mission" type blue and green.
XKW, 30,1mc, 100w. Will soon move to new location and 200w. power.		FTU, 14mc.	L.Y.P, 14mc. FB photo QSL.
KG, 25,950kc, 100w.		FQY, 14,162kc, 200w. Comic "Dentist" QSL. First Europe report.	MBE, 14mc, 450w.
AH, 14mc.		FYJ, 14mc, 170w.	MGB, 14mc, 200w.
AM, 14mc. Famous Don C. Wallace.		GAL, 14mc, 140w.	MR, 14mc, 1kw. FB QSL, in red, etc., on silver.
ANU, 14mc, 150w.		GAT, 14mc. "Cat" type QSL.	MWD, 14mc.
ATQ, 14mc, 400w.		GCT, 14mc, 750w.	MXD, 14mc, 300w.
BHO, 14mc, 120w.		GCX, 14mc. Owl type QSL, in blue, etc.	MXW, 14mc, 70w. FB photo QSL.
BJB, 14mc, 200w.		GYO, 200w.	MYO, 14mc, 200w. First G report.
BJI, 14mc, 150w.		HAA, 14mc, 160w.	NLP, 14mc, 200w.
BKY, 14mc, 550w.		HAR, 14mc. First G report and FB photo QSL.	NNR, 14mc, 300w.
BOS, 14mc, 500w. Futurist QSL.		HEG, 14mc.	OCH, 14mc.
BQY, 14mc. FB photo QSL.		HJU, FB photo QSL, and being re-broadcast from 160m.	PN, 14mc. FB coloured view QSL.
BYW, 14mc, 500w. First G report.		HOW, 14mc, 700w. FB eagle, etc., QSL.	RX, 14mc.
CAN, 14mc, 50w. FB photo QSL.		ISH, 14mc. Largest W6 QSL, I've seen. (8½ ins. x 5½ ins.)	SJ, 14mc, 350w.
CC, 14mc.			UT, 14,216kc, 400w.
			VI, 14mc. College QSL.

### ● Condx—Wx

The log sheets have been sent to those who applied for them ("DX Corner," November).

This scheme has only just started, so it is too early for any results yet. As soon as some of the data received has been summarised details will appear here, so please try to spare a few minutes during the week to help.

### ● Expeditions

Fresh news from ARRL advises that the MacGregor Arctic Expedition, WAWG, on 12,460 kc. is working W3QP Monday-Thursday at 23.30 G.M.T.

OX2QY, Etah, Greenland, is using the call WIXAB for N.B.C. programmes. Another chance to get that rare W1 veri.

## ● Shack Photo

The photo this month comes from **BILL CROFT, BRISTOL**, and shows some of his 190 veri's from 48 countries. A new one heard the other day was **VQ1AB**, Fanning Island, in the Pacific. Fb going. He says conditions on 20 have been simply grand, and his log proves it.



By the way, many SWL's like to have a photo of their shack on their cards, so if you send your photo to this Corner for publication, the block will be sent to you later, and you can then have the photo printed on your cards.

Congratulations to Harold Taylor for the neat way he arranges his log, as shown under. It will help the printers, who have to compose the matter from your copy, if you will oblige likewise.

W1	F3HM
AAK	VE
ADM	2KC
W8	3ANF
BDS	HI7G
BLP	SP1HH

L. LEVITT, Well Lane, Kippax, Leeds.  
20-metre 'phone.

W5 FHJ, APM, DUK, BUM, AHK, W6 NMI, ITH, CTT, CQI, EYI, KUF, FGU, BAW, OBE, RBY, EJK, W7 FOH, DUV, VE3EO, 9BW, 3MD, 5PA, VK2XU, PK, XS, APO, 3ZZ, VV, KX, 4BK, CO2JJ, WW, WZ, RA, 6OM, 7HF, CX, AT, PA, HI3M, 5X, 7G, XE1 FG, GK, VO6L, 6V, PY5AQ, LU5CZ, TI2RC, ZBIL, IH, OA4AL, ES5D, VSIAP, ZU6P, CN8AT, AJ, AM, TF3P, PI1J, LY1CC, IX, HB9CH, AB, SP1CC, DC, HH.

10-metre 'phone.

W5 CHG, EV, ZA, AXJ, EEX, FNH, AHJ, ZV, W6 JTO, MVL, LWN, OZE, W7FCH, W9 VHR, VLI, YKR, OSO, GCO, GCT, OSH, GHR, LUV, ZXL, HKZ, and W1, 2, 3, 4, and 8's, K6MBT, VE 1DZ, CR, 2KX, VO1J, K4EMG, ZE1JR, ZS 6T, AJ, ZT6J, ZU6P, V66YR, VU2ON, FA3JY.

N. J. RUTTER, 23, Bouverie Avenue, Swindon, Wilts.

F88AH, OQ5AA, VQ4CRE, ZS3F, W5 AIJ, AKZ, ASG, BCU, BEK, BJO, BLW, BVH, COF, CYC, DAN, EEN, FNA, GIB, GPL, YI, ZS, W6 AH, AL, AM, BFC, CNA, CUU, DEP, EJC, FDN, FFN, FTU, GCT, ITH, JKR, JPW, JTF, LYM, MWD, NNR, OD, SKK, W7 DNP, EKA, FQK, W9 CXG, WJJ (Denver, Col.), W10XDA, VE4 LX, MO, OK, W0 II, IP, 6D, 6JO, XE1GK, LK, 2FC, CE1AH, 3AC, AI, CO, DG, CO2AG,

AK, EG, KI, LY, RA, 7CX, VP, 8JB, RC, CX2AK, 3BA, HC 1FG, JB, JW, HH2B, 5PA, HI5X, 7G, HK3JA, K4DDH, ENY, SA, LUIH, EX, 5AN, CZ, 7AG, 8AB, 9BV, NY2AE, OA4AJ, L, N, PY1AH, PA, FR, MK, 2AC, AL, DN, FF, CC, JN, 4BI, 5AQ, QI, T11AF, 2AV, FG, OFR, RC, VP3BC, 5PZ, 6TR, 6YB, YV5AG, ZP2AC, KALMF, PK4DG, VS2AK, K6KMB, NZQ, OQE, VK 2ABE, AP, AZ, CI, HF, NY, QR, RJ, TC, TR, VB, VV, XS, XU, 3AL, EG, KI, KR, KX, MR, PE, PI, WA, XJ, ZL, ZZ, 4KO, WU, 5AI, AW, GS.

H. SUGDEN, 15, Arnelcliffe Terrace, Legrams Lane, Bradford.

W 7FOK, 6ITH, EJC, FTU, DEP, NNR, GCT, CQI, MLC, AM, AL, NTX, LLO, FJK, BAW, BPM, CUU, BFC, IZH, IFS, 5YF, ZS, FCI, BCU, AFG, EHM, DNV, DAN, FHJ, FKV, HTU, JC, RDP, VE 9HF, 5GM, JK, 3EO, LI, 2CA, HE, BG, AA, NI, KO, BO, ILR, DX, CR, GR, BK, BE, FX, CF, VO 6L, JO, ZY, II, J, VK3 KX, PE, ZR, BC, 2XU, BG, VP6 YB, TR, VS2AK, PK1ZZ, ZT2G, ZS3F, CX2AV, T2RIE, FG, AV, KP, L19BV, 8DR, AB, 7AG, 5CZ, AN, 4BI, KA, III, QA, PY 1FR, GO, 2FF, 5AM, AQ, CO8 MA, JK, EC, 6OM, 2EG, WZ, JJ, RA, HY, 7VP, CE3 CO, DW, AW, AL HI 7I, 4E, IK 3JA, 4AG, IH2B, FB8AH, ZE1JA, ZBIL, VV5 AA, AK, XE 1GK, IV, 2FC, 3AR, K 7FBE, 6NZQ, MXX, BNR, OQE, 4ENY, DDII, EJJ, UG, KALMF.

W. PETERS, 82, Salisbury Road, Barnet, Herts.

10 metres.

W1 AAK, ADM, ADR, ACC, BGT, BJE, BLR, BQO, COO, COS, DJK, DPJ, FYC, HVS, IKX, W2 DXT, FBO, FGI, HEM, HGU, JAB, JKO, KHR, KJY, W3 AIR, BGR, BZJ, CBT, CKT, GI, GSV, GVZ, W4 BYY, EC, EDD, EEV, EPA, ETF, FT, W5 BHM, CCU, VV, ZA, W6 AK, HX, NLS, W8 BDS, BLP, CFU, CLS, EBS, KYY, MDH, MWI, QUL, W9 BHT, BMX, CIL, CLO, FAA, TIO, TFV, WMD, G5 AU, KIL, SA, G6 AG, CL, GO, KO, LI, WU, F3HM, 8LX, VE 2KC, 3ANF, HI7G, SP1HH.

20 metres.

COGOM, CT2AB, SP1DC, VE1EE (Portable in connection with the Montreal Radio Exhibition), VE2RG, VO6D, SU1SG, W5BVM, NE1KE.

80 metres.

W 1AVG, 2AU, JP, GFE, 3CT, BJ, 4DGK, 8GHI, QI. HAROLD TAYLOR, Eardisley, Cefn Glas, Penyfai, Bridgend, Glas. 22/9/37 to 13/11/37.

20 metres.

W5 BUZ, CQP, FHJ, JC, ZA, W6 AH, AKQ, DEP, BFC, BPM, CTI, CQI, EIP, FKK, FTU, GCT, HAW, ITH, JPW, KCO, LHF, LYM, MH, NNR, PB, W7FOK, W9 FJF, WJJ, (EL, Colorado), K6 BAZ, BNR, KMB, MXX, NTV, NZQ, OQE, K7FBE, VE 2BE, HE, 3AFD, DA, FO, ST, 9AL, CO 2EG, JJ, LY, OK, WZ, 3AA, 6OM, 7CX, VP, 8AF, T12 AV, FG, HI5X, VP6TR, NY2AE, IH2B, 5PA, HC1FG, HK4AG, XE1J, GK, 3AR, V55AA, ABF, OA4AI, LU1H, 4BL, 5AN, CE1AO, 3CO, ZBH, IL, FBSAF, AH, IIS1U, P18AD, VS 1AF, 2AF, AK, AO, 6AB, 7RF, KA 1BH, HS, KY, ME, MH, YL, PK1ZZ, 2WL, VQ4CRE, VK 2HF, UB, VV, XU, 3AJ, AI, KX, PE, WA, ZB, ZL, ZZ, 4BB, 5TI.

10 metres.

W1 AA, ADM, AEP, AJZ, COO, CCZ, DQK, EER, EZW, GJZ, HQN, IFD, IVK, IYE, KJE, WV, W2 AMF, AMM, HGU, INX, ISY, JCY, JIL, JOX, KHI, KHR, KOJ, UL, W3 AIR, AKX, AUP, BJZ, CVC, FGW, FKK, GHS, GSV, JMC, WA, W4 BYY, DRJ, EDD, EF, FT, FO, GB, W5 EHM, FDE, ZA, W7 ECV, FDL, W8 CHQ, EBS, HHH, JFC, KYY, LIR, PHD, OTK, W9 AGO, BHT, EII, GEC, SPV, MDE, VU2CQ, VE3ANF, FA3JY.

## S.R.C.C. PARTY

An unusual Christmas party for hams is announced by the Surrey Radio Contact Club, to take place on December 14.

All formality is to be dispensed with, the supper being in the nature of a ragglew. Special competitions on bugs and mikes are to be features, together with a lucky draw on the tickets.

Those wishing to attend are requested to advise the hon. secretary, A. B. Willsher (2CCZ), 14, Lytton Gardens, Wallington, Surrey. Tickets will be 3s. 6d. each, and the venue, which will be in Croydon, will be advised during the next few days.

The next meeting of the club will take place on December 7 at The Alhambra Hotel, Wellesley Road, Croydon, at 8 p.m., when a debate will take place on "Should High Power be Abolished?"

# THROUGH THE WINDOW

## DISTANCE AND DIRECTION

Does Greenland count as Europe or America? Which paths do signals from New York and Alaska take?

Look at your atlas and you will see how difficult it is to answer these questions. A glance at an ordinary map indicates that signals from Alaska came from due west, whereas the true (Great Circle) direction is nearer north-west.

To solve these, and many other problems, Webb's Radio have produced two unique aids, a radio globe of the world, and an azimuthal map.

The globe is a 12-inch globe with a difference. The prefix of every country is clearly marked (the prefix being special letters allotted to each country so that the nationality of stations may be recognised—similar to the "GB," "F," etc. to be seen on cars when touring abroad), the various time zones are indicated, and the boundaries of each continent are shown according to the I.A.R.U. definition, enabling the user to ascertain immediately the continent to which any locality belongs.

To find the true radio path between any two points is simple. A piece of thread is stretched between them, when the true direction can be seen. This is a great help in erecting an aerial in the best position for maximum results from particular directions. A scale is provided so that the distance can be readily calculated.

Finished in oxydised bronze this world globe is an attractive addition to any shack or room. The price is 27s. 6d.

An azimuthal map looks peculiar compared with a Mercator's, the type normally used. With a Mercator's projection it is impossible to plot the Great Circle distance between two points, but using an azimuthal projection the countries are "moved round" so that not only is their true direction shown, but also the distance between places can be measured accurately.

An examination of a normal type map will show that degrees of latitude vary, getting larger as the poles are approached. Measurements of distance from north to south are therefore inaccurate.

This azimuthal map, centred on London, is corrected for this defect. Designed expressly for radio use, such vital information as international prefixes, time zones, etc. is shown, and it will be found a valuable adjunct to the equipment of any listener or transmitter.

Printed in colour on art paper, size 40 inches by 30 inches, the cost to amateurs is 4s. 6d., while a de-luxe edition, printed on glazed linen, and mounted on rollers, will be available at 10s. 6d.

## NEW TRANSMITTING COILS

For many years the "fashionable" transmitting coil has been the self-supporting type, using heavy gauge copper tube or wire. The reason for this goes back to the old 440-200-metre days, when it was customary to wind a medium gauge wire on some sort of former, usually of the ribbed-ebonite type.

When everyone went "short-wave" it was found that the material of which these formers were made was very inefficient at the higher frequencies in-

olved. The only thing to do, as no better material was to be had, was to make the coils "self-supporting," which meant the use of a fairly heavy conductor.

It was soon found that a heavy conductor caused losses, due to eddy current and self-capacity effects. Smaller wire could not be used without support, so we had to put up with losses. Apart from this loss, a serious defect was that of the difficulty of making the coil plug-in with more than two connections to it. The addition of a link to feed a low impedance line to the aerial, or another stage, necessitating five connections, produced further difficulties, and in general it has been necessary to compromise between optimum coupling and mechanical mounting.

The development of special ceramics for high frequency work now enables a coil to be wound on a former which entails practically no loss and which simplifies the problem of mounting when a number of taps are to be used.

The Raymart Company has been quick to realise the electrical and mechanical advantages of this material, and have now produced a range of plug-in transmitting coils, covering from 20 to 160 metres, and possessing all the features mentioned. The standard model consists of a centre tapped coil, wound on special low-loss ceramic former, having three plugs, and designed to mount in a three-point socket. The prices have been fixed at 10s. 6d. per coil, and 1s. 6d. for the socket.

## A NEW TUNING PACK

The "Transatlantic" tuning pack manufactured by The Mains Radio Development Co. will be found suitable for the home constructor who wishes to convert his old broadcast set for all-wave operation.

The pack consists of a complete high-frequency stage of a receiver and has a pre-selector valve, triode-hexode frequency changer, and one intermediate frequency valve. There are two intermediate transformers so that the output from the i.f. valve can be taken direct to a double-diode triode second detector/a.v.c., therefore a.v.c. may be applied to a terminal on the chassis.

An existing amplifier may be used, or the makers can supply associated stages. Prices for the tuner are, two-gang, 49s. 6d., and three-gang 69s. 6d.

Ranges are 12 to 80 metres with medium and long-wave bands. Photograph above will convey the compactness of the larger model we have for test purposes which are not yet complete, and results to date indicate that the attention paid to constructional detail has reflected favourably on performance; components are all by factors of high repute, thus the prices quoted above represent the highest standard of value.

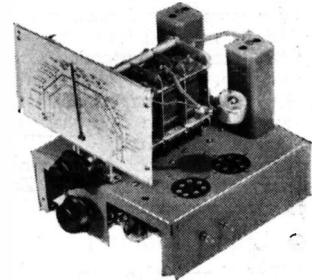

# A Week-end from Ten to Eighty Metres

By A. W. MARRIOTT (S.-W.M. Advertising Staff)

AS A COMMERCIAL operator I must confess that I have looked down with contempt upon short-wave listening, and the simple apparatus used. Challenged to give reasons for this attitude, I had to admit that I had no experience of s.-w. listening, so I readily accepted an invitation to test a simple short-wave receiver, and record my impressions, and it is hoped that the following account of some of the happenings heard on these wavelengths will be of interest to other readers. All times are G.M.T. and wavelengths as near accurate as possible; the test took place during the week-end November 6.

My receiver was the S.-W. MAGAZINE One-Valver, using a pair of Brown's headphones, 120 v. h.t. and the same aerial as used for medium and long-wave reception (50 feet total length and 25 feet high). Locality: Southend-on-Sea.

## ● C.W. on "Ten," 'Phone on "Thirteen" and "Nineteen"

Switching on at 16.30 on November 6, with the 10-metre coil plugged in, search was made on this band till 17.00. During this time W8LYQ was heard calling G2WD, and both VE4JV and W6FZA calling CQ dx ten. No contacts appeared to have been made. Then at 17.05 W9RIA was heard working G5RRI on ten, telling him that he had called him "plenty," and that QRM was bad and QRK? All these stations were on c.w. and sigs. R3 to R4.

The 13 m. band was next tried and at 17.10 W2XE on 13.9 m. was tuned in, the volume being truly surprising for a receiver using only one valve. Various musical items by Bob Gibson's Band were played and announced. There was very little fading and sigs. R5. A change to 19.5 m. was made at 18.00 and an announcement "this is W2XAD, the General Electric Company of Schenectady, relaying a programme from WGY" was heard with practically no fading. A little above W2XAD a talk in German by a lady from Zeesen (DJQ) which was preceded by a bugle call.

## ● Learn Morse!

For those who can read Morse a vast field of interest and entertainment opens up. At 18.30 two-way communication on 20 m. c.w. between U1CO and G8FZ was followed, U1CO thanking G8FZ for report and very nice QSO and nice dx, and telling him that he was using 20 watts, and G8FZ replying "ur 20 watts f.b. hr. input 25 watts, 73's so long." Sigs. from U1CO were R3, Morse speed about 23 words per min. and both note and sending of U1CO were excellent. His Morse was indeed a pleasure to read. The QRM was rather bad, but that's the great advantage of c.w.—you can get through. Whilst on the subject of Morse it may be as well to mention the numerous commercial c.w. stations between the amateur bands which are heard at colossal strength most times of the day. Such stations as JNB, EAV, WSC, and PPX, to mention

only a few, sending their call-signs incessantly, preceded by a few v's and often followed by ABC. One wonders if they ever send any traffic. PPX sending at 27 words per min. on approximately 14.5 m. often repeats words twice and is an excellent station to copy for those wishing to improve their speed. A little higher up on about 15 m. a commercial sending press news in English at 30 words per min. was tuned in. This speed I might mention was actually timed and incidentally is just about my limit. I simply had to spend 10 minutes copying for the sending was perfect, automatic no doubt. Time 21.30-21.40. Perhaps some enlightened reader can identify this station.

## ● Back to the Lower Band

The ten-metre band was now tried again but nothing was heard so a change up to 20 was made where a running commentary on a rugger match, in characteristic American style was heard at 21.55. The Big Bad Wolf (a term of endearment, apparently, for one of the players) being very much in evidence. Sigs. R7. The period spent listening to this station wasn't long enough to identify. At 22.16, W2TY of Long Island, New York, was heard calling ON4WF in Belgium on 'phone with little fading. From 22.30-22.55 several stations were heard, which, judging by the type of music being transmitted were South Americans, and quality was poor. During this same period a station in Havana, Cuba (rest of call lost through QRM) was heard on 'phone telling F8BC that he couldn't get him on account of QRM from English, Canadian and South American stations. Sigs. were about R6.

It was decided to try something nearer home and at 23.00 it needed no searching to find Rome 2RO on the 31-metre band, on 'phone, giving news in English. His sigs. were R9 but there was deep fading. A German station around 49 metres was tuned in at 23.30 just in time to hear the end of the programme and the announcer, using English, sending special greetings to the fair sex and announcing the programme for next Saturday at 23.00.

By this time BED was calling (sigs. R9 plus) and having a dislike for burning the midnight oil it was decided to switch off for the night and resume the interesting search next day.

## ● Sunday—10 metres again

On Sunday morning, a ten-minute spell from 09.30-09.40 was spent on the 10-metre band and during this short period G6DH was heard calling "test ten," and UK3AH calling "CQ ten." Both were on c.w. and sigs. R3 and R2-R6 respectively. Listening in earnest, however, was not commenced until 11.00 when the same band was again tried and at 11.05 UK1CC was heard on c.w. calling CQ and telling someone that he was "getting off the band." His sigs. were R3. Going a little higher in wavelength, the commercial station DFJ on about

15 metres was heard calling LQC in Argentina on c.w., sigs. R7, speed about 8 words per minute.

Having a weakness for Morse it was decided to see what the commercials were doing and from 11.15 to 11.30 several messages to ships from IAC Rome, on about 19 metres were copied. Most of these were in Italian but some were in English. Judging by the faultless regularity of the sending I should say that this was mechanical, speed being about 23 words per min. and sigs. R9 plus. At 11.35 press news in English at 17 words per min. on about 20 metres was copied, sigs. again R9 plus. This station was not identified, but perhaps some reader can supply the data.

### ● The Hams on "20"

Up to now no special endeavour had been made to see what the amateurs on 20 were doing so a change to this wavelength was made at 11.40. The QRM was simply terrific so that during ten minutes of listening no station could be identified. At 11.50 a 'phone station with a woman commentator was heard on this band describing, in English, the celebrations of the 20th Anniversary of the Russian Revolution, but was not identified. At 12.10, GI5QX, Belfast, was heard on 'phone, at R8, calling "Test 20," but owing to the racket the station contacted was missed, however, GI5QX was heard telling someone that "last night dx was very good but the night before was the star turn of the month for dx, QSA5 R8." His remark, "exactly like 40 this morning" seemed to imply that he was also experiencing QRM. Then G5SO was next picked out of the racket calling "hello test 20 metres" on 'phone, contacting G8KW whom he told he had worked before on 40. His sigs. were R8.

During this same period several amateurs were using c.w. and the sending of some is not all that may be desired. Call-signs, which of necessity are sent three times, are run into one another with the result that, if for any reason one should miss the first letter or two, a general sorting out has to be done before one can find where the call begins and ends. You would think they had never heard of "spacing." Many 'phone stations were still coming through and at 12.40 G6KF, Liverpool, was heard calling and testing and asking for reports of his transmission. Another station on 'phone at 12.44—? Washington calling G5BN, but the rest of the call was swamped by QRM. Conditions on 20 were certainly very bad. GM8CN was heard on c.w. telling G2HK that he had a contact with a W2 which was not too good on account of heavy QRM, and at 13.10 G2UK was calling G6CT on 20 m. c.w., but again QRM prevented me hearing if he contacted him. Sigs. from G2UK were R9 plus.

This being one of the unlucky days, apparently, for 20 metres it was decided to go to the more peaceful region of ten, and here, at 13.36 W9WSY on c.w. was calling G2XC ten—sigs. R1 to R5 which faded right out at times. Morse speed 18 words per min. G2XC was not heard to reply. By way of change from amateur 'phone and c.w. the broadcast station W2XE, Wayne, on 13.9 m. was tuned in at 13.45, just in time to hear the tail-end of a "Lyric Serenade" and the commencement of "Radio Spotlight." Sigs. were R4 and fading slight.

Not having yet heard VK2ME an effort was made to fetch in this station and an hour was spent from 15.00 to 16.00 searching the 31 m. band, but the only reward was the German and Italian Broadcast stations operating.

### ● Final Listen Round

No results worthy of note were forthcoming on the 80 m. band during Saturday and Sunday and it would be interesting to know if other readers had the same experience. Since 80 was dead and there was too much QRM on 20 and 40 to be comfortable the ten-metre coil was put into service again. Both W6MCQ and W9VBQ were heard calling "CQ ten," on c.w., and at 16.42 W8QOK, also on c.w., was telling EI5G that his sigs. were f.b. and that he must eat also. (Evidently the inner-man calling). There is no doubt that the 10-metre band is truly interesting and daylight appears to be the best period for listening. There is practically no static; very little QRM and no one seems to send more than 10 to 12 words per min. on c.w. when working on this band.

At 16.55 a broadcast station, sigs. R4, kept me wondering for 5 minutes who it might be and after waiting patiently for the announcement discovered this was GSG on 16.86 metres ending the programme with the musical item "Agitated Ivories" and the announcement "good night and good luck wherever you are." I expect all short-wave listeners have experienced the same disappointment, but it does at least give a useful check to the tuning of the receiver.

As nothing of particular note had yet been heard on 40 metres this band was tuned in at 19.30 and GI2CC was heard working ON4DMC on 'phone. Sigs. were R9 with little fading and excellent quality. Apparently ON4DMC had difficulty with English so GI2CC repeated his report in French, and although I am not conversant with the French language his dit dit dah dit dah dit dah bon soir" certainly sounded "tres bon" to me.

Well, I had had a week-end of real entertainment and was convinced that there is as much interest below 200 metres as above, so at this stage closed down too. Finally, I would say to all who are procrastinating over learning Morse—don't—you are missing a new field of interest and entertainment.

### R.S.G.B. ANNOUNCE FIRST 56MC INTERNATIONAL CONTEST

To stimulate interest in 56-mc. operation, R.S.G.B. have arranged an international contest on this band, starting January 1, 1938, ending December 31, 1938.

Scores will be computed from the distance between stations, the allowance being:

1 point	for contacts between 200 and 1,000 miles.
5 points	" " " 1,001 " 2,000 "
10 points	" " " 2,001 " 3,000 "
15 points	" " " 3,001 " 4,000 "
	etc.

The test is open to any amateur possessing a 56-mc. permit, and entrants must submit a monthly report of stations worked or heard, together with notes on conditions experienced, power used, and any other information of value.

To count points, the same station must only be worked once within a seven-day period, and all stations must be operating at their fixed address, not portable.

An excellent rule is that all entrants must use d.c.c.w., 'phone or modulated c.w. being definitely banned. This will ensure the use of decent modern transmitters, the development of which has been so retarded by the use of "wobulated" portable gear.

"ON THE AMATEUR BANDS"—*cont. from p. 13.*

so I am looking forward to seeing his new station.

Austin Forsyth, G6FO, our designer, spent an evening with me during a short visit to town. Four hours talking "shop," but we enjoyed it. I live 100 yards from the main Brighton road, so he was able to hear some real man-made static.

He is putting the finishing touches to an exciter unit using a couple of Tungram APP4G's. Sounds a hot job to me, practically all-band operation with a 1.7 mc. crystal, enough kick to drive a 50-watt final, so look out for it soon.

Another thing he is doing is arranging some tests with U.S.A. on 1.7 for early next year. Anyone interested?

### ● Ancient History

O. M. Davies (2PC) is another old timer coming back to the game. He mentions 2AZ, the late William le Quex, who was an ardent "ham" around 1922. Of the others 2KW is now in the talkie game, 2KF in the B.B.C., and 2NM (of Empire Broadcast fame) still comes on occasionally.

2PC helped at 2KW during the early trans-Atlantic tests. Paul Godley came over from U.S.A. on behalf of A.R.R.L. to listen for yank signals. He brought over a colossal superhet, which he used in a tent at Ardrossan, Scotland, in conjunction with a Beverage aerial. 2PC says his memories of the tests chiefly consist of rising at 2 a.m. and cycling to Sale, where he listened with his friend on a 3 r.f.-v-2 l.f. receiver he and 2KW made for the job. Tuning it was like trying to work out the combination of a safe: ganging was unthought of then, but they did have some luck in the tests.

Later 2KW got a 1-kw. permit, and rigged up a transmitter with home-made transformer and ump-teen jam-jars for an electrolytic rectifier. Every time the key was pressed all the street lights blinked in sympathy!

### ● Contacts wanted

H. Hirschberg, of Clapham, S.W., writes that on a card from W5FAG, it states that this is his first European report, and that he would like contacts with this country. He is on every weekend, 14 mc., 'phone and c.w.

QRU, 73, Merry Xmas, QSK, SK.

"QUERIES"—*continued from p. 14.*

average power will drop, and we shall be able to use Heising modulation without the enormous battery drain when constant carrier 'phone is used.

Using a class B modulator the modulator valve will not take power when there is no speech being transmitted, so we do not have to worry about this valve. The problem that remains is to prevent the p.a. from taking power, which can be done either by giving it a high negative grid bias, or by either cutting off the power to the c.o. or making its grid so negative that it stops oscillating.

Various ideas are: the use of relays to cut off the h.t., or a rectified voltage for the bias obtained from a rectifier (a Westector for preference) operating in the output circuit of the driver stage for the class B valve.

A delay circuit will also be necessary, otherwise speech will be cut off between syllables, but this is only a minor matter, which can be added when the control circuit has been designed.

We haven't had much time to experiment in this direction, but what little we have done shows promise. At any rate it is interesting work, and is a line of experiment for those with A.A. licences to while away the time waiting for a full ticket.

### ● Anode Bypass Condenser

Many amateurs using 1,500 volts h.t. use a 1,500-volt working bypass condenser. With a class C final the anode volts applied may be only 1,500 but the peak volts are nearer 4,000. No wonder condensers blow. When anode modulation is used the peak voltage is at least doubled, and the condensers are more apt to give way. That so few breakdowns do occur is due to the factor of safety the makers allow, but this condenser is worthy of more attention than is usually paid to it. I have been stations where every care and expense has been made to get the utmost efficiency, yet a most unsuitable type of condenser has been used in this important position. R.F. watts are precious, don't waste them in the transmitter, they are more valuable in the aerial. Have a look at your anode bypass, it may be the cause of erratic operation on 28 mc.

---

## CLUB ACTIVITIES

---

Reports for inclusion under this head must reach us by the 15th.

---

### BIDEFORD

On November 3 the Bideford and District Short-Wave Society successfully held its second annual dinner, and were honoured with the presence of G6GM (Holsworthy), and Mr. A. Cornish (Torrington Radio Society) and its members; other amateurs present were G6FO, G8US and 2ADJ.

On November 8 tests were carried out with a "Stentorian" speaker. This was voted fine business, and the Society decided to procure one for its own use. Anyone interested in membership should apply to the Hon. Secretary, Mr. W. G. Couch, "Hillside," Glen Gardens, Bideford.

### BOURNEMOUTH—POOLE

It is proposed to form a club in the Bournemouth-Poole area to meet monthly, under the title "The East Dorset and West Hants Radio Club." The co-operation of G5CH has been obtained and others in the district are being approached. The proposed subscription is 5s. per annum. Enquiries would be welcomed from anyone in the area interested, and these should be addressed to DAVID M. WILLIAMS (BSWL 832), Provisional Secretary, "Amberley," Cromwell Road, Poole.

### BRIGHTON

A Brighton Chapter of the British Short-Wave League was inaugurated on November 26 with a good attendance. The meeting consisted of electing the necessary officials. Members' achievements and QSL cards received were discussed and inspected. Regular meetings have been arranged for the winter. Anyone interested should write to the B.S.W.L. T.R. for Brighton: N. OWEN (2AFO), 6, Elder Street, Brighton, 1. All are welcome.

### DOLLIS HILL

Ten-metre transmission and reception will form the subject of a talk by Mr. H. Wilkins (G6WN) to members of the Dollis Hill Radio Communication



Society, on December 7. A "Simple Mathematics and Ohms Law" talk is arranged for the December 21 meeting. The honorary secretary, J. R. HODGKYN'S (2CQF), 102, Crest Road, Cricklewood, N.W.2, extends an invitation to interested persons to attend these meetings at the Brancroft Schools, Warren Road, at 8 p.m.

#### ENFIELD

Although formed but recently the Enfield Radio Society has been established on a firm basis and is already very active. Meetings are held every Monday. Applications for membership have been large, and the present members include several "old hands," beginners, together with a number of local hams. It is hoped to arrange an extensive programme for the remainder of the winter session. Applications for membership will be welcomed, and should be sent to the Secretary: L. A. FENN, 47, Cecil Avenue, Enfield.

#### EXETER

At the meeting of the Exeter and District Wireless Society held on October 25 Mr. R. C. Lawes, A.M.I.E.E., took as his subject for a lecture, "Direction Finding." The latest types of apparatus were described in detail and the lecture was made more interesting by the fact that during the last few months, Mr. Lawes has installed direction finders on ocean-going racing yachts, and he himself took part in this year's Fastnet Yacht race. The types of errors which are likely to be found in the practical application of this side of radio engineering were described and well illustrated by the lecturer with diagrams.

Mr. Lawes went on to say that he found it quite practical to navigate any sea-going craft by using radio alone and he instanced a crossing from Fastnet Rock to the Scilly Islands, a distance of approximately 200 miles. On this particular leg of the Yacht race no stellar observations were obtained owing to thick weather, but the lighthouse on Round Island in the Scilly Islands was found with ease. It was also shown by Mr. Lawes that it made very little difference whether the apparatus was fixed above or below the water line of a ship and he had no doubt that similar success could be obtained from land craft such as tanks, armoured motor cars, etc.

Mr. Rumball, during his recent lecture to members, demonstrated various makes of car radios in particular and also showed how the many sources of interferences could be overlooked. Many new vibrators were demonstrated and also various aerial systems in use for radio installations on cars, etc.

At the November 8 meeting a lecture was given by Mr. D. R. Barber, B.Sc., F.R.A.S. The title of the lecture was "The Ionosphere." Mr. Barber exhibited numerous slides and took his audience through the various layers, pointing out the peculiarities of each. A remarkable fact proved that in the ozonosphere the temperature is always 30 degrees centigrade, i.e., hotter than the earth's surface. The two layers which are 60 miles and 150 miles above the earth's surface are more or less produced by the action of ultra violet rays. The next part of his lecture dealt with polarization and here again it was shown that in the northern hemisphere the left-hand wave was about five times as strong as the right-hand one, whereas in the southern hemisphere the reverse was the case.

Methods were shown in the calculation of the heights of various layers and how radio echoes are recorded. On some slides it was clearly shown how

one radio signal produced three and five separate echoes. The lecturer went on to say that the lower layers were discovered two years ago and they only existed in the summer and it is these layers which are designated D1 and D2 which affect ultra short-wave radio work. Solar activity and its effect on cable and radio transmission was also dealt with.

Meetings are held each Monday at 3, Dix's Field, Exeter, at 8 p.m. and those interested should get in touch with the Secretary, Mr. W. CHING, 9, Sivell Place, Heavitree, Exeter.

#### ILFORD

Last month saw the production of No. 1 of the Ilford and District Radio Society's *Bulletin*, a monthly news-letter that has interest for members and non-members alike, for there are technical notes interspersed with those of more local interest. Annual subscription is 1s.

The hon. press secretary (H. T. STOTT, 2COT) in his covering letter says: "You will see by the syllabus on page 4 that we are as active as ever, and despite the alleged 'lowering of interest in home radio construction and activities of an experimental nature' (sic) we are able to record at this date that a number of new members have joined. On November 12 a representative number of our members visited the Southend Society at their H.Q. at Leigh Technical College, where a lecture on 'Modern High-definition Television' was given by Mr. Watson of E.M.I. The lecturer gave a most interesting talk, and went very fully into many points of his subject. The proceedings terminated with many questions."

Fixtures for Thursdays in December include, in the following order: Loudspeaker demonstration and talk, Mr. H. A. Hartley; Gramophone demonstration and talk, 2COT; Junk Sale; Informal Evening; the last evening is open for fixture. Further details will be given prospective members by hon. secretary C. E. LARGEN, 44, Trelawney Road, Barkingside, Ilford (Royal 4361, Chigwell 126).

#### NORTHERN IRELAND

The general monthly meeting of the Radio Society of Northern Ireland was held on November 3, in the Y.M.C.A. (Belfast) Club Rooms, with the permission of the Association's Radio Club. After routine business it was announced that the services of a professional operator had been secured for the benefit of all members who should avail themselves of this splendid opportunity of learning the code in the proper manner.

On November 6 a visit was paid to the Short-Wave Telephone Link at Ballygomartin by permission of M. C. Cooper, A.R.C.Sc.I., A.M.I.E.E., who welcomed the party. Mr. G. Edwards, engineer-in-charge of the Station, and his two able assistants then took the members on their tour of inspection and all are unanimous in their appreciation of the perfectly lucid manner in which the various apparatus was described.

Members are steadily increasing and full particulars may be had from the Hon. Sec., Mr. C. TAYLOR (2AOB); 2, York Crescent, Shore Road, Belfast.

#### SOUTHEND

At a meeting held on October 29 Mr. H. G. Menage, of R. A. Rothermel, Ltd., gave a lecture to members of the Southend and District Radio and Scientific Society on "Some Interesting Applications of Piezo-Electric Crystals." In addition to the better-known applications such as pick-ups, micro-

phones and speakers, the lecturer described and demonstrated crystal-operated devices for testing the human heart, checking the movement of watches and recording vibration in motor car engines.

In view of the great demand, a further direction-finding contest was held on Sunday, November 7. The start was from Rayleigh, Essex and the first competitor to find the concealed transmitter was Mr. G. T. Peck, the second being Mr. K. W. Harbridge (G2KH). It had been announced that this would definitely be the last outdoor meeting in the present year but it is understood that a petition has been organised, requesting the committee to arrange a further contest as soon as possible.—Hon. Sec., F. S. ADAMS, Chippenham, Eastern Avenue, Southend-on-Sea.

#### SURREY

The lecturer at the October 19 meeting of the Surrey Radio Contact Club was Mr. Miles (G2NK), Technical Manager of A.C.S., who brought with him three communication receivers of American manufacture which he demonstrated. They were: National 101X, with crystal filter, Hallicrafter Sky Challenger, and an R.C.A.111—also a crystal-gate receiver. Mr. Miles explained that as the British manufacturers did not market a real amateur receiver, American products had to be imported to satisfy the needs of present-day amateur radio. The large number of amateurs in the U.S.A. and the interference created by crowding them into the narrow width allotted had ruled the design of these sets.

The sensitivity of all three sets on a six-foot aerial was marked. The selectivity of the crystal-gate circuit was of a degree hitherto unknown to many of the members present. On the National, the dial and the band-spreading arrangements had been so well arranged that one division (a quarter-inch space on the circumference of the dial) represented, on the 14 mc, band 1 kc. Such a spread, the lecturer assured us, enabled measurements of drift in frequency when the transmitter was warming up, to be readily determined.

Of particular interest to those members who are troubled with ignition interference, was the highly efficient noise-suppression circuit of the R.C.A. receiver. A hearty vote of thanks to the lecturer closed the meeting. The lecturer afterwards informed us that, from our comments and opinions, much had been learned of the amateur's idea of an ideal receiver which may yet be marketed in this country as an all-British receiver for amateur band work. Full details of the club may be obtained from the hon. secretary, A. B. WILSHIRE, 14, Lytton Gardens, Wallington.

#### THORNTON HEATH

By the time this report appears the Short-Wave Radio and Television Society of Thornton Heath hope to have erected a new H.Q. aerial which is to be a Windom; they will be pleased to receive reception reports from readers on 40-meter fone and c.w. transmissions. (Call G8GY).

A successful and enjoyable junk sale was held recently and for the first time radio journals and magazines were sold in addition to the usual run of components and accessories.

An increase in membership is reported and the Secretary reminds readers, whether beginners or old hands, that they are at all times welcome to the meetings either as potential members or visitors.—Hon. Sec., Mr. JAS. T. WEBBER, 368, Brigstock Road, Thornton Heath.

#### TOTTENHAM

Three successful Visitors' Evenings were held on the 11th, 12th and 13th of November by the Tottenham Short-Wave Club—the number applying for membership was gratifying. Thanks are due to Mr. Cholot for demonstrating the Lissen Hi-Q short-wave components and All-Wave Receiver No. 8114. Although the aerial system was not of the best the demonstration was voted by all as a complete success. We should also like to thank THE SHORT-WAVE MAGAZINE for their kind co-operation, Messrs. Stratton and Co. and The Whiteley Manufacturing Co. (for the loan of a "Stentorian" speaker). Considerable interest was shown in the apparatus assembled by club members, and special mention is due to Mr. Symons for hard work in this respect. THE SHORT-WAVE MAGAZINE's One-Valve Class B receiver was assembled and excited interest.—Hon. Secretary, EDWIN JONES, 60, Walmer Terrace, Firs Lane, Palmers Green, N.13.

#### WELLINGBOROUGH

The fortnightly meeting of the Wellingborough and District Radio and Television took place at Wellingborough on November 10, when a lecture and demonstration of THE SHORT-WAVE MAGAZINE Class B battery receiver was given by the hon. sec., Mr. L. F. PARKER (G5LP), who prefaced his description of the receiver by saying that it was refreshing in these days of multi-valve receivers to see published a design of a short-wave receiver capable of being constructed by the novice at low cost and producing such excellent results as had been obtained with this receiver.

The volume obtainable was really remarkable and with 150 volts h.t. and a current consumption of less than four milliamperes, the receiver was capable of giving quite good loudspeaker reproduction of the more powerful short-wave broadcasting stations. Sensitivity was of a high order and during a short test all continents were heard on telephony in a little over half-an-hour. The reaction control was faultless and the Eddystone band-spreading system incorporated enabled even the beginner to obtain equal results.

Even on the very high frequencies above 28 megacycles the receiver still functioned excellently and ten-metre 'phone from U.S.A. could be logged whenever the ten-metre band was alive, showing that the receiver was very suitable indeed for amateur communication purposes. After the talk, a number of questions were asked regarding the circuit and operation of the receiver and the thanks of the Society were expressed to the Editor of THE SHORT-WAVE MAGAZINE for making the interesting meeting possible.

#### WEST SUSSEX

The West Sussex Short-Wave and Television Club was formed at Chichester on September 14 and now has a membership of 27—more are required. Full details will be gladly sent to anyone interested. A general meeting was held at "The Waggon and Lamb" on October 5. Our President gave a very interesting talk on his radio reminiscences from 1913 until the present day. He spoke about his first 100-watt licence whereby he was allowed to use this input for two hours a week, his Empire broadcasting experiments, and concluded with some advice on transmitter and aerial design. The talk was greatly appreciated by all present. The Club is applying for an A.A. licence on all bands.—Hon. Secretary, L.A.C. J. WILLIAMS (2BBB), H.Q. Flight, 43 (F) Squadron, R.A.F., Tangmere, Sussex.

#### QUERY COUPON

S.-W.M. 12/37.

Station	Dial	Call	Wave	Freq.
PITTSBURGH		W8XK	13.93	21.54
DAVENTRY		GSJ	13.93	21.53
WAYNE		W2XE	13.94	21.52
DAVENTRY		GSH	13.97	21.47
BANGKOK		HS8PJ	15.77	19.02
DAVENTRY		GSJ	16.86	17.79
BOUNDBROOK		W3XAL	16.87	17.78
HUIZEN		PHI	16.88	17.77
ZEESSEN		DJE	16.89	17.76
WAYNE		W2XE	16.89	17.76
BUDAPEST		HAS3	19.52	15.37
SCHENECTADY		W2XAD	19.57	15.33
DAVENTRY		GSP	19.60	15.31
BUENOS AIRES		LRU	19.62	15.29
ZEESSEN		DJQ	19.63	15.28
WAYNE		W2XE	19.65	15.27
DAVENTRY		GSJ	19.66	15.26
BOSTON		W1XAL	19.67	15.26
RADIO COLONIAL		TPA2	19.68	15.24
EINDHOVEN		PCJ	19.71	15.22
PODEBRADY		OLR5A	19.71	15.23
PITTSBURGH		W8XK	19.72	15.21
ZEESSEN		DJB	19.74	15.20
HONG KONG		ZBW4	19.75	15.19
DAVENTRY		GSO	19.76	15.18
TOKIO		JZK	19.80	15.16
SOURABAYA		YDC	19.80	15.15
DAVENTRY		GSF	19.82	15.14
VATICAN CITY		HVJ	19.84	15.12
ZEESSEN		D.II.	19.85	15.11
SOFIA		LZA	20.24	14.88
WARSAW		SPW	22.00	13.83
SANTIAGO (Chile)		CB615	24.39	12.30
REYKJAVIK		TFJ	24.52	12.23
MOSCOW		RV59	25.00	12.00
RADIO COLONIAL		TPA5	25.23	11.88
PITTSBURGH		W8XK	25.27	11.87
LISBON		CSW	25.34	11.84
PODEBRADY		OLR4A	25.34	11.84
WAYNE		W2XE	25.36	11.83
LISBON		CT1AA	25.36	11.83
ROME		I2RO4	25.40	11.81
TOKIO		JZJ	25.42	11.80
VIENNA		OER2	25.42	11.80
BOSTON		W1XAL	25.45	11.79
ZEESSEN		DJD	25.49	11.77
DAVENTRY		GSD	25.53	11.75
HUIZEN		PHI	25.57	11.74
WINNIPEG		CJRX	25.60	11.72
RADIO COLONIAL		TPA4	25.60	11.72
HAVANA		COCX	26.24	11.43
RADIO NATIONS		HBO	26.31	11.40
BUENOS AIRES		LSX	28.99	10.35
RUYSSELEDE		ORK	29.04	10.33
LISBON		CSW	27.17	11.04
MADRID		EAQ	30.43	9.86
HAVANA		COCQ	30.77	9.75
LISBON		CTICT	31.00	9.68
BUENOS AIRES		LRX	31.06	9.66
LISBON		CT1AA	31.09	9.65
CARTAGENA		HJ1ABP	31.25	9.62
CARACAS		YV5RA	31.25	9.60
MOSCOW		RV96	31.25	9.60
RADIO NATIONS		HBL	31.27	9.59
PHILADELPHIA		W3XAU	31.28	9.59
SYDNEY		VK3ME	31.28	9.59
EINDHOVEN		PCJ	31.28	9.59

Station	Dial	Call	Wave	Freq.
DAVENTRY		GSC	31.32	9.58
LYNDHURST		VK3LR	31.32	9.58
MILLIS		W1XK	31.35	9.57
BOMBAY		VUB	31.38	9.56
ZEESSEN		DJA	31.38	9.56
PODEBRADY		OLR3A	31.41	9.55
SUVA (Fiji)		VPD2	31.46	9.54
ZEESSEN		DJN	31.46	9.54
JELOJ		LKJ1	31.48	9.53
TOKIO		JZI	31.48	9.53
SCHENECTADY		W2XAF	31.48	9.53
HONG KONG		ZBW3	31.49	9.52
MELBOURNE		VK3ME	31.55	9.51
DAVENTRY		GSB	31.55	9.51
CARTAGENA		HJ1ABE	31.58	9.50
RIO DE JANEIRO		PRF5	31.58	9.50
MEXICO CITY		XEWV	31.58	9.50
MADRID		EAR	31.62	9.49
HAVANA		COCH	31.82	9.43
BANGKOK		HS8PJ	31.85	9.35
LIMA		OAX4I	32.12	9.34
BUDAPEST		HAT4	32.88	9.12
RADIO NATIONS		HBP	38.48	7.80
TOKIO		JVP	39.95	7.51
SAN DOMINGO		HIT	45.25	6.63
NANKING		XGOX	43.99	6.82
VALENCIA		YV4RB	46.01	6.52
MARACAIBO		YV1RH	47.12	6.36
MARACAIBO		YV5RP	47.84	6.27
HAVANA		COKG	48.39	6.20
MARACAIBO		YV5RD	48.78	6.16
WINNIPEG		CJRO	48.78	6.15
PITTSBURGH		W8XK	48.86	6.14
JELOJ		LKJ1	48.94	6.13
HAVANA (CUBA)		COCJ	48.94	6.13
GEORGETOWN		VP3BG	48.94	6.13
BOGOTA		HJ3ABX	48.96	6.13
MEXICO CITY		XEUZ	49.02	6.12
WAYNE		W2XE	49.02	6.12
CHICAGO		W9XF	49.18	6.10
BOUNDBROOK		W3XAL	49.18	6.10
BELGRADE		YUA	49.18	6.10
TORONTO		CRCX	49.26	6.09
HONG KONG		ZBW2	49.26	6.09
NAIROBI		VQ7LO	49.32	6.08
CHICAGO		W9XAA	49.34	6.08
LIMA		OAX4Z	49.33	6.08
GEORGETOWN		VP3MR	49.42	6.07
MARACAIBO		YV1RD	49.42	6.07
PHILADELPHIA		W3XAU	49.50	6.06
CINCINNATI		W8XAL	49.50	6.06
COPENHAGEN		OXY	49.50	6.06
MOTALA		SBG	49.50	6.06
BOGOTA		HJ3ABD	49.59	6.05
BOSTON		W1XAL	49.67	6.04
PANAMA CITY		HP5B	49.75	6.03
ZEESSEN		DJC	49.83	6.02
BOGOTA		HJ3ABH	49.85	6.01
HAVANA		COCO	49.85	6.01
PODEBRADY		OLR2A	49.92	6.01
MONTREAL		CFCX	49.96	6.00
MEXICO CITY		XEBT	50.00	6.00
MOSCOW		RW59	50.00	6.00
VATICAN CITY		HVJ	50.26	5.97
MARACAIBO		YV1RB	51.28	5.85
CARACAS		YV5RC	51.72	5.80
KHARBAROVSK		RV15	70.20	4.27

G2NO  
H. R. ADAMS

SELECTED ITEMS FROM  
OUR LIST

**MICROPHONES**

Shure, 701A. Grill type. 84/-  
Astatic D104 75/-  
Webb's Transverse Carbon,  
with table stand. 25/-  
With floor stand.

**VALPEY CRYSTALS**

7 Mc. mounted.  
Calibrated to + or - .1 per  
cent. 15/6  
Unmounted, as above 10/6

**DUMONT CATHODE  
RAY OSCILLOSCOPE.**

Model 164. 3-in. tube.  
Vertical and Horizontal Ampli-  
fiers. Amplified sweep.  
Internal Power Pack.  
Price complete 18 guineas  
913 1-in. Cathode Ray Tube. 37/6

**ACORNS.** Price reduced.  
Type 955 Triode. 25/6  
Types 954, 956 Pentodes. 36/-

**RAYTHEON TUBES**

**RK-34 Duplex Transmitting  
Triode.** 22/6  
**RK-39 Beam Power TX.** 22/6  
**RK-47 (Beam Power RK-20).**  
105/-  
100-TH, New Eimac. 95/-  
RK-20A replacing RK-20. 95/-  
RK-25 and RK-23. 27/6

**TAYLOR**

Taylor T.125. £4 5s. 0d.  
Taylor T.20. 17/6  
Taylor TZ.20. 17/6  
Taylor 866 Junior. 7/6  
Taylor 866. 11/6  
Taylor T.55. 45/-

**POWER TRANSFORMERS**

Filament Transformers, single  
winding. Up to 30 watts. 12/6  
Twin Winding, up to 30 watts.  
15/6  
Triple Winding, up to 40 watts.  
19/-  
High Voltage Transformers.  
750-0-750 at 200 mils, inter-  
leaved. £2 13s. 0d.  
1,000-0-1,000 at 200 mils.  
£3 15s. 0d.  
1,000-0-1,000 at 350 mils.  
£4 10s. 0d.  
1,000-0-1,000 at 500 mils.  
£5 0s. 0d.

Swinging Chokes.  
5 to 25H at 100 m.a. 15/6  
5 to 25H at 200 m.a. 21/-  
Filter Chokes.  
20 Henry at 120 m.a. 15/6  
20 Henry at 200 m.a. 28/-  
Other sizes to order.

**CLEARANCE OFFERS.**

Mu-Metal Microphone Trans-  
formers (cost 55/- each). 7/6  
Mu-Metal Smoothing Chokes.  
5.2H, 120 m.a. 3/6  
4-in. Transmitter Bakelite Dials.  
½-in. spindle. 6d. each

**EDDYSTONE ALL-WORLD  
TWO,** complete with valves,  
colls, calibration chart, ready  
for use. Price £3 17s. 6d.  
Aerovox 2 mfd. 2,000 v. WKG.  
9/6

G6VA  
E. J. PICKARD

# WEBB'S

## PRODUCE THE RADIO AMATEUR'S GLOBE AND MAP OF THE WORLD

12" Radio  
Globe

Mounted,  
Fully  
Coloured

International  
Prefixes



PRICE  
27/6

Immediate  
Delivery

EQUIDISTANT AZIMUTHAL MAP OF THE WORLD  
CENTRED ON ENGLAND  
ALL INTERNATIONAL PREFIXES MARKED  
FULLY COLOURED. SIZE 30 in. by 40 in.

PRICE 4/6

A limited number of Maps mounted on linen, with roller, at 10/6.  
BOTH AVAILABLE DECEMBER 1st.

**TED McELROY, WORLD'S CHAMPION TELEGRAPHIST, RELEASES  
A NEW STRAIGHT KEY.**

LARGE CONTACTS. HEAVY CAST BASE. DELIGHTFUL ACTION Price 10/-  
MAC OSCILLATOR.  
FOR PRACTICE. PRODUCES A 1,000 CYCLE NOTE - - - 10/-  
KEY AND OSCILLATOR COMBINED - - - - - 20/-  
1938 McELROY BUG KEY - - - - - 38/-

## WEBB'S CARRY THE STOCKS

### WEEKLY CONSIGNMENTS

DIRECT FROM THE FACTORIES OF

**RME, HALLICRAFTERS, TAYLOR, RAYTHEON, HARVEY, etc.**

ASSURE THAT YOU RECEIVE PROMPT DELIVERY AND BRAND NEW GOODS  
EVERY MEMBER OF OUR STAFF IS A 100% 'OLD TIMER,' THOROUGHLY  
HAPPY IN HIS WORK OF MAKING WEBB'S THE AMATEUR CENTRE

CALL AND ENJOY A PERSONAL CONTACT

# WEBB'S RADIO

(C. WEBB, LTD.)

14 SOHO STREET., OXFORD STREET, LONDON, W.1.

Phone : GERrard 2089

Midland Depot : For Callers Only :

41, CARRS LANE, BIRMINGHAM.

Phone : Midland 3771

G2CY  
H. W. STEWART

## COMMUNICATION TYPE RECEIVERS

**RME-69.** 1938.  
The Amateur's finest receiver  
Price £39 15s. 0d.

**RME-69-LSI.**  
Incorporating the famous Lamb  
Noise Silencer unit.  
Price £43 10s. 0d.

**RME-DB.20.**  
Two-Stage H.F. Pre-Selector.  
9 to 550 metres.  
Built-in Power Pack (230 v.).  
Price £12 10s. 0d.

**1938 HALLICRAFTER.**  
The New Super Sky Rider  
Crystal Gate, "R" Meter.  
1,000 deg. Band Spread.  
5 to 550 metres.  
Price 230-v. model £32 0s. 0d.

**1938 SKY CHALLENGER**  
9 Tubes.  
Fully calibrated.  
9 to 550 meters.  
Crystal Gate.  
Price 230-v. model £25 0s. 0d.

**1938 SKY CHIEF**  
7 Tubes (1 R.F.).  
Built-in Speaker.  
Price complete £12 10s. 0d.

**THE NEW SKY BUDDY.**  
5 Tubes.  
17 to 550 metres.  
Built-in Speaker.  
Price complete £9 0s. 0d.

**NATIONAL.**  
National "One-Ten"  
The finest U.H.F. Receiver.  
NOTE REDUCED PRICE.  
Complete with Tubes.  
£18 10s. 0d.

**National H.R.O. Senior**  
Price complete £49 15s. 0d.  
**National H.R.O. Junior.**  
Price complete £39 15s. 0d.

**NEW NATIONAL 80X**  
Delivery is expected Decem-  
ber 1st.  
A.C./D.C. Operation.  
Price £23 0s. 0d.

**HARVEY TRANSMITTERS  
UH-X-10**  
10 to 20 watts R.F.  
5 to 160 metres.  
Crystal Control.  
Price Transmitter bare  
£16 15s. 0d.

**HARVEY 80T**  
Complete for two-band opera-  
tion. £63 17s. 0d.

**UH-X-35**  
20, 10, 5 and 2½ metres.  
100 watts input.  
Price complete £110 0s. 0d.

WRITE FOR LIST AND  
DETAILED HIRE-  
PURCHASE FACILITIES

WIJYN  
TED McELROY