

SHORTWAVE MAGAZINE

BRITAIN'S BEST RADIO MAGAZINE

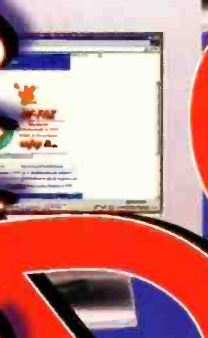

Decoding
FAZ Reception in 30 Minutes; Decade Web Watch; Digital Frequency Tables

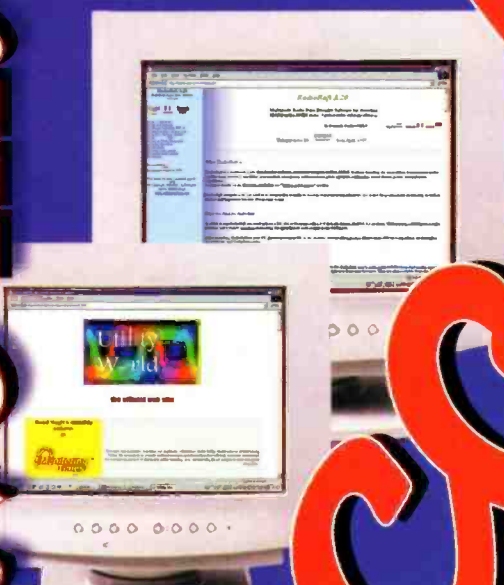

RECEIVING INMARSAT
WHAT TO DO



HALLICRAFTERS SX-117

JOHN WILSON WITH ANOTHER
VALVED CLASSIC RECEIVER

September 2000 £2.99



09 >

The new ALINCO DJ-X2

micro-sized go anywhere scanner is small enough to fit comfortably into a shirt pocket and yet its in-built speaker gives amazing clarity of audio from the sensitive receiver. Take it with you to airshows, boat shows, on holiday - its discrete size enabling reception just about anywhere, without attracting unwanted attention.

Its easy to use, with a host of optional accessories and enough power for the most demanding user.

For airband enthusiasts the Alinco DJ-X2 has the new 8.33kHz Civil Airband Channels.

This has to be
'THE SCANNER' of year 2000!

FEATURES

- Receives: 522kHz - 999.995MHz AM WFM NFM
- Selectable scan modes
- Audio descrambler
- Bug detector - detects presence and frequency of bug giving audible warning
- Selectable internal / external antenna
- Internal or external supply
- Program Search banks
- Illuminated backlight display
- 2 performance modes easy and expert
- RX attenuator
- Auto power off mode
- Priority channel monitoring
- Squelch control
- Volume control

SPECIFICATIONS:

- IF: 1st 248.45MHz 2nd 38.85MHz, 3rd 450KHz
- Frequency range: 522kHz - 999.995MHz
- Sensitivity FM 30-770MHz: -6dB u FM 770MHz: -2.5dB u WFM 11dB u AM 0.5-1.62MHz: 15dB u AM 1.62MHz: 3dB u
- Steps 5, 6.26, 8.33, 10, 12.5, 15, 20, 25, 30, 50, 100, Auto
- Modes: AM WFM NFM
- Memories: 700
- Antenna Connector: 5MA
- Power output audio: max 30mW (32 ohms)
- Power supply: 4.5V DC
- Weight: 85g
- Size: 58W x 90H x 15Dmm

Optional Accessories

£239.95

£6 p&p



Flying

YUPITERU MVT 7100EU

Probably the most popular high end Scanner. It's easy to use and can receive just about anything going!

- 530kHz-1650MHz
- AM/FM/WFM/SSB/CW
- 1000 Memories
- C/w NiCads & charger

PRICE MATCH

£249.95

- OP51 Soft Case£17.95 + £2 p&p

We are proud to be authorised by
YUPITERU JAPAN
to distribute their SCANNERS in the United Kingdom

AR 108

Palm sized Airband & VHF Scanner

A new dedicated handheld scanning receiver that has been optimised to give powerful long distance reception of Civil Airband and VHF. It is compact and small enough to fit comfortably in a top pocket.

Features include:

- Frequency: Airband 108 - 136.975MHz VHF Band 136 - 180MHz
- Modes: AM or FM
- Memories: 99
- Selective Channel Steps: S, 10, 12.5, 15, 25, 1MHz
- Dual Watch Function
- Key Lock
- Battery Save Function
- Battery Voltage Indicator
- Supplied C/W Earphone, Belt Clip, Carrying Strap

£69.95

£6 p&p

- Mains Chargers£8.95

NEVADA®

DISTRIBUTION DIVISION

**ORDER
HOTLINE**
023 9231 3090

- FAX: 023 9231 3091
- E-MAIL: info@nevada.co.uk
- WEBSITE: http://www.nevada.co.uk

High - the new Alinco DJ-X2

MICRO SIZED SCANNER



ALINCO DJ-X10E

Wideband scanning receiver

- Receives 100kHz - 2000MHz
- Multi Mode Reception AM - VFM - NFM - SSB - CW
- 1200 Memory Channels
- Channel Scope spectrum analyser that allows monitoring of 40 channels
- Channel Scope Peak Search
- Advanced Scanning features

Programmed Scan	VFO search
(up to 10 groups)	Dual VFO search
Programmed Memory Scan	Band excursion scan
Any Memory Scan	Priority scan
Mode Scan	Any channel ship scan
- User Friendly features
 - Help messages - Personalised Channel names - Memory cloning - Auto memory write scan - Beginner/Expert Mode - Memory Tune Mode

DJ-X10E includes FREE



- MAINS DROP IN CHARGER
For easy and convenient use
- NICAD BATTERY PACK
4.8V DC 700mAh NiCad battery
- BELT CLIP
- CARRYING STRAP
- FLEXIBLE LOW PROFILE ANTENNA

- Large Clear Illuminated Display
- Timer Functions with auto on/off facility
- Battery Save Facility
- Squelch Control
- Stylish cabinet with large speaker
- A super sensitive receiver
- Dual VFOs
- Facilities for cloning another set
- Built-in 24 hour clock
- Display - Contrast - Control
- Low battery alarm
- Switchable Attenuator
- Selectable control Beep tone
- Keypad lock control

SPECIFICATIONS

Frequency.....100kHz - 2000MHz
 Memories.....1200
 Scan Speed.....25 ch/sec
 Scan Steps.....Selectable (50Hz - 500kHz)
 in 20 fixed steps
 Receiver.....Triple Superheterodyne
 Dimensions...57(H) x 150(W) x 25.5(D)
 Weight.....320g
 (with EBP-37N Battery pack)

OPTIONAL EXTRAS

EBP-33N.....Small size 650mAh NiCad.....£39.95
 EBP-34N.....Long life 1200mAh NiCad.....£49.95
 ESC-29.....Standard Soft Case.....£14.95
 EBC-6.....Mobile Mounting Bracket.....£12.95
 EME-6.....Earphone.....£10.95

£295

£8 p&p

We are one of Europe's largest Scanner Specialists

UK Distributors for Alinco & Yupiteru products

• Unit 1 • Fitzherbert Spur • Farlington • Portsmouth • Hants • PO6 1TT



DEALERS!

for further details contact
 our TRADE DEPARTMENT
 Phone:
 Intl: +44 (0)23 9231 3095
 Fax:
 Intl: +44 (0)23 9231 3091

contents

Vol. 58 Issue 09 September 2000

ISSN 0037-4261

ON SALE AUGUST 24

Next issue on sale September 28



features

BROADCAST

8 LM&S

13 Bandscan Australia

Decode Special

25 The 30 Minute FAX Guide

Ever wanted to try your hand at FAX reception, but didn't quite know where to start? Well, this is just for you! Mike Richards guides you through a step-by-step process that should get you on-the-air in less than 30 minutes.

33 Utility Software Round-Up

Mike Richards presents his choice of software for 'decode' use.

42 Decode - The Column

44 Complex Frequency Listings

Mike Richards invites you to exercise your decoder with more than just RTTY and FAX. Go on, delve into some more exotic modes with the 'Decode Special' complex list.

47 Utility Web Round-Up

With many readers now starting to use the world wide web as a prime source of information, a 'Decoding Special' would not be complete without Mike Richards compiling a round-up of some of the best web sites.

Join the SWM Readers E-mail forum, send an E-mail to: SWM_readers-subscribe@egroups.com

SWM Author Info To provide you with a ready reference here are the contact details of all our regular authors.

Airband
Godfrey Manning G4GLM, c/o The Godfrey Manning Aircraft Museum, 63 The Drive, Edgware, Middlesex HA8 8PS

Amateur Bands
Paul Essery GW3KFE, PO Box 4, Newtown, Powys SY16 1ZZ

Attention 123!
Enigma, 17-21 Chapel Street, Bradford, West Yorkshire BD1 5DT. E-mail: enigma@pwpublishing.ltd.uk

Bandscan
Bandscan America
Gerry Dexter, c/o SWM Editorial Offices. E-mail: gdexter@pwpublishing.ltd.uk

Bandscan Australia
Greg Baker, PO Box 3307, Manuka, ACT2603, Australia. E-mail: greg.baker@pwpublishing.ltd.uk

Bandscan Europe
Peter Shore, c/o SWM Editorial Offices. E-mail: peter.shore@pwpublishing.ltd.uk

Decode
Mike Richards G4WNC, PO Box 1863, Ringwood, Hampshire BH24 3XD. E-mail: decode@pwpublishing.ltd.uk

DXTV
Keith Hamer and Garry Smith, 17 Collingham Gardens, Derby DE2 4FS

Info In Orbit
Lawrence Harris, 5 Burnham Park Road, Peverell, Plymouth, Devon PL3 5QB. E-mail: info.orbit@pwpublishing.ltd.uk

LM&S and Maritime Beacons
Brian Oddy G3FEX, Three Corners, Merryfield Way, Storrington, West Sussex RH20 4NS.

MilAir
Peter Bond, c/o SWM Editorial Offices. E-mail: milair@pwpublishing.ltd.uk

Off The Record
Andy Cadier, 28 Romney Avenue, Folkstone, Kent CT20 3QJ. E-mail: off.the.record@pwpublishing.ltd.uk

Propagation
Jacques d'Avignon VE3VIA. E-mail: jacques@pwpublishing.ltd.uk

Satellite TV News
Roger Bunney, 35 Grayling Mead, Fishlake, Romsey, Hampshire SO51 7RU.

Scanning
Dave Roberts, c/o SWM Editorial Offices.

E-mail: scanning@pwpublishing.ltd.uk

ShackWare
Jerry Glenwright, 16 Copeman Street, Norwich, Norfolk NR1 2HH. E-mail: shackware@pwpublishing.ltd.uk

SSB Utilities
Graham Tanner, 64 Attlee Road, Hayes, Middlesex UB4 9JE. E-mail: ssb.utilis@pwpublishing.ltd.uk

World Wide Radio Guide
Paul Beam, c/o SWM Editorial Offices. E-mail: wwrwg@pwpublishing.ltd.uk

NEXT MONTH IN OCTOBER SWM

- World Space Radio - Digital International Radio
- Thoughts On Station Identification Techniques
- Kitchen Cupboard Crystal Set
- Iron Curtain Radio
- & much more! *contents subject to change

14 Inmarsat Reception

Just why would you want to monitor Inmarsat? Kevin Nice explains and looks at suitable equipment.

16 The SX-117: A Well Kept Secret

Back in the 1960s American products ruled the roost, and there could be no better example of American receivers of this period than one from Hallicrafters - John Wilson G3PCY checks out the SX-117.

23 Low-Noise Medium Wave & Tropical Band Antennas

In the concluding half of this series, Joe Carr K4IPV looks at some more useful antennas for frequencies up to 7.5MHz, just the job if you are a low-band DXer.



EDITOR:
Kevin Nice, G7TZC, BRS95787

NEWS AND PRODUCTION EDITOR:
Zoë Shortland

ART DIRECTOR:
Steve Hunt

ART EDITOR:
John Kitching

EDITORIAL ADDRESS:
Arrowsmith Court, Station Approach,
Broadstone,
Dorset BH18 8PW
Telephone: (01202) 659910
Facsimile: (01202) 659950

If you wish to send E-mail to anyone at *SWM* then our Internet domain name is:
pwpublishing.ltd.uk
Simply add the name of the person you wish to contact.
For example:
kevin.nice@pwpublishing.ltd.uk

BOOKS, BACK ISSUES & SUBSCRIPTIONS (ALL ORDERS)
(01202) 659930
(Out-of-hours service by answering machine)

ADVERTISEMENT DEPARTMENT
(Broadstone)
ADVERTISING SALES:
Chris Steadman MBIM

ADVERTISEMENT TYPESETTING & PRODUCTION:
Peter Eldrett
Telephone: (01202) 659920
Facsimile: (01202) 659950

ADVERTISEMENT MANAGER:
Roger Hall G4TNT
PO Box 948, London SW6 2DS
Telephone: 020-7731 6222
Facsimile: 020-7384 1031
Mobile: (07885) 851385

regular columns



60



66

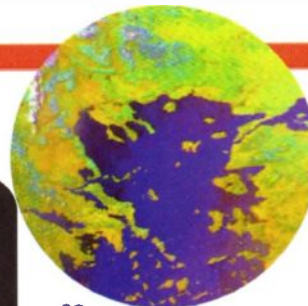

68

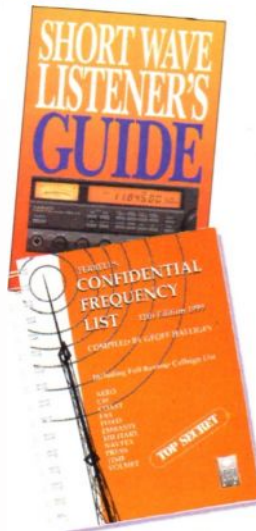

50

Airband	60	Order Form	76
Amateur Bands	56	Propagation Extra	73
Bandscan Australia	13	Propagation Forecast	72
Book Listing	37	QSL	5
Book Profiles	50	Rallies	7
Communiqué	6	Satellite TV News	66
Decode	42	Scanning	57
DXTV	61	ShackWare	53
Editorial	4	SSB Utilities	52
Info In Orbit	68	Subscription Offer	32
LM&S	8	Trading Post	75
Maritime Beacons	65	What's In <i>PW</i>	32
MilAir	55		

The quickest & most comprehensive radio-related book service in the UK!

© PW PUBLISHING LTD. 2008.

Copyright in all drawings, photographs and articles published in *Short Wave Magazine* is fully protected and reproduction or imitation in whole or in part is expressly forbidden. All reasonable precautions are taken by *Short Wave Magazine* to ensure that the advice and data given to our readers is reliable. We cannot, however, guarantee it and we cannot accept legal responsibility for it. Prices are those current as we go to press. *Short Wave Magazine*, USPS No. 006996, is published monthly for £33 (UK) per year by PW Publishing Ltd., Arrowsmith Court, Station Approach, Broadstone, Dorset BH18 8PW. Second Class Postage paid at South Hackensack. Postmaster: Send USA address changes to Royal Mail International, c/o Yellowstone International, 2375 Pratt Boulevard, Elk Grove Village, IL 60007-5537.

DISCLAIMER: *Short Wave Magazine* wishes in no way to either condone, or encourage, listeners to monitor frequencies and services which are prohibited by law. We respectfully refer you all to both the Wireless Telegraphy Act 1949, and the Interception of Communications Act 1985. Some of the products offered for sale in advertisements in this magazine may have been obtained from abroad or from unauthorised sources. *Short Wave Magazine* advises readers contemplating mail order to enquire whether the products are suitable for use in the UK and have full after-sales back-up available. The Publishers of *Short Wave Magazine* wish to point out that it is the responsibility of readers to ascertain the legality or otherwise of items offered for sale by advertisers in this magazine.



SWM Services

Subscriptions

Subscriptions are available at £33 per annum to UK addresses, £40 in Europe and £44 (Airsaver), £50 (Airmail) overseas. Subscription copies are despatched by accelerated Surface Post outside Europe. Airmail rates for overseas subscriptions can be quoted on request. Joint subscriptions to both *Short Wave Magazine* and *Practical Wireless* are available at £55 (UK) £68 (Europe) and £74 (rest of world), £85 (airmail).

Components For SWM Projects

In general all components used in constructing SWM projects are available from a variety of component suppliers. Where special, or difficult to obtain, components are specified, a supplier will be quoted in the article. The printed circuit boards for SWM projects are available from the SWM PCB Service, **KANGA PRODUCTS, Sandford Works, Cobden Street, Long Eaton, Nottingham NG10 1BL. Tel: 0115 - 967 0918. Fax: 0870 - 056 8608.**

Photocopies & Back Issues

We have a selection of back issues, covering the past three years of SWM. If you are looking for an article or review that you missed first time around, we can help. If we don't have the whole issue we can always supply a photocopy of the article. Back issues for SWM are £2.99 each and photocopies are £2 per article.

Binders are also available (each binder takes one volume) for £6.50 plus £1 P&P for one binder, £2 P&P for two or more, UK or overseas. Prices include VAT where appropriate.

A complete review listing for SWM/PW is also available from the Editorial Offices for £1 inc P&P.

Placing An Order

Orders for back numbers, binders and items from our Book Store should be sent to: **PW Publishing Ltd., FREEPOST, Post Sales Department, Arrowsmith Court, Station Approach, Broadstone Dorset BH18 8PW**, with details of your credit card or a cheque or postal order payable to PW Publishing Ltd. Cheques with overseas orders must be drawn on a London Clearing Bank and in Sterling. Credit card orders (Access, Mastercard, Eurocard, AMEX or Visa) are also welcome by telephone to Broadstone (01202) 659930. An answering machine will accept your order out of office hours and during busy periods in the office. You can also FAX an order, giving full details to Broadstone (01202) 659950. The E-mail address is bookstore@pwpublishing.ltd.uk

Technical Help

We regret that due to Editorial time scales, replies to technical queries cannot be given over the telephone. Any technical queries by E-mail are very unlikely to receive immediate attention either. So, if you require help with problems relating to topics covered by SWM, then please write to the Editorial Offices, we will do our best to help and reply by mail.

ed's comments

It's funny, but I was in a small way proved right the other day about something I've maintained for a while now. I believe that h.f. communications will continue to be used for a considerable time into the future due to the fact that use of the h.f. spectrum is somewhat more cost effective than satellite services. The case in point, is that AFN, the American Forces Network have, whilst I was writing the Inmarsat article (on page 14 of this issue), dropped their service on Inmarsat AOR-E in favour of h.f. distribution...on the grounds of cost. I have maintained that in spite of opinions to the contrary that h.f. is far from dead as a means to global communication. This view is down to the simple economics of h.f. point to point circuits versus a satellite solution. Coupled with the fact that most

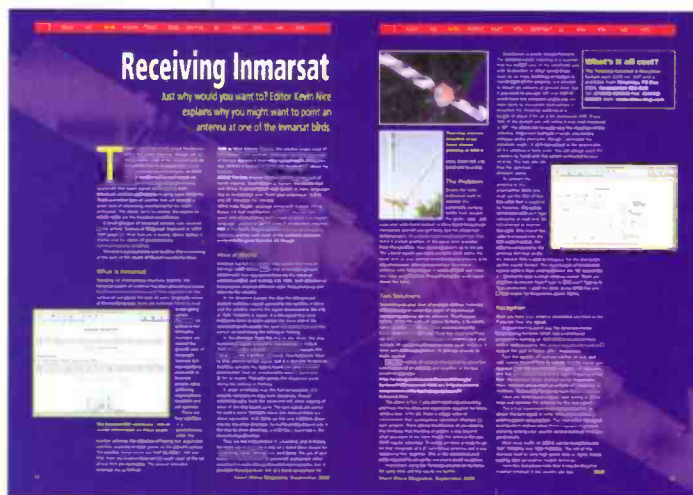
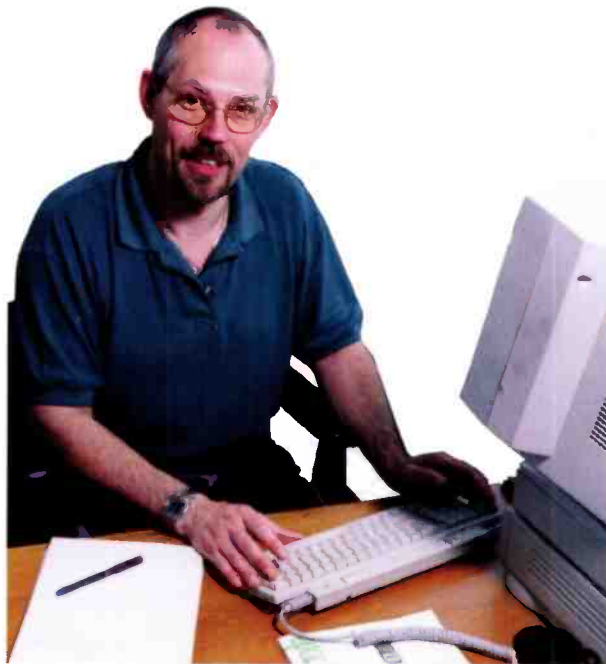

modern utility users utilise automatic link analysis to continually determine the most reliable frequencies to provide a reliable link and the very high cost of satellite communications for low bandwidth use just makes short waves a viable solution for many. Long live h.f. use!

Classic Reviews

I have had a considerable amount of very positive feedback regarding the reviews of older classic receivers by John Wilson. I want to say thank you to all those who have commented, I certainly do intend continuing with this exercise. The intention is to provide a reference source for those who want to know more than just basic specifications for a radio. John's methods of examining a radio by using it as it was intended and by making relevant performance measurement is a sure way to enable prospective buyers and current owners to access whether a specific radio is for them or not. As the series continues it will build into an invaluable reference source that will be second to none. As an aside, John and I have a lengthy list of review candidates already, but if anyone has any specific requests of suitable classics then please drop me a

line. If you should happen to have a sample of a rare classic that you could make available, please let me know too.

Top Ten Receivers

Thanks to all those readers who responded to my plea last month, I now have a grand total of 20 responses. Perhaps at this point I ought to make it clear that any information that is sent to the Editorial Offices is treated confidentially. Personal details will not be published unless permission has been given by the sender. Is that what you're all worried about or can't you be bothered to share with me what receiver and antenna you use? Don't be shy and by the way, whether you use a crystal set or a multi-thousand pound receiver it doesn't matter, all are equally valid in my opinion. The responses so far do make for interesting reading, I just would love some more input so we can have a realistic picture of just what equipment is favoured by SWM readers.

New Acquisition

PW Publishing Ltd., our publishers have just acquired communications magazine *Radio Active* with a view to broadening their title base. *Radio Active* will continue to be edited by Elaine Richards, former PWP employee and one time Assistant Editor of SWM. *Radio Active* regularly covers a broad range of topics including CB radio. Why not look out for it in the Newsagents or call the SWM Book Store for a copy.

Right, I'm off on my summer hols now - look out noise free location here I come.

73

Kevin

Dear Sir

I have been a s.w.l. for approx. three years and find the hobby fascinating. To extend the enjoyment of the hobby, I decided in February this year to send cards direct to contacts heard on the bands. The response has been tremendous, receiving packages, QSL cards and lovely letters from amateurs all over the world.

Enclosed is the first negative response I have received, no friendly message on the back, only a note stuck to it. Excepting not all my cards would be returned (30 to 40% at the moment) due to destination, expense, etc. I was a little surprised by it.

I would be interested to hear any comments regarding this. By the way, I have replied to the radio amateur thanking him for his card, including an IRC and a photo of me in the shack. Great magazine!

P.S. I have just started a RAE course (Novice).

M. Tomlinson
Derbyshire

By my own experience, I think you've had a very good return rate. It's different with broadcast QSLs as the stations have a budget, so you can expect a much lighter return rate. Have a look at Paul Essery's 'The QSL Business' in August's SWM for more info. on increasing your chances. Good luck with the RAE course. - Ed.

Dear Sir

I found that the 'Decode' column in June 2000 brought back a host of memories of the good old days of telegraphs. A few points on the way I saw it.

Baudot may well have invented the 5 unit code, but it was Murray who turned it into the 7.5 unit code required to operate the teleprinter. The Americans being first came up with the lower Baud rate of 45.5, 60w.p.m as opposed to 66w.p.m. for 50 Baud (for straight f.s.k. Baud rate = bits per second). As a useful memory aid, Mark think of Marking time the stop bit, Off, negative. Space, Start bit, On, positive.

Yes 80+80V could be a bit lively if you put your head between the wires of the saddle pair on a frosty morning (the pair of wires carried directly on the top of the pole often used for telegraphs, alarms and other non standard circuits).

Reminisces about the tiddums or fox box on a well adjusted machine 1:1s would actual print out RYs (look out at the rallies, I have seen good specimens going for only a couple of pounds, get those old machines working again).

Having worked on a good many printers over the years, I still have a great deal of affection for the Creed No.7. It is the one machine which when turned by hand, the operating sequence can be seen in slow motion and most faults readily identified. The machine, when fitted with a synchronous motor (a late Creed mod), is both quiet electrically and acoustically (no carbon dust) and makes a great museum piece.

Finally, in my opinion, for a signal to be considered to be RTTY then it should be generated by one of the mechanical Tele Type machines, not a computer, which after all is only using CCITT Alphabet No.2, when it may as well use the No.5 (As-Kee!) and stick to Packet, PSK31, etc. leaving Baudot, Hellschreiber and other mechanical wonders to their own wonderful past. Emulate on receive if you must, but you can't beat the real thing!

And yes if you have a mechanical bent and want to get your hands dirty on old mechanical Stroweger telephone exchanges or play with red 'phone boxes (button A/B, etc.) then join me at The Avoncroft Museum of Buildings, volunteers are always welcome.

A. Malcolm G8DEC
Worcs

Dear Sir

I am trying to locate a program to run an ERA Morse Reader on a PC without much success, does anyone know of such a program and where I can get a copy from? Any help will be gratefully received.

John Collinson M1CWO
via E-mail

Dear Sir

I read John Wilson's review of the AR88 in the July issue of SWM with a big lump in my throat because it was my second proper h.f. receiver and it introduced me to the marvels of valve technology. The ceramic wafers and valveholders and the neat layout were a revelation after seeing contemporary sets made here such as the WS19 and R107. Mine came with a proper 'S'-meter in a separate box which I duly installed. It was remarkably linear for a device made in the 1940s. My modifications over the years have been:-

1) Bolting on a pair of smart chrome handles to the front panel. Purists will wince, but the set looks even better and handling it is less awkward. 2) Installing a twin triode product detector as per the RSGB Handbook, relay switched between a.m. and s.s.b./c.w. This improves the set considerably and removed the requirement to adjust the r.f. gain all the time and 3) installing a Kokusai mechanical filter to sharpen up the selectivity on s.s.b. on selectivity position 3. However, the tuning was too fast to use the filter easily and I later removed it.

I must extract my AR88 from limbo in a cupboard and revive it. Any readers doing this would be advised to assume that many resistors will have risen in value and that some of the inter-stage capacitors may now be leaky, to check first and replace as needed. It is also likely that re-alignment will be needed to achieve the results measured by John on what was clearly a mint specimen, but that's half the fun. Be careful of the h.t. though.

The gearbox may also need thorough cleaning to achieve the silky feel. In another valved set I removed the gearbox and soaked it in petrol to remove the dried up lubricant and accumulated dirt and relubricated with PTFE grease obtained from a cycle shop. It should not be too difficult with the AR88 gearbox because there are no string drives and pointers to get in the way, each shaft runs in ball bearings and each end bearing is adjustable.

Why could we not make sets of this quality?

Michael O'Beirne G8MOB
Surrey

Dear Sir

In reply to D.J. Goacher G3LLZ's enquiry re: reference to receiver performance.

1) 'Problems In Receivers', Angus McKenzie G3OSS, *Amateur Radio*, July 1985.

2) 'Receiver Front-End Limitations', Gordon King G4VFV, *Practical Wireless*, June 1992.

3) 'High Frequency Receiver Design', John Dyer, *Radio Electronics World*, February 1983.

4) 'From The Lab To The Shack', Angus McKenzie G3OSS, *Amateur Radio*, date unknown.

5) 'Understanding Receiver Parameter', Peter Chadwick G3RZP, *Practical Wireless*, February 1981.

6) 'Receiver Specifications Explained', Peter Buchan, *Short Wave Magazine*, August 1994.

7) 'Practical Synthesizers & How They Work', Ian Poole, *Practical Wireless*, June 1992.

8) *RSGB Bulletin*, August 1984, page 77.

And then of course there is *The Buyers Guide To Amateur Radio* by Angus McKenzie, RSGB, 1986. This includes 40 pages of general testing and 20 pages relating to receiver performance. Probably no longer obtainable.

Can you persuade John Wilson to write a follow up to Angus McKenzie's book which is now completely out-of-date? Their last Kenwood review was the R-2000, a Yaesu FRG-8800 and JRC NRD-505.

Regarding John's review of the new HF-350, as he implies, the price is too high compared with the others mentioned (AKD HF-35 £160!). What he has never mentioned and which has a very high brief review is the AOR AR3030. This has everything and compared with other similar receivers is the tops: 1) proper r.f. gain control, 2) 3 speed tuning, 3) keypad, 4) active antenna included, 5) f.m., 6) a 7 s.s.b. filter, 7) front panel speaker, 8) computer control, 9) and the rest!

Now then, what about readers' receiver reviews. Results in June SWM sunk without trace!

P.S. Tell John to keep up the reviews.

Ted Kimber
Somerset

Ted, thanks for the list of references, you've saved me the job. As for the series of reviews by John, well, that's just what we're doing! - Ed.

Is there something you want to get off your chest? Do you have a problem fellow readers can solve? If so then drop a line to the Editor at QSL, *Short Wave Magazine*, Arrowsmith Court, Station Approach, Broadstone, Dorset BH18 8PW.

THE BEST LETTER WILL RECEIVE A £20 VOUCHER TO SPEND ON ANY SWM SERVICE.

TOP
QSL



Compiled by Zoë Shortland - News & Production Editor

On-Line Retail Store

Prime2000 is one of the latest companies to launch an on-line retail store. But shopping at Prime2000 is not just about clicking a few impersonal buttons. Prime2000 aims to combine the best elements of high street shopping with the price advantages and convenience of buying on the web.

Specialising in home electrical goods, the Prime2000 site uses a virtual shop assistant to help customers get the best out of their visit to the store. Product categories include a wide range of kitchen appliances and the latest in home audio and visual technology, as well as home and personal care items. Just like in the best electrical stores, the Prime2000 assistant can offer helpful

advice about the products, together with a jargon-busting glossary of the more common technical terms. If you're new to shopping on the web, she can also offer a clear and friendly guide to the site, which will make it easy for you to find your way round and choose the goods you want.

A newly developed feature which you won't yet find on many on-line shops is a useful compare facility. So, once you've narrowed down your preferences, you can look at possible products in more detail before choosing between them. By clicking on the items you wish to compare, you can view them all together on one page, with headline features and pictures clearly displayed.

Prime2000 is also part of the Which? Web Trader scheme, which enables you to buy with confidence, knowing that the company you're dealing with will trade fairly and squarely with all its customers. Visit the Prime2000 electrical store at www.prime2000.co.uk

New Plug-In Coils

Two new plug-in coils have been added to the **Isoplethics** range. Based on the standard 120, B9A-base formers, the 120/MW covers the medium wave and the 120/LW the long wave broadcast bands with a 350pF tuning capacitor. With an addition 500pF, the 120/LW coil tunes the 134kHz amateur band. Traditional wave-winding is used for the 120/MW tuned winding, and for all three 120/LW windings.

Available initially in three-winding versions, inductances are: MW version - 180µH, LW version - 2.0mH. Auxiliary-tuned winding turns ratios are both 3.5:1. The auxiliary windings are suitable for reaction and antenna or r.f. transformer coupling. Both ends of the tuned windings are brought out to two pins to minimise losses.

These coils are eminently suitable for simple receiver projects, either valve or semiconductor. They come complete with a detailed Application Note. Prices are: 120/MW - £7.45

and 120/LW - £7.75 and include VAT & P&P within the EU. Order from **Isoplethics at 13 Greenway Close, North Walsham, Norfolk NR28 0DE, Tel: (01692) 403230.**



Knighthood Awarded

The **British Wireless for the Blind Fund** is proud to announce that its Chairman **John Wall CBE, MA** (Oxon) has recently been awarded a knighthood in recognition of his services to help people in the United Kingdom who are blind. Visually impaired himself, Sir John became the Chairman in 1991, the same year that he was appointed as Deputy Master of the High Court Chancery Division - the first blind person to hold this prestigious post.

The British Wireless for the Blind Fund is a national, totally independent charity based in Chatham, Kent. The fund is dedicated to providing specially adapted audio equipment to UK-registered blind people, over the age of eight, who are in need. A wide choice of equipment is available, including push button radios, radio-cassette recorder, TV sound only receivers and a specially commissioned CD radio-cassette recorder. All are provided on free permanent loan for life.



The British Wireless for the Blind Fund's new Chairman - Sir John Wall.

Club Corner

On the 25th August 200, the **Torbay Amateur Radio Society** are having their annual BBQ at the Headquarters the Highweek family and social club in Newton Abbot. Non members welcome. Make a date also in your diary for August 27th, which is the Torbay ARS's Mobile Rally at Churston Grammar School, Torbay, Devon. All welcome. More information from **John G4VUD**, Rally Co-ordinator, on **(01626) 205514** (answerphone during office hours) or visit rally@tars.org.uk

The **Bangor & District Amateur Radio Society** meet on the 1st Wednesday of every month in the Clandeboye Lodge Hotel, Bangor, at 2000. On Wednesday 6 September they are holding their AGM, which is always a very popular night, where they review club activities over the last year and elect their committee for the new year. Visitors and new members are always most welcome. More information from **Mike G14XSF** on **028-4277 2383** or visit the club web site at <http://welcome.tofdars>

Members of the **Telford & District Radio Society** meet at 2000 every Wednesday at the Community Centre, Bank Road, Dawley, Telford, Shropshire. There are lots of activities planned throughout the year, so if you would like to find out more, contact **Mike Street G3JKX**, Hon. Sec. on **(01952) 299677**.

Members of the **Wakefield & District Radio Society** meet at 2000 at the Ossett Community Centre, Prospect Road, Ossett, West Yorkshire. Just a few up and coming events are: Aug 1: Treasure Hunt, 8th: Rally meeting, 15th: On the air/natter night, 22nd: Visit, 29th: Video evening. More information from **John G7JTH** on **(01924) 251822**.

The **Hoddesdon Radio Club** welcomes all short wave listeners to the Conservative Club, Rye Road, Hoddesdon, Herts. Meetings take place on Tuesdays. If you would like more details, contact **Don** on **0208-292 3678**.

Millennium Conference

Hilary Clayton-Smith G4JKS, 1999 President of the RSGB, is to address the opening dinner at WACRAL's BiMillennium House Party, which is to be held on the 21-24th September at the De Montford Hotel, Kenilworth. She has also kindly agreed to present a special lecture, during the conference, on the RSGB and upon her specialist subject of EMC and the radio amateur.

Members and non-members are invited to join in a lively weekend of Christian and radio oriented events including a visit to the Leicester Show (Donington), on-air activity, discussions and Novice licence training. Programme details, dinner and residential reservations can be made by contacting **Dr. Geoff Peterson G4EZX**, **124 Darnley Road, Gravesend, Kent DA11 0SN** or E-mail Geoff at geoff.peterson@zetnet.co.uk

Powerful Addition

Haydon Communications

would like to announce the latest addition to their range of power supplies. The new DPS-1020 is a commercial grade 25A switch-mode power supply which Haydon say, " thanks to its amazing build quality, suffers from no adverse noise generation and hence offers superb noise free use on any h.f. transceiver".

This power supply incorporates many unique features including over voltage protection, short-circuit current limiting with warning indication along with more output sockets than most other power supplies available. The DPS-1020 also has a detachable mains power lead (supplied) and only weighs in at 2.3kg - certainly a must at £79.95 + £10 P&P.

Contact Haydon Communications at **Unit 1, Thurrock Commercial Park, Purfleet Industrial Estate, London Road, Nr. Aveley, Essex RM15 4YD, Tel: (01708) 862524, FAX: (01708) 868441** for more details.



Reunite On Retired Site

www.retirement-matters.co.uk - the UK web site targeted at the 'mature surfer', recently announced another new section - the pen-pal and reunion/find-a-friend service. By joining the retirement-matters club, the mature surfer obtains access to the pen-pal circle and have access to a section that can reunite them with a long lost friend!

Registration is easy - by completing a simple form, the mature surfer can advise who they are seeking, where they were last seen and give an E-mail address for contact to be made. Reunions can then be posted on the web site and will be displayed, free of charge, for three months!

Other sections of www.retirement-matters.co.uk also include Travel, Leisure, Lifestyle, News & Features, Friends & Family, Health & Personal Care and a growing retirement-matters club. Each of these sections contain a mixture of topical information addressing sensitive issues such as bereavement and useful tips on how to plan a reunion, find a friend or researching a family tree. A section on Law & Finance will also shortly be available.

For more information, E-mail: enquiries@retirement-matters.co.uk

Maplin's Multimeter

The need for measurement functionality, accuracy and reliability is always a chief concern to professional engineers and technicians. The Maplin Pro 2 Multimeter (£79.99) is a fully auto-ranging multimeter that has the accuracy, quality and features demanded by both professional engineer and the serious hobbyist.

In addition to the basic DMM functions, it has additional features such as capacitance, frequency, duty cycle and min/max/average readings. The Maplin Pro 2 has a large digital display with an analogue bar graph which provides trend information on fast changing signals.

Another Multimeter products in Maplin's portfolio is the Maplin Pro 4 Multimeter (£89.99).

The Pro 4 is a precision meter with similar features to the Maplin Pro 2. In addition it features a 10A range for measurements on amplifiers and high current circuits. Built to a very high quality, the Maplin Pro series can be supplied with an optional calibration certificate.

More information from **Maplin Electronics on (0870) 264 6000** or visit their web site at <http://www.maplin.co.uk> and look under 'New Products'.



rallies

Attention Please!

Would you like to have your Rally publicised? If so, all you have to do is put together as much information as possible about the Rally, i.e. date, location, times, who to contact, etc. and send it to the Editorial Offices.

August 27: The Milton Keynes ARS will be holding their 14th fayre and car boot at Bletchley Park Museum. Open to Traders from 0700, £7 in advance, £10 on the day. Doors open to buyers at 0900 and entrance is just £1. Talk-in on 145.550/433.550MHz, refreshments, Morse tests, museum open. For more details contact **Dave G3ZPA** on (01908) 501310 or E-mail: m0bz@bletchley.madefish.com

August 27: The Coleraine & District ARS will be holding their annual rally at the Bohill Hotel, Coleraine. Usual traders and Bring & Buy present, doors open at 1200, all welcome. Further details are available from **Brian G8LTB** on 0287-035 8664 or **Jim G4ORI** on 0287-035 2393.

August 28: Huntingdonshire Amateur Radio Rally will take place at Emulf Community School, St. Neots, Cambridgeshire (near Tesco Superstore on A428). Open 1000-1400, admission £1.50. Hot and cold refreshments available, features hall and car boot sale on handstanding. Talk-in on S22. Details from **David Leech G7DIU** on (01480) 431333 (between 0900-2100).

September 3: The Andover Radio Amateurs' Radio Rally takes place at the Middle Wallop Airfield, near Andover. More information from **Jack G0UJW** on (01264) 391383.

September 3: The Bristol Computer & Radio Rally will take place at the Brunel Centre, Temple Meads Station, Bristol. Doors open 1030 (disabled access from 1015) and close at 1600. Admission is £1.50, accompanied children under 12 free. There will be 250+ tables, table hire at £15 each, large Bring & Buy, under £30 Bring & Buy and refreshments. More details from **Muriel Baker, 62 Court Farm Road, Whitchurch, Bristol BS14 0EG** or telephone (01275) 834282 (24-hour answerphone).

September 10: The Lincoln Short Wave Club are holding their Hamfest at the Lincolnshire Show Ground, on the A15, five miles north of Lincoln. There will be extensive parking, talk-in on 2m (144MHz), catering and refreshments, trade stands, Bring & Buy, car boot sale, flea market, Morse tests and other attractions. Admission is £2 per person (under 14s free). Contact **John G8VGF** on (01522) 525760

September 10: The Telford Radio Rally moves to a new unique location at RAF Museum Cosford, Shropshire - 3.2km south on A41 off J3 M54, 32km NW Birmingham. Buy, sell and browse amongst the aircraft. There will be traders, a Bring & Buy, flea market, Morse tests, RSGB & Special Interest Groups, refreshments, disabled facilities and a talk-in on S22. Further details from **Bob M5BWQ** on (01952) 770922 or E-mail: bob@somrob.u-net.com Trader enquiries to **Jim G8UGL** on (01952) 684173 or E-mail: jim@tweedale15.freereserve.co.uk or visit their web site at: www.telford-rally.co.uk

September 22/23: The 29th Leicester Amateur Radio Show and Convention takes place this weekend at The Castle Donington International Exhibition Centre, Donington Park, NW Leicestershire. Doors open 0930-1730 each day, admission £3 (one day ticket), £5 (two day ticket), concessions available and under 14s free. Over 150 stands of computers, radio and electronics including flea market, Bring & Buy, clubs and societies and Morse tests on demand. For more information contact **Geoff Dover G4AFJ** on (01455) 823344 or E-mail g4afj@argonet.co.uk

October 1: The Great Lumley Amateur Radio & Electronics Society are holding their rally at the Great Lumley Community Centre, Front Street, Great Lumley, near Chester le Street, County Durham, just off the A1(M). There will be free parking, plus easy access, good, inexpensive food and drink, radio, hobbies, electronics, computer, satellite and component stalls, Bring & Buy in two sections - junk and good buys. Doors open 1100 (1030 for disabled visitors). Admission is £1, free of charge to under 14s accompanied by an adult. Talk-in. Further details on 0191-384 2803 or 0208-937 2772 or from Rally Organiser **Nancy Bone G7UUR**, 48 South Street, Durham City DH1 4QP.

October 15: The Blackwood Radio, Computer & Electronics Rally is to be held again at the Newport Centre, Newport, South Wales, which is about 2km from J25A on the M4. Opens at 1030/1100. There will be a Bring & Buy, talk-in, car parks, trade stands, special interest groups, licensed bar, catering, disabled facilities and family attractions. Further information can be obtained from **Stuart Instone G6WNP** on (01495) 240260/(07970) 777756 (combined telephone/FAX number) or E-mail: fireham@aol.com

October 15: The HomeSea Amateur Radio Club Rally will be taking place on this day. For more details on where it is and what will be there, contact **Duncan G3TLI** on (01964) 532588.

October 29: The Galashiels & District Amateur Radio Society are holding their Annual Radio & Computer Rally at The Volunteer Hall, St Johns Street, Galashiels, Scottish Borders, from 1100-1600. There will be traders, Bring & Buy and refreshments, etc. More details from **Jim GM7LUN** on (01896) 850245 or E-mail: jimk@gm7lun.freereserve.co.uk

November 4/5: The 14th North Wales Radio & Electronics Show will be held at the North Wales Conference Centre, Llandudno. The show opens at 1000 both days and the entrance fee is £2 for adults and under 14s free when accompanied by an adult. There will be a club room and an extensive Bring & Buy. **M. Mee GW7NFY** on (01745) 591704 (combined telephone and FAX number).

November 12: The Midland Amateur Radio Society are holding their 12th Radio & Computer Rally at Stockland Green Leisure Centre, Slade Road, Erdington, Birmingham. Doors open at 1000. There will be a large, free car park, special interest exhibits, local clubs, etc. Trader information from **Norman G8BHE** on 0121-422 9787 or general information from **Peter G8DRN** on 0121-443 1189.

November 12: The Tenth Great Northern Hamfest takes place at the Metrodome Leisure Complex, Queens Road, Bamsley, South Yorkshire. Doors open at 1000. For further information please contact the Hamfest Manager, **Ernie Bailey G4LUE**, 8 Hild Ave, Cudworth, Bamsley, Yorkshire S72 8RN or telephone on (01226) 716339 or (07787) 546515 (mobile).

November 25: The Rochdale & District Amateur Radio Society are holding their traditional radio rally at St Vincent de Paul Catholic Church Hall, Caldershaw Road, off the A680 Edenfield Road, approx two miles west of Rochdale. Follow the orange arrows from M62 J20. Doors open 1030, 1015 for disabled visitors. Entrance fee is just £1 and there will be refreshments/rest area. **John G70AI**, evenings, on (01706) 376204.

November 25/26: The London Amateur Radio & Computer Show is to be held at the Lee Valley Leisure Centre, Picketts Lock Lane, Edmonton, London N9. There will be trade stands, talk-in on 2m and 70cm, Bring & Buy, special interest groups, free parking, disabled facilities, camp site, family attractions, licensed bar, catering and Morse tests. Doors open on Saturday at 1015 till 1700 and on the Sunday from 1000 till 1600. Further information on (01923) 893929.

November 26: The Bishop Auckland Radio Amateurs Club (BARAC) Rally will take place at Spennymoor Leisure Centre. This venue is ideally suited for both trader and disabled visitors as it boasts good parking and access to large ground floor hall. There will be the usual radio, computer, electronics and Bring & Buy stalls, as well as catering and bar facilities. Morse tests are available on demand. There will be lots to do for all the family within the Leisure Centre for members of the family not interested in radio. Doors open 1100 (1030 for disabled visitors). Admission is £1, under 14s free of charge. Talk-in on S22. **Mark G6GFG** on (01388) 745353 or **G70CK** on (01388) 762678

Send your news and rally details to Zoë Shortland at the Editorial Offices

■ BRIAN ODDY G3FEX, THREE CORNERS, MERRYFIELD WAY, STORRINGTON, WEST SUSSEX RH20 4NS

LM&S



Much of the energy which reaches the Earth from our nearest star, which we call the Sun, is in the form of light, heat and ultra-violet radiation. The latter plays an important role from the radio standpoint because it ionises the gases in the upper layers of our atmosphere to form the ionosphere.

The intensity of ionisation is greatest when large numbers of sunspots are present on the surface of the Sun because they emit huge amounts of ultra-violet radiation. They are evident in large numbers just now because we are in the maximum period of an 11 year solar cycle (No.23). As a result reception is mainly good in the higher frequency short wave bands and poor at lower frequencies. The reverse situation will occur when we reach the minimum period.

Long Wave Reports

Note: l.w. & m.w. frequencies in kHz; s.w. in MHz; Time in UTC (=GMT). Unless otherwise stated, all logs were compiled during June.

A broadcast from Ríkisutvarpid (RUV) in Reykjavik via their 300kW outlet at Gufuskalar, W.Iceland on **189kHz** was picked up after midnight by **Eddie McKeown** in Newry. He rated the transmission SINPO 25312 at 0055UTC.

Quite unusual conditions were observed during the evening of June 30 by **Fred Pallant** in Storrington. Several of the transmissions which he can normally receive clearly were either weak or missing!

Medium Wave Reports

There was only a brief period each night during June when the whole of the transatlantic path between E.Canada/E.USA and the UK was in darkness. No doubt it was that factor which discouraged most listeners here from searching the band for transmissions from m.w. stations located over there. The lack of reports was not unexpected.

However, the long hours of daylight here did not deter some UK listeners from searching the band from dusk until late at night for the sky waves from m.w. stations in the Middle East, N.Africa and Scandinavia. Although their findings were not as extensive as in the winter months they compiled some interesting reports - see chart.

Some of the regular contributors to the LM&S charts concentrated on the m.w. local radio scene and they picked up the ground waves from some quite distant local radio stations - see chart. In Morden **Sheila Hughes** combined her listening interests with gardening activities by taking her Sony ICF-SW7600DS portable into her little garden potting shed where she spends time sowing seeds in trays, re-potting, etc.

A holiday in Aberystwyth during the second week of June enabled **Bernard Curtis** (Stalbridge) to explore the band from an alternative location. He took his Realistic DX-400 receiver and home-built loop antenna with him and received a quite different selection of local radio stations.

During a short break in Minsterworth, Gloucester **Simon Hockenull** (E.Bristol) searched the band with a Roberts R617 portable, which he

powered from batteries. The level of electrical noise in that area proved to be very low and he was surprised by the number of distant local radio stations he was able to receive - see chart.

Long Wave Chart

Freq (kHz)	Station	Country	Power (kW)	Listener
153	Bechar	Algeria	1000	E*
153	Donebach DLF	Germany	500	C,D*,E*,F,G*,H*,J,X*
162	Allouis	France	2000	C,D*,E*,F,G*,H*,J,X*,X*
171	B'shakovo etc	Russia	1200	E*
177	Oranienburg	Germany	500	D*,E*,F,G*,H*,J,X*
183	Saarlouis	Germany	2000	C,D*,E*,F,G*,H*,J,X*
189	Gufuskalar	W.Iceland	150	E*
198	Droitwich BBC	UK	500	C*,D*,E*,F,H*,J,X
207	Munich DLF	Germany	500	D*,E*,F,G*,H*,J,X*
207	Azilal	Morocco	800	A*
216	Roumoules RMC	S.France	1400	C,D*,E*,F,G*,H*,J,X*
225	Polskie R-1	Poland	?	B*,C*,D*,E*,H*,J,X*
234	Beidweiler	Luxembourg	2000	D*,E*,F,G*,H*,J,X*
243	Kalundborg	Denmark	300-	A,C,D*,E*,F,G*,H*,J,X*
252	Atlantic 252	Eire	500	D*,E*,F,G*,H*,J,X
261	Burg(R. Ropaz)	Germany	85	C,D*,E*,F,G*,H*,J,X
270	Topolina	Czech Rep	1500	C*,D*,E*,F,G*,H*,J,X
279	Sasnovy	Belarus	500	C*,E*

Note: Entries marked * were logged during darkness. All other entries were logged during daylight or at dawn/dusk. Listeners:-

- (A) Simon Hockenull, E.Bristol.
- (B) Simon Hockenull, while in Minsterworth, Glos.
- (C) Sheila Hughes, Morden.
- (D) Rhoderick Illman, Oxted.
- (E) Eddie McKeown, Newry.
- (F) George Millmore, Wootton, IoW.
- (G) Fred Pallant, Storrington.
- (H) Tom Smyth, Co.Fermanagh.
- (I) Phil Townsend, E.London.
- (J) Fred Wilmshurst, Northampton.
- (X) Anthony Johnson, Livingston, W.Lothian

Short Wave Reports

Radio France International (RFI) is continuing to broadcast daily to listeners in E.C.Africa in the **25MHz (11m)** band. In that area reception of their transmission on **25.820** (Fr 0900-1300) is likely to be very good indeed just now but once again no reports arrived here to confirm this. In the UK reception varies considerably because the transmission arrives via back scatter and other unreliable modes. The SINPO ratings and comments in the latest reports from UK listeners were as follows: 33443 at 0905UTC by **Robert Connolly** in Killeel; 45534 at 0930 by **Vic Prier** in Colyton; "normally barely audible" in E.Bristol but it peaked 55545 at 1020UTC during a sporadic E opening on May 27; 45343 at 1030 in Newry; 15222 at 1045 in Storrington; 35343 at 1209 by **Fred Wilmshurst** in Northampton; 33333 at 1245 in Stalbridge.

There were no reports of reception in

the UK of the upper sideband (u.s.b.) transmissions from Radio For Peace International (RFPI), Costa Rica on **25.930** (Eng to Americas 1200-?). They are not beamed towards the UK and the recent propagation forecasts prepared by **Jacques D'Avignon** for SWM suggest that the path to the UK may not be open but short term changes in propagation often occur so it may be worth monitoring that frequency from mid-day.

Many of the broadcasts in the **21MHz (13m)** band are beamed to distant countries but quite a few of them can be received in the UK. Those intended for listeners in Europe can usually be received very well indeed but from time to time solar events result in sudden ionospheric disturbances (s.i.d.), which may last for a short while or several hours.

The most distant broadcaster to reach our shores in this band is R.Australia. During the early morning their broadcast to Pacific areas via Shepparton on **21.725** (Eng 0200-0900) can often be received here. It was rated 34333 at 0850 by **Stan Evans** in Herstmonceux. They also beam to Asia via Shepparton on **21.820** (Eng 0900-1400), rated 24122 at 0908 in Newry.

Also received here before noon were R.Pakistan **21.460** (Ur to Eur 0800?-1100, Eng 1100-1105), rated 54444 at 0906 by **Tom Winzor** in Plymouth; DW via ? **21.680** (Eng to Oceania? 0900-0950) 44433 at 0921 by **Martin Venner** in St.Austell; R.Austria Int, Moosbrunn **21.765** (Ger, Eng to Australia 0930-1000) 34443 at 0930 in Killeel; R.Ext.España via Noblejas **21.570** (Sp to S.America 1000?-1700) 43353 at 1007 in Colyton; BBC via Seychelles **21.470** (Eng to Africa 0900-1300) 44333 at 1015 in Morden; Swiss R.Int via Sottens **21.770** (Eng, Ger, Fr, It to Asia 1100-1330) 35544 at 1105 in Northampton.

After mid-day HCJB Quito, Ecuador **21.455** (Eng [upper sideband + pilot carrier u.s.b. + p.c.]) was rated 33333 at 1315 by **David Hall** in Morpeth; UAE Abu Dhabi **21.735** (Ar to N.Africa 0700-1600) 44334 at 1340 by **Robert Hughes** in Liverpool; UAER, Dubai **21.605** (Eng to Eur 1330-1350) 44444 at 1350 by **Rhoderick Illman** in Oxted; BBC via Ascension Is **21.660** (Eng to Africa 1400-1700) SIO 333 at 1400 by **Tom Smyth** in Co.Fermanagh; R.France Int **21.685** (Fr to W.Africa 0900-1600) 33333 at 1450 in Stalbridge; BBC via Cyprus **21.470** (Eng to Africa 1300-1700) 35433 at 1500 in E.Bristol; WYFR Okeechobee, USA **21.455** (Eng to Eur 1600?-?) 44223 at 1745 by **Peter Pollard** in Rugby.

In the **18MHz (15m)** band R.Norway Int **18.910** (Norw to Australia 0900-0929) was rated 45444 at 0925 in Northampton; R.Sweden **18.960** (Eng to N.America 1330-1400) 54444 at 1330 in Plymouth; Christian Science BC via WSHB Cypress Creek **18.910** (Fr to E.C.Africa 1600-1750?) 44242 at 1723 in Newry.

R.New Zealand is the most distant broadcaster to reach our shores in the **17MHz (16m)** band. Their 100kW transmission from Rangitai, N.Island is beamed to Pacific areas on **17.675** (Eng 1755-0705). It was rated 35533 at 0615 by **David Edwardson** in Walsend. At 0705 they change frequency to **11.720MHz** in the **25m** band.

During the early morning R.Australia can often be received here well while beaming to Asia via Shepparton on **17.750** (Eng 0000-0500, 0600-0830, 0830-1100). Their transmission was rated 44444 at 0550 in Morpeth & 32232 at 0900 in St.Austell.

Some of the many other broadcasts in this band which often reach the UK originate from the BBC via Ascension Is **17.830** (Eng to Africa 0800-2100), rated 44243 at 0929 in Newry; BBC via Masirah Is, Oman **17.790** (Eng to Asia 0600-0800, 0900-1100) 32322 at 0945 in Killeel; R.Jordan via Al Karanah **17.680** (Eng to N.America 1000-1200) 55544 at 1010 in Herstmonceux; Voice of Turkey **17.830** (Eng to Eur? 1230-1325) 54444 at 1249 in Plymouth; R.Romania Int **17.770** (Eng to W.Eur, N.America 1300-1356) 53443 at 1310 in Herstmonceux; R.Romania Int **17.790** (Eng to Asia, Australia 1300-1356) SIO 433 at 1300 in Co.Fermanagh; Israel R. Jerusalem **17.545** (Heb [Home Svce relay] to Eur, N.America 0600-1900) 44454 at 1405 in Liverpool; R.France Int via ? **17.620** (Eng to E.Africa, M.East 1400-1500) 34343 at 1405 in Rugby.

Later, WHRI via Maine, USA **17.650** (Eng to Eur, M.East, Africa 1600-2300) was 44434 at 1745 in Stalbridge; BBC via Ascension Is **17.830** (Eng to Africa 0800-2100) 45534 at 1818 in Colyton; R.Nederlands via Bonaire, Ned.Antilles **17.605** (Eng to Africa 1830-2025) 45444 at 1835 in Northampton; DW via Gauen? **17.810** (Eng to Africa 1900-1930) 44444 at 1900 by **Gerald Guest** in Dudley; HCJB Quito, Ecuador **17.660** (Eng to Eur 1900-2200) 44333 at 1910 in Morden; RCI via Sackville, Canada **17.695** (Fr to Africa 1800-2000) 35444 at 1930 in Storrington; Qatar BS, Doha **17.895** (Ar to Eur 1700-2130) 44444 at 2114 in Oxted; VOA via Greenville, USA **17.725** (Fr, Eng to Africa 1830-2200) 35533 at 2120 in E.Bristol.

Despite the high level of activity in the **21 & 17MHz** bands there is still plenty to interest the listener in the **15MHz (19m)** band. During the early morning R.Australia may be heard beaming to Asia via Shepparton on **15.415** (Eng 0100-0400, 0600-0900), rated 33343 at 0739 in Oxted; also to Pacific areas via Shepparton on **15.240** (Eng 0100-0900), rated 33333 at 0832 by **Vera Brindley** in Woodhall Spa.

Also received during the morning were HCJB Quito, Ecuador **15.160** (Eng to Eur? 0600-0800), rated 55555 at 0625 in Morpeth; R.Slovakia Int **15.460** (Eng to Australia? 0700-0730) 32322 at 0707 in St.Austell; V of Armenia, Yerevan **15.270** (Various to Eur, M.East

[Eng 0840-0900] Sun) 43343 at 0845 in Newry; Swiss R.Int via Julich, Germany **15.315** (Eng, Ger, Fr, It to SW.Eur 1000-1230) 54444 at 1000 in Kilkeel; WEWN via Vandiver, USA **15.745** (Eng to Eur 1000-2200) 54444 at 1020 in Morden; Israel R, Jerusalem **15.640** (Eng to Eur? 1030-7) 35553 at 1030 in Wallsend; R.Bulgaria **15.700** (Eng to W.Eur 1100-1200) 45444 at 1110 in Northampton.

After mid-day R.Romania Int **15.390** (Eng to W.Eur 1300-1356) was a potent 55544 at 1305 in Herstmonceux; Israel R, Jerusalem **15.650** (Eng to Eur? 1400-1430) 54444 at 1403 in Plymouth; R.Oman via Thumrait **15.140** (Eng to M.East) SIO 322 at 1430 in Co.Fermanagh; Africa No.1, Gabon **15.475** (Fr to W.Africa 1600-1900) 35433 at 1721 in Storrington; R.Denmark via R.Norway Int **15.735** (Da to M.East 1730-1800) 44454 at 1755 in Liverpool; All India R. via Bangalore **15.200** (Eng to W.Africa 1745-1945) 34333 at 1910 in Colyton; V of Indonesia, Jakarta **15.150** (Eng to Eur, Africa 2000-2100) 45433 at 2011 in E.Bristol; V of Africa via Sabrata, Libya **15.415** (Eng to M.East, Eur 2015-2100) 33333 at 2029 in Rugby; R.Taipei Int via WYFR **15.600** (Eng to Eur 2200-2300) 33233 at 2200 by **Clare Pinder** in Appleby; BBC via Ascension Is **15.400** (Eng to Africa 1500-2300) 55545 at 2245 in Stalbridge; VOA via ? **15.250** (Eng to S.Asia? 0100-0300) SIO 444 at 0143 by **Francis Hearne** in N.Bristol.

Reception from some areas has also been good in the **13MHz (22m)** band. Mentioned in the reports were R.Australia via Shepparton **13.605** (Eng to Pacific 0800-1200), rated 33333 at 1005 in Kilkeel; R.Kuwait via Kabb **13.620** (Ar to Eur, N.America 0930-1605) 44333 at 1111 in Oxted; Croatian R, Zargreb **13.830** (News in Eng to Eur, N.America) 44233 at 1207 in Newry; R.Prague, Czech Rep. **13.580** (Eng to Eur, Asia 1300-1330) 54444 at 1312 in Plymouth; UAER, Dubai **13.675** (Eng to Eur 1330-1355) 44444 at 1345 in Colyton; RUV Reykjavik, Iceland **13.860** (Ic to N.America? 15107-1530?) 33233 at 1525 in Liverpool; BBC via Rampisham, UK **13.745** (Russian Service 1400-2030) 55555 at 1530 in Stalbridge; R.Austria Int via Moosbrunn **13.730** (Eng to Eur, Africa 1630-1700) SIO 433 at 1630 in Co.Fermanagh; Swiss R.Int via Sottens **13.770** (It, Ar, Eng, Ger, Fr to N.East, Africa 1830-2130) 44444 at 2000 in Appleby; Vatican R, Italy **13.765** (Eng to Africa 2000-2030) 44333 at 2010 in Morden; V of Vietnam, Hanoi **13.740** (Eng to Eur 2030-2100) 44333 at 2030 in Rugby; R.Havana Cuba **13.750** (Eng to Eur 2100-?) 33222 at 2100 in Appleby; R.Damascus, Syria **13.610** (Eng to Eur 2005-2105; Eng to America, Pacific 2105-2205) 35333 at 2012 in E.Bristol & 34333 at 2121 in Woodhall Spa; RCI via Sackville, Canada **13.650** (Eng to Eur 2000-2200) 45544 at 2140 in Northampton; V of Turkey, Ankara **13.640** (Eng to Eur 2200-2300) 55555 at 2210 in St.Austell.

Although R.New Zealand's broadcasts to Pacific areas in the **11MHz (25m)** band often reach the UK reception here tends to be poor. Typical ratings for their 100kW transmission on **11.720** (Eng 0705-1005) were 33222 at 0735 in Appleby and 32233 at 0845 in St.Austell.

Many other broadcasters also use this band to reach listeners in chosen areas during the day. They include R.Korea Int via Sackville? **11.715** (Eng to E.U.S.A 1030-1100), rated 34243 at 1049 in Newry; R.France Int via Allouis? **11.670** (Eng to Eur 1200-1257) 43334 at 1245 in Stalbridge; R.Jordan via Al Karanah **11.690** (Eng to W.Eur, E.U.S.A 1300-1730) 54444 at 1312 in Plymouth; R.Netherlands via Tashkent **12.075** (Eng to S.Asia 1430-1630) 43333 at 1430 in Morden; R.Japan via Sri Lanka **11.880** (Eng to M.East 1400-1500) 44433 at 1445 in Herstmonceux; R.Australia via Shepparton **11.660** (Various to Asia 1430-1700) 44444 at 1520 in Morpeth; VOA via Philippines **12.040** (Eng to Asia 1500-1600) 32222 at 1520 in Liverpool.

During the evening the BBC via Woofferton, UK **12.095** (Eng to Asia 1700-2100) was 34343 at 1815 in Rugby; VOA via Thailand **12.015** (Eng to M.East? 1900-2000) 43332 at 1923 in Oxted; V of Mediterranean, Malta via Russia? **12.060** (Eng to Eur, N.Africa 1900-2000) 44423 at 1925 in Colyton; China R.Int via ? **11.790** (Eng to Eur 2000-2100) 32233 at 2010 in St.Austell; R.Damascus, Syria **12.085** (Ger, Fr, Eng to Eur 1805-2105) 44434 at 2014 in E.Bristol; R.Bulgaria **11.700** (Eng to Eur 2100-2200) 44444 at 2118 in Woodhall Spa; R.Japan via Ascension Is **11.855** (Eng to S.Africa? 2100-2200) SIO 444 at 2130 in Co.Fermanagh; BBC via Ascension Is **12.095** (Eng to S.America 2100-0300) 45343 at 2135 in Northampton.

In the **9MHz (31m)** band the reception of broadcasts to Europe has been reported as generally good. Some to other areas were also mentioned in the reports from UK listeners. China R.Int via R.Ext.España **9.690** (Eng to USA 0300-0357) was rated SIO 333 at 0314 in N.Bristol; HCJB Quito, Ecuador **9.745** (Eng to America 0500-0600) 33333 at 0509 in Woodhall Spa; R.Havana Cuba **9.820** (Eng to USA 0100-0700) 43333 at 0545 in Morpeth; TWR Monte Carlo, Monaco **9.870** (Eng to Eur 0655-0820) 44444 at 0735 in St.Austell; R.Finland via Pori **9.560** (Eng to SW.Eur 0800-0900 Sat) 55544 at 0805 in Herstmonceux; Christian Science BC via WSHB Cypress Creek, USA **9.860** (Sp to Eur? 0800-1000) 54445 at 0820 in Stalbridge; R.Vilnius, Lithuania **9.710** (Eng to Eur 0930-1000) 54444 at 0930 in Plymouth; AWR via Forli **9.610** (Eng to Eur? 0930-1000) 24222 at 0945 in Newry; R.Mediterranean Int, Morocco **9.575** (Ar, Fr to N.Africa, S.Eur 0500-0100) 34443 at 1015 in Kilkeel; R.Netherlands via Wertachtal **9.860** (Eng to Eur 1030-1225) 44444 at 1030 in Dudley; V of Turkey, Ankara **9.460** (Tur to Eur 0800-2200) 35543 at 1237 in Wallsend.

Later, China R.Int via ? **9.440** (Eng to Eur, N.Africa 1900-2100) was 32222 at 1925 in Liverpool; R.Polonia (Polish R, Warsaw) **9.540** (Eng to Eur 1930-2030 [replaces 9.525]) 33222 at 2000 in Morden; VOIRI Tehran, Iran **9.022** (Eng to W.Eur 1930-2030) 33333 at 2010 in Rugby; VOA via Sao Tome **9.780** (Fr to Africa 1830-2130) 44343 at 2023 in Storrington; R.Australia via Shepparton **9.500** (Eng to Asia 1430-2130) 32232 at 2024 in Colyton; R.Japan via Skelton, UK **9.810** (Eng to Eur 2100-2200) 33233 at 2100 in Appleby; R.Bulgaria **9.400** (Eng to Eur? 2100-2200?) 44344 at 2105 in Oxted; R.Sweden **9.435** (Sw, Eng to Eur 2100-2200) 55545 at 2132 in N.Bristol; R.Cairo, Egypt **9.990** (Eng to Eur 2115-2245) 55544 at 2137 in Northampton; R.Netherlands via Bonaire, Ned.Antilles **9.795** (Eng to N.America 2330-0125) SIO 555 at 2330 in Co.Fermanagh.

The **7MHz (41m)** band also carries a number of broadcasts for listeners in Europe. Some originate from R.Japan via Woofferton, UK **7.230** (Eng, Jap 0500-0700), rated 44444 at 0513 in Woodhall Spa; V of the Mediterranean, Malta via Russia? **7.150** (Eng 0600-0630) 44444 at 0609 in Newry; WYFR via Okeechobee, USA **7.355** (Eng 0600-0800, also to Africa) 34333 at 0614 in Rugby; Vatican R, Italy **7.250** (Various) 44444 at 0630 in Morden; R.Norway Int **7.485** (Norw 0700-0730) 44444 at 0710 in Colyton; R.Canada Int via Skelton, UK **7.235** (Fr 1900-2000) 44444 at 1913 in Oxted; R.Norway Int **7.485** (Norw 1900-1930) 54554 at 1915 in Plymouth; RAI Rome **7.290** (Eng 1935-1955) 43333 at 1935 in Appleby; AIR via Bangalore **7.410** (Eng 1745-1945) 43444 at 1940 in Liverpool; Voice of Greece, Athens **7.475** (Eng, Gr) 55444 at 1957 in Northampton; DW via Sines? **7.130** (Eng 2000-2045) 54545 at 2043 in E.Bristol; V of Turkey **7.190** (Eng 2200-2245?) 43333 at 2207 in St.Austell.

Some for other areas may also be received here. They include the Voice of Nigeria, Ikorodu **7.255** (Fr to Africa 1800-1900), rated 33433 at 1840 in Storrington; R.France Int **7.315** (Fr to N.Africa 2000-2200) 54445 at 2050 in Stalbridge; KTBN via Salt Lake City, USA **7.510** (Eng to N.America 0000-1600) 34333 at 0352 in Morpeth.

Many interesting broadcasts for listeners in Europe may be received in the **6MHz (49m)** band. Some come from R.Vlaanderen Int, Belgium **5.985** (Eng 0700-0730), rated 33233 at 0700 in Appleby; R.Netherlands via Julich, Germany **6.045** (Eng 1030-1225) 55444 at 1030 in Newry; Deutsch Welle (DW) via Julich? **6.140** (Eng Service) SIO 222 at 1500 in Co.Fermanagh; R.Prague, Czech Rep. **5.930** (Eng 1700-1727) 55555 at 1710 in Plymouth; Swiss R.Int via Julich, Germany **6.110** (Ger, It, Fr, Eng 1730-1930) 44444 at 1740 in Rugby; R.Sweden via Horby **6.065** (Eng 1730-1800) 45534 at 1751 in Colyton; Sri Lanka BC via Skelton, UK **6.010** (Eng to Eur 1900-2000 Sun) 44444 at 1928 in St.Austell; R.Finland, Helsinki **6.110** (Eng 1930-1945) 53433 at 1935 in Herstmonceux; R.Canada Int via Skelton, UK **5.995** (Fr, Eng 1900-2200) SIO 444 at 2009 in N.Bristol; R.Japan via Skelton, UK **6.115** (Eng 2100-2200) 54455 at 2100 in Dudley; BBC via Rampisham, UK **6.195** (Eng 0400-0700, 1900-2300) 55544 at 2218 in Northampton.

Also mentioned were a few to other areas. They originated from VOA via Sao Tome **6.035** (Eng to W.Africa 1800-2230), rated 43333 at 1845 in Morden; BBC via Antigua, W.Indies **5.975** (Eng to C/N.America 2100-0800) 44544 at 2352 in E.Bristol; BBC via Ascension Is **6.005** (Eng to S.Africa 0300-0400 & W.Africa 0400-0600) 43434 at 0415 in Stalbridge.

Continued on page 12

Note: Entries marked * were logged during darkness. All other entries were logged during daylight or at dawn/dusk.

Listeners:

- (A) Robert Connolly, Kilkeel.
- (B) Bernard Curtis, while near Aberystwyth.
- (C) Simon Hockenhull, E.Bristol.
- (D) Simon Hockenhull, while in Minsterworth, Glos.
- (E) Sheila Hughes, Morden.
- (F) Rhoderick Illman, Oxted.
- (G) George Millmore, Wootton, IoW.
- (H) Tom Smyth, Co.Fermanagh.
- (I) Phil Townsend, E.London.
- (J) Bruce Watt, W.London.
- (K) Fred Wilmshurst, Northampton.
- (L) Tom Winzor, Plymouth.
- (X) Anthony Johnson, Livingston, W.Lothian.

Local Radio Chart

Freq (kHz)	Station	ILR BBC	e.m.r.p (kW)	Listener
558	Spectrum, London	I	0.80	F*K
603	Capital G, Lnt brne	I	0.10	A,G,I,K
630	R.Bedfordshire(3CR)	B	2.00	D,G,I,K
630	R.Cornwall	B	2.00	A,B,G
657	R.Clywd	B	2.00	A,G,I
657	R.Cornwall	B	0.50	A,G
666	Ci.Gold 666, Exeter	J	0.34	A,C,D,G,K
666	R.York	B	0.80	A
729	BBC Essex	B	0.20	E,F*,G,I,K
738	Hereford/Worcester	B	0.037	C,D,I,K
756	R.Cumbria	B	1.00	A,X*
756	The Magic 756, Powys	I	0.63	A,C,D,G,K
765	BBC Essex	B	0.50	A,E,F*,G,H,K
774	R.Kent	B	0.70	G,I,K
774	Ci.Gold 774, Glos	I	0.14	G,K
792	Ci.Gold 792, Bedford	I	0.27	G,I,K
792	R.Foyle	B	1.00	A
801	R.Devon	B	2.00	A,B,D,G
828	Ci.Gold 828, Luton	J	0.20	L,K
828	Magic 828, Leeds	I	0.12	A
828	Asian Netwk Sedgley	B	0.20	D,I
828	ZCR Ci.G Boumment h	I	0.27	G
837	R.Cumbria/Furness	B	1.50	A
837	Asian Netwk Leica	B	0.45	A,G,K
855	R.Devon	B	1.00	A,G,I
855	R.Lancashire	B	1.50	A
855	R.Norfolk, Postwick	B	1.50	H*,J
855	Sunshine 855, Ludlow	J	0.15	C,D,E,K
873	R.Norfolk, W.Lynn	B	0.30	G,I,K
936	Brunel CG, W.Wilts	J	0.18	D,G,H*,K
936	Fresh AM, Hawes	I	1.00	A
945	Ci.Gold GEM, Derby	J	0.20	A,K
945	Capital G, Bexhill	I	0.75	E,G,I
954	Ci.Gold 954, Torquay	I	0.32	G
954	Ci.Gold 954, H'ford	I	0.16	A,D,K
963	Asian Sd, E.Lancs	I	0.80	A
963	Liberty R, Hackney	I	1.00	E*,G,X*
972	Liberty R, Southall	I	1.00	A,E*,G,H,K
990	R.Devon, E.Devon	B	1.00	A,G
990	Ci.G, Wolverhampton	I	0.09	D,K
999	C.Gold GEM Nott ham	I	0.25	K
999	Magic 9-99 Pstn	I	0.80	A
999	R.Solent	B	1.00	E*,G,I
999	Valley R, Aberdare	I	0.300	D
1017	Ci.G, WABC, Sh'rsire	I	0.70	A,D,I,K
1026	R.Cambridgeshire	B	0.50	F,I,K
1026	Downtown R, Belfast	I	1.70	A,B,H
1026	R.Jersey	B	1.00	A,G
1035	R.TL C'try(Ritz)1035	I	1.00	B*,G,K
1035	N.Sound 2, Aberdeen	I	0.78	A
1116	R.Derby	B	1.20	A,H*,J,K
1116	R.Guernsey	B	0.50	E,G
1116	Valley R, Ebbw Vale	I	0.50	D,J
1152	LBC 1152 AM	I	23.50	G,H,K
1152	Pic'ly 1152, Manch'r	I	1.50	A
1152	Ci.G, Birmingham	I	3.00	D,K
1161	R.Bedfordshire(3CR)	B	1.00	H*,I,K
1161	Brunel Ci.G, Swindon	I	0.16	D
1161	Magic 1F, Goxhill	I	0.35	A
1161	Southern Counties R	B	1.00	F,G
1170	Magic 1170, Stockton	I	0.32	A
1170	Capital G, Portsm'th	I	0.50	E,F,G
1170	1170AM, High Wycombe	I	0.25	E,I,K
1242	Capital G, Maidstone	I	0.32	E,F,G,I
1251	C.G Amber, Bury StEd	I	0.76	A,I,K
1260	Brunel CG, Bristol	I	1.60	D,G
1260	SabrasSnd, Leicester	I	0.29	D,K
1278	Ci.Gold 1278 W.York	I	0.43	A
1296	Radio XL, Birmingham	I	5.00	C,D,E*,G,H*,K
1305	Magic AM, Barmley	I	0.15	A
1305	Premier via ?	I	0.50	A,G,K
1305	Touch AM, Newport	I	0.20	G
1323	Capital G, Southwick	I	0.50	F,G,I,K
1323	Somersersnd, Bristol	B	0.63	A
1332	Premier, Battersea	I	1.00	G
1332	Ci.Gold 1332, Pt'bo	I	0.60	A,J
1332	Wiltshire Sound	B	0.30	D,G
1359	Breeze, Chelmsford	I	0.28	E,F
1359	Ci.Gold 1359, C'try	I	0.27	D,K
1359	R.Solent	B	0.85	G
1359	Touch AM, Cardiff	I	0.20	D
1368	R.Lincolnshire	B	2.00	K
1368	Southern Counties R	B	0.50	E,G,I
1368	Wiltshire Sound	I	0.10	D,G
1377	Asian Sd, Rochdale	I	0.10	A
1413	R.Gloucester via ?	I	?	K
1413	Premier via ?	I	0.50	G
1413	Fresh AM, Skipton	I	0.10	A
1431	Breeze, Southend	I	0.35	F,I
1431	Ci.Gold, Reading	I	0.14	G,K
1449	R.Peterboro/Camb's	B	0.15	A,K
1458	R.Cumbria	B	0.50	A
1458	R.Devon	B	2.00	A,G
1458	Sunrise, London	I	50.00	G,K
1458	Asian Netwk Langley	B	5.00	D,K
1485	Ci.Gold, Newbury	I	1.00	D,K
1485	R.Merseyside	B	1.20	A,G
1485	Southern Counties R	B	1.00	G,I
1503	R.Stoke-on-Trent	B	1.00	A,G*,H,K
1521	Breeze, Reigate	I	0.64	E,G,I,K
1530	R.Essex, Southend	B	0.15	G,I
1530	Ci.Gold W.Yorks	I	0.74	A
1530	Ci.Gold Worcester	I	0.52	D,G,K
1548	R.Bristol	B	5.00	D
1548	Capital G, London	I	97.50	A,G,J
1557	R.Lancashire	B	0.25	A
1557	Ci.Gold D7, N.hant	I	0.76	D,I,K
1557	Capital G, So'ton	I	0.50	E,G
1566	CountySnd, Guildford	I	0.50	F,I,L
1584	London Turkish R	I	0.20	G
1584	R.Nottingham	B	1.00	K
1584	R.Shropshire	B	0.50	A,D
1602	R.Kent	B	0.25	G,I

£99.95

LOG PERIODIC MLP32

Freq. Range 100-1300MHz
Length 1420mm Wide Band 16 Element directional beam which gives a maximum of 11-13Db Gain Forward and 15Db Gain Front to Back Ratio. Complete with mounting hardware. (The Ultimate Receiving Antenna - a must for the Dedicated Listener.)

ROTATOR AR-300XL

- * Rotation Torque-222Kg
 - * Vertical Load-45Kg
 - * Mast Size - 28-44mm
 - * Control Box-230v AC
 - * Cable-3 core
 - * Direct Compass Bearings
- (Ideal for Light to Medium Beams, i.e. LOG PERIODIC above.)



£49.95

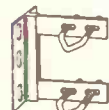

6" STAND OFF BRACKET

Complete with 'U' Bolts

£6.00

9" STAND OFF BRACKET

Complete with 'U' Bolts

£9.00

MD37 SKY WIRE (LONG WIRE BALUN KIT)

25 METRES OF ENAMELLED WIRE & INSULATOR
FOR USE ON WITH RECEIVER 0 - 40 Mhz. ALL MODE NO ATU REQUIRED 2 'S' POINTS GREATER SIGNAL THAN OTHER BALUNS. MATCHES ANY LONG WIRE TO 50 OHMS



£29.95

5' SWAGED POLES

Heavy Duty Ali (1.2mm wall)
SINGLE 1 1/4"..... £6.00
SET OF FOUR 1 1/4". £19.95
SINGLE 1 1/2"..... £9.00
SET OF FOUR 1 1/2". £29.95

CONNECTORS

- PL259/9..... 0.75 each
- PL259/6..... 0.75 each
- PL259/7 for mini 8 1.00 each
- BNC (Screw Type) 8 1.00 each
- BNC (Solder Type) 8 1.00 each
- N TYPE for N582.50 each
- N TYPE for RF213 ..2.50 each
- SO239 to BNC1.50 each
- PL259 to BNC2.00 each
- N TYPE to SO239 ..3.00 each

CABLE

- RG213 MILITARY 0.85 per mtr.
- MINI RFB 0.85 per mtr.
- RG58 STANDARD 0.35 per mtr.
- RG58 MILITARY 0.60 per mtr.

WEATHER SATELLITE ANTENNA

TURNSTILE 137

Freq. 137.5 Mhz
Length 1000mm

This Antenna is designed for external use to receive weather satellite signals. Complete with mounting hardware.

£39.95

(Simple and easy to install a must for the enthusiast who has it all.)



UK SCANNING DIRECTORY

7th edition

£19.50



SUPER SCANAIR BASE (Airband)

(Stainless Steel)
Freq. Range Receive 117-140MHz
Transmit 117-140MHz
Length 825mm
Connector-N TYPE

This is a transmitting & receiving antenna designed for the aircraft frequency range. (For the control tower & aircraft listener.)

£29.95

SUPER SCAN STICK

Freq. Range 0-2000MHz
Length 1000mm

It will receive all frequencies at all levels unlike a mono band antenna. It has 4 capacitor loaded coils inside the vertical element to give maximum sensitivity to even the weakest of signals. (Ideal for the New Beginner and the Experienced Listener alike.)

£49.95

SUPER SCAN STICK II

Freq. Range 0-2000 Mhz.
Length 1500mm.

This is designed for external use. It will receive all frequencies. at all levels unlike a mono band antenna. It has 8 capacitor loaded coils inside the vertical element to give maximum sensitivity to even the weakest of signals plus there is an extra 3db gain over the standard super scan stick. (For the expert who wants that extra sensitivity)

MULTI SCAN STICK II

Freq. Range Receive (0-2000MHz) Transmit (144-146 MHz)
Gain 4.00dbd (420-430 MHz) Gain 6.00dbd Length 1500mm
Same as Super Scan Stick but with extra gain, makes it an even better antenna for the amateur and expert alike. (Ideal for the Ham Radio user)

£39.95

MULTISCAN STICK

Freq. Range Receive - 0-2000 Mhz.

Transmit 144 - 146 Mhz gain 2.5 DBd
420 - 430 Mhz gain 4.5 DBd
Length 1000 mm.

Although marginally compromising sensitivity the multi scan stick has within its transmitting capabilities plus gain makes it an excellent antenna for the amateur and expert alike. Comes complete with mounting hardware and brackets. (Ideal for the amateurs ham radio - user).

£89.95

IVX 2000

Freq. Range Receive - 0-2000 Mhz.

Transmit 50 - 52 Mhz gain 2.00DBd
144 - 146 Mhz gain 4.00 DBh
420 - 430 Mhz gain 6.00 DBd
Length 2.5 m.

For external use, but at a pinch can be used in the loft. It has been finely tuned to make this Antenna the best there is. It has stainless steel radials and hardware. (THE BEST)

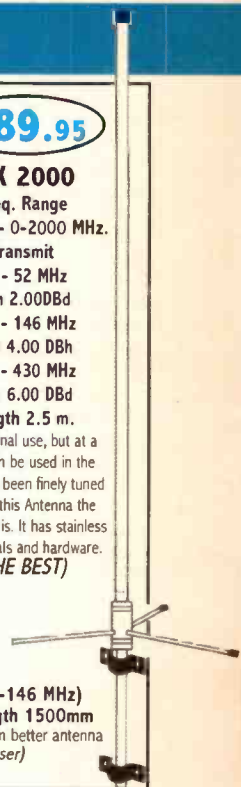

T&K BRACKETS

Complete with 'U' Bolts



- 12"- £10.95
- 18"- £14.95
- 24"- £16.95

MWA-H.F. WIRE ANTENNA

Freq. Range 1.1-30MHz Adjustable Length up to 60 Metres
Internal or external use. The long wire is known to be one of the best antennas for shortwave (HF) receiving. Comes complete with con box and dog bones, wire etc. (A must for the short wave listener.)

£29.95

SWP 2000 FREQ. 25 - 2000

Mhz. Length 515mm.
Multiband good sensitivity for its small size. Fitted with two suction cups for ease of fitting to any smooth surface (i.e. inside of car window) comes with 5 metres of mini coax and BNC connector. (Good for the car user who doesn't want an external antenna.)

£29.95

SWP HF30

Freq. Range 0.05-30MHz Length 770mm
Although small, surprisingly sensitive for the H.F. user. Fitted with two suction cups for ease of fitting to any smooth surface (i.e. inside of car window) comes with 5 metres of mini coax and BNC connector. (Good for the car user who doesn't want an external antenna.)

£39.95



HF DISCONE

Freq. Range 0.05-2000MHz
Length 1840mm
Internal or External use (A Tri-Plane Antenna). Same as the Super Discone but with enhanced HF capabilities, comes complete with mounting hardware and brackets. (Ideal for the Short Wave H.F. Listener.)

£49.95

ROYAL DISCONE 2000

(Stainless Steel)

Freq. Range Receive 25-2000MHz
Transmit 50-52MHz
144-146MHz 430-440MHz 900-986MHz
Length 1540mm
Connector-N TYPE The Ultimate Discone Design.

£49.95



4.5DB GAIN OVER STANDARD DISCONE! Highly sensitive, with an amazing range of transmitting frequencies, comes complete with mounting hardware & brackets (The Best There is).

£39.95



SUPER DISCONE

Freq. Range 25-2000MHz
Length 1380mm
Internal or External use (A Tri-Plane Antenna). The angle of the ground planes are specially designed to give maximum receiving performance within the discone design. The Super Discone gives up to 3Db gain over a standard conventional discone. Comes complete with mounting hardware and brackets. (Ideal for the Experienced Enthusiast.)

MRW-100

(Super Gainer) (Rubber Duck) Wideband extra sensitive Dedicated VHF/UHF all mode Length 400mm. PP £2.00

£19.95

MRP-2000 (Preamplifier)

Freq Range 25-2000 Mhz 9-15v input (Battery not included) 14 db Gain. Complete with lead and BNC connectors.

£49.95

G. SCAN II

Freq. Range 25-2000 MHz.Length 620 mm.

Magnetic mount Mobile Scanner Antenna. 2 vertical loaded coils for good sensitivity complete with magnetic mount and 4mts of coax, terminated with BNC plug. (Good for when you are driving about)

£19.95

MRP-125 (Preamplifier)

Freq Range 118-137 Mhz 9-15v input (Battery not included) 14 db Gain Complete with lead and BNC connectors.

£44.95

CIVIL AND MILITARY RECEIVING ANTENNAS

- AR30 (Length 1000mm GAIN 3.6 & 6.5).....Price £39.95
- AR50 (Length 1500mm GAIN 5.0 & 7.5).....Price £64.95



**BEARCAT
UBC-60XLT**
66-512 MHz
£79.95



**BEARCAT
UBC-120XLT**
66-512 MHz
£99.95



**BEARCAT
UBC-220XLT**
66-956 MHz
£119.95



**UNIDEN
UBC-860XLT**
66-88, 108-174,
406-512,
806-956 MHz
£129.95



**BEARCAT
UBC-3000XLT**
25-550, 760-1300 MHz
£189.95



UBC-9000XLT
25-550,
760-1300 MHz
£219.95



**YUPITERU
MVT-7100EU**
530 KHz - 1650 MHz
£199.95



**YUPITERU
MVT-9000
Mk II**
530 KHz - 2039 MHz
£319.95



**YUPITERU
MVT-8000**
100KHz - 1300 MHz
£299.95



**ALINCO
DJ-X2**
522 KHz -
999.995 MHz
£239.95



**ICOM
IC-R2**
500 KHz - 1300 MHz
£129.95



ICOM IC-R10
500 KHz - 1300 MHz
£249.95



**A.O.R.
AR8000**
500 KHz - 1900 MHz
£249.95



**A.O.R.
AR8200
(series II)**
500 KHz - 2040 MHz
£399.95



**MAYCOM
AR108**
108-136.975,
136-180 MHz
£69.95



**YAESU
VR-500**
100 KHz - 1300 MHz
£249.95



**WATSON
WAB-10**
AM 520-1720 KHz
FM 87.3 - 104 MHz
£39.95



**ADD £6 P&P
PER ORDER**

Tropical Bands Chart

Freq (MHz)	Station	Country	UTC	DXer
2.310	ABC Alice Springs	Australia	2210	J
3.230	SABC Meyerton	S.Africa	2021	G
3.255	BBC via Meyerton	S.Africa	2021	E,G,J
3.270	Nambian BC, Windhoek	Namibia	2029	A,G,J
3.290	Nambian BC, Windhoek	Namibia	2020	A,G,J
3.316	SLBS Goderich	Sierra Leone	2019	G
3.320	SABC (RSG) Meyerton	S.Africa	2019	A,F,G,J
3.335	CBS Taipei	Taiwan	2040	G,J
3.365	GBC R-2	Ghana	2228	F,G,J,L
3.380	NBC Blantyre	Malawi	2015	G
3.915	BBC via Kranji	Singapore	2100	A,C,E,F,J,K,L
3.955	R. Taipei via Skelton	England	1800	D,H,I,M
3.970	R. Korea via Skelton	England	2100	C,D,H,K
3.975	R. Budapest	Hungary	2130	D,E,F,H,J,K
3.985	Nexus, Milan	Italy	2043	D,F,J
3.995	DW via Julich	Germany	2138	A,D,E,F,L
4.005	Vatican R.	Italy	2205	F
4.760	ELVA Monrovia	Liberia	2136	F
4.765	R. Rural, Santarem	Brazil	0135	A
4.770	FRNC Kaduna	Nigeria	2016	D,E,G,J
4.777	R. Gabon, Libreville	Gabon	1940	G
4.783	RTM Bamako	Mali	2015	D,E,G
4.785	Cairi Porto Velho	Brazil	0125	A
4.815	R. diff TV Burkina	Ouagadougou	2026	G,J
4.820	R. Botswana, Gaborone	Botswana	2019	B,G
4.830	R. Tachira	Venezuela	0354	A,B
4.835	RTM Bamako	Mali	2146	E,F,G,J,L
4.845	ORTM Nouakchott	Mauritania	1921	A,F,G
4.850	R. Yaounde	Cameroon	2139	F,L
4.860	AIR Delhi	India	1904	G
4.870	SLCB Colombo	Sri Lanka	0115	A
4.875	R. Roraima, Boa Vista	Brazil	0120	A,B
4.885	R. Clube do Para	Brazil	0345	B
4.885	R. Difusora Acreana	Brazil	0135	A
4.885	KBC East Sca Nairobi	Kenya	1904	G
4.890	RFI Paris	via Gabon	0358	B,F
4.890	R. Port Moresby	Pap.N. Guinea	2005	G
4.895	R. IPB AM C'po Grande	Brazil	0328	B

Freq (MHz)	Station	Country	UTC	DXer
4.905	Anhanguera	Brazil	0330	B
4.915	GBC-1, Accra	Ghana	2050	D,F,G
4.915	Pakistan BC, Islamabad	Pakistan	0115	A
4.920	R. Quito, Quito	Ecuador	0445	B,D
4.950	AIR Srinagar	India	0120	A
4.950	VOA via Sao Tome	Sao Tome	2030	G,H
4.965	R. Alvorada	Brazil	0125	A
4.965	Christian Voice	Zambia	1902	B,F,G
4.975	R. Uganda, Kampala	Uganda	1950	D,G,J
4.980	Ecos del Torbes	Venezuela	0350	B
4.985	R. Brazil Central	Brazil	0505	A,D
5.009	R. TV Malagasy	Madagascar	1838	G
5.019	R. Garoua	Cameroon	2024	G
5.020	La V du Sahel, Niamey	Niger	2105	F,G,J
5.025	R. Parakou	Benin	2033	E,G
5.025	R. Rebelde, Habana	Cuba	0120	A,B
5.025	R. Uganda, Kampala	Uganda	1858	D,G
5.030	AWR Latin America	Costa Rica	0125	A,B
5.035	R. Bangui	C. Africa	2034	G
5.047	R. Togo, Lome	Togo	2120	D,E,G,L
5.050	R. Tanzania	Tanzania	1858	G
5.055	Faro del Caribe	Costa Rica	0410	B
5.055	RFD Cayenne (Matoury)	French Guiana	0130	A
5.100	R. Liberia, Totota	Liberia	2034	E,G

- DXers:**
- (A) Robert Connolly, Killeel.
 - (B) David Hall, Morpeth.
 - (C) Simon Hockenhill, E. Bristol.
 - (D) Sheila Hughes, Morden.
 - (E) Rhoderick Illman, Oxted.
 - (F) Eddie McKeown, Newry.
 - (G) Fred Pallant, Storrington.
 - (H) Clare Pinder, while in Appleby.
 - (I) Peter Pollard, Rugby.
 - (J) Vic Prier, Colyton.
 - (K) Tom Smyth, Co. Fermanagh.
 - (L) Fred Wilmshurst, Northampton.
 - (M) Tom Winzor, Plymouth.

LM&S continued

The SINPO code is used for broadcast station reports, here is an explanation of the code.

Signal Strength

- 5 excellent
- 4 good
- 3 fair
- 2 poor
- 1 barely audible

Interference

- 5 nil
- 4 slight
- 3 moderate
- 2 severe
- 1 extreme

Noise

- 5 nil
- 4 slight
- 3 moderate
- 2 severe
- 1 extreme

Propagation Disturbance

- 5 nil
- 4 slight
- 3 moderate
- 2 severe
- 1 extreme

Overall Merit

- 5 excellent
- 4 good
- 3 fair
- 2 poor
- 1 unusable

Medium Wave Chart

Freq (kHz)	Station	Country	Power (kW)	Listener
520	Hof/Wurzburg(BR)	Germany	0.2	F*
531	Ain Belda	Algeria	600/300	G*
531	Berg	Germany	20	G
531	RNE5 via ?	Spain	?	G,X
531	Beromunste	Switzerland	500	F*,I*,L*
540	Wavre	Belgium	150/50	E*,F*,G,L
540	Sidi Benour	Morocco	600	F*
549	Les Trembles	Algeria	600	F*,G*
549	Thurnau (DLF)	Germany	200	E*,F*,G,J,L
558	Espoo	Finland	50	F*
558	RNE5 via ?	Spain	?	F*,G*,X*
567	Tullamore(RTE1)	Eire	500	C*,E*,F*,G,I,J,L*,X
576	Muhlacker(SDR)	Germany	500	E*,F*,G*,J
585	Paris(FIP)	France	8	G,J
585	Madrid(RNE1)	Spain	200	B*,E*,F*
585	Dumfries(BBC Scot)	UK	2	A,F*,X
594	Frankfurt(HR)	Germany	1000/400	E*,F*,G*,J,X*
594	Muge	Portugal	100	F*
603	Lyon	France	300	B*,G
603	Sevilla(RNE5)	Spain	50	F*,G*
603	Newcastle(BBC)	UK	2	F*,X*
612	Athlone(RTE2)	Eire	00	AB*,CD*,F*,J,K,L,X
621	Wavre	Belgium	80	F*,G,J,L
630	Vigra	Norway	100	B*,F*,X*
630	Tunis-Djedeida	Tunisia	600	B*,F*
639	Praha(Liblice)	Czech	1500	F*
639	RNE1 via ?	Spain	?	B*,F*,G*,X*
648	RNE1 via ?	Spain	10	F*
648	Orfordness(BBC)	UK	500	A,C,F*,G,J,L,X*
657	Wrexham(BBC Wales)	UK	2	A,C,F*,I*,L
666	Messkirch(Rohrd SWF)	Germany	150	F*,X*
666	Lisboa	Portugal	135	F*
675	R10 FM	Holland	120	C,F*,G,I*,J,L*,X*
684	Sevilla(RNE1)	Spain	500	B*,F*,G*,X*
693	Droitwich(BBC5)	UK	150	G,K,L*
702	Flensburg(NDR)	Germany	5	F*
711	Rennes 1	France	300	B,C,F*,G,J,L,X*
711	Laayoune	Morocco	600	G*
720	Lots Rd, Ldn(BBC4)	UK	0.5	D,G
729	Cork(RTE1)	Eire	10	F*,G,J
729	RNE1 via ?	Spain	?	F*,X*
738	Paris	France	4	F*,G
738	Barcelona(RNE1)	Spain	500	F*,G*,X*
747	Flevo(Hilv2)	Holland	400	C,F*,G,J,L*,X*
756	Braunschweig(DLF)	Germany	800/200	F*,G*,X*
756	Redruth(BBC)	UK	2	F*
775	Sottens	Switzerland	500	F*,G*,X*
774	Enniskillen(BBC)	N. Ireland	1	F*,I,X*
774	RNE1 via ?	Spain	?	F*,I*,X*
783	Leipzig(MDR)	Germany	100	F*,G*
783	Miramar(R. Porto)	Portugal	100	F*,G*
792	Limoges	France	300	F*,G
792	Sevilla(SER)	Spain	20	F*,G*
801	Munchen-Ismaning	Germany	300	E*,F*
801	RNE1 via ?	Spain	?	F*
810	Volgograd	Russia	150	G*
810	Westerglen(BBC Scot)	UK	100	F*,G*,I,L*,X*
819	Batra	Egypt	450	F*
819	S. Sebastian(EI)	Spain	5	F*
828	Rotterdam	Holland	20	D,F*,J
837	Nancy	France	200	F*,I
837	COPE via ?	Spain	?	F*,G*
846	Rome	Italy	1200	B*,F*,G*,L*
855	RNE1 via ?	Spain	?	B*,F*,G*,I,L*,X*
864	Santah	Egypt	500	B*,F*
864	Paris	France	300	C,G,J

Freq (kHz)	Station	Country	Power (kW)	Listener
864	St. Petersburg(TWR)	Russia	?	F*
873	Frankfurt(AFN)	Germany	150	F*,G*,K*
873	Enniskillen(R.U.I)	UK	1	F*,J
882	Washford(BBC Wales)	UK	100	E*,F*,G,J,L
891	Algiers	Algeria	600/300	B*,D*,F*,G*
891	Hulsberg	Netherlands	20	J
900	Brno(CRo2)	Czech Rep	25	F*
900	Milan	Italy	600	B*,F*,G*,I*
909	Lisnagarvey(BBC5)	N. Ireland	10	I
909	Bmans PN(BBC5)	UK	140	G,K,L
918	Domzale	Slovenia	600/100	F*
927	Wolvertem	Belgium	300	F*,G,I*,J,L*
936	Bremen	Germany	100	F*,G*
954	Brno (CRo2)	Czech Rep.	200	F*,G*
954	Madrid(CI)	Spain	20	F*,I*
963	Pori	Finland	600	B*,F*,G*
963	Tir Chonaili	Eire	10	I*
972	Hamburg(NDR)	Germany	300	F*,G*,X*
981	Alger	Algeria	600/300	G*
990	Berlin	Germany	300	F*,G*
990	R. Bilbao(SER)	Spain	10	G*
990	Redmoss(BBC)	UK	1	F*
990	Tywyn(BBC)	UK	1	I*
999	Schwerin (RIAS)	Germany	20	D*,J*
999	Madrid(COPE)	Spain	50	D*,J*
1008	Flevo(Hilv-5)	Holland	400	F*,G,I*,J,L
1017	Rheinsender(SWF)	Germany	600	F*,G*,I*,X*
1017	RNE5 via ?	Spain	?	F*,G*
1035	Lisbon(Prog3)	Portugal	120	F*,G
1044	Dresden(MDR)	Germany	20	F*
1044	SER via ?	Spain	?	F*,G*
1053	Talk Sport via ?	UK	?	F*,G,I,K,L,X*
1062	Kalundborg	Denmark	250	F*,G*,J*
1062	R. Uno via ?	Italy	?	F*
1071	Bilbao(EI)	Spain	5	F*
1071	Talk Sport via ?	UK	?	F*
1080	SER via ?	Spain	?	F*,G*
1089	Talk Sport via ?	UK	?	F*,G,I,K,L,X
1098	Nitra(Jarok)	Slovakia	1500	F*,G*
1098	RNE5 via ?	Spain	?	F*
1107	AFN via ?	Germany	10	B*,F*
1107	Talk Sport via ?	UK	?	F*,G
1116	Bari	Italy	150	B*
1125	La Louvieve	Belgium	20	F*,G*,J
1125	Deanovic	Croatia	100	B*
1134	Zadar(Croatian R)	Croatia	600/1200	B*,F*,G*,L*
1143	AFN via ?	Germany	1	F*,G*
1143	COPE via ?	Spain	2	F*
1152	RNE5 via ?	Spain	10	G*
1179	Solvesborg	Sweden	600	B*,F*,G*,I*,L*
1188	Kuurne	Belgium	5	F*,G*,J
1197	Munich(VOA)	Germany	300	F*
1197	Virgin via ?	UK	?	F*,G,I,L
1206	Bordeaux	France	100	F*
1215	Virgin via ?	UK	?	D,F*,G,I,L,X*
1224	Lelystad	Holland	50	F*,G*
1224	COPE via ?	Spain	?	D*
1233	RFE via ?	Czech Rep.	?	F*
1233	Virgin via ?	UK	?	D,F*,I,L
1242	Virgin via ?	UK	?	F*,I,X*
1251	Mercali	Hungary	500	F*
1251	Huisberg	Netherlands	10	F*,G*
1260	SER via ?	Spain	?	F*
1260	Guildford (V)	UK	0.5	D
1269	Neumunster(DLF)	Germany	600	D*,F*,G*,I*,L*,X*
1278	Dublin/Cork(RTE2)	Eire	10	C,D*,F*,G*,I,L,X*
1287	RFE via ?	Czech Rep.	?	F*,G*,L*
1287	Lerida(SER)	Spain	10	D*
1296	Vancouver(COPE)	Spain	10	D

Note: Entries marked * were logged during darkness. All other entries were logged during daylight or at dawn/dusk.

- Listeners:**
- (A) Bernard Curtis, while near Aberystwyth.
 - (B) Simon Hockenhill, E. Bristol.
 - (C) Simon Hockenhill, while in Minsterworth, Glos.
 - (D) Sheila Hughes, Morden.
 - (E) Rhoderick Illman, Oxted.
 - (F) Eddie McKeown, Newry.
 - (G) George Millmore, Wootton lo W.
 - (H) Clare Pinder, while in Appleby.
 - (I) Tom Smyth, Co. Fermanagh.
 - (J) Phil Townsend, E. London.
 - (K) Bruce Watt, W. London.
 - (L) Fred Wilmshurst, Northampton.
 - (X) Anthony Johnson, Livingston, W. Lothian

■ Greg Baker, PO BOX 3307, MANUKA, ACT 2603, AUSTRALIA

■ E-MAIL: greg@pcug.org.au

Bandscan Australia

As I reported in my last column, I toured parts of the United Kingdom in May and June. It was a very pleasant experience making the long plane trip worthwhile. I was pleased to catch up with Kevin and Zoë at the SWM offices in Broadstone and with long time correspondent Martyn Gardiner in Portsmouth. They helped to make my stay a memorable one.

In my absence from Australia there have been things happening on the broadcasting front including news from the Cox Peninsula short wave transmission site near Darwin and the collapse of a deal designed to increase income for the Australian Broadcasting Corporation (ABC). For the Internet connected I have a few web sites to visit.

Radio Australia

As I have reported here before, the Australian government has been trying for some time to sell off what used to be the Radio Australia (RA) Cox Peninsula transmission facilities. Well the long search is over with the government intent on selling the facility to Christian Vision, reported here as a British fundamentalist Christian group.

Christian Vision will use the facility to broadcast its message across Indonesia, China and India. Christian Vision appears to be bankrolled by British businessman Bob Edmiston and can be found on the Internet at <http://www.christian-vision.org>

The government has not disclosed the sale price, but it seems that they are selling a ten year lease to the Christian broadcaster. It is a sensitive time for Christian - Muslim relations in Indonesia and many see the government's decision as being unnecessarily insensitive and inflammatory.

Commentators believe that this is virtually the end of RA in much of Asia but Christian Vision has indicated a willingness to negotiate use of the facility with RA. The government has been strangely silent on the issue but the federal Labour Party opposition leader has been reported as saying that in government he would seek to regain control of the Cox Peninsula site for RA.

Restrictions

The government has been ruffling other feathers too with a bill before parliament which gives the Minister for Foreign Affairs the right to restrict the broadcast into Asia by Australian-based international broadcasters of radio or television programs considered to be against the national interest. This move has been slammed in Thailand where a major newspaper has accused the Australian government of hypocrisy over the issue; Australia has been critical in the past of press controls throughout Asia.

The proposals to deal with international broadcasters operating out of Australia was so controversial that the government was forced to put this legislation into a separate bill. This bill has yet to pass parliament and may be held up further as the Australian Democrats - the political party holding the balance of power in the Senate, the parliament's upper house - push for regulations to force the new leases of the Cox Peninsula facility to accommodate several hours per day for RA.

ABC & Telstra

I reported last time that the ABC and Telstra were working on a multi-million dollar deal to sell ABC news content to Telstra for use through the telecommunications company's Internet site. The ABC does not broadcast advertising material or - in theory at least - endorse commercial products or enterprises. There was considerable public and media concern that the ABC would be seen as endorsing Telstra and be sitting alongside possible advertising material on the Telstra site.

Another concern was that Telstra might have a say in

the program mix at the ABC. The deal finally fell through, not over principles, however, but over the amount of content the ABC was willing to provide for the money and over the costs to the ABC of servicing the deal. Readers will notice that the ABC icon has now disappeared from the Telstra home page at <http://www.telstra.com.au/>

Internet Sites

The Australian Parliamentary Library has prepared a number of what it calls E-briefs to give background to current issues and to provide links to further Internet resources. These include an E-brief on digital television and datacasting at <http://www.aph.gov.au/library/intguide/SP/digtv.htm> and on the telecommunications universal service obligation at <http://www.aph.gov.au/library/intguide/SP/uso.htm>

For the legal-minded they have discussions of impending legislation - on, among other things - broadcasting bills currently before parliament. One of interest is the bill giving the authorities some control over foreign broadcasters operating from Australian soil mentioned above. The discussion on that bill is at <http://www.aph.gov.au/library/pubs/bd/1999-2000/2000BD121.htm>

Sydney 2000

I reported last time the right of television and radio stations to record or broadcast any material in the six Olympic Live sites of the 2000 Sydney Olympic Games will be restricted. Details now revealed show that eight broadcasters per day will be selected from a roster to film in public areas of the Games venue.

Two issues have now arisen. One is that there is serious concern that these restrictions contravene Australia's obligations under international trade agreements. The other is that the United States broadcaster NBC which has paid \$A715 million (275 million) for the right to broadcast Sydney 2000 events, will delay its telecast to coincide with US prime time.

The difficulty here is, of course, that NBC could be pipped at the post by other broadcasters doing live interviews with medal winners before NBC has broadcast an event. No doubt this will all be resolved before 15 September when the Games open, but I wonder how the Games organisers expect to keep broadcasters out of public areas.

Communications Authority

Still on the subject of the Sydney 2000 Olympic Games, in line with its role the Australian Communications Authority (ACA) has been tasked with advising and managing many of the facets of communications during the Games. These include advising visiting people and companies what Australian standards and requirements are for communications devices and advising the Sydney Organising Committee for the Olympic Games (SOCOG) about their own communications needs and the way that all communications can be made to function throughout the myriad of sites and venues in Sydney and elsewhere. Information on this ACA role is at <http://www.aca.gov.au/sydney2000>



Other News

RA has begun to provide content in the compressed MP3 computer format to CBS Taiwan which transmits the RA Asia-Pacific program to Taiwan and China. It is reported that the content is provided free of charge in the interests of RA being heard in that region.

The BBC is now the best known broadcaster in Indonesia, a position which has been held by RA for many years. According to a BBC study, the BBC reaches 6.2 million people in Indonesia compared to RA's 2.4 million.

In this year's federal government budget the ABC has been given funding for hardware upgrades needed for the introduction of digital television but missed out on funding vitally needed for programming in the digital era. There have been some doubts about the transmissions RA makes from leased transmitters in Taiwan. Temporary leases to broadcast two hours per day are about due to run out and the ABC claims it has no money with which to renew the lease.

I welcome any news and comments. In particular I am interested in any s.w.l. information on Australian stations heard by SWM readers so I can chase up more details and interesting snippets from this end. My address is PO Box 3307, Manuka, ACT 2603, Australia. For personal replies please send two IRCs. Those with an Internet connection can get me at greg@pcug.org.au or gregbaker@hotmail.com

Receiving Inmarsat

Just why would you want to? Editor Kevin Nice explains why you might want to point an antenna at one of the Inmarsat birds.

There's been a lot of talk about the demise of h.f. for utility listening, though just at the probable peak of the sunspot cycle 23 it's not the time to be pessimistic about short wave signals and stations. As *SWM* regular readers will be well aware we have good coverage of geostationary spacecraft that beam signals earth bound, both broadcast satellites and remote imaging types (WXSATS). There is another type of satellite that can provide a great deal of interesting monitoring for the keen enthusiast. The object, or to be correct, the objects to which I refer are the Inmarsat constellation.

A brief glimpse of Inmarsat services was covered in the article 'Genius or Magician' featured in *SWM* 1997 page 25. That feature is mainly about Arthur C. Clarke and his vision of geostationary communications satellites.

This one is a preparatory one to allow the monitoring of the part of the results of Clarke's wonderful ideas.

What Is Inmarsat

Standing for International Maritime Satellite, the Inmarsat system of satellites has been providing a means to allow communication to and from anywhere on the surface of our planet for over 20 years. Originally aimed at the maritime user, there are terminals fitted to most

ocean going vessels. However, the system is not limited to maritime use, indeed the growth area of Inmarsat's business is in non-maritime users such as business people, news gathering organisations, travellers and aid agencies.

There are four satellites in a geostationary orbit, this

number achieves the objective of having two acquirable satellites available in most places on the planet's surface.

The satellite designations are AOR-W, AOR-E, IOR and POR, from my location here on the south coast of the UK all but POR are receivable. The area of intended

coverage are as follows:

AOR-W West Atlantic Region, this satellite covers most of the northern and southern American continent plus most of Europe. Carried is much clear speech traffic 24 hours a day. AOR-W is located at 54°W and elevated 12° above my horizon.

AOR-E The East Atlantic Region satellite covers part of North America, South America, Europe, the Middle East and Africa. It carries lots of clear speech in many languages due to its coverage area. Point your antenna at 15.5°W and 28° elevation for this one.

IOR-E India Region coverage along with Europe, Africa, Russia, Far East and Western Australia. You can hear a great deal of interesting traffic most of which is in English language. Located at 64.5°E some 7° of elevation required.

POR is the Pacific Region satellite this one covers Japan, Australia and the west coast of the northern American continent. No good from the UK though.

How it Works

Inmarsat is a full duplex two way system that links an Inmarsat earth station and a ship or portable ground station with two way connections via the Inmarsat satellites (AOR-E and AOR-W, IOR, POR). Each direction of transmission involves different radio frequencies up and down to the satellite.

In the direction toward the ship the LES (ground station) radiates a signal upward to the satellite at 6GHz and the satellite repeats the signal downward to the ship at 1535-1542MHz (L-band). It is this signal that most hobbyists listen to and it carries the shore end of the conversation it's usually the land-line connection and the person on land doing the talking or FAXing.

In the direction from the ship to the shore, the ship transmits a signal upward to the satellite at 1636.5-1643.5MHz (also L-band) and the satellite repeats this signal at 3.600-3.620GHz (C-band). Few hobbyists listen to this satellite to LES signal, but it is possible to receive it with a suitable PLL type C-band LNB and a circular polarisation feed on a reasonable sized C-band dish (2.5m or more). This side carries the shipboard party doing the talking or FAXing.

In order to reliably hear the full conversation, it is actually necessary to copy both directions, though sometimes echo from the shore end will allow copying of some of the ship board party. The two signals are paired - for each L-band 1535MHz down link channel there is a direct equivalent 1636.5MHz up link and 3.600GHz down link for the other direction. So traffic on the C-band side is the ship to shore direction, and on the L-band side is the shore to ship direction.

They are not independent or unrelated, and in theory for every signal going to a ship on L-band there should be a matching signal coming back on C band. The use of spot beams on the *INMARSAT III* spacecraft and certain other complexities make this pairing a bit more complex, but in principle there is a down link at C-band somewhere for

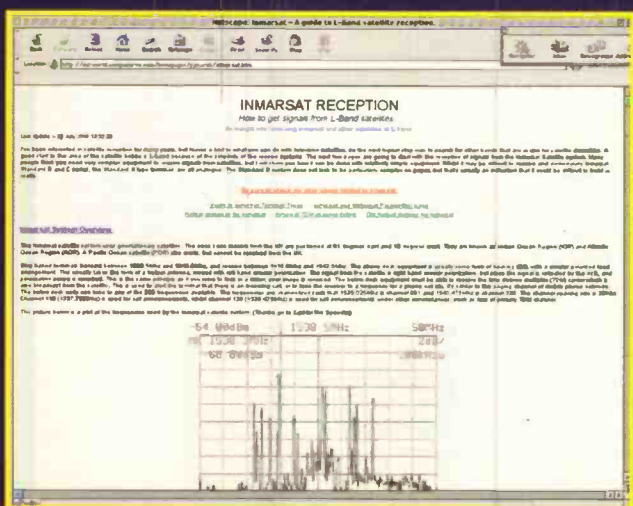

The Internet DIY resources - lots of useful information on these pages.

number achieves the objective of having two acquirable satellites available in most places on the planet's surface. The satellite designations are AOR-W, AOR-E, IOR and POR, from my location here on the south coast of the UK all but POR are receivable. The area of intended coverage are as follows:

The SX-117 - A V

Back in the 1960s American products ruled the roost, and there could be no better example of American receivers of this period than one from Hallicrafters - John Wilson G3PCY checks out the SX-117.

I have to start this month by acknowledging a moment of sheer silliness in my review of the excellent little HF-350, when I said that the receiver had no provision for high impedance antenna inputs. It was only when I turned the receiver round again to restore the switch for the voltage feed to an active antenna that I saw that below the SO-239 coaxial antenna connector there was indeed a two terminal input for 500Ω antennas. I can't understand what made me miss them, nor indeed how Lowe Electronics missed the error when the draft review was submitted for comment before going to press. Praise the Lord and pass the Alzheimer pills Gladys.

Having introduced you all to the delights of new (Collins 955-1) and old (AR88D) receivers in recent months, and having mentioned my dusting off a Hallicrafters SX-117, the Editor suggested that I pitch my next offering in the middle of the 1960s when American products ruled the roost, and there could be no better example of American receivers of this period than one from Hallicrafters. I'm sorry if your particular interest is in the latest whizzo multi-band scanner, but from the mail received here it seems that *Short Wave Magazine* has a large number of readers who enjoy the listening hobby between 10kHz and 30MHz and appreciate the analysis I try to give on the kind of older receivers many of them are still using to great effect.

Although my last nostalgic review was of an RCA product, there is little doubt that the mid 20th century hobby receiver market was dominated by three names; Collins, Hammarlund and Hallicrafters. I haven't ignored other firms such as National; its just that as far as the UK was concerned, these three were the most prominent.

Adding An X

Hallicrafters was founded by Bill Halligan before the Second World War, and the first receiver to carry what was to become a familiar series of type numbers was the S-1 Skyrider of 1934. The Hallicrafters receivers started to wear an even more recognisable name by 1936 when the inclusion of a crystal filter in their receivers was shown by adding an X to the type number, for example the SX-24 and SX-28.

Many newcomers to post war radio managed to get hold of an SX-28, by now known as a Super Skyrider, as a result of them coming on to the Government surplus market. I last saw a really nice example of an SX-28 in the showroom of the

Gramophone Man in Wellington only a few weeks ago. My fingers were hovering over my cheque book when I saw what superb condition it was in, but I managed to resist long enough to leave the shop (but I left carrying a Collins 75A-1 which will appear in these pages in the future).

I don't intend to make this a history of Hallicrafters because I don't know the whole story and in any case the subject is covered in books by authors such as Raymond Moore, so I'll just give a brief run down on the technical changes which occurred in the 1945 to 1960 period.

Technical Changes

Until the late 1940s, American receiver design was pretty much settled on the single conversion superheterodyne configuration with an i.f. of 455kHz and a fully tunable local oscillator. The general coverage receivers often used a main dial to cover the h.f. spectrum in about four ranges with a separate bandspread dial driving a low value variable capacitor for the broadcast and/or the radio amateur bands.

This design carried on for some years and in the case of Hallicrafters it was not until the appearance of the SX-101 between 1956 and 1958 that the idea of an amateur band only receiver came into being. Even then the conversion oscillator for tuning the receiver was a free running design with, in the case of the SX-101, seven bands with tuning ranges limited to the relatively narrow amateur bands of the day.

Using a tunable first conversion oscillator carries with it several disadvantages, amongst them being different tuning rates on each band and hence different dial calibration; instability caused by having a mechanical bandswitch involved in each tuning range; seriously non-linear dial calibration and last but not least, difficulty in achieving and retaining correct dial calibration and tracking from one end of a band to the other.

The black art of three point tracking is now lost to most of us, but I believe that anyone who got something like an SX-101 into proper end to end alignment on all bands would find the star of Bethlehem shining over his work bench and three wise men knocking on the door to congratulate him on a miracle.

Better Design

The SX-101 was the last of the heavier if better designs to come from Hallicrafters, but the tunable conversion oscillator carried on until 1961/2 when the SX-111 and SX-112 represented the final models to use the technique. However, at least in the later receivers up to and including the SX-111 and 112, Hallicrafters had begun to use double conversion superhet design with intermediate frequencies of 1650 and 50kHz, receiver selectivity being defined by L/C filtering at the final 50kHz i.f. These frequencies were carried on into the next, sadly short-lived generation of receivers represented by the triple conversion, tunable i.f., SX-115 and SX-117. There you are, I finally got to the point.

The SX-115 and 117 were proof that someone at Hallicrafters had finally realised that the concept of having a tunable i.f. in a receiver preceded by a crystal controlled



SX-117 and passive pre-selector.

Well Kept Secret



conversion oscillator for each band provided the answer to many of the problems which beset the tunable oscillator approach; constant and repeatable dial calibration for every band; good spectral purity which made for

quiet receivers; simplicity of oscillator design since the tunable oscillator had only a single range to cover, with no band switching involved.

The irony of this late flowering of design was that Art Collins had introduced the tunable i.f. system in his first 75A receiver in 1946, in fact, the concept was often referred to as the Collins Conversion System. Its just that no one seemed to take any notice of Collins until 1960 (apart from Drake in 1957 with the 1-A receiver), by which time it was too late for survival. Hammarlund, as far as I know, never even tried to build a tunable i.f. receiver, soldering on with the old conversion methods until the company disappeared.

Collection Of Landmarks

And so to the SX-117, which is the second one I have owned in my hobby lifetime so I know that the performance of it is representative of the breed. If you take a look at the Collins S-line equipment, you will immediately see that Hallicrafters must have attempted to make the SX-117 look like it. The same front panel proportions, the same perforated wrap-round cabinet, even the same panel and case colours.

From the two-man lift weight of an SX-28 to the tuck it under your arm of an SX-117 represents the end of one era and the start of something new. New it was, but it was virtually the last receiver of the SX series, and there was nothing before or after the SX-117 which looked or performed like it. That's why its in my collection of landmarks.

Incidentally, Hallicrafters were not alone in copying the external design from Collins. Take a look at the British

produced KW 2000 series of equipment to see what I mean. Even better, compare the circuit of the KW 2000 with that of the Collins KWM-2. You will find very little difference.

Classic Collins

The SX 117 receiver architecture is classic Collins, starting off with a single 6DC6 r.f. amplifier ahead of the first mixer using a 6EA8 where the incoming signals are mixed with the output from a 12AT7 crystal oscillator using the Butler configuration. Spectral purity of a crystal is, as you all know by now, extremely good indeed, and the phase noise performance of the Butler oscillator is outstanding.

The following tunable i.f. covers 6 to 6.5MHz, which means that the first crystal oscillator operates at 6.5MHz above the lower received frequency. Keeping the oscillator higher than the signal means that the main tuning dial always tunes in the same direction, although with a 500kHz total tuning range on the dial there have to be two sets of numbers, one reading 0 to 500 and the other 500 to 1000.

The actual dial calibration is basic, and in no way compares with the excellent 1kHz readout of contemporary Collins receivers, but it was a great deal better than previous offerings from Hallicrafters, and when I used the SX-117 in West Africa where my previous receiver had been a GEC BRT-400, I couldn't believe how wonderful it was to actually know (more or less) what frequency I was operating on.

The second i.f. was 1650kHz as used already by Hallicrafters, with conversion down to the final i.f. of 50kHz by switched crystal oscillator frequencies of 1600 and 1700kHz. This gave instant and accurate switching from u.s.b. to l.s.b. that again was a revelation in 1962 (unless you were a Collins owner).

Receiver selectivity was determined at 50kHz, and Hallicrafters had developed considerable expertise in providing selectable i.f. bandwidth using critically coupled tuned circuits at these low frequencies. It's worth noting that Drake carried on in this vein, and their latest receivers for the 1990s still use low frequency L/C tuned i.f. filtering to define receiver bandwidth. The 6dB bandwidths of the SX-117 are 500Hz, 2.5 and 5kHz, which provide a nice balance between the needs of amateur and broadcast listeners.

Relative Merit

There is a long standing debate about the relative merits of crystal filters, mechanical filters, L/C filters and d.s.p. when used to determine receiver bandwidth, and most people agree that properly designed L/C filters do sound exceedingly nice (rather like Mr. Kipling's cakes) on speech, whereas mechanical filters can sometimes give a (dare I say it) mechanical edge, and d.s.p. can behave very strangely indeed on a.m. broadcast signals.

The sides of the i.f. filter passband in the SX-117 are steep, but not vertical, and as a result of this the recovered audio in any mode sounds particularly pleasant, see Fig. 1.

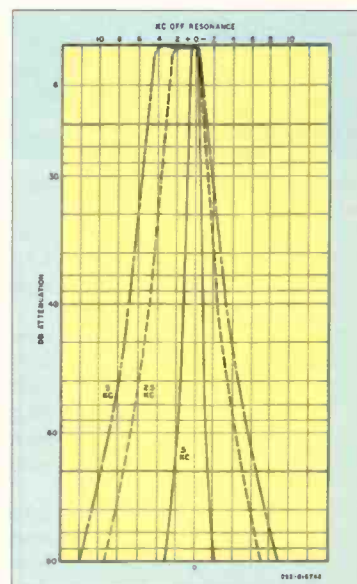

Fig. 1: The SX-117 i.f. selectivity curves.

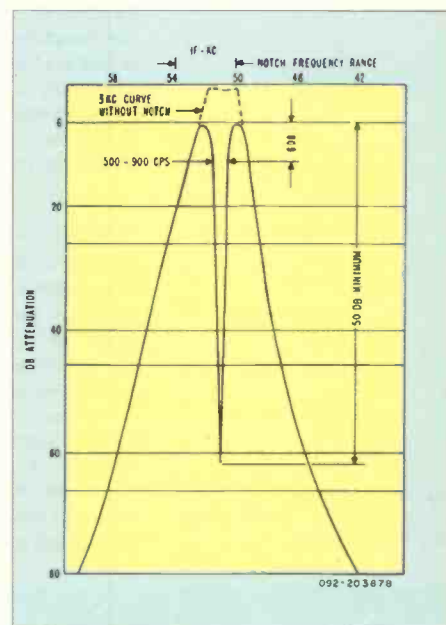
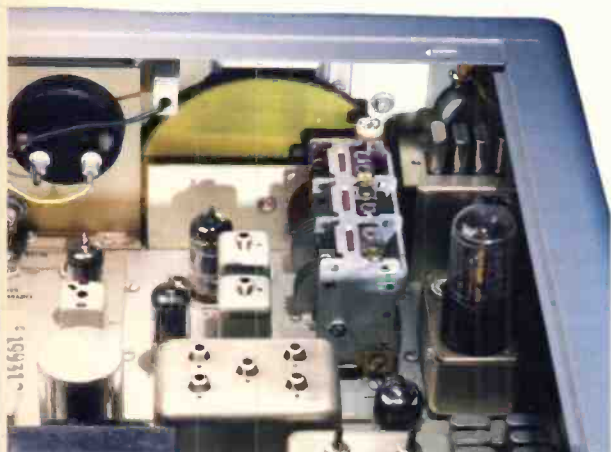
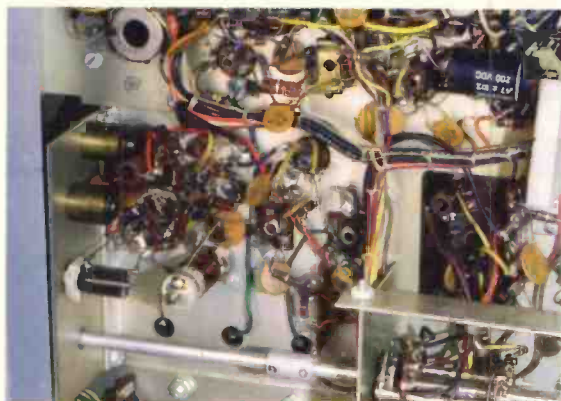

Fig. 2: Tunable notch characteristics.





Point to point wiring under the chassis.

see Fig. 2. Final demodulation is carried out using a tunable, rather than crystal controlled oscillator, and this makes the SX-117 a good c.w. receiver since you can set the b.f.o. to any frequency offset on either side of the received signal, c.w. listeners will know how useful that can be.

Audio output? Well it has to be a decent sized valve running in Class A with a solid output transformer and negative feedback to the cathode of the first audio stage; result? Smooth and mellow as always with valve output stages.

Incidentally, anyone who reads *Electronic and Wireless World* will have seen an article in a recent issue which debunks the whole idea of using THD (total harmonic distortion) measurements to define the performance of audio amplifiers, and proposes the wider acceptance of intermodulation measurements as used at r.f. Contained in the same article is a comment on 'Valve Sound' which gives very persuasive reasons for (a) its existence, and (b) its pleasant acceptance by the human ear. Just listen to an AR88 to know what it all means.

Frequencies Covered

There are undoubtedly things about the SX-117 that betray its age, apart from the fact that it gets warm and glows in the dark. It was sold as an amateur band receiver with conversion crystals for 80, 40, 20, 15 and one segment of the 10m amateur bands. Top band did not come into the frame, obviously.

However, the r.f. preselector will cover all frequencies from 3 to 30MHz, so by plugging in the appropriate first crystal you can obtain any 500kHz segment within the overall 3 to 30MHz range. Hallicrafters thoughtfully provided a separate bank of four crystal holders for this purpose, but you would need an awful lot of accessory

crystals to get from 3 to 30MHz continuously.

For frequencies below 3MHz and down to 85kHz, there was a separate outboard preselector called the HA-10, and therefore for medium wave use you could plug in a conversion crystal of 7MHz and tune 500kHz to 1MHz, or a 6.5MHz crystal to go down from 500 to 85kHz. Hallicrafters were a bit wary about converting from 6 to 6.5MHz r.f. signals to a tunable i.f. of 6 to 6.5MHz, so the tuning range from 5.5 to 7MHz is carefully ignored in the handbook table

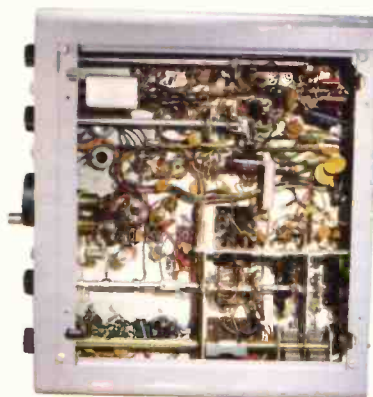
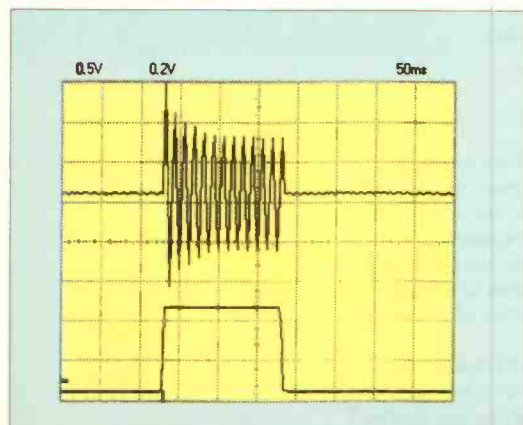

Fig. 3: Hallicrafters SX-117 a.g.c. response, -103dBm to -53dBm, 50ms/div.



Perhaps you would only notice the sloping shoulders in a 40m CQ WW DX contest, but for most purposes there is nothing old fashioned about the SX-117 (I can scarcely believe that its 40 years old).

Another nice feature of the 50kHz i.f. is that a tunable notch filter has been included, and this is so smooth and effective that it can be used all the time without punching phasey holes in the received signal,

showing the conversion crystal frequencies.

There is also a handbook mention of the 1.6, 1.65 and 1.7MHz frequencies as ones to avoid, presumably because of second i.f. breakthrough and the risk of beating occurring between the incoming signal and the two conversion oscillators. Apart from these obvious frequencies there seem to be no others which could cause trouble, and I certainly didn't find any signals when testing the SX-117, although I only had the amateur band crystals fitted and wasn't able to go all the way from 85kHz to 30MHz.

Too Quiet?

Connecting an antenna and switching on was not quite like the feeling given by the AR88 but waiting for the warm-up certainly was. The drift performance was very good for the period, with the handbook quoting Better than 300 c.p.s. (Hz) after warm-up, but no idea of how long this should take. I let it settle down for about ten minutes before tuning around.

The eerily quiet quotation from that early review was so apt that I began to feel that the receiver was perhaps **too** quiet, but signals appeared out of

nowhere and sounded beautifully clean and clear. However, when listening to 80m s.s.b. nets containing signals of all strengths I noticed that the audio had to be turned up to get a decent listening level on weak signals, and if they were followed by a strong signal the audio blew my head off.

Clearly the a.g.c. system was not working too well, and investigation of the circuit showed that the a.g.c. detector had a threshold voltage applied to it of 30Vd.c. derived from the 160Vd.c. h.t. supply. Even in a valve receiver with a high gain i.f. system the idea that the i.f. signal had to reach 30V before it developed any a.g.c. was a bit silly, and I remembered at this point that I had

written to Hallicrafters from 5N2 land back in 1964 to query some of the performance figures and I still have their reply listing a whole series of small modifications (Never, never dispose of technical information) which included a mod. to the a.g.c. threshold potential divider to bring the threshold voltage down to 5V. So it was stop the tuning and get modifying to bring my SX-117 up to the later specification, including amongst other things a change to the first mixer from pentode to triode operation.

What a pleasure it was to get inside a classic American receiver of this period, and I reflected a little on the fact that Hallicrafters assumed that anyone who owned an SX-117 at the time was probably competent to carry out the modifications without any further assistance than a circuit. Is it still true?

Delight To Use

Back to the tuning around; did the mods make any difference? Certainly the a.g.c. performance was improved, but the receiver still felt too quiet, although this was indeed how I remembered it from all those years ago. Incidentally, just who did buy my first SX-117 after I traded it in to Bill Lowe in exchange for an NCX-5 transceiver? If your SX-117 has a custom made slatted wooden transit box with foam lining, then it was mine.

Apart from the lack of dial calibration to the standard we have all come to accept as normal, the SX-117 was a delight to use, and comparing it side by side with modern offerings didn't make me want to change over. True, there are no fancy memory facilities, no synchronous a.m., no general coverage unless you had a bunch of accessory crystals, but neither was there the gritty unpleasant audio so often delivered by single chip output stages nor any funny noises from the a.g.c. system, nor any low level

Continued on page 22...

HAYDON

COMMUNICATIONS



NEXT DAY DELIVERY TO MOST AREAS, £10.00.



MAIL ORDER: 01708 862524

QUALITY USED EQUIPMENT



**ICOM
RC-R72**

Immaculate condition. **£299.95**

- Yaesu FRG-100 Immaculate£299.95
- HF-225 Incls FM/AM synch, battery pack/keypad£249.95
- HF-150 VGC£199.95
- Target HF-3 As new£89.95
- DX-394 Immaculate£109.95
- Sony SW-100E As new£99.95
- Garmin GPSIII As new£199.95
- Garmin GPSIII + As new£289.95
- MFJ-784B DSP filter£119.95
- VC-20 VHF converter for R-5000£79.95



**REALISTIC
PRO-2042**

As new. **£149.95**

- AR5000 State of art receiver£999.00
- IC-8500 Immaculate condition£999.00
- IC-R7100 As new£599.00
- IC-R7000 VGC£399.95
- PCR-1000 As new£199.95
- PCR-100 As new£149.95
- Winradio WR-1500E As new£99.95
- BC-9000XLT VGC£189.95
- AR3000A VGC£499.95
- MVT-8000 As new£199.95



**YUPITERU
MVT-9000**

As new. **£249.95**

- MVT-7100 As new£149.95
- MVT-3300 As new£99.95
- AR8000 As new£189.95
- Comtel 216 25-1300MHz£129.95
- Comtel 214 VGC Frequency 66-990 with gaps£99.95
- IC-R10 As new£229.95
- AR8200 As new£299.95
- IC-R2 As new£109.95
- MVT-7000 VGC£129.95
- DJ-X10 As new£199.95

THE SHORT WAVE ACCESSORIES SPECIALIST



**Q-TEK WIRE
CYCLOPSE**

Your eye-in-the-sky. The ultimate short wave receiving antenna.

Doesn't your short wave receiver deserve something better than just a simple long wire? Well, here it is - the wire Cyclops. A unique ready to go antenna system that works from 0-30MHz. The antenna is centre fed with coax (supplied) and incorporates six tuned coils for optimum reception. The system also incorporates an anti-interference balun and comes ready assembled for immediate use. At only 15.5mtrs (51ft) long it will certainly fit most gardens. (Mounts horizontally down garden). Includes 20m coax lead and PL-259plugs.

INTRO PRICE **£59.95** P&P £8.50



**Q-TEK APOLLO
2000MKII**

A brilliant new compact indoor antenna that covers 0-1650MHz and is just 20" tall (collapsed). Supplied with coax and BNC plug fitted.

ONLY **£49.95** P&P £5

**RECHARGEABLE
ALKALINE CELLS**

Starter kit includes charger & 4 x AA cells.



£13.99
+ £2.50 P&P.

Please note that only the special cells can be recharged with this charger.

- Extra cells available @
- 8 x AA pack £10.99 £1 P&P Rechargeable Alkaline. No memory effects. 1.5V cells
- 4 x AA pack £5.99 £1 P&P 3 x capacity of nicads.
- 4 x AAA £6.25 £1 P&P NO QUIBBLE WARRANTY



**THE VERTICAL
CYCLOPSE**

This new short wave listeners antenna was initially made specifically for one of our commercial customers but we felt the general public would find it of great interest. At only just over 7 feet high this vertical short wave receiving antenna will give amazing results from 0.2-30MHz and thanks to its commercial construction you simply erect it and away you go. Length 7'6". Coax supplied: 20m and PL-259 plugs. SSP £129.00.

INTRO PRICE **£69.95** P&P £8.50



AIR-44

(Airband base)
Prof quality base antenna for AIRBAND. (Civil & military). With SO-239 fitting (1.7m long).
Gain 4.5/7dB.

£69.95 P&P £8.50

AIR-33 (As above) 1m long. Gain 3/6dB.
£44.95 P&P £5

GLOBAL AT-2000

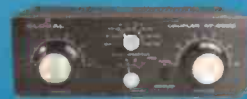

Deluxe SW ATU
0-30MHz.
SO239 fittings.

ONLY **£85.00**
P&P £5

(Probably the best ATU around)



Q-TEK D.C. 2000

A high performance wideband discone offering superb performance from 25-2000MHz. Transmit range:- 6m, 2m, 70cm, 32cm & 23cm (power handling 200W). Fitted with low loss 'N' type connector. Supplied with mounting brackets.

OUR PRICE **£54.95** P&P £8.50

Comments from John Griffiths
Putting the DC-2000 up gave me a tremendous boost to all signals with the ancient AR-2000 coming alive! Signals were well received and I found that I wandered out of airband - my usual haunt - into all manner of areas that previously have been less than good here due to my location!

REGULAR-GAINER RH-770

BNC 21cm flexible whip that is ideal as replacement

OUR PRICE **£14.95** P&P £1.50

SUPER-GAINER RH-9000

BNC 40cm flexible model for the ultimate in gain.

OUR PRICE **£19.95** P&P £1.50



**SCANMASTER
SP-55**

Boost reception of your scanner with this pre-amp. 25-1500MHz, variable gain, band pass filters. (Up to 20dB gain). £69.95

SPECIAL OFFER

£49.95
P&P £3.50

OUR BEST
SELLER

HAYDON

COMMUNICATIONS

MAIL ORDER: 01708 862524



NEXT DAY DELIVERY TO MOST AREAS, £10.00.

SONY SW-30



The ideal holiday partner! ★ Fully digital world receiver ★ FM/MW/SW ★ Covers all short wave broadcast/medium wave plus FM stereo (on headphones) ★ Programmable

- memories ★ Digital local + world clock
- ★ Sleep timer + alarm function
- ★ 1kHz tuning for short wave ★ Auto scan ★ Short wave guide book included. RRP £79.95.

HALF PRICE **£39.95**
P&P £7.00

Once they've gone they've gone

SONY SW-100E



- ★ Miniature portable all mode SW receiver
- ★ Station presets for 50 frequencies ★ Single side band system
- ★ Synchronous detector
- ★ Tuning in 100Hz + 1kHz steps ★ Includes compact antenna/stereo earphones/carrying case RRP £229.95.

SPECIAL OFFER **£129.95**
P&P £10

SANGEAN ATS-813 ACS



- ★ Portable SW receiver with built-in cassette deck ★ 54 memory presets ★ Continuous coverage 150kHz-30MHz (all mode) ★ SW tuning in 1kHz steps ★ FM coverage 87.5-108MHz.

SPECIAL OFFER **£139.95**
P&P £10

SANGEAN ATS-909

A superb performance portable/base synthesized world receiver with true SSB and 40Hz tuning for ultra clean reception. The same radio is sold under the Roberts name at nearly twice the price. Other features include RDS facility, 306 memories and FM stereo through headphones. The ATS-909 represents superb value for money.



ONLY **£129.95** P&P £10

Optional deluxe stereo/mono headphones for short wave portablesonly £7.99 P&P £2

ICOM IC-8500



"Next generation" technology brings you super wide band, all mode

coverage from 0.1 to 2GHz. It's a professional quality communications receiver with versatile features from high speed scanning to computer control. The IC-8500 covers a wide frequency range continuously from 0.1 to 2000MHz with 10Hz resolution while maintaining a high receive sensitivity. (Includes PSU).

SALE PRICE **£1199.95**

FAIRHAVEN RD-500VX+



0-1750MHz, all mode, fully featured. We have had this unit independently tested & compared to other radios priced at around £1500 and in our opinion this is the best there is. Incl's optional PC control kit. Buy yours before the price increases. New RRP ~~£899.00~~

OUR PRICE **£799.00**

REALISTIC DX-394



- ★ Superb performance SW receiver
- ★ 0.2-30MHz (all mode)
- ★ Selectable tuning steps (down to 100Hz)

Was £199.00
SPECIAL OFFER **£149.95**

- ★ 240 or 12V
- ★ Digital S-meter
- ★ Attenuator
- ★ Key pad entry
- ★ 160 memories
- ★ Clock/timer ★ Noise blanker
- ★ Limit scan ★ Tape output

COMMTEL COM-225



This scanner covers the full frequency range 25-1300MHz. (AM/FM/WFM). It is controlled by a specially designed

micro processor, which offers many additional convenient functions. It has 500 channels that can be loaded into 10 banks. SSP £299.95.

OUR PRICE **£219.00**

Bearcat UBC-9000XLTour price £219.00

AR5000



The AR-5000 advances the frontiers of performance providing excellent strong signal handling, high sensitivity and wide band coverage. Covers 10kHz-2600MHz.

THE PROFESSIONALS CHOICE SPECIAL OFFER **£1299.95**

AR5000 + 3 Special offer£15.29
AR3000A Special offer£679.00
SDU5500 Special offer£799.00

ICOM IC-R75



The short wave receiver for the true enthusiast.
● 0.03-60MHz (all mode).

- Synchronous AM detection
- PC control capability

Buy one this month and we'll give you a free DSP unit & power supply worth over £100.00

★★★★ WRTH gave it 4 star rating

OUR PRICE **£625.00**

YAESU FRG-100



This is a high performance communications receiver providing general coverage

reception in CW, SSB, AM and FM modes from 50kHz- 30MHz. Micro processor control of major functions permit ease of operation and features that both new and seasoned short wave listeners will appreciate, at an affordable price.

ONLY **£349.95**

(Optional FM unit £35.00)

ICOM PCR-1000



Bring another world to your computer. The PCR-1000 connects externally to your computer and offers exceptional receiver performance. 0.5-1300MHz (all mode). Includes SSB. £349.00.

Amazing front end performance

UK's LOWEST PRICE **£269.00**

UT-106 Optional DSP unit£79.95

SHOWROOM & MAIL ORDER:

Unit 1, Thurrock Commercial Park,
Purfleet Industrial Estate, London Rd,
Nr. Aveley, Essex RM15 4YD
TEL: 01708 862524
FAX: 01708 868441
Open Mon - Fri 8am - 4.30pm.
Sat 8am - 1.00pm

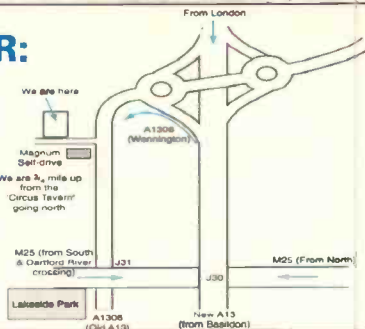

W. MIDLANDS SHOWROOM

Unit 1, Canal View Ind. Est.,
Brettel Lane,
Brierley Hill
W. Mids. DY5 3LQ
Open Mon-Fri 9.30-5pm.
Sat 9.30-2pm
NO MAIL ORDER TO
MIDLANDS BRANCH



AR8200 SERIES-2

Never before has one hand portable offered so much.
★ Covers 530kHz-2040MHz (all mode) ★ Computer control capability ★ 8-33kHz steps for the new airband spacing ★ Reaction tune capability ★ Includes

nicads/charger/antenna and car lead.

SPECIAL OFFER £395.00

AR8000 Wideband scanner£249.95
Yaesu VR-500 Wideband scanner£249.00



MVT-7100EU

Wideband hand-held scanner covers 500kHz-1650MHz. (All mode). Includes nicad/car charger/charger/antenna. Extremely user-friendly hand-held receiver with outstanding performance unmatched by its rivals.

SPECIAL OFFER

£199.95

MVT-9000MkII Hand-held scanner£319.95
Soft case for 7100EU/9000 - specify.....£19.99

GARMIN GPS SYSTEMS

STREET PILOT UK



The Street Pilot UK package includes dash mount, 8MB datacard, PC interface cable, 12V adaptor, UK metroguide map source CD.

£549.00

Garmin Street Pilot mono Special offer£419.00

STREET PILOT COLOUR MAP UK



Package includes UK metro guide mapsource CD, 8 megabyte datacard, PC interface cable, cigarette lighter adaptor, portable

antenna + dashboard mount.

SPECIAL OFFER £649.00

Garmin Street Pilot colour£549.00
Carry case for Street Pilot.....£14.99
8 meg-mem + mapsource CD.....£139.95
16 meg-mem + mapsource CD.....£169.95
Mapsource CD£79.95
8 meg data card.....£69.95
16 meg data card.....£99.95



ICOM IC-R2

Miniature wideband hand-held scanner covers 0.5-1300MHz (AM, FM/WFM). Search banks memories and many more features.

£129.00



IC-R10 Wideband scanner£249.95



COMTEL CM-307

Palm sized dedicated airband scanning receiver. Covers airband 108-136.975MHz VHF 136-180MHz with 99 memories (AM/FM).

ONLY

£59.95

Optional batteries + charger £13.99.



MOTOROLA TA-200

★ Typically up to 3Km range dependent upon terrain
★ Large, easy to read LCD screen with user-friendly icons
★ You choose who to talk to and select from 300 channel settings
★ Rugged and stylish design - choose from yellow or blue

★ One button operation - easy for adults and children to use, simply push to talk.

ONLY £69.95 or 2 for £129.00



WATSON HUNTER

Frequency counter covers 10MHz-3GHz. Supplied with telescopic antenna, nicad & charger.

ONLY

£59.95

P&P £5.

Techtoyz micro counter£69.95
Opto Cub frequency counter.....£99.95
Opto Mini Scout 10MHz- 1.4GHz£139.00
Opto Scout (400 memories).....£319.95
Opto CD-100 multicounter£349.95

GPS-12 NAVIGATOR

(now with 24 hour battery life) 12 channel receiver. Includes:- UTM, ordnance survey, waterproof to IPX-7 standard).



SALE PRICE

£129.95

GARMIN GPSIII PLUS



Powered by AA cells or 13.8V, this compact navigational system gives detailed maps of the UK and Europe. Supplied with data

lead and free on-board maps.

SALE PRICE £329.95

Active Magmount antenna Only£39.95
Cigar power lead Only£20.00

GARMIN ETREX SUMMIT



First combination GPS, altimeter and electronic compass in one small box.

SALE PRICE

£189.95

Etrex Special offer£109.95
Emap Special offer£199.95



BA-928

WEATHER CLOCK.

- Weather forecast
- Atmospheric pressure (+ 24 hour history)
- Moon phase
- Wireless outdoor temp sensor
- Time/date/alarm
- Table & wall mount
- Incl's batteries + 1 outdoor sensor

£89.95

P&P £4



BA-888

ELECTRONIC BAROMETER/CLOCK.

- Temp/weather/forecast/pressure barometric trend
- 24hr bargraph
- 12/24hr clock & alarm
- Humidity
- Table/wall mount

£69.95

P&P £4

The SX-117

...continued
from page 18

spurious squeaks caused by synthesiser unwanted products, so on balance, the SX-117 is a fine receiver by any standards.

I carried on to put the receiver through the tests I apply to modern equipment and the SX-

117 turned out much as expected. Sensitivity was -109dBm on 80 and 40m, rising (falling?) to -116dBm on 20m, -112dBm on 15 and back to -107dBm on 10m. Measurement of third order intercept point turned in a dynamic range of 82dB and an IP3 of 3dBm which is rather better than contemporary valve receivers of the 1960s, but the advantage of having a tuned r.f. stage showed in the second order intercept of $+78\text{dBm}$ with a dynamic range of 102dB .

I couldn't use my standard test frequencies of 6.5 and 7MHz for this because the SX-117 didn't tune to 13.5MHz, so instead used 7 and 7.4MHz, resolving the second order product at 14.4MHz. Phase noise was as low as one has come to expect from the Collins conversion system using a crystal oscillator for initial conversion, and better than the HF-350 receiver reviewed last month.

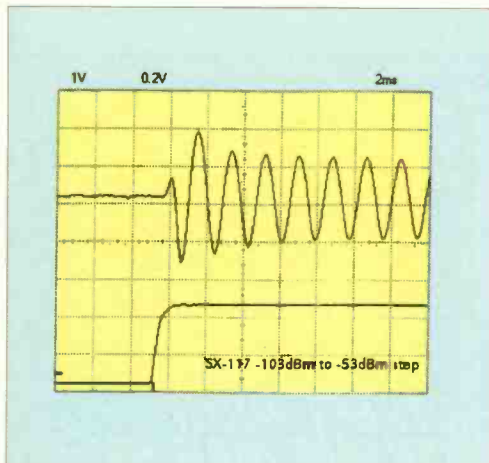
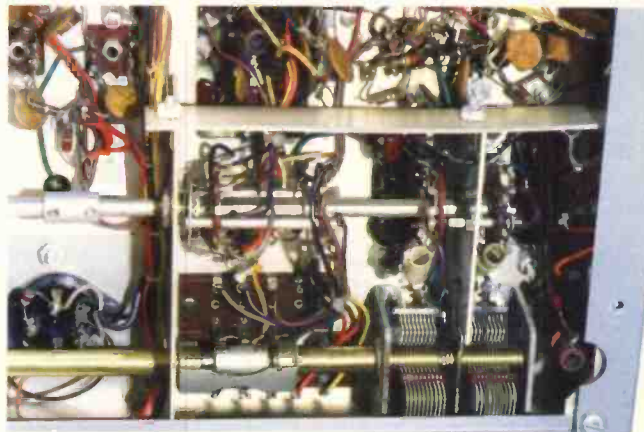

Fig. 4: Hallicrafters SX-117 a.g.c. response, leading edge of r.f. burst 2ms/div.

Audio Response

However, it was when using my a.g.c. test procedure that I began to think about a possible difference between valve and solid-state receivers when it comes to performance under sudden large changes in input signal. I hope to follow this up in a future article but for the moment will refer you to the results in Fig. 3 and Fig. 4 which show the audio response to a 150ms burst of r.f. signal from -103dBm to -53dBm (approximately $S4$ to $S9+20\text{dB}$). You will note that the audio output has higher amplitude at the start of the burst, and this is due to the delay caused by passage of the r.f. through the receiver before any a.g.c. control voltage is developed.

The second illustration is an expansion of the leading edge of the input signal and you can see that the initial audio peak is very well controlled and undistorted even though the receiver is, at that moment, operating at full gain. This is typical of the valve receivers I have so far tested

using this method, but with solid state receivers the results are not at all the same, with the leading edge of the resultant audio often appearing at very high amplitude. More will come in the later article.

One thing which was also apparent from the a.g.c. tests on the SX-117 was that the receiver is definitely short of overall gain, and this is why it has the reputation for being eerily quiet. As I have said, I have experience of two different examples of this receiver and they both seemed to demonstrate the lack of gain.

I am currently looking into this in more detail and if I have the time to follow it up completely I will let you know what I find. What I now need is another working example of the SX-117 (is anyone out there listening who might help?).

Overall Conclusions

The fact that the SX-117 is forty years old does not detract from its very acceptable performance in the 21st Century, and I'm sure that many more receivers of this era will give, and indeed are still giving very good results for their owners. I believe, based on my close involvement with the Japanese manufacturing industry from the late 1960s to date, that the introduction of the first generation of solid state receivers resulted in a giant leap backwards in r.f. performance, and it was only in the early 1990s that solid state hobby equipment began to get back to the levels we had come to accept as normal from the earlier valve designs.

I would just love to line up a series of receivers and transceivers starting with a Yaesu FT-101 and working through, say, a TS-520S, TS-830S, TS-930S and including an NRD-525, Drake R7, etc. and just see how they perform under controlled test conditions. I do have test results from our early days of development with the HF-125 receiver which showed that the Drake R-4C was streets ahead of everything else in the field, but of course I don't need to remind you that the R-4C was a valve receiver...Q.E.D.

For general listeners owning something like the SX-117 should provide all that they need, with r.f. performance which is not likely to be significantly bettered by today's expensive equipment. There are some areas of performance such as audio quality and behaviour under difficult signal conditions in which the older tune receivers can actually be much better than modern equivalents, so if you can do without memory facilities and pinpoint dial accuracy, why not try one or more of these wonderfully satisfying old receivers.

Essential reading on the subject is Raymond S. Moore's *Communications Receivers, The Vacuum Tube Era* which can be obtained from the *Short Wave Magazine Book Store* (see page 50 for a summary - Ed). Prepare to be enchanted, and enjoy your listening, whatever receiver is in front of you.

SWM

Fig. 5: Block diagram of the SX-117.

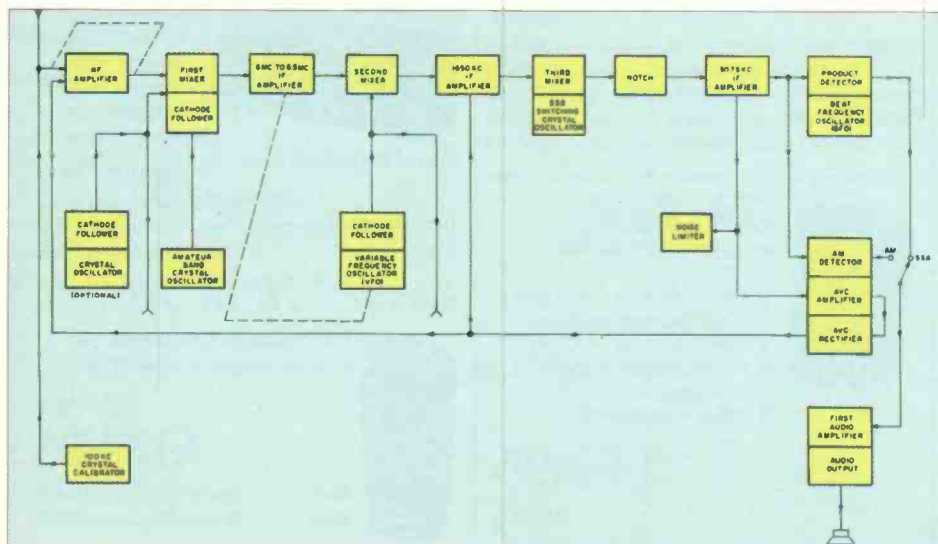

Low Noise Medium Wave & Tropical Band Antennas

Part 2

In the concluding half of this series, Joe Carr K4IPV looks at some more useful antennas for frequencies up to 7.5MHz, just the job if you are a low-band DXer.

Other Approaches To Low-Noise Low-Band Antennas

The small loop antenna is well known to readers, and the Beverage is a bit of a pain in the neck for all but the wealthy (and only those with lots of land). There are, however, other approaches that can be used.

Koontz's EWE Antenna

The EWE antenna (Koontz 1995) emerged recently as one solution to the low-noise low-band antenna problem - see Fig. 2.5 for the basic EWE antenna. It consists of two vertical sections (labelled L1) and a horizontal section (L2). The EWE looks superficially like a Beverage antenna, but it isn't. Like the Beverage it is erected about $L1 = 3m$ above the Earth's surface. Unlike the Beverage, it is only $L2 = 6.5\text{-meters}$ long at 3.5MHz. Those dimensions make it affordable for average folks.

The far end segment is terminated in an 850Ω resistor. This resistor should be a carbon composition or metal film resistor, and never a wire-wound resistor.

The receiver end must be matched to the receiver's 50Ω input impedance. Transformer T1 is provided for this purpose. It has a turns ratio of 3:1 to provide the 9:1 impedance ratio required to match the 450Ω antenna impedance to the 50Ω receiver impedance. A powdered iron toroid core made of -2, -6 or -15 material will be sufficient. A suitable transformer can be made using a T-50-15 (red/white) core. Use about 20-turns of any size enamelled wire.

The azimuth and elevation patterns for the Koontz EWE antenna are shown in Fig. 2.6 and Fig. 2.7. These patterns were simulated from the *Nec-WIN Basic* software available from Nittany-Scientific. The patterns in Fig. 2.6 are based on the Sommerfield-Norton standard ground model, with the azimuth being seen in Fig. 2.6a and the elevation in Fig. 2.6b. The same types of pattern are seen for a "real" ground based on suburban soil are shown in Fig. 2.7a (azimuth) and Fig. 2.7b (elevation).

Reversible EWE

The EWE antenna can be made reversible (Koontz 1995) by using a system such as Fig. 2.5b. The feed point and termination circuits are co-located at the receiver. Transformer T1, coil L1, resistor R1 and d.p.d.t. switch S1 are installed in a shielded metal box. The outputs of the box (i.e. centre terminals of the d.p.d.t. switch) are connected to the bases of the vertical (L1) sections of the EWE antenna. According to Koontz, the simple resistive termination was not sufficient, so he added an inductive reactance in series with a resistance. This is the method used on Beverage antennas to make a steerable null, and that effect is seen on the EWE as well.

Dual EWE Antenna

A modification of the EWE antenna (Koontz 1996) that permits switchable bi-directionality can be seen in Fig. 2.8a. Four EWE antennas are arranged in North-South (N-S) and East-West (E-W) directions. The feed points (A, B, C and D) are connected to a switch circuit such as shown in Fig. 2.8b. The directivity of the antenna is controlled by opening and closing the four switches (S1-S4).

N4PC Loop

Paul Carr N4PC (no relation) designed the horizontal loop shown in Fig. 2.9 (viewed from above). This loop is not a 'small loop' because it is close to quarter wavelength on each side. This antenna is also sometimes called the dual delta design. The 'bases' of the

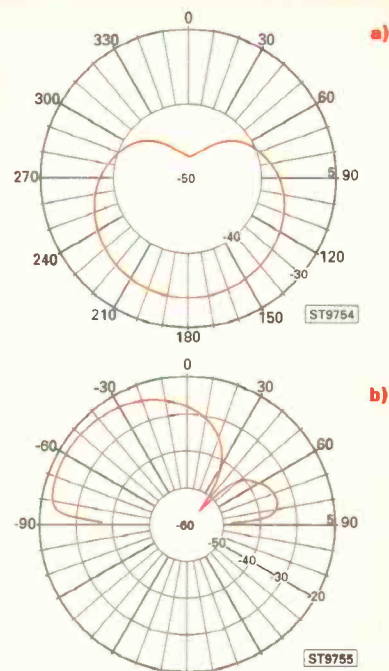

Fig. 2.6: Patterns of the EWE over one type of ground: a) Azimuth and b) elevation.

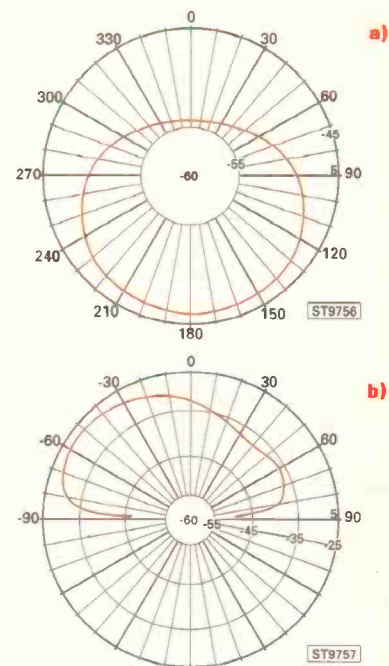
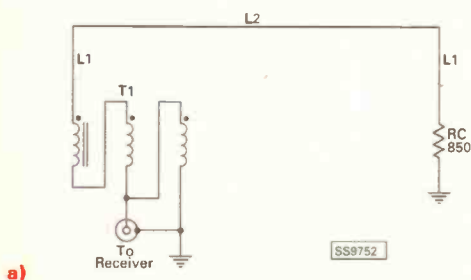
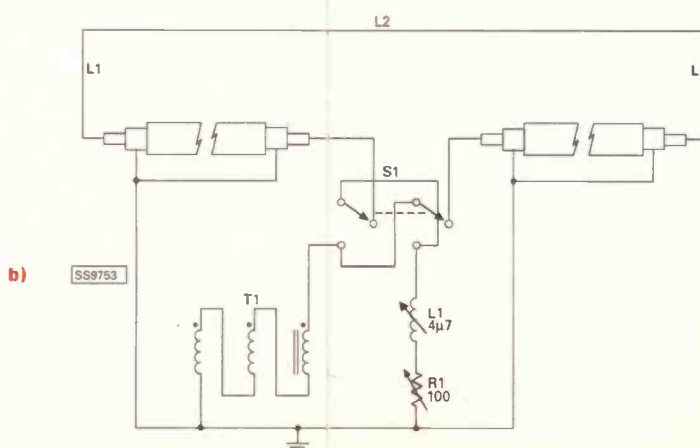

Fig. 2.7: Alternate patterns with changed ground conditions.



a)

Fig. 2.5:
a) EWE antenna;
b) Reversible EWE design.



b)

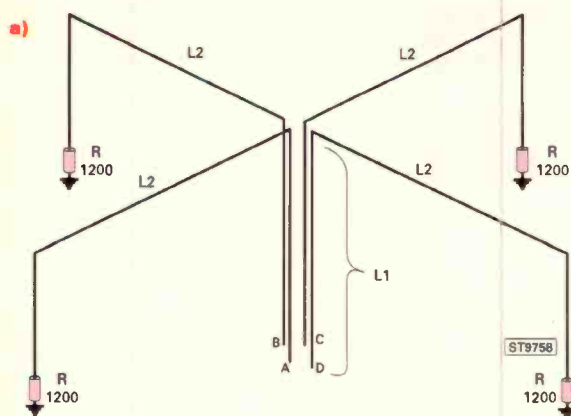

Fig. 2.8: a) Dual EWE switchable antennas; b) Switching circuit.

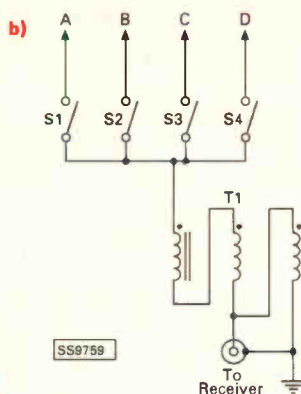

Fig. 2.9: N4PC loop antenna.

References

Andress, Ed (1996). 'A K6ST1 Low-Noise Receiving Antenna for 80 and 160m'. *QST*, 79, 9, p.37. September 1995.

Beezley, Brian (1995). 'A Receiving Antenna that Rejects Local Noise', *QST*, 79, 9, p. 31 September 1995. Brian Beezley also created several antenna modelling and simulation software packages that can be used for testing the concepts in this article before actually erecting an antenna. His software is superior to the 'freeware' mini-NEC program because of several factors, one of which is that he more adequately deals with ground conditions.

Carr, Joseph J. (1994). *Receiving Antenna Handbook*. San Diego: HighText Publications.

Koontz, Floyd A. (1993). 'A High-Directivity Receiving Antenna for 3.8 MHz', *QST*, August 1993. ARRL, Newington, CT.

Koontz, Floyd A (1995). 'Is This EWE For You?', *QST*, 79, 2, February 1995. ARRL, Newington, CT.

Koontz, Floyd A (1996). 'More EWES For You' *QST*, January 1996. ARRL, Newington, CT.

NecWin Basic antenna modeling software. Nittany-Scientific.

two triangles are crossed over, so there is a 180° phase shift. The antenna is fed at the centre by 450Ω twin-lead transmission line. An impedance matching transformer is needed to reduce the impedance to 50Ω. The transformer should be a BALUN type in order to make the balanced twin-lead compatible with the unbalanced receiver input.

Horizontal Small Loop

A small horizontal low-noise antenna for low-band (Beezley 1996) is shown in **Fig. 2.10a**. This antenna has a net signal-to-noise ratio improvement of 24.6dB compared with a reference vertical (dBV), even though the level of the desired signal is about -20.5dBV. It is superficially similar to the N4PC loop, but uses sides of 0.36λ each. A harness made of 450Ω twin-lead connects the halves of the antenna. Note that the twin lead is twisted once at one end.

The antenna is fed in the geometric centre of the twin-lead section through a transformer network. The transformer is wound on a type-77 ferrite core. The windings marked 'A' are each eight turns, while winding 'B' is nine turns. Use any convenient size enamelled wire. The capacitor will be about 40pF at 3.5MHz.

A variant feed system by Andress (1996) is shown in **Fig. 2.10c**. The transformer is made using type-77 ferrite toroid cores (e.g. FT-82-77). The antenna side of the transformer has four turns of wire, while the receiver side has ten turns at 80m and twenty turns at 160m. Enamelled wire of any convenient size can be used. The capacitor should be about 80pF at 3.5MHz and 500pF at 2MHz.

The azimuth pattern for this antenna is shown in **Fig. 2.10d**. Note that it is a 'figure of eight' with two maxima and two minima.

A claim made for this antenna (Beezley 1996) is that, with the use of a preamplifier, the antenna will produce a minimum of four 'S'-units improvement in ground wave noise reception regardless of the direction of the noise source. The sky wave signal-to-noise ratio improvement can approach 30dB.

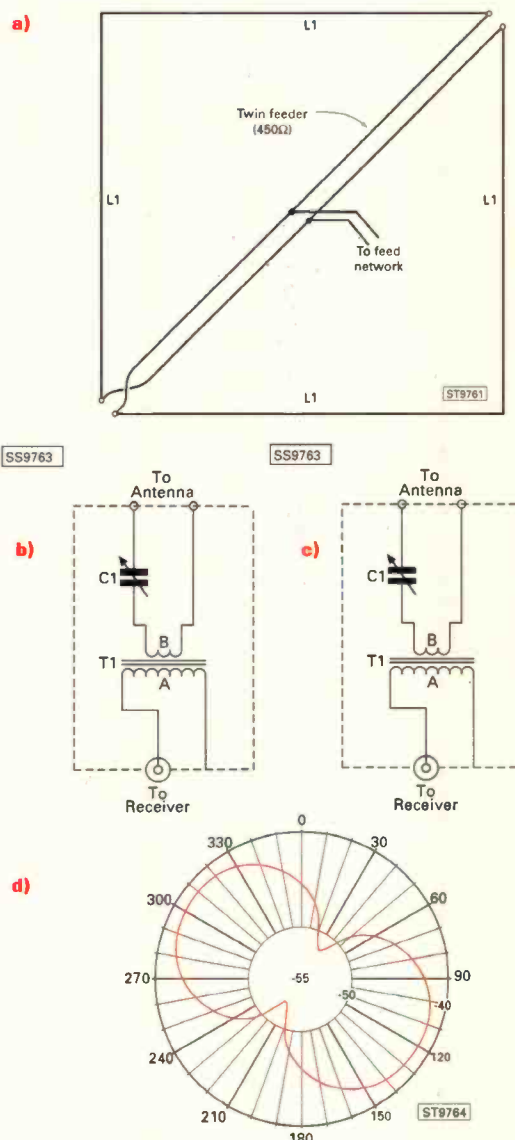

Fig. 2.10: a) Beezley loop; b) feed network; c) alternate feed network; d) azimuth pattern.

Conclusion

The medium wave and tropical bands are full of activity, but are often obscured due to man-made and natural noise sources. Using the antennas discussed in this article can render the bands far more usable, at low cost, and doesn't take an estate that would make a Texas rancher green with envy.

SWM

We will match or Beat

Competitive prices

on genuine U.K stock

On-line catalogue:

wspic.com



22 Main Road, Hoc

W&

Waters &

New 2000 sq. ft. Showroom
3000 Products
On Display **Now Open**

No clutter or cramped surroundings
Air conditioned with plenty of seating
50 radios on permant demonstration
New customer car park at front

We've created the UK's most spacious amateur radio showroom, with comfortable surroundings and plenty of space to sit down and try any radio of your choice. There are no compromises. Imagine sitting in comfort, with coffee and tea on call, and being able to play with whatever rig takes your fancy. Experience the widest range of accessories ever displayed. Browse through an amazing variety of items dedicated to radio communications. There's only one truly dedicated Ham Store!

Scancat Has Arrived!

Direct From USA



Virtual Receiver

Control your radio from your PC. With virtual receiver (illustrated) your handheld becomes a base station receiver. Supports all data port receivers from AOR, Icom, Yaesu, Kenwood and some Bearcat. And you get the following exciting features.

- * Unlimited memories
- * Spectrum scope
- * 100 scan bands
- * CTCSS & DCS mode
- * Direct keyboard entry
- * Logging File
- * Personal data base
- * Access import
- * Voice recording (SE version only)

The latest version of this software is now available for immediate shipment.

UBC-3000XLT
25MHz - 1.3GHz

It has 400 channel memories, Automatic store and automatic sorting, Ultra fast scan rate, LCD backlight, 300ch per sec. scan rate, Data skip function, Supplied with AC adapter/charger and AA ni-cads.

£199.95
Plus £8.00 Carr.

SANGEAN Badged up by Roberts at inflated prices. Sold by us at prices enjoyed by European's.

Sangean ATS-818 Short-Wave Portable SSB AM & Broadcast **Sangean ATS-818ACS**



£129.95
Plus £8.00 Carr.

A compact portable station covering short wave to 30MHz, LW/MW and FM broadcast. There are 54 memories in which to store your favourite stations. Power is via 6 AA 818 but with built-in cassette recorder and AC power supply accessory. £159.95

Again, cheaper than the model badged up in the UK by Ropberts! (Shades of the car industry here!) Like the ATS-favourite stations. Power is via 6 AA 818 but with built-in cassette recorder and AC power supply accessory. £159.95

Plus £8.00 Carr.

Adds Features
Views Spectrum
Creates Logs
Keyboard Entry



Spectrum Scope

It's BIG



Very BIG



AOR-3000A Receiver 100kHz - 2036MHz

The AOR-3000A goes on and on. It offers a wide frequency range at a very competitive price. Features include USB, LSB, CW, AM, FM * Fast 50 channels per sec search, * GaAsFET RF amplifier * Wide range of tuning steps from 50Hz * RS-232 port * 400 memory channels * Built-in clock * Channel pass feature * Back illumination * Rear whip antenna etc. Ask for leaflet.



£699
Plus £7.50 Carr.

Special Offer

SAVE £50



30kHz - 30MHz NASA HF-4E Receiver

Computer Compatible FREE Software Disk

This new receiver covers 30kHz to 30MHz and is designed for SSB, CW and AM reception. A much improved version of the Target HF-3, it is fitted with 2.6kHz SSB filter, advanced mixer design, backlit display, active antenna facility, and computer output. Included in the package is a software disk and 12V AC mains adapter. Optional self-powered active antenna £59.95

£149
Plus £8.00 Carr.

Was £199.95

IC-R75 Receiver 30kHz - 60MHz

FREE AC PSU & DSP Unit

ICOM

The IC-R75 has received rave reviews in the Amateur Radio Press. It's a very serious short wave receiver with coverage right up to the exciting 6m Ham Band. Features include USB, LSB, CW, AM, FM * 101 Memories * Super High Dynamic Range * Synchronous AM detection * Twin Pass band Tuning * Digital Signal Processing * Automatic Notch Filter * 101 Alphanumeric Memories * RF Gain/Squelch * Clock * Numeric keypad * Attenuator * 2-level Pre-Amp * Scanning.



£629
Plus £7.50 Carr.

YAESU FRG-100 Receiver
50kHz - 30MHz

The FRG-100 has stood the test of time. It offers full coverage of the short wave bands plus long wave and medium wave. It features, * USB, LSB, AM, CW, * 50 memories * 2 stage attenuator * Noise Blanker * Band Scanning * Memory Scanning * Dual Speed AGC * High and low impedance antenna inputs * Programmable steps from 10Hz - 1kHz * Optional Narrow Filters, PSU and FM board * BFO reverse for CW * Twin Clocks. Ask for leaflet.



£389
Plus £7.50 Carr.

0kHz - 32MHz AOR-7030 Receiver

Needing little introduction, this receiver has become a classic of design. Features USB, LSB, CW, AM, FM, * 100 Memories * Dual VFOs * Resolution to 10Hz * Clock and Timer * Variable Bandwidth * Wide Dynamic Range * Seamless Tuning using Single Loop DDS * Clear LCD Readout * Infrared Remote Controller * AC Power Supply. Send for leaflet.



Phone
Plus £7.50 Carr.

Fairhaven RD-500VX 20kHz - 1.75GHz



Phone
Plus £7.50 Carr.

This very wide range receiver offers a complete listener station in one package. Features include USB, LSB, CW, AM, FM, Video out * 5Hz step accuracy * Over 13,000 memories with 20 Alphanumeric Characters * Noise Blanker * Text Search * Pass Band Tuning * Stereo CW Reception * Notch & Peak Filter etc.

Retail Mon-Sat 9.00-5.30pm

e-mail: sales@wsplc.com. Orders only

Stanton PLC



Freephone 0500 73 73 88

Yupiteru MVT-9000EU Mk2
100kHz - 1.99GHz

Latest Mk2 Version

Phone
Plus £7.50 Carr.



Here's your chance to purchase the latest scanning receiver from Yupiteru at an unbelievable price. Covering the complete radio spectrum from long wave to UHF, you have a complete station in your pocket. Features include NFM, WFM, NAM, WAM, LSB, USB, CW, * 7 Frequency steps * 1,000 Memories in 20 banks * 500 Pass memories * 10 Priority channels, * Band Scope display * Duplex receive function lets you hear both sides of the conversation * Fast tune function, * Built-in AM antenna * Dual frequency display * Fast keypad entry, * Rechargeable batteries, AC charger and helical antenna.

Phone
Plus £8.00 Carr.

Yupiteru MVT-7100EU
100kHz - 1.65GHz

Probably the best value for money, it has stood the test of time and is very sensitive. Offers USB, LSB, CW, AM, FM, WFM, * 1,000 memories * 500 Pass channels * 12 Tuning steps * Fast scan speed * Rechargeable batteries, AC charger and telescopic antenna.

Yupiteru MVT-7000EX
100kHz - 1.3GHz

The ideal scanner for those who are mainly interested in VHF and UHF listening. Features include, FM, WFM, AM reception * 200 memories in 10 banks * 20 steps per sec scanning * 6 Tuning steps * Good sensitivity * Supplied with rechargeable ni-cads and AC charger. Telescopic antenna included.

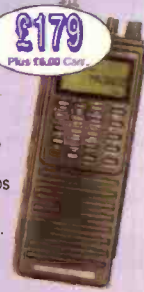

£179
Plus £8.00 Carr.

AOR-8200
500kHz - 2040MHz

This wide range scanner is fitted with a data port for computer control. Features include USB, LSB, CW, FM, WFM * Programmable steps * 1000 memories in 20 banks * Alphanumeric display * Built-in AM antenna * 8.33kHz steps for air band * Rechargeable ni-cads, AC charger and helical antenna.

Phone
Plus £8.00 Carr.

IC-R10E
500kHz - 1300MHz

USB, LSB, CW, AM, FM, WFM * 1,000 Memories * Bandscope * Noise Blanker * Wide range of tuning steps * alphanumeric Display * Real Time Band Scope * Voice scan feature * Data output port * Programmable scanning * Ni-cad pack, AC charger and helical antenna.

£249
Plus £7.50 Carr.

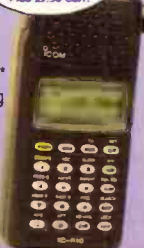

IC-R2
500kHz - 1309MHz

This palm size handy offers great performance. Offers FM, WFM and AM * Auto squelch * 400 Memories * 11 Tuning steps * CTCSS decode * Duplex monitoring feature * PC Programmable * Built-in attenuator * Priority watch * Needs 2 x AA cells (extra). Antenna included.

£129
Plus £7.50 Carr.



ICOM New ICR-3E Scanner WITH TV RECEPTION!

- * NSTC/PAL TV Receive.
- * Wideband AM & FM Receive (No SSB)
- * 496 KHz - 2450 MHz frequency coverage.
- * Memory: Extensive Storage.
- * Display: Detailed data control display.
- * Dual Receive.
- * AC charger and batteries included.

Icom have launched a new scanner with a built-in TV receiver. So when there is nothing to listen to, you can watch the pictures. You will need to be in a good signal area to get best results.

Phone



UBC - 220XLT HANDHELD SCANNER

Ideal for general listening, this scanner covers all the major bands from 66MHz - 956MHz AM and FM. 200 memories and a very fast scanning speed make this a very attractive buy. You also get the flexible short antenna, AC charger and batteries. Very popular with Airband listeners.

£119.95
Plus £6.00 Carr.

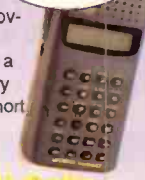

Double Your Lifespan with Cells

These Nexcell Ni-MH cells have around twice the capacity of ni-cads and no memory effect. The AA size are 1350mAh. Ideal for handhelds and digital cameras. As supplied to the police.

- 4 x AA cells £9.95
- 4 x AAA cells £9.95
- Charger for above £9.95
- Carriage £2 maximum. Quantity discounts - phone.



ICOM PCR-1800 10kHz - 1300MHz Computer controlled Receiver

Mode: USB, LSB, CW, AM, FM, WFM.

Connect this up to your PC and enjoy high quality reception with an amazing station data base and memory log. Can be used remotely from PC. Requires PC not included.



£279.95
Plus £8.00 Carr.

Hoka Gold-3 Decoding Software

THE SECRET'S OUT!



We are now the UK distributors. As used by governments, it can decode just about any form of data transmission on HF and VHF. Simply connect between PC and Rx audio. Can be loaded on any number of PCs. This is very advanced programme. £349.95 Plus £2.00 Carr.

GPS is now ten times more accurate!

Thanks to the American's switching off the error system

& GARMIN. Full details and great prices on **On-line Catalogue** **wsplc.com**

WATSON Capture that Frequency!

10MHz - 3GHz Hunts down Frequencies

Supplied with telescopic antenna and AC battery charger. If you are within 200 ft or so of the handheld, you should be able to read off the frequency. Note it down and enter it in your scanner. It's that simple and it's pocket sized. £59.95 Plus £8.00 Carr.



FBI - 9 Skin Coloured Earpiece

The FBI-9 is a brand new design that is skin coloured to make it far less obvious when worn. The cable and cable exits will take a strain of 12kg so it won't break in commercial applications.



£9.95
Plus £2.00 Carr.

W-LW8 MkII Long Wire Baton

Just attach any length of wire and feed back to radio with coax cable. Reduces interference and improves matching to receiver. £22.95 Plus £2.00 Carr.



JM-838WF



Jumbo 12 hour radio locked clock with weather forecaster, barometer, date & time, internal temperature. £49.95 Plus £2.00 Carr.

WWC-411



Jumbo 266mm diam wall clock. 12/24 hours, day date and internal temp C or F. £34.95 Plus £2.00 Carr.

MFJ-125



24 hour quartz clock with smaller dial, date and 12 hour sweep dials. Each can be set independently. £34.95 Plus £2.00 Carr.

WS-Desktop

The answer to those who want to improve the scanner performance using an indoor antenna. Covers 25 - 1300MHz and includes coax cable terminated with BNC plug. £49.95 Plus £7.50 Carr.

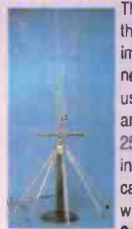

WS-Mobile Antenna

Just 0.9m high with magnetic base and 4m cable terminated with BNC plug. Covers 25 - 1300MHz and is the ideal choice for scanner users. £24.95 Plus £7.50 Carr.

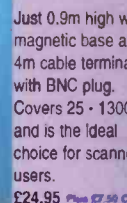

SWL DX-1 HF Ant.

Covers 1.5 - 30MHz and is 50m long. With 10m feeder wire back to receiver. An ideal general purpose antenna. £25.95 Plus £5.50 Carr.



Global AT-2000

The classic wire antenna tuner for short wave listening. Covering 1.8 - 30MHz, it includes our exclusive Q-switch, which improves front-end selectivity. Just connect a random length of wire and connect a coax cable from ATU back to receiver. £89.95 Plus £5.00 Carr.

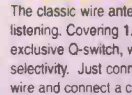

High Quality Coax Switch

Select two antennas or feeding two receivers at the flick of a switch. Rated up to 600MHz and almost half the price of competitive models. SO-239 sockets. £12.95 Plus £2.00 Carr.



RM-838 Radio Controlled

A radio controlled clock at a price, only W & S offers! Large display with signal strength indicator. 2 programmable alarms and snooze feature. £9.95 Plus £2.00 Carr.



EA-928U Weather Station

Self-contained indicating weather forecast, pressure with 24-hour history (altitude adjustment), indoor and outdoor temperature, moon phases, time, day week, alarm, table or wall mount, AA cells included, plus wireless linked remote temp. sensor. £79.95 Plus £2.00 Carr.



WS-Base Discone

The classic antenna covering 25MHz to 1300MHz. Ideal for all scanners. Height is 1.2m. Just connect coax cable to the SO-239 socket. Suitable for indoor or outdoor use. £49.95 Plus £2.00 Carr.



QS-300 Desk Stand

Designed for all handheld scanners. Your scanner sits on the adjustable holder and a short BNC cable runs to an SO-239 socket, ready for you to plug your external antenna into. A really smart device. £13.95 Plus £2.00 Carr.

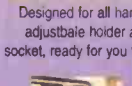

QS-400

The dash mount that enables any handheld to be mounted on the vent grill of your car. £9.95 Plus £2.00 Carr.





Computer Line-In connection

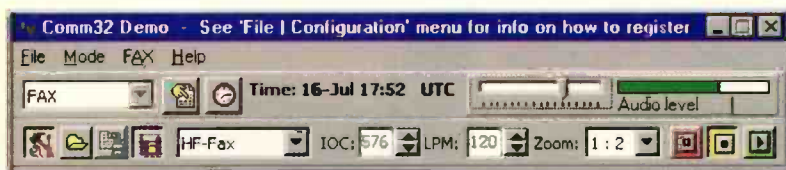

The level adjustment panel.

use the external speaker or headphone jack.

The other end of this lead goes to the 'Line-in' socket on your soundcard. You might have to check the manual to see which one to use, as some of them are just colour coded rather than sign written.

If this has all gone to plan and you have

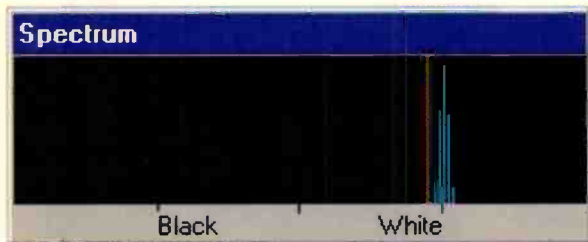

A correctly tuned FAX signal on Idle.

JVCComm32 running you should see the audio level indicator move either into the green or maybe red. If it moves into the red you need to use the audio level slider to reduce the level to keep the bar green. This is essential to maintain good picture quality.

If you don't get any indication of a signal you will probably find the word 'none' in the window at the side of the audio level panel - this means you've yet to choose the mode you're going to receive. Click on the drop-down button and select FAX and it should all spring to life.

If you still don't have any luck, you may have a slightly unusual soundcard or you may be plugged into the wrong socket at the back. Finding the right socket may have to be trial and error.

Coping with an unusual soundcard is not difficult. Press 'START' followed by 'Settings' then 'Control Panel'. Double-click on the 'Multimedia' icon. Press the 'Audio' tab and click on the recording button - it's usually shown by a picture of a microphone and a slider control.

You should now see a series of sliders with the option to click a 'Select' box under each. Choose the 'Line' slider and you should see the bar graph come to life - you can make sure the slider is around halfway up at this point.

First Picture

Now all you need to do is wait for the transmission to start and you will be able to see your first picture. The recognition of the picture format and speed is done automatically by *JVCComm32* by using the start tone and synchronisation pulses that occur at the start of each picture.

If a picture's already in progress you can force a manual start by pressing the 'Play' arrow just underneath the level indicator. If you do this you will find that the edge of the picture often appears in the middle of the screen - don't worry about this it's easy to fix later.

All Of A Tilt!

Unless you're very lucky you will probably find that your first picture arrives with a terrible slant - this is due to inaccuracies in your PC's internal clock and is dead easy to fix. First wait until you have at least half a screen's worth of image received. Now stop the reception by pressing the disable button under the level indicator. You can then press the small toolbox icon to show the FAX toolkit - if it's not already showing.

From here you press the slant correction button and move your cursor to the top of what should be a vertical line in the picture. Click the mouse and drag the line to the bottom of the screen. You now need to move the line you've just drawn so that it follows the slant of the picture.

Once you've done this just click the mouse again and press OK. You will get a message saying the correction that's been applied and you're done. From now on you should get perfectly aligned pictures. If you should find they start to slant again, you just have to repeat this process.

Time's Up

Ok, that's it, your time is up! Just how well did you do? I'm sure that the vast majority of you will have great images displayed and stored within the 30 minute limit.

Tidy-up

Once you've received your pictures, *JVCComm32* automatically stores them so that you can print them at a later date. There is also a stack of excellent manipulation tools so that you can tidy-up your images before printing.

Registration

One last plea, software such as *JVCComm32* takes a lot of development work and in the case of this program it's done mainly out of a love of the hobby. Registration for the full version costs just £49.99 and can be done on the 'phone to **Pervisell** on **(01494) 443033**. Alternatively you can order on-line via their web site.





NEVER BEFORE HAS ONE HAND PORTABLE OFFERED SO MUCH

The AR8200 represented a beacon when first released, technology marches forward with the NEW AR8200 SERIES-2 keeping the innovative concept and forward thinking alive and bright. It has not been easy improving on what many thought to be the ultimate, however the NEW AR8200 SERIES-2 does provide even more with nothing taken away. A Temperature Compensated Crystal Oscillator (TCXO) now forms the heart of the NEW AR8200 SERIES-2, this ensures **high stability** with **minimal internal spuri...** the TCXO replaces a crystal reference as commonly employed in other receivers and is usually only seen in top of the range (more expensive) table-top models such as the AR5000 and AR7030. Performance too has seen the AOR R&D team fine tuning the design for **best sensitivity and strong signal handling** over the extremely wide coverage of 530kHz to 2040MHz (all mode receive without gaps).

The aerial has also been replaced by a **telescopic whip** on a swivel base, this ensures the best results, a medium wave bar aerial is also provided as standard. The design team have certainly been taking account of customers wishes, the keyboard ZERO key has been swapped in position with the DECIMAL to match the telephone layout, LCD illumination has been increased (for improved visibility) and following requests for longer operation **between charges, the 4 x AA size NiCads have been increased in capacity**, again reflecting improvements in modern technology. The obvious change has been left for last... the **cabinet colour** has been changed from green to **black!**

The list of features is vast, large multi-section backlit LCD, side mounted navigation keys and rotary tuning control, alpha-numeric text comments for memory channels, banks and search. The all mode receive features Wide, Standard and Narrow AM with Wide FM, Narrow FM and Super Narrow FM bandwidths provided, tuning step sizes are programmable in all modes down to 50Hz with comprehensive step adjust and correctly implemented 8.33kHz for the new VHF airband spacing. Connection to a computer is possible with the optional CC8200 lead/interface with free PC software available from the AOR web site. Unique optional slot cards further enhance features offering CTCSS, Tone Eliminator, Record / Playback, Voice Inverter, External Memories (backup for 4000). Other options include the RT8200 for 'reaction tune' with the Opto Scout and other compatible devices, clone lead, soft case, option lead, record interface. Even the operating manual reflects the careful design being 140 pages of ENGLISH language with plenty of illustrations.



```

BEEP = 03
LAMP AUTO
CONTRAST 10
Next
    
```

```

POWER-SAVE
DELAY = OFF
CYCLE 3.0s
Next
    
```

```

COPY 2320
LOAD SAVE
ALL-DATA
Next
    
```

```

SCAN-GROUP 1
ABCDEFGHIJ
abcdefghij
BANK LINK
    
```

```

2UFO AM 25.0k
U-A 123.5000
M-WRITE E25
PROTECT OFF
    
```

```

HLD
80.000 ↔ 10M
MKR 80.000
    
```

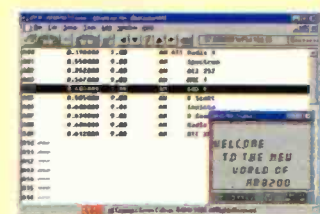

```

EDIT MEM-CH
MEM LSB 0.05k
29 14.200
BANK/CH SEL
    
```

```

(AFC)
2UFO NFM 20.0k
U-A 1295.0000
U-B 88.0000
    
```

```

(DUP)
2UFO NFM 20.0k
U-A 439.9000
U-B 88.0000
    
```

```

ADJ
2UFO NFM 14.0k
U-A 145.2100
U-B 76.1000
S_
    
```

```

(PRI)
PRIO NFM
MKR 145.0000
144M HAMBAND
S_
    
```

New Collins mechanical 300Hz filter AR7030 & AR7030 PLUS special promotion Sept / Oct'2000

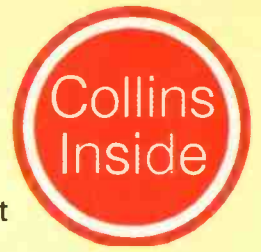

The Collins name has been synonymous with high quality mechanical filters for many years and the company association with AOR is longstanding. With the boundaries of technology being pushed all the time, we are happy to announce that a new Collins mechanical 300Hz filter is now available to extend the range of available filters for use in the AR7030 short wave receiver, AR5000 & AR3000+3 wide band receiver and other units such as the AR3030.

The brief specification of the new filter is as follows:

Filter:	300 Hz mechanical
Part number:	MF300 (526-8733-010)
3dB bandwidth:	0.3kHz ± 60Hz
60dB bandwidth:	1.0 kHz maximum
Number of resonators:	7

The new MF300 is pin-compatible with the earlier MF500 filters for easy substitution and fitting. Best of all, the price is the same as the other filters in the existing range making the MF300 an ideal cost effective choice when compared to narrow CW crystal filters.

To mark the arrival of the new Collins 300Hz mechanical filter, a special promotion is being offered for all new purchases of specially produced "Collins inside" AR7030 & AR7030 PLUS short wave receivers. If you purchase a new AR7030 or AR7030 PLUS promotional set (which is available during September'00 and October'00 from participating dealers), you may have the MF300 filter pre-fitted completely free of charge, in place of the Collins 300Hz filter you may select any one Collins mechanical filter from those available:

MF300	300Hz CW filter
MF500	500Hz CW filter
MF2.5	2.5kHz SSB filter
MF4	4.0kHz narrow AM filter
MF6	6.0kHz AM filter

This will result in the AR7030 & AR7030 PLUS having five filters included in the special promotional price instead of the usual four. As an extra 'bonus', the TW7030 telescopic whip will be bundled in as part of the promotional package. The cost saving for this package based on list price is £86.95 (inc VAT). **See the table opposite...**

The AR7030 & AR7030 PLUS are recognised internationally for their high performance and highly configurable features, this being as a result of forward thinking, innovation and attention to detail. The same careful attention is taken during the manufacture of the AR7030 & AR7030 PLUS, few mass produced units enjoy such hands-on care.

Manufacture of the printed circuit boards predominantly feature surface mount components placed by a multi-million pound automated production line, this provides high quality and repeatable results. The front panel is CNC machined to exacting standards with sub assembly being carried out by hand here in our Belper workshop ensuring close inspection and high precision.

Alignment is controlled by computer so that no point can be skipped, if the receiver fails a test, it is not possible to spuriously progress, this results in the performance of each and every set being almost identical, even in respect of signal meter calibration. The AR7030 features a TCXO (Temperature Compensated Crystal Reference) which ensures the highest stability, this reference oscillator is set up using an oven-stabilised workshop reference which is calibrated to an on-air reference.



During manufacture, the receivers are soak tested for a minimum of 48 hours and are thermally cycled as part of the synchronous AM alignment procedure (which includes temperature compensation). Final test is meticulously carried out with the receiver being tested on several signal generator determined points followed by on-air testing both from the internal speaker and headphones. Detailed records are kept for each receiver (not just by batch) and carry details of build date, notes, AGC calibration, filter bandwidths and performance parameters such as IP2 and IP3. While other manufacturers are out-working product to cost driven areas of the world, here in the UK we continue building the AR7030 with the care it deserves so that you may enjoy monitoring the world-over with the knowledge you have probably the best analogue short wave receiver ever built.

Promotional packages:-

AR7030 promotional standard receiver , 100 memories Fitted with four filters, typical displayed bandwidths are 2.2kHz (CFJ455K14), 5.5kHz (CFW455IT), 6.5kHz (CFW455HT), 9.5kHz (CFU455G)	£799.00
ADD one Collins mechanical filter free of charge (usually £74.00) from:-	
MF300	300Hz CW filter
MF500	500Hz CW filter
MF2.5	2.5kHz SSB filter
MF4	4.0kHz narrow AM filter
MF6	6.0kHz AM filter
Free telescopic whip aerial (usually £12.95)	
Promotional price	£799.00
You save (£74.00 + £12.95)	£86.95

If required, optional NB7030 noise blanker, notch, enhanced CPU (£198.00)

AR7030 PLUS promotional receiver , 400 memories Fitted with four filters, typical displayed bandwidths are 2.2kHz (CFJ455K14), 4.0kHz (CFK455J), 5.5kHz (CFW455IT), 9.5kHz (CFU455G)	£949.00
ADD one Collins mechanical filter free of charge (usually £74.00) from:-	
MF300	300Hz CW filter
MF500	500Hz CW filter
MF2.5	2.5kHz SSB filter
MF4	4.0kHz narrow AM filter
MF6	6.0kHz AM filter
Free telescopic whip aerial (usually £12.95)	
Promotional price	£949.00
You save (£74.00 + £12.95)	£86.95

If required, optional UPNB7030 noise blanker, notch, (£163.00)

The Collins filters are of course available separately, the list price is £74.00 each plus £2.00 P&P (inc VAT). Remember, this promotion is available only via participating dealers through the months of September & October'00. The carton of the promotional AR7030 & AR7030 PLUS is clearly marked with a bright red "Collins inside" label, you choose which Collins filter is fitted - free. As a result of a choice being available, please allow a short time for orders to be passed through and processed (and for supply of further Collins filter stocks should demand for a particular type be highly requested).

Participating dealers include:

Waters & Stanton PLC, Essex 01702 206835	Nevada Communications, Portsmouth 023 9231 3090
Martin Lynch & Sons, London 0208 566 1120	ASK Electronics, London 0207 637 0353
Haydon Communications, Essex 01708 862524	Haydon Communications, West Mids 01384 481681
Javiation, Bradford 01274 732146	Radio World, Walsall 01922 414796
A.R.C., Merseyside 01925 229881	

AOR (UK) LTD 4E East Mill, Bridgefoot, Belper, Derbyshire, DE56 2UA England
Tel: 01773 880788 Fax: 01773 880780
 info@aoruk.com www.aoruk.com E&OE

radio reading at its very best

AVAILABLE AT MOST WHOLESALE NEWSAGENTS NATIONWIDE. If your local outlet doesn't stock PW or SWM order your regular copy.

The magazine that brings you Amateur Radio & So Much More

PRACTICAL WIRELESS

Next Month in *Practical Wireless*, the magazine that brings you Amateur Radio & So Much More

IT'S A CLASSIC

* **Rob Mannion G3XFD** revisits the Kenwood TS-830 – a classic rig that makes a great second-hand purchase



TUNE-IN

* **Tom Walters** joins *PW* with the first of his monthly reports from the h.f. Broadcast bands around the world

STATESIDE NEWS

* **Ed Taylor N0ED** rounds up the news from 'across the pond' in Scene USA

Electronics-In-Action

* Join **Tex Swann G1TEX** for hints, tips and ideas on all things electronic

SHOW GUIDE

* It's show time! - Read our guide for the low-down on the 29th Leicester Amateur Radio Show and Convention



Plus all your regular favourites including:

Radio Basics
Bargain Basement
Carrying on the Practical Way
Keylines
What Is A? News

Radio Scene
Valve & Vintage
Antenna Workshop
and much, much more!
* Contents subject to change

CAN YOU AFFORD TO MISS IT? - OCTOBER 2000 ISSUE ON SALE 14 SEPTEMBER
PLACE YOUR ORDER TODAY!



Subscribe To SWM In Three Easy Instalments! *short wave magazine*

Want to subscribe to *Short Wave Magazine* but can't afford the initial subscription fee? Well, why not take this opportunity to order a subscription and pay for it in **three easy instalments**?*

Your subscription will begin with the **October 2000 issue of *Short Wave Magazine*** and end with the **September 2001 issue**.

Payments will be accepted by three post dated cheques drawn on a UK bank. (You must send three cheques with your order - the first cheque dated immediately, the second dated 1/12/2000 and the third dated 1/4/2001).

To order, please use the order form on this page or telephone the *SWM* Subscriptions department on **(01202) 659930** and quote **SWM9**.

* **Sorry but this offer is not available to overseas customers**

Subscription Prices UK only

Cost of Sub	£33
1st payment	£11
2nd payment	£11
3rd payment	£11

Send This Order Form To: Subscription Dept, PW Publishing Ltd., Arrowsmith Court, Station Approach, Broadstone, Dorset BH18 8PW.

I would like to subscribe to *SWM* in three easy instalments.

Name

Address

Postcode

Telephone No.

I enclose three cheques (Payable to PW Publishing Ltd.)

1st Cheque (payable immediately) £

2nd Cheque (dated 1/12/2000) £

3rd Cheque (dated 1/4/2001) £

Signature

DECODE SPECIAL DECODE SPECIAL DECODE SPECIAL DECODE SPECIAL

Utility Software Round Up

Mike Richards muses about his choice of software for 'decode' use.

Choosing The Right Hardware

Fortunately, market forces have largely done this for us. Despite its shortcomings, there is no getting away from the fact that the PC reigns supreme in the hobbyist marketplace. Because enthusiasts write most of the software associated with utility listening, it's no surprise to find that the vast majority of programs have been produced for the PC.

Whilst there are some excellent programs available for the MAC, you really ought to be aiming for a PC based system if you're starting from scratch. The next question of course is which one to buy. If you're buying new I suggest you buy a PC magazine or two and look out for group reviews of PCs in your price range. One of the best magazines for this in my experience is *PC World*. Their



Comparator Interface from Pervissell.

reviews appear particularly unbiased and their tests are based on good science rather than just the subjective opinion of the reviewer.

If you're buying second-hand, or on a tight budget like most of us, then you need to be aiming for a Pentium processor running at 133MHz or faster with *Windows 95* or *98* installed. The second-hand market is very buoyant and there are lots of bargains to be had from people who are upgrading to the latest spec PCs.

A typical 133MHz Pentium will sell for around £150-£200 and that's with a load of software. If you can't run to this and are prepared to run some of the older software, you could go for a 486-based processor running at 33 or 66MHz. These can be picked-up for £50+ and offer a very cheap route into the data side of the hobby.

Registration

One of the real delights of our hobby is that most of the software we need is distributed as shareware so

it's really easy to try it out and make sure you're happy before you part with any hard earned cash. Whilst some authors apply restrictions to their programs to persuade you to buy the full version, others supply the complete fully working version and rely on your conscience for registration. It really is important that you register the program and pay the fee if you want to use it.

The programs described here have largely been written by enthusiasts out of a love for the hobby. By registering you give them encouragement to continue. This encouragement means that the program will continue to be developed and we all benefit in the long run.

Software Groups

For utility fans there are three types of software that you will probably need at some time or another. The first and most obvious is the decoding software itself. This is the clever bit that turns the whistles and whines you hear through your receiver into something intelligible you can see on your computer screen. The second types are the rig control programs. These are programs that link your receiver to the computer in such a way that you can control most of the functions from the keyboard.

The main benefit of these programs is the ease with which you can store and categorise your favourite stations for instant recall. Particularly interesting are the ones that can feed from commercial frequency lists such as the *Super Frequency List* by Klingenfuss. The last of the three groups is the analysis software that can be a great

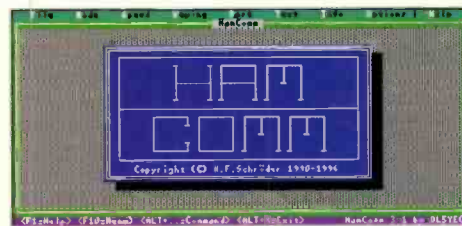

Hamcomm start-up screen.

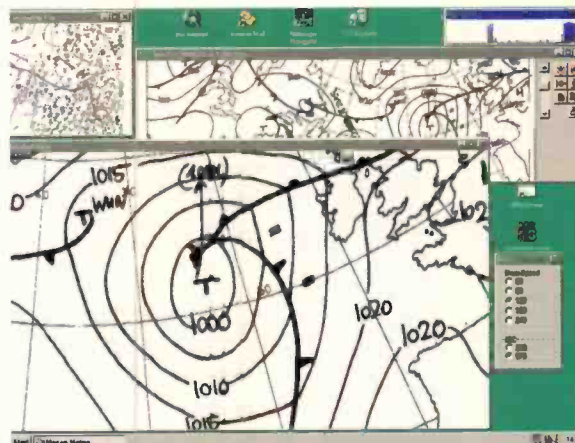

Mscan Meteo FAX Program.

Continued on page 36...

DECODE SPECIAL DECODE SPECIAL DECODE SPECIAL DECODE SPECIAL



Beacat UBC 3000XL

Uniden's top of the range scanner has 400 channel near continuous channel coverage from 25 to 1300MHz. New TWIN TURBO search and scan allow high speed scanning or searching to give lightning quick results. The set is packed with new features:

- 25 - 550, 760 - 1300 MHz
- AM/FM/WFM
- 400 memory Ch
- TURBO SCAN 100 Ch/Second
- TURBO SEARCH 300 St/Second
- Automatic Frequency Storage
- Selectable Attenuator
- Automatic Frequency Sorting
- Data Skip
- Delay Key ● Channel Count Key
- Supplied complete with earphone, case, belt clip, charger and rubber duck antenna



£189
£8 p&p

YUPITERU MVT 3300

BULK PURCHASE ENABLES US TO BRING YOU THIS STUNNING JAPANESE MANUFACTURED SCANNER AT AN UNBEATABLE PRICE. THE RECEIVER HAS EXCELLENT PERFORMANCE AND COVERS UP TO 1000MHZ WITH SELECTABLE MODES.

- 66 - 88MHz, 108 - 170MHz, 300 - 470MHz, 806 - 1000MHz
- MODES: AM/NFM
- STEPS: 5, 6.25, 10, 12.5, 25kHz
- MEMORIES: 200
- BAND MEMORIES: 10 (user re-programmable)
- PRIORITY CHANNELS: 10
- SCAN/SEARCH SPEED: 30/ sec
- Requires 4 x AA batteries
- SUPPLIED WITH: Antenna, Earpiece, Carrying Strap and built-in Desk Stand



SPECIAL OFFER

ONLY £159 £129
£8 p&p

AR 8200 (SERIES 2)

LATEST model!



- 530kHz-204MHz
- All Mode inc 8.33kHz AM
- 1000 Memories
- Plus LOTS MORE!

PRICE MATCH £439
£8 p&p

We carry the FULL RANGE of accessories!

Beacat UBC 220XL

Uniden has built its reputation on reliability, ease of use and quality of reception with its most popular model, the 220XL. Ideal for Aircraft, Public Service & UHF Communications.

- 66 - 956 MHz (with gaps)
- AM/FM
- 200 memories
- TURBO SCAN 100 Ch/Second
- TURBO SEARCH 300 St/Second
- Data Skip facility
- 10 Priority Channels
- Memory Backup
- Supplied complete with earphone, belt clip, charger and rubber duck antenna

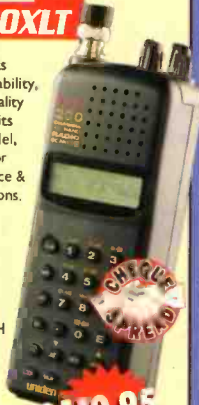

£119.95
£8 p&p

Beacat UBC 120XL

Perfect for long distance reception of Aircraft, Public Services, Land Mobile and much more! Outstanding value for money!

- 66 - 512 MHz (with gaps)
- AM/FM/WFM
- 100 memory channels
- TURBO SCAN 100 Channel/Second
- TURBO SEARCH 300 St/Second
- Data Skip facility
- 10 Priority Channels
- Programmable Search
- Channel Lockout Key



£99.95
£8 p&p

Beacat UBC 860XL

AIRBAND Base Scanner

A stylish low profile base scanner with TWIN TURBO scan and search facility. Covers civil airband, marine, police, cellular plus more!

- 66-88, 108-174, 406-512, 806-956MHz
- 100 mems ● Turbo Scan - 300 steps/sec



£129.95
£6 p&p

Beacat UBC 60XL

A brand new low cost scanner that covers MARINE, POLICE, LAND MOBILE and more!

- 66 - 512 MHz (with gaps)
- 30 memories
- Channel or Frequency display
- Priority Channel
- Channel Lockout
- Scan Delay



£79.95
£8 p&p

ICOM IC-R2

- 500kHz - 1310MHz
- AM/FM/WFM
- 400 memories
- 10dB Attenuation
- Uses 2 AA Batteries (not supplied)
- Auto Squelch
- Tone Squelch for quiet operation
- Optional software available for cloning



£149
£8 p&p

PRICE MATCH

YAESU VR500 ULTRA COMPACT RADIO

- 100kHz - 1299995MHz
- FM, Wide FM, USB, LSB, CW, AM
- 1091 Memory channels
- Direct keypad frequency entry
- 60 Channel Bandscope
- RF squelch system
- Clone capability
- Menu customisation
- Weighs only 220 grammes!
- Supplied with Antenna, Carrying Strap, Belt Clip
- Optional Charger: NC60



PRICE MATCH

£299
£8 p&p

HOT NEWS!

NEW! AR 8600 Mobile Wideband Receiver



- 500kHz - 2,040MHz
- 8.33kHz airband steps
- LOTS MORE!

NEW! YAESU VR5000 Mobile Wideband Receiver



- 100kHz - 1,300MHz
- Multi mode
- Real time band scope
- Optional DSP bandpass, notch & noise reduction
- Optional filters

visit our website for full details on these new models
www.nevada.co.uk

BEST PRICES ON GARMIN GPS PRODUCTS!

GPS III PLUS

- GPS 12 £129.95
- GPS 12 CX £239.95
- GPS 12 MAP £329.00
- GPS 12XL £189.95
- E-MAP £199.95
- E-TREX £119.95
- GPS 148 £209.95

MAP SOURCE CD ROMS

Available for UK, France, Germany, Italy etc. £69.95
FULL RANGE OF GARMIN ACCESSORIES IN STOCK - CALL FOR INFO & PRICES

USED EQUIPMENT

ALL SAFETY TESTED & GUARANTEED FOR 3 MONTHS

SHORTWAVE RECEIVERS	
AKO TARGET HF3 S. Based - as new	129
DRAKE SW2 HF Receiver - ex demo	399
GRUNDIG YB500 SW Portable - ex demo	99
SONY ICF SW77 Shortwave Portable	189
ICOM R75 HF to 60kHz + UT102	625
ICOM IC-R7100 Wideband Base Receiver	599
ICOM IC-R70 HF Receiver	225
ICOM IC-R72 HF Receiver	399
ICOM IC-R75 + UT102 HF Receiver	625
JRC 535 Quality HF RX Base	799
KENWOOD R5000 HF-tuned VHF module choice from	599
SCANNING RECEIVERS	
BEACAT UBC80XL Base Scanner	105
COMMET S10 Handheld Scanner	145
COMMET COM202 50 Channel Scanner	59
ICOM IC-R1 Handheld Scanner	159
ICOM PCR1000 Computer based scanner + UT106	225
REALISTIC PRO 2026 Patrolman	120
YUPITERU VT125 Handheld Scanner	249
YUPITERU VT125 Airband Scanner	185
YUPITERU MVT7100 Handheld Scanner	149

STOCK ARRIVING DAILY - CALL

023 9231 3090

e-mail: info@nevada.co.uk • website: www.nevada.co.uk

NEW OPENING HOURS

MON - FRI 9.30 - 5.30
CLOSED ALL DAY SATURDAY

• Unit 1 • Fitzherbert Spur • Farlington • Portsmouth • PO6 1TT



to be BETTER!



USE YOUR CREDIT CARD FOR SAME DAY DESPATCH!

MasterCard
VISA
DELTA

SERVING THE SHORTWAVE & SCANNING ENTHUSIAST for more than 30 YEARS!

ROBERTS R9914
PLL Digital World Band Radio

NEW!

£99.95
~~£6 p.p.~~

- LW/MW/FM/SW • 45 presets
- SSB reception • Tuning 1kHz steps
- Direct keypad + rotary tuning
- Clock/alarm functions • AC adaptor

ICOM IC-R75

CHEQUE SPREAD

IN STOCK! READY TO SHIP!

The LATEST HOT Receiver from ICOM

PRICE MATCH

£625
~~£8 p.p.~~

- 0.03 - 60MHz
- Twin PBT built-in
- PC control capability
- Synchronous AM detection

ICOM IC-R8500

CHEQUE SPREAD

PRICE MATCH

YES, we've got them IN STOCK! This receiver is everything we hoped it would be, covering 100kHz - 2GHz and lots of features, including computer control. PAY BY 3 POST DATED CHEQUES!

£1599.99
~~RRP £8 p.p.~~

GRUNDIG YB400

CHEQUE SPREAD

PORTABLE SW RADIO

"Best performance for price size category, and among the choicest portables of any size."
"The 400's FM performance is right up there with the very best among world band radios."
Passport to World Band Radio

- General coverage receive (144kHz - 30MHz)
- SW: 1.711-26.1MHz • FM Stereo: 87.5-108MHz • MW/LW
- SSB reception (both USB/LSB) (± 1kHz fine tuning)
- 40 station preset • Fine tuning • Dual alarm clock
- Narrow-/Wide bandwidth • DX/Local sensitivity
- Auto Search • Sleep timer • Snooze timer
- Mains or Battery powered (with optional mains adaptor)
- Supplied c/w
- SW Handbook • Carrying case
- Ed Wire Antenna • Carry Strap

£120
~~£6 p.p.~~

ROBERTS R861

£199
~~£179~~
~~£6 p.p.~~

Synthesised Receiver
FM Stereo/MW/LW/SW PLL

- 307 memories
- ATS auto scan • E2 PROM for mem.
- FM stereo via earphones
- 29 pages SW stations memory
- 8 characters for editing station name

JRC NRD-545

TOP OF THE RANGE WITH DSP

PRICE MATCH

£1,499
~~£8 p.p.~~

VNF CONVERTER
30 - 2000MHz
£299

- LSB/USB/CW/RTTY/AM
- 100kHz - 30MHz
- Noise Reduction
- Notch Filter

JRC NRD-345

CHEQUE SPREAD

£499
~~£8 p.p.~~

- AM synchronous detector • Low noise PLL chip
- Noise blanker • Wide dynamic range
- Sensitive receiver • R5232 computer I/F
- 100 memories • Clock/Timer functions
- Supplied c/w AC mains adaptor

ROBERTS R881

£79.95
~~£6 p.p.~~

FM/MW/SW • 45 Station Pre-sets

- Automatic preset system
- Direct keyboard tuning • Alarm/timer
- 12/24 hr clock • Keypad
- FM thru earphones • Carry pouch

YAESU FRG-100

PRICE MATCH

£369
~~£8 p.p.~~

This receiver provides solid coverage from 50kHz to 30MHz with all mode reception of AM, SSB and CW. The set requires 12V DC.

FAIRHAVEN RD-500DX

NEW UPDATED MODEL - 20kHz - 1.7GHz

IN STOCK READY TO SHIP

£799
~~£8 p.p.~~

GRUNDIG PORSCHE P2000

A stylish radio designed by F.A. Porsche

- FM Stereo
- AM/FM/MW 13 SW bands from 2.3MHz-26.1MHz
- 20 station presets
- Auto search
- Clock, alarm, sleep function, world times
- Supplied c/w leather cover & in-ear stereo headphones
- Mains or Battery (Optional AC adaptor)

£89.95
~~£6 p.p.~~

ROBERTS R809

£100
~~£6 p.p.~~

- PLL multi-band digital preset stereo world radio
- 5 tuning methods & 54 preset stations
- Dual time display • Clock/alarm
- Complete with soft carrying pouch
- Cont. AM coverage 150kHz - 29.99MHz

SANGEAN AT5909

CHEQUE SPREAD

PRICE MATCH

£169
~~£8 p.p.~~

ULTRA COMPACT Digital Multiband Radio with SSB

- Covers: FM Stereo MW/LW/SW
- 307 memories • Auto Tune System
- RDS (Radio Data System)
- Plus LOTS MORE!

OPTIONAL MAINS ADAPTOR £9.95

SANGEAN AT5818

UNBEATABLE VALUE FOR MONEY!

SW WITH SSB

SPECIAL!

£99
~~£8 p.p.~~

- 150kHz - 29.99MHz • AM Wide/Narrow filter
- 87.5kHz - 108MHz • RF gain control
- 54 memories
- AM/FM/SSB

OPTIONAL MAINS ADAPTOR £9.95

GRUNDIG OCEAN BOY

- 3 Band FM/MW/LW
- RDS Radio Data System
- Radio text
- EON traffic system
- 30 presets
- Last station memory
- Local/DX sensitivity
- Clock with features
- Mains or Battery

£59.95
~~£6 p.p.~~

JRC ST3

HEADPHONES

A real quality pair of headphones designed for the discerning shortwave and communications enthusiasts

£69.95
~~£4.95 p.p.~~

AOR AR 5000

CHEQUE SPREAD

IN STOCK READY TO SHIP

£1,199
~~£8 p.p.~~

PRICE MATCH

- 10kHz - 2.6GHz

All mode top class receiver and scanner packed with features

AOR AR 5000+3

CHEQUE SPREAD

IN STOCK READY TO SHIP

£1,799
~~£8 p.p.~~

PRICE MATCH

- 10kHz - 2.6GHz

The Plus 3 has factory fitted options, noise blanker, synchronous AM & automatic frequency control pre-installed

AKO HF3 5

CHEQUE SPREAD

SHORTWAVE RECEIVER
30kHz - 30MHz

£159.95
~~£8 p.p.~~

SCANMASTER SP55

WIDEBAND PREAMP

Improve the reception of your scanner!

- 24 - 1500MHz
- Variable gain (-3dB to +20)
- 3 bandpass filters
- Battery or 12V operation

£59.95
~~£4.75 p.p.~~

AOR AR 3000A

SHIPPED TODAY!

£799
~~£8 p.p.~~

PRICE MATCH

- 100kHz - 2036MHz

Classic receiver as used by Government, Military etc

AR 3000A + £899 **PRICE MATCH**

AOR AR 7030

SHIPPED TODAY!

£799
~~£8 p.p.~~

£749
~~£8 p.p.~~

- 0kHz - 32MHz

High dynamic range short wave receiver HAD MANY RAVE REVIEWS WORLDWIDE!

AR 7030 + £949 **£849**

ICOM PCR 1000

COMPUTER RADIO SYSTEM

- 100kHz - 1300MHz
- ALL MODE RECEPTION
- PLUS LOTS MORE!

PRICE MATCH

£349.95
~~£82.00~~
~~£8 p.p.~~

PCR OPTION DSP UNIT UT 106

Palstar AM30

Active Antenna/Preamplifier

£69.95
~~£6 p.p.~~

- ACTIVE ANTENNA
- SHORTWAVE PRE-AMPLIFIER
- ACTIVE ANTENNA/TUNER
- Freq: 100kHz-30MHz
- Power: 12V DC/battery (supplied)
- Antenna: Telescopic whip included for use as an active antenna



ITS EASY TO PAY - Pay by three post dated cheques!

- Simply divide the price into 3 equal payments. (ON ANY ITEM OVER £100)
- Write 3 cheques dated in consecutive months starting with today's date.
- Write your telephone No, cheque card No & expiry date on the back of each cheque.
- Post them to us, enclosing your name & address & we will (subject to status) send your goods immediately.



The books listed have been selected as being of special interest to our readers. They are supplied direct to your door. Many titles are overseas in origin.

SWM Book Store

LISTENING GUIDES

Airband

	Pages	Price
ABC AIRBAND RADIO GUIDE 4th Edition	96	£7.99
ABC BRITISH AIRPORTS (6th Edition) A. Wright	112	£8.99
ABC CIVIL AIRLINER RECOGNITION 6th Edition, Peter R. March	128	£9.99
AIR TRAFFIC CONTROL 7th Edition, Graham Duke	112	£8.99
AIRWAYS 2000	134	£9.95
CALLSIGN 2000	168	£9.95
FLIGHT ROUTINGS 2000, Williams	160	£7.95
NORTH ATLANTIC FLIGHT COMMUNICATIONS 2nd Edition (inc. software)	172	£16.50
UNDERSTANDING ACARS		
3rd Edition, Aircraft Communications Addressing and Reporting System, Ed Flynn	80	£9.95
WORLD AIRLINE FLEET & SELCAL DIRECTORY	300	£16.00
WORLDWIDE AERONAUTICAL COMMUNICATIONS FREQUENCY DIRECTORY 2nd Edition, Robert E. Evans	260	£19.95

Datamodes

FAX & RTTY WEATHER REPORTS, Philip Mitchell	88	£11.50
KLINGENFUSS 1999/2000 GUIDE TO WORLD-WIDE WEATHER SERVICES 19th Edition		
Joerg Kligenfuss	436	£23.00
WEATHER REPORTS FROM RADIO SOURCES, Philip Mitchell	32	£7.50
RADIO DATA CODE MANUAL, 16th Edition, Joerg Kligenfuss	788	£30.00
RADIOTELEX MESSAGES (25 Years of Monitoring Global Teletypewriter & Data Communications, 1st Edition)	568	£20.00

DXTV

OXTV FOR BEGINNERS, Simon Hamer	31	£3.95
GUIDE TO DXTV, Keith Hamer & Garry Smith	36	£3.95
GUIDE TO WORLDWIDE TV TEST CARDS	60	£4.95
MASTS - PRACTICAL IDEAS FOR THE DXER, Hamer/Smith	36	£4.95
THIS IS BBC TV - FIRST 30YRS OF TV GRAPHICS, Keith Hamer & Garry Smith	38	£4.95
THE FIRST 30 YEARS OF BBC 2, Keith Hamer & Garry Smith	60	£4.95

Frequency Guides

2000 SUPER FREQUENCY LIST on CDROM, Joerg Kligenfuss	n/a	£23.00
FERRELL'S CONFIDENTIAL FREQUENCY LIST NEW 11th Edition	450	£19.95
GLOBAL RADIO GUIDE 2000	32	£3.95
GUIDE TO UTILITY RADIO STATIONS 2000, 18th Edition, Joerg Kligenfuss	580	£30.00
PASSPORT TO WORLD BAND RADIO 2000	528	£15.50
RADIO LISTENERS GUIDE 2000	128	£4.95
SHORTWAVE FREQUENCY GUIDE 2000, Joerg Kligenfuss	564	£23.00
SHORTWAVE INTERNATIONAL FREQUENCY GUIDE	176	£12.95
WORLD RADIO TV HANDBOOK 2000	640	£19.95

General

BUYING A USED SHORT WAVE RECEIVER NEW 4th Edition, F. Osterman	78	£5.95
GETTING ON TRACK WITH APRS, Stan Horzepa WA1LOU	165	£11.50
POW WENT THE PIRATES, Keith Skues	588	£16.95
RADIO COMMUNICATIONS HANDBOOK, New 7th Edition, Dick Biddulph/Chris Lorek	580	£28.00
RADIO SCIENCE OBSERVATION Volume 1 (inc. CD-ROM), Joe Carr	414	£26.95
SHORT WAVE COMMUNICATIONS, Peter Rouse GU1DKD	187	£4.50
SHORT WAVE EAVESDROPPER CD-ROM	n/a	£16.50
SHORT WAVE RADIO LISTENING FOR BEGINNERS	174	£14.95
SHORTWAVE RECEIVERS PAST & PRESENT (NEW 3rd Edition)	450	£25.95
SHORTWAVE LISTENER'S GUIDE, Ian Poole	192	£15.95
THE COMPLETE SHORT WAVE LISTENER'S HANDBOOK New 5th Edition, Andrew Yoder	410	£19.95

Maritime

ELECTRONICS AFLOAT, Tim Bartlett	92	£8.95
GMDSS FOR SMALL CRAFT, Alan Clemmetsen	94	£11.95
RADAR FOR SMALL CRAFT, Tim Bartlett	96	£11.95
SCANNING THE MARITIME BANDS, 2nd Edition	158	£9.75
THE VHF GMDSS HANDBOOK, New Edition, Michael Gale	64	£8.95
WATCHERS OF THE WAVES, Brian Faulkner	118	£13.50

Satellite

AN INTRODUCTION TO SATELLITE COMMUNICATIONS BP326.F.A. Wilson	230	£5.95
ARRL SATELLITE ANTHOLOGY 5th Edition	150	£11.50
NEWNES GUIDE TO SATELLITE TV, Derek Stephenson	371	£19.95
SATELLITE HANDBOOK (ARRL) New Edition		
Martin Davidoff K2UBC	370	£15.50
SATELLITE PROJECTS HANDBOOK, Lawrence Harris	174	£14.99
SATELLITE TELEVISION, A layman's guide, Peter Pearson	73	£1.00
WEATHER SATELLITE HANDBOOK, 5th Edition, Dr Ralph E. Taggart WB8DGT	192	£15.50

Scanning

AN INTRODUCTION TO SCANNERS AND SCANNING BP311, I.D. Poole	152	£4.99
SCANNER BUSTERS 2, D.C. Poole	100	£6.00
SCANNERS 2 INTERNATIONAL, Peter Rouse GU1DKD	261	£12.95
SCANNERS 3 PUTTING SCANNERS INTO PRACTICE		
4th Revision, Peter Rouse	271	£10.95
SCANNERS 4 SCANNING INTO THE FUTURE, Bill Robertson	245	£10.95
SCANNING SECRETS, Mark Francis	280	£16.95
UK SCANNING DIRECTORY New 7th Edition	604	£19.50
ULTIMATE SCANNING GUIDE, Richard Allport	640	£19.99

AMATEUR RADIO

Amateur Television

AN INTRODUCTION TO AMATEUR TELEVISION		
Mike Wooding G8IQM & Trevor Brown G8CJS	156	£5.00
THE AMATEUR TV COMPENDIUM, Mike Wooding G8IQM	104	£3.50

Antennas & Transmission Lines

	Pages	Price
25 SIMPLE AMATEUR BAND AERIALS BP125, E.M. Noll	63	£1.95
26 SIMPLE INDOOR AND WINDOW AERIALS BP136, E.M. Noll	60	£1.76
25 SIMPLE TROPICAL AND MW BAND AERIALS BP145, E.M. Noll	54	£1.75
ANTENNA IMPEDANCE MATCHING (ARRL), Wilfred N. Caron	195	£15.50
ANTENNA TOOLKIT (inc. CD-ROM), Joseph J. Carr	214	£25.00
ARRL ANTENNA BOOK 18th Edition	732	£24.00
ARRL ANTENNA BOOK ON CD-ROM	n/a	O/P
ARRL ANTENNA COMPENDIUM Volume One	175	£10.50
ARRL ANTENNA COMPENDIUM Volume Two	208	£10.50
ARRL ANTENNA COMPENDIUM Volume Three, Edited by Jerry Hall K1TD	236	£11.50
ARRL ANTENNA COMPENDIUM Volume Four	204	£16.50
ARRL ANTENNA COMPENDIUM Volume Five	200	£16.50
ARRL ANTENNA COMPENDIUM Volume Six (inc CDROM)	200	£16.50
BEAM ANTENNA HANDBOOK, W.I. Orr W6SAI & S.D. Cowan W2LX	268	£8.95
BUILDING & USING BALUNS, Jerry Sevick	125	£18.95
CUBICAL QUAD ANTENNAS 3rd Edition, William Orr W6SAI and Stuart Cowan W2LX	110	£8.95
EXPERIMENTAL ANTENNA TOPICS BP278, H.C. Wright	70	£3.50
G-QRP CLUB ANTENNA HANDBOOK		
Compiled and edited by P. Linsley G3PDL & T. Nicholson KA9WRU/GWOLNQ	155	£7.25
HF ANTENNA COLLECTION (RSGB), Edited by Erwin David G4LQI	233	£9.99
HF ANTENNAS FOR ALL LOCATIONS (RSGB), Les Moxon G6XN	322	£7.99
MORE OUT OF THIN AIR (PWP)	112	£6.95
ON4UN'S LOW BAND DXING (ARRL), J. Devoldere	330	£23.00
PHYSICAL DESIGN OF YAGI ANTENNAS (ARRL)	270	£15.50
PRACTICAL ANTENNAS FOR NOVICES, John Heys G3BDQ	52	£6.30
PRACTICAL ANTENNA HANDBOOK 3rd Edition, (inc. software) Joseph J. Carr	580	£32.45
PRACTICAL WIRE ANTENNAS RSGB, John Heys G3BDQ	100	£8.95
RADIO ANTENNAS & PROPAGATION, William Gosling	260	£19.99
RADIO AMATEUR ANTENNA HANDBOOK, W.I. Orr W6SAI & S.D. Cowan W2LX	188	£8.95
RECEIVING ANTENNA HANDBOOK, Joe Carr	189	£17.50
SIMPLE, LOW-COST WIRE ANTENNAS FOR RADIO AMATEURS	224	£8.95
THE RIGHT ANTENNA, How To Select & Install Antennas For Entertainment & Communication Devices, 2nd Edition, Alvis J. Evans	78	£16.95
THE TRUTH ABOUT CB ANTENNAS, (Orr & Cowan) W.I. Orr W6SAI & S.D. Cowan W2LX	188	£8.95
VERTICAL ANTENNAS, W.I. Orr W6SAI & S.D. Cowan W2LX	192	£8.95
VERTICAL ANTENNA CLASSICS (ARRL), R. Schetsen	123	£11.50
W1FB'S ANTENNA NOTEBOOK (ARRL), Doug DeMaw W1FB	123	£6.00
WIRE ANTENNA CLASSICS (ARRL)	144	£11.50
YOUR ANTENNA COMPANION, Paul Danzer	130	£7.50

Beginners (inc RAE)

AN INTRODUCTION TO AMATEUR RADIO - New Edition, Ian Poole G3YWX	160	£4.99
BASIC RADIO PRINCIPLES & TECHNOLOGY, Ian Poole G3YWX	282	£14.99
BASIC RADIO & ELECTRONIC CALCULATIONS, Ray Petri GOOAT	160	£13.95
AN RAE STUDENTS NOTEBOOK, Bob Griffiths G7NH8	76	£6.95
PRACTICAL RECEIVERS FOR BEGINNERS (RSGB), John Case GW4HWR	165	£14.50
PRACTICAL TRANSMITTERS FOR NOVICES, John Case GW4HWR	126	£12.50
RADIO AMATEURS EXAMINATION/END OF COURSE TEST PAPERS, Ray Petri GOOAT	104	£13.95
RAE MANUAL (RSGB), New Revised Edition	127	£15.00
THE NOVICE LICENCE STUDENT'S NOTEBOOK, John Case GW4HWR	124	£6.00
THE NOVICE RADIO AMATEURS EXAMINATION HANDBOOK (BP378)		
Ian Poole G3YWX	150	£4.95
THE RADIO AMATEURS' QUESTION & ANSWER REFERENCE MANUAL, Fifth Edition, Ray Petri GOOAT	208	£13.95
TRAINING FOR THE NOVICE LICENCE A MANUAL FOR THE INSTRUCTOR (RSGB) John Case GW4HWR	101	£6.75
YOUR FIRST AMATEUR STATION, (RSGB) Colin Redwood G6MXL	120	£5.75

Callbooks

JOINT INTERNATIONAL & NORTH AMERICAN CALLBOOK (CD-ROM)	n/a	£30.00
PW UK & EIRE AMATEUR CALLSIGN (CD-ROM)	n/a	£7.50
RSGB YEARBOOK 2000 EDITION	432	£19.99

Computing

AN INTRODUCTION TO THE WORLDWIDE WEB FOR PC AND MAC USERS, (BP390) D.C. & O. Bishop	148	£6.99
HOW TO EXPAND & UPGRADE YOUR PC BP450		
R. A. Penfold	170	£6.99
INTERFACING PCs AND COMPATIBLES BP487, R. A. Penfold	86	£4.99
NEWNES COMPUTER ENGINEER'S POCKET BOOK Third Edition, Michael Tooley	256	£12.95
PERSONAL COMPUTERS IN THE HAM SHACK (ARRL)	284	£11.50
THE INTERNET AND WORLD WIDE WEB EXPLAINED, J. Shelley	130	£5.95
WINDOWS '98 ASSISTANT (BP454) I. Sinclair	160	£6.99
WINDOWS '98 EXPLAINED (BP456), N. Kantaris & P. Oliver	160	£6.99
WINDOWS '98 - HARD DISK & FILE MANAGEMENT, (BP455) J. Getandy	160	£6.99

EMC

ARRL RFI BOOK (Practical Cures For Radio Frequency Interference)	316	£15.50
INTERFERENCE HANDBOOK, William R. Nelson WA6FGG	250	£9.50
RSGB GUIDE TO EMC, 2nd Edition, Robin Page-Jones G3JWL	204	£18.50

Historical

100 RADIO HOOK UPS, 2nd Edition (reprinted)	48	£3.35
1934 OFFICIAL SHORT WAVE RADIO MANUAL, Edited by Hugo Gernsback	260	£11.85
COLLECTOR'S GUIDE TO TRANSISTOR RADIOS (2nd Edition), Marty & Sue Bunis	320	£16.95
COMMUNICATIONS RECEIVERS - THE VACUUM TUBE ERA, R.S. Moore	141	£17.95
GUIDE TO OLD RADIOS, POINTERS, PICTURES, PRICES, David & Betty Johnson	278	£19.95
HENLEYS 222 RADIO CIRCUIT DIAGRAMS (1924)	271	£9.45
HOW TO BUILD THE TWINPLEX REGENERATIVE RECEIVER, Lindsay	63	£5.75
HOW TO BUILD YOUR FIRST VACUUM TUBE REGENERATIVE RECEIVER, T.J. Lindsay	127	£7.30
HOW TO BUILD YOUR RADIO RECEIVER (A4) (Popular Radio Handbook No. 1)	100	£6.95
HOW TO MAKE A NEUTRODYNE RECEIVER, Webb	63	£5.00
OLD TIME RADIOS - RESTORATION & REPAIR, J. Carr	256	£20.95
SECRETS OF HOMEBUILT REGENERATIVE RECEIVERS (Rockey)	127	£7.95
SEEING BY WIRELESS - THE STORY OF BAIRD TELEVISION, Ray Herbert	27	£4.95
THOSE GREAT OLD HANDBOOK RECEIVERS (1929 - 1934)	94	£6.95
TRANSISTOR RADIO! - A COLLECTOR'S ENCYCLOPEDIA & PRICE GUIDE		
David & Robert Lane	170	£19.95
VISION BY RADIO (1925) (Jenkin)	140	£7.85
DOUBLE TESLA-ODDIN COIL	24	£3.95

STOP PRESS!

ML&S Appointed Official UK distributor for JRC Ham products.

Continuing the success of ML&S for short wave & Scanning equipment in the U.K., we are proud to announce our appointment by JRC U.K. Ltd. All products purchased from ML&S will therefore be backed by the UK importer.

Internationally accepted as the benchmark receiver throughout the world, the NRD-545 is still the professional's choice.

Specifications

- Frequency Range .1 - 29.9999MHz
- Type of reception USB, LSB, CW, RTTY, AM, FM, WFM (When CHE-199 installed)
- Memories 1000 channels
- Receiving system Triple superhetrodyne
- Image rejection 70dB or more
- IF rejection 70dB or more
- Dimensions 330W x 130H x 285D (mm)
- Weight Approx. 7.5kg

Features

- Digital Signal Processing by One-Chip DSP
- Wide Band 30-2000MHz
- Converter option (CHE-199)
- Remote control by PC

SEE THE NEW 'SHOPPING BASKET' ML&S WEB SITE AND

The JRC NRD 545 Deluxe Receiver

Save almost **£500 off the package deal & pay nothing until February 2001**

RRP £1699 ML&S £1299!
Also available on finance,
NO DEPOSIT & 48 payments
of only £39.53, p/m

Special Package Deal

A new NRD-545 with matching Deluxe Speaker NVA-319 & optional VHF/UHF converter CHE-199 allowing coverage on AM/FM/WBFM up to 2000MHz.

Total RRP £2197.00 ML&S £1649.
Also available on finance, NO DEPOSIT & 48 payments of only £57.63 p/m



NEW Icom ICR-3e

It seems Icom have done it again, with the far eastern release of the worlds first handheld scanner receiver, with something extra special to keep you interested even if the waves are dead: a fully functional, built-in multi mode colour TV! This breathtaking achievement has had everyone at Northfield Avenue gasping all day, and we haven't even seen a full spec yet! however, we've managed to gather the following tidbits from our friends at Icom...

- PAL TV
Receive: audio and video at full scan rate!
- Wideband Scanner Receiver
- .495KHz - 2450MHz Frequency coverage.
- Full Range of accessories
- Dual Receive.

Expected
Nov!!!



Yaesu VR-500 Pocket Scanner

100kHz - 1.3GHz
AM/FM/WFM/SSB/CW
BAND SCOPE
PC PROGRAMMABLE
Only £199.95

NEW YAESU VR5000

Yaesu have just announced a new base scanner. This is their first scanner

Features include:

- 12 volt operation
- 100kHz - 25999.9998MHz frequency range
- Operating modes are CW, LSB, USB, AM, AM-N, WAM, FMN AND WFM
- Real Time Band Scope
- 2000 memories
- World Clock
- Case size is 180w x 70 h x 203 deep. (Weight approx 1.9kg).
- Options include:
■ DSP Bandpass, Notch and Noise Reduction Filters
■ Digital Voice Recorders

CALL NOW FOR THE LATEST UPDATE.



Icom IC-R75E

AVAILABLE ON FREE FINANCE - ZERO APR
ONLY £99 DEPOSIT, THEN 12 x £50 p/m.

FREE
M-DEL AT-2 Antenna Tuner
worth £69.95

MARTIN LYNCH & SONS
140-142 NORTHFIELD AVENUE,
EALING, LONDON W13 9SB

● TEL: 0208 566 1120 ● FAX: 0208 566 1207 ●

Martin Lynch can also offer finance terms up to 48 months with no deposit. We welcome your part exchange against any

The JRC NRD-345



Whilst JRC offer the ultimate receiver in the shape of the NRD-545, for those of you who can't quite convince yourself, the NRD-345 makes a low cost alternative. Simple to use and built to the same standards as its big brother, take a closer look at the 345 and of course the price!

- .1 - 30MHz Coverage
- AM/CW/SSB/Fax
- AM Synchronous Detection
- One Chip DDS-1C Digital Synthesizer
- Noise Blanker
- High Sensitivity & wide dynamic range

RRP £699 **ML&S £399**

Also available of finance, NO DEPOSIT & 24 payments of £20.31 p/m.

NEW AOR AR-8600

At last the long-awaited base version of the AOR8200. While the operation and logic of this unit are the same as the AOR8200 the AOR8600 front end is re-designed to cope with base antennae. This radio will be at

home in the car or on the desk top. Coverage is 500kHz - 2040MHz.

Options include computer control, Plug-in memory module for 400 memories, CTCSS decode, Record Chip for 20 seconds of audio, Tone Eliminator and Voice Inverter.

PRICE TO BE ANNOUNCED



AOR AR-5000A

RRP £1395.00
NO DEPOSIT,
THEN 36 x £51.85 p/m.

AOR AR-5000+3

The AR-5000+3 including AFC, Synchronous AM & noise blanker.
RRP £1699 NO DEPOSIT,
THEN 36 X £58.54 p/m.



AOR AR-3000A

RRP £699.00
NO DEPOSIT,
THEN 36 x £25.98 p/m.

AOR AR-3000A plus

RRP £819.00
NO DEPOSIT,
THEN 36 x £30.44 p/m.

FULL RANGE OF DRESSLER ANTENNAS NOW BACK IN STOCK!



Icom PCR-1000
FREE MyDEL AT2!
RRP £349.
DSP UT-106 at only £59.95.
AVAILABLE ON FREE FINANCE - ZERO APR
ONLY £49 DEPOSIT, THEN 12 x £25 p/m.
including a FREE MyDEL ATU AT2 worth £69.95!



Icom ICR-2E
Including matching Icom LC-143 carry case & FREE carriage.
£149.00



AOR AR-8200 MkII
Now with higher power NiCads, TXCXO, New Black Cabinet and other enhancements.
In stock in limited numbers at £419.00
No deposit and 36 x £15.57 p/m.

Garmin Street Pilot

The Street pilot is an excellent in car GPS unit with map detail down to street level.



The amber backlit display is easy to read and makes the unit ideal for navigation in unknown territory. The Street Pilot is also at home with APRS when used in conjunction with a THD7E or TMD700E. Supplied with *The UK Metro Guide* on CD Rom, an 8mb Ram module cigar Lead, PC lead and a magnetic roof mount antenna the system is all ready to go at **£595.00** including delivery to your Door.

Garmin E Map

The Garmin Emap is a hand held version of the Street Pilot and comes with Data lead, 8 mb Ram Card & *UK Metro Guide* on CD Rom at only **£329.00**.



The Garmin GPS3plus

The ever popular GPS3 now has more map detail and allows upload to street level. Available at **£339.00**



Road and Recreation CD Rom available at £99.00

dressler active antennas

This outstanding range is ideal for use with all base station receivers, the ICR-8500, AR-5000, PCR-1000, NRD-545, FRG-100 & more! Beautifully constructed and designed in Germany - we are pleased to be appointed for this range of products.

FINANCE EXAMPLE

All examples do not include P&P.

Cash Price	Deposit	PAID IN 6 MONTHS	APR
£299	NIL	£299	0%
OR			
Cash Price	36 Payments of	Total Credit Price (T.A.P.)	APR
£299	£12.98	£467.28	26.9%

Written quotations available on request

	Pages	Price
RADIO TESLA - THE SECRET'S OF TESLA'S RADIO AND WIRELESS POWER	36	£5.30
TESLA COIL	24	£3.95
TESLA - THE LOST INVENTIONS	32	£4.75
TESLA - THE TRUE WIRELESS	16	£3.95
THE MAN WHO INVENTED THE TWENTIETH CENTURY: NIKOLA TESLA, FORGOTTEN GENIUS OF ELECTRICITY	245	£12.99
THE TESLA HIGH FREQUENCY COIL (1910)	120	£6.95

Crystal Set Books (Xtal Set Society)

THE XTAL SET SOCIETY NEWSLETTER, Volume 1 & 2 Combined, Phil Anderson W0XI	96	£14.00
THE CRYSTAL SET HANDBOOK & VOL. 3 XTAL SET SOCIETY NEWSLETTER, Phil Anderson W0XI	134	£8.00
THE XTAL SET SOCIETY NEWSLETTER, Volume 4, Phil Anderson W0XI	88	£7.00
CRYSTAL SETS, The Xtal Set Society Newsletter, Volume 5, Phil Anderson W0XI	88	£7.00
CRYSTAL SET BUILDING & MORE (Vol 6 & 7 of Xtal Set Society Newsletter)	168	£11.00
CRYSTAL RADIO HISTORY, FUNDAMENTALS AND DESIGN, P.A. Kinzie	122	£8.00
CRYSTAL SET PROJECTS - 15 RADIO PROJECTS YOU CAN BUILD, Phil Anderson	160	£10.00
CRYSTAL SET LOOPERS; A3 TUBER & MORE, Volume 8 Xtal Set Society Newsletter	128	£10.50

Maps & Log Books

AMATEUR RADIO LOGBOOK (RSGB)	50	£3.75
AMATEUR RADIO WORLD ATLAS (A4 SIZE)	20	£8.00
GREAT CIRCLE MAP 600mm x 600mm	n/a	£1.50
NORTH ATLANTIC ROUTE CHART	740 x 520mm	£9.00
QTH LOCATOR MAP OF EUROPE, New Edition	1080 x 680mm	£7.00
RADIO AMATEURS MAP OF THE WORLD, New Edition	980 x 680mm	£7.00
RECEIVING STATION LOG BOOK (RSGB)	60	£3.75

Morse

SECRETS OF LEARNING MORSE CODE Mark Francis	84	£6.95
---	----	-------

Microwaves

AN INTRODUCTION TO MICROWAVES (BP312), F.A. Wilson	134	£3.95
ARRL UHF/MICROWAVE EXPERIMENTER'S MANUAL, Various Authors	446	£15.50
ARRL UHF/MICROWAVE PROJECT MANUAL VOL 2	160	£11.50
ARRL UHF/MICROWAVES PROJECT MANUAL (ARRL)	352	£16.50
MICROWAVE & WIRELESS COMMUNICATIONS TECHNOLOGY, Joseph J. Carr	436	£36.00
MICROWAVE HANDBOOK - COMPONENTS & OPERATING VOL 1 (RSGB)	110	£12.00
MICROWAVE HANDBOOK - CONSTRUCTION & TESTING VOL 2 (RSGB)	120	£18.99
MICROWAVE HANDBOOK - BANDS & EQUIPMENT VOL 3 (RSGB)	140	£18.99

Operating & Handbooks

ALL ABOUT HAM RADIO, Harry Helms	290	£16.50
ARRL HANDBOOK 2000 76th Edition	380	£24.00
ARRL HANDBOOK 2000 ON CDROM	n/a	£33.00
ARRL OPERATING MANUAL NEW EDITION	420	£18.50
ARRL RADIO BUYERS SOURCEBOOK VOL 1.1 (QST Reviews 1981-1991)	280	£11.50
ARRL RADIO BUYERS SOURCEBOOK VOL 1.2 (QST Reviews 1991-1993)	240	£11.50
ARRL VHF/UHF RADIO BUYER'S SOURCEBOOK	120	£11.50
COMPLETE DX'ER, Bob Locher	204	£9.50
DISCOVERING DXING (2nd Edition), John Zondlo	90	£7.50
HAM RADIO MADE EASY (ARRL), Steve Ford	204	£11.50
HINTS AND KINKS FOR THE RADIO AMATEUR, Edited by Charles L. Hutchinson and David Newkirk	129	£9.50
LOW PROFILE AMATEUR RADIO (ARRL), Jim Kearman KR1S	124	£7.50
SETTING UP AN AMATEUR RADIO STATION BP300, I.D. Poole	81	£3.95
TRANSMITTER HUNTING - RADIO DIRECTION FINDING SIMPLIFIED, Joseph D. Moell & Thomas N. Curlee	325	£24.95

Packet

HF DIGITAL COMPANION, Steve Ford	120	£7.50
NOS INTRO: TCP/IP OVER PACKET RADIO, Ian Wade G3NRW	356	£11.50
PACKET RADIO PRIMER (RSGB), Dave Comber G8UYZ & Martyn Corft G8NZU	266	£8.95
PACKET, SPEED & MORE SPEED APPLICATIONS (ARRL)	148	£10.50
PRACTICAL PACKET RADIO, Stan Horzepa	140	£10.50
YOUR PACKET COMPANION, Steve Ford W881MY	170	£7.50

Propagation

AN INTRODUCTION TO RADIO WAVE PROPAGATION BP293, J.G. Lee	116	£3.95
YOUR GUIDE TO PROPAGATION (RSGB) Ian Poole	88	£6.95

QRP

ARRL LOWER POWER COMMUNICATIONS - THE ART & SCIENCE OF QRP, Richard Arland K7SZ	204	£11.50
QRP POWER (ARRL)	188	£11.50
G-QRP CLUB CIRCUIT HANDBOOK, Edited by Rev. G. Dobbs G3RJV	96	£9.00
INTRODUCING QRP, Dick Pascoe G0BPS	48	£6.95
W1FB'S QRP NOTEBOOK (ARRL), 2nd Edition, Doug DeMaw W1FB	175	£8.00

Test Equipment

AN INTRODUCTION TO THE ELECTROMAGNETIC WAVE BP315, F.A. Wilson	122	£4.95
BUILD YOUR OWN TEST EQUIPMENT, Davidson	285	£19.95
GETTING THE MOST FROM YOUR MULTIMETER BP239, R.A. Penfold	102	£2.95
HANDS-ON GUIDE TO OSCILLOSCOPES, Barry Ross	228	£20.95
HOW TO USE OSCILLOSCOPES & OTHER TEST EQUIPMENT BP267, R.A. Penfold	104	£3.50
OSCILLOSCOPES - HOW TO USE THEM/HOW THEY WORK, 4th edition, Ian Hickman	259	£17.99

	Pages	Price
TEST EQUIPMENT CONSTRUCTION BP248, R.A. Penfold	104	£3.99
TEST EQUIPMENT FOR THE RADIO AMATEUR, Clive Smith G4FZH	170	£10.95

VHF

ALL ABOUT VHF AMATEUR RADIO, W. I. Orr W6SAI	163	£8.95
VHF/UHF HANDBOOK (RSGB), Dick Bliddulph G8PDS	180	£22.00
YOUR MOBILE COMPANION, Roger Butch	190	£8.50
YOUR VHF COMPANION, Steve Ford	230	£7.50

ELECTRONICS

General

BEGINNERS GUIDE TO MODERN ELECTRONIC COMPONENTS BP285	166	£4.99
CIRCUIT SOURCE BOOK 1 - BP321, R.A. Penfold	182	£4.95
CIRCUIT SOURCE BOOK 2 - BP322, R.A. Penfold	214	£4.95
DIGITAL ELECTRONICS (CD-ROM), Mike Tooley	n/a	£45.00
ELECTRONIC PROJECT BUILDING FOR BEGINNERS, R. Penfold, (BP392)	110	£4.95
ENCYCLOPEDIA OF ELECTRONIC CIRCUITS Vol. 7	1128	£32.95
FAULT FINDING ELECTRONIC PROJECTS BP381	133	£4.99
GETTING STARTED IN PRACTICAL ELECTRONICS BP345, Owen Bishop	198	£4.95
HOW ELECTRONIC THINGS WORK ... AND WHAT TO DO WHEN THEY DON'T, Goodman	196	£16.95
HOW TO TEST ALMOST EVERYTHING ELECTRONIC	326	£16.95
LADDER CRYSTAL FILTERS, John Fivnichny N2DCH	134	£14.95
NEWNES AUDIO AND HI-FI ENGINEER'S POCKET BOOK 3rd Edition, Vivian Capel	210	£14.95
PARTS GALLERY & ELECTRONICS CIRCUITS & COMPONENTS (CD-ROM), Mike Tooley	n/a	£35.00
PICTUTOR (CD-ROM), John Decker	n/a	£45.00
POWER SUPPLY PROJECTS BP76, R.A. Penfold	89	£3.99
PRACTICAL DIGITAL ELECTRONICS FOR TECHNICIANS, Will Kimber	262	£12.99
PRACTICAL ELECTRONIC FILTERS BP299, Owen Bishop	89	£4.95
PRACTICAL ELECTRONICS HANDBOOK, Ian Sinclair	439	£14.95
PRACTICAL OSCILLATOR CIRCUITS BP393, A. Flind	136	£4.99
RADIO ENGINEERS FACTFINDER FOR WINDOWS (Floppy Disk) John Davies	n/a	£18.00
RADIO FREQUENCY TRANSISTORS, PRINCIPLES & PRACTICAL APPLICATIONS Dye/Granberg (Motorola), Hardback	235	£39.95
SCROGGIES - FOUNDATIONS OF WIRELESS & ELECTRONICS, 11th Edition	292	£19.99
TECHNICAL TOPICS SCRAPBOOK (RSGB), 1990-94, Pat Hawker	310	£13.50
THE ART OF SOLDERING BP324, R. Brewster	84	£3.99
UNDERSTANDING BASIC ELECTRONICS (ARRL)	314	£15.50
UNDERSTANDING DIGITAL TECHNOLOGY, F. Wilson, (BP376)	110	£4.95
W1FB'S DESIGN NOTEBOOK (ARRL), Doug DeMaw W1FB	195	£8.00

Data

ARRL ELECTRONICS DATA BOOK, Doug DeMaw W1FB	260	£8.95
ELECTRONIC HOBBYIST DATA BOOK BP396, R.A. Penfold	242	£5.95
LF SOURCE BOOK (RSGB) 2nd Edition, Peter Dodd	130	£8.99
PRACTICAL ELECTRONIC DESIGN DATA BP316, Owen Bishop	327	£5.99
PRACTICAL RF HANDBOOK (2nd Edition), Ian Hickman	302	£19.99
RF CIRCUIT DESIGNS, Chris Bowick	176	£18.99
SECRETS OF RF CIRCUIT DESIGN, New Edition (Hardback) Joseph Carr	405	£41.95
SOLID STATE DESIGN FOR THE RADIO AMATEUR (ARRL) Les Hayward W7Z0I & Doug DeMaw W1FB	256	£11.50
SPREAD SPECTRUM SOURCE BOOK	320	£15.50
TOWERS INTERNATIONAL MOSPOWER & OTHER FET SELECTOR	140	£19.95
TOWERS INTERNATIONAL TRANSISTOR SELECTOR - UPDATE 5	476	£24.95
TRANSISTOR DATA TABLES (BP401)	178	£5.95

Projects

33 SIMPLE WEEKEND PROJECTS/CO	68	£7.95
BUILD YOUR OWN INTELLIGENT AMATEUR RADIO TRANSCEIVER, Randy L. Henderson	350	£26.95
COIL DESIGN & CONSTRUCTION MANUAL BP160, B.B. Babani	106	£3.95
HOW TO DESIGN & MAKE YOUR OWN PCBs BP121, R.A. Penfold	66	£3.99
MORE ADVANCED POWER SUPPLY PROJECTS BP192, R.A. Penfold	92	£2.95
POWER SUPPLY PROJECTS (A collection of innovative and practical design projects), Newnes	170	£10.95
PROJECTS FOR RADIO AMATEURS & SWLs BP304, R.A. Penfold	92	£3.95
RADIO RECEIVER PROJECTS YOU CAN BUILD	312	£20.95
SIMPLE SHORT WAVE RECEIVER CONSTRUCTION BP275, R.A. Penfold	88	£3.95

Valves/Tubes

ELECTRON TUBE LOCATOR, George H. Fathauer	350	£21.95
ESSENTIAL CHARACTERISTICS (TUBES & TRANSISTORS) (Original publishers General Electric)		
Re-published by Antique Electronic Supply (Arizona)	475	£10.50
HANDBOOK OF RADIO, TV, INDUSTRIAL & TRANSMITTING TUBE & VALVE EQUIVALENTS	60	£2.95
RADIO VALVE GUIDE BOOK VOL 1	54	£2.95
RADIO VALVE GUIDE BOOK VOL 2	42	£2.95
RADIO VALVE GUIDE BOOK VOL 3	40	£2.95
RADIO VALVE GUIDE BOOK VOL 4	48	£2.95
RADIO VALVE GUIDE BOOK VOL 5	44	£2.95
MASTER INDEX TO VALVE TYPES, BOOKS 1-5	40	£1.50
RCA RECEIVING TUBE MANUAL (Original Publishers Radio Corporation Of America), Re-published by Antique Electronic Supply (Arizona)	384	£10.50
RCA TRANSMITTING TUBES (Original Publisher Radio Corporation of America) Re-published by Antique Electronic Supply (Arizona)	318	£10.50
TUBE SUBSTITUTION HANDBOOK	150	£15.50
VALVE AMPLIFIERS, Morgan Jones	374	£25.00
VALVE & TRANSISTOR AUDIO AMPLIFIERS, John Lindsay Hood	310	£19.95

CALL SHELAGH OR JEAN ON

Telephone
(01202) 659930

Check out our Website for a selected description of these books

www.pwpublishing.ltd.uk/books



OR USE THE ORDER FORM ON PAGE 76

Please note: Cash not accepted with mail orders.

ASK ELECTRONICS LTD

248/250 TOTTENHAM COURT ROAD
LONDON W1P 9AD

Tel: 0171-637 0353/0590
Fax: 0171-637 2690

PLEASE MAKE ALL
CHEQUES PAYABLE
TO: ASK ELECTRONICS
All products are
subject to a posting &
packaging charge

YOUR SONY SPECIALIST

All products covered by a total
manufacturers guarantee

NEW FROM SONY

ICF-SW1000T RRP £449.....	ASK price £360.00
<i>As reviewed in Short Wave Magazine April '96 issue</i>	
ICF-SW77150-29995kHz, usb/lb cw, 160 mem-ories & labelling facility, 5 event timer, world timer RRP £429.95.....	ASK price £330.00
ICF-SW07 New inc PSU &	
ANLP-1 antenna.....	ASK price £250.00
ICF-SW55 RRP £299.95.....	ASK price £225.00
ICF-SW100E RRP £219.95.....	ASK price £169.95
ICF-SW100S Includes AN-100 & dual voltage mains adaptor.....	£199.95
ICF-SW7600G RRP £199.95.....	ASK price £120.00
ICF-SW30 RRP £79.95.....	ASK price £69.95
ICF-SW10 RRP £49.95.....	ASK price £39.95
ICF-SW40 RRP £119.95.....	ASK price £84.95
AN1 Active SW antenna RRP £74.95.....	ASK price £59.95
AN-71 Wire antenna.....	£7.99
AN-100 Active antenna for ICF-SW100 or ICF-SW7600G.....	£49.95
AN-102 Compact active antenna.....	£59.95
AN-71 antenna.....	£59.95

ROBERTS

R-862.....	£30.00
R-881.....	£70.00
R-809.....	£90.00
R-876.....	£115.00
R-827.....	£140.00
R-861.....	£175.00
RC-828.....	£189.00

GRUNDIG

Yacht Boy 500 ..	£79.95
Yacht Boy 400 ..	£89.95

We also stock a range
of books for frequency
scanning

SANGEAN

ATS-909.....	£160.00
ATS-818ACS.....	£165.00
ATS-818.....	£120.00
ATS-808.....	£85.00
ATS-606.....	£105.00
ATS-404.....	£60.00
ATS-305.....	£60.00

GARMIN GPS SYSTEMS

Street Pilot UK - in car navigation system with street level mapping includes Atlantic international database, UK Metroguide Mapsource CD, 8mb datacard, PC interface and cigar lighter adaptor, dashboard mount.....**£Phone**
Street Pilot - as above but no Metroguide and datacard.....**£Phone**
Street Pilot Colour Map UK - as Street Pilot UK but colour.....**£Phone**
Street Pilot Colour Map - as Street Pilot but colour.....**£Phone**
EMAP UK - as Street Pilot UK but hand-held and no cigar lighter adaptor.....**£Phone**
EMAP - as Street Pilot but no cigar lighter adaptor.....**£Phone**
GPS III plus - car or portable GPS with Atlantic international database,

display switch able from landscape to portrait, removable antenna, accepts down loaded map data from various map source CDs.....**£Phone**
GPS 12 Map - as above except display is not switchable.....**£Phone**
GPS III Plus - European city point data switchable display.....**£Phone**
GPS 12CX - hand-held GPS with colour display, city point data.....**£Phone**
GPS 12XL - hand-held GPS with city point data.....**£Phone**
GPS 12 - hand-held GPS.....**£Phone**
Etrex - smallest hand-held GPS.....**£Phone**
GPS 48 - includes city point and marine database.....**£Phone**
MAP SOURCE CD'S, DATA CARD AND A FULL RANGE OF GARMIN ACCESSORIES IN STOCK

SCANNERS & TRANCEIVERS

YUPITERU

MVT-9000MkII 100kHz-1.99GHz, all mode.....	£319.95
MVT-7100 100kHz-1.65GHz all mode.....	£195.00
VT-225 Civil and military air band receiver.....	£199.95
VT-125 Civil airband receiver.....	£159.95
MVT-8000 Base/mobile receiver, 200kHz-1.3GHz.....	£294.95

ICOM

IC-R2 500kHz-1300MHz, AM, FM, WFM, 400 ch, hand-held communications receiver.....	£135.00
IC-R10 100kHz-1300MHz, all mode, 1000 channels hand-held communications receiver.....	£270.00
IC-PCR100 100kHz-1300MHz, AM, FM, WFM, PC communications receiver.....	£185.00
IC-PCR1000 100kHz-1300MHz, all mode PC communications receiver.....	£325.00
IC-R75 30kHz-60MHz, AMS, AM, FM, USB, LSB, RTTY, CW.....	£645.00

AOR

AR7030 High quality short wave receiver with remote control.....	£675.00
AR7030 Plus an enhanced version of the above.....	£750.00
AR5000 10kHz-2600MHz all mode receiver.....	£1295.00

AR5000+ An enhanced version of the above.....	£1460.00
AR3000A 100kHz-2036MHz all mode.....	£695.00
AR3000A+ An enhanced version of the above.....	£780.00
AR8000 Handy 530kHz-1900MHz all mode.....	£289.95
AR8200 Handy 530kHz-2040MHz all mode.....	£340.00
ARD2 ACARS and Navtex decoder and display.....	£295.00
SDU5000 Spectrum display unit SRP £799 now only.....	£480.00
SDU5500 New version of SDU5000 including PSU.....	£770.00

ALL AOR ACCESSORIES ARE AVAILABLE

YEASU

VR-500 Compact handy 500kHz-1300MHz all mode.....	£???.??
---	---------

License free transceivers

FOR COMMERCIAL AND LEISURE USE

Motorola TA200.....	£130.00 for 2
TA288.....	£190.00 for 2, rechargeable battery included
Handiepro.....	£320.00 for 2, rechargeable battery included
Icom IC-F4SR.....	£160.00 (PMR-446 or SRBR)
Kenwood TK-361.....	£160.00 (PMR-446 or SRBR)
Cobra PMR-250.....	£115.00 (rechargeable battery included)
PMR-300.....	£125.00 (rechargeable battery & vibracall)
Multicom PRO.....	£115.00

For the best prices give us a call on: 0171-637 0353



RIG
Remote Imaging Group™

Do you know that there are weather satellites passing overhead right now?

With fairly simple equipment YOU could be receiving their weather pictures at home!

The Remote Imaging Group is an international group of over 2000 enthusiasts who are interested in receiving weather satellite transmissions from all over the world. We publish a 100 page quarterly journal that contains articles and information related to the reception of weather satellite meteorological transmissions. The journal includes regular articles on meteorology, and understanding weather satellite images, it also contains reviews and constructional articles as well as lots of images, some in colour! RIG maintains a large shareware and image library for members' use and provides comprehensive helplines for those that need it. RIG also endeavours to provide all the equipment required to receive weather satellite images directly, and also carries adverts from manufacturers that give generous discounts ONLY to RIG members! In short the benefits of membership are too good to miss so why not join our 2000 plus international membership NOW?

Membership rates are for a FULL year's journals (x4):-
£11 (UK) £13 (EU outside UK) £15 (Outside EU).

For more information visit our internet website at:-
<http://www.rig.org.uk>

For a free information pack send a large SAE to:-
**RIG - S5D, 34 Ellerton Road, Surbiton
Surrey KT6 7TX, England**



SSE HIGH QUALITY ACCESSORIES
Solid State Electronics (UK)
SCANNING RECEIVERS · PMR 446 · CB · AMATEUR RADIO

1. **JIM PSU-101A Mk5.** UK manufactured 230V AC professional PSU with adjustable Radio Base Holder combined. For Pocket Scanners, LPD's, PMR 446, etc. Two DC output sockets, one for the Radio, one for accessories. **12 VOLT DC** output. A 9 volt version is available. CE approved. **PRICE: £26.95**

2. **JIM PSU-101AC Mk5.** As above but includes a **12"** fitted 50 ohm cable BNC to BNC socket. **PRICE: £29.95**

3. A UK manufactured adjustable **DESK HOLDER STAND** for PMR 446, Pocket Scanners, CB, Ham, PMR, Marine, etc. A choice of two models. **BHA3A** - NO coaxial cable. **PRICE: £13.95.** **BHA3AC** - Includes 50 ohm cable with BNC to BNC with a 'right angle' BNC plug. **PRICE: £15.95**



4. A unique Radio Holder by SSE for use with Pocket Scanners and Handheld Transceivers fitted with 'BELT CLIPS'. For use in **Cars, Trucks, Boats**, etc. Keep your valuable radio secure and NOT on the floor. NO risky tape or Air Vent fittings. **JIM RHM-2000. PRICE: £8.95**

5. **NF.96XI-1.** Adjustable "RF" Notch Filter (not shown) for scanning RX, etc. Reduce the problems of overload, breakthrough, paging tones and SW interference. Tuning range approximately 80-190MHz (use up to approximately 2000MHz). Professional die-cast box with BNC sockets. **PRICE: £24.00**



Payment by **POSTAL ORDER** or **CHEQUE**. Standard postage is **(PLUS) £1.75 per order within the UK.**

NOTE: For further information on SSE products send a **A5 SAE** to:
Solid State Electronics (UK) SWM
6 The Orchard, Bassett Green Village, Southampton SO16 3NA
Tel: 023 80769598 · Fax: 023 80768315
Email: soldstate@ssejlm.co.uk
Visit our web site: www.ssejlm.co.uk

The **JIM** logo is a registered trade mark of Solid State Electronics (UK)

TELFORD RADIO RALLY 2000

New Unique Location **SIMPLY THE BEST?**
**RAF MUSEUM COSFORD
SHROPSHIRE**

2 miles S on A41 off J3 - M54

SUNDAY 10 SEPTEMBER

IMPORTANT - Gates open 10.00 hrs until 17.00 hrs

Buy, Sell or Browse amongst the AIRCRAFT

Amateur Radio & Computer Equipment plus Components

TELFORD RALLY
2000

**EVENT
OF THE
YEAR**

Royal Air Force Museum
COSFORD

REFRESHMENTS & BAR - possibly BBQ

TALK IN - S22

ENTRY Adult £4.50 · Child £2.75 · Seniors £3.50 **PARKING FREE**

DETAILS - GENERAL **Bob M5BWQ 01952.770922**
bob@somrob.u-net.com

DETAILS - TRADERS **Jim G8UGL 01952.684173**
jim@tweedale15.freemove.co.uk

WEB SITE - www.telford-rally.co.uk



The **SHORTWAVE** Shop

18 FAIRMILE ROAD, CHRISTCHURCH, DORSET BH23 2LJ
Phone Fax 01202 490099 SHORTWAVE HOTLINE: 07000 CQDXCQ (273927)

THE COMMUNICATION SPECIALISTS

Receivers - Scanners - Transceivers

Call & discuss which part of the radio spectrum you wish to operate and we will advise you on the most cost effective way achieving it.

● Full range of new & secondhand equipment available.

● We stock all leading brands:-
Airband Amateur CB, Marine Shortwave
Licence-Free Family Radio

● Business and security radios



**LARGER
SHOWROOM**

For Year 2000

More receivers,
scanners, transceivers,
books and accessories.



SHORT WAVE ADVICE LINE
01202 490099

**ALINCO, AOR,
AKD, BEARCAT,
COMTEL, DRAKE,
FAIRHAVEN,
ICOM,
KENWOOD,
JRC, LOWE,
MAYCOM, MFJ,
OPTO,
WELLBROOK,
YUPITERU,
YAESU**



Call for latest second-hand list or visit our
website <http://www.shortwave.co.uk>

4 MILES FROM BOURNEMOUTH INTERNATIONAL AIRPORT ON B3073
300 YARDS FROM CHRISTCHURCH RAILWAY STATION, FORECOURT PARKING FOR DISABLED

29th LEICESTER AMATEUR RADIO SHOW AND CONVENTION

**150 STANDS of COMPUTERS, RADIOS and ELECTRONICS
at**

**THE CASTLE DONINGTON
INTERNATIONAL EXHIBITION
CENTRE, DONINGTON PARK
NW LEICESTERSHIRE**

less than 5 minutes from J23A & J24 M1 Motorway

on

**Friday 22nd & Saturday 23rd
SEPTEMBER 2000**

OPENING TIMES 9.30am to 5.30pm each day

Features a Convention, Flea Market, Bring and Buy, Lal & National Clubs & Societies. Morse tests on demand, demonstration amateur radio stations, camping and caravanning on site

TALK IN 145.550 & 433.550MHz

ADMISSION PRICES

**1 day ticket £3, concessions (OAPs & under 16) £2.50 2 DAY TICKET £5,
concession £4. Under 14 free when accompanied by an adult**

**FOR FURTHER DETAILS & THE MOST UP-TO-DATE INFORMATION SEE OUR INTERNET SITE at
<http://www.lars.org.uk>**

TRADERS STAND BOOKINGS

contact John Theodorson, G4MTP on tel/fax 01604 790966 E-mail g4mtp@lars.org.uk

FLEA MARKET BOOKINGS

contact John Senior, G7RXS. on 0116 284 1517, E-mail SENIORJA@aol.com

CAMPING & CARAVANNING BOOKINGS & INFO

contact Don Winters, G3IPL, 01604 830560, E-mail don.winters@virgin.net

All other enquiries to Geoff Dover, G4AFJ, on tel: 01455 823344, fax: 01455 828273,
E-mail: g4afj@argonet.co.uk

SRP TRADING

1686 Bristol Road South, Rednal, Birmingham B45 9TZ

★ ★ TRADE AND EXPORT ENQUIRIES WELCOME ★ ★



SKYSCAN V1300 DISCONE

Vertical & horizontal elements enhance reception from 25-1300MHz. Constructed from the best s/steel & aluminium. Complete with pole & pole clamps.

£49.95 + P&P



SKYSCAN DESKTOP

Desktop discone antenna for scanning receivers. Ideal for indoor use or as a car antenna when the car is stationary. Covers 25-1300MHz. Comes complete with 4m RG58 coax cable and BNC connector.

£49.00 + P&P



NEW SKYSCAN DOUBLE DISCONE

Broadband discone high gain and low radiation: 25-1300 Rx 2m Tx. Constructed of best stainless steel.

Come complete with mounting pole & brackets. Connections SO239. £39.95 + P&P



SKYSCAN DX

External tubular antenna for scanning receivers. Covers 60-1000MHz. Can be mounted to a pole or hung from a hook using loop provided. Size: 900 x 30mm. Connection SO239.

£19.95 + P&P

SKYSCAN AIRBASE

Civil airband base station antenna with extended receive capability. Civil airband antenna offering dedicated 118-137MHz Tx/Rx & 25-1300MHz Rx. Built using good quality fibreglass s/steel and chromed brass to withstand the weather. Complete with mounting tube and clamps.

Dimensions: 1100H x

1100mmW. Connection SO239. £39.95 + P&P

WIDEBANDER

Wideband "super strength" micro magnetic antenna. Wideband 25-2000MHz micro magnetic antenna featuring 30mm rare earth magnet to ensure it stays where placed. Complete with miniature 50Ω coaxial cable and BNC plug.

£29.95 + P&P



AIRBANDER

Micro magnetic car antenna for better reception on the civil aircraft band. 108-136MHz featuring 30mm rare earth magnet to ensure it stays in place. Complete with miniature 50Ω coaxial cable and BNC plug.

£19.95 + P&P



PILOT

Dedicated civil & military airband "super strength" micro magnetic antenna. 108-137MHz & 225-400MHz micro magnetic antenna. Complete with 50Ω miniature coaxial cable and BNC plug.

£24.95 + P&P



T & K STAND OFF BRACKETS

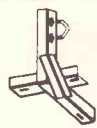

T & K stand off brackets to clear roof overhang and support masting poles for aerial erection. Available with 12", 18" and 24" stand off's.

12" £9.95 18" £11.95 24" £13.95 + P&P.

SKY SCAN TELESCOPIC

Centre loaded telescopic whip antenna for hand-held radio. Improved reception on hand-held scanners. Receives 25-1300MHz. Connection BNC type.

£9.95 + P&P



SILVER DIAMOND

Four band discone. TX 6m, 2m, 70cm & 23cm, 200W, RX25-1300MHz. Stainless steel construction. Connection type 'N'.

£29.95 + P&P



G5RV ANTENNAS

Full size G5RV is 102 feet long and transmits 80m to 10m

amateur bands. Half size G5RV is 52 feet long and transmits 40m to 10 amateur bands.

Full size G5RV £20.00 + P&P
Half size G5RV £15.00 + P&P



COAX BARGAINS

100 meter roll of RG213. Only £69.95 free + P&P.

100 meter roll of RG58 military spec. only £35.00 free + P&P.

ROTATOR AR300XL

Max load 60kg (with support bearing) 360deg. rotation in approx 65sec. (Support bearing optional £14.95)

£39.95 + P&P.



6" MINI STAND OFF

Short metal 6" standoff for light aerials. Bolts to wall or chimney stack. Complete with U-bolts.

£6.50 + P&P.

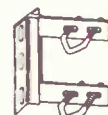

SHORT WAVE PORTABLE ANTENNA

Compact portable short wave longwire antenna on a reel.

£7.99 + P&P



SRP 2mtr/70cm BASE COLINEAR

Constructed using good quality fibreglass with stainless steel to withstand the weather. Complete with mounting equipment.

£29.95 + P&P



WIDEBAND PRE-AMP

100MHz-1GHz. With adjustable amplification level of up to 20dB. DC adaptor.

£39.95 + P&P.

PHONE!! WE ARE PROBABLY THE MOST COMPETITIVE PRICES IN THE UK PHONE!!

Yupiteru MVT-7100
Yupiteru MVT-9000
AOR AR8200 Series 2
Icom IC-R2

New!!
Yupiteru MVT-7300
New!!
Alinco DJ-X2

Uniden Bearcat
UBC-220XLT
Uniden Bearcat
UBC-3000XLT

Uniden Bearcat
UBC-9000XLT
Uniden Bearcat
UBC-860XLT

Maycom AR-108
Commтел 307
Commтел 306
etc., etc., etc

Opening times: Mon-Sat 9.30am to 5.15pm. We are Kenwood, Yaesu, Icom, & Alinco dealers.

Trade customers are you getting the best deal? Phone and find out!

Call Mary (MOBMH) or Dave on

0121-460 1581, 0121-457 7788 FAX: 0121-457 9009

Book Profiles

Short Wave Listener's Guide

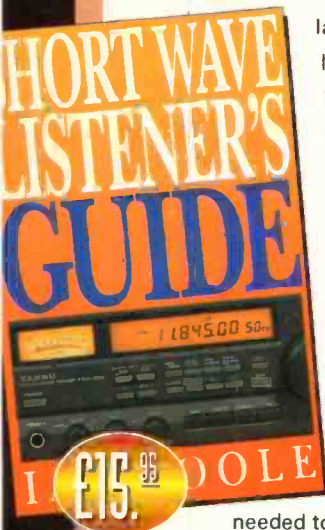

Ian Poole, one of the leading writers on radio, is the author of this complete practical guide to short wave listening. The *Short Wave Listener's Guide* explains exactly what short wave listening is, how radio waves travel, what equipment is

needed to receive a signal, how to set up and run a short wave listening station and how to obtain an amateur radio licence.

Each topic covered is clearly illustrated and explained. The practicalities of short wave listening are discussed, from buying new or second-hand and making and erecting an antenna, to selecting ancillary equipment to enhance the operation of receivers and antennas. **£15.95.**

Shortwave Radio Listening For Beginners

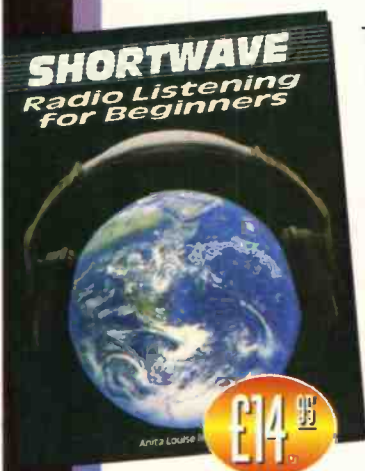

This book provides all the hands-on information you need to get off to a quick start with this fascinating hobby and listen in on today's most unique radio

This month Editor Kevin Nice has selected five titles for you to choose from. The first three are aimed at the beginner and are a worthwhile addition for those starting out. Remember, you can order your books by 'phone, FAX, E-mail or post.

broadcasts from across the country and around the world. An excellent introductory guide, this book describes in easy to understand non-technical terms: how short wave radio works, available equipment and where to find it, what stations can be heard and when, how to become a licensed amateur radio operator and much more. **£14.95.**

The Complete Shortwave Listener's Handbook

This A to Z guide for everyone from complete beginners to advanced hobbyists is your all-in-one partner in listening. All you need is enthusiasm to use this book. Chapters include: help with choosing and using equipment, guidance on finding hot, newsworthy stations, up-to-date listings of stations and frequencies, insider's guide to web sites, simple and cheap ways to improve reception, equipment dealer address and much more. All for **£19.95.**

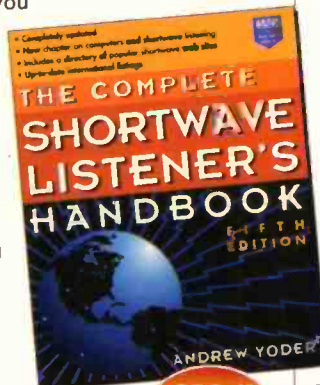

Communications Receivers - The Vacuum Tube Era has extensive revisions, corrections and new information, 19 more pages, index by model number or name and an added antenna input and audio output characteristics to the data. Order your copy for **£17.95.**



Ferrell's Confidential Frequency List - 11th Edition

Why settle for second best when you can have the ultimate in utility frequency guides.

Ferrell's CFL is produced by the Publishers of *SWM* and *PW*, *PW Publishing Ltd.*

The 11th edition is the culmination of years of monitoring experience and loggings. If you hear a utility station, you can be confident in discovering who, what and where with *Ferrell's CFL*, the definitive first choice. Order your copy now for **£19.95.**

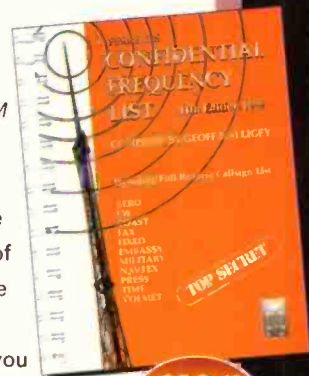

Communications Receivers - The Vacuum Tube Era: 1932-1981

A book recommended by *SWM's* John Wilson, an essential for your bookshelf if you have any interest in valved receivers. Now in its 4th edition,

To order any of the titles mentioned on this page please use the Order Form in this issue or telephone Jean or Shelagh on (01202) 659930.

JAVIATION

Carlton Works, Carlton Street,
Bradford BD7 1DA

**AOR AR8200
Series II**
Call for latest
package deals

**ICOM IC-R2
£149.00**
including
RS-232 Interface

**MVT-7100's
£215.00**

With our own 40 page
"English" manual

MVT-9000 MkII
For the best price on this
new model, give us a call.

If you would like a
printed catalogue, please
feel free to contact us or
send a large S.A.E. (40p).
Thanks.

Telephone: (01274) 732146

www.javiation.co.uk

**Computer Interfaces
RS-8200**

Housed in DB-25 the RS-8200 allows
computer control of the AR8200 and
supports both software and hardware
squellch detect. £39.99.

RS-8200D

As above but with a NFM Discriminator
output

RS-2700/8000

Housed in DB-25 this interface is compatible
with both the AR7200 & AR8000. Supplied
with a Flat Flexible Cable for use with both
these models. Now available for just £34.99.

JAV-232

Not only compatible with the AR8200 but
many other receivers also including the
AR8000, AR2700, Alinco DJ-X10, Icom
IC-R10 and IC-R2 to name a few. When used
with the AR8000 or AR8200 the JAV-232 also
provides a squellch activated tape recording
circuit and audio. The AR8200 connections
also provide a FM Discriminator output for
DATA decoding. The JAV-232 costs £69.99
but for connection to the AR8200 an
optional OS-8200/DIN lead is required at
£17.50.

Other interfaces for the Icom IC-R2,
IC-R10 Trident TRX-100XLT and Alinco
DJ-X10 also available.

Amateur ARC Radio Communications ARC Ltd

TUE TO SAT
10am-5pm

We are the largest stockists of both new and secondhand
amateur radio equipment in the north of England - fact not
fiction! Our company boasts a full time service department
authorised by all the major suppliers.

WHEN YOU BUY FROM US YOU HAVE COMPLETE PEACE OF MIND!



**AOR AR8200
Series 2**

AOR have done it again!
It can't have been easy to
improve their ultimate
scanner, but they have and
the AR8200 Series 2
provides even more without
losing out on any of the
original features.

TCXO ensures high
stability with minimal interant spuri.
Telescopic whip. Black cabinet. Higher
power nicads.

£439.00 RRP.

PHONE FOR OUR PRICE



**PCR
1000**

The explosive
growth of the internet in the last few years
has brought a wealth of information to PC
users everywhere. However, long before
this the airwaves have been filled with
communications of all kinds - broadcast
radio and TV, ham station, marine and
aviation to name a few. The PCR-1000
lets you listen in to this exciting world
from your own computer. The RRP has
now gone up to £349, however we do have
a number of units still available at

£299.00 SO DON'T MISS OUT!
PCR-100's also in stock.....Price £199.00

**BUDGET PRICED SCANNER
MAYCOM 108**

Palm sized airband and VHF
scanner.

★ Airband 108-136.975MHz
★ VHF 136-180MHz H AM
or FM

★ 99 memories
★ Selective channel steps
★ Plus lots more
PRICE £69.95



**NEW FROM ICOM
ICOM IC-R2**

This new handy size scanner is
both economical to run and at
a very affordable price!

RRP
£149.00

NEW MOTOROLA TALKABOUT
TA-300 HANDIES NOW IN STOCK! Ideal for keeping in
touch over a distance of 1 mile. many uses such as family
outing, ramblers, small business, le, garden centres. Buy a
pair now for £179 and save £30 on RRP.

**GRUNDIG
YB-400
PORTABLE SW
RADIO**



Ideal portable radio at a very affordable
price. Reviewed by *Passport to World
Band Radio* as "best performance for
price, size category and among the
choicest portables of any size or any
price". ★ General coverage 144kHz-
30MHz ★ SW 1.77-26.1MHz ★ FM
stereo 87.5-108MHz ★ MW/LW H SSB
reception ★ 40 station presets plus many
more features. **£120.00**

FAIRHAVEN RD-500VX



This new updated version offers you wide
band coverage on all modes SSB-CW-FM
and AM. The huge 2Mb memory capacity
and alphanumeric display enables you to
build up an extensive data base of stations.
20kHz-1.7GHz. RRP £899.95
£89.95 deposit, 36 x £32.50 p/m.

PHOTAVIA PRESS AIRWAVES 2000

THE NEW 7th EDITION OF THE UK'S MOST COMPREHENSIVE AND
UP TO DATE HF/VHF/UHF AVIATION FREQUENCY DIRECTORY
AS/WIRE SPIRAL BOUND - FULLY UPDATED FOR 2000

TOWER - APPROACH - RADAR - GROUND - AIR TO AIR - RANGES - ATIS - GCI
SQUADRON OPS - AIR REFUELLING - VOLMET - AIRLINE OPS - AWACS - SAR
AIR DEFENCE RADAR (UK & EUROPE) - GROUND OPS - AEROBATIC TEAMS
UK/EUROPEAN CIVIL & MILITARY AREA RADAR - MILITARY AIRFIELD STUDS
4 LETTER AIRFIELD CODES - RUNWAYS - SSR CODES - UK BASED MILITARY UNITS
MAPS OF - UK TRANSMITTER SITES AND FREQUENCIES - MILITARY TACAN ROUTES
LOW ALTITUDE AND AIR REFUELLING AREAS - UK RADAR SECTORS AND FREQUENCIES
UK PRIMARY AIRWAYS AND REPORTING POINTS - UK SUPERSONIC ROUTES
UK OCEANIC ROUTES AND FREQUENCIES - MAJOR WORLD AIR ROUTE HF AREAS

MILITARY AND CIVIL HF DIRECTORY - (INCLUDES MANY DISCRETE FREQUENCIES AND
CHANNEL DESIGNATORS) - RAF/ROYAL NAVY - WORLDWIDE/NATO MILITARY AIR-ARMS
UN - US MILITARY GLOBAL HF NET - MYSTIC STAR - US NAVY - US COAST GUARD
HURRICANE HUNTERS - VOLMET - SEARCH AND RESCUE - SPACE SHUTTLE - MAJOR WORLD
AIR ROUTES - AIRLINE OPS - LONG DISTANCE OPERATIONS CONTROL - DOMESTIC CIVIL HF
UK PRICE **£9.95 INCLUDING FREE P&P / EIRE & EEC ADD £1**

CALLSIGN 2000

THE NEW 6TH EDITION OF OUR CIVIL AND MILITARY AVIATION
CALLSIGN DIRECTORY - FULLY UPDATED - OVER 3050 CHANGES
168 PAGES - WIRE SPIRAL BOUND - OVER 8450 AVIATION CALLSIGNS

MILITARY DIRECTORY - CALLSIGNS ARE LISTED ALPHABETICALLY AND
ALSO BY AIRARM / SQUADRON - INFORMATION INCLUDES : CALLSIGN
AIRCRAFT TYPE - CODE - UNIT/SQUADRON - HOME BASE - REMARKS
CIVIL DIRECTORY - CIVIL CALLSIGNS FROM OVER 180 COUNTRIES ARE
LISTED ALPHABETICALLY AND ALSO BY THREE LETTER AIR TRAFFIC PREFIX
INFORMATION INCLUDES: CALLSIGN - THREE LETTER ATC PREFIX
AIRLINE OR OPERATOR - COUNTRY OF ORIGIN - REGISTRATION PREFIX

UK **£9.95 INCLUDING FREE P&P / EIRE & EEC ADD £1**

VISIT OUR NEW WEB SITE AT: www.photav.demon.co.uk
(SORRY - NO CREDIT CARDS) CHEQUES/EUROCHEQUES/POSTAL ORDERS/PAYABLE TO:
PHOTAVIA PRESS (DEPT SW) - SUNRISE BREAK
CHISELDON FARM - SOUTHDOWN HILL - BRIXHAM
DEVON - TQ5 0AE - UK Tel: 01803 855599

LARGE SELECTION OF SECONDHAND EQUIPMENT:-

STAR BUY	
Kenwood R-5000 mint condition.....	£399
JRC NRD-525 mint condition.....	£400
Kenwood R-2000 boxed.....	£275
Yupiter MVT-9000 as new.....	£240
Century 21D.....	£150
Icom PCR-1000 + DSP immaculate condition.....	£325
Yaesu FRG-100 VGC.....	£275
Draite R-SE.....	£650
FRG-8800 + VHF converter.....	£450
ICS FAX-1.....	ETEL
KAM plus.....	£225
Icom IC-R71E.....	ETEL
Tokyo HX-240.....	£150
MFJ-948.....	£60
Kenwood TM-741E trihandler.....	£450
Kenwood TS-8305 + EP-925/SP-430.....	ETEL

AOR AR8000.....	£199
Yaesu FRG-9600.....	£250
Icom IC-7068MK1.....	£499
Icom IC-R70.....	£350
2 x T-SE.....	each £175

ACCESSORIES

UK Scanning Directory.....	£18.50
Watson QS-200 mobile unit.....	£4.95
Watson QS-400 adjustable holder.....	£9.95
Carrying cases for scanners from.....	£17.00
Ferrells Confidential Freq List.....	£19.99
Scanmaster Base Antenna.....	£39.95
Scanmaster Discone Antenna.....	£49.95
Watson W-901 regular gainer ant.....	£12.95
Universal 3 in 1 swan neck holder - screw fit/ stick lupo on glass.....	£17.50
Kat Today Ultimate Scanning Guide + Disc.....	£19.50

FINANCE EXAMPLE:- £699. Deposit £69, 36 x £25.52 p/m. APR 29.8%

Tel: 01925 229881 Fax: 01925 229882

Contact our web-site: <http://www.arcoms.force9.co.uk> FREE PARKING
AVAILABLE

38 Bridge Street, Earlestown,
Newton-le-Willows,
Merseyside WA12 9BA

■ GRAHAM TANNER, 64 ATTLEE ROAD, HAYES, MIDDLESEX UB4 9JE

■ E-MAIL: ssb.utilis@pwpublishing.ltd.uk

SSB Utilities

More MSF

A few months back I mentioned the transmission of the MSF time signal from Rugby, and mentioned that the signal was prepared and radiated from there. The following month I had to offer a correction, as several readers had written to say that the signal originated from the National Physics Laboratory at Teddington in southwest London, and was delivered by land-line to the transmitter at Rugby.

Well, this month I have a correction to the correction! It appears that my original comment was correct all along.

Wally Badz wrote to say that the MSF time signal is prepared and transmitted from Rugby, and it is controlled by atomic clocks provided by the NPL, **on-site** at Rugby. The land-line connection between the NPL and the Rugby site is a facility to correct any difference in the transmitted 60kHz signal monitored at the NPL and the reference atomic clocks at the NPL. The NPL does **not** provide the signal that is transmitted by the Rugby transmitter. For further information, **Wally** suggests that you visit the NPL website (see Web Watch).

At first I was sceptical of this information, but **Wally** goes on to explain why his information is correct. **Wally** used to be a BT Engineer and used to travel to the Rugby site for regular meetings. The meetings were held in the building that houses the MSF transmitter, and antenna tuning system that is built in a wooden room! The transmitter is connected, via the tuning unit, to a T-shaped antenna suspended between two 250m high masts situated 850m apart.

Wally says that he regularly walked past the original valved transmitter, now superseded by a solid-state one, and was once given a guided tour around the whole MSF system by the regular maintenance staff.

Wally's final comment is that there are, in fact, three (yes, three) atomic clocks at Rugby. The Master clock, a backup clock and the third clock that checks the accuracy of the first two.

On the same subject, **Ken Taylor** writes to say that he is still confused regarding my comments about Rugby and MSF - I hope the above explanation from **Wally** will answer all your questions.

Fellow columnist **Godfrey Manning** also added in his comments regarding MSF, claiming that the atomic clocks were at NPL in Teddington, not at Rugby. As we have seen above, there is evidence from somebody 'who was there' who knows different. However, **Godfrey** does ask a good leading question - where will MSF come from when Rugby closes? Does anyone have any ideas or theories?

Books

One of the questions that I regularly get asked, either in letters or E-mails, is which frequency guide I use, or which I would recommend. I find it quite difficult to recommend any single book or guide, as I tend to get different bits of information from different books.

For a general selection of frequency information I tend to use either *Ferrell's Confidential Frequency List* (CFL) or the *Klingenfuss Utility Guide*, as both these books tend to give a better broad coverage. When it comes to aeronautical and military voice frequencies, I tend to stick with either *Airwaves* or a new book called *Military Air Scan 2000*.

The *Airwaves 2000* book follows the style of previous years - a comprehensive listing of h.f., v.h.f. and u.h.f. aeronautical frequencies arranged into different sections, with listings by location and user, and in frequency order. Over the years I have collected together a number of 'other frequencies' from various sources (e.g., ground service frequencies for various airfields, or new Airline company frequencies) and these are scattered about my copy on various scraps of paper and Post-It notes.

What I do like about the *Airwaves 2000* book is the selection of maps at the back which illustrate the way that

the UK is broken-down into sectors, their frequency allocations, upper air routes and reporting points, and (one of my favourites and most used pages) a map showing the oceanic entry points.

The book is not perfect, in my opinion, as I think that the layout could be improved in some areas. I find the v.h.f./u.h.f. listing by location is a bit hard to read as it is difficult to see where the entry for each airfield begins - so in my copy I have underlined each airfield name so that it stands out better.

One final cryptic comment about *Airwaves 2000* - what is the ICAO Designator for RNAS Yeovilton, and why does it have the wrong runway headings listed? If you already have a copy of the book, you can investigate this for yourself. If you don't have a copy, they are available from the *SWM Book Store* (see under 'Airband' in the Listening Guides section).

The other book that I have just recently been using is *Military Air Scan 2000* from MGT Publishing. I would consider that this book is more suitable for regular or experienced listeners, as it appears to be 'mostly a list of numbers' at first. This book was compiled from the quarterly subscription-magazine *Military Air Scan Network News* (MASNN).

Once you spend some time examining the book and understanding the content, it is a very good book that you can 'dip in' for a list of frequencies in various areas. It covers a wider category of military frequencies than most other books, as it also contains frequencies for lots of ground services at airfields which you would not normally associate with 'military'. It is principally aimed at the listener who wants to listen to military, so civil aeronautical frequencies are in the minority.

The Major World Air Route Area frequencies cover just four pages, while the World Air Arm Global Nets information covers nine pages. This book also covers satellite communications in the u.h.f. band. For the h.f. listener who wants to hear military traffic, the pages of h.f. frequencies cover almost all the major h.f. users in a matter of pages, and includes many 'channel numbers', so you can follow the signals as they change frequency.

The *SWM Book Store* does not stock *Military Air Scan 2000*, so you will either need to contact the publishers directly, or try specialist aviation bookshops. The publishers are: **MGT Publishing, PO Box 564, Norwich, NR7 8DD, England**. I bought my copy from: **The Aviation Hobby Shop (TAHS), Horton Parade, Horton Road, West Drayton, Middlesex**. The book is priced at £8.99, and worth every penny in my opinion.

Web Watch

NPL, Teddington - <http://www.npl.co.uk/npl/ctm/msf.html>

Airwaves 2000 (Photavia Press) - <http://www.photav.demon.co.uk>

Military Air Scan 2000 - <http://www.mgtpublishing.com>

Southbound II - <http://www.vmf.com/ssbvoice.htm> (a brief mention, including time and frequency details).

Boat Race?

John Thomsom from Lancashire writes to tell me about some signals that he has been hearing on consecutive nights during June and July. **John** says that he thinks it is some kind of boat race, and suggests that myself and others might like to listen in to the communications.

The frequency that **John** was listening to was 12.359MHz at 2200 each night, and **John** says that the vessels are contacting a station with the callsign 'Southbound II'.

As soon as I saw this callsign, I immediately knew that this is no boat race - it is a station in the Caribbean (I think!) who provides a monitoring and weather relay service for yachts in the Atlantic Ocean. Many yachts are out of contact with home for long periods, and 'Southbound II', crewed by weather guru Herb Hilgenberge, provides a service where mariners can report their position on a regular basis, receive a brief weather report, and generally chat with other yachts. In many cases single yachts will meet-up with others as a result of these contacts, so that they can sail together and get 'safety in numbers'.

Herb provides tailored forecasts for individual cruisers at 2000UTC each day on either 8.294 or 12.359MHz upper sideband. His well-deserved reputation for extremely accurate and precise forecasts makes him worth listening to. The operation is semi-official (so I've been told), but many yachtsmen prefer to rely upon the service of 'Southbound II' as it is so informal, almost like a group of friends meeting in a pub! However, the services of the vessel are mentioned in many official web-pages - try a simple search on 'southbound II' and see how many matches you get!

As a mark of respect for Herb's services, yachtsmen and mariners in the Atlantic and Caribbean have made many comments, such as: "There is nobody better at analysing satellite imagery and determining real weather conditions," says Capt. Andrew Bass of the US Naval Academy Sailing Squadron in Annapolis, Maryland. "Without him, life at sea would be a lot more dangerous". One testimonial from Joe Bass, skipper of the US-based *Sea Bass*, was unequivocal: "I've sailed 100,000 nautical miles, but if Herb told me to jump up and down and bark like a dog, I would".

■ JERRY GLENWRIGHT, 16 COPEMAN STREET, NORWICH, NORFOLK NR1 2HH

■ E-MAIL: shackware@pwpublishing.ltd.uk

ShackWare

So much for this year's Sporadic-E season - talk about a poor summer! Sunshine over dear old Shoreham has been confined to maybe an hour a week and very often even that's been blighted by torrential downpours. Well, yes, I'm exaggerating, but only a little...anyway, enough whinging and on with your letters.

Mailbag

Previous correspondent **David Holdsworth** (dvdhldswrths898@netscapeonline.co.uk) sent me an E-mail following an upgrade from his original BBC B computer to a PC compatible. David has recently embarked on an Open University course and writes "I got rid of all my BBC computers and I wonder if you can now help me with a problem I have with a PC. I am doing an Open University course entitled *You, Your Computer and the Internet*. I have permission from the university to play around with programs for decoding and so on but being disabled, I can't afford a lot of disks to put into my PC. Is it possible for you to ask your readers if they can please donate any disks for decoding such as SSTV, WEFAX, c.w. or any related items? This would be much appreciated and I hope I'm not being too outrageous in asking for help. My PC runs at 150MHz and I have about 995megs of hard drive space left".

Well, David, I'm sure 'ShackWare' readers might be able to come up with some spare disks of stuff to send to you. Also, given that you now have a PC and you're on the Internet, it might be a good idea to look for some of the excellent shareware decoding software which is available for download from various sites. Try the truly excellent *HF-FAX* at ourworld.compuserve.com/homepages/hffax/ as a perfect jumping off point for a host of downloadable software.

Readers who can contribute software should contact David directly at **11 Star Farm Close, Bradwell, Great Yarmouth, Norfolk NR31 8UZ** and you can telephone him on **(01493) 300955**.

After relaying the news of the return of Greenweld, the electronic spares company now under new management, I had an interesting E-mail from **Jack Nelson GODNC** who, like me, regularly bought spares and obsolete equipment from the company. We both agreed the return of Greenweld was welcome news indeed.

Recently, I had another E-mail from Jack who writes "The July issue of 'ShackWare' made me dive under the bench to retrieve two Sinclair Spectrum machines that had been lying idle for quite some time. I decoded some SSTV with them and wondered why I had forked out £1000 on my PC!

"Also, I still use my old Compaq 386 with *Windows 3.1* for sending and receiving RTTY. I have had it for many years now and would not be without it".

For me, Jack has captured perfectly the reason why older computers are such a good idea. No doubt that 386 Compaq accounted for a heavy investment when new and it's great that Jack can continue to make good use of it. Also, utilising the old 386 in this way completely frees up his every-day PC for other work. You can find machines like this under the pasting tables at computer fairs and the like for just a few pounds nowadays, but they make for truly excellent workhorses in the shack. Jack continues...

"I contacted the new Greenweld to see if it would continue the scheme by which 'Gold Subscribers' enjoyed cheaper postal rates as they did before the take-over. Greenweld said it would and to watch out for the new flyer. It never came. I went to the company's web site but found that it was incomplete. I tried a couple of weeks

later but there was no change. Then the site was unobtainable and I have a feeling that all is not well".

I'm afraid I've been unable to reach the new Greenweld site either and nor have I had any other contact from the company so it seems a distinct possibility that it's experiencing difficulties once again. If anyone has information, let me know (via E-mail - see above) and I'll pass it on. Fingers crossed it's still in operation!

Regular readers might remember the plight of **John Boulton** who appeared in 'ShackWare' in July. Like Jack, John also uses a Compaq PC, however John's is a Compaq Portable II. These early portables - 'luggable' is a better description - were real leading-edge technology back in the 1980s when they were first available and can still be put to productive use now (well, I would say that, this is 'ShackWare' after all!).

John was experiencing difficulty because he doesn't "...have the start-up disks 'User Diagnostics' and 'User Programs' which I believe are necessary to boot the machine". I rummaged on the web but found nothing to suggest that what was needed was anything other than simple DOS boot disks which I sent to John in the post.

However, **Ryan Hodges** (rhodges@breathemail.net) has had much experience with the old Compaq and he E-mailed to enlighten me - and John - on one or two points. "I have repaired and serviced many of these machines in the past," writes Ryan, "and the problem is that the disposable battery runs out and the CMOS system memory loses its settings (unless it was one of the examples with a Dallas clock chip with a built-in battery).

"Firstly, the battery needs to be replaced and secondly, the machine requires a special boot/setup disk to restore the CMOS settings. The boot disk is available from the Compaq web site. The battery can be replaced with three alkaline cells or, if the machine has a Dallas clock chip, it can be replaced for a cost of £15 from an electronics company such as RS. John will have to take his machine apart to see what type it is and to make the necessary repairs".

Thanks for that excellent advice Ryan which I'm sure will help John resurrect the ailing Compaq.

Speedy Spares

There's one problem with being known as a tinkerer of old silicon - friends bring their ancient machines to you and expect you to put them right! Ah well, if I'm honest, I'm always on for opening up an old computer and having a rummage inside.

Recently, a friend brought a Packard Bell PC compatible to me which, though it was running perfectly well, was slow to say the least when compared with modern machines. The Packard had been bought from one of those out-of-town monsters which also sell washing machines, microwave ovens and the like and it had come as part of a package which also included a desk!

To cut a long story short (and to get to the point of this anecdote for s.w.l.s) I looked into upgrading the machine from its paltry 100MHz, but as it had a bus speed of just 60MHz and an old Socket 7 processor slot, I held out little hope. A search of the web turned up Evergreen Technologies, a company which manufactures replacement and upgrade processors. However, these devices could only be fitted to PCs with a 66MHz bus speed - drat! I scanned through the (largely useless) literature that came with the machine and realised that with a bit of messing around with the clock multiplier I could increase the bus speed to a 'more standard' 66MHz.

This I did, the new chip came from one of the many PC mail-order companies, I installed it and...well, amazingly, it worked perfectly first time! The processor comes with full instructions, it's own on-chip cache and cooling fan and is, essentially, a simple plug-in upgrade. It cost just over £100. With the hard drive upgraded from 1.2Gb to 8Gb (at a cost of £89) and its new AMD K6 processor with 3DNow technology and a clock speed of 333MHz, the old Packard is absolutely flying!

A worthwhile upgrade at a very reasonable price for any s.w.l. and far better than replacing your old workhorse for a new PC at a cost of £1000 or more.

And Finally

While I always try to answer correspondence promptly, pressure of work, a wife and three unruly children often mean that some letters which require a bit of research get put on hold for rather longer than I'm comfortable with. Just such a blip is about to take place because, after many false starts over the past five years or so, we've sold the house and we're moving to Norfolk.

I lived in Norfolk after graduating in the 1980s and have hankered to return to its somewhat slower pace of life ever since leaving. Now we're doing just that. I'll publish our new address in the next instalment of 'ShackWare' but in the meantime, it's probably not a good idea to send any more letters to Downland Avenue.

Enjoy what's left of the 'summer', good listening, and spare a thought for me: my entire shack - radios, computers, books, soldering iron, 'scope and everything else is packed away in boxes ready for the move - groan!

WINRADIO®

TAKING THE EUROPEAN RADIO MARKET BY STORM

FREEPHONE 0800 0746263 TO PLACE A CREDITCARD ORDER

*Receive a FREE Mini-Cone Antenna With Every WR-3100 order!**

JOIN THE TRUNKED RADIO REVOLUTION WITH YOUR WINRADIO RECEIVER!

1. Enjoy multiple, major trunk tracking modes
2. Automatic traffic following & sophisticated control panel
3. Take comfort in the automatic volume control
4. Single & dual receiver modes
5. Convenient inbuilt electronic logger and database
6. Comes complete with an inbuilt traffic recorder
7. Full XRS™- compliant technology

The WINRADIO Trunking Option*

Trunking systems are used by public safety, transportation, business, law enforcement, government, military and other organisations. This software includes major trunking modes: Motorola SmartNet® and MPT1327.

ONLY £81.07 inc vat

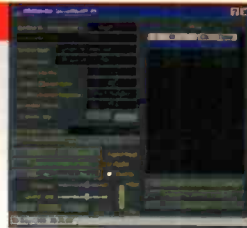

TAKE A LOOK AT WINRADIO'S DIGITAL SUITE

1. WEFAX / HF Fax
2. Packet Radio for HF and VHF
3. Aircraft Addressing and Reporting System (ACARS)
4. Audio Oscilloscope, real time Spectrum Analyzer with calibration cursors
5. Squelch-controlled AF Recorder
6. DTMF CTSS decode and analyse

The DSP applet provided with the WR3100i spectrum monitor ISA card (£995+VAT) allows continuous control of audio bandwidth and other signal conditioning functions.

ONLY £81.07 inc vat

(requires SoundBlaster 16 compatible sound card)

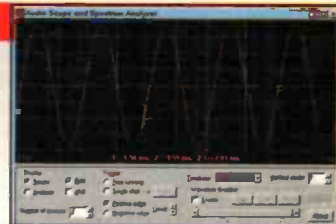

WINRADIO® PC RECEIVERS

Available as either an internal ISA card that slips inside your PC, or as an external (portable) unit. WinRADIO combines the power of your PC with the very latest in synthesised receivers.

YOU CAN USE WINRADIO™ SCANNING PC COMMUNICATION RECEIVERS FOR:

Broadcast, media monitoring, professional & amateur radio communications, scanning, spot frequency, whole spectrum monitoring, instrumentation surveillance and recording.

If you're after the ultimate receiver-in-a-PC with full DSP then smile and say, "Hello" to the new **WR3100i-DSP** with its hardware for real-time recording, signal conditioning and decoding applications. It's all you need.

NEW EXTERNAL MODELS

EXTERNAL WINRADIO™

We are now able to offer you a complete range of stand-alone WinRADIO comms systems:

- WR1000e - £359 inc vat
- WR1550e - £429 inc vat
- WR3100e - £1169 inc vat

Each stand-alone unit connects to your PC through either the basic RS232, or through an optional PCMCIA adapter (for high speed control).

The units are powered through either your existing 12v supply, or through an (optional) NiMH rechargeable 12v battery pack.

"It's software is excellent.. more versatile and less idiosyncratic than that of the Icom IC-PCR1000"

WRTH 1999 Review

"Five stars for its mechanical design"

WRTH 1999 Review

"Most Innovative Receiver"

WRTH 1998 Awards



Model Name/Number	WR-1000i & WR-1000e	WR-1550i & WR-1550e	WR-3100i & WR-3100e
Construction of internals	WR-1000i/WR-1550i-3100iDSP- Internal full length ISA cards		
Construction of externals	WR-1000e/WR-1550e - 3100e - external RS232/PCMCIA (optional)		
Frequency range	0.5-1300 MHz	0.15-1500 MHz	0.15-1500 MHz
Modes	AM,SSB/CW,FM-N,FM-W	AM,LSB,USB,CW,FM-N,FM-W	AM,LSB,USB,CW,FM-N,FM-W
Tuning resolution	100 Hz (5 Hz BFO)	10 Hz (1Hz for SSB and CW)	10 Hz (1Hz for SSB and CW)
IF bandwidths	6 kHz (AM/SSB), 17 kHz (FM-N), 230 kHz (W)	2.5 kHz(SSB/CW), 6 kHz (AM) 17 kHz (FM-N), 230 kHz (W)	2.5 kHz(SSB/CW), 6 kHz (AM) 17 kHz (FM-N), 230 kHz (W)
Receiver type	PLL-based triple-conv. superhet		
Scanning speed	10 ch/sec (AM), 50 ch/sec (FM)		
Audio output on card	200mW	200mW	200mW
Max on one motherboard	8 cards	8 cards	6-8 cards (please ask)
Dynamic range	65 dB	70 dB	85dB
IF shift (passband tuning)	no	±2 kHz	±2 kHz
DSP in hardware	no - use optional DS software		YES (ISA card ONLY)
IRQ required	no	no	yes (for ISA card)
Spectrum Scope	yes	yes	yes
Visitune	yes	yes	yes
Published software API	yes	yes	yes (also DSP)
Internal ISA cards	£299 inc vat	£369 inc vat	£1169.13 inc
External units	£359 inc vat	£429 inc vat	£1169.13 inc (hardware DSP only internal)

PCMCIA Adapter (external): £69.00 inc vat when bought with 'e' series unit (otherwise: £99 inc vat)
 PPS NiMH 12v Battery Pack & Chrg: £99 inc vat when purchased with 'e' series unit (otherwise: £139 inc vat)
 The WinRADIO Digital Suite: £74.99 inc vat when purchased with a WinRADIO receiver (otherwise: £81.05 inc vat)

For your free (no obligation) info pack & WinRADIO demo disk go to: <http://www.broadercasting.com>. If you don't have access to the internet then by all means feel free to phone/fax us. *Trunked radio transmissions should only be received & decoded with permission of the originator of the transmission.

Please send all your enquiries to: info@broadercasting.com or Telephone: 0800 0746 263 or +44 (0)1245 348000 - Fax: +44 (0)1245 287057
 Broadercasting Communication Systems, Unit B, Chelford Court, Robjohns Road, Chelmsford, Essex, CM1 3AG, United Kingdom

E&O WinRADIO and Visitune are trademarks of Rosetta Labs. Australia - copyright Broadercasting Communications Systems
 Broadercasting Communication Systems is a trading name of USP Networks Ltd. *Free gifts are subject to availability
 Registered trademarks are the property of their respective owners

■ PETER BOND c/o EDITORIAL OFFICES, BROADSTONE

■ E-MAIL: milair@pwpublishing.ltd.uk

MilAir

Mildenhall Update

Following on from last month - in the quieter moments during my three days at Mildenhall I managed to briefly scan through the 406 - 420MHz band. As previously reported, these frequencies are being digitised. Mildenhall appears to have almost completed the conversion with the following frequencies being heard with digital signals only: 410.6, 410.8, 411.475, 417.725 and 418.175.

The only frequencies that are not converted appear to be those that are linked to the Tower/ATC. I heard an airfield sweeper talking to Ground in the clear on 410.475 and 419.275. One source has suggested that some of the old radios were issued to other agencies for use over the Air Fete week which would explain some of the in the clear conversations with UK voices heard on frequencies such as 410.425 and 417.175.

I did hear several frequencies used in the clear at Lakenheath, they were as follows: 410.25 maintenance? 410.275, 411.95 (also digital), 412.275 plus 418.65 which may have been Transit Alert? Digital only frequencies at Lakenheath were: 411.675 and 419.2. It was only a brief search, so any further information would be welcome.

The new v.h.f. frequency noted as Lakenheath Arrivals - 123.825 - remains in use in mid July. I suggested that it may replace 137.2, but local sources indicate that they believe that it is to replace 128.9. Thanks to several readers I am pleased to say that my interpretation of the 494th FS F-15E callsign appears to be confirmed as 'DRAG 61'.

The B-2 was callsign FURY 85 not 95 and one reader noted the AC-130 as NOTE 61, but I suspect that 'GHOST 61' is correct as it is their primary callsign. Incidentally, did anyone notice that there were a quite a number of callsigns in use using the numbers 61 and 81?

A friend who stayed on at Mildenhall after the show reports that an Air Force Reserve KC-135E from the 940th ARW was using what appears to be a new callsign, in this case 'RESORT 31'. The aircraft departed Mildenhall but soon returned, presumably with a technical problem. This is a relatively new callsign, a bit of research suggests that it has been used since early May by tanker deployments from Mildenhall to Incirlik in Turkey.

Also heard in mid June was another new Tanker callsign, STARKY. This was noted in use by aircraft from both the 927th ARW and the 940th ARW which are both Air Force Reserve units. Thanks to **JL** and **Kev**.

London Mil

Following on from July *SWM* where 255.925 was reported in March as an AWACS frequency allocated by London Military as a discrete. Two further reports have since been received concerning this frequency, the first also heard an AWACS calling 'MAGIC 31' the second was on the 21st June when aircraft were heard dogfighting and reporting targets splashed.

I have searched all my records back to January 1997 but can find no other reference to this frequency apart from the two this year. I have included the frequency in my London memory banks for the last eight weeks but so far have not heard it in use. As always anyone got any ideas? Thanks to **Fred** and the anon.



Tiger striped, Austrian AF SAAB 105 arriving at Air Fete 2000.

LTW

The Lyneham Transport Wing C-130s have been noted on two occasions using the callsign EARTHQUAKE. One of my correspondents has suggested that it is an exercise or paradrop callsign as he heard them using it whilst engaged in practice low level drops across Salisbury Plain. He also reports that the Salisbury Plain frequency 282.25 was red-hot that day. The 'Herks' were also noted using the Forward Air Control frequency 258.8, which I thought was rather unusual.

Going Mobile

The subject of antennas is rarely far from the MilAir text and for that matter the other *Short Wave Magazine* columns. During one of the lengthy showers at Mildenhall, (sorry to mention that again), I discussed antennas at length with several enthusiasts and in particular the various mobile rigs that people use. Whilst we have discussed base station antennas in the column many times we have rarely touched on mobile set-ups and I was surprised at some of the innovative ideas enthusiasts had tried for better results.

Most modern cars are reasonable noise suppressed so that their a.m./f.m. car radios can work interference free. These same suppressers should do the job for a well sited airband radio and antenna. In addition to purpose built antennas, some of the various antenna ideas that were put to me included, using a switched car antenna, mobile 'phone antenna, bare wire taped to the rear screen and using the car body shell!

Consequently, along with the ideas I already have, I am looking to our readers for their recommendations for shop bought antennas or even home designs to find the best performing mobile MilAir airband antenna. If you have used one that you feel out performs all others, please drop me a line or an E-mail and we will discuss the subject at length in future columns.

Incidentally regarding antennas, if I am allowed to be slightly tongue in cheek, have you noticed that there are certain enthusiasts that I shall call the 'Antenna Optimists'. Despite owning a good base station radio, low loss down leads and a roof mounted discone they are convinced that there is another magical antenna out there that will pull in those impossible to hear transmissions.

They read the pages of *SWM*, (quite rightly!), from cover to cover and then suddenly come across the advert for a new antenna, the Hoki Koki 2000. With a list of specifications that would not be out of place at Fylingdales and a gain of 100dB this has to be the ultimate antenna. Having parted with hard earned cash the antenna is installed and whilst it performs admirably they are disappointed that they still can't hear aircraft on the u.h.f. ground frequency at Ramstein, (Germany). OK so I'm being just a little over the top, but to be honest, like me, you wouldn't be a true radio enthusiast if couldn't you see just a tiny element of yourself in that description!

P.S. Please don't write in, the Hoki Koki 2000 doesn't exist - unfortunately!

■ PAUL ESSERY GW3KFE, PO BOX 4, NEWTOWN, POWYS SY16 1ZZ

Amateur Bands

The increase in the noise level, particularly on the low bands, annoys us all. Start with the antenna - inspect all joints for bad soldering or corrosion. Next go round the house switching things on and off. If you find the problem at home, mend or suppress it.

For noises further afield - my old sailing radio gives Top Band and a signal meter - a 'tranny' would serve. First, I drew a large-scale plan on which to plot several bearings - the null is off the ends of a ferrite rod, remember. Try and do this when cars are absent or at least not moving!

Remember, the radio contains a speaker magnet, so your compass must be several feet from the radio. The plot will be a polygon depending on how many bearings you took. A second round from inside the first, maybe.

My noise turned out to be a 13A plugtop with the 'live' screw slack - my neighbour burned himself on it, so he now understands more about fire risks - and I can receive again.

One needs to be a wee bit wary though. For example, the local repeater is normally very strong. However, on occasion when a rain-cloud comes over the hill, noise all but swamps it. You can't suppress anything 'natural'. So, always try to be sure that the problem is not Mother Nature! Also, it hardly needs me to remind you that the first thing with problems of this sort must be good neighbour relations.

What's Doing?

Thanks to 59(9) DX Report, we note that Cocos-Keeling Is VK9C may be looked for around October 21 - November 4 by way of VK9CK and VK9CZ. Main activity 50MHz, but when that band is dead, look for them at 7MHz up.

408/RX0A is in Kosovo and is RW3AH at **PO Box 899, Moscow 127018 Russia.**

Kingman Reef, KH5K, is due in October with a good team of operators. Also in October (5-12) a team of YL operators will sign AX9YL from Norfolk Island - cards via the bureau or **Gwen Tilson VK3DYL, 3 Gould Court, Mt Waverley VIC 3149, Australia.** Still in October (6-15) another VK lot will be on Broughton Is with the callsign VI2BI and QSL route via VK2EO. East Timor looks to be in October too.

Finally, here we note OD5/F5SQM has replaced the 7MHz antenna with a wire for 1.8 and 3.5MHz. You might just catch him before QRT in late September.

The Set Listening Period

Norman Henbrey lives in Northiam, runs an NRD-525 into a Top Band quarter-wave, end-fed via a magnetic balun. He mentions G3PCY's reference to the Murphy baffle receiver restoration - this was the very type on which Norman first found the amateur bands in 1947!

The other entrant, **Philip Davies** of Market Drayton, has an R72 and a random wire again fed by a magnetic balun. Conditions seemed passable, as both logged DS5USH (S. Korea) plus all continents but Oceania. Activity seemed low. Neither missed much, so I guess we call this a draw!

ILA

As always *Just Listening* contains columns covering all sorts of listening. Membership details from **ILA, 1 Jersey Street, Hafod, Swansea SA1 2HF.**

Letters

Godfrey Manning G4GLM of the 'Airband' column in *SWM*, picks up on the June piece. He has a waterproof case for his hand-held, originally made by **Aquamant (UK) Ltd., 1A Broughton Street London SW8 3QJ.** On the 'Pelican' question Godfrey wonders if this might be the firm that sells underwater torches through **Maplin** or, maybe, **Burton McCall Industrial Ltd., Samuel Street, Leicester.** That being said, Godfrey points out that his information is dated - but worth a try.

The all-c.w. report from **Ted Trowell** found the bands poor. On 10MHz he logged OY/DL2VFR at 2000, 14MHz at 2100 saw TF/AD7U, 18MHz around 1400 meant EP2AC (QSL via RV6AB), 1500 9M2TO, JW/DL3NRV, 1700 BV3/DJ3KR and at 200KP2J.

Up again to 21MHz for (0900) 5B4/UA4RC, (1400) VU2BK, HL5AP, DS3FQY, FR5BT, JH4UYB, N6MJ. An hour later saw VQ9VK (QSL via N1TO), 4Z5FW, 4X6PT, JT1FCZ, 9V1JA, VR2JY, BV3/DJ3KR, ZS6NJ, YCOLND (a YL op), E4/G3WQU and at 1900 PY1QN.

24MHz wasn't so popular, with 9J2BO, ZS5LB, PY2OW all around 1500. On 28MHz 1000 saw FM5BH, VQ9NL and at 1500 CX4GLX, EA6ZY, PY2OW, TF3IRA, ZX5J, LU5CW, VP5GA, P49V, OY1CT, 5B4/YL2KL, PY6AN and LU6UO

Next **John Collins** in Birmingham who sat on 7MHz to log the *Operation Dynamo* special commemoratives: GB60DYN, GB2IDS, GB60SF/MM, F6IIL/P on Normandy Beach, ON4BAF, GB0HI (IOTA EU-120), GM4GPP in Shetland, EI9FN in Co Galway, GB6OOD, DL8BMW (who was being jammed!) GB2IWM, GB3RN (with s.a.e. to **GB3RN, c/o HMS Collingwood, Fareham, Hants.** John reckons congratulations are due to all the people involved in these 'Operation Dynamo' commemoratives. Of others, OZ1KSN on IOTA EU171 attracted a mighty pile-up one evening. Others noted were GB0DBP, GB4WTC, LA5RJA/MM west of EI, GB2RWW, EA9DX, M2000/28B, GB0VIK, UN7PPF and at 0100 LU4DX was over the 59 mark.

John asks about s.w.l. numbers. 'Nationals' such as RSGB, ILA, ISWL, keep records of licensed amateurs by their callsigns, but for listeners they give a number. So, a member of ILA might call himself 'Joe Sope, ILA 2001' on his QSLs and letters. I was, back in 1951, RSGB BRS 19385. No amateur radio group that I know of normally reissues such numbers or callsigns.

Now **Colin Dean** in Barnsley who had an oddity on 3.5MHz in the form of 4L26MAY. On 14MHz he found E4/OK1FHI and VO2NS. 18MHz was for AP2JZB, EX2X, FR5GQ, JA1-3, JA9, JY5HX, NL7Z, OH0RJ, OX2K, OY4TN, TA2BK, UN7PCZ, YC0JVT, 3V8BB, 5H1/PA3GID, 5R8FU, 5Z4IC and 9M8HI while 21MHz permitted Colin to unearth A41KJ, A92GE, A92GJ, AP2AC, AX8NSB, BV2FT, BV4VE, BW2000, BY5QE, C6ANI, DS1-5, DU1IVT, EK8WY, EL2DT, EP3PTT, ET3AA, ET3KV, ET3VSC, EY8ZC, EZ1EIC, FG5FC, FH/TU5AX, FM5GU, FR5DX, FR5FD, FR5ZQ/G, FY/F5KEE, HL1-2, HL4-5, HL0, HS1NGR, HS0/G3UUM, OH0CW, OH0RB, OX2K, R1AND, S79KMD, TF8GX, TT8JLB, T77T, UA0SJ, VK2KPP, VP2EY, VR2MY, VU2SDN, V51ED, YB1-2, YB5-6, YB8, YB0, 4K5CW, 4L1ZG, 4W6GH, 5A1A, 5R8GN, 5X1GS, K2KW/6Y5, 7Q7JL, 7Q7RM, 8J9AAA, 9J2BO, 9K2OK, 9M8J, 9N7RB and 9V1CP. Finally, 28MHz where he tripped over D38AF, OD5PN, YB0ARJ and ZD7VC.

Finally, **Peter** and **Paul Goodhall** from Oxford. Conditions generally poor so the 'right time' was needed! Apart then from the Euros and the Ws, on Eighty we see LU1TV and on 10MHz DK0WCY - more than just a beacon! 14MHz offered YB1XUR, ZB2F, V85QQ, VK2s, VK3s, S57NPR, A61AQ, RA2FJ/MM in the Baltic, second mate Alex on a cargo ship without normal R/Os, FY5FG, VK7CW, with 28MHz from VK2FY.

On 21MHz EA7BR, EA7ESH, PY6MLK. On 24MHz JJ3GPJ, OD5/OK1MU, TA2BK, JH1RFR. So much for the written log for the first part of June. Now to the printed-out ones! The first four pages are solid c.w. Apart from the Europeans and the Americans, we can see 9M2TO, TR8CA, PY1BOA, a reference at one point to 'QRM' working 'QRM', 9H3HY, V31HF, VY2JG, 4S7BRG, CP1FQ PY0AM, VK3BCY, JR7XKN, JA7QOU, JH3AIU, all noted at 14MHz and upwards.

By next weekend, they'd moved the printer into portrait mode, mostly logging sideband but with a smattering of c.w., p.s.k., S5TV and RTTY. On this log we see JA3CZY, JA4KEA, TR8CO (and on 18MHz), VP9KK, UA0SJ, PR7FB, CU3AN, VE1MT, VK5TD, VK6JJ, VK6JC, JO2SIF, T77C, VE2PC, A41KJ, JR3GIY, VK4IRS/M; on PSK BV4VE, UR7HO, K2CJP, CT1AAL, plus on slow-scan TV 9A3RS, RA3PP, IK6XAF, 9A/HA5KKW, then RTTY between 9ADF9NW. That makes a log containing five different modes - what about some of you folks out there sending in logs with even more different modes?

Finally, I was asked what bands I use or listen on. Basically, whatever takes my fancy, using my TS-440, TS-520S, home-brew QRP rig, or whatever. At the moment it seems to be 10MHz and direct-conversion receiver.

Finis

That's it again. Deadline is as ever, to arrive by the first of the month, addressed to me at Box 4, Newtown SY16 1ZZ.

■ DAVE ROBERTS *cb* SWM EDITORIAL OFFICES, BROADSTONE

■ E-MAIL: scanning@pwpublishing.ltd.uk

Scanning

Was anyone listening on the 9th of June? Well, that was the only day for ages when we heard any strong signals on low v.h.f.! And those signals were from Europe and not the US. I was contacted by **Geoff Holman** who was listening to French (or French speaking) traffic on 40MHz and the amateur band on 50MHz was open to Europe too. But that has been pretty much as far as it has gone for ages now. So, I shall not dwell on the sorry state of the bands, but go straight into correspondence received.

Your Letters

Firstly from **Les Wilson** who has obviously given a fair bit of thought himself to the perfect scanner as mentioned in July *SWM*. Les reckons an essential item is a button to erase all the memories and search banks. Darn good idea, Les, a 'Bust Button' would be a most useful item to ensure comms security in times of stress. If things were not quite so drastic, Les also suggests that to discourage unauthorised use of the receiver that memories and search memories should be password protected. Another star idea. Manufacturers take note!

Costas from Athens has also written regarding marine u.h.f. transmissions and he confirms that quite a number of larger vessels have repeater stations installed, including freighters and tankers. I never mention your surname, Costas, as I don't want to cause you any grief from the authorities there because I am not too sure on the legalities of radio monitoring in your country.

Just because the two way radio users are getting more secure radio equipment doesn't mean that you should take up rug making. Remember their units still have to transmit something. So start with the transmit frequency of the mobile or hand-held unit of the agency from which you wish to glean information.

Enter the information into your scanner receiver and listen carefully. Listen to the relative signal strength. A receiver with an 'S'-meter is useful but not necessary. Is there mobile flutter on the signal or a more gradual fading? Flutter (a swift, almost pulsed, fading of the signal) may indicate that the radio is vehicle borne while a signal with a slower fade or more erratic signal may tell you that the unit is hand-held.

So now you should know whether your target is in a vehicle or on foot. If you think that you have a foot unit received and the signal is strong, then using your body as a shield try and find the direction from which the signal is coming. Go to a fairly open area and hold the hand-held radio close to your body at about chest height. Turn slowly and you will find that at some point the signal will increase in strength as you turn. You get the idea.

For more accurate pinpointing of base or static sites then hook up a small beam antenna, for the correct frequency band, to the radio and turn the beam until you obtain the strongest signal. That is the direction from which your transmission is coming. Remember to do this in an open area so that the received signal is not being reflected off a nearby building thus giving you a false reading.

By taking bearings from different locations you can plot the location of the static transmission to a specific locale. So now you know the area of operation of the transmitter and you will have a fair idea of the agency from the frequency they are using.

Congratulations, you have made your first move in Signals Intelligence (SIGINT).

Mobile Tracking

More sophisticated set-ups are possible for mobile tracking. Datong make a fine mobile d.f. set-up but it is too expensive for amateurs to consider. I did see an old type Datong d.f. unit for sale in a radio magazine's small ads recently, but I don't remember which one I'm afraid.

The ideal set-up would be a frequency sniffer hooked up to a scanner via reaction tune and the whole lot run through a mobile d.f. set-up. In one of the hobby radio magazines there was an article on a build-it-yourself mobile d.f. unit. Does anyone remember the publication and do you have the article?

Tom Findlay recalls that the unit looked a bit like the Datong set with a circle of light emitting diodes. Ideas anyone? With the d.f. and the reaction tuned scanner mounted in a vehicle as you go about your daily business you would soon glean more information than ever you wanted even if transmissions were scrambled or encrypted.

If you don't have a d.f. set but you do have a reaction tuned set then run it mobile and prepare to be surprised at the information you gather, which is what **John H.** from near Newcastle upon Tyne did. John gets out on foot in Newcastle city centre and has sometimes found himself in the thick of the action. John operates covertly with a concealed scanner and earpiece and has witnessed all sorts of goings on! What's more, no one has a clue that he is operating in the midst of them.

I saw a design for a wireless earpiece some years ago. Does anyone have a copy? I think John could use one.

Specific Frequencies

Frequencies are like the weather, they tend to change a lot. So I only rarely mention specific frequencies in this column preferring to recommend that listeners obtain their information from the two main sources of such data which are, of course, *PROMA* and *The UK Scanning Directory*. *PROMA* in particular being very up-to-date and depending on many listeners to provide current data.

The third source is the Internet. Not all readers of *SWM* have such access so I try not to harp on about the net too much. (*In fact, our reader survey indicated that about 10% have access - Ed*). For your listening pleasure, however, I commend you to simplex frequency listening. Often providing more entertaining traffic than more formal, controlled nets, simplex users are worth monitoring.

For those of you who like hearing more 'official' type traffic then I suggest the two v.h.f. simplex frequencies listed as 21 and 22 on page 168 of the 7th edition of *UKSD* and all of the simplex u.h.f. frequencies in the 450-456MHz section of *PROMA* or the *UKSD*. Sorry to be obtuse about this. For non official listening, try searching between 454 and 455MHz in 12.5kHz steps and 168 and 169MHz in high band v.h.f. You may get some entertainment.



Listen In

Now to change the subject, readers that live in towns or other built up areas may find it difficult to contact others with an interest in monitoring that live in your area. Exchanging technical information can only enhance knowledge. Difficult, though, if you don't know anyone in the area who shares your interest.

By no means all of us have an amateur licence. So this is where the new PMR446 radios come into their own. If everyone with an interest in scanning got on air on their PMR446 sets at 1900 every Sunday, perhaps on channel 7 (446.08125), without CTCSS, then maybe you might make useful contacts.

Whenever I am in England I shall give it a go at that time, but I reside in a very isolated area normally. Nevertheless I shall be shouting on a Sunday wherever I am.

Oh, and finally make sure that you don't listen at the top end of PMR446 by mistake as there is some discrete f.m. simplex voice traffic to be found there in some parts of the UK. The traffic usually being characterised by its informality.

In any event please let me know what you hear and especially if you manage to hook up with any like minded monitors!



RADIOWORLD

(WEST MIDLANDS)

42 BROOK LANE
 GREAT WYRLEY, WALSALL
 WEST MIDLANDS WS6 6BQ
 WE ARE 5 MINS AWAY FROM J11 M6

SALES & SERVICE
 TEL: 01922 414796
 FAX: 01922 417829

**TELEPHONE SALES ON
 01922 414796**





Open
 Mon-Fri 9.30 -
 6.00pm.
 Sat 9.30 -
 4.00pm



There is NO CHARGE for
 using credit cards

WANTED
 USED
 EQUIPMENT
 PX WELCOME
 BEST PRICES
 PAID!

Telephone
 Dave (G1LBE)
 for more
 details.

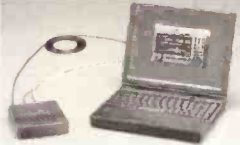
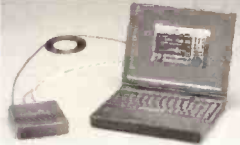
	Model	Description	£ RRP inc VAT
	AOR AR5000	High performance full featured wide band all mode base receiver 10kHz - 2600 Mhz. IF selection as standard 220kHz, 110kHz, 30kHz, 15kHz, 6kHz, 3kHz (500Hz optional). Supplied with mains power supply.	£1359.00
	AR5000+3	High performance base receiver with three enhanced options factory fitted: noise blanker, synchronous AM, automatic frequency control.	£1529.00
	AR3000A	Unique all mode extremely wide band base-mobile receiver 100kHz - 2036mhz with no gaps. RS232 port fitted.	£750.00
	AR3000A +(plus)	Customised AR3000A with switchable narrow SM & SAT filters, Tape relay, SDU ready and discriminator output.	£829.00
	AR3000A Series 2	New advanced wide band all mode hand-held receiver with enhanced microprocessor facilities, slot card options available, multi-function display.	£409.00
	ICOM AR8000	The New Concept. Wide band all mode hand-held receiver with many microprocessor facilities, dot matrix display and computer compatibility.	£296.00
	ICOM R2	0.1300mhz Handie. Fits in the palm of your hand. AM/FM, FM Narrow - 450 memory channels	£139.00
	IC R8500	100kHz - 2GHz Continuous. All mode no gaps. 1000 Memories. 4IF band widths	
	PCR1000	Excellent all round for the professional listener	£1440.00
	IC-R75E	0-60MHz. High Stability receiver circuit 100 DB Dynamic range. Twin bandpass Tuning. Optional digital processor. Best selling receiver	£629.00
	IC-PCR1000 & PCR 100	ICOM PCR1000 - 0-1300mhz. All modes. Computer driven. On screen programming. Band scope. Instant band scope access via mouse. List of features, call for brochure.	
	PCR100		£199.00
			PCR 1000 £299.00, PCR 100 £199.00 (SAME SPEC WITHOUT SSB)

THIS IS JUST A SMALL SELECTION OF OUR STOCK!!!

FINANCE NOW AVAILABLE. PHONE DAVE FOR DETAILS!

GARMIN GPSIII



Moving map features basemap, built-in European,

African and Middle East to 20mi; includes lakes, rivers, cities, railways, coastlines, motorways and roads. Uploadable CD ROM, detailed map data available from MapSource CDs.

RWP **£339.00**

GARMIN STREET PILOT



Built-in international map contains motorways, major roads, lakes, rivers,

streams, airports, cities, towns, coastlines, motorway exits plus waypoints.

STREET PILOT COLOUR
 RWP **£575.00**

STREET PILOT
 RWP **£410.00**

GARMIN GPS12



The Garmin GPS12 series products are as rugged as GPS gets. Military-tough construction and waterproof cases make these units ideal companions for any outdoor adventure. All feature a 12 channel receiver that locks onto stellites fast and stays locked on, even under extreme conditions. These units may be tough on the outside, but their operations are easy and logical.

RWP **£129.00**

Email: sales@radioworld.co.uk
Visit our website at www.radioworld.co.uk

ICOM

YAESU

KENWOOD

ALINCO

AOR

YUPITERU

YUPITERU MVT 9000 EU

Yupiteru's flagship model, with a range exceeding 2000mhz, a real time bandscope.



- 531 kHz - 2039 Mhz
- 1000 memory channels
- All modes: W-FM, FM, N-AM, AM, LSB, USB, CW
- Multiple scanning steps 50Hz - 125kHz
- Alpha numeric display
- Band scope with marker function for direct access to displayed frequencies
- Duplex receive capability - hear split frequency signals easily with VFOs
- 20 search bands
- Fast tune facility gives 10 times function for quick tuning
- Built-in ferrite rod antenna for AM broadcast reception
- OP90 Soft Case

YUPITERU MVT 3300EU

An exciting new handheld packed with features - but at a price you can afford! The receiver has "breathtaking performance" ensuring this set is destined to be a number one seller



- FREQUENCY
66 - 88MHz
108 - 170MHz
300 - 470MHz
806 - 1000MHz
- MODES: AM/NFM
- STEPS:
5, 6.25, 10, 12.5, 25kHz
- MEMORIES: 200
- BAND MEMORIES: 10 (user re-programmable)
- PRIORITY CHANNELS: 10
- SCAN/SEARCH SPEED:
30 per sec
- POWER: Requires 4 x AA batteries
- SUPPLIED WITH: Antenna, Earpiece, Carrying Strap and built-in Desk Stand

YUPITERU MVT 7100 EU



Probably the most popular high end Scanner. It's easy to use and can receive just about anything going!

- 530kHz - 1650mhz
- AM/FM/WFM/SSB/CW
- 1000 Memories
- C/W N/Cads & charger
- OP51 Soft Case £17.95 + £2 p&p

£££...phone for details

USED EQUIPMENT PRICE LIST

MAKE	MODEL	PRICE		
ALINCO	ADI-147 2M MOBILE 50w	£165.00	KENWOOD	SM-220 STATION MONITOR
ALINCO	ADI-446 70cm MOBILE 35w	£189.00	KENWOOD	SP-31 EXT SPEAKER
ALINCO	DJ-10X SCANNER (BOXED)	£210.00	KENWOOD	TL-922 AMP 3-500's
ALINCO	DJ-G5 EY DUAL BAND HANDY	£199.00	KENWOOD	TM-251 2M FM 50W PACKET READY
ALINCO	DR-150 2M/FM/ 50w MOBILE	£200.00	KENWOOD	TM-255E 2M MOBILE MULTI MODE TRANS
ALINCO	DR-590 DUAL BAND MOBILE	£175.00	KENWOOD	TM-455E 70CM MOBILE MULTI MODE TRANS
ALINCO	DR-599 DUAL BAND MOBILE	£245.00	KENWOOD	TM-742E DUAL BAND , DUAL READOUT
ALINCO	DX-70T 100W MOBILE / HF	£475.00	KENWOOD	TM-751E 2M 25W MULTI MODE
ALINCO	EDX 1 TUNER MOBILE / HF	£100.00	KENWOOD	TRIO R-2000 Inc CONVERTER
ALPHA	87A FULLY AUTOMATIC AMP	£3,750.00	KENWOOD	TS-50S MOBILE TRANSCEIVER 100W
AMERITRON	QSK-5 2.5kw QSK SWITCH	£199.00	KENWOOD	TS530SP HF 'CLASSIC' MAINS
AOR	AR-1500 HANDY RECEIVER INC SSB	£99.00	KENWOOD	TS-570DG 3 MONTHS OLD!
AOR	AR-3000A RECEIVER	£495.00	KENWOOD	TS-711E 2m MULTI MODE TRANSCEIVER
AOR	AR-3000A+	£595.00	KENWOOD	TS-811E 70cm MULTI MODE TRANSCEIVER
AOR	AR-5000 RECEIVER	£1,199.00	KENWOOD	TS-830S HG 'CLASSIC' MAINS
AOR	AR-7030 REMOTE CONTROL RECEIVER	£595.00	KENWOOD	TS-850 SAT 100w HF BASE TRANSCEIVER
AOR	AR-8000 HANDY RECIEVER	£199.00	KENWOOD	TS-870 DSP HF/BASE TRANSCEIVER
AOR	AR-8200 MK1 HANDY RECEIVER	£280.00	KENWOOD	TS-940 SAT BUILT IN TUNER
DRAKE	R8E RECEIVER INC CONVERTER	£595.00	KENWOOD	TS-950 SD DIGITAL 150W TRANSCEIVER
ICOM	IC-207 DUAL BAND MOBILE	£275.00	LINEAR AMP	EXPLORER AMP
ICOM	IC-2800 DUAL BAND COLOUR SCREEN	£285.00	REALISTIC	DX-394 HF RECEIVER (BOXED)
ICOM	IC-290D 25W MULTI MODE MINT!	£275.00	UNIDEN	BEARCAT 860XLT SCANNER BASE
ICOM	IC-4KL AMP 1K. SOLID STATE	£1,999.00	YAESU	FC-20 Automatic ATU
ICOM	IC-725 HF MOBILE 100w	£400.00	YAESU	FC-757 ATU Automatic Antenna Tuner
ICOM	IC-728 HF MOBILE 100w	£425.00	YAESU	FC-902 500w Antenna Tuner
ICOM	IC-730 HF MOBILE 100w	£250.00	YAESU	FL-2100Z AMP
ICOM	IC-735 HF 100W	£450.00	YAESU	FRG-100
ICOM	IC-745 HF BASE inc FM 100w	£425.00	YAESU	FRG-9600 RECEIVER
ICOM	IC-746 HF/50/2M 100w	£999.00	YAESU	FT-ONE BASE HF / AC MAINS TRANS
ICOM	IC-751 BASE HF CLASSIC!	£425.00	YAESU	FT-1000MP AC LATEST SERIAL No. !
ICOM	IC-756 HF/6M BASE TRANSCEIVER	£1,050.00	YAESU	FT-101ZD HF TRANSCEIVER
ICOM	IC-765 HF BASE 100w	£950.00	YAESU	FT-101ZD MK111 FM HF TRANSCEIVER
ICOM	IC-775DSP 200w HF BASE TRANSCEIVER	£1,799.00	YAESU	FT-102 BASE TRANSCEIVER 150w
ICOM	IC-821 H 2/70/ BASE TRANSCEIVER	£750.00	YAESU	FT-3000M 70w 2m MOBILE TRANS
ICOM	IC-W31E DUAL BAND HANDY	£175.00	YAESU	FT-5100 DUAL BAND MOBILE TRANS 50w
ICOM	PS-15 POWER SUPPLY	£100.00	YAESU	FT-5200 DUAL BAND MOBILE TRANS 50w
ICOM	PS-55 PSU 20 amp	£120.00	YAESU	FT-650 AC 26-50MHz 100w Base (VERY RARE)
ICOM	R10 HANDY SCANNER	£199.00	YAESU	FT-726R 2/70/6M TRANSCEIVER
ICOM	R2 HANDY RECEIVER	£110.00	YAESU	FT-736R 2/70 cm BASE AC
ICOM	SP-20 EXT SPEAKER	£85.00	YAESU	FT-767GX 2/70/6M HF inc ATU
ICOM	T81E QUAD BAND HANDY	£250.00	YAESU	FT-7B HF MOBILE TRANSCEIVER MINT!
ICOM	T8E TRI BAND HANDY	£195.00	YAESU	FT-840 HF MOBILE-BASE TRANSCEIVER
JRC	JRC-245 HF Trans inc filters HF/6M AC 150w	£1,199.00	YAESU	FT-847 HF/6M/2M/70cm/4m
KENWOOD	AT-300 AUTO ATU	£220.00	YAESU	FT-8500 DUAL BAND MOBILE TRANS 50w
KENWOOD	DSP-100 DSP UNIT 450-etc.	£275.00	YAESU	FT-920 HF 50 MHz BASE TRANSCEIVER
KENWOOD	PS-31 PSU MATCHING TS-850	£150.00	YAESU	FT-990 AC HF BASE TRANSCEIVER
KENWOOD	R-5000 RECEIVER Inc Converter	£595.00	YAESU	SP-102 Ext Speaker inc filters
				VX-500 HANDY SCANNER

■ GODFREY MANNING G4GLM, C/O THE GODFREY MANNING AIRCRAFT MUSEUM, 63 THE DRIVE, EDGWARE, MIDDLESEX HA8 8PS

Airband

On behalf of all readers, thank-you to the benefactors who donated material for my reader offer (June). They know who they are. Also, thanks to you, the readers, for your enthusiastic uptake. Everything went!

A gentleman rang me some weeks ago to enquire about the Antonov AN-2 biplane. Sorry, Sir, I didn't record your name, nor had I any useful information to impart at the time. I have since discovered the AN-2 Club and membership enquiries are invited by telephoning (01707) 262774. On offer to members is the possibility of flying in it.

Another enthusiasts' club looks after Dakota N47FK. Membership again offers possible flight opportunities and the chance to maintain the aircraft. Contact **The Dakota Trust, PO Box 96, Reading RG7 4EH**.

Was your GPS affected between August 11 and 18? The MoD were testing the affects of jamming on GPS in an area centred 5nm south-east of Llanwrtyd Wells, Wales (AIC 57/2000 from the CAA). Write in if you noticed anything.

Procedures

Pilots are forbidden to land on an occupied runway. Recently, the phrase "Land after..." has been adopted by controllers. This means, clear land as long as the previous aircraft has left the runway. It assumes that the approaching pilot has the conflicting traffic in sight, but that traffic is expected to vacate the runway in good time.

Apparently, it's becoming a problem at the busier airports in the United States. Thanks to **Martin Sutton** (CAA), who often contributes to this column, for explaining the situation in *GASIL 3* of 2000.

What routes might **George Jacob** (29km north of Cardiff) see overhead? This location is close to the Brecon v.o.r. beacon (BCN, 117.45MHz). Overflying are airways UA25 (north-south), UG1 (east-west) and UB40 (from Brecon to the south-west). Likely London Control frequency is 133.6MHz. Concorde flies almost over Cardiff on airway SL2 or over the Bristol Channel on SL3/SL5, both possibly a bit far south for you, George. Expect control on 134.75MHz.

Northolt, not far from my Museum, once relied on Precision Approach Radar ("talkdown") for landing in bad weather. This old-fashioned system has now been upgraded by the addition of i.l.s. (I NHT, 108.55MHz). Helpful on a day like today, autumnal mid-July weather (!), when I've just watched the Battle of Britain Memorial Flight Lancaster fly low past my window, nearly scraping the clouds, whilst I type this. The Lanc is anachronistic, they didn't exist as early as the Battle of Britain, being developed from the Manchester later in the War.

What aeronautical services are on 40.2MHz? None that I know of, although some receivers are prone to strong signal breakthrough even when tuned to an entirely different frequency. However, 40.2 is not twice a 10.7 i.f. away from any obvious frequency, either. At the peak of the sunspot cycle (about now) transmissions on this

frequency originating in the USA can be received in the UK. Perhaps they use it for airport ground operations over there, with Tower relayed on it for safety?

This train of thought has been set off by **Dave Whelan** (Huddersfield), and I must also point out to him that neither Manchester nor Leeds and Bradford Airports have a runway 27.

Nav Aids

What do you think about Morse Code? No, don't write to me to perpetuate the debate. The story so far is as follows. Radio amateurs need to pass a Morse exam to operate on h.f. because, originally, other essential users (especially marine) shared the bands and might need to warn an amateur to clear the frequency and Morse was the only means that they could do this. The requirement was all about safety.

Now that this requirement has ceased, some amateurs think that Morse is still a jolly good idea to restrict others from obtaining h.f. privileges, even though such a hurdle was never originally intended. Others, in my view more balanced, enthuse about the great communications efficiency of Morse even though it is recognised that it is no longer essential as far as safety is concerned.

What they've all forgotten is that there is still one service that continues to use Morse in a safety-critical context: aviation! Each time a pilot tunes in a new radio beacon (navigation aid), it must be confirmed that it is indeed the correct one. This is done by listening to the Morse code audible identification that each beacon transmits and which any scanner covering the correct frequency can receive.

These beacons are shown on the charts that may be obtained from sources suggested below (see 'Information Sources') or, as **Anonymous** (*Casa Loma*) found out, on those distributed by my previous reader offer. An n.d.b. is generally a boring vertical mast, not particularly tall, perhaps with some capacity radials on top.

A v.o.r. on the other hand is an impressive structure, a circular grid raised one storey above ground with antenna lumps around its periphery and an equipment cabin beneath. Communications relays are at Birdlip, Chedburgh, Clee Hill, Daventry, Davidstow Moor, Grantham, Greenford, Kelsall, Preston, Rothwell, Snaefell, Swingfield, Trimmingham, Ventnor, Waringham and Winstone. The CAA prohibits me from listing the actual frequencies on which each operate.

I doubt if any will operate directly from the new *en-route* centre at Swanwick. The centre will doubtless connect to the existing relays. As I mentioned in August, there's no date for its opening as technical problems are still to be overcome. So, **Nigel Cook** (Southampton) will have to wait. Oceanic clearances are provided by Swanwick, Nigel (based at Prestwick - beware the similar names!), and I don't expect this to change.

Frequency & Operational News

From the CAA comes *AIP* amendments (thanks to Martin Sutton), *AIC 42/2000* and *GASIL 3* of 2000. These tell me that Halfpenny Green (quaint name) is now known as Wolverhampton. Bound to cause confusion. Oxford's new arrival ATIS 136.225 joins the existing departure ATIS 121.7MHz. Redhill's new Visual Reference Points are at the M25/M23 motorway junction, Reigate station, Godstone, and Godstone station. Shoreham's points are Washington intersection (A24/A283



Abbreviations

AIB	Air Accidents Investigation Branch
AIC	Aeronautical Information Circular
AIP	Aeronautical Information Publication
ATIS	Automatic Terminal Information Service
ATZ	Aerodrome Traffic Zone
CAA	Civil Aviation Authority
CD-ROM	Compact Disc - Read Only Memory
GASIL	General Aviation Safety Information Leaflet
GPS	Global Positioning System
h.f.	high frequency
i.f.	intermediate frequency
i.l.s.	instrument landing system
kHz	kilohertz
MATZ	Military Aerodrome Traffic Zone
MHz	megahertz
MoD	Ministry of Defence
nav.	navigation, navigational
n.d.b.	non-directional beacon
nm	nautical miles
v.h.f.	very high frequency
v.o.r.	very high frequency omnidirectional radio range



Stinson Voyager 165.
Christine Mlynek.

Continued on page 62

■ KEITH HAMER & GARRY SMITH, 17 COLLINGHAM GARDENS, DERBY DE22 4FS

DX Television

Long intense openings, high m.u.f.s and plenty of exotic DX from the Middle East have all contributed to June being the best-ever for Sporadic-E reception. As a result, there is a packed reception log!

Reception Reports

On June 9th at 1530, **Peter Barclay** (Sunderland) received an English drama with Arabic subtitles on E2. In the top-left corner of the picture there was a large dark '1' logo with smaller white '1' inside.

More unidentified Arabic encounters occurred on the 13th when **Peter Chalkley** (Luton) saw pictures on E2 and E3 from 1530UTC. Around 1730, **Tim Bucknall** (Congleton) received the Koran and a news bulletin from Syrian TV on E2.

The 28th was another exceptional day for Arabic reception throughout the UK with a morning opening lasting almost two hours. **Peter Barclay**, **Tom Crane** (Hawkwell), and **Peter Barber** (Coventry) all identified Syrian TV by its large L-shaped logo on E4. Jordan (JTV) also emerged briefly on E3 and again on the 30th at 1106UTC, reports **Stephen Michie** (Bristol).

At one stage on the 28th, Tom Crane became aware of another Arabic broadcast on E2. A national flag was shown briefly composed of three horizontal strips with a solid-looking circular logo in the centre. Tom feels it looked more like Egypt than Iran. There is a 900W repeater at Dumyat. At 0900, a weak test card was visible on E3.

Other Reception

Denmark E3 was widely received on the 9th via short-skip Sporadic-E. Peter Barber logged the Belgian E3 outlet on the 10th, presumably also via short-skip Sporadic-E. Also on the 10th, at around 0630UTC, **David Hamilton** (Cumnock, Ayrshire) and **Stephen Michie** (Bristol) noticed a blank raster with an S-2 logo in the top-left of the screen. This was also seen earlier in the season and is thought to be a new Italian private station operating on Channel A.

Using a massive seven-element Yagi, **Steve Reed** (Nantwich) reports Ukrainian signals on R1, identified by the '1+1' logo. On the same day, Tom Crane successfully captured RTL KLUB from Hungary in PAL colour at 1715UTC.

Peter is certain that a programme on E3 was carrying the ORF-1 logo on the 12th. There are several low-power repeaters operating and these have been received in

Fig. 2: A programme caption from Sweden, received by Stephen. Note the 'UR' identification in the top-left corner and the www.ur.se/mix website caption.

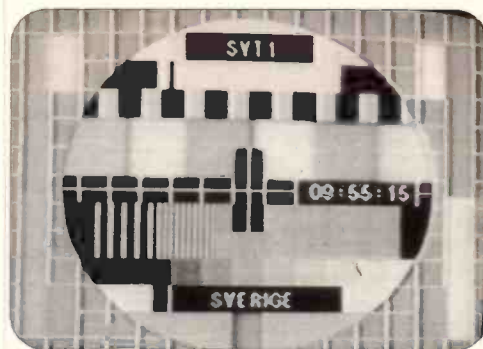

Fig. 1: The SVT-1 PM5534 test card from Sweden, received on June 9th by Stephen Michie in Bristol.



June Sporadic-E Log

Reports have been supplied by Stephen Michie, Peter Barber, Peter Barclay, Peter Chalkley, David Hamilton, Vincent Richardson, **John Woodcock** (Basingstoke), **Barry Bowman** (Manchester), **Simon Hockenull** (Bristol) and **Ian Milton** (Ryton).

Day	Log
1	Italy (RAIUNO) A and B; Italy (VIDEO) E2; Slovenia (SLO-1) E3; Croatia (HRT-1) E4; Hungary (RTL KLUB) R2; Norway (NRK-1) E2; Spain (TVE-1) E2; Corsica (Canal Plus) L2.
2	Norway (NRK-1) E2; Spain (TVE-1) E2, E3 and E4; France (Canal Plus) L3; Corsica L4; Hungary R2; Italy (RAIUNO) A and B; Italy (VIDEO) E2; Slovenia E3; Croatia E4; Portugal (RTP-1) E3.
3	Italy (RAIUNO) A; Finland (YLE-1) E3 and E4; Norway E2 and E3; Sweden (SVT-1) E2, E3 and E4; Estonia (ETV) R2; Russia (RTR) R2; Ukraine (YT-1) R2; Croatia E4; Portugal E3; Spain E3.
5	Spain E2, E3 and E4; Portugal E3; Italy (RAIUNO) A and B; Italy (TVA) A; Corsica (Canal Plus) L2 and L4; France L3; Germany (ARD) E2; Hungary (RTL KLUB) R2.
6	Spain E2 and E3; Italy (RAIUNO) A; Sweden E2.
7	Spain E2, E3 and E4; Portugal E3; Italy (RAIUNO) B; Italy (TVA) A.
9	Germany (ARD) E2, E3 and E4; Czech Republic (NOVA) R1 and R2; Italy (RAIUNO) A and B; Italy (TVA) A; Italy (VIDEO) E2; Corsica L2 and L4; Croatia E4; Slovenia E3; Denmark (DR-TV) E3; Germany E3 and E4; Switzerland (SF-1 DRS) E2 and E3; France L3; Austria (ORF-1) E2a and E4; Belarus (BT-1) R1 and R2; Russia (RTR) R3; Spain E2, E3 and E4; Portugal E3; Hungary (RTL KLUB) R2; Czech Republic (NOVA) R2; Belarus (BT-1) R1 and R3; Estonia R2; Ukraine (YT-2) R1 and R2; Rumania (TVR-1) R2; Lithuania (LRT) R2; Albania (TV-SH) C; Sweden E2, E3 and E4; Norway E2; Unidentified G-204 test card on R2 at 1145; Unidentified Arabic subtitled programme with '1' logo in top-left on E2 at 1509.
10	Slovenia E3; Croatia E4; Italy (RAIUNO) A and B; Italy (TVA) A; Spain E2, E3 and E4; Portugal E3; Hungary (RTL KLUB) R2; Germany E2 and E4; Serbia (RTS) E3; Switzerland E2 (SF-1 DRS), E3 (SF-1 DRS) and E4 (TSR-1); France L3; Corsica L2 and L4; Norway E2; Belgium (RTBF-1) E3.
11	Croatia E4; Slovenia E3; Belarus (BT-1) R1, R2 and R3; Lithuania R2; Germany E2 and E4; Denmark (DR-TV) E3; Russia (RTR) R2 and R3; Ukraine (YT-1) R1 and R2; Moldova (TVM) R2; Estonia R2; Lithuania R2; Czech Republic (NOVA) R2; Hungary (RTL KLUB) R2; Italy (RAIUNO) A and B; Italy (TVA) A; Spain E2, E3 and E4; Portugal E3; Slovenia E3; Italy (RAIUNO) A and B; France L3; Norway E2 and E3; Sweden E2, E3 and E4; Albania C.
12	Hungary (RTL KLUB) R2; Czech Republic (NOVA) R2; Croatia E4; Slovenia E3; Rumania (TVR-1) R3; Lithuania R2; Germany E2, E3 and E4; Austria (ORF-1) E3; Albania C; Italy (RAIUNO) A and B; Italy (TVA) A; Spain E2, E3 and E4; Portugal E3; France L3; Unidentified Arabic signals E2 and E3 at 1530UTC.
13	Italy (RAIUNO) A, B and C; Italy (TVA) A; Spain E2, E3 and E4; Portugal E3; Croatia
	E4; Slovenia E3; Rumania (TVR-1) R3; Hungary (RTL KLUB) R2; Germany E2, E3 and E4; Ukraine (YT-1) R3; Moldova (TVM) R2; Rumania (TVR-1) R3; Albania C; Switzerland E3; France L3; Corsica L2 and L4; Czech Republic (NOVA) R2; Lithuania R2; Syria (SYR-2) at 1730UTC.
14	Spain E2, E3 and E4; Portugal E3; Italy (RAIUNO) A and B; Italy (VIDEO) E2; France L3; Corsica L4; Croatia E4; Hungary (RTL KLUB) R2; Lithuania (LRT) R2.
15	Italy (RAIUNO) A; Switzerland E3.
16	Spain E2, E3 and E4; Portugal E3; Italy (RAIUNO) A.
18	Spain E2, E3 and E4; Italy (RAIUNO) A and B; Italy (VIDEO) E2; France L3; Slovenia E3; Portugal E2 and E3; Rumania (TVR-1) R2. Unidentified weak signals on E2 from the south-west at 1409UTC.
19	Spain E2 and E3; Italy (RAIUNO) A.
20	Corsica L2 and L4; France L3; Portugal E2 and E3; Spain E2, E3 and E4; Croatia E4; Austria (ORF-1) E4; Switzerland (SF-1 DRS) E2 and E3; Switzerland (TSR-1) E4; Germany E2; Hungary (RTL KLUB) R2; Norway E2, E3 and E4; Sweden E2, E3 and E4; Finland E3; Italy (RAIUNO) A and B; Unidentified blank raster on A at 1330UTC.
21	Spain E2 and E3; Portugal E3; Italy (RAIUNO) A and B.
22	Sweden E2, E3 and E4; Norway E2, E3 and E4; Spain E2, E3 and E4; Portugal E3.
23	Spain E2, E3 and E4; Portugal E2 and E3; France L3; Germany E2 and E4; Italy (RAIUNO) A; Switzerland E3; Czech Republic (NOVA) R2.
24	Spain E2, E3 and E4; Portugal E3; France L3; Switzerland E2; Italy (RAIUNO) A and B; Italy (TVA) A; Italy (VIDEO) E2; Corsica L2; Hungary (MTV-1) R1; Germany E2; Norway E2; Jordan (JTV) E3 at 1903UTC.
25	Spain E2, E3 and E4; Portugal E2, E3 and E4; Italy (RAIUNO) A; Italy (TVA) A.
26	Portugal E3.
27	Spain E2, E3 and E4; Portugal E3; Corsica L2 and L4; France L3; Croatia E4; Slovenia E3; Italy (RAIUNO) A and B; Italy (TVA) A; Italy (VIDEO) E2; Ukraine (YT-1) R2; Czech Republic (NOVA) R2; Slovakia (STV-1) R2; Albania C; Russia (ORT) R3; Hungary (RTL KLUB); Austria E4; Moldova R2; Ukraine (YT-1) R2.
28	Hungary R1 (MTV-1) and R2 (RTL KLUB); Serbia E3; Czech Republic (NOVA) R2; Croatia E4; Ukraine (YT-1) R2; Spain E2 and E3; Norway E2, E3 and E4; Switzerland E3; Germany E2 and E3; Italy (RAIUNO) A and B; Italy (TVA) A; Russia (RTR) R1 and R2; Russia (ORT) R3; Ukraine (YT-1) R2; Estonia R2; Belarus (BT-1) R1; Sweden (SVT) E2; Syria (SYR-1) E2 and E4 from 1026UTC; Jordan E3 at 1051UTC.
29	Spain E3; Sweden E2 and E4; Finland E3 and E4; Norway (NRK) E2; Italy (RAIUNO) A; Italy (TVA) A; Croatia E4; Slovenia E3; Germany E2; Hungary (RTL KLUB) R2; Czech Republic (NOVA) R2; Ukraine (YT-1) R2 and R3; Russia (ORT) R1; Jordan (JTV) E3.
30	Spain E2, E3 and E4; Portugal E3; Norway E2 and E3; Sweden E2 and E3; Denmark E3; Switzerland E2; Germany E2 and E4; Italy (RAIUNO) A and B; Italy (TVA) A; Corsica L2; France L3; Slovenia E3; Croatia E4; Ukraine (YT-1) R2; Hungary (RTL KLUB) R2; Austria E2a and E4; Russia (RTR) R2; Rumania (TVR-1) R3; Czech Republic (NOVA) R1 and R2; Unidentified Arabic sign-language programme on E2 at 1030UTC; Iran (IRIB) E2 and E3; Jordan E3 at 1106UTC.

DXTV

Continued from page 61

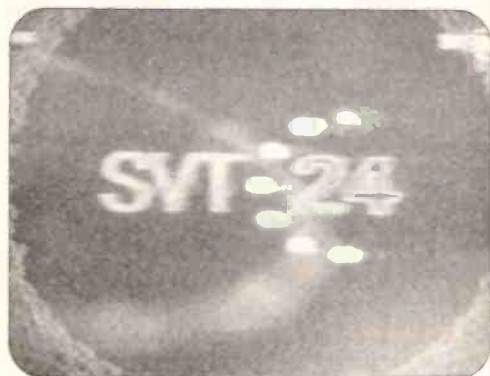

Fig. 3: The 'SVT 24' News programme from Sweden, received by Stephen Michie.

the past. At 1024UTC on the 25th, Peter identified the Portuguese 35W RTP-1 repeater on E4 located at Valenca do Duro.

Lt. Col. Rana Roy (India) reports an FuBK test card from the west on E2/R1 at 1815 local time on the 12th.

FM Reports

Tim Bucknall identified Radio Nostalgie (Lebanon) on 87.7 and 88.00MHz on the 13th from 1730UTC. Meanwhile, using a Kenwood KRC-158RA radio with car antenna, atop Great Ormes Head, Llandudno, **Vincent Richardson** (Dolgarrog) encountered a silent carrier on 104.6MHz with RNA LIFE' RDS. The only 'RNA' station listed is on 96.6MHz, which is Arbroath Infirmary, so perhaps this was some other hospital service.

Irish stations were also heard. **Iain Menzies** (Aberdeen) has noticed a religious broadcast on 87.7MHz. Its origin is unknown but the sound quality was appalling.

David Edwardson (Wallsend) is using a Sony CMTCP1 r.d.s. receiver fed from a loft-mounted four-element Yagi with its dipole replaced by a circular loop of coax to improve gain and bandwidth. David has already experienced Sporadic-E signals drowning out local f.m. relays on 95.65 and 104.25MHz.

David Alley (Bristol) has heard several Italian f.m. stations during recent Sporadic-E openings, also an unlisted 'BBC R1' signal on 93.40MHz. Foreign TV sound on 106.2MHz has been traced to the second harmonic of the Italian 'VIDEO' transmitter which operates just below E2.

Service Information

Stephen Michie has supplied the following information:-

Estonia: New closedown graphics and two new test cards have been introduced. The PM5544 is used with 'EESTI TV' at the top and a large black caption at the bottom. The FuBK carries the identification 'EESTI TV TALLINN'.

Ukraine: Graphics resembling propellers link the YT-2 adverts. **Lithuania:** A standard G-204 test card is displayed followed by colour bars with an LRT logo in the top-left of the screen. A new clock is in use.

Germany: ARD now uses a digital clock.

Keep On Writing!

Please send your DXTV, slow-scan TV and f.m. reception reports, news, off-screen photographs and information to arrive by the first of the month to:- **Garry Smith, 17 Collingham Gardens, Derby DE22 4FS.** We can also use off-air pictures stored as 'JPG' files on PC disks and good-quality video recordings.



Fig. 4: This month's jaunt 'Down Memory Lane'. The plastic-looking thistle logo used by ITV in Scotland.

Airband

Continued from page 60



Isaacs Fury II. Christine Mlynek.

roads) and Lewes intersection (A27/A26 roads). Scampton is active again with an ATZ/MATZ.

The new Athens Airport is now open, reports local **Costas Krallis SV1XV.** ILS (I ATR) Localiser is on 111.1 with Glideslope 331.7MHz. First arrival on June 22 was Beech King Air 200 registered SX-ECG. My only flights to (old) Athens were in 1969 and involved a Douglas DC-6B (registered SX-DAM). You've brought back some memories, Costas!

A beacon is lost: Middle Wallop n.d.b. 376kHz. One less for the students of propagation.

An official v.h.f. interпилot air-to-air frequency has finally been granted for operations over the North Atlantic and, no surprise, it's 123.45MHz. Presumably this replaces 131.8.

On takeoff at major airports, a clearance might just be the Standard Instrument Departure (SID) which is to be followed. So it is important to know what these are. The following SIDs have been introduced: Guernsey GULDA 1E & 1W, KOKOS 1E & 1W; Jersey KOKOS 1A & 1B. The same applies to Standard Terminal Arrival Routes (STARs), of which Edinburgh TWEED EDN 1C has been deleted. New STARs are: Guernsey 1J, Jersey 1T & 1S.

Information Sources

How do you get to see the SID/STAR routes? They're on the various charts published by suppliers (CAA included) listed in my *Airband Factsheet*. If you have access to a computer, the UK AIP on CD-ROM also shows them. You can subscribe to 13 annual editions or, for £11.75 inc. VAT (plus any extra overseas postage), obtain just a single copy from the CAA.

Whereas ATIS will tell you weather and operational information for its specific aerodrome, you can now get free weather reports for any UK airfield from the Meteorological Office. The catch is that this is only possible if you have access to the Internet (at <http://www.met-office.gov.uk/aviation>).

If ordering charts from the CAA, please note that the new agent is **CAA Chart Sales (AFE), Unit 1a Ringway Trading Estate, Shadowmoss Road, Manchester M22 5LH,** telephone 0161-499 0013. Please add this to *Airband Factsheet* Issue 11.

How do you get the *Factsheet*? Send a self-addressed post-paid reply envelope (to hold two A4 sheets), marked with your request, to the Broadstone editorial offices (but **not** to me!).

General radio information is provided by the Radiocommunications Agency (RA). A useful publication shows the radio spectrum with different coloured bands according to purpose, and **Stacy Barron** (Carlisle) can get one free by ringing the RA library. Try (020) 7211 0502/0505/0160/0211.

If an aircraft accident occurs, it is reported in the *AAIB Bulletin*. **Alan Burnett-Provan** (Solihull) learnt of an emergency to an aircraft local to him. If this appears in any future *Bulletin* you will read more about it here.

Next month I will answer **Meg Hertz, Peter Cookson** and **John Weir**. All other letters received up to July 12 have been answered. The next three deadlines (for topical information) are September 12, October 9 and November 6. Replies always appear in this column and it is regretted that no direct correspondence is possible.

Revealing a Remarkable Receiver



Icom are proud to announce their latest radio receiver - the IC-R75. This dedicated HF+50 MHz, all-mode unit has frequency coverage stretching from 30kHz to 60MHz in USB, LSB, CW, RTTY, AM, FM and S-AM. In addition to an extremely sensitive receiver, the twin PBT, 2-level pre-amp, selectable Auto-Gain Control (AGC) and noise blanker help to capture and clean up DX signals, whilst the RF attenuator reduces interference from strong local stations. The IC-R75 also has a Synchronous AM detection circuit to prevent audio distortion while receiving AM broadcasts.

A comprehensive range of features can be found in this extremely compact radio, measuring only 241(W) x 94(H) x 229(D) mm. These small dimensions give complete installation flexibility however you choose to operate, as a base or mobile.

The user-friendly front panel has a large, clear, alphanumeric LCD display. This shows the frequency or '6+2' character channel name. The panel also has a numeric keypad to allow direct frequency entry or memory channel selection. The SQL control may also be configured to adjust RF gain and/or squelch threshold. The large, front-mounted speaker provides clear audio, even at the maximum level of 2 watts.

Other features include a bar graph-style, digital signal meter, 99 memory channels, 2 programmable scan edges, an internal clock with ON/OFF timer functions and three speed-selectable scan functions; (program scan, memory scan and priority scan).

This superb receiver is designed to suit a range of market sectors from the demanding 'decoder' to the interested SWL. The IC-R75 incorporates Icom's leading edge technology and offers a range of features that make it exceptional in many ways. It sets a new standard for performance and value, and will become a popular choice for SWL's everywhere.

Icom (UK) Ltd. Sea Street Herne Bay Kent CT6 8LD. Telephone: 01227 741741. Fax: 01227 741742.
 URL: www.icomuk.co.uk E-mail: info@icomuk.co.uk

ALA 1530 LOOP ANTENNA

As reviewed in the May '99 SWM

This active loop sets new standards for the listener. For the first time it is possible to reject locally radiated and mains borne noise and still provide improved sensitivity compared to larger antennas. 1m dia. Aluminium loop is designed for outdoors, even at ground level. The loop has a frequency range from 150kHz to 30MHz and matches directly to the receiver. With 30dB nulls to reduce interference, LW, MW and SW its reception is outstanding. Technical spec. is excellent with 2nd and 3rd order intercept points of +70dBm and +40dBm respectively.

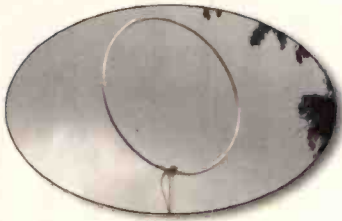

SUPPLIED COMPLETE WITH ANTENNA INTERFACE AND A PSU.

£119.95 incl. postage. Add £20 overseas

WELLBROOK COMMUNICATIONS

Wellbrook House, Brookside Road,
Bransgore, Hants BH23 8NA

Tel: (01425) 674174

E-mail: sales@wellbrook.uk.com

Visit our web site: www.wellbrook.uk.com

Also from The Shortwave Shop (01202) 490099

The Aviation Hobby Centre

Visitors Centre, Main Terminal
Birmingham International Airport B26 3QJ

Tel: 0121-782 2112 Fax: 0121-782 6423

E-mail: orders@aviationhobbycentre.co.uk

Issue 7 of our UK Pocket Frequency Guide is available. Full Civil & Military Frequencies plus much more Still the best at £3.95 + 50p P&P.

Also - Videos by RSVP, Intelligent TV & Video & Avion. Models by Gemini, Herpa, Dragon Wings. Books by Ian Allan, Arliffe, BuchAir, Mach III, Air Britain, The Aviation Hobby Shop (TAHS).

Please ring or send for a free catalogue or visit our web site at www.aviationhobbycentre.co.uk

SPECIAL OFFER

RACAL H.F. Communications Receiver RA1792

• Fully synthesized solid state receiver as used by government departments

• 150kHz - 30MHz

• Modes: LSB, USB, AM, CW & FM

• Digital AGC scan facility

• 100 channel memory



Price: **£550.00** (incl. VAT @ 17.5%)
P&P £15.00 (mainland UK)

★★ Callers welcome strictly by appointment ★★

TELFORD ELECTRONICS
OLD OFFICERS MESS, HOO FARM, HUMBERS LANE,
HORTON, TELFORD, SHROPSHIRE TF6 6DJ, UK
PHONE: (0044) 01952 605451 FAX: (0044) 01952 677978
E-mail: telfordelectronics@telford2.demon.co.uk
Web site: <http://www.telford-electronics.com>

WE NOW ACCEPT ALL MAJOR CREDIT CARDS. OVERSEAS ORDERS WELCOME. PLEASE SEND LARGE SAE FOR DETAILS.



Back Issues Only

£1⁵⁰

KEEP YOUR FINGER ON THE PULSE!

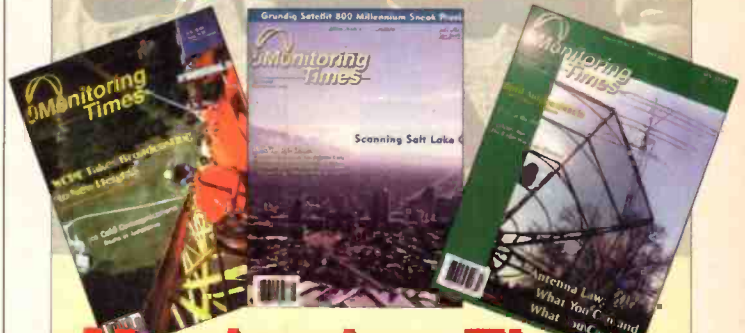

Monitoring Times

Have you ever wondered what the world of radio monitoring is like state-side? Then turn to a copy of *Monitoring Times* for the answers.....

Catch up with the latest news, views, - reviews and discover where to tune your dial for extensive English language short wave broadcasts. Satellite communication systems including commercial, military and private set ups are also explored inside *Monitoring Times* as well as topical features, practical advice and regular reports.

To whet your appetite the Book Store are offering back issues from Dec 1999 to May 2000 for just **£1.50 each!**

(UK only, overseas readers please add 50p per copy P&P)

Take a look at the features you've been missing...

December 1999 - Tuning into the National Power Grid, Aiming your HF Antenna & Around the World by Radio.

March 2000 - Decoding the Russian NavSats, Forbidden Signals, How far is "Line of Sight"? & TWR on a.m. from Bonaire.

January 2000 - Ice Cold Communications - Radio in Antarctica, Radio Shack PRO-92 Review & American FM Radio in the New Millennium.

April 2000 - Antenna Law: The do's and don'ts, Crisis at VOA & The Radio War over Vietnam.

February 2000 - Communications in a crisis, Using Music to identify SW Stations & Dxing the a.m. Broadcast band.

May 2000 - Grundig Satellit 800 sneak preview, Scanning Salt Lake City, & Build a budget FM-DX antenna.

Order now while stocks last!

Tel: (01202) 659930

Fax: (01202) 659950

E-mail: bookstore@pwpublishing.ltd.uk

For subscription prices see the Order Form on page 66.

■ BRIAN ODDY G3FEX, THREE CORNERS, MERRYFIELD WAY, STORRINGTON, WEST SUSSEX RH20 4NS

Maritime Beacons

Following the closure earlier this year of the beacons along the coast of France and some of the Dutch and German ones too (see June *SWM*) most of the listeners who searched the band during daylight in April, May and June were disappointed because they were unable to detect the ground waves from any of the more distant beacons which are still in service. No doubt they are buried under the high level of electrical noise which exists in many locations. A few listeners were fortunate because there are clear sea paths to their location, which result in little attenuation of the signals.

However, the listeners who searched the band after dark, when the sky waves from distant beacons reach the UK, found plenty to interest them! Those at La Isleta (LT) and Punta Lantaila (NA) on the Canaries, which share **291.9kHz**, were amongst the entries in an extensive log compiled by **Robert Connolly** in Kilkeel. He heard two beacons on the coast of Tunisia for the first time - Cap Bon (BN) on **296.5** and El Attaia (KR) **298.5**. Whilst searching the band he noticed few changes except that Kalpieda, Lithuania (KA) was operating on **305.0** instead of **312.5**. The beacons in the Baltic chain on **312.5** were fairly inaudible for the majority of the period.

In Northampton, **Fred Wilmshurst** used an Icom IC-R70 receiver plus Global AT-1000 and a random wire in the loft to search the band after dark. He picked up the sky waves from eight beacons along the coast of Spain, the most distant being Rota, SW.Spain (D) on **303.0** and Punta de Llobregat, S.Spain (OR) on **303.5**. He also heard the beacons at Carla Figuera, Majorca (FI) **286.5** and Mahon, Minorca (MH) on **292.0**. Two on the Faeroe Is - Myggenaes (MY) on **337.0** and Akraberg (AB) **381.0** - were amongst the entries in his interesting log but due to interference from two aero beacons he was unable to positively identify the Prins Christian Sund beacon (OZN) on **372.0**, which is located on the most southerly tip of Greenland.

Down in W.Sussex **Fred Pallant** (Storrington) searched the band at dusk. He found he could hear only

four beacons, of which Mahon, Minorca (MH) on **292.0** was the most distant. The others were at Cabo Machichaco, NE.Spain (MH) on **284.5**; Cabo Villano, N.Spain (VI) **290.5**; Torre de Hercules, N.Spain (L) **301.5**.

During a visit to Scotland in April **Brian Keyte** (Gt.Bookham) spent a while at Rhue by Ullerpool. He powered his AOR AR7030 receiver from the car battery and used a barbed wire field fence as a long wire antenna. Some quite distant beacons were logged including Prins Christian Sund, S.Greenland (OZN) on **372.0**, heard at 0947UTC and Dalatangi Lt, Iceland (DA) on **305.7** at 1523UTC. However, reception was not helped by an electric fence around the farm, which operated 24 hours a day and radiated the callsign (E) at huge strength! Upon returning home he compiled an interesting log, mainly after dark - see chart.

Over on the Isle of Man, **Albert Moore** (Douglas) heard the beacon at Punta D Maestra, Italy (ME) on **304.0** for the first time on May 28, just after dark. He compiled an interesting log (see chart) but found the conditions rather poor during June with lots of static and noise. In view of President Clinton's press statement that he has agreed to do away with the deliberate errors in the Global Positioning System (GPS) Albert is wondering if there will be a reduction in the digital noises on the band since the need for differential (DGPS) corrections may no longer arise. For a brief outline of GPS and the use of former l.w. radio beacons to radiate DGPS corrections please refer to the beacon article in the December '98 *SWM*.

DXers:-

- (A) Robert Connolly, Kilkeel.
- (B) Brian Keyte, Gt.Bookham.
- (C) Brian Keyte, while at Rhue by Ullapool.
- (D) Albert Moore, Douglas, IoM.
- (E) Fred Pallant, Storrington.
- (F) Fred Wilmshurst, Northampton.

Note:

Entries marked * were logged during darkness.
All other entries were logged during daylight or at dawn/dusk.

Long Wave Maritime Radiobeacon Chart

Freq (kHz)	C/S	Station Name	Location	DXer
284.5	MA	Cabo Machichaco	NE.Spain	A,B,C,D,E*,F*
285.0	NO	Cabo de la Nao Lt	S.Spain	A*,B,D
286.5	FI	Cala Figuera	Majorca	A*,B*,D,F*
286.5	PZ	Cozzo Spadaro	Sicily	A*
287.3	HA	Haifa Lt	Israel	A*
288.5	FI	Cabo Finisterre Lt	N.W.Spain	A,B*,D,F*
288.5	UD	Cabo Salou	S.Spain	A*
289.5	NP	Punta Carena	Italy	B*
290.5	VI	Cabo Villano Lt	N.Spain	A,B,C,D,E*,F*
291.0	SN	Cabo San Sebastian	S.Spain	B*
291.9	LT	La Isleta	Canaries	A*
291.9	NA	Punta Lantaila	Canaries	A*
292.0	MH	Mahon, Minorca	Balearic Is	A*,B*,C*,D,E*,F*
293.5	RO	Cabo Silleiro Lt	N.Spain	A*
295.5	CB	La Corbiere Lt	Jersey C.I.	A,B
296.0	KN	Skrova Lt	Norway	A*,C*
296.5	BN	Cap Bon	Tunisia	A*
297.0	B	Cabo Trafalgar	SW.Spain	A*
297.5	MA	Mantyluoto	Finland	A*
297.5	PS	Cabo Penas Lt	N.Spain	A
298.0	TA	Cabo Gata	S.Spain	A*
298.5	KR	El Attaia	Tunisia	A*
299.0	O	Tarifa	S.Spain	A*
299.5	VS	Vieste Lt	Italy	A*
301.0	HA	Pt del Hank	Morocco	A*
301.5	L	Torre de Hercules	N.Spain	A*,B*,D,E*,F*
303.0	D	Rota	SW.Spain	A*,B,D,F*
303.5	OR	Punta de Llobregat	S.Spain	A*,B*,C*,D,F*
304.0	ME	Punta D.Maestra	Italy	D*
304.5	MY	Cabo Mayor Lt	N.Spain	A,B,D,F*
305.0	KA	Klaipeda Rear Lt	Lithuania	A*,B*
305.7	DA	Dalatangi Lt	Iceland	B*,C
306.5	H	Hel Lt	Poland	A*,B*,C*
307.5	RS	Ristna	Estonia	A*,B*,C,D,F*
308.0	MO	Ponta Moriea	Cape Verde	A*
309.0	CI	San Benedetto Lt	Italy	A*
309.5	BA	Punta Estaca Bares	N.Spain	A,B,C,D,F*
309.5	OD	Odesskiy	Ukraine	C*
310.0	IP	Capo Sandalo Lt	Sardinia	B*
310.5	AS	Castellon	Spain	A*
310.5	GV	Genova	Italy	A*
311.5	SA	Senigallia	Italy	A*
312.0	SP	Cap Spartel	Morocco	A*
312.5	BK	Baltijsk	Russia	A*,B*,C*
312.5	BT	Mys Taran Lt	Russia	A*,B*,C*
312.5	DB	Doobskiy	Ukraine	A*
313.0	PA	Cabo de Palos Lt	S.Spain	A*
314.5	TL	Punta D.Penna	Italy	A*,B*,D*
315.5	ND	Nida	Lithuania	A*
337.0	MY	Myggenaes	Faeroe Is	A*,B*,F*
372.0	OZN	Prins Chris's Sund	Greenland	A*,C
381.0	AB	Akraberg	Faeroe Is	A*,B*,C,F*
404.0	NL	Nolso	Faeroe Is	A*,B*,C

■ ROGER BUNNEY, 35 GRAYLING MEAD, FISHLAKE, ROMSEY, HANTS SO51 7RU

Satellite TV News

The satellite waves are increasingly going digital and although there is still much programme activity to be seen in analogue, the outside broadcast feeder links to the studios in analogue are becoming something of a rarity. It was therefore an unusual sighting during the UEFA football antics in the Benelux to see the OB circuit to the BBC on *Telecom 2C* @ 3°E using both analogue and 'encrypted' with SIS - sound in syncs.

Sound in syncs is a very early method of digitising the accompanying programme audio and inserting this within the



These are live pictures from a recent Kourou rocket launch when *Eutelsat W4* was placed into orbit. Two cameras are mounted on the rocket housing giving dramatic views from the rocket as it lifts away from earth into space. 1) shows the main rocket prior to the 1st stage jetison. 2) and 3) is from another camera showing the 3rd stage prior to the satellite being 'pushed off' into space. The earth is in the background.

picture line syncs of the video signal. The result is a fluctuating image, the 'shaking' relating to the programme audio and, of course, no analogue audio.

The SIS BBC feeder was active daily during the UEFA football games at 12.606GHz-V. The picture can be stabilised and the audio recovered with a Dutch made 'EBU Descrambler' - I acquired mine from Meteor Satellites at Bristol some years back.

The 'EBU' as above is the European Broadcasting Union and they exclusively used SIS up to about two years ago for all international circuits, they then went MPEG 4:2:2 and the screens went black! Though the UEFA football occupied the satellite circuits during June, the hooligan outbreaks filled up the airwaves unfortunately.

In an Amsterdam UEFA Euro 2000 interview fed via *NSS-K*, 21.5°W on June 20th, the German reporter referred to 'the German fans and the English hooligans' ('Intrax 14HBR' service id, 11.520GHz-H, SR 5632+FEC 3/4). The UK v. Germany at Charleioi, Belgium, on the 20th June anticipated a mega punch up, but the action passed relatively quietly. The BBC were feeding via *Eutelsat W4* @ 36°E @ 11.002GHz and with other broadcaster feeds (of the match) at 11.050, 11.087GHz on the same bird.

Meanwhile, APTN UKI-194 were sending pictures from the town on the *Telecom 2A* sat @ 8°W (12.57GHz-H) showing a complete lack of police presence. A more interesting (American) football occasion was on June 17 when via *NSS-K* the National Football League - Europe League - were running the Berlin Thunders v. Frankfurt Galaxy out of the World Stadium at Frankfurt, Germany, this broadcast for Fox Sports. This was fed in digital 11.559GHz-H (5632+3/4) and also in a parallel feed analogue 11.676GHz-V, unusual in that the digital feed (of the same picture) clearly revealed a two second delay compared to the analogue. Perhaps the delay results in digital encoding - any comments?

International football circuits were fed via *Intelsat 602* @ 62°E mainly in digital and for many active readers this is a low horizon bird and not visible to most of us living within the typical urban environment. The overall period of the Euro 2000 Football Championships ran June 10th through to July 2nd.

A more exciting sporting event was screened over a Reuters *NSS-K* lease (11.462GHz-V; 5632+3/4) for the American sports channel ESPN morning of July 9th when recorded action of the previous day were shown - this the 'Reno Rodeo' from Nevada. The rodeo was a true cowboy action scenario with cows being lassoed, bucking broncos and within a traditional arena - the contestants didn't wear Colt 45s though!

The American rodeo scene is obviously big business as all the contestants were from national rodeo teams and there's big bucks for the winners. Rodeo league tables were shown from other rodeo events from cowboy towns in Arizona, Texas, etc. Interesting and makes a change from the ever present American PGA golf matches.

Another dramatic sport from the 'States is motor racing and June 18th provided live track pictures from the Pikes Peak International Raceway, this for the ABC Sports network including full commentary and ad breaks. *NSS-K* again on the 'BT Washington' lease - 11.559GHz-H - 5632+3/4.

The *Tour de France* usually provides us with breathtaking photography as the racing bikes in their usual precision fashion zoom round mountain bends and slopes, unfortunately and again with the greater use of digital, the late afternoon racing this year has proved difficult in actually locating the downlinks. *Eutelsat II-F4* @ 10°E carried some racing activity - 11.040GHz-H (6111+3/4) and a quick check on the *Telecom* birds found nothing, though the UK's Wimbledon was airing on 8°W for Premiere Sport - in fact this latter satellite often carries various OB offerings for the BBC, ITV, BT, SISLink and other broadcasters, both in Ku and *Telecom* bands.

Main Wimbledon output seemed to be carried over on *W4*, 36°E, 'ITN LINKS UKI-506' were fired up @ 11.087GHz-H, 5632+3/4. *Sirius* @ 5°E also seems to pick up a wide variety of 'occasional' traffic and Wimbledon 2000 also appeared here for the Lady's Finale (12.607GHz-V) and parallel transmission on *NSS-K*, 21.5°W.

For daytime enthusiasts cricket was also being distributed over *W4* (the test between S. Africa and England). I happened to scan across the 8°W *Telecom* bird one night and came across the ITN Euronews programme channel, this is lurking at 11.646GHz-H digital. Put your receiver into auto for this one as I found it with an unusual SR 4440+3/4!

Mid June saw the change-over of *Eutelsat* satellites at 36°E, there being a gradual move from the incumbent *2F3* to *W4*. The latter is the new kid on the block as *2F3* has moved off-stage. Checking across *Telecom 2A* @ 8°W early July and a small programme (?) bouquet popped up at 11.553GHz-H (SR 27500+3/4) - service ident 'FSP-1' thru to 'FSP-4'. Some weeks earlier all that registered were the FSP1-4 and blank screen, this time however the screen revealed the large caption 'MEDIAGATE' and an inlaid digital clock.

Dorking, Surrey satellite zapper **Roy Carman** was checking out *W4* @ 36°E for signals on the 23rd June and found 'Sky News Folkstone' (SIS 26 G00136G) - 11.0050GHz-H running a news feed out of Folkstone, a modern court house with a prison van arriving. The reason for the court activity was revealed later at 11.087GHz-H also on *W4*, the first court appearance of the lorry driver of the 'death container', the lorry that arrived at Dover off the ferry with 58 dead and two surviving illegal Chinese immigrants.



A recent New York originated test card on a trans-Atlantic lease on *NSS-K*.



The Reuters *NSS-K* lease with a feed ex Brussels during the UEFA football events.



The service ident of this digital feed often states 'Sat Video House' and another *NSS-K* signal.

Roy also sighted the Dutch amateur TV downlink during June, this via *Eutelsat W2* @ 16°E at 12.729GHz-H digital @ SR2000; FEC 3/4. An odd image, this showed as its centre piece a bespectacled rabbit toothed character holding a 'Hollywood Oscar' type award, itself resembling the character with the words 'complete anorak' written across it!

I've aired elsewhere the problem of non-locking of strong digital satellite signals and I'd like to hear any comments arising. Checking out the *Telstar-12* bird @ 15°W on June 20th I found a very strong signal at 11.491GHz-H. The receiver was in 'auto' and locked up at 90% of signal strength f.s.d. - i.e. strong - with digital parameters SR 26000 + FEC 5/6. The receiver simply refused to download into memory, a phenomena that has been experienced by other sat-zappers. Perhaps the incoming signal is in PowerVu, 4:2:2 or in an equally alien state and dislikes our MPEG-2 standard receivers...

Roy Carman found high drama June 28th on the German *Kopernikus DFS-2* @ 28.5°E concerning the bulk tanker *Judy Litrico*, whilst in transit she sprang a leak - not water flowing in but part of its radio active cargo leaking out! The ship was moved into a large sea lock for containment of the active effluent at Essland, Kiel. The 'NDR SH Magazin' downlink carried live reports and 'disaster reviews' into their programming and early evening magazine programme. Noted at 12.640GHz-V digital (SR 6111+3/4).

A letter arrived from **Edmund Spicer** (Littlehampton), that town in recent times unfortunately headline news after the Sarah Payne disappearance. Edmund lives near to the local police station and noted many satellite trucks operational, both marked SISLink, BBC, ITN and several others unmarked, all linking back to network via 36°E - other than the local BBC South truck that appeared to be using a 2.5GHz terrestrial link antenna pointing towards Rowridge.

Edmund is still active with French TV reception via *Telecom 2B* @ 5°W, he's viewed the French TV services on this bird since 1993 and feels that the everyday exposure to the domestic services helped him gain his French degree. Canal+ has opened an analogue service - using Syster encryption - on this sat @ 12.648GHz-V and in stereo using the 7.02 and 7.20MHz subcarriers. Interesting that the mono sound is encrypted at 6.60MHz but the two afore mentioned stereo carriers are in the clear - all the other analogue services on 2B transmit in mono. Previously *RTL-9* during its stay on 2B was in stereo.

An E-mail from **Tim McClelland**, a French TV anorak on Bournemouth Bay, adds more information - Canal+ is using SECAM, in the clear for part of the daytime but encrypts during the evening and night. On the same satellite *TV5* has moved to 12.584GHz using PAL (not SECAM as reported in other listings) with J17 audio @ 5.80GHz.

Finally an update of our July column, page 58, column two concerning a possible Qantas aircraft hi-jack April 22nd. It's thanks to **Jonathan Garratt's** E-mail, he's the Head of Broadcast and Satellite Operations at Image Unlimited, Rome, and advises of the real facts. The Qantas plane was hidden from public view in a corner of Rome's Fiumicino-Leonardo Da Vinci Airport after a wheel fell off during take-off on a Melbourne flight that morning!

Jonathan actually uplinked the signal in 35°C heat for Australia via SISLink and BT Tower, London. It made breaking news back in Oz on Channel 7 but no other broadcasters were interested. The uplink truck was Image's UKI-425 which is based in Rome along with other mobile sat linking equipment.

Orbital News

'The Money Channel' that appears within the Astra/Sky Digital 28.2°E digital package is living up to its name, losses are over expectation (£4.1 million to end March) and some £11 million has been raised in on-going funding. Problems have arisen with (lack of) access problems onto digital cable, insufficient subscribers and reluctance of broadcast/cablecasters to take the channel on-board

following costs of the 'free' digital boxes.

German sat terrestrial and sat broadcaster SAT-1 has merged with Pro Sieben Media to create Germany's largest TV/media company pushing the former top-dog Bertelsmann empire into second place. The new group will 'develop alliances with broadcasters in other European countries'.

BSKYB have been instructed to provide domestic equipment access to e-commerce groups, banks, etc. via the digital boxes now in subscribers houses. A 'reasonable charge' will be made to commercial groups seeking access to the system.

ITV-1, 2 and BSKYB are still at loggerheads at the former's refusal to take space on the 28°E Sky digital satellite despite other UK terrestrials taking downlink capacity. ITV argue on the number of regional variations despite falling viewing figures.

Although there are more Sky analogue channels closing on *Astra 1* analogue @ 19°E, the Germans are queuing up to take up the capacity for their own programming and using both analogue and digital transmission. Sky Cinema and The Racing Channel close late August and the German channel Viva has already apparently booked part of the vacated space. Interestingly, the Turner channel TCM (Turner Classic Movies) has moved onto Astra analogue taking over the TNT channel space.

'InfoNews Channel' has opened beaming a 24-hour news channel across mainland China and operated by Phoenix Satellite TV Holdings. Both Murdoch's Star TV and a Shanghai business group have funded the channel which will construct a new HQ at Shenzhen, Southern China. Expansion plans include a Cantonese language channel a Chinese language channel for North America.

CNN has opened a new South Asian regional channel targetting India with five hour programme blocks in the English language. The Delhi based office suggest that the programming is not a local or national news service but international in concept with an Indian point of view.

Indian PAY-TV operator ZEE-TV is opening 'ZEE Sports' early August featuring both international and Indian sports, e.g. cricket, initially in digital FTA and then to subscription after the free sampler period. 'CEE-Entertainment' will be opening a movie/general entertainment end 2000 in a 'South Indian language' for the Middle East and spreading coverage to Europe and later North America.

The CNBC-Europe satellite channel is launching a regional variation covering Turkey early Autumn and offering general entertainment plus business/financial news with a Turkish bias, the production centre will be at Istanbul and work in conjunction with a local terrestrial 'Kanal E'.

Press releases from Eutelsat comment on their orbital capacity growth with SESAT (April 17); W4 (May 24) and *Telecom 2D* plus *Telecom 2A* @ 8°W. Eutelsat have just ordered *HOT BIRD-7* to slot at 13°E, the 40 transponder craft arriving in orbit late Spring 2002.

The new 36°E, W4 sat will take on board Africa's Multichoice PAY-TV downlinking operation with at least 30 TV channels. W4 will also beam Portuguese TV programming into Angola and Mozambique from the RTP-1, SIC and TV Globo home services.

Mid June saw the new *Eutelsat W4* and SESAT satellites enter service at 36°E taking over from the incumbent *Eutelsat 2F3*, the latter moving towards the *Telecom* slot @ 8°W. The Spanish Hispasat company have agreed the purchase and launch of a new satellite - *Hispasat-1D* - to slot into a 30°W orbit by mid 2003.

Just along the road the *Telecom 2C* satellite at 3°E is to move to 5°W replacing the elderly *Telecom 2B*. France Telecom have yet to advise a date for the change.



During the Little Ships to Dunkirk event June 2nd, Sky fed live pictures back to the UK via 36°E.



Analogue TV is still alive and well as witness this test card on *Eutelsat W2* @ 16°E.



Edmund Spicer in Littlehampton uses this dented 600mm Amstrad dish for his satellite reception, it works well for an ex student on a very tight budget!

■ LAWRENCE HARRIS, 5 BURNHAM PARK ROAD, PEVERELL, PLYMOUTH, DEVON PL3 5QB

■ E-MAIL: info_orbit@pwpublishing.ltd.uk ■ WEB SITE: http://www.ichycoo-park.freeserve.co.uk

Info in Orbit

NOAA-15 Makes Headlines

I watched the early pass of *NOAA-15* on 10 July and saw almost continuous errors in the data. The next pass was the same. The sound of the a.p.t. - usually a pleasing 'clip-clop' as the side-by-side pictures are transmitted - confirmed that all was far from well with the satellite.

An E-mail to the WXSAT forums on the Internet was joined by other reports noting the problem. With the launch of *NOAA-L* then scheduled for the end of August, my first thoughts were that at least a replacement satellite was available. Then I remembered that the orbital plane of *NOAA-16* was already planned and published by NOAA, see Fig. 1. Basically, it was not a suitable replacement for *NOAA-15*.

Wayne Winston of NOAA provided the definitive comments about the *NOAA-15/NOAA-16* situation. "The satellite is already delivered to Vandenberg and is less than a month away from being 'bolted' to the launch vehicle. The satellites are built with a morning or afternoon orbit in mind;

Fig. 1: Scheduled launch data.

Spacecraft	Likely Orbit	Planned Launch	Launch Vehicle
<i>NOAA-L</i>	PM	August 29, 2000	<i>Titan II</i>
<i>NOAA-M</i>	AM/PM	May 2001	<i>Titan II</i>
<i>METOP-1</i>	AM	June 2003	<i>Ariane-5</i>
<i>NOAA-N</i>	PM	December 2003	<i>Delta II</i>
<i>METOP-2</i>	AM	Spring 2008	<i>Ariane-5</i>
<i>NOAA-N</i>	PM	January 2008	<i>Delta II</i>

for instance, *NOAA-16* carries a Solar Backscatter Ultraviolet Radiometer (SBUV) that measures ozone through the depth of the atmosphere. This instrument only works in an afternoon orbit (and is therefore) - useless in a *NOAA-15* type morning orbit".

Wayne added "and there is the looming possibility that the *NOAA-15* failure analysis might indicate something more than a random failure. That would mean the possibility of another launch delay and rework of the *NOAA-16* AVHRR (advanced very high resolution radiometer). Lot of tough decisions here for the satellite management team - we'll have to wait and see!".

Within a few hours, *NOAA-15* was transmitting

largely 'blank' a.p.t. and h.r.p.t. Their 'bulletin announcements' web site and the Internet mailing lists were updated: "The h.r.p.t. transmission from *NOAA-15* has been experiencing severe problems with signal synchronisation since early on 10 July, UTC". They confirmed ongoing analysis of the telemetry.

Amateurs Help Monitor NOAA-15

When a satellite is having problems, engineers check out a number of parameters that are transmitted as 'house-keeping' data. Transmissions on h.r.p.t. include near-continuous readouts of the status of equipment onboard the satellite, and may provide information leading to the identification of the causes of problems.

One overall problem is that the satellites cannot be continuously monitored. *NOAA-15* passes over various countries, so amateurs were able to forward a steady stream of



Fig. 3: *RESURS 01-N4* image from Dave Ball 7 July 0948UTC.

reports concerning the a.p.t. and (when possible) the h.r.p.t. content of the data flow.

Update 1 at 1400UTC on 10 July confirmed: "First indications are that of a possible failure of the AVHRR instrument scan motor. Scanner problems will affect all AVHRR output, both h.r.p.t. and a.p.t. data transmissions. NOAA personnel are awaiting more information from telemetry when the satellite is again within view of the NOAA Command and Data Acquisition (CDA) stations".

At 1610UTC on 10 July, NOAA commanded the Manipulated Information Rate Processor (MIRP) to be switched from AVHRR (the imaging scanner) sync to internal sync. This had the effect of replacing image data with internally generated data. This restored instrument data in the h.r.p.t. data stream. The a.p.t. data was similarly replaced. NOAA then announced "It appears the AVHRR instrument scan motor is severely degraded. NOAA, NASA, the AVHRR instrument manufacturer and spacecraft vendor continue to investigate this event, and seek possible solutions. However, if the scan motor cannot be restored to an operating state, there will be no further AVHRR image data from *NOAA-15*".

By the morning of 12 July, NOAA announced that the AVHRR scan motor was operating at a higher than normal current, indicating the presence of a drag torque in the instrument, though adding that the variability of the current had been reduced. Attempts would be made to resynchronise the MIRP with the AVHRR, and the results were being monitored and evaluated by NOAA over several orbits.

If the engineering test data was favourable, re-synchronisation would be established, and usable AVHRR data would be possible. "A procedure is being developed to return the MIRP in internal synchronisation in the event of further AVHRR scan motor anomalies".

I missed the early evening *NOAA-15* pass on 12 July, but the middle pass provided excellent data - much to the relief of many people! An announcement by NOAA at 2000UTC on 12 July confirmed that re-synchronisation had been successful - but added "Unfortunately, checks on the telemetry show that although image data has been successfully received during the past 24 hours (as at mid-July) observation indicates the AVHRR scanner motor current is very slowly increasing. This may indicate that an unstable motor current and synchronisation jitter problems similar to what was experienced early on July 10, could resume shortly. If this does occur, the MIRP will be commanded to internal synch and image data will again be lost".

The Office of Satellite Operations (OSO) of NOAA/NESDIS

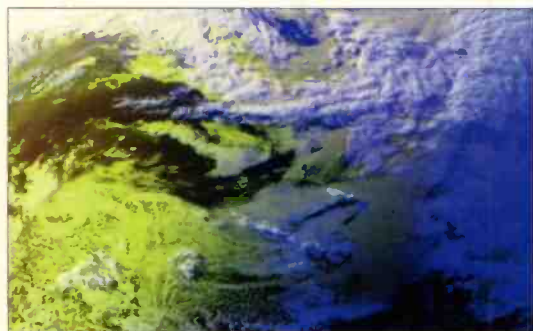

Fig. 2: *NOAA-15* evening pass 12 July.



Fig. 4: OKEAN-O 27 June 0756UTC from Les Hamilton.

confirmed the next day that NOAA-15s AVHRR had continued to provide usable data. "The motor current continued to be carefully monitored to verify instrument performance and to provide additional data for anomaly analysis. While these instrument operating parameters have been somewhat erratic, they are still currently within the control margins of the instrument". Information courtesy **Tom Renkevans** of the Satellite Analysis Branch, NOAA/NESDIS/SSS, and **Wayne Winston**.

Current WXSATs

With NOAA-15 possibly leaving operational status if problems persist, there is unlikely to be a suitable replacement in the near future. As at mid-July there are still reports of occasional errors in the data; we can but hope!

Meanwhile, NOAA-12 and NOAA-14 remain operational, the latter likely to be replaced by NOAA-L (NOAA-16 after launch). METEOR 3-5 resumed transmissions on 137.30MHz in early July after another passage through a 'low solar illumination' zone. METEOR 2-21 was commanded on during June, to replace METEOR 3-5. It transmitted a.p.t. on 137.40MHz, but was still transmitting after METEOR 3-5 returned to active service. RESURS 01-N4 continued regular transmissions on 137.85MHz throughout the period - as illustrated by Fig. 3 from **Dave Ball**.

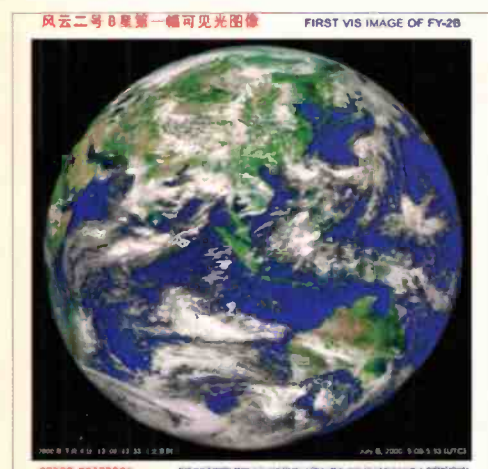

Fig. 5: First visible-light image from FY-2B released on 6 July courtesy National Satellite Meteorological Centre (NSMC) of the China Meteorological Association.

Launch Date For NOAA-L

Late news in mid-July came the possible postponement of launch from 29 August by up to 14 days.

OKEAN-O Activity

The Russian oceanographic satellite OKEAN-O has spent long periods without transmitting a.p.t. signals, but recently resumed occasional transmissions. I have only logged one such transmission, but others have recorded several passes. **Les Hamilton**, software expert with the Remote Imaging Group, made Fig. 4 available for publication - an early morning pass from OKEAN-O on 27 June. This was a 7° elevation pass - and therefore below my 10° eastern horizon limit! With the image set to display correctly, one can notice that the numbers are reversed and the clock counting backwards - a situation that has existed since launch.

FENGYUN-2B Launched

The new Chinese satellite FY-2B was launched on 25 June, 2000 at Xichang launch centre with a Long March 3 vehicle. The satellite will be located in geo-stationary orbit at 105°E longitude. FY-2B is the second Chinese spin-stabilised geo-synchronous, Earth observation satellite, and can obtain hourly, full disc earth images in three channels: visible (0.55-1.05µm), infrared (10.5-12.5µm) and water vapor (6.2-7.6µm).

Resolution of the image at ground-level is 1.25km for the visible channel, and 5km for the infrared and water vapor channels. The satellite will broadcast low resolution WEFAX images and collect data from automatic data collection platforms.

Once the satellite is positioned, in-orbit tests and trial operations will take six months; the formal broadcast of high resolution data and WEFAX images will then commence. Before that, transmissions will be irregular. China has announced that transmission of stretched VISSR data and WEFAX image are free - there will be no encryption.

China plans to develop and launch ten advanced meteorological satellites into orbit in the coming decade, to improve the accuracy of weather and natural disaster forecasts. **Yan Hong**, deputy director of the China Meteorological Administration (CMA), told the Xinhua news agency that the Chinese Government has approved a plan by the administration to develop and launch the satellites costing about US\$ 700 million. The satellites, together with the five meteorological satellites still orbiting the earth, will help China form a complete meteorological satellite system in the near future.

MSG-1 - METEOSAT Second Generation Launch Delay

Eumetsat have announced a further significant delay to the launch of their all-digital geostationary satellite MSG-1. Originally scheduled for launch this October, and subsequently delayed to July 2001, the earliest launch date is now January 2002. The main problem is a serious delay with the ground station segment, and continued worries concerning vibration problems if an Ariane-5 launcher is utilised. Eumetsat are satisfied that the existing geostationary satellites, in particular METEOSAT-7, have sufficient fuel to ensure operations until 2003 and beyond if necessary.

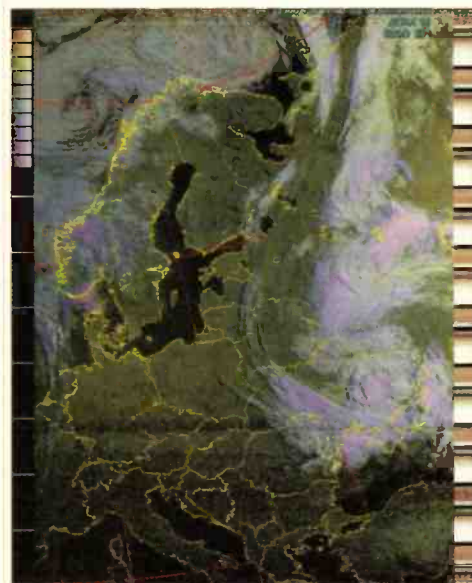

Fig. 6: NOAA-12 0420UTC 21 June 2000 from David Taylor.

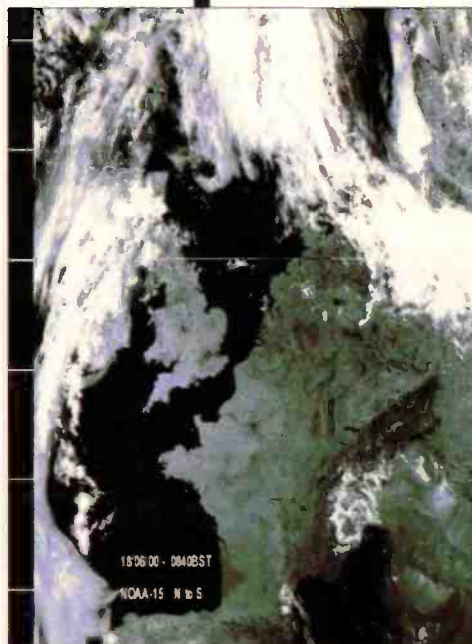

Fig. 7: NOAA-15 18 June 0740UTC.

Solstice Images

I find WXSAT images taken on the days of the solstice to be unusually fascinating, but this year we were visiting daughter Catherine and grandson Joseph in London, and I did not want to leave any computers powered up. In contrast, while absent in Canada visiting fellow WXSAT enthusiast Milan Konecny, **David Taylor** left his equipment in full operation and acquired a complete set of images.

David kindly sent me a series of these images, including **Fig. 6**. The night-time passes of *NOAA-14* and *NOAA-12* see significant levels of solar illumination. To produce this image, David recorded the audio signal of the a.p.t. using the program *wxsat* running under *Windows NT*, and then used his program *SatSignal* to process the resultant wav file. Image processing consisted of enhancing the contrast level by adjusting 'gamma' in order to improve the brightness. Country outlines were added.

Nev Cooper uses a.p.t. satellite images on the daily World Wide Weather Maritime Mobile Net (21.303MHz at 1300UTC), along with other Internet weather downloads, for advising 'ham yachties' of forecast weather. Nev sent **Fig. 7** - a *NOAA-15* a.p.t. image, and suggests a visit to their web site <http://users.breathemail.net/g3lmo/index.htm> for further information:

Pyrenees - Early Morning HRPT

Many years ago my wife Marion worked for a time as a student helper at a weather station in Birmingham, where she learned about chart interpretation. Data was received from volunteer weather monitors around the country who operated their own 'climate stations'.

I was therefore pleased to receive correspondence from **Cedric Roberts** who has been running a climate station for the Met Office since January 1956 - as a hobby - having been supplying them with rainfall data on a daily basis since 1 January 1946. Cedric tells me that he has found (and still finds) this to be fascinating and has had immense enjoyment from the hobby over the years. He now has such a huge data base

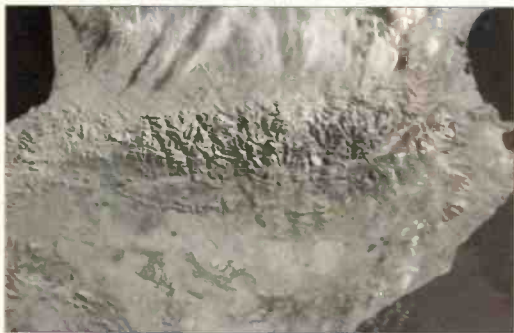

Fig. 8: Pyrenees - NOAA-12 high resolution image 17 June from Cedric Roberts.

that he believes it is possible to see that the climate is changing. "I began with a 'flower pot' rain gauge in 1946 and now have a fully operational manual station as well as an automated one, plus an excellent satellite system". Cedric's retirement 14 years ago has enabled him to make full use of his time.

Like me, Cedric has a very limited horizon for his h.r.p.t. tracking dish, so does not leave his equipment running full time, but merely operates it for selected passes. **Figure 8** is an image taken from *NOAA-12* on 17 June at 0554. It shows the Pyrenees in some detail, being early morning image illuminated by a low elevation sun. His system was made by Dartcom.

Mell Tucker received the details about building a QFH (quadrifilar helix) antenna last winter, and managed to construct and mount it on the mast. Mell contacted me to comment on the vast improvement between his new QFH and

the crossed dipole (with reflector) that he had used for three years. Mell sent **Fig. 9**, a *NOAA-14* image received using the antenna.

Featured Region - Aegean Sea

With a high resolution telemetry tracking dish installed in my backyard, I am always looking for those glimpses of areas around Europe that are only visible when one of the satellites passes through any of the small gaps between roofs, trees and nearby hills. Greece is mostly out of bounds to my system but I have noticed that every few days, it appears just within range.

One recent instance is shown in **Fig. 10** when the region was nearly cloud-free, enabling me to obtain a good quality image. This multi-spectral image includes western Turkey, as well as a little 'noise'! My longer term plan is to have the tracking dish mounted nearer the roof, from where the view should be hugely improved.

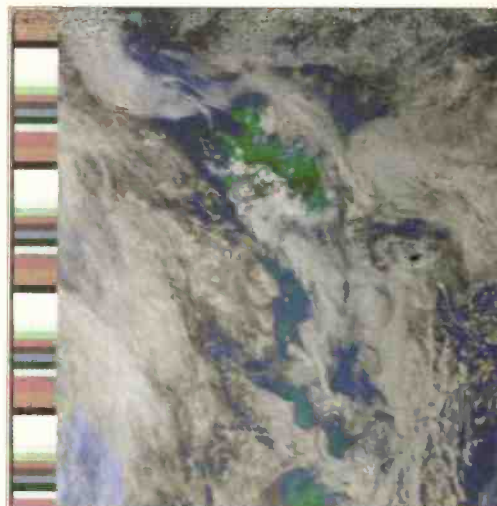

Fig. 9: NOAA-14 a.p.t. image 1438UTC 25 June from Mell Tucker.

Mystery Landscape?

The image shown in last month's column is the section of the river Danube, a few miles east of Belgrade and west of the Transylvanian Alps.

Next Month

Following an E-mail question and answer session with **Olga Tarakanova** of R&D Centre ScanEx, I am pleased to announce that next month's 'Info' will include her comments about the METEOR, RESURS and OKEAN satellites' operations.

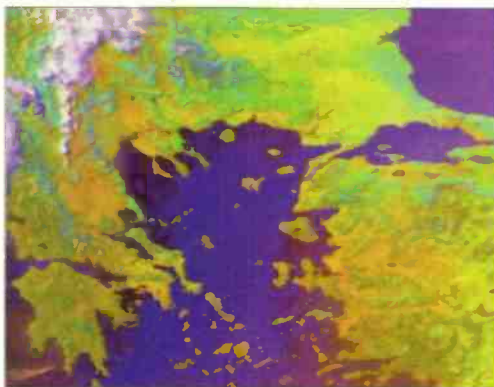

Fig. 10: Aegean sea NOAA-12 h.r.p.t. 1553UTC 12 June.

Kepler Elements - WXSATs, MIR and Shuttle

If you want a computer disk file containing recent elements for the WXSATs, AMSATS and others of general interest, together with a large file holding elements for thousands of satellites please enclose 50p with a PC-formatted disk and stamped envelope to the address at the head of the page. A print-out is included that identifies NASA catalogue numbers for the WXSATs. The disk file is ideal for automatic updating of tracking software.

Frequencies

NOAA-14 transmits a.p.t. on 137.62MHz.

NOAA-12 and *NOAA-15* transmit a.p.t. on 137.50MHz.

METEOR 3-5 transmits a.p.t. on 137.30MHz.

OKEAN-4 and *SICH-1* use 137.40MHz (or near!) for brief transmissions.

RESURS 01#4 transmits a.p.t. on 137.85MHz.

METEOSAT-7 (geostationary) uses 1691 and 1694.5MHz for WEFAX.

Timestep

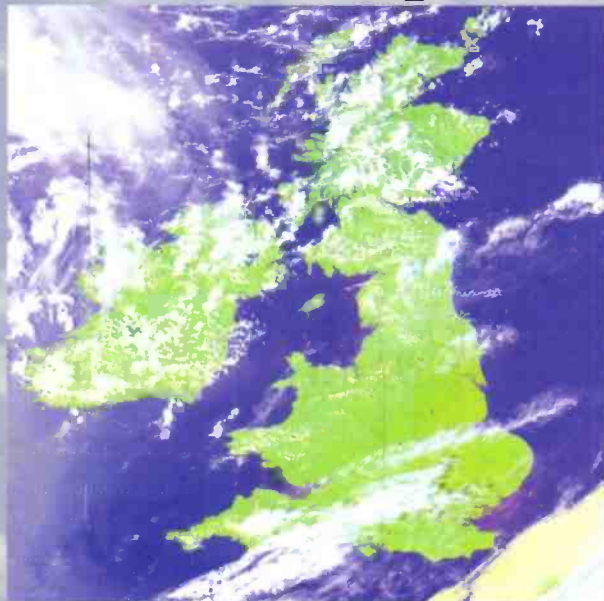

PROsat for Windows is used by most leading weather satellite enthusiasts. They have grown up using Timestep products and now rely on the superior image quality and ease of use provided by PROsat for Windows. Features such as real time reception, auto-scheduling, temperature readout, totally automatic reception of all NOAA's and Soviet satellites and automatic animation have made PROsat the preferred package. For weather satellite systems contact :

Timestep PO Box 2001 Newmarket CB8 8XB England
Tel: 01440 820040 Fax: 01440 820281
www.time-step.com email information@time-step.com

Aerial Techniques

59 Watcombe Road, Southbourne, Bournemouth, Dorset BH6 3LX
Tel: 01202-423555 Fax: 01202-425055
 E-mail: atech@direon.co.uk

Panasonic TU-DSB30

Digital Satellite Receiver.

Complete system including 60cm dish kit

For reception of BBC1, BBC2, Channel 4, Channel 5, BBC Choice, BBC Knowledge and BBC News 24.

£399.00

inc VAT

You may also subscribe to Sky pay to view channels. No subscription to pay. No phone line connection required.



THOMSON

MULTI-SYSTEM 14" PAL/SECAM/NTSC colour TV

(with infra-red remote control)

■ 14" screen multi-standard ■ PAL/SECAM
 ■ NTSC (via Scart) ■ VHF-UHF hyperband tuner
 ■ 59 channel memory ■ Fastext teletext ■ S-VHS (via Scart) ■ Headphone socket ■ 240V AC operation.
 Covers VHF (bands 1, 2 & 3), UHF, plus In between cable channels. PAL system 1 (for UK), PAL systems B/G (for Europe), SECAM L (for France), SECAM B/G. Including NTSC 4.43MHz via the scart.

£269.00 inc VAT

MULTI-SYSTEM PAL/SECAM/NTSC video recorder (with infra-red remote control)

■ Tuner reception: PAL 1/G, D/K, SECAM B/G, L, L'
 ■ Nicam hi-fi stereo ■ 99 channel memory ■ Hyperband tuner
 ■ 4 head dual azimuth ■ Auto long play ■ NTSC via scart ■ Video plus ■ 8 event - 1 year
 Satellite control ■ 2 Eurocart sockets ■ 3 phono video/audit L/R ■ Autoprogramming ■ Jog shuttle
 Multi-system compatibility. Covers VHF, UHF and cable channels.

£399.00 inc VAT

FULLY COMPREHENSIVE 35 PAGE CATALOGUE

Available by return of post for only £1.50 or ring with your credit card (fully refundable on first purchase over £20). WE SUPPLY/STOCK THE VARIOUS EQUIPMENT WITHIN.

Overnight delivery by insured courier £10.00

Interested in vintage wireless or military radio?

Why not subscribe to *The Vintage Wireless Trader*. Published approx every six weeks. Contains 100s of out of print old and collectable wireless books, magazines, ephemera, vintage communication and domestic receivers, government surplus military equipment, valves and components etc. at affordable prices as well as subscribers wants and sales. Published at approx 8 week intervals. Send \$10 for next eight issues.

NEW BOOKS

Mullard Valve Data and Equivalents Handbook. Over 275 pages of valve data, base connections, characteristics operating conditions for Mullard Valves and their equivalent makes. Facsimile reprint. **£16.50 P&P £2.25.**

The Winning Edge. 1939-1945 Naval Technology in Action. This new book presents descriptions of WWII technical developments of numerous devices including ASDIC, SONAR, RADAR, HF/DF, Rocket Projectiles etc. Includes details of sensitive listening stations relaying enemy messages to cryptographers. 235 pages. Illustrated with photos and drawings. Published at £19.00. Our price **£11.50 P&P £2.50.**

AVO Valve Tester Switch Selector Code and Valve Data and Equivalents Book. Covers AVO testers type CT160, VT160, VCM MKI, VCM MKII, VCM MKIII, VCM MKIV, VCM163. Over 240 pages covering all the necessary settings and data for testing 1000's of valves. Facsimile reprint. **£15.00 P&P £2.25.**

The Ultra-Magic Deals by B. F. Smith. A well researched book on Ultra codebreaking operations providing a fascinating study of the technologies, personalities and politics of Britain and America's most mysterious secret - the pooling of their cryptological intelligence against Germany and Japan. Includes recently released details of Bletchley Park operations and is one of the few books published on cryptanalytic operations. 276 pages. Published at £17.95. Our price **£11.50 P&P £2.75.**

Top Secret Exchange by David Zimmerman. *The Tizzard Mission and the Scientific War.* This book tells the exciting story of the exchange between Britain and the USA in WW2 of their military technical secrets including British radar, the magnetron, etc. Over 252 pages with photos. Invaluable to anyone interested in early radar. Published at £18.99. Our price **£11.50 P&P £2.50.**

For the digital satellite experimenter (not digital television).

A digital satellite set top receiver. 950-1460MHz. For 19.2 and 64kbps data rates to RS232/449 output. Suitable for weather maps, low res pictures using Viterbi/Reed-Solomon RS Fec system. Needs dish and LNB. Brand new and boxed with manual. **£30.00 carriage £9.00.**

SCOOP PURCHASE

Fluke hand-held digital multimeter model 8024B. Cancelled exports order. 750V AC/DC, 2 amp AC/DC. Resistance 20 megohm + Siemens range. Also measures temp. -20C to +1265C. Temp probe not included. Calibrated for K type thermocouple. Peak hold facility. Supplied brand new & boxed but with original purchasing organisations small identifying mark on case. Test leads and handbook included offered at a fraction of original price. **£47.50 P&P \$6.50.**

VALVES GALORE!

Most valves available at low prices from stock otherwise obtained. Amateur radio, vintage audio and military. Phone or SAE for quote.



(Dept SW) CHEVET SUPPLIES LTD.
 157 Dickson Road, BLACKPOOL FY1 2EU



Tel: (01253) 751858. Fax: (01253) 302979. TELEPHONE ORDERS ACCEPTED.
E-mail: chevet@globalnet.co.uk Visit our web-site: www.chevet-supplies.co.uk

Callers welcome Tuesday, Thursday, Friday and Saturday 10am - 6pm

DEDICATED TO THE SCANNING AND SHORTWAVE ENTHUSIAST. WE'RE MORE THAN JUST SOFTWARE!

NEW!
JUST RELEASED!
VERSION 7.5

SCANCAT GOLD for Windows SE

Since 1989, The Recognized Leader in Computer Control

Once you use SCANCAT with YOUR radio, you'll NEVER use your radio again WITHOUT SCANCAT!

SCANCAT supports almost ALL computer controlled radios by: AOR, DRAKE, KENWOOD, ICOM, YAesu and JRC (NRD) Plus PRO-2005/6/35/42 (with OS456/535). Lowe HF-150, and Watkins-Johnson.

NOW SUPPORTS AOR AR168 - AR2208 & TENTEX RX230

SCANCAT GOLD FOR WINDOWS "SE" (Surveillance-Enhanced) All Scancat Windows Features Plus...

- Selective Sound Recording using PC-compatible sound card. "Point & Shoot" playback by individual hits.
- Demographic search for frequency co-ordination and 2-way Usage Analysis.
- Detailed logging to ASCII type files with DATE, TIME, Sig Str, Air Time.
- 8 New sweep Analysis Functions.
- Exclusive "MACRO" control by frequency of Dwell, Hang, Resume, Sig. Threshold and even 6 separate programmable, audible alarms.
- Command line options for TIMED ON/OFF (Unattended) logging/searches.
- Run as many as 6 different CI-V addressable radios as "Master/Slave".
- New! Scheduling/Recording Functions.

With Scancat Gold for Windows "SE" your spectrum never looked so good! Load virtually any database and Scancat "SE" will examine your database, plot each and every frequency, no matter what the range, and "paint" the entire analysis on your screen.

SEVERAL GRAPHICAL ANALYSIS MODES AVAILABLE
 • IF THAT ISN'T ENOUGH, try this... Multicolored, 3-D "Spatial/Landscape".

- By Signal Strength per frequency in a "histogram".
- By Signal Strength plotted in individual dots.
- By Number of hits per frequency in a "histogram".

SCANCAT GOLD "SE" .. \$159.95 + s & h* UPGRADE SCANCAT GOLD V7.5 "SE" .. \$59.95 + s & h*
SCANCAT'S WINDOWS FEATURES

- Unattended Logging of frequencies
- Scan Create Disk Files
- Spectrum Analysis to Screen OR Printer
- Supports PerCon, Mr. Scanner, and Betty Bearcat CD Roms.
- Scan VHF & HF Icom's Simultaneously.
- LINK up to 100 Disk files or ranges
- MULTIPLE search filters for Diskfile Scanning.
- New -- Programmable Favorite Frequency "Quick Buttons"
- Search by CTCSS & DCS tones with OS456/535 or DC440 (ICOM only).
- INCLUDES several large shortwave and VHF/UHF databases

SCANCAT GOLD FOR WINDOWS (NON-"SE") .. \$99.95 + s & h* UPGRADE TO V7.5 .. \$29.95 + s & h*
 All the features you EXPECT from a true Windows application such as:

- VERSATILE "Functional" spectrum analysis. NOT just a "pretty face". Spectrum is held in memory for long term accumulation. Simply "mouse over" to read frequency of spectrum location. "CLICK" to immediately tune your receiver. You can even accumulate a spectrum from scanning DISKFILES of random frequencies!
- DIRECT scanning of most DBASE, FOXPRO, ACCESS, BTRIEVE files WITHOUT "importing".
- UNIQUE database management system with moveable columns. Even SPLIT columns into doubles or triples for easy viewing of ALL important data on one screen.
- Exclusive "SLIDE RULE" tuner. Click or "skate" your mouse over our Slide-Tuner to change frequencies effortlessly! OR use our graphical tuning knob.

*\$5 U.S. \$7.50 FOREIGN

FREE FREQ FILES WEB ADDRESS - www.scancat.com FREE DEMOS

Order direct or contact your favorite dealer
COMPUTER AIDED TECHNOLOGIES
 P.O. Box 18285 Shreveport, LA 71138
 Phone: (318) 687-4444 FAX: (318) 686-0449
 Info/Tech Support: (318) 687-2555 (9 a.m. - 1 p.m. Central M-F)

Propagation Forecasts

How to use the Propagation Charts

The charts contain three plots. The lower dashed line represents the lowest usable frequency (LUF), or ALF (Absorption Limiting Frequency). The chances of success below this frequency are very slim.

The middle line indicates the optimum working frequency (OWF) with a 90% probability of success for the particular path and time.

Lastly, the upper dashed line represents the maximum usable frequency (MUF), a 50%

probability of success for the path and time.

To make use of the charts you must select the chart most closely located to the region containing the station that you wish to hear. By selecting the time chosen for listening on the horizontal axis, the best frequencies for listening can be determined by the values of the intersections of the plots against frequency.

Good luck and happy listening.

September 2000
Circuits to London

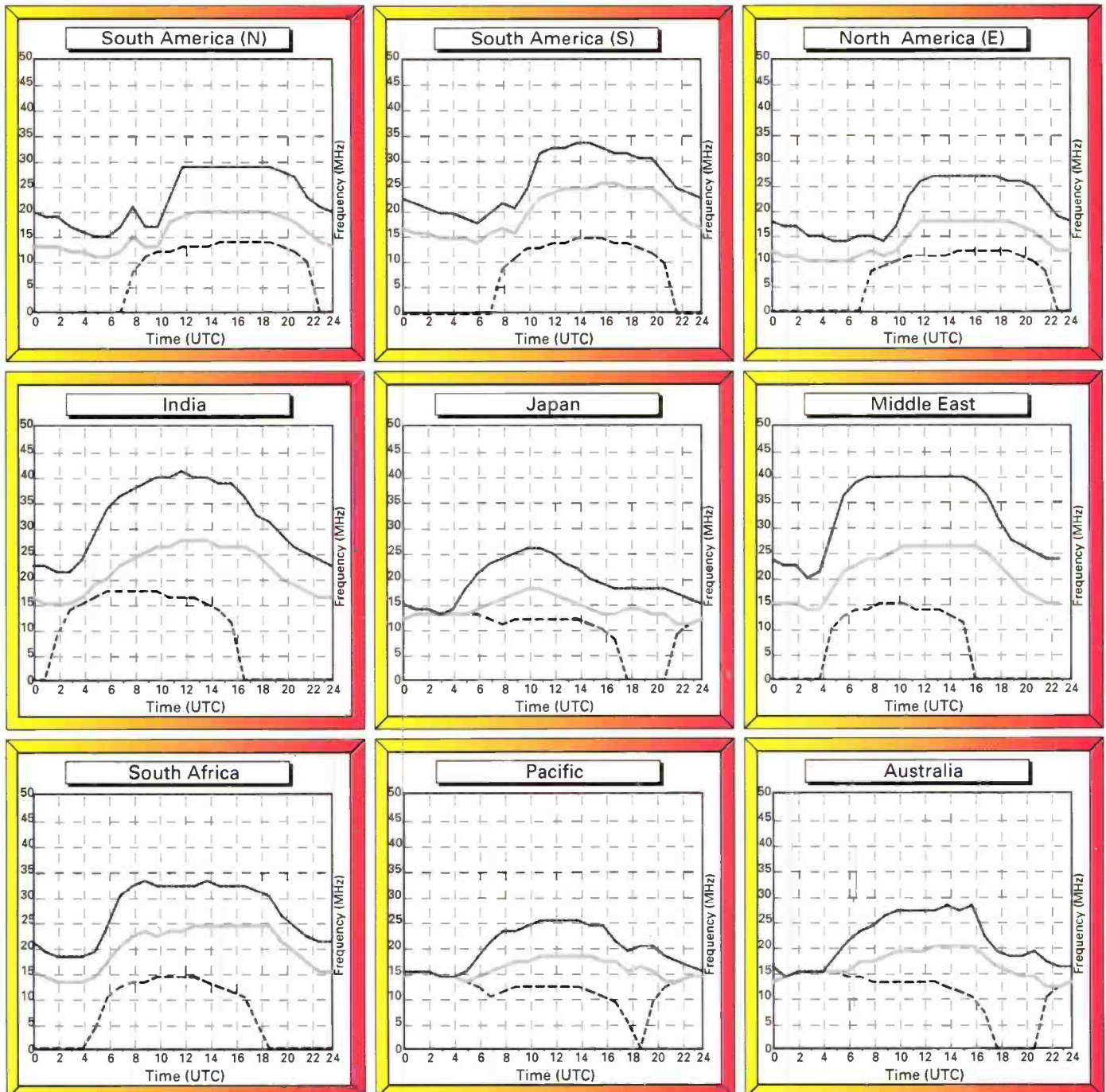

Propagation Extra

Ron Ham's barometric pressure chart, taken at Storrington, W. Sussex, July 2000.

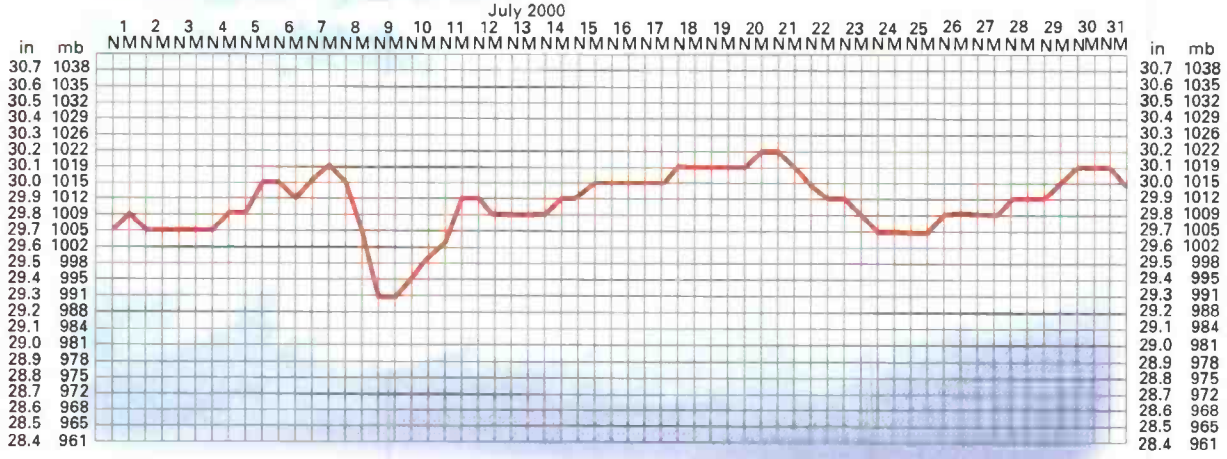

July Data

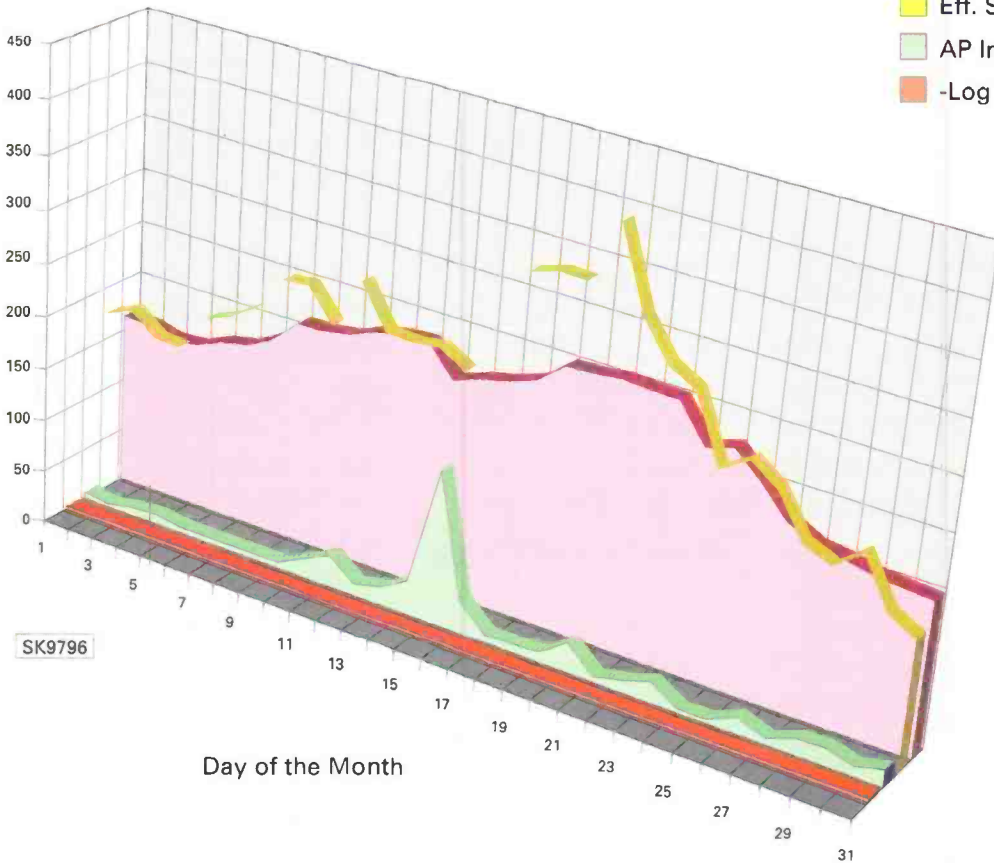

guide to the chart

The 10.7cm solar radio flux is used as an indicator of the general level of solar activity.

The K and AP indices are measures of geomagnetic activity.

The K index ranges from zero (very quiet) to nine (severely disturbed). K values of five or greater correspond to geomagnetic storm conditions that can relate to poor propagation conditions.

The AP index ranges from 0 to 400. An AP of 30 is the threshold for geomagnetic storm conditions.

JAYCEE ELECTRONICS LTD

20 Woodside Way, Glenrothes, Fife, Scotland KY7 5DF
 Tel: (01592) 756962 • Fax No. (01592) 610451
 Opening hours: Tues-Fri 9am to 5pm. Sat 9am to 4pm. Closed Sun & Mon.
KENWOOD, YAESU & ICOM APPROVED DEALERS
 A good stock of new and secondhand equipment always in stock.
 Check out our web site. See our secondhand list that is regularly updated.
www.jayceecomms.com

NORTHERN SHORTWAVE CENTRE

BLACKDYKE RD, KINGSTOWN IND EST., CARLISLE, CUMBRIA CA3 0PJ
 Phone/Fax: 01228 590011
 David Brown G4KFN
 New and used short wave receivers, scanning radios, amateur radio equipment and accessories plus books and magazines.



Shortwave Eavesdropper CD-ROM

Now only £12
 incl. world-wide delivery

- Over 32,000 frequencies
 - 42,000 callsigns
 - Sort by frequencies, users or any other combination
 - Covers Military, Aeronautical, Ships and much more
- Instant access is given to a vast frequency and call-sign database listing military, tactical, ships - naval and merchant, embassies, aeronautical, weather stations and countless more. In-depth country by country information containing QSL addresses, schedules, examples of traffic, maps, a DX Edge, extensive help menus and a very large list of aircraft and ARQ SEL-CAL codes are also included. IBM PC or compatible 4MB RAM running Microsoft Windows 3.1, 95 or 98.

Ask for FREE catalogue of all books Allow 14 days delivery

INTERPRODUCTS (SW100)
 8 Abbot Street, Perth PH2 0EB, Scotland
 Tel: 01738 441199 Fax: 01738 626953

Simon Collings

Closing down clearout - all must go!

Visit my website or send for a list of once and for all special offers on radio related products.

<http://www.scnt01426.pwp.blueyonder.co.uk>

Simon Collings, 46 St. Michaels Road, Cheltenham, Gloucestershire GL51 5RR Answering service: 01242 514429

Please mention
Short Wave Magazine
 when replying to
 advertisements.



FLIGHTDECK

AVIATION EMPORIUM
 Scanners, Books, Models, Videos, Charts, Apparel, Software and more.

Send £2.00 (credited against order) for our illustrated catalogue or visit our web site at:
www.flightdeck.co.uk

Flightdeck, Dept SW, 252A Finney Lane
 Heald Green, Cheadle, Cheshire SK8 3QD
 Tel: 0161-499 9350. Fax: 0161-499 9349
 E-mail: FlightDek@aol.com

The Kits with ALL the Bits!

- DTR series Single-band CW, TX/RX for 80, 40 or 30m£97.80
 - CARLTON 3-band receiver. 80, 40, 20m (kit only).....£69.50
 - TU4 Antenna tuner with built-in SWR meter. 80W.....£68.00
 - TU3 Antenna tuner for receiving or low power TX.....£44.00
- Postage on the above kits£4.00

- TUA1 MkII SWR meter - very sensitive for QRP£20.50 P&P £1.50
 - AF2 Active Audio Filter for CW.....£16.50 P&P £1.50
- 'NOVICE' SW and MW receivers and 'NOVICE' Amplifier kits. Ideal projects for the Novice RAE Course - just £8 each plus £1.00 postage.

SEND LARGE SSAE FOR FULL DETAILS OF THESE AND THE REST OF OUR RANGE.

LAKE ELECTRONICS

7 Middleton Close, Nuthall, Notts NG16 1BX
 Tel: (0115) 9382509 Callers by appointment only please

DEMODULATORS FOR JVFAX HAMCOMM SKYSPY RADIORAF V3.20 DL4SAW & POCSAG AND NOW JVCMM32 + PSK31 TRANSMIT

- All Demods have 25 way female 'D' type - ORIGINAL RECEIVE ONLY £16.99
- NEW • RECEIVE ONLY with SoundCard Cable (saves cable swapping) £19.99
- POCSAG RECEIVE version (as Rx only with variable hysteresis) £19.99
- NEW • POCSAG RECEIVE with SoundCard Cable (saves cable swapping) £22.99
- Original TRANSMIT version (Pocsag Rx + Fax/SSTV/HamComm Tx) £24.99
- JVComm/PSK31 Tx (Pocsag Rx + Fax/ SSTV/HamComm/JVC32/PSK21 Tx) £29.99
- Adaptors 25m/9f £3.00 25m/25m £3.00 25m/9f Cable (ATX/Laptop) £6.00
- 4-way RS232 Switch Box £17.50 1m 25-way Cable £6.00 Shareware on 3.5" disks
- JVFAX7 + HamComm 3.1 + Pktmon12 + Pocsag (PD2.05) + Wxgraph + Frege £2.50
- RADIORAF V3.20 £2.50 DL4SAW SSTV (V1.2) £2.50 JVCmm32 V1.0 (3 disks) £4.50

REGISTERED VERSIONS OF SOFTWARE

- SkySpy V2.0 £24.99 DL4SAW/GSHPC SSTV V2.3 £34.99 JVComm32 V1.0 £49.99
- HamComm 3.1 £19.99 Pocsag (PD2.05) £19.99 RadioRaft V3.20 £24.99
- All prices UK/Eire inc VAT + P&P. For non-EU deduct 17.5% VAT.
- All products (except software) carry a full money back guarantee.
- Minimum Credit Card order £15.00. Outside British Isles add £2.00.

Pervisell Ltd, 8 Temple End, High Wycombe Bucks HP13 5DR

Tel: (01494) 443033 Fax: (01494) 448236
www.pervisell.com e-mail: ham@pervisell.com



QSL COMMUNICATIONS

UNIT 6, WORLE INDUSTRIAL CENTRE, COKER ROAD
 WORLE, WESTON-SUPER-MARE BS22 6BX

TEL/FAX 01934 512757
 E-mail: jayne@qslcomms.f9.co.uk

- AOR AR8200 Series 2** £PHONE
- YAESU VR-500** £265.00
- ICOM IC-R10** £270.00

- ANTENNAS**
- G5RV full size£24.00
- G5RV half size£21.00
- Discone 25-1300MHz..£39.95
- Magnetic balan£24.95
- SECONDHAND**
- Sony ICF-SW100.....£80.00
- Yaesu FRG-7 + tuner£150.00
- Jil RF-5080 500-800 converter ..£49.00
- Yaesu FRT-7700 tuner£49.00

SECONDHAND EQUIPMENT WANTED

EARTH RODS 4ft long, adjustable brass fixing
 Solid copper £10.99 P&P £4.00
 Copper plated steel £8.99 P&P £4.00

Carriage charges dependant of items and weight

QSL CARDS
 SEND
 LARGE SAE
 FOR SAM-
 PLES



PACK OF 10
£10.00
 INC P&P

SUBSCRIPTION RATES

See Page 32 for Special Subs Offer

SHORT WAVE MAGAZINE - 6 MONTHS

£17.50 (UK)

SHORT WAVE MAGAZINE - 1 YEAR

£33.00 (UK) £40.00 (Europe)

£44.00 (Rest of World Airmail) £50.00 (Rest of World Airmail)

JOINT SUBSCRIPTION WITH PRACTICAL WIRELESS (1 YEAR)

£55.00 (UK) £68.00 (Europe Airmail)

£74.00 (Rest of World Airmail)

£85.00 (Rest of World Airmail)

Please start my subscription with the.....issue.

MONITORING TIMES - 1 Year (12 issues)

£38 (UK) £43 (Europe Airmail)

£49 (Rest of World Airmail)

BINDERS

Please send meSWM Binders at **£6.50**£

Postal charges: £1.25 for one, £2.50 for two or more (overseas surface)

FREE P&P If you order two or more (UK only)£

Please send me the following books

.....£

.....£

.....£

Postal charges.

UK: £1.25 for one item,

£2.50 for two or more items£

Overseas: £2.50 for one item, £4.00 for two items,

then add an additional 50p per item£

NEW FASTER NEXT DAY SERVICE (UK)

(For orders received before noon) £4.50£

GRAND TOTAL£

Order Form

FOR ALL MAIL ORDER PURCHASES IN **SHORT WAVE MAGAZINE**

You can now order on-line.

See www.pwpublishing.ltd.uk/books/ for more information

Back issues at £2.99 inc. P&P.
Phone, FAX or E-mail for availability

TELEPHONE ORDERS TAKEN ON (01202) 659930

between the hours of 9.00am - 5.00pm. Outside these hours your order will be recorded on an answerphone

FAX ORDERS TAKEN ON (01202) 659950

Or please fill in the details ticking the relevant boxes, a photocopy will be acceptable to save you cutting your treasured copy!

To: **PW Publishing Ltd., FREEPOST, Arrowsmith Court, Station Approach, Broadstone, Dorset BH18 8PW.**

PAYMENT DETAILS

Name

Address

..... Postcode

Telephone No.

I enclose cheque/PO (Payable to PW Publishing Ltd.) £

Or
Charge to my MasterCard/Visa/Switch/AMEX Card the amount of £

Card No.



Valid fromto

Issue No: Tel:

Signature

Orders are normally despatched by return of post but please allow 28 days for delivery. Prices correct at time of going to press. **Please note:** all payments must be made in Sterling. Cash not accepted.

TELEPHONE ORDERS TAKEN ON (01202) 659930

FAX ORDERS TAKEN ON (01202) 659950

Index to advertisers

Aerial Techniques	71
AOR (UK) Ltd	30, 31
ARC Ltd	51
ASK Electronics	41
Broadcasting Communications	54
Chevet Supplies	71
Computer Aided Technology	71
Flightdeck	74
Haydon Communications	19, 20, 21
Icom (UK) Ltd	63
Interproducts	74
Javiation	51
Jaycee Electronics	74

Lake Electronics	74
Leicester ARC	46
Lowe Electronics	OBC
Martin Lynch & Sons	38, 39
Monitoring Times	64
Moonraker (UK) Ltd	10, 11
Nevada	IFC, 1, 34, 35
Northern Short Wave Centre	74
Pervisell Ltd	74
PhotAvia Press	51
Practical Wireless	32
QSL Communications	74
Radioworld	58, 59

Remote Imaging Group	43
Roberts Radio	IBC
Simon Collings	74
Solid State	43
SRP Trading	48
Telford ARC	43
Telford Electronics	64
The Aviation Hobby Centre	64
The Shortwave Shop	43
Timestep Weather Systems	71
Waters & Stanton plc	26, 27
Wellbrook Communications	64

PUBLISHED on the fourth Thursday of each month by PW Publishing Ltd., Arrowsmith Court, Station Approach, Broadstone, Dorset BH18 8PW. Printed in England by Southernprint (Web Offset), Factory Road, Upton Industrial Estate, Poole, Dorset BH16 5SN. Tel: (01202) 622226. Distributed by Seymour, 86 Newman Street, London W1P 3LD. Tel: 0171-396 8000. Fax: 0171-396 8002. Web: <http://www.seymour.co.uk>. Sole Agents for Australia and New Zealand - Gordon and Gotch (Asia) Ltd.; South Africa - Central News Agency Ltd. Subscriptions INLAND £33, EUROPE £40, REST OF WORLD (Airmail) £44, REST OF WORLD (Airmail) £50 payable to SHORT WAVE MAGAZINE, Subscription Department, PW Publishing Ltd., Arrowsmith Court, Station Approach, Broadstone, Dorset BH18 8PW. SHORT WAVE MAGAZINE is sold subject to the following conditions, namely that it shall not without the written consent of the publishers first having been given, be lent, re-sold, hired out or otherwise disposed of by way of trade at more than the recommended selling price shown on the cover and that it shall not be lent, re-sold, hired out or otherwise disposed of in a mutilated condition or in any unauthorised cover by way of Trade, or affixed to or as part of any publication or advertising, literary or pictorial matter whatsoever.

ROBERTS

Sound for Generations



The New R9914 from Roberts

PLL digital world band radio – ideal for **BBC** WORLD SERVICE

- LW/MW/FM/SW wavebands
- 45 station presets
- SSB for reception of single sideband and CW transmissions
- Direct keypad tuning
- Rotary tuning
- Station tuning in 1kHz steps
- Dual conversion for improved SW image rejection
- Digital clock
- Alarm/time functions
- Key lock
- FM stereo via earphones
- Soft carry pouch
- Complete with AC adaptor



BY APPOINTMENT TO
HER MAJESTY THE QUEEN
SUPPLIERS & MANUFACTURERS
OF RADIO AND TELEVISION
ROBERTS RADIO LIMITED



BY APPOINTMENT
H.M. QUEEN ELIZABETH
THE QUEEN MOTHER
RADIO MANUFACTURERS
ROBERTS RADIO LIMITED



BY APPOINTMENT
H.R.H. THE PRINCE OF WALES
MANUFACTURERS & SUPPLIERS OF
RADIO RECEIVERS
ROBERTS RADIO LIMITED

ROBERTS RADIO LIMITED

PO Box 130, Mexborough, South Yorkshire S64 8YT

Tel: +44 (0) 1709 571722 Fax: +44 (0) 1709 571255 Website: www.robertsradio.co.uk

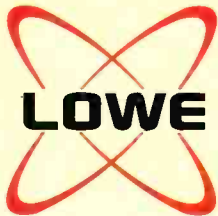

LOWE ELECTRONICS LTD

Here at Lowe Electronics we've been advising people on short wave listening for over thirty years. That kind of makes us unique as we believe no other company can match our expertise in this field.

Check out our website!

Introducing the new Lowe HF350



The new Lowe HF350 is a simple to operate receiver with excellent performance. It is based on an original American design with several important modifications from European RF design specialists. The result is a receiver with very good strong signal handling capabilities using high performance ceramic filters to achieve selectivity. The front end has optimised band pass filters to minimise break through.

The tuning control changes speed as the knob is rotated faster, also pushing the control in changes between fast and slow tuning speed. There are 100 memories available which hold all settings such as mode, attenuator, etc. The receiver has been designed with the requirements of operating in Europe in an environment of high powered broadcast stations in mind.

It is very simple to use, and after a few moments experimenting with the controls you will be able to drive it without even opening the manual. All external connections needed are available on the rear panel, and the receiver can be run from internal batteries or an external 12V DC power source. It is ready for an active antenna, with a DC feed already available at the antenna socket.

ONLY £375 inc VAT

PLEASE CONTACT LOWE ELECTRONICS FOR MORE DETAILS AND SPECIFICATIONS



BRAND NEW Lowe HF150 RECEIVERS

Extra special once in a life time never to be repeated offer!

ONLY £249 inc VAT
+ £10.00 carriage

LIMITED STOCKS,
FIRST COME FIRST
SERVED.

**Lowe Electronics Ltd
Chesterfield Road
Matlock
Derbyshire
DE4 5LE**

**Tel: (01629) 580800
Fax: (01629) 580020
E-mail: info@lowe.co.uk
www.lowe.co.uk**

**Send us four first-class
stamps for our latest full
colour catalogue, full of
receivers, antennas, books,
accessories, nightvision and
GPS receivers and more!**