

The

RADIO AMATEUR

Vol. 8

Number 2

FEBRUARY

1953

inc. "Short Wave News"

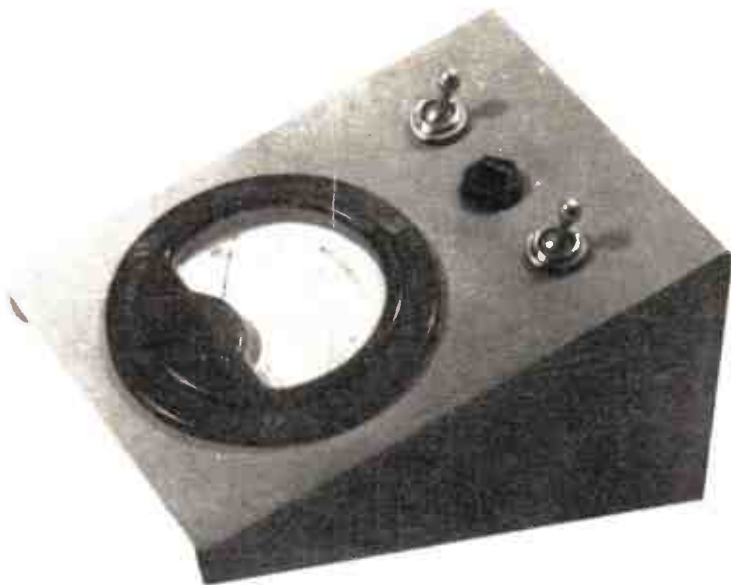

Modulation Meter and Phone Monitor. Constructional details within.

IN THIS ISSUE . . .

High Gain VHF Preampifier. Noise Figures, Noise Factors and Signal to Noise Ratios. The Versatile Grid Dip Meter Modulation Meter and Phone Monitor. Workshop Practice—Soldering. Aerial Radiation Patterns—The "Quad". Design of Mains Transformers. Earning those Cards. Ionospheric Monitoring for the Amateur. Broadcast Band, Amateur Band and VHF News, etc., etc.

16

"The RADIO AMATEUR OPERATOR'S HANDBOOK"

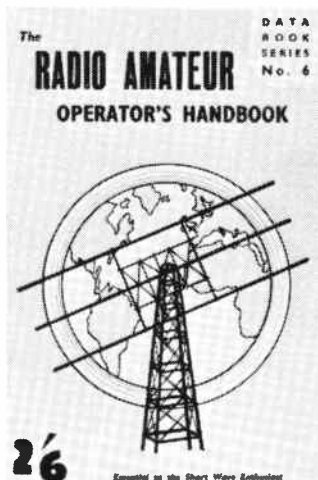

This publication is a successor to our very successful "OP-AID". Completely revised and with additional information, it is even more useful than that publication was and we advise you to order straight away.

For those who did not see our "OP-AID" may we say that it contained all those details of information which the radio amateur and SWL constantly require. Right up-to-the-minute Amateur Band Prefix lists, both alphabetically and by country, Zone Boundaries, Call Areas, Mileage Tables, QSL Bureaux, "Q" and "Z" Codes, WWV Skeds, and much other information, as well as a selection of maps of DX areas.

This is an indispensable Handbook for every amateur radio station.

Price 2/6, postage 2d.

DATA PUBLICATIONS, 57 MAIDA VALE, LONDON, W.9

IN EVERY RADIO SET THERE ARE

500 reasons why you should use . . .

The average radio set contains about 500 soldered connections — make sure of perfect reception by using only Ersin Multicore for all soldering on your equipment.

The three cores of extra-active non-corrosive Ersin Flux not only prevent the formation of oxides, but actually clear the oxides from the metal to be soldered, saving time and trouble, and ensuring the highest standard of sound precision soldered joints.

MULTICORE SOLDERS LTD.
MULTICORE WORKS, MAYLAND AVENUE,
Hemel Hempstead, Herts. Boxmoor 3636 (3 lines)



LAWRENCE'S SPECIAL OFFER!

- T 1154 Transmitter with Valves £6 0s. 0d. P.Pd.
- R 1155 Receiver with Power Unit and 10" L.S. £19 0s. 0d. P.Pd.
- Wavemeter W 1117 125 KC to 20 MC £7 7s. 6d. P.Pd.
- Wavemeter W 1238 234 MC to 100 MC £4 7s. 6d. P.Pd.
- Wavemeter W 1081 135 KC to 15 MC £3 7s. 6d. P.Pd.

Also Quick Repair Service

S.E.A. for complete list including Model Railways, Technical Books.

LAWRENCE FRANKEL MAIL ORDER,
134 CRANLEY GDNS., LONDON, N.10
TUDor 1404.

RADIOCRAFT PRESELECTORS

There is no reason why you should be missing that elusive DX—it is there and can be made quite readable. Why not invest in a two-stage preselector giving a gain of 18-20dB and stop being 'out in the cold' when DX is about. Radiocraft Preselector make those 53 signals into 59 'locals' and at the same time give a vastly improved signal to noise ratio with your receiver. If you are troubled with second channel or image interference a preselector makes an effective cure once and for all. These units will revolutionise your listening and you will wonder how you managed without one before!

PS7 Unit—2-tuned RF stages, with built-in power pack for AC mains, housed in attractive Imhof cabinet, calibrated dial, RF Gain, Aerial trimmer, 1.5-30mcs in 3 bands with a fourth position of the switch to cut off HT and connect aerial straight through to receiver. Valves used are 6AM6 (EF91-Z77) type. The price of the PS7 is £9/12/6d. carriage paid. Other models also available and details are given in List TR7.

Special offer of DET18's (35T) used but guaranteed OK at 19/- each.

Single screened wire at 3/- per dozen yards, or 3½d. per yard.

R1155 owners please note that we can alter your RX so that it covers the 160m band, dial calibrated, inc. return carriage at a cost of £2. Quotations supplied for special equipment.

RADIOCRAFT LTD.,

**25 Beardell Street, Westow Hill,
Upper Norwood, London, S.E.19**

Telephone: GIPsy Hill 5585

**Coronation
QSL's**

Why not send a distinctive QSL this year? Special designs to celebrate Coronation Year available from G6MN who has supplied 'special' QSL's for discriminating users all over the world.

Attractive "Coronation - 1953" designs now available from

**G6MN, Castlemount,
Worksop, Notts.**

**FOR HIGH FIDELITY
RECORDINGS**



Careful design and rigid control in manufacture, provide the critical listener with a reliable hard-wearing tape that will help to get the very best results from any tape recorder.

MAGNETIC DATA

Coercivity 240-260 Oersteds
Total Remanent Flux 0.4/0.5 lines ¼ in. width
Uniformity throughout a reel ±0.5 db.

FREQUENCY RANGE

50 c/s to 10 Kc/s at a playing speed of 7½ in./sec.

Medium coercivity gives a high signal output with an extended high-frequency response, whilst still retaining an easy erasure. Signal/noise ratio is high; transfer and distortion are negligible.

PLAYING TIMES (per track)

REELS	1¼"/SEC	3¼"/SEC	7½"/SEC	15"/SEC
1200 Ft.	120 Min.	60 Min.	30 Min.	15 Min.
600 Ft.	60 Min.	30 Min.	15 Min.	7½ Min.
300 Ft.	30 Min.	15 Min.	7½ Min.	3¾ Min.

2,400 ft. Professional Reels (10½ ins. diameter, double sided spools) now available.

Further information obtainable on request.

Minnesota Mining & Manufacturing Co., Ltd., 167 Strand, London, W.C.2.

Telephone: TEMple Bar 6363

CLYDESDALE

Bargains in Ex-Service Equipment

THE R1155 AS A COMMUNICATIONS RECEIVER WITH 9 VALVES FOR 200-250 VOLTS A.C. MAINS

Comprises:—RECEIVER UNIT R1155 WITH:—5 Switched Bands, 18-7.5 Mc/s = 17-40 metres. 7.5-3 Mc/s = 40-100 metres. 1,500-600 kc/s = 200-500 metres. 500-200 kc/s = 600-1,500 metres. 200-75 kc/s = 1,500-4,000 metres.

7 Valves: VR99 (X65). 3/VR100 (KTW61). 2/VR101 (DH63). V1103 (Y.63) ME: DF Valves left out. Simple controls. Slow motion 2 speed Tuning Manual Volume Control. Wave Change Switch. Also optional B.F.O., A.V.C., Magic Eye Tuning Indicator. In black metal case 16½ x 9 x 9in.

Plus:—COMBINED OUTPUT/POWER PACK, with 2 valves, Pentode Output and Rectifier Bin. Speaker, Mains and output transformers. Tone Control, On/Off Switch. In black crackle metal case, 16½ x 9 x 9in.

With Receiver Unit appearance as new ask for **£21.0.0** Both Units Carriage Paid
No. C/E6AC

With Receiver Unit appearance good ask for **£20.0.0** Both Units Carriage Paid
No. C/H916AC

With Receiver Unit appearance rough ask for **£18.10.0** Both Units Carriage Paid
No. C/H898AC

NEW 192 PAGE CATALOGUE, LIST 8D NOW IN THE PRESS. 1/6 when ready, credited on first purchase of 10/-

Order direct from: **CLYDESDALE SUPPLY CO., LTD.**
2 BRIDGE STREET, GLASGOW, C.5
Branches in Scotland, England and North Ireland



For . . .

- Loudspeakers and Phones
- Transformers and Chokes
- Meters & Test Equipment
- Pickups and Turntables
- Switches and Dials
- Metalwork and Bakelite
- Books and Tools
- Valve Holders and Cans
- Metal Rectifiers
- Valves and CR Tubes
- Cabinets and Cases
- Capacitors and Resistors
- Coils and Formers
- Plugs and Sockets
- Aerials and Insulators
- Motors and Generators
- Wires and Cables
- Panel Lights and Fuses
- Recorders and Parts

Sleeving, Nuts and Bolts, Tags, Clips, Grommets and all other bits and pieces.

NOTHING TOO LARGE—NOTHING TOO SMALL

H. L. SMITH & CO., LTD.

287 9 Edgware Road, London, W.2

Telephone : Paddington 5891.
Hours 9 till 6 (Thursday, 1 o'clock).

Near Edgware Road Stations, Metropolitan and Bakerloo.

CONTENTS

	<i>Page</i>
High Gain, Low Noise, VHF Pre-amplifier - - - -	44
Noise Figures, Noise Factors and Signal to Noise Ratios - -	47
The Versatile Grid Dip Meter -	48
A Modulation Meter and Phone Monitor - - - -	52
Workshop Practice - - -	53
Aerial Radiation Patterns - -	54
The Design of Mains Transformers Part 6 - - - -	56
Earning those Cards - - -	61
Ionospheric Monitoring for the Radio Amateur - - - -	62
Broadcast Bands Review - -	64
On the Higher Frequencies - -	69
Amateur Bands Commentary - -	74
Club News - - - -	78
Book Review - - - -	79

The RADIO AMATEUR

Vol. 8 No. 2

February

incorporating "SHORT WAVE NEWS"

Editorial & Advertising Offices : 57 Maida Vale, London, W.9

Tel. CUN. 6518

EDITOR : Arthur C. Gee. G2UK.

Annual Subscription 18s.

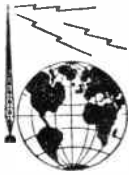

EDITORIAL

We were quite rightly taken to task recently by a correspondent for our indiscriminate use of the terms "aerial" and "antenna." As our correspondent pointed out, antennae are organs possessed by insects. "An aerial" is the correct term for a radio "sky-wire."

Like so many technical subjects of recent origin, radio now suffers from a multiplicity of terms and symbols, which have come to the science from various sources, so that almost every item is now known or indicated in a variety of ways. This difficulty of terminology is commonly found in any branch of science at its inception and only as the years pass by and common usage dictates the custom, do the various alternatives die out.

In spite of this process of "natural selection" some terms live on or are re-introduced accidentally and we find ourselves back again with several names for the same thing, a state of affairs which is not particularly helpful, nor scientifically desirable. It is a good thing, therefore, to occasionally take stock of the situation and see just what undergrowth needs cutting away.

With ideas such as this in mind, we were particularly interested to see a little handbook produced by the British Standards Institution entitled "Letter Symbols for Electronic

Valves." In this, an endeavour has been made to unify the symbols peculiar to the valve industry. There are other similar publications issued by the British Standards Institution and it is to be hoped that technical writers and others who set the fashion in terminology will endeavour to use some such standard glossary of terms more often than many are accustomed to doing at present.

Those who have contributed to any of our publications will know that we ourselves issue a pamphlet giving "preferred" terms and symbols for the guidance of our authors and we would remind intending contributors that they should obtain a copy of this before writing anything for our consideration. It is quite surprising how quickly an example set by the press, will influence public opinion. We pride ourselves on the fact that since we have taken a strong line against the term "ham radio" for our hobby, this idiotic title has appeared less and less in other publications and in public references to our activities.

We feel very satisfied that we have played such a major part in changing the title of our interest from one which produced public ridicule to that which brings us nearer to the prestige we deserve.

—2UK.

THE CONTENTS of this magazine are strictly copyright and may not be reproduced without obtaining prior permission from the Editor. Opinions expressed by contributors are not necessarily of the Editor or proprietors.

THE EDITOR invites original contributions on short wave radio subjects. All material used will be paid for. Articles should be clearly written, preferably typewritten, and photographs should be clear and sharp. Diagrams need not be large or perfectly drawn, as our draughtsmen will redraw in most cases, but relevant information should be included. All MSS must be accompanied by a stamped addressed envelope for reply or return. Each item must bear the sender's name and address.

Component Review. Manufacturers, publishers, etc., are invited to submit samples or information of new products for review in the section.

CHEQUES and Postal Orders to be made payable to "Amalgamated Short Wave Press Ltd."

ALL CORRESPONDENCE should be addressed to "The Radio Amateur," 57 Maida Vale, Paddington, London, W.9. Telephone CUN. 6518.

A Companion Journal to THE RADIO CONSTRUCTOR

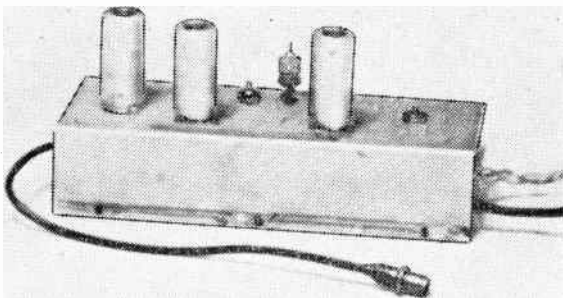

HIGH GAIN, LOW NOISE, VHF PRE- AMPLIFIER

by
H. E. SMITH, G6UH

Foreword

It has been felt for some time that some of the more common valves designed for VHF operation are not being used to the best advantage in present-day circuits. For instance, the usual type of grounded grid-Pre-amplifier throws away almost two-thirds of the signal in obtaining an impedance match from anode to cathode of the following valve. Some operators are turning to the expensive "Lighthouse" and Co-Planer types of VHF valves in order to obtain a more satisfactory performance. For the majority however, these types are so costly that they can be ruled out.

It was decided to investigate the possibility of finding a suitable circuit which would outperform, both in signal to noise ratio and overall gain, the more usual type of pre-amplifier.

The EC91 valve was chosen because of its good equivalent noise resistance figure, and because it is easily obtainable at reasonable cost. The component values chosen for the circuit are the result of much experimental work and should be followed to the letter.

The Circuit

Fig. 1 shows the full circuit (the mixer is not shown, but this was an ECC91, one half as mixer, and the other as a Colpitts oscillator) and it will be seen that the first stage is a Cathode Follower. This gives a power gain of at least 15 dbs.

V2 is a somewhat unorthodox grounded grid stage with the grid effectively grounded to RF, and has a power gain of approximately 12 dbs. (It will also be noted that the impedance matching between V1 and V2 is accurate, thus no signal is lost in transit).

V3 is an orthodox grounded grid stage, again matched to the preceding stage, and has a stage gain of approx. 12 dbs. (power).

The anode choke in this last stage must present a load of approx. 12k at 145 Mcs. Details for winding this and other chokes are given later.

The resistor R3 is the common output load of V1 and input load for V2. The purpose of R1 and R2 is to eliminate the shunting of the tuned circuit by the low cathode impedance.

The slight feedback introduced by this network also cancels out a large amount of the noise generated in V1, R5 and C4 form a simple filter to earth the anode of V1 to RF.

C5 effectively earths the grid of V2 to RF. The input and output circuits are matched to the feeder by the capacitive reactance method and optimum coupling is obtained for co-axial feeders of between 50 and 100 ohms impedance. If balanced feeders are used it will be necessary to fit a balance to unbalance transformer in order to obtain the full benefit of this coupling method.

A reactive component is introduced in the output by this method, but it has no detrimental effect whatsoever.

Inductances

All three inductances are wound with No. 18 s.w.g. Enamelled copper wire on $\frac{3}{8}$ in. formers, tuned with dust iron plungers.

L1 and L3 consist of four complete turns, each turn spaced by twice the wire diameter. L2 also has four turns but the spacing between turns is about half that of L1 and L3.

Chokes

The three heater chokes are wound as follows:—For each choke take 19 inches of No. 26 Enamelled copper wire and close wind on to a $\frac{1}{4}$ inch former. Paxolin or Keramot is suitable, but not Ebonite or wood. The anode choke for V2 and the cathode choke for V3 are each made up with 13 inches of No. 26 s.w.g. Enamelled copper wire close wound on

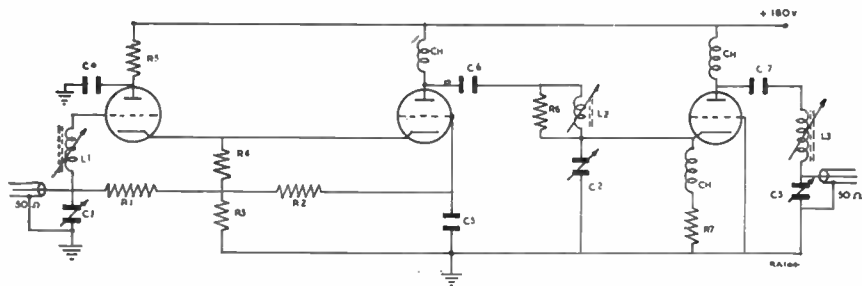

Fig. 1.

C1, C2, C3 Philips 3-30 pf.
 Trimmers
 R1, R2, 0.47 Megohms.
 R3 3KΩ.
 R4 120Ω.

C6, C7 .001 mfd.
 C4 .005 mfd.
 C5 330 pf.
 R5 47Ω. R6 10KΩ.
 L1, L2, L3 and Chokes, See text.

a 50 or 100k ceramic type resistor. The anode choke for V3 is wound with 20 inches of No. 28 s.w.g. Enamelled copper wire, close wound on to a ceramic resistor as above.

Circuit Layout

All the precautions usually taken with VHF pre-amplifiers should be carefully followed. Each stage must be screened from the next, and all three valves fitted with screening cans.

The Philips trimmer should be mounted so that it is accessible from the top of the chassis.

(A clearance hole for a trimming tool can be drilled in the top of the chassis with the trimmer mounted beneath). All chokes should be positioned so that no mutual coupling can take place between them. The cathode and anode chokes of V3 in particular should be positioned at right angles to each other.

There is no need to go to the extreme of fixing the under-chassis screens across the valve bases. Provided the three inductances are well screened from each other, there will be no instability.



Under chassis view of the pre-amplifier

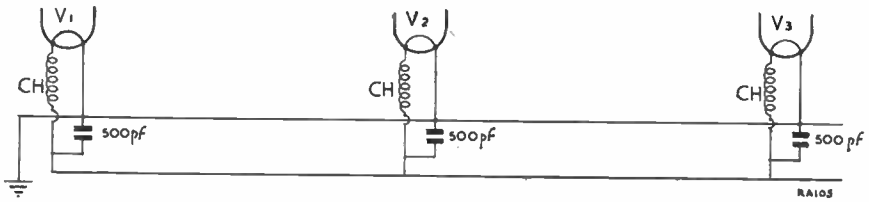

FIG 2 THE HEATER CIRCUITS

Tuning Procedure and General Notes

As mentioned previously, the Pre-amplifier was tested with an ECC91 mixer/oscillator. Assuming the mixer stage is suitably coupled by a short length of co-axial cable to the pre-amp, and in tune, the feeder is coupled to the input, and L3 and L2 are trimmed for maximum noise in that order, with C1 and C3 screwed full in.

All other adjustments must be done on a signal (or a signal generator). These are best carried out with the aid of an output meter on the main receiver, as the average S meter is not

sensitive enough to register the slight changes in signal level which are so important to notice in the alignment.

Having tuned in a signal, adjust L3 plunger and C3 for maximum signal *trimming both at the same time* until an optimum position has been reached. Repeat the procedure with L2 and C2. Optimum setting of C2 will be somewhere near half mesh.

Now adjust L1 and C1 for maximum. A setting will be reached where the noise level falls as the signal strength rises. If the signal falls as the signal strength rises. If the signal falls as the signal strength rises. If the signal falls as the signal strength rises. (Contd. on p. 63)

Fig 3.

6J6 mixer-oscillator as used for the pre-amplifier tests.

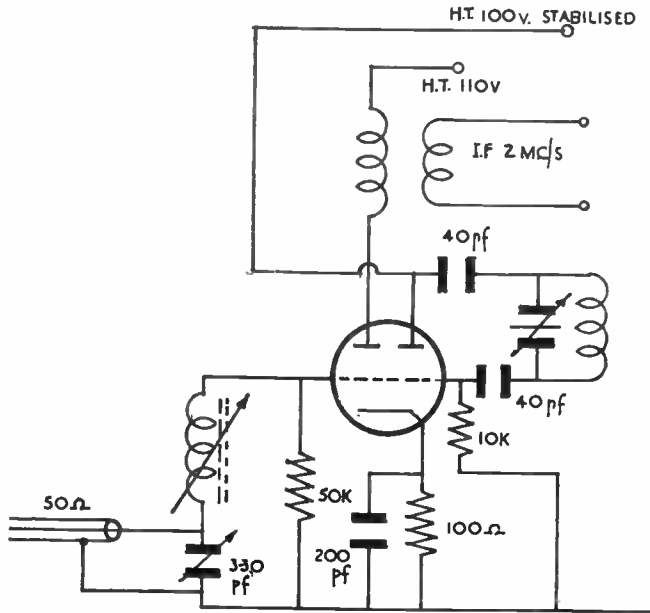

NOISE FIGURES, NOISE FACTORS and SIGNAL TO NOISE RATIOS

by EVAN JOHNSON

There seems to be a great deal of confusion between the terms Noise Figure and Signal to Noise Ratio. It has even been stated in print recently, although not in this journal, that noise figure and noise factor are the same thing.

Actually all these terms mean quite different things. It is possible for a receiver to have an almost perfect noise figure and yet have a much poorer signal to noise ratio. So let us consider these terms and see exactly what is meant by each.

Noise Figure

Regular readers of the *Radio Amateur* will know that all receivers generate noise in the input and aerial circuits due to random movement of the electrons comprising the electric currents flowing. Many scientists have studied this effect (named after its discoverer, Boltzmann) and have found that the noise power (measured in watts like any other power) is given by the product of the bandwidth and the temperature multiplied by a constant.

For room temperatures this works out to very nearly 4×10^{-18} watts per Kilocycle of receiver bandwidth, or 4 micro-micro-micro watts per Kc.

This may seem a very small quantity, but the impression is misleading. Take a television receiver of 2 megacycles bandwidth fed from an 80 ohm cable. The noise power is 8×10^{-15} watts making the noise voltage just under a microvolt. By no means a negligible quantity.

Incidentally, although temperature comes into the calculation there is no chance of reducing it to decrease the noise. Temperatures are measured from absolute zero nearly 500 degrees F. below freezing. So a bath of liquid air for the set and aerial would be the least that would make any worthwhile difference!

A perfect receiver adds nothing to this basic level of noise. Thus we arrive at the definition of the noise figure of a receiver; the ratio of the actual noise generated to the noise generated by a perfect receiver of that bandwidth.

Noise Factor

Now the estimation of any quantity concerned with human perceptions is made very much easier if reduced to a logarithmic scale. The unit is usually the decibel (ten times the logarithm of the power ratio) and one decibel, (about 10%) is roughly the minimum worthwhile improvement that the human brain can grasp, in terms of hearing, sight, or even money!

The decibel system also has the very great advantage that gains or losses through the system can be summed very easily to arrive at the overall effect and consequently are invariably used by engineers. And it must be agreed that the expression of, for instance, 27 decibels above noise, meaning 27 perceptible increases in level, conveys a far more realistic idea of its effect than 500 times the power.

Hence the communications engineer prefers to measure his receiver noise figures in decibels, and to distinguish one set of units from the other the logarithmic system is called the Noise Factor. The relationship is, of course,

$$\text{Noise Factor} = 10 \times \text{Log. Noise figure}$$

Signal to Noise Ratio

The signal to noise ratio is the final criterion of receiver performance, but it is far from as easily defined as Noise Figure. Firstly, the receiver has no control over the transmission, and secondly, the receiver is far from being the only noise source effecting the signal. Ask anyone watching a television receiver situated in a house near a main road.

However, receivers are frequently specified in terms of the signal required to equal noise; although this practice is much less common than it was, mainly because of the anomalies that can arise from this method.

Assume that we have two perfect receivers, one the television set mentioned earlier and the other a communications receiver, tuned to a telephony transmission. The former will have four hundred times the noise power of the latter. But if the two transmissions are of the same field strength the signal to noise ratios will be identical.

But now receive the speech on the television receiver, the signal to noise ratio drops 400 times or 26 db. Easily enough to make good programme value unbearable. Yet a filter in the IF of the television set 5 kcs wide will make the signal to noise ratio revert to the level in the sound receiver. Conversely if we attempt to receive the television signal on the sound receiver the result will be a hopelessly smudged picture.

The point of all this is that, although a signal generator, being a very narrow band transmission, will make one receiver appear to be 400 times better than the other, their signal to noise ratios are identical for their respective transmission. And if we use the perfect television receiver for sound reception, although its noise figure is unity, the signal to noise ratio is 26 db worse than perfect.

(Contd. on p. 60)

THE VERSATILE GRID DIP METER

by

ANGUS D. TAYLOR,
G8PG

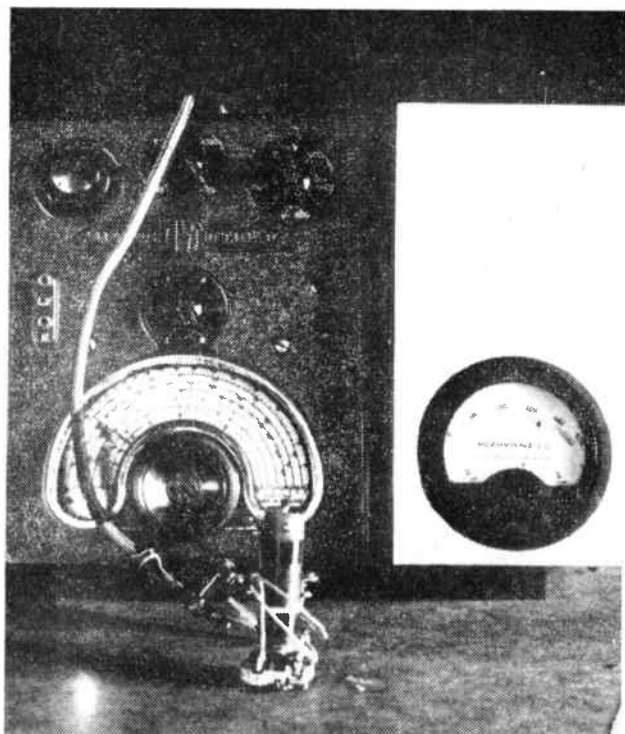

A commercial signal generator adapted for grid dip use being used to measure the resonant frequency of an ex-government I.F. transformer. In this case the meter box has been made larger than usual and also contains a stabilised power supply for the oscillator, the two being held together as a single assembly by means of dural strips running across the back.

Introduction

The grid dip meter is a most useful instrument which well deserves the attention of the serious amateur. Though simple and inexpensive, it can be made to perform a number of useful roles around the shack and will save the construction of several other types of test equipment. The grid dip oscillator itself consists of a simple all-wave oscillator, using either switched or plug-in coils, and with a 0-500 micro-amp meter connected in series with the earthy end of the grid leak resistor. The grid coil of the oscillator is link-coupled to the circuit under test, preferably through a length of screened cable, a typical set-up resembling that shown in Fig. 1. The action of the circuit is simple. If the pick-up loop at the end of the screened cable be coupled to a tuned circuit and the GDO tuned through the resonant frequency of this circuit, energy is

absorbed from the GDO, causing a decrease in feedback and a decrease in oscillator grid current. As the micro-ammeter is connected in such a way as to read grid current, its reading will dip sharply as the oscillator is tuned through the resonant frequency of the circuit under test, being lowest when the oscillator is tuned to exactly the resonant frequency of the unknown circuit. A few moments thought will indicate the large number of uses to which such an arrangement may be put, and it is proposed to describe some of the more important applications during the course of this article. Where it is proposed to construct a GDO from scratch, it is well worth considering the possibility of combining the functions of the GD oscillator with those of a signal generator. The use of a twin-triode valve plus a few extra components will provide a source of modulation and still further extend the usefulness of the instrument. Where an existing signal generator, either of the home-built or commercial type is available, it can be quickly converted for use as a GDO. The only modification necessary is to wire the micro-amp meter in series with the earthy end of the grid leak (using good rigid connections) and to mount the micro-amp meter on the equipment. If a suitable pick-up loop is then connected across

the signal generator output leads in place to the dummy aerial, the instrument should function as a grid dip meter. In some instruments there will be sufficient room to mount the micro-amp meter on the front panel, but with others it will be necessary to mount the meter in a small metal box and bolt this to the side of the signal generator cabinet. One word of warning—do NOT attempt to use a frequency meter as a GDO. A frequency meter is a precision instrument and should be reserved exclusively for the accurate measurement of frequency. It will often prove useful for setting-up the GDO when precision measurements of resonant frequency are required, however. The only other operation necessary when setting-up the GDO for the first time is to check for any resonances on the output leads. With the pick-up coil in circuit but not coupled to anything, tune carefully through the various ranges the oscillator covers, watching carefully for any sudden dip in grid current. Where such a dip occurs, it indicates resonance in the output leads and should be noted for future reference.

Applications

In this section, it is proposed to outline some GDO more important uses to which the of the may be put. In all these applications the operation of the meter follows the same basic principle—the resonance indication obtained is used either for calibration purposes, for alignment purposes or for comparison purposes.

Resonance Indication Used for Calibration and Alignment

Under this heading a number of useful

measurements can be made. Suppose that it is desired to calibrate an absorption wavemeter. The GDO is loosely coupled to the wavemeter by means of the pick-up coil and resonance measurements are made at (say) every five degrees on the wavemeter tuning dial. As each measurement is made the frequency of the GDO is checked against the station frequency meter. This results in a series of dial reading/frequency checks which can be drawn up into an accurate calibration curve.

Again, suppose that it is desired to match several tuning coils. Select one coil as a standard, connect a suitable condenser across it and trim the number of turns until the GDO indicates resonance at exactly the desired frequency. (The last few fine adjustments can be made by sliding the end turn of the coil in and out to get the exact inductance required, cementing it in place when the operation is completed). Having adjusted the first coil, leave the GDO set, place the other coils across the fixed condenser in turn and adjust their inductance until the GDO indicates resonance. The coils are then accurately matched.

The instrument can prove very useful in lining up BCI and TVI traps, the traps being accurately tuned to the desired frequency by means of the GDO and then given a final check-up when installed at the receiver.

For an interference free method of resonating a dipole or similar aerial, the GDO takes some beating. If it is link coupled to the aerial under test the exact resonant frequency of the aerial can be quickly found and any

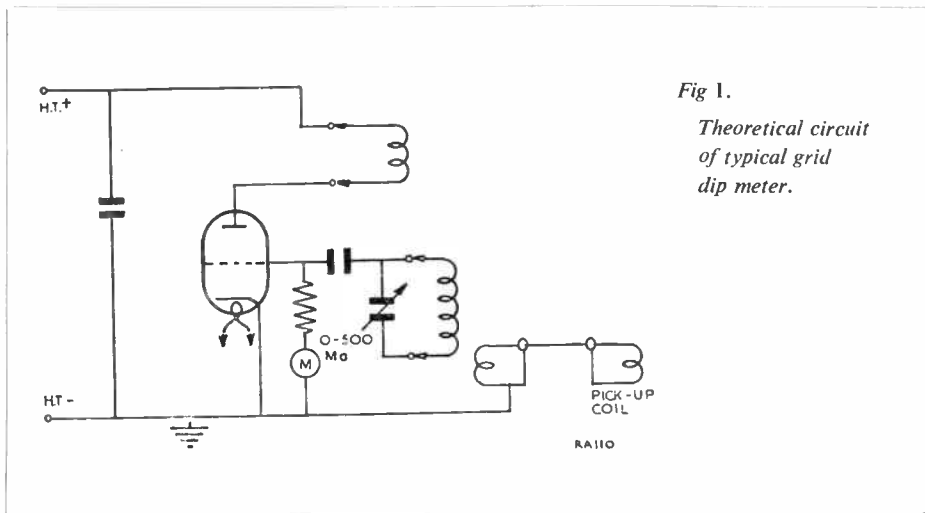

Fig 1.
Theoretical circuit of typical grid dip meter.

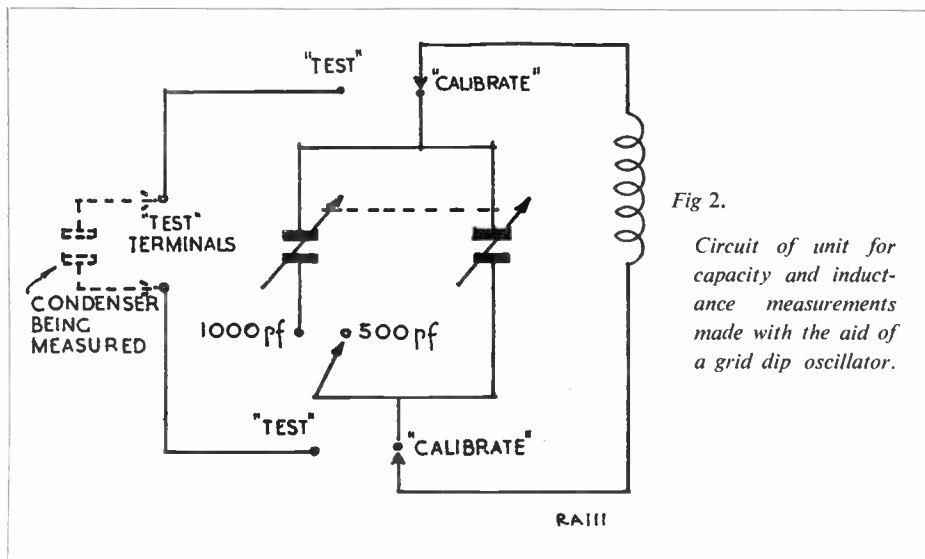

Fig 2.

Circuit of unit for capacity and inductance measurements made with the aid of a grid dip oscillator.

subsequent "pruning" carried out accurately and without causing interference to other operators.

Where unscreened coils are used, the GDO can often be employed for the "cold" alignment of tuned circuits in transmitters and receivers (bearing in mind that the valve inter-electrode capacities may alter when the equipment is switched on and so necessitate a final adjustment under actual operating conditions), but where screening cans are used they must be taken off to couple in the GDO, thus altering circuit conditions to such an extent as to render GDO readings useless.

Resonance Indication for Comparison Purposes

Under this rather formidable heading is hidden the fact that, with the addition of some simple equipment, the GDO can be used as a substitute for that expensive piece of equip-

ment, a capacity and inductance bridge. The method of measuring capacity requires the use of a calibrated variable condenser, and the unit described will cover capacities in the order of 10-1,000 picfarads, the lower reading being governed by the minimum capacity of the particular condenser used. The calibrated condenser unit consists of a standard 500 pf twin gang condenser, a coil and two switches, together with a good quality slow motion drive. The switches consist of a double-pole double-throw switch used to switch from the calibrated condenser to the condenser being measured and a single-pole double-throw switch which allows either a single 500 pf section or the two 500 pf sections in parallel to be used, thus providing a capacity range up to 1,000 pfd. The actual size of the coil is not important, but it should be selected so that a resonance indication can be obtained

Fig 3.

Values of fixed condensers—preferably 5% tolerance type—needed to make up calibrated capacitor unit. One terminal of each should be brought out to a terminal or plug socket and the other terminal of each joined together and taken to second terminal on unit.

500 pf. 250 pf. 200 pf. 100 pf. 50 pf. 25 pf. 10 pf. 5 pf.

Combination	Actual Value	Combination	Actual Value	Combination	Actual Value
	5 pf		100 pf	(250+50+25)	325 pf
(5+10)	10 pf	(100+10)	110 pf	(250+100)	350 pf
	15 pf	(100+25)	125 pf	(250+100+25)	375 pf
(5+25)	25 pf	(100+50)	150 pf	(250+100+50)	400 pf
(5+10+25)	30 pf	(100+50+25)	175 pf	(250+100+50+25)	425 pf
	40 pf		200 pf	(250+200)	450 pf
(10+50)	50 pf	(200+25)	225 pf	(250+200+25)	475 pf
(25+50)	60 pf	(250+25)	250 pf	(250+200+50)	500 pf
(10+25+50)	75 pf	(250+50)	275 pf		
	85 pf		300 pf		

Fig. 4. Table showing method of connecting condensers to give 5-500 pf calibration points. Figures in brackets show parallel connections for required value. To calibrate 505-1,000 pf, use values shown plus 500 pf in parallel.

throughout the whole capacity swing of the variable condenser. The unit is illustrated in Fig. 2.

Having assembled the calibrated condenser unit, it is next necessary to calibrate it. Eight fixed condensers of the values shown in Fig. 3 should be obtained, preferably of the 5% tolerance type. By using various combinations of these condensers as shown in Fig. 4, it is possible to set up some fifty different values of capacity in the range 5-1,000 pf. As each different value of capacity is set up, it should be connected to the "test" terminals of the standard unit and the GDO tuned to resonance. The switch should then be put to "calibrate" and the twin gang condenser swung until resonance is obtained. The capacity setting and dial reading are then noted. When the operation has been carried out for all the combinations of fixed condensers, a complete set of capacity/dial reading figures for the variable condenser will be available and can be plotted into a graph. Once this is done, any unknown condenser can be measured by connecting it to the "test" terminals and tuning the GDO to resonance, then switching over to "calibrate" and tuning the calibrated variable condenser until resonance is once more obtained. The values of the two condensers are now equal and can be found by referring to the calibrated condenser capacity/dial reading graph.

The GDO can also be conveniently used to measure inductance. If a suitable condenser be connected across the coil under test and the resonant frequency found, the inductance of the coil can be calculated by use of the formula $L = \frac{25,330}{C \times f^2}$ where L is in microhenries, C in picofarads and f in megacycles.

100 pf seems a convenient value of condenser to use with this formula, but for the benefit of those who do not wish to use mathematics, a table of frequencies and inductances for coils of 2.5 to 50 micro-henry tuned by a 50 pf condenser will be found in Fig. 5 and should allow most amateur measurements to be carried out without use of further calculations.

Conclusion

No doubt many amateurs can add to the list of GDO uses outlined above, but it is hoped that this article will serve as an introduction to the subject for those who have not yet used one of these versatile instruments.

Frequency Mcs	Inductance (micro-hy)
14.5	2.5
12	3.5
10	5
8.2	7.5
7.2	10
5.9	15
5.1	20
4.55	25
4.15	30
3.9	35
3.6	40
3.4	45
3.25	50

Fig. 5 Table showing inductance against frequency for coils tuned by a 50 picofarad condenser.

A MODULATION METER and PHONE MONITOR

Constructional details of the unit shown on the front cover

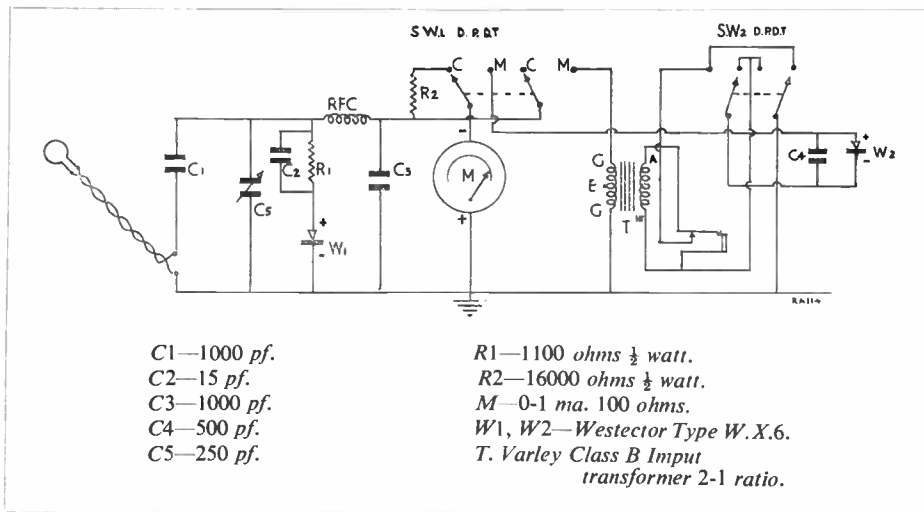

A very useful little instrument which does not seem to be as well known in this country as it should be, is the modulation meter and phone monitor described herewith. The reason for its rarity in English Amateur radio stations may well be that the circuit usually appears in American publications with U.S.A. components specified, the values of which are not shown, so that to reproduce the meter in this country, some experimentation becomes necessary. The instrument described herewith uses components readily available in this country. Most of them, in fact, will be found around any well stocked amateur radio station.

Under para. 12 of the "Conditions" upon which our licences are based, there appears the statement that "care must be taken to avoid overmodulation." The instrument described herewith is ideally suited for this purpose and it will also prove very useful for aurally monitoring the quality of one's phone transmissions.

As will be seen from the circuit diagrams, the principle used is that of rectifying a small fraction of the r.f. output from the p.a. coil of the transmitter by means of a Westector and passing this rectified current to a 0.1 milliammeter, on which its value can be read. By means of a DPDT switch, it is also possible to divert the r.f. through an audio transformer T, to a second Westector and thence to the meter. By ascertaining the read-

ings of the meter for unmodulated and modulated carrier it is possible to calculate the percentage of modulation. Provision is also made by means of Jack J, to insert a pair of headphones into the audio part of the circuit, so that aural monitoring of the signal can take place.

The arrangement and layout are not critical, all that is virtually required is some means of mounting the meter in a convenient manner with room beneath it for the audio transformer and associated components. In the writer's case, it was most convenient to have the unit on the operating desk adjacent to the receiver and for this purpose, the style of case shown in our front cover illustration proved most convenient, the unit being connected to a single turn link on the transmitter by several feet of flat twin cable. In order to accommodate the components specified, the instrument case should measure 4 in. by 6 in. on the face, 6 in. by 4½ in. by 7½ in. on the sides and 4 in. by 4½ in. on the back. A 2½ in. hole is required to take the meter and three ½ in. holes along the top to take the two switches and the jack. Any available 0.1 milliammeter can of course be used and the fixing hole for it should, of course, be of the appropriate size. If you do not fancy the idea of making up the case yourself try Philpott's Metalworks Ltd., Chapman Street, Loughborough.

HINTS ON SOLDERING

Some amateurs find great difficulty in making good soldered joints, yet it is quite a simple process provided the reasonable precautions given below are adhered to.

First carefully choose your iron. If electricity is available there are many small cheap irons on the market, admirably suited for radio purposes, the current consumption being only 250 watts. For the making of small joints such as wires, tags, etc., a bit say $2\frac{1}{2}$ inches long and $\frac{3}{4}$ inches diameter is satisfactory. This can be shaped or bent if necessary, so as it can easily be inserted between the various components, without the body of the iron which contains the heating element fouling and burning them. Many of the small irons have "slipout" bits, so a straight or bent one can be inserted, depending upon the job in hand.

Soldering bits very rapidly become oxidised particularly if the iron is allowed to overheat, and the faces which are wetted by the flux or solder become pitted. Contact with the work therefore is impaired, so filing becomes necessary. Always make sure your iron faces have a clean flat surface that tins uniformly. That is essential for the making of a good joint.

To prepare the bit, file the surfaces until they are bright and free from pits, and immediately apply resin cored solder if available, and wipe quickly with a piece of rag. Repeat this tinning whenever the surfaces become tarnished. Where ordinary strip solder is used, after filing apply flux to the surfaces, then solder and wipe with a fluxy rag.

Next, the job in hand to be soldered. Make sure your wire or part to be soldered is clean and free from grease, otherwise the solder will not flow. Emery paper the wire tag, or part, if same is not tinned, until brightly burnished and apply flux to keep same from oxidising. It is advisable to tin both surfaces before jointing, as the solder when applied to the joint to be made will run swiftly and evenly and ensure a perfect sweat. This will avoid a high resistance joint, a trouble frequently met with in radio sets and difficult to trace. In the case of soldering wires or tags to a large surface such as earthing to a metal box, the small iron itself will not be suitable, as the large surface will cool the bit quicker than the heat applied to it. To make a satisfactory joint, external heat should be applied to the point where the joint is to be made, by means of a small spirit lamp. As this becomes hot apply the flux, and then run on solder with the iron, so as to obtain a good tinned surface and whilst hot sweat down the wire.

FLUXES

In the case of resin cored solder no other flux is required, as this is carried in the core of the solder itself. For the soldering of copper wires where resin cored solder is not available, a resin flux can easily be made as follows.

Take one ounce of resin, crush it to powder, and add to four ounces of methylated spirit. To hasten the digestion the liquid can be stood in hot water, but on no account apply a naked flame, as an explosion may result. If necessary this solution can be made more active by the addition of 5 per cent. of lactic or Oleic Acid, but the odour from this is not pleasant.

PASTE FLUXES

There are several preparations already mixed at present on the market such as Fluxite, which are quite suitable for the soldering of copper joints, so it is hardly necessary to give a formula for these types, especially as the ingredients are not readily available. Zinc chloride, or killed spirit, as it is called made by dropping zinc scrap into spirits of Salts, should never be used on copper or brass, because of its corrosive action. If used as a flux for sweating iron, the surfaces should be thoroughly washed afterwards.

SOLDERS

3 parts lead, 3 parts tin, 1 part bismuth, melting point, 310°F .

2 parts lead, 2 parts tin, 1 part bismuth, melting point, 290°F .

1 part lead, 1 part tin, 2 parts bismuth, melting point, 200°F .

GOOD NEWS FOR F.M. ENTHUSIASTS

As from January 31st next, British amateurs will be allowed to use Frequency Modulation in the following frequency bands :—

1715-2000 kc/s, 3500-3635 kc/s, 3685-3800 kc/s, 7000-7300 kc/s, 14000-14350 kc/s, 21000-21450 kc/s.

This new facility has been obtained as the result of prolonged negotiations between the R.S.G.B. and the G.P.O.

First year licensees will be allowed to use F1 and other licensees F1, F2, and F3 subject to the following proviso :—

That the carrier frequency is at least 10 kc/s within the limits of the frequency band in use and that the maximum deviation of carrier frequency shall not exceed 2.5 kc/s. The maximum effective modulating frequency shall be limited to 4 kc/s, and the audio frequency input to the frequency modulator at any frequency higher than 4 kc/s shall not be less than 26db below the maximum input at lower frequencies.—*R.S.G.B. Bulletin.*

AERIAL RADIATION PATTERNS

by F. C. JUDD, G2BCX

No. 1 THE "QUAD" AERIAL

As mentioned in the Editorial of our November number, Mr. Judd begins his series of Aerial Radiation Patterns with the "Quad" aerial. Each month he will give data obtained from his Aerial Models on new aerial systems of interest to the amateur.

Introduction

Patterns can be calculated to show both the horizontal and vertical directivity of radiation from a single wire aerial or an array of driven or parasitic elements. They can also be plotted from an actual aerial providing there is some means of moving a field strength meter through the different planes of radiation. With large and high aerials this would be exceedingly difficult and in most cases impossible, but with the aid of models of the same aerials operating at very high frequencies, not only can the radiation patterns be plotted, but various effects simulated as well (Ref. 1). The patterns shown in this series have all been taken from model aerials operated at 3,000 Mcs. In some cases simulation of the effects of surrounding buildings and other aerials, etc. will be shown, but in all cases the patterns will be those of aerials which are either new to the Radio Amateur, unusual from a point of view of location (folding to fit a small space, etc.), or of special interest with regard to VHF

All the theoretical patterns of the better known and standard types of aerial, dipoles, long wires, driven and parasitic arrays and so on, may be found in the various radio handbooks, but in cases of unusual operation with a standard aerial, both the theoretical and model patterns will be shown. However, in almost every case the location itself would decide the ultimate directivity and efficiency, but the patterns taken from the models may be accepted as being reasonably reliable and will show very closely the radiation likely to be expected from average surroundings. As a check on the accuracy of polar patterns from model aerials, the writer has also plotted the field strength of one or two full size aerials from which models have later been made. In each case the results have been accurate enough to warrant considerable reliability.

Examples will also be shown of VHF arrays such as the Helix, the Quad and other unusual aerials. In these cases some notes on polarization, etc., will be given.

The radiation pattern in Fig. 1 is from a "Quad" aerial and shows both the vertical (upper half) and the horizontal directivity (lower half). With a two element Quad composed of a driven element and a reflector a maximum forward gain of approximately

7db (over a dipole) can be obtained. It may be seen from the polar diagrams that radiation in the horizontal plane covers a fairly wide area, whilst the vertical directivity, at both low and high angles, caters for short and long skip conditions. The horizontal pattern (A) was taken at 20 degrees as indicated on the vertical radiation angles and the pattern (B) at 38 degrees (vertical angle). For a similar lobe shape the antenna should be operated at of height of at least three-quarters of a wavelength. Both elements are square (Driven element (A)—Reflector (B)) as indicated in the inset of Fig. 1 and may be constructed in 12 or 14 s.w.g. wire or thin tube on stand-off insulators mounted on a suitable frame. The feeders are of the 600 ohm open wire line and may be tuned from the transmitter (maximum current to the aerial). The only other adjustment is that of tuning the stub on the reflector; this is set for maximum forward gain. It may be better to use a single turn for the reflector as a two turn loop will be found frequency sensitive. The spacing between elements (D) is 0.15λ —(3½ ft. for 21 Mcs)—2½ ft. for 29 to 30 Mcs) the length of each side (L) is 0.25λ —(11 ft. 4 ins. for 21 Mcs)—(8 ft. 3 ins. for 29 to 30 Mcs)—(see inset of Fig. 1). The tuning stub should be a little longer than a quarter-wavelength and adjusted with the shorting bar accordingly. The writer has constructed a three-element version of this aerial by adding a director (same construction as the reflector) spaced at 0.1λ in front of the driven element. The aerial showed a gain approaching that of a six-element Yagi. Further details of the aerial may be found in the A.R.R.L. Antenna Handbook. At 144 Mcs and higher the aerial should be quite useful, is not too large or difficult to construct, and involves no critical tuning or trimming processes. Polarization is in the horizontal plane although for some reason the 3,000 Mcs model showed considerable vertically polarized radiation. (Ref. 2.)

Ref. 1. Radiation Patterns and other Measurements with High Frequency Models of Aerials. F. C. Judd, G2BCX—*Radio Amateur*, Nov., Dec., etc., 1952.

Ref. 2. The "Quad" Antenna. *Q.S.T.*, Nov., 1948.

Fig. 1

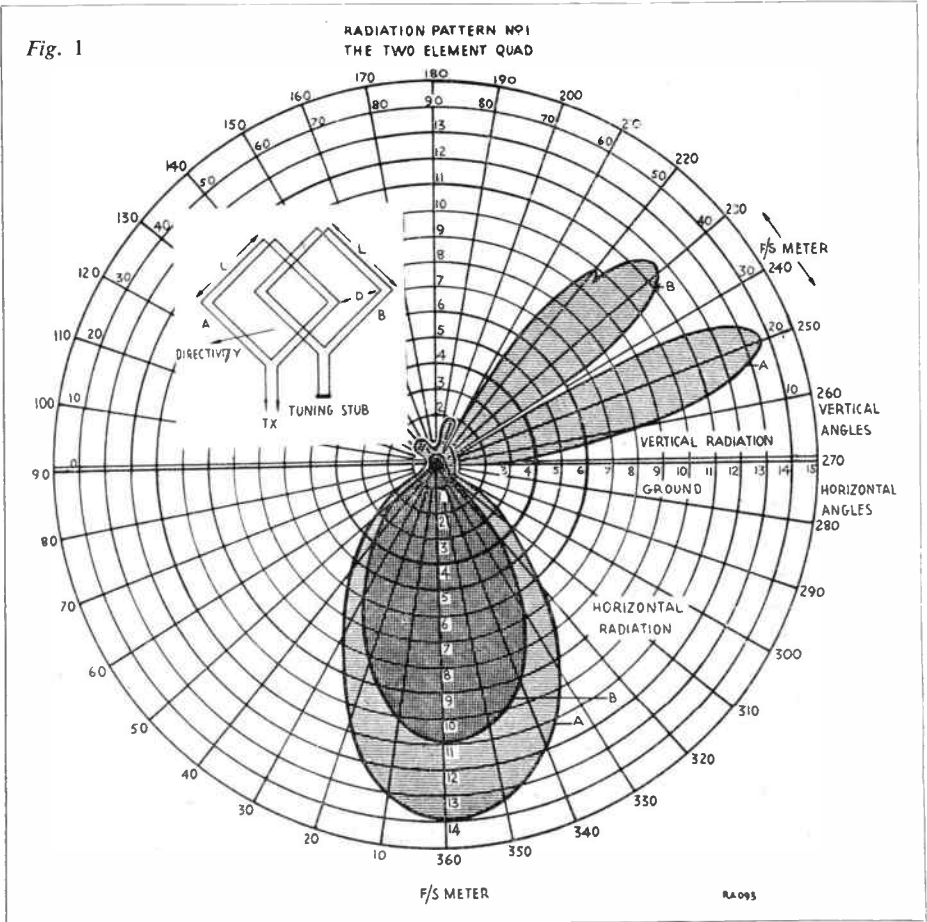

MODULATION METER (Contd. from p. 52)

Apart from the fact that the audio transformer must have a ratio of 2 : 1, any type can be used. The smaller this component, the smaller can the unit be as a whole.

Little comment on construction is necessary. Capacity C5 may or may not be necessary depending on the length and the frequency in use. Some experimentation in relation to the value of this component may well be carried out, but usually sufficient r.f. will be picked up to make this value quite uncritical.

Having completed the construction, check over and couple to the transmitter via a single turn coil spaced a couple of inches or so from

the end of the p.a. coil. Switch SW1 to the "unmodulated carrier" position and increase the coupling between link and tank coil or adjust C2 until a maximum meter reading is obtained. Endeavour to make this full scale meter reading viz. 1 MA. Now switch SW1 to the "modulated carrier" position and apply modulation to the carrier when the meter will kick up to a reading proportional to the percentage of modulation, giving the same reading as that for carrier only, for 100% modulation.

Switch SW2 reverses the polarity of the modulation check giving an indication of both "up" and "down" peaks.

THE DESIGN OF MAINS TRANSFORMERS

Part 6.

by W. E. THOMPSON

Before passing on to consider the question of insulation, may we correct a misprint occurring in last month's issue, on page 18, line 4, the stampings are given as $\frac{1}{4}$ " wide, they should be $\frac{1}{2}$ " wide.

Whatever type of transformer is contemplated, it is of importance that its insulation shall be able to withstand the high voltage gradients that will exist under working conditions. A cursory examination of the usual rectifier circuits does not readily reveal the high voltages that will appear between windings, and between windings and core, in the process of rectification. In the interests of reliability and safety one must therefore ensure that the leakage path for peak voltages is a difficult one for them to negotiate. Some mention was made earlier of the necessity to provide inter-layer paper insulation, so that the voltage differences between the ends of layers shall be prevented from causing breakdown, and some guide to the amount of insulation to be provided between windings was given when specifying Empire cloth for this purpose.

It is now necessary to point to some features of different types of rectifiers and show how and where peak voltages are developed. In Fig. 10 is shown a simple and everyday half-wave metal rectifier circuit. The transformer is providing 300 V rms, so the peak voltage will be 1.414 times this value, that is, 424 V peak. When the rectifier conducts the

reservoir capacitor will be charged to this peak value; on the next half-cycle when the rectifier does not conduct there will be a positive peak voltage of 424 V on the "positive" side of the rectifier due to the charge on the capacitor, and a similar negative voltage on the "negative" side from the transformer winding, so the total peak inverse voltage (p.i.v.) across the rectifier is 848 V. The rectifier must therefore be able to withstand this high p.i.v., and it should be noted also that the wiring on each side of the rectifier should be able to stand up to it. With this circuit, the negative HT rail and the transformer core are earthed, so the p.i.v. between secondary winding and core will be that which is developed across the winding; the insulation used must therefore have a higher breakdown voltage than this p.i.v.

A somewhat different state of affairs exists in Fig. 11 where the metal rectifier is replaced by a valve, which of course has to have a separate heater winding. Here, on negative half-cycles when the rectifier is not conducting, the valve will also have a p.i.v. of 848 V across it, between anode and cathode, but this voltage also appears between the HT and heater windings of the transformer. The voltage between HT winding and core is still 424 V peak, but it is double this value between windings, so the insulation between windings has to be even better. A full-wave rectifier

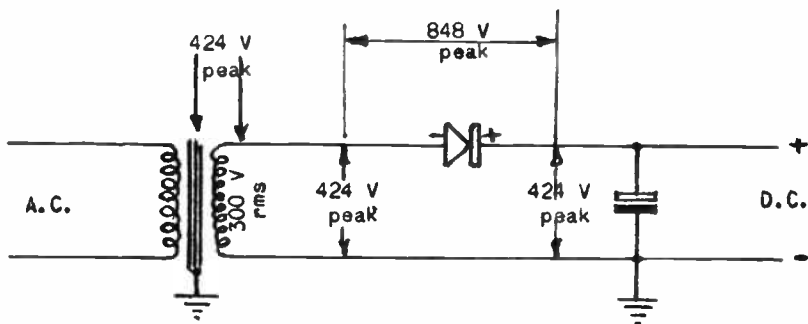

Fig. 10. Half-wave metal rectifier circuit, showing peak voltages.

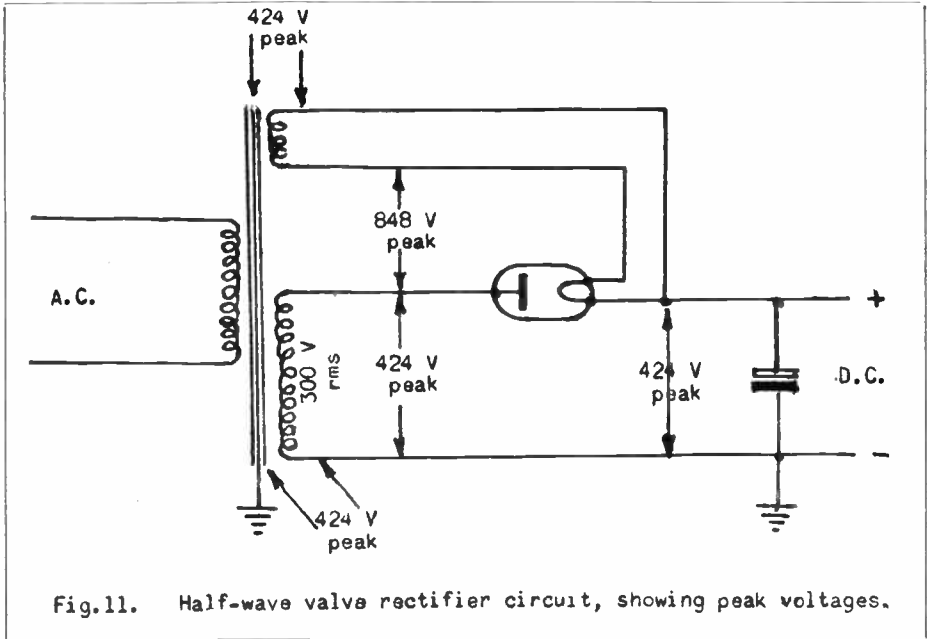

Fig.11. Half-wave valve rectifier circuit, showing peak voltages.

will have similar p.i.v.'s across its windings, as can be visualized by regarding it as two half-wave rectifiers which conduct during opposite half-cycles.

The p.i.v.'s which will exist on transformers rated for higher outputs can readily be seen to be quite large; a full-wave winding for a 5U4 valve, for instance, running at 450 V rms on each anode, will have nearly 1,300 V peak between HT and heater windings, and half this value between windings and core; this can be a damaging voltage under breakdown conditions. In general, it can be stated that the insulation between these windings for either full- or half-wave rectifier circuits should be able to withstand at least 3 times the rms voltage output of the HT secondary, and $1\frac{1}{2}$ times this voltage between windings and core.

E.H.T. Transformers

Although mains rectifier high voltage circuits are on the way out, they are still in use for many home-built television sets using such cathode-ray tubes as the popular VCR 97. Some constructors have made use of other "surplus" tubes which may require anything up to 4 kV on the final anode. Consequently, transformers for such E.H.T. voltages need to have more than usual attention paid to their insulation, and even the method of winding needs to be modified to guard against the possible effects of high-voltage gradients. Some remarks concerning this aspect may not come amiss, for it is possible that some folk

would wish to wind their own transformers, or even re-wind an existing component should it break down in service.

Where there is high voltage, sharp points should be avoided. If two wires are soldered together leaving a pointed end on wire or solder, a first-class discharge point is made available, so such joints should always be rounded off as much as possible. Even though an actual spark may not occur, a corona can be set up around the point, and this will rapidly cause deterioration of adjacent insulation and eventually break it down, when of course a spark will occur. The higher the peak voltages encountered, the more care must we pay to possible discharge points. As a corona cannot be heard, as can a spark, its damaging effects take place without making themselves immediately evident. Those who have experienced a corona taking place will recognise its characteristic purple glow and the strong smell of ozone it causes. A corona also causes nitrogen oxides to be developed; These, and ozone, have a serious deleterious effect on the usual insulating materials. The effect is cumulative—the gasses attack the insulation, which deteriorates, so allowing higher leakage current to pass. The corona becomes larger, and so intensifies the attack on the insulation. This effect builds up until finally the insulation breaks down. Rubber is particularly prone to attack by corona discharges, and for this reason rubber-covered

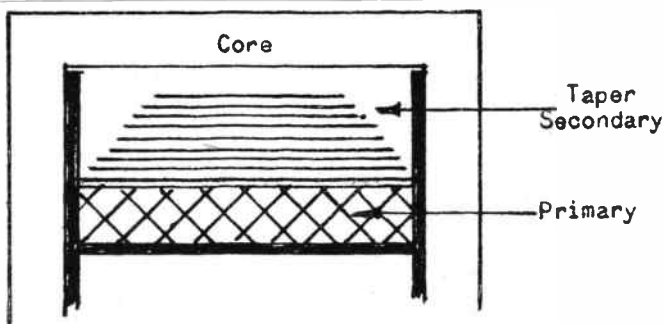

Fig.12. E.H.T. transformer with taper-wound secondary.

wires, or rubber in other forms of insulation, should never be used in a high-voltage transformer. Plastic-covered wires, and plastic insulants, have greater resistance to attack and are far more reliable in service, but care should be taken not to soften plastics by heat, as for instance, when soldering a flexible lead-out wire to the winding wire of a transformer. For this reason also, much care is needed if the transformer is baked to dry it out after winding; long baking at low heat is required rather than a shorter treatment at greater heat.

As it is unlikely that the home-constructor will have anything like the manufacturer's facilities for heat treatment and impregnation of finished windings, he must pay attention to the fact that some form of winding protection is desirable, and in fact necessary, in high-voltage transformers. Wax-dipping, after a slow baking to remove moisture from the transformer, will serve to prevent the ingress

of dampness, or reduce the effects of condensation, but care must be used not to crack the surface of the wax otherwise its effectiveness is rendered almost useless. There are air-drying impregnating varnishes available commercially, small quantities of which could perhaps be obtained from local firms who specialize in small motor repairs and re-winds. The author would suggest, however, that polystyrene coil dope, which has excellent insulating properties and high penetration power, can form a good impregnation for transformer coils. To test this view, a small winding was recently made up which had a radial thickness of 0.5 in. and a length of 0.5 in. Layers were interleaved with paper 0.5 mil thick obtained from an old paper capacitor, and DSC wire was used to assist penetration by absorption. The finished coil was gently warmed in the domestic electric cooker until it was just too hot to hold with comfort, and then totally immersed in polystyrene dope. It was taken out after ten minutes, and left

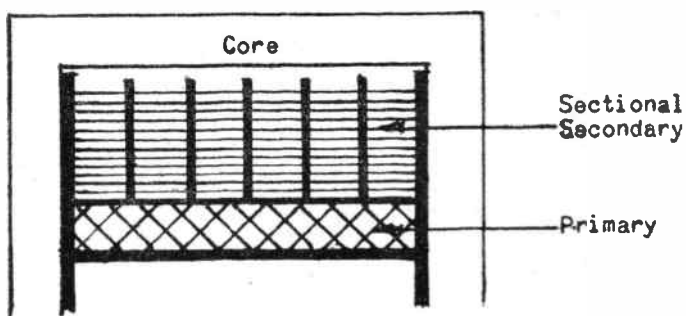

Fig.13. E.H.T. transformer with section-wound secondary.

to drain off and harden. The only high test voltage available was 7 kV on the anode of the CRT in the home-built TV set, so the inner end of the winding was joined to the tube anode and the coil laid on the chassis of the set, with no insulating material intervening, but the outer end of the winding was kept clear of earthed bodies. This end of wire was treated to a nice large blob of solder, which in turn was dipped several times in just-melted wax scraped off a cardboard capacitor to provide a thick coating of insulation. This test set-up was run for a whole evening's television reception, and the coil insulation stood up to the test. A further test was made by connecting the coil to the anode of the line output valve where a transient voltage with a steep wave-front is encountered, and still the insulation proved adequate. On conclusion

between coil and core. The more sections into which the winding is separated, the lower is the voltage gradient between sectional layers, and adjacent sections should be wound in opposite directions so that inners and outers come out at the same point and joined together, to reduce the potential gradient at the points of entry of the wire.

A combination of these two forms of winding result in the sort of coil depicted in Fig. 14. The inner end of the deepest section is the earthy end. The insulation at the bottom of each slot is built up so that a series of steps is formed, and the windings reduced in height progressively towards the high-potential end. This form of winding has the advantages of both the taper and the sectionalized coil so far as potential gradients and insulation are concerned. Adjacent sections should be wound

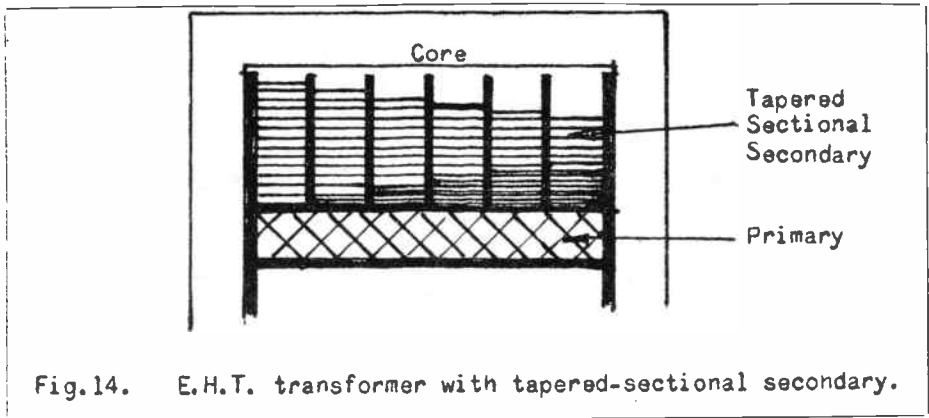

Fig.14. E.H.T. transformer with tapered-sectional secondary.

of these tests, the coil was cut through with a hacksaw and the turns prised apart; the whole of the coil was found to be completely impregnated with polystyrene. The coil dope used was obtained from L. Miller, of 8, Kenton Park Crescent, Kenton, Middlesex, who regularly advertises his "Panl" and "Motl" finishes in the columns of this journal.

So far as actual windings are concerned, there are several methods which can be used. Taper winding, as shown in Fig. 12, only slightly reduces the risk of breakdown between different layers, but it does increase considerably the leakage path between windings and core. The inner end of the winding should be the earthy end, obviously. The sectionalized form of winding, Fig. 13, effectively breaks up the winding so that failures between layers are prevented, but, as opposed to the taper winding, it does not greatly reduce the possibility of breakdown

in opposite directions as for the usual type of sectional winding.

Further improvement of insulation to prevent breakdown to core can be effected by using core-shields, as in Fig. 15. These can be made from waxed card, several thicknesses being used rather than one very thick piece.

Coil bobbins are best made from waxed paper or thin waxed card, several layers being used to make up a thickness of material not less than one-eighth inch. Paxolin, despite its good insulating properties at relatively low voltages, does not show up so well at high voltages. It has a breakdown value of about 10-25 kV/mm, but this figure can be seriously reduced if the smooth and shiny surface becomes contaminated by even slight traces of moisture. Waxed paper, however, has a breakdown value of about 45 kV/mm, which is much superior to paxolin and other phenol-formaldehyde materials. In fact, waxed paper

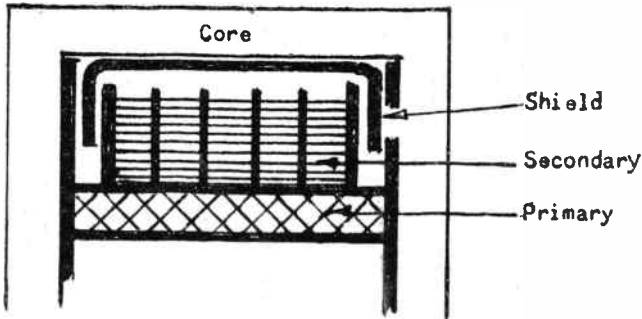

Fig.15. E.H.T. transformer with shield for additional insulation.

is one of the finest insulants one can use—it has a breakdown voltage value far greater than most other materials. A further disadvantage of paxolin, and some other materials which have a smooth surface, is the affinity to “tracking” under breakdown conditions.

Small discharges leave a slight carbon deposit, and continued discharges cause a build-up of deposit which finally results in a fairly low-resistance track. High voltages take to this sort of thing like a duck to water.

NOISE FIGURES, NOISE FACTORS, etc.

(continued from page 47)

Bandwidths

So it is obvious that for best signal to noise ratio the receiver bandwidth should just be adequate for the required transmission. Some typical bandwidths are shown in the table.

It does not matter where the bandwidth is clipped, provided that it is after the first stages in the receiver, where the noise is generated. The IF amplifier is the obvious place although sometimes, in addition, the “audio stages are used as well.

improvement. Although, of course, the background noise will drop 26 db on all transmissions which can be received with the narrower bandwidth.

These are, of course, methods of reducing the transmitted bandwidth for any given type of signal. For instance the single sideband suppressed carrier system, used on international telephony gives, overall, an improvement of the same order as multiplying the transmitter power by ten.

But there are others, such as the Vocodo, which can given even more startling improvements. But these are far beyond the scope of this article and discussions on them must be left to another occasion.

Reverting to our example, however, if one attempted to use the television receiver with a 5 kcs filter for telephony reception the gain will probably seem to be inadequate. A receiver designer calculates the input noise level and adds in the probable atmospheric noise. This, when modified by the estimated receiver noise factor gives him the first stage noise level. He then calculates the maximum receiver gain required to bring this noise up to full output level. This gives him an ample margin for component variations as noise will never be required to give full output.

In domestic receivers he may even work to a figure about 30 db above first stage noise on the assumption that the transmission needs to be at this level for good programme value.

In either case, if the bandwidth is clipped to reduce the noise 26 db, then 26 db extra gain must be provided to take full advantage of the

TABLE

Transmission	Typical Bandwidth
Navigational Beacons ..	2-3 cycles
Hand Morse	100 cycles
Telephony	5 kcs
Music (normal)	10 kcs
High Fidelity	30 kcs
FM Broadcast	100 kcs
Television	3-6 Mcs
High Definition Radar..	20-50 Mcs

EARNING THOSE CARDS

by J. C. SYMES

Some hints by a well known DX'er on how to get rare cards like the one shown herewith.

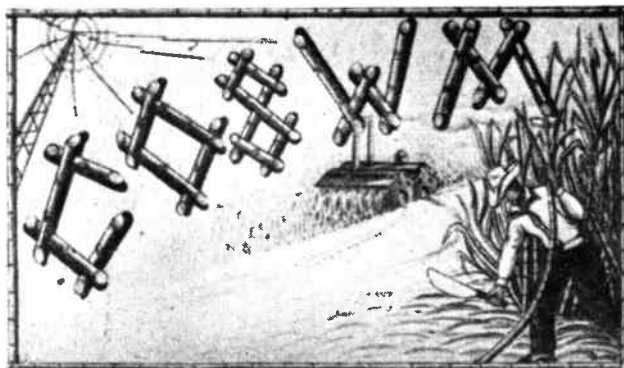

Many words of wisdom have been written about this aspect of our hobby. Despite their instructiveness, we hear stories, only too often, of useless reports condemned to wastepaper baskets and moans from SWL's that their report/reply ratios are too low. An alarming number of amateurs regard the majority of reporting SWL's as a pest. To give reasons for this sorry state of affairs, one has to dig down to the very foundations of this reporting system before the weaknesses are unearthed.

The main weakness appears to be an unwillingness to put oneself out in order to earn a reply. An attitude of—"I sent a report, I should get a reply" is utterly wrong if we are to remain in good odour with the transmitting fraternity on this question. After all, the recipient is not beholden to reply. A scrappy, hasty report is pure selfishness. It is asking for "something for nothing." Now let's have a look at the conscientious type. In nine cases out of ten he wants a QSL Card from the station heard to step up his total countries confirmed, or to fill that gap on the wallpaper, but his whole attitude is different. He wants something, but he is also anxious to give in return. He can achieve this by giving service, in other words, making out a report as comprehensive, as legible, as helpful as he possibly can. He sends reports over a period wherever possible; he listens around the band and gives comparative reports on other stations emanating from the same area; he sends details of general band conditions, weather, type of

QSB, and dozens of little things that the bad type won't bother with. The compilation of his report will probably take him over half an hour but he knows that it is worth while.

Here is another weakness. Too many reports are stereotyped, commonly known as the "rubber stamp" type. For heavens sake, break down a bit and be friendly; after all, the whole basis of Amateur Radio is built up on a spirit of friendship. Do make a point of sending a cheery letter with the report. The recipient is a human being; he has taken up transmitting because he gets enjoyment out of it. If he enjoyed the QSO which is the subject of your correspondence, a decent report and a friendly letter will bring that QSO to life again. Not only that, but there are dozens of friendships to be made all over the world through the simple medium of being human and not a reporting machine.

All this effort is more than repaid when the QSL's roll in with remarks such as "This is the finest report I've ever received"; "Thank you for your VY FB RPT—pse. listen for —, he would welcome a rpt. from U" and "I'll take this up to the Club and show them how it should be done." These little notations give added zest to the hobby and make one feel that an SWL can be useful to others.

A final word—next time you're in the shack cast your eyes over the "mural decorations" and ask yourself this question, "How many of those cards did I earn?"

IONOSPHERIC MONITORING for the RADIO AMATEUR

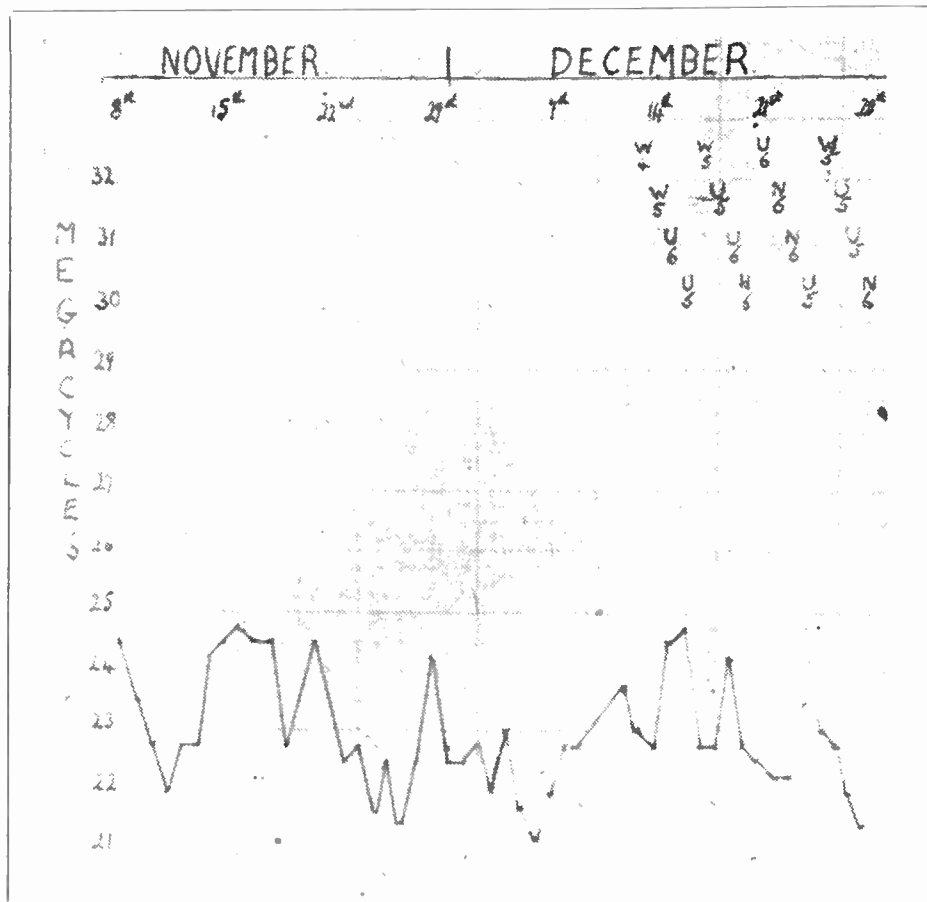

Scientific observation projects have been suggested many times in the past as useful and interesting work for the radio amateur, but practically none of the suggestions made have ever come to much. For various reasons very few radio amateurs are able to devote time as regularly as is usually required for work of this nature.

Most readers will be familiar with the name of Mr. Denis Heightman, G6DH, as being that of one of the leading advocates of scientific observation for radio amateurs and they will know that he himself has contributed extensively to our knowledge of the ionosphere through his consistent observations extending over a number of years. This work brought him the Clerk-Maxwell Prize recently for a paper he read on this subject before the Brit. I.R.E.

One of the observations which G6DH has regularly made consists in checking daily the highest frequency ionospherically propagated signal heard on his station receiver. He makes these checks several times a day, and as the MUF varies, so its changes show up by similar variations in the frequency of the highest signal audible. This simple method gives a very good indication of the propagation characteristics of the ionosphere.

Similar checks have been made at your editor's station during the past few months and the graph shown herewith records the results for November and December of last year.

We are not going to make extravagant claims for the amount of information which can be drawn from this graph, but we do think it is of sufficient interest to reproduce

for our Dx minded readers and it does give some clue to future trends on the higher frequency amateur bands. We propose publishing this graph from time to time as a record of ionospheric conditions and we should be very pleased to hear from any reader who would like to co-operate in carrying out similar observations.

The small letters and figures shown toward the top right-hand corner of the graph are the ionospheric propagation symbols received from WWV at 1250 GMT each day. Their meaning is fully explained in the new edition of "The Radio Amateur Operator's Handbook," which we have just published.

VHF PRE-AMPLIFIER (Contd. from p. 46)

is about mid band, there will be no need to touch these input circuits again. (Note: It will probably not be possible to carry out this alignment procedure during one transmission of the received signal, as it is not a process which can be done quickly, so one must be prepared to exercise plenty of patience. The successful operation of the amplifier depends upon correct alignment and this extra care will be found to be well worth while.

As a quick check on alignment, remove the feeder and substitute it with a carbon resistor of equivalent value. The noise level on the output meter should fall by *at least* 10 db.

After tuning up, the second and third circuits should be staggered slightly to provide for maximum sensitivity over the whole band.

Gain and Noise Figures

The measured gain from this amplifier, using a reliable signal generator and a valve voltmeter, was found to be just over 40 *db*s, a figure which well exceeds that of any type of pre-amplifier using the same number of EC91 valves.

The noise figure is slightly better than 4 *db*s when measured by the diode method, but appears to be considerably better than this when compared on actual signals with other types of pre-amps. As examples, signals were at least 3 S points up against a two-stage grounded grid amplifier using EC91's, with an increase in noise of only half an S point. This gives a clear 15 db increase in signal level.

Compared with a well designed two-stage GL446a grounded grid pre-amp with co-axial input circuitry the results were most satisfactory. The noise figure was slightly worse (just under half a db) but the overall gain was improved by more than 12 db. Tested against a two-stage push-pull 6J6 amplifier, it outperformed this one in every way. The noise figure being more than 2 db better and the gain over 15 db better.

The outstanding performance of this unit is most noticeable on weak signals, and the ability to resolve weak phone carriers is most marked.

Finally, it cannot be stressed too strongly that the alignment of the tuned circuits *must* be carried most carefully, and exactly in the manner outlined above, otherwise inferior performance will result.

NEWS FROM SWEDEN

From Our Swedish Correspondent

WASM, The SSA Certificate WASM (worked All SM districts) is getting more and more popular. Up to now about 150 such certificates have been sent out to amateurs all over the world. If you do not know the regulations, here they are:—

Europeans have to work at least two amateur radio stations in each of the seven districts SM1—SM7. A minimum report of RS(T) 33(8) is necessary. Send the verifications and the application to SSA, Stockholm 4, Sweden, together with 10 international reply coupons, and in due course you will get a very nice silk cloth suitable for a shack table or to hang on the wall.

WGSA, The Gothenburg Amateur Radio Association invites you to qualify for the WGSA Certificate. The rules are:—

Each two-way contact with an amateur in Gothenburg on each band gives one point. Of course only one contact with the same amateur is allowed on each band. Ten such points should be obtained and only contacts made after January 1st, 1953, count. QSL cards or any other written information should be sent to the Secretary of GSA, Karl O. Friden, Smørbollsgatan 1A, Gothenburg 4, Sweden.

21 Mcs Band, The SM boys got the 21 Mcs band for phone and CW on January 1st, 1953. From that date all the Atlantic City amateur radio regulations have come into force in Sweden.

Conditions have been poor during the first week but SM5KP on phone and SM5CO on CW have already worked all continents except South America.

With greetings from SM-land, Hans Eliaeson, SM5WL.

BROADCAST BANDS REVIEW

by JACK FAIRS

All Times G.M.T.
"Nf"—New Frequency.

As this is the first "Review" to be written since the festive season, we would like to thank all readers and Dx-ers who sent along Christmas Greetings and cards, etc. We are only sorry that it was hardly possible to reply to them all, but they were, without exception, greatly appreciated. Now for the news of the month.

EUROPE

Spain. Robert Mercier of Juvisy-sur-Orge, France, sends us another detailed account of his Dx activities, and starting off with this country we note two new "school stations." "Radio Juventud de La Coruna" ("del Frente de Juventud, Estacion Escuela No. 11") was found on 7035 kcs at 1700 on Sunday, 14th December. The other is "Radio Barbastro del Frente de Juventud," operating on 7400 kcs and heard to close at 1410. (This station is located at Barbastro, in the province of Huesca, and has a power of 80 watts.—Scribe).

"Radio Alerta," Valencia, is now on 6950 varying to 6955 kcs, and "Radio Nacional de Espana en Malaga" appears to have settled for 6975 kcs. (Mercier. Agreed, OM!—JF).

Iceland. Ian Hardwick, Thames Line, New Zealand, has been logging TFJ Reykjavik, 12175 kcs, with fair signals at 1615-1630 Sundays.

England. GRP is now on 17870 kcs (Nf) with the GOS for India at 1515-1615; this is a move from 18130 kcs, which has been inactive for some time. (BBC via "New Zealand DX Times.")

AFRICA

Canary Islands. EA8AB Santa Cruz de Tenerife, is heard in the evenings near 7305 kcs, just on the HF side of Pan-American Radio (7300 kcs), to sign-off around 2300, or 2330 on Saturdays. They announce as "Transmite Estaciones EAJ43 y EA8AB, Radio Club de Tenerife, Santa Cruz de Tenerife." (Sidney Pearce, Berkhamsted. Rx: Hallicrafters "Sky Champion.")

Angola. The "Radio Clube de Angola," Luanda, is reported to have moved the 9 Mcs frequency (CR6RN) from 9632 to 9687 kcs (Nf), and heard in South Africa at 1115-1330 and 1830-2130 (to 2230 on Saturdays) in parallel with 4873 (CR6RA), 7142 (CR6RL) and 11862 kcs. ("Sweden Calling Dx-ers!")

CR6AA "Radiodifusora Lobito" is listed on 4806, 5033 and 7177 kcs, with English broadcasts on Fridays at 2000-2030. ("Back to the Bible" Programme schedule, via Radio Sweden.) CR6RG "Radio Diamang," Dundo, has moved the 6870 kcs transmissions to 7065 times are 1800-1930 in parallel with

9344 kcs. (NZ DX Times.) CR6RD "Radio Club do Huambo," Nova Lisboa, now uses 9705 and 7096 kcs in parallel at 1730-2030; on Sundays has been noted to open at 1430. ("Australian DX-ers Calling.")

Cape Verde Islands. According to a fb QSL Card received by Bill Griffith, Ashtead, CR4AA "Radio Clube de Cabo Verde," Praia, transmits daily at 2000-2200 on 7132 and 5895 kcs, and both Tx's are of 3 kW output. Robert Mercier reports 7130 kcs instead of the former 7112, to close at 2205.

Gold Coast. ZOY Accra, 4915 kcs, is heard on weekdays with records from around 1730, "Gold Coast News" at 1745, and the weather forecast plus recordings from 1753 to close with "God Save the Queen" at 1800 (Pearce.)

Union of South Africa. The SABC African Service is broadcast by a 5 kW Tx at Robert Heights (15 miles south of Victoria), and the schedule is 0830-1215 (Saturday and Sunday, 0830-1345) on 15230 kcs, then daily at 1400-1630 on 11937 kcs, and 1645-2005 on 9870 kcs. Programmes in English are on Tuesdays, Thursdays and Saturdays, with Afrikaans other days. ("World Radio Handbook.")

The new SABC transmissions for South West Africa (not to be confused with the above), are on 9680 kcs (Nf) at these times: 0445-0630, 0815-1215 and 1400-2105 Monday-Friday; Saturdays at 0445-0630, 0815-2150; Sundays at 0555-0630, 0815-2105. (NZDXT.)

Ivory Coast. "Radio Abidjan" has been reported on 18135 kcs (Nf) by WRH, at 0645-0730, 1215-1300 and 1830-2100.

Mozambique. The Portuguese Network at Lourenco Marques is now reported using 11955 kcs (Nf) at 1800-2015; CR7BG (15285 kcs) remains in operation at 1700-1800, and both are in parallel with CR7BV (4872 kcs). (Radio Sweden.) This 4 Mcs station has been measured here on 4868 kcs at 1915, when the "Sabre Dance" was followed by "Aqui Lourenco Marques, Radio Clube de Mocambique. . ." (Scribe.) Sidney Pearce also quotes 4868 kcs for CR7BV, heard from around 1630. The English Network has been dug out of the 25-metre band on 11745 kcs around 1700 with very weak signals. (Robert Mercier.)

Station CR7IB "Emissora do Aero Clube da Beira," Beira, has been noted in South Africa on 7258 kcs (Nf). Schedule is now 1600-2030.

NEAR EAST

Kuwait. W. D. N. Berry of Huddersfield has sent along some further "on-the-spot" data on "Radio Kuwait" operating on 5000 kcs. The power is 1 kW, and transmission



Etienne Heritier, HE9RDX, in Basle, who gives the monthly amateur-band listening report in the Swiss Shortwave Service's DX programme, first Tuesday and Wednesday of each month. Full programme schedules available from S.S.S., Berne, Switzerland.

times are 1630-1900 (winter) and 1730-2000 (summer), with an additional period on Fridays at 0500-0700. Programmes are made up of Arabic music and topical features. The Chief Broadcasting Officer (and announcer) is H. E. Shaikh Abdulla Mobarak, Chief of Public Security, and the address for reports is: The Broadcasting Officer, Radio Station, Security Department, Kuwait, Arabia. Ian Hardwick can hear this station with fair signals in New Zealand.

Saudi Arabia. Details of the "Saudi-Arabian Broadcasting, Mecca" are also listed by D. Berry, as copied while in Kuwait: 725 kcs (MW) and 3970 kcs for Ryadi (Central Arabia) and the Persian Gulf; "40 metres" (7140 kcs ?) for Egypt; 6100 kcs for Syria and Lebanon; 11850 or 11950 kcs for Indonesia. Programmes are in Arabic during the afternoon and early evening, Urdu at 1300-1340, and Indonesian at 1400-1440.

Iran. EQO Teheran, 3980 kcs: heard with S9-plus signals in Kuwait around 1420. (D. Berry.) This station is an outstanding signal in New Zealand around 1330. (NZ DX Times.)

Afghanistan. Kabul Radio, 9975 kcs, is now on the air in English at 1530-1545; on Sundays sign-off is usually around 1600. (Pearce.)

Iraq. Radio Baghdad is now using the 6135 kcs outlet, in parallel with 11724, for the English transmission to Europe at 1915-2000, and has been logged by Ron. D. Young of Chelmsford on his S.740. Full schedule is 0355-0600, 0900-1100 and 1330-2000, all in Arabic except the last 45 minutes. (NZ DX Times.) Arabic programmes were heard on 7092 kcs at 1830, but had closed by 1930. (D. Berry). Sign-off is probably 1915—Scribe.

ASIA

Vietnam. Sidney Pearce has been hearing "Radio France-Asie" in Saigon during the afternoons on 9754 kcs, with French news at 1515 and closing at 1530 with "La Marseillaise"; on Saturdays has been heard to 1600. The 6116 kcs outlet was Q4 S5-6 here with French news at 2315. "Radio Cambodge," Phnom-Penh, 6090 kcs, has news in French at 1200 and 2315, and "Radio Hanoi" ("Station Nord") has moved from 6165 to

9670 kcs, running the schedule : 2300-0000, 0330-0515, 1000-1330. ("Universalite," bulletin of the Universal Radio DX Club, California, USA.)

Ceylon. The Government station, "Radio Colombo" on 4900 kcs, is rarely reported, but has lately been heard with fair signals in New Zealand at 1415. (Arthur Cushen, Onvercargill.)

Indonesia. "Radio and Television News" of the US reports that Ambon (Moluccas) has not been operating on 11089 kcs (see the "Review" for last October), and according to "Radio Republik Indonesia," the only station in Ambon is YDR on 4865 kcs. Graham Hutchins of "Radio Australia," commenting on this report, adds that there is, however, something on this frequency.

A new United States Service is planned by the "Voice of Indonesia," Djakarta, and the new 9866 kcs signals are confirmed as being those of the latest 50 kW Tx. This one has news in Indonesian at 1430. (Ian Hardwick and Sidney Pearce.)

John M. Simpson (Hassocks, Sussex), has logged YDJ at Jogjakarta (Java), 5060 kcs, at 2245-2330 ; reception was better at 2300 when a USSR station, using practically the same frequency, signed-off. YDB2 Djakarta (Java), 4910 kcs (1 kW): Q3 S3-4 with Indonesian songs until 2330, when the call "Radio Republik Indonesia, Djakarta" came over quite clearly. (Scribe.) YDP Medan (Sumatra), 4930 kcs (1 kW): Q3 S3 at 530-1615. Positive identification was ensured at 1545 by the two words: "Studio Medan. . ." (Scribe.)

Korea. HLKA Seoul is now reported to be using 9555 kcs (Nf) in parallel with 7935.

China (Communist Govt.). "Radio Free Japan" is a communist-controlled station operating from an unknown location somewhere in China, and uses 6310, 10180 and 11896 kcs all in parallel ; schedule is 1000-1100, 1230-1330, 2000-2100 and 0300-0400. (URDXC). A new outlet for Radio Peking is reported by "Sweden Calling Dx-ers," this being 9430 kcs, in parallel with 6100, 6500, 9040 and 10200 kcs around 1500. Shanghai on 5980 kcs was Q4 S4 at 2315 with QRM from ZFY. (John Simpson.)

India. The External Services of All India Radio, New Delhi, include the following transmissions, all of which are audible in Europe: To the Middle East at 1645-1715 (5980 and 7170 kcs) and 1730-1900 (4940, 5960 and 7170 kcs); to Western Europe, North Africa and the Levant at 1945-2030 (4940, 5960 and 7170 kcs), including News in French at 1950 ; English to Europe and the UK at 1945-2045 (4880 and 7275 kcs). (WRH) Sidney Pearce lists the latter transmission on 4875 and 7275 kcs, adding that they are announced as "4.88 and 7.28 Mcs." Roy

Patrick comments on the 4 Mcs frequency being used for international broadcasting, and it certainly appears to be the first time such a low frequency has been used for the European Service, at any rate !

Portuguese India. "Radio Goa" can be heard on occasions around 1530 on 9610 kcs, with the English edition of "Bringing Christ to the Nations." Roy Patrick, Oldham, reports this item, adding that they are usually swamped by "jammers" at approx. 1545. Sidney Pearce lists them at the same times until wiped out at 1600 by "Radio Norway." Robert Mercier can hear them until close-down at 1730, but on certain occasions reception is impossible for LLG on the same frequency.

PACIFIC

Philippines. The 2 kW station DZB2 of the Far East Broadcasting Company, Manila, has been logged here in England by John Simpson on a frequency of 3345.5 kcs. (DZB2 was reported to have moved from 3320 in the "Review" for last September.) Signals were Q4-5 S5-7, plus a few bursts of CW QRM, at 1605 to close at 1703, and the identification "This is the Call of the Orient" was given every 15 minutes. Your Scribe had also found DZB2, but during their "morning" transmissions around 2215-2300, and on one occasion signals were, to our surprise, pinning the S-meter needle against the stop ! A request programme, with announcements in English and Tagalog, seems to be a fairly regular feature up to 2230, when news in Tagalog is read until 2245. The call noted was as mentioned above plus: ". . . Station DZAS, 680 kcs, and six Shortwave Stations in Manila."

DZ16 of the same network has been measured by the BBC (Singapore), and found to be on 17806 kcs. GSV (17810 kcs) is suffering from QRM, and DZ16 may have to make a move. (Arthur Cushen.)

Western Samoa. Test transmissions on 6040 kcs are due to commence from Apia, relaying the MW Station ZM2AP on 1420 kcs, according to "Radio Australia." The last series of tests from ZM2AP, planned some 12 months ago, were cancelled. (Scribe.)

Australia. VLX4 Perth, 4897.5 kcs, can be heard from around 1525 on Saturdays with dance music to sign-off at 1600 with the National Anthem, after giving the time (at 1558) as "2358." (Pearce.) Logged with News at 1500 and Q4 S5 signals. (Scribe.) VLM4 Brisbane, 4917.5 kcs: heard with music at 0830 and weather report at 0900. (Simpson.)

NORTH AND CENTRAL AMERICA

Canada. The International Service of the CBC has replaced CKRZ (6060 kcs) by CKOB (6090 kcs) for the European transmissions at 1900-2330. CKOB is heard in parallel with CKLP (9585 kcs) in English at 2230-2300.

(Pearce and Mercier.) CJCX Sydney, 6010 kcs, is on the air from 0445 to 0010 (URDXC); CJCX relays CJCJ and is operated by Cape Breton Broadcasters Limited.

Nicaragua. YNVP "La Voz de Nicaragua," Managua, has returned to the 6185 kcs frequency from 6700, and heard by Robert Mercier at 0300 at fair strength. (This item cancels that in the issue of last July, and YNVP seems to alternate between these two channels.) YNLAT Granada, has been heard in the States on 7625 kcs at 0000-0030 with very bad CW QRM; the call was "La Voz del Mombacho." (URDXC.) YNLAT appears to have been dropped from many station lists. (Scribe.)

Guatemala. "La Voz de Guatemala," Guatemala City, operates the following stations: TGW (640 kcs MW, 10 kW), TGWC (1520 kcs MW, 1 kW), TGWA (9760 and 15170 kcs, 10 kW) and TGWB (6180 kcs, 1 kW), reports Ian Hardwick.

Honduras Republic. HRN "La Voz de Honduras," Tegucigalpa, has been noted on a measured 5885 kcs, (URDXC) yet is listed at present on 5875 (Scribe.)

El Salvador. YSUA "Radio Mil Cincuenta," San Salvador, has been found on 6188 kcs (Nf) by Robert Mercier, who reports good reception around 2315. This must be a move from 6100 kcs. Station YSWW at Santa Ana, is now operating on 5975 kcs (Nf) according to URDXC, and noted around 0140. Roy Patrick has also caught YSWW (for the first time—it is certainly one of the elusive ones!) and though Roy doesn't give a frequency, he adds that there was QRM from ZFY (5981 kcs), while Andorra was off the air, so our guess is somewhere around 5985-5990 kcs (?).

Haiti. Station 4VEH Cap Haitien is still wandering around the 31-metre band, and has been reported using 9680 and 9690 kcs; English programmes are now at 1130-1200 and 1300-1345 daily, 1130-1200 and 1230-1345 Sundays, 0130-0200 on Mondays. (URDXC.) The 6 Mcs outlet of "Radio Haiti," Port-au-Prince, should be 4VHW, and not 4VSW as mentioned last month. Robert Mercier, adding to this correction, says that 4VHW has moved from 6177 to about 5840 kcs, and is audible around 2200 just on the HF side of CQM4 Bissau. 4VRW is still on 10070 kcs.

Dominican Republic. HI8Z "Cadena Nacional de Radio," Santiago, has been heard in the US around 0125 on a measured frequency of 5023 kcs (URDXC.)

Jamaica. ZQ1 Kingston is listed by John Simpson on both 3360 and 4950 kcs outlets, in parallel with the BBC News at 2300, and call "This is Radio Jamaica" at 2314.

SOUTH AMERICA

French Guiana. Cayenne. A shortwave broadcasting station is now operating in

Cayenne, and for this first report we are indebted to Robert Mercier. Test transmissions on Wednesdays and Saturdays have been heard on 6200 kcs (announced) at 2300 to 2400; the call is "Ici Cayenne, Radiodiffusion Francaise" and programmes open and close with "La Marseillaise." This station was heard for the first time on November 26th, and signal strength was about equal to that of ZFY and PZH5. Robert adds an interesting note to this item: French Guiana, like Martinique, Guadeloupe, La Reunion and Algeria, is a "departement" of France, and not a colony. These territories have exactly the same laws and administration as France itself, being considered as a part of France on another continent.

Colombia. HJEF Cali, 4768 kcs, identifies as "Radiodifusora Occidente, Cali, Colombia—HJEF y HJEL, una emisora de Ca-Ra-Col, primera Cadena Radial Colombia." HJKH "Accion Cultural Popular," Sutaenza, has been logged in the US on a measured frequency of 5070 kcs (listed on 5060). (URDXC.)

Brazil. ZYZ20 "Radio Relogio Federal," the Standard Time Service station in Rio de Janeiro, has been heard on its allotted frequency of 4905 kcs, apparently testing. Signals were Q4 S5 around 2315-2340, when typical Brazilian dance music was featured, with the call at 2333. No time announcements were given on this occasion (December 30th). (Scribe.)

PRK5 "Radio Inconfidencia" at Belo Horizonte (Minas Gerais) has been measured on 5995 kcs (URDXC) instead of the former 6000. PRA8 "Radio Clube de Pernambuco," Recife, has been widely reported on the previously-inactive 11865 kcs channel, from 1800 to close at 2000. Sidney Pearce says signals are good, but there is severe QRM at times from Luanda on 11862 kcs.

The new station at Sao Paulo, ZYR63 "Radio Emissora de Piratininga," has already been discovered by Bill Griffith on 6025 kcs around 2200; this station is also heard by Arthur Cushen, but has QRM from DZH6 (6030 kcs). Roy Patrick offers a selection of Medium-wave Brazilian Dx in the shape of PRE8 "Radio Nacional," Rio de Janeiro on 980 kcs, PRG3 "Radio Tupi," Rio de Janeiro on 1280 kcs, and "Radio Excelsior" on 1100 kcs. (The latter is now listed as the new PRG9 "Radio Nacional" at Sao Paulo, which is relayed on 9545 and 11805 kcs—both Nf's.) The time for this MW Dx is from 2330 onwards.

Venezuela. YVLK "Radio Rumbos," Caracas, 4973 kcs, is now broadcasting an English hour for American listeners in that country, at 2300-2400 Monday thro' Friday. The first 45 minutes is devoted to a disc-jockey show called "The Supper Club," and a round-up of the World News is presented at

2345. The announcer is Jay Farr, who also reads a 15-minute summary, in English, of the Venezuelan news of the week each Monday at 1815, over YVVO "Radiodifusora Nacional" on 6170 kcs. (URDXC.) YVLK is now using a new transmitter of 10 kW. (Radio Sweden.) The above English programmes are heard well in Europe, and are reported by Ron. Young, Roy Patrick and Sidney Pearce.

The call-letters of "Radio Barquisimeto" on 9510 kcs are YVXJ (power is 4 kW) and *not* YVKJ as mentioned last month; other outlets are YVMQ (4 kW) on 4940 kcs, and YVMR (3 kW) on 1490 kcs MW. (Robert Mercier and "Radio Australia.") Stanley Coppel of Belfast, Northern Ireland, lists YVMQ with Q5 S8 signals at 0025, together with YVKM "Radio Continente," Caracas, 5030 kcs, and YVKD "Radio Cultura," Caracas, 5050 kcs, both Q5 S8 around 0100.

Ecuador. HCPZ6 "Radio el Sol" at Latacunga is a new station of 200 watts on 9540 kcs. ("World Radio Handbook.")

Chile. CE1190 "Radio Cooperativa Vitalicia, La Voz del Chile para toda America" ("The Voice of Chile for all America") at Valparaiso, has been spotted on about 11938 kcs, using the above slogan at 2200, by Robert Mercier. (Note: This station used 11940 kcs for a short while in October, 1951. The regular channel is, of course, 11900 kcs. Scribe.)

CONCLUSION

Here is the Honour Roll of Countries Verified (Shortwave Broadcast only) as it stands at January 1st, 1953. We regret that three members' names did not appear last time, but this is a complete list up to the time of writing. We have received one or two suggestions from readers that a list of Countries Heard could be run parallel with the H.R.; this would also be for Shortwave Broadcast Stations only, and if we receive enough support, we shall list 'em for you. The positions would still, of course, be determined by the number of Countries Verified, as at present. So get counting, OM's!

Broadcast News, schedules, and your most interesting DX items are always welcome, and should be sent to: J. Fairs, 2a Durham Road, Redcar, Yorkshire, England, to arrive by 25th February (as it is a short month!) for inclusion in the April issue.

The Editor and your Scribe thank all contributors to this column, and all items are duly acknowledged.

All the best until next month, 73 and Good DX to you all.

HONOUR ROLL

1. Sidney Pearce	131
2. Arthur Cuchen (NZ)	127
3. Jack Fairs	91
4. Mike O'Sullivan	89
5. Roy Patrick	87
6. Carl Shapiro	83
Stanley Coppel	83
Ivor J. Street	83
7. William P. Griffith	80
8. Ian Hardwick (NZ)	70
9. Dr. James Kyle	67
10. Manfred Lepple (Germany)	66
11. Bert Clear	63
12. Ronald Thorndike	54
Tony Allmey	54
13. John Whittington	50
14. Phil. Allwood	48
15. Fred Pilkington (MM)	41
16. John Bell	37
17. Alex Mackenzie	36
18. J. S. Bollard	35
Kalevi Ant-Wuorinen (Finland)	35
19. Robert Mercier (France)	34
20. F. C. Boucher	31
21. Paul R. Warner	30

RADIO CONSTRUCTOR—March Issue
CONTENTS

Suggested Circuits : A Signal Generator Without Trimmings, by G. A. French.
In Your Workshop, by J. R. D.
General Purpose Test Meter, by F. G. Rayer.
Valves & Their Power Supplies, Part 4, by F. L. Bayliss, A.M.I.E.T.
Radio Control Equipment, Part 1, by Raymond F. Stock.
Picture Tube Defects, by Gordon J. King, A.M.I.P.R.E.
Trade Review : The Ronette Crystal Pick-Up.
Obtaining Smooth Reaction, by James S. Kendall, Assoc.Brit.I.R.E., M.I.P.R.E.
The "Coronet" SW Converter, by G. Blundell
Quality Radio Unit for the "Magna-View," Part 1, by A. S. Torrance, A.M.I.P.R.E., A.M.T.S.
Book Reviews
Radio Miscellany, by Centre Tap
From Our Mailbag
Query Corner—A Service for Readers

ON THE HIGHER FREQUENCIES

Monthly Notes and News

by H. E. SMITH, G6UH

That "October Editorial" Again

We have searched the pages of the Bulletin in vain for any further reference to the statements printed in the Editorial of the October issue regarding VHF operation. We take it, then, that the RSGB are in favour of adopting the procedure advocated by the Hon. Editor. Can it possibly be that the Council are so apathetic to the cause of VHF that they intend to allow these comments to pass uncorrected? Neither have they seen fit, up to the time of writing these notes, to publish any of the letters which they have received on the subject. There have been instances in the past where certain journals have made a practice of never publishing anything contrary to the views of the Editor, but we never suspected that the RSGB would ever allow a state of affairs to exist where such a charge might be levelled at them. The RSGB claim to support the cause of VHF by devoting two pages or so of the Bulletin to VHF Notes each month. Then right out of the blue (and *not* from the pen of the VHF Editor) comes a shoal of inaccurate comments, so distorted and unreasonable, that the newcomer would obtain a completely erroneous picture of the conditions existing on the band. Leadership, not Mis-leadership is the thing required for the VHF man, and this applies to an even greater degree to the would-be VHF man. Our own comments in the December issue were ignored by the RSGB, and we expect our January comments to be treated likewise. Perhaps they are applying the "let sleeping dogs lie" theory. If this is so, they are making yet another mistake, because this dog does not intend to lie down. We should like to know the answers to these questions: "Are the Council of the RSGB in agreement with the comments contained in the Editorial of the October Bulletin? Do the RSGB as a body intend to give any active support or backing to any serious research work on the VHF bands?"

Are the Council of the RSGB fully aware of the extent of the loss of prestige caused by the comments in the Bulletin?

Indexes of Vol : 7 of "The Radio Amateur" are now available, free of charge, upon receipt of a stamped addressed envelope. Mark your cover "Index RA" and forward to Data Publications, 57, Maida Vale, London. W.9.

If the Society intends to take no action other than which it claims to be taking at the moment, the VHF man will be forced to look for leadership elsewhere. Concerted action is necessary if any really serious research work is to be attempted on 145 Mcs, and this can only be achieved if there is a central body to formulate the procedure. We have received much correspondence on the subject since our comments in the December issue, and in every single case agreement with us is voiced. Therefore, we invite the RSGB to speak out and either defend or condemn the statements made in the October Bulletin. Everyone will then know exactly where they are.

(We do apologise for starting these February notes in a manner which might be interpreted as being an attack on the RSGB. It is in no sense an attack. Everyone who read the column referred to, must be feeling a little uneasy regarding the policy of the Society towards VHF, and we, as supporters of the cause of VHF, are making an effort to solve the mystery).

The VHF Newcomer

There have been numerous requests for a discourse on suitable valves for VHF work, so we shall devote most of the available space to this topic this month. It will, perhaps, be of more interest if we keep to the more easily obtainable and reasonably priced types. Although there are many other types than those mentioned which will *work* on 144 Mcs, the performance in most cases is far inferior to that required for really good results, so we have refrained from mentioning these. The comments which accompany each type are based on our own actual experience with them.

American 6J4/Mullard EC91 (B7G based G.G. Triode)

Similar characteristics but base connections differ. One of the best of the more common valves for the RF stage of the converter. Excellent noise figure and high slope. Also suitable as triode mixer. This valve is wasted as an oscillator, and if you have several, keep them as spares for the RF stage and use something like a 6C4 for the oscillator stage. Never exceed 150 volts on the anode. Also suitable as oscillator or RF amplifier up to 430 Mcs when used in trough or co-axial circuits.

American 6J6/Mullard ECC91 (B7G based twin triode)

Similar characteristics and base connections

identical. Suitable as PP RF stage on 144 and 430 Mcs. Neutralisation necessary with capacitors of approximately 2 pf maximum capacity. Good noise figure, but not as good as two 6J4's in push-pull. Never exceed 100 volts on the anode. This valve will also operate as mixer or oscillator up to 430 Mcs. **Brimar 12AT7** (B9A Noval based twin triode with separate cathodes)

Superior to the 6J6 as RF amplifier at 144 Mcs, and having two cathodes may be used as a PP GG stage. As a straightforward RF amplifier, neutralisation is rather more difficult to obtain than with the 6J6. Works well as a cascode amplifier. Suitable as an oscillator up to 500 Mcs, maximum anode volts 250.

American 6AK5/Mullard EC95 (B7G based pentode)

This is the only really suitable valve for optimum performance of the Wallman Cascode circuit. Has 100 per cent operational efficiency at 144 Mcs, and works well as a mixer or oscillator, but excels as a triode connected RF stage. When wired as a pentode, with 180 volts HT and 200 ohm bias resistor the amplification factor is over 3,000.

Mullard EF50/Service Types VR91, ARP35, CVI901 (B9G based pentode)

Found in many surplus units this valve has a noise figure of approximately three times that of the 6J4, and its performance will, therefore, be inferior. It will, however, get you going on the band, and many VHF operators used these valves before the newer B7G types were so readily obtainable. When used as an oscillator it is often difficult to obtain a T9 note because of modulation hum, which is difficult to cure, unless you are prepared to run it with DC on the heater.

Mullard EF54/RL7 Service Types VR136, CVI136 (B9G based pentode)

Much better noise figure than the EF50, and is capable of good results as an RF amplifier, mixer or oscillator for 144 Mcs. Many operators still use this valve as the RF amplifier in the converter with quite good results. Do not exceed 250 volts on the anode.

American 954/M.O.V.ZA2 (acorn pentode)

Still found in certain surplus equipment. Capable of results on 144 Mcs, superior to the EF54 and almost equalling the 6J6. Its comparatively high noise figure is the limiting factor.

American 955/M.O.V.HA2 (acorn triode)

Also still found in some surplus equipment. Makes an excellent VHF oscillator, up to 600 Mcs, and in a carefully designed converter will provide results comparable with the 6J4 although the noise figure is slightly worse. Like the 954, however, the fragile construction makes it *not* entirely suitable for amateur work. **American 9001 and 9003** (B7G based pentode and var. mu. pentode)

Used in much of the American VHF equipment, superseding the 954 type valve. Will provide results superior to the EF54.

These valves will operate quite comfortably on 11 Mcs, and if you have any of them around, by all means use them. It must be remembered, however, that they will not give such good results as the later 6AK5 types. When used as a mixer, the 9001 is every bit as good as the Z77 or an EF54.

American 9002 (B7G based triode)

Mainly useful as an oscillator up to 400 Mcs. Noise figure is much higher than the 6J4, and it is not very suitable as an RF amplifier or mixer.

American 6C4 (B7G based triode)

Like the previous valve, mainly useful as an oscillator up to 300 Mcs. Noise figure is fairly high, but may be used as a neutralised RF amplifier with results inferior to the 6J4.

So much, then, for some of the more common types of valves suitable for use on 145 Mcs and higher. Many of the types mentioned are still available through the surplus channels at reasonable prices, and will at least serve to get you going on the VHF bands. Many beginners on the band have been disappointed with the results obtained because they used valves which were never designed for use up to 145 Mcs. A golden rule is *never* to use an octal based valve for 145 Mcs RF or mixer stage. A notable exception to this rule is the American HY 615 which has the anode and grid connections brought out through the glass.

We seem to have dwelt so long on this valve question that there is very little room for any other topics. But we will find room for a brief line or two on a query we have received on heater chokes. The actual query was "Is it necessary to include a heater RF choke in the *earthed* heater lead, and should the by-pass condenser be fitted across the actual heater pins or across the input side of the chokes?"

By all means fit two chokes in the heater leads, especially if a grounded grid stage is in use. Some of the signal is bound to be absorbed by the Cathode/Heater capacitance if the heater is not held above earth to RF. A good heater choke for 145 Mcs work may be made up on a ceramic resistor (any value resistor between 10 k and 2 Megohms) using 19 in. of 24 SWG enamelled wire close wound.

The by-pass capacitor should *not* be wired across the valveholder, but from the input side of the unearthed heater choke to earth. If neither heater is earthed, two capacitors will be required from the input side of each choke to earth. 250 to 350 pf is a suitable value to use. So that about concludes this section for the month. We stress that we can only carry on these notes for the newcomer if you write in with your suggestions, problems, or any tips which you consider

may be of interest to newcomers on the band. We intend to deal only with genuine queries and extracts from letters, so please drop your conductor a line. No matter how simple it may appear to you, there may be somebody, somewhere, who is waiting for the answer to that very thing.

STATION REPORTS AND NEWS

In spite of the continued activity, quite a nice selection of reports have been received again. Your conductor is also pleased to report that G6UH is about on the band again with somewhat more regularity than during the past few months. We are also more than pleased to note that G6CW has, after all, decided not to QRT on the VHF bands. We heard him operating on January 4th, but did not succeed in having a QSO. G3EHY has also been well heard and called with no result. Louis is usually so busy working people that it's almost a matter of queuing up for him. Since your conductor has been back in circulation, it is more apparent than ever that many 'phone stations are still not signing off on CW. Weak carriers are heard quite frequently towards the north, and it is a great pity that a sign off on CW is not given. This point is also noted by G3HZK who is operating under extremely difficult conditions with a simple dipole, and if only some identification were given by these stations it would be of tremendous assistance. So please 'phone stations, try and remember to give an occasional callsign on CW, preferably at the end of each transmission.

G3EHY (Banwell, Somerset) has a lot to say about the inactivity. "It is," says Louis, "deplorable," and in his opinion is due to the lack of the true pioneering spirit in any but a very few of the stations who remain on the band. Look at the records which have been set up, positions of certain stations in County Lists and whatnot, and then weigh up the conditions existing when these positions were attained. The answer is, when conditions were favourable and DX working was simple and easy. From a scientific point of view all this is worthless, and yet it is all given the greatest publicity, and these "heroes" sit back and bask in the sunshine of their simple "achievements." G3EHY has tackled many of these stations in an effort to get some co-operation in two-way schedules during the winter, but in the main, they all found excuses.

Is it that they do not want to run the risk of being knocked off their shaky pinnacles by failing to show consistency of operation under all conditions? Regarding the "fine weather operator," Louis says, "It's like some great footballer who says, 'I am only going to play in the spring, boys. It's too cold in the winter and my wife doesn't like the dirt I bring in.' But I'll be seeing you, and mean-

while keep my name before the public." (Hi). (Well put OM! What could be nearer the truth?)

On the subject of the RSGB October Editorial (in the Bulletin), G3EHY makes some very pointed comments: "The attitude of the RSGB is completely sterile. The remarks in the recent Editorial were so inaccurate, showed such a complete ignorance of what has already been achieved on the UHF bands, and gave such a distorted view to any newcomer who might have been tempted to try his hand, that in my opinion, they have lowered the prestige of the Bulletin to a depth from which it will take a long time to recover." A carefully considered letter written by G3EHY to the VHF Editor, which was in turn, passed to the Council, has not appeared in the Bulletin, and Louis suggests that it appears that any views which are contrary to those of the Editor are being suppressed. "Furthermore," says G3EHY, "your own comments in the December issue of the *Radio Amateur* were not even commented on by the Bulletin, and your further remarks in the January issue will no doubt receive the same treatment." . . . "Could you ever come across a more self-satisfied ignorance than this? Which, moreover, shows a complete obtuseness and thorough contempt of all scientific work which has been put into the matter of DX working on the 2 metre band. Not only are the RSGB officials failing to give any useful leadership to research work on the VHF bands, but they are, by their own pronouncements, proving to be, through ignorance and incompetence, incapable of any such leadership."

(Note.—At the risk of being accused of turning these columns into a political battleground, we feel it our duty to publish the above comments from G3EHY. Many other comments have been received from contributors in the same strain, and these comments just about sum up the general feeling of many VHF operators.

In spite of the poor measure of activity, G3EHY has found some very good openings during December, and on many occasions northern stations were worked, mostly at 150 miles or over. Several London stations were worked, and these usually reported that local activity was confined to themselves. In spite of the fact that the meteorological conditions were the worst for any December since we have enjoyed the use of the 2 metre band, it was proved on several occasions that DX up to 268 miles was possible. On sked calls to Ireland, QSO's were obtained with G13GQB (268 miles) on eight evenings, and on a further ten occasions the signals from Ireland were copied without an actual QSO being made. On a contour map, range after range of Welsh

mountains intervene, the QTH's at both ends are nothing to shout about, in fact G3EHY is at sea level, and the gear used is that which any amateur could construct at small expense. "So," says G3EHY, "there is no reason why many other stations could not partake in these openings, which are there for the taking."

G3EHY's activity is noted by G3MI (Chesham, Bucks.), who writes: "I heard an excellent signal from G3EHY on January 3rd calling CQ to the north and apparently getting no replies. I called my head off but could not raise him. *There was not another signal to be heard on the band at the time.*" G3MI usually comes on at 11 p.m., being too busy to appear earlier, and on a number of nights there has been nothing audible at all, and seldom more than two or three signals from the London area. Bob's ratio of replies to CQ's is about one in ten, and he hopes to get a little spare time in the near future to build a respectable aerial for 70 cms in the hope of hearing a few more signals "If anyone ever works on that band" Hi. There will be one less operating on 70 cms in the very near future.

We hear from G5GX (Hull, Yorks.), that he will be dismantling the 70 cms gear because of the lack of activity, and Malcolm is having second thoughts about rebuilding his 2 metre mast also. Both he and the other Hull stations agree that it is hardly worth going to a lot of trouble and expense to operate on a band which is only used for some four months of the year! A friend of G5GX, Roland Boards, of Cottingham, has recently been given his ticket, G3ITI, and is operating on 70 cms and 144 Mcs (144.360). Apart from initial QSO's with G5GX on both bands, he has put out dozens of CQ calls night after night with a negative result. (A separate report from G3ITI follows this one). So G5GX, G3ITI and G6XX of Goole, all listen to the 2 metre stations operating on "Top Band" and 3.5 Mcs. Hi.

We are extremely sorry to hear from G5GX that his old "sparring partner" G6OS is rather ill in hospital, and will have to take things very easily when he gets out again. As no doubt many operators on the old 5 metre band will remember, G6OS and G5GX were the king pin stations of Hull. We should like to wish G6OS a very speedy recovery and we shall reserve a space in these columns for his VHF report when he returns to the band.

So now a welcome to G3ITI (Cottingham, Yorks.), who sends us his first VHF report. Roland started up in December, and has spent many lonely hours calling CQ. "Fortunately," says he, "G5GX hears nothing also, otherwise I should have pulled the converter to pieces long ago." G3ITI is using an

832 running at 20 watts, with a four element Yagi about 35 feet high. The converter is a much modified 6J6 RF/6J6 mixer with crystal controlled oscillator piped into an AR88 at 9 to 11 Mcs.

(Many thanks for the notes, O.M. For goodness sake do not get disheartened at the lack of activity and leave the band. Your conductor is going to put up a special aerial lined up on Hull, so you will stand a good chance of one more QSO at least. Hi).

From Cottingham to March, Cambs., and G3WW, who is known in the best quarters as "Range Buster 3WW." Perhaps a better title would be "Optical range Buster" in view of his repeated QSO's with G4DC. This latter station, it will be remembered, not only has an RF stage that works, but has an excellent pair of specs (according to latest reports). On the 30th November G3WW worked G3DIV and G6RH. December 6th brought another new contact, G8MW (near Mansfield, Notts.). On the 7th, G2ANT was worked for the first time for some months, and G2AVR was heard working what was thought to be a French station. On the 14th, a QSO with G3GJZ, Newmarket, Suffolk, who is operating on 144.600 Mcs. G3WW managed another QSO with G4DC on the 15th and on the 18th G6TA, G3DIV and G2MV. G3AVO/A, worked on the 21st, has just moved from Royston, Herts., to Bassingbourne, Cambs., so he is once again a new contact. G3AVO/A has operated in at least five counties now.

On Christmas Eve between 1850 and 2003 G3WW have five contacts in five counties. These included G8WW, who has been absent from the band for a year or so, and G8VR who has also not been on the band for some months. From the 1st of July, 1952, to 31st of December, 1952, G3WW worked 218 different stations, with a total of 552 separate QSO's.

QSO's for the whole of 1952 totalled 1,019 in *ten countries*. (Phew!)

A note from our old friend G5LK (Reigate, Surrey) speaks of slightly more activity than during the previous month. Leslie was pleased to hear G3GAV (Winchester) on the band again, and it seems that conditions in that area for hearing London stations have not been very good of late. G3HWJ was also worked for the first time, and he is putting out a good signal from the SCR522. G5LK wishes to acknowledge the great help given to him by G3GBO, and says Don's signals seem to improve week by week. (Which reminds us, where is your report this month, Don?)

Les was also extremely pleased to work his old friend G5NF, who has AC mains at long last, and hopes to be more active on the band

from now on. Another station with a much improved signal is G2AHP, whose "diligent searching" of the band has not yet located G5LK!

As the crow flies, it is a short hop from Reigate to Edenbridge and G2KF. Jack has had more than his share of business QRM of late, and to add to his difficulties, his array was blown down during the gales about two months before Christmas and he has had no time to replace it. He has managed to erect a four element Yagi on a 20-foot pole and several QSO's have been made, including one with G8AO/MM off Harwich, and several locals and semi-locals. The gear at G2KF remains the same, SCR522 and a G2IQ converter. Input is about 18 watts.

From his lonely outpost in Hythe, Kent, comes a plea from G5MR. Vernon is brief and to the point. More CW and less phone. More operation during the early evening. More beaming to the south-east. "This may sound selfish," says Vernon, "but I would point out that you will also stand a chance of working a Continental station as well as yours sincerely, G5MR" (What about it blokes? It's not much use us trying, we can only work G5MR during contests. Hi).

Old Timer G8LN (Plumstead, London, S.E.18) once again honours us with some comments. Will agrees with our comments regarding "net" operation, and suggests that much of this local working could easily take place on 144. He also finds the same curious effect as we do, that in spite of the fact that many stations say they have put out a number of CQ calls, he does not hear them. Conditions at times have been exceptionally good, especially during the week-end of December 6th and again the week-end of January 4th. The QTH is a very poor one, at G8LN, and the Cambridge stations can only be heard under extremely good conditions. Many stations appear to be missing calls, and Will thinks the answer may be to call more on CW, and then revert to phone if necessary when the contact has been established. G8LN says "Keep your listener section alive. More reports from listeners are wanted. Can you publish Calls Heard lists?" (The answer to this is, we are trying in every way possible to keep the listener section alive and we are certainly glad to publish Calls Heard if they are sent in. There still seems to be a certain shyness on the part of many listeners. Some still think that unless they send in imposing lists of calls, they will not be interesting enough to publish. We have stressed again and again the fact that even a dozen or less calls heard will be of interest to the stations concerned, especially if they are DX or semi-DX).

G8LN is one more station who is con-

sidering casting the VHF gear to the redundant shelf, as it is a waste of time warming up the shack for a single QSO or so each evening. He says it is only the fascination of VHF which prevents him from going QRT. (Please do not give up hope, OM. Perhaps there will be some more general activity before long, who knows?)

A short note from Gw2ADZ (Llanymynech) informs us that Bill is still busy on the reconstruction of his gear. The job is now almost complete and the transmitter line-up is 6J6 (overtone oscillator), push-pull 6C4 stage, 832 and 829b. The overtone oscillator stage seems to be the complete solution to TVI troubles. In the Llanymynech area some viewers look in to Holme Moss and others to Sutton Coldfield, so Bill has to avoid all harmonics between 48 and 63 Mcs. By the time these notes appear Gw2ADZ will probably be back on the band again, and we hope the rebuilt gear will provide him with even better DX contacts.

It was nice to receive a letter from G8SB (Prestwich, Lancs.), and will all readers please note the change of QTH. Although this new QTH is on one of the highest points in the Manchester area, G8SB is on the wrong side of a hill to the south, and in a deep dip on the side of the hill. Some preliminary listening with a temporary indoor aerial points to the fact that the QTH may be a very poor one for VHF, but as soon as the weather improves, the main aerial will be erected (a "City Slicker" with reflectors). We do hope that G8SB finds the locality better than it appears to be and wish him the best of luck.

G3HBW (Wembley, Middlesex) found conditions generally poor, but the week-end of January 3rd provided a few DX and semi-DX contacts. These included G3IAI of Northampton (S9 phone), and on the evening of the 4th both G3IAI and G2HCG were peaking to S9. G3FAN was also worked, and his signals peaked from S7/8 to some 15 db over S9. G2UQ (Whittlesy, Cambs.) and finally a QSO with G6CW (Nottingham).

New stations worked include G2DDD (Littlehampton), G3IEI (Kingsclere) and G3EGV (Farnborough). On December 22nd G6PG (Dartford) was worked. G6PG was using a dipole 10 feet above ground with 12 watts input, and his signals were received at 549. To cap this one, a QSO was had with G6XM (25 miles) who was using an aerial only 5 feet high. His signals were S6 phone. (There seems to be an idea here for a Contest. Hi).

Talking about ideas for Contests, G3HZK (Hayes, Middlesex) suggests that it might be a good idea to stage a Contest with a handicap factor using the number of half waves on the aerial, counting parasitic elements as half wave

elements. What do other people think about this? (If the majority think the same as they did about our idea for a Contest in January, we shall receive about three letters. Hi). John is now on phone with a simple clamp modulator which provides about 12 watts output from the transmitter. The experiments with the DC coupled cascode are nearly complete, and it is much easier to get going than the other types of cascode circuit. AI2AT7 is used for the two sections. One new station has been worked during December, G31EX (Uxbridge, Middx.). As we have stated before, G3HZK is very poorly placed for the erection of a good outside aerial, and he asks us to try and prise a design for a turnstile array out of some of the Midland boys for publication in this journal. (Well, what about it somebody? We shall be glad to publish an article on turnstile arrays if anyone would like to send one in). G3HZK says "Activity seems to be improving and I can hear many carriers, but they are mostly on phone and too weak to read." (Another case for sending the call sign on CW at the end of the transmission).

That seems to be the end of the transmitter notes for the month. Having reorganised our filing system (?) we are pretty sure that everyone has been included this time. Among the notable absentees are Ei2W and G8AO/MM. We are sorry to have no news from Ireland this time, but we know how busy Ei2W is right now, and in any case, he did not expect to be back on the band before the end of January. As for G8AO/MM, we know he is still afloat as several stations have reported working him. We gather, however, that Eddie is getting "browned off" with the inactivity, especially in the "Southern Approaches."

Stations Heard Reports

We shall be very glad to receive lists of stations *heard* but not worked, from any transmitter. No matter how short the list or how near or far the station was. We feel that this will be of great help to the station just starting up on the band, and to those who live in difficult QTH's. We will even refund the postage if you wish it. Please drop your list along to your conductor direct. Thanks in advance.

LISTENER SECTION

G8LN says "Keep your Listener Section alive." If it had not been for the *two* stalwarts who sent in reports this month, we should have found it extremely difficult to do so. We hear there is a keen VHF listener in Winchester, Mr. Stan Hyde (informant G5LK), so now then OM, what about sending in a few of those Calls Heard? You will be welcomed in these columns. If anyone else knows of any VHF listeners, please let us know. Supposing we offered a 6J4 as a bait? (We said

"Supposing") we wonder if that would bring any reports in. Your conductor is, in fact, considering if anything can be done in the way of material encouragement to the VHF listener so there might be a further announcement regarding this in the near future.

So now to the two reports. Len Whitmill of Harrow Weald has increased his all-time score to 445 stations heard. New ones include G3DJX, G3EGV, G4GT, G2RD and G3HZK. (John, you have been heard in Harrow!)

On 70 Mcs the score is 14 stations in 6 counties.

In spite of the generally low activity, Len has quite an imposing list of Calls Heard covering the period December 3rd to January 3rd. G2AHP, ANT, AVR, DTO, DUV, FVD, HDZ, HIF, MV, RD, YB. G3AGR, BPM, CVO, DJX, EBW, EGV, ENI, FOU, FUH, GBO, HCU, HSC, HZK, ISA, SM. G4DC, GT, RO. G5DT, LK, NF. G6RH, TA, YP. G8LN, G8AO/MA. On 70 cms G2DD, MV, RD, WJ. G4RO, G5DT, G6NF. (Keep it up, Len, you are doing fine).

Reg Russell (Southampton) has almost finished his rebuilding programme and by the time this appears he will be listening intently again. Meanwhile, another converter is under construction. This time to the design by G5JU (with slight mods) as detailed in the *Radio Amateur*. The oscillator and mixer are built as a separate unit so that any kind of front end can be added. (Just like our own job OM). Reg says the oscillator described by G5JU is very good indeed. Stability is of a very high order and the note is T9. Conditions on the night of January 4th were very good, G6RH and G2MC being heard at good strength, and many more stations would have been heard if they had been on.

Reg has extended the feeder to the living room, in order that he may listen in the warm. "I'm d— if I will sit under the beam this weather, even if the band is open to W7," says he. (We would sit on the roof in a snow-storm if the 2 metre band was open to W7. Hi). Reg hopes to turn in a more detailed report next month, as he will be having a little more time to spend on the band.

A very hearty "Thank you" to these two listeners for keeping the section open this month.

So that concludes our VHF section for yet another month. We do thank everybody for the interesting reports. Don't forget the zero date is February 7th, a day or two before, if possible, direct to your conductor at 176, Station Road, Hayes, Middlesex, please.

Good hunting to you all, with 73.

G6UH (145.000 Mcs).

AMATEUR BANDS COMMENTARY

by

STANLEY HERBERT, G3ATU

Here we go again, but this month sees a big change in the territory which has produced DX results.

In the main, users of the HF bands have had a lean time of it to say the least. Twenty, for most of the month, has been plain awful. One or two short-lived openings was all it could manage. Ten is still, like Drake's drum, very much Six Fathoms Deep and Forty much as usual—a good proposition for the really keen types who are able to read signals two or three layers down.

The big news, however, belongs to The Top Band, which has more than fulfilled our expectations.

Enthusiasts who were keen enough to forego a certain amount of sleep were able to participate in some wonderful trans-Atlantic openings. Sterling work, in fact, has been done and it seems reasonable to expect that this winter will provide the most exciting Top Band doings ever. The snag lies in the time the DX comes in. For the American path, 0530 or thereabouts seems so far to have provided peak signals, although by the time you read this, the peak may be a little later. In any event, the month of February should be worth a little early rising on occasion.

The Top Band DX to Date

N. C. Smith (Petts Wood) provides the opening DX summary and also passes along a list of quite outstanding DX heard by John Hall of Croydon. On the morning of December 28th, Norman picked up the following CW stations: K2ANR, VE1EA, WIBB, 1LYV, 1SS, 2EQS, 2HCW, 2WWP, 3EIS, 3HL and 4JBF (Kentucky). Several other signals were heard "in the mush."

J. L. Hall (Croydon) using an S750 receiver, achieved the following: VE1EA, 1HJ, 3AAZ, W1AYG, 1BB, 1LYV, 2AMC, 2EQS, 2JPW, 2KNZ, 2QOS, 2WH, 2WWP, 3AJS, 3HL, 3HQG, 4CRN, 4POB, 4VFL, 4VUA, 8JNC, 9NH (Indiana) and ØNWX.

At 0446, W2HCW was heard on Phone at S9, calling "CQ DX"! Heard also were W9C?, KP4?, K2BWR? and WITTA?. WØNWX has been heard several times since, at around 0700 and the latest catch is WØFXV, who is in Minnesota, according to our call-book. Fine work, that lot, and as N.C.S. remarks, "John must have a good location." He must have something special in the way of aerials, too, we imagine! The KP4 is especially interesting, and we hope that by now he has popped up again and has been definitely identified. If this happens, it will

make the first KP4 to be heard over here, as far as we know.

J. Whittington (Worthing), who missed OH7OH last month, made up for it in a big way by logging OH3NY, WIBB, 1LYV and W2EQS, all around 0530.

B. J. C. Brown (Derby) confesses to a big thrill in pulling in his first ever trans-Atlantic DX in the shape of WIBB, 1LYV, 2ESQ and 3EIS. In addition, he heard OH2YV, 3NY and sundry GM/GI/GW. He enjoys Top Band listening. There's always plenty of activity after dark and, we would add, the standard of operating is considerably higher than is the case on most other bands.

R. Winters (Melton Mowbray), who had hopes of hitting the high spots over the holidays, found himself instead with receiver trouble. Bad luck, but these things are sent to try us! All is now OK once more, and we hope that by now the "R.W." log is bursting with choice DX. Meanwhile, twelve counties have been logged in the short time available.

G3HMR (Windermere) writes to report nil activity. He is still in the throes of construction. Better press on, Guy, or you'll miss the boat as far as the W's are concerned!

MF2AG (Trieste) tells us he is active on the band at odd times, coinciding with his spells of night duty. He uses 5 to 10 watts into a Twenty metre dipole with the feeders strapped and is VFO between 1.8 and 1.9 Mcs. Operations usually commence around 2305 GMT. Duncan can't start earlier, as he causes BCI to a couple of military stations, who do not appreciate such goings on! When he does get on, he puts a good signal over, despite the aerial limitations and we hope he will enable lots of chasers to chalk up a brand new Top Band country this winter.

G3ATU (Sunderland) missed the first trans-Atlantic Test, on account of no rig, but before this issue goes to press, he has hopes of at least hearing some DX!

Twenty Metres

"Poor Old Twenty," as so many of our readers now call it, is sagging badly in the middle these days. However, let's see what it has been able to offer us of late.

P. D. Lucas (Redhill) dug into the noise for EL2P, HR1SO, KP4AZ and KL7AFR (1130) on Phone. When the Phone band went dead CW was heard from CT2BO, LU8EE, OD5, SUIJP and ZS5LN.

D. L. McLean (Yeovil) remarks that Twenty, although not good, has been his best DX band.

He found an occasional opening around 0730, when Japan was audible, KA21M and KA2MB being the boys concerned. Other Phones were CN8GV/AM, CR6AT, 6BX, HZ1, KG4AO, MI3DW, SU5EB, VQ3BU, ZC6UNJ, ZD4AX, 4BK, ZL4AQ (1905), ZS30, twenty-six assorted ZS's and ZS6ZU/P (14349-1705). Don, too, finds the band fading out most nights after 1930.

H. Lee (Oslo), as might be expected at his high latitude, finds the band flat after 1800. His best on Phone were EA8AY, KP4USA, OY2Z, TA2EFA, VP6SR, ZL2ADS, 2BE (the lucky man with the mighty Rhombic), ZS6BY.

Henry has been checking up on countries heard and finds his all-time total standing at 150, with 120 post-war and 118 confirmed. Unfortunately, an incendiary bomb destroyed all the pre-war logs and QSL's. Incidentally, the Forty Metre Phone score is 50 countries, which is not bad going.

D. Wilson (West Hartlepool), despite poor conditions, turned up seven new countries on Phone, in the shape of CS3AC, EA9AI, KG4AF, OQ5BG, SV5UN, VP5AK and VQ2DT, plus ZS6ZU/P and sundry ZS's of the ordinary kind.

D.W. wonders where Marion Island is and if it is a separate country. Yes, and it is approximately 4800S-3800W, making it SSW of Cape Town. VP5AK, also queried, is in Jamaica.

P. Hunt (alias "Anon," Ellistown) pulled in Phone from ZL1HY, VK2, 3, 6 and 8(??), KP4, KL7AFR, 7ZG, HI6EC, VP9BC, HP1CC, CR6BX, HX1AB, VS7WA, SU and W4NXJ/VO2, all before 1700, when the band did the usual.

P. M. White (Williton) once more is not "tickled" by the present state of affairs, especially in the early mornings. However, he heard his first VK, VK3BU and collected other new ones in CR4AI, HA5BE, KL7AIR, VP4AC and SV5UN, bringing the 1952 score up to 29Z and 88C since April. This is all on Phone. Other recent Phone has come from EA6AR, PJ2AC, LUIFRG and numerous Africans.

P.M.W. hopes shortly to have an R1155, which will allow him to listen on several bands and not just on Twenty, as at the present.

P. M. Crawford (Darlington) took advantage of the odd opening and unearthed VU2MA, CR4AI, VE, XE1HE, FP8AP, KZ5AB, TI2TG, on Phone and UQ2, UB5, KZ5BS, AP4UN, CO8MP, 2MO, ZK1AA, VP9BG and MD-AGX on the key. The latter mentioned station was a R.A.F. Sunderland, testing equipment off Atoll in the Indian Ocean. Star "gotaway" was AC3PT, being called by W5NHH. Hard to bear, Martin, but you

don't seem to be doing too badly as it is!

R. Balister (Croxley Green) found VK coming through at midday and W5, 6 and 7 around 1500 GMT. Phone was pulled in from MI3KE, OX, SU5EB, VK2LK and the following, all /VO2—K1FBH, W2OJ, 3MQN and 4NXJ. Roger wonders whether anyone can throw some light on this recent crop of portable VO2's.

CW (which seems to be coming along nicely) accounted for EA9AP, LZ1, OD5, UG6KAA, VK3CP, 3LD (1300), VE7AEU (1600), VE7CN (0900), W5, 6, 7, Ø, ZC4IP and 4X4RE. The Twenty Metre score for 1952 reached 31Z, 111C.

R. Goodman (Edgware) has once more made good use of his small receiver, with which he pulled in CR6AJ, EA9AS, HC1FG (1805), HK4HV (1830), SV5UN, VK2QR, VP2AJ, 6SD, VQ4OC (0715), ZD4AX (0840), ZL2BE, ZS5, 6 and 6ZU/P, W1 to 7 and a couple of /VO2's as his best on Phone.

Ron would like a HAZ Marathon or contest of some description for QRP receivers.

C. J. Goddard (Warwick) did a little stock-taking and found his total for the last five months of 1952 (after his return from abroad), stood at the even century. Recent CW catches were SVØWB, UG6KAA, MI3SL, FP8A (1220), OY2Z LZ1K, BA4AF, SU1GG, 1HS, VP4LZ and VK's 3AWW and 4HD. The most consistent Phone came from VQ2JC (1715), OD5AJ and TA3AA.

N. C. Smith's best on CW were FB8ZZ (1500), FB8BB (1820) and FK8AB (0900), with AP2K, FP8AP, CR7CH, KG6GX (1000), VE5MB, VK7KB, ZL and ZD2HAH, all in the "Not to be sneezed at" category. On Phone, Norman singles out AP2L (1930), FB8ZZ, HP1CC (1450), I5SG (1620), VK6MB, 6RW (1300) and ZD4BK (1530) and for good measure, throws in HZ1AB, KV4BB, ZS6BW and ZL2BE.

J. Whittington's CW efforts produced KP4CC LZ1KSA, VK3 and a rare one in these days, CE5AW. Phone came from OY2Z (1230), FQ8AJ (2000), VK5ZR and YVICA.

John finished 1952 with the creditable score of 38Z—154C, Phone/CW.

B. J. C. Brown ended the year with 33Z—118C, a big improvement on his 1951 total. He, too, found the band going out early in the evenings, with ZL2BE often the only DX signal in the early mornings. Phone DX includes CO2OZ (1340), 8MP (1920), SU5EB, VK4KS, 5EN, 5GT, VQ2DT and some ZS's. FA, OX, TF, VE8SO (1710), W6 and WØ were pulled in on the key.

R. Winters, who as we mentioned earlier, has not yet got going properly, heard short skip from Europe, including EA6AR (Balearic

Is.) and from Africa, with CN8's pre-dominating.

GM3DHD passed along the news, via W1MCW, that the CEØAA Easter Island expedition is now scheduled for March, so keep listening. Remember they will probably be there for only a very few days. DHD has had a letter from ZC5VR, who is perfectly genuine and is at Sandakan, British North Borneo. He has been off the air since the middle of October, but expects to be active once again by the end of January. Take a listen on Twenty—he may be on now! Both Phone and CW will be used.

Further news from '3DHD is that VK1HM is on Cocos Island, thus replacing ZC2MAC. Why exactly the VK1 prefix, we wouldn't know, but there he is and there he is due to remain for the next two years, so there need surely be no undue panic.

Our own researches unearthed the fact that VK9YV, currently active on Twenty CW, is at Lae, New Guinea. KB6AQ is on Phone and has been heard in Europe around 0800 GMT and the fine signal coming from VQ2DT is due to an ET3446 into a Vee Beam with six waves to each leg. Quite a set-up.

Rumour has it that 11NMC (famous in the Ten Metre days as 11 No More Cash/MM) is endeavouring to obtain permission to operate from Portuguese India (CR8). If he succeeds—and we surely hope he will—look for him on Phone. And, of course, as we mentioned last month, HZ1MY is aiming in the same direction, so that they may even be able to work a CR8 themselves!

AP2S is a new U.N. station now active on CW, from Srinagar, in Kashmir which, of course, counts as Pakistan for DX purposes.

OX3AN puts a strong signal in from South Greenland these days. Our particular reason for mentioning him is his awe inspiring QTH—Tingmiarmiut. Try saying that quickly once or twice when the bands get boring! Too easy? Then try OX3SF—he lives at Kangerdlugssuak! And that, as far as Twenty is concerned, is that.

Forty Metres

The big news of this band concerns the U.S.A. As D. L. McLean and others report, "W" amateurs are to be allowed the use of Phone, with effect from February 20th next. The frequencies allowed will be 7200 to 7300 kcs, so we can expect a certain amount of fun and games in connection with the various broadcast stations operating up there.

At the same time the Novice Class (WN's) will be given the privilege of operating CW between 7175 and 7200 kcs.

Simultaneously comes the not so welcome announcement that Radio Teletype (RTTY)

and Frequency Shift Keying (FSK) will be permitted in the CW portions of the Eighty, Forty and Twenty Metre Bands. So we can expect new and stranger noises to add to the collection we already have to put up with.

H. Lee added two new countries to his Phone total. These were LU4BH and MD4GB; Henry heard EA7CP also and was counting him as Rio-de-Oro, but this, unhappily, is not the case. Although EA7 appears in many out-of-date lists as "Rio," it is in fact the Spanish province of Andalusia which uses the prefix. At the time of writing, Rio-de-Oro has no officially allotted prefix, nor is their any activity at present from that spot.

R. Ballister has devoted more time to Forty of late—in fact already this year he has grabbed twenty-four countries in seven zones. CW accounted for most of the DX, with AP2K (2000), CN8, EA6AU, KP4UW, FF8AG, LU6AX (2030), MD5RS (2000), LZ, OD5AD, OY2A, PY, SU1FX, IHS, TA, TF, UA9KAB (Zone 17, we think), UG6KAA, VU2EY (1530), YI2AM, 2FD, ZC4RS, 4X4 and 5A3. On Phone, Roger heard FA8TF and YI2AM.

N. C. Smith started the New Year in fine style. He put on his phones at 0046 on January 1st and was shaken to hear KH6BB at S7! Further digging uncovered AP2K, CE3AX (2340), UAØKKC, VP4LZ (0000), VP7NB (0625), W7VY (1625) and ZS91 (1700) as the pick on CW. Other noteworthy CW came from CT2AA, CM7PG, UD6KAB, UF6, VK2CI (1740), VK3, 5, 6VC, VQ2GW (0015), VQ4AQ, 4HJP (1900) and lots of ZS and ZL.

Norman's statistics show 200 countries in 1952 as against 210 in 1951 and he is away to a flying start for '53 with 63 so far, including Zone 39, which is one of the sticky ones.

B. J. C. Brown finds the Code of great assistance in picking out the DX on Forty. CN8, EA6AU, EA8BC, FF8AW, PY, TA, TF, VQ4HJP, ZC4DP, ZS5, 4X4 and ZL are recent scalps.

Fifteen Metres

We have decided to call the band Fifteen in preference to Fourteen Metres, then we may not get all mixed up between Fourteen Metres and Fourteen Megacycles!

Activity is on the increase, but is still very largely concentrated on weekends.

D. L. McLean remarks on this. His Phone offerings are CR6AT (1500), FF8, OD5, PY, TA, VE3, VQ2DC, YI2AM, ZD9AA (1520), ZE2JV, 2KH, ZS1 and 6, ZS7C (1450), 4X4AA and some N. Africans.

P. M. Crawford pulled in VK2ANN, VK4HR, KV4AA, ZD9AA, BP7NM (we were about to suggest VP7NM for that one, but we seem to remember this BP7 type cropping

up before somewhere. Possibly a "flying saucer" op), and AP2L. Phone was heard from TA3AA and a CN8.

R. Balister didn't find things wildly exciting, but got hold of TA3AA, VE3KF, VK6MB, YI2AM and a LA8 on Phone.

R. Goodman heard VK6MB and 6RW, also OQ5VL, VP6SD, VP9BG, ZS5, 6, ZS7C (1500) and sundry short haul stuff. ZD9AA got away. The band score to date is 13Z—17C.

N. C. Smith divides his findings into "Best" and "Lesser Fry." On CW, his best are AP2K (0930), VK5FH (1130) and ZS3K (1350). The lesser fry include FF8, KP4, OQ, WØ and YO3RD. On Phone, the story goes CR7AH (1440), ZS7C (1400), with lesser CN2, OD5, CE3CZ (1530), VE1, 3, ZS and ZE2KH.

J. Whittington gives the news that the SM Boys were allowed the band as from January 1st.

B. J. C. Brown heard WØBLZ (So. Dakota) for a new State on CW, and Phone from VP9BG, 6SD and some N. Africans.

Eighty Metres

Or actually, Eighty Metres and odd items of other bands. Eighty has been good for the Atlantic path on most nights during the past week or two and odd pieces of unusual DX have been there, hiding amongst the pseudo-morse of the non-amateur stations on the low end of the band.

N. C. Smith, for instance, picked up VU5NC on 3502 kcs at 0130. Interesting, very. Could be genuine and probably is. The time is right for that part of the world.

Another good catch of Norman's was VK5KO (1852). '5KO was active a year or two ago and we are glad to see him back. WØMP came through at 0815 and others, all CW, included MF2AE, OY3IGO, various U's, VE1, WP4RE (Porto Rican Novice), WN4YJQ and W8ZY.

Norman mentions a Russian Phone contest, due on January 11th. It took place right enough, apparently mostly in the Twenty Metre CW band!

D. L. McLean has always been one of the keenest Ten Metre searchers and checks the band daily, so when he reports only ZB1IL, W2NAK/MM (Off Crete) and a couple of unreadable ZS's, you can take it that Ten has had it for the time being. This being so, Don transferred his attentions to Eighty Phone, where he heard VE1JY, seven W1's, W2'3'4, W5RFG and W8UKS. Conditions were good, but terrific CW QRM prevented many other calls being logged.

R. Balister popped in two quick ones, 9S4BE and YO3VG.

R. Goodman combed the Phone band and got CN8, KP4AN, 4CP, 4ES, KV4BB, VP9BE, all around 0100, ZS6OW (0315), VE1

and ten W's, including W7VD (0320) and WØPRZ (0330).

The band score is now 13Z—30C.

B. J. C. Brown finds the Non-Amateur Things on Eighty's low end a considerable trial, so he listened on Phone and snagged KP4EM and a selection of W's.

Late Note—Top Band

We managed to get on for the second Test and found conditions excellent. The first signal heard was W1BB (S8 at 0500). He reported QRN troublesome after a snowstorm. Activity was high on both sides of the Atlantic and G3ATU heard fifteen W's, including W9MVF and was lucky enough to work VE1HJ and WITCR.

Quite a number of G's were doing well. G3PU, G3FGT and G5RI were all heard knocking off the DX, as was EI9J, who was in great demand.

We shall be interested to hear how you readers made out and we have a sneaking suspicion that something really juicy may have been turned up by the keen types.

The Radio Amateur Operator's Handbook

There are several queries in this and most previous commentaries as to the status of one call or another. The Handbook contains a detailed and comprehensive Countries list which should answer all your questions about which are separate countries and which are not. It is completely up-to-date except for Qatar, which present owners of the book should add as "Qatar—No official prefix—Zone 21."

DX QTH's

- AP2L. P.O. Box 151, Karachi, Pakistan.
- ET3R. Debebe Gabre Amlak, P.O. Box 1636, Addis Ababa, Ethiopia.
- FO8AB. Jos Bourne, Ave Cdt Chesse, Papeete, Tahiti.
- OY2Z. Johan Ziska, Torshavn, Faroe Is.
- OY3IGO. Ingvar G. Olsen, Torshavn, Faroe Is.

QSL's Received

The best in this department are D. L. McLean, HB9JZ/HE, OQ5CA, PY6DU, ZK1BC.

P. Hunt, VQ4CO, VS9AW, OD5AJ, MP4KAC, ZC6UNJ.

J. Whittington, AP2L, CE7AQ. (By return air mail—14 Mc Phone), CR9AF, KV4AQ.

G3ATU has recently collected from ET3R, FR7ZA, VK1BS (1 year) and VK1YG (2 years).

Which is all for this month. Reports as usual to Roker House, South Cliff, Roker, Sunderland, by the first post February 7th at the latest please. Good hunting and 73.

CLUB NEWS

Club Secretaries are invited to submit notes for this feature by 9th February, for inclusion in next month's issue.

Hastings and District Amateur Radio Club. Hon. Sec.: W. E. Thompson, 8, Coventry Road, St. Leonards-on-Sea.

The December 16th meeting was treated to a lecture by the President, L. H. Thomas (G6QB) entitled Aerials, Part II. The first part of this lecture had been given at a previous meeting, and this second part had been eagerly awaited.

A slight alteration in procedure was adopted at this meeting, the lecture being given first, and the formal business dealt with after refreshment break. This seems to meet with approval.

At the meeting held on December 30th the Chairman, G. W. Spray (G3FXA) gave an interesting talk on Frequency Measurement. A lively discussion ensued which revealed a keen interest in this essential subject. One wonders how many calibrators are being constructed as a result of G3FXA's disclosure of a little-known method of nobbling the B.B.C.'s steam radio to derive a frequency check!

February meetings will be held on the 10th and 24th, at the Saxon Cafe, 7.30 p.m.

Cambridge and District Amateur Radio Club. Hon. Sec.: T. A. T. Davies, "Meadow Side," Camberton, Cambridge.

The February meeting of the above Club will be held at the "Jolly Waterman," Cambridge, on the 13th February, 1953, at 8.0 p.m.

The evening will be given over to a Junk Sale and only those who have been to one of our junk sales know what bargains are usually offered.

Gateshead and District Radio Club. Hon. Sec.: J. Kennedy, G3IHD, 11, Lanthwaite Road, Gateshead, 9.

The Club recently held a very successful Ham Festival at their H.Q. Mechanics Institute, 7, Whitehall Road, Gateshead. Through the co-operation of members and their wives tea was provided and light refreshment served, and a film show, and a working demonstration of a home-built tape recorder and vision receiver given.

Another recent effort took the form of a competition for the best home-built piece of amateur electronic apparatus at which all the entries were of a high standard of workmanship.

Lectures and Morse classes are regularly available, and new members are assured of a warm welcome.

The TOPS CW Club. Hon. Sec.: J. P. Evans, GW8WJ 2 Ffordd Ty Newydd, Meliden, Flintshire.

The Hester Trophy Contest, an Annual event, will have taken place before this appears in print. Results will appear in next month's edition. The Silver Trophy, donated by G5HS, already has the following calls engraved upon it (Past Holders): GM3CXE, G3CKL, G3CED, G3DCS, G3FEX, GM3FXM and Present Holders DL7AH.

Articles in the Club rag "QMF" have recently spotlighted aerial couplers, and Pi/Collins in particular. Incorrectly tuned, these FB couplers can become the source of much headache. A word to the wise: "Are you sure ALL your soup is radiating on the DESIRED Frequency?" For example, several G's have been heard on 80 when supposedly on 40. In one case the G was actually on 20 calling a W6! Yet he was S5 at a reception point over 200 miles away, on 80 metres. Nuff sed.

Incidentally, we always advise fellow amateurs in such cases, and the results of tests and correspondence are reproduced, from time to time, in "QMF."

One of the main points in case of couplers is to turretize or use separate coils for each band. If you MUST use one coil for two bands then USE HALF INCH COPPER STRIP AS A SHORTING LINK.

Recent recruits to Tops are: SM7ACR, EI9H, G2BJN, G3CYS, G3HUM, G5AO.

A very brief survey of Tops Membership shows approximately 42 ex-Army, 41 ex-RAF, 23 ex-RN, 22 ex-MN ops. In fact, we are divided into Sections which creates friendly rivalry in our Contests.

In conclusion, let me quote from a recent letter from one of our "oldest" Members: "I am pleased to belong to this friendly 'Tops' Club which doesn't claim to formulate policy, or represent any particular section of the Ham fraternity, and I trust will not try to. I'd

like it to stay as it is—merely a collection of bods with a common interest, and no axes to grind."

The Slade Radio Society. Hon. Publicity Officer: M. D. Fowler, 25, Crossway Lane, Perry Barr, Birmingham 22B.

As usual, the last meeting before Christmas was devoted to fun and games. The event was well attended by many members and their ladies, with everyone having an excellent time. Part of the entertainment was a short film show provided by two society members. On January 9th there was a lecture on "Radio Frequency Heating." On February 6th the subject will be "Radio Mathematics" and on February 20th there will be a film show. Both meetings will be held at the Church House, Erdington, Birmingham, commencing at 7.45 p.m. On both evenings a Morse class will be held from 7 p.m.—7.45 p.m. Visitors are welcome to all meetings and further details may be obtained from the Hon. Sec., Mr. C. N. Smart, 110, Woolmore Road, Birmingham 23.

The Television Society. Hon. Sec.: G. Parr, M.I.E.E. Meetings are held at the Cinematograph Exhibitors' Association, 164, Shaftesbury Avenue, W.C.2, and commence at 7 p.m.

February 12th, The Importance of the D.C. Component by D. C. Birkishaw, M.B.E. (BBC Television). February 27th, The Scanning Electron Microscope. D. McMullan, M.A. (Cambridge University).

Non-members of the Society are admitted to meetings on the presentation of a signed ticket obtainable from any member, or from the Hon. Lecture Secretary, Mr. G. T. Clack, 43, Mandeville House, Notre Dame Estate, S.W.4.

West Lancs Radio Society. Hon. Sec.: B. J. Whitty, G3HWX, 46, Argo Road, Waterloo, Liverpool 22.

The main news this month concerns a change of Club premises. A general meeting was called in December and it was decided to take over the tenancy of the Scouts' Hall, East Street, off South Road, Waterloo. The hall in question is much bigger than the present one and has much better facilities. Meetings will be held every Thursday evening at 8 p.m.

The Society's Christmas party was held at Latham Hall, Seaforth on December 17th. This included dancing, party games, for which there were over twenty prizes and a thirty-minute session of "Twenty Questions," which was recorded and was enjoyed by all. Before very long, it is hoped, we shall have a Club transmitter on the air. Arrangements are in hand for a comprehensive series of lectures every fourth week and the normal programmes will be followed as far as possible.

New members will be made very welcome. Kingston and District Amateur Radio Society. Hon. Sec.: R. S. Babbs, 28, Grove Lane, Kingston-upon-Thames.

On the 3rd January, a Social took place at which over a hundred members and their friends were present. The guests of honour were Mr. and Mrs. L. Cooper, this being the first function attended by G5LC as President of the R.S.G.B. An excellent programme consisting of vocalists, entertainers, and a cabaret had been provided. Dancing took place until midnight at which hour a very enjoyable evening terminated.

The future programme includes talks on receivers, film strips and lectures by technicians from several radio firms. Morse classes are continuing on alternate Fridays, and it is hoped to resume the Radio Theory classes shortly. All meetings are held at Penrhyn House, 5, Penrhyn Road, Kingston, at 7.45 p.m.

Southend and District Radio Society. Hon. Sec.: G. Chapman, B.E.M., Bell Hotel, 20, Leigh Hill, Leigh-on-Sea, Essex.

A talk on "D/F Receivers" was given on 9th January, and the Annual General Meeting was held on the 23rd January. Meetings are now held in room "L" of the London Road Annex of the Municipal College. It is hoped to arrange a visit shortly to the Rochford Hospital to see the electrical installation there. Mr. C. J. Vann, of the Post Office Telephones Dept., who has undertaken the maintenance of the General Hospital Wireless installation, would appreciate some help from members of the Society. It is hoped to arrange a meeting soon to settle details of what help the Society can give in this direction.

SMALL ADVERTISEMENTS

Readers' small advertisements will be accepted at 2d. per word, minimum charge 2s. Trade advertisements will be accepted at 6d. per word, minimum charge 6s. If a Box number is required, an additional charge of 1/- will be made. Terms: Cash with order. All copy must be in hand by the 12th of the month for insertion in the following month's issue.

PRIVATE

WANTED URGENTLY. Why not turn some of that unused surplus gear back into cash? Good prices paid for BC221's; BC312's, with or without dynamos; BC348's. 813's; 726A's; 4E27's; 250TL's; 450TL's. Box No. B175.

FOR SALE. Amateurs' surplus transformers, 230v input, 300v. 2-0-2-4v. secondaries, 25s. each. EF50 Red 6s. Miniature battery radio, 4 valve, size 6 in. by 3 in., with speaker but less valves, 35s. Wearite "P" Coils, 2s. SAE for list. C. Bull, 74, Cornwall Road, Rouvly, Middx.

RX. DCR19 (Denco), excellent condition. Offers to Box No. C104.

FOR SALE. Transmitter 14/28 Mcs with modulator (both P/P 807's) and power packs. 65 watts can easily be increased to 150 by increasing xmtr volts only. £20 or exchange Tape Deck or Oscilloscope. Woden 2CH 250 ma choke, 55s. Four brand new boxed 866A rectifiers for 50s. Millar, Brook House, Fovant, Wilts.

VCR97 TV. Working, P/P Sound, magnifier, carefully built, £17 10s. Belling "H" 50 ft. co-ax, 50s. (London). Maher, Bosslane, Hughenden, High Wycombe.

FOR SALE. RCA 7-valve amplifier, 6L6, P/P, 100 db gain, output 15-600 ohms, complete with manual, 120v. mains. As new, £6. 13, Windmill Road, Thame, Oxon.

FOR SALE. Partly assembled Viewmaster, cost £21 (no tube). London frequency. Offers. Box No. C105.

PRIVATE TUITION given (in London) for the City and Guilds Radio Servicing Certificate Examination. Box No. B186.

FOR SALE. Tape recorder or Clifton deck, £20 or TV, J. Stattock, 135, Buntingsdale Estate, Stoke Heath, Salop.

FOR SALE. "Scanco" line trans, deflector coils, focus coil, 5kV trans. Suitable E.E. Telesior, £4 the set. Mullard 7in. magnetic tube £3. Pye 45 Mcs strip £1. D.C. Battery Eliminator 7s. 6d. Goodwin, 6, Upper TOLLINGTON Park, London, N.4.

EXPERIMENTER has quantity of apparatus for disposal; IF strip 194, with valves £1 15s. RF26 £1 15s. RF25 modified Sutton Stock £1 5s. EF50's 6s. each. Lists for S.A.E. BM/NMLG, London, W.C.1.

WANTED. Practical Television Vol. 1, No. 7, Vol. 2, No. 17. Dyer, 50, Juniper House, Pomeroy Street, London, S.E.14.

VCR97's TESTED. Full picture, in crates, 35s. carriage paid. R. Harvey, Westerton Drive, Bridge of Allen, Stirlingshire.

TAPE RECORDER. Home built in two units, (1) Qualtape deck, (2) Highgain amplifier and power pack, with 8 in. Wharfedale speaker. £25 or offer, buyer collects. Bysh, 86, Barrenger Road, London, N.10.

TRADE

AMATEUR STATION RECORD CARDS. 6 in. by 4 in., best quality card, for recording that QSO and full details of the contact. An invaluable aid to quick reference of stations worked, etc., 3s. per 100 from Data Publications, 57, Maida Vale, London, W.9.

METALWORK. All types cabinets, chassis, racks, etc., to your own specifications. Philpott's Metalworks, Ltd. (Dept. R.A.), Chapman Street, Loughborough.

"GLOBE-KING" (Regd.) Miniature Single Valve Receiver gets real DX—Amateur Radio enthusiasts should send for free copy of interesting literature and catalogue (enclose stamp for postage). Write to makers: Johnson (Radio), 46 Friar Street, Worcester.

BOOKBINDING. Volumes of Radio Constructor and Radio Amateur fully bound, imitation leather, gold lettering. 7s. 6d. post free. Prices for other publications on application. Jerome Alcock, CHEADLE, Stoke-on-Trent.

"PANL"—the air drying black crackle for the amateur, 4s. 6d. per 4 oz. jar, from L. Miller, 8 Kenton Park Crescent, Middx.

VIEWMASTER, exact specified parts at list price by return of post, also Valves and CRT's, stamp for list. James H. Martin and Co., Dept. R.A., BCM/EDHWA, London, W.C.1.

BLUEPRINTS. High Gain 10 Metre Converter, with a de-luxe circuit comprising EF91 RF stage, ECC91 double triode mixer and oscillator, EF92 IF amplifier, with stabilised voltage supply via a 7475. 1s. 8d. post free with full instructions. A.S.W.P., 57 Maida Vale, London, W.9.

REPRINT. Converting the TR1196 Receiver. Full details on converting this unit, which may be purchased quite cheaply, into a very sensitive all-wave receiver. 6d. post free. A.S.W.P., 57 Maida Vale, London, W.9.

JOIN THE ISWL. Over twenty free services to members including QSL Bureau, Translation, Technical and Identification depts. Dx certificates, contests and activities for the SWL together with over seventy local Groups in this country. Monthly magazine "MONITOR," containing articles of general interest to the SWL and League member. Membership 10s. 6d. per annum. 86 Barrenger Road, London, N.10.

We regret that, due to pressure on our space, the feature "Strictly for the Beginner" has had to be omitted this month. It will be continued next month with "More on Modulation."

SCOTTISH INSURANCE CORPORATION LTD.

62-63 CHEAPSIDE
LONDON, E.C.2

TELEVISION SETS AND SHORT WAVE TRANSMITTERS

Television Sets and Short Wave Transmitters/Receivers are expensive to acquire and you no doubt highly prize your installation. Apart from the value of your Set, you might be held responsible should injury be caused by a fault in the Set, or injury or damage by your Aerial collapsing.

A "Scottish" special policy for Television Sets and Short Wave Transmitters/Receivers provides the following cover :—

- (a) Loss or damage to installation (including in the case of Television Sets the Cathode Ray Tube) by Fire, Explosion, Lightning, Theft or Accidental External Means at any private dwelling house.
- (b) (i) Legal Liability for bodily injury to Third Parties or damage to their property arising out of the breakage or collapse of the Aerial Fittings or Mast, or through any defect in the Set. Indemnity £10,000 any one accident.
- (ii) Damage to your property or that of your landlord arising out of the breakage or collapse of the Aerial Fittings or Mast, but not exceeding £500.

The cost of Cover (a) is 5/- a year for Sets worth £50 or less, and for sets valued at more than £50 the cost is in proportion. Cover (b) (i) and (ii) costs only 2/6d. a year if taken with Cover (a), or 5/- if taken alone.

Why not BE PRUDENT AND INSURE your installation—it is well worth while AT THE VERY LOW COST INVOLVED.

FRED'S Radio Cabin

Olympic Coil Packs, 3 Wave Band	... 24/6
AC/DC Amplifiers	... £3.15.0
AC. TRF Midget Sets	... £6.10.0
Tyana Soldering Irons	... 16/9
Sleeving (12 yds.)	... 2/9
400Ω w/w Pots	... 2/6
VR54	... 2/6
6K, 7K, 10K, 30K, w/w 2ow Res	... 1/6
50 pF and 20 pF Ceramic Trimmers	... 1/-
3P., 3w., WCS	... 2/3
Indoor T.V. Aerial	... 7/6
10 Amp. Mains Filters	... 10/-
4P., 2w., WCS	... 2/6
8 way Jones Plugs, 1/-	... 6 pin. 6d.
3 Link Aerial Insulators	... 6d.
1", 1½" Plastic Tube	... 1/- yard
Yaxley Wafers, 2P., 4w.	... 3d. ea., 2/6 doz.
.005/1,000 volt, Tubular Condensers	... 6d.
.5 and .25, 350 volt	... 6d. ea., 4/- doz.
240,000Ω, 5w., Carbon	... 6d. ea., 4/- doz.
.0003 T.C.C., Mica Condensers	... 6d. each

77 NEWINGTON BUTTS
ELEPHANT AND CASTLE
LONDON SE 11
RODNEY 2180

WORLD RADIO HANDBOOK

Seventh Edition, 1953. Price 8/6d.

New Edition—just published. Revised and enlarged—contains all information covering the world's broadcasting stations.

Compiled from authoritative data, **WORLD RADIO HANDBOOK** is an invaluable "Who's Who" and a ready-made log book for all in any way interested in Broadcast station listening on a world scale. The detail given is designed to facilitate easy identification of Broadcast stations, covering announcement procedure, interval signals, wavelength, personnel and station addresses and containing information about Television stations from all over the world.

WORLD RADIO HANDBOOK is recommended by such authorities as the United Nations Organisation, International Radio Union, and the United Nations Educational, Scientific and Cultural Organisation.

In the new edition, the United Nations publish the following message about **WORLD RADIO HANDBOOK**:

"To build a lasting peace it is essential to use every means of furthering understanding. The special contribution broadcasters and telecasters can make is by sending through the air, over all frontiers, news and pictures of what their peoples are doing and thinking and of how their work and their life fit into the story of man's struggle to master his environment and himself.

WORLD RADIO HANDBOOK brings together all the information needed by broadcasters and radio listeners desirous of following programmes in any other country. We find it indispensable ourselves and cordially commend it to others." Peter Aylen, Director United Nations Radio Division.

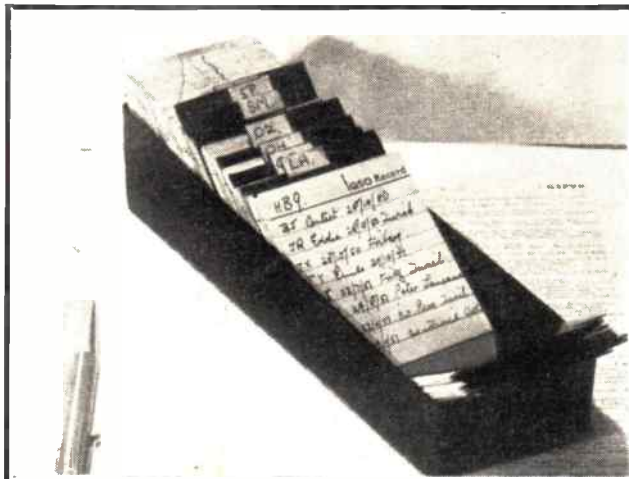

**USEFUL
ACCESSORIES**

**'MINICARD'
RECORD
CARDS**

from
A.S.W.P.
57 Maida Vale,
Paddington,
London, W.9

QSO Record cards 2½ ins. x 2½ ins. printed both sides, available for amateur station records, at 3/3 per 100 post paid. Metal filing trays as shown, heavy gauge steel, green enamel to hold 500 cards, 3/3 post paid.

RADIO BOOKS

VALVE TECHNIQUE (RSGB) - 3/9	WORLD RADIO VALVE HAND- BOOK (O. Johansen) - 11/9
RECEIVERS (RSGB) - 3/9	WORLD RADIO HANDBOOK (O. Johansen) - 8/9
TELEVISION INTERFERENCE (RSGB) - 2/3	HOW TO LISTEN TO THE WORLD (O. Johansen) - 1/11
SIMPLE TRANSMITTING EQUIP- MENT (RSGB) - 2/3	INEXPENSIVE TELEVISION (ASWP Ltd.) - 2/8
RSGB CALL BOOK - 3/9	TV FAULT FINDING (ASWP Ltd.) 5/3

Above prices inclusive of postage, etc.

DATA PUBLICATIONS

Lyon Court, 57 Maida Vale, London, W.9. Tel. CUN 6579

Published by Data Publications (Amalgamated Short Wave Press Ltd.), 57 Maida Vale, Paddington, W.9
and Printed by Hanbury, Tomsett & Co., Ltd., Kensal Rise, N.W.10