

Short Wave News

1/3

Vol. 3 No. 9
Sept., 1948

For Transmitter and Listener



Contents

Amateur Radio in Post-war
Germany
Around the Broadcast Bands
V.H.F. News
On the Ham Bands
I.S.W.L. Notes and News

RADIO PICTURES

A review of Radio-transmitted
picture methods

QRP Club Notes—Contest
My Favourite Receiver
Resonant Lines
Around the Shacks

SHORT WAVE TRANSMISSIONS FROM THE ANTARCTIC

A commentary of ship and shore
stations operating with scientific
expeditions in the Antarctic

Trade and Book Reviews

AN AMALGAMATED SHORT WAVE PRESS PUBLICATION

BARGAINS from VALLANCE'S

BENDIX RADIO COMPASS UNIT BC 433G.

15 valves, 4-6K7, 2-6B8, 2-2051, 6N7, 6SC7, 6L7, 6J5, 5Z4, 200-1750 kc. Brand new. Makes a fine long-wave broadcast Receiver, £6 plus 7/6d. carriage.

U.S. TESTMETERS.

M/C. 1,000 ohms, P.V. D.C. 0-30 v. 0-300 v. 0-1,500 v. A.C. 0-15 v. 0-150 v. 150 m.a. 0-3,000 and 0-300,000 ohms by 8-way rotary switch. Complete with test prods. Manufactured by Triumph of Chicago. £4 10s., plus 1/6d. registered post.

WESTON RECEIVERS RUI9.

Ex-U.S. Army 195—13,575 kcs., 6-valves, 9 coils, H.R.O. type, £7 10s. plus 5/- carriage.

MODULATOR UNITS BC 456B.

Weston. 12J5 transformer coupled to 1625 with VR150 stabiliser and 3 relays complete, less power supply, 25/-, plus 3/- carriage.

TUSB, TU7B, TU9B.

All at 25/-, plus 3/6d. carriage.

MARKER BEACON RECEIVERS BC. 357.

Ideal for experimenting with radio-controlled devices of all sorts. Two valve receiver, operating built in, S.P.D.T. relay from modulated signals. Includes valves and relays, 9/-, plus 1/6 packing and postage.

RADAR SET. SCR. 521.

Makes an excellent foundation unit for a high gain scope. Complete with 4-6AC7, 3-6H6 valves, but less 5BP1 cathode ray tube. Mumetal screen is provided. Brand new in black ripple case 45/-, plus 3/6d. carriage.

"Q-MAX" CHASSIS CUTTERS.

For an easy, quick way of cutting holes in sheet metal or aluminium. The cutter consists of a die, a punch, and an Allan screw. Available in the following sizes: $\frac{3}{8}$ " Button base, 9/6d., $\frac{1}{2}$ " B8G, 9/6d., plus 9d. for key. $\frac{1}{4}$ " Octal base, $\frac{1}{4}$ ", $\frac{1}{2}$ ", all at 12/6d., plus 1/- for key.

S. M. U. DIALS.

This is an excellent mechanical bandspread drive and dial with a ratio of 100-1. The dial is scaled for S.L.F. logarithmic and square law readings, calibrated 0-180 degrees. Price 10/- each.

CARBON THROAT MIKES.

These are lightweight compact units of American manufacture and are complete with fixing strap, cord and 2-pin plug. Brand new, 1/5d. each. Postage 9d. extra.

HEADPHONES.

An extremely sensitive pair of American lightweight headphones with an impedance of 600 ohms. They are suitable for crystal sets or receivers with low impedance output. With a 4-l (approx.) transformer matching can be effected to high impedance lines. Complete with rubber cushion ear pads, leather head-bands, headphone cord and jack plug. Individually boxed, and new, 3/9d. per pair. Postage 1/- extra.

MT/M1 COMPACT MAINS TRANSFORMER.

This small drop-through transformer is ideal for V.F.O.'s, Test instruments, midget receivers and a host of other applications where size is the limiting factor.

Primary 200/150 v. A.C. (Screened).

Secondaries, 6.3 v. 3 amp., 4 or 5 v. at 2 amp. tapped 260-260 v. 80 m.a.

Dimensions : $3\frac{1}{4}" \times 2\frac{1}{4}" \times 2"$. Price 22/6d. Postage 1/-.

DINKIE SPEAKERS for Communication Receivers.

Housed in an attractive die-cast cabinet finished in black or grey crackle, and fitted with the latest F.W.5 concentrated flux unit (8,500 lines). Speech coil impedance 2 to 4 ohms. Dimensions $6" \times 7\frac{1}{4}" \times 2\frac{1}{4}"$. Price 38/6d.

WEARITE "P" COILS.

A series of unscreened superhet coils covering 12-2,000 metres in six-coil sets tuned by 0.0005 mfd. condenser for 465 kcs. I.F. Three types per range, Aerial. H.F. transformer and Oscillator. Price 3/- each.

HEAYBERD T1 TRICKLE CHARGER.

Charges 2 v. at $\frac{1}{2}$ amp. or 6 v. at $\frac{1}{2}$ amp. 200/250 v. A.C. input. Will keep your accumulators fully charged. Price 24/2d.

CRYPTON A2.

Will charge 2 v., 6 v. or 12 v. batteries at 2 amp. Input 200/250 v. A.C. Mains with 9 amp. meter for measuring charging current. Excellent for charging car batteries. Price 118/-.

VIDOR POWER UNITS.

Completely converts an all-dry Battery set into a mains set. Input 200/250 v. A.C. Mains. Output 90 volts 10 m.a. and 1.4 v. 0.23 amp. Price £5 15s.

SPARES FOR THE CONSTRUCTOR.

2, 4 and 6BA nuts and bolts, 2, 4 and 6BA solder tags, 2/3d. gross. 2, 4 and 6BA washers, 2/3d. gross, also grub screws. *Wireless World* Valve Data Manual, 2/-, Bernards 3/6d.

SPECIAL OFFER.

Everett-Edgumbe moving coil meters, 6 ins. scale, calibrated 0-150 volts, with full scale deflection 0-1 m.a. in black bakelite case, size $7" \times 7" \times 2\frac{1}{4}"$. This meter has a magnificent movement, 1,000 ohms per volt. Price £4 10s. only.

PIFCO RADIOMETER, A.C. and D.C.

The Sherlock Holmes of Radio—saves worry and trouble, and solves all difficulties; can be used for testing motor car lighting circuits, H.T. and L.T. Batteries, A.C. Mains direct, valves and a host of other applications.

Measures :—A.C. and D.C. voltage 0-6 volts also 0-240 volts. D.C. current 0-30 m.a.

Valve testing, 4 and 5-pin. English valves for filament continuity.

Resistance test.

A test instrument at a reasonable price, 25/- only.

SPEDY POSTAL SERVICE C.W.O. or C.O.D.

When sending C.W.O., please include sufficient extra for post and packing.

VALLANCE & DAVISON LTD.

144 BRIGGATE, LEEDS, 1

Telephone: 29428/9

Staff Call Signs:—G2HHV, G8SX, G3ABD, G3CML

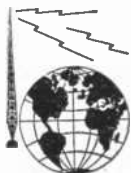

Short Wave News

Vol 3 No 9

Annual Subscription 16/-

September, 1948

ARTHUR C. GEE, G2UK
Technical Editor :
LIONEL E. HOWES, G3AYA

Editors :
W. NORMAN STEVENS, G3AKA
Advertisement & Business Manager:
C. W. C. OVERLAND, G2ATV

EDITORIAL

WE should like to draw attention to a matter of very considerable importance to all readers with transmitting licences, viz., the growing carelessness of operating just outside the band limits. We have already referred to this matter in the last number of our companion journal the *Radio Constructor* drawing readers attention to some remarks on this subject from Mr. Cyril Wright of the Monitoring Department of the Leicester Telecommunications Laboratory, but we feel that the matter warrants sufficient publicity to make it worthwhile repeating in these pages.

Mr. Wright informs us that out-of-the-band operation is becoming so widespread, that the authorities are becoming seriously concerned about it.

We ourselves feel that whilst some foreign amateurs may deliberately operate out of the bands to get themselves dx contacts, no British amateur is ever so fool-hardy as this. Sometimes, inadvertently, those with VFO's may get out if they operate too close to the band edges. Most of the snags of the VFO, such as bad notes and instability have been mastered now. One certainly does not hear the bad signals from these causes nowadays, as one did when VFO's first came into fashion. But the versatility of the VFO can be its undoing, and operators of this type of gear must be careful not to get out of the band limits.

It seems to us that there are three chief reasons for this out-of-band operation. Firstly, there is that of placing too much confidence in the calibration of one's receiver. Unless your receiver has some form of standard oscillator such as a 100 Kcs. quartz bar incorporated in it, you cannot rely on it to give you the band edges. Few receivers are sufficiently accurately calibrated; have enough bandwidth; or retain their calibration well enough, to enable them to be

used in a way which requires a performance only reasonably expected of a frequency meter.

The next most common cause of getting out of the band is that of calling a station near the band edges on his own frequency, assuming that he must be in the band. Sometimes he is not! And then the Monitoring people put a black mark against a "G" station as well as against the foreigner.

Finally there are those people who rely on the calibration of their VFO. You may be able to rely on it. You may not. It depends on your VFO. But at least you should know to what limits you can go with it. Don't take chances with one that there may be some doubt about. If your transmitter is not crystal controlled, you must have an accurate and reliable frequency meter in your station. Use this to give you the band edges, not the VFO.

OUT OF THE BAND?

In conclusion, we would like to suggest to the SWL fraternity that they could perform a most useful service by equipping themselves with accurate frequency measuring gear and checking stations on the band edges. A timely warning, sent in a friendly, tactful way to a station getting "dangerously" near, may help him avoid more serious trouble. Something on the lines of an SWL Report Card or one of our Report Sheets bearing simply the words:—"Your transmission on.....at.....GMT to.....was checked here on a.....Type Freq. Meter and found to be (say) 14415 kcs. Trusting this information may be of use to you O.M.", should not cause offence to even the most susceptible!

We should like to hear from any SWL who has measuring gear, which he considers would be accurate enough for this purpose, viz., an accuracy of ± 0.1 per cent. A.C.G.

THE EDITORS invite original contributions on short wave radio subjects. All material used will be paid for. Articles should be clearly written, preferably typewritten, and photographs should be clear and sharp. Diagrams need not be large or perfectly drawn, as our draughtsman will redraw in most cases, but relevant information should be included. All MSS must be accompanied by a stamped addressed envelope for reply or return. Each item must bear the sender's name and address.

COMPONENT REVIEW. Manufacturers, publishers, etc., are invited to submit samples or information of new products for review in this section.

CHEQUES and Postal Orders to be made payable to "Amalgamated Short Wave Press Ltd."

ALL CORRESPONDENCE should be addressed to "Short Wave News," 57 Maida Vale, Paddington, London, W.9. Telephone CUN. 6579.

AMATEUR RADIO IN POST-WAR GERMANY

WE have recently received from several of our readers in Germany news of the progress of amateur radio in post-war Germany. The following article is compiled from information sent us by Waldemar Keller, and a YL reader, Sigrid Ulrich ISWL D/1826. Allowing the fair sex to speak first we have great pleasure in printing Sigrid's letter first:—

"Since I am a member of the ISWL, I like very much to read your magazine the SWN. It is always writing about the most interesting subjects, which can only interest a SWL. And so I am waiting already the first days of each month for the arrival of it. The mail service is very good, it only takes three to four days to get here.

I am not sure if you are hearing much about the activities and happenings of the German Amateur Radio Club (DARC)? This club is the oldest one in the country. There are one or two clubs which started during the post-war time, but I myself joined certainly also the DARC. We had our yearly meeting, the ham fest, this time on May 8/9 in Bad Lauterbach Harz. About 2000 amateurs met together and the two days were spent with meetings of the different province clubs, interesting speeches of the DARC President, representatives of the town, of military government, RSGB, ARRL, professors and scientists, so as other interesting reports. An equipment fair, including the amateur station of D21Y was liked very much by the OMs, YLs and XYLs. This meeting, the second one after the war, which also ended with a dance, shows and entertainment, was a great success for the German amateurs.

I am passing along some photographs, which I took there. I hope you will like them."

From Waldemar Keller we have received the following:—

"Following the conclusion of hostilities, German amateurs began to get going again as SWLs and when in July 1946 Germans were permitted to send letters to other countries, the first QSLs were sent off. This led to some trouble, as a week later, the Field Security Police visited the writer, asking about these cards! "Where," they asked, "is the transmitter?" Some suspicious neighbours, hearing sounds of morse code coming from the shack, had informed the police that a hidden transmitter was in use! However, an inspection proved to their satisfaction that all was well.

The first response to my batch of QSLs was from G8UR. This encouraged me greatly as I then felt that even the war had not destroyed the old ham-spirit.

In September, 1946, the first steps were made to form a new amateur club in Germany. In Stuttgart some old amateurs got together and formed the "Wurttemberg-Badischer Radio Club" and they produced "QRV" as a club-magazine.

Due to the Zonal state of Germany it lasted for some time, and the knowledge of its existence spread but slowly throughout Germany. However, step by step, more of the old amateurs joined and in June 1947 it was possible to hold the first post-war German Ham-feast at Stuttgart. Special QSL cards were printed and were sent to amateurs abroad, to show that the ham-spirit was not dead in Germany. It was at this Ham feast that the DARC was proposed as the National Radio Club for the whole of Germany. Since October, 1946, another radio club had been in existence in Hanover. It was the ARBD. In May, 1947, both the ARBD and the DARC got their permits from the British P and T Branch, allowing them to run clubs to gather together shortwave amateurs and shortwave listeners in the British Zone of Germany. In the meantime a great number of QSLs had been sent out by SWL's, but only about 10 per cent were acknowledged, no doubt due to the fact that IRCs cannot be bought in Germany yet.

In May 1947 the first VHF signals were heard by amateurs in Germany. British, Italian and Czechoslovakian stations were heard and the writer sent off over a hundred QSLs. In order to get more cards, it was necessary to collect old postcards and use them! There is a great lack of spare parts and technical literature at present in Germany. Consequently the first VHF gear was rather comical! My own was a separate r.f. stage connected to the audio stages of the h.c. set. The high spot of the gear was a little rotary beam, constructed from curtain rods, fixed just below the straw roof of my former lodging. The only difficulty was that I had to have a very long length of wire on the headphones, so that I could run out of doors to turn the beam in the right direction.

Unfortunately, some people cannot wait for regulations to be passed and the first batch of unlicensed stations which appeared on the air in April 1947 were joined by many new ones. Pirate activity increased, some people thinking it to be the only way to force the authorities to licence German amateurs. Postbox 585, Stuttgart, became known to amateurs abroad as the QSL Bureau of these unlicensed stations.

In January, 1948, one of the pirate stations published something about new German licences being granted by the Authorities under the prefix DA. Many amateurs abroad believed that this was in fact true, particularly as many QSL cards were sent out by these DA stations. Every contact encouraged these DAs with the result that to-day many stations are operating on the air, even though the operator has no knowledge of the morse code and knows nothing about amateur procedure. People who learned the principles of radio transmission during the war regarded the air as a field free to everyone, and often went on with bad notes and worse modula-



The president of the DARC addressing some of the 2000 German amateurs at the DARC Hamfest at Bad Lauterbach/Harz



D21Y, with his rig, surrounded by enthusiastic DARC members at the recent Hamfest

tion. They were to be found on 80 and 40 metres first, but later found their way to 10 and 20. As only a few stations were put down by the Authorities, these DAs felt very encouraged and it will take some time to round them all up—as is being done, slowly but effectively. German amateurs are themselves very anxious that these pirates should be suppressed, as the cessation of piracy is one of the conditions upon which the authorities have agreed to re-issue licences.

German P and T authorities have made

proposals to the American and British authorities for the restoration of transmitting facilities in their respective zones and on June 30th, 1948, agreement was reached on these proposals. German authorities have been instructed to prepare for the re-issue of licences, and it is expected that the first officially licensed German amateurs will soon be heard on the air. The examinations and licensing conditions will be based on the British ones although maximum power will probably be 50 watts.

Around the Broadcast Bands

A Monthly Survey by "MONITOR"

All times are given in G.M.T.

(For EST subtract five hours; for AEST add ten hours)

ALL news for this column should be addressed to: Monitor c/o SWN to reach your Scribe by the 1st of the month latest. Very little change takes place in the Honour Roll this month. Now for the month's news:

● Asia

Korea. HLKA Seoul 7930 kcs. heard by your Scribe at 2030 with call "Korean Broadcasting System HLKA" followed by talk in Korean. Signals were only R3-5 with very heavy QRN and CW QRM with the Crystal 'in' on my AR77E. Anyway this is a nice catch for the Country Collectors. Arthur Cushen our good friend down in Invercargill N.Z. writes in to say that they sign on at 2000 at fine strength there followed by American musical numbers. Power is 5 kw.

India. Bob Iball of Worksop has been doing a bit of early morning listening and has heard the two Delhi stations VUD10 17830 kcs. and VUD7 15160 kcs. both QSA5 R7 at 0315-0400. . . News in foreign language followed by news in English at 0330 then Native Orchestra. D.O. French (Norwich) lists VUD8 15350 VUD11 15290 and VUD7 15160 kcs., also 21510 kcs., at 1000 giving English news and programme summary. VUD8 appears to sign on and off frequently and VUD7 is occasionally blotted out by OZH2.

Ray Aldridge (Amersham) logged VUD10 at 0615 with R9 signals giving news in English.

Iran. EQB 15100 kcs. Teheran news read by lady at 1900 (In Persian I expect OM). Cushen has letter Veri from Radio Tabriz which gives the schedules: 11960 kcs. 1000-1130 6990 kcs. 1400-1800 (Eng. at 1720) Special Friday trans. on 11 mc. freq. 0630-1100.

Syria

Damascus. 12000 kcs. heard R6 at 1800 with CW QRM (Aldridge) Pearce has logged them with strong signals evenings with Arabic progs. and occasional interludes of Western type recordings until sign off with March at 2100 (previously 2000).

Indonesia. Radio Indonesia Batavia has apparently dropped Eng. Broadcast 1700-1800 on 19345 kcs. and 1700-1730 on 17630 kcs. Now both give French prog. at 1700-1730 foll. by Arabic BC (Pearce).

● Australasia

New Guinea. Port Moresby. Arthur Cushen reports the ABC New Guinea Service which opened on June 29th and operating on 7270 kcs. Announces as "9PA and VLT5" Port Moresby. Gives ABC News at 1100 and signs off at 1200. Sats. 1300. Carries many ABC progs. from the Mainland. VLT7 also operating on 9520 kcs. and heard at 0800 but not very good, GWJ

causing bad QRM earlier. Announces "New Guinea" . . . Service of Australian Broadcasting Commission. Any reports on this station would be appreciated by your Scribe if heard in the Brit. Is.

New Zealand. Cushen says that big changes in frequencies take place in New Zealand on Sept. 1st and the Short Wave Service should then also come into force . . . at last! (Lets have the gen. Arthur, as you get it, OM).

Australia. Ray Aldridge reports the Evening BC to Brit. Is. at 2100 with R9 signals from VLC and R8 from VLB2. 15200 and 9650 kcs. respectively. Sidney Pearce logged the BC to the West Coast of USA and South Africa at 1500-1615 the best channel being VLA6 on 15200 kcs. in parallel with VLC3 11760 kcs., VLG8 9680 kcs. and VLB9 9615 kcs. VLG8 from 1515. Iball lists VLB5 21540 kcs. at 0310-0400 R7-3 QSA5-3 with deep QSB. The ABC Inter State Programmes have been heard over VLH5 15230 kcs. at 0630 with QSA5 R4-6 signals by Aldridge. (Hope the YL is now out of Hospital and a speedy recovery to her OM). Ray says that another page of BC news would not be a bad idea! If some kind gentleman would allow us a little more paper we would be glad to make it TWO pages OM.

● Africa

Portugese Guinea. "Radio Bissau" CQM4 Bissau 7943 kcs. has been heard at 2120-2300 being best at 2200 with R7-8 signals QSA3-4. (Aldridge). Heard by your Scribe closing at 2300 with National Anthem . . . "A Portugesa." Has had Auto CW QRM.R6-4 at this time.

Angola. CR6RF Benguela 8090 kcs. has been logged by Pearce from 1830 and often R6-7 before closing at 2100 with "A Portugesa". Has Man and Woman announcers. This reader says that CW QRM spoils transmission and makes call sound like "Radio Clube—Angola."

Heard by your Scribe at 2059 QSA3 R4-7 with bad CW QRM closing after announcements by man. After Anthem has several gong notes. You may QSL to . . . Radio Clube de Benguela, Station CR6RF Caixa Postal 19 Benguela. Aldridge logged them at 2000 R7.

French Camerouns. Douala. FIA 9160 kcs. "Radio Douala" heard R7 at 2000 (Aldridge) RX: Sky Champion and 66 ft. Windom Antenna, 30 ft. high.

● North America

Mexico. XEWW Mexico City 9500 kcs. heard at 0545 with R7 signals. Chimes, call XEW y XEWW "La Voz de America Latina" and news in Spanish. XEBT also in Mexico City logged on 9625 kcs. and often R6 around 0530 with

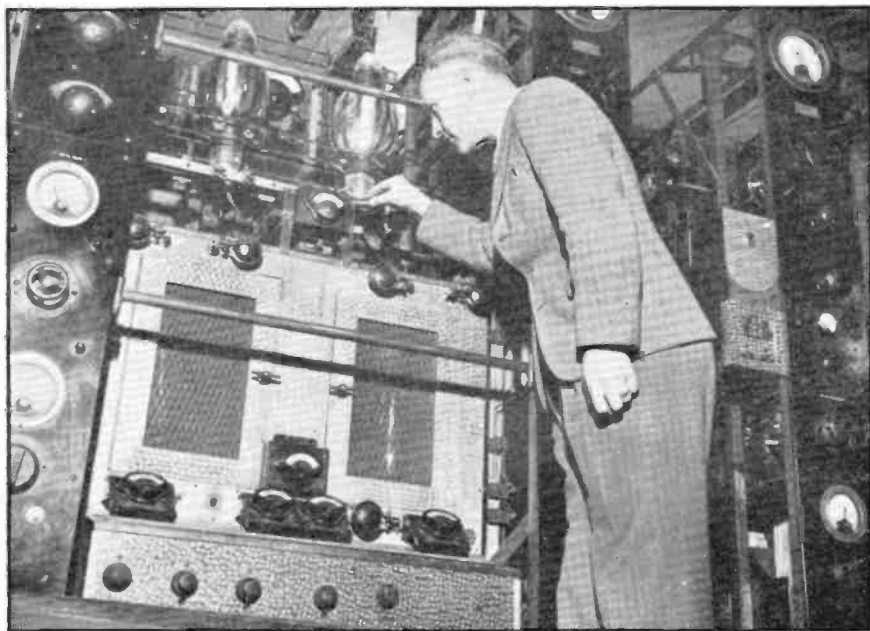

A view of one of the Transmitters at Ongar, Essex

Dance music. Signs off at 0600 (sometimes 0620) with recording of "Liebestraume" (Pearce). Aldridge also lists these two stations closing at 0600 with announcements by man. Signals were R8. Pearce says that the best time for logging Latin Americans is 0400-0600 when they are to be heard closing down which gives one a better chance of positive identification. You've got something there Sidney!

U.S.A. (West Coast). David French has logged the following Californians in KNBI 15130 kcs. heard carrying UN progs. at 0730-0845, KGEI 15210 kcs. AFRS prog. from 0330-1030 KNBX 15250 kcs. heard signing off at 0845.

U.S.A. (East Coast). C. J. T. Carr of Ramsgate sends along schedules he has received from WRUL 15290 kcs., WRUW 17755 kcs., WRUX 11730 kcs.:

West Indies. Cushen reports a station believed to be located in Puerto Rico and operating on 4785 kcs. and heard opening at 0900 daily with "Star Spangled Banner" foll. by Orchestral prog. All announcements are in Spanish.

Trinidad, BWI. VP4RD 9625 kcs. Port of Spain has been heard by your Scribe with much improved signals than of late at 2315. Signals QSA4 R6-8. Relay from B.B.C. of "West Indian Diary" prog. Aldridge lists them at 2300 also at R8. Bob Iball says they were QSA4

R4-6 from 2215-2245 while giving a Quiz prog. foll. by Sponsored prog. and Light music. Call at 2230 was "This is Radio Trinidad."

Six QRA's Section

Sent in by Sidney Pearce. This month he selects the following: Radio Monte Carlo . . . 16 Boul Princesse Charlotte, Monte Carlo, Monaco. Radio International . . . 34 Goya St. Tangier, N. Africa. YNOW . . . La Voz de la America Central, Apartado 47 Managua, Nicaragua. PJC2 . . . CUROM Princess Juliana Zender Willemstad Curacao N.W.I. Radio Algeria . . . 10 Rue Hoche Algiers Algeria Fr. North Africa. CR6RN CR6RL etc. . . . Radio Clube de Angola, Caixa Postal 229 Luanda Angola, P.W.A.

QSL Section

Sidney Pearce: CE1190 YFA4 Radio Tabriz, YV5RN Singapore (15300 kcs.), OIX4 (15190 kcs.) TAQ XGOA Monte Carlo KGEI, KGEX, VLC3, VLG4, VLB11, Copenhagen EAJ43 (7260 kcs.), Ray Aldridge: YV5RN, VLH4, VLH3, Dakar, YFA4, HI2T, Omdurman. Your Scribe from Manila (11890 kcs.) Munich (9540 kcs.) both say they appreciate reports. Arthur Cushen: XGOY (15170) Tabriz Rome. (6085) Belgrade (6150) CNR3 (16660) VLW5 (9610), Manilla (155330) (11890) WOOW (9700), WCRC (21570) YV1RV.

(Continued on page 240)

V.H.F. NEWS

Auroral Reflection Again.

THE most interesting event of the month was the occurrence of auroral reflection on Sunday August 8th.

Arthur Simons, G5BD, Mablethorpe; reporting on this, said that he first noticed it at 1430 when GM2DAU suddenly appeared on the band. His signals were followed by those of GM6JH, GM6XI and GM3BBW. Later the Northern Ireland stations G15SJ and G13ZX were heard. In every case the beam was pointing to the north and all signals had the characteristic fluttery T4-T6 note. Further signals were heard from the Durham and Newcastle area, including G4LX, G8VV, G3CYY and G8JO.

Apart from this excitement, little else of note occurred on the band. There has been some Sporadic E with signals from SM and OK predominating, but activity has not been at a high level.

The Reading Radio Society ran a very successful Five Metre Direction Finding Contest on Sunday, 25th July. Seven groups, comprising thirty-two persons, competed. The equipment had to be such that it could be carried by walkers or cyclists and points were allocated for accuracy of bearings rather than speed in locating the transmitter. Two groups did succeed in locating the Tx in 2½ hours. At the following meeting, the D/F maps were examined and Mr. Guy, G8TH, was declared the winner.

Our Czechoslovakian Representative, Otakar Halas, OK3RR, has sent us a report on VHF activities in his country. Quite a number of the OK's are interested in 60 Mcs. and there are plenty of signals to be heard on this band as the following extract from OK3RR's log will show. On 2nd July, between 1748 and 1907 GMT the following were logged:—OE1CTF, G3KX, G5MP, G3AVF, OK1FF, G16VV, OE1CD, G2XC, F8NW, G2HLE, G8DL, G3APY, OK1RN, G5CX, OK1QD, G6OS, OK2MV, G2AVF, F3JQ, G2ADZ, E18G, G2ADZ, SM7CT, F8LO, OK3JL, G5PP, G6LK, G8WV, ON4AP, F3DC, G3WS, G3CU, G2KI and G6UH. The receiver was a Hallcrafters S 36A.

Rubens Villela, ISWL/PY 1305, writing from Sao Paulo, Brazil, says:—"The VHF's of 27 to 42 Mcs. are 'hot' over here, being full of American and European FM, AM and radio-beacons, and strong harmonics of cw commercials. WWV on 30 Mcs. is often heard, but poorly. Once I heard the Indiana police around 31.0 and at the same time the Buenos Aires police radio on 31.7 Mcs. Both these were coming in at QSA5-R8! One of the strongest harmonics is that of HJ03, Bogoto, 18150 kcs., on 36300 kcs., the harmonic usually being stronger than the fundamental. The most usual signals to be heard over

30 Mcs. are what I believe to be radio beacons. They consist of a carrier with a musical note modulation, sometimes continuous, sometimes broken to give an identification signal. Some heard here in the mornings are:—GF? around 32.95 Mcs., MVT 32.98, LB 33.7, HV 33.2 (heard QRMing S. Paulo's police) FD, 32.95. Sometimes these stations come in at QSA5!"

A 'first' 60 Mcs. log is submitted this month by M. Wallace, G/641, West Norwood, S.E.2. During the month he has heard G2MV, CKQ, ZV, AXG, BB, DSU, QY, DD, XC, BD, GX, CXM, MR, APZ, 3CU, BHR, BR, FP, CGQ, PX, BXE, 4NT, CG, AP, LU, LX, IG, CL, KF, 5KH, LC, JM, MI, XV, RP, UM, MR, UD, BD, WP, 6VP, CB, JK, NF, NK, VX, MN, 8KZ, SK, TL, KL, SM, UR, GM3SW, 30L, SM5VL, 5SI, OK2MV. PAøJW, øAD. F3DN, 3JB, I1ABR. A pretty good log o.m. for a first. So far 'Mike' has heard 64 stations in 15 counties and 7 countries The Rx is a Type 26 into an SX16. The aerial consists of two half wave dipoles NE/SW and NW/SE.

Another reader who has got the Type 26 Converter going well is Bill Martin, Gen. Sec. of the Clifton Amateur Radio Soc.—the SE London Chapter of the ISWL. He heard F9AQ, Toulon, I1ABR, I1ATS and OK3ID during recent spells of Spor. E. Regarding 'Gs,' Bill says he has heard some 70 stations in 9 counties and he remarks that he is very impressed by the good activity on '5.' He has been experimenting with an indoor dipole and enjoying himself running round the room altering directivity on different signals! The Clifton ARS are encouraging '5' metre activity in the Club as a change from dxing on the other bands.

E. A. Coates's best dx for the month was SM5OI, UG, AEC and VL, I1ABR and OK3ID. G3BWS, 2AJ and 8SK were all heard working portable and 19 other 'Gs' were heard during the month.

Denis Heightman and XYL are just back from a holiday in France where they met a number of the VHF experts in that country. Activity over there has been much the same as in this country, but Denis tells us that the French amateurs have been licenced for 144 and 72 Mcs. for about a month now. He says he believes that the same is true in Holland too.

144 MCS.

NOW RELEASED FOR AMATEUR USE

The HF portion of the 144-146 Mcs. band is open for amateur operation as from September 1st. The details are:—

145-146 Mcs.

Phone or CW

25 watts input maximum

The remainder of the band, will, we assume, be released when certain "vital services" have been transferred elsewhere.

On the Ham Bands

Conducted by LES COUPLAND

G2BQC

General.

FROM Rubens S. Villela, PY1305, Sao Paulo, Brazil, we have some "gen" on the VP8 situation. The seven British Antarctic bases have been permitted to operate in the ham bands, and are as follows:—Base "A": VP8AJ; "B": VP8AK (Deception Is.); "D": VP8AL; "E": VP8AM (Marguerite Bay); "F": VP8AN; "G": VP8AO; "H": VP8AP. Base leaders are responsible for the handling of the stations. VP8AM is active on 14 Mcs. is a "bug key" merchant, and he does QSL. Presumably the QRA for any of the above would be call sign, Base letter, British Antarctic. That's the best I can do for the time being with the VP8 chaps.

Luiza is the Meteorological Observatory on Laurie Island, S. Orkneys.

CE72A and 72B are the Chilean Bases on Greenwich Island, and Discovery Bay, and are active on 14 Mcs. A p.c. from H.Q. (Presumed, as it is not signed, hi) says ZL2AVE skeds G2AK on 3.5 around 1900 GMT. most evenings. Must listen some time!

Don Robertson informs me that GM3CCK is active on 40 in Kirkwell, Orkney Islands, which is very interesting. Tnx Don.

D.X. CONTESTS.

VK-ZL DX contest.

- 1201 GMT October 1st
to 1159 GMT October 3rd CW.
- 1201 GMT October 8th
1159 GMT October 10th Phone
- 1201 GMT October 15th
1159 GMT October 17th CW.
- 1201 GMT October 22nd
1159 GMT October 24th Phone

VK and ZL stations will call "CQ DX Test." Others will call "CQ VK/ZL." Details of the receiving contest will be given next month.

"CQ" Magazine DX Contest

Oct. 30th-Nov. 1st (phone) and Nov. 6th-Nov. 8th (CW). Periods start and terminate at 0200 GMT on all dates.

D. L. McLean requires QRA's of EP1B (28 Mcs.) ZNP8 (14 Mcs.) and VR2AZ/VR1. Any offers? A letter was received from W5ZG for a report on his 28 Mc. phone, when 5ZG was mobile in his car with 50 watts to a 9 ft. vertical rod on his bumper. His RX was a converter in a car radio; needless to say the report was appreciated.

XC6AJ was operating from Amman in Arabia, and should be O.K. H.P. Bull queries KC4AA, but I think this will be KP4AA, OB, don't know for sure though.

John Waters has been surprised with ten recently hearing PY in his lunch hour, and also reports a very strong signal like a beacon station from 28 to 28.6 Mcs., no, OB, I have not heard it here, but we do get odd "met" balloons on ten (they are not very strong here).

Readers' Reports

E. Calfley, G1462, (Great Yarmouth), who sends his first report, starts the ball rolling this month. Receivers used are a 6v super and also the "Ham Bander." DX heard includes CT3MN, IS1AYN, TI2OA, TI2RC, VB5KBA, VK7AZ, VE8DM, ZC6LA, also numerous Ws, VKs and ZL. No band is mentioned, but it looks like 14 Mcs. Let's hear from you again, OB.

E. W. J. Field, G962, (Watford), lists IIA XU (Sicily), MI3BC, and MD1H, which are new ones for his "countries heard." Congrats ob: once again 14 Mcs. I presume.

Arthur Levi, G138, (Belfast) sent a card along with the info that a station using the call sign 4UN was operating from Rhodes, using a BC610 and was mobile! Arthur also sends along his DX log for 14 Mcs., K2UN was heard with G2AIS at the mike, which is nice to know about. DX includes C7TY, CT3MN, EA2KL, EK1AL, MD, FA8CC, HC1FG, 7KD, HH3BL, HI6EC, HZ30/P, OE1DF, MD7QRP (EX-D4ABO) OQ5DH, LL; SV8AG, TG9RV, VP6MO, VP9F, VS7PS, XE1AC, YN1LB, ZC6LA, YY, which is a fine effort Arthur ob.

D. L. McLean, (Yeovil), "turns up on sked" with his usual amazing log, which includes the following: 28 Mcs., AR8AD, CE3AB, CN8BA, 8EK, CX10B, 4CS, EP1B, EL2A, 6A, 8A, KP4CI, LU3DH, 5AD, 9DJR, MD1H, 4JC, MF2AA, OQ5AB, 5BR, PY1ACQ, 1AGP, 2AMT, 2DG, SHF1X, ST2AM, 2CH, 2JF, VP4TG, VQ2DH, 3JMT, 4HRP, 4NSH, VS7PW, 7RF, VU2GB, ZBIS, ZA, ZC6JP, ZE1JB, 2JA, ZP8AC, ZS1ED, 6CY.

14 Mcs., C7TY, D4AVL/MD7, EA7BH, EK1AD, HC1FG, 7KB, HH2PB, HK1AO, MF2AA, OA4AT, OQ5AV, 5CA, OX3BD, TG9MG, TI2HB, VE4GE, 5JC, 7JK, 8AW, VK2AHJ, 2HW, 3HF, 7AV, 7YL, VQ2JC, 4ERR, W7GC, (Nev), XE1BW, 2KW, 3AF, YN1LB, ZC6LA, ZD1BD, also ZNP8, who gave his QTH as Jerusalem, which will most likely be O.K.

And to round off we have a 1.7 Mcs. log. All on phone, G2AGO, 2CBH, 2CY, 2CZH, 2FLK, 2FRG, 2HAI, 2II, 2LD, 2MM, 2OO/A, 2SC, 2TZ, 3AAK,

3ARD, 3BCP, 3BF, 3BYV, 3CO, 3FJ, 3MK, 3MT, 4OK, 5CI, 5MM, 5OP, 5SK, 5UF, 5XR, 6GN, 6GU, 6HN, 6HX, 6MB, 6RH/A, 6SQ, 8CT, 8DG, 8SK, 8TK, 8UD, GM6SR, GW2BG, 3BUT, 4FW, all stations on an AR88LF. You sure hear the stuff in Yeovil, ob.

"IS" is the new prefix for Sardinia, OM.

Don Robertson, GM1051, (Wick), our DX King from North of the Border, follows up with another exceptional log, and certainly puts GM on the DX map. 28 Mcs.: OQ5BQ, CX4CS, PY3BX, D4AVL, W2RMV/MM, PY1ACP, ZS1PT, LU8EE, GC2RS, VQ4HRP, ASC, LU3DH, ZSIAL, CT1TT, OQ5AB, ST2CH, AR8AB, PY2JU, CN8BA, CR7AP, LX2DM, and CE7aa which is a good catch.

14 Mcs. cw gave forth ZS6oi, LU6dix, HC1jw, PY1ahl, KP4cc, ZA2aa (!), MD4th, AR8oi, LU6aji, CX2ic, VE7jk, LU7bh, FE8ab, VS6ac, CR6ai, J3aad, EA5be, KV4al, HE41 (?), J9acb, VQ2gw, ZS6gj, VS7ki, 1a, MD7af, PY1dg, OQ5ll, ZS6gl, VS7ph, VE5rw, ZD7c, VE4ku, VS9gt, J2ahl, PY1ay, T12exo, VK71j, VS7es, Clcc, VU2hf, EA9ai, MI3ac, W8lzk/KP4, C7ok, ST2gh, KH6rp, ZD2rgy, ZD9aa, EL4a, PZ1fm, W4dgv/KX6, EA8ea, YV1ai, FM8ad, FK8ab, TA2ru, VQ5gtw, HL1an, ZC1am, VK6mo, KG6dg, TF3ea, VK7cb, CR6af, VU7rm, HL1ae, HL1at, and last but not least UM8kaa, a real hot one, but did that fellow drift, or did he? A really good log, and the plums every time.

John Waters, G1282 (Birmingham), sent in a very nice letter once again, and also his best DX heard. CE2CC, PY7QG, PY6AO, CX5AP, VP6TO, VP4TA, OX3GE, EL2A, VQ3JMT, OQ5BR, ZE1JB, ST2FU, and says CR9AG obliged very promptly with his QSL. I have passed your 5m log to 2UK. You certainly heard the DX that afternoon, John. Keep at it.

Derek W. Bruce, G734 (London S.E.9) wishes to congratulate Monty Preston on his recent DX log. Derek sends in his choice ones as follows, 14 Mcs. cw CR6ai, 7af, 7mb, FE8ab, MI3ab, 3fg, VQ4sgc, VQ8af, ZD119, ZD1L9/EL, 2rgy, 4ab (who was heard at 0600 GMT the other morning at 2bqc, which is unusual), ZD4at, 9aa, and ZS3ea, Vy fb log. On phone FQ8SN, MI3AB, 3CD, MD4JG, OQ5AV, 5BR, 5CF, 5CL, ST2FU, VQ2JC, AJP, 2PL, 4ASC, 4CRE, 4DFF, 4ERR, 4JGK, 4NSH, 4SC, 5GHE, and ZS3F, which covers Africa pretty well. What about S. America next, Derek?

Martin Harrison, G54 (Co. Durham) tears me off a strip for not publishing his SLP report, sorry OB, we will see if we can make it next time. Gen on VP8 station and XG6AJ in General Notes, hope it helps you out. I will QSP your message to G4GL. Martin's log includes (3.5 phone) PY2APU, PY4RJ (7 Mcs. cw) CT2ag, VE2aal, 3blu, all W districts (except Wø), XE1hv, UQ2ai, 2kaa, HI2my and CO5PL on phone. 14 Mcs. cw, produced C7ty, CE7aa, CR6ar, 7mb,

FE8ab, FQ8sn, KL7gg, KG6dg, KZ5cl, MD7hv, 7qrp, OQ5go, UF6kaa, UG6kaa, UH8kaa, UI8ac, which is a very nice all band log, and I am sure will be of interest to the other "DX hounds."

Les. H. Waime, G328 (Yeovil) put on his tropical kit for the recent hot spell, and lists the following 7 Mcs. cw. KH6dp, 6dp, Wøysm, W6fl1, also a few 2's and 4's, 14 Mcs. turned out CR7al, J3acd, LU3rl, LU5ax, PY1cn, PY4ac, UG6kaa, UH8kaa, VE1cm, VK5ps, VQ4kgk, VS7al, W51w, W71db, YA3a, and his pal YA3b (perhaps!). How's your "640" going Les OB? I have increased the bandspread on mine, and will let anyone have the "gen" who is interested.

J. T. Carr, G1431 (Ramsgate) uses a McMichael 4Z7 RX, and a very poor aerial but, nevertheless, puts in an excellent log, which includes TA3FAS (Ankara), ZC6MA, TI2RC, AH, TG9RV, VK7AZ, LU6AJ, HH3DC, OA4BH, PY2OE. I should say the ON4's are O.K. as they run three letter call signs.

B. L. L. Winchester, G2152 (Eastbourne) sends in his "first." Welcome to the ranks. RX used is an Eddystone AW4. Don't worry about not hearing much on ten, it is only open for short periods; should be better about the end of September. Starting with 1.7 Mcs. G3BUR/A, 3BUB, 6UB, 2DSB, Next we drop to 14 Mcs. and find the following phone log, CX2CO, TA3-FAS, PY4CT, TI2MA, UB5KW, VE1ET, 1FQ, 1QH, 2MC, HC1FG, LU4DD, 4HE, being the plums. Bill has only been on seven weeks, so what will he do in seven years time? Go "nuts" or stick it! I'll bet he sticks it. Good luck, Bill.

G. M. Leach, G89 (Plymouth), who, by his ISWL number, is an old timer, lists the following on 3.5 Mcs., W2OOG, WINQ, W1CTI, who called three stations and didn't raise anyone. I'll bet he would be "sore" if he knew his signs were logged in G!

Otaker Halas, OK3RR, has QSO'd the following G's on 3.5 and 7 Mcs. G3BLP, G3BUH, G5AQ, G2CMK, G2ATZ, G5LH, G3CED, G3ARM, G3BR4, G2FP, G2AUI, G5PS, G2DRW, G3DIM, GM3CCK, GM3RL, G3SU, G2AXA, G2FH, G3APO, G3AGG, G3CQB, G3DTF, G3BRV, G3DHL, G2BTO, G3DDG. The ones in italics have not QSL'd to date, so what about it, chaps.

Geoffrey Pennington, G1185, (Rowley Regis), uses an O-V-I, and works his DX'ing in with his schooling. 14 Mcs. C1CH, CX2CO, HC1FG, LU7GH, MD2B, PY4BU, PY7AD, SV2AG, TA3FAS, VK2VA, VK4AGU, (suggest VK2AGU), VP9F, VQ3HGE, VQ4ASC, G26LA, ZL2BT, which must have shaken the 2-valver.

A. Baldwin, G193, (Leytonstone), lists 7 Mcs. cw, CT2ag, KP4fl, VE6kx, and, 14 Mcs. cw, AC4ak (doubtful), CM2gk, 2wd, CPlap, CR6ai, EL8a, FT4an, HL1ae, J2aal, 3aad, 9acs, KH6rp, KL7cz, KP4ht, MI3ab, OQ5ra, OX3mg, PK6xa, TI2kp, UAøpa, UD6kb, UD6kaa, 6wd, VE7aad,

This is the very attractive QSL card of W5KUC as received by S. A. Herbert, G3ATU. The TX at 5KUC runs a pair of 250 TH's with a cool kilowatt input. The RX is an HRO7 and the aerial is a 3-element rotary beam.



7zz, 7om, VQ4sgc, VS2bt, W4gav/KP4, XE1rs, ZC1cl, ZC6ao, ZD2rgy, ZL2dt, 3jd, and on phone CO2LY, HC7zm, VP9F, VQ2JC, VQ4DFF, XE1AC, ZC6LA, 6XY, ZL3BT, which is very fb.

R. W. Ainge, G219 (Nr. Crewe), queries MD7QRP, but he is O.K. I think, and is ex-D4ABD. RX used 0-V-2, and W8JK aerial. 14 Mcs. phone, CM9AA, CP1AP, CX2CO, HC2KQ, 2KJ, LU5AX, 6AJ, 2FN, OA4M, 4AI, OQ5BI, TG9RV, VP6MO, 2AG, 2GB, 9F, VQ4DFF, 4HRP, 4ASC, 4NSH, XE1AC, YS1AC, 2AM, 3PL, YV5ABX, 5AV, 5AB, ZC6SQ, also FQ8SN.

W. J. C. Pinnell, G1832, has been trying out a one-tuber, and was amazed at the results. 7 Mcs. CT2ag, K2aj, OY3g (oh dear, another!) W1bgm, 5bcz. It really got amongst the DX on 14 Mcs. with CE3ag, EL8a, CR7mb, KZ5ak, TG9jk, 9rv, TI2exo, UF6kab, VO6an, 6x and ZD4al, a really fine show, OB. His V55R, also pulled in CT3MN, CT3aa, EP3h, J8acd, MI3fg, Wømcf/ci, YS3pl, ZD11g and ZE2JR, phone and cw. Hope you make your School Cert., OB, 73 and luck.

Michael Dransfield, G1731 (Purley), praises his 1155RX, and has certainly heard some good stuff, the choice ones being, AP4B, AR8AB, C1CH, CE1AM, 3CU, CO8NP, FT4AF, HC2KJ, 6AR, 7KD, HH3DL, HK1FU, KG6NR, 6DL, KH6GN, KP4AL, 4B1, W4IRC/KP4, MD2B, MD7QRP, OA4AI, 4BK, PK4PQ, TG9AB, 9RV, TI2KQ, 2OA, VE7JK, 8MI, VO6HS, VP2GB, 5AN, 5AS, 5RS, 9F, VS1AY, 7PS, XE1AC, 1YE, ZB2D(?), ZC6LA, ZS6DY, 6DS, ZL2BT, 4BN, 4FO, 4GA, 4NF, and cw AP2f, ZB2ar(c), 2b. Michael wants information on station BCB heard

in QSO with G2aym on 7 Mcs. also M1B, 14 Mcs. XG6AJ, and last but not least ZT1AV. Any gen?

Fred Clarke, G2FAY (Oldham), has dropped down to 14 Mcs. and comments on the awful QRM and also draws attention to two pre-war G3s who were holding a nattering contest on 14050 kcs. Despite all this, Fred has knocked off VE8md, ZL2bv, ZL2fi, ZL4do, VK3vj, VK3cx, VK5rl, CR7af, LU2ed and KH6ij. Also in the log is AC4au who said "QSL via AR8AB"! 32 States have been worked at 2FAY. Good going, OM. Fred will be back on 7 Mcs. this coming season and is aiming at WAC on that band. Hope you make it, Fred.

DX QSL's Received

E. Cafley, G1462: CE3CU, CO2JL, CX2CO, HC2KL, OA4AT, PY2AMT, PY1KZ, PY5AQ, TG9JK, VE3AJG, VK4WJ, VO2AV, VP4TAE, W3KXU, WøOEV, XE2AV, YV5AK, Z55DS,

E. W. J. Field, G926: W5ASG, (Ark), W7JPY, (Ariz), W6AGT, EZP. 6YLC/M/M. SS. Exempler, 30 watts, VP2GE (Grenada), TG9JK, KG6CS, YV4AM.

D. L. McLean: HL1AN, MD1H, KH6IJ, VE4WB, VK2NS, 2VA, 5TR, W2RNV/MM 19 watts, 5AFX, 4NDB, 5ZG/Mobile, 6FNK, 6YLC/MM, ZL3AW, ZL3AW, ZS1DU.

Don Robertson, GM1051: VE3AWB, WøRZQ, KP4KD, KV4AA, HH2LR, W8WNO, W9ONZ, VE6LT, 4OM, MB9BB, KG6AG, WøILLN, MD1H, W7JEF/KG6, VK3QW, VK3OQ.

W. J. C. Pinnell, G1832: D5AA, XE1GX, AR8AB, HK1OZ, VQ4RAW.

SHORT WAVE NEWS

L. H. Waine. CT1NT, HC2KJ, TC9JK, VE2JA, VE6LB, VK6PW, W2SBR, W3LOE, and ZS6DJ.

MONITOR SESSIONS

Session 8

Two reports were not to hand in time for publication with the rest of the logs for this session, but here they are now:—

E. A. Coates, RX "504," Aerial; Dipole. PY1NK, PY2AU, PY2JU, PY4LZ, PY6AV, CX2CO, LU4BH, LU5AX, LU6AJ, YV5AB.

G. Oliver, RX: R1116A, Aerial; Inverted L: PY2JU, PY6AP, LU4BH, LU6AJ.

Session 9

(July 21st 2000-2130 GMT. 3.5 Mcs.)

F. Randall, G530: ON4LV, ON4SE, OZ5WP, PAøADJ, PAøBW, PAøHT.

J. Spenser (RX-B2; Aerial-Inverted L): ON4ZF, OZ3WP, PAøADJ, PAøCT, PAøHB, PAøSP. Jim mentions heavy QRN.

W. J. C. Pinnell, G1832 (RX-V55R): DA3ff, DA3xa, DA4ul, F8qa, OK1ce, ON4JN, OZ1ea, OZ1j, OZ4ft, PAøabc, øbt, øhd, øRJ, øry, øTOM, øtri.

A. C. Hutchings, G1834. (RX-Sky Champion. Aerial-Doublet): PAøADJ, PAøHD, PAøTOM, PAøWQ. Alan also heard MFA21 and GQR5 in QSO and plenty of Gs and QRN.

M. Dransfield, G1731 (RX-R1155. Aerial-64 ft. long wire): F3JX, F3XF, F9FT, ON4CW, ON4JN, OZ3FL, OZ3WP, OZ3WS, PAøADJ, BT, CT, DT, HD, TOM, QG, WVD. Also PAøtri on CW. Michael says that No. 9 was the noisiest session yet with the QRN drowning all the weaker signals. The noise peaked 3.8 Mcs. Michael also heard XG6AJ (he is OK, OM).

Session 10

(August 1st 0800-1000 GMT. 14 Mcs.)

F. T. A. Randall: (RX-BC348 and Preslector); FA8WN, KH6PP, TI2OA, VK2TI, VK3ADI, VK3GU, VK3HW, VK3LN, VK3YH, VK3ZL, VK5XD, W2SMA, W3FII. Fred says the band was full of signals—quite different to our usual sessions (we must be slipping!).

E. A. Coates (RX-"504"). Aerial-half wave doublet: FA3GZ, VK2ADR, VK2XG, VK3HF, VK3LN, VK5KM.

R. Masters (RX-Sky Champion Aerial-Inverted L): FA9io, CN8mi, EK1MD, EA9AI, CN8MA, FA9HS, VK3AJ, VK3HF, VK3HW, VK3IK. Sorry Reg, but UB5 and MF2 are in Europe!

T. Jones: KH6ba, KH6ij, KL7gg, VK3ww, ZL3bv.

D. G. Garrard (RX-BC342. Aerial-Inverted L): EA9AI, LU2AS, VK3ADR, VK3HF, VK3HG, VK3XD, VK3YH, VK5XC, W3MRH.

M. Dransfield: CN8AM, CN8BI, CN8MI, FA8BE, KH6GH, TI2OA, VK2XC, VK3AUR, VK3AWN, VK3HF, VK3HG, VK3ZL, VK5HM, VK5XO, VK6DD. Michael nearly missed the session as he happened to glance at SWN at 0815 and noticed that a session was in progress. He mentions the complete lack of Ws at his QRA. His first KH6 was heard during this period.

Future Sessions

Sessions 11 and 12 will have passed by the time you read this. Below are the repeated details for 13 and 14 and also the following two periods. 13 and 14 should prove interesting as these bands seem to be the favourites. We are taking a gamble in putting in a 28 Mcs. period as the band *should* be open again by then. Also, for the 7 Mcs. fiends, No. 16 should produce something interesting. Here are the details:—

Monitor Session 13

Date: September 10th. Time 1930-2100. Band 3.5 Mcs. Target: Outside British Isles.

Monitor Session 14

Date: September 19th. Time: 0830-1100. Band: 14 Mcs. Target: Outside Europe.

Monitor Session 15

Date: October 16th. Time: 1700-1900. Band: 28 Mcs. Target: Outside Europe (Except W1, 2, 3 and 8).

Monitor Session 16

Date: October 23rd. Time: 2130-2300. Band: 7 Mcs. Target: Any station outside of Zone 14.

Deadline for No's 13 and 14 is September 30th. For 15 and 16 it is November 8th.

TOPICAL DX QRA's

AP4D: Signal Regiment, Peshawar, Pakistan.
AP5A: 5, Taylor Police Radio Station, Cantonments, Lahore.
CPIAQ: E. D. Zarate, Claudio Sanjines 20, La Paz, Bolivia.
CR7AD: Box 12, Quelimane, Mozambique.
CLMY: Box 1606, Shanghai, China.
C7TN: Box 52, Peiping, China.
EL7A: Firestone Rubber Plantation, Harbel, Liberia.
HC7KD: P.O. Box 340, Quito, Ecuador.
KL7IT: P.O. Box 1994, Fairbanks, Alaska.
MD7QR: AACA, USAAF, attached RAF, Nicosia, Cyprus.
PK7UK: Radio Section, Biak Island, N.E.I.
ST2RL: c/o Box 253, Khartoum, Sudan.
SVøAG: U.S. Military Mission, Athens, Greece, APO57, U.S. Army.
TA3FAS: U.S. Military Mission, Ankara, Turkey.
VP9CC: Box 20, Mangrove Bay, Bermuda.
VQ4DF: P.O. Box 3015, Mombassa, Kenya.
VS4WL: R.A.F. Detachment, Lubuan.
XG6AJ: (G6AJ in Oman) H. W. Hamblin, 11, Thofas, Cooks Sportsground, Beckenham, Kent.
YV1AN: Louis Fuenmayor, P.O. Box 197, Maricaoibo.
YV8AG: c/o Creole Petroleum Co. Caripito, EDO Monagas, Venezuela.
ZC6LA: P.O. Box 4150, Tel Aviv, State of Israel.
ZC6AL: Box 4150, Tel Aviv, State of Israel.
XS3C: Box 513, Windhoek, S.W. Africa.
ZS9D: Box 14, Francistown, Bechuanaland.

SWN QSL LADDER

(for confirmed amateur reception)

This month we see quite a few changes in the Ladder and welcome one or two newcomers. Monty Preston keeps his lead with his countries now at 130 and also reaching his 48th State—nice work, OM. Strongly challenging for second place is a new Ladderite, E. A. A. Hardwick who clocks in with 130 countries also, but who is slightly below Monty in States and Zones. Ernie Field of Watford is another new one who comes well up in the list with his 86 countries (what are your other scores, OM?). Here are this month's final positions.

Position	Name	Countries	States	Zones
1	M. Preston (London)	130	48	38
2	E. A. A. Hardwick (Misterton) ...	130	35	35
3	C. G. Tilly (Bristol) ...	121	44	36
4	D. L. McLean (Yeovil)	118	48	36
5	A. J. Slater (Southwick)	96	45	33
6	A. H. Onslow (Hove) ...	94	47	?
7	E. W. J. Field (Watford)	86	?	?
8	A. Levi (Belfast) ...	74	12	29
9	D. Robertson (Wick) ...	68	38	20
10	E. Caley (Yarmouth)...	64	29	24
11	R. Masters (Portsmouth)	62	41	29
12	W. Winchester (Eastbourne) ...	48	?	20
13	D. Garrard (Ipswich) ...	45	22	13
14	P. Bysh (London) ...	41	18	13
15	L. H. Waine (Yeovil)	39	37	21
16	D. Shallcross (Borrowash) ...	28	2	6
17	J. J. Carr (Ramsgate)...	12	9	14

JOTTINGS

The J9 district has been changed around somewhat. The boys in Okinawa are now allocated the prefix KR6 (which is now the official one for the Ruyuku Islands). The Marshall Islands, hitherto J9, now boasts the prefix KX6.

Here is some data on QSL Bureaux, additional to the list appearing in this year's "Annual":—

Ecuador: QSL's for HCl stations can now be sent to HClJW, P.O. Box 2536, Quito. HC2 stations may be reached through HC2OA, P.O. Box 502, Guayaquil. The rest of the HC districts are unserved by a Bureau and must still be sent direct.

Ethiopia: The new Bureau for ET's is: ET3AJ, P.O. Box 90, Addis Ababa.

Honduras Republic: HR cards are now handled by HRIAT, Oscar Alvarado Trochez, Tegucigalpa.

Guantanamo Bay: It is now possible to use a Bureau address for those NY4's. The QRA is Box 35Q, NAS Navy No. 115, c/o Fleet Post Office, New York.

Panama Republic: The Bureau has now changed hands, the new one being at Box 1616, Panama City.

SWL DX YARDSTICK

A suggestion for a new scoring system for the DX-er.—

(Before we proceed any further let us explain that we are neutral! This space is devoted to airing the views of Monty Preston, who forwards the basis of a scheme for DX scoring. It would be appreciated if readers would send along their comments and suggestions on the following idea, printed herewith as received from the author.—Ed.)

We have our Zone System and Country Scoring, but I consider that this idea is rather harder and more interesting. Contestants would be asked to claim scores on the following basis—each country heard would score points as follows:—

Distance of station	Points
0—1000 ...	1
1000—2000 ...	2
2000—3000 ...	4
3000—4000 ...	6
4000—5000 ...	10
5000—6000 ...	16
6000—7000 ...	22
7000—8000 ...	28
8000—9000 ...	36
9000—10,000 ...	44
10,000—11,000 ...	52
11,000—12,000 ...	64
12,000—13,000 ...	80

To assess an individual score it would be necessary to ascertain the number of countries heard and the total number of points. Then an average would be taken. As an example:—

Countries heard—100; No. of points—1700.
Average score—17.0.

Naturally, the best average would be aimed at. In this scheme one would obtain more credit for say a country 8000 miles away than one in Europe. This obviously makes the DX-er go out for the more distant ones and the whole scheme would, I feel, stimulate the interest in DX scoring which comes rather boring once one had heard all the 40 Zones and clocked up a hundred or so countries, both the feats being comparatively simple these days. It would be interesting to hear what other readers think of the idea.

FRENCH HOSPITALITY

Following our Editorial last month on "Exchange Holidays," we have had a letter from ISWL G7, saying that he and his family have just returned from a perfect holiday in Paris as the guests of the ISWL Representative, Henri Discazaux, F9BS., and his friends F3LK, F9IU and F3QO. He would like to thank these amateurs and also the management of the "Royal Hotel," Vincennes, for the real hospitality they were shown during their visit to France.



International Short Wave League

MONTHLY NOTES
BY G3AKA

ANNUAL SUBSCRIPTION 1/-

News from the Chapters.

West London (Sec.: J. Hebborn, 71 Saxon Drive, Acton, W.3.)

The Chapter continues to progress. Talks have recently been given, including "The History of Amateur Radio," by Harry Lee and "Short Wave Listening" by G3AKA. A talk on "Short Wave Aerials" by G3UQ is scheduled for the near future and others will be delivered in due course. Apart from the interesting meetings, with their morse classes, talks, discussions and so forth, the Chapter has recently made two very interesting and enjoyable visits. The first was to the premises of Electronic Prototype Designers Ltd., where electronic keys, universal supply units, a one-kilowatt transmitter (contained complete in two suitcases!) and an ingenious recording unit, employing the teleion valve, were demonstrated. Much interest was taken in the AR88 that was available also! We thank Mr. Lalewicz for a most enjoyable evening.

The second visit was a conducted tour, by George Blain, over the V.G. Manufacturing Co. Ltd. This firm manufactures ceramics and the Chapter was shown every process from the actual raw materials to the finished glazed ceramic product. Everyone agreed that they were surprised at the amount of work and processing required to turn out a small stand-off insulator! Thanks, George, and may the "saggers" never sag!

Constructional work continues, though a slight hold-up has been occasioned owing to a fortnight's recess which was considered timely since most Chapters members seemed to be on holiday during those two weeks. Meetings continued from August 19th and will be held weekly again.

South London (Sec. W. A. Martin, 21 Brixton Hill, London, S.W.2.)

We are pleased to hear that of those who sat for the last amateur exam, a large percentage passed. So look out for a large bunch of new G3—'s from down Brixton way.

The Winter session starts on September 1st and it looks like the lads will be kept busy. There will be on the agenda items for the SWL, the transmitter, the VHF gang and so on. We hear that the canteen now boasts some NAAFI-type half-pint mugs, so the whistle-wetting dept. will be happy! Field days are also in the offing—weather permitting. Visits are being organised, including the RSGB exhibition.

North West London (Sec.: F. Wells, 8 Evangelist Road, Kentish Town, N.W.5.)

Congrats. to the chairman, E. R. Cooper, on passing the ham exam. The morse practice is

now in full swing in readiness for the test. Good luck, OM. The latest addition to the club gear is a battery-operated wavemeter and a power pack. The club receiver, which has been in use for some time, is now being subjected to the mystic process known as "hotting up." The club's honorary Norwegian member is now on his way back home—*bon voyage* OM. We hear that the club is getting very interested in 144 Mcs. and wonder if other Chapters are likely to be active on this frequency?

Birmingham (Sec.: G. Moore, 42 Fern Road, Erdington, B'ham. 24.)

Owing to a change in programme, due to members' holidays, we have little to report this month. When the new session starts several interesting items are already booked down, such as talks (one on "Station Construction" should be most interesting) and a possible visit to the Droitwich transmitter.

Manchester (Sec.: M. I. Wilks, 57 Longley Lane, Northenden, M/c.)

Since the initial notice last month much progress has been made. The Chapter will be called the South Manchester Amateur Radio Society and will run at present with this committee:— M. I. Wilks (Secretary), A. E. Pritchard (Treasurer) and C. M. Denny, G6DN (Chairman). A membership drive for new members in Manchester is well under way and is producing good results thanks to the energies of the committee. We hope to give fuller details of activities next month.

Swansea (Sec.: W. H. Longhurst, GW3AAO, 82 Gower Road, Sketty, Swansea.)

Though there has been a slight falling off of activity (more or less accepted at this time of the year), there has been no slackening of enthusiasm from the "stalwarts." The "Old Timers" of the district are said to be very apathetic but this does not deter the spirit of the Chapter. It is planned to hold an exhibition in the Patti Pavilion in the Autumn with other societies. The Chapter hopes to contribute such items as remote radio control gear, photo-cell equipment and a TX in full glory. From the future, back to the present; the main job at the club at present is in repairing the shack roof!

YOUR LOCAL CHAPTER

If you are not already a member of your local Chapter, why not drop a line to your secretary and get the gen? You will be made welcome at any local meeting and you will be able to meet your fellow enthusiasts. There is nothing like a good rag-chew!

Here is a complete list of League Chapters and the address of the secretaries:—

I.S.W.L. CHAPTERS

- Barnet: F. T. A. Randall, 15 Windsor Road, Barnet.
 Essex (Dagenham): K. R. Goodley, 34 Blenheim Ave., Ilford.
 Ipswich: H. W. Dean, 11 Royal Hospital School, Ipswich.
 Manchester: M. I. Wilks, 57 Longley Lane, Northenden M/c.
 London, E.: A. Baldwin, 28 Wallwood Road, Leytonstone, E.11.
 London, N.W.: F. Wells, 8 Evangelist Road, Kentish Town, N.W.5.
 London, S.: W. A. Martin, 21 Brixton Hill, London, S.W.2.
 London, W.: J. Hebborn, 71 Saxon Drive, Acton, W.3.
 Rotherham/Sheffield: W. B. Kendall, 13 Fraser Road, Rotherham.
 Portsmouth: R. Masters, 62 Battenburgh Avenue, North End, Portsmouth.
 Plymouth: G. J. Harvey, 5 Garfield Terrace, Stoke, Plymouth.
 Swansea: W. H. Longhurst, 82 Gower Road, Sketty, Swansea.
 Watford: R. W. S. Halsey, 7 North Approach, Watford.
 Southwick: J. Short, 112 Southwick Street, Southwick.
 Birmingham: G. Moore, 42 Fern Road, Erdington, Birmingham, 24.
 Preston: C. Aspinall, "The Willows," Fernor Road, Tarleton, near Preston.
 Cork: K. Layton, 2 Sheares Street, Cork City.
 Bristol: D. J. West, 9 Novers Park Drive, Novers Park, Bristol, 3.

CHAPTERS IN FORMATION

- Knareborough: P. Lumb, 25 Pearl Street, Harrogate.
 Wrexham: D. Rickers, 97 Ruabon Road, Wrexham.
 Bromley: A. Veness, 37 Park Road, Bromley, Kent.
 Mansfield: F. P. Atkins, 11 Lord Street, Mansfield.
 Folkestone: K. Callow, 5 St. John's Church Road, Folkestone.
 Glasgow: W. A. Gorman, 15 Northburn Street, Glasgow, C.4.
 Stamford: F. K. Parker, 122 Empingham Road, Stamford, Lincs.
 Driffield: J. E. Price, 12 Hutton Road, Cranswick, near Driffield.

JOIN YOUR LOCAL CHAPTER—NOW!

Report of Essex Activity

(From K. R. Goodley, 34 Blenheim Avenue, Ilford.)

Meetings are held every Tuesday at Valence House, Dagenham, though support would be appreciated from more members in the district. The winter session is full of interesting items and we appeal to all members to do their best to come along and join in the activities. Field Days, following the successful first event, will now be a regular item on the agenda and will be held every other month.

Urgently needed—a TR for Southend district! We have more than enough members to form a club there, so how about a volunteer for the TR's job?

We were sorry when Peter Redman was "called to the colours." Pete was a really hard-working TR and, though the going was tough, never let a set-back dismay him. Good luck, OM, and we will be looking forward to having you back. We are fortunate to have another hard-working member to take over while Pete is away.

Our aim is to get meetings organised throughout

the county, so what better than every Essex member drop a line, or call on, his nearest TR?

THE QRP RECEIVER SECTION

Report from Alec Jocham (119 Exeter Road, Dawlish, Devon).

The section grows slowly and we have had some interesting new members recently. J. Fowle, G500, has now moved off to the East with the RAF. Good luck OM. J. Whitefield is the first member of the section who uses a mains operated rx but is now busy with a portable job for the holidays. G1323 wants a full page for the QRP section! E. Bedford, G2062, of Boston, is building an O-v-O. Two more new members are Mr. and Mrs. R. Pyatt. Grace is our first YL member and her "better half," Roger, suggests a duplicated news sheet for the section. This would certainly solve the problem of space and it would be greatly appreciated if anyone who is able to help in the direction of the necessary gear would please drop me a line.

Other new members have been R. Howard, G1568, who sends along two photos of his RX and a nice log of broadcast and ham stations which really is good going. C. H. M. Joule, G1877, is another one-valve DX-er who has heard some good DX. G1877 intends to get his ham ticket one day. Good show OM.

District Notes and General Gossip

The CR for Lincolnshire asks for applications for the position of TR for Lincoln. Offers, please, to R. C. Ground, Park House, Eastgate, Louth.

A DR has been appointed to cater for North-East Durham. He is S. Oake, Overacres, St. Johns Avenue, Hebburn-on-Tyne. Local members please note.

Stan White, G3CMO, says that any member interested in aeriels and propagation can drop him a line and he would be pleased to correspond. We have talked Stan into becoming CR for Cornwall! His address is "Collede," Old Polzeath, Wadebridge, Cornwall.

Ham hospitality is offered by D. Coppendale, G3BNI, who very generously offers to "show the ropes" of transmitting to any young members and also would be pleased to see any member at his shack. Nice gesture, OM, and greatly appreciated. The QRA is 9 Mordern Road, Chadwell Heath and the telephone number is Seven Kings, 3594.

Change around at Rugby. Our old friend W. H. Tanser has had to resign due to pressure of work. A new TR has been appointed and is interested in getting a club going. His QRA is David Wilson, 29 Alwyn Road, Old Bilton, Rugby. Whilst in Warwickshire, we need a TR for Coventry, so what say someone?

Conrad Tilly, "The ear of the West Country," one of our champion DX-ers, finds he has little time to devote to TR-ing in Bristol. However,

(Continued on page 240)

CLYDESDALE

FOR BARGAINS IN EX-SERVICE

A Selection of the Best

BRAND NEW

Don't miss this EXCEPTIONAL Bargain!! All metal (tubular) construction. Lightweight. Rigid, for TV, VHF or F.B. D.X.

Half-Wave Dipole Aerial, 9' 3" with reflector 9' 7" and crossarm 4' 11½" for approx. 6 metres, either vertical or horizontal mtg. to existing mast or wall bracket with 39' of 80 ohm. 12 mm. co-axial cable and co-axial plug.

CLYDESDALE'S
PRICE ONLY

21/- each

Carriage
Paid

or packed in a Wood case, **28/6** each. Carriage Paid

RI155 RECEIVER

A 10 Valve Communication and D.F. B. 500-75 Mcs. in 5 W.B., complete with v. case 16½ × 9 × 9 ins., less power pack.

CLYDESDALE'S
PRICE ONLY

£12/-
Full details

RECEIVER UNIT. TYPE 78

A Superhet Receiver, covering 2.4-5.9 M. bands, with 5-6.3V. Valves, ECH35, EF, trimmer control 12V. 100 kcs. Xtal. S.M. case 10" × 8½" × 6½". Unused condition.

CLYDESDALE'S
PRICE ONLY

59

Co-axial Cable

Coil (12 yards) first class co-axial cable.

CLYDESDALE'S
PRICE ONLY

7/0

BRAND NEW. Ex-R.A.F.

AI134 BATTERY AMPLIFIER

Two Stages. Two Valves, VR21 (PM2) input and output transformers, for inter- in metal case 7" × 5" × 4½", finish Black.

CLYDESDALE'S
PRICE ONLY

15/-

BRAND NEW, in maker's carton

A MAINS MOTOR, for 200-250 volts simply wiring, data supplied.

MOTOR GENERATOR TYPE 29

Input 24 volts. 16 amps. Output 12 200 ma. Dimensions 11" × 5½" × 5½".

Very useful for light bench work, a 1" available for driving when the fan is removed.

CLYDESDALE'S
PRICE ONLY

25/- each

BRAND NEW

SLOW MOTION DIAL

with Vernier 200-1 reduction

Calibrated 0-100 Black with White Numerals

CLYDESDALE'S
PRICE ONLY

4

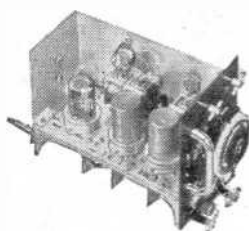

Brand New in maker's cartons

EX-R.A.F.

R.F. Unit 26 For 5-6 metres. 65-50 Mcs.
R.F. Unit 27. For 3.5-5 metres. 85-65 Mcs.

Complete with valves

CLYDESDALE'S
PRICE ONLY

35/- each

Post
Paid

BRAND NEW

MAGNETIC KEYING RELAY TYPE 85.

For 6 Volt operation 3 Solenoids 6 pole C/O. Would make a fine aerial C/O relay. Size 7½" × 3¼" × 3¼". Bakelite insulation. Ask for D200.

CLYDESDALE'S
PRICE ONLY

5/6 each

Post
Paid

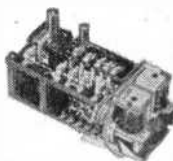

BRAND NEW, in maker's carton

MASTER CONTACTOR

Precision winding clock movement with thermal controlled heater, etc., used for sending impulses to remote Contactor, fitted in rubber-lined box.

CLYDESDALE'S
PRICE ONLY

19/6 each

Post
Paid

BRAND NEW, in maker's carton

REMOTE CONTACTOR No. 4

Relay (24V) and drive mechanism, switch, etc. Used for remote switching of transmitters.

CLYDESDALE'S
PRICE ONLY

3/11 each

Post
Paid

SEND NOW FOR NEW ILLUSTRATED LIST

(Write Name and Address in BLOCK LETTERS please)

CLYDESDALE SUPPLY CO LTD

• The Radioman's Shop •

ICES ELECTRONIC EQUIPMENT

Best British Equipment

F. Receiver for 18-3 Mcs., 1500-600 kes.,
valves, Circuit and plugs, etc., in metal

2/12/0 each
on request

Carriage and
Packing Paid

.9 Mcs., 5.8-13.0 Mcs., in two switched
EF39, EF50, EA50, 6J5 for 26V. Desynn
S.M. Drive, etc., less power pack, in metal
on.

9/6 each

Carriage Paid
in Transit Box

e. Approximately 80 ohms. 12 mm.

7/6 per coil

Post
Paid

M2HL), VR35 (QP22B) with Mic. QPP
er-com., pre-amp or mod. Unit complete
k. With circuit.

5/- each

Post
Paid

olts A.C. by

1200 volts,

1" spindle is
removed.

Carriage
Paid



umersals. 6" in diameter. Front panel mtg.

4/6 each

Post
Paid

Ex-R.A.F. MAINS TRANSFORMER (Varley)

Pri: 0-200-210-220-230-240-250V.

Sec: 1. 500-0-500V. 120 mA.

2. 2-0-2V. 3.5A.

3. 2-0-2V. 4A.

4. 2-0-2V. 4A.

5. 10V. 1A.

Heavy laminated core. Weight 7 lb.

CLYDESDALE'S
PRICE ONLY

35/-

each

Carriage
Paid

Interested in Transformers? Send for special list



BRAND NEW

12 VOLTS. 75 a.h. ACCUMULATOR

In waxed Teak box with hinged lid, metal carrying
handles at sides. Wing nut terminals. Size 16½" x
8" x 11¼" high.

CLYDESDALE'S
PRICE ONLY

£5

each

Packed in Wood Box
Carriage Paid

BRAND NEW

12 VOLT 72 a.h. ACCUMULATOR

Standard car type construction. Moulded case, height
8" x 14" x 7". Wing nut terminals.

CLYDESDALE'S
PRICE ONLY

£6/15/0

each

Carriage
Paid

Packed in a Wood Case



olts A.C. by

1200 volts,

1" spindle is
removed.

Carriage
Paid

BRAND NEW

12 VOLT 40 a.h. ACCUMULATOR

In moulded case 7" x 10½" x 5", with terminal connections, carrying strap and handles.

CLYDESDALE'S
PRICE ONLY

65/-

each

Carriage
Paid

BRAND NEW

CHARGING BOARD CONTROL PANEL

Up to 50V. D.C. 1260 watts. Includes 5 M.C. ammeters (1-0/40a, 4-0/15a). 1 M.C.
0/40 Voltmeter. 5 H.D. slider resistances, etc. Complete in metal case with fold-
back doors. Size 18" x 17" x 8½".

CLYDESDALE'S
PRICE ONLY

63/-

each

Carriage
Paid

Packed in a Wood Case

2 BRIDGE STREET, GLASGOW, C.5

Phone: SOUTH 2706/9

VISIT OUR BRANCHES IN SCOTLAND, ENGLAND AND NORTHERN IRELAND

RADIO PICTURES

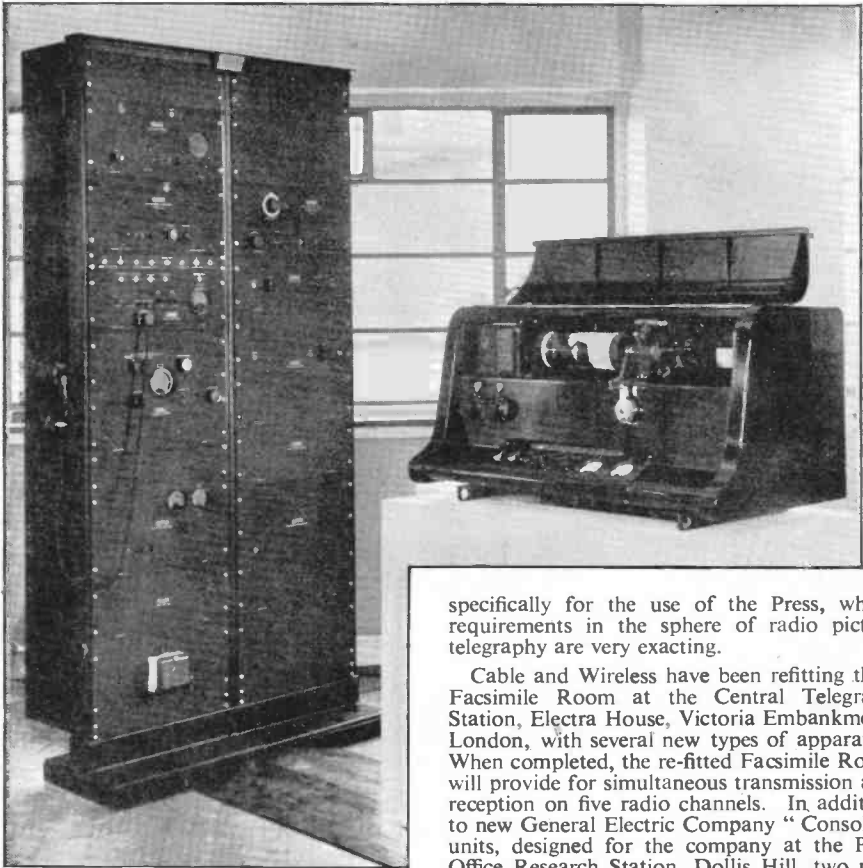

THE number of radio circuits for the transmission of pictures is increasing rapidly and readers will have noticed in our pages recently, brief particulars of new circuits extending to countries as far away as Australia.

This service, which prior to the war, was regarded as somewhat of a novelty, has now reached such a standard, that the final transmitted picture has, in many cases, a finish, making it indistinguishable from a high class photograph. We reproduce herewith, two transmitted pictures, which illustrate very well, the extremely high standard of reproduction possible with the latest Muirhead equipment shewn in our heading illustration. These two pictures show that both the intricate detail of maps and the quality necessary for art reproduction, can be covered adequately by the Muirhead equipment, which was designed

specifically for the use of the Press, whose requirements in the sphere of radio picture telegraphy are very exacting.

Cable and Wireless have been refitting their Facsimile Room at the Central Telegraph Station, Electra House, Victoria Embankment, London, with several new types of apparatus. When completed, the re-fitted Facsimile Room will provide for simultaneous transmission and reception on five radio channels. In addition to new General Electric Company "Console" units, designed for the company at the Post Office Research Station, Dollis Hill, two new "Belinographe" units, designed and manufactured by Edouard Belin of Malmaison, France, have been installed.

The G.E.C. apparatus is a self-contained unit built in console form for alternative transmission and reception. It is capable of transmitting and receiving about five pictures an hour. The Belinographe apparatus has its control panel separate from the transmission-reception apparatus. It is capable of simultaneous transmission and reception at the rate of four pictures or more an hour. Reception can take place in normal lighting, the receiving cylinder being contained in a light-proof compartment, which can be loaded in a dark room prior to reception.

Cable and Wireless are also installing the new Muirhead equipment, already mentioned. This equipment was designed by Muirhead engineers in co-operation with Mr. F. W. Jarvis of the "Daily Mail." The photos





Cable and Wireless Facsimile Room. Mr. R. Willis, Facsimile Room Supervisor, transmitting a picture overseas on a Belinographic Unit. The reception drum (right) is shown uncovered. One of the G.E.C. Console Units is shown on the left for comparison.

illustrating the capability of this apparatus, which we reproduce, were transmitted fifteen months after designing was commenced !

Most readers will know that the principle of picture transmission is that of rotating step by step the picture or a photograph negative of it, in front of a light sensitive cell, so that the light from successive segments of the picture falls on it in a systematic manner. The fluctuating current from the cell, resulting from the varying intensity of light passed by the picture is used to control a radio or land line transmitter. The impulses from this control receiver, which in turn produces a fluctuating beam of light which "retraces" the picture on light sensitive photographic material. The speed of rotation of the picture

being transmitted and that of the receiving material must of course be very accurately synchronised. The perfection of reproduction in the Muirhead equipment is largely attributed to an accurately cut ratchet which moves forward in discreet steps a carriage, on which the revolving drum and its motor are mounted. The drum on which the picture to be transmitted or received is placed, is 3½ in. by 10 in. long. It is run at one or two r.p.s. and traversed in front of the optical head at 100 or 150 lines per inch. Synchronisation between transmitter and receiver is effected by means of tuning forks which drive phonic motors. The latter, with the help of additional DC motors, rotate the drums. The transmitter and receiver can be coupled by telephone or radio link.

GBIRS

This is the call-sign of the headquarters station of the RSGB. On September 1st the inaugural transmission will take place. The time will be 1900 GMT. From this day onwards the station will act as a frequency marker on exactly 3,500.25 kcs. and will radiate a two-minute automatic

message, at 12 wpm, commencing at each hour from 0600-0000 (midnight).

Although the transmitter, using 300 watts, is capable of operation on all frequencies from 1.5-20 Mcs., no announcement has yet been made with regard to other possible transmissions on frequencies apart from 3500.25 kcs.

QRP CLUB NOTES

BY
MAL GEDDES
G2SO

IN my last notes it was suggested that this Section organised another low power Contest, and readers' opinions were requested. I have, therefore, made arrangements with the Editors to sponsor the Second QRP Contest in October. Many readers did not like to spend a whole week on a contest of this description, so you will see that this one will be somewhat shorter. Here, then, are the Rules.

SWN QRP CONTEST

RULES AND CONDITIONS

1. To be held over the period of Friday (2200 GMT) the 29th October, to 2200 GMT on 31st October (Sunday).

2. Power supply to transmitter is limited to one standard 120 v H.T. Battery.

3. Power output is limited only to that which can be obtained from the battery.

4. A contestant may contact any given Station more than once, providing that not more than one contact is made per band with that Station.

5. Contestants may choose any, or all, of the following bands: 1.8, 3.5, 7 and 14 Mcs.

6. Either AC or DC can be used to supply the filaments of the valves.

7. No signal transmitted with a T7 note or under will be allowed.

8. Conditions of licence must be observed.

9. Contest is restricted to stations with the following prefixes: G, GC, GI, GM, GW and GD.

10. Points to be scored as follows:—

One point per contact, multiplied by the number of Countries worked, multiplied by the number of bands worked—provided that at least five stations are contacted on each band used. Thus, 25 Stations worked 25 points.

3 Bands used 25 × 3 75.

10 Countries worked 75 × 10 750

11. Completed logs, typed if possible, must be returned to this office within 14 days of the close of the Contest. Address logs to "QRP Contest," c/o *Short Wave News*.

12. Details of equipment used during the Contest must be submitted with final log (and a photograph of gear, if possible).

It has been suggested that foreign Stations might like to enter the Contest, but many prefer that it should be an all "G" affair. I do think, however, that any foreign Station who might like to enter the idea in a friendly way, and who keeps to the Rules similar to the British Competitors', should enter his results and these logs will be published as an extra in the final results, apart from the British Competitors.

I do hope that more Competitors will take part in this, the second Contest. At least three Competitors in this town have promised their support, so what about it, you fellows?

Notes for this month are small as space will not allow more details on account of the Contest announcement. G3BEC (Yeovil), who has used QRP for some time without much success, has at last been active on 3.5 Mcs. with a 3 watts to a CO/PA, and a 132 ft. end-on aerial, his best contact to date being one with SM71Z obtaining RST569. He mentions G6GM of Holdsworthly, Devon, who is on this band with 1 watt, and also G2ND at Lands End, who worked a UA3 in Moscow with 2 watts (on 7 Mcs. I suppose?)

G6ZN writes to say that he has not been very active during the summer months, but the other Sunday he came on 14 Mcs. with his usual 3 watt Hartley tx, and received a report of RST 599x from EA3MA and 569 from WIKUW, together with numerous Europeans. During NFD he contacted 83 Stations, including 61 portables on 3.5 Mcs. Certainly very good for low power. He was using a portable transmitter in the field-day, and a 132 ft. aerial. That's all for this month, so see you in the QRP Contest.

* * *

AMATEUR RADIO IN INDIA

D. C. Shahani

SWN Indian Correspondent

India, though divided just a year ago, is still a very big country, having a population of some 350 million people. Very few are interested in radio as a hobby as there is little spare time, most having to work hard for a living. However times are changing and more and more young men are taking an interest in this fascinating science.

It will surprise many to learn that India has only some 50 amateurs and that few of these are active on the air. The following are active on 14 Mcs. phone:—VU2DY, Nagpur; VU2CQ, Bombay; VU2CA, Bombay; VU2GB, Bombay; VU2ET, Calcutta; VU2MX, Bombay; VU2EY, Jubbulpore; VU2BH, Ahmedabad and VU2DH in Cochin.

Amateurs work under considerable difficulties in India. The Government is not very sympathetic because of the possibility of the amateur using his transmitter for political and subversive activities. Before a licence is granted, thorough inquiries are made into the bona fides of the applicant. It may take up to a year to get a licence through. The annual fee is 10/- and a morse test must be taken.

There are few radio societies in India. One of the most recently formed in the India Radio Society and there is also an organisation known as the Indian Radio Amateurs League. One of the main difficulties is the lack of components, particularly for transmitting gear, and what there are are exorbitantly expensive.

MY FAVOURITE RECEIVER

No. 19. K. F. NORVALL

(We apologise for having omitted a "Favourite Receiver" article in the last two issues, but space has been very hard pressed. We hope that the two receiver articles that appeared in those issues will compensate. We hope to publish this feature every month again henceforth—we have enough articles in the file for over a year's issues!—ED.)

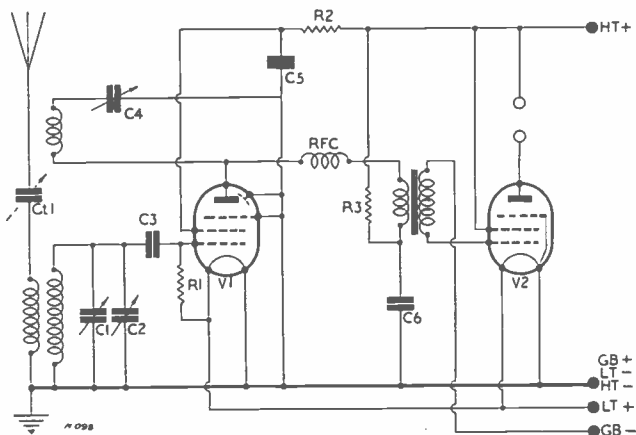

Fig. 1 (left). The original circuit.

THE circuit shown in Fig. 1; depicts the receiver "as was". It is a fairly orthodox O-V-1, using an SP2 for detector and an SPT210 tetrode as the output valve. Normal type reaction is used in the detector stage, which is transformer coupled in a parallel-fed circuit to the audio stage. The latter stage is also straightforward with no "frills."

Though the receiver performed as well as could be expected, it was later decided to incorporate some refinements in the output stage. Fig. 2 shows the modified output stage; the thin lines being the existing coupling circuit from the detector stage. The actual coupling remained the same, the main alterations being in the output valve HT leads. First of all the screen-grid lead of the SPT210 was supplied with a 10 K ohm resistor and suitably decoupled. The anode supply was taken through an RF Choke, with a 0.004 μ F capacitor taken from each side of this component to earth. The third modification was the provision of a volume control, taken care of by wiring a quarter-megohm potentiometer across the secondary of the coupling transformer.

Needless to say, the final output stage showed considerable improvement over the original circuit.

Fig. 2 (below). Modified output stage. (Existing components from detector stage are shown in light line.)

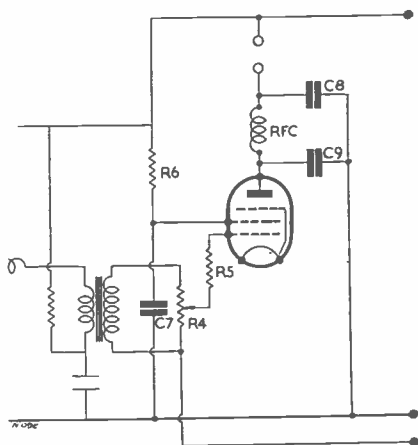

List of Components

C1	160 μ F.	C6	2.0 μ F	C5	0.1 μ F	Ctl.	Aerial trimmer.
C2	15 μ F	C7	20. μ F	R1	5 M Ω	Resistors	
C3	300 μ F	C8	0.004 μ F	R2	$\frac{1}{2}$ M Ω	R4	250,000 Ω
C4	200 μ F	C9	0.004 μ F	R3	25,000 Ω	R5	50,000 Ω
						R6	10,000 Ω

Resonant Lines

V.H.F. Converters.

SINCE describing the Converter for the Basic Superhet in the March issue there has been some discussion on the comparative performance of such a Unit and the Service types 24 to 27. Actually the performance of either is very much of the same order. On the point of cost the Service types score heavily, but one built on 'amateur lines has the advantages of enabling parts already on hand to be incorporated, will yield far more in the way of usable components if later broken down and is infinitely better for experimental purposes. Incidentally with my oft confessed penchant for bargains I bought one of each of the Service types and for cheapness would warmly recommend the type 24 (to those still unacquainted with it), for use on the 28 Mcs/band. With three flexibly coupled 15uF variable capacitors and all the "trimmers" removed except one in each stage, it spreads the 10 metre band nearly through the full travel without alteration to the existing coils—an extremely quick and simple conversion. Type 25 is ideal for television sound without modification.

One point which has led to much misunderstanding: the valves in both the 24 and 25 are SP61's. The frequently repeated mistake that they are SP41's is no doubt due to a misprint in the RSGB Service Valve Equivalents Booklet under VR65 (or CV1065). In fairness to the RSGB it must be added the misprint was noted and corrected in a subsequent Bulletin, but of course, the whole edition was wrong and many non-members seem to be unaware of the mistake. The Units type 26 and 27 are both tuned by 75 uF capacitors and use EF54's (VR136) for the r.f. and mixer stages and an EC52 (VR137) as the oscillator. Incidentally these are shown in the Booklet as Mullard RL7 and RL16 respectively—their CV (Common Valve) Nos, are 1136 and 1137.

The 26 covers the 5 metre band nicely without any alteration, tuning from 50 to 65 Mcs., but the frequency coverage of the 27 (65 to 85 Mcs. has less interest for amateur use unless the coils are re-wound. For the benefit of those who may not have realised it—the coils in both these types are the easily obtained "Alladin" formers (without slugs) so dear to the TV experimenters. They cost only 6d. each and they enable experimental coils to be made up without disturbing the windings. The original coils can thus be removed and retained for possible refitting later, and no alterations need be made to the chassis or wiring.

WITH EARS PRICKED UP.

Recently I wrote of things heard at a Club Meeting and as those comments were both contradicted and endorsed, but nevertheless enjoyed by many readers, I decided to note down some of the more pointed bits heard on forty and eighty. I often wonder why listeners do not use these bands more when tired of DX hunting—they are often far more fun than a B.B.C. variety programme. Without further ado here are a few jottings from my notebook.

PEACE AND QUIET.

"Yes, old man, this is the table top job I am using up here. The XYL wouldn't have any more stuff in the living room."

QSL-ING.

"Ask any amateur you like how many replies he has to his QSL's and you'll find it's about 70%. If, as all they claim, they verify 100%, where do the other 30% go?"

POINTED.

"G2—is using some barbed wire he's got nailed along the fence or something. Reckons he gets better results than with his old aerial."

TURN ON THE HEAT.

"The sparrows round here are tough. If I put any seeds in the garden they sit on the fence and watch where I put them and then dig 'em out when my back's turned. In winter they sit on the driven element of the beam to warm their feet."

ON HIS OWN HEAD.

"Yes, that was old G2—. We call him the village poisoner and if you have ever seen him with his hat off you'll know why we ask about the hair-restorer he displays on the counter."

HOME, JAMES, AND DON'T SPARE THE HORSES.

"There was a good crowd there until someone came in and said the band was open for "G" DX. Then half of them went home."

SHEDDING THE LOAD.

"Every time he presses the key the street lamps go dim."

NO SECRECY.

"I never use CW since I brought this in the living room. The XYL thinks it's unsociable."

IS IT TRUE WHAT THEY SAY ABOUT FORTY.

"There's a much better spirit on 7 Mcs. Far more ham gear too, instead of streamlined commercial stuff and you're always sure of a decent ragchew with someone really interested in radio and not simply DX and QSL hunting."

TOO BAD TO BE TRUE.

"He gave me a play-back of my own transmission. They were my words all right but I don't think my voice really sounds like that even with this microphone."

W.A.C. ?

"Yes, he's getting quite a lot of cards meant for someone pirating his call. Better DX than he's ever worked himself."

WITHOUT COMMENT.

"I got the circuit from QST, and like all American circuits I've tried, it worked first time—which is more than I can say of some of the English ones I've tried."

Yes, dear readers, some time when I am not quite so busy I must have a look round and see if the trawlers are as rich as they were in pre-war years!

Bencie Yap



AROUND THE SHACKS

No. 20

Headquarters
Station of the
East London
ISWL Chapter

THIS Station is owned and operated by A. BALDWIN, ISWL G193 who has been a keen SWL since 1937 when operations commenced with an O-V-O. The present equipment has been evolved since demob from the forces in February 1946.

Top left is the station's heterodyne frequency meter, accurate to within $\frac{1}{2}$ kc., built from government surplus and incorporating bandspread tuning—the dial itself reading 1 kc. per division. The whole unit is contained within a rigid metal box from the local junk store. The valve is a VR65 and power is derived from the left hand RX. In the centre is the indicator panel, the left hand light (red) indicates that the left hand RX is in use, the right hand light (green) operates when the RX on the right is in operation. The centre light (red) glows when the shack power is on. On the top right is the speaker for the centre RX.

Lower left is the speaker for the left hand RX. Both the outside receivers are similar. They are very much modified B2 government surplus receivers that have been literally torn apart and used as the "heart" of a communications set. These sets now include a regenerative tuned RF stage with inductances switchable from the front

panel, antennae trimmer, indicator or pilot light, "magic eye" (Mullard EM4) bandspread, audio filter, switchable BFO and switchable fone or speaker output. The centre RX is the famous "Hambander," recently acquired—a vy fb equipment! Speakers are both Rola, one 6 in. and the other 8 in. Phones are (a) Ericsson and (b) government surplus moving coil.

Antennae are (1) Inverted "V"— $1\frac{1}{2}$ wave per "leg" 35 ft. high. (2) 35 ft. wire, E-W 66 ft. high. The station includes an antennae control panel (not shown) on which both aerial terminate and are quickly switchable to all receivers by means of knife switches. Also contained but not shown is an "admin" table on which is contained a card index system for the amateur stations and one for Bc stations—the latter using the SWN index cards. A workbench complete with power, light, tools and the inevitable junk box complete the equipment whilst an extensive library supplies most of the "gen"!

With this equipment some 39 Zones and 123 countries, all on amateur bands, have been received to date *this year*—mostly on CW.

Linked with this station in the Leytonstone area are five other SWL posts who, by pre-arrangement,

(Continued on Page 240)

SW Transmissions from the Antarctic

There are at present a number of scientific expeditions operating in the Antarctic from both ship and shore bases. One of our readers, Rubens J. Villela, Sao Paulo, Brazil, has sent us the following information about these expeditions.

Rubens has made a speciality of the expeditions and we feel the following report is an excellent example to other SWL of the type of work which can be produced by the really keen SWL. Rubens is 18 years old and uses a Hallicrafters S 40 receiver. His antenna is an inverted L, 33 ft. long, located in the roof of the house.—Ed.

The RONNE Antarctic Research Expedition.

THE first notice I had on the R.A.R.E. was in the "QST" of March, 1947. I read the "Port of Beaumont, Texas" is assigned the call AYZH and several freqs. on the 36-metre ship band. I know the AYZH departed from Texas on January 25, and reached the coast of Antarctica on March 12, 1947.

On June 18th, 1947, I picked up the *New York Times* station, WHD, on 16720 kcs., calling the AYZH and asking for answer on 12480, and saying "QTC lots." However, no reply was heard. After this date, WHD no more called the ship (at least, not on 16.72); and continued to pass traffic only to LI2B, the expedition Kon-Tiki. I did not look for WHD on their other freq. of 8360.

On December 29, 1947, I received a letter from a SWL of West Virginia, USA.—Mr. W. J. Arthur—saying that RARE had been heard on fone on 9135, 12862.5, 17310, 22225, 22250, and about 16210, with assigned calls *KICJ*, *KQL*, and *AYZH*. By the way, the freqs. of 9135, 12862.5 and 17310 were also utilised by the NBC station (KNBH) installed in Brazil for special programs to USA, at the time of the sun's eclipse of May 20, 1947.

On January 3, 1948, at 2338Z I heard for the first time WEK, New Orleans, on 17270a, giving messages to the KICJ. And on Jan. 5, at 2114Z, I heard KICJ for the first time, on 17310, in automatic CW: "WCA de KICJ ere KQL OM K" KICJ was received here QSA3/2. At 2302 GMT KICJ was already in tfc. to WEK. Since this date I have logged several contacts with WEK, and lots of msgs were copied here. Commander Finn Ronne literally enthused about me with his simple style, in describing things about Antarctica! I'm now always interested in reading anything about that "lost white continent," where the "six feet three and a half inch radio operator Lawrence D. Kelsey" gained "a total of forty-five pounds in less than six months." Also, it was funny to listen to a ragchewing between KICJ and WEK's op, on Jan 7. he said: "We were working cargo with no shirts today . . . but during winter it was ruffer, temperature 38F below . . . penguins are punky little devils . . . they beat our shins with their wings if we approach their nests" . . . hi!

Generally speaking, reception of KIJC on 17310 was characterized by the fading, sometimes signals varied from S9 to S2, in a very brief period! However, I believe, if my rcvrs were working properly, the QSB would not be so accentuated. Such a QSB was also noted in the signs. of G1S9, 16940, aboard USS Burton Island, and of CARA, 16600, Chilean ship Rancagua, both near Marguerite Bay, at the time considered. On frequencies below 13 Mcs. a slight QSB was noted only on fone transmissions of stations in Antarctica (LQX, Melchior, LQX2, Deception Is., both on 12330; CARA, 11029; also LRW, S. Orkneys, 13700).

Sometimes KICJ sign. on 1731; suffered heavy CW-QRM from BOAC stations in the Orient: ZKC2, Kaitak (Hongkong?); ZQK3, Singapore; HSD, Bangkok; VJA, Australia, etc. The worst one was ZCK2. I observed that KICJ freq. of 17310 varied within about 5 kc.

I only heard KICJ twice on 12862.5; once on June 21, 1948, at 0002, QSA3 (comparatively poor); and again on Feb. 27, at 0154 (sig. better and stronger than those of CCP, Punta Arenas, 12950).

I did not hear W3LYK/Antarctica on the ham bands, but I did not try very carefully (although I had heard WEXO, the "Yankee"; RAEM, in the Arctic; W5MET/MM, QRD Tocopilla, Chile; VP8AD, S. Georgia).

On Mar. 19, the following advice msg. was copied from GLY, 19100a, commercial station of London, sent to VPC, Port Stanley, Falkland Is.: "A10 Portishead Radio Port Stanley 20-SD67/18 Urgent Commander Vinn Ronne MV Port of Beaumont AYZM via Portishead Radio. Can sender give particulars of voyage?"

On Mar. 26, VPC passed the following msg. to GLW, at 2117Z: "S nr. 69 PSy ETAT 5226 1415—Commander Finn Ronne MV Port of Beaumont/AYZH via Capetown Radio—Reference to your enquiry regarding ice condition Marguerite Bay. Sea ice broke up . . . etc. . . signed: Governor." On Mar. 28, the tfc. list of ZSC, Capetown Radio, included the AYZH (at 0020Z on 8440).

On Apr. 7, VPC sent this msg. to Antarctic Base "E": "A9 Capetown—Major Butler VPRZ—Msg. of 26th to Comdr. Finn Ronne MV Port

of Beaumont undlvd. vessel did not communicate" They did QTA it.

Several "press" msgs. copied here fm. VPC, Port Stanley, 8550, sent to London newspapers, mention often the RARE, specially the person of Comdr. Finn Ronne. One of them says, for instance: "A privatized expedition under Comdr. Finn Ronne wintered last year Stonington Is. F.R. is from USA and is working in cooperation in a gratifying manner with our men . . ." And so on. Special references were done to the RARE and to Mr. Finn Ronne in the FIDS Governor's speech of Feb. 22, regardless the rescue of a crashed British plane and of an American who had fallen into a crevasse, the joint sledging trips, etc.

The information on the RARE and on the Australian Exp. I got from American SWLs, but all other items reported below were "fished" and compiled here after a very careful and exhaustive "hunting" in the shortwave bands.—

AMERICAN EXPEDITION (US NAVY)

The Second Antarctic Development Project (AG88) of the US Navy was made up by two icebreakers—the USS Burton Island and the USS Edisto. Main purpose was to chart and complete Byrd findings.

The Burton Island departed from California, USA, on Nov. 21, 1947, to Samoa, where she joined the Edisto. Then both ships left that island on Dec. 5, proceeding independently to Scott Is. Planned route was Scott Is.-Balleny Is.-Bunger Oasis; then ashore of the continent to Little America, Porter I Is. and Marguerite Bay.

Assigned calls are *NIQC* for the Burton Is., and *NIQY* for the Edisto. To the entire task group was assigned the call *G1S9*, probably aboard the Burton Is.; this station relayed almost all the tlc. of the other ships, and only a few msgs. were copied here directly from *NIQC* or *NIQU*. Most used freq. was 16940; also 12705—to NSS, Washington, DC, NPM, Pearl Harbor, etc., all them in the same calling freq. Sometimes it was necessary to pass tlc. via NBA, Balboa, CZ. Call of Tutuila, Samoa, is *NPU*—. In general, the signals of *G1S9* were unreadable here (revr w/ poor sensitivity) and only a few msgs. were copied. Contacts had been done around 0100Z, and sigs. were more solid after 0130Z, hr. Apparently, *G1S9* had not good reception for the US Navy stations. Some QSB was noted in *G1S9*'s sigs. hr and in USA. Msgs. consisted of coded WX, situation or merely position reports (sit-rep. positrep), and others. Vessels copied the NPM "Fox". A sitrep from *G1S9* (Jan. 10) says "This is definitely a bad ice year in this area." (Bunger Oasis.)

By the way, I also followed the 1946/47 US Navy-Bryd Exp. (This was the first hunting I ever made in radio—by that time I still didn't know almost nothing about US Navy com-

munications . . .). Main station of the "Operation Highjump," TF68, was T6L8, on USS Mount Olympus, and had a special circuit with NSS (12435, 16580, 20725, 24870, 13680), using the freqs. of 12885, 13420, 17180, 19090, 21925, 25770—CW and teletype-radiophone on 9440 and 13 mcs. Mostly used freq. was 21925. Also had 12510, 16680 and probably the harmonics of 4170, 8350, for contacts with the other task groups.

I have here the October, 1947, issue of the National Geographic Magazine with Byrd's article (and maps) on the expedition.

BRITISH SHIPS AND STATIONS

Bases:

There are seven (or perhaps eight) British bases in Antarctica; five of them are in the sector claimed by Argentina and Chile:—

Stonington Island (Marguerite Bay).
Deception Island (Whalers Bay).
Admiralty Bay (King George I Islands).
Port Lockroy.
Argentine Islands.
Hope Bay.
Signy Islands.

They are designated with letters of the alphabet from A to H (except the C): Base A, Base B, Base D, etc. Assigned call letters are: *GNME*, *GNME2*, 3, 4, 5, 6, 7. Sometimes abbreviated calls are used, as G5, G3, etc. Chief base is the "E," *GNME5*, located at Marguerite Bay. Base B, *GNME2*, is at Deception Island. At Port Lockroy, was installed recently the only ionospheric observing set in Antarctica. Base G may be Admiralty bay.

The following freqs. are assigned to the bases, for CW and 'phone operation; 3000, 4000, 4400, 6400, 8000, 8800, 16520; and 12685 (probably). They have a xtal of 6342.5, but I believe it is used only on the 2nd harmonic—12685 (this latter freq. was also utilized by G8XY/P, of a British expedition to Newfoundland, that had been contacting GZZ9, also in the same frequency).

GNME5 contacts the other bases at 2300z on 6400; 1200Z and 1800Z on the 12 mc. freq. (in CW, but sometimes makes tests in fone); collects then the WX obs. reports of the bases.

Contacts VPC, Port Stanley, 8550a, at 2330 on 8800; 1230 and 1830Z on 16520. Passes then a WX synop and relays msgs. from the other bases. *GNME2* will be making tests of WX broadcasts at 2330Z on 4400, 1230Z and 1830Z on 8800, when new xmttr installed.

These routine time skeds. with VPC would be modified—probably advanced to 15 minutes later —when the new W/T station in Stanley be fully operative.

Reception for the British bases here in S. Paulo is poor. For instance, while Base B, Deception, is QSA2/1 on 6400, the Argentine base at that

same island is QSA3/4 on 6610. It seems the xmters of the British bases are low-powered. GNME5 puts in the strongest sigs. hr: QSA2/3 on 6400, and QSA3/3 on 6400, and QSA3 on 8800, at 2330Z. Actually, GNME5 is some 10 kc. below the "announced" freq. of 8800 (QRM-ing WWMW, Philadelphia; WWMA, Detroit, and others in CW). The 6400 freq. is badly QRMed by Russians CW stations (UWZ, UUX, etc.).

VPC, Port Stanley, operates on several freqs. most used is 8550:

To GNME5—2330, and probably also at 1230 and 1830. Occasionally contacts the other bases, too.

To ZBH, South Georgia—2300 around 1230.

To the most important ships—several hours.

To London, GLW, 19100, or GLY, 11420—2100 and 0000 (commercial tfc.)

To LPD, Buenos Aires (8410, 16665)—1200.

To LGC, Bergen, Norway (11170)—2230.

WX "FICol" (Falkland Is. collect) broadcasts—2200, 0100, 1415(?).

19980a: To GYJ9, London, 13690, 21070—1800 for the Admiralty tfc).

8390a: To GYC, London, 9105a—0200Z (discontinued now?) (Admiralty tfc).

8400a: To ships in general; CQs arnd 2130Z; also on 500 kc.

Other freqs. apparently not in use at present: 8290, one near 11 mc., 12370, arnd 12.6, 16880, 17100, 19510. Last year, I heard VPC on long wave on our BC set, a few kcs. above 500 kc., QSA1/2, 0100. The new station VPC has been testing on 8555, and comes in hr poorer than the "old" VPC (which is very strong!). Both stations use mainly M.C.W.

ZBH, S. Georgia (Leith Harbour), 11200, 8350, makes CQ to ships at 0100 on 8350, and listens on 36-metre band.

SHIPS

The following ships belong to the F.I.D.S. (Falkland Is. Dependencies Survey), and are usually in Antarctic waters; they operate mainly on the 36-metre ship band, in C.W.:

GFLF, M.V. "John Biscoe," 8250, employed as a relief ship to bases.

JGF, H.M.S. "Snipe," 8280a. (Has also a call "TYY").

VPRZ, F.I.D.S. "Fitzroy," 8280, 405 kc.

These ships work mainly VPC (8550a), ZSC, Capetown (8380) and the bases. The GFLF was reported by VPC as testing on fone, on 8000kc., by the time the "Nigeria" was in the far southern dependencies.

The "Snipe" had been using the call letters TYY for contacting ZSC, on about the same freqs. of XTT. She departed to Port Stanley priorly to the Nigeria (according to a msg. passed to ZSC, on 16585, at 1410Z, she left Grytviiken, S. Georgia, on Feb. 10, 1400z).

A "press" msg. fm VPC says:—"During the winter months a special programme called "Calling all FIDS" is broadcast by Stanley BC station. This is well received and among items are messages from parents of Falkland islanders living in our far southern dependencies. In a most successful programme last Christmas his excellency and Mrs. Clifford took part. This helps to link our dependencies to the capital. As these programmes are heard by Argentina and Chile no doubt they will also try and copy us in this as in other things . . ." and so on.

Also, a special local news bulletin is transmitted to the bases and to ZBH, by VPC, on 8550a, on Mondays or Fridays only, at 2330Z, in C.W.

(Continued next month)

INVISIBLE REPORTS!

The "National Newsagent, Bookseller and Stationer" draws attention in a recent issue to the subject of ball-pointed pens. It appears that certain continental manufacturers are using writing fluids that, within a few weeks, just fade away! To the ham it would be very frustrating to turn back the pages of his log-book only to be rewarded by blank pages! Also, of course, the SWL who sends a report may well never receive a QSL simply because when his report arrived the fluid had faded and nothing could be read. The Dutch authorities have banned the use of this type of pen for Post Office documents, but we cannot, of course tell whether pens manufactured in this country use writing fluids that have the disadvantage of fading after a few months. We would appreciate comments from readers who have been using this type of pen for any considerable length of time.

A NEW FACE

No, we are not talking about beauty treatment! We mean typeface. Observant readers will no doubt have noticed already that this issue of the "News" has a somewhat different appearance. We are now using what is termed "Bodoni" type. The use of this type enables us to pack much more information into each issue so that despite the paper shortages we are now offering you several hundreds of extra words each month. Though more words are used, the new type does not result in a cramped appearance. On the contrary, it is even easier to read, as the letters being small, enable more space to be used between lines, while at the same time being denser than the old face. The result is of black and white against grey and white.

BROADCAST BANDS

(Continued from page 221)

● Honour Roll

Name and Country	Countries verified	Countries heard
S. Pearce (Eng.)	108	113
A. Cushen (N. Zealand)	107	—
J. Beauvoir (Natal)	85	106
M. Preston (Eng.)	73	119
E. W. Field (Eng.)	52	76
J. A. Jagger (Eng.)	50	98
A. Levi (N. Ireland)	49	55
Dr. T. B. Williamson (Eng.)	47	102
A. V. Wilkinson (Eng.)	41	99
C. M. Southall (U.S.A.)	41	76
G. H. Friend (Eng.)	40	62
L. W. Lewis (Eng.)	39	74
D. O. French (Eng.)	29	62
E. Strangeway (Eng.)	20	71
S. D. Tovey (Eng.)	12	56
R. Iball (Eng.)	11	63
J. Burden (Eng.)	6	104

N.B.—All lists must include only Broadcast stations and purely Short Wave ones. For newcomers mark country and station heard/verified.

Acknowledgments

The Editors and Monitor wish to thank all those who have kindly sent along news compiled in this article.

* * *

SHACKS (Continued from page 236)

keep a survey of one broadcast band and all amateur bands. The broadcast band is altered every fortnight i.e. the current survey being on the 15 Mcs. band. Also, a target station is selected fortnightly for observation, VP4RD being this period's choice. All information so received is then collated and will be forwarded to ISWL HQ. Membership of the chapter entails no rules—it asks only for enthusiasm and there are no financial obligations of any sort whatsoever. Meetings are held fortnightly at the HQ Station.

* * *

ISWL (Continued from page 229)

Dud West has popped into the breach and his address is to be found in the Chapter list elsewhere. Good luck OM.

Over to Glos. . . local members please note a new QRA for the CR—D. C. Wright, Park Cottage, Twynning, near Tewkesbury. A new brace of TR's have been appointed, viz: J. Nottingham, Wickeridge Farm, Folly Lane, Stroud and D. G. Martin, 65a Winchcombe Street, Cheltenham. Will members in the districts please contact? Tnx.

* * *

GENTLE REMINDER

Have you had your copy of the "Annual" yet? If you are a DX'er, either amateur or broadcast, you simply cannot get along without a copy! See advertisement on outside back cover.

PYE V.H.F. Radio Telephone's success at Spa Car Racing Events

"LES ANGLAIS SONT ENCORE FORMIDABLES"

BRITISH V.H.F. radio-telephone equipment scored a sensational success in a new field on the 10th/11th July, when the three radio-equipped HRG cars captained by Peter Clark won the team prize in the Belgian 24-hour race at Spa, thus securing for Britain the premier award in the premier European road-racing event.

During the race, which was run under bad weather conditions, over 20 major crashes occurred, and so excellent was the transmission and reception of the Pye radio equipment used by the HRG cars that their main station in the pits was linked via its P.A. tappings with the ambulance tents, and as the cars tore round the circuit their drivers were reporting crashes and calling and directing the ambulances. The team was on the air for part of the time as a live broadcast over Radio Belge; this was recorded on strip and so good was the reception that it is understood that Decca have arranged to re-record the impromptu programme on disc.

The BHF installations, made by Pye Telecommunications Ltd. of Cambridge, were the same as those already installed in some 50 taxi fleets and scores of other transport devices in this country, literally revolutionizing transport control in the 10 months since the first GPO licence was issued for business radio. This was obtained by Pye, who have since made over 80% of the installations in use in Britain, including hundreds for the Home Office.

Peter Clark, captain of the winning team, said on his return: "The three mobile units and main set worked perfectly throughout 24 hours of continuous use despite the abnormal stresses imposed by racing. We definitely could not have won without the Pye equipment; on one occasion a car broke down out on the circuit and the chief mechanic was able to tell the driver how to get it back to the pits over the radio. The Belgians were almost as enthusiastic about the equipment as we were."

The great HRG win was a mutual triumph for the cars and their drivers: and for the Pye installations, and as the Belgian press and radio gave major space and time to the story it has meant tremendous publicity of the best type for British cars and RT equipment. "Les Anglais," say the Belgians now, "sont encore formidables!"

* * *

ANOTHER REMINDER

Concerning the ISWL badge. These are now available, in either stud or brooch types, at 3/6 from ISWL HQ. Every member should wear one of these attractive three-colour badges. Have you had one yet?

TRADE REVIEW

BOOK REVIEW

F. B. Products of 41 Carlisle Street, Bradford, Yorks., have sent us samples of their interesting range of aluminium chassis. It is obvious that some careful thought was put into the design of these chassis as they are of a design not hitherto seen. The theme is the emphasis on rigidity—an important item when it comes to aluminium chassis, which are too often rather too flimsy for satisfactory work.

To ensure adequate rigidity, the "FB" chassis have two features of interest. Firstly, the "ends" of the top of chassis are bent over to form a flange to prevent excessive flexibility. Secondly a novel feature is included beneath the chassis. The latter consists of two stays, both fitted to the main chassis with four bolts, countersunk so that the surface is free from protruding bolt heads which would be inconvenient when fitting the panel, etc. The stays are also of aluminium and are bent strips, the ends of which are subjected to the same treatment at the top of the chassis, i.e., they have their ends bent to give added rigidity.

At present, three sizes are available, 5 in. by 8½ in., 10 in. by 8½ in. and 17 in. by 10 in.; prices being 5/-, 6/6 and 9/- respectively. The smallest size is particularly interesting since chassis of these dimensions are not always easy to obtain. The sub-chassis in all cases is 2½ in., which allows ample room for almost any need.

We are informed that holes will be drilled and punched at a nominal cost. Templates should be supplied as a guide to the required positions. Though only three sizes have been quoted, it is understood that chassis can be made to order of any size. Delivery on stock models is by return of post; on specially made chassis 2-3 days.

DANISH WORLD RADIO HANDBOOK FOR BROADCAST LISTENERS

We have received from O. Lund Johansen, Copenhagen, Denmark, a copy of the *World Radio Handbook for Listeners*. This reference book is published in several languages two or three times a year, and whilst money restrictions make its acquisition in this country difficult at present we feel that this excellent publication deserves mention in our pages.

The Handbook gives most extensive information on all the chief broadcasting stations, SW—medium and long—in the world. Frequencies, wavelengths, call signs and power are shown, the address of each station and the names and titles of the leading personalities of the company owning the station.

A survey of the type of programme radiated during the day is given and hints on identification, including the musical score of chimes etc., are included.

A feature much appreciated by SWL's is a note regarding whether or not verifications are sent and what type they are—letters, QSL's, cards, photos, etc.

The book is most beautifully produced in a style which makes those of us in this country who have to publish under the cramping restrictions of paper rationing, just green with envy. It is well illustrated, with pictorial maps and photos. Altogether a very high class production. Its representatives in this country are:—Vagn. H. Fenger, Det Danske Selskab, 136 Oaktree Lane, Selly Oak, Birmingham; Erling Norlev, Det Danske Selskab, 74, Deanwood Avenue, Muirend, Glasgow, S.4., Scotland; and Count Scheel, Danish Information Office, London.

A.C.G.

H.A.C.

Short-Wave Equipment

Noted for over 15 years for
Short-Wave Receivers and Kits of quality

One Valve Kit, Model "C" - Price 20/-
Two " " " " "E" - Price 43/-

These kits are complete with all components, accessories, and full instructions. Before ordering send stamped addressed envelope for descriptive catalogue.

Note new sole address:

"H.A.C." SHORT-WAVE PRODUCTS (Dept. SWN).
66 New Bond Street, London, W.1

"You'll probably get it at

Smith's of Edgware Road"

The Book on how to make it,
The Material to make it with,
The Components to put in it,
The Equipment to test it with,
The Cabinet to put it in.
(AND a fair deal!)

H. L. SMITH & CO. LTD.

287-9 EDGWARE ROAD, LONDON, W.2

Near Edgware Road Met. and Bakerloo
Phone Pad 5891 :: Hours 9-6 (Thurs. 1 o/c.)

SMALL ADVERTISEMENTS

Readers' small advertisements will be accepted at 3d. per word, minimum charge 3/-. Trade advertisements will be accepted at 6d. per word, minimum charge 6/-. If a Box Number is required, an additional charge of 1/6 will be made. Terms: Cash with order. All copy must be in hand by the 10th of the month for insertion in the following month's issue.

PRIVATE

FOR SALE: 1155 Receiver in good condition, with power pack for AC mains, and P.P. output, with 12 inch Vitavox speaker. Price £12. London area. Call for demonstration, or write to 142 Dibdin House, Maida Vale, W.9.

SACRIFICE: 1-v-2, crackle cabinet, 12 6-pin coils, 9-360 metres. 0-v-1, 2-16 metres, cabinet 7½ x 4 x 3½. Eliminator and charger, Accumulator. All spanking condition. £12 or offers.—Dean, 4 Picton Street, Leeds 12.

Ex-U.S. Air Force Command Transmitter. SCR274. 5-7.5 Mcs. 6J5 ECO plus Crystal. Parallel 1625's PA. (12v versions of 807). Needs Power pack. Supplied with circuit diagram. £2 10 0. Box 1037 Amalgamated Short Wave Press, 57 Maida Vale, Paddington, London, W.9.

Crystal Monitor, Type 4A, ex-R.A.F. 100-130 Mcs. Crystal check. 230 v. A.C. input. £2 10 0. American 3" Cathode Ray Tube, complete with holder and mumetal shield. Type 3 BP1. 6.3v heater. New 25/- Rothermel Senior crystal pick-up 25/- T1154 Transmitter. Ex-R.A.F. complete with all valves. Has been used on Ham bands. £2 10 0. Box 1035.

Air Ministry Type 37 Oscillator. Brand new. Modified for Ham use. C.W and fone. 20-80 Mcs. 807 in final. 230v. A.C. with circuit diagram. £10 0 0. Box 1036.

Billy or RCA 100 kcs. Crystals, new, for frequency standard in hermetically sealed mounting with holder. £1 0 0.

Mains Transformer 200-250 AC. 350-0-350. 180 M/A. 3 LT windings, 4V, 3A, 4V, 4A, 4V, 4A. 15/-.

Valves. Slightly used, but guaranteed O.K. P.T.15/. 12/6 each. ISWL/G15, 64, Cavendish Road, Kilburn, London, N.W.6.

COMMUNICATIONS RECEIVER. AC, 6 valves, bandsread, BFO, etc., 6-550 metres, in good condition. £12 or near offer. M. Preston, 15 Temperley Road, London, S.W.12.

TRADE

RAYMART Stockist. Also Denco, Wearite, etc. SMITH'S Radio Supplies for everything Radio. Quick Service. Send stamp for lists. 98 West End Road, Morecambe.

J. V. NEWSON, G3GY ex G2GF, 28 Market Place, North Walsham, Norfolk. Everything for the Ham and Constructor, large stocks of the things you want. Eddystone, Raymart, Hamrad, Labgear, Woden, Weymouth, Wearite, etc. Stamped envelope with enquiries.

CALL BOOK. Complete list of HAMS throughout the world 10/-, plus 9d. postage. Radio Handbook latest edition 17/6, post paid. Order now, the above are in stock. C.Q.—The Amateur magazine published in the U.S.A., subscribe now, only 17/6 for 12 large monthly issues. Dale International Publications, 105 Bolsover Street, London, W.1.

G6MN for the "best" QSL's and approved log books, send for samples: G6MN, Bridge Street, Worksop, Notts.

QSLs and G.P.O. approved log books. Samples free. Atkinson Bros., Printers, Elland, Yorks.

BUILDING RADIO IS EASY

If you know how

Books in which Experts give you valuable information.— "The Principles of Short Wave Reception" 1/6. "Short Wave Radio Handbook" 2/-. "These you can hear" 2/-. "The Basic Superhet" 1/-. "Communication Receivers Manual" 2/6. "Radio Designers Manual" 2/6. "Radio Constructors Manual" 3/-. "Radio Tuner Unit Manual" 2/6. "The Telesvisor Manual" 2/6. "Television Constructors Manual" 3/6. "V.H.F. Technique" 3/6. "Valve Technique" 3/6. "Ultra Short Wave Handbook" 2/6. "Radio Hints Manual" 1/6. "Amateur Transmitters Construction Manual" 2/6. "The Transmitting Licence" 9d. "Modera Radio Test Gear Construction" 1/6. "Cathode Ray Oscilloscope Manual" 2/-. "Radio Repairs Manual" 2/6. "Frequency Modulation Receivers Manual" 2/6. "Car and Portable Radio Constructors Manual" 2/6. "Sound Equipment Manual" 2/6. "Radio Calculations" 3/6. "Wireless Amplifier Manual" 2/-. "Eddystone Short Wave Manual No. 5" 2/6. "Eddystone Short Wave Manual No. 6" 2/6. "Denco Technical Bulletin No. 1" 3/-. "Denco Technical Bulletin No. 2" 3/-. "Short Wave Listeners' Annual, 1948", 3/6.

Postage extra on orders under £2.

Send now for our 60 page illustrated "Ham Catalogue No. 6." This contains details and data on over 1,000 components by the leading makers. Price 9d. post free.

SOUTHERN RADIO

AND ELECTRICAL SUPPLIES

85 FISHERTON STREET, SALISBURY, WILTS.

Telephone: Salisbury 2108

IMPORTANT NEWS!!

AMERICAN MAGAZINES

We are pleased to inform readers of the "Short Wave News" that the Government have appreciated the necessity for allowing technical magazines to enter this country from abroad.

We feel that the Government's decision is just, particularly with regard to the amateurs who have contributed so much to the development of radio communications. We therefore have pleasure in giving an abbreviated list of the radio publications that we handle, but would remind you that we are agents for all American technical publications, and shall be pleased to receive your enquiries:—

Q.S.T.	25/-	per year
C.Q.	17/6	per year
ELECTRONICS	75/-	per year
AUDIO ENGINEERING	20/-	per year
COMMUNICATIONS	15/-	per year
RADIO CRAFT	22/6	per year
RADIO NEWS	25/-	per year
					(All Post Paid)	

Upon receipt of your order and remittance, we will Air Mail the Publishers in order to ensure that your first copy reaches you with the minimum of delay.

DALE INTERNATIONAL

Publications Limited,

105 BOLSOVER ST., LONDON, W.1

Telephone: MUSeum 1023

Obtain the
**P.M.G.
CERTIFICATE**

with the personal
assistance of E.M.I. Scientists

A special correspondence course for those wishing to take the P.M.G. certificate has been planned by E.M.I. Institutes. It brings you tuition under the personal supervision of E.M.I. scientists, several of whom hold the transmitting licence. College and other correspondence courses, covering basic radio and basic television are also available.

A former student writes . . . "the excellence of the course . . . absolutely assured my success in the examination."
—J. I. (Cumberland.)

Write for details to:—The Principal:

E.M.I. INSTITUTES LIMITED
Dept. 50, 43 Grove Park Road, Chiswick, London
Telephone: CHISWICK 4417/8

*E.M.I. Institutes—the Training College with Britain's
Leading Electronic Organisation behind it.*

E.48

SHORT WAVE CONVERTORS. Ex-RAF RF UNITS. Complete ready made convertors that require little alteration. Normal voltages, input. TYPES 24 and 25, cover 15-30 Mcs. and 30-45 Mcs. respectively, and are complete with 3 valves, slightly used models at 16/6d. each, or **BRAND NEW IN MAKERS' CARTONS** 25/- (postage 1/6d.). TYPES 26 and 27 cover 45-60 Mcs. and 60-85 Mcs. respectively. They are fitted with a 3" illuminated slow motion dial, and are also complete with 3 valves. **BRAND NEW IN MAKERS' CARTONS, ONLY 35/- each, or a few slightly used TYPE 27 only at 27/6d.**

TELEVISION CONSTRUCTION UNITS. Two items of ex-RAF RADAR gear which will make a television receiver with little alteration, and the provision of a power supply. ITEM 1 is the R 3118 1½ METRE SUPERHET RECEIVER. The I.F. is 12 Mcs. and the I.F. Transformers provide for 4 Mcs. band width. This unit incorporates its own power supply for normal AC mains input, and it is complete with 15 valves as follows: 6 type SP61, 3 EA50, 2 EF54, and 1 each EC52, P61, 5Z4G, and Y63 Tuning Indicator. **ONLY 79/6d. (carriage etc., 15/-).**

ITEM 2 is the RADAR INDICATOR TYPE 6. This incorporates a 6" Short Persistence Tube VCR97, and 4 valves Type EF50, and EB34. **ONLY 67/6d (carriage etc. 15/-).** EACH PAIR OF THE ABOVE UNITS IS SUPPLIED WITH A COPY OF THE CONSTRUCTION DETAILS FOR "THE £15 TELEVISION RECEIVER."

C.W.O. Please

S.A.E. for lists

U.E.I. CORP.

The Radio Corner, 138 Grays Inn Road, London W.C.1

(Terminus 7937)

(Open until 1 pm. Saturdays, we are 2 mins. from High Holborn, 5 mins. from King's Cross)

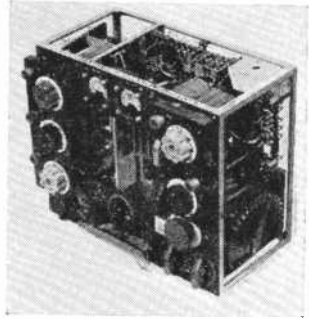

1154 Tx. as illustrated, complete with all valves, for phone C.W. or M.C.W., price £8.

BC 603 Rx. Frequency Modulation Receiver with 10 valves, manual tuning, a bargain at £7 10s.

BC 453, 6 valve receivers brand new at 40/-. 30 ft. sectional masts 25/-. H.R. Headphones 8/6 and dozens of other items much too varied to list in an advert. Stockists of all the well known makes, Denco, Belling-Lee, Gardners, Labgear, Wearite, Woden, etc. All orders for new and surplus gear are **CARRIAGE FREE**, delivery guaranteed by return of post, a very useful service when you require something in a hurry. Our 10 page catalogue gives details of all the items stocked, as well as our free gift scheme, may we send you a copy, post free? Save time and money, order from

TORBAY ELECTRIC

43 COLLEY END PARK, PAIGNTON, S. DEVON

1000's and 1000's
of "VERIES" and
SWL/QLS CARDS

have been supplied for Hams in
many Countries by:

G 6 M N

who knows your requirements

Printer of QSL'S
since 1925

Send for Samples to:

G 6 M N

CASTLEMOUNT,

WORKSOP, NOTTS.

Now Ready

THE 1948 EDITION OF THE
SHORT WAVE LISTENERS
ANNUAL

The new edition contains **112 Pages**
Crammed full of data for the DX-er.

Among the new features are:- Radio Zone Boundaries—Society QSL Bureaux of the World—Tabulated Schedules of W/T stations—International Short Wave League Section—State and Zone Record Tables—Time and Frequency Check Transmissions—Postal Data—DX Maps.

READERS OF LAST YEAR'S "ANNUAL" WILL NEED NO RECOMMENDATION. NEW READERS WILL BE ASSURED OF AN INFORMATIVE BOOK THAT WILL BE CONSTANTLY IN USE—Either as a SWL or a transmitting amateur.

Obtainable from your Local Bookseller at

3/6

Or Direct From The Publishers at
3/9 post paid

The popular features contained in last year's edition are all enlarged and/or revised.

AMALGAMATED SHORT WAVE PRESS, LTD., 57 Maida Vale, Paddington, London, W.9

The "HAMBANDER" COMMUNICATIONS RECEIVER
The Natural Choice for the S.W.L.



A complete receiving station for only **£22/10/0**
Don't delay, send today 2½d. stamp for Illustrated Brochure.

Direct from Factory to you
Hire Purchase facilities.

RADIOVISION (Leicester) Ltd. 58-60 RUTLAND STREET
LEICESTER Phone 20167

The leading makers of amateur communications receivers in the British Isles.