

# SHORT WAVE NEWS

Vol. 2 • No. 12

DECEMBER, 1947

*In this Issue*

## **V.H.F. News**

**Amateur Radio  
Exhibition Report**

**Around the  
Broadcast Bands**

**Two Receivers are  
better than one!**

**Radio Station OIX-7**

**Resonant Lines**

**Around the Shacks**

**I.S.W.L. Notes**

**On the Ham Bands**

**My Favourite Receiver**

**Radio Amateurs'  
Examination Report**

**Component Review**



The Swedish Ship "Albatros," famous as the home of radio station SHFIX

**AN AMALGAMATED  
SHORT WAVE PRESS  
PUBLICATION**

**1/3**

# 'The TAYLOR JUNIOR'

MODEL 120A

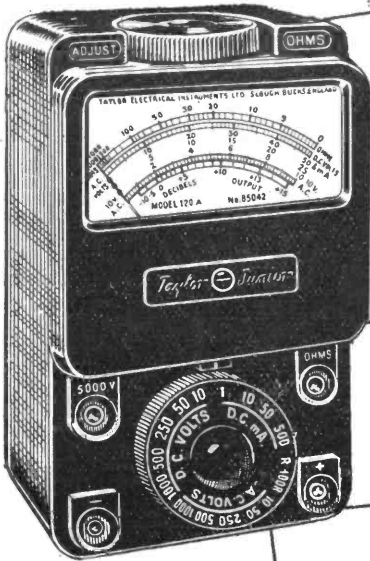

*A Real*  
**UNIVERSAL  
METER**

*to fit your pocket  
and your purse*

*Immediate  
Delivery*

LIST PRICE

**£7.10.0**

HIRE PURCHASE TERMS:  
14/10 down and 11 monthly  
payments of 14/4

Write for des-  
criptive leaflet

## SPECIFICATION

- 21 Ranges
- Sensitivity 1000 ohms per volt D.C. and A.C. on all ranges
- Sixteen Position Range Selector Switch
- 5 D.C. Volt, 5 A.C. Volt, 4 D.C. Current, 2 Resistance Ranges
- D.C. Volts: 5 mV to 5000 volts  
A.C. Volts: 0.2 V to 5000 volts  
D.C. Current: 20  $\mu$ A to 500 mA.
- Resistance: 0.5 to 200000 ohms with internal battery 500 ohms to 20 meg-ohms with external battery
- Size only 4 $\frac{1}{4}$ in. x 3 $\frac{1}{2}$ in. x 1 15/16in.

# TAYLOR

ELECTRICAL INSTRUMENTS LTD

TAYLOR ELECTRICAL INSTRUMENTS LTD 419-424 MONTROSE AVENUE  
Telephone: SLOUGH 21381 SLOUGH, BUCKS.

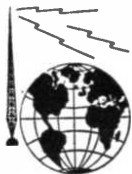

# Short Wave News

Vol 2 No 12

Annual Subscription 16/-

December, 1947

Editors:

ARTHUR C. GEE, G2UK

W. NORMAN STEVENS, G3AKA

Advertisement & Business Manager:

C. W. C. OVERLAND, G2ATV

## Editorial

**T**HOUGH we have always advocated a more intelligent approach to the hobby of short wave reception reporting, it was not until May of this year that we really opened our hearts and penned an Editorial on the subject. This Editorial was the opening shot to our general campaign and has, we are pleased to announce, caused much comment. Letters from readers on the subject, including the remarks in the Editorial and in subsequent writings on this topic, have been many. Almost without exception our readers have given their verbal support to our views and we feel gratified that our campaign was justified and had the backing of that section of the fraternity towards which the big guns were directed.

That our comments have aroused considerable interest overseas is also evident and most gratifying. The first indication that others were taking up the matter came in the August issue of Chicago's "Radio News," when Kenneth Boord, the Short Wave Editor, quoted verbatim the greater part of our Editorial. Mr. Boord says he agrees 100 per cent. with sentiments expressed therein regarding poor reports and inadequacy of SWL cards. He adds but "Amen" to our remarks.

The second revival of our Editorial took place in a recent issue of Sweden's "Roster i Radio." In an article on the subject Arne Skoog repeated our remarks and added some comments of his own concerning the matter. Mr. Skoog defends the Swedish

SWL's on the grounds that the type of card they use does provide a comprehensive report. We readily agree that they do, as our report forms do, but our reference to SWL cards were to those more generally used, of postcard size, and which cannot possibly be of much use to the recipient. Mr. Skoog, in referring to our now famous words of censure, remarks "The views quoted are doubtless correct and one must feel a grim satisfaction that they have been brought before the public. The questions are of great importance for the future of short wave radio."

Another aspect is mentioned by Arne Skoog, that of the stations attitude to the SWL. He agrees that it is deplorable to consider a station as merely a means whereby a QSL can be added to one's collection, but wonders why it is that many stations radiate programmes of such a poor nature as to repel listeners from consistent listening. The final paragraph of this article reads "All of us who are interested in short wave listening must join in helping to outline its future in the best possible way. We, as listeners, can do so by helping stations with suggestions and criticisms as well as reception reports. We must remember that occasional reports that a station has been listened to during a short length of time are of comparatively little value."

That such interest is being taken in this matter, not only here but overseas, is a healthy sign. For our part, the next step in the encouragement of better reporting will be given in full next issue, and will be in the form of a contest.

W.N.S.

## XMAS 1947

*The Staff and Contributors join in wishing all readers a Merry Xmas and a New Year full of DX and free from QRM!*

# THE AMATEUR RADIO EXHIBITION

**T**HIS Exhibition, organised by the Radio Society of Gt. Britain, the first of what will most certainly become one of the most popular events in the radio amateur's calendar, was held at the Royal Hotel, Woburn Place, London, from November 19th-22nd. The purpose of the exhibition was, to quote the catalogue, "to bring to the notice of the 14000 members of the R.S.G.B. and interested non-members, much that is new in that section of the radio industry which caters especially for the radio amateur." And this the Exhibition certainly did do. From rack built 150 watt transmitters, to the smallest parts which would help in the building of the most modest rig; from luxury communication receivers, to all sorts of receiving components; from test instruments to books and periodicals. Those who cater for the radio amateur were there in strength and they put on a really first rate show.

**Odeon Radio**, showed a very fine rack built 150 watt phone/cw Tx with band switching coil turret and 813 in the final. A beauty, which must have made many a mouth water! Other exhibits on this stand included a 25 watt CW Tx; a 50 watt phone/cw Tx; a 120 watt modulator; power packs giving up to 1200 volts and much other most interesting equipment; such as their electronic Morse key.

A great deal of time could have been very pleasantly spent at the stand of **Labgear**, examining all the items this firm had on show. Their 4 band, high power coil turret, attracted much attention, as did their 14-60 Mcs. preselector/converter. Other complete units to be seen here included modulation monitoring oscilloscopes, power packs, VFO units and frequency meters.

The most interesting exhibit on the **Denco (Clacton) Ltd.**, stand was the prototype of their new DCR 19 communications receiver. Other receivers shown included broadcast sets for export, with ten wave bands; a commercial receiver covering 150 kcs. to 30 Mcs.—one of the few commercial broadcast receivers covering all the amateur bands up to 30 Mcs.—as well as a very comprehensive selection of their well-known components.

Communication receivers were also shown on the stand of **Stratton and Co. Ltd.**, where their new "640" and "680" receivers were to be seen and the new E.M.I. com-

munications receiver was on view on **E.M.I. Sales and Service Ltd.**, stand. Their **Fisk Solariscope**—reviewed in "S.W.N." last month—was demonstrated on this stand.

Test instruments and meters were shown by **Taylor Electric Instruments Ltd.**, and **Measuring Instruments (Pullin) Ltd.** The **Mullard Wireless Service Co., Ltd.**, showed a very comprehensive range of valves. E.M.I. were also showing transmitting valves of interest to the amateur. Some interesting exhibits were to be found on the stand of the **Telegraph Construction and Maintenance Co., Ltd.**, including a section devoted to special metals such as high permeability alloys, Nickel Iron laminations and Mumetal shields, Beryllium Copper springs and contacts, thermostatic bimetals and alloys such as "Telcoseal" for making glass seals. On this stand too, their new 150 ohm and 300 ohm transmission line as well as co-axial and balanced-twin cable were to be seen. **Messrs. Belling & Lee, Ltd.**, exhibited their comprehensive range of components, including some useful co-axial connectors, plugs and sockets.

**Radiocraft Ltd.**, showed a variety of their standard lines which they are retailing under the name of **R.A.M. Products**. Various complete transmitters, converters, VFO's, field strength meters, etc., were to be found on this stand. **Radiomart Ltd.**, showed a wide range of capacitors, as well as many other components and **Southern Radio and Electrical Supplies**, showed many ranges of products. The **Woden Transformer Co., Ltd.**, displayed a selection of their well-known transformers and chokes as well as some complete 60 watt modulators. **Antiference Ltd.**, showed aerial equipment including the "Arnine" aerial.

Altogether an extremely good show, far too comprehensive for us to cover at all adequately in the limited space available. We extend our hearty congratulations to Mr. Horace Freeman, the exhibition manager, for the way in which the exhibition was arranged and to the organisers for their initiative in staging such a show. Next year we expect to see an even larger Exhibition. From Mr. John Clarricoats we gather that this year's exhibition was very well attended and from conversations with our trade friends on the Stands, that they are well satisfied with the interest which was shown in their products. It is good indeed to see British manufacturers able to supply so well the equipment we have always wanted to buy from British sources. Make sure you visit next year's amateur "Radiolympia."

# V.H.F. News

---

## 50 Mcs. Opens for DX

**A**S many readers will have already heard, the news of the month was the opening of 50 Mcs. for DX contacts—particularly with America—and the temporary permission given by the GPO to selected amateurs to operate on this band.

The excitement began as far back as October 26th, when 50 Mcs. opened to enable G6DH to hear WIHDQ calling CQ at 1347 GMT. A number of 28/50 Mcs. cross-band QSO's were subsequently worked by various G and W stations. On the 27th, G5BY worked more W's cross-band, but an interesting feature was that nothing was heard at G6DH's station at Clacton-on-Sea throughout the day. It seemed that G5BY's location, 200 miles further west, was just within the skip distance from America whilst the skip distance did not increase sufficiently to bring 6DH within range of the W's.

On the 28th, the band really did open up. From 1232 onward, W1CGY, W1HDQ, W1PTA, W1CLS, W2AMJ, W2AMJ, W2BYN and W3CIR/1 were all heard. VE1QZ was audible at 1240 GMT, being the first VE 50 Mcs. signal to be heard in this country. The first European contact with U.S.A. was made by PAoUN on the 28th, when he worked WIHDQ.

The next few days were full of excitement. Conditions remained good and many cross-band contacts with W stations were made. There was feverish activity in many stations over this side in rigging suitable aerials for the band. G5BD got a 50 Mcs. dipole up beneath his main Zepp. F8ZS managed to hear W3CIR on a hastily erected indoor dipole and G6DH built and rigged a three element beam in two hours!

## 50 Mcs. Permits Granted

The real thrill came on November 5th, when restricted permission to work on 50 Mcs. was given to twenty-four VHF enthusiasts who by their previous good work had proved themselves suitable candidates for such a licence. These twenty-four were circularised by the R.S.G.B. and told they could use 50-54 Mcs. forthwith. We feel that the R.S.G.B. is to be heartily congratulated at getting these facilities so quickly and commendation is due to the GPO for their sympathetic consideration of the matter. The whole question was put through quickly enough to enable VHF enthusiasts to enjoy a chance they had been

waiting for for a long time. The band may be used until December 31st when its future use will be further considered. Only those who have specific authority to use this band may do so. There has not been a general release to transmitting amateurs of this band. Certain spot frequencies have been specified which must be kept free of interference, but most British amateurs are keeping pretty close to 50 Mcs.

Since the 5th November, there has been a great race for "first contacts." Arthur Simons, G5BD, made the first G/VE contact on the 7th November. G6DH managed MD5KW, Ken Ellis, for the first G/Suez Canal Zone contact. This was on November 10th, at 0900 GMT. This QSO was an outstandingly successful one, Ken giving Denis a phone report of 20 db over S9! The Middle East stations have been working numerous stations to the south of them, particularly those in South Africa, so one way and another, 50 Mcs. has been really lively over this side of the Atlantic.

Since the 11th November, the band has closed for DX, but a number of 50 Mcs. inter-G QSO's have been made between those stations having authority to use the band. G6DH for instance, has worked several stations located in the London area. It is quite possible that the band may open for DX again as the MUF has been showing some high peaks again quite recently.

## 60 Mcs. Activity

With all this excitement on 50 Mcs., 60 Mcs. has been almost completely neglected. Conditions for 60 Mcs. propagation have been poor as well, so it is not surprising that very little activity has been reported on the band. The regulars maintain contact, but even with them, QSO's have been few.

## MUF Recording. A Chance for SWL's

We have received several letters recently from various sources, suggesting that much valuable data could be collected by amateurs in the realm of recording MUF's. This suggestion should prove particularly interesting to those SWL's with a scientific outlook. The daily recording of such observations has a fascination of its own for those with the right temperament. We should be very pleased to hear from any readers who have receivers covering say 30 to 60 Mcs., who would be prepared to record **regularly** daily observations of the MUF. We suggest that those who are really keen on such work, record at times convenient to themselves, the highest frequency signals heard in this range. Observations should be made daily and if possible, a schedule of times adhered to, but this is not absolutely necessary, as if enough recordings were made, it

(Cont. on p.332)

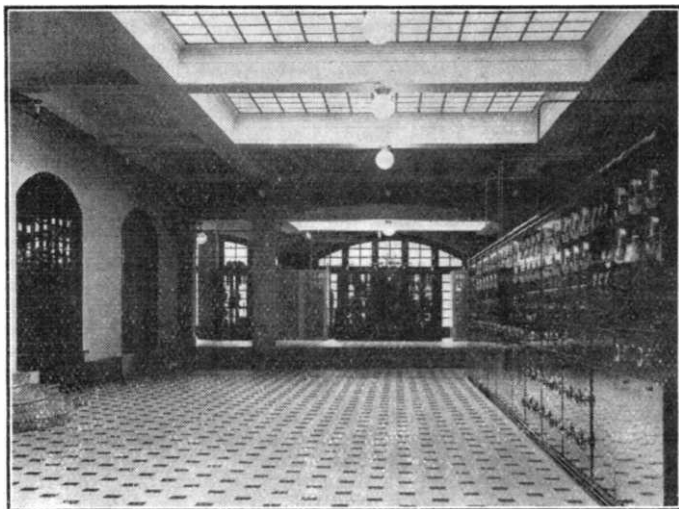

A neat transmitter room at "Radio Andorra"

## Around the Broadcast Bands

Monthly survey by "MONITOR"

All times are given in G.M.T.

(For EST subtract five hours; for AEST add ten hours.)

**F**IRSTLY your scribe would like to convey greetings to all our many readers at home and overseas for the Festive Season. A very Merry Xmas and a most prosperous New Year and good DX to you all. Many thanks for your support through the past year, which we hope will continue.

For the benefit of our new readers the address for all matter for this column is: Monitor c/o "S.W.N." to arrive not later than the 5th of the month.

Now for the month's news.

### ● Asia

**Malaya.** Singapore. The Far Eastern Broadcasting Service sends their General schedule operating from October 3rd, as follows:

0800-1700—11735 kcs. Orange Network  
677c kcs.

0800-1700—15310 kcs. Purple Network

0800-1030—21720 kcs.

1030-1700—9690 kcs.

A radio Malaya relay is given from 0530-0630 on the 6, 11, 15 and 21 Mcs. channels also. Ray Aldridge of Amersham sends in a neat log, mentioning Singapore on its 9 Mcs. channel with news in English at 1500. Says signals were R6-7 and some QRM is experienced. K. S. Adam (Darlington) has heard them QSA5 R9 at 1600 also on 9 Mcs. D. O. French (Norwich) states that Radio Malaya tests on 6130 kcs. and uses 7200 and 4825 kcs. This reader states that he is hearing good signals from Singapore on their 9 Mcs. frequency and that their 6 Mcs. transmission has improved lately. Sorry to hear your MCR1 RX is "laid up" O.M. Dr. T. B. Williamson (St. Albans)

sends in a nice log again this month and notes Singapore on its 6 Mcs. freq. at 1800 with call "Far Eastern Broadcasting Service." Bad heterodyne QRM. This reader also logged Kuala Lumpur on 6050 kcs. at 1550-1600 with call and "Appointment with Fear" programme. Announced as "This is Radio Malaya broadcasting from Kuala Lumpur." Sidney Pearce (Berkhamsted) lists Radio Malaya on its 4 Mcs. channel with good signals sometimes from 1500 with Blue Network programmes, closing at 1533 after news headlines except Saturdays when it closes at 1603.

Another very fine report comes from Kenya Colony in a most excellently laid out log of stations heard there by R. F. B. Featherstone. Firstly he mentions the 6 Mcs. freq. of Singapore with QSA5 R9 signals giving news at 1430. 9 Mcs. transmission was heard at 1400-1515 QSA3 R6. At 1400 Radio Malaya on 6045 kcs. was heard broadcasting a speech by the Governor-General on the new Legislative Programme for Singapore.

**Ceylon.** Colombo. Radio SEAC now use 17770 and 15120 kcs. freq. for their beamed transmission to the British Isles from 1830-2030 Sundays. Programme opens with record requests from relatives of Servicemen in SEAC. Those requests should be sent along to the following QRA: Phil Beacon, Radio SEAC, Colombo, Ceylon if you have anyone serving out there. Heard with R9 signals by M. D. Francies of London, N.W.5, who sends in this news.

Pearce reports ZOH Colombo on 4900 kcs. with R7 signals at 1600 giving news relay from BBC and closing at 1700 with

**SHORT WAVE NEWS**

Nat. Anthem. Suffers bad CW QRM. R. Aldridge reports them at 1630 R5.

T. B. Williamson logged Radio SEAC on their 6075 kcs. channel at 1615 QSA3 R7 giving call as "Forces Broadcasting Service" and dance music.

**India.** Madras VUM2 9565 kcs. heard QSA3 R4 around 1730-1800 with news in English and talks, also native music. Closes at 1800. Call "This is All India Radio, Madras." (Williamson). Pearce reports them on 4920 kcs. (VUM) signing off at 1700. VUD Delhi was heard at 1530 with news in English on 4960 kcs., also a station on 4880 kcs. which he believes was in Bombay giving native music at 1730. (Could be VUB2 who uses this freq., O.M.)

**Tashkent (U.S.S.R.)** Pearce reports Tashkent on 6825 kcs. giving news, commentary and music beamed to India at 1700-1730 in English. Signals were R6. Bob Iball of Worksop, who sends in a massive list of DX heard at his QRA, lists them also with the call "This is Tashkent calling." Uses a lady announcer. Broadcasts from 1700-1730 presumably Suns. and Weds. only. When closing says "Time in Tashkent is now 1130 p.m. Good Night." Yes, Bob, it is in Asia and the postage is 3d. Suggest you send your report to Radio Centre, Moscow.

**Azerbaijan (Iran).** R. Aldridge reports Radio Tabriz on 12180 kcs. with R8 signals at 1850. Although call is given as "Radio Tabriz, Azerbaijan" their letter Veri does not mention it, only Tabriz, Iran, is given. This does not count as a separate country. How many countries have YOU heard and number verified? Your scribe would like to hear from readers about this and maybe we will run a monthly list if support is great enough.

● **West Indies/Central America**

**Trinidad.** VP4RD Port of Spain has been logged by several readers this month and reports are as follows: T. B. Williamson heard them at 2315 giving call as "Radio Trinidad" and relaying BBC programme "London calling the West Indies." Signals were QSA3 R5. Freq. 9625 kcs. Your scribe heard them at 2230 playing recordings interspersed by advert. announcements. QSA4 R6-7. Heavy hum on carrier. Modulation appears to be rather low.

In a letter from the General Manager (Mr. William MacLurg) Trinidad Broadcasting Co., Ltd., Broadcasting House, 11b Maraval Road, Port of Spain mention is made of 500 watts power and programmes are taken from the MW station (1295 kcs). D. O. French sends in schedule as follows: Suns., 1100-1800, 2000-0300. Weekdays,

1100-1300, 1600-1800, 2000-0300 on 9625 kcs.

A. Aldridge heard them at 2300 with QSA4 R9 signals also logged by K. S. Adam around 2300 QSA4 R6.

**Haiti.** HHCN Port-au-Prince heard regularly on 5660 kcs. around 2330-0200. After many attempts it was identified at 2350 with call in French. Most of time it is blasted out by auto CW says T. B. Williamson who reports them.

**Honduras.** Roger Legge (New York) states that a new station is to be heard from Tegucigalpa. HRA "La Voz de Lempira" operating on 6050 kcs. from 0000-0300. Williamson lists HRD La Ceiba on approx. 6045 kcs. giving call as "HRA La Voz de Atlantica." Heard at 0200 QSA3 R3-4. (Surely HRA on 6050 kcs. O.M.)

**Panama.** HOLA Colon 9505 kcs. "Radio Atlantico" very weak at 2200 giving English Programme. (Williamson).

● **Australasia**

**Australia.** R. F. B. Featherstone sends in schedule of "Radio Australia" transmissions as taken from a recent "DXers Calling" programme from R.A.

0300-0400 VLB5 21540 kcs. Beam to Japan (Forces Prog.)

VLC9	17840	
VLG6	15240	
0300-0400 VLA9	21600	Sat., Sun.
0330-0645 VLB5		Sat. only. Sports BC.
	VLC6	
0430-0645 VLA5	15320	Beam to N. America
	VLC7	11840
	VLC6	
0600-0645 VLC9		French to Tahiti
	VLC6	
	VLA6	15200
0630-0650 VLA6		Sats. only
0700-0815 VLA6		Beam to Siam
	VLB10	To British Isles
	VLC9	
0745-0845 VLC4	15320	Closes at 0745
	VLC3	To New Caledonia
	VLG3	11710
0830-1200 VLA6		Forces Prog.
	VLB10	
0855-1200 VLC4		Beam to Asia
	VLG10	11760
1100-1145 VLA6		
	VLA8	11760
1130-1200 VLC7		
1200-1315 VLA8		Beam to British Isles ✓
	VLB9	9615
1200-1400 VLB10		
1200-1250 VLC4		
1215-1400 VLA6		
1215-1300 VLG4	11840	Beam to S. Africa
1300-1415 VLB	9540	Beam to N. America
	VLC7	
1400-1500 VLA6		Beam to British Isles
	VLG10	
1430-1500 VLB4	11810	
1500-1515 VLA8		Beam to N. America
	VLC6	9615
1515-1615 VLG4		Beam to S. Africa
	VLB	
2000-2130 VLC11	15210	Beam to British Isles
	VLA8	
2200-2315 VLG7	15160	
2115-2315 VLA6		
2145-2315 VLB7	17800	Forces Prog.
	VLC9	Beam to N. America
		Beam to S. America

R.F.B.F. has logged the following: VLB10 QSA5 R9, VLC9 5 9, VLA6 3 5, all at 0730, VLC4 3 5, at 0800, VLC7 5, 9, at 1405, VLB at 1300 4, 7, VLQ3 9660 kcs. Brisbane Queensland of the National Broadcasting System was logged at 1400 when closing. Your scribe has just received a QSL card for this frequency. VLQ3 also heard by A. Aldridge at 2015 with R7 signals and VLH5 Melbourne (ABC) R5 at 2040 on 15200 kcs. VLG10 heard at 1345 R8. Pearce lists: VLA6 well heard from 1300, in parallel with VLG10 at 1400 R5-7. VLA8 and VLB9 heard at 1500 with BC to West Coast of U.S.A. VLC7 very strong from 1430-1500. VLA6 very good at 0700-0830. R8 signals from VLB10. VLC9 usually weak. R7 over VLB 9to 2115, bad QRM, VLC11 R7-8 when not jammed by WBOS, VLA8 very good. Both sign off at 2130. VLA7 (VLB7?) 17800 kcs. and VLC9 heard from 2145.

VLC11 has been logged by your scribe at 2000 opening with clock chimes. QSA3 R6-9 with very bad Hetro from WBOS. VLG10 QSA3 R4 (QRM from Moscow), VLA6 QSA4 R7 at 1255-1330, VLC11 QSA3 R8 2015-2100, VLA8 QSA5 R8 at same time, VLB9 QSA5 R5-6 at 2015-2100 with some CW QRM.

● Africa

**Angola.** Sidney Pearce sends in schedule of transmissions from the Radio Clube do Angola, Luanda.

Weekdays: CR6RA 11035 kcs. 0600-0700, 1115-1245; Suns.: 1115-1245, CR6RL 15915 kcs. 0700-0800, 1115-1245, 1830-2100; Suns.: 1115-1245, 1530-1730. CR6N 9475 kcs. 1115-1245, 1830-2100; Suns.: 0800-0930, 1115-1245, 1430-1730. Also listed is CR6RC 7299 kcs. but apparently not in use. Pearce has heard CR6RN with R6 signals at sign on 1830 to close at 2100 Nat. Anthem.

Your scribe logged CR6RL at 1900 with call by lady announcer "Radio Clube do Angola, Luanda" followed by Portugese songs and Outside BC at 2010. Man and woman announcers are used. Signals were QSA3 R7-4. Very bad CW QRM near frequency.

H. Westman (Upington, South Africa) lists CR6RF of the Radio Clube do Benguela on 7100 kcs. and states that it is well heard until close down at 1900 with Nat. Anthem. He says they send a very nice QSL card in green, white and red with Elephant pointing its trunk on the map of Africa at Angola.

**Mozambique.** Pearce has heard Lourenco Marques on 4915 kcs. with R7 signals on

Sundays giving sponsored programmes around 1730.

**Madagascar.** FIQA heard on 6065 kcs. at 1600 with weather report and call by woman "Ici Radio Tanarive" followed by French songs. (Williamson). Heard 1700-1845 on 9705 kcs. with French programme. Announcements at 1845. Signals QSA4 R8. (Featherstone).

**Cameroons (Fr.)** "Radio Douala" Douala FWA is heard regularly from 1700-1800 at sign off. All announcements are in French. (Westman).

● Europe

**Luxemburg.** Roy Patrick who is a Theatre Sound Recording Electrical Engineer and on tour with famous stage shows (his notepaper says so!) with home QRA in Woking sends in schedule of Radio Luxemburg's experimental transmissions on the following frequencies: 15350 kcs. 0410-0510, 1700-1740. 9527 kcs. 1040-1100, 1740-1800. 6099 kcs. 0410-0510, 1900-2100. Power is 5 kW. Reports are requested to: Radio Luxemburg, Compagnie Luxembourgeoise de Radiodiffusion, Luxemburg. Roy says he has heard them on all frequencies with R8 signals when he was in Manchester, Sunderland and Hanley Stoke. He is ISWL/G699/Portable!

**Monaco.** Pearce reports Radio Monte Carlo on 6130 kcs. at 2130 until sign-off at 2215 after the reading of news in French. Often good signal.

**Germany.** Stuttgart operated by AFN on 6180 kcs. and using about 1kW power, takes programmes from MW transmitter. Schedule: Suns. 0700-2300, Mon. to Fri. 1030-1330 and 1530-2230, Sats. 1030-2300. First test transmission took place on August 8th and official opening on September 14th. Transmitter is located at Mühlacker, Nr. Stuttgart. (Waldemar F. Kehler, Schleswig-Holstein, B.Z.G.)

● Acknowledgements

Ray Aldridge ISWL/G85 (Amersham, Bucks.), K. S. Adam ISWL/G277 (Darlington), D. O. French ISWL/G426 (Norwich), Dr. T. B. Williamson ISWL/G247 (St. Albans, Herts.), Sidney Pearce BSWL336 (Berkhamsted, Herts.), M. D. Francies ISWL/G1248 (London, N.W.5.), Bob Iball ISWL/G941 (Worksop, Notts.), R. F. B. Featherstone (Nakuru, Kenya Colony), Roger Legge (New York, U.S.A.), H. Westman ISWL/ZS993 (Upington, S. Africa), Roy Patrick ISWL/G699 (Woking, Surrey), Waldemar F. Kehler, Schleswig-Holstein, B.Z.G.)



# Two Receivers are better than one!

By Len Miller

MANY SWL's get exasperated when they hear one side of a conversation and cannot retune quickly enough to hear the other fellow's answer. Usually they are just in time to hear "Thanks, old man—over," and then frantically search for the original sig!

If the SWL is a "straight" man, a double receiver does not make a very big hole in the pocket book, as the audio and power sections can easily be made common to both.

In practice, one unit of the double receiver can be left tuned to the original signal while the other unit is utilised to search for the "answer." When they are both tuned in, the SWL can lean back and hear the conversation in comfort!

The double receiver offers other advantages. Using two aerials, it is possible to tune both units to the same station, and, providing the aerials are spaced apart, a form of diversity reception is obtained, and fading is to a great extent minimised. (It should be borne in mind that a signal does not normally fade at the same time at the same place). Also, when listening to a commercial station, one unit can be tuned to say, the '11 metre transmission, and the other unit to the 15 metre (assuming they are both transmitting the same programme!) with a consequent improvement in signal strength, and possibly less fading.

Although a simple 0-v-1 rig is described in this article, it is entirely up to the con-

structor (and his pocket book!) to add RF stages or build super-het units, as the principle is the same in every case.

Fig. 1 shows two separate detector stages being fed into a common output valve. V1 and V2 and their associated components are in effect two separate one-valve sets, and although two triodes are shown for simplicity, RF pentodes may be used if desired, and the constructor can employ his own pet detector circuit as he wishes.

The method of feeding the two outputs into a single A.F. valve calls for some consideration in design. Some form of manual volume control (apart from the reaction control) is desirable, especially for CW reception, and the method outlined in Fig. 1 is satisfactory in every respect. The resistors R1 and R2 are essential in order to keep each volume control reasonably independent of one another. As these are in series with the grid circuit they have no effect on signal strength. Without these series grid resistors independent volume control would be impossible, as when either control is at "minimum," the grid of V3 would be at earth potential and no signal of any description would be receivable.

There are no snags from the practical side. Normal set design procedure should be followed, short leads, etc., but it is advisable to screen the two detector sections from each other.

Now then, SWL's try a double receiver next time, and you will wonder how you ever managed with only one!

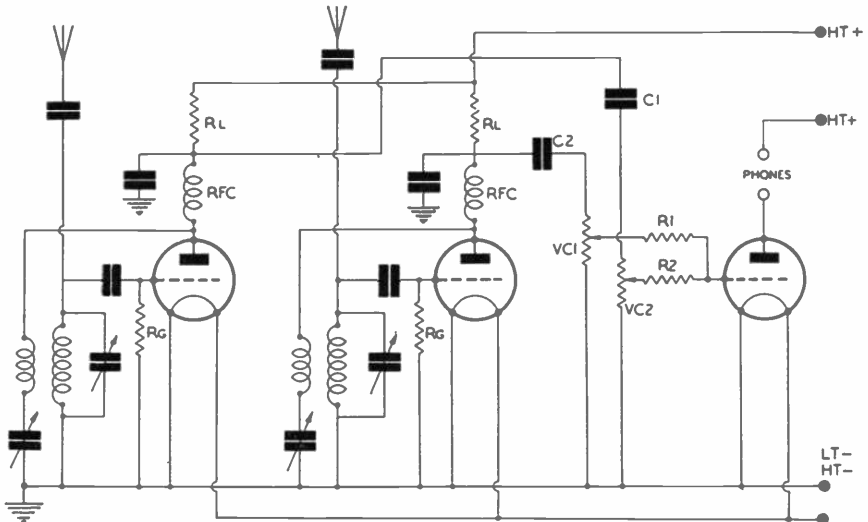

RL 50K~ each R1/R2 1M~ each VC1/VC2 0.25 M~ each C1/C2 .01  $\mu$ F each

# Station Description

## No. 14 RADIO OIX-7

**M**ANY readers will have heard the very fine signals put into this country during the past few months by the experimental transmitter OIX-7 owned by the Finnish Broadcasting Company. Operating in the 14 Mcs. amateur band, this transmitter gave many 14 Mcs. phone operators some of their most pleasurable QSOs and it gives us great pleasure to be able to describe this station for the benefit of our readers.

The Finnish Broadcasting Company owns several 10 to 15 kW short wave broadcast transmitters working in the broadcast bands. These have been on the air regularly since 1938 with rhombic aerials directed to the North and South of America. Very few reports were received from these countries for reception of these transmissions however and the engineers were at a loss to know just why. The northern location of Finland, the relatively low aerial power, the aurora, etc., were all suggested as possible causes.

In order to obtain more information on propagation conditions it was decided to put an experimental transmitter on the air

to make contact with amateur stations and thus get first hand information of how signals were getting out. OIX-7 was therefore built and put on the air on 28424 kcs. to start with. Subsequently operation was extended to cover the 14 Mcs. band.

The RF side of the transmitter is a five stage unit with an input to the final amplifier of 500-600 watts. A 6V6G is used in a crystal oscillator stage working on 7 Mcs. This is followed by two frequency doubler stages using 807's. An 814 is then used as an intermediate amplifier driving a pair of Amperex HF 300's in push-pull in the final amplifier.

The modulator comprises two 810 valves in Class B driven by four 6B4G's in Class A. Preceding this driver stage is a 6N7 resistance-capacitance phase inverter. The modulator is connected via a transformer to an ordinary 500 ohm telephone line 4 miles long, at the other end of which is the speech amplifier, the whole transmitter being remotely controlled over a two-pair telephone line.

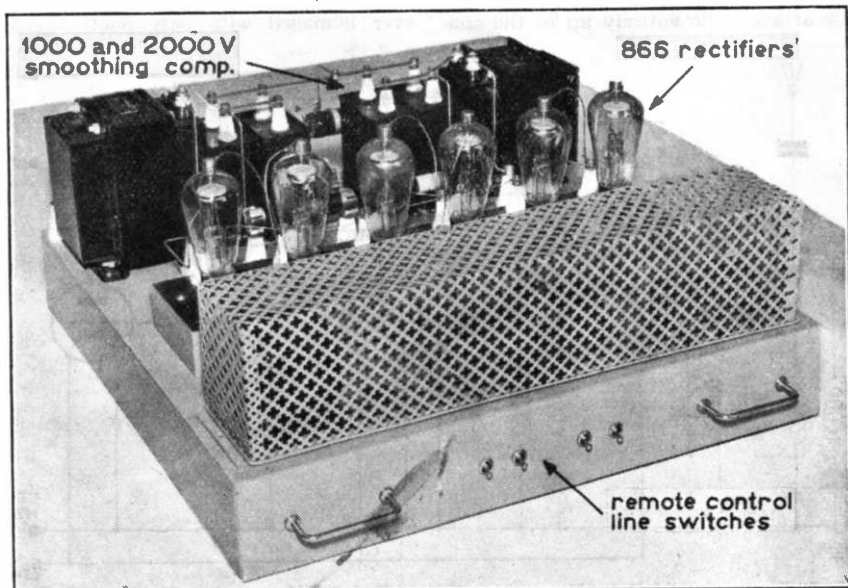

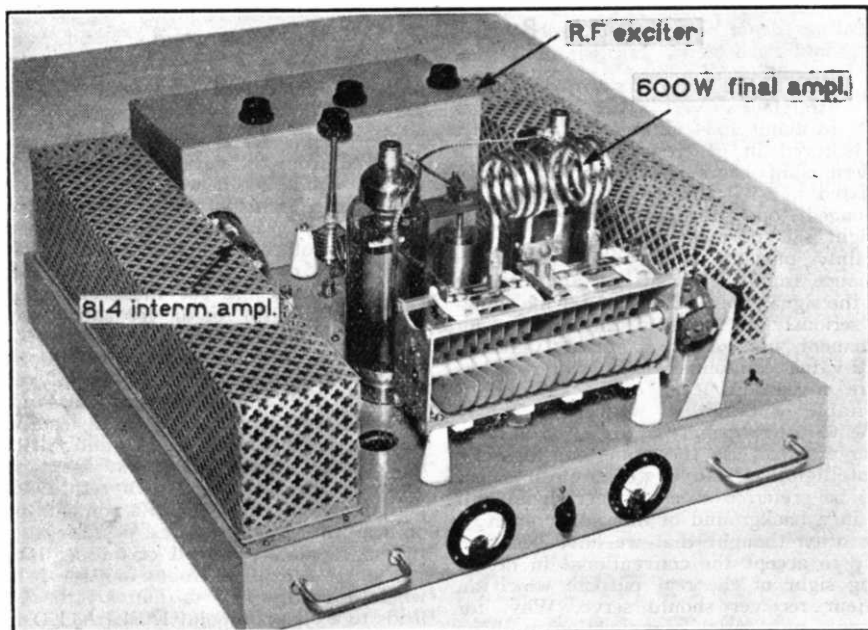

The 2000 volt supply for the final amplifier and the modulator is obtained from a 3 phase full wave rectifier using six 866 mercury vapour valves. A system of relays is built into the cathode circuit of the final amplifier to provide for keying, for change over from CW to phone and to ensure that the modulator is not switched on before the final amplifier.

The aerials in use at the time of writing consist of "Lazy H" types, one being directed to N. and S. America; the other to S. Africa. The station was put on the air for the first time on February 22<sup>nd</sup>, '47, and within a week, 130 amateur phone contacts in the Americas had been made. Since then, contacts with almost every part of the world have been made.

The transmitter is located on the local 10 kW broadcasting station site three miles away from the town. This was done with a view to eliminating interference to local broadcast listeners. As we have said, complete control is effected over a pair of telephone wires, which carry the speech, switch on the plate voltages, change from CW to phone, etc. With the transmitter situated so

far from the receiver, "break-in" operation works perfectly.

Our illustrations show the RF chassis and the power pack. The RF chassis contains the crystal oscillator and frequency doublers which are placed in the screening box at the rear of the chassis. The 814 intermediate amplifier projects horizontally from one end of the box as shown. The final amplifier occupies the centre of the chassis. The perforated metal covers house the auxiliary rectifiers and relays. Similar construction is used for the modulator and rectifier units, all three being mounted one above the other in an open wooden rack.

The transmitter was designed by Mr. K. S. Sainio ("Charles") OH2NM, who also is the operator whose voice is most frequently heard when OIX-7 is on the air. A most interesting feature of OIX-7 is the descriptive pamphlet sent with the station's QSL card giving complete details of the transmitter including circuit diagrams—a unique and most interesting type of QSL and a real souvenir for those who have enjoyed a QSO with this station.

# Resonant Lines

## By Centre Tap

**R**ECENTLY I had occasion to re-hash a straight receiver—a two-valve chassis of about 1934 vintage. In those days we believed in generous spacing so with modern components it comfortably accommodated a 2-v-0 line-up. It was my first prolonged operating experience with a straight set for many a long year and it certainly put up a very satisfying performance from the sensitivity angle but it was the signal/noise ratio that set me thinking seriously in terms of the straight for permanent use. After so many years of multi-valve communications type receivers where a certain level of background is inevitable, I began to wonder if we are prone to tolerate noise a little too easily.

For amateur use the prime consideration is intelligibility and a weak, clean signal is to be preferred to a stronger signal half lost in a background of hiss and crackle. I have often thought that we have been too ready to accept the conventional in design losing sight of the real purpose which an amateur receiver should serve. Why, for instance, must all communication receivers have an output of 3 or 4 watts when throughout its entire Shack life it will be used either on headphones or with a speaker not more than 3 or 4 feet away from your elbow. Yet the manufacturers offer us a receiver designed chiefly for uses not strictly amateur—it is certainly not what we really need and strangely enough, in the main, the more ambitious home constructor slavishly follows the convention—except for a few, and they are content to merely omit the L.F. side.

Amateur radio has already lost much of its character and individuality, particularly as far as receivers are concerned. Let us not overlook the fact there is plenty of room for a specialised straight receiver and in some ways it could be better suited for amateur use. The leaky grid detector is still the most sensitive known and with 2 or even 3 stages of tuned R.F. which can by careful design be made to behave with perfect stability, and special attention to selectivity, it might well be developed to do all that the amateur or S.W.L. needs. It will not be the perfect set, but then the superhet has many imperfections.

### Tying 'Em Down

That old chassis revived memories and conjured up visions of its contemporary and earlier model—expansive dimensions, awkward coils, lengthy control extensions

and dangling valves from which the bases had been laboriously removed.

Short-wave work then seemed so far removed from ordinary radio and I found myself wondering if we still put as much loving care and patient experiment into present day gear despite the fundamental simplicity of those early circuits. I finally decided we didn't—because it is no longer necessary. We just get the stuff designed (by someone else) for the job and no longer have to adapt and improvise. Little points to which we devoted so much attention are now taken for granted and it is only when a newly built circuit fails to come up to expectations or shows signs of instability that we go to extreme lengths and fall back on our old tricks. Then we again start seriously juggling with earth return leads, perhaps joining them all to a common point on the chassis as near as possible to the tuning capacitor, or coil or adding bits of screening. I can remember one set I built where I finally had to join all the earth leads to a common point INSULATED from the chassis! Apart from ensuring that the earth leads are short, the chassis not used to carry currents, or that connections are not taken to points where the chassis potential is at variance, modern components can be expected to perform efficiently without elaborate precaution, and to my mind, some of the fun of overcoming obstacles is lost. I then give up thinking of yesteryear for fear of getting over-sentimental!

### Turning on The Heat

Thinking of chassis joints reminded me that the soldering of leads direct to the chassis presents a problem to many constructors and poor joints of this type often prove to be the unsuspected source of trouble. It is almost impossible to make a really sound connection with an ordinary "domestic" soldering iron whether of the electric variety or not.

The large area of the chassis cannot be raised to a high enough temperature and this is particularly so in the case of copper because of its high heat conductivity. It is not only essential to have a large, heavy bit, capable of storing sufficient heat, but the bit must be shaped so that as large an area of it as possible can be used to make heat contact with the chassis. Even then it will take anything up to ten seconds to get the solder fully molten when a slight "rubbing" will help it to take.

A plain iron is usually to be preferred for this type of work but I have successfully used a heavy bit made to clamp over the normal bit of an ordinary electric iron, although it means quite a wait until it reaches working temperatures.

**Litz Wire**

Beginners are often puzzled when to use Litzendraht wire and what are the advantages to be gained. It is generally realised that solid wire, at higher frequencies, increases in resistance, due to what is commonly called the "skin effect." At the higher frequencies the current flows almost solely on the outside of the wire, thus reducing the amount of conductivity area.

Litz wire is an attempt to overcome this by using multi-stranded wire where each strand is insulated by a coating of enamel. The strands are carefully interwoven so that each in turn is in the centre and then brought out to the surface, thus dividing the current over a larger and more effective conducting area.

This is all very simple in theory but unfortunately the use of the enamel insulation gives rise to capacities between the strands which, in turn, increases the resistance which we have so carefully sought to reduce, until at a given point the extra loss more than offsets the improvement gained by stranding the wire. The point occurs at a given frequency and as it varies with different sizes of wire (both gauge of the strands and their number) it is not easily possible to define this "critical frequency." Thus its indiscriminate use may prove a disadvantage.

Litz wire is not often used by amateurs nowadays since the components to which it is most suited are no longer made at home. In any case the very slight advantages gained can so easily be outweighed by poor joints—the complete removal of the enamel from each strand without damaging the wire can only be satisfactorily done chemically. Carefully stripping the covering and splaying the strands before dipping into methylated spirits to dissolve the enamel and wiping with a cloth is perhaps the most effective method for home use.

**From the U.S.A.**

By Grove Calkins

(S.W.N. Correspondent)

An entirely new art, Printed Radios, is now being developed. It is of a purely economic nature, due to the high costs of production today (radios are selling at more than 50 per cent. over their pre-war

figures). The more labour that is expended on a radio receiver the more expensive will be the finished article, and in the U.S.A. as elsewhere, it is not so much the cost of the materials that causes such high prices as the cost of labour. The importance of the new printed radio receiver will be obvious as it will cost less to produce and lends itself ideally to mass-production. The system is perfectly simple and consists of a "chassis" of a few layers of insulating laminations (as bakelite) upon which is impressed the "wiring" in the form of silver deposits. Where "wires" cross, grooves are provided. Thus it will be seen that the set can be "wired up" almost in one operation, and such things as dry joints will be eliminated!

According to Radio Craft, Citizens Radio is about to come out of the blueprint stage and fifty manufacturers and experimenters are already talking on the allocated band of 460-470 Mcs. under experimental licences. About 500 small portables are already in use by police, firemen, foresters, geologists and motion picture producers.

**The 807 as a High-Mu Triode**

Some interest has been shown recently in the possibilities of using 807 valves as high-mu triodes for such purposes as zero-bias Class B amplification. From the last number of RADIOTRONICS we learn that the Amalgamated Wireless Valve Co., Pty. Ltd. of Sydney, N.S.W. have recently carried out tests on a few 807's in this direction, using the valves with control grid and screen tied together. The following data was obtained:—

With a plate current of 25 mA.:—

Amplification factor	...	195
Mutual conductance	...	4500 ohms
Plate resistance	...	43000 ohms

The plate current at zero bias was approximately as under:—

Plate Voltage	...	Plate Current
200 volts	...	1.9 mA.
300 volts	...	2.9 mA.
400 volts	...	3.7 mA.
500 volts	...	4.8 mA.
600 volts	...	5.6 mA.
700 volts	...	6.7 mA.

The tests at positive voltage were very disappointing, owing to the heavy grid current. Whilst it may find limited application as a high-gain resistance-coupled amplifier operating in the negative grid region, the 807 is not suitable as a zero-bias Class B amplifier.

# AROUND THE SHACKS No. 12

YI2AT ● YI2CA ● YI2JJ

By Jack Leppard

(**Editorial Note:**—This edition of our shack reviews is an unusual one inasmuch as the shacks described are now no longer occupied for the purpose of DX-ing. The stations to be described are those of the boys who

created such interest by their activities from Habbaniya in Iraq, namely YI2AT, YI2JJ and YI2CA. The article has been written by a close friend of these operators who is now back in Blighty).

As readers will know by now, we have had a general "close-down" out here due to Service regulations and this has made things a little difficult. However I have managed to collect some data from the lads just before they dismantled their gear (this explains the absence of QSL's in the photos) and trust that it will be of interest to readers who have worked or heard the gang.

I managed to collect plenty of information from YI2AT, YI2CA and YI2JJ, whom I must thank for their co-operation, but with the others I had less luck. YI2AH, although quite authentic, was rather a mystery man and never seemed to be at home when I

called. YI2KP was still in the experimental stage and having more than a handful of trouble with power supplies who he was obliged to QRT. YI2WM was down at Shaibah and though I wrote him a letter asking for a few trade secrets, I never had a reply.

**YI2AT:** Operated by Albert Tungate, known to friends as Eddie. I have here at my elbow a massive document entitled "The Life and Death of YI2AT" from which I will sort out some interesting data. Firstly comes the rig, which was: TX: 6L6 Tritet into a Class C 807. Grid modulated, with a 6F6. Input 12 watts. Operation confined to 28 Mcs., 'phone and CW. Rx: National HRO. Aerial:: 80 half waves long wire (1250 feet!) Zepp fed, 90ft. high and beamed on Southern England.

Eddie was forced to QRT, as were the rest of the hams out here by a regulation forbidding service components to be used in amateur stations. This applied not only to new gear but to surplus gear, disused or salvaged. As civilian gear is almost unobtainable it meant complete QRT. Eddie first became interested in ham radio when he met Jimmy Gough, operator of YI2CA, and reasoned that if 2CA could do it then so could he! After much delving into text books and some experimenting with 2CA, his first low powered rig was ready for action and using an indoor aerial a CQ was sent out. Back came G3DO, and Eddie was so scared that he forgot all the abbreviations and even sent his own call as G2DO!! Then a fourteen half-wave aerial was installed which was 70 ft. high. The next step was the building of a modulator, which was made possible only by the assistance of 2CA who kindly supplied the components. His first attempts at phone work were not successful as he only had one crystal, and that was in the CW band. To use his own words the CW boys showed him no mercy and cut him to ribbons. After obtaining a new crystal he set about the DX and knocked off some nice stuff.

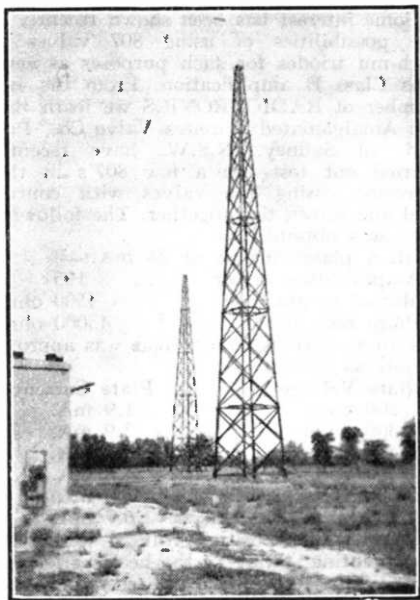

YI2AT: The famous 90 ft. masts, referred to by Eddie as his "sticks"

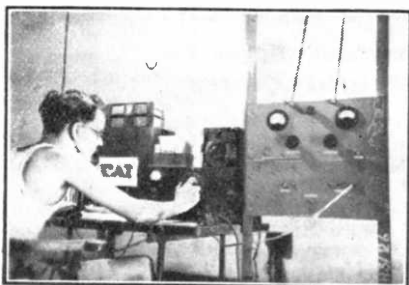

YI2AT searching the band. Albert was "renamed" Eddie by his pals as an abbreviation for Edison —a tribute to his genius(?)

Then came the blow that the shack was required for Service purposes and this was only solved by the action of 2CA who presented Eddie with half of his own shack and the two of them worked on a rota system. This was the time when Eddie acquired his now famous 80 half-wave aerial! With a new rig, an HRO and his famous aerial, Eddie never looked back. The DX he worked would make any ham green with envy and he became known as the "12 watt globe trotter." Once the aerial tuner developed a fault and rather than take time off to repair it he disconnected it altogether and attached three turns of insulated wire to the ends of the feeders, pushing them straight into the 807 anode coil. The shock came when G6DH picked him up on 42 Mcs. at QSA5 R6! Then came the sad day when we all had to close down but it may not be long before the old YI gang are all active with G calls.

YI2JJ: Operated by LAC Jackson, now off the air and posted to a station on the Persian Gulf, where he hopes to stage a come-back. Whilst operating from Habbaniya, his rig was: TX: 6Y6 (ECO), 6V6 (FD), KT8C (PA). Modulated by two 6F6 in push-pull, giving anode and screen modulation. 6C5 and 6J5 in cascade as drivers.



Eddie, of YI2AT, taking a trip up the lattice tower

Input 40 watts. Operated on 14 Mcs., phone and CW. RX: SX28. Aerial: 15 ft. centre fed tuned wire indoors, 8 ft. high. The photograph shows the station the day before it was dismantled.

YI2CA: There cannot be many who have not heard "The Golden Voice of Iraq," or in other words Jimmy Gough, operator of YI2CA. He, alas, is also off the air now, but for much brighter reasons—he has returned to "G." His wonderfully consistent signals can be put down to his aerial systems as he was a great experimenter in this direction and, like YI2AT, had access to wonderful facilities. The TX was 6L6 Tritet, 807 FD and two TZ40's in the PA. Two more TZ40's were used to modulate the rig. Operation was on 28 Mcs. phone and CW with an input of between 120-150 watts. The receiver was a National HRO. The most interesting part of the station was the aerial systems. Although Jimmy occasionally used the 80 half-wave long wire, his favourites were an 8-element 8JK beam, a 3-element rotary and, the piece de resistance, an 18-element Sterba Curtain.

That's about the story. Jimmy seems to have been rather camera shy as I could not find any photos of him and, as he was already en route for Blighty when my camera had been rigged up, we cannot add him to the Rogues Gallery! By the way, the second op on YI2CA was Charlie Ashley.

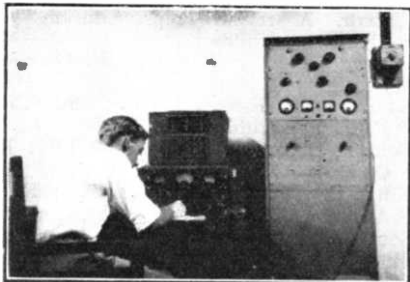

YI2JJ, with LAC Jackson at the "works"



# International Short Wave League

Annual Subscription 1/-  
**Monthly Notes**

## Local News

**T**HE ever-present bogey, limitation of space, makes it impossible for us to give all the local news that we would like. The sheaves of reports that we receive each month from local representatives provides enough material to fill the complete magazine almost! We would like to emphasise that although we cannot possibly do more than to insert the more important of local announcements all reports received are appreciated and filed. Perhaps CR's could take a tip from our Eire representative, Gerard Brazil, who circulates a monthly "Newsletter" to all members in his area. This "Newsletter" is a fine effort and Gerard is to be congratulated on his initiative. If any other representative, either in the United Kingdom or overseas, would like samples of this monthly production as a guide we would be pleased to send them on request.

## New Representatives

### TOWN:

**Ashford:** F. L. Leach, 88 Essella Road, Ashford.

**Preston/Southport:** C. Aspinall, "The Willows," Fermor Road, Tarleton, nr. Preston.

**Folkestone:** J. H. Budd, 4 Station Cottages, Dover Road.

**Sheffield:** J. Blakely, 85 Sandford Grove Road, Sheffield.

**Tunbridge Wells:** A. C. Pollard, 67 Upper Grosvenor Road, Tunbridge Wells.

**Ipswich:** J. E. Dean, 11 Royal Hospital School, Ipswich.

**Weymouth:** D. E. Warren, 9 Mitchell Street, Weymouth.

**Workington:** F. Chidlow, 9 Wedgewood Street, Seddick, Workington.

### COUNTY:

**Bucks.:** B. Hayes, 8 Althorpe Crescent, New Bradwell, Bletchley.

**Lanarks.:** A. R. Williamson, 14 Coronation Road, New Stevenson, Motherwell.

**Somerset:** G. V. Farrance, 80 Ashleigh Avenue, Bridgwater.

### OVERSEAS

**India:** E. Dawson, VU2FS, Suite 8, 9 Dacres Lane, Calcutta.

**France:** H. Disciaux, F9BS, 12 rue Cerrillon, Vincennes, Siene.

**Mauritius:** M. I. Dada, 24 Volcy Pougnet Street, Port Louis.

**Somalia:** 2321765 SSM Hutton T., Post Office Box 436, Mogadishu, Somalia.

## Local Notes:

F. Leslie Leach has unfortunately had to resign his position as CR for Gloucestershire, as he has moved to Kent. He has kindly offered to act as TR for Ashford and his new QRA will be found in the above list. We invite applications for a successor to the post of CR for Glos.

Another change-over occurs in Devon. Dick Hexter is now in Germany and so cannot continue his activities. The former Deputy-CR has now taken over and his QRA is: Alec Jotcham, 119 Exeter Road, Dawlish. Devon members are requested to note this change and to contact their new CR. Please enclose SAE with correspondence.

Due to the new status of the Dominion of India, our former representative, D. C. Shahani, will henceforth be the representative for Pakistan. The new rep. for the Dominion of India is announced in the above list of new representatives.

Finally, Herbert Pithouse has recently changed his occupation which has resulted in his being unable to continue as TR for Swindon. We are particularly anxious to obtain either a new TR for the town or a county representative for Wiltshire. Any offers?

## Essex County Meeting

Recently, two county meetings have been held in Essex, the first at Chelmsford and the second at Clacton. On the agenda were such matters as Representation, Administration, Finance, Social, Meetings and so forth. A revised representation was agreed upon as follows:—

County Secretary: (CR): K. R. Goodley, G239.

South West Essex: (ex-Romford TR): P. F. T. Redman, G186.

Central Essex: (ex-Chelmsford TR): W. C. Mills, G261.

Northern Essex: (ex-Clacton TR): R. J. Appleby, G988.

South Eastern Essex: Position vacant.

It was decided to continue the present idea of County Meetings, with local meetings as soon as the necessary support was



forthcoming. Visits to places of radio interest were discussed and it was agreed to put the matter in hand. A Travelling Folder was decided upon and details will be sent to Essex members shortly. It was agreed that, though the attendance was good, many Essex members were to be censured for failing to acknowledge several circular letters. It was agreed that, in future, notification of meetings and activities will only be sent to such members who attended the previous meetings, members who had acknowledged previous communications and new members.

Essex local meetings are at present:

Central: Chelmsford Radio Society (ISWL), W. C. Mills, 3 Elm Cottages, School Lane, Broomfield.

South West: S.W. District ISWL Branch: K. R. Goodley, 34 Blenheim Avenue, Valentines Park, Ilford.

The Essex representatives have been putting in a lot of hard work since the League was formed and they ask every member in the county to do their best to co-operate. Those not already in touch are invited to contact the CR, Ken Goodley, at their earliest convenience.

### Birmingham

A set-back in the form of National Service has done nothing to deter the growth of this Chapter. Malcolm Taylor, whose initiative and enthusiasm was instrumental in getting the Chapter formed early this year is now in the Army. We wish him the best of luck and look forward to the day when he will be able to partake in active ISWL affairs again. His duties have been taken over by the capable Geoff. Moore, whose QRA is 42 Fern Road, Erdington, Birmingham 24. The minutes of the last few meetings show that enthusiasm is still high and local members should waste no time in joining the group. We understand that the Walsall society is co-operating with the Birmingham Chapter.

**North West London** (Sec.: G. Lewis, 484 Finchley Road, London, N.W.11.)

The club now has its five-member committee and is going on nicely. On the constructional and experimental side, the club now caters for all frequencies from 1-10000 Mcs.!! Morse and theory classes are going well and in fact progress is more than satisfactory. Local members not already in contact are invited to write to the Secretary for details.

### CQ's and SOS's

From time to time, we get literature from manufacturers intended for ISWL members. In these cases, the manufacturers ignore the members' addresses (and names!) and merely address them to HQ. The selection we have at present are as follows: (1)

A letter from the "Anglo-French Periodicals and Publicity," (2) Leaflets and literature from "Pye Limited" concerning television receivers, (3) A letter from "A. C. Cossor Ltd." regarding Cossor Service Manuals, (4) Leaflet from "R.A.P., Distribution Limited" and (5) Details from "Thorns" of their garden sheds!

Will members who have been expecting replies from the above firms, please notify us and we will send along the appropriate literature.

Of a different nature, we often get requests for data on surplus gear that we are unable to answer. Can any members rally round to supply data on the following equipment? Here are the sets in question, together with the members who need the data. R.A.F. receiver 1147B: Wiring diagram needed, also details of the I.F.: G. M. Down, 47 Kendall Avenue South, Sanderstead, Kent. R101 receiver: Details on coils needed: 3056321 LAC Dodd, Air-men's Mess, 13 M.U., R.A.F., Henlow, Beds.

Army 208 Receiver/Army receiver 103A: Correspondence required with anyone who has used either of these receivers: E. A. Kimber, 7 Van Mildern Terrace, Stockton, Co. Durham.

R.A.F. receiver R1334: Circuit details required: E. A. Coates, 4 Victoria Road, New Barnet, Herts.

Finally, will Spr. L. Bushell, ISWL/G90 please inform HQ of his present QRA since correspondence to his service address (Merebrook Camp, Worcs.) has been returned to us?

### New leaflets

A new four-page leaflet is now being sent to new members as they join the League. These leaflets contain full details of all ISWL services and supplies. If any existing member would like one of these helpful leaflets, just send along a S.A.E. and it will be despatched.

### New Services

We have pleasure in announcing yet another service for the benefit of members. It is the AMATEUR STATION QRA SERVICE, which is under the management of P. B. Wood, 35 Third Avenue, Denvilles, Havant, Hants.

This service is intended for those members interested in sending their reports or QSL's direct to stations and not through any Bureau. All you have to do is to send along a sheet of paper with the call signs of the appropriate stations down the left hand side, leaving sufficient room for the QRA's to be filled in. Just two points: (a) we cannot guarantee to be able to supply

(Cont. on p.332)

# On the Ham Bands

Conducted by "CQ"

## ● 14 Mcs.

After careful consideration of facts, a new policy has been decided upon for the future presentation of the DX bands commentaries. We like to be fair and give all readers a chance to have their DX news published, but with the present restriction of space it appears to be an awful waste to devote excessive space to individual logs. The point is that the publication of dozens of logs is futile inasmuch as many calls are repeated time and time again, and no really useful purpose is served. Therefore, in future, we will be publishing, for each band, ONE full DX log which will be carefully selected as being the best, and the best ten or so calls from each remaining log. The full log will give everyone an idea of what can be heard whilst the cutting down of the remaining logs will give everyone a chance to have his best "snips" published. We will do our best to "stagger" the selected complete logs so that one reader will not have a complete monopoly month to month. ("DX" by the way will be ascertained in the strictest sense—i.e. no W's, East Coast VE's etc.)

It must be emphasised that actual DX news, that is, data, will not be affected by the above rulings. We cannot have too much factual data about stations and conditions and we urge readers to concentrate on these subjects. And now for this month's selected log, which is that of our good friend Al Slater of Southwick, Sussex:—

AR8AB, 8BC, 8BM; C3AC, 4CK; CP5ET, EL5B, FF8FP, HH2CW, 2LD, 3VE; HZ1AB, J2AVA, 2CAL, 2GHQ, 2HYS, 2ROC, 5AAJ, 5AAL, 8AAA, 9AAS; KA7GC, KG6AI, 6AW/VK9 (Admiralty Islands), KH6JQ, PK4BU, 4CL, 4FH; NY4ZQ, OQ5CA, OX3BD, 3GE, 3GG; PK1MH, VE8MB, 8OG, 8OO; VK6AP, 7AJ; VP2AD, 2GB, 4TX, 5AS, 9L; VR2AP, 6AA; VS2BU, W3KXO/J9, 6WCN/KG6, 7ELJ/KL7, 9TKS/KP4; XZ2AG, YN1HT, ZC1AL, ZL2BE, 2JD, 3AW, 3BV, 4AO, 4AT, 4FO, 4GA; ZS1GR.

Al mentions the good conditions prevailing most mornings, with W6, VK, VE7, KL7 and the Pacific stations. He notes the absence of interest around lunch times, except for the occasional appearance of J's, but comments on the interesting stations to be heard during the evenings.

A. H. Onslow, also from "Way Down South." has had some good DX. Last month he logged 8 new countries, bringing the total to 142. He describes the early morning conditions as "perfect," with stuff like VR5, VR2, KP6 and KM6—all new countries—and the "lesser DX" like KH6, KL7, ZL, etc. Bert, now getting along fine with his CW, heard his first UA9. He also logged FG8D, which represents a very fine catch, if genuine, and informs us that ZS6OL is in Bechuanaland—anyone heard this one yet? Finally, from QST, Bert mentions that HSI1LN, 1DI, 1CF and 1MR are one and the same station, the different call signs being used by the four operators. Incidentally, our friend is one of the lucky ones to possess a QSL card from M1A.

D. L. McLean (Yeovil) sends along some massive lists of DX. He has a QSL from CN8BA, which is the same design as that of CN8BB (mentioned in "QSL Corner," "S.W.N.," September, page 243) and explains it as follows: Apparently the design is an advertisement, the words on the card meaning "Thanks to the Export Bureau, like the waves the products of Morocco go around the world." So now we know! In his fine 'phone log, we note CR4HF (at 1730), I1AHK (Sardinia), ST2GE, VK7AJ, VP5AN, VS7IT, ZD1BD (2200), ZL2BT, GX, 4GA, ZS2AQ, G, 6BJ, JA.

Donald Robertson, GM1051, up in the extreme North of GM, tried 7 Mcs. for DX but gave up after only hearing W's and KP4cc. Conditions may not have been too good on that occasion, O.M., as the DX has been coming in very nicely, especially the ZL's, so suggest you have another "bash." Don also tried 3.5 Mcs. without success, only hearing Europeans. However, he did hear plenty of R9-plus QRN and "fish-phone"! Which would seem to explain things, since with an R9 background one could not expect to hear intelligent signals of lesser strength. (The W phones inhabit the 75-metre band, O.M.) Amongst his best on 14 Mcs. were VS2BU, VS7IT, ZD4AB, W3JRP/KG6, J9AGT, 3AAD; VQ3EDD.

A. Baldwin, G193 (London, E.11.) has heard some interesting DX. VP8ad was heard in QSO with VP8ai at 2115, whilst VS9af was heard to say that as his shack was in the crater of an extinct volcano he didn't get out so well on 28 Mcs.! G193

thinks that he was the first SWL to report reception of KX6USN on Bikini Atoll and he follows this up by reporting KX6af at 1630, RST 358. Other interesting items were C7tk, VE8og (Victoria Island), KL7ln, VU2rs, rw; ZD1bd, 4ab, 4ap (2130) and VS1ce. On 7 Mcs. he pulled in W5kqq and PY1lg and has now migrated to 3.5 Mcs. to try his luck. His final comments are "Seem to be a lot of phone DX chasers about—doesn't anyone read CW these days?" Not many, it seems.

**James Endersby**, GW703 (Old Colwyn) has logged two of the new U.S.A. K prefix, namely K2NR and K9AAY. His comments on the band are limited to the observation of VP5AS as most of his listening has been on 28 Mcs.

**D. Garrard**, G632 (Ipswich) takes his bow and sends along some nice calls logged, listening being restricted to between 1900-2200. Best are EL5B, HZ1AB, OX3BD, GG, GE; PK1AD, VS2BU, XE1IZ, ZC6BS and ZL2GX. Derek would like to swap SWL cards with any ISWL members, his QRA being 17 Hill House Road, Ipswich.

Many thanks to the following readers for logs, for which we unfortunately cannot find space for this month: D. E. Hayes, G323; P. G. Castle, G866; R. V. Aldridge; G. Tivey, G693; L. C. Gallie, G1200; G. W. Cardwell, G1396.

● 28 Mcs.. News

Without a doubt, the DX has been romping in on this band to such an extent that almost every country has become "local." The logs we have received this month contain so much DX that the whole affair tends to become monotonous reading. Definitely the most prolific DX log has come from **Reg Masters**, G407, of Portsmouth (these South Coast boys certainly lead the way in the DX game!). Sporting through literally scores of calls we have selected: AC4YN (0900, Q4 R5—Reg Fox, please copy!), CR9AM (1400), AG; CM9AA (Experimental Station), J2AAC, AYY, BON, FOX, XYM, 8AAA, ACS, AFK, 9AAO, AAS, ABK, ABX, ANT (all heard between 0730-1130); KL7DY, KW6AC (R9 at 1310), KZ5AZ, CS; NY4AB, LM, ZQ; OQ5BA, MD6AR, TF3EA (1400), VP5EM, FR, 6CDI, ZI; VS7PW, VU2AF, BF, CS, CD, CQ, 7AB, JU; XZ2DN, KM, YT; ZE1JE, JZ; ZD4AB, AL; 20 ZL's, 13 ZS's, etc. After all that, there is not much else to add! Reg mentions that North Americans sometimes come in as early as 1100 but often not until 1700, the latter days being poor for all-round DX. In the early mornings the ZL's have been pounding in from as early as 0630. A new country heard was LZ1AB at 1300.

● Topical DX QRA's

- D5AA: SP74622, BPM 415, French Zone of Germany.
- FG8D: Box 39, Point-a-Pitre, Guadeloupe.
- J2AAG: Navy 3923, c/o PM, San Francisco.
- J2AMA: APO 328, c/o PM, San Francisco.
- J2FOX: APO 503, c/o PM, San Francisco.
- J4WWP: W. Page, CSO Branch, HQ British Commonwealth Occupation Forces, Japan.
- J5AAQ: 19th Inf., APO 24, Unit 2, c/o PM, San Francisco.
- J8AFT: AACS, APO 713, c/o PM, S.F.
- J8AFK: APO 710, c/o PM, S.F.
- J9AAO: APO239, c/o PM, S.F.
- J9AAO, J9AAS, J9ANT: APO 239, c/o PM, S.F.
- KW6AC: c/o CAA, Wake Island, Central Pacific.
- KZ5AY: P.O. Box 57, Howard Field, Panama Canal Zone.
- KZ5BA: P.O. Box 65, Curunda, P.C.Z.
- M1A: Dr. Corrado Francini, Republic of San Marino.
- MD5NK: No. 1 Sqdn., No. 3 GHQ Signals Regt., M.E.L.F.
- OX3BD: BW3, Samiutak, Greenland, APO 858, c/o PM, New York.
- OX3MC: APO658, c/o PM, New York.
- SU1JM: TWA Communications Dept., Farouk Field, Cairo.
- VP4TT: Walter Field, Trinidad.
- VP4TAD: APO 857, c/o PM, Miami, Florida.
- VP4JC: c/o Telephone Company, Bridgetown, Barbados.
- VQ3PYE: Box 568, Dar-es-Salaam, Tanganyika.
- VR2AC: Box 338, Suva, Fiji.
- VR3A: R. Garrett; Washington Isle, via Fanning Island.
- VS2BO: c/o DDME, HQ Malaya Command, Kuala Lumpur, Malaya.
- VS7FF: Box 433, c/o GPO, Colombo, Ceylon.
- W2WMMV/C9: Box 10, Navy 3930, FPO, San Francisco.
- ZD4AC: P.O. Box 555, Accra, Gold Coast.
- ZS6OL: c/o R.A.F., Gaborones, Bechuanaland Protectorate.

(Thanks to J. H. Endersby, D. L. McLean, R. W. Ainge and D. Robertson for several of those listed above).

G407 would like to know if any readers have heard Missouri, N. Dakota and Wyoming on ten metres as he needs these for HAS. He has now logged 134 countries, which is pretty good going. Finally, Reg remarks on the absence of obvious pirates these days. Incidentally, G407 is also in on this card-swap business and for those interested his QRA is 62 Battenburg Avenue, North End, Portsmouth.

Following on close behind is **D. L. McLean** and his best ones were CR9AG, KG6AF, BT; KW6AC, TG9RV, VQ2DH, PL, 3PYE; VU2BJ, TM, 7AB, BR (0720); ZD2KC, 4AL; ZE1JS, and masses of VK, ZL, ZS calls. Really a very fine effort.

**Donald Robertson**, up in Bonnie GM, has been seeing the Northern Lights which he says are beautiful to look at but grim as far as DX is concerned. The pick-of-the-bunch are C1CH, OQ5BA, VU7AB, ST2FT, KG6BI, W2WMMV/C9, YS3PL, XZ2YT and a Baker's Dozen of ZL's.

**A. E. Lincoln**, G289 (Grimsby) sends along EP4TA (is this VP4TA?), MD6AR, PZ1A, ST2MP, VP4TT, 6CDI; VQ3PYE, 4ERR, 5DES; VS1AT, 7BH, VU2TM,

7JU, YN1HB, ZS1T, ZC4AB (?), 6JP; ZD2KC, 4AL. Albert compiled his log by sending in one station from each country heard—a good idea which could be copied.

Derek Garrard, G632, has J9AAC, KG6AAF (or KG6AF?), KV4AV, NY4AB, LM; OA4F, OQ5BA, TZ5AB (is this KZ5AB, O.M.?), VP4TT, 5EM, 6HR; VR9RM (there aint no such prefix!), VU2BF, TH, TM; ZC6JP, ZD2KC.

James Endersby logged all W States except Nevada, Colorado and New Mexico, during the month. He heard many VK's but failed with ZS. As far as he was concerned, the band opened at 0900 with the Far East, then South America at 1130, U.S.A. about 1200 with the West Coast W's around 1600 and Pacific and Arctic about 1800. He also heard some U.S.A. weather stations on approx. 31.2 Mcs., viz.: W8XP, XT, XQ, UN and WJAM. Has anyone any info. about these stations, please? James noted an unusual effect from EI3J. This station had an "Around the world echo" and was almost unintelligible owing to the fact that there were three or four echoes on signals! James sends in a very fine log, full of J, KH, KL7, ZL and /MM calls and also a complete list of States heard (with call signs of stations).

The best ones from the log of Bill Harris, G467, are OA4AN, PK2RK (1300), OQ5BA, VU2BB, 7AB, JU; XZ2KM and ZD2KC.

Leslie Waine, G328, rebuilt his receiver (the S.W.N. TRF3) and on the first day of trying out heard 129 W's between 1300-1430 and 1800-2145, as follows—W1: nil, W2: 30, W3: 23, W4: 4, W5:2, W6: 9, W7: nil, W8: 40, W9: 13 and W0: 8. Which all goes to show . . . Other interesting ones were HH5PA, HK3DW, KL7DY, VU2GB and HC2OA.

R. W. Ainge, G219 (Crewe) made his first onslaught on ten metres and was rewarded by CM9AA (he is OK, O.M.), CR9AG, J2FOX, PK2RK, ST2JF, VK6KW, VP4TAX, 5EM, 6HR; VS7PW, VU2GB, 7BR, ZD2KC and ZE1JZ.

G. W. Cardwell, G1396 (Barnsley) pulled in PK4CL, ST2MP, VK4BT, VD, VQ3BB, VU7AB, ZC6MB, ZS2AR, 4AF.

● **Black List**

E. A. A. Hardwick sends along his list of "coupon-snatchers," all of which had detailed reports, reply coupons and ample time for replying. The VO2AF episode gets more puzzling this month. Mr. Hardwick bears out the original statement by virtue of the fact that he heard 2AF boasting to a pal in the U.S.A. about "the sacks of SWL reports I receive and destroy." Furthermore VO2AF stated that if anyone

wanted the foreign stamps before he burnt the lot they could have them. From this evidence it appears that A. E. Lincoln was very fortunate to get his card! We can only say now that VO2AF should be appointed the President of the Coupon Snatchers. Mr. Hardwick goes on to mention that generally speaking British Colonial stations seem to be the worst offenders. It is impossible to print the whole list of this reader's black-listed stations, but we are keeping it for reference. Amongst them we see: CR7BB, EL2A, 5A, 5B (two reports each), HH5PA, 2CW; HZ1AB, KG6GM, OX3GC, OQ5BE, BH, BR; PK4HB, ST2KA, TR1P, VQ3TOM, 4JBC, DK, 5DES, PDB; VU7AB, BR; YS3PL, and dozens more. It will be seen that several of the above have previously QSL'd, so more information is needed.

Don Robertson reports this message on a QSL from VP6LN . . . "Your report correct and appreciated. In this out of the way place we never reply to SWL's—as there are too many." Sounds slightly inconsistent! Well, all we can do is to gather all the data we can on this QSL situation, so please, O.M.'s, let us know how you are faring. Thanks.

**TEN METRE REVIEW  
(OCTOBER)**

By C. H. Ranft, G5RF

**T**RADITION has it that 28 Mcs. is a very variable band which is either dead or only just open. During October, however, its "habituals" have been presented with the somewhat unnerving spectacle of signals dropping down because 28 Mcs. was too low a frequency for certain paths, particularly East and West. It is reported that W signals have been better on some early afternoons on 50 Mcs. than on 28.

Conditions have in general been good over most paths though there was a disturbed period at the beginning of the month when N. American and ZL signals were heard weakly or not at all.

This interruption coincided with a period of very high North/South MUF's which enabled ZS1T and ZS1P to QSO Europe on a number of occasions on 50 Mcs.

On many days the band has been open very early indeed—often the MUF to the East having risen to spectacular heights by 0630 GMT. On these days ZL signals have been coming through "before breakfast."

**Continental Review:—**

**Europe.** Stations over 1000 miles distant only, apart from "DX scatter" propagation of nearer signals. UA and OH signals very



W2AFQ of Brockport, New York, putting out a "CQ" on 14 Mcs.

strong in the mornings. Surprisingly, tropospheric GDX quite good some late evenings.

**Asia.** Fairly consistent, in the mornings only. At disturbed periods as at beginning of month (8th-12th October). South Western Asia—VU7AB, VU7JU, UH8AA and ZC6 boys—better than other parts.

When high latitudes not subject to disturbance VS6AC a good signal.

**Africa.** Pretty consistent but QRK's lower than in summer. ZD4AB a good signal many mornings early. Peak time late afternoon for ZS with quick drop by 1730 GMT.

**N. America.** Overwhelming QRK's and QRM from noon onwards except for disturbance at beginning of month. Some falling off in QRK in early afternoon due to exceptionally high MUF. VE6 and VE7 stations audible on good days peaking 1800-1900 GMT.

**N.B.:** WWV 30 Mcs. very useful for checking frequency sub-standards.

**S. America.** Not so consistent now as summer. Audible some late mornings and in the evenings mixed up with the North American racket, also good signals for a short time after the evening North American fade-out, occasionally.

**Oceania.** VK—Audible with reasonable consistency in mornings up to 1300 GMT. At disturbed periods VK6 only audible.

The "Long route" over Pacific workable or audible October 5th, 6th, 24th, 25th, 27th (particularly good night).

ZL—Good signals on many mornings from 0630-1100 GMT. This route, particularly ZL1 and ZL2 traverses very high latitudes in Northern Hemisphere and is thus more liable to interruption at disturbed periods than other routes to Oceania.

#### The VK Contest

Good fun while it lasted. 5RF "had a go" and heard 5LB, 6CJ and 81G batting away. Did anyone hear or work a VK7? For that matter has anyone ever heard a VK7 on 28 Mcs.?

#### ● Query Corner

Before we go any further, the biggest news is possibly that we now have the QRA of M1A. This station has surprised us all by sending out QSL's, and his correct address has been inserted in the usual dept.

A query of long standing, viz.: YO5WZ, is again asked for by D. Robertson. Thanks to G5RF we now know that he is operating from North West Rumania and will QSL. His QRA is c/o Box 326, Bucharest, but it is most important that cards, etc. be sent UNDERCOVER otherwise the consequences for the operator will be serious.

R. G. Smith says how about UK3hg? Heard CQ'ing for four minutes giving his call very clearly. All we can suggest is that it may be VK3hg and that his bug is misfiring! We are not very pleased with this explanation and readers comments would be appreciated. D. L. McLean, and others,

want the gen on EDC. As far as we know this is another case of a commercial-gone-ham to while away his spare time! D. L. M. also wants some data on CR4HF.

● Gossip

David Mitchell, GW6AA, asks for all cards for him to be sent to BM/GAA, London, W.C.1, as he will soon be leaving for New Zealand and has no fixed address at present.

S/L. Harry Pain sends along the latest gen from Burma. XZ2DN, "Andy," will be leaving shortly for Blighty and Harry, XZ2HP, will be taking over the rig. Maybe you will get that G contact now, O.M.! During a sked with AC4YN, it transpired that a certain pirate has been using the call of AC4YN on 28 Mcs. As a matter of fact 4YN has not yet succeeded in working either a G or W on 28 Mcs. phone—so that stations in these countries who think they have worked Tibet on this band have "had it." In connection with this, Reg Fox, operator of AC4YN, says that if the boys do not behave themselves on the bands, particularly 14 Mcs., then he will have no alternative but to QRT. Trouble is that the VFO spivs "gang up" on him and cause such QRM that contacts that are made are completely ruined. When a QSO has been established, these aforementioned spivs still keep calling him not only on his own frequency but sliding up on the frequency of the person being worked. The resultant QRM has caused Reg to completely QRT for a while. Perhaps the ether poluters are now happy in the fact that they completely spoil the activities of a fellow enthusiast every time they swish their wretched VFO's. Ham spirit? Who's kidding! By the way, Reg mentions the fact that there may soon be another station on the bands with an AC4 prefix. Another victim for the DX-gluttons?

D. L. McLean brings to our notice the fact that at his Yeovil QRA he can hear quite regularly stations from South Wales on Sunday mornings at good strength. He says "why not use top band for these local QSO's instead of congested 7 Mcs. band?" Probably because the boys are not satisfied until they get a "99 db over S9" report! Ask some of them what 99 db's are—the answer should be interesting. Seriously, though, why clutter up a useful DX band for purely local chatter? Or has that been asked before? Incidentally, friend McLean has pre-war QSL cards from W1CPI and W2HHM for their 1.7 Mcs. phone signals.

R/O R. G. Smith in Castel Benito has now fixed himself up as a SWL station and

seems to be pulling in the DX nicely. One evening he heard W2qqa, W4hyb, W8cjm and VE3ael all calling a certain G8--- without success. Which goes to show that it's no good putting out a hefty signal if you cannot hear the replies! Reg says that MD2A is now QRT, having returned to his native South Africa, but that 2B, 2C, 2D, 2E and 2F are all active on the air. An interesting one logged recently was G2fdf/Y13. Has anyone any data please?

OX3GD says that QSL's for contacts between the dates of May 25th/July 7th, 1947 should be sent via WoRMN.

Cliff Ranft, G5RF, points out that ET11K asks for QSL's via I.A.R.U. and not A.R.U.

● Odd Jottings

Sudan is now well in the limelight, since besides the regular ST2AM and ST2MP we now have 2AN, 2RL (ex-G2FKN), 2GE, 2FT and 2JF . . . MD7RH and MD7EL are now in Suez with the calls MD5CH and 5EL respectively so that those who didn't get Cyprus will have to wait a while . . . W3RC was the op. for KX6USN, now QRT. The call will not be used again . . . Also QRT are VU2LR, AC3SS, VS1AQ and HZ1AB, the first three being on their way back to Blighty and the latter to the U.S.A. . . . ET1JF is not where he says he is, according to QST . . . G3BYF is now in South Africa with the call ZS6YF . . . Nice 'uns heard lately include VS9et (Trucial Oman), HR1CE, FG8AA, VP8am, KJ6AA and TI5RGM.

● DX QSL's Received

D. L. McLean: HC1OB, M1A, MB9AD, 9AG; OA4BF, 4BR; OQ5BW, UA1AA, VU2TM, W6MBD, 6PDB; CR9AG, KZ5NB, OA4OA, PY5AQ, VKZNO, ABU, 3IK, 4KW, KH; VP2GE, VS9AA, ZLIKT, 2JD, FF, 4AT; ZS5Q.

A. J. Slater: CT1QN, KG6AE, VK2ZC, UA1AA.

A. H. Onslow: SU1HF, ZD4AL, CT1QN, OA4BR, M1A.

R. W. Ainge: CE4BP, LU7BU, PY1JY, 2QK, 7QG; VK2ADC, 3AHB, 6KW.

C. G. Tilly: W6GGE, C1JC, YR5USA, VS2BU, 2BG; TI2JE, EL5A, VQ2PL, PY4IR, 1ACQ; HZ1AB.

J. Edwards: CO6BD, CX2AX, EA9AI, KP4AU, OA4M, YS3PL, TI2JE, W6PDB, 6VFR.

W. E. Harris: CE3FW, HK3DW, HZ1AB, LU3DH, MD5AF, OQ5AE, VE7AJN, 8NW; YR5X, ZC6JF, ZL3AW, 3LE, 4AT.

D. Hayes: VK2FG, KP4CO, YV5AB, MB9AD, SV1AH.

● **G Calls Heard Overseas**

**H. Westman**, ZS993, Upingham, South Africa. RX: SX28. Aerial: Close spaced beam 45 ft. high. 14 Mcs.: G2FN (5), 3MT (6), TU (5), 4FC (5), HW (6), 6DP (8), 8WS (7). 28 Mcs.: G2MF (4), ZB (6), 4CY (5), MT (6), 5BR (8), CP (4), 6AW (6), 8AK (7), DM (7), GW3AX (9). R strengths are given in brackets.

**R. W. A. McKichan**, Hong Kong. RX: Home-built superhet. 28 Mcs.: G2SB (59), VH(47), BZZ (47), HIO (59), CBA (58), agx (589x), 3AX (59), BK (58), YM (49), ANE (47), 4CY (47), CG (47), MS (59), 5CP (59), OO (36), 6OS (49), ZH (59), OM (59), 8QX (59), SY (47), GW2UU (59), 3UO (58). QSA/R values given in brackets.

**R. F. B. Featherstone**, Nakura, Kenya. RX: Marconi 822. Aerial: 100 ft. x 50ft. high. 14 Mcs.: 2AIS, 3BLT, DO, FA, GA, PM, 3FC, HW, 5PN, PP, RL, 6AG, XR, 8IJ, IO, TH, CL, UR.

**J. Davis**, Khartoum. "Regulars" on 14 Mcs.: G2HF, MF, 3MK, MY, 8QW.

**A. Teeter**, Rumson, New Jersey. 28 Mcs.: G2EC, DU, MI, PL, VH, ZF, ZQ, ADA, ANJ, AMD, COP, FYO, HIO, 3AO, KB, WT, WW, AEW, BJO, BPW, 4GZ, HD, CI, KC, NT, 5BM, CP, KS, TP, 6AG, BW, JK, JL, LD, NB, RH, PU, WG, 8AX, AY, CD, DU, KH, MX, RR, RS, SY, TV, GM3AJX, 8MN, GW5XN. 14 Mcs.: G3BM, 6BY, 8QW, GM8MN.

**Nice Types**

**A monthly record of prize lids**

**VS9--**, who stated that when the German nationals are allowed on the air again he would not enter into any QSO's with them.

**G5---**, who was radiating R6 overtones on 1.7 Mcs. from his 14 Mcs. transmissions. He was sent a letter explaining all, from another local ham, accompanied with the offer to co-operate in any tests. The letter has never been acknowledged.

The **unknown quantity** from Wales who came up on 7 Mcs. 'phone with the announcement "This is Charlie Jones broadcasting from Wales."

**G2---**, who stated on his QSL card, "Fill in your own report, O.M., as I don't keep a log book."

The **bunch from Darlington** (G2---, G3---, G3--- and two G8's) who use full whack on 7 Mcs. for cross-town QSO's, some of them between 200 yard distances. The G2 overmodulates and has strong harmonics, the G3's are operating without

**[DX PREDICTION FOR MID-NOVEMBER to MID-DECEMBER**

(7 and 14 Mcs. through courtesy of Geoff Hutson, G6GH. 28, 50 and 60 Mcs. with acknowledgements to Denis Heightman, G6DH. Times in GMT.

**7 Mcs. Conditions**

0700-0800—LU, PY, ZL, W1.  
2000-2100—VK, ZL, ZS.  
2300-2400—LU, PY.

**14 Mcs. Conditions**

0700-0800—ZL.  
1400 —Asians.  
1500-1600—W6.  
1700-1900—W.7, Africans, PY, LU.

**28 Mcs. Conditions**

Generally conditions will be good for E.-W. working in daylight. No ionospheric storms likely. Southerly working, whilst fairly consistent, will not provide such strong signals as those obtained near the equinoxes. The band will normally open first, to the S.E., about 0700. By 0800, Far East and Australasian signals will be audible, remaining in until 1300. S. Africans should be heard from 0900-1630. S. American circuit will open 0900 and remain in until 1900. W's and VE's should be in by 1300, fading by 1830.

**50 and 60 Mcs. Conditions**

The 50 Mcs. path to N. America may open on several days, generally between 1400-1600. From 0900-1100, may be an opening to S.E. Look out for MD5KW and SU1HF between 0845 and 1015. It is not expected that "super" distances will be covered, optimum skip being about 3000 or less.

With the coming of cold weather, tropo conditions will give shorter working distances. Contacts over 100 miles will be the exception. In mild weather, with ground temperatures over 40 degrees F., longer distances may be covered.

'phone permits and have fruity harmonics, whilst the G8's should be old enough to know better.

(N.B.—If any reader has any offerings for this section we would be pleased to have them for publication.)





# Radio Amateurs' Examination

Report on the Examination held on Wednesday, May 14th, 1947

WE have just received from the City and Guilds of London Institute a report, on the last amateurs' examination. A falling off in the percentage of passes is commented on and it is suggested that a number of persons had sat for the examination without adequate preparation. The majority of entries were found

to be of extremely low standard and "from the phraseology and vocabulary used, and the general way in which the answers were given, it is apparent that a large number of entrants . . . had received little or no coaching for the Radio Amateurs' Examination." Below, we reproduce the paper set.

## THE PAPER

1. An alternating voltage of 10 volts at a frequency of  $\frac{100}{2\pi}$  Mcs. is applied to a circuit consisting of the following elements connected in series:—

- (i) an inductance of 10 micro-Henrys,
- (ii) a capacitance of 10 pico-farads,
- (iii) a resistance of 10 ohms.

- (a) What current flows through the circuit? (5 marks.)
- (b) What voltage appears across the inductance? (5 marks.)

2. What is meant by the "selectivity" of a tuned circuit? On what circuit constants does it depend?

Why is this quality necessary in a receiver? (10 marks.)

3. What is understood by the term "C.W." and what special method is needed to detect C.W. signals? Describe a circuit arrangement which could be used for this purpose, illustrating your answer by a diagram. (10 marks.)

4. What is meant by modulation? Describe a method of modulating a typical low-power R.F. amplifier. (10 marks.)

5. What are the relative advantages and disadvantages of a variable-frequency master oscillator over a crystal-controlled oscillator for use in an amateur transmitter? Describe a variable-frequency oscillator of good frequency-stability. (15 marks.)

6. Describe, with the aid of a diagram, the circuit arrangement of a low-power crystal-controlled transmitter for the 58.5 to 60 Mcs. frequency band. (15 marks.)

7. Describe FOUR types of aerial commonly used for amateur transmission and how they may be coupled to the transmitter. What are their relative advantages and disadvantages? (10 marks.)

8. Condition 8 of the Postmaster-General's licence to establish an amateur wireless station stipulates:—

"Where the sending apparatus is not crystal-controlled there should be kept at the station . . . a reliable frequency meter of the piezo-electric crystal type or other type approved by the Postmaster-General, for measuring the frequency to an accuracy of not less than  $\pm 0.1$  per cent."

Describe an apparatus to meet the foregoing requirement. Illustrate your answer by a diagram and explain how the apparatus is used. (20 marks.)

Year	No. of Cands.	No. of Passes	No. of Failures	Percentage of Failures
1947	326	120	206	63
1946 (November)	216	150	66	30.5
1946 (May)	182	145	37	22.2

Details of Examinations held since commencement

(ISWL—Cont. from p.323)

every QRA but will be able to tackle the majority, if not all. (b) Have mercy on Mr. Wood and keep your lists down to a workable size!

Whilst on the subject of members' services, we hope to be able to announce another unique service next month which will be of special value to members interested in surplus radio gear.

From Worcestershire

(By R. G. Barrell, CR).

Meetings are now held regularly at the TR's QRA at Malvern "Hill Rise," Danemore, (Welland) every Sunday morning from 1000-1200. Members are also welcome any evening of the week at this address.

The Worcester TR says "Get to know your fellow members! Contact me at 1 York Place and lend some support towards starting regular meetings."

We in Worcestershire are most anxious for support from members from the above and other areas. Will members please contact their TR or myself at 4 Bromyard Road, Tenbury Wells. Thank you, O.M.'s.

**ISWL Renewals:** Subscriptions are now due from members with numbers between 396 and 442. Next month numbers 443-515 become due. There are also a few members (between 1-395) whose subscriptions expired last month. Will the members in question please send along their "bobs" as soon as possible. Thank you.

**Technical Hitch:** Owing to a typographical error, the large transmitter shown on last month's cover was given to be 30 kW instead of 130 kW.

**In preparation.** The 1948 Edition of the "Short Wave Listeners' Annual" is now in preparation. It will be larger than the 1947 Edition and will contain much new material.

(V.H.F. NEWS—Con. from p.311) would be possible to fill up a pretty complete data sheet for each day. If each individual making such observations sent in his data to your VHF conductor, the latter would compile a chart consolidating all the data sent in, which would constitute a most useful piece of amateur observational work of value to those official sources requiring such records. So if any readers are interested in such a scheme, please write in, c/o the Editors.

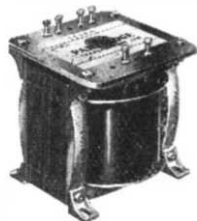

For the past 15 years we have devoted our energies exclusively to the manufacture of Transformers and Chokes. Modern transformer technique is essentially the province of a specialist. Our technical department will be pleased to assist you in your transformer problems. Illustrated above is one of our varied range of styles shown in our catalogue—Free on request.

Telephone:

Abbey 2244

**PARTRIDGE**

**TRANSFORMERS LTD**

76-8, PETTY FRANCE, LONDON, S.W.1.

**EX-ARMY RADAR RECEIVER TYPE R.D.F7.**  
Covers 150-165 Mcs. with variable tuning. 10 valves, lined up as follows: 6 type SP 41, 2 type EA 50, 1 type RL 7, 1 type RL 16. Manufactured by RGD. BRAND NEW IN ORIGINAL CASES. ONLY 59/6 (Carriage, etc. 7/6).

**MICROPHONE & HEADPHONE SETS**

Ex-Canadian Army. 4000 ohms phones with rubber noise excluders, and a first grade carbon mike. BRAND NEW. 10/6 (Postage 9d.)

**MCR 1 POWER PACKS.**

A.C. or D.C. mains input 107-235 volts, output 90 volts H.T. and 7.5 volts L.T. Metal rectification and efficient smoothing, incorporated. Complete in grey metal case size 8 1/2 in. x 3 1/2 in. x 2 1/2 in. ONLY 39/6. (Carriage 1/6).

**T 1154 TRANSMITTER KITS.**

The complete "left hand" and "right hand" panels of the T 1154, comprising the Master Oscillator Tuning Unit and the Output Unit for P.A. Only requires the addition of the valve section to complete the Transmitter covering 10-5.5 Mcs., 5.5-3 Mcs., and 500-200 kcs. Circuit details supplied. Or can be used as a basis for any Tx. BRAND NEW IN MAKER'S CARTONS, ONLY 40/- (Carriage, etc. 6/6), or either unit 24/6 (Carriage 3/6).

C.W.O. please. S.A.E. for current list.

**U.E.I. CORP.**

The Radio Corner,

138 GRAYS INN ROAD, W.C.1

(Terminus 7937)

We are 2 mins. from High Holborn. 5 mins. from Kings Cross.

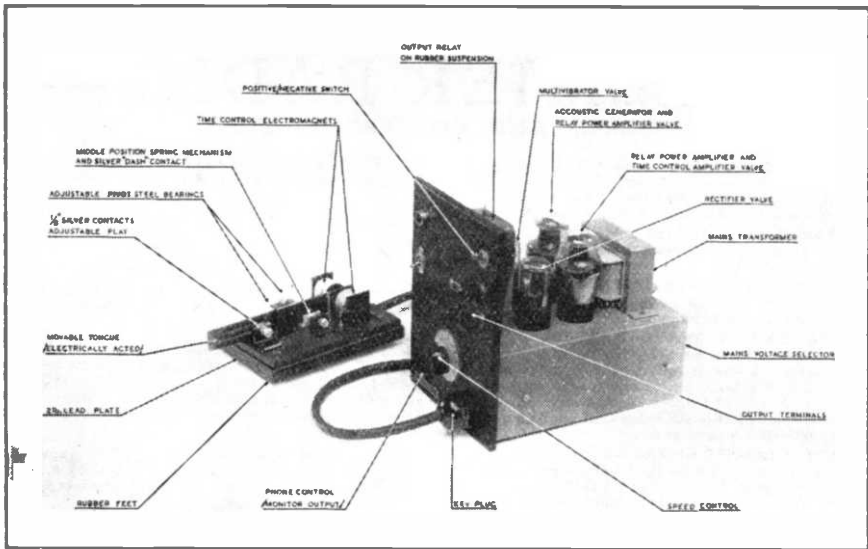

# Component Review

## An Electronic Key

**T**HIS novel instrument marketed by Electronics Prototype Designers Limited, of 123 Millway, London, N.W.7, is designed to facilitate the sending of morse and to improve the efficiency of such sending. The dominant factor of the electronic key is the practical elimination of the "human" element and not only sends automatic dots, as in the "bug" key, but automatic dashes. In this way, absolutely correct spacing is ensured. Apart from the improvement in the quality of sending, the electronic keyer also makes possible greater speed in sending. It has been proved that skilled operators, who found it impossible to increase their speeds under existing methods, have increased their sending by 30 per cent. within a few days of using the electronic key.

The electronic key consists of the Electronic Impulsator, which includes the output relay and an acoustic heterodyne for control purposes, and the Key itself, in which are incorporated electro-magnetic controls. The unit is for 230v. A.C. mains operation and is built into an iron box 6in. x 9in. A knob on the panel allows the speed of sending to be varied between 5 and more than 35 w.p.m. When this gear was being demonstrated to us, it was claimed that all a person had to know to use the key was an idea of the morse characters. To prove this we set the speed

to 5 w.p.m. and put a typist on the key with a copy of the morse code in front of her. After having mastered the use of the key (one side for dots and the other for dashes) she produced perfect morse signals! The main difference between this key and a bug key is that only a very faint pressure is needed to set it operating, with the result that absolutely tireless operating may be had. When the last dots or dashes of a series commence, the completion of the dot or dash will be formed automatically by a specially electro-magnet. This gives the operator a considerably longer period in which to switch over the key to the opposite position than is provided for in the ordinary bug key and thereby ensures smooth and less tiring movement on the part of the operator. It is obvious, then, that owing to the timing of the pulses being regulated by the Impulsator, it is rendered absolutely independent of faulty movements on the part of the operator. The same thing, of course applies to the ratio of the dot/dash duration.

We can readily endorse the statement that after a few hours of training, an unskilled operator can transmit almost perfect morse characters, since the instrument itself controls the dots, dashes and the interval timing. Only the number of impulses are controlled by the operator. The price of the complete unit is £25.

# PREMIER RADIO

MORRIS AND CO. (RADIO), LTD.

**ALUMINIUM CHASSIS.**—Substantially made of bright aluminium, with four sides, 10in. x 8in. x 2½in., 7/-; 12in. x 9in. x 2½in., 7/9; 16in. x 8in. x 2½in., 8/6; 20in. x 8in. x 2½in., 10/6; 22in. x 10in. x 2½in., 13/6.

**SUPERSENSITIVE DOUBLE HEADPHONES.**—Balanced armature with reed driven aluminium diaphragm. 60 ohms, 8/6.

**ELECTROLYTIC CONDENSERS.**—Miniature meta can type, 8 mfd. 500 v.w., 3/-; 16 mfd. 500 v.w., 4/-; 8x8 mfd. 500 v.w., 6/6; 50 mfd. 12 v., 1/9.

**2-VALVE, SHORT WAVE BATTERY KIT.**—A complete Kit of Parts for a 2-valve receiver, covering 15-600 metres, including valves, coils, drilled chassis, H.T. and L.T. dry batteries, to last approximately 6 to 12 months. A pair of Double Headphones and full instructions. Price £3/10/-. An Extra Coil can be supplied, covering 600-1900 metres at 4/-.

**ROTARY TRANSFORMERS.**—Input 12 v., output 180 v. 30 mA., 4 v. 2-3 A. with 19 volts input, output is 50 per cent. higher. May be used on D.C. mains as L.T. Charger. With small conversion could operate as D.C. Motor. Original cost over £5. Employ powerful ring magnet. Price 10/- each.

**OUTPUT TRANSFORMERS.**—A super production. By means of ingenious series-parallel arrangement, all windings are used at all times. Match any tube, single or push-pull to any voice coil 2-30 ohms. 7 watts, 22/6; 15 watts, 30/-; 30 watts, 49/6; 60 watts, 59/6.

**BATTERY CHARGER KITS.**—All Incorporate metal rectifiers, input 200-250 v. A.C. 40/100 cycles.

To charge 2 v. accumulator at ½ amp. ... ..	15/-
"   6 v.   "   "   1 amp. ... ..	17/6
"   12 v.   "   "   1 amp. ... ..	22/6
"   6 or 12 v.   "   "   4 amp. ... ..	...

Complete with Variable resistance and meter £3/15/-  
To charge 6 or 12 v. Accumulator at 6 amps.  
ditto ... .. £5

**H.T. ELIMINATOR AND TRICKLE CHARGER KIT.**—Consists of a complete kit of parts to construct an H.T. Eliminator with an output of 120 v. at 20 mA. and provision for trickle charging a 2 v. accumulator. Two metal rectifiers are employed. With circuit, price 30/-.

**RADIOGRAM CABINETS.**—Dignified appearance and good workmanship. Size 34½in. high, 19 in. deep, 36in. wide. Send for illustration. Cabinet only, £26. With Electric Motor and Pick-up, £32/16/-.

**ROTARY TRANSFORMERS.**—Size only 7in. by 4½in. diameter. With 6 v. input; output 200 v. 50 mA. With 12 v. input; output 400 v. 80 mA. Price 20/-

**ROTARY TRANSFORMERS.**—With 12 v. input; output 600 v. 250 mA. With 6 v. input; output 280 v. 250 mA., Price £3.

**OUR 1947 LIST IS NOW AVAILABLE.** All enquiries must be accompanied by a 2½d. stamp.

**ALL POST ORDERS TO:** Jubilee Works, 167, Lower Clapton Road, London, E.5. (Amherst 4723.)  
**CALLERS TO:** 169, Fleet Street, E.C.4. (Central 2833.)

## YOU TOO CAN HAVE AN EFFICIENT RECEIVING STATION LIKE THIS!

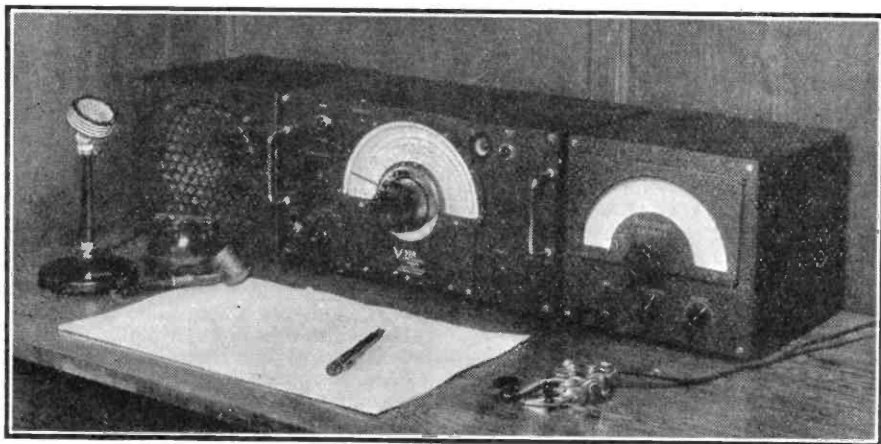

WRITE FOR ILLUSTRATED BROCHURE WHICH FULLY DESCRIBES THIS BRITISH BUILT RECEIVING EQUIPMENT  
HIRE PURCHASE FACILITIES AVAILABLE

**RADIOVISION (Leicester) LTD.** 58-60 RUTLAND STREET  
Phone: LEICESTER 20167



**FOR FREQUENCY SUB-STANDARDS**  
 TYPE JCF/200, 100 KC/S

Available from stock adjusted to  $\pm 0.01\%$ .  
 Higher accuracies supplied to special order  
 PRICES ON APPLICATION

**G.E.C.**

**QUARTZ CRYSTAL UNITS**

FOR STABLE FREQUENCY GENERATION

FEATURES

Low temperature coefficient—less than 2 in  $10^6$  per  $^{\circ}\text{C}$ .  
 Patented nodal suspension. Mounted in vacuum; performance independent of climatic conditions. Exceptionally high Q value. High stability. Small size, 3" x 5/8" overall excluding pins. Fits standard miniature deaf aid valve socket

V WIREMOUNTING  
 BRITISH PATENT NO 578290

The type JCF/200 unit illustrated above is representative of the wide range of vacuum type units available for low and medium frequencies

These will be on show at our  
 Stand No. 75 Radiolympia

**SALFORD ELECTRICAL INSTRUMENTS LTD.**  
 PEEL WORKS SALFORD 3  
 Phone: BLA. 6688 (6 lines) Grams & Cables "Sparkless, Manchester"

Proprietors. THE GENERAL ELECTRIC CO. LTD. England.

**SHORT WAVE (HULL) RADIO**

G5GX

offer

- 3 gang .00025 variable condensers ... 11/11
- 2 gang .00025 variable condensers ... 8/11
- Dipole aerial couplers ... 5/-

**VARIABLE INDUCTANCES**

Ceramic insulation throughout—silver plated coil  
 —tune 40, 20 and 10 metres with approx. 40 pF  
 fixed condenser 10/6

**RECEIVER KITS**

- O.V.I. (Less cabinet) ... £6
- 1.V.2. ... £10
- 1 (Tuned) V.2. ... £12/12/-

All complete to last detail but less batteries and supplied in black crackle steel cabinet (unless otherwise stated).

**TRANSMITTER KITS**

- 10 watt CW transmitter kit, complete with crystal and coils £11
- 25/50 watt CW transmitter kit complete with crystal and coils for any one band £19/10/-

Further details supplied on request  
 Every type of amateur gear constructed to your specification at moderate charges.

LET US QUOTE YOU

No job too small No job too large

at

**SHORT WAVE (HULL) RADIO**

30/32 PRINCE'S AVENUE, HULL  
 'Phone 7168

**EVERY AMATEUR NEEDS THIS . . .**

We believe in giving service beyond the sale. That's why we back our products with helpful technical literature. Our new 40 page fully illustrated catalogue is a gold mine of information for all radio "hams." Hundreds of items by well-known makers, including DENCO, EDYSTONE, O-MAX, RAYMART, WODEN, AVO, BELLING-LEE, COLVERN, Q.C.C., ROTHERMEL, WEARTE, J.B., N.S.F., etc., and clear illustrations are given with the necessary technical data. We believe this to be the finest "ham" catalogue of goods available in this country, and we have many testimonials praising our effort in producing in these difficult times a really worth while list. Whether you are a "G" or a S.W.L. you are bound to find plenty of interest. Please send 9d. and a request for catalogue No. 6, and we will mail by return. From no other single source is such information available.

ORDER YOUR COPY NOW

**SOUTHERN RADIO and Electrical Supplies**

85 FISHERTON STREET, SALISBURY, WILTS.

Telephone: Salisbury 2108

# SMALL ADVERTISEMENTS

Readers' small advertisements will be accepted at 3d. per word, minimum charge 3/-. Trade advertisements will be accepted at 6d. per word, minimum charge 6/-. If a Box Number is required, an additional charge of 1/6 will be made. Terms: Cash with order. All copy must be in hand by the 10th of the month for insertion in the following month's issue.

## PRIVATE

SALE MCR1 midget receiver complete with phones, power pack, £7 10s. Box 1025.

## TRADE

**COPPER WIRE.** Enamelled, Tinned, Cotton, Silk-covered. All gauges. Screws, nuts, washers, soldering tags, eyelets. Ebonite and laminated Bakelite panels. Coil formers. Covered wires, ear-phones, etc. List S.A.E. Post Radio Supplies, 33 Bourne Gardens, London, E.4.

QSL's and G.P.O. approved log books, samples free, from Atkinson Bros., Printers, Elland.

**AMATEUR Radio Specialists.** Send 2d. stamp for our Monthly Bulletin. Hallicrafters, National, Eddystone, Labgear, Berrys, Q.Max, Radiocraft, RX, TX parts, meters, etc. Johnsons (Radio), Macclesfield, Dept. N.

QSL CARDS. Send for free samples. G2DJA, 137 Randall Avenue, London, N.W.2.

G6MN for the "best" QSL's and approved log books, send for samples: G6MN, Bridge Street, Worksop, Notts.

**H. FRANKS, 58, New Oxford Street, W.C.1.**  
Tel.: Mus. 9594. Sangamo synchronous motors, self-starting, 200-250v AC 50 cy. consumption 2½ watts, size 2¼in. x 2¼in., geared 1 rev 60 mins., can be reset to zero by friction drive from front or back shaft, ½in. x 1/10in. to run clockwise, ideal movements for making electric clocks, time switches, etc., nickel-plated finish, price 22/6 ea.; 12 to 1 dial trains to fit above spindle, 2/6 per set extra; F/3.5 lenses, 2 inch focus by well-known makers, ex-Govt. stock, as new, fitted in oxidised mount, flange, etc., ideal for enlargers, projectors, cameras, etc.; price 27/6 each, postage 6d. **To callers only.** Selsyn motors, K20 aerial cameras, heavy duty L.F. chokes, change-over relays as used in 1154 transmitter, sun-vic delayed action controls, G.E.C. gas-filled mercury relays, blower motors, 1000 volts 200 mA. transformers, multi-way screened cable and plugs; C.R. power units, type 526; performance meters, type 53874; AC mains wavemeters, type W1252; battery wavemeters, type W1095; receivers, type 1147; AC mains power packs for 1147; receivers 3132; indicator modulators, auto transformers; receivers, type 76A; battery driven amplifiers, large assortments of volt, amp and milliameters, neutralizing units with RF meters, metal rectifiers, relays, vibrator packs, inter-com sets, signal generators DC to AC converters; Brown's A type headphones; E.M.I. cathode-ray tubes; 6-valve receivers incorporating Clystron unit, etc., etc.

## ADAMS RADIO AMATEUR GEAR

We have everything for the serious experimenter including "Lighthouse and Acorn" valves, High Frequency Transmitters and Receivers, complete kits for Amateur Television reception from £25.

Send for our complete list price 6d.

Cathode Ray Tubes ECR30 42/6, ECR35 65/-, ECR60 80/-, holders and masks in stock.

**ELECTRON HOUSE 655 FULHAM ROAD SW 6**

Phone RENown 4178

Tube Station:  
Walham Green.

Buses:  
14, 11, 28, 91 & 96

## H.A.C.

### Short-Wave Equipment

Noted for over 15 years for Short-Wave Receivers and Kits of quality.

One Valve Kit, Model "C" - Price 20/-  
Two " " " "E" - " 43/-

These kits are complete with all components, accessories, and full instructions. Before ordering send stamped addressed envelope for descriptive catalogue.

Note new sole address :-

"H.A.C." SHORT-WAVE PRODUCTS  
(Dept. SWN).  
66 New Bond Street, London, W.1

## SPECIAL OFFER—This Month ONLY!

We have left a very few 10 VALVE COMMUNICATIONS RECEIVERS. Type BC603D. Ex-U.S. Army. These are slightly soiled and less speakers, but otherwise complete, with 10 valves and 24v. power unit. Frequency coverage 20-28 Mcs. Overall size 11in. x 7in. x 1½in. Valve line-up: 6AC7 (3), 6J5 (1), 125G7 (2), 646 (1), 6V6GT (1), 6SL7GT (2). Tuning is manual and also by push-button pre-set mechanism. A very fine precision bulb job which cost 10 times the price now offered.

**ONLY £3/10/-** Carriage and Packing 10/-

Or less all valves £2/2/- Carriage and packing 10/-

## M.O.S.

**MAIL ORDER SUPPLY Co. Dept. SWN**  
24 New Rd., London, E.1. Stepney Green 2760-3906

# Vallance's Special Offers

Aerial Lead-in low loss, 3/3. Aerial "T" pieces, 1/3  
Aerial Insulators 3in., 2/6. Aerial Insulators  
7in., 7/10.

**CERAMIC VALVEHOLDERS**—4-pin English, 1/3;  
5-pin English, 1/3; 7-pin English, 1/6; 8-pin Eng-  
lish, 1/6; 4-pin UX, 1/6; 5-pin UX, 1/6; 7-pin UX,  
1/6; 8-pin International Octal, 1/6; Acorn type,  
2/6; Button Base type, 1/1.

**CERAMIC COIL FORMERS**—3½in. x 1½in. 32  
Grooves, 4/9; 5in. x 2in. 24 Grooves, 6/9; 5in. x  
2in. 26 Grooves, 7/6; Bases in Ceramic, 6/9; Sub-  
Bases in Ceramic, 6/9.

**COIL HOLDERS**—CERAMIC—4-pin 1/-; 6-pin 1/6;  
7-pin 1/6; Coil Holders, Bakelite, 1/9.

**COIL FORMERS** 6-pin—Plain, 3/-; Threaded, 3/3.

**COUPLERS**—Rigid, 9d.; Flexible, 1/3 & 2/6.

**CABINET ASSEMBLIES**—Cabinet and Panel,  
65/-; Chassis for above, 12/6; Chromium Handles,  
6/- & 7/6; Cabinets, 25/-; Die Cast Chassis, 9/6.

**DIALS**—Miniature Dials, Black, 5/6; Miniature  
Dials, Silver, 7/-; Die Cast Boxes, 4½in. x 3½in. x  
2in. 7/-; Extension Control Outfits, 2/6; Feed-  
through Insulators, 1/3.

**FEED-THROUGH BUSHES**—2BA, 4d. pr.; 4BA,  
3d. pr.; Feeder Spreaders, 6in., 1/-; Flexible  
Driving Shaft, 6/-.

**H.F. CHOKES**—2.5 M.H. 120 mA., 3/-; 1.25 M.H.  
50 mA., 60-15 Mcs., 2/6; 1.5 M.H. 250 mA. 60-1  
Mcs., 3/-; 17.9 M.H. 24-150 kcs., 4/-; 5.6 M.H.  
120-25 Mcs., 1/9.

**HIGH GRADE KNOBS—INSTRUMENT**—Fluted,  
2½in., 2/11; Fluted, 1½in., 1/11; High Note  
Buzzers 3/6.

**INDICATOR LAMPS**—In Red, Green, Blue,  
White, 2/9.

**I.F. TRANSFORMERS. (AIR SPACED TRIM-  
MERS)**—1½in. x 2in. x 2½in. 450/465 kcs., 19/6.

**KNOBS, BLACK BAKELITE, LARGE**—With 4in.  
0-100 calibrated skirt, 6/6; 2½in. 0-100 calibrated  
skirt, 3/11; With skirt, 3/6; Large Knob only, 2/6;  
Medium Knob only, 1/9; Small Knob only, 9d.

**KNOBS POINTER**—2½in., 1/3; 1½in., 10d. Lead-  
Through Porcelain Insulators, 2/6; Miniature  
Pointer Knobs, 9d.; Miniature Stand-off Insulators,  
9d.

**MOULDED INSULATORS** 1½in. HIGH—1000  
volts working, Red and Black, 1/6.

**NEUTRALISING CONDENSERS CERAMIC**—  
Min. 1.5 pF, Max 5 pF, 3/6; Pre-set Control and  
Escutcheon, 2/6.

**POPULAR GRADE KNOBS**—2½in. Instrument,  
2/3; 1½in. Instrument, 1/9; ¾in. Instrument, 1/3.

**WELWYN CRACKED CARBON PRECISION  
RESISTORS**—±1% 1 watt 1/5 each. Values, 900,  
400, 24000, 49000, 99000, 100000, 240000 and 499000  
ohms.

**PYREX BOWL INSULATORS**—Ideal for lead-ins,  
aerials, etc., 9d. each.

**5-WAY GROUP BOARDS**, fitted with 3-0.1 mfd.  
condensers. 350v and 3-½ watt resistors, with  
mounting bracket. Brand new 1/6 each.

**PUSH BUTTON ASSEMBLIES**. 5-way switches.  
on jack principle, 1 make and 1 break, first class  
quality, 3/-.

**VALVES ex-Government**—807 15/-; EF50 7/6; 813  
75/-; 35T 63/-; 1S4 11/3; 6BL7GT 12/-; 866 27/6.

**VOLTAGE REGULATORS**—VR75/30 15/3; VR90/  
OB3 15/3; VR105/30 15/3; VR150/30 18/3.

**ZONE MAPS**—Short Wave Mag type, printed  
two colours on paper, 3/9.

**PERIBRAID SLEEVING**—Finest quality for high  
voltage, 1 mm., 1.5 mm., 3 mm., blue, yellow or  
green 6d. yard.

**AMERICAN LINE CORDS**—33in. long 0.3 amp.  
2-way, fitted 5 amp. 2-pin plug, and American  
2-pin flat socket 7/11.

**COLLARO AUTOCHANGER** and pick-up, com-  
prising induction motor, tapped for 100/250v A.C.  
Mains. Plays eight 10in. or 12in. records—mixed,  
if desired. Any record can be repeated or rejected  
at will. Cabinet in highly polished dark walnut  
veneer, rounded corners and of exceptional finish.  
Price £28 7s. 4d., inc. tax.

**BARGAINS IN EX-GOVERNMENT SURPLUS  
COMPONENTS**—Short Wave Chokes, 5 to 180  
metres, 1/-; Parmeke Smoothing Chokes, 12 H,  
120 mA., 21/5; 12 H, 150 mA., 22/6.

**Condensers Paper—metal case**—4 mF 1500v.w. 12/6;  
4 mF 500v.w. 4/6; 2 mF 1000v.w. 2/6; 1 mF  
1000v.w. 3/6.

**Midget Variable Condensers**—18 pF single gang  
3/3; 27 pF single gang 3/3; 75 pF single gang 3/6;  
100 pF single gang 2/8; 160 pF single gang 4/-;  
50 plus 50 plus 25 pF three gang 10/-; 50 plus 50  
pF twin gang 8/-; 75 plus 75 pF twin gang 9/-;  
160 plus 160 pF twin gang 8/3; 250 pF single gang  
4/2.

**High Voltage Mica Condensers**—.0005 mF 2200v.  
9d.; .0001 mF 2200v. 9d.; .005 mF 2200v. 9d.; .001  
mF 5000v. 1/9.

**Ceramic Trimmers**—10-100 pF single 9d.; 5-40 pF  
double 9d.; 15-45 pF double 9d. 3.5-30 pF double 9d.

**Walkie-Talkie**—Telescopic Aerials 8ft. 6in. ex-  
tended, 15in. closed 15/- post free.

**SPECIAL OFFER**—Everett-Edgcumbe Moving  
Coil Meters, 6in. scale, calibrated 0-150v. full  
scale deflection 0-1 mA. in black bakelite case,  
size 7in. x 7in. x 2½in. This meter has a magnifi-  
cent movement and is worth double the price.  
Provides an ideal base for multirange meter 1000  
ohms per volt. Price 5s. Limited supplies.

SPEEDY POSTAL SERVICE, C.W.O. or C.O.D.

## VALLANCE'S

144 BRIGGATE, LEEDS 1

Tel.: 29428/9

Staff call signs: G2HHV, G8SX, G3ABD, G3AHV, G3BDD.

# CLYDESDALE

GM3ASM  
GM3BL

THE RADIOMAN'S SHOP  
FOR BARGAINS IN EX-SERVICES ELECTRONIC EQUIPMENT

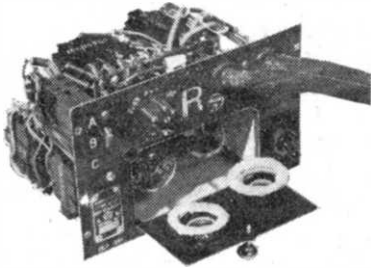

## A.1134 JUNCTION PANEL

10D/13336 contains 10 way and 4 way sockets, 6-2 way and 2-3 way terminal blocks and DP/ST Switch mtd. on board 6in. x 4½in.

OUR PRICE ONLY **3/6** each

Post and Packing 1/- extra.

## BRAND NEW

## A.1134 BATTERY AMPLIFIER

2 valve, 2 stage pre-amp. and interconn. unit, complete with valves. QP21 and 210LF, Trans., condensers, switches, etc., in metal cabinet 7in. x 5in. x 4½in. approx., with circuit.

OUR PRICE ONLY **13/6** each

Post and Packing 1/6 extra.

## A.1134 4 WAY BATTERY CABLE SOCKET

OUR PRICE ONLY **8d.** each  
Post 3d. extra



## R.1481 V.H.F. R/T RECEIVER

For 65 to 86 Mcs. 10 valves 2/SP41's, 4/EF39's, EF34, EK32, 6J5, P41, plus Voltage Stabiliser, 7475. Screened RF Unit, S.M. Tuning Dial, 4 Tuned R.F. Circuits, "S" Meter, BFO Attenuator, 250, 60. 15 mW. 600 ohms phone output. Circuit. Power input required 210v. 55mA. H.T. 6.3v. 3.5a. L.T., suitable for conversion. Rack mtg. enclosed chassis, finish grey, 19in. x 10½in. x 11in. Tested and guaranteed working before despatch.

OUR PRICE ONLY **£8-19-6** each

Carriage and packing 15/- extra

Still available and Brand New. Wheatstone Bridge, WA10771 Resistance and Continuity Test Set at 42/-, plus 8/- carriage and packing.

Ex-U.S. Navy Cathode Ray Indicator and repeater Amplifier Unit AN/APA-1 at 90/-, plus 7/6 carriage and packing. Set of plugs for AN/APA-1 at 7/6, post free.

SEND NOW FOR NEW ILLUSTRATED LIST

(Write Name and Address in BLOCK LETTERS please)

# CLYDESDALE SUPPLY CO LTD

2 BRIDGE STREET - GLASGOW - C.5

'Phone : SOUTH 2706/9

VISIT OUR BRANCHES IN SCOTLAND, ENGLAND AND NORTHERN IRELAND