

Over 100,000 Copies

Thirty Five Cents

RADIO REVIEW

Reg. U.S. Pat. Off.

*A Digest of the Latest
Radio Hookups*

Edited by S. Gernsback

Containing
Illustrated
Radio Encyclopedia

See Page 81



Published by the
CONSRAD CO. Inc.

Here they are



HARKNESS RECEIVER

A simple, non-oscillating receiver, easy to build, easy to tune and log, only two tuning dials, very compact.

Blueprints of all wiring and panel layout furnished with instruction booklet. PRICE.....50c



PORTABLE RECEIVER

A circuit specially designed for light weight when constructed. Circuit is of Reflex type, highly efficient. This is a receiver of a thousand uses, operating entirely from dry batteries.

Everything furnished in pattern for quick construction and good results. PRICE.....50c



5-TUBE COCKADAY

The improved Cockaday circuit with special push-pull amplification that gives special DX reception on the loud speaker though the medium of maximum amplification. Designed for easy construction by the set builder. All blueprints furnished full size together with complete instruction booklet. PRICE.....50c



ALL ABOUT AERIALS

Here's a Pattern giving complete instructions for the most practical, standard Aerials in use today, together with diagrams for installing them.

Don't overlook your Aerial. Upon it depends half the quality of reception from your set. PRICE.....50c

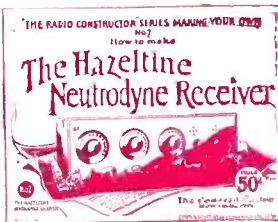

The NEUTRODYNE

This circuit is used by fifteen of the largest radio set manufacturers. 2 stages of radio frequency amplification, 2 of audio amplification and detector.

Blueprints of all wiring and panel furnished full size; also complete instruction booklet. PRICE.....50c

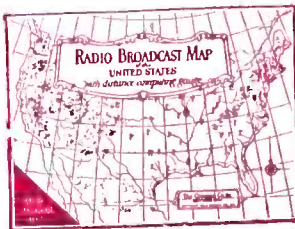

RADIO MAP

Radio's most complete map of broadcast stations on cloth. A map that will last a life-time. Gives distance from any point by means of special printed ruling strip that comes with the map. Printed clearly in large type for easy reading and logging. PRICE.....50c



The SUPER-HETERODYNE

Radio's most popular receiver. Perfectly balanced, maximum amplification, only 3 tuning dials, natural tonal quality.

Blueprints of wiring and panel 19 1/2 by 44 inches; also 16 - page instruction booklet. PRICE.....\$1.00



A REFLEX RECEIVER

One of the simplest, yet most efficient radio circuits. Can be built by anyone, only five or six ordinary tools required for construction.

Pattern contains full sized blueprints and instruction booklet. PRICE.....50c



20 RADIO DIAGRAMS

Revised and enlarged edition. Just off the press containing complete diagrams for 20 of the season's most popular circuits. With this pattern you can select your own circuit or try several different hookups until you have secured the one most satisfactory. PRICE..50c

The famous Consrad Patterns. Now used by thousands upon thousands of Radio Set Builders at home. The greatest radio patterns made — blueprints all drawn full size — ready for instant use.

COMPLETE LIST OF CONSRAD PATTERNS

- How to Make a Two-Stage Amplifier.
- How to Make a Reinartz Receiver.
- How to Make a Reflex Receiver.
- How To Make a Cockaday Receiver.
- How to Make a Neutrodyne Receiver.
- How to Make a Autoplex Receiver.
- How to Make the S. T. 100 Receiver.
- How to Make a Five Tube Cockaday Receiver.
- How to Make a Portable Receiver.
- How to Make a Harkness Receiver.
- How to Make The Original Genuine Super-Heterodyne. Price \$1.00.
- How to Make a Low Loss Receiver.
- How to Make the Tropadyne Superadio
- Radio Map of the U. S. on Cloth.
- 20 Radio Diagrams and Hook-ups, New Edition.
- All About Aerials and Their Construction.
- Radio Amateurs Practical Design Data.

SOLD BY ALL RADIO AND NEWS DEALERS

Published and Distributed by
THE CONSRAD CO.
 233 Fulton St., New York, N. Y.

RADIO REVIEW

REG. U.S. PAT. OFF.

A Digest of the Latest Radio Hookups from the Radio Press of the World

In This Issue

S. GERNSBACK'S RADIO ENCYCLOPEDIA Fourth Installment

NOT so many years ago, radio was a pastime of the initiated few. Not infrequently indeed, in the mind of the outsider, was it dismissed as a hobby of persons whom he put down, in unadorned parlance, as a peculiar kind of day-dreaming "bug."

¶ Today radio is not only an admittedly popular sport, but an unfailing recreational mainstay, and a seriously-to-be-reckoned-with educational instrument and cultural force; not only in our own country, but in every part of the civilized world.

¶ Radio has traveled with marvelous super-speed the span of its evolution from what seems in the backward glance like a curiously prehistoric, rudimentary stage to its present-day completeness and complexity. In the beginning, some fifteen years back, there was, for instance, no such thing as a complete receiving set. The would-be radio devotee had to buy every part, sometimes even construct those parts himself, and then assemble them after a more or less self-devised plan to build his set.

¶ Does the present-day amateur, we wonder, really see—and appreciate—the advantages he has over the predecessors who blazed the trail for him? We doubt it.

¶ And what an easy job our contemporary radio enthusiast has compared to that of the pioneers in the art. First of all, he lives in a world in which almost everyone he knows—friend, neighbor, comrade, is on the *qui vive* for the latest news and the latest wrinkles in radio. Radio is "the thing." Paralleling this vogue, he has access to hundreds of publications specializing in nothing but radio, from which he can make any one of several choices to give him the particular information he desires at the moment, whether it be on points of direction and suggestion on home construction, or the latest developments of the science as a whole.

¶ RADIO REVIEW itself, coming into existence as it has by force of a direct and insistent demand for a magazine of this sort, assembling and making available in digest form the almost overwhelming mass of day-by-day output in radio information, is another and significant index of the growth of the prevalent enthusiasm and practical interest in everything pertaining to radio today.

¶ On the concrete side, scores of manufacturers are turning out thousands of radio parts in an endless diversification, explaining their special uses and qualities by every device of advertising and publicity. Big hardware concerns sell special tools designed exclusively for radio construction. Every succeeding day sees new time and money-saving devices being put on the market, such as coil winding machines, coil formers, wire benders, panel drills, soldering outfits, and on through an almost inexhaustible list of first aids to radio comfort and economy. Special patterns, blue-prints, layouts, "make your own" guides and textbooks, vie for consumption in a profuse competition.

¶ And yet there are persons who complain that the constructing amateur is dying out, and advance the prophecy that his species, a few years from now, will be as dead as Tut-ankh-amen—except also as a possible historical curiosity. To get at the truth of this view, RADIO REVIEW has decided to make a survey of the actual present facts of the situation.

¶ We should be glad to know what our readers think on this point, in the light of their own acquaintance and experience in the field of amateur radio. Is amateur interest in constructional experimentation really passing, or only just beginning? A symposium of opinions along these lines, from our readers everywhere in the country, should be not only interesting but enlightening.

¶ Write your opinion on the subject to the editors of RADIO REVIEW. They will appreciate having it, on their own behalf and on that of their whole circle of readers.

The Consrad Co., Inc.

233 Fulton Street

PUBLISHERS

New York, N. Y.

RADIO REVIEW

Reg. U.S. Pat. Off.

*A Digest of the Latest
Radio Hookups*

Volume I

Number 4

OCTOBER, 1925

Contents of This Issue

	<i>Page</i>		<i>Page</i>
The Interflex Receiver	3	Another One-Control Receiver.....	49
A Technical Editor's Set	7	A Neutrodyne with Resistance Amplifier.....	51
The Midget Super.....	11	Receiving Without an Antenna or Loop.....	53
A Simple Browning-Drake Set.....	15	A Selective Single Tube Reflex.....	56
Radio Broadcast's Phonograph Receiver.....	19	The Greene Concert Selector.....	59
The Batteryless Receiver.....	31	A Four-Tube DX Receiver.....	63
A Neatly Designed Super-Heterodyne.....	35	A New Non-Radiating Receiver.....	65
The Metropolitan Local Set.....	37	An Impedance-Coupled Amplifier.....	67
An Attractive 3-Tube Regenerative Set.....	39	Data On "B" Battery Eliminators.....	68
How to Make a Two-Step Amplifier.....	41	A Two-Tube Power Amplifier.....	71
An Edison Storage "B" Battery.....	43	Single Tube Regenerative Hookups.....	73
An All-Wave Low-Wave Set.....	45	Crystal Sets for the Experimenter.....	76
		S. Gernsback's Radio Encyclopedia.....	81

RADIO REVIEW, OCTOBER, 1925

VOLUME I, NUMBER 4

Published monthly by The Conrad Co., Inc., 233 Fulton Street, New York, N. Y., telephone number Cortland 7777; H. Gernsback, President; S. Gernsback, Vice President and Treasurer; R. W. De Mott, Secretary. Price 35c a copy; subscriptions \$3.50 a year in the United States of America, Canada and all countries within the domestic postal zone; elsewhere \$4.00 a year, payable in advance. Subscriptions only acceptable in U. S. currency or stamps. No foreign currency or stamps. Checks and money orders should be drawn to the order of THE CONRAD CO., Inc.

When subscribing to RADIO REVIEW, send your name and remittance to The Conrad Company, Inc., 233 Fulton Street, New York, N. Y. Mention that you desire to subscribe to RADIO REVIEW. We also publish and distribute the "RADIO LISTENER'S GUIDE AND RADIO CALL BOOK." CONRAD PATTERNS, E. I. COMPANY BOOKS, etc. Write clearly.

Application entered as second class matter at the New York Post Office under Act of Congress of March 3rd, 1879.

PRINTED IN THE U. S. A.

General Advertising Department
53 Park Place
New York City

Western Advertising Representatives
Finucan & McClure
720 Cass St., Chicago, Ill.

Pacific Coast Advertising Representatives
A. J. Norris Hill Co.
Hearst Bldg., San Francisco, Calif.

New England Advertising Representative
T. F. Magrane
Park Square Building, Boston, Mass.

Kansas City Advertising Representative
Davies & Dillon
15 W. Tenth St., Kansas City, Mo.

RADIO REVIEW

SIDNEY GERNSBACK, Editor.
W.G. MANY, Associate Editor.
Offices, 233 Fulton St. New York City.

Vol. I

OCTOBER, 1925

No. 4

The Interflex Receiver

Employing an Unusual Reflex Circuit with Crystal for Rectifier

IN this article from *Radio News*, New York, Hugo Gernsback describes a rather unusual single control set that bids fair to become popular. It has several original twists and brings out a principle that is but little known.

is connected right into the grid circuit. The writer at the time thought that this was original, but later found that the principle was known, having been previously described in some scientific papers.

there regeneration. The crystal in the grid circuit acts as a detector, while the first tube acts as an amplifier; the amplification depending upon the crystal is from 10 to 20. In other words, if you use a crystal detector alone, the

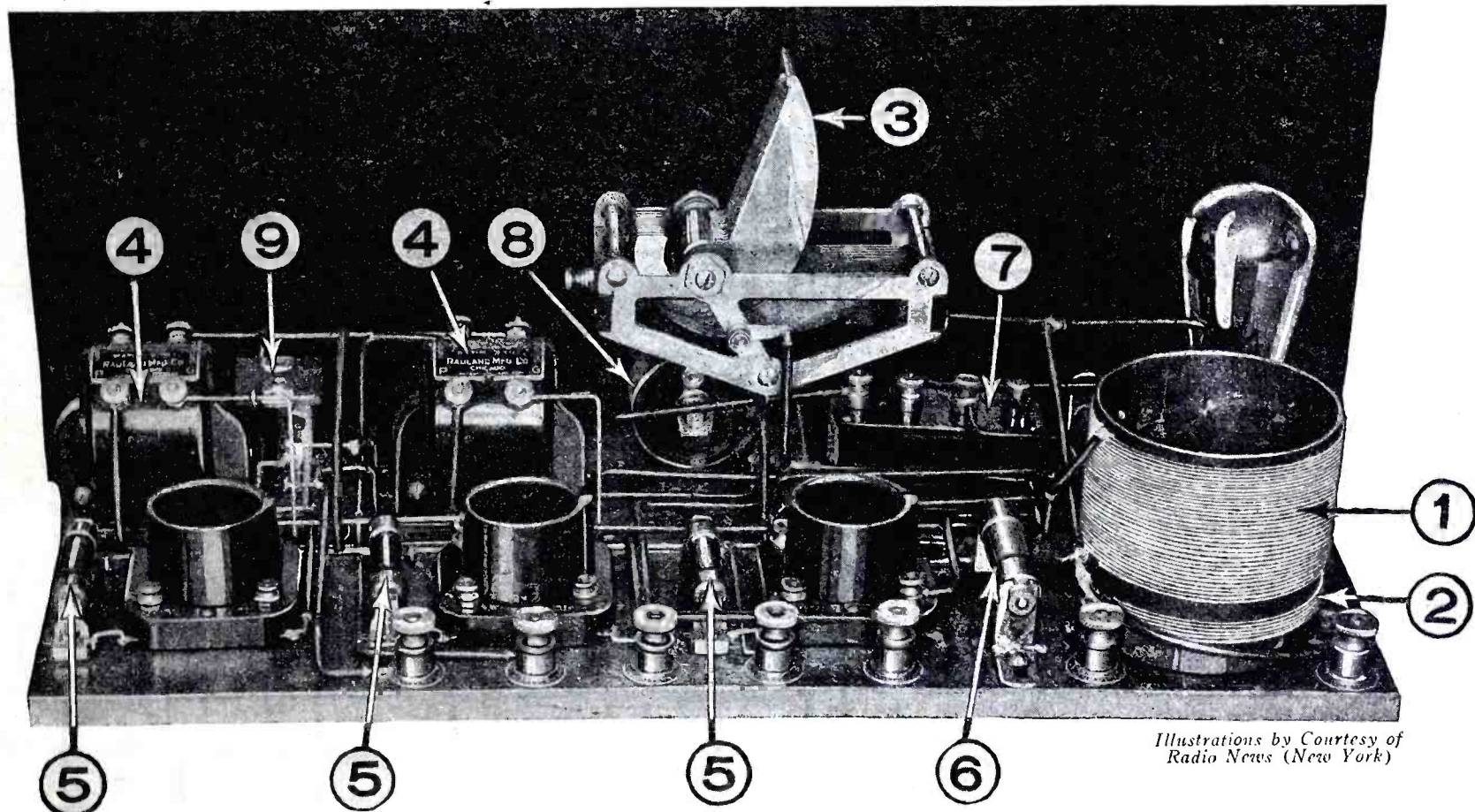

Illustrations by Courtesy of
Radio News (New York)

The Interflex receiver as it appears from the rear when completely assembled and wired. 1 and 2 are secondary and aperiodic primary respectively. 3 is the straight-line frequency condenser. 4, audio transformers. 5, Amperites. 6, fixed carborundum crystal. 7, radio frequency transformer. 8, potentiometer. 9, fixed by-pass condenser.

The circuit employed belongs essentially to the radio frequency family and the complete set as shown in the accompanying photos includes some of the most modern component parts. Mr. Gernsback tells the whole story and gives details for constructing the set in the following:

Some years ago, while experimenting with a crystal-vacuum tube combination, we fell upon a circuit shown in Fig. 1, in which a crystal detector

The final circuit evolved is the one shown in Fig. 1. The coil L-1 is a 3-inch tube, wound with about 55 turns of No. 20 S.C.C. wire, while the condenser C should have a capacity of 0.0005 mf. The crystal A may be any good crystal, although the writer in his experiments has found that a fixed carborundum crystal is the best, because it is the most stable. Any good vacuum tube may be used.

This circuit is not a reflex, nor is

addition of the tube will give an amplification of 10 to 20 times. The same is the case, in this particular circuit, if you use a tube alone, when the addition of the crystal will give you great amplification.

This circuit is remarkable in that there is no distortion, and the reception of the signals is about as clear as the writer has ever heard. The only drawback with this circuit is that it tunes broadly—that is, for local stations.

Note the simplicity of this layout. It makes for an ideal assembly of an excellent set. If you follow it you will have no trouble. Use a colored pencil when going over the black connecting lines, as soon as you have made two connections. You will then be sure not to have any omissions or make any errors. Note that crystal detector, 6, does not work in all positions. It may have to be reversed for best results. 1 and 2 are secondary and aperiodic primary respectively. 3 is the straight-line frequency condenser. 4, audio transformer. 5, Amperites. 6, fixed carborundum crystal. 7, radio frequency transformer. 8, potentiometer. 9 is a .00025 mf. fixed condenser. The value of this condenser will depend upon the transformer employed.

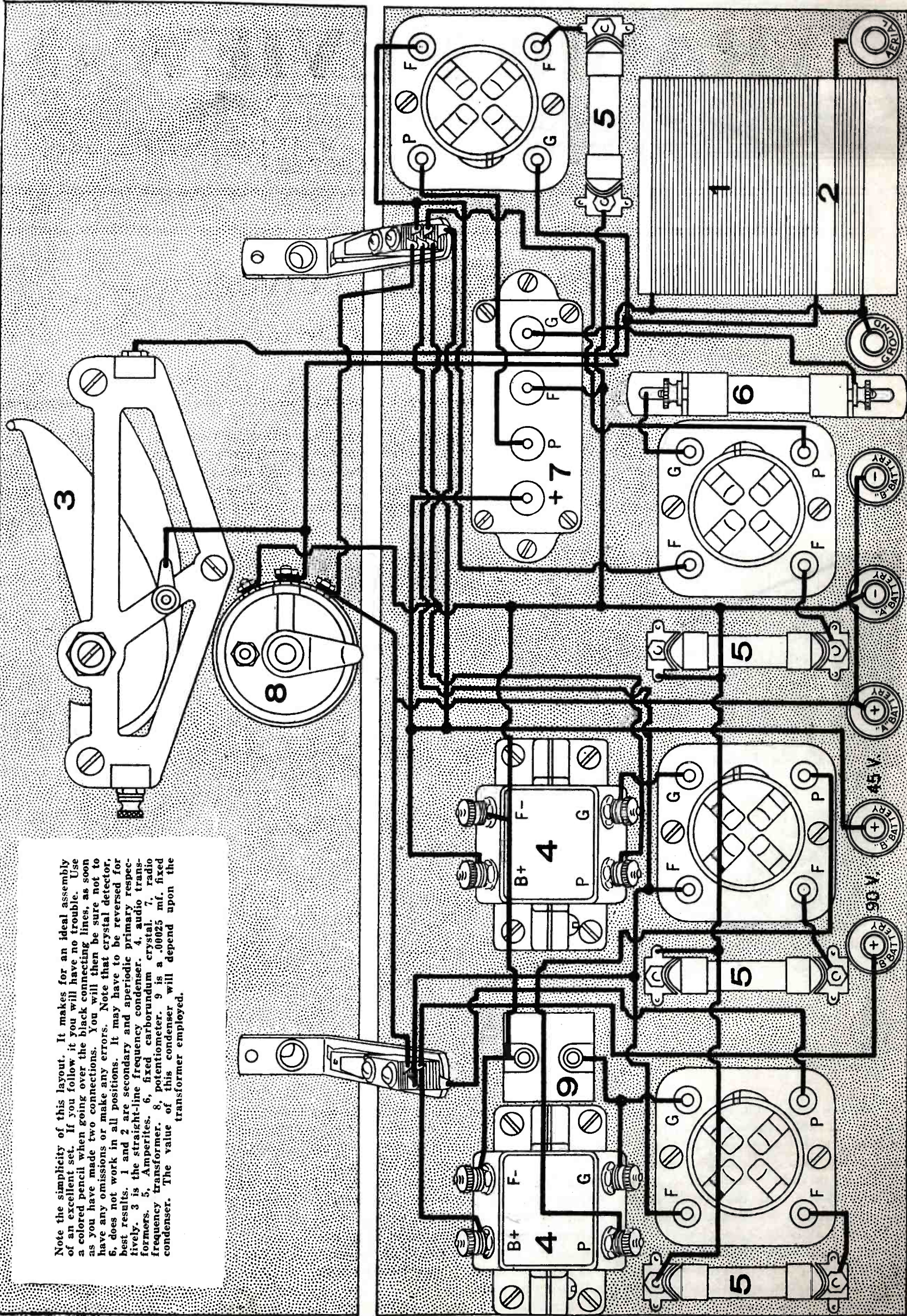

A surprising fact, which the writer believes has not been recorded heretofore, is that this circuit is really excellent for DX work. With a single-tube set of this kind the writer has listened repeatedly, in New York City, using a 60-foot aerial and ground, to stations in Philadelphia, Atlantic City, Pittsburgh, Springfield (Mass.), all of the Chicago stations and WOC, Davenport, which was the furthest station recorded on this circuit and is at a distance of 1,100 miles.

On DX the tuning is quite sharp and a vernier dial should be used, otherwise, you are likely to pass over the signals. It should be remembered that you *hear no squeal* in this circuit, since it works exactly like a crystal set. The tuning, therefore, is absolutely silent—hence, the tuning motion must be slow if you want to hear the far-distant stations. It goes without saying that you will not be able, with this hook-up, to receive the DX stations unless the locals are silent. But you will be surprised at the great clarity of the signals.

If you do not care for a very sharp tuning, then you may construct a 3-tube set along these lines, merely adding a

radio, and do not care to handle many dials, which, as a rule, confuse them.

The set is simplicity itself and can be constructed easily by any one. Although it contains only four tubes, the writer has made repeated comparisons between some of the well-known five-tube sets and this one, and he has yet to find one which gives louder reception and is as clear as the Interflex-Four.

Furthermore, the tuning can be done in a fraction of the time of the standard five-tube sets so much in vogue now.

The circuit, as will be seen from Fig. 2, comprises one stage of radio frequency, coupled to the fixed crystal detector. The second tube, therefore, is not the detector tube, but is an amplifier. The third and fourth tubes are amplifiers as well.

From this it will be seen why these four tubes equal five or more of the conventional tuned radio frequency sets.

Constructional Details

The usual panel and baseboard are used. Two filament control jacks (the one at the left being for the phones—the one at the right for loud speaker)

The crystal detector may be any good crystal, and the better the crystal the better will be the results. But here the writer wishes to make a few remarks: If the crystal detector is too sensitive, and if it takes too much time

PARTS NEEDED FOR THE INTERFLEX

- 1 Panel and baseboard, 7 inches by 18 inches.
- 1 .0005 variable condenser, straight-line frequency type.
- 1 Tuning inductance, tube, 3 inches in dia.; wound with 50 turns of No. 20 D.C.C. wire. Antenna inductance, six to ten turns of the same wire.
- 1 Radio frequency transformer, 220 to 550 meters.
- 4 Standard 201-A type sockets.
- 4 Amperite resistances.
- 1 Fixed crystal detector with mounting.
- 1 Double-circuit jack.
- 1 Filament control jack.
- 2 Audio frequency transformers.
- 1 Potentiometer, 400 ohms.
- 1 Fixed condenser, .002 mfd.
- 1 Vernier dial.
- Binding posts, bus wire, screws, nuts, etc.

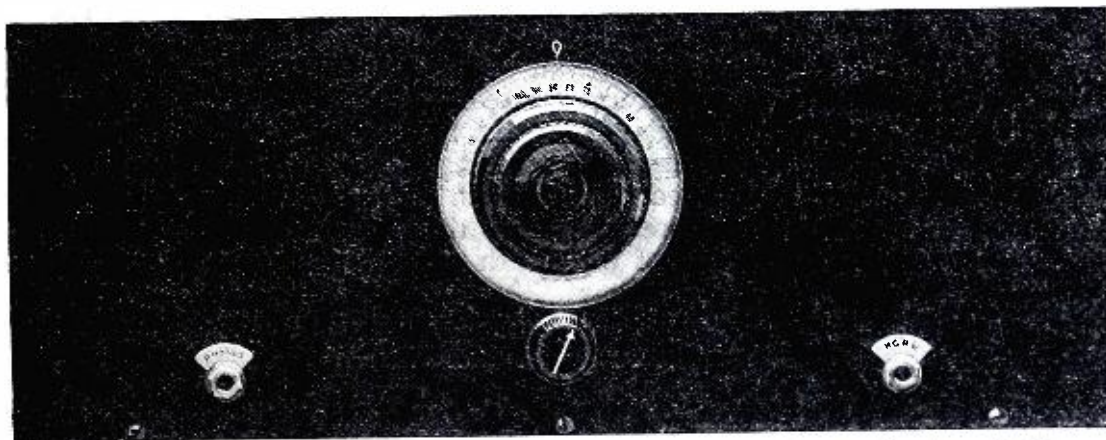

Only one vernier tuning dial is used. The indicator knob below is the potentiometer. No filament switch is used. Instead, two automatic filament jacks are incorporated in the set.

2-step amplifier, and the signals will come roaring in, as with the best 4-tube circuit.

This set, mind you, gives you quality and no distortion at all.

The Interflex-Four

The circuit has given such good results that it seemed a pity that it should not be used in a real set. So the writer set about rectifying this, and the Interflex-Four, shown in Fig. 2, as well as in the accompanying photographs, is the result.

This set has been used for some time by the writer and he heartily recommends it to those who wish to have a set of great simplicity, where there is practically but a single control to be handled, where sharpness of signals is desired, and where, most of all, clarity of signals and absolute absence of distortion is wanted. Also, the set should be good for DX work.

All of this is incorporated in the Interflex-Four, and the writer particularly recommends the set to your home folk who do not know much about

are used. The writer recommends the use of a straight-line frequency condenser. A potentiometer of 400 ohms *must* be used. A lower-resistance one is not recommended, because no really sharp DX tuning can be accomplished with it. No rheostats of any kind are used. Instead, automatic filament resistances, which work exceedingly well in this circuit, are used throughout. This does away with two extra controls, which are not needed in the circuit.

The inductance consists of a bakelite or other good tube three inches in diameter, three inches in length. The aperiodic primary consists of 10 turns of No. 20 D.C.C. wire. A blank space of 5/16 inch is left between the primary and the secondary. The secondary consists of the same wire, of which 50 turns are wound upon the tube, which almost fills up the remaining space.

Note in the connections that a jumper lead is connected between the ground and the filament side of the inductance. This increases the power of the set somewhat. It is also better for DX.

to adjust, the writer recommends that it be not used. Static and strong signals will invariably knock out its sensitivity and render the whole set useless. So many reflex set users have found, to their sorrow, that the crystal detector is usually the rock upon which the whole set founders.

If galena, which is the most satisfactory in some respects, is employed, use only the so-called "million-point" mineral, which has a granular surface.

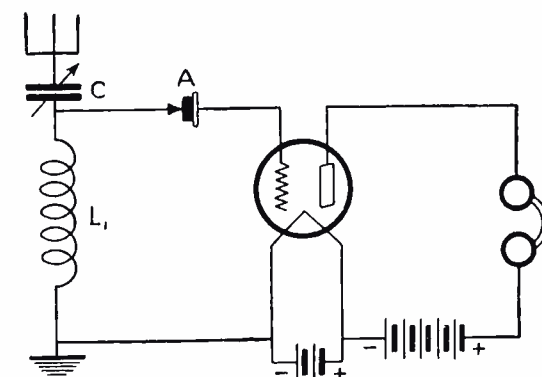

Fig. 1. The fundamental circuit of the Interflex set. The crystal detector "A" works best in one position.

This is the "argentiferous galena." And if possible get away from the adjustable feature, because when laymen have to use a set it should be so built that it cannot be tampered with.

There are several good fixed detectors on the market now which, if made by reliable concerns, can be trusted to work out satisfactorily. The writer must be specific here and wishes to say that he uses, and has been using for months, a carborundum fixed crystal detector which, while not perhaps as sensitive as galena, is certainly the most stable thing he ever came across, and he has worked with all of them. He has used a single detector for many months

now, and has had the set operating dur-
grace, and one reason why the Inter-
ing the worst static of the summer,
when lightning could be seen, and
when tremendous static crashes came

Reversing it would greatly reduce the
signal's strength.

The coils marked "RF" comprise a
standard radio frequency transformer,
such as may be purchased at any radio

strength. If the set has a tendency to
howl or whistle, it is probably the fault
of one of the transformers. In that
case, it is suggested that you use a
small fixed condenser, C-2, as indi-

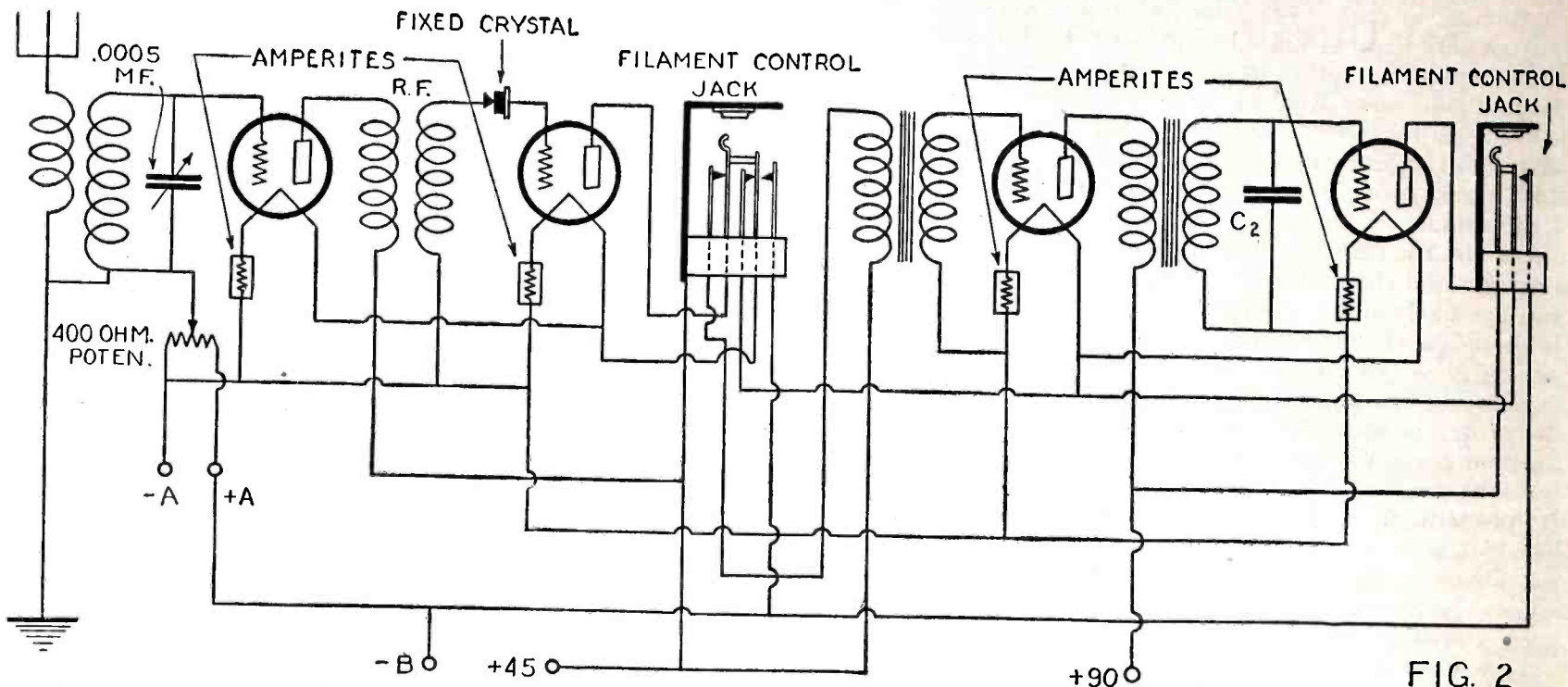

Fig. 2. Diagram of connections for Interflex-Four, consisting of one stage of radio frequency amplification, crystal detector, and three stages of audio frequency amplification, of which two stages are transformer-coupled. No switch is used in this circuit. The automatic filament control jacks are used instead. Note particularly that, for best results, the aperiodic primary should be grounded on the filament side. Condenser C₂ is to be used only if set develops audio frequency howl.

out of the horn. Nevertheless, in no
case has this crystal refused to work,
nor has its usefulness been impaired.
Its stability, therefore, is its one saving
flex-Four has been such an outstanding
success with the writer.

The fixed crystal, as will be noted, is

shop. Not all radio frequency trans-
formers work satisfactorily in this set,
and it may be necessary to try several
before the right one is discovered. The
writer has tried both the air-core and
the iron-core, and while several of the
iron-core type worked well, in many

cated. This may be of .00025 capacity.

If the set has been completed ac-
cording to the instructions given here
and in the layout it should be noted
that the second tube voltage should,
with a good tube, be not more than
22½. While some tubes may require

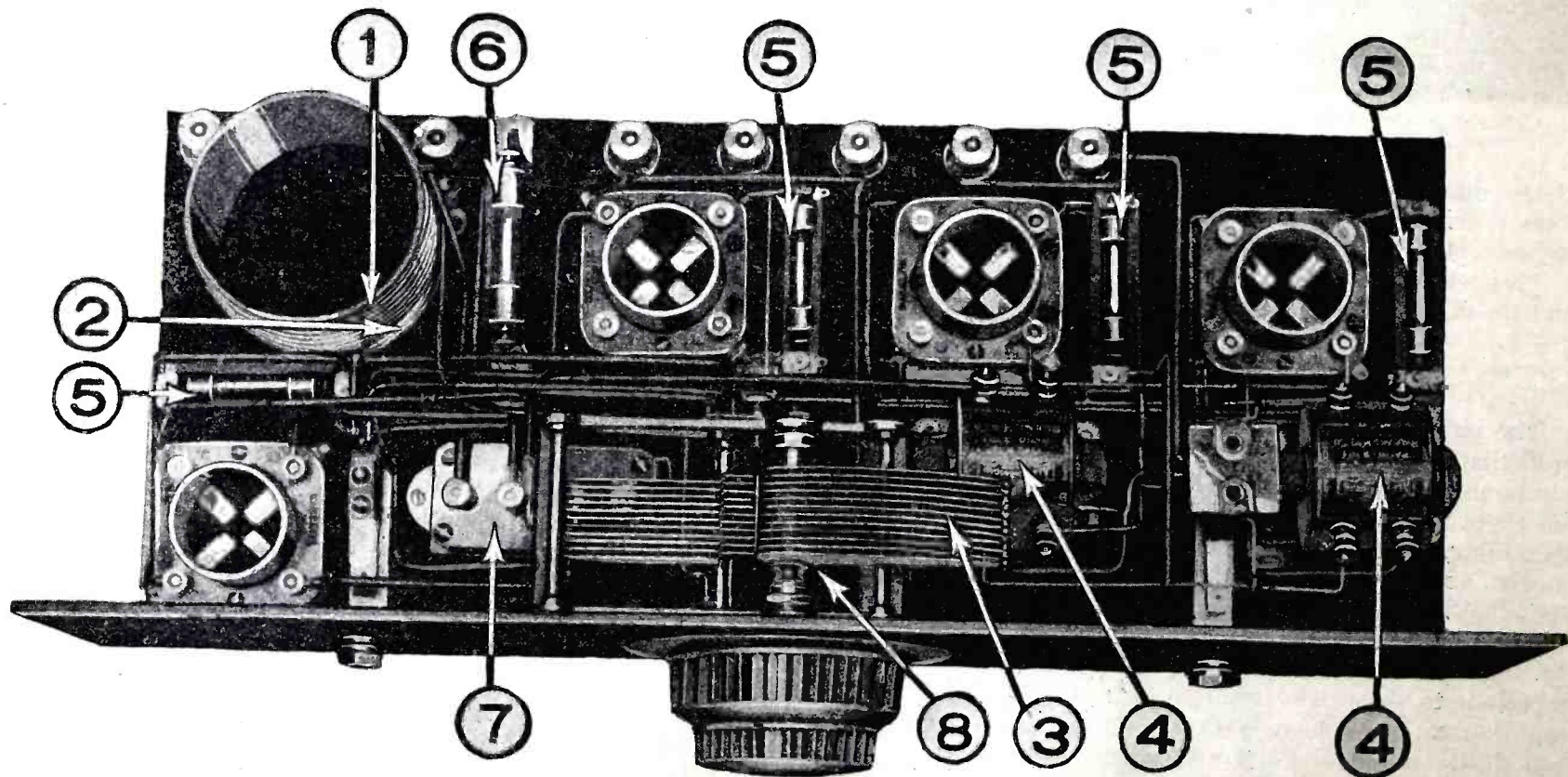

The numbers given here correspond to those on the drawings in the preceding pages. Note the compactness of this set.

mounted between brackets and looks
somewhat like a fuse, when mounted.
It is put in this position and never
changed. With this particular crystal,
as with many others, it was noted that
it must be used in one direction only.

cases, the air-core type was found to
work better.

On the audio frequency side two
standard transformers, ratio 3 to 1 are
used. A good transformer should be
used here in order to increase the signal

45 volts, the writer does not recom-
mend it. Nothing is gained by it but a
waste of current, and distortion of the
signals. The total "B" battery voltage
is 90 volts for all the other tubes. The
(Continued on page 14)

A Technical Editor's Set

An Ultra-Sensitive Three Tube Regenerator for the D X Fan

WITH all the changes in radio apparatus, we find nearly all of the latest models containing elements and principles that have been in use for several years. The craze for non-oscillating sets has cast a cloud of temporary disapproval over the old-fashioned regenerative receivers. It is well to remember, however, that practically without exception the means used to control oscillation also result in a loss of sensitivity. For this reason many of the oldtimers still remain faithful to the regenerator. Now it is a fact that a regenerative receiver carefully designed and as carefully handled need not cause murderous hatred among the neighbors due to squeals being radiated. If you really want to sit in on some DX this winter, you will not be disappointed by following the advice and instructions of Felix Anderson, whose article on the subject of a low-loss, regenerative receiver is presented here from *On The Air* magazine, Chicago, Ill., of which Mr. Anderson is Technical Editor. His article follows:

Ten years of active experience in the radio game as a transmitting ham, experimenter, student and teacher of radio have taught me that the balmy days of summer and early fall are the logical days for renovating, rebuilding and general installation of radio receiving sets. If you have been a broadcast enthusiast for any length of time, you have doubtless acquired the habit. Summer static, decreased ranges and outside interests contribute largely to the "seasonal" aspect of the game, something that many writers, manufacturers and advertising men are seeking to ignore. Regardless of how the issue is ducked, the summer days are coincident with decreased interest, especially with respect to listening.

It is the wise citizen radioist, however, that employs this season to greater or less advantage, and the wise radio fan does so by utilizing inactivity in listening time at constructing new sets or in remodeling and rebuilding his last season's receiver.

If you have not already rebuilt your set this summer, it would be well to get started now before the cold weather sets in.

Truly, this time of the year is the time when one should consider how the late fall and winter programs are to be enjoyed. Like coal, the cost of radio goes up with colder weather—and around Christmas time it becomes nearly as scarce, with respect to apparatus and accessories.

What Type of Set?

In the past six months we have witnessed a veritable deluge of varied supers, multi-supers, auto-super heteros

stations, and also the overwhelming multiplication of the low wave class A broadcasters that now virtually "infest" the air.

Then, too, I have always harbored a

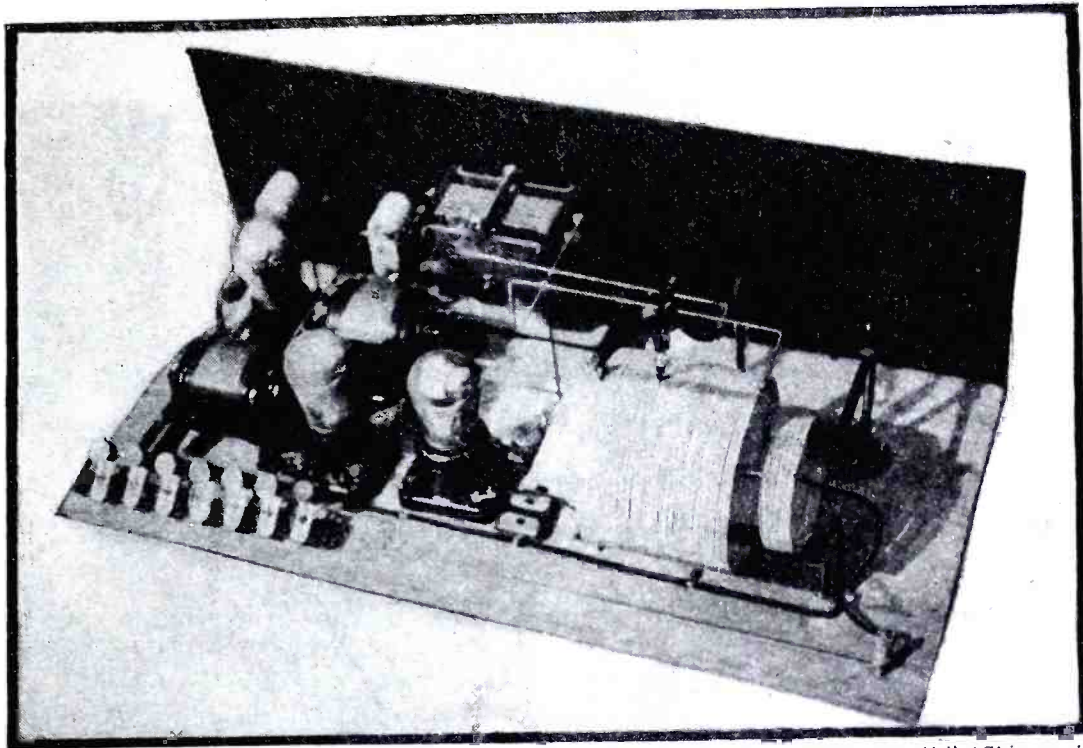

Illustrations by Courtesy of "On the Air" (Chicago, Ill.)

A perspective view of the receiver described by Felix Anderson, Technical Editor of "On the Air" Magazine. All the battery leads, and leads common to the ground, are run in a well-defined path along the baseboard in No. 18 rubber insulated cable. Note the clip arrangement as mentioned in the article.

and flexes. Furthermore, we are more or less acquainted with their peculiarities, their traits and results, and we are

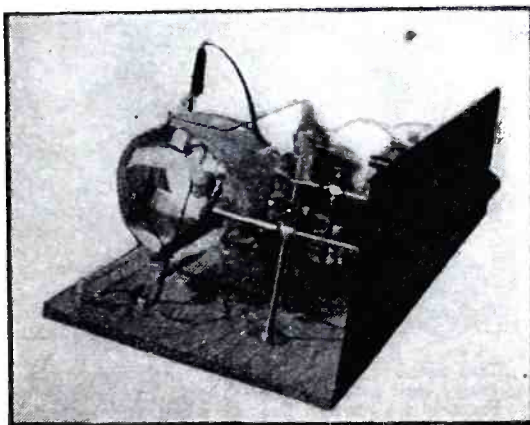

This side view gives you an idea of the antenna and tickler coil mountings. A threaded brass rod furnishes the vertical adjustment, and a brass washer soldered to the shaft makes the horizontal adjustment permanent and smooth. The clip used to enable separation of the lower wave stations can be seen on the coil.

in a more advantageous position to judge them as affects their merits.

In general, I have come to the conclusion that the set in vogue this fall will be one of the three-tube type—preferably a sharp tuning regenerative affair. I base this contention on the ever increasing number of high-power

rather sympathetic interest in the three-tube, loosely coupled, tickler-feedback, regenerative set, because of the many records I have been able to make for myself, and for the excellent showing this smaller, less expensive contraption will make against five-, six- and eight-tube sets. If you feel as I do, you can easily recognize this preference for the smaller fellow that will lick the big bruiser all hollow. So my choice rests with the Old Reliable, brought up to date with some of the remarkable new units and accessories that the profession now boasts.

Some of the Advantages

Briefly, let me enumerate some of the features of the set that I am appointing to do.

A specially wound coil, incorporating some of the latest ideas in low loss design, together with one of the new low loss condensers makes it highly selective. This selectivity is further emphasized by the use of a low ratio of antenna to secondary circuit, which likewise reduces the nuisance of malignant squeals so often evident in broadcast reception.

The receiver has five controls in all on the panel. Only two of these are

actively used, the secondary tuning circuit selecting the station and the regeneration controlling the audibility and which contributes to the distance-getting qualities of the set. The remaining three are but rough settings, the antenna coil angle being varied with the knob you see at the extreme left of the panel view (controlling the input, and incidentally the selectivity and volume as well); the two filament controls, one for the detector which must be separate and one for the two audio amplifiers.

This trick is accomplished by spreading the tuning of these stations out over the scale by means of a tapped coil. The coil consists of a 47-turn, 4-inch, specially-wound, spaced-turn, winding, with a tap at the thirtieth turn. When the clip (used to vary the number of turns) is on the forty-seventh turn the set tunes (with a .0005 mfd. Cardwell) from 300 to 600 meters with plenty of separation on the high wave stations, and when attached to the thirtieth turn, WQJ at 448 meters can be received with the dial set at 95.

more interesting, so let's hop to it.

Our first consideration lies in the selection of the proper parts and accessories. I am giving the trade names of them just as I used them, not because they advertise or do not advertise, but because I believe they are worth specifying.

List of Parts

- 1 Bakelite, formica or hard rubber panel, 7 x 21 x 3/16 inch.
- 2 Dials, 3-inch size.
- 1 National Velvet vernier dial, 4-inch size.

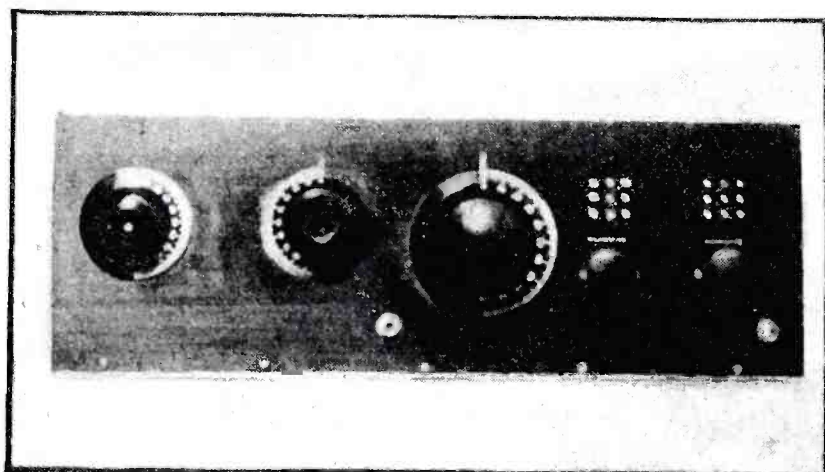

Simplicity and efficiency are the keynote of the panel design of this three-tube regenerator.



The coils are set far back to offset hand capacity. The high frequency wiring is kept clear of the baseboard.

Two Audio Stages Plenty

The set employs two low ratio high grade stages of audio amplification, connected in the usual cascade fashion, which furnish ample volume on stations two thousand miles away. A fixed pencil mark grid leak is used—chiefly because its performance is thoroughly satisfactory, and also because of its inexpensive nature.

Openwork construction, plenty of room for charged bodies and wire, carefully placed units together with an unusually unique style of wiring makes this set, in my estimation, one of the most efficient that I have yet seen designed.

With respect to selectivity, it might be well to state that my location is not one to be envied. One mile from WEBH, less than that from WQJ, and with WBBM, WIBO, WENR, WDBY, within a radius of 5 miles with WGN, KYW, WLS, WMAQ, WGES, WBBM, and WMBB within 10 miles. And they all seem to be going at once when I want to try for long distance. Right here, I want to say that I'm no radio liar, and I don't claim to tune them all out and get anything I want. But I do break through with this set, and with at least half of the above broadcasters going, I tune KDKA, WOC, WSAI, all the suburban stations like WTAS, WJJD, WHT and WORD and listen to them with little or no interference. I can separate WLS from either WGN or WEBH (one mile away) without the least interference from either—no noises or mush either.

This spreads the tuning on the lower waves out considerably, and enables me to separate the Class A stations without especial difficulty. When the dial is set around 10 the 180 meter phones of the amateurs can be heard,

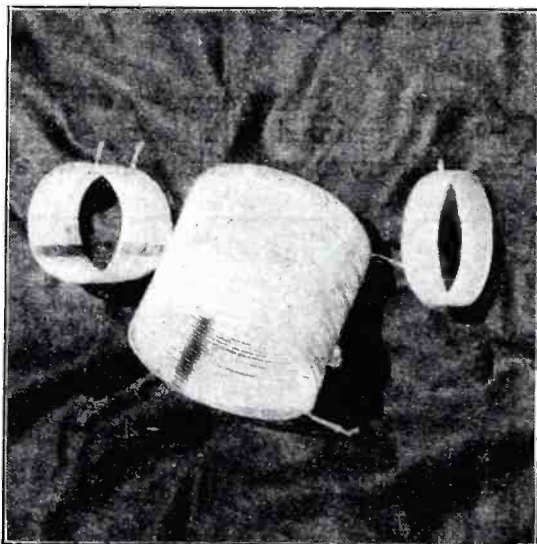

The finished coils look like this. The tickler (left) and antenna coil (right) are wound on bottles, which are broken when the collodion is dry.

and not infrequently have I enjoyed listening to them "chew" the rag back and forth. With the clip set at the forty-seventh turn, the tuning of the low-wave stations becomes very critical, decidedly so under 350 meters. By setting the dial at 95 I often copy stations on lake steamboats.

How to Make the Set

But this recounting of results is nearly always boring. The description of its construction is immeasurably

- 2 Allen-Bradley carbon disk rheostats, universal type.
- 1 Carter 4-spring jack.
- 1 Carter 1-spring jack.
- 6 Roundhead brass screws, 3/4 inch.
- 1 Yellow clear pine baseboard (dried and sparvarnished). Size 10 x 21 x 1/2 inch.
- 2 Threaded brass rods 3 1/2 inches long 3/16 in. stock.
- 4 Bolts to fit.
- 2 Brass coil mounting brackets 1 1/4 inches high with 1/2 inch feet top and bottom.
- 2 Pieces of bakelite for coil mounting 5 x 1/2 x 1/4 inch.
- 2 Pieces of brass rod 6 inches long 1/4 inch stock for shafts L₁ and L₂.
- 4 Pieces flexible wire lead for L₁ and L₂ 8 inches long.
- 1 Small clip, tight jawed.
- 2 Pieces brass 2 x 1/2 inch 1/32 stock. Shaft bearings.
- 1 Pyrex, or porcelain socket.
- 2 Kellogg tube sockets (audio stages).
- 1 Cardwell 21-plate .0005 mfd. condenser.
- 2 Karas Harmonik audio transformers.
- 1 Fleming binding post rack (has 7 posts).
- 3 Dubilier or Muter .00025 mfd. condensers, fixed.
- 1 Dubilier or Muter .002 mfd. condenser, fixed.
- 3 UV201A or Musselman 201A tubes.
- 1 Pencil Mark grid leak (round type with cap).
- 4 Lengths bus bar wire.
- 5 Feet No. 18 rubber-covered wire.
- 2 Dozen assorted mounting screws.

- 1 A battery.
- 2 B batteries, Burgess or Eveready, 45-volt.
- 1 Antenna not over 85 feet total length.
- 1 Spool No. 18 DCC wire, 1/2 pound.
- 1 Spool No. 22 DCC wire, 1/4 pound.

Drilling the Panel

First drill 5 holes of 1/8 inch size along the bottom edge of the panel, 1/4 inch from the edge. Start the first one 1 7/8 inches from the left-hand end of the panel, and then drill them 4 3/8 inches apart until 5 holes have been made. These holes mark the bottom of the panel, and are used to screw the panel and baseboard together. Using the left-hand, 7-inch side of the panel as a square, draw a line the length of the sheet, three (3) inches from the top. Measure 2 5/8 inches along this line, and make a mark. This marks the place for the shaft of the antenna coil L₁. Along this same line measure off 7 5/8 inches, and make another mark. This is the tickler coil shaft hole marking. The distance between the two holes should be 5 inches.

To mount the condenser divide the panel into 3 1/2-inch halves, and draw a line marking the center. Measure off 12 inches from the left-hand side of the panel, and make a marker on the line which divides the panel into two even halves. This is the point for your condenser shaft. The other mounting holes for this unit and the National vernier dial are determined from the template and the instructions enclosed with these pieces of apparatus.

The rheostat positions are located by measuring off a line 2 5/8 inches from the bottom edge of the panel. Then the detector rheostat is located by measuring along this line 5 1/2 inches from the right-hand side of the panel. The

audio rheostat is similarly located on this line 2 1/2 inches from the RH edge.

The jack holes are located by drawing a line along the length of the panel 1 1/4 inches from the bottom edge. The first jack is then placed 9 1/2 inches along this line, measuring from the left-hand end of the panel. The second jack is 1 1/4 inches along the horizontal line, this distance being measured from the right-hand end of the panel. I drilled a series of 9 holes above each rheostat for ornamental purposes, in rows of three, the first row being 1 1/2 inches from the top of the panel. The center row is exactly above the rheostat knob, and the holes are separated by a half inch.

Use your own judgment on the sizes of the drills, and follow the templates and instructions given with the condenser and dial. Only one hole apiece is necessary for the rheostats and jacks.



As each cut is made, it is "backed" up with gummed paper so that the form can be taken apart without wrecking the finished inductance.

The shaft holes should be drilled with a quarter-inch drill, and they should be made carefully, since the panel acts as a bearing for the shaft in turning.

Engrave indicators if you wish, and fill them with jewelers' wax, Bon-Ami or other white substance. I used nail white.

If you have made a neat job the panel need not be grained, but if you find it has been scratched in the course of drilling, grain it by rubbing it with a medium or fine sandpaper until all the shiny surfacing has been removed, and then wipe it with a rag which has been saturated with thin oil.

The Shaft Mountings

Next prepare the shaft mountings consisting of the threaded brass rod. Drill two holes in the baseboard, one

2 5/8 inches and the other 7 5/8 inches from the side that is screwed to the panel. Countersink the bottom. Then make the bushing



The winding form is slit in three sections with a scissors, cutting the cardboard lengthwise. A common Quaker Oats box serves the purpose.

bending the two 2 x 1/2 inch brass pieces around the rods that are to be the shafts, and drill a small hole in the leftover. Spring them apart, and put a small bolt with a nut to fit through these holes for tension adjustment. Then solder the round side of these bushings to the threaded brass rod, and screw the support into place on the baseboard with the two bolts for that purpose.

The shafts are then stepped into holes drilled into the small pieces of bakelite (2 x 1/2 x 1/2 inch), and are held in place with collodion or glue. The coils are tied to these pieces with thread.

Winding the Coils

Procure two bottles 2 3/4 inches outside diameter. Next cut three strips of celluloid (auto curtain stuff is O. K.), the strips being the length of the bottle and about 3/16 inch wide. Fasten them to the bottle securely, dividing the circumference into three even sections. They may be held in place with gummed paper or tape.

The coils L¹ and L² are wound on forms like the one described, L¹ having 20 turns, and L² having 40 turns. The ends of the wire (beginning end and finish of the coils) are held in place with tape or gummed paper, and collodion is painted over the wire exactly where the celluloid strips lie on the glass. When this has been done set them aside until thoroughly dry. Then break the bottles gently, and, lo! you have an air supported coil.

The secondary coil L² is wound slightly differently. Procure a Quaker

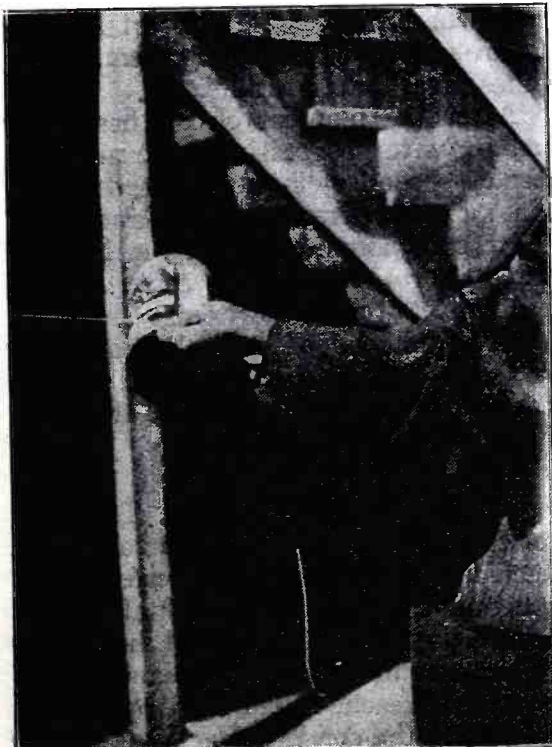

After the strips of celluloid have been fixed in place with gummed tape, the wire is fastened to some distant post or fixture and the turns are rolled on.

Oats box, and slit it into three longitudinal sections, one at a time. As each slit is made, back it up with gummed paper. (See the illustrations accompanying.) Then three strips of celluloid are laid over the cuts and fastened into place with gummed paper. Punch two holes in the cardboard former, and thread the wire through and start winding. No. 18 DCC wire is used on this

The clip, soldered to a piece of flexible wire, which is in turn soldered to a piece of bus bar connected to the A plus side of the filament and the rotary condenser plates, is held rigid on a piece of glass rod stepped into a hole in the baseboard, and held firm with glue or collodion. The photograph on the title page of this article gives the detail.

can see what is meant from the illustration on this page. Immediately to the left of the second audio transformer, and directly under the condenser. The wire running from the binding post rack in the illustration along the two tube sockets, and by the coil is the A plus—ground wire, and shows how the insulation is chipped off and the joints soldered in T fashion to the main

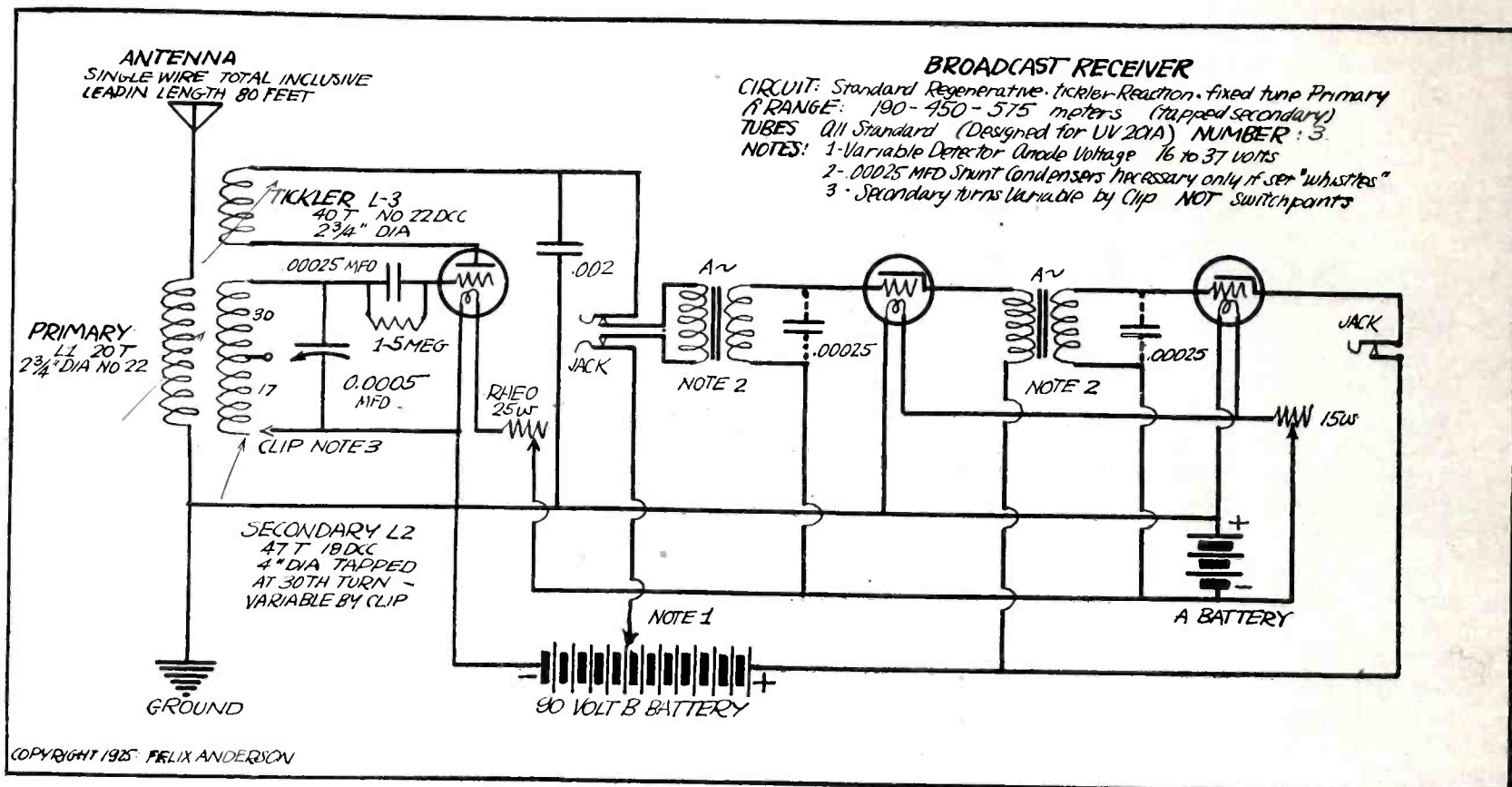

A detailed wiring diagram of Mr. Anderson's three-tube broadcast receiver as described herewith. All data is clearly indicated in the notations.

coil. The turns of this coil, as well as those of L¹ and L² are spaced, that is each turn is wound with a space between it and the preceding turn, the space being about the thickness of the wire. The turns are rolled on, the rolling being accomplished by unwinding sufficient wire for the coil before starting the rolling, and straightening by fastening it securely to some post or object, and pulling until all the kinks have been removed.

When 30 turns have been made, make a twisted loop, and tighten it down to the former. Then resume winding until 47 turns have been rolled on. This number of turns is satisfactory if a Cardwell condenser is used. If you intend to use another type, better put on a few more turns—say about 55 and prune the coil down till a 535 meter station comes in at about 85 on the secondary dial, with the clip set at the 47th end turn.

After the required number of turns have been wound, fasten the finish end and paint over the wire at the celluloid strips. Allow the collodion to dry thoroughly. Then with a knife, cut away the gummed paper strip backing the longitudinal cuts, and the form will come out easily. Do this carefully, so as not to spoil the cylindrical effect of the coil.

Mounting

Next mount the condenser and dial, the rheostats and jacks, and screw the panel to the baseboard.

Inspect the terminals and connections of the sockets and transformers thoroughly, and bend the springs of the tube sockets up so that no poor connections exist.

Then proceed to screw these units into plate on the baseboard as shown in the illustration on this page. Mount the Fleming binding post rack on the back right hand end of the baseboard. The respective parts are as follows: Directly back of the condenser is the detector tube and socket, then the second audio tube, immediately under the end of the condenser the first AF transformer for stage number one, and directly back of the most right hand rheostat is the first audio frequency tube. Back of this we have the second audio transformer. You see the apparatus has been so placed to shorten leads, and at the same time to minimize the wiring of the set.

Wiring

Start wiring the set by putting in the filament circuits, using the No. 18 rubber insulated wire. This wiring is all run along the floor of the baseboard, and is kept bunched and in a well defined path throughout the set. You

wires. The A plus, A minus, all the B battery leads and wires connecting to the ground are made with the rubber covered wire. The plate, grid and audio input and output leads alone are made with bus bar. Only 9 connections are made with this bus bar wiring.

Since all coils are wound in the same direction it will make little or no difference where the flexible leads of L¹ and L² are soldered. Reversing them sometimes gives better results.

After the filament circuit has been put in, wire progressively the antenna circuit, secondary input circuit, detector plate circuit, first amplifier and then the second amplifier. All the battery leads in rubber covered cable should be completed first, however.

The grid condenser and leak are soldered directly to the grid post, having been soldered together before the wiring commences.

Operation

Operation is very simple. The batteries and intercepting circuits are connected up, and the tubes inserted. Inspection of the wiring should take place before the B circuit is closed, however.

Increase the filament brilliancy until normal is reached, and start operating by setting the condenser at 50 degrees. Advance the tickler till the set oscillates. If it does not do so immediately, (Continued on page 14)

The Midget Super

A Seven-Tube 45,000 Cycle Super-Heterodyne in Kodak Size Employing U.V. 199 Tubes

THE average conception of a super-heterodyne receiver pictures an outfit 2 ft. long, 7 or more inches in height and at least 8 in. deep. We have been told that to cram all the parts of so elaborate a circuit as the super into a smaller space than the conventional arrangement would be to invite all kinds of trouble from howling due to coupling between transformers to broad tuning resulting from the feeding of oscillator current through the various wires of the set.

While this claim is true to a certain extent, much of the apparatus can be placed in very close proximity if care is taken in shielding the intermediate transformer group and in keeping the field of the oscillator coil at a considerable distance from the intermediate amplifier.

With the latter idea in mind, *W. P. Brush*, a radio experimenter, constructed a portable set which occupies a minimum of space, weighs only 7½ lbs. with the vacuum tubes, and yet does not have any of the troubles predicted.

Radio the first part of this year. In the photos herewith only the actual receiver is shown. It may be either mounted in a cabinet for home use or a

used, and the arrangement of the rest of the equipment is made to conform with the size of the panel. The illustrations give an accurate picture of the

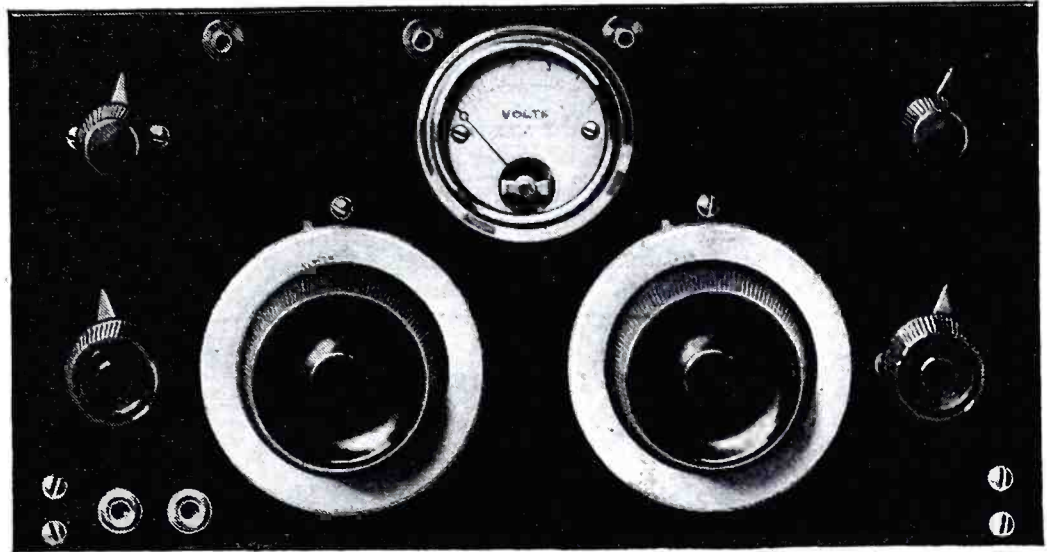

The front panel view of the midget super. Note how close the two variable condenser dials are located and the other controls surrounding them.

leather carrying case with a collapsible loop, the latter outfit weighing about 25 to 30 pounds complete with small

compactness and excellent arrangement of the various sockets, transformers and condensers, the vacuum tubes showing admirably the relative size of the set. The constructor can readily follow the layout from these photos, using the parts as described in the following.

Description of Parts

The accompanying table gives a complete list of parts used in building the set, together with a list of parts that might also be used, if the constructor prefers to build a larger or standard size super. No specific recommendation for any of these parts is implied, the list being made up from those most generally available at radio stores. There are undoubtedly other parts, not here listed, that will suffice.

To facilitate laying out the panel drilling and the apparatus on the base-board a full size drawing of the panel layout should be drawn on a piece of paper to the dimensions given in Fig. 3. Paste the template on the panel, and with a center punch mark the centers of the holes directly through the paper.

The first named parts in the list are those used in the Midget set, and if other parts are used, the panel template will not be correct. Where flat head machine or wood screws are used the holes in the panel should be counter-sunk.

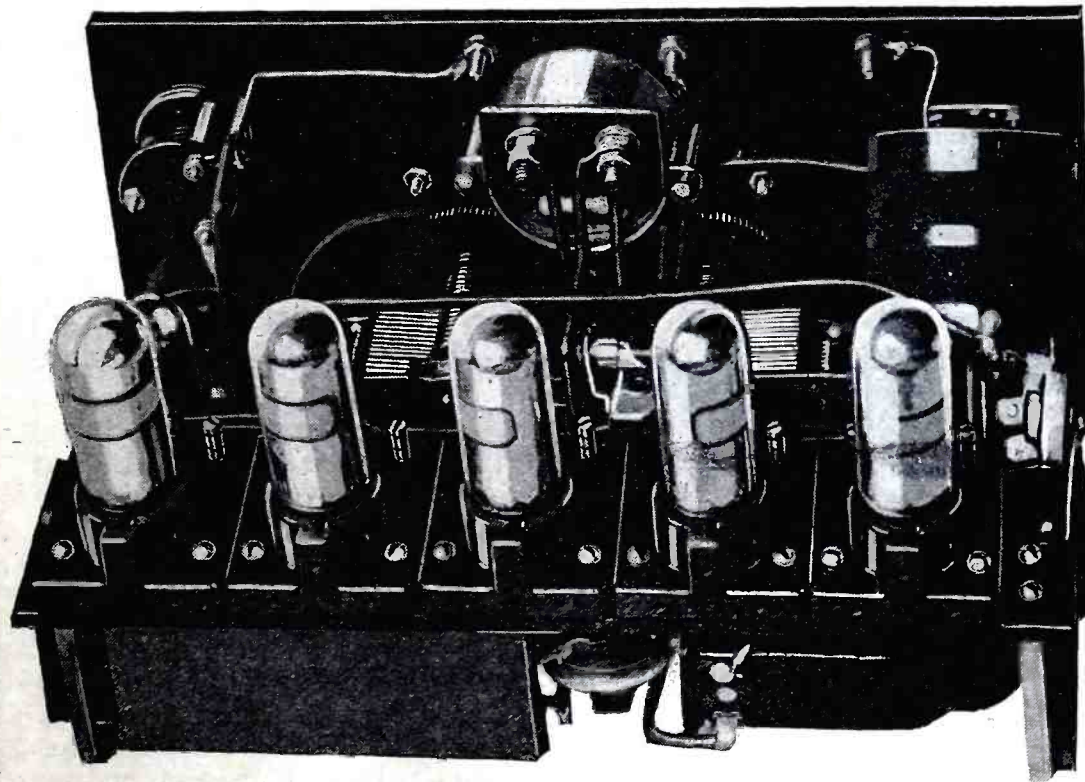

Illustrations by Courtesy of Radio (San Francisco, Cal.)

Rear view of the completed super-heterodyne arranged in compact form. Only five of the seven tubes can be seen as the remaining two are mounted between the panel and the shelf in the back of the set.

Clinton Osborne describes this set in *Radio*, San Francisco, Cal., giving full details for its construction as follows:

The Midget Super described herewith employs the circuit of the "Best Super-Heterodyne," which appeared in

size "A" and "B" batteries. For home use this set is ideal when installed in a desk or small table.

A 3/16 in. panel of bakelite 5¾ in. by 11 in., on which all of the necessary panel apparatus could be crowded, is

The intermediate frequency transformers should be such as to give good amplification at 45,000 cycles, and the input impedance of each primary should approximate the output impedance of the UV-199 or C-299 tubes, an important consideration. The iron core construction of the untuned stages limits the stray field and permits of close spacing, without shielding. The tuned transformer should be of the same type as named first in the list herewith if the set is to operate with the fixed condenser specified in the circuit diagram. If another tuned transformer is used, it would be best to use a fixed condenser of the value specified by the manufacturer of the transformer in the circular accompanying the apparatus.

The various fixed condensers should be of standard manufacture.

For providing the various negative grid potentials the Burgess No. 5,540 7½-volt "C" battery is specified be-

cause it has enough taps to accomplish the desired results.

For those who wish to use an an-

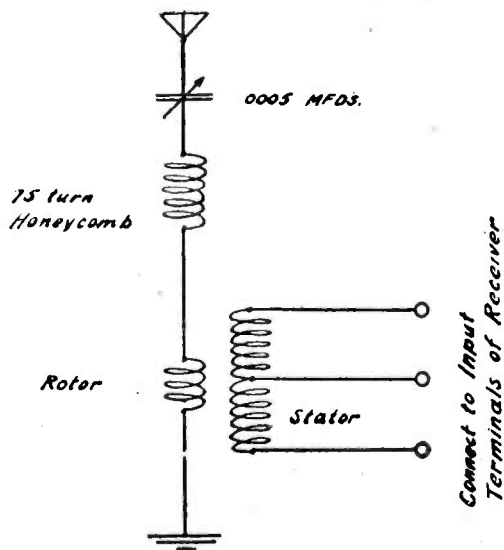

Circuit diagram of the antenna adapter.

tenna with this set, the circuit diagram showing the additional apparatus

needed is given herewith. The coupler consists of a standard 180-degree vario-coupler, similar to the oscillator-coupler used in the receiving set. The antenna circuit should consist of a .0005 mfd. (23-plate) variable condenser, not necessarily of the vernier type, a 75-turn honeycomb or other compact inductance coil, and the rotor of the coupler. In order to prevent the reception of a large amount of noise, static and interference, it will be necessary to operate the antenna coupler at minimum coupling, doing most of the tuning with the antenna series condenser. It would be well to shield the inside of the box containing the antenna tuner so as to increase the selectivity. Many have tried grounding one side of the loop antenna, with good results, although the directional properties of the loop will be somewhat impaired. However, for remote districts where local interference is not known, this would certainly improve the signal strength on distant stations.

PARTS FOR THE MIDGET SUPER

3 Untuned I. F. Transformers, Remler 600—All-American, Baldwin, Pacific, Branston, Jefferson, Phoenix, Receptrad, Silver-Marshall.

1 Tuned I. F. Transformer, Remler 610—All-American, Baldwin, Pacific, Branston, Jefferson, Phoenix, Receptrad, Silver-Marshall.

1 A. F. Transformer (6:1 ratio preferred), General Radio—Acme, All-American, Amertran, Coto, Dongan, Ford Mica, Jefferson, Kellogg, Modern, N. Y. Coil, Peerless, Precise, Premier, Samson, Stromberg-Carlson.

5 Phone Tip Jacks, 2 for loud speaker and 3 for loop (small binding posts may be used instead of the latter).

1 Oscillator-Coupler, Remler 631—Baldwin-Pacific, Branston, Phoenix, Receptrad, Silver-Marshall.

2 Rheostats, General Radio—Allen-Bradley, Amsco, Carter, Central, Cutler-Hammer, Erla, Filko, General Instrument, Kellogg.

2 Variable Condensers, Remler 631—Acme, Allen-Bradley, American Brand, Bremer-Tully, Bruno, Cardwell, General Instrument, General Radio, Heath, Marco, National, Signal, Silver-Marshall, U. S. Tool.

1 Midget Condenser, Chelton 860.

5 Small Tube Sockets, Remler 399—Benjamin, Amsco, Chelsea, Cutler-Hammer, Frost, General, Radio, Heath, Marco, Silver-Marshall.

1 Voltmeter, Hoyt.

2 2 mfd. Fixed Condensers, Kellogg 62; 1 .006 mfd. Fixed Condenser, N. Y. Coil; 2 .0025 mfd. Fixed Condensers, N. Y. Coil; 1 .00025 mfd. Fixed Condenser, Dubilier 640; 1 .0005 mfd. Fixed Condenser, Dubilier. With grid leak mounting.

1 Grid Leak, Daven, Durham, Electrad.

1 "C" Battery, Burgess 5540—Eveready.

1 Nazeley Suportena Loop.

1 Panel, Bakelite—Celeron, Pantasote, Radion, Spaulding.

1 Baseboard.

Construction of Parts

Many readers may desire to construct as much of the apparatus as is possible, and it is for their benefit that data on the construction of the oscillator coil and 45,000 cycle amplifying transformers are given.

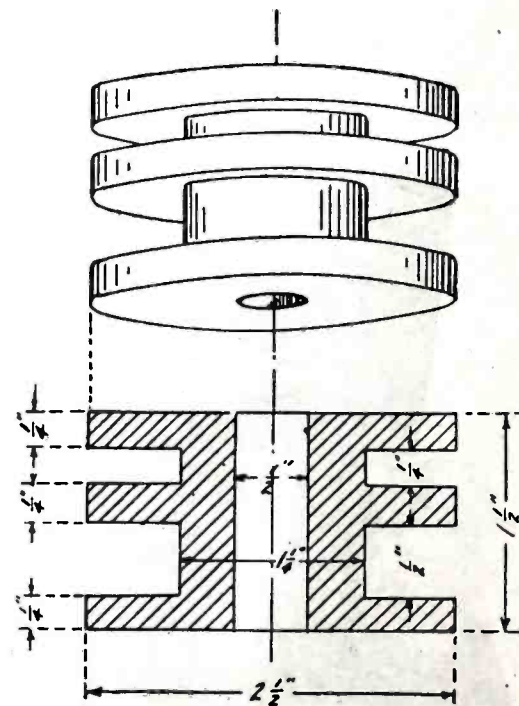

Spool dimensions for untuned transformers.

The oscillator coil consists of 70 turns of No. 26 D. C. C. wire, wound in two sections of 35 turns each, on a 2¼-in. tube. The grid coil is 20 turns of No. 26 D. C. C. wire wound on a 1⅝-in. tube, and arranged to rotate within the oscillator coil in a manner similar to the rotor of a 180-degree coupler. Pigtail leads should be used for the rotor connections.

The untuned transformers should be wound as follows: Turn out three hardwood spools, each with two slots for the windings, one slot being ¼ in. and the other ½ in. in width. The

principal dimensions of the spools are given herewith. A hole $\frac{1}{2}$ in. in diameter should be bored in the center of the spool, for the core. The primary winding should consist of 450 turns of No. 30 D. S. wire, wound in the $\frac{1}{4}$ in. slot. No particular order should be observed in winding the coil, the wires being placed in a haphazard manner to reduce the distributed capacity effects. The secondary winding

and the secondary condenser should be omitted. The four leads from the windings should be terminated in a manner similar to that described for the untuned transformers.

made with a hack saw in order to the small piece of metal used on dial as a stop. The voltmeter selected because of its small size, fitting above and between the two air condensers. On each side of the condenser group is a small rheostat, each condenser end plate being filed away for $\frac{1}{8}$ in. in order to make room for the rheostats.

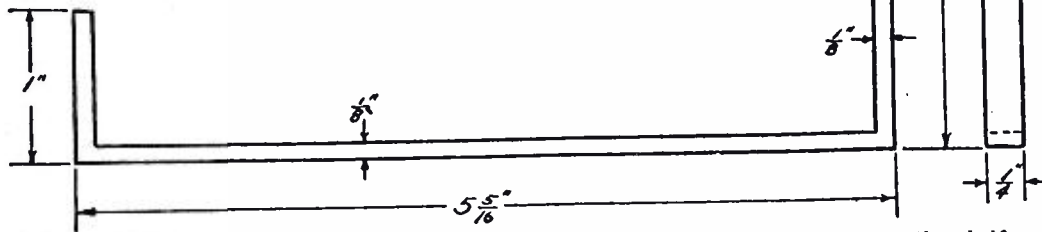

Fig. 1. Details of the bracket pieces which are fixed to the panel for supporting the shelf on which five of the vacuum tube sockets are mounted.

should be 2,100 turns of No. 36 single silk wire, wound in the $\frac{1}{2}$ in slot. For the core material, use either a bundle of fine iron wires, such as No. 36 gauge, or a bundle of flat strips of silicon steel, not over .003 in. in thickness. Ordinary heavy transformer iron or silicon steel will not do. The thinner the laminations the better the transformer will be. Small lugs should be provided for terminals, the inside primary lead going to the plate, outside primary to the "B" battery, inside secondary to the filament and outside secondary to the grid, in each transformer.

The single tuned transformer is wound on a spool, turned from seasoned hardwood with flange $\frac{1}{4}$ in. in width, a diameter of $2\frac{1}{2}$ in., a hub of 1 in. and a slot $\frac{1}{2}$ in. in diameter. On this spool wind 250 turns of No. 30 D. C. C. wire, in a haphazard manner. Place a layer of insulating paper over this winding, and wind on 1600 turns of No. 36 single silk or enameled wire,

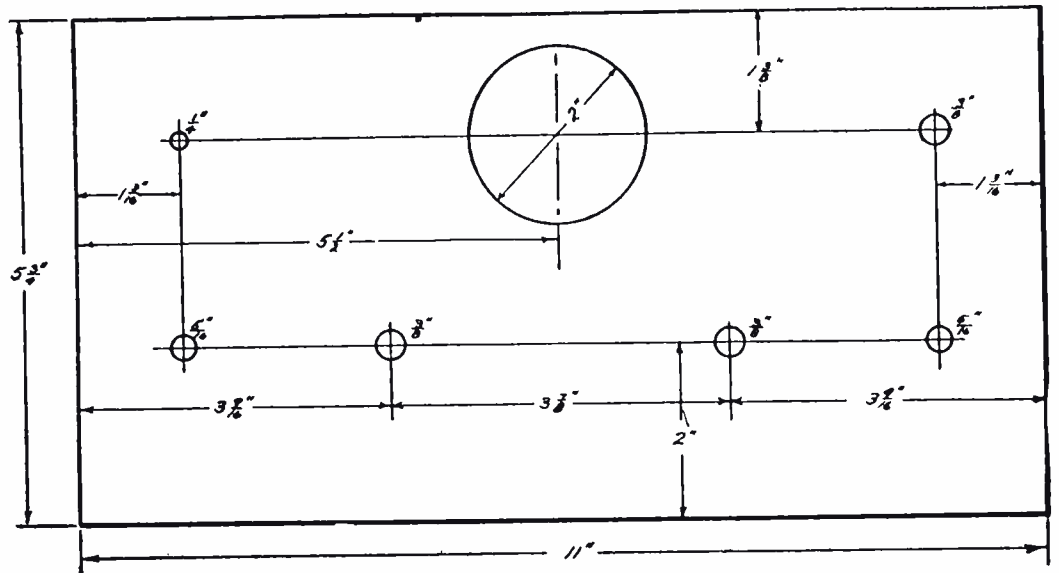

Fig. 3. Panel layout of the midget super. It will be noted that a two inch hole is drilled in the center for a voltmeter. If the constructor desires he can omit this instrument.

Mounting Assembly

Two Remler condensers are mounted at 90 degrees from their usual position, in order to take up as little room as possible when at their minimum capacity position. As the dials furnished

site ends of the panel. The oscillator tube is mounted directly underneath the oscillator coil and adjacent to the oscillator condenser. The first detector tube is mounted under the main filament rheostat.

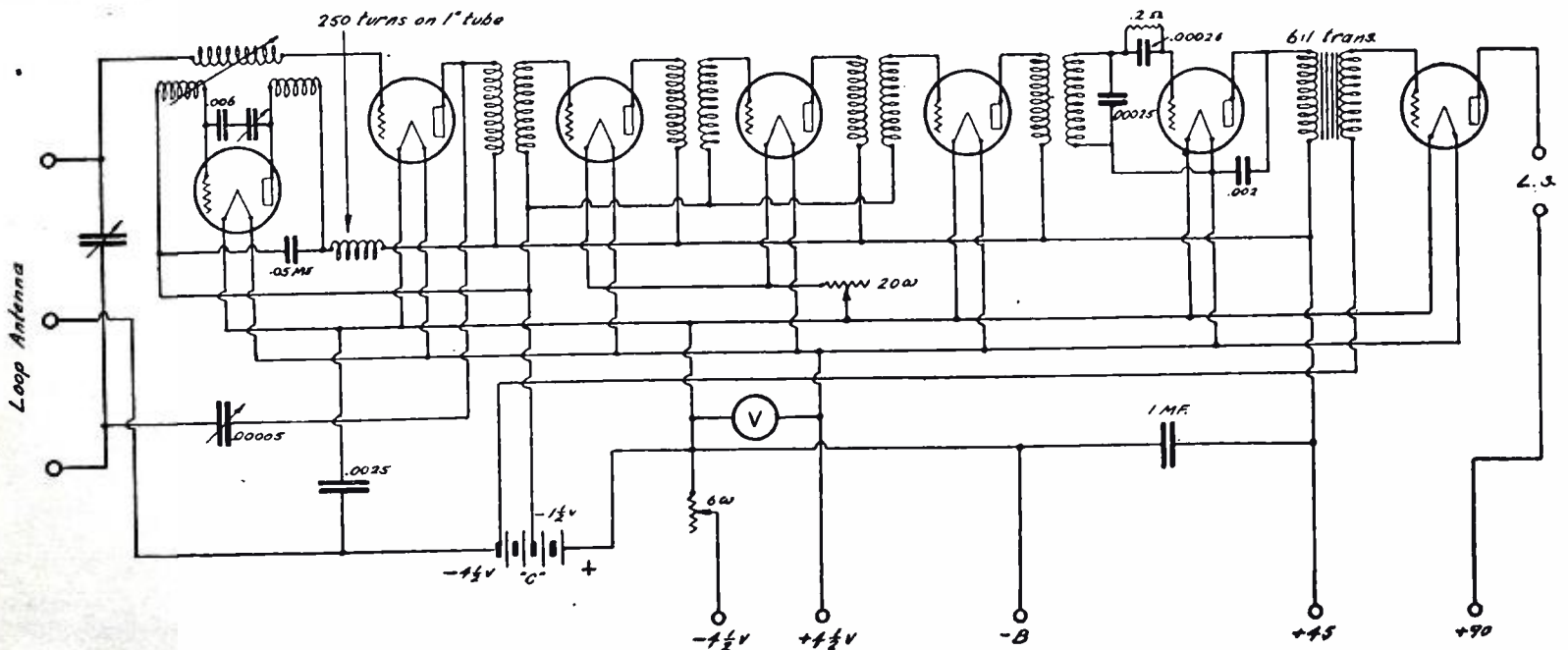

Fig. 2. The wiring diagram of the set in schematic form. The battery leads are brought out through the rear by means of colored wire cables or lengths of lampcord. The three loop terminals are fixed to the top of panel and loud speaker to phone tip jacks.

for the secondary coil. If this transformer is used in the circuit, the primary condenser should be .005 mfd.,

with the condensers are 4 in. in diameter, it was necessary to cut them down to $2\frac{1}{2}$ in. each, the cut being

A pair of brackets made from flat brass strip, as shown in Fig. 1, support the bakelite shelf at the rear of the set,

on which are mounted the remaining five tube sockets, the transformers and miscellaneous apparatus. The oscillator and first detector sockets are fastened to the bottom of the brackets at each end of the panel. The bakelite shelf is $2\frac{1}{4} \times 11$ in., of $\frac{3}{16}$ in. bakelite, the five sockets completely covering the top of the shelf. Underneath the shelf are mounted the three intermediate frequency transformers, crowded together and shielded from each other by a copper sheet, all shields being tied to the negative "A" battery.

The tuned transformer is removed from its bakelite case and mounted between the intermediate group and the audio transformer, which can be seen clearly in the illustration. Back of the intermediate transformers is mounted a 1 mfd. by-pass condenser, of the ultra-thin type.

The schematic circuit diagram is shown in Fig. 2. A 6 to 1 ratio transformer is used, in order to obtain as much voltage amplification in the audio stage as is consistent with fair quality.

In order to localize the oscillator current as much as practicable, a small

radio frequency choke is placed in the oscillator plate battery lead, between the oscillator coil and the point in the "B" battery lead where battery voltage is supplied to the other parts of the set. This choke may be made by winding 250 turns of No. 32 cotton covered wire on an ordinary wooden spool such as is supplied with sewing thread. The wire may be wound jumble fashion, and the spool can be mounted next the audio amplifier tube, as shown in the picture.

Looking at the rear of the set, the tubes mounted on the shelf are as follows, reading left to right: 1st, 2nd and 3rd intermediate amplifiers, 2nd detector and audio amplifier. This method brings the output of the set to a pair of phone tip jacks mounted on the front of the panel, there being no arrangement for plugging in on the detector tube.

The panel layout is shown in Fig. 3, the voltmeter hole being cut for a Hoyt instrument. No drilling holes are shown for the mounting screws of the rheostats, as apparatus other than that shown in the pictures may be used.

Some difficulty will be experienced in wiring the set, as the arrangement of parts is very cramped. It is well to wire up the vacuum tube circuit, including the oscillator and 1st detector tubes, before fastening the shelf and bracket assembly to the panel. The final connections to the panel apparatus can then be made without much trouble. Anyone never having built a multi-tube set before would do well to try something else first, as full detailed working drawings of the set cannot be furnished here, and the successful construction of the outfit rests with the mechanical ability of the worker.

No claims for great selectivity or distance are made for this outfit, and for city use, a larger layout is more desirable, but for reception in the country, where powerful stations are somewhat distant, it has no peer. Successful reception of stations on the loud-speaker, over a distance of 2000 miles at night, using a portable loop antenna, has been had with this set and there is every reason to believe that anyone handy with tools and familiar with common radio circuits can do as well.

The Interflex Receiver

(Continued from page 6)

writer has used 201-A and 301-A tubes, although any other tube may be used.

What This Set Can Do

The writer has given a log of stations pulled in on a single evening. All of these were on the loud speaker and it should be noted that all of them were received while the locals were going. It should be noted also that such stations as KDKA, operating on 306 meters, and WGBS, operating on 316, could be separated nicely without interference from each other. Also station KDKA, 306 meters, and WPG, Atlantic City, 300 meters, could be

tuned in easily without interference from each other.

The writer is well aware of the fact that these are not records by any means, and that a super-heterodyne or a good 5-tube radio frequency set may tune more closely and more sharply, but the writer maintains that for a single-dial control, with very little fusing with the potentiometer, the results are not easily duplicated with other sets.

Furthermore, this set tunes from 550 meters down to about 200. This is not a theory, but actual fact. Most sets that claim this range find it impossible to tune down even to WRNY, on 258 meters.

On local stations the potentiometer setting is not critical, while on DX work it needs more or less attention. The writer recommends that this set be used with aerials of a total length of not more than 75 feet. This includes the length of aerial plus lead-in. A long aerial makes for more interference. A good indoor aerial may be used if absolutely necessary, although the writer does not recommend it.

It will be noted that this set is entirely automatic, as the telephone plug or loud speaker plug automatically lights the bulbs. No switch of any kind is used.

A Technical Editor's Set

(Continued from page 10)

adjust the grid leak until it breaks into generating with a soft hiss. Knocking indicates too high a resistance of the leak—more pencil marking should be added. If it sounds mushy, erase until the best effect is obtained.

The rest is very simple. Rotate the

secondary dial, with the antenna coil set parallel to the secondary inductance, and when a signal is heard, increase the regeneration until the best reception is obtained.

Not infrequently, I find that the present day tubes when used as audio

amplifiers, give off a high pitched whine or whistle, and to eliminate this I solder a .00025 mfd. fixed condenser across the G and F minus terminals of the transformers. This simple expedient eliminates the objectionable noise entirely.

A Simple Browning-Drake Set

How to Make a Two-Tube Receiver with Full Details for the Coils Used

PROBABLY every one of our readers who is interested in radio reception is a DX fan and enjoys the thrill of bringing in stations thousands of miles away. For just this type, the set described on this and the three following pages was selected. With its one stage of tuned, neutralized radio frequency amplification, when properly designed and constructed, this system of reception gives excellent results. Used with a two-stage audio amplifier, loud speaker results are to be noticed in almost every instance. Usually it is only necessary to use one stage of audio frequency amplification to accomplish this.

A. P. Peck gives full details for the construction of this simple Browning-Drake set in *Science and Invention*, New York, that can be easily constructed and wired from step by step illustrations.

In the photograph at the right the author is shown testing the set for volume and selectivity. After the set was properly neutralized and the variable grid leak was set at the correct value, determined by experimentation, local stations could be easily and quickly separated and distant stations tuned in.



Illustrations by Courtesy of Science & Invention (New York)

In this circuit, with the home-made coils described on a following page or with the standard manufactured type, a fixed series antenna condenser is necessary for best results. This is shown in

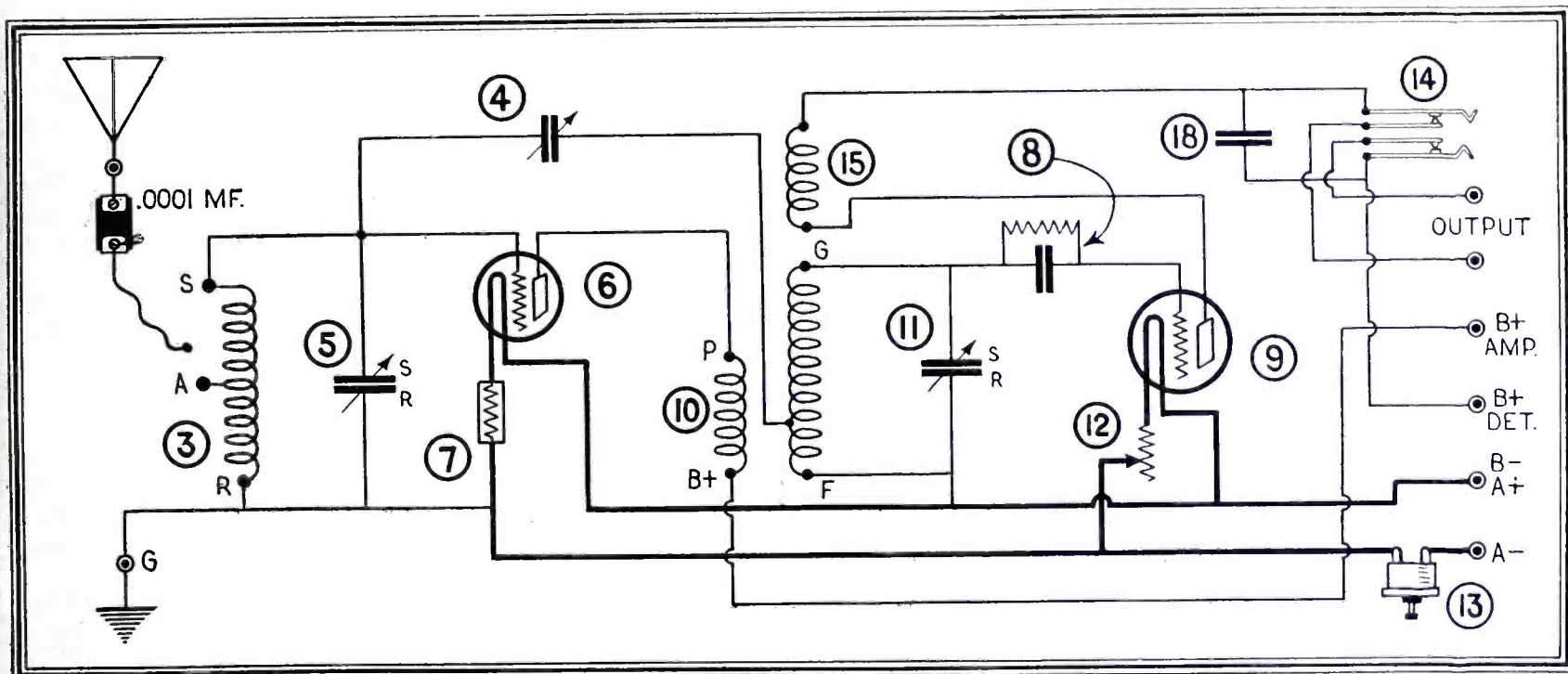

The above circuit diagram shows all of the connections for this two-tube Browning-Drake unit. The parts have been carefully selected and the home-made coils wound for the very best results. Follow directions carefully and you will have a set that will justify all your troubles.

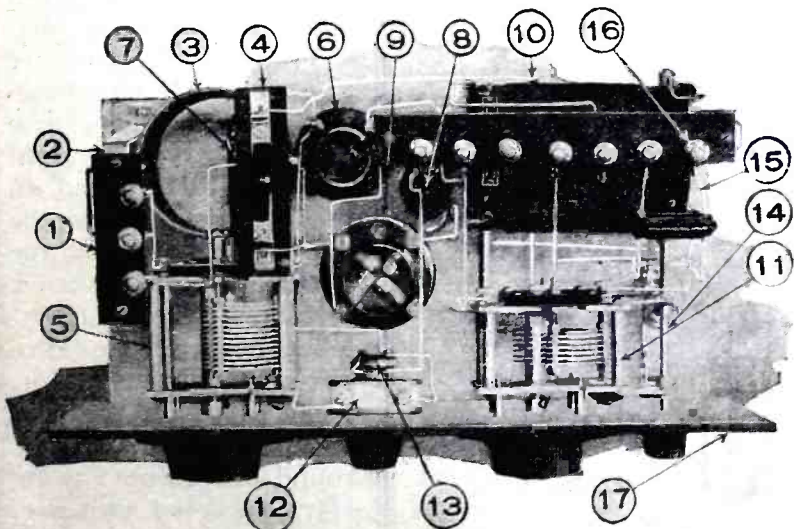

In the top view of this receiving set, shown above, all of the parts are assigned numbers. These are carried out through the entire article so that reference can be made quickly and easily. Manufactured parts are illustrated, but home-made coils are described in connection with this article.

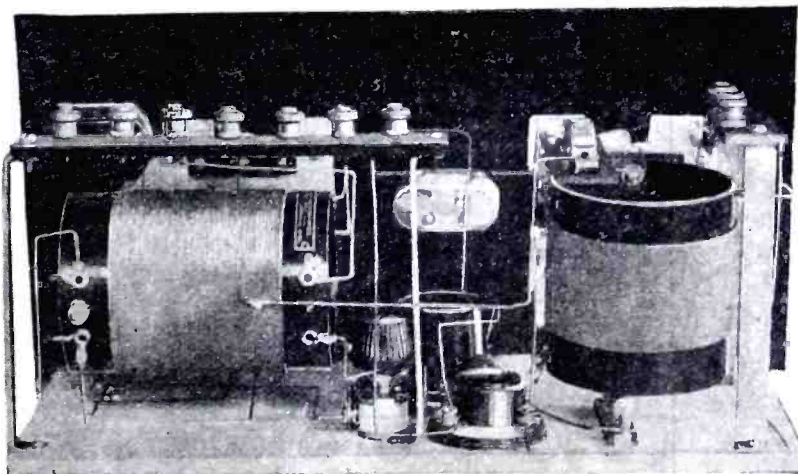

A rear view of the completed set is shown above. Note the mounting of the neutralizing condenser in a convenient location and the long supports used for raising the binding post strips to a point where they can easily be reached. The fixed filament resistance, 7, is located on the baseboard under the antenna tuning coil.

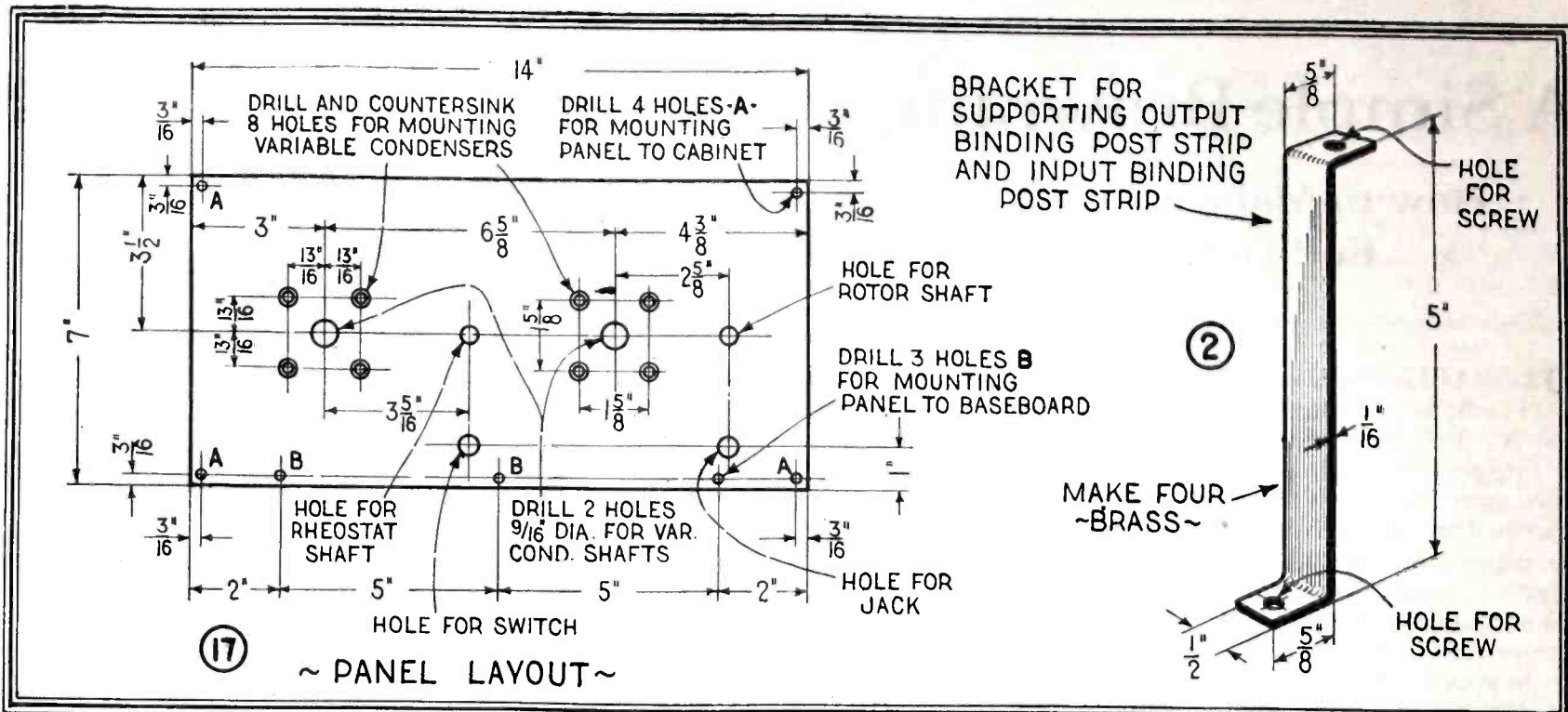

the schematic diagram, but not in the photographs, or the progressive circuits. In the particular set illustrated this series condenser was an external adjunct and was permanently connected in the antenna lead-in. A flexible wire from this condenser was

brought in through the back of the cabinet and the end of it connected to one or the other of the aerial binding posts. For short aerial connect to post S, and for a long one to post A. Many users of sets of this type have found that it will work very well on an

aerial only ten feet long. Of course, if you desire, this condenser can be incorporated in the set.

The illustration directly above gives all of the details for laying out the panel of this receiver and for making the brackets which support the binding post strips.

The numbers correspond with those on the photograph on the preceding page. The panel is laid out for using the standard condensers furnished with the Browning-Drake kit and the holes are placed to allow the use of the vernier dials supplied with that kit. When you make the brackets for the binding post strips, you may have to turn the bases towards the other side in order to get them on the baseboard. In any event, this can be quickly determined when you are arranging the layout of the parts.

The first progressive wiring diagram is given herewith. In this diagram, all of the parts are shown with the baseboard and the panel laid flat, instead of at right angles to each other. In this way the parts can be more plainly seen and the wiring diagram is easier to follow. Only the filament connections are shown in this section, while those for the grid and plate circuits will be found on the next page. If you proceed with wiring of your set by following these diagrams one at a time, you cannot go wrong. Wire first the

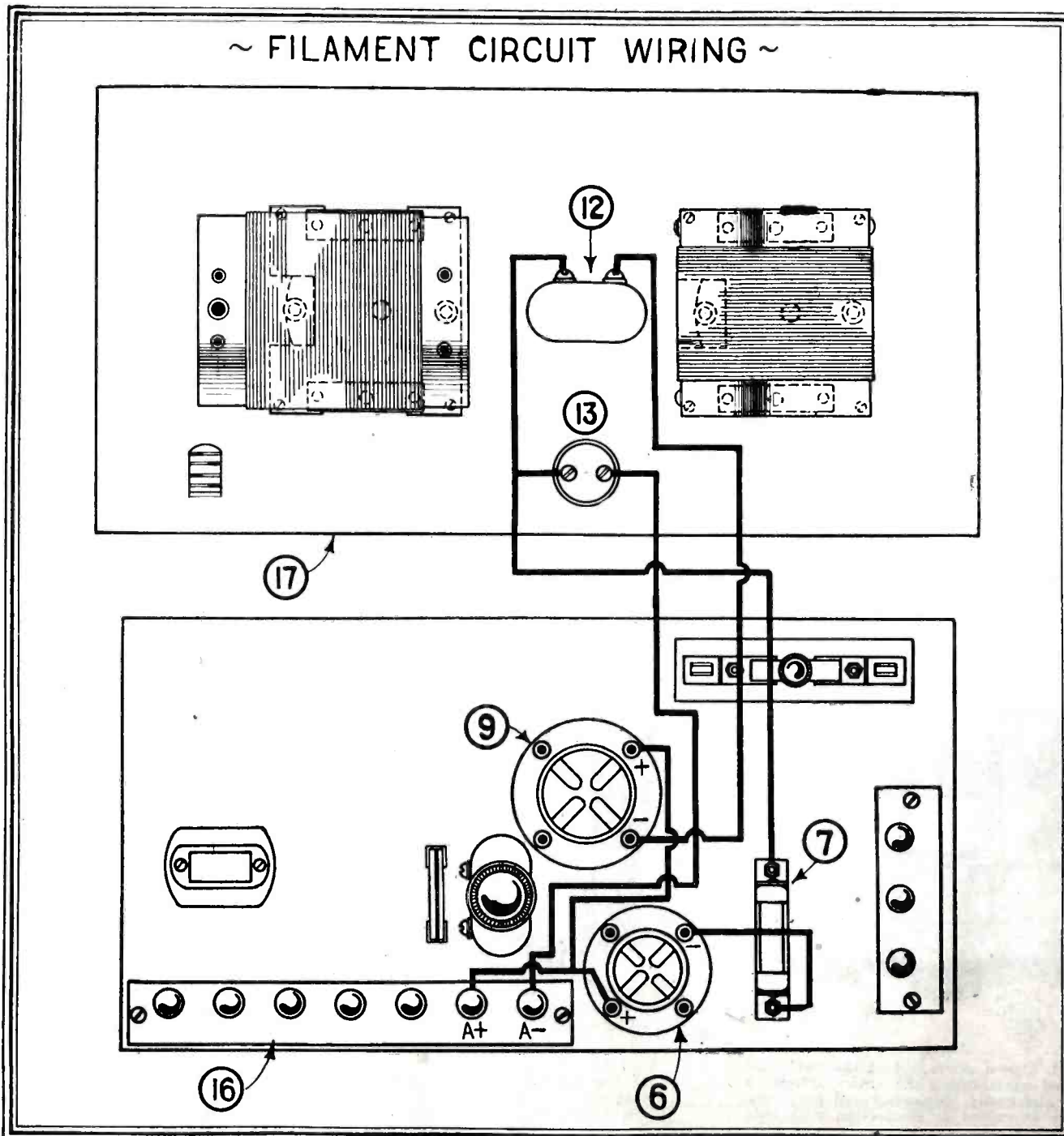

filament circuits: then put in the grid connections and finally the plate wires.

The diagram at the right shows all of the connections for the grid and filament circuits of this set. The grid wires are shown in heavy lines while the filament connections that were shown in detail on the preceding page appear in fine lines. The neutralizing condenser 4, which is mounted on a little bracket fastened to the antenna tuning condenser is shown here placed on the baseboard for the sake of clarity only. Mount it as shown in the photographs on the first page of this article when you come to the actual construction of this set. In this way it is easily accessible for neutralizing the set. The combination grid leak and condenser, 8, is placed on the baseboard inasmuch as the leak does not require frequent adjustment. A fixed resistance capable of operating a UV-199 tube directly on a storage battery is shown at 7. In this way, a special rheostat or a tapped "A" battery is not necessary.

The remainder of the connections for this set are shown below in the plate circuit wiring diagram. The fixed condenser, 18, should be connected across the two outside springs of the jack rather than across the two leads to the output binding posts, as shown in the photographs. The reason for this is that with the connections shown below, the condenser will be in shunt with the phones, when they are plugged into the jack, 18, and will also be across the audio frequency amplifying trans-

former when this two-tube set is used with an additional unit. If the condenser is placed across the output leads, it will not be in the circuit when the phones are used. This is not to be de-

sired. In the diagram below, the rotor, 15, is shown. This is controlled by a long shaft placed beside the detector tuning condenser and protruding through the panel a short distance away from the dial controlling that instrument. A small knob placed on the end of the shaft allows the operator to turn the rotor and thus control regeneration. In this set, because of the neutralized radio frequency amplifier, radiation to an appreciable degree cannot take place even though the tickler is coupled so closely to the detector tuning coil that the set squeals.

You may wonder why two different types of tubes are used in this receiving set. The reason is that a UV-199 or a DV-3 tube is a somewhat better radio frequency amplifier than a UV-201A and is much easier to neutralize and that the latter is a good detector. Therefore, we use one of these low-power tubes for the amplifier and control the filament of it with a fixed resistance unit that will allow the 3-volt filament to operate on a 6-volt storage battery, without fear of burning it out. The resistance is of a well-known cartridge type and serves the purpose very well.

The method of balancing or neutralizing this set is as follows: After connecting everything correctly and placing the aerial and ground wires on their binding posts, tune in a local station and take the resistance unit out of its clip. Now re-tune the set slightly and the local station will be heard. Adjust the set until the station is at its loudest

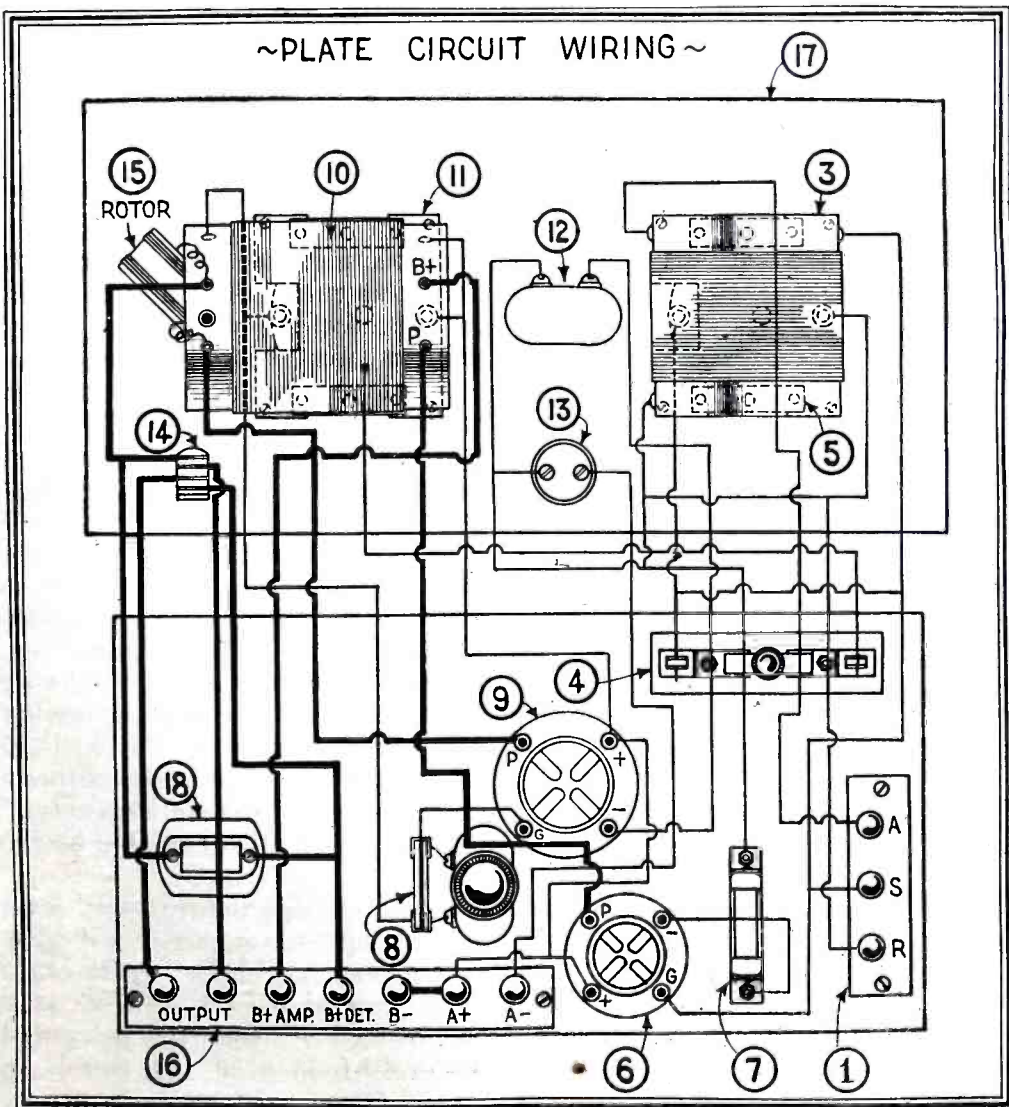
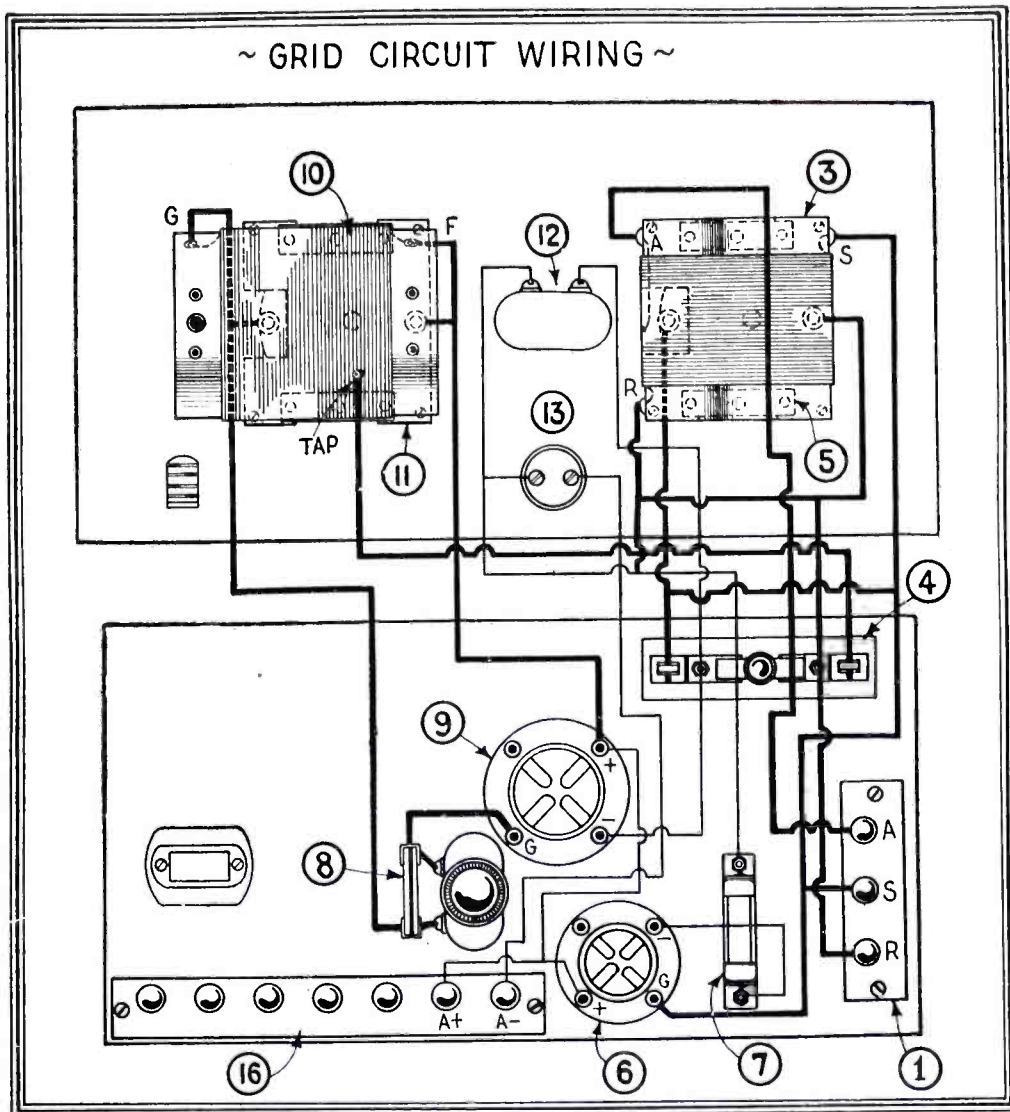

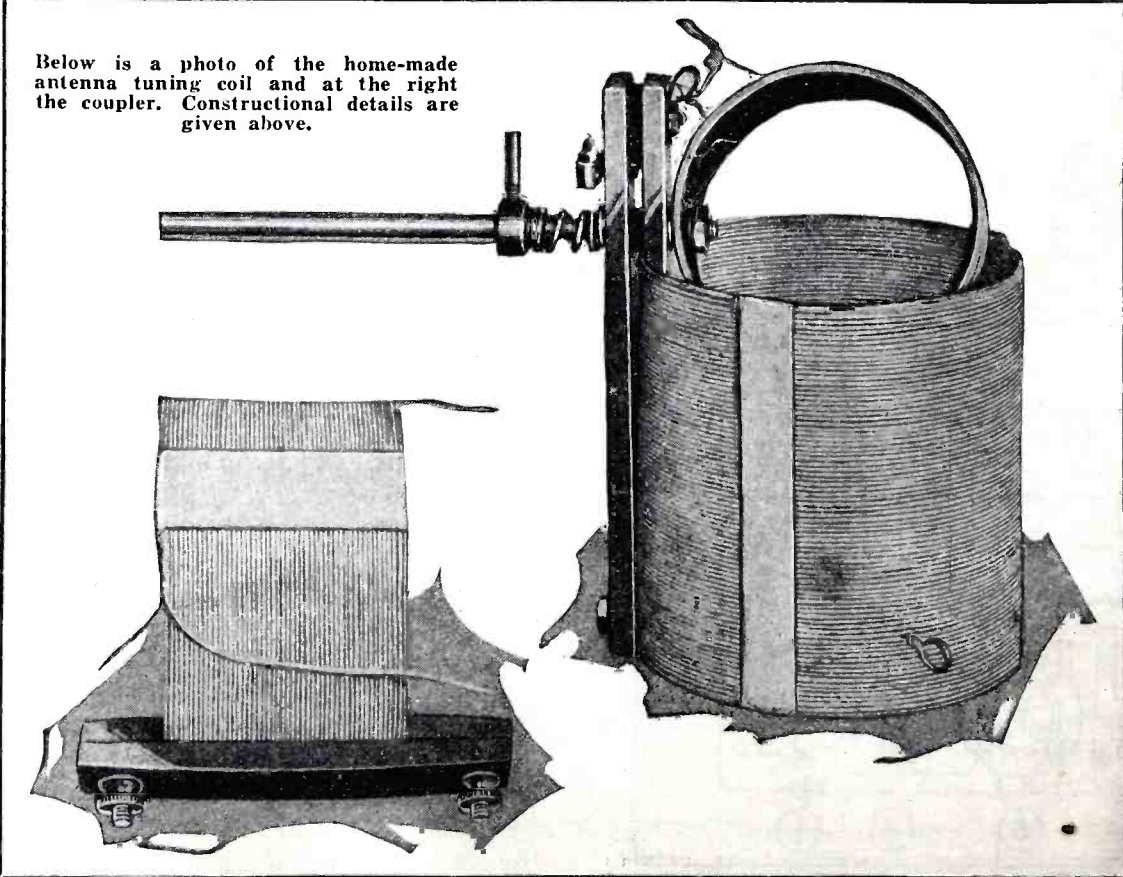
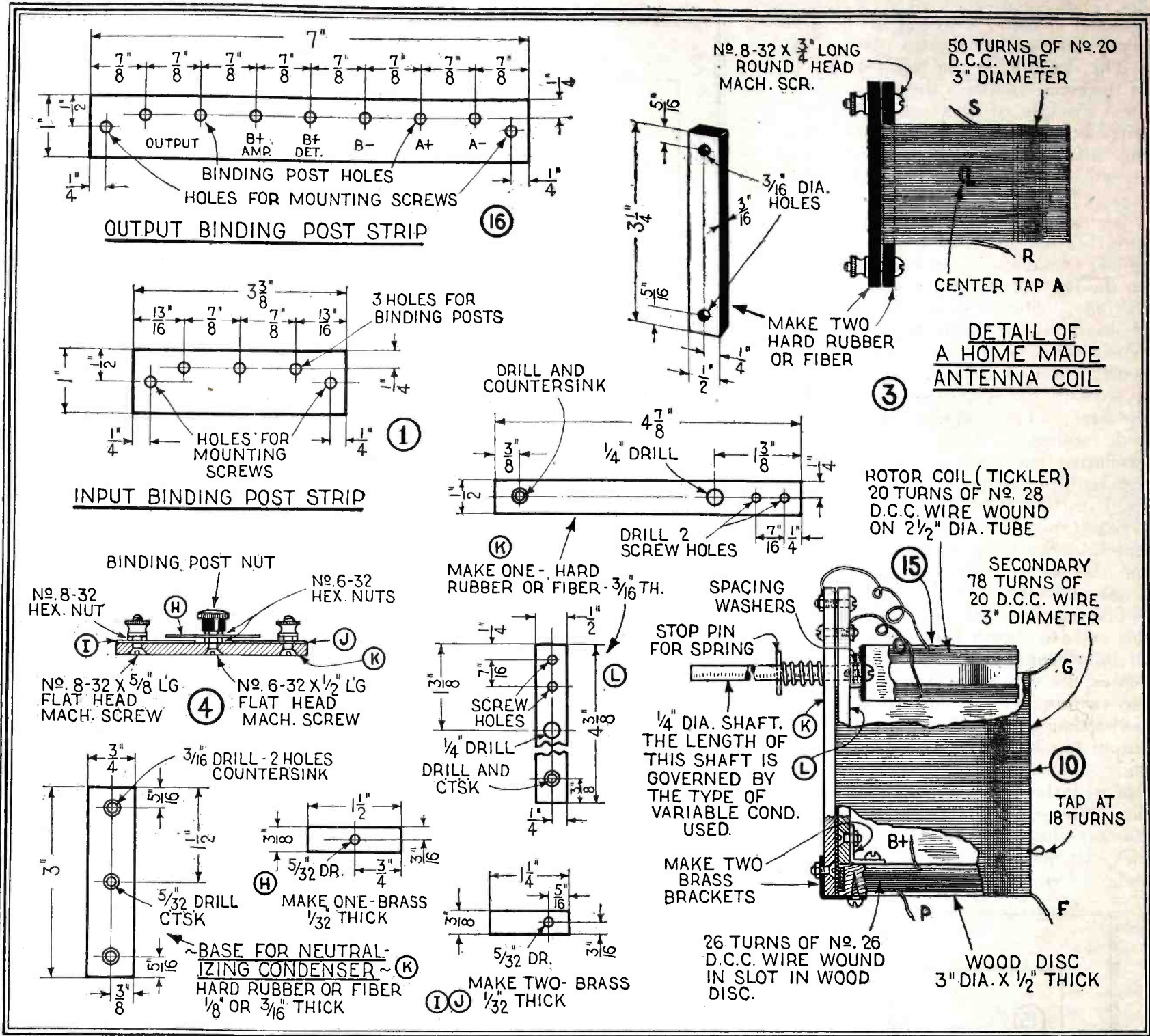

Below is a photo of the home-made antenna tuning coil and at the right the coupler. Constructional details are given above.

and then set the balancing condenser, until changes in the antenna condenser do not affect the signal strength. This point is usually identical with the setting of the balancing condenser for minimum signal strength. Now replace the resistance unit and the set is ready for operation. A good way to test for the proper operation of the set is to place the tickler coil at various settings until, by placing a finger on the stator plates of the detector tuning condenser, 11, a "pluck" will be heard in the phones or loud speaker. This shows that the detector circuit is oscillating. Tune in a station by the well-known squeal method and then adjust the tickler coil until the station is clear and there is no whistle generated by the set itself.

A set of this nature, used with an audio frequency amplifier, will give excellent results on DX. On the Eastern coast, reception of California stations has often been reported using only a 30- or 40-foot aerial. Of course, much
(Continued on page 38)

Radio Broadcast's Phonograph Receiver

An Entirely New Method of Building the Four-Tube Roberts Receiver for Installation in Any Phonograph

THE most popular phonograph today is the phonograph in which radio is an integral part. It is possible to double the use and value of the many thousands of phonographs in this country to make them better instruments for the home by using some sort of radio receiver in connection with them. For some months, it has been possible to buy factory-made radio receivers which could be fitted into a compartment of the phonograph. But the home constructor has had to worry along as best he could.

Radio Broadcast magazine determined to experiment with the idea of furnishing the best design possible for home constructed receivers in the phonograph and struck on various compact models of the Roberts receiver.

The phonograph is a very satisfactory means of entertainment, and we feel sure that by the proper design of a receiver for incorporation in practically any model of phonograph we are going to present something of great use to our readers. Many a perfectly good phonograph has been done out of a home by the radio set. Many more have been

pushed aside, and their sole present use is to hold a beautiful lamp or a flower pot.

Details of a practical set for the phonograph were recently described in

Radio Broadcast by Arthur H. Lynch as follows:

Radio has brought a new problem into the home. Space in many modern homes is often scarce. When the



Illustrations by Courtesy of *Radio Broadcast* (New York)

A view showing how *Radio Broadcast's* phonograph set looks installed in a console model talking machine. The complete set including batteries are installed in the left-hand compartment and the loud speaker attached to the tone chamber.

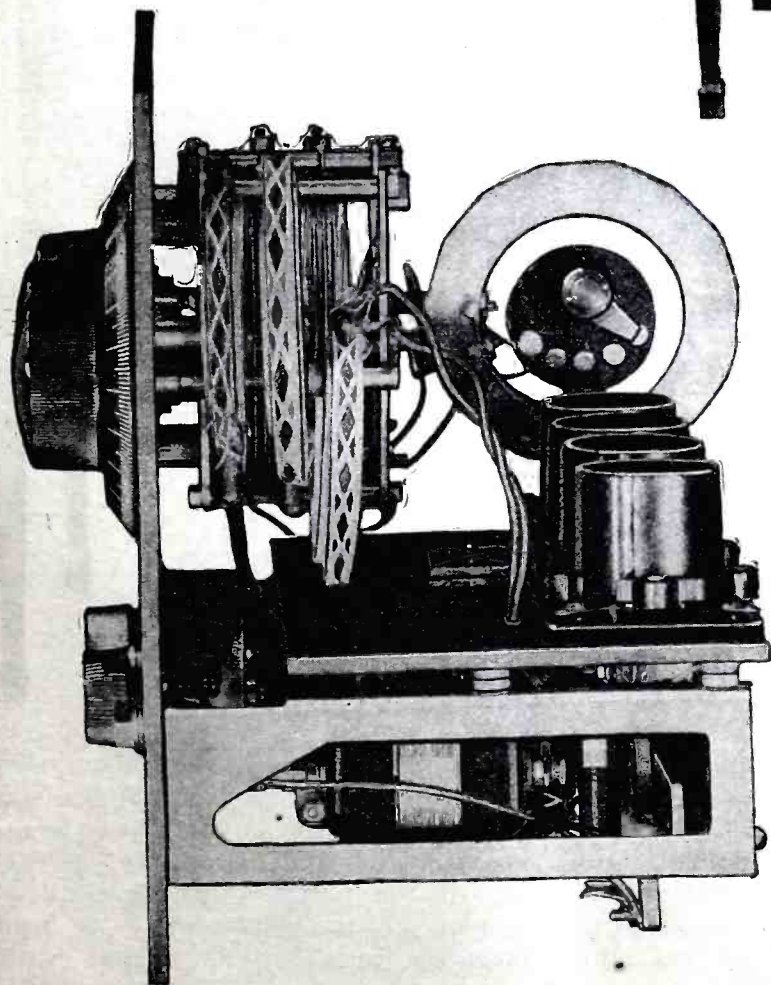

A side view of Model No. 1. The principal points shown in this illustration are the extreme rigidity of assembly and indication of the compactness of the unit. In this case a panel fourteen inches high has been used to fit the console requiring a vertical assembly. In an assembly of this kind it is entirely practical to fit it into a wooden carrying case for portable purposes. Dry cells and the necessary B batteries may have plenty of room below the receiver assembly. Though dry cell tubes may be used in this way, better results are obtained from standard tubes with a storage battery. The use of a small switch mounted in the antenna coupler to permit regulation of the left-hand tuning dial for antennas of different lengths makes the panel assembly more presentable. Since this switch need only be adjusted once for a given antenna and then remains a fixture there is no need for having it on the panel. This idea was suggested by P. R.

Morrison of Freeport, Long Island, New York.

piano, the books, the library table, and the phonograph are properly placed. where to put the radio receiver has caused many brows to wrinkle. If a

ceivers will allow the constructor to utilize the handsome qualities of his phonograph cabinet, and the excellent sound chamber of that instrument. For

A radio receiver for a phonograph has to be designed so that it will fit the various cabinets in which it might be installed. The Radio Broadcast Phonograph Receiver consists of an extremely compact unit employing the excellent circuit developed by Walter Van Braam Roberts of Princeton University. The unit itself is so designed that it can be adapted to a panel of any size. The dimensions of the panel conform to the size of the phonograph cabinet into which the receiver is to be put.

The Main Features of the Phonograph Receiver

The following description will show just how to build this receiver, using standard parts of various types. The photographs which are reproduced herewith show just what we have been able to do with the Phonograph Receiver and several representative types of phonograph cabinets. For the experienced radio constructor, the photographs are self explanatory, but for the builder who sets great store by complete constructional details there may be a few minor points not included in this article, although, the illustrations give a general idea of construction which is all that can be offered here. Other details on building a Roberts 4 tube receiver appeared in the May issue of *Radio Review*.

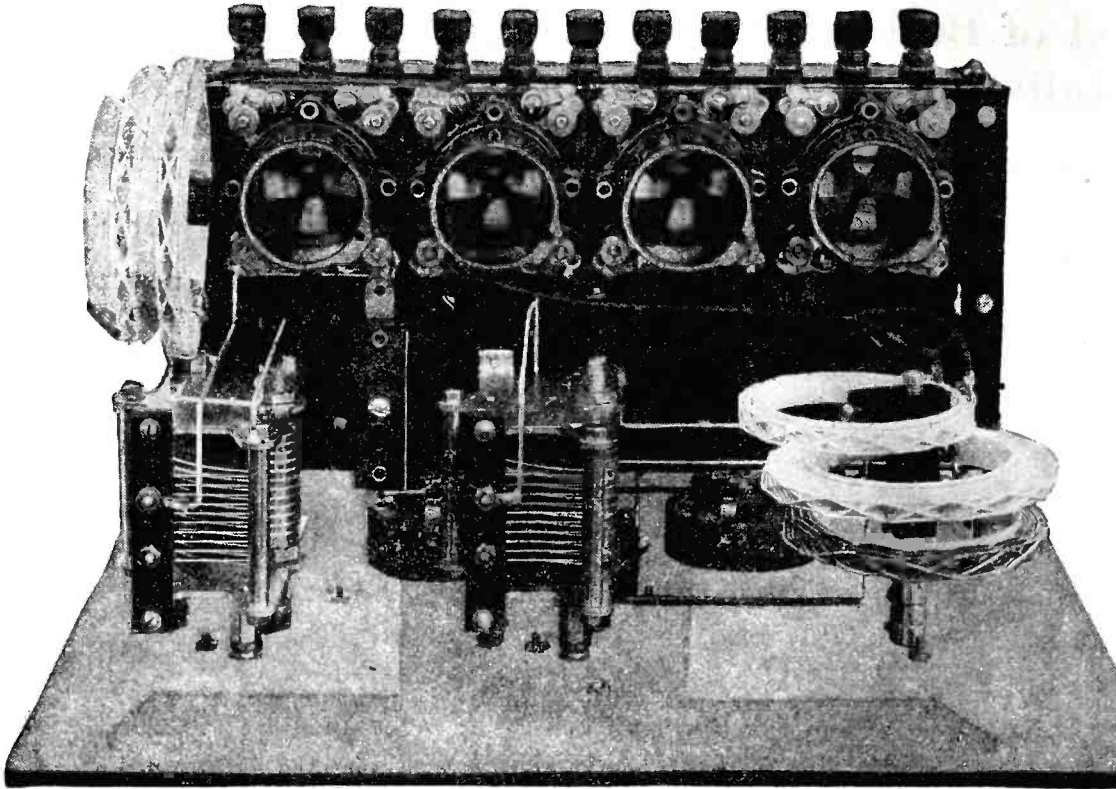

Top view of the phonograph unit. Particular attention is called to the assembly of the sub-panel as well as the position of the tube sockets. In order to permit the complete unit to be used in either a vertical or horizontal position without requiring a single change in construction and to offset the possibility of the tube filaments sagging and touching the grids, the correct placing of the sockets is important. Even though this receiver is very compact, it will be observed that there is no crowding.

phonograph is part of the household equipment, it is often necessary to relegate it to an inconspicuous corner. And, if our observation counts for anything, there are entirely too many phonographs that are now gathering whatever dust the housewife will permit it to collect. Too many phonographs are not used from one end of the year to the other. This has been the case in the homes of a number of

these two reasons alone, we believe that many, many phonographs are going to come out of the shadow, not only to be seen but to be used again.

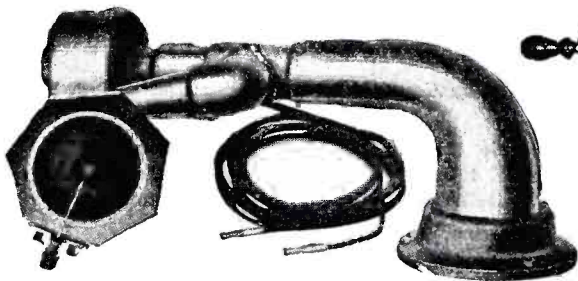

A loud speaker and phonograph tone-arm now available from many phonograph dealers.

our staff and in the homes of many people with whom we come in contact. We hope to show the home constructor how he may very desirably combine the beauty of his phonograph with the efficiency and compactness of a home constructed four-tube receiver.

Home constructors, ever since they began their researches with blue print and pliers have naturally turned more of their attention to the electrical side of their receiver than they have to what might be called the aesthetic side. If the set was put together and it worked, the cabinet in which the set was contained was often a secondary consideration.

Radio Broadcast's Phonograph Re-

If you use this combined radio-phonograph unit, there is no reason why you should ever be deprived of the very best in the world's entertainment. When the radio programs do not suit your mood, there is certain to be a record among your collection which will suit the occasion.

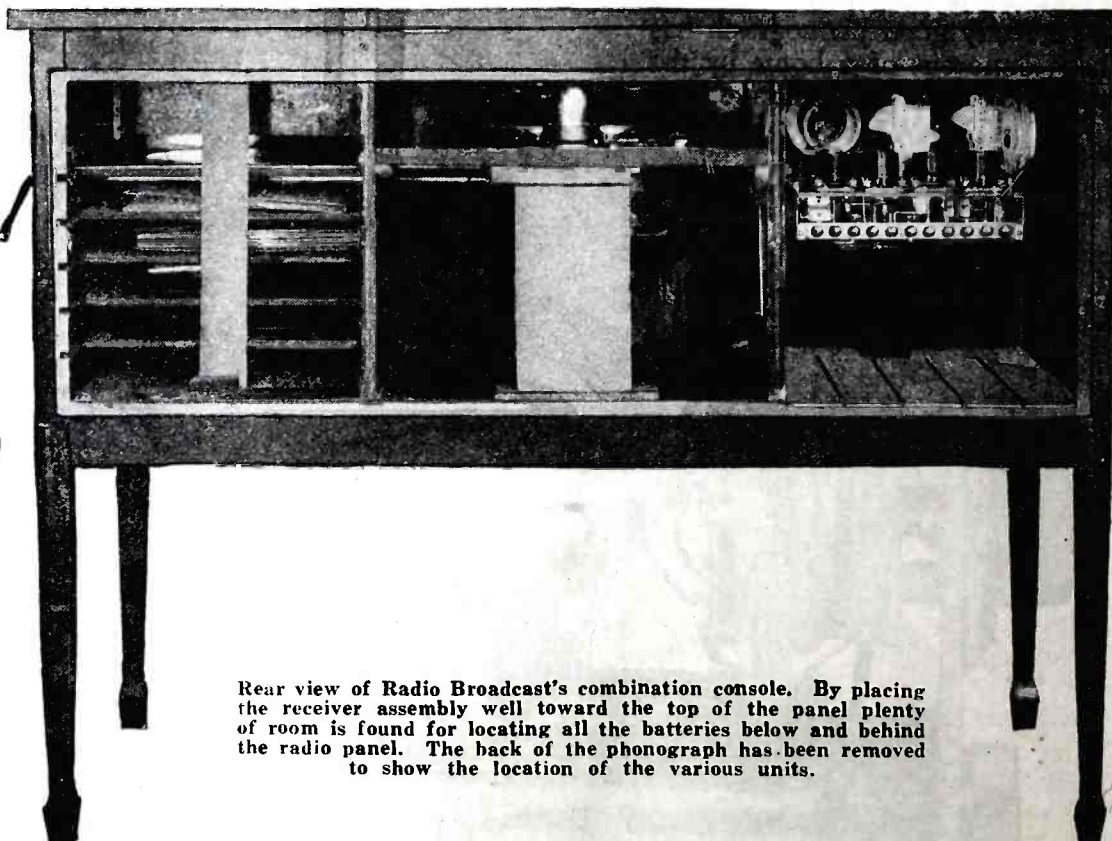

Rear view of Radio Broadcast's combination console. By placing the receiver assembly well toward the top of the panel plenty of room is found for locating all the batteries below and behind the radio panel. The back of the phonograph has been removed to show the location of the various units.

The main feature of the Phonograph Receivers is its wonderful compactness. The panel layout, as you will observe, is extremely symmetrical. The assembly of the parts is not particularly difficult and the results which we have obtained with several models with which we have been experimenting

have been highly satisfactory. This Phonograph Receiver combines all the good features of the Four-Tube Roberts Receiver, plus some very significant mechanical and electrical improvements.

The possibilities of this Phonograph Receiver are best shown by an examination of the accompanying illustrations.

A great many Victor phonographs of the upright type are in use to-day. In these, the record cabinet is of two kinds. Some have two sets of shelves; the upper holding books for ten-inch records and the lower holding books for twelve-inch records. In order to fit the Phonograph Receiver in such a cabinet, it is merely necessary to remove the upper shelf and find some other convenient place for them. An unused corner of a bookcase does very well. A panel of wood or some composition is then made to fit the space previously occupied by the record-books and the receiver-unit is then fitted directly to this panel, or to a sub-panel mounted on the panel which is substituted for the record-book shelf.

The illustrations show that this radio-phonograph combination will save a great deal of space, and since the storage battery and the B batteries may be included in the phonograph itself they are permanently placed out of sight. This is, of course, impossible when the radio set is used on some sort of table.

In another upright Victor model, there are a series of four to six shelves used to hold the phonograph records, with books to contain them. In placing the Phonograph Receiver in such a cabinet, it is only necessary to measure about twelve inches down from the upper end of the record space, remove

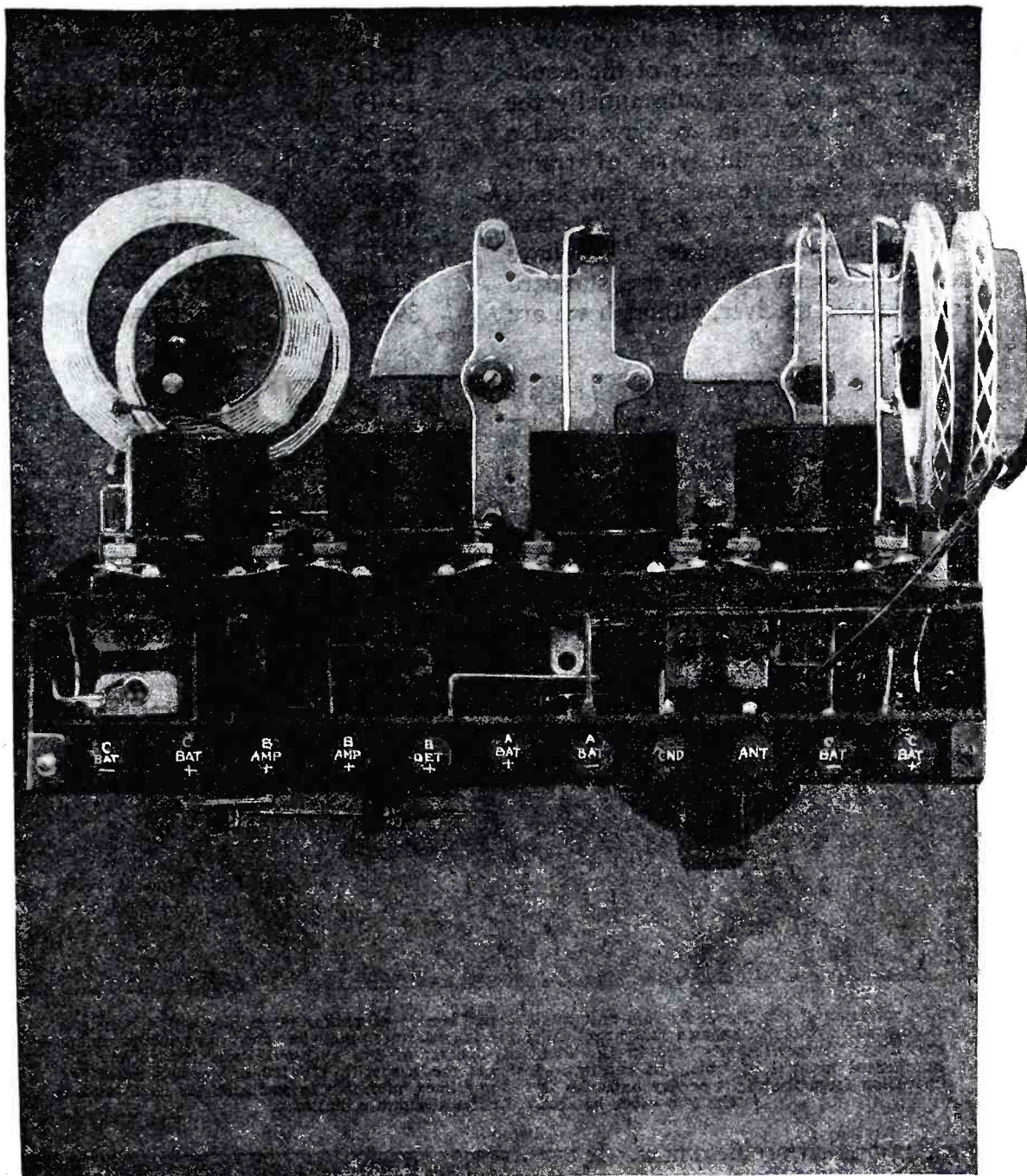

The above photo shows how the unit appears from the rear. All binding posts are clearly marked.

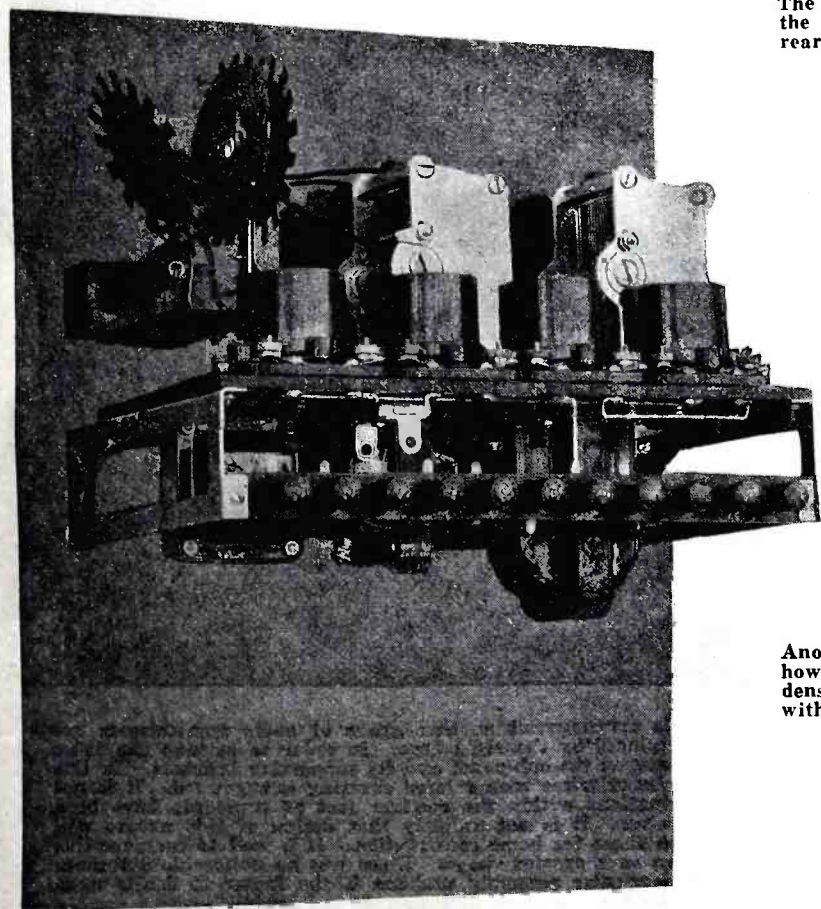

Another rear view showing how other coils and condensers may be employed without any change in layout.

the shelves and have a panel of wood or composition made to fit this space.

There are a great many receiver devices now on the market which enable one to use a so-called loud speaker attachment with the phonograph. These devices are connected to the audio output of the receiver and the unit itself mechanically coupled to the tone-arm of the phonograph. The sound compartment of the phonograph is used as the loud speaker. This operation is very simple, as can be seen from one of the illustrations. The character of the signal resulting from the use of a good loud speaker attachment and the phonograph itself as the "loud speaker" is extremely good. There are also some new types of tone-arms which combine both the tone arm for the phonograph and an attachment for employing the loud speaker unit. In such a combination, the phonograph or loud speaker attachment may be used at will without taking the sound box from the tone-arm. A tone-arm of the sort described has been used in our laboratory and has produced very satisfactory results.

In our experiments with this new design, we have used a great number

of different radio parts designed for the same purpose. In practically every case, the overall efficiency of the resulting models has been substantially the same. For example, we have used a number of different types of transformers. We have used various kinds of coils, various makes of rheostats, and vacuum tube sockets. We have not as yet been able to use standard jacks in this receiver, although we are

Dial Settings	Call Letters		
12-12	WCAD	41-41	WLIT
15-15	WEAN	42-42	WOR
19-19	WTAS, WPG	45-45	CHYC
21-21	KDKA	46-46	PWX
22-22	WGBS	49-49	WLW
28-28	WLS	52-52	WOS
31-31	CFCA	57-57	WJZ
32-32	WHN	60-60	WCAE
34-34	WGN	62-62	WCAP
39-39	WTAM	64-64	WEEI
		69-69	WEAF
		80-80	WNYC

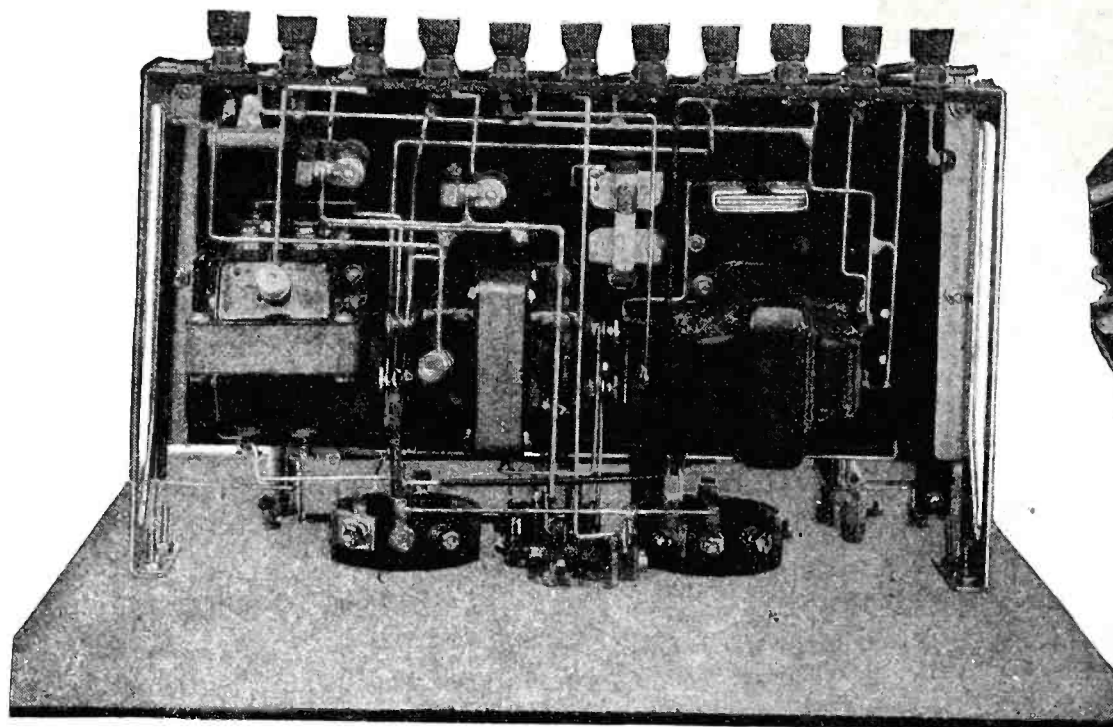

The set from the bottom. In this unit audio transformers of rather large physical dimensions were used in order to be sure that practically any transformers may be employed without undue crowding. Amperites are used in the filament circuits of the push-pull tubes to reduce the number of manual controls. In receivers designed for use with UV-199 or similar tubes for operation from flashlight or dry batteries it is sometimes advisable to use a single rheostat for the two tubes as shown in the schematic diagram.

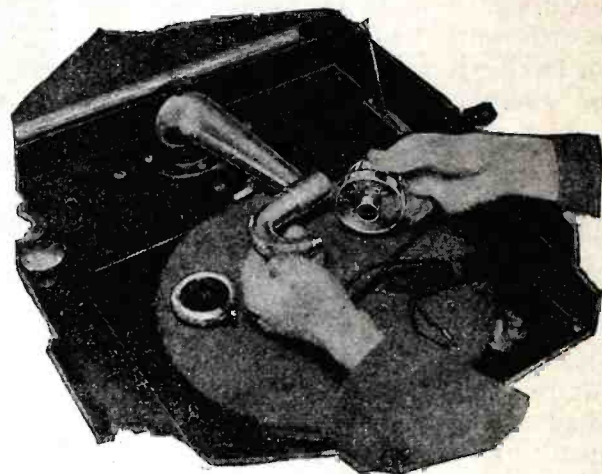

A simple method of converting the tone chamber of a phonograph into a loud speaker.

When this log was made, the set was tuned with but two controls. The rheostat and tickler controls were not used. It will be noted that the positions of the two dials throughout this log coincide over the entire broadcast range.

working on that problem now. It may, perhaps, be difficult for some constructors to secure circular jacks as used in these Phonograph Receivers in their locality, but these may be obtained by mail order in a few days from almost any part of the country.

It may be seen from the illustrations accompanying this article, that it is not necessary to use one specified unit in building this receiver. For example, any good audio transformer will function satisfactorily in the reflex stage, and any good push-pull transformer will work in the amplifier arrangement. The panel and sub-base arrangements have been designed to accommodate practically an .0005 mfd. condenser, and almost any tube sockets and other parts which make up the assemblage.

Radio Broadcast's Phonograph Receiver has not been designed to satisfy the demand for the ultimate in radio reception. It will, however, bring in excellent quality with very good volume and at the same time cover a very reasonable wavelength range. With a similar set operated here on Long Island, N. Y., during the month of April, and using but two tubes, the following log was made in one hour and twenty minutes:

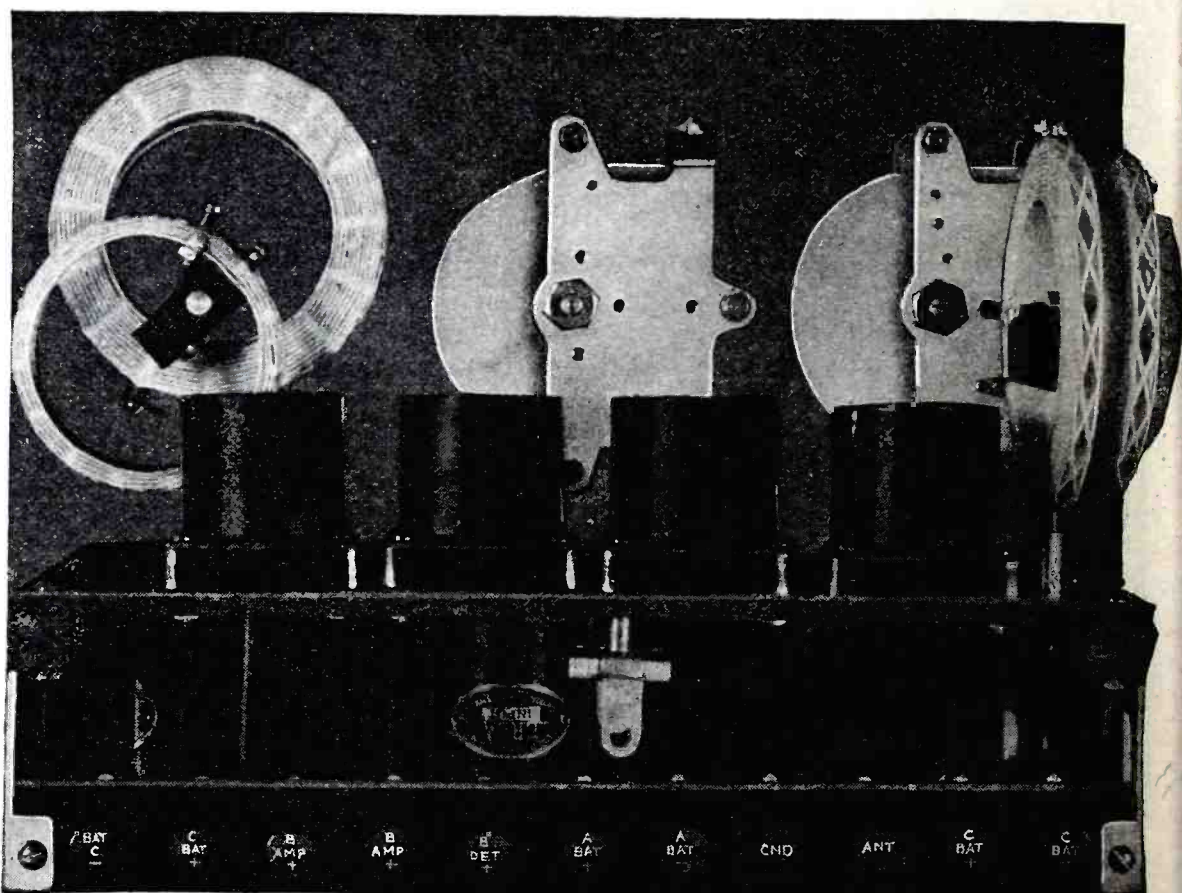

Another view of the back panel. In this arrangement another group of audio transformers are used and the spring sockets have been replaced by the rigid type. In order to cushion the tubes two strips of sponge rubber are placed between the sub-panel and its supporting brackets. In this receiver, flexible wiring is used and a series of wires with colored covering is suggested. It is not a difficult matter to arrange color combinations within the receiver just as standards have been suggested for the wiring outside the receiver. It is not unlikely that design of this nature will soon find its way into receivers other than those for home construction. It is well to compare this unit with the other back panel view shown on a previous page. There was no noticeable difference in performance. Convenience for your particular assembly problem is the factor to decide upon between the two.

How to Assemble and Wire the Sub-Panel

Before drilling holes in the sub-panel for mounting the various units it must

be prepared by the transformers, but make certain that there is plenty of space surrounding each unit to permit the wiring to be done easily.

will be found very helpful. Then too, it is good practise to wire as much of the panel as possible before the sub-panel is attached. If this plan is fol-

The unit on a smaller panel. This model shows a very symmetrical panel design. The application of a unit like this to any phonograph is a very simple matter. It is merely necessary to procure a piece of five-ply veneer large enough to fill the desired space, cut a hole in wherever the unit will fit most satisfactorily and set it in place. If, to conserve space, it is necessary to install the receiver in a side-wise position, the precaution concerning the position of the tube sockets to prevent sagging filaments touching the grids must be taken into consideration and the mounting of the sockets changed accordingly. The engraving may then be put on the proper part of the panel to make reading the dials from the side unnecessary.

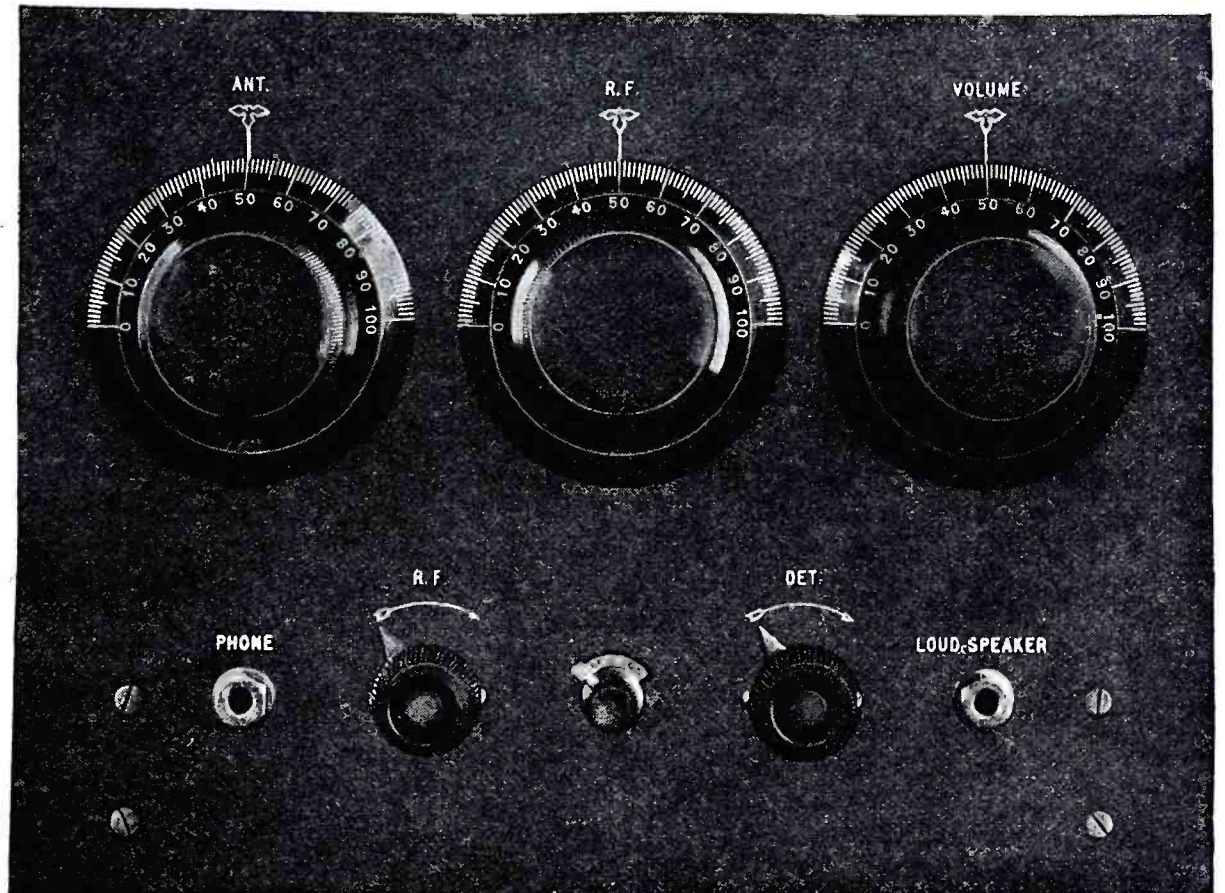

hold, it is advisable to place the sub-panel itself upon the brackets which are going to support it on the main panel. Then place the tube sockets in

It is good practise to do as much wiring on the sub-panel as possible before permanently attaching it to the panel as shown in Fig. 1.

lowed the balance of the wiring will be brought to a minimum and the attendant work will be much simplified.

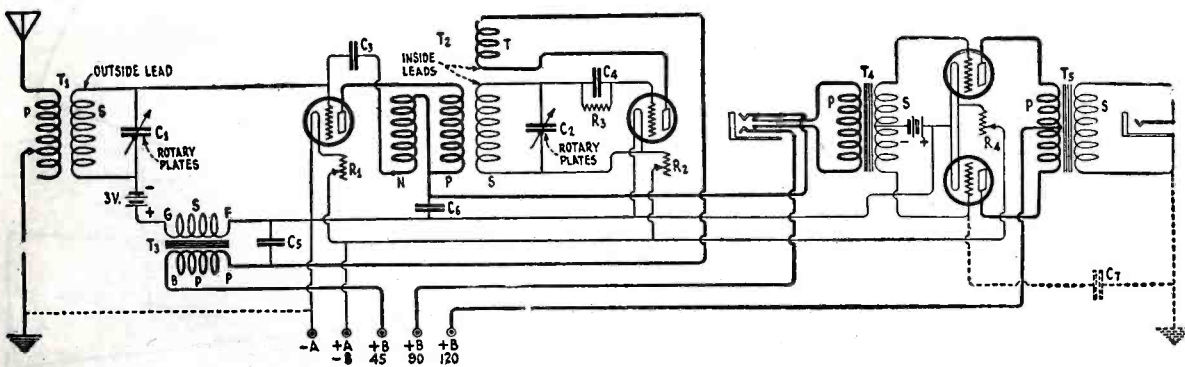

The wiring diagram above differs from that shown below in several minor details. Simple jacks are used instead of those incorporating the filament control feature. A rheostat controls the filaments in the push-pull tubes instead of the Amperites. The circuit above is a much simpler wiring job, but where the receiver is to be used by the entire family the additional wiring necessitated in the diagram below will be found very much worth while. The dotted lines in both these diagrams illustrate simple and effective methods for overcoming any difficulties which may arise in the audio amplifiers such as a continual whistle which was observed when certain transformer combinations were used.

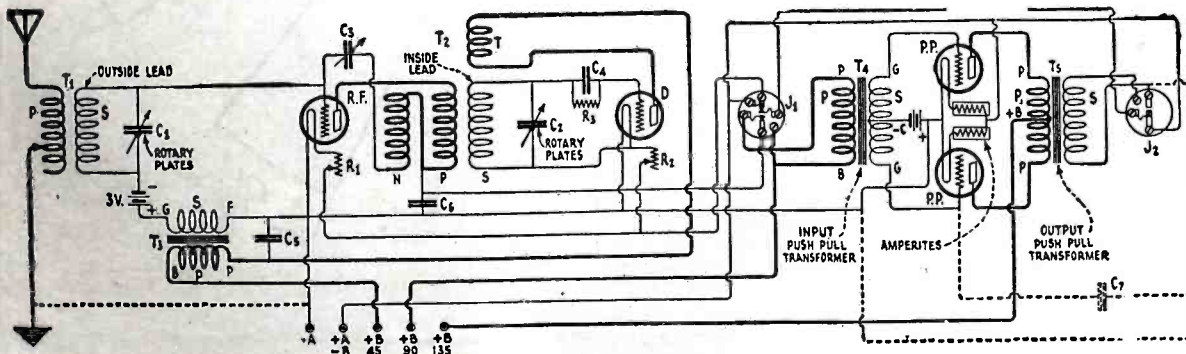

The Panel

their proper places and if necessary, secure them with a few pieces of string. Then turn the sub-panel upside down and mark off the positions to be occu-

In arranging the units on the panel, the layouts shown in the photographs,

will be found to read approximately the same for given stations within the tuning range. This feature is particularly valuable when the receiver is used by

Home-Made Coils

One of the simplest forms of coil for home construction and which may be used in this receiver is the spider-web coil. The form dimensions are given in Fig. 2. The various wire sizes, and the number of turns to be wound on each coil are indicated in the caption of Fig. 2.

A simple and good method of mounting and coupling home made coils has been designed by John B. Brennan, Technical Editor of *Radio Broadcast*. This system is illustrated in Fig. 3 A-B.

Antenna Switch

In order to compensate for the use of antennas of various lengths, a switch is placed in the antenna circuit to alter the number of turns in the primary of the antenna coupler. By the proper adjustment of this switch, the two main control dials, the antenna and the radio-frequency tuning dials,

an inexperienced person. In order to make the layout of our phonograph model more symmetrical we have placed this switch behind the panel as shown in Fig. 4. When the receiver has been completed it should be tested before it is placed in its cabinet and

system for applying bushings of this kind is shown in the photo of the back panel on a previous page.

Tube Irregularities

Tubes, particularly those which have been in use for some time, are often

tor and vice versa. Therefore, the tubes must be tried in various positions until the best combination is found.

About Plate and Grid Voltages

The plate voltage on the radio and audio-amplifier tubes is not critical and

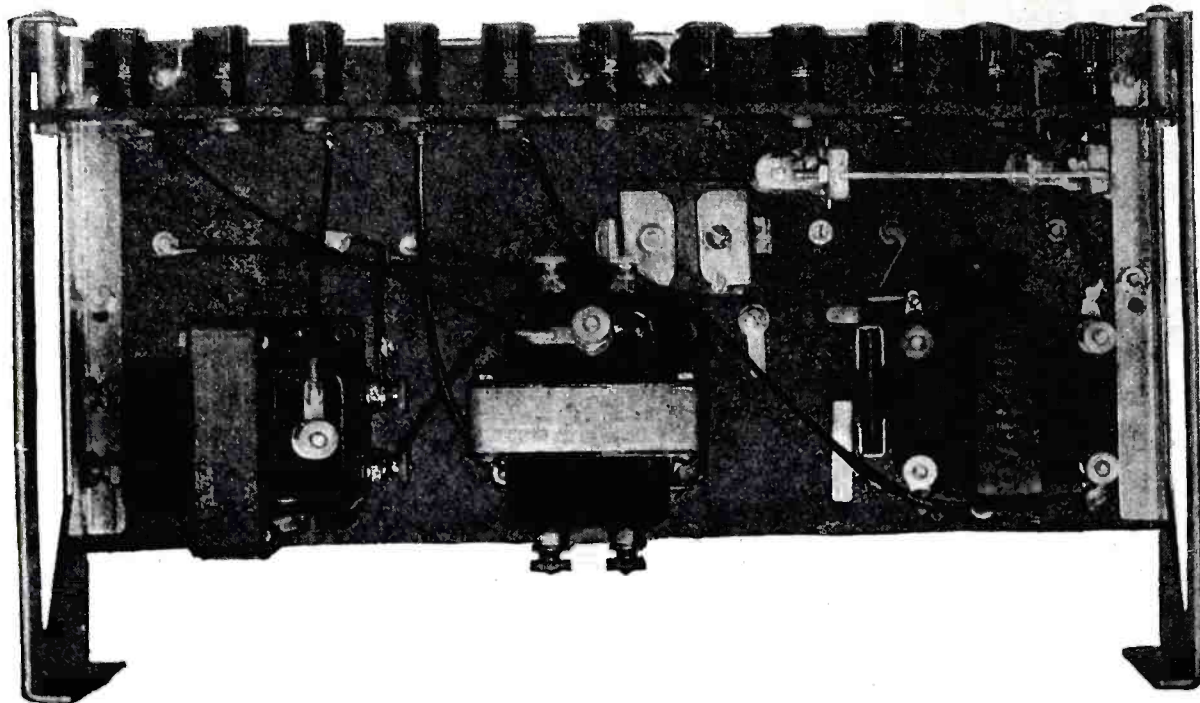

Another sub-panel view from the bottom. All the wiring shown in this illustration may be done before the sub-panel and main panel are permanently joined. In order to conserve space the strip carrying the binding posts is held away from the outer end of the brackets by two bushings and long machine screws. The space saved in this way is nearly three-quarters of an inch.

the proper setting for the antenna switch should be determined.

Rubber Bushings

Where cushion sockets are not used, sponge rubber, which may be procured from many dealers, or from several radio mail order houses or rubber companies, is ideal for cushioning the tubes to prevent microphonic noises which are sometimes noticed where rigid con-

Fig. 2. A template for the spider web coils. This sketch is exact size. The windings for these coils, as used in various parts of the Roberts circuit and indicated by the letters are as follows: Antenna coil T1; P, 40 turns No. 22 D.C.C. wire tapped 1-2-5-10-20-30-40; S, 44 turns No. 22 D.C.C. wire; Tuner T2; N, 20 turns No. 26 D.C.C. wire; P, 20 turns No. 26 D.C.C. wire (two wires of N and P are wound parallel as a pair on one spider web form as shown at the right. One end of each wire from opposite ends are connected together on this coil); S, 44 turns No. 22 D.C.C. wire; T, 18 turns No. 22 D.C.C. wire.

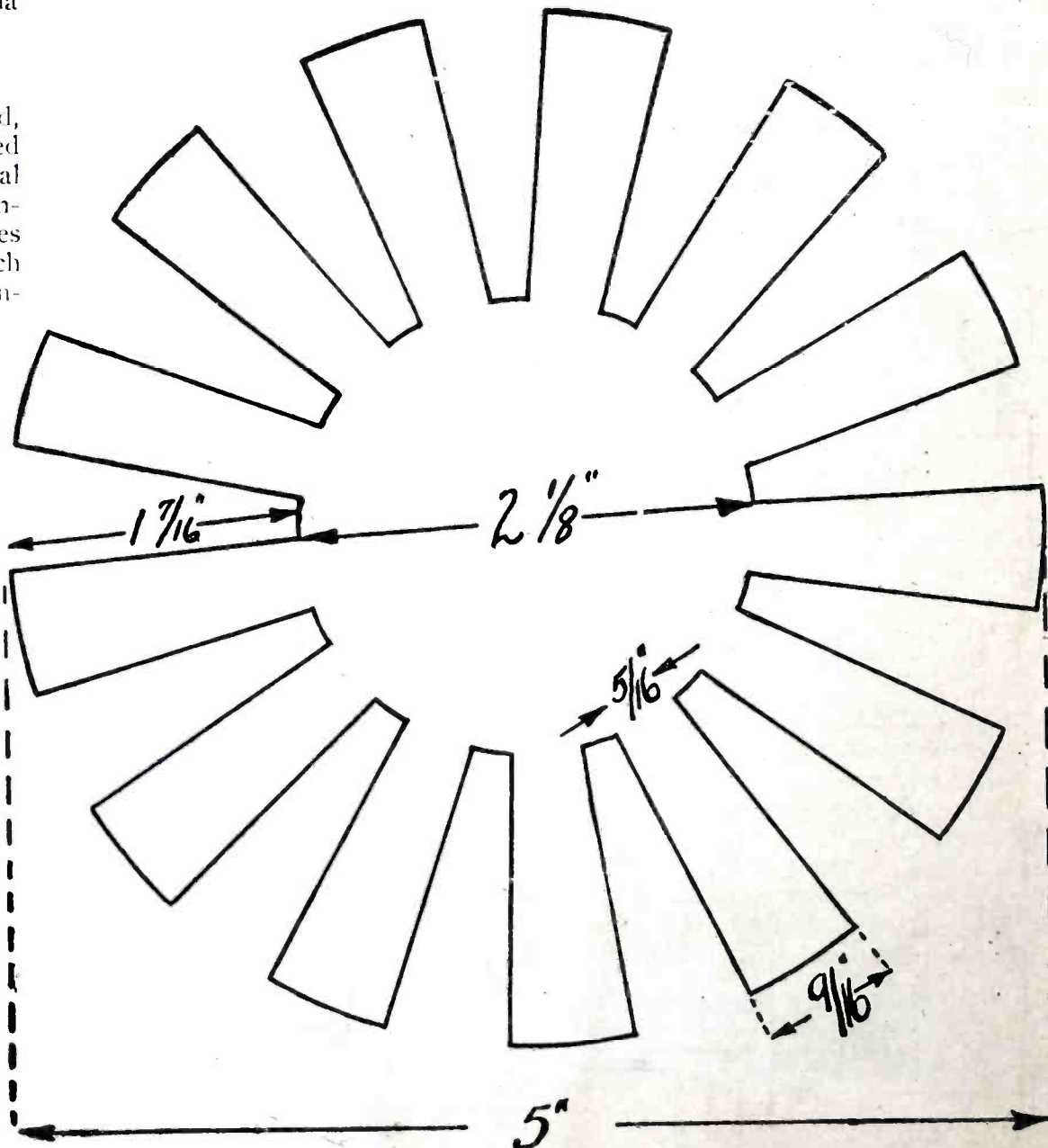

struction is used. Flexible wiring is employed between the main and the sub-panels. This is necessary to insure the success of the cushioning. An ideal

found to be anything but uniform in performance. A tube which may do very well as a radio or audio amplifier may not function properly as a detec-

for practical purposes in the home we have found 90 volts to be ideal. It is unnecessary, unless great volume is required, to use more than 90 volts in any

part of the circuit, and it has been found that a jumper between the two last terminals on the binding post strip, as indicated by the dotted line in Fig. 9, serves to bring this voltage into play on all tubes but the detector.

Making a Portable of the Radio Broadcast Phonograph Receiver

In Fig. 7, we illustrate a receiver which was made to fit in a console phonograph. By removing the entire

few weeks, three dry cells will suffice, but for periods longer than a month we recommend the use of four cells.

The plate current drain with dry cell tubes is very low and for this reason the very small B batteries may

Fig. 1. Sub-panel assembly. The photograph illustrates how the rheostat panel and tube sockets are mounted upon the brackets. All connecting leads to the main panel are temporarily coiled and labeled until this assembly is ready for further use.

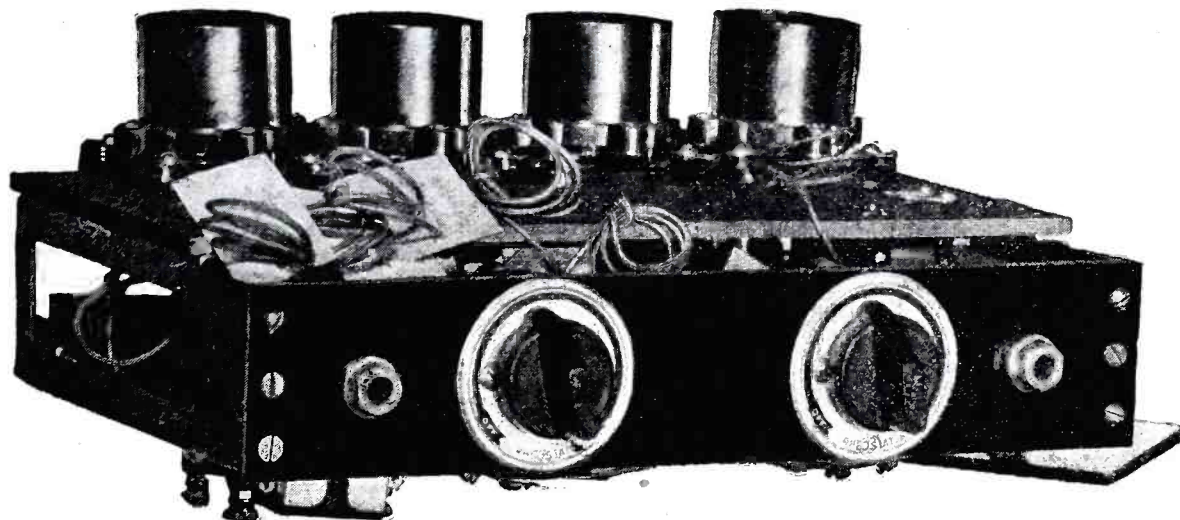

Caution: When using the jumper between the terminals plus 90 and plus 135, in the diagram as indicated in Fig.

unit from the console and placing it in a wooden carrying case, or other container, and using dry cell tubes we

be used. When operating the receiver about two hours a day, these batteries will last a month or more. There is

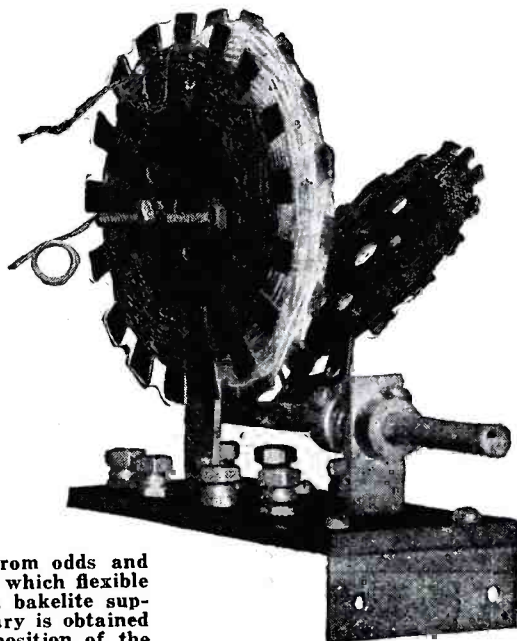
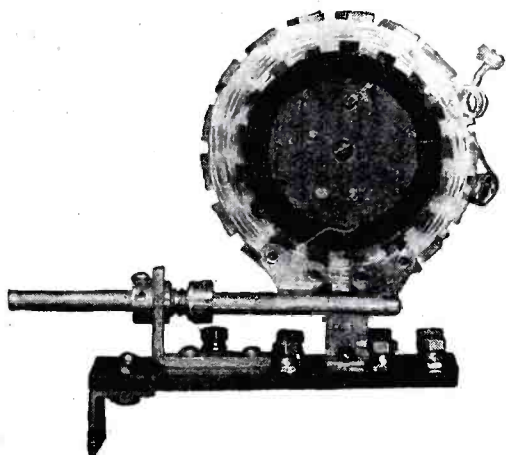

Fig. 3A-B. A home-made coil unit constructed from odds and ends around the laboratory. The binding posts to which flexible leads from the coils are attached are mounted on bakelite supports. Coupling between the primary and secondary is obtained by loosening the hexagon nuts and shifting the position of the primary coil.

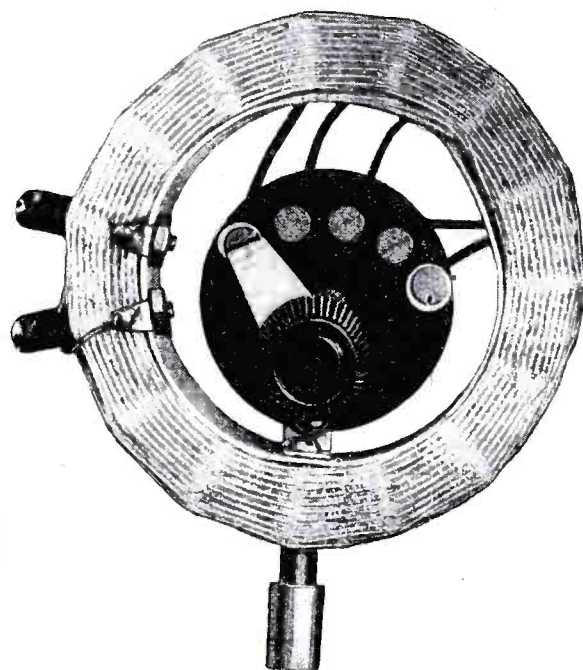

Fig. 4. The tap switch. The antenna coil sections may be included in the primary circuit by means of this switch which is mounted upon a piece of bakelite supported within the coil unit as shown above. This is a control which need not be varied once the correct adjustment has been obtained. Therefore, it is not necessary to mount the switch upon the panel proper.

9, make sure that the 135-volt connection to the B battery is taken off. Otherwise the last section of the battery will be ruined. Compare Figs. 9 and 10.

have an ideal portable for use on automobile trips, boat rides, and other portable uses.

For use of this sort we have found that WD-12 tubes are very satisfactory and that either three or four standard

The regeneration of volume of this receiver must be controlled smoothly, and we have found that much depends on the type of detector tube used. The 45 volts indicated in the diagrams is a very flexible standard, and various voltages from 8 to 90 have been employed successfully with various tubes. The detector connection in Fig. 8 is therefore variable.

room enough for the sky-scraper type, however, and they will last much longer and are more worthwhile where weight is not the primary consideration.

The Portable Antenna

There are many methods for the provision of antenna for use with this receiver in the open. No doubt there is a good market for an antenna made in the form of a reel, similar to a fishing reel. Several antenna reels have been brought to us in an unfinished condition, but we know of none now on the market. This type of radio specialty offers a very attractive field, and we believe that the concern that will manufacture such an antenna will have no trouble in marketing this product.

Center Holes Only

Templates for drilling accompany all modern parts, and to avoid giving the impression that particular units must be employed, we have merely indicated the center holes for condensers, coils, rheostats, jacks and the filament switch mounting in the panel-layouts.

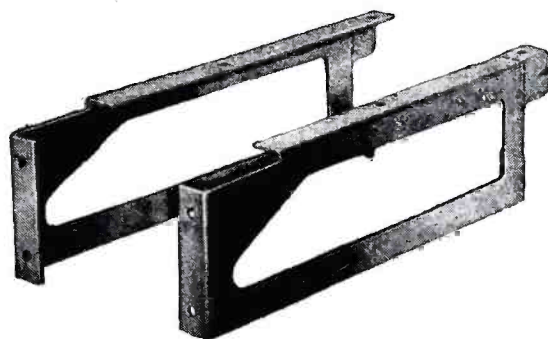

Fig. 5. The brackets for supporting the sub-panel upon which is mounted the transformer, etc. The projected parts of the brackets toward the right are removed.

dry cells connected in parallel work very nicely. If the receiver is not to be used as a portable for more than a

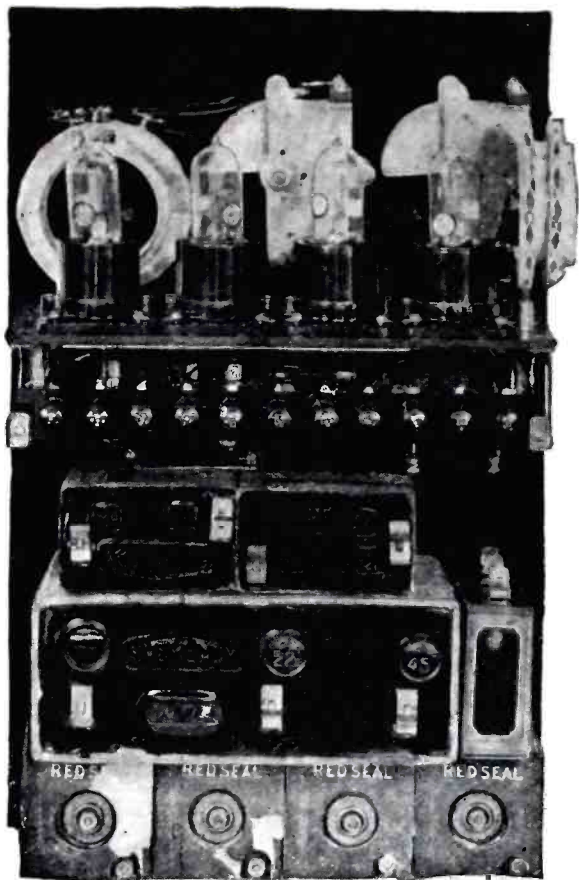

Fig. 7. The batteries are here shown stacked up to fit underneath the sub-panel. This receiver may be used as a portable outfit shown at the left. 1½-volt dry cell tubes are used.

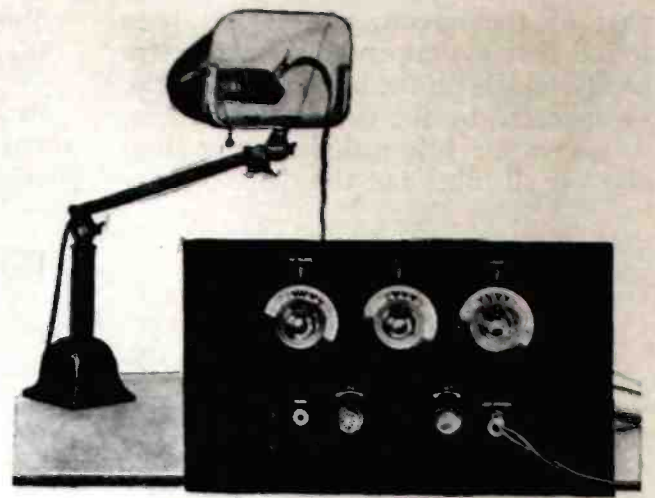

Fig. 12. Another antenna substitute is shown at the right. This unit is merely plugged in to any electric light lamp socket. Several methods of use are shown in Fig. 13.

Fig. 13. At the right is shown several ways in which the Ducon lamp-socket antenna may be connected to the receiver.

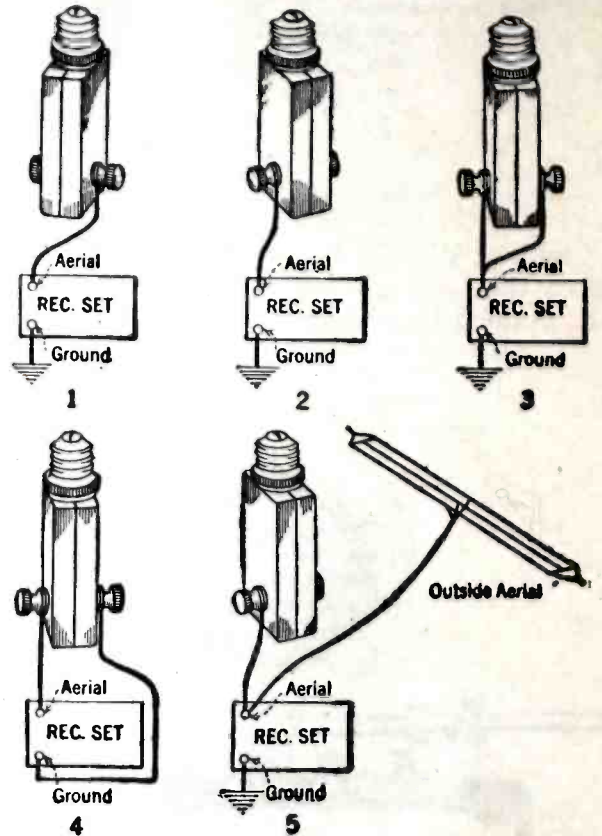

Fig. 8. Testing plate voltage at the left. For some detector tubes it is necessary to employ a definite plate voltage which must be ascertained by actual test. The pointed lead attached to the B plus binding post may be touched upon the several taps of the first 45-volt B battery until the desired value of plate voltage is obtained.

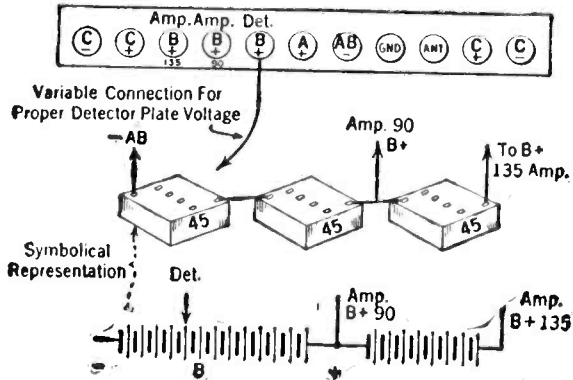

Fig. 10. Below shows how the connections are made when the full 135 volts are used. Note that the jumper connection between the 90-volt and 135-volt positive terminals for the amplifier as shown in Fig. 9 is removed.

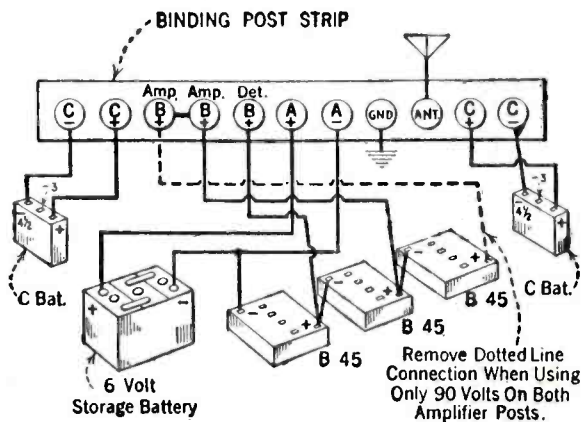
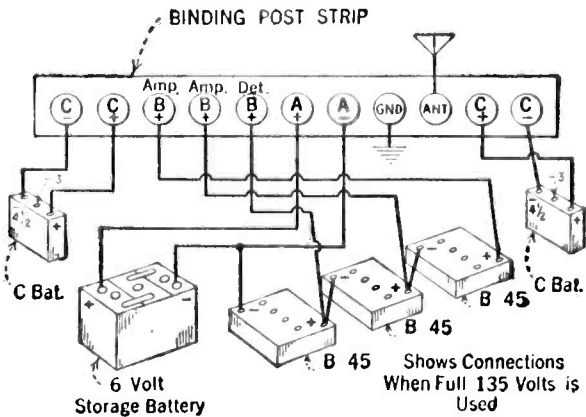

Fig. 9. The jumper connection. When it is desired to use but 90 volts upon the amplifier tubes the connections to the B batteries must be made as shown above. The connection represented by the dotted line is removed and a jumper connection is fastened between the amplifier B plus binding posts.

Fig. 6. A Jewett Highboy loud speaker-radio cabinet in which has been combined a loud speaker, a battery cabinet and receiver housing. The sliding doors have been so arranged that any standard-sized receiver may be fitted within the housing. There is still ample room for the installation of a home-made or portable phonograph.

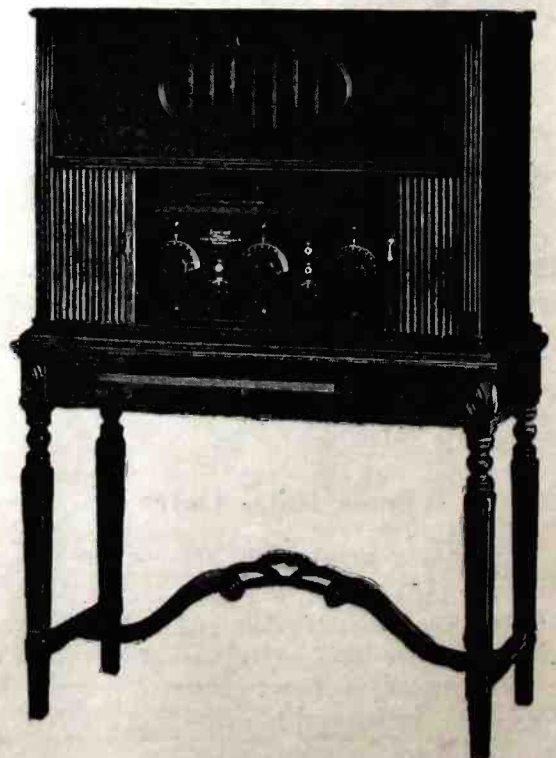

Fig. 11. Antenna substitute for an outside antenna called the Antennaphone. It is only necessary to place a metal disc under a desk telephone to obtain an antenna installation. The disc is then connected to the antenna binding post on the receiver. Wire is supplied for this purpose.

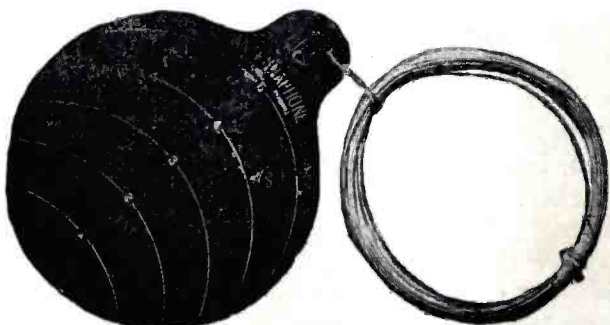



Fig. 15. A standard form of radio-phonograph. In this cabinet, manufactured by the Sonora Phonograph Company, has been built a Roberts four-tube receiver. The compartment underneath the receiver contains all the necessary batteries for its operation.



Fig. 16. The rear view of the Sonora cabinet illustrating the ample space which has been provided for the installation of even larger types of storage B battery. The removable back panel is shown at the right of the main cabinet.

Fig. 17. At the right is shown how flexible wiring is used to connect the parts beneath the sub-panel. This is a receiver employing the new type of Como push-pull amplifying transformers. It will be seen from this photograph that the direct wiring has been employed. When wiring the set, the constructor is advised to follow one of the schematic diagrams given on page 23. Either rheostats or amperite filament controls may be used as shown in these circuits. A general sub-panel layout of parts is given in Fig. 14 on page 29.

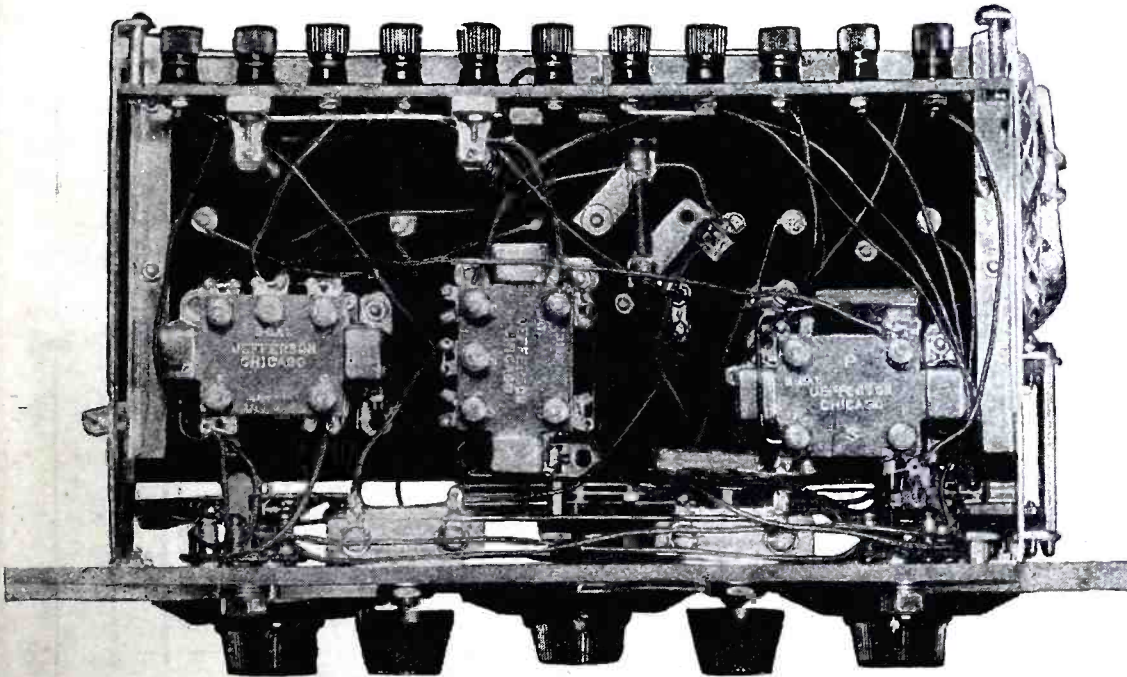
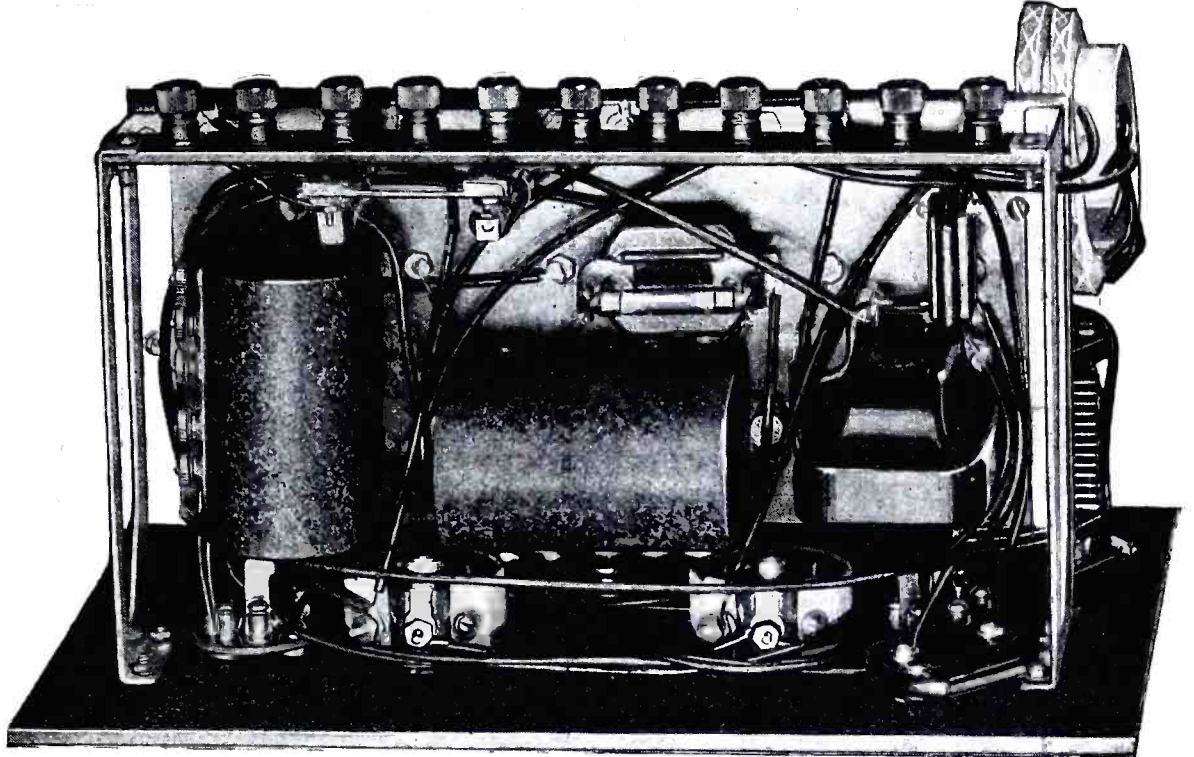

Fig. 18. Above is shown the sub-panel from the bottom illustrating the use of Jefferson push-pull transformers. The same make of audio transformer has been employed for the audio-reflex stage. Note the method of wiring for direct connections between parts.



Fig. 19. Here is illustrated a method of mounting the Radio Broadcast phonograph receiver unit in that part of a Victrola cabinet ordinarily used for the storage of phonograph records. Several shelves have been removed to make room for the unit and some shelves for records still remain. A loud speaker unit has been mounted on the tone arm, thereby making use of the Victrola sound box mounted within the cabinet.

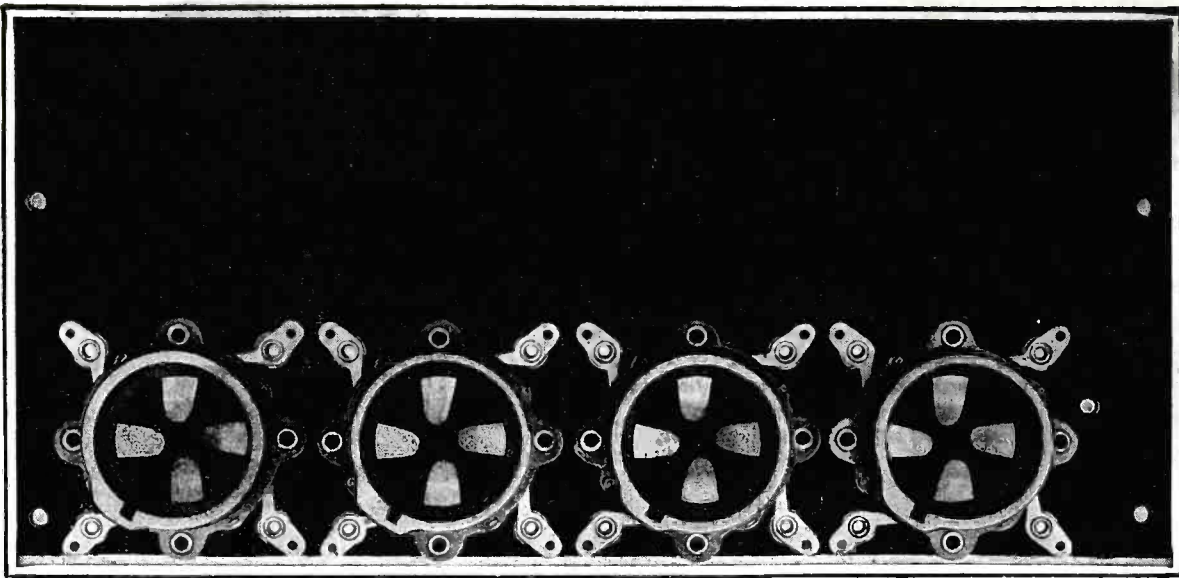

Fig. 20. The cushion sockets. The photograph above illustrates how the Benjamin spring cushion sockets may be mounted directly on the sub-panel. A manufactured unit of this type is being marketed by the Benjamin Company.

Fig. 25 shows a very fine addition to any radio and phonograph combination. The use of the phonograph horn for either radio or phonograph purposes may be had by turning the knob shown in the direct center of the illustration below. The loud speaker unit is mounted upon the cap of the Selectron unit. The tone arm fits on the right side and the speaker unit on the left.



Fig. 21. Layout of the bakelite binding post strip is given at the left. All dimensions are clearly indicated. A No. 27 drill is used for the holes.

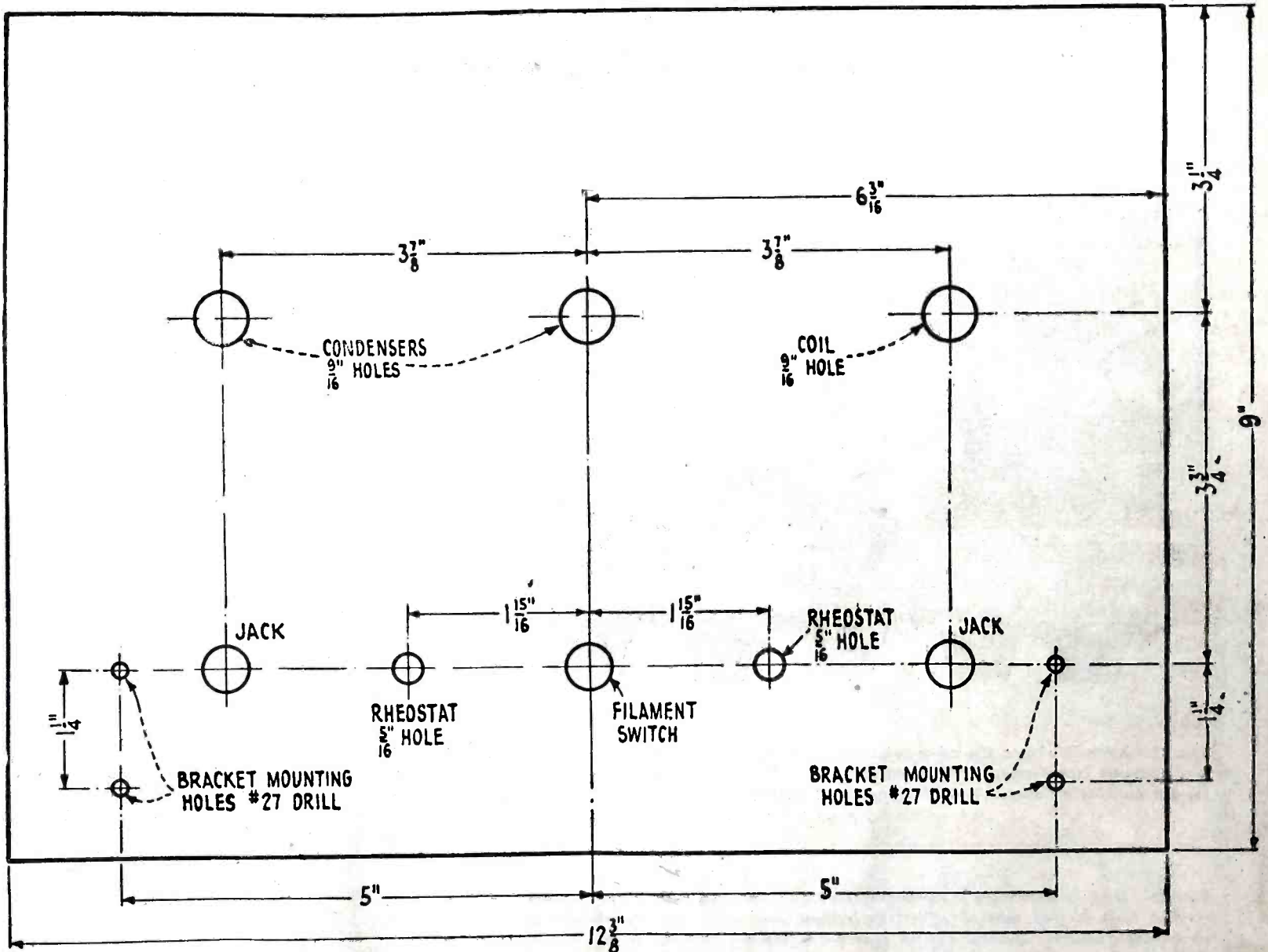
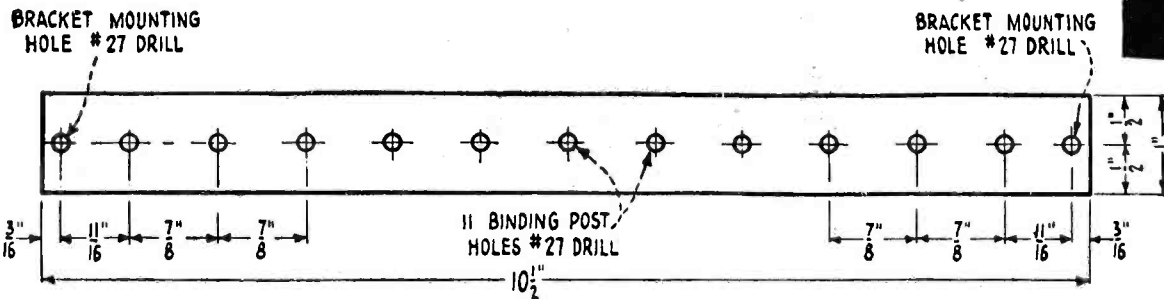

Fig. 24. The main panel layout, showing drill sizes and dimensions. No condenser mounting holes are indicated because this depends upon the type of condenser used.

There are several other antenna devices for use in connection with electric light circuits and telephone lines which make a regular antenna unnecessary. Where there is a portable receiver and a small loud speaker at hand that may be put in the car, it is becoming increasingly popular for the radio enthusiast to take his "music box" with him when visiting friends. This makes comparison of results obtained in various locations with different types of receivers possible and frequently makes an otherwise boresome visit a really pleasant one.

The antennaphone, which is illustrated in Fig. 11, is a very simple device and is in no way connected to the telephone. It is laid on a table or other convenient place and the telephone is set down on it. This makes the use of a regular antenna unnecessary.

The antenna attachments for use with the light sockets are illustrated in Fig. 12 and the various methods for employing them are illustrated in Fig. 13. It is impossible to tell in advance just which connection will be best. Each should be tried. Devices of this kind have been found of little value in some places but better than a regular antenna in others. Radio products of reliable manufacture are sold on a money-back-guarantee basis. They are well worth trying for those whose problem of antenna erection is difficult and often impossible.

Any Standard Parts May Be Used

There is little necessity for reviewing the havoc caused by the new and novel features which have attracted the buying public from time to time. Buyers have spent large sums of money in the purchase of new equipment, spuriously advertised, only to find that their money had been grossly misspent and that their purchases were neither new nor revolutionary. Quite

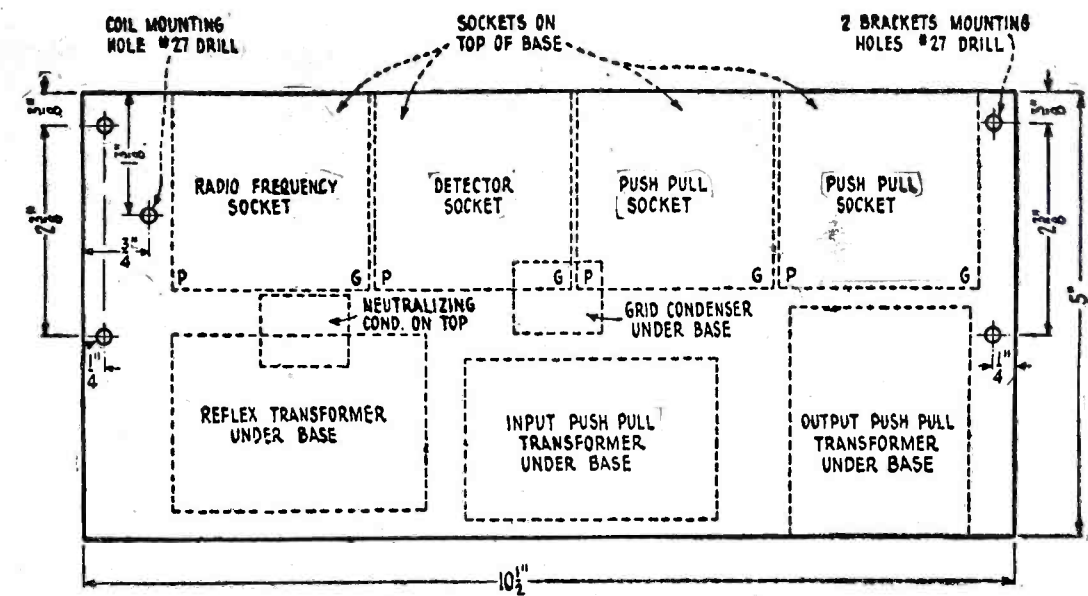

Fig. 14. The sub-panel layout showing how the parts are placed underneath the base. All parts are clearly marked and dimensions given in order that the constructor can follow this plan.

probably many individuals have grown to think that the manufacturers desired only to sell parts regardless of the satisfaction that they might otherwise give.

After all, there is but one basis upon which a parts business can exist and that is to give the home builder at least some value for the money he has expended.

For example, there once was heralded a revolutionary super-heterodyne which employed nine tubes. As a result of the publicity it received many of the parts specified for use in it were sold to jobbers and dealers in comparatively large quantities. But it did not last long; it was too unreliable for that. As an example of its "efficiency" it consumed 73 milliamperes in the plate circuit—a good super-heterodyne should not use more than 20, and many require much less. Now, 73 milliamperes means that dry cells are out of the question and even battery eliminators cannot be used. There

is then nothing left but storage B battery operation. When equally satisfactory results may be obtained—and this is stating the case conservatively—from one of the receivers employing the Roberts circuit and four tubes drawing less than 10 milliamperes, it is not difficult to understand what we are talking about when we say we are trying to show how good radio parts can be bought by the interested constructor, and real service be secured from their use.

Radio Broadcast's Phonograph Receiver may be constructed by the use of any good standard parts, but we strongly oppose the use of parts which have not become standard.

After all, it is the consumer who eventually pays the piper and we can but hope that he, in making his purchase, will choose only those products which he knows to be sound. Eventually this practice will lead to a market unencumbered by the "gyp" parasites which at times even now defile it.

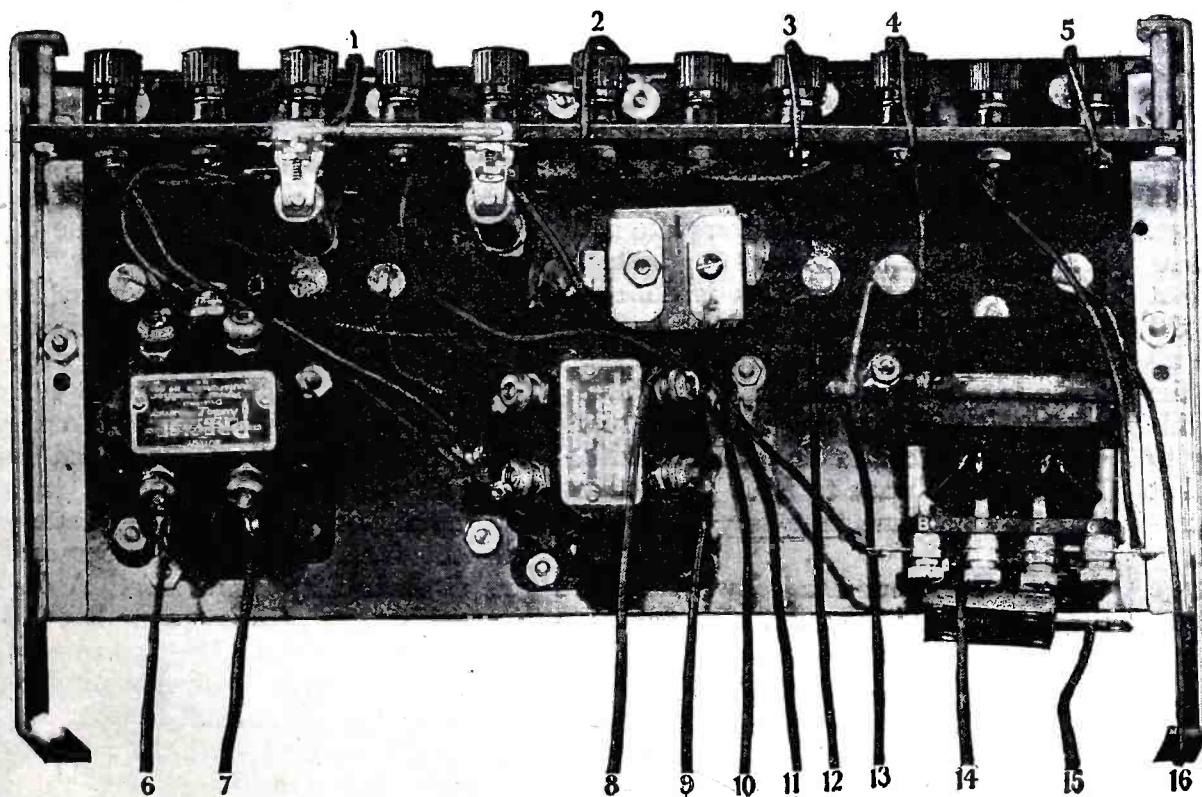

Fig. 22. Sub-base with most of the wiring completed. The circuit diagram is shown on page 23. The numbered leads are connected to the following terminals: No. 1 goes to the single circuit inside jack. No. 2 connects to the outside filament circuit and double circuit jack. No. 3 goes to the ground lead and the switch arm. No. 4 leads to the antenna coil T-1. No. 5 connects to the inside secondary T-2 and to the rotary C-1. Nos. 6 and 7 go to the output jack, single circuit. No. 8 goes to the inside jack, double circuit. No. 9 to the outside jack, double circuit. No. 10 goes to stationary plate C-2 inside T-2 secondary. No. 11 goes to the N-P coil neutralizing condenser. No. 12 connects to the tickler coil detector plate. No. 13 goes to stationary plate C-1 and outside secondary T-1. No. 14 is connected directly to the tickler. No. 15, to the center tap N-P and No. 16 to N-P coil plate.

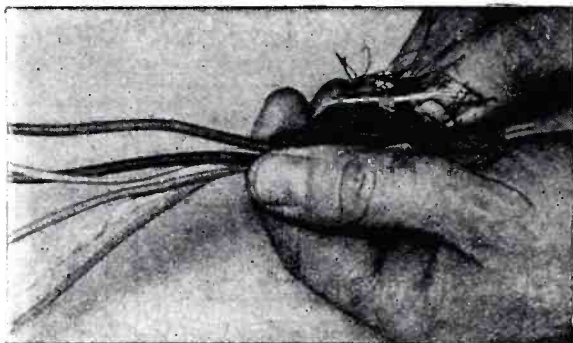

Fig. 1



Fig. 2

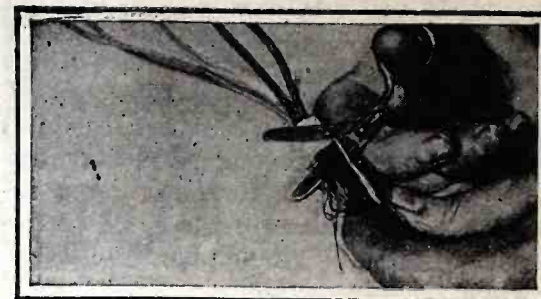
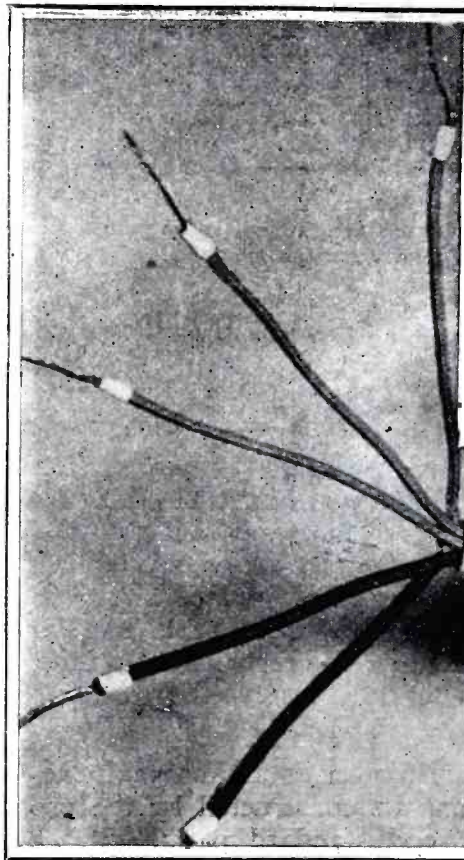

Fig. 3



A Connection Cord for Outside Leads of Radio Broadcast's Phonograph Receiver

Figs. 1 to 4 show the processes in preparing the wires for attaching at both ends. The cable, composed of two No. 16 and three No. 20 conductors is used to connect the batteries to the set. The conductors are each rubber insulated and each of a different color. First shirr the outer braid back about six or eight inches, or as far back as is necessary to make connections. Next fold the loose ends back over the cable and finish off neatly by wrapping a piece of half-inch adhesive tape around the cable as shown in Fig. 2. With scissors, trim off the frayed edges as shown in Fig. 3. In preparing the individual conductors, slice the insulation at three or four points

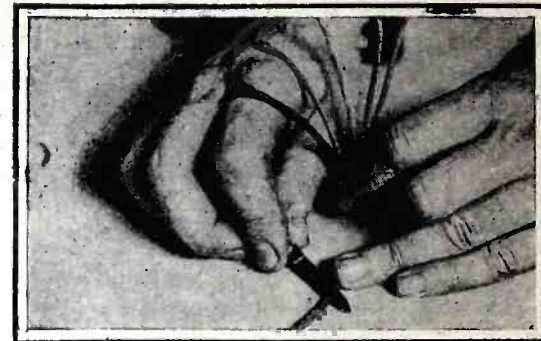

Fig. 4

around the wire about one inch back, permitting the insulation to be removed very easily. The finished ends may be wrapped with a quarter-inch strip of adhesive tape for neatness. If some shellac is available, the ends might be dipped in it and dried before the insulation is removed. The copper wire should be scraped brightly and twisted tightly to prevent the wires from spreading. The photo at the left shows one end of the completed lead. In the Radio Broadcast's Phonograph Receiver, the top lead is plus B 120 volts, the next to the left is plus B 90 volts, the third plus B 45 volts, the next plus A, and the last minus A and B. This does not provide for C battery connections, which should be made with separate leads. The C battery itself can well be included inside the set. Considerable importance attaches to proper C battery potential in this receiver.

Sulphation of Storage Battery Plates

SULPHATED plates are in the order of abuses which put storage batteries out of condition. Sulphation is directly due to permitting a partly run down battery to stand for a long period of time in this condition. Very often a battery is put away for a period of several months in a run down condition and when put back in the set is useless. It will not hold a charge. There is just one way to put the battery back in service. Drain out what remains of the electrolyte and wash the battery thoroughly so as to remove all sediment. Do not try to chip the white coating from the plates as this will only result in permanent injury to the battery. When you are sure that the battery is clean, have new electrolyte put in each cell and put the battery on a heavy charge. The heavy charge will dissolve the white crystalline substance which encrusts the plate. When the last of the sulphate has been dissolved the battery should be slowly but thoroughly discharged and then recharged. The battery will then be in

condition to efficiently operate your set.

Sulphation is also caused by improperly replenishing the battery with ordinary water that contains natural salts. The battery should always be refilled with distilled water if it is to be kept in prime condition. Never add any acid. The water should be kept at a constant level of about one-quarter of an inch above the plate and it should be added after the battery has been recharged. This is done to keep the level down during the recharging process when the battery is given to a more or less violent bubbling so that it will not slop over and ruin whatever it comes in contact with. Right here I want to issue a warning that may at some time save you your eyesight.

Never get your head down close to the vent hole of the cell of a battery during the process of recharging in an attempt to see what is going on inside the battery or to find out what the water level is. Very often during the period of bubbling the acid electrolyte

will pop several inches out of the hole. Another and more important warning is never go near the vent hole of a battery with a lighted match, as the hydrogen gas given off during the recharging process is highly explosive and likely to result in an accident. If you must look in the battery do it with the aid of an electric torch and keep your face at least a foot from the top of the battery.

When putting the battery away for any period of time either fully charge it and if possible give it a little overcharge, particularly if the battery is to be stored in the cold weather. In this way sulphation will be avoided and the possibility of freezing reduced to a minimum. A fully charged battery will not freeze until the temperature gets down to fifty below zero. A discharged battery will freeze at about 10 degrees above zero. The freezing of a battery results in broken separators and buckled plates, as well as split cells, reducing it to junk.—*N. Y. Evening World.*

The Batteryless Receiver

A Compact Combination of Reflex Receiver with an "A" and "B" Current Supply Set

THE widespread use of alternating current rectifying devices to eliminate the "B" battery from the radio receiver has attracted the attention of the radio public, especially those to whom the cost of battery maintenance is a major item. Most of these current tap devices supply the plate voltage for the receiver, but no provision is made for lighting the filaments of the receiving tubes from A.C., for the reason that the circuit of the receiver must be changed to make such operation practicable. One manufacturer developed

nomical to construct and operate, and can be made up in its entirety from standard radio and house wiring supplies. It is amply protected against short circuits to the house lighting circuit, is not dangerous to operate, and fully answers the needs of those who desire a selective receiver which will operate a loud speaker and yet employ no batteries. It is ideal for congested city districts where the numerous high-powered broadcast stations make distant reception difficult as a rule, and since it does not radiate energy into the

broadcast centers to build the set exactly as shown.

With the best apparatus available in the open market, it is not possible to entirely cut out the alternating current hum when lighting the filaments of a multi-tube receiver. This hum is not objectionable when using a loud speaker and is hardly audible when a station is being received, but it is strong enough with the headphones to prevent reception of weak signals. So for those whose radio health depends upon getting the most possible distance with a

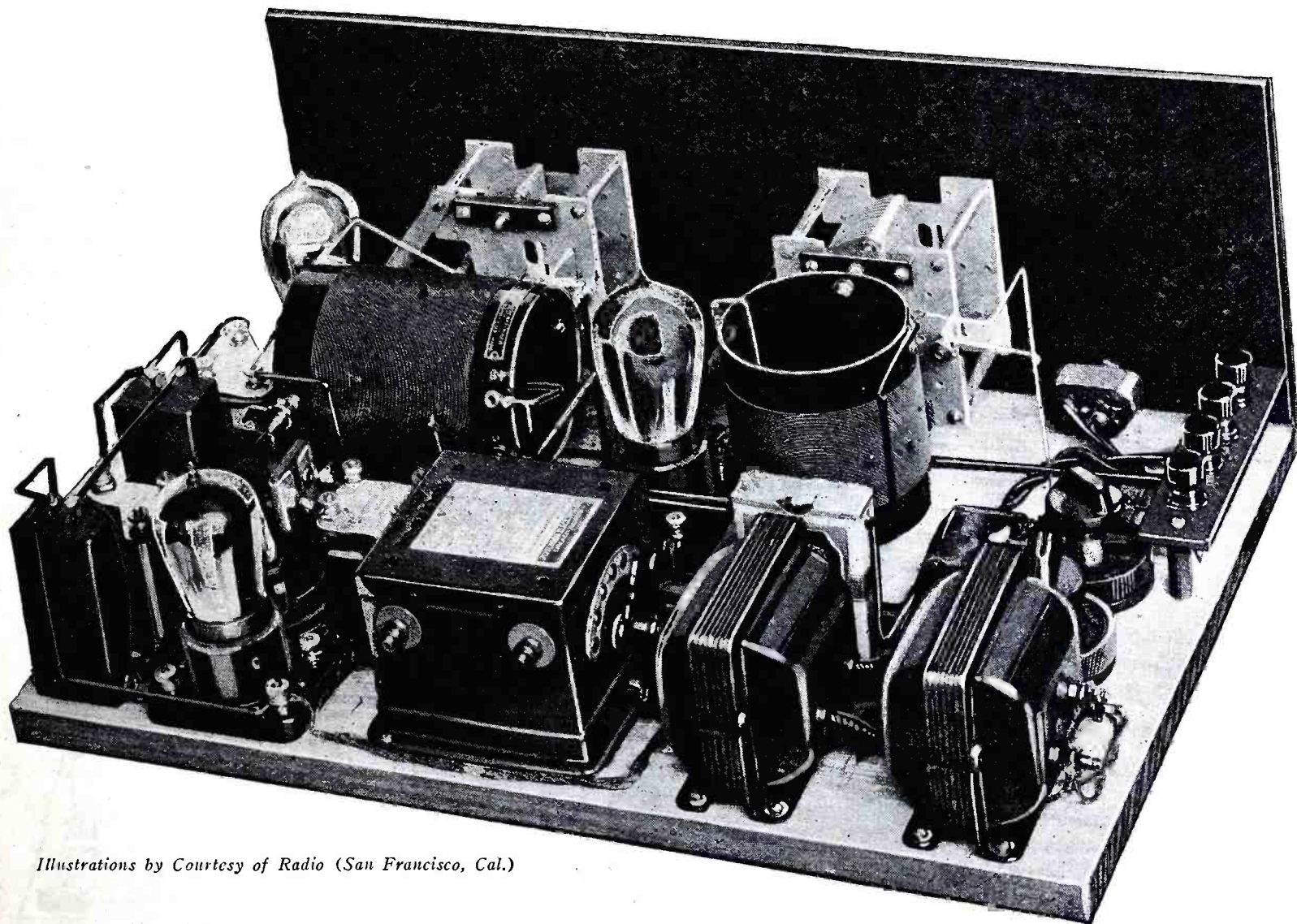

Illustrations by Courtesy of Radio (San Francisco, Cal.)

Rear view of the batteryless receiver showing the arrangement of parts on the panel and baseboard.

such a device two years ago, to accompany a particular type of power amplifier, but it did not come into general use since it was adapted for one special application and could not easily be attached to other sets.

The receiver herein described by G. M. Best recently appeared in *Radio Magazine*, San Francisco, Cal. It operates entirely from A.C. mains, is eco-

nomical to construct and operate, and can be made up in its entirety from standard radio and house wiring supplies. Mr. Best describes the set as follows:

Before giving the construction details of the set, it is well to state that under ordinary conditions, with a 50-ft. antenna 25 to 50 ft. above the ground, this set has a loud speaker range of not over 100 miles at night. Hence it would not be advisable for anyone living at a considerable distance from the

given amount of apparatus, we do not recommend this arrangement.

The receiver, as illustrated, consists of two vacuum tubes with associated apparatus to provide one stage of radio frequency amplification, crystal detector, and two stages of audio frequency amplification, the radio stage being reflexed to provide the first audio stage. The current supply system is mounted on the same baseboard, to the rear of

the receiving apparatus, and consists of three transformers, a rectifier tube and a filter.

The list of parts given will enable

the slider of the 200-ohm potentiometer.

The first vacuum tube amplifies the high frequency currents and delivers

former, at a point 12 turns from the low potential end, and the grid of the first vacuum tube. This condenser provides neutralization of the elements of the tube and once adjusted does not need further attention.

It is not absolutely necessary to use the receiving circuit described above. Almost any good arrangement of one stage radio frequency amplification, crystal detector and two audio stages will do, as long as the filament circuit is wired according to the approved method as shown in the circuit diagrams.

In the power end of the circuit, 110 volts A.C. is brought in to the primaries of two bell ringing transformers, one wire going through the main switch to provide control over the set. These two transformers step the 110 volts down to 8 volts, one transformer being connected directly to the filaments of the two vacuum tubes through a 6-ohm rheostat, and the other transformer providing voltage to light the filament of the rectifier tube. A UV-201-A or C-301-A tube with the grid and plate connected together is used as the rectifier or a Western Electric 217-A rectifier tube will do as well. A rheostat of 20 ohms is provided in the filament circuit of the rectifier to obtain the proper adjustment of filament voltage.

The third bell transformer is connected in the circuit in a unique manner. The secondary is used as a primary winding and is bridged across the

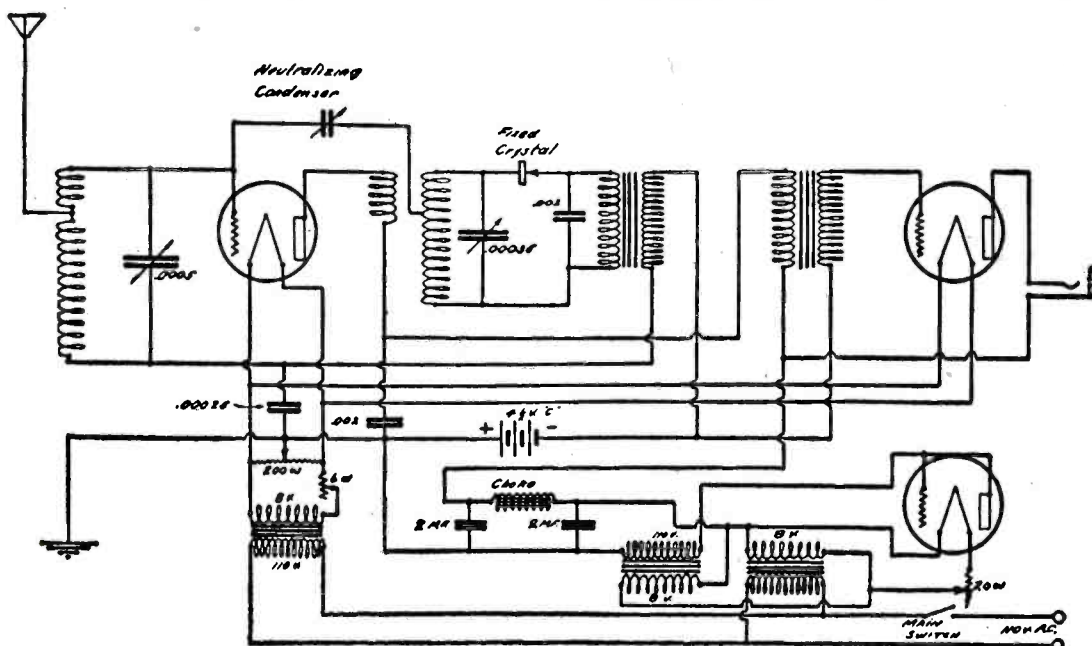

Fig. 1. The schematic wiring diagram of the batteryless set.

the selection of good material and it is particularly important that the power apparatus be of good make and designed to carry the load. For the filter choke, the secondary winding of an audio frequency transformer was used, the primary winding having been burned out. This is a good way to make use of an otherwise useless piece of equipment and saves the construction of a special choke coil, or the use of a new audio transformer. The 2-mfd. paper condensers should be capable of withstanding a voltage of 250 D.C. even though the voltage delivered to the receiving tubes is only 90 D.C. at the most. The three bell ringing transformers should each have a rated power output of at least 10 watts in order to carry the load without heating. The main power switch mounted on the front of the panel must be capable of handling 110 volts. Ordinary cheap jack switches will not do and may be the cause of severe shocks if defective. The Cutler-Hammer switch for filament circuits is rated at 3 amperes, 110 volts, and is a safe one to use in the circuit. The radio frequency transformers are National Browning-Drake coils, which were selected because of their efficiency. The tickler coil mounted inside the second transformer was removed, since it cannot be used in this circuit. For those who wish to construct their own coils, data will be given later in this article.

The schematic circuit diagram, Fig. 1, shows the method of connecting each part in the best manner and is useful in discussing the theory of the circuit. The antenna circuit consists of a single coil, tapped at one point to permit change of the antenna connection. This coil is tuned by a 23 plate condenser having a maximum capacity of .0005 mfd. A .00025 mfd. mica condenser permits the high frequency in the antenna system to reach the ground via

them to the crystal detector through the radio frequency transformer. The transformer is tuned by an 11 plate condenser of .00035 mfd. capacity, this control and the condenser in the antenna circuit being the two tuning controls of the receiver. The crystal detector, which is of the fixed type to avoid extra adjustments, delivers its output to the first audio frequency transformer, the secondary of which is connected back to the grid of the first vacuum tube. This tube amplifies the

audio frequency output of the transformer and delivers it to the second vacuum tube. This tube gives further amplification and delivers the audio frequency output to the loud speaker.

A small balancing condenser of .00005 mfd. capacity, of the midget type, is connected between the secondary of the radio frequency trans-

secondary of the transformer supplying the rectifier filament. The primary of this transformer is then used as a 110-volt secondary and supplies the high voltage for the rectifier. The purpose of this arrangement is to insulate the rectifier tube from the 110-volt line, for if the tube was directly connected to the line a dangerous condition would

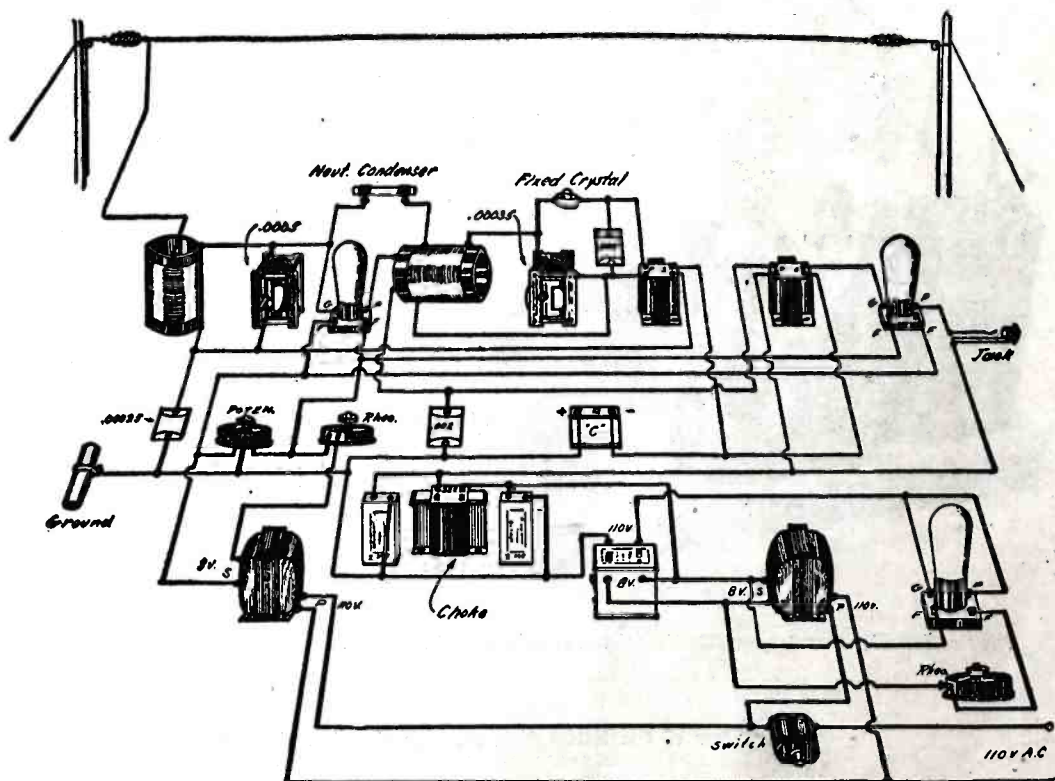

Fig. 2. A pictorial wiring diagram showing how the various components are connected.

result in that an accidental ground on one side of the line connections would blow the house fuses and might cause a fire in the set. With the insulating transformer in the circuit this danger is obviated.

In the set illustrated a toy transformer having a variable secondary was used, thus providing voltage regulation for the rectifier circuit. The secondary is variable in 1½-volt steps so that the turns ratio of the transformer may be varied to provide a voltage lower than 110 to the rectifier tube if desired. The rectifier tube delivers approximately 110 volts of pulsating D.C. to the filter system, the windings of which reduce the voltage to 90, the correct amount for the receiving circuit.

Electrical balance is obtained in the filament circuit of the receiving set by means of the 200-ohm potentiometer, the grid return and negative plate connections being tied to the slider of the potentiometer and the outside terminals of the potentiometer being bridged to the filament circuit.

As this rectifier system rectifies only half the alternating current wave, the question naturally arises as to whether another rectifier tube should be used in

sists of an audio frequency stage, the plate potential for which is supplied by a rectifier tube operating on half the alternating current wave, and the filament current from a 4.4-volt secondary winding of the power transformer.

The general layout of the panel is

other extra supports if the screws are driven in tightly. On the panel are mounted the air condensers with associated coils, the main line switch balancing condenser and output jack.

The assembly of the apparatus on the baseboard is shown in the pictorial

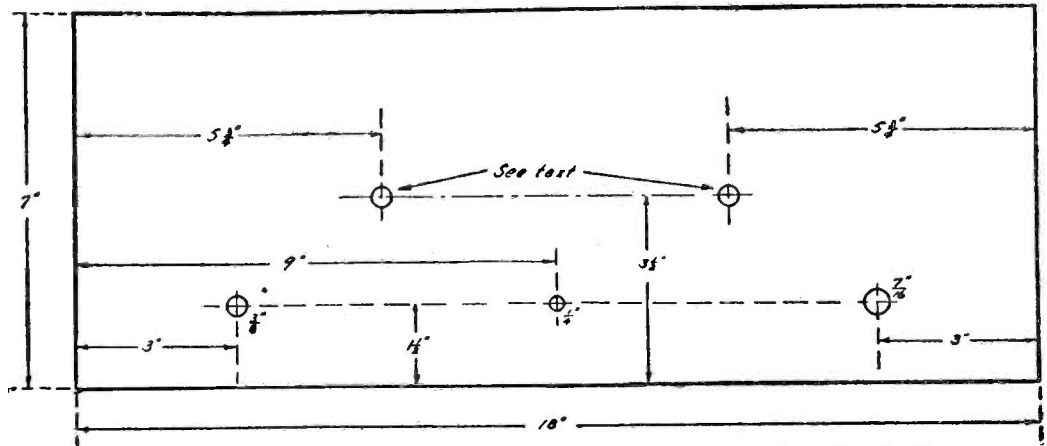
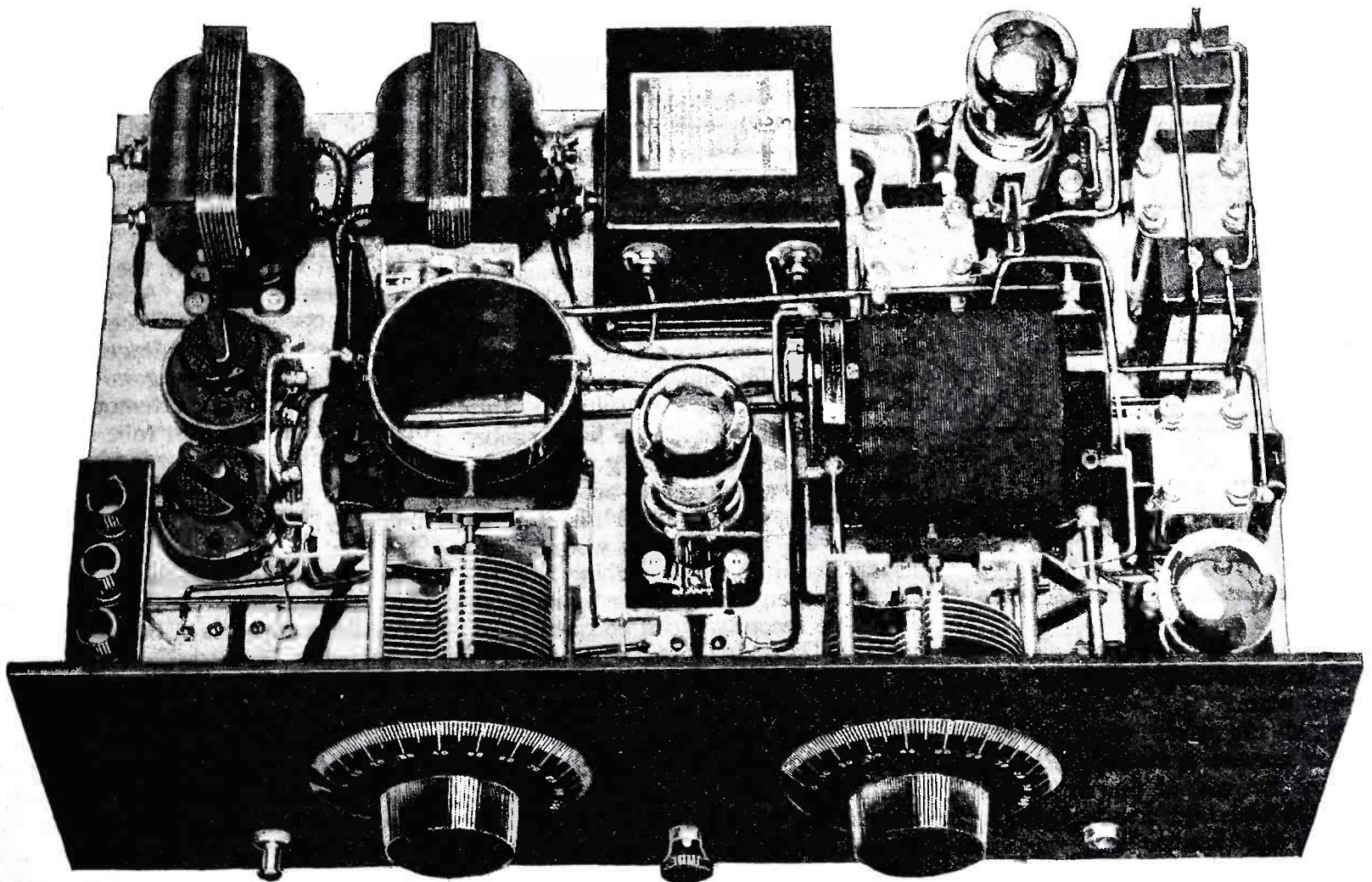

Fig. 3. Panel layout for the batteryless receiver giving dimensions for drilling.

shown in Fig. 3, the panel being 7x18x 3/16 in. It will be noted that only the shaft hole for each air condenser is shown in the layout, the reason for this being that air condensers other than those shown in the illustration may be used in the circuit, and as most condensers are now accompanied by a drill-

wiring diagram, Fig. 2, the power apparatus being mounted at the rear and the receiving set equipment to the front of the board. A set of four binding posts mounted on a small bakelite strip is placed on the baseboard directly back of the line switch, to provide terminals for the 110 volts A.C., antenna and



A front view of the set looking down from the top. Note the neatness in the layout of parts which should be carefully duplicated by the constructor.

order to have full wave rectification. Such a procedure is not necessary, as the filter will deliver a D.C. voltage quiet enough for all purposes. This system of half wave rectification is rapidly coming into general use, as is shown by the appearance on the market of the new Western Electric 25-A power amplifier. This amplifier con-

ing template, the holes for the mounting screws can readily be marked on the panel.

The baseboard should be of good grade non-warping wood and is 12x18 x 3/4 in. The panel is fastened to the baseboard with 3/4-in. wood screws placed along the bottom edge of the panel, and does not need brackets or

ground connections. The details of this binding post mounting are shown in Fig. 4. The fixed crystal detector is mounted on the baseboard directly under the tuned radio transformer, but can be reached easily with a soldering iron if it is placed as shown in the pictorial diagram.

In wiring the set, it is well to do as

much as possible of the baseboard wiring, particularly the filter and rectifier tube circuits, before mounting the panel to the baseboard. The two bell transformers are each provided with a pair of heavily insulated wires as primary terminals, and these two pairs of wires should be connected in parallel with a piece of twisted lamp cord for connection to the binding post strip. This set of connections should be soldered and thoroughly taped to make it safe, and if the constructor feels that he is not capable of doing a first-class job, he should take the baseboard to a good electric shop and have the primary transformer connections made by an experienced electrician. After the primary connections are finished, twisted pair wires should be run from the two secondary windings to their respective sockets. Any good twisted pair wire of at least 20 B. & S. gauge will do, twisted lamp cord being especially recommended for the work. For the high voltage connections to the rectifier tube and filter circuit, tinned copper wire of No. 16 B. & S. gauge was used, with a good grade of spaghetti for insulation.

The builder of current supply sets is cautioned against using audio frequency transformers as power transformers in place of correctly designed power apparatus. The use of the former will result in many exposed terminals in the set, all of which have a potential of at least 110 volts, and unless these termi-

presence of short circuits, if any. A short circuit in the power apparatus would be accompanied by a loud humming noise in the transformers, and they would soon become too hot to touch. If such a condition occurs the wiring of the rectifier and receiver tube filaments should be thoroughly checked,

of the tubes in their sockets. It is best to first place the rectifier tube in its socket and turn on the current. Adjust the filament to a normal brilliancy and short circuit the terminals of the 2-mfd. condenser on the receiving set side of the filter coil with a piece of insulated wire. If a snappy spark is seen, the rectifier is working properly and need not be further adjusted.

Place the receiving tubes in their sockets and adjust the filament voltage to the lowest point consistent with good quality and volume in the loud speaker. With the potentiometer slider set at either end of its resistance unit a loud humming noise will be heard in the loud speaker, and as the slider is brought nearer to the center of the resistance, the noise will decrease until a point is found on the resistance where the noise is at a minimum.

The rectifier tube filament rheostat should now be varied until an adjustment is found where cutting more resistance into the rheostat will affect the volume in the loud speaker. This means that the rectifier tube filament is operating at the lowest possible voltage to give the required high voltage output from the filter and will result in long tube life.

The adjustment of the neutralizing condenser is the next step in completing the receiver. Tune in a local station until it is being received as loudly as possible. Remove the first vacuum tube from its sockets and place a piece of paper over one of the filament springs of the socket. Replace the tube, and undoubtedly the station will still be heard faintly. Adjust the neutralizing condenser until the station signals either disappear altogether or are faintest, and do not again adjust the condenser thereafter. Remove the piece of paper from the first tube socket and the set will now be properly adjusted so that it cannot radiate energy into the antenna, should the first vacuum tube oscillate.

In regard to the selection of audio frequency transformers, a choice must be made at the time of building the set. If low ratio, high quality transformers are used, they are so efficient at the very low frequencies, from 60 to 200 cycles, that they will pass considerable noise due to the use of alternating current in lighting the filament of the first vacuum tube and this noise may be objectionable to the owner of the set, with certain types of loud speakers. If high ratio transformers having turns ratio of $4\frac{1}{2}$ to 1 or more are used, they will not pass the low frequency noise and the set will be quiet in operation, but unfortunately will not give as good musical quality in the loud speaker due to the cutting off of most of the very low frequencies. So the selection of the transformers is left to you. If you want no noise in the loud speaker due

(Continued on page 36)

LIST OF PARTS

- 3 10-watt bell trans.
- 3 Vacuum tube sockets.
- 1 Set Browning-Drake Coils—National or home-made—see text.
- 2 Audio freq. trans.—see text.
- 1 Variable cond.—.00035 mfd.—see text.
- 1 Variable cond.—.0005 mfd.—see text.
- 1 Fixed crystal detector.
- 1 20-ohm rheostat.
- 1 6-ohm rheostat.
- 1 200-ohm potentiometer.
- 1 Single circuit jack.
- 1 Balancing cond. .00005 mfd.
- 1 Cutler-Hammer switch.
- 2 Mica cond. .002 mfd.
- 1 Mica cond. .00025 mfd.
- 1 Filter coil—see text.
- 2 2-mfd. paper condensers.
- 1 Bakelite panel, 7x18 in.
- 4 Rubber insulated binding posts.
- 1 Baseboard, 12x18x $\frac{1}{2}$ in.
- 3 A type vacuum tubes.

especially with regard to the socket springs, which occasionally become shorted together.

Those desiring to construct their own radio frequency coils will find the following dimensions satisfactory for the present radiocast wave band with the average antenna system:

The antenna coil consists of 50 turns of No. 20 D.S.C. wire wound on a 3-in. tube. The coil is tapped at the 25th turn, in order that those having a very long antenna may tune to the radiocast wave band. The radio frequency transformer can be made as follows. In a piece of 3-in. bakelite or hard rubber tubing $\frac{1}{2}$ -in. long, cut a groove $\frac{3}{8}$ -in. wide and deep enough to accommodate the primary winding, which is 26 turns of No. 26 D.S.C. wire wound haphazard fashion. If the tubing is $\frac{1}{16}$ -in. thick the groove can be made $\frac{1}{32}$ -in. The secondary coil consists of 78 turns of No. 20 D.S.C. wire, one end of which is wound directly over the primary winding. A tap is taken out at the 18th turn to permit connection of the neutralizing condenser.

More detailed data on the construction of the above coils is given in an article by A. P. Peck on page 18 in this issue of *Radio Review*.

In selecting a fixed crystal, it is a good idea to first test it by placing it in series with a pair of headphones across the antenna tuned coil, thus providing a single circuit crystal set. If the crystal gives loud signals from the local stations and does not get out of adjustment when the apparatus is jarred, it will be O. K. to use in the A.C. layout.

After the wiring is thoroughly checked the set is ready for insertion

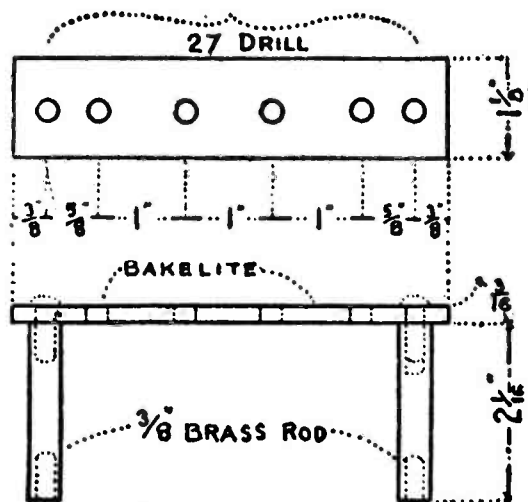

Fig. 4. Mounting strip for binding posts.

nals are thoroughly taped and protected, dangerous shocks and hazard of fire may occur.

After all the power wiring is done, the panel may be fastened to the baseboard and the rest of the wiring completed. For the high frequency end of the circuit bare bus-bar wire was used, spaghetti-insulated only where there was danger of two wires touching each other at some exposed point. The employment of spaghetti for conditions other than above is a useless waste of money and does not add to the efficiency of the set.

After completing the wiring, it is advisable to connect it to the 110-volt lighting supply, with the tubes removed from the sockets, and turn on the current for a few minutes to detect the

A Neatly Designed Super-Heterodyne

Care in the Design of this Set is
Not Overlooked

SINCE the first issue of *Radio Review* was published, we have presented various types of super-heterodyne, all of which have proven very efficient. However, we do not assume the claim of any as being the "last word in radio receivers." What we like about this one is that it doesn't make any unreasonable claims for its distance-getting properties, and it does lay stress on neatness and compactness; but, best of all, the self-explanatory photos given herewith, make this set easy to build by following the same layout with standard parts.

The description of the compact super-heterodyne shown in the accompanying photos appeared in a recent issue of *Radio News*, New York, and is given in the following.

There is a widespread idea that a standard super-heterodyne, because it has eight tubes instead of five, is about three-fifths again as good a set as a standard five-tube receiver. Without attempting to say whether this is or is not a fair estimate of the general superiority of the super, it should be pointed out that there are quite important differences of a fundamental nature between the usual five- and eight-tube receivers which make it unfair to both types to judge by the number of tubes alone.

The super-heterodyne has no need of more than two main tuning controls, and at least one of these can be made

Quality vs. Selectivity

A set which will separate stations a fraction of a meter apart may be an interesting plaything, but a set which will put into the loud speaker actual musical tones from distant stations 2 or 3 meters apart is a much more useful piece of property. The set here de-

little, indeed, to be desired in a musical way.

The set is built on a panel 7x18 inches and a sub-panel 7x17 inches. It can thus be slipped into any standard 18-inch cabinet, and is also splendidly adapted for use as a portable set.

No attempt will be made here to outline the general theory of super-hetero-

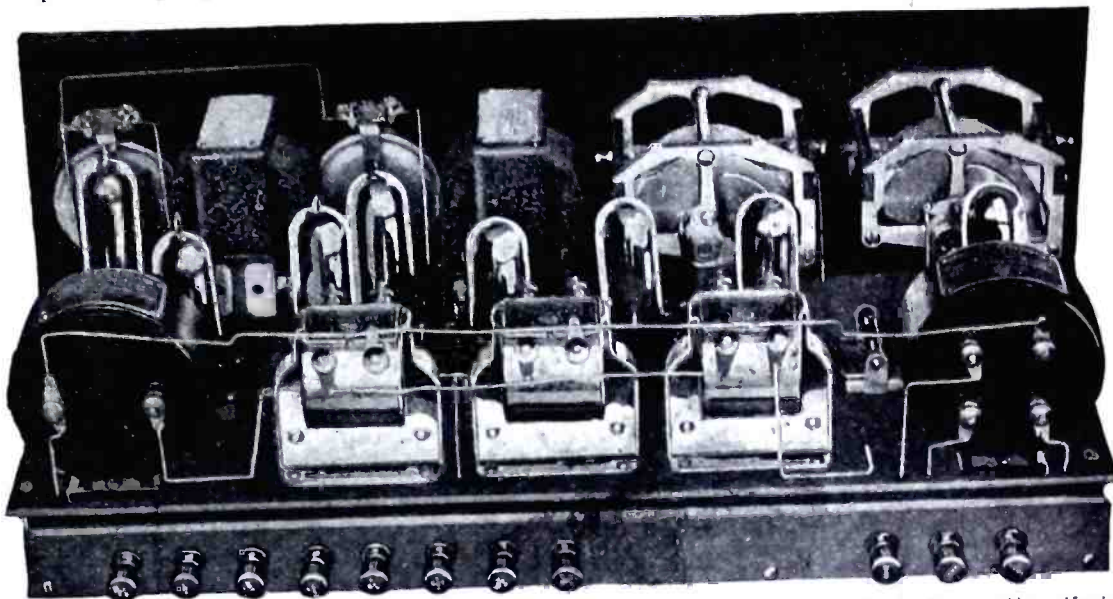

Illustrations by Courtesy of *Radio News* (New York)
Rear view of the super-heterodyne receiver showing how, by this arrangement of apparatus, it is possible to build the set on a 7 x 18-inch panel.

scribed has sufficient selectivity, when operated at Chicago, to tune through the 16 local stations and pick up Los Angeles and other Pacific Coast stations whenever their signals are distinguishable from static in Chicago. With this degree of selectivity, there is

dyne operation. The circuit of the present set is practically standard. Some will object that it is not possible to get the last degree of amplifying power out of a super without potentiometers, numerous rheostats, adjustments of oscillator coupling and other complications. These claims may be admitted at once: it is generally found that when all such aids are utilized to best advantage even a seven-tube super will receive any signal down to the noise level. In the present design it has been considered better to get an added margin of sensitiveness by using the additional tube (which introduces no extra operations in using the set) rather than to adopt these extra sub-controls and assume that they will be used to their full effectiveness. Much the same applies to the possibilities of saving in the number of tubes through reflexing and combining of oscillator and first detector. These are complications which have been properly avoided.

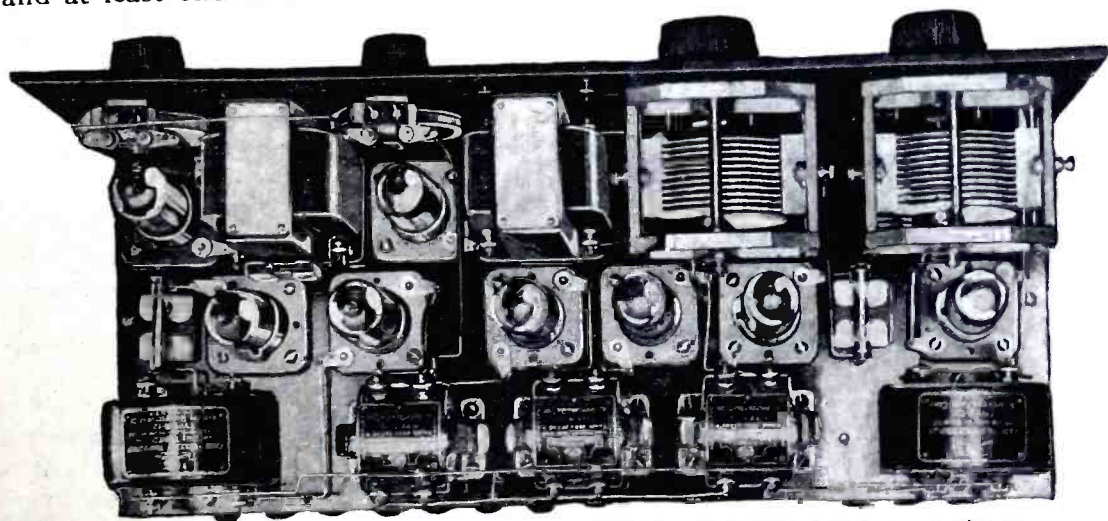

Top view of the super-heterodyne receiver which is remarkable for its compactness.

practically as sharp as the builder desires to make it. The degree of selectivity secured in a properly designed super-heterodyne is a compromise between the desirability of extremely sharp tuning and the necessity of preserving tone quality.

preserved a quality of tone which differentiates the set at once from the "tuning-stunt" super-heterodyne. With the addition of laboratory-grade audio transformers to carry this same completeness of overtones into the loud speaker, we have a set which leaves

Assembling the Set

The sub-panel construction, employing the binding posts of the tube socket very largely to carry connections from one side of the sub-panel to the other, enables the set to have a clean-cut ap-

pearance from above, which is almost never attained in supers.

Before any of the tube sockets are mounted they should be carefully prepared by reversing the necessary screws, as shown, in each socket; two or three are reversed in each case, and these serve to attach the sockets to the sub-panel, as well as to carry electrical connections through the sub-panel.

soldering, the nut between socket base and sub-panel may come loose, and it is inaccessible to hold while tightening the screw. In this case, simply loosen the bottom nut and press it (or the screw) tightly upward; this pressure will hold the inaccessible nut still for tightening.

When the set is completed, it is best to try connecting the "A" battery to

with this super that slightly better results are obtained by tapping a little off center. The feed-back provided by this tapped loop is controlled through the .000045 variable condenser. Increasing this capacity up toward the point of oscillation will be found to sharpen the tuning and probably increase the volume of signals.

The small variable condenser is for

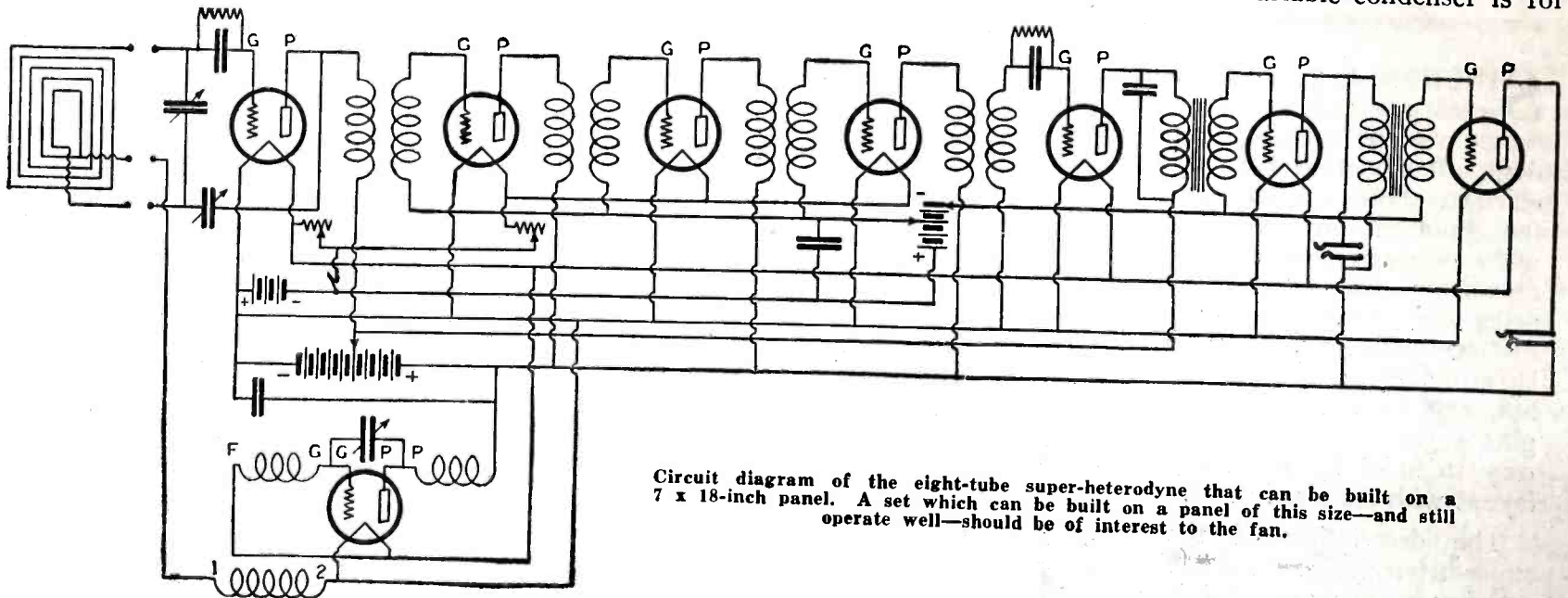

Circuit diagram of the eight-tube super-heterodyne that can be built on a 7 x 18-inch panel. A set which can be built on a panel of this size—and still operate well—should be of interest to the fan.

All of the reversed screws must be finally tightened, with nuts holding the contact springs, before being mounted on the sub-panel; then, before the nut is attached on the bottom of the sub-panel the lug should be attached there also, and turned in the proper direction. Lugs are to be bent up.

First, the set can be wired quickly and neatly without using "spaghetti" tubing, except in two or three places where specified.

Second, wires need never run over the ends of screws so as to prevent access with a socket wrench.

If wiring directions are followed exactly, it will be found possible to remove and disconnect any instrument in the entire set without disturbing any other—a feature which is too frequently lost sight of in the building of elaborate radio sets.

A difficulty which may be encountered with these inverted socket screws is that in giving the lower nut at the lower end a final tightening after

the "B" battery terminals of the set to make sure that the tubes do not light. If they do, it of course indicates the presence of a wiring error, which would blow the tubes if the "B" battery was connected. If this test shows

controlling the loop regeneration, and in operation it is simply left "out" entirely until the set is working satisfactorily on reasonably strong signals. Throwing this small condenser part way in then introduces a feed-back

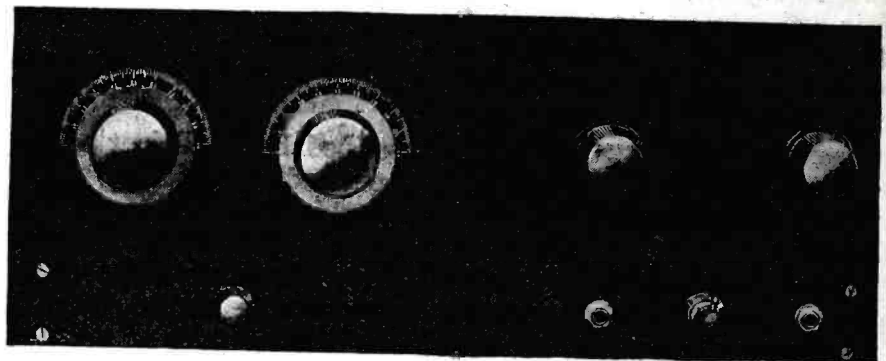

Panel view showing the small condenser knob below the two large dials.

no trouble, the batteries may be connected for regular operation.

The three "loop" binding posts are to be connected to any standard tapped loop, the center post going to the tap. Loops are commonly tapped at the center of the winding. It may be found

which sharpens the tuning and materially increases the sensitiveness of the set for use in long-distance reception. It should, of course, never be turned on enough to cause oscillation of the first detector tube—which is indicated, when it occurs, by a click and mushy signals.

The Batteryless Receiver

(Continued from page 34)

to the use of A.C., and can stand slightly poorer quality, use high ratio transformers. If you demand perfect quality of output and do not mind a faint A.C. hum when the music or speech is soft or feeble, use transformers having a 2:1 turns ratio.

If it is desired to have a greater range than is possible with the arrangement described, an extra radio frequency stage with its tuned transformer may be added ahead of the present set. This will require an extra dial on the panel and another neutral-

izing condenser, but will not increase the hum in the loud speaker. The same tuned transformer as used in the two-tube set may be employed for the additional stage, being mounted at right angles to the other coils in the set to prevent coupling.

The Metropolitan Local Set

Tone Quality Is Preserved with Full Volume Plus Selectivity
from Local Broadcasters

"THE 3-tube set the circuit of which is shown in Fig. 3 is a stand-by that brings in all the local stations with loud speaker volume of moderate intensity but wonderful quality. Utmost simplicity of operation consistent with satisfactory selectivity, greatest purity of tone obtainable with standard parts, and strictest economy of operation were the objects sought."

These are the claims made for The Metropolitan Local Set as recently pre-

It may be any one of a number of low-loss coils on the market. L2 and L3 constitute a home-made radio-frequency transformer. The core is a 1-in. diameter birch dowel 1 in. long. This is made into a spool by cementing two insulating washers $1\frac{1}{4}$ in. in diameter to the two ends. The primary winding L3 is wound next to the core and it consists of 20 turns of No. 36 double cotton covered wire. This winding is covered with several layers of heavy

more room will be needed than shown in the photo on the front cover.

Coil Adjustment

It will be necessary to adjust the two coils so that the two tuned circuits L1 and L2 are in resonance with the same wave at some setting of the double condenser. This is best done by putting more turns on L2 than necessary and then removing a turn at a time until a given signal is loudest. In the present

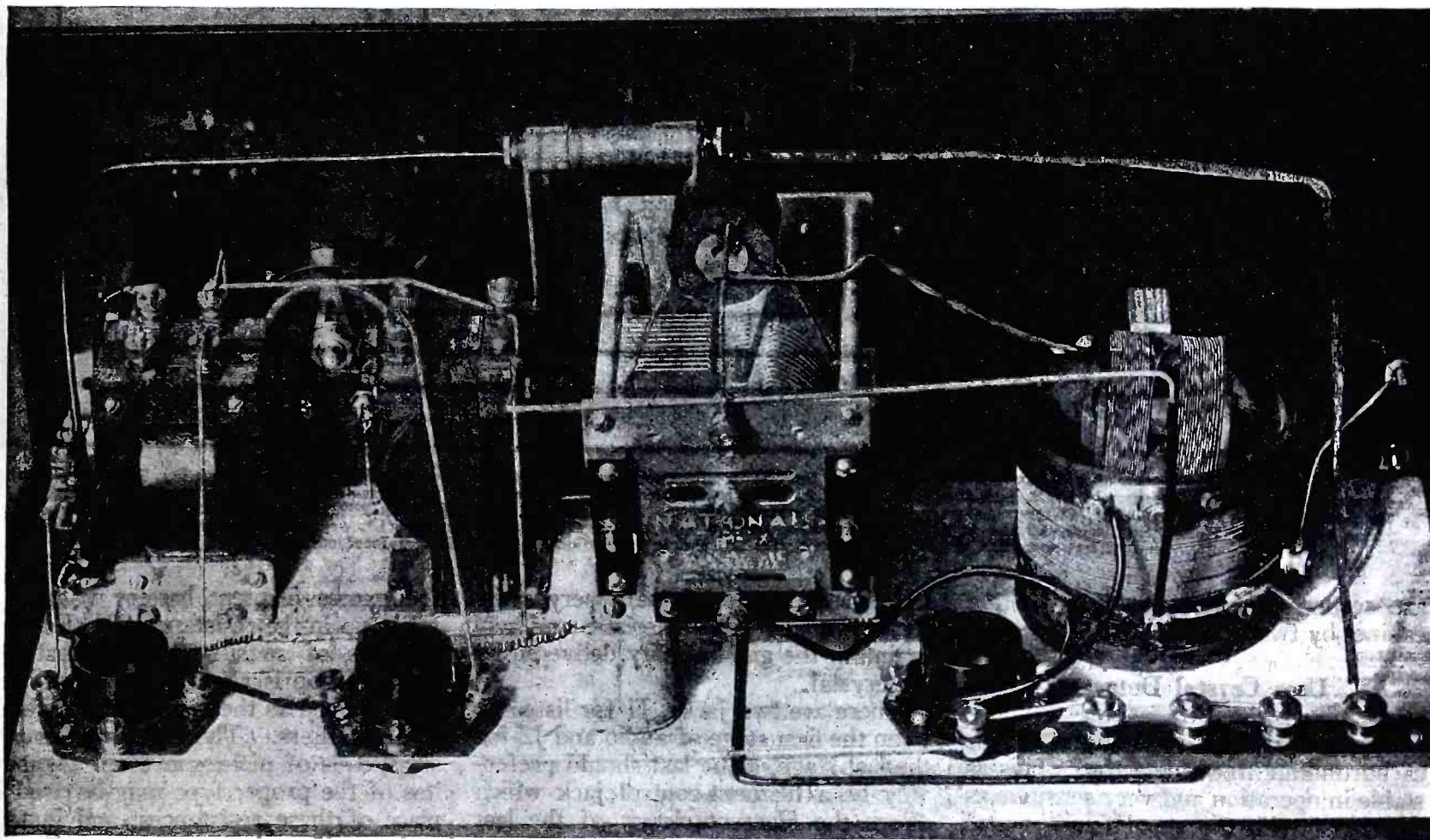

Illustrations by Courtesy of Radio World (New York)

The rear view of the Metropolitan Local Set, which employs a double condenser as two controls and affords very fine signal quality.

sented in *Radio World*, New York, by J. E. Anderson. Mr. Anderson describes the set in *Radio World* as follows:

To obtain simplicity of operation a double condenser is used for the two tuned circuits. For selectivity a low-loss tuning coil was used in the radio-frequency amplifier and this stage was made regenerative. A crystal detector and two high-grade audio-frequency transformers were selected. For economy of operation dry-cell tubes were employed.

Winding the Coils

The coils L0, L1, T are the three windings of a standard 3-circuit tuner.

wrapping paper. Then on top of this is wound the secondary L2, consisting of 93 turns of the same kind of wire. The secondary is wound in two layers since the wire used winds about $\frac{7}{32}$ turns to the inch. The two layers were separated from each other in the same manner as were the two windings. A protective layer of mending tape was put over the secondary. The terminals of the two windings were brought out to small wood screws fastened in the ends of the wooden core and these were tinned for soldering connections. The transformer L2, L3 may be wound with heavier wire, or it may even be a low-loss RF tuning unit. In that case

set the final adjustment left 93 turns on L2.

How Panel Is Arranged

The panel layout is shown in Fig. 2. At the lower left corner are the two binding posts for antenna and ground. Symmetrically placed in the right-hand corner are the two jacks. The single main control is in the center, which actuates the rotor of the double condenser. On the left of the main control is the knob controlling the tickler and on the right of it is the rheostat. Directly under the main control is the filament switch S. The panel is 7x18 in.

The set was mounted in a cabinet 7x18x10 $\frac{1}{4}$ in. A deep cabinet was se-

lected so that all the batteries could be mounted back of the baseboard. Three No. 6 dry cells and two upright 22½-volt plate batteries are used, and these

become crushed, which destroys the sensitivity.

The two audio-frequency transformers used are Federal 65 (first AF) and 65A (second AF). These were se-

control the current in all the tubes. This is used mainly to take up the excess A battery voltage when the cells are new over the "discharge" voltage. A 6- to 10-ohm rheostat is sufficient. Most of

LIST OF PARTS

- 1 Low-loss 3-circuit tuning coil (L0, L1, T).
- 1 RF tuning coil (L3, L2).
- 1 Double condenser with vernier dial, .0005 mfd. (National).
- 2 Audio-frequency transformers.
- 1 Fixed carborundum crystal (Cr).
- 1 Double-circuit jack and 1 single-circuit jack (J1, J2).
- 3 Sockets.
- 3 Ballast resistances or Amperites (R).
- 1 Rheostat, 6 to 10 ohms (Rh).
- 1 Filament switch (S).
- 6 Binding posts.
- 1 Small knob for tickler control.
- 1 Panel 7x18 in. and 1 baseboard to match.

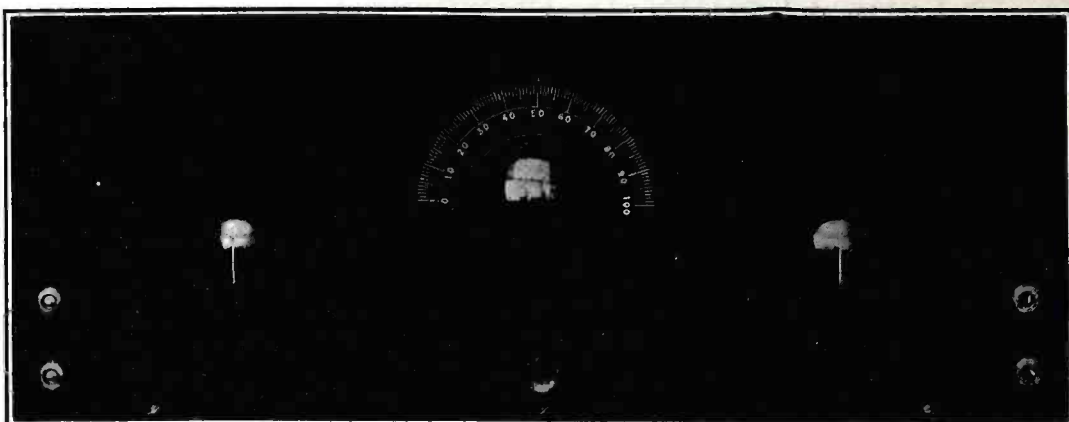

Fig. 2. The panel layout of the Metropolitan set.

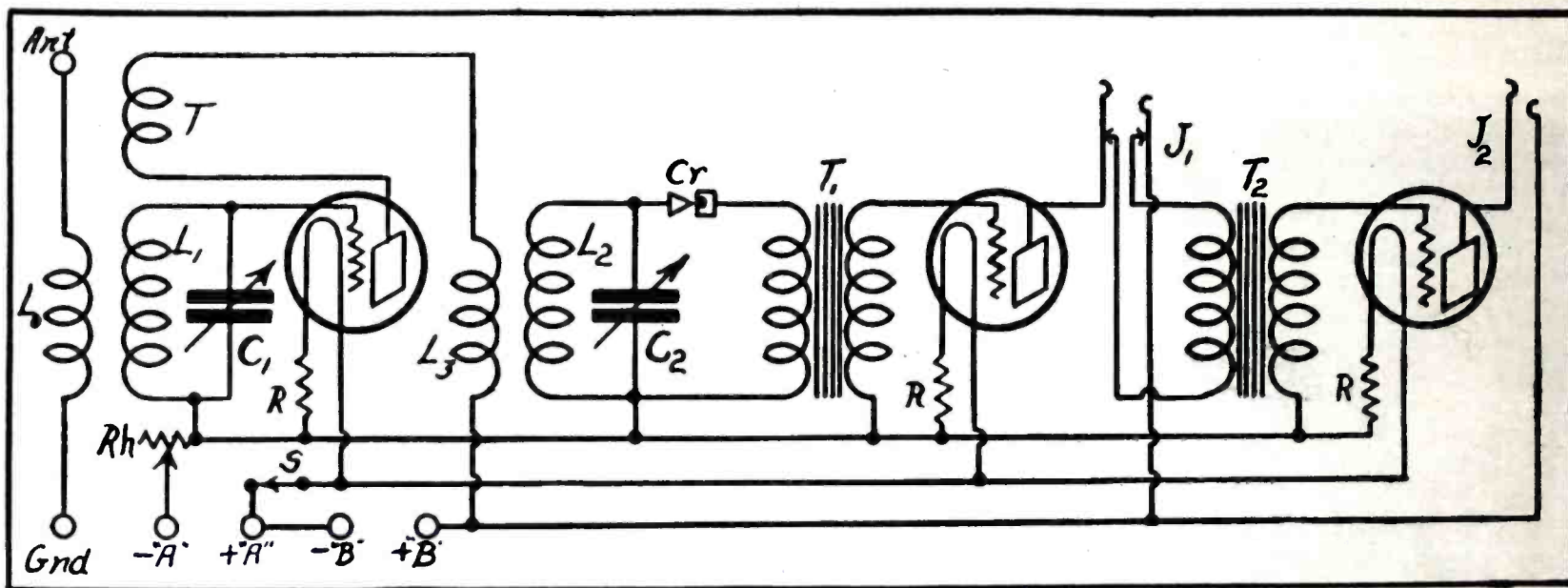

Fig. 3. The wiring diagram of a 3-tube set that is selective for use in metropolitan areas and which gives fine quality of signals. There are two controls, the double condenser, C1, C2, and the tickler T. L0, L1, T is a 3-circuit tuning coil. On a 3½ in. diameter a home-made tuner might consist of 10-turn primary (L0), 43-turn secondary (L1), both wound with No. 22 SSC wire. The tickler on 2¼ in. diameter, 2¼ in. high, wound base 28 turns of No. 26 SSC wire. L3, L2 is the tuned coupling transformer and may be wound like L0, L1, or as specified by the author. This set has some DX possibilities, but is designed primarily for quality reception of local stations.

are securely held to the back of the cabinet by two brass strips.

Uses Crystal Detector

The crystal employed is the new type carborundum fixed detector. This is stable in operation and very sensitive as compared with the usual fixed crystal detectors. However, it must be handled with reasonable care or the sensitive carborundum point, which rests against a burnished steel plate, may

be damaged because they have a very satisfactory quality characteristic and will maintain the good quality delivered by the crystal.

There are two jacks, J1 for listening in on the first stage of audio and J2 for the last stage. The last should preferably be a filament-control jack which closes the filament circuit of the last tube when the plug is inserted in it. Otherwise put a switch in the FX lead of the last tube.

A single rheostat Rh is used to con-

the excess filament battery voltage is taken up in the resistances R. Each of these is of such magnitude that the voltage drop is about .8 volt, and this drop is used as the bias on the grids of the amplifiers. These resistances are small coils of nichrome wire. Amperites of the proper type may be used in place of these resistances, and in that case the single rheostat may be dispensed with, or it may be inserted in series with the filament of the first tube only.

A Simple Browning-Drake Set

(Continued from page 18)

depends upon the correct construction of the set.

A home-made coupler for use in this set is illustrated in the photos and the details are shown at 10 and 15 in the drawing. For compactness this coil is mounted in back of the variable con-

denser, whereupon a long shaft is necessary for controlling the tickler. To make these self-supporting coils, lay four strips of adhesive tape, with the sticky side up, lengthwise on a round glass bottle and space them equally distant around the circumference. Wind the wire over these strips and when

completed fold the ends over as shown. Coat the coil with collodion and remove the bottle. If necessary, break the bottle. The primary is wound in a groove cut in a wooden disk as shown. The exact number of turns on the rotor or tickler coil can best be determined by experimenting.

An Attractive 3-Tube Regenerative Set

An Efficient and Modernized Version of the Ever-Popular Three-Tube Regenerative Receiver

IN these days of rapid changes in style of radio receivers, and with the multiplicity of "dynes" and "flexes" we are prone to forget the old friends in our continuous striving for new circuits. Five-tube radio frequency outfits have given us the long-sought freedom from howls; careful husbanding of electrical resources has permitted us to make three tubes do essentially the same work, with the saving of a control or two and the current drain of two extra tubes; there are a dozen and one reasons successfully advanced in favor of the new era, and yet many prefer to remain true to the old favorite—the three-tube regenerator.

Perhaps to some extent we are fundamentalists, but after spending some years at the receiving end we find it hard to divorce ourselves entirely from the first love. *Kenneth M. Swezey* has written a fine descriptive article covering details of the old favorite. It is all dressed up in the newest styles and unless you are a pronounced agnostic or have something very satisfactory at present, sit down and try it out. The article appeared in *The New York Herald Tribune*, and is given here with illustrations and schematic diagram.

Within the last few years dozens of hookups and hundreds of variations have been devised, but when all is said and done it can be proved that some of

lot, not counting the cost of renewal tubes and batteries.

With regeneration and two stages of audio-frequency amplification a well-made set ought to give volume sufficient for any home requirement.

You notice I qualify my statement

all been simplified, the mechanical construction is strong and the finished apparatus equals that of any on the market.

The chief requirement for sharp tuning and volume in any set is low resistance and low distributed capacity in the

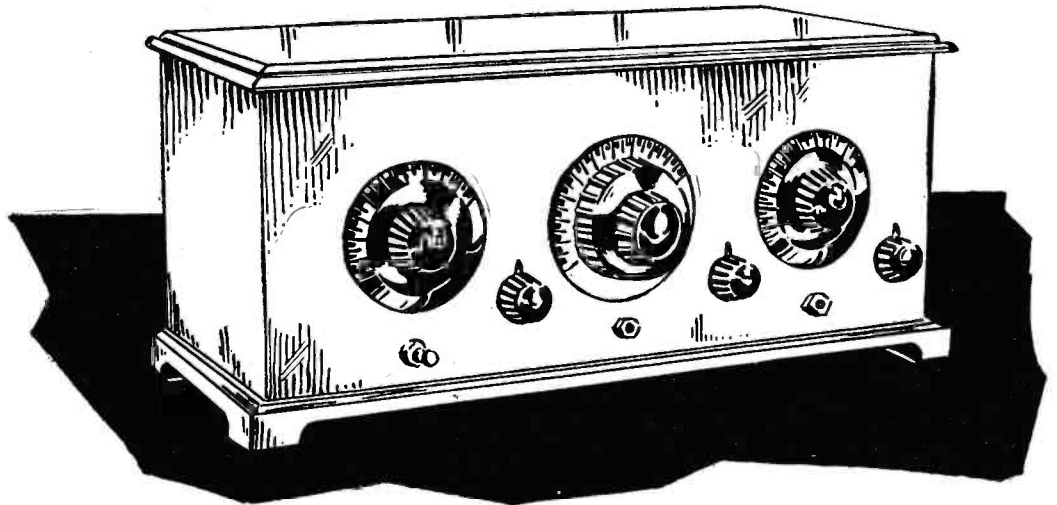

Illustrations by Courtesy of N. Y. Herald Tribune

Front view of the completed three-tube regenerative set. The center dial is of the vernier type as this control requires most careful adjustment in tuning in stations.

of obtainable results by the condition that the set be properly designed and constructed. The design and the construction are the weights in the balance that determine the results, and one should not condemn any set without first ascertaining whether it is the absolute best of its type.

primary and secondary circuits. This means that the wiring should be kept reasonably large, all connections should be as perfect as possible and little insulating material should be allowed within the field of coils, about condensers or between wires.

The function of regeneration itself is, in effect, to reduce the resistance, thus allowing more current to flow, but it is evident that the final resistance will be lower if the original resistance is low. So don't depend too much upon the magic of your hookup.

If you buy your coupler ready made, which in most cases is the more sensible way, the outer tube may have to be rewound to suit this particular circuit. The inner tube should be about three inches in diameter and the outer one about four. This may seem quite a separation to have between the two tubes, but regeneration may be adjusted more sharply by having this coupling loose.

Wind the outside tube with either No. 20 or 22 double cotton-covered wire. Seventy-one turns may be wound in a continuous sequence, and later a tap may be taken off the sixth turn, to be used as a combination ground connection and connection to the secondary condenser and the filament of the detector tube. This semi-a-periodic and conductively coupled primary eliminates a control and makes the tuning

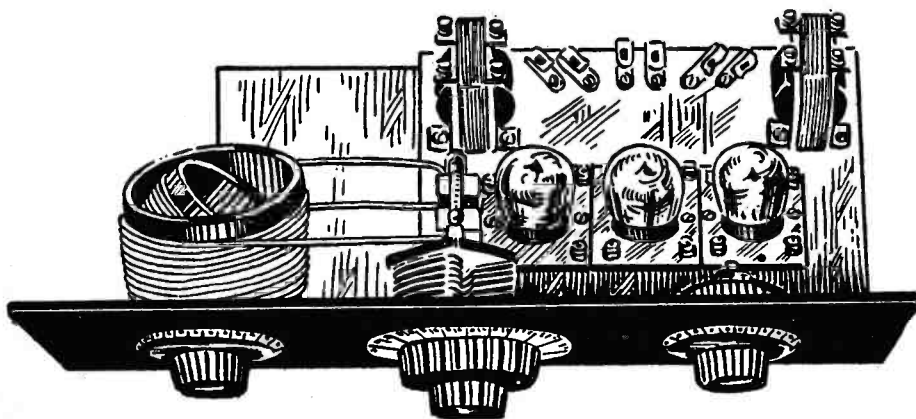

Sketch showing a top perspective view of the set. Note that most all the wiring is beneath the subpanel.

the original circuits, simple and without frills, surpass many of the moderns for all-around reliability and ease of operation.

Regeneration has its faults, it is true, but for economy and simplicity of construction it as yet has found no equal. When properly designed and built a one-tube regenerative set will give results equal to a set having a detector and two stages of radio-frequency amplification. And to the beginner this saving in original cost means a whole

Admittedly, the average radio fan is learning more and more about the technical workings of his pleasurable hobby by both study and practice, but few are as yet in the stage where they can design their own apparatus for the greatest mechanical and electrical efficiency. So I have chosen a particular set, built by a fellow fan and expert radio builder of Brooklyn, to serve as an example. If it can be said that there is any standard radio set this is a close approach to it. The circuits and controls have

approximately the same on antennæ of widely varying lengths.

The secondary, or the rotating tube, should have thirty-three turns of double cotton-covered wire of a size somewhere between 22 and 26. There is already much resistance in the circuit in which this coil is connected, and therefore larger wires would not appreciably help.

In selecting a variable condenser it will pay you to get the best, and as the capacity need only be .00025 mfd. a good one will cost little more than a

A rheostat is used to control only the detector tube, and either fixed resistance units or amperites may be used on the amplifier tubes. The value of the detector tube rheostat depends upon the kind of tube which is to be used. For a UV-200 tube use a rheostat of about four or six ohms. The same may be used for the WD-11 or WD-12. For the UV-201A twenty ohms is about right and for the UV-199 at least thirty is necessary for proper control.

For good volume it is best to use the 201A tubes, for although they require

springs. This is important, for much noise is caused by these springs weakening and making a microphonic connection.

The panel should be 18 in. long, 7 in. high and 3/16 in. thick. In this set, the glossy, mahogany-brown radion was used. The two 3-in. dials at the right and left and the center vernier dial were chosen to match. The arrangement shown in the sketch gives a perfect balance of the external parts, and with a polished mahogany or walnut cabinet gives a really beautiful and finished appearance.

A wood sub-base, which is 1/2 in. thick, 10 in. long and 6 1/2 in. wide, supports all the apparatus except the coupler, the variable condenser and the rheostat.

This in turn is supported by the heavy angle of the jacks, which are mounted in an inverted position. The screws which bind together the jack springs and the insulating separators are carefully removed and longer wood or machine screws are inserted, long enough to fasten to the sub-base.

The transformers are separated so far that the cores need not be arranged at right angles. Between them are arranged six Fahnestock binding posts for the purposes marked. A separate post may be added for the minus of the "B" battery, or this may be connected directly to the minus A post. Two other binding posts are mounted on the left side of the sub-base for the aerial and the ground. Wires are led from these posts to their respective appliances through tiny holes drilled near the bottom of the back of the cabinet. This has been found to be the neatest and most satisfactory method.

Posts are provided for a "C" battery. When less than 45 volts is used as a "B" battery these may be short-circuited and no "C" battery need be used; but when 90 volts is used on the plate of the amplifier tubes a "C" battery of about 6 volts is almost necessary to give the increased volume and help reduce the "B" battery current.

The wiring and the assembly are obvious from the illustrations and diagram. Make connections as short and as direct as possible, never neglecting to solder every one. Be sure to follow the hookup closely.

If you connect the transformer shieldings and the rotary plates of condenser to the ground post you will have little, if any, hand capacity effect.

Most any aerial of reasonable size may be used with this set. The author knows this, for he has seen antennæ all the way from 25 to 300 feet long connected to it, giving good results in most every case. However, one from about 80 to 120 feet long will be generally the most satisfactory for broadcast wavelengths.

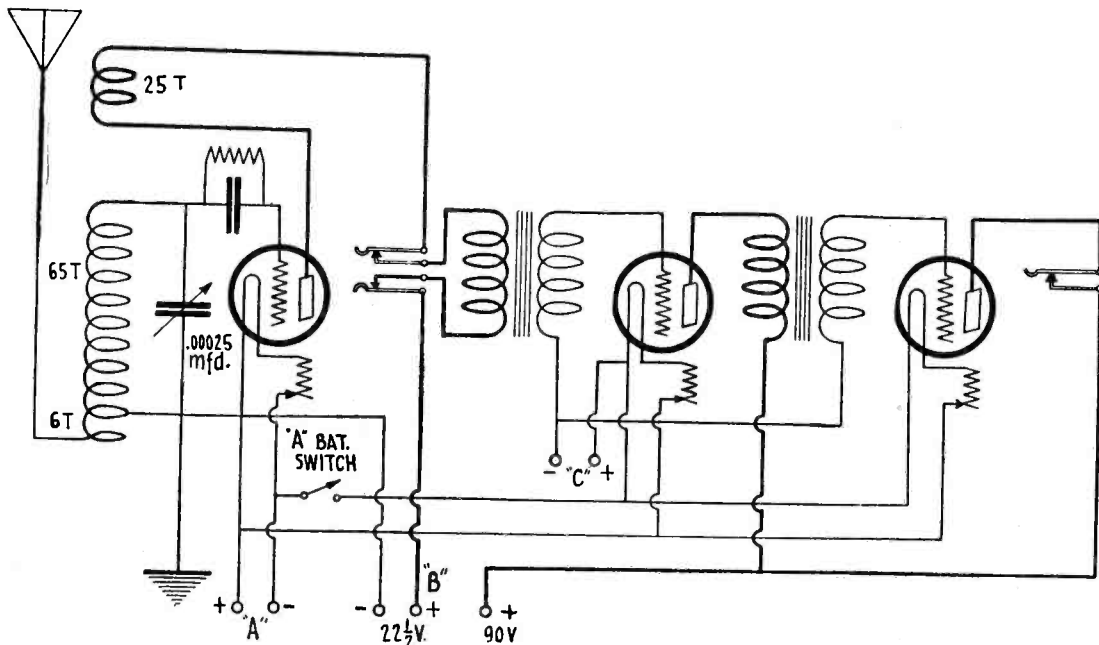

Wiring diagram of the attractive three-tube regenerative set.

poor one. Get one that turns easily, without binding or jerking; still, one that will stay rigidly in the position in which it is set. See that it has little dielectric or insulating material in its field, for much of this introduces a loss.

It is generally better not to get a condenser that has separate vernier plates, as the insulation between these and the main plates causes losses, and besides this an extra vernier is inconvenient. There are a few good condensers that employ them, but they are rapidly going out of style. Usually when you want to increase the wavelength slightly by using the vernier the plates are already at their maximum limit and vice versa. Furthermore, when such plates are used there is absolutely no way of accurately checking your dial reading, for the vernier may cause the true capacity reading to vary a few degrees either way.

However, a good vernier of some sort is quite essential for this set, and I would advise the prospective builder to look over the various varieties of condensers that have reduction gearing and to look also to the several really excellent vernier dials that fit on any condenser.

Two transformers are required, and for maximum volume, with freedom from distortion, I would recommend that a transformer with a ratio of approximately 4 to 1 be used.

a six-volt battery they normally draw but a quarter ampere each. The 199 tubes come next, but for an equal volume they require a greater "B" battery voltage. Three of these tubes can be operated quite economically on three No. 6 dry cells connected in series.

One double and one single circuit jack are necessary for making the loud speaker connection. The double circuit jack may be either connected in the detector circuit, as shown in the diagram, to be used for plugging in a pair of phones, or it may be connected to the first amplifier, so as to get two variations of loud-speaker intensity.

The grid condenser fixed .00025 condenser, which makes use of a mica dielectric that is held firmly and permanently to the plates, and the grid leak should be sealed to prevent change. The value of the latter is about two megohms.

An "A" battery switch is used to control either the entire three tubes or just the two amplifier tubes. In the diagram it is used to control the latter, thus making it possible to turn on the detector tube independently from the amplifier, enabling the phones to be used without burning the amplifier tubes or necessitating their removal from the sockets.

Secure three sockets that are strongly made and that have four good contact

How to Make a Two-Step Amplifier

Complete Details for Building a Highly Efficient Audio Amplifier for Use with Any Set

IN many articles appearing in *Radio Review*, various types of tuners using only a vacuum tube detector or a detector and one or two stages of radio frequency amplification are described. In some cases these are designed to be used in connection with this audio frequency amplifier. Thus two purposes will be served by this article by *A. P. Peck*, which recently appeared in *Science & Invention*, New York. You can build the amplifier and use it with your present set. When future articles appear, if you are of an experimental turn of mind, you can try out the tuners and radio frequency amplifiers and obtain good volume by connecting this audio frequency amplifier in the circuit. Mr. Peck's article is as follows:

When the design of this two-stage amplifier was first undertaken, the writer took into consideration just what the various readers would desire in an amplifier. Many are equipped with one- and two-tube sets of different designs and desire to have greater volume produced by their sets. The obvious solution to this problem is the installation of an audio frequency amplifier. Since the sets throughout the country differ so greatly in construction, the amplifier was designed so that it could be used with practically any existing type of set with few, if any, changes on the present one. Therefore, the circuit of this amplifier starts at the output of the detector on any set. If a

shown in Figs. 1 and 2. When the station is tuned in on its best, plug the loud speaker into jack 10, and remove plug from jack 9. The reason for not using the detector jack is because when

This will not happen if the procedure outlined above is followed.

The main consideration in the construction of an audio frequency amplifier is the selection of the transformers.

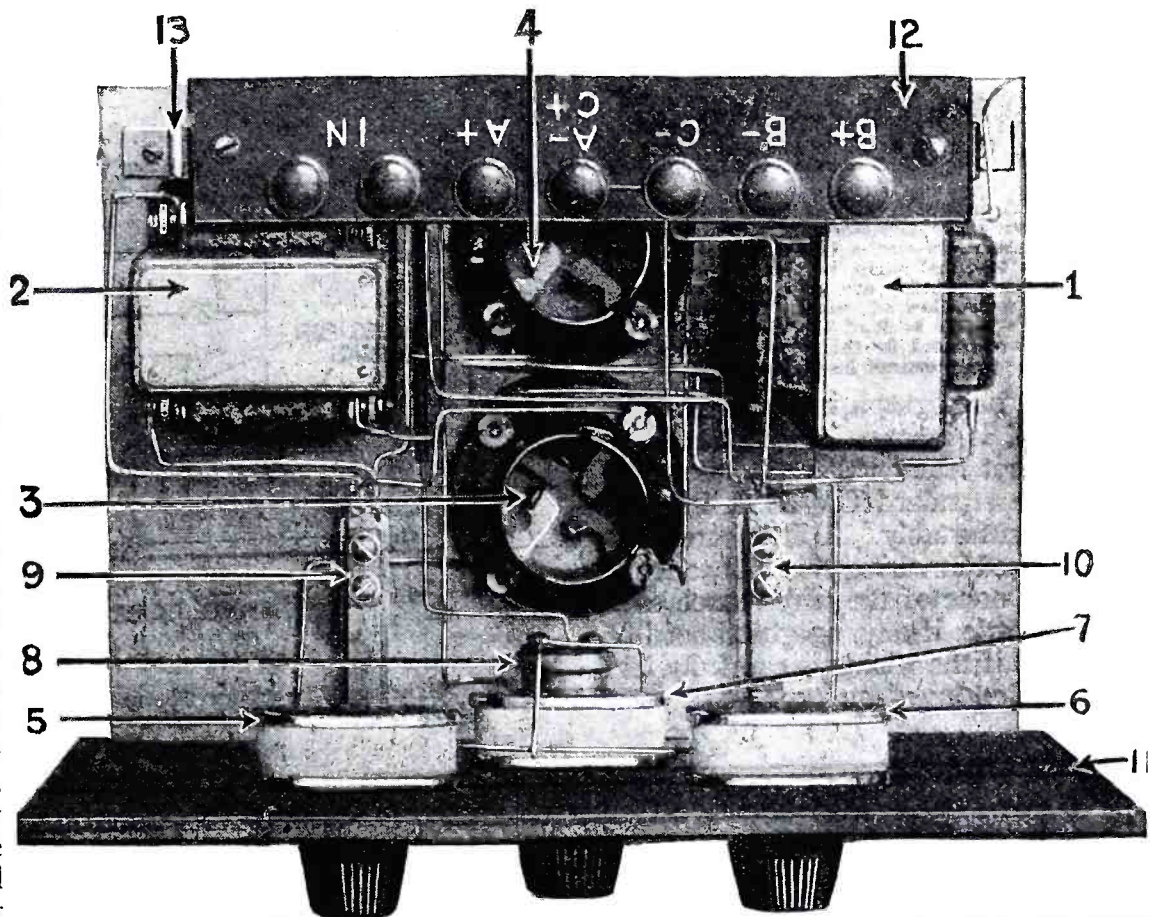

Illustrations by courtesy of *Science and Invention*, (New York)

Fig. 1. The illustration above is a top view of this two-stage amplifier which was designed by the writer to give the very best possible results and to be so arranged that it can be connected to any set from which it is desired to obtain more volume. The numbers on the photograph above correspond to those on the drawings.

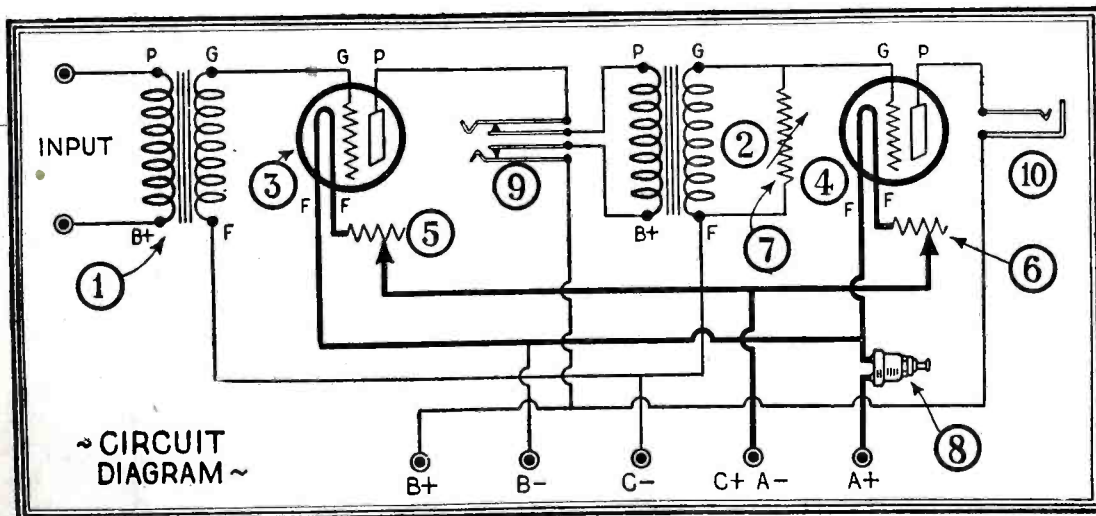

Fig. 2. The circuit diagram of the two-stage amplifier. No jack has been provided in the input circuit as this causes a detuning effect when the plug is removed therefrom and placed in the first or second stage of audio frequency amplification. The variable resistance 7 controls volume.

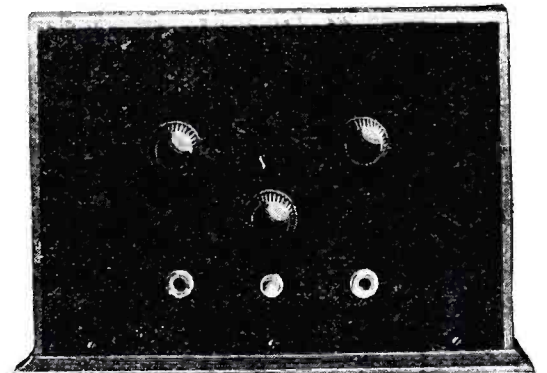

Fig. 3. The simple yet symmetrical panel of the two-stage amplifier. The two upper knobs control the filaments of the tubes. Of course, these controls could be incorporated in one rheostat, but in the author's opinion greater flexibility and better results are obtained if each filament in a set has its own separate control. The center knob is the volume control and the jacks and switch are placed in a line near the base.

jack is incorporated in the existing receiver, it may be left in the circuit, but should not be used. Do all your tuning with the phone plug in the jack, 9,

the plug is removed therefrom, there will be a slight change in tuning and when you plug in on the second stage it will be necessary to slightly retune.

Those shown herewith are one of the best types obtainable on the market today and give excellent volume. They are rather large in size and, therefore, a

little difficulty may be encountered when attempting to mount them on a baseboard cut to fit a 7 x 10" panel and cabinet. However, a little judicious care at this point will produce the desired results. The layout shown in Fig. 1 is rather unusual for this type of unit, but by placing the instruments as shown, the best arrangement of various leads could be obtained. It may seem

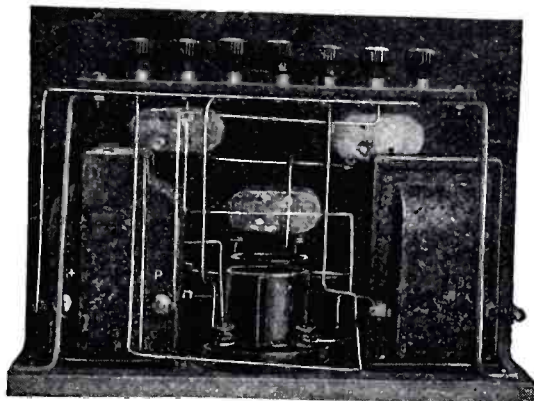

Fig. 4. A rear view of this two-stage amplifier showing the transformers mounted near the back at right-angles to each other. Note how the terminal strip is mounted on long brackets so that they are in a handy position for the connection of wires. This strip is very close to the back of the cabinet and unless it is mounted in this way, the binding posts cannot be reached.

from the photograph in Fig. 1 that the socket, 4, is inaccessible. This, however, is not true as there is just room to slide a standard UV-201A into the socket comfortably. A little care must be exercised in wiring this unit to make sure that none of the wires touch each other. Little, if any, spaghetti need be employed if the wiring is carefully laid (Continued on page 44)

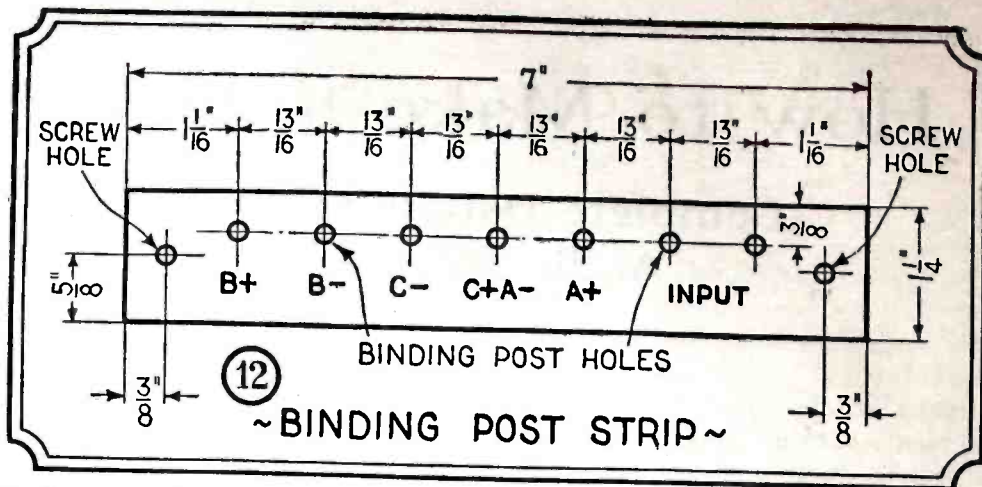

Fig. 5. The binding post strip to be mounted on the brackets. 13, is shown in detail above. This may be made of hard rubber, radion, bakelite or celeron.

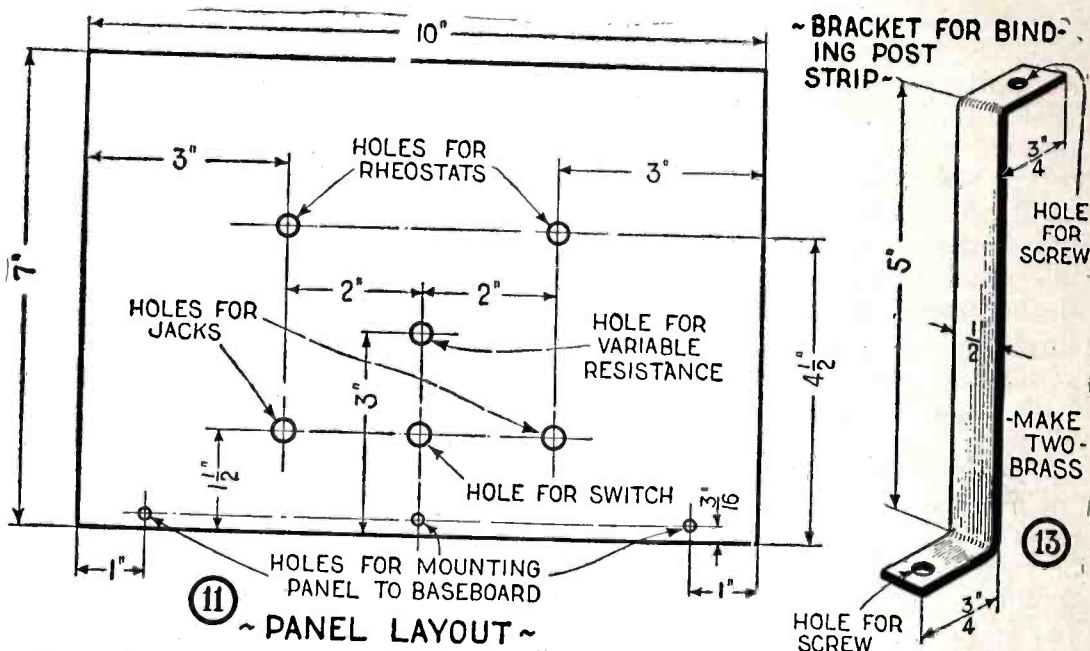

Fig. 6. The panel layout for the two-stage amplifier is given above at 11. The panel may be of hard rubber, radion, bakelite or celeron. The terminal strip bracket is shown at 13.

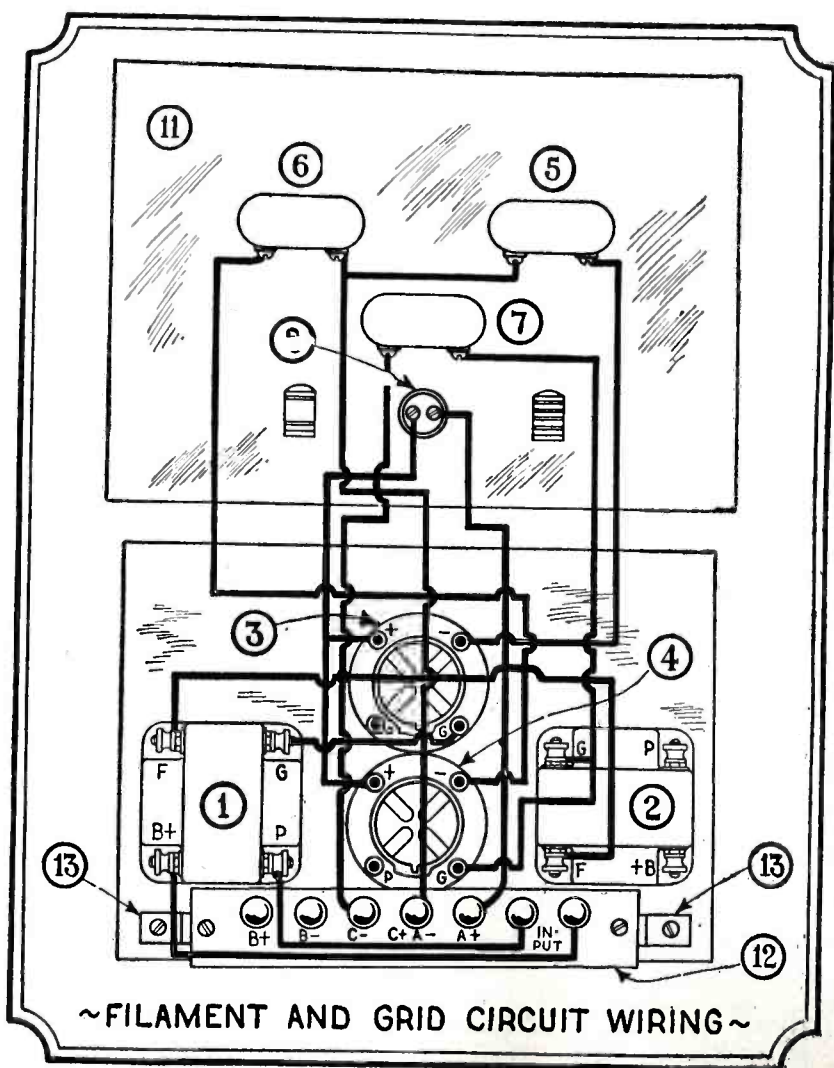

Fig. 7. The filament and grid circuit wiring is shown above. The input connections to the first transformer are also indicated.

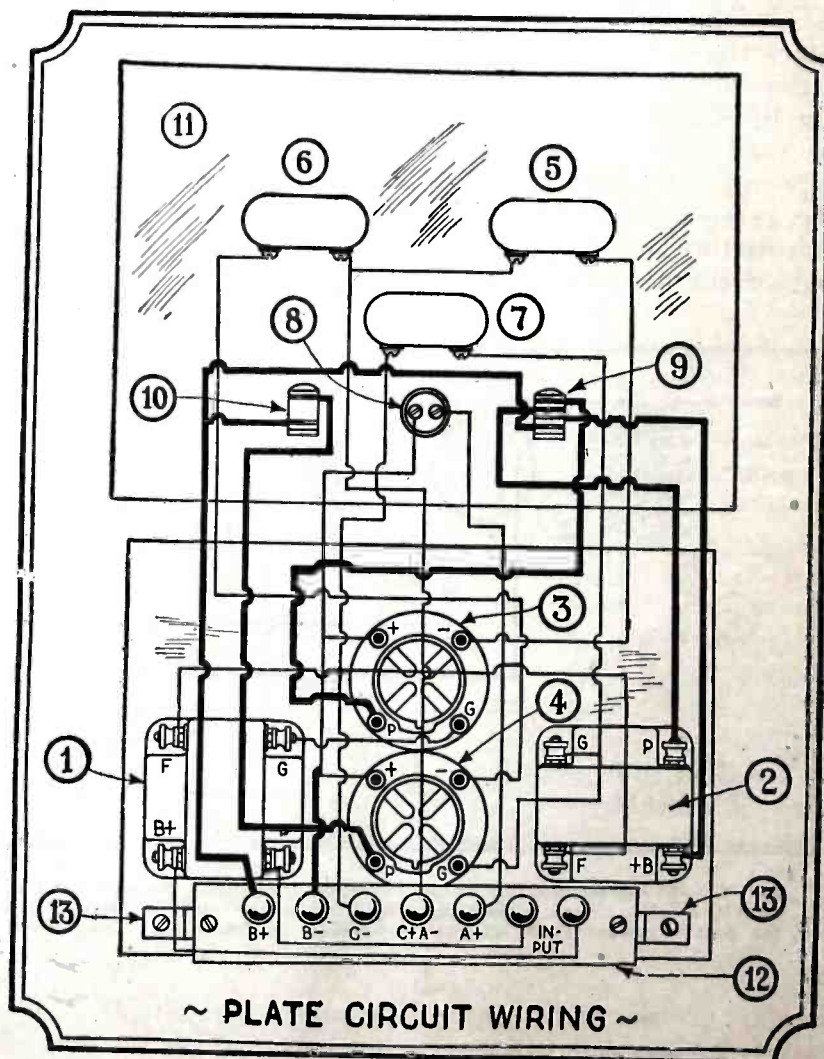

Fig. 8. All of the connections in the various plate circuits are shown above. The grid wiring is indicated in light lines.

An Edison Storage "B" Battery

An Excellent Solution of Problem Presented
by Short-Lived "B" Batteries

MR. L. W. Harold, writing in *Radio Journal*, Los Angeles, California, offers a very interesting problem, or rather solution to a problem, which may be considered as based on the law of conservation of energy. The proposition is this: Is it not better to spend a few extra dollars now, expend a fair amount of energy, and dissipate a reasonable amount of time, than to do a fair percentage of each about once in two or three months for the rest of the life of your radio set? If the problem seems too abstruse thus far let's present it more clearly. Is it not better to build a storage "B" battery at a nominal expense and maintain it at an equally nominal expense, than to use the dry type of "B" battery and have the expense of frequent renewal coupled with the fact that it may turn noisy at the wrong moment and spoil your favorite opera?

If you decide in favor of the wet "B" battery idea and have the patience, you will find the following data about all the assistance needed.

It is advisable to wash out the old Edison cells before attempting to dismantle them, because the electrolyte is very destructive to the hands. Make an incision in the side of the iron container near the top with a small chisel or old knife, then, with a pair of tin snips, cut completely around the top. Remove the plates from the can and

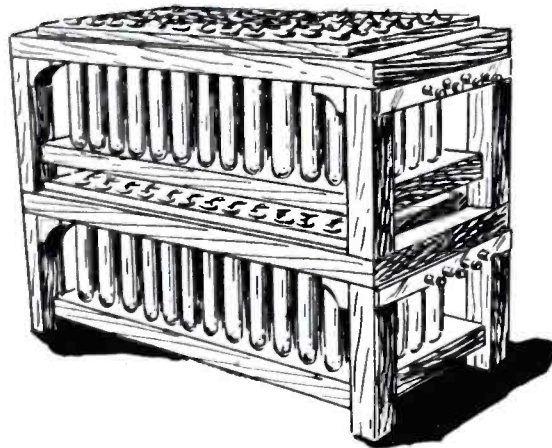

Illustrations by Courtesy of
Radio Journal (Los Angeles, Cal.)

How the battery looks when completed.

is just enough resistance in the circuit that will permit the wire to become red. After the annealing process, the wire will be found to be very soft. Cut the large wire in three inch lengths; the small wire should be cut in six inch lengths. Seventy-two of the large wires should have their ends bent as shown in Fig. 1. This is most easily done by clamping the wire horizontally in a vise and allowing about five-eighths of an inch to project from the side of the jaws. Stand so that the projecting end points directly toward you. Then grip the wire with a pair of pliers so that the end of the plier jaws are in the center of the exposed wire. Keep the pliers in a horizontal position with the handle always pointing toward you. Then with a single motion push the pliers to one side and away from you.

You are now ready to weld the connecting wire to the elements. Welding, by the way, is absolutely necessary if you want a quiet battery. If you possess a small current transformer delivering around 60 amperes at ten volts

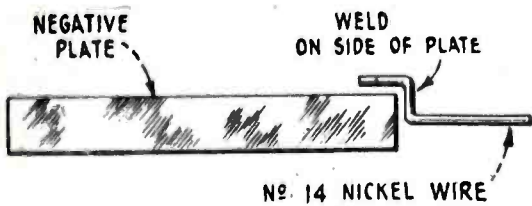

FIG. 1

separate them. The positive plates are composed of a large number of small tubes, remove these tubes by cutting away the containing grid. The negative plates are made up from a large number of flat pockets, these can be removed by bending the plates back and forth or by cutting away the iron grid. These tubes and pockets will be the elements for our small cells.

The nickel wire is too stiff to handle so it should be annealed by heating it

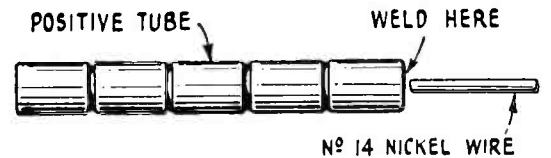

FIG. 2

pressure the welding operation can be done quickly. Otherwise resort to a storage battery. A ten volt sign lighting transformer is ideal for this purpose, connect one side of your low voltage source of power to a vise, connect the other through a heavy, flexible lead to an arc light carbon. This is all important, the carbon should be about the size of a lead pencil. Now clamp one of the elements in the vise with one hand, hold the piece of wire on the element at the point to be welded. Place a pinch of borax on the welding point to act as a flux; now, with the free hand, lightly press the carbon on the welding point. The joint is heated because of the resistance of the contact and not by any actual arc. The current should be regulated so that the joint will quickly attain the welding heat. If too much current is used the joint will sputter and burn away; if too little is used the joint will heat too slowly, this will allow the heat to be communicated to surrounding parts. The right current will soon be found by experimenting. As soon as the metal is in a plas-

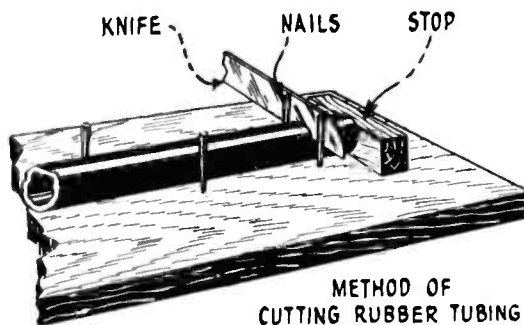

FIG. 3

to a red heat. This can be done by connecting the large wire across the terminals of a storage battery. If the wire is too long, the resistance will be so high that the wire cannot attain the red heat; if too short, the wire will get white hot and the life will be burned out. The small wire can be annealed by putting it across the 110 volt lighting circuit. Start out with about 25 feet, decreasing the length until there

A hundred volt battery will require 72 cells. Therefore purchase one half gross of 1"x6" test tubes, 40 feet of No. 14 nickle wire, 150 feet of No. 24 nickel wire, 3 feet of rubber tubing, having a hole 5/16" in diameter, and a 1/8" wall, 1 1/2 feet of rubber tubing having a hole 1/4" in diameter and an outside diameter just large enough to fit within the test tube, a couple of old Edison cells, and finally a gallon of Edison battery electrolyte.

The test tubes can be obtained from a chemical supply house, the nickel wire from one of the larger hardware concerns, and the old Edison cells and electrolyte from some garage that caters to Edison battery users. The small rubber tubing usually is carried in stock by rubber concerns. The large tubing should be made to order. This is not as expensive as it sounds. I paid sixty cents a pound and got four pounds, the length was just a little over three feet. The rubber man simply rolls up rubber sheeting to the required thickness and vulcanizes it.

tic state, push a little harder on the carbon. This will effect the union of the wire and the element. The actual welding operation should consume about two seconds.

Next cut both sizes of rubber tubing in quarter inch lengths, for this operation it is advisable to lay the tubing flat on a board, nail a strip of wood on one end of the board to act as a stop. Drive some nails into the board to guide the knife, it will be necessary to use a long, very sharp knife. Cut 144 pieces from

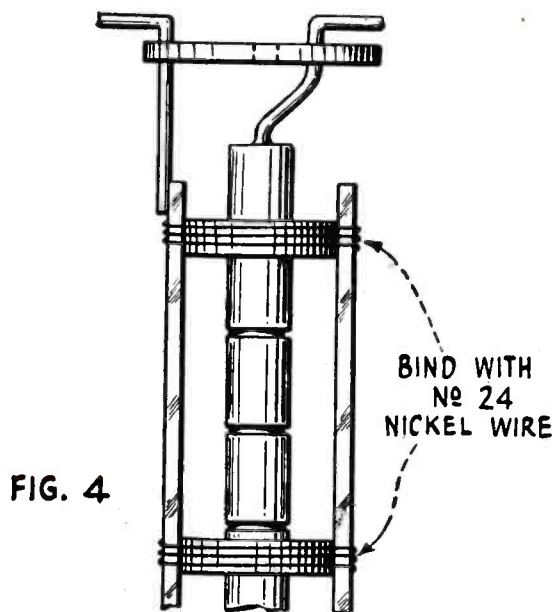

the small tubing and 72 pieces from the large tubing.

Now drive a nail through each large rubber washer at two points diametrically opposite, and close to the edge, this makes holes which will be used to bring out the leads from the elements.

Now you are ready to assemble your battery. The pieces of small rubber tubing are spacers. Two should be slipped on to each positive tube. Now take two negative plates, one with a lead and one without, and place them on opposite side of the positive tube. The small wire should be wound

around the elements just over the rubber separators as binding wire. Now thread on the large rubber washer, bend the projecting leads at right angles. Your completed elements should look like Fig. 4.

The container rack had better be made with twelve holes one way and six the other way. This will provide for 72 cells. Only the top section of the container has the holes, the bottom is solid. The completed cells fit through the holes and rest on the bottom shelf. The top section (with holes) should be either soaked in hot paraffine or else painted with an alkali resisting paint. This is very important because there is apt to be current leakage across the wood if it once becomes soaked with the conducting alkali. The bottom shelf should have a narrow strip of wood fastened around its entire circumference. After the cells are in place the bottom shelf should be filled up with melted roofing asphalt. The little strips prevent the asphalt from running out. The asphalt prevents the cells from moving and thereby saves them from breakage. Should any test tube accidentally be broken, it can be removed by pouring hot water in the test tube through a rubber hose, the hose is used so as to get the hot water down to the bottom of the test tube so that the asphalt may be softened.

The projecting leads from each cell must now be welded together. Of course, the negative plates of one cell should be connected to the positive tube of the following cell. This had best be done by bending up adjacent wires, cutting them off so that they are at the same height, connect one side of your welding supply to BOTH wires. Place a little borax on top of the two wires and press the piece of carbon (connected to the other side of the welding supply) straight down on the joint. It

is advisable to take taps at 22 and 45 volts. This will be at the 18th cell, and the 36th cell, a terminal strip at one end of the rack completes the battery.

The chief objection to an Edison

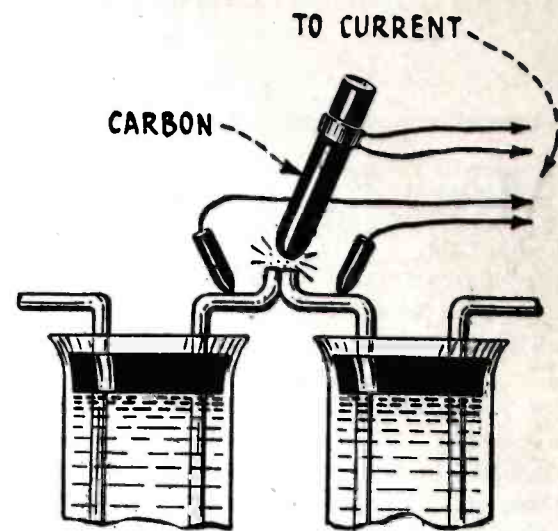

battery is the tendency for salts to form on the top of the cells. This can be overcome to a small extent by using a solution that has been diluted slightly with distilled water. The specific gravity should be about 1200°.

Trouble may be experienced in filling the cells if the filler holes once become wet. You may therefore be obliged to construct a small funnel with a small tube that will go through the filler hole and still leave space for the air to escape. Do not make the mistake of filling the cells too full. If you do, they will boil over while being charged.

Two batteries as described above have been in continuous use over a year. They have given perfect satisfaction during all this time, they have had water added with a medicine dropper just once, and then it was not really necessary. It really is surprising to see how slowly evaporation takes place.

How to Make A Two-Step Amplifier

(Continued from page 42)

out. In the set illustrated, only one short piece was necessary to separate one "A" and one "B" battery connection.

Many constructors are in the habit of using square bus wire for the connections of a radio set. This material is always tedious to work with and often does not produce the results desired. No. 14 bare copper wire will give as good results and is easier to use. The soft drawn material is to be preferred.

The constructional details of the various parts of this two-stage amplifier are given in the illustrations. Working from these diagrams you can

quickly and easily wire the set absolutely correct. In the diagrams we have shown the wires running over the sockets. This was done for the sake of clarity and the correct way in which to run the wires may be easily seen in Fig. 1.

Binding posts have been provided for the connection to a "C" battery. The use of this unit reduces the drain on the "B" battery and lengthens its life. A voltage of 3 to 4½ volts should be employed. Try various voltages until the best is obtained. If a "C" battery is not used, or if at some time your "C" battery gives out and you cannot obtain another at once, connect a short

length of wire between the two "C" battery binding posts. This will complete the circuit and allow operation without the battery.

The variable resistance, 7, shown in Fig. 2 is a volume control and aids in eliminating tube noises and distortion. When putting the set into operation turn the volume control knob to the left until it comes out of the threaded sleeve. Then start turning it in to the right and with the set in operation, continue until the best results are obtained. On very loud signals the knob should be turned quite far in.

After a signal is tuned in, adjust the rheostats to the best operating position.

An All-Wave Low-Wave Set

Details for Building An Up-to-date Receiver for Amateur Reception

SO many requests have been received for information on the construction of new sets for the reception of short waves used by amateurs that we feel it is only proper that we serve this class of readers with the desired data. One of the best types of short-wave sets has recently been described by A. P. Peck, 3MO, in *The Experimenter*, and we are sure that the constructor will find this receiver to fulfill requirements. Moreover, with a few changes this set can readily be adapted to broadcast reception. Mr. Peck describes the All-Wave Low-Wave Set in *The Experimenter* as follows:

The set that has been designed and constructed and that is illustrated in the photographs herewith is one employing a rather unusual circuit. At first glance it appears to be a combination of several types, and that is just exactly what it is. A feed-back arrangement is used for regeneration and oscillation, but the control of this part of the circuit is not the usual movable tickler coil. The coil is, of course, present in the set, but is fixed in its relation to the secondary. The regeneration, or oscillation, is controlled by means of a variable by-pass condenser and the results are astonishing. Instead of the usual home-made, rickety, flimsy, movable

had ever operated. By rotating the variable feed-back condenser, the circuit could be brought up to the oscillation point and would go into oscillation with a smoothness that was astonishing. Only a soft hiss was heard in the phones when the circuit started to oscillate and after a C.W. signal was tuned

the value of this device and, therefore, a continuously variable leak comes in handy. Inasmuch as it is not often used, it was located on the baseboard. This was done not only for the reason mentioned, but also so that the lead from the combination grid leak and condenser to the grid binding post on the

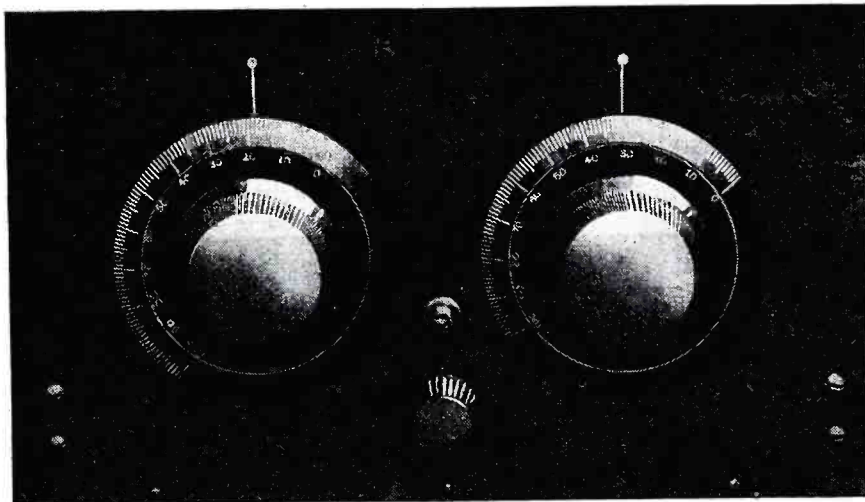

Illustrations by Courtesy of *The Experimenter* (New York)

A panel view of the low-wave receiver showing the extreme simplicity of the layout. The dial markers were scratched into the panel and filled with white lead.

in with the tuning condenser it could be brought up to its maximum volume, with relative ease. All of this action, of course, depends upon the correct ad-

socket will be as short as possible. This is another important point to remember. If this lead is long, the set will be hard to control and unstable in operation. Therefore, make it as short as is physically possible.

The distance between the tickler coil and the secondary coil must also be determined by experiment. The position shown in the photographs is approximately correct for the particular coils that the writer used. A small variation of this distance may mean the difference between an unstable and a stable one. The third point to be carefully watched in the operation of this set is the capacity of the tiny antenna coupling condenser. This device is built of two small sheets of aluminum with active areas about $\frac{1}{2}$ inch square. The space between them is approximately $\frac{1}{4}$ of an inch and must be varied until the best signal strength with good control is obtained. It can be varied merely by pressing the top sheet down and bending it a little so that it stays closer to the bottom sheet.

Let us next consider the construction of the coils. The one which is the combination primary and secondary should be of the low-loss type. An excellent method of constructing coils of this nature can be seen in the various photographs of the set and in the close-up of the coil in Fig. 2. This only applies to the secondary coil. The

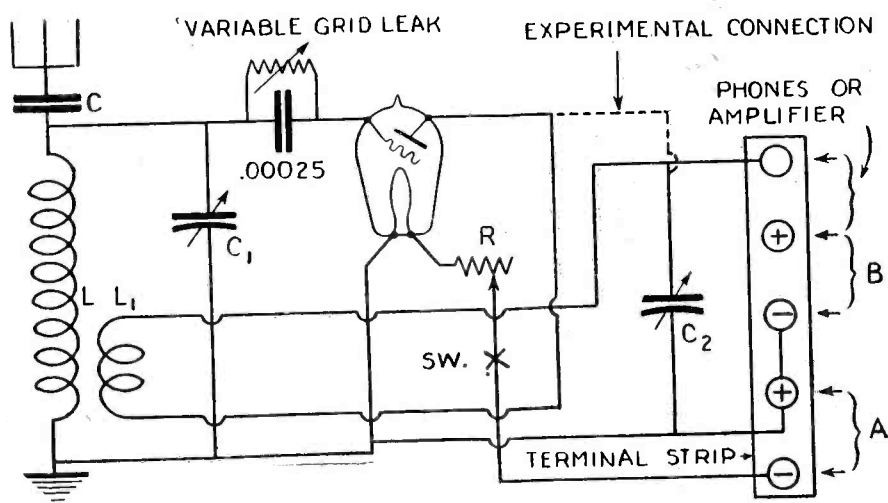

Fig. 1. The circuit diagram above shows the connections for the low-wave receiver, with an experimental connection indicated. Try both ways of connecting feed-back condenser C2.

tickler coil with its troublesome pigtailed and unstable operation, all we have to do to control the set is to rotate a smooth-running and easily operated variable condenser. In this way, many of the defects of the standard three-circuit coupler are overcome. When the writer finished the set illustrated, a great surprise was in store. When everything had been correctly adjusted, it was found that the oscillation control was the smoothest of any set that he

justment of one or two of the parts. In the first place, a variable grid leak must be used in order to get the very best of results. Of course, if you have two or three dozen fixed grid leaks on hand, of various rated capacities, you could probably find one of them that will suit the purposes of this set. However, it is far better to use a good standard type of variable grid leak, such as the one illustrated. With different tubes, you will have to change

tickler need not be wound in this fashion and was wound on a standard basket-weave form for convenience sake. It was then tied together and used as shown.

The complete method of constructing the low-loss secondary coil was as follows: Double cotton-covered No. 12 wire was used, although this may be slightly smaller. The form for making up the coil was first made as shown in Fig. 4. A tube 4 inches in diameter and of arbitrary length was slotted for $3\frac{1}{2}$ inches with four slots, each $\frac{1}{4}$ of an inch wide and spaced evenly around the circumference. The heavy wire was then wound on a 3-inch form, being careful to straighten the wire out as the winding is being done. Wind 3 or 4 more turns of wire than you will need on your finished coil. Upon releasing this wire, after it is wound on the 3-inch form, it will spring out slightly and will form a spiral about $3\frac{1}{2}$ inches in diameter. This can now

length of the coil. Four strips will be necessary and the material from a draftsman's discarded triangle will be found excellent. Clamp the four strips

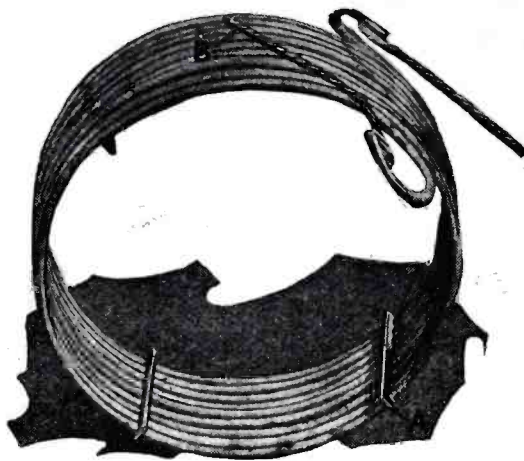

Fig. 2. One of the low-loss coils showing the supporting strips and leads.

in a vise, allowing the edges to project about half of their width. Hold three hacksaw blades together and cut slots

collodion or amyl acetate. In case you find trouble in holding the strip to the wire with this material, dissolve a small quantity of celluloid in the liquid. This will make it heavier and of a consistency that will surely serve the purpose. After all four strips are securely fastened in place, allow the coil to dry for several hours, whereupon it can be slipped off the form and the ends shaped for mounting. In the particular coil that is illustrated, which was designed for 40-meter work, the coils happened to be wound in the wrong direction and, therefore, the leads had to be crossed, as shown in Fig. 2. Inasmuch as the ends were cut too short, an additional length had to be soldered on, as shown. Probably, however, the reader can profit by the writer's mistakes and wind the coils correctly the first time.

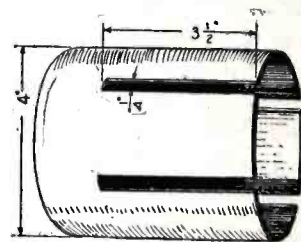

Fig. 4. The form used for winding the low-loss coils used in this tuner.

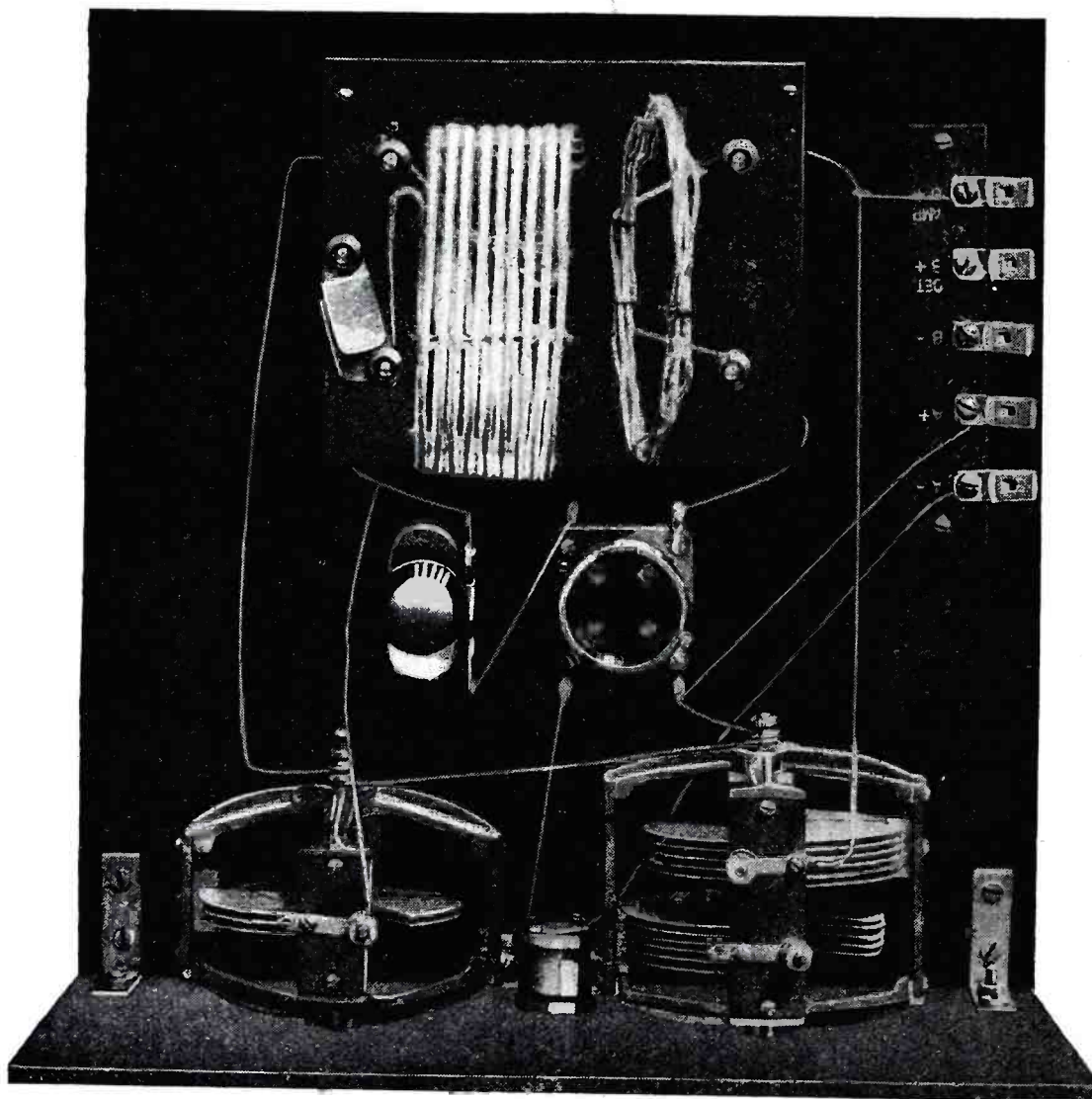

Fig. 3. The top view of this highly efficient receiving set showing the layout of the various instruments and the straight connections between them.

be worked over the 4-inch form, and will be found to hug that form closely. By following this procedure, the usual difficulty experienced in holding the turns in place on the 4-inch form will be eliminated. Put as many turns of wire on the form as you will need for the particular band that you have to cover, consulting the table of turns below. Now cut up some strips of fairly heavy celluloid, $\frac{3}{16}$ of an inch wide and about $\frac{1}{2}$ inch longer than the

through half the width of the strips. The number of slots necessary will be determined by the number of turns on the coil and their distance apart should be equal to the thickness of the wire used. Now take these prepared strips of celluloid and hold one of them under and against the wire wound on the form, using one slot for this purpose. Work the wire into the notches cut in the strip until you have every turn in its correct position. Fasten them with

When the writer built this set, only one single section Bruno condenser was at hand and later one of the two-section types was pressed into use. However, only one of the units is used for the oscillation control and, therefore, you can use any condenser with a maximum capacity of .00025 mfd. that you may have at hand. The tuning condenser, however, is much smaller in size so that the range will be spread over a greater space on the dial. A standard 11-plate condenser was taken apart and reduced to 5 plates by the mere process of tearing out the surplus plates. The result can easily be seen in the photograph in Fig. 3.

In case the reader desires to adapt a set of this nature to broadcast reception, it is not advisable to use the capacity coupled antenna scheme shown. In fact, an inductively coupled primary should be incorporated and may consist of four or five turns of No. 16 D.C.C. wire, wound in the same low-loss style as the secondary. This will prevent radiation, which would cause trouble if the capacity coupled antenna

(Continued on page 48)

An Easily Controlled Four-Tube Set

Two Controls Operate This Simple Receiver

THE most simple type of a four-tube circuit should consist of one stage of radio frequency amplification, a detector and two stages of audio frequency amplification. If more stages of radio frequency are used, the receiver will of course be more sensitive, but it will also require more controls if the radio stages are of the tuned type.

The circuit shown in the accompanying drawing and described in the following recently appeared in the *Chi-*

No. 24 double silk covered magnet wire.

The ends of this coil are anchored in the usual way, by drilling two small holes through the tubing and putting the end of the wire down through one of them and up through the other. These holes are one-quarter of an inch apart and in line with the direction of the winding.

This will require a space of $1\frac{1}{2}$ inches, so the winding should be started at a point $\frac{3}{4}$ of an inch from

turns of the No. 24 wire and is wound in the same direction as the first coil. In fact, all of the coils are wound in the same direction.

When the fifty-six turns have been wound and the ends anchored, put on a piece of the empire cloth at the bottom and wind ten turns on top of it, as was done on the first coil. This winding should be carefully and neatly done, as it will then make a nice looking and efficient job. This is all that will have to be made at home.

EASILY CONTROLLED FOUR TUBE CIRCUIT

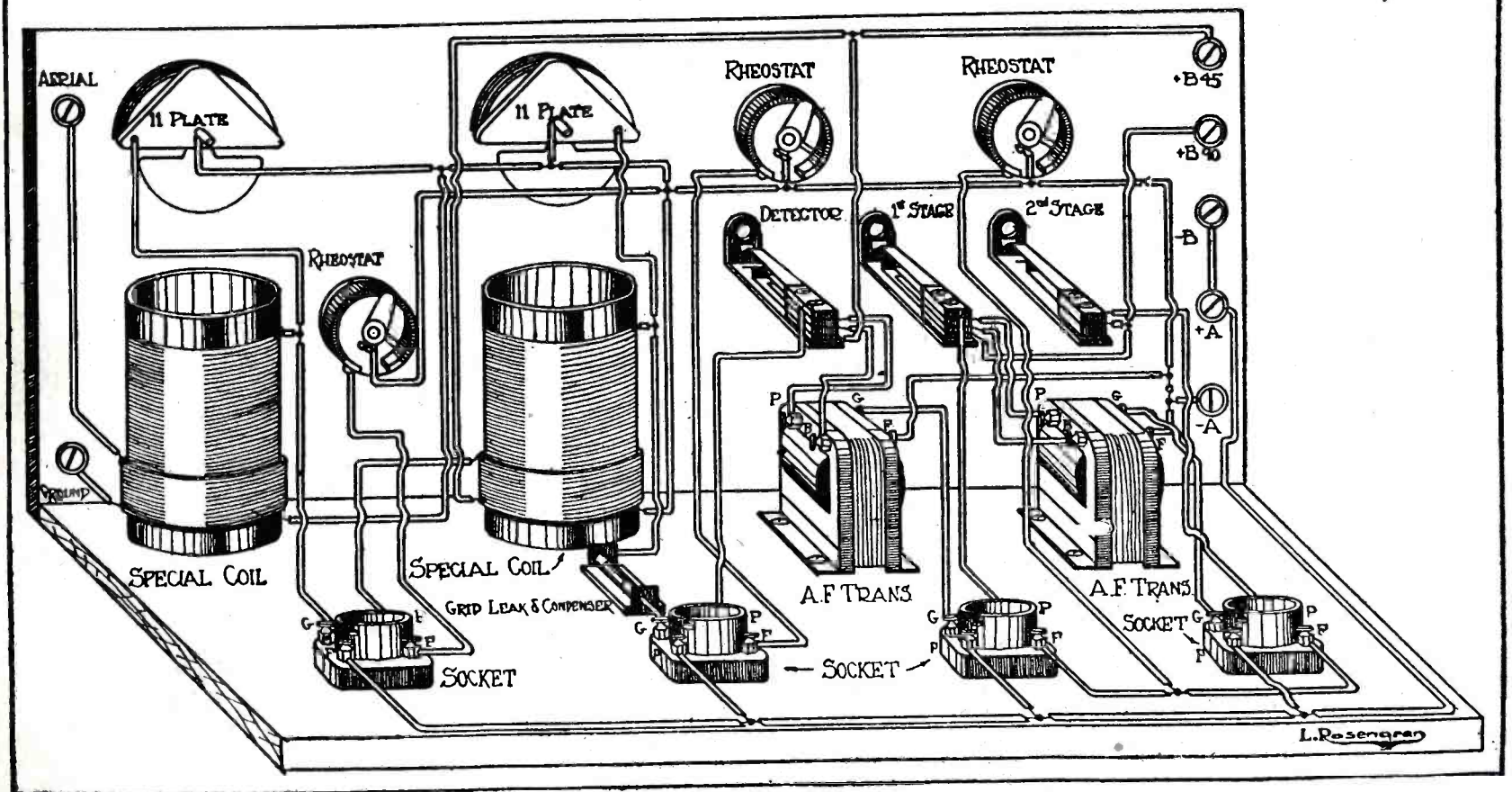

Illustration by Courtesy of Chicago Herald and Examiner.

A picture layout of the easily controlled four-tube set showing the arrangement of parts on the baseboard and panel. The wiring can also be followed from this illustration. If the above panel layout does not appeal to the constructor, alterations to suit can be made providing the radio frequency coils are not placed too close together.

Chicago Herald and Examiner. The set employs two controls which may be set so that the dial readings will be the same on both for any given station. Frank D. Pearne, the author of the article, gave the details for construction as follows:

Two Special Coils

First procure two pieces of bakelite or cardboard tubing three inches in diameter and three inches long. On one of these wind the secondary of the input transformer, which is the one shown on the left of the drawing. This winding will consist of sixty turns of

the end of the tube; over the lower end of this winding wrap a layer or two of empire cloth, or linen tape $\frac{1}{2}$ inch wide, and on top of this wind another coil of ten turns of the same size of wire.

Anchor the ends of this by tying it in place with the ends of pieces of linen thread which are placed over the tape before the coil is wound. Leave the ends of the thread extending out so that there will be plenty of thread to tie the ends in place.

Winding Second Coil

Next wind the second coil on the other tube. This consists of fifty-six

The rest of the apparatus is to be purchased at the radio store, and consists of two rheostats each having a resistance of 25 ohms, two double circuit packs, one single circuit jack, two audio frequency transformers having a ratio of 4 to 1, four standard sockets, two dials (if the dials are not furnished with the condensers), one fixed mica grid condenser having a capacity of .00025 M. F., one grid leak having a resistance of $1\frac{1}{2}$ megohms, seven binding posts, one bakelite panel $7 \times 18 \times \frac{3}{16}$ inches, one baseboard $6 \times 17 \times \frac{1}{2}$ inches, twenty-five feet of No. 14 tinned copper bus bar wire, one six-volt storage battery, two 45-

volt plate batteries, one pair of phones and a loud speaker and four UV-201-A vacuum tubes.

These parts are assembled somewhat as shown on the drawing and the wiring is then started.

The Wiring Job

Connect the aerial binding post to the top of the ten turn coil which is wound over the sixty turns. The lower terminal of this ten turn coil is connected to the ground binding post on the panel. The top terminal of the sixty turn coil is connected to the stationary plates of the first eleven plate variable condensers, to the bottom grid of the first tube.

The bottom terminal of this sixty turn coil is connected to the rotating plates of both of the variable condensers, to the bottom terminal of the fifty-six turn coil, to the sliding contacts on all the rheostats, to the posts marked "—F" on both of the audio frequency transformers and to the negative filament battery post on the panel. The top terminal of the fifty-six turn coil is connected to the sta-

tionary plates of the second variable condenser and to one terminal of the grid condenser and grid leak.

The post "P" on the first socket is connected to the top terminal of the second ten turn coil, and the bottom terminal of this coil is connected to the bottom spring on the first jack and to the positive forty-five volt plate battery post on the panel. The other terminal of the grid leak and condenser is connected to the grid post on the second socket.

The post marked "P" on this socket is connected to the top spring of the first jack, the second spring of which is connected to the post marked "P" on the first transformer, and the third spring is connected to the post marked "B" on this transformer.

Second Jack Connection

The post "G" on the first transformer is connected to the post marked "G" on the third socket, and post "P" on this socket is connected to the top spring on the second jack.

The second spring of this jack is

connected to the post "P" on the second transformer, and the third spring is connected to the post "B" on the same transformer. The bottom spring, as well as the bottom spring on the third jack, is connected to the positive ninety volt plate battery post on the panel.

The post "G" on the second transformer is connected to the post marked "G" on the fourth socket, and the post "P" on this socket is connected to the top spring on the third jack.

The negative plate battery binding post and the positive filament battery post on the panel are connected together and to one filament binding post on each of the four sockets. The remaining filament post on the first socket is connected to the resistance terminal of the first rheostat, and the remaining filament post on the second socket is connected to the resistance terminal of the second rheostat.

The two remaining filament posts on the third and fourth sockets are connected together and to the resistance terminal of the third rheostat.

An All-Wave Low-Wave Set

(Continued from page 46)

system were used on broadcast wavelengths. For this work, the circuit described and the method of regeneration control used will be found to be very good. The control of volume, as the condenser C2 might be called, gives very good results. A signal can be brought up to its maximum strength and held at that point without the usual distortion that takes place when a tickler coil is brought up to full regeneration or suddenly spills over into oscillation.

The following sizes of coils will cover the amateur bands very effectively:

Wave-length.	Secondary turns.	Tickler turns.
6	1	2
15	3	3
30	7	3
50	9	3
125	18	4
220	25	6

For the broadcast band the type of coil described will be rather bulky, although it can be used. In such an event, use 45 turns of No. 20 D.C.C. wire in the secondary, 10 in the tickler and a .0005 tuning condenser with a .0005 feed-back condenser.

In the above table, the lowest range that can be reached with the smallest coil or the one-turn coil is much lower than you will ever need. The maximum wave-length to which this will tune is approximately 10 meters. From

there on up to the 25-turn coil you will be able to cover every band of wavelengths used by amateurs today.

Do not forget, however, if you wish to adapt this set to broadcast reception that you must use a loose-coupled primary. Failure to do this will make you most unpopular with your neighbors, inasmuch as a set of this type with a capacity coupled antenna circuit will radiate terrifically. If you so desire, a little ingenuity will enable you to fix up a switch or plug arrangement whereby you can quickly change your set from short-wave to broadcast-wave reception. In fact, it is entirely possible, and some amateurs prefer, to make this set inductively coupled over its entire range. Some do not like the capacity coupled antenna system and, therefore, a separate primary can be used for all waves. In such an event, use the primary mentioned above for broadcast reception and a 3-turn coil for short-wave reception. We are sure that a set of this nature will furnish all your expectations for a short-wave set and will give you all the satisfaction that is possible.

When you start tuning down around the 20- and 40-meter wave-length bands, you will find that the tuning is extremely sharp. In fact, you will be able to do much better work if you incorporated an external vernier on the panel of the set. The cheap types using a rubber wheel in frictional con-

tact with the dial are perfectly satisfactory and give excellent results. Possibly one will say that they do not look as good as standard vernier dials, but on the other hand they work just as well, so why worry about looks?

In tuning this set, place the oscillation control dial at a point where the set is in quiet oscillation. You can test for this point by listening for the "pluck" that will be heard if you touch your finger to the grid binding post of the socket when the set is in oscillation. You will find that the oscillation control dial need only be varied over a space of possibly ten degrees on either side of this point, and it should be varied simultaneously with the tuning dial as you cover the entire range of the set. After you have worked the set for a short time you will acquire the knack of tuning it correctly, as it is very simple to handle. Because of the type of oscillation control that is used in this set, varying such control has little if any effect on the tuning of the set. Therefore, you can log this tuner quite accurately and can check your transmitter with it.

Considering the fact that there are quite a few foreign amateurs on the air using 20 and 40 meters, the one who constructs this tuner will find himself amply rewarded for his labors. Certainly one cannot help feeling thrilled by the signals from some far-distant country!

Another One-Control Receiver

A Three-Section Condenser Tunes a Five-Tube Set with One Dial

THE most popular type of receiving set today is the tuned radio-frequency receiver and to date there are many varieties. All follow the same fundamental circuit principles. When two stages of tuned radio frequency are employed and the construction details are in keeping with good engineering practice, all the points that make up a good broadcast receiver are available.

Matter of Design

This feat was not accomplished as easily as might appear, but after considerable work on the part of engineers it has been made possible. The one controlling factor in producing a receiver with one control is the design of the radio frequency coils and the variable condensers. The variable condenser must be low-loss and must be a precision made product if it is to

actually supported on air and only makes contact with glass, which is one of the best of high frequency insulators. The windings are so designed that no centralizing is necessary, thus simplifying the construction of the set.

Parts Required

Probably the most important unit for this set is the Bruno "Three-in-one" variable condenser, and since

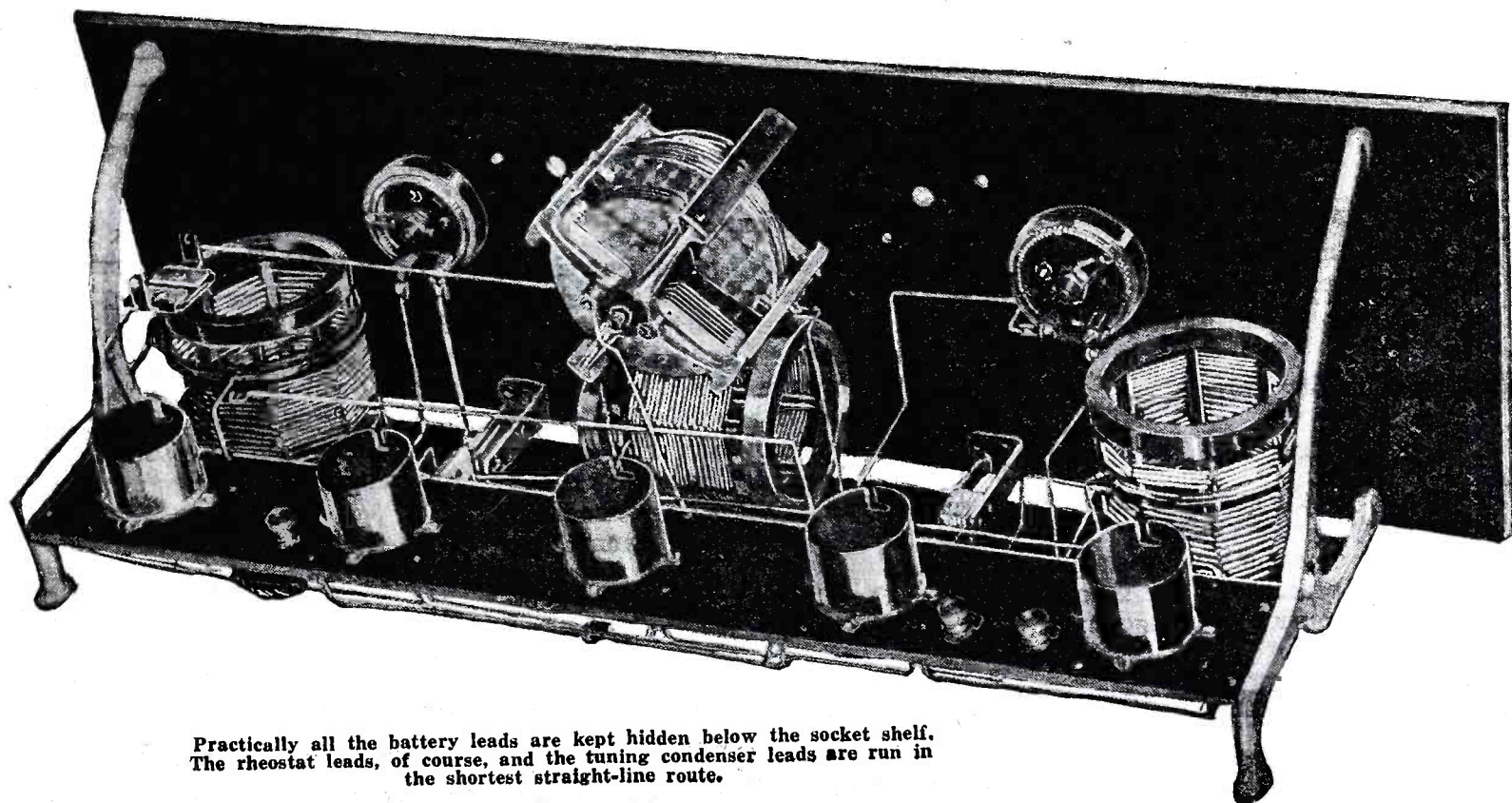

Practically all the battery leads are kept hidden below the socket shelf. The rheostat leads, of course, and the tuning condenser leads are run in the shortest straight-line route.

Illustrations by Courtesy of *Wireless Age* (New York)

Sidney E. Finklestein in *Wireless Age*, New York, gives details for building a receiver at this time, employing only one tuning control. His article reads as follows:

The tuned radio frequency receiver possesses selectivity, volume and faithfulness of reproduction, but has one disadvantage, that is expressed by many who already have a set of this kind, and that is the customary three dials for tuning. Because of this disadvantage many fail to obtain the best that is in their set, as they do not seem to be able to master the manipulation of the three dials. In the radio receiver described below, a great step toward the refinement of the tuned radio receiver has been taken by reducing the tuning controls to one.

function properly. The one used in the set below is really three condensers in one; that is, there are three separate sets of condenser plates. The three stator sections are insulated from one another, while the rotor plates are on the same shaft. This unique construction insures that the three condensers are synchronized, thus tuning each portion of the circuit alike.

The radio frequency coils are also very important in this set and have been designed to possess the highest possible efficiency. These coils embody a new idea in the supporting member of the coils. They are wound on quartzite rods which are held between two rings of hard rubber, thus forming a cylindrical cage. With this type of winding form the coil is vir-

there is but one type of this condenser on the market at this writing, the radio fan should not go wrong in selecting the right one. The radio frequency coils described above are made by the same concern and are designed to be used with the special condenser.

In order to build the set as shown in the accompanying illustration, new five "gang" sockets will also be required. The audio transformers should be of high quality, as well as the rest of the material listed:

One panel, 7x24 in.

Two Bruno 20-ohm rheostats.

One five-"gang" socket (or five standard sockets).

Three Bruno non-oscillating R. F. coils.

One Bruno ultra-vario condenser (three in one or four in one).

- One audio transformer (5-1 ratio).
- One audio transformer (3-1 ratio).
- One double circuit jack.
- One single circuit jack.
- One Sangamo grid condenser (.00025 mfd.).
- One Veby gridleak (2 megohms).

transformers are mounted in the rear of the panel. This may be accomplished by using the customary base-board or by the use of special brackets and sub-panels, which is well worth the extra work and is the way recommended by the author.

looking at the rear of the set, the first radio frequency socket. The centre socket should be for the second stage of radio frequency and the one on the extreme left end the detector. That next to the detector is for the first stage of audio frequency and the re-

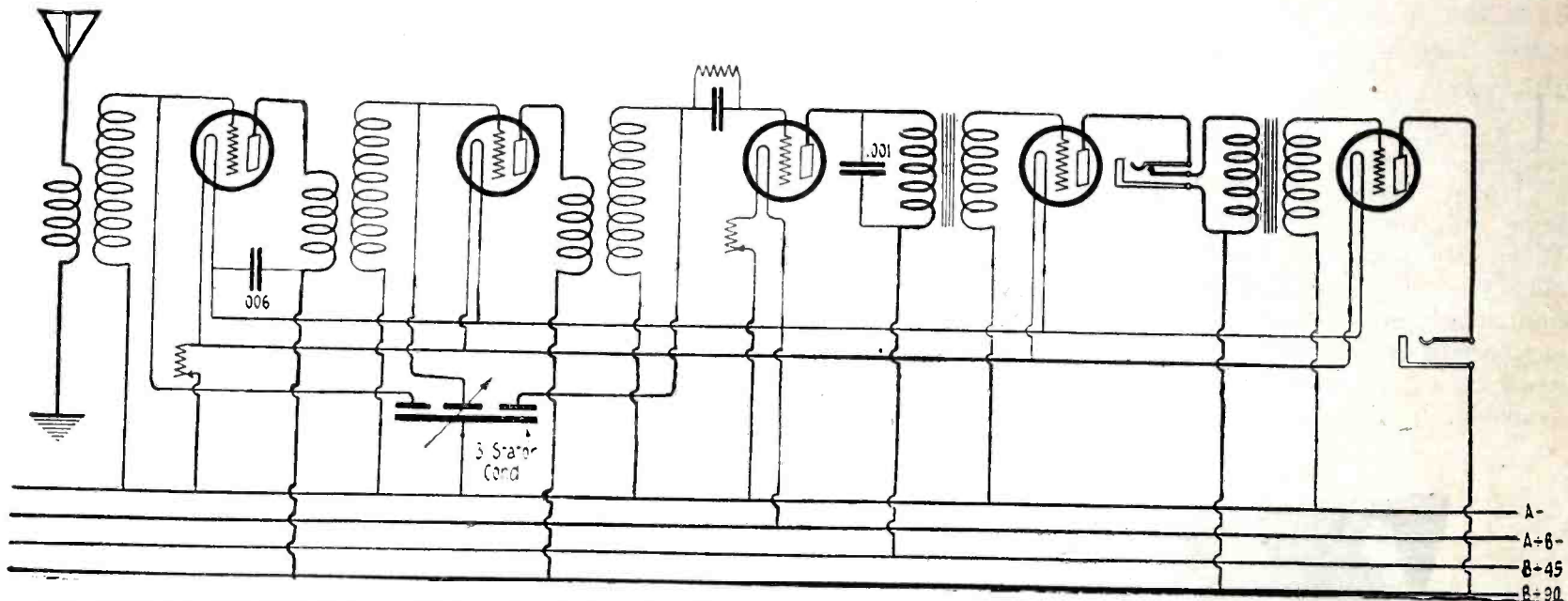

This shows how the triple-stator variable condenser tunes the three radio-frequency transformers simultaneously. The common rotary plates are connected to the negative A battery

- One battery switch.
- Two Bruno brackets for sub-panel and "gang" sockets.
- One Sangamo condenser (.00025 mfd.).
- Six Bruno binding posts.

Construction

The panel layout is exceedingly simple, there being but one control. Thus it is possible to give the panel a simple and dignified appearance. The special tuning condenser should be mounted

Wiring

Needless to say, the filament circuit is the first to be wired. Care should be taken to get the polarity of the filament leads correct, as this is so often overlooked by the radio fan. After this is done, it is a good plan to test this circuit by connecting the filament battery to the set and inserting a tube in each socket to make sure rheostats, battery switch and socket contacts are all right.

Proceed with the rest of the wiring, making sure to connect the radio fre-

quency coils correctly. The antenna tuning coil, or first radio frequency coil, is the one with the largest number of primary turns (eight turns). It should be remembered that the grid return leads from each coil are connected to the rotor of the condenser, which is a common connection for each stage.

maintaining socket serves as the second stage of audio frequency amplification. It will be found that this arrangement makes the wiring exceedingly simple, and if done in a workmanlike manner will present a fine appearance. Well-soldered joints should be made, using only resin core solder and a hot soldering iron.

Recheck Connections

When the work on the set is finished, go over the wiring and check it carefully with the circuit diagram and see

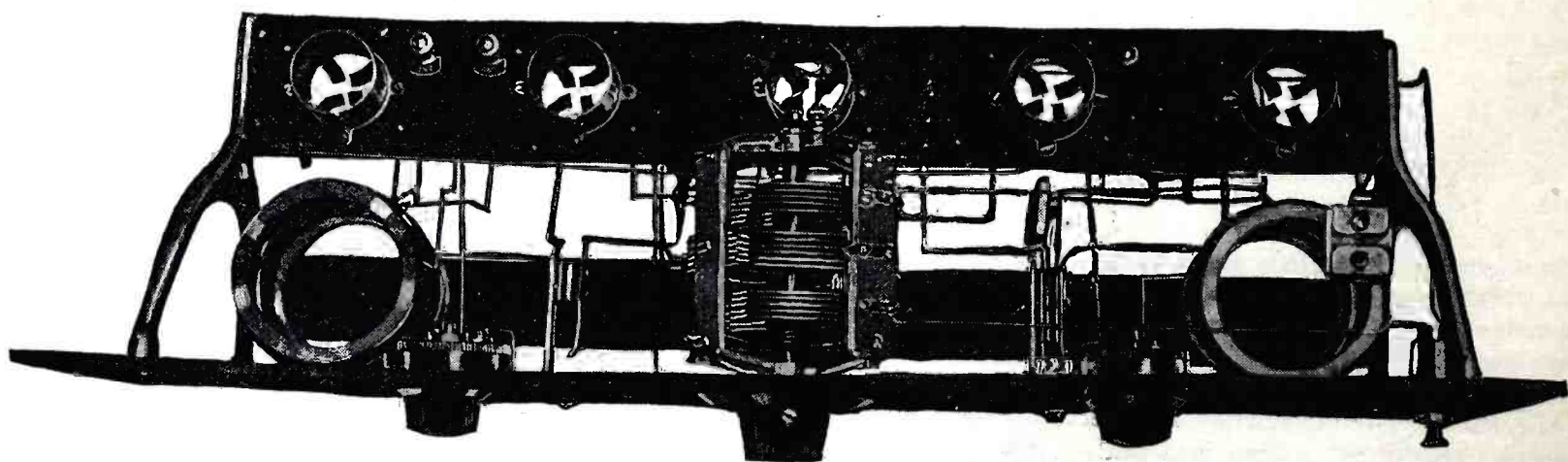

An excellent view of the completed receiver showing the relationship between the instruments mounted on the panel and the tube sockets on the sub-panel.

in the center of the panel, from left to right and just above the centre from top to bottom. The two rheostat dials are placed one on each side of the master tuning dial, these being on the horizontal centre line. The jacks and battery switch are placed in line about two inches from the bottom. This arrangement is very striking and is a departure from present layouts.

Next, the coils and sockets and

quency coils correctly. The antenna tuning coil, or first radio frequency coil, is the one with the largest number of primary turns (eight turns). It should be remembered that the grid return leads from each coil are connected to the rotor of the condenser, which is a common connection for each stage.

In wiring the sockets, the arrangement that makes wiring easy is to make the extreme right socket, when

that each lead is correct. This done, connect the batteries to the set. "B" battery voltages should be forty-five for the detector and ninety volts for the remaining tubes. Six volts are used for the "A" battery when 201A type tubes are used.

There are no tuning directions necessary, as there is but one dial to turn. Rotate this tuning dial slowly and then log the stations that come in.

A Neutrodyne with Resistance Amplifier

Radio Frequency Transformers Used in This Receiver Can Be Easily Made at Home

ONE of the most practical forms of radio frequency receivers in general use today is the neutrodyne. This is because of the exceptionally true tonal reproduction with maximum efficiency obtained from the radio frequency amplifiers. Another point about this set is that it gives ample

as if the piano was in the same room. They have a true musical ring to them. He does not overlook the sibilants and the high tones. You do not have to guess at the S's; you hear them as they were spoken. Perhaps they are a little too much accentuated, but that is mostly a psychologic effect; you have

When the radio fan is seeking good quality it is necessary that he should eliminate as many of the sources of distortion enumerated above as possible, also as completely as possible. The resistance-coupled type of amplifier is inherently free from many of those causes and many of the others may

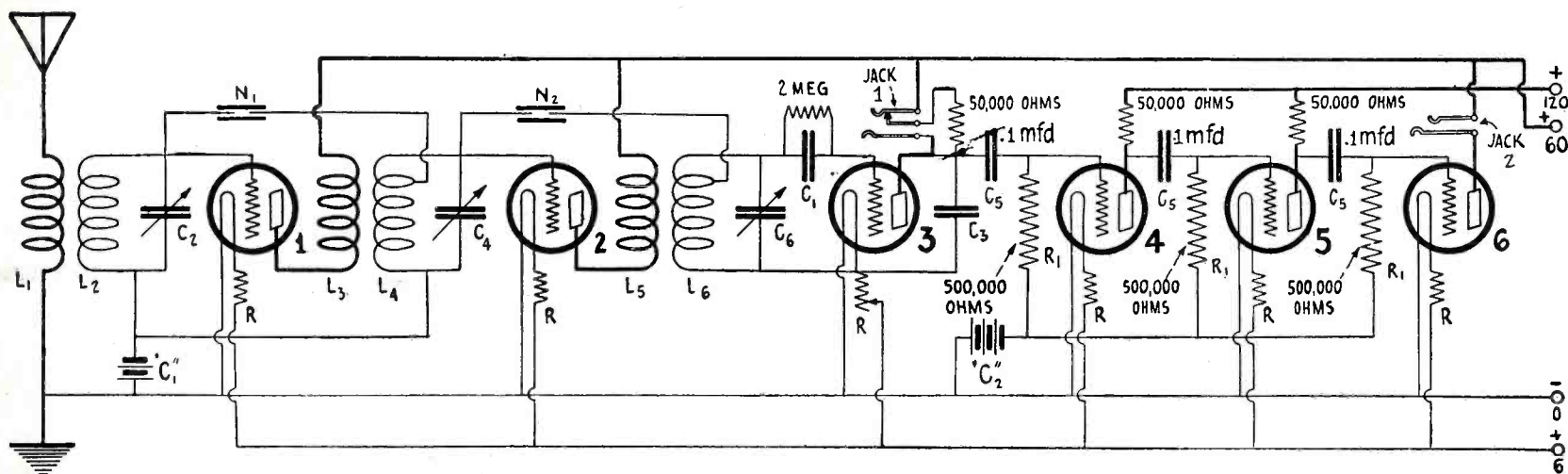

Fig. 1. A schematic wiring diagram of the Neutrodyne receiver with resistance coupled audio frequency amplifier. This hookup is fully described in the text of the article.

selectivity. The greater number of neutrodynes in use, however, employ straight transformer coupled audio amplifiers and this form of amplification cannot be equally compared with resistance coupled amplification in preserving tone quality. Therefore, we are presenting herewith an article by J. E. Anderson, which appeared in *The New York Herald-Tribune* on the construction of a neutrodyne with a resistance coupled audio amplifier and we believe the home radio constructor will find this set fully as efficient as the author claims. Mr. Anderson tells his story as follows:

The cry in radio circles has been selectivity and volume. But there is no trick at all to get great volume out of the radio receiver, which fact is attested by the abundance of radio squawkers everywhere. The novelty of having a big noise in the house and calling it radio is wearing off. The pride of a radio owner is now beginning to center on selectivity and quality, the latter in particular, as that is still a rare attribute of a radio receiver.

He no longer boasts about how many blocks away from the loud speaker the latter can be heard, but he calls attention to the excellent quality of the signals as heard a few feet away from the set. He calls attention to the manner in which the low notes of the piano come through. No thumping, but just

heard so many loud speakers with the S's suppressed.

Now there are a great many sources of bad quality in a radio receiver. The tubes may be operated over a portion of the grid voltage, plate current characteristic which is badly curved; the

readily be eliminated. Hence from a quality point of view it is superior to all others. Its disadvantage is that it requires a greater number of tubes to produce the same signal intensity than transformer coupled circuits. This, however, is not a serious matter in a

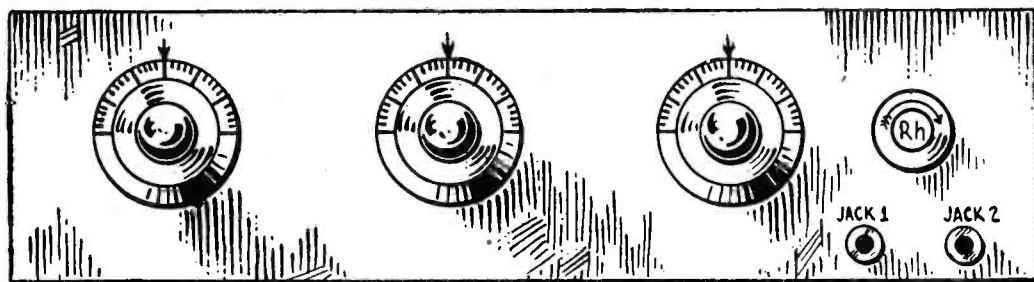

Illustrations by Courtesy of N. Y. Herald Tribune.

Fig. 2. A suitable layout for the set. This is based on the standard 7 x 26 in. size which is ordinarily used for neutrodynes.

tubes may be overloaded; in a choke coil coupled amplifier the impedances may be too low; the audio-frequency amplifying transformers may be improperly designed—the most frequent cause, perhaps; the loud speaker unit may not be correctly designed; the horn of the speaker may have resonance points for certain frequencies; the loud speaker may be seriously overloaded. In many cases, of course, the signals are badly distorted before they take the air at the transmitting station. The simplest remedy for that type of distortion is to turn the knobs of the tuner.

circuit which already uses many tubes, and the gain in quality far outweighs the small additional cost of a tube or two. Usually three stages of resistance-coupled amplification connected to a good detector will give sufficient volume to operate satisfactorily a loud speaker.

Receiver Description

Below is described a receiver employing six tubes, two of which are radio frequency amplifiers, one a detector, and three audio-frequency amplifiers. The radio-frequency portion employs capacity neutralization to pre-

vent self oscillations, and the audio-frequency portion employs resistance coupling between the stages. This circuit is as selective and sensitive as the ordinary well known neutrodynes and it is capable of delivering loud speaker volume of high quality.

The three tuning units, including coils and condensers, should be ordinary neutroformers which may be purchased in almost any radio store ready for mounting on the panel and for connecting up in the circuit. Only the best and recognized makes should

fixed condensers in the circuit should have mica dielectric. N-1 and N-2 are two neutralizing condensers and may be of several types obtainable on the market.

The grid leak resistance in the detector should be about two megohms. The grid leak resistances R-1 in the three audio-frequency amplifiers should be about 500,000 ohms each. The three coupling resistances in this amplifier should be about 50,000 ohms.

Only one rheostat, Rh, in the detector, is used in the circuit. For the

correct value by experiment by determining which gives the purest quality and at the same time loudest volume. It is always desirable to use a rather high plate battery voltage.

An open circuit antenna and a good ground should be used with the receiver. A heavy copper conductor running directly to the nearest cold water pipe and soldered to it makes the best ground. The antenna should be a heavy copper wire erected outdoors if possible, from 75 to 150 feet in length, but a smaller indoor an-

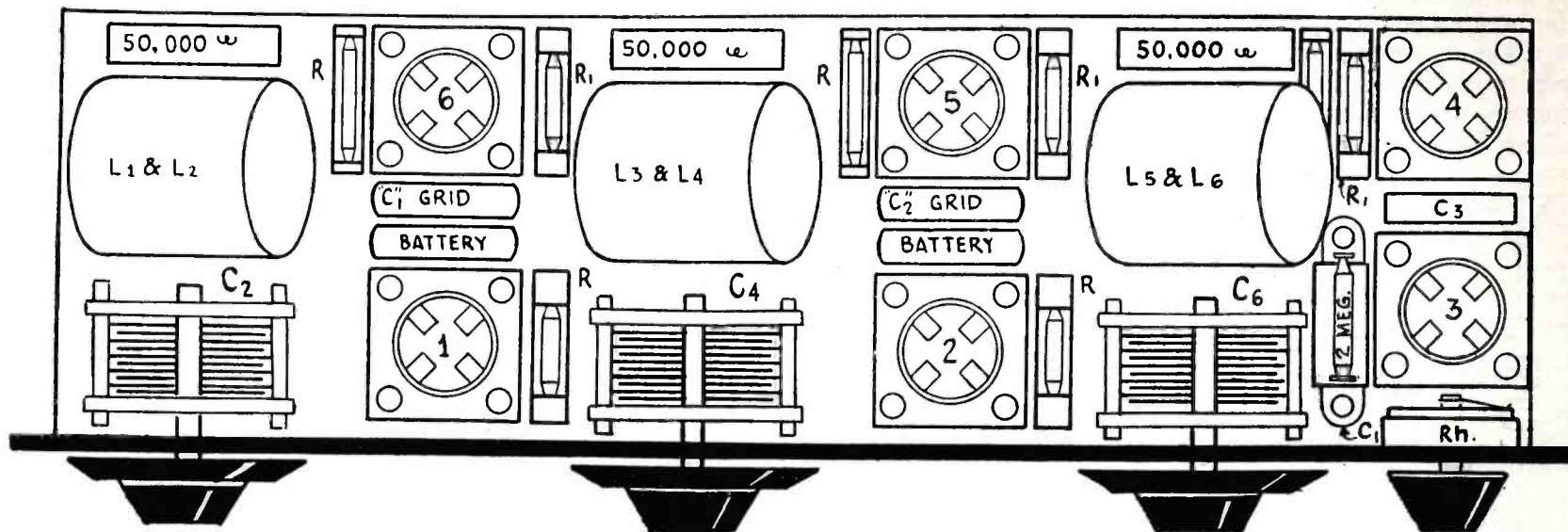

Fig. 3. The baseboard layout of the neutrodyne with resistance coupled amplifier. The parts are all clearly indicated to conform with the diagram given in Fig. 1.

be employed. Avoid the "gyp" brands which may be offered at a lower price than the standard articles. The pain of parting with an extra dollar is not nearly as great, nor will it last as long, as the regret at having been "stung" by an inferior piece of goods.

There are many who may desire to make their own coupling and tuning units. The following design has given good results and may be employed: Coils L-1, L-3 and L-5 each consist of 6-10 turns or No. 24 double cotton covered wire on a bakelite tube 3 inches in diameter. Coils L-2, L-4 and L-6 each consists of sixty turns of the same size wire wound on the same tubes. Each of these coils has a tap at the seventeenth turn, measured from the primary winding in each case. L-1 and L-2 are wound on one tube, L-3 and L-4 on another and L-5 and L-6 on a third. In each case the primary and the secondary are wound in the same direction, but there is a separation of about one-fourth of an inch between them. When these coils have been wound they are mounted on the 17-plate condensers in the same way as the commercial coils.

Condenser C-1 should have a capacity of .00025 microfarad. C-3 is a by-pass condenser across the coupling resistance, or across the telephones when they are inserted into jack 1. Its value should be about .001 microfarad. The three condensers C-5 are used to prevent the grids from becoming positive. They should each have capacity of .1 microfarad or greater. All the

sake of simplicity fixed resistance R or automatic filament resistances are used in the other tubes. This greatly simplifies both construction and operation of the set. The automatic-filament resistance may be of the Amperite type, and the values depend on the type of tube used. If fixed resistances are used each of the R resistances should be 4 ohms when UV-201A are connected across a 6-volt battery. A fixed resistance or Amperite may even be used for the detector tube filament circuit. Six ohms is about the right value, as it is desirable to operate the detector at a temperature slightly less than that of the amplifiers.

C is a grid biasing battery for the two radio frequency amplifiers. Its value should be 4.5 volts. C-2 is a grid biasing battery for the three audio-frequency amplifiers. The correct value of this depends on the effective value of the plate potential on those tubes. This effective value is the plate battery voltage, 120 volts, diminished by the fall of potential in the coupling resistances. Assuming that the plate impedance of the tubes is 20,000 ohms and the coupling resistance is 50,000 ohms, the current flowing in the plate circuit with a voltage of 120 is 127 milliamperes. Hence the fall of potential in the coupling resistance is 86 volts, and the effective value on the plate is 34 volts. This voltage requires no negative bias. If the battery voltage were raised to 150 the negative bias should be about .5 volts under these assumptions. It is best to find the

tenna may also be employed if desired.

The best tubes for this circuit are the UV-201A or C-301A types. These will give greater amplification and better quality than the smaller types of tubes. A six volt storage battery of about 90 ampere-hour capacity is required for supplying the filament current for these tubes.

Panel Lay-Out

A suitable panel layout for this receiver is shown in Fig. 2. This is based on the standard size of 7"x26", which is ordinarily used for neutrodynes. The tuning units have been separated much farther than is usual, which has been done to reduce undesired coupling between stages and to make neutralization easier. Since there is only one rheostat in the circuit, this has been placed on the extreme right hand end of the panel, and the two jacks have been placed directly under it.

The baseboard arrangement shown in Fig. 3 has been designed to fit the panel layout in Fig. 2. The various coils, condensers, resistances and batteries are marked in conformity with the same parts on the panel layout and on the circuit diagram of Fig. 1. The two neutralizing condensers N-1 and N-2 are not shown on Fig. 3, but these may be placed on the baseboard under the second two radio-frequency transformers, L-3 and L-4 and L-5 and L-6, where they are easily accessible for adjustment. The large blocking condensers C-5 have also been omitted

(Continued on page 66)

Receiving without an Antenna or Loop

A Description of the Set of Station MSU, France, which Operates without Aerial or Loop

IN this article by a distinguished French amateur, *Lieutenant Sudre*, we are taken into a field of extraordinary scope and possibility and we find our old friend Super-regeneration, attired in novel dress and applied to the proposition of radio reception, both amateur and broadcast, using but one tube and operating without any of the conventional collective means such as loops or aerials. The author reports hearing programs from English stations with his receiver located at Toulon, France. The distance from Toulon to London is between 600 and 700 miles airline, a fair enough distance for one tube under any conditions, but a most noteworthy performance where no loop or antenna was used.

It was not the intention of the author, nor is it our intention in presenting the article in English, to infer that such reception with one tube and no antenna is a simple matter. The Super-regenerative system is at best a ticklish affair and the utilization of the principle in the manner here described naturally complicates the operation to a great extent. The experiment should not be undertaken in a casual way. Extreme care must be taken to remove or reduce all extraneous influences; to prevent the detrimental effect of "body capacity," and particularly in the close adjustment of the set.

Due to the differences between the French and English methods of expressing technical problems it was impossible to offer a literal translation of *Lieutenant Sudre's* article and many liberties have been taken with his excellent descriptions in order to make it comprehensible to our readers. It will be noted, for example, that reference is often made to "connection" and "disconnection." This is merely one way of describing the effect of blocking or stopping of the circuit. When the breaks are infrequent they can be counted readily, but as the grid potential is made more positive the frequency of the breaks increases until they reach a point at which they appear as a whistle of more or less volume. This will be discerned by the technically versed as the "variation frequency" which requires such careful consideration in Armstrong's Super-regenerative system. In some of the American modifications of the circuit means are taken to increase the pitch or frequency beyond audibility and this is approximately what the author accomplishes here.

It will be understood that constants of the circuit are open to much experimental work. For various wave bands, such as the amateur, broadcast, government and so on, changes will necessarily be made in the inductances and capacities. A good plan will be to construct this receiver on a large board, with ample spacing of all parts. Be sure the board is perfectly dry and then

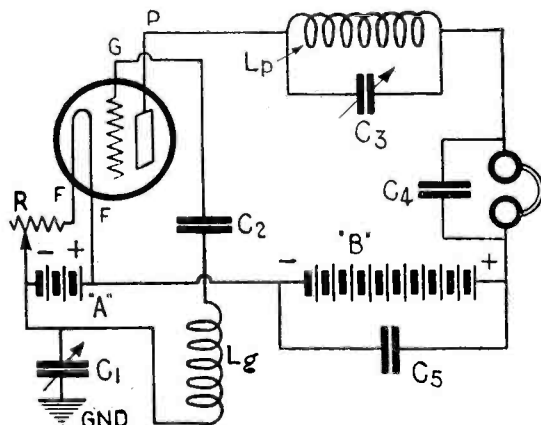

Fig. I. Schematic diagram of connections for one-tube receiver. Note carefully all lettered parts and refer to text.

insulate each unit from the base. Low-loss instruments and coils may be used to good advantage here, where the slightest loss not only may impair the volume of signals, but can easily throw the receiver out of the perfect balance that is so essential. A suggested layout is given, but obviously, the constructor who is sufficiently versed to assay this rather difficult task will have his own ideas on the matter of placement of the components.

In the article we have inserted occasional parenthetical notations to clear up points that do not seem lucid. This article first appeared in a contemporary French periodical, *Radio-Revue*, Paris, France. Singularly enough the name of the journal is the French equivalent of our own *Radio Review*. The complete data follows:

Some time ago our distinguished general secretary, *Mr. Ouimet*, in a conference on the future of radio, held at Tours, France, foresaw operation without antenna or loop, at least insofar as reception was concerned. Many of his listeners were inclined to the belief that the idea was somewhat premature; that the time was not ripe for such an advance. And now it is nearly a year since station MSU commenced operating without any antenna or loop, to the great satisfaction of its owner. The splendid results which I obtained under the most unfavorable conditions (English concerts at Toulon on one tube), show once more the marvellous

sensitivity of the three element vacuum tube. I am sure that if the amateurs having 4 or 5 tube sets suspected only a small fraction of the results possible with one tube, they would rush to their sets immediately after having read this article and attempt to reduce the number of tubes to a minimum.

We will leave the too general considerations in order to start immediately with the subject of this article. The receiver is a one tube set. As shown in the sketch it is an ordinary regenerative detector having certain peculiarities which we will indicate immediately.

First: There is no coupling between L_g and L_p .

Second: The condenser "C²", called the detection condenser, has a value of .004 microfarads. That is about twenty times the value of the ordinary grid condenser.

Third: As in an ordinary detector the grid must be positive in relation to the filament, but here it is connected to the positive "B" battery (45+ or 90+). Experience has shown that this arrangement is much more "energetic" and flexible than if connected to the positive "A" battery. One quarter of an hour should be sufficient to build such a receiver. I must remark here that the adjustment is very delicate and

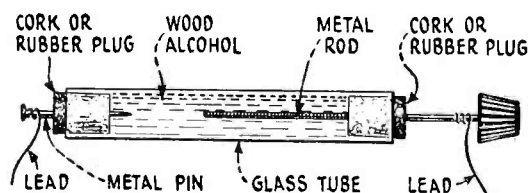

Fig. II. A simple form of variable high resistance element. The leads appear at either end.

the amateur who experiments with it must have a thorough knowledge of the nature and origin of the noises and peculiarities of a tube set.

A Description of the Set—the Parts Used

Induction Coils.

(a) Coil L_g .

40 or 45 turns of double cotton covered wire (about 22 or 24 D.C.C.) wound on a tube three inches in diameter. The coil is tapped at every fifth turn.

(b) Plate coil L_p .

Same dimensions as above but wound in the opposite direction. (In view of the previous notation to the effect that there is no coupling between coils L_p and L_g this may seem paradoxical. The author evidently intended to convey the impression that external conflicting fields might occur

were the two coils wound in the same direction and placed near each other.)

Condenser.

(a) Condenser C1 is variable having a capacity of .00025 mfd. This condenser should have a long insulated handle or be tuned by means of a hard rubber or bakelite rod with a rubber attachment to act as vernier. (An eleven or thirteen plate condenser should suffice. Ed.)

what in eliminating difficult factors in operation.

The tube used was of very low filament consumption, using 2.8 volts and consuming but a small fraction of an ampere.

The ground wire may be connected to a water pipe or other good metal ground.

Location of the Receiver. Avoid the presence of any metallic substance or

the amplification of the signals due to the regeneration is limited, either by the saturation current of the plate or by the fact that increase of regeneration beyond a certain point compensates the entire effective resistance of the circuit (grid) and actually produces a negative value, the tube then having a tendency to break into violent oscillating under the slightest exterior influence. (And as the author puts it, "to the

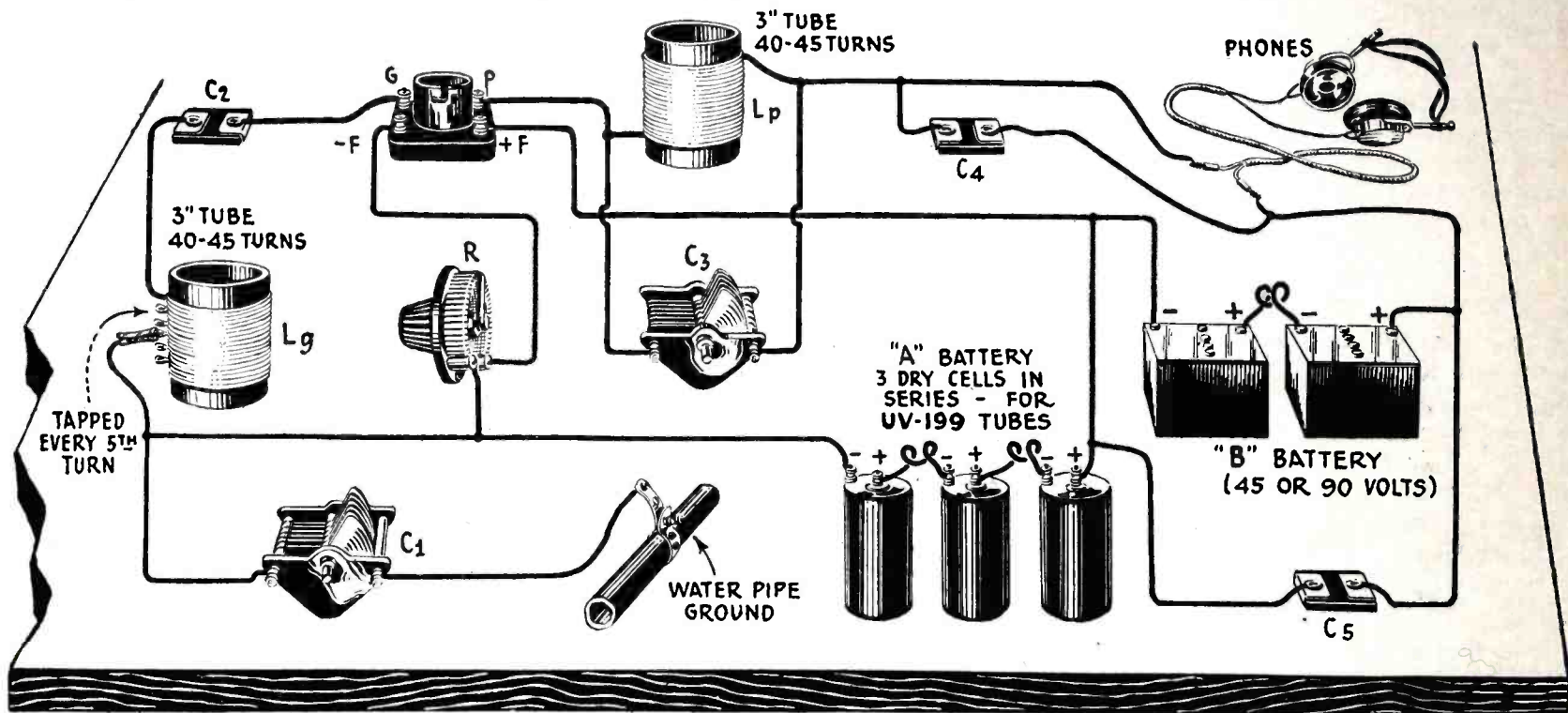

Fig. III. Perspective diagram showing a suggested method of arranging parts on a large board. The ground connection is shown on the board to make the connections clear.

(b) Plate circuit or reaction condenser C3. Variable capacity .001 mfd. Also to be equipped with long handle. (This is a most important unit and should be the best obtainable. Ed.)

(c) Detection condenser C2. Fixed condenser capacity from .002 to .004 mfd.

(d) Phone by-pass condenser C4, fixed .001 to .002 mfd.

(e) Battery by-pass fixed condenser. Absolutely essential where the internal resistance of the "B" battery is high. This is C5 and is the usual high value unit.

Grid Leak.

This must be a variable unit and should range from 0 to 25 or 30 megohms. A very satisfactory one may be made by using a small glass tube having a quantity of wood alcohol. A contact is used at either end and by adjusting the rod more or less of the alcohol is placed in the circuit. The illustration shows a convenient form. (There are several high value resistances made by American manufacturers.)

Head Phones.

Ordinary phones in parallel, each having high resistance, preferably 2000 ohms. The sensitivity of this receiver is so great that it is advisable to use phones having composition shells rather than the usual metal type. This is not strictly essential as the results given here were obtained with the conventional phones but may help some-

any coil not in use, in the neighborhood of the set. Be as far as possible from wires carrying light or power supply. During adjustment of the set make sure it is not in contact with any conducting material, even a moist board. These precautions are necessary owing to the extreme sensitivity of the set.

An Attempt to Explain the Operation of the Set

The astonishing sensitivity of a set operating with none of the ordinary forms of collective agency such as loops or aeri-als cannot be explained by the theory of regeneration alone, for which reason the results of observations and measurements will be gone into more fully.

The action of a regenerative detector is well known but may be dwelt with briefly. A part of the high frequency energy that is a component of the energy present in the plate circuit is fed back to the grid circuit of the same tube, either by double transformation (electromagnetic coupling) or without transformation but by electrostatic coupling. It is observed that if this action of "feeding-back" is accomplished under certain conditions, notably where the current is in phase with the incoming oscillations of the antenna, the strength of the incoming oscillations is increased. There is also in this case, the possibility of reception of CW or undamped oscillations.

Now in the case of feed-back action

great harm of the diaphragms of the phones and the tympanium of the listener.") Armstrong has found the solution to the problem, in fact he showed that it is possible to operate a tube even in this zone of regeneration where the reaction is so great that the tube has a tendency to oscillate violently. It is only necessary to apply in the grid circuit of variable voltage of a relatively low frequency—for example 15,000 cycles. The variation of grid potential must be considerable, possibly about ten volts on either side (positive or negative) of a certain voltage.

The method used by Armstrong was to place in series with the grid circuit of a regenerative detector, a second oscillation circuit and to insert a second inductance coil in the plate circuit to produce, by induction, powerful oscillations of the order of say, 15,000 cycles. These oscillations are purely local and have no influence on the original oscillations of the tube, which was regulated to receive the incoming signals. (These incoming oscillations would have a frequency ranging from about 500,000 cycles to 1,200,000 cycles, or roughly from 600 meters down to 250 meters, for broadcast.) The foregoing was necessary in order to make clear the following: It is evident that any device which will allow variation of the grid potential, say 15,000 times per second, will produce the result of super-regeneration as attained by Armstrong.

We can now direct our attention to the receiver. A millimeter placed in the plate circuit will show when the grid potential is zero, and if the filament is of a certain temperature the plate current will be discontinuous, even if there are no incoming signals from the antenna. The set will give the impression of being periodically connected and disconnected. The frequency of this steady series of seeming breaks will be very low, probably three or four times per second. Each "connection" or "disconnection" will be indicated by a deflection of the millimeter needle or by a click in the phones. If the grid is made more positive we can observe that the number of breaks increases. The deflections of the needle will occur at more frequent intervals and the clicks in the phones will also be more frequent. If the grid is made still more positive we arrive at a point where the "interruption frequency" is so high that the needle of the meter, due to its inertia, can no longer keep pace with the oscillations and remains virtually still, while at the same time the diaphragms will respond with a low-pitched sound of considerable power. A further increase in the grid potential raises the pitch of the sound emitted by the phones but decreases its strength. The plate current decreases and it seems that, though there are no external oscillations, the grid is subjected to a faster change of potential (many thousands per second) and the effect is similar to that in a super-regenerative system.

The relatively slow variation of the grid potential is due either to the influence of the plate on the grid (electromagnetic or electrostatic coupling) as is the case with a super-regenerator, or to the internal capacity (capacity of the tube elements), the latter being the cause in the case under discussion. This action is very powerful as the variation of the plate current in a small French tube has a value from .5 to .6 milliamperes. (The UV199 will serve the purpose. The meter may have a range of about 5 milliamperes. Editor.)

Everything said regarding the standard super-regenerative system may be applied to this receiver.

Adjustment of the Set

I am starting this section under the heading Adjustment. It is fraught with possibilities and perhaps much that can be ignored. Don't be discouraged, however, if I tell you that the adjustment of the set is not easy. For those with no experience it may prove extremely difficult. I expect that, armed with great patience and ably assisted by your tools you have been able to build the receiver. Perhaps you have hit it right the first time without suspecting it.

First light your tubes, put on the headphones and watch results, having

the following admonitions in mind: Follow them closely; it is not likely that you will fail to obtain some results or noises at once.

tapped will be much more pronounced when the receiver is about to be "disconnected."

3. Having made sure that the tube

TABLE 1

Variable Element—Grid Leak, also Millimeter in Plate Circuit		
Value of Leak Resistance	Characteristic Noises in Operation of Set.	Grid Potential
Infinity	2 or 3 clicks per second. Needle of millimeter oscillates around an average value.	0
Many tens of Megs	Clicks are more frequent and needle vibrates rapidly.	Very slightly positive
20 to 25 Megs.	Clicks very frequent. Needle no longer moves due to its inertia.	Slightly positive
10 to 15 Megs.	Phone diaphragm emits low-pitched noise, becoming more sharp as grid potential rises.	Very positive

(Note. The settings of the condenser dial will naturally vary somewhat with the particular parts used. These tables are given partly because they represent much hard work on the part of the author and partly because, while not accurate, the relative action will be the same no matter what dials are used. Utilize them chiefly in order to grasp the sequence of characteristic effects.)

TABLE 2

Variable Element—Reaction Condenser C3 in Plate Circuit, also Milliammeter		
Setting of Condenser	Characteristic Noises of Set	Role Played By Tube
	Tube rings loudly.	
0° to 10°	No noises except spark signals from nearby, powerful stations. Parasitic noises not audible.	Detector
10°	The receiver is "connected" at this setting. Undamped waves of nearby stations, spark signals and atmospherics audible at this point.	Detector-Autodyne
20°	First zone "super". Second click. Weak, shrill whistle. Excellent zone for reception. Great amplification and remarkable sensitivity.	Detector-Autodyne Super-regenerative
23°	Second zone "super". Howling, coupled with noise of boiling water. Signals completely submerged by parasitic noises and while amplification is tremendous reception is impossible.	Detector-Autodyne Super-regenerative
32°	Same noises as in first zone.	Detector-Autodyne Super-regenerative
35°	The receiver is "disconnected" the first time. Same noises as in second zone and characteristics for reception are the same.	Detector-Autodyne
60°	Receiver is "disconnected" the second time,	Detector
Up to 180°	Same as from zero to ten degrees.	

1. The tube should ring strongly if you tap it with the finger.

2. By rotation of the tickler you will hear a click in the phones. This means that the receiver is "connected" or "disconnected" as explained earlier. In order to establish which of the two, remember that:

(a) There will be a certain hissing noise each time before the receiver is "connected".

(b) The ring when the tube is

is "connected" increase the value of the capacity at the terminals of the reaction or tickler coil in the plate circuit (C3). You will then hear a second click, which means that the receiver is "disconnected" but that the tube is about to enter a new phase of operation. Note: This second click is immediately followed by a weak whistle of very high pitch. If the capacity is then increased, the whistle will be amplified and become a howl. At the same time other

(Continued on page 70)

A Selective Single Tube Reflex

Maximum Results from One Tube Set Used by English Radio Fans

THE old saw about initial expense being less than the upkeep may well be applied to radio apparatus, at least insofar as the number of tubes used in the receiver are concerned. Here, however, we find it possible at times to keep the upkeep at a low figure and at the same time reduce the necessary initial expense. Experimental work with one tube reflex sets has shown that it is possible to obtain excellent results both for sensitivity and volume by use of a crystal detector in conjunction with one amplifier tube used as a dual radio frequency and audio frequency amplifier. Obviously the drain on the "A" battery is held at a minimum and the consumption of current from the "B" battery may also be somewhat reduced.

Referring to the circuit diagram, it will be seen that the circuit adopted is of the reflex type, somewhat similar to

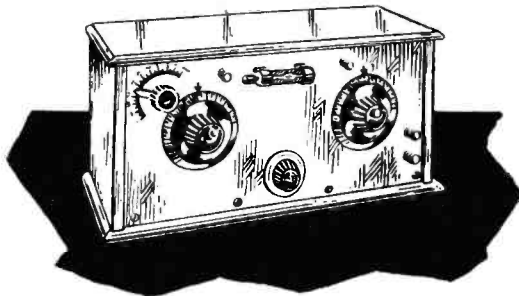

Illustrations by Courtesy of *Wireless World* (London, England)
Sketch showing the selective single tube reflex as it appears when completed.

that popularized by Voigt, using untuned aerial, tuned tube-to-crystal transformer, and crystal detector. The

The rectified crystal output is reflexed back to the tube, as very appreciable audio frequency amplification is thus obtainable. For the sake of stability and freedom from buzzing, no audio transformer is used. As there is no step-up of voltage to the grid, the tube may well be of the high amplification type, and the 216A type is suitable if very loud signals are required.

Type of Tube

For ordinary requirements, a general purpose tube, such as the UV201A, works admirably. It will generally be found that there is less interference from the local station if a power tube such as the VT2 or 216A is used, with suitable grid-bias and ample "B" battery. Presumably this is due to the fact that the long, straight part of the characteristic curve of this type of

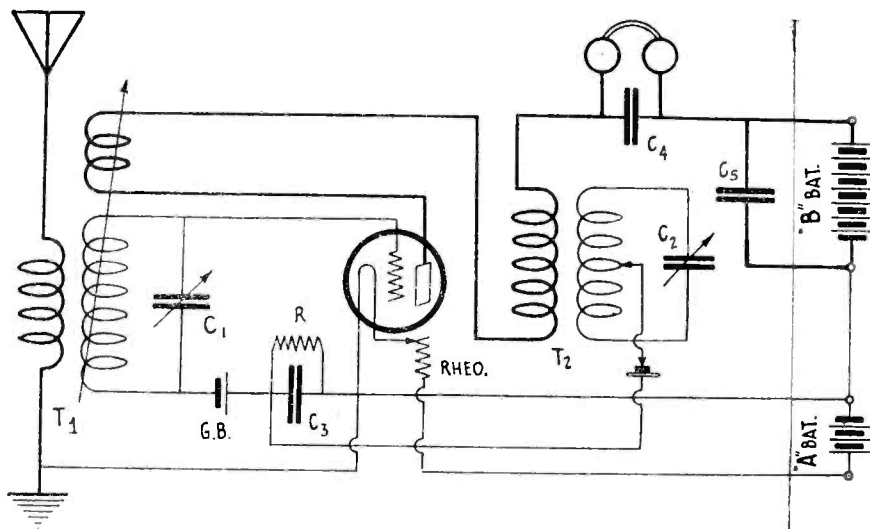

Fig. 1. Coupling between the windings in T_1 and T_2 is fixed and selectivity is maintained in the crystal circuit by tapping off only a portion of the secondary turns. Reflexing is carried out by an original method in which a potential is developed across a high resistance (R) connected in the grid circuit.

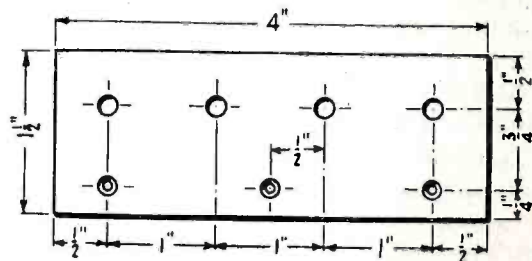

Fig. 3. The terminal strip. A = 3/16in.; B = 1/8in. and countersunk.

tube does not allow any "bottom bend" rectification of a strong signal, and the full filtering effect of the sharply tuned tube-to-crystal radio-frequency transformer is obtained. The untuned aerial, coupled circuit tuner, gives in

Writing in a contemporary English journal, *Wireless World*, London, England, H. F. Smith has described a one tube reflex receiver that meets many of the requirements ordinarily demanded of two and three tube sets. Mr. Smith's description of the set is as follows:

A few words regarding considerations influencing the design of the set may be of interest. It is generally realized that a detector tube, with regeneration brought up to the critical point, is, in skilled hands, capable of long range reception, but, unfortunately, if the grid is made sufficiently positive for good detection by the usual leaky grid condenser method, really smooth regeneration is seldom attainable. A crystal detector is, therefore, used, and it is possible to work the tube at its best both for amplification and regeneration.

rectified pulses from the detector are fed back to the tube without the intermediary of audio frequency transformer.

itself good selectivity without multiplication of controls. It should be noted that, as the grid circuit of the tube is lightly damped, oscillation will

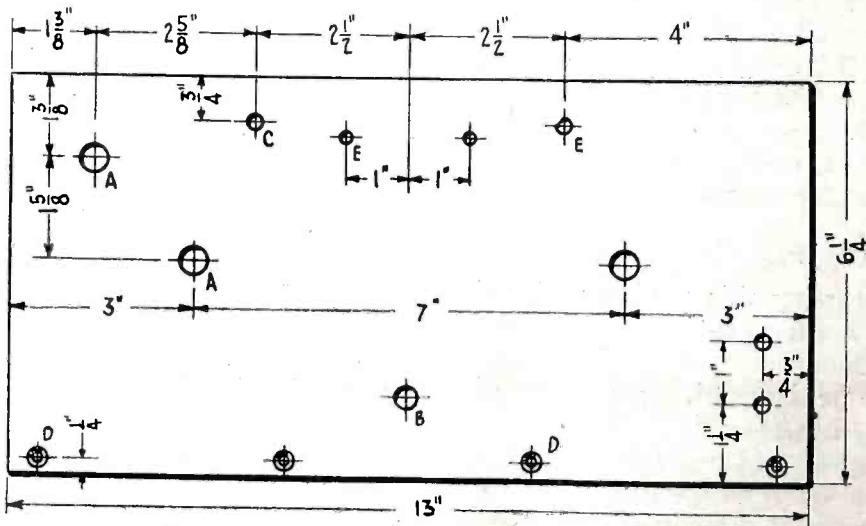

Fig. 2. Details for drilling the front panel. Sizes of holes: A = 7/16in.; B = 5/16in.; C = 5/32in.; D = 5/32in. and countersunk; E = 1/8in.

normally occur when this and the plate circuit are brought nearly into tune. This self-oscillation is prevented by

dyne" fashion, and are, in fact, very similar to the transformers used in that circuit. The panel of the set illustrated

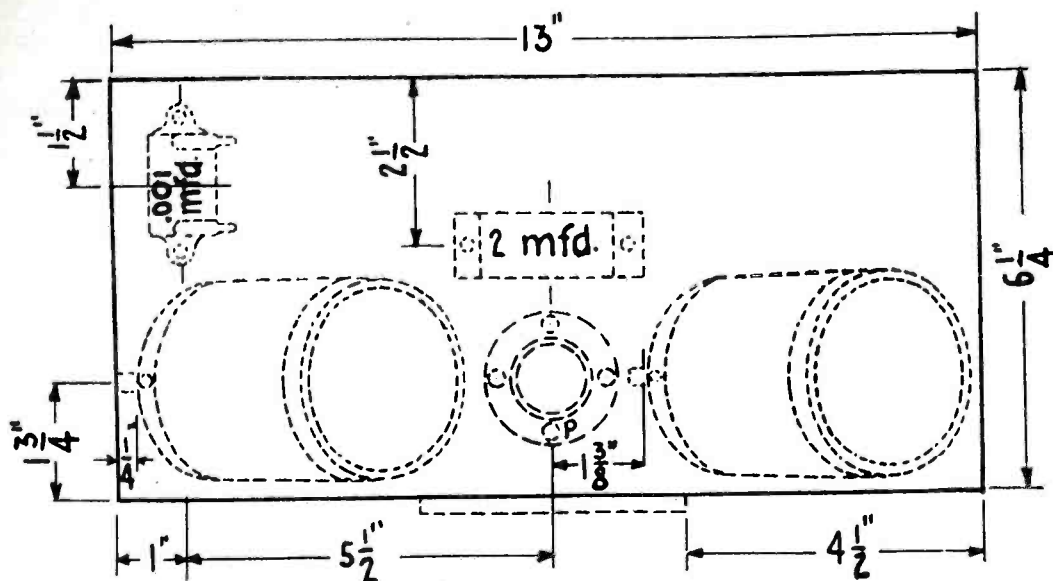

Fig. 4. Positions for mounting the parts to the baseboard.

the damping effect of the crystal, which is, however, connected across only a portion of the tube-to-crystal transformer (about half of it or sometimes even less). If the usual artificial or treated galena is used, the output will be much greater than if connected across the whole inductance, and tuning will be sharper. It is suggested that the constructor try various tapping points before permanently wiring up, always bearing in mind the need of including enough turns to stabilize the set. If a detector of high resistance, and consequently lower damping, such as the perikon or new semi-permanent type, is used, there must be more inductance in the crystal circuit, and the tapping may be taken from the 60th turn from the bottom. Incidentally, it may be remarked that troubles with dual tube and crystal circuits are often

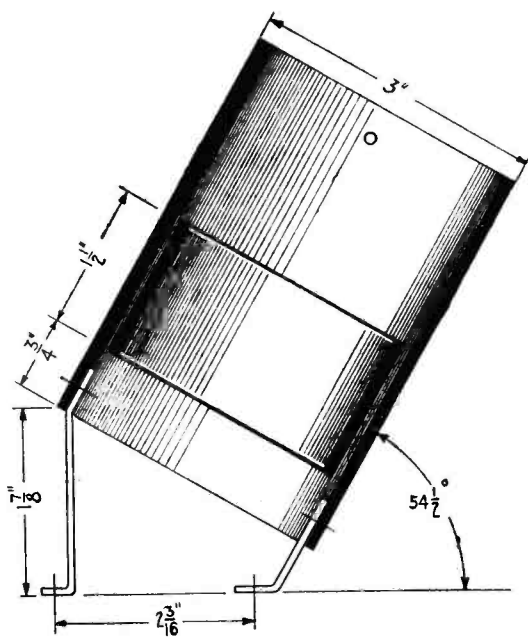

Fig. 6. Constructional details for setting up the radio frequency transformers.

panel is given, though positions will vary slightly according to the makes of parts used. The layout shown is, however, a good one to follow. On the panel are mounted the variable condensers, tickler coil, filament resistance, crystal detector, telephone and high voltage by-pass condensers, terminals, and feed-back condenser C_3 , with its shunting resistance. The value of this latter is not critical, as it merely

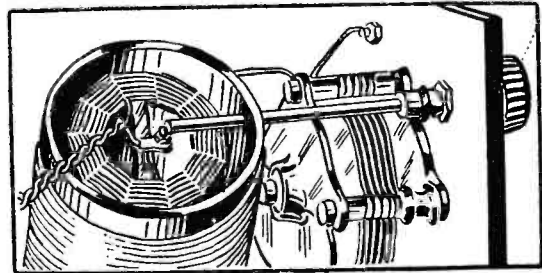

Fig. 5. Regenerative coupling is provided by means of a basket wound spiderweb coil rotatable in the end of the aerial transformer.

permits of a biasing voltage being impressed on the grid, without appreciably reducing the audio frequency pulses applied to it.

Parts Needed

- Panel, 14 in. \times 8 in.
- Wooden baseboard, 13 1/4 in. \times 6 1/2 in.
- 2 Bakelite tubes, 4 1/4 in. long \times 3 in. dia., 1/8 in. wall.
- 2 Bakelite tubes, 1 1/2 in. long \times 3 in. dia., 1/8 in. wall.
- 1/2 lb. No. 22 D.C.C. copper wire.
- Small quantity No. 20 D.C.C. and No. 24 D.S.C. wire.
- 2 Variable condensers, 0.0003 mfd., with verniers.
- For tickler coil: basket form, 1 3/8 in. inside dia., 2 3/8 in. outside dia., length threaded rod, "one-hole" panel bushing, knob and pointer.
- Tube socket.
- Filament rheostat.
- Crystal Detector.
- 2 0.001 fixed condensers.
- Fixed resistance, 100,000 ohms to 1 megohm.
- Fixed condenser, 0.5 to 2 mfd.
- Connecting wire, sleeving, screws, etc.
- Cabinet.

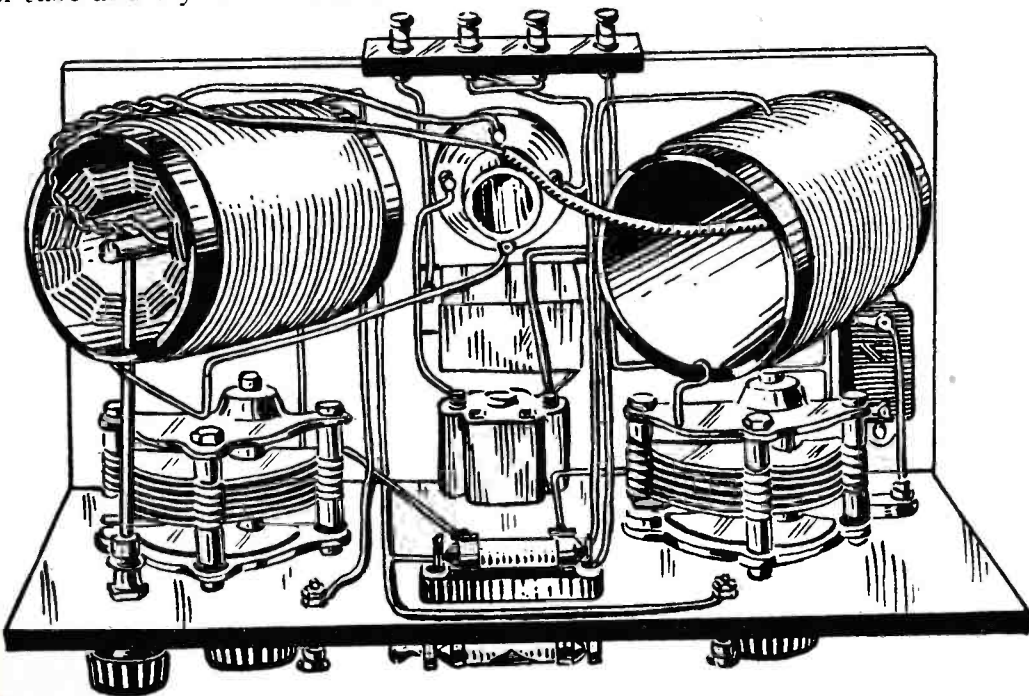

Fig. 8. A top view of the set showing the arrangements of the parts and wiring. It will be seen that the small bolts used for attaching the crystal detector to the front of the panel also secure the grid leak and condenser.

due to too heavy damping by the detector.

To reduce to a minimum the magnetic coupling between the coils, they are tilted up in the usual "Neutro-

measures 14 in. \times 8 in.; this length cannot be appreciably reduced if adequate spacing between the transformer is to be provided.

A dimensioned drilling plan for the

The two transformers, which cover the broadcast waveband when tuned by 0.0003 mfd. condensers (C_1 and C_2) of fairly low minimum capacity, are similar in construction, except that T_2 has a greater number of primary turns, and a tapping point is provided about the middle of the secondary for connection to the crystal. All windings are put on in the same direction. T_1 has 15 turns of No. 20 wire on the primary and 80 turns of No. 22 on the secondary former. T_2 has respectively 25 and 80 turns of the same sizes of wire. Both the secondary forms are of 3 in. diameter, and the primary windings are slipped into the bottom ends of the secondaries. If it is not possible to obtain a bakelite tube of the

correct diameter ($2\frac{5}{8}$ in.) for these primary forms, a length of 3in. tube, $1\frac{1}{2}$ in. long, may be reduced by cutting out a small piece, binding with wire,

of nuts and a spring washer at the back.

The style of wiring shown will be found convenient and effective; all "A"

covered flex for the connections to the tickler coil.

The crystal detector should be rigid and well made; the small plug-in pattern shown is convenient and stable. Reversal of connections to the crystal should be tried if regeneration is not sufficiently smooth.

The operation of the set, once the correct values of "B" battery voltage, filament current, crystal tapping point, and grid bias (if any) have been found, is fairly simple and straightforward. Both condensers are varied together, and the readings will be nearly the same on each. As stated above, the tube will oscillate when the grid and plate circuits are brought into tune, unless the damping effect of the crystal is present. It is therefore desirable to set the detector when the grid circuit is detuned, while listening to a signal which would be very strong if both circuits were correctly tuned. The tickler coil should be at zero coupling. Never try to adjust on a weak signal, or with both circuits in tune.

If a tube of the power type is used, it may be found that oscillation is produced too easily, and reversed tickler connections are necessary to prevent it. The remedy for this is to move the crystal connection a little higher up the secondary winding of T_2 , and possibly to remove a few turns from the tickler coil. It may also improve matters if about five turns are taken off the primary winding of this transformer. Again, if a tube with high impedance and high amplification factor is used, reversed conditions will obtain, and it will probably be necessary to add a few turns to both the primary and tickler coil.

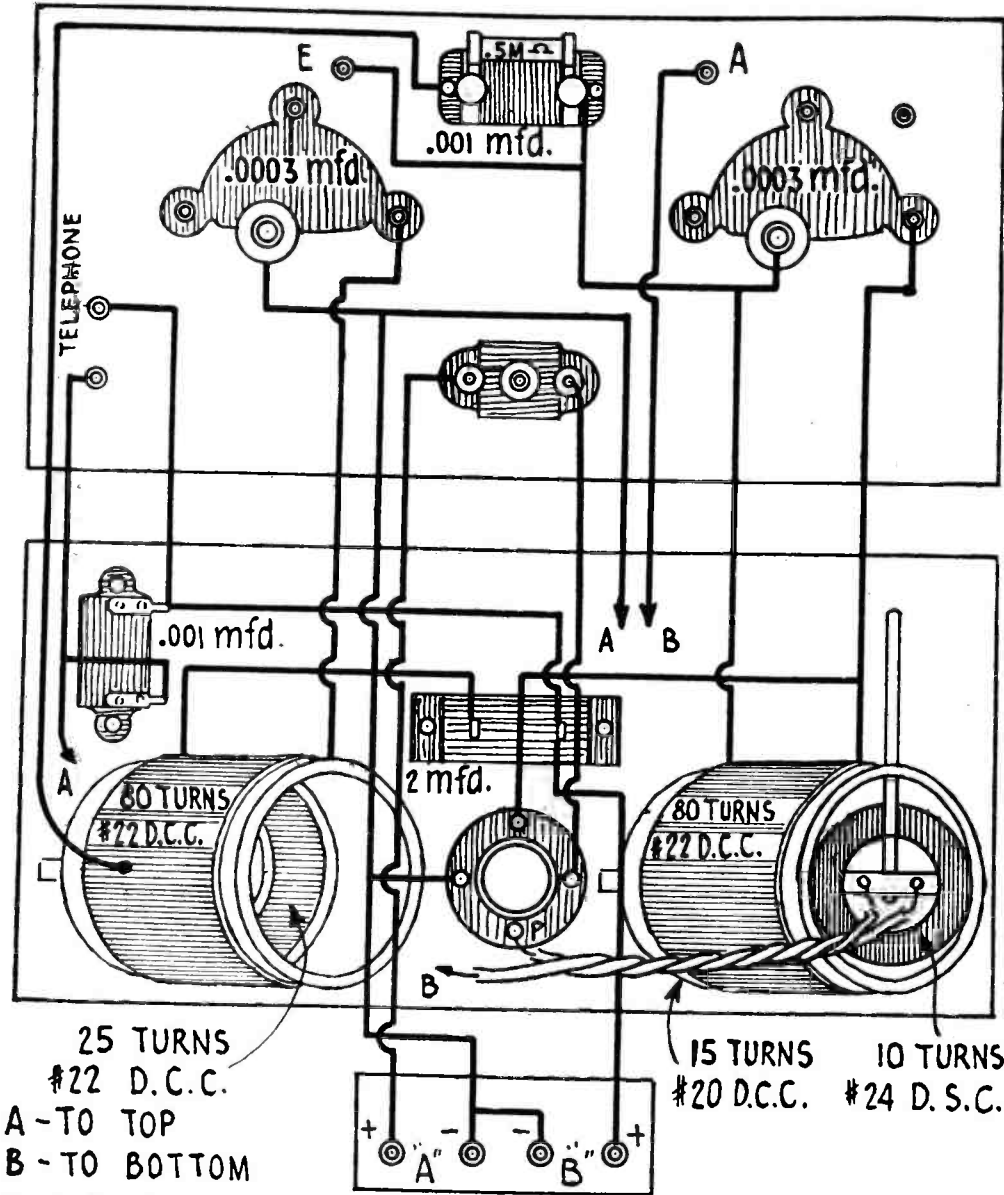

Fig. 7. Practical wiring diagram. The leads A and B are connected to the primary windings of the radio frequency transformers.

and immersing in hot water. The connections are as follows:— T_1 .—Bottom end of primary to aerial, top to ground; bottom end of secondary to feed-back condenser C_3 , top to grid. T_2 .—Bottom end of primary to tickler coil, top to phones; bottom end of secondary to—"A" battery, top to variable condenser. Note that in each case the moving plates of the variable condensers connected across the secondary windings go to the bottom ends. The transformers are fitted to the baseboard by means of a light brass angle piece, which can be bent to give the desired angle. A small grid bias cell, if necessary, may be secured to the base by a fibre strap.

The tickler coil consists of about 20 turns of No. 24 double silk covered wire on a small basket form, which may be cut from $\frac{1}{8}$ in. bakelite sheet with a scroll-saw, or one of the commercial patterns, stamped in fibre may be used. It should be fitted immediately above the top of transformer T_1 . A small bakelite block is bolted to the centre, and is drilled to receive the end of the threaded brass control rod. This rod passes through the panel bushing, and is secured in position by a couple

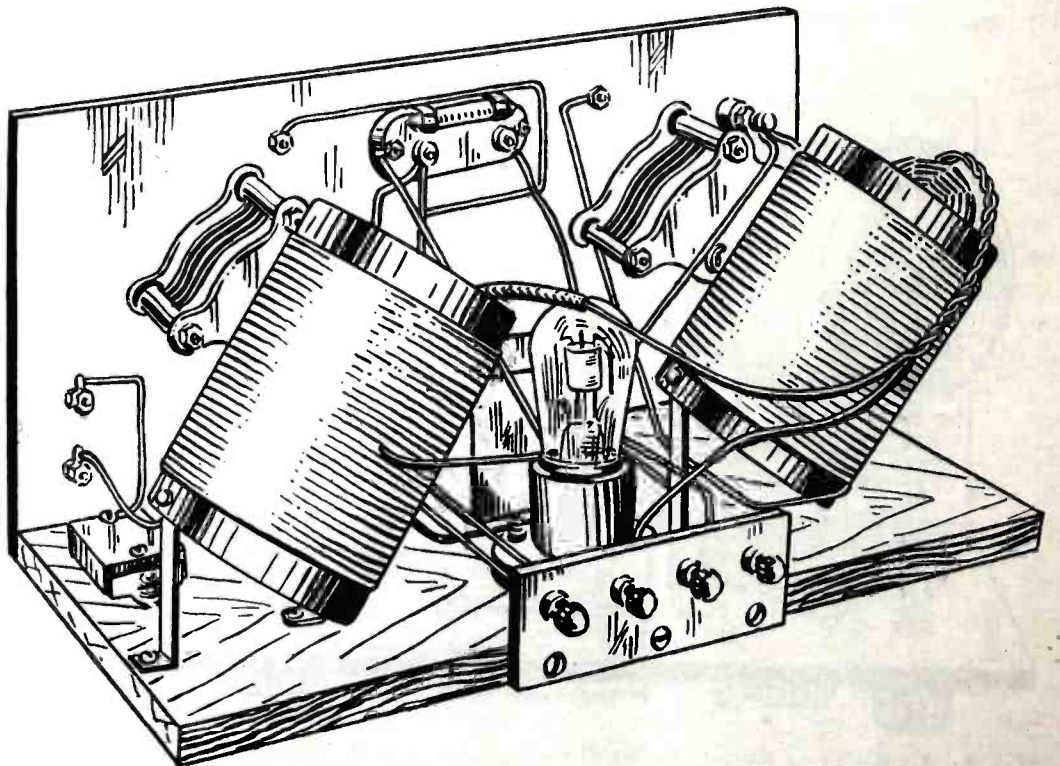

Fig. 9. Another view of the rear showing how the parts are arranged and wired. This layout can be followed by the constructor to the veriest detail.

battery and ground potential leads are carried in insulating sleeving, and kept down on the panel or baseboard, while heavier bare wire is used for most of the radio-frequency leads, and rubber-

The receiver may be fitted into a cabinet of the usual pattern, with lift-up lid. A tube observation window is of advantage if a bright-burning tube is used.

The Greene Concert Selector

A Non-Radiating Four-Tube Receiver Using One Stage of Regenerative Radio Frequency Amplification

THE radio enthusiast who spends spare moments in the construction of various new receivers, and as well, the fan who builds one for permanent use, will find no end of really efficient arrangements described in the various periodicals. Unfortunately (for the other listeners) however, many of these sets represent the fruits of efforts directed wholly toward quality, volume or distance, and not enough attention is given the comfort and enjoyment of the neighboring broadcast listener. It is a refreshing change from this unsatisfactory order of things to find a receiver that possesses the virtues demanded by its owner, without sacrificing the pleasure of other fans by radiating howls and assorted squeals of an interfering nature.

We might go on indefinitely recounting the obvious virtues of a set that affords selectivity, quality, volume and distance without the troublesome radiation, but *L. C. Greene* has covered the subject so well in his article in *Radio*, San Francisco, Calif., that we will leave the rest to him.

The "Concert Selector" (name registered with U. S. Patent office) is an extremely selective, sensitive and efficient radiocast receiver, designed by the author to function with four tubes. It employs one stage of regenerative, tuned, radio frequency amplification, a non-regenerative detector, and two stages of audio frequently amplification.

Our experience has proven that the regenerative radio frequency amplifier is superior to either two stages of non-regenerative radio frequency, or one stage of radio frequency, and regenerative detector. The radio frequency stage is neutralized.

The radiation ordinarily associated with such a combination is obviated by the use of a clarifying selector whose construction is described later. This gives such loose coupling with the antenna coil that there is practically no transfer of energy between the oscillating coil and the antenna, and consequently no blooming.

Oscillation in the first tube is controlled by a potentiometer with a .005 mfd. by-pass condenser which admits only the direct current component of the grid current to the comparatively high resistance winding and gives a smooth, positive control of oscillation.

The other variation from standard

practice is the use of a vario-transformer to couple the plate circuit of the r. f. amplifier to the grid circuit of the detector. This device, whose construction is described, is merely an efficient type of tuned radio frequency transformer built on the variometer principle. With a UV-199 tube it gives a

the baseboard. On the panel, from right to left are the battery switches, clarifying selector, potentiometer with .005 mfd. fixed condenser, variable condenser, variotransformer, and two jacks. On the baseboard are the four sockets with associated filament control cartridges, grid leak and condenser,

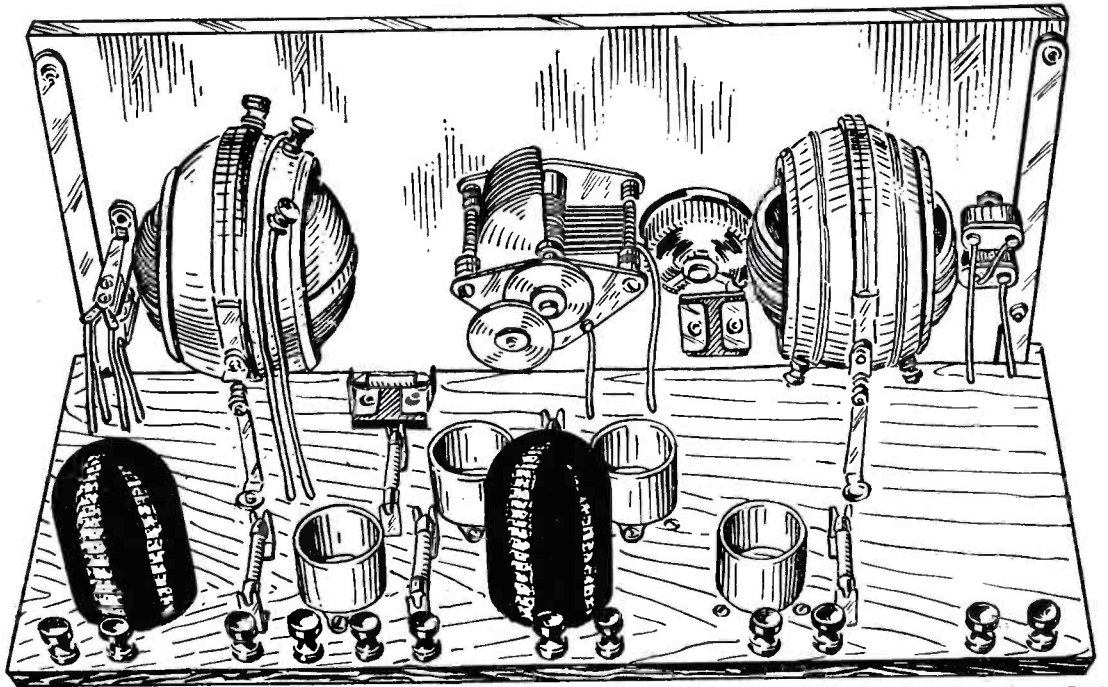

Fig. 2. Sketch showing rear of the set and the arrangement of its parts. All wiring is beneath the sub-panel.

voltage amplification of from 11 to 18 times for wavelengths from 200 to 600 meters respectively when the amplifier is in the non-regenerative condition. When regeneration is admitted, an amplification of 30 for one stage has been attained under laboratory conditions.

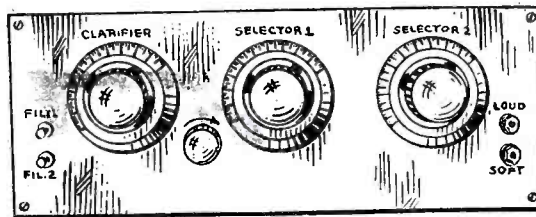

Fig. 1. The front panel layout of the four-tube Greene Concert Selector described herewith.

Filament control cartridges (Culver-Stearns) are used in place of rheostats in the sets built by the author. These are available in different styles to supply the correct voltage for any type of tube used, assuming a 6 volt "A" battery supply. They obviate the danger of over-voltage to thoriated tungsten filaments.

The general arrangement of parts in the completed set is shown in Fig. 2. Most of the wiring is concealed beneath

audio transformers and twelve binding posts.

The front panel view in Fig. 1 shows the dials for the clarifier, the 1st selector (variable condenser), and the 2nd selector (variotransformer), together

LIST OF PARTS

- One panel, 7x18x3/16 in.
- Three 3 3/4 in. dials.
- One .0005 mfd. variable condenser.
- One 200-ohm potentiometer.
- One Type CS clarifying selector.
- One Type VT-25 variotransformer.
- Four sockets.
- One .005 mfd. fixed mica condenser.
- One .00025 mfd. condenser with 10 meg. ohm grid leak.
- Two battery switches.
- Four filament control cartridges (or rheostats).
- Two double circuit jacks.
- Two audio frequency transformers.
- Twelve binding posts.
- One baseboard, 18x10x5/8 in., 19 ft. spaghetti, wire, etc.
- One .002 mica condenser.

with the filament switches, at the extreme left, the potentiometer control, and the jacks.

The circuit diagram is shown in Fig. 3. VCS and VT are respectively the

variable clarifying selector and the variotransformer. It will be noted that no condenser is used in tuning the grid circuit of the detector tube. Attention is called to the position of FC-1, FC-2,

and wiring of parts. The 10½ in. spring between the shafts of the clarifying selector and the variotransformer is chosen so as to give maximum amplification. Using UV-199 or C-299

only between 450 meters and then only when the potentiometer is advanced far toward the negative side.

Tuning will be found quite simple. The left hand dial controlling the

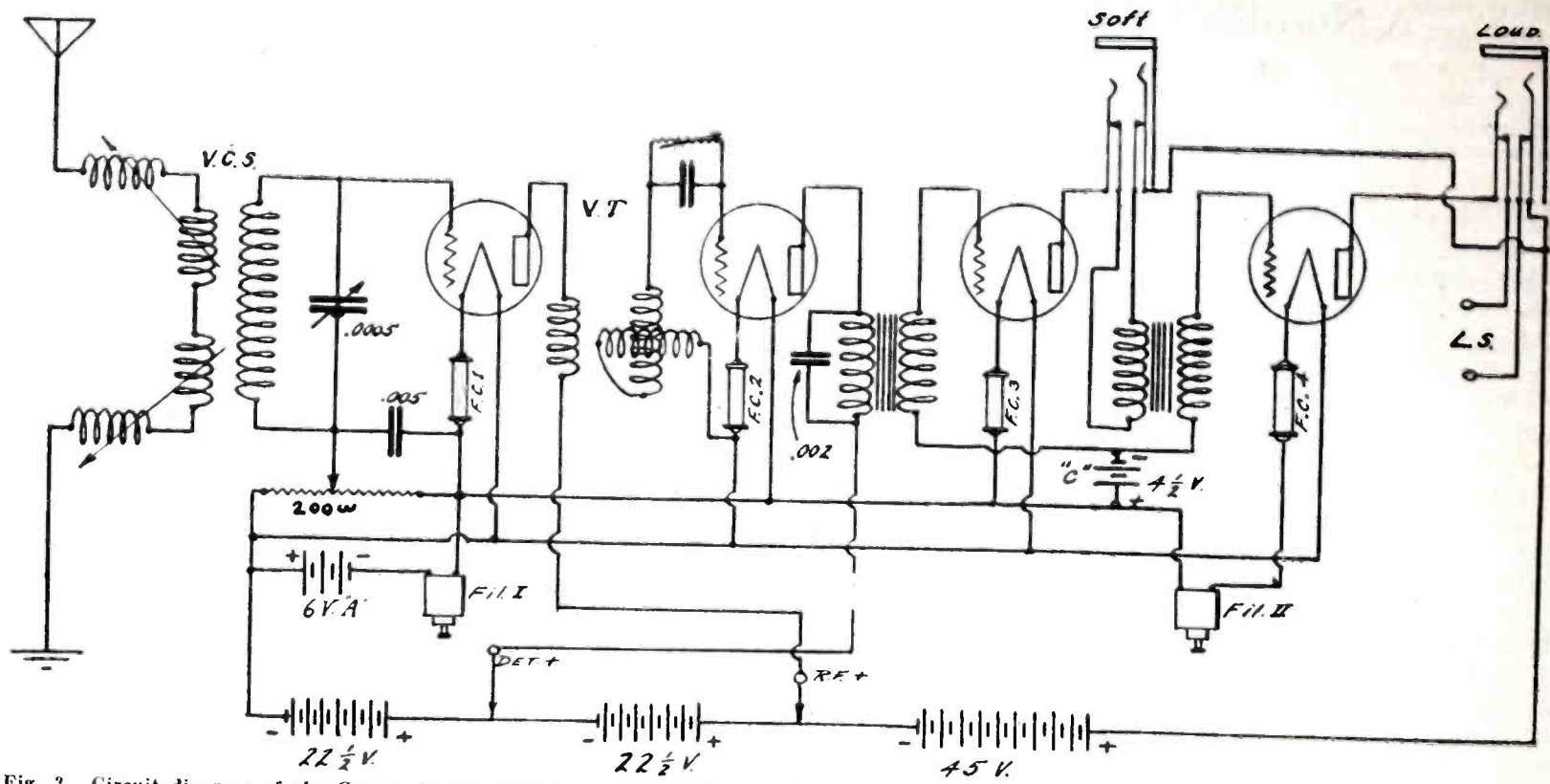

Fig. 3. Circuit diagram of the Greene Concert Selector. Care should be taken when wiring the set to follow this diagram to the veriest detail.

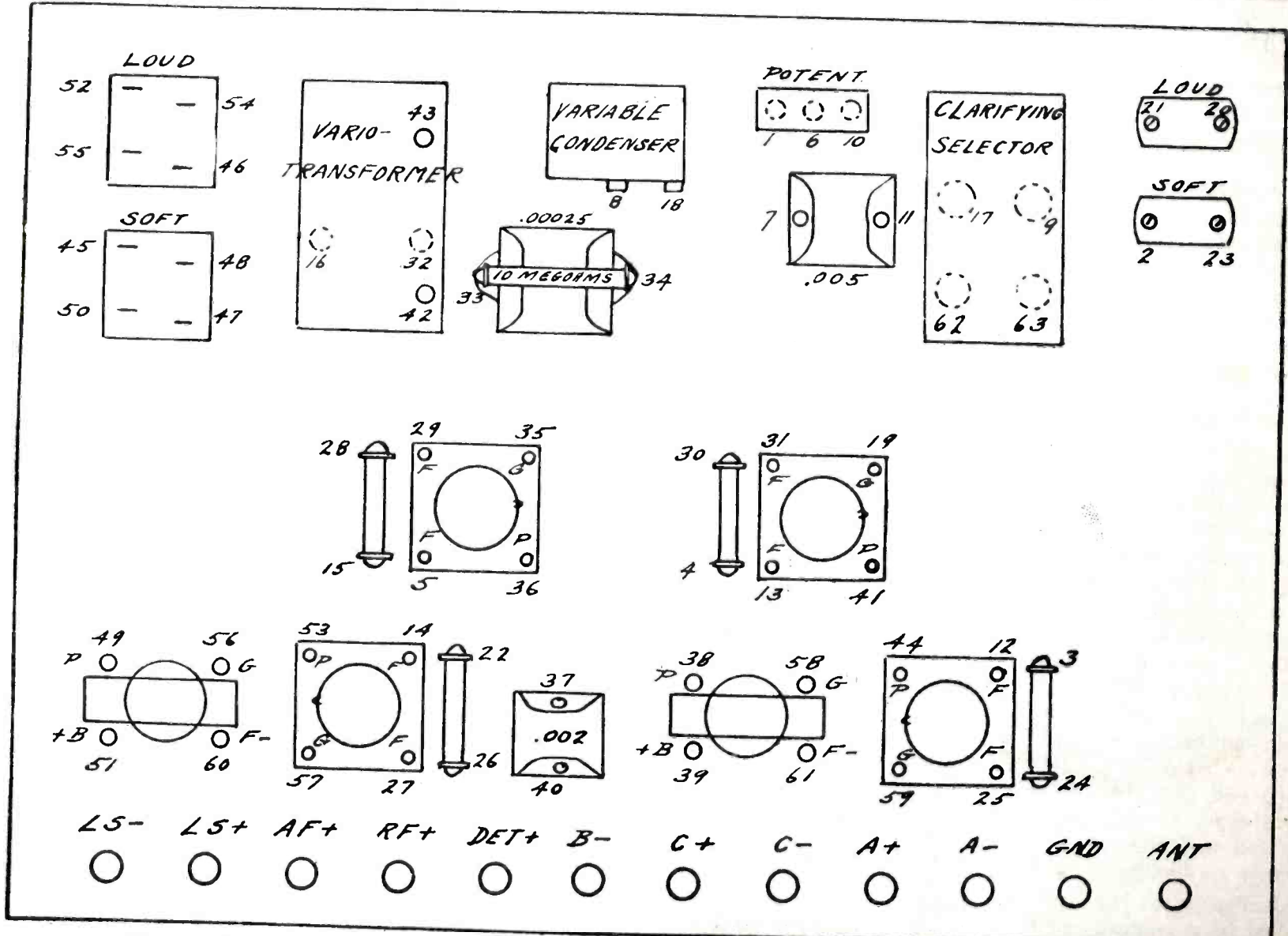

Fig. 4. A layout of parts showing how the Greene Concert Selector is wired according to directions given in this article.

FC-3 and FC-4 in the filament leads and to the separate voltage tap for the r. f. tube plate.

tubes the entire radiocast range can be covered without oscillation of the r. f. tube when using direct negative grid return. With "A" tubes it oscillates

clarifying selector should be set at 50 for the trial. Then by varying the two dials marked Selector 1 and Selector 2 (center and right hand) up and down

the scale keeping within a few degrees of each other, stations will be picked up. Any tendency of the tubes to oscillate should be controlled by the potentiometer which should be advanced further toward the positive side as the wavelength being received is lowered. After a station has been picked up the proper setting of the clarifier dial will make the receiver as sharp as is desired. The setting of the clarifier should be followed by a slight readjustment of the condenser dial marked Selector 2.

When the bottom switch on the left hand side of the panel is turned on the first three tubes are lighted. The plug for the telephones or loudspeaker should then be inserted in the bottom jack marked *soft*. By turning on the second left hand switch at the top the fourth tube is lighted and the plug may be inserted in the upper jack marked *loud*. Turning off the bottom switch extinguishes all the tubes. The loudspeaker may be connected to the terminals provided for it on the terminal board in the rear. When the plug is inserted in either jack the signals are cut off from the speaker. When the plug is removed the speaker operates. Care should be taken to connect the speaker with the proper polarity so that the maximum of volume and quality will be obtained. A comparison of the two possible connections will determine the proper polarity.

In placing the tube sockets the notch in the socket shell provided for the pin of the tube must be placed as shown in Fig. 4. In mounting the potentiometer on the panel be sure to attach three

binding posts are on the bottom of the instrument. For instance, all the binding posts on the clarifying selector are

When setting the dials of the completed selector for zero reading see that the wires which run from the rear

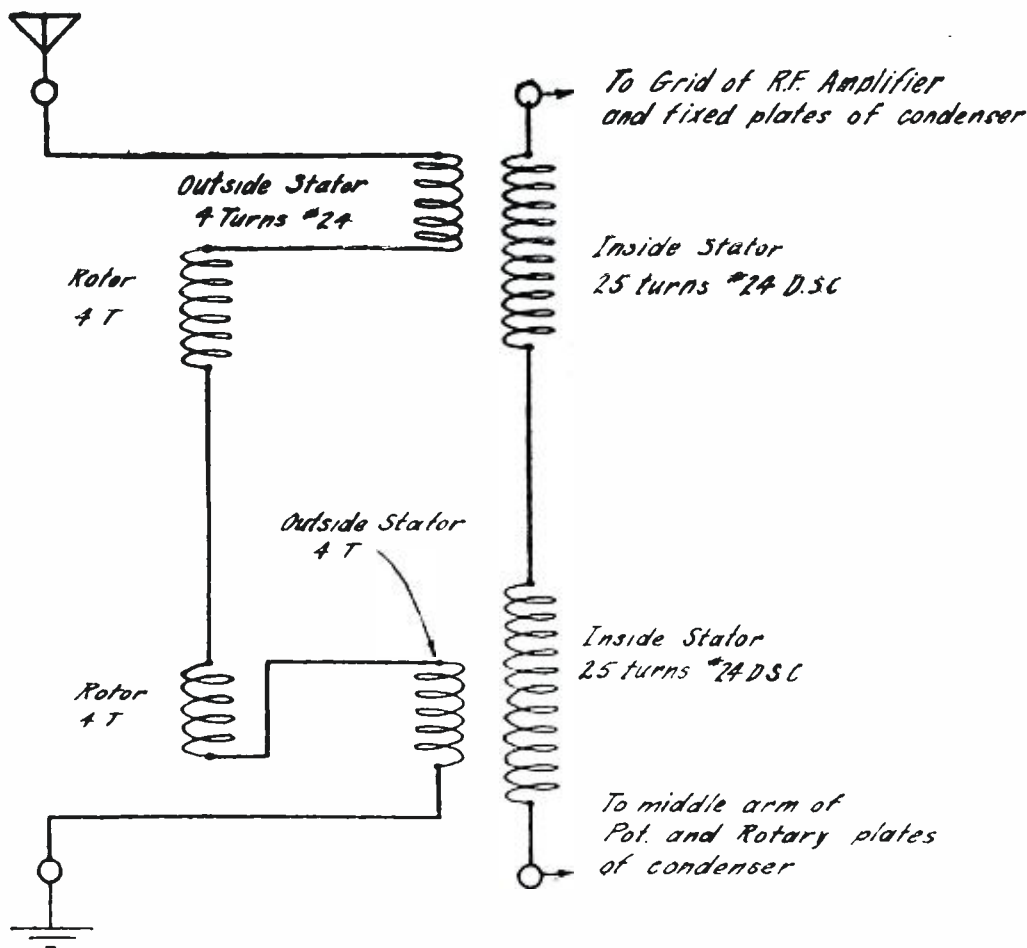

Fig. 5. Diagram of clarifying selector connections.

on the bottom of the instrument. When the clarifying selector is properly mounted on the panel all four posts on

shaft to the edge of the rotor of the clarifier and variotransformer extend to the right when the instrument is

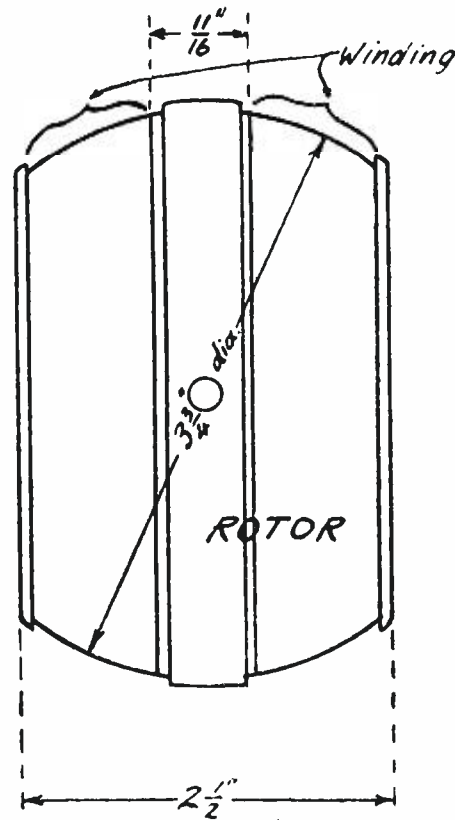
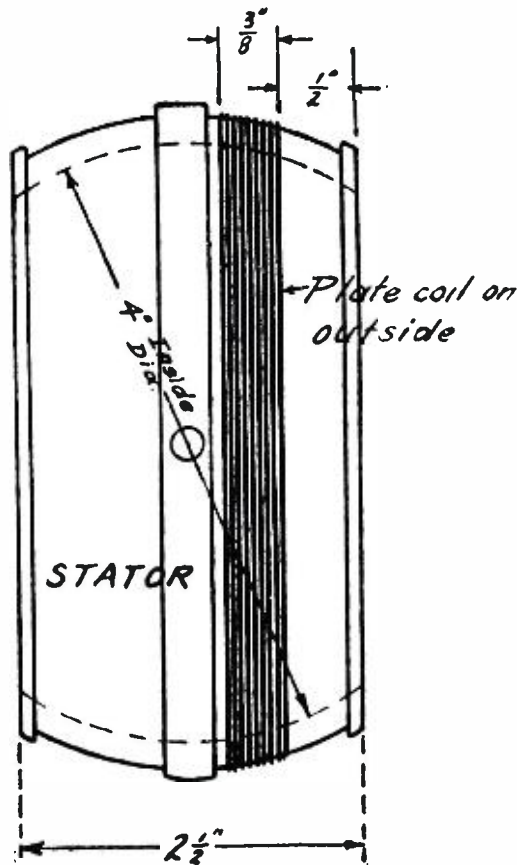
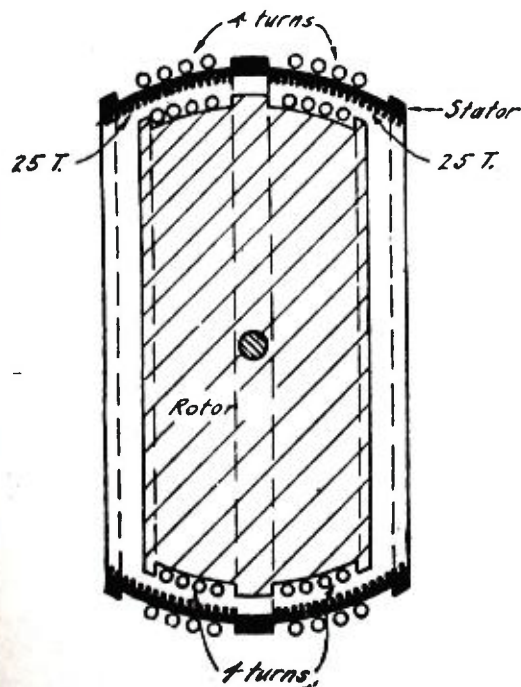

Fig. 6. Giving dimensions for the variotransformer. The construction of the clarifying selector is shown at the left.

pieces of wire, one to each binding post, before mounting it on the panel. This will save considerable time and much patience. These wires should be about two feet long.

It will be noticed in Fig. 4 that some of the binding posts are indicated as dotted circles. This means that the

instrument point downward toward the baseboard. When the variotransformer is properly mounted the outside windings of this instrument are next to the variable condenser and not next to the jacks. It very important to mount these two instruments in the manner described.

viewed from the front of the receiver. The condenser should have all of the plates to mesh for a dial reading of 100.

Before commencing to wire your receiver check up on the assembly of apparatus on both panels and baseboard. Make sure that your sockets are prop-

erly arranged else the wiring directions which follow will be of absolutely no value to you. In checking the placement of parts study Figs. 2 and 4.

Have at hand a good clean soldering iron, string solder, soldering paste, a pair of wire cutters and a piece of old cloth with which the soldering iron should be frequently wiped. Use as little soldering paste as possible and wipe clean every soldered joint before

42; 43 to RF positive post; 44 to 45; 46 to 47 and continue to AE positive post. In making connections to the soldering tabs on the phone jacks, solder to these tabs with reference to numbers on the top spring, the next lower spring, the spring next the bottom and the bottom spring. Don't pay any attention to the direction in which the soldering tabs point as some jacks in this respect are just the reverse in

morsels out to the radio enthusiast as examples of what can be done with a single stage of good radio frequency. Superheterodynes take notice. Freak reception you say? Granted. Let us regard them as the proverbial straw which shows which way the wind blows.

Construction of Special Parts

For the experimenter and others preferring to construct the Langbein & Kaufman clarifying selector and variotransformers complete dimensions and diagrams are given herewith. In each instrument the winding form is made of special hard rubber having a low dielectric loss. The wire used for winding is No. 24 double silk covered and is held in place by a compound of para rubber in solution. Both instruments are shaped and operated like a variometer.

The inside of the clarifying selector's stator form carries the winding which in shunt with the variable condenser, forms the tuned grid circuit of the r. f. tube. On each side of the outside of the stator form are two 3-turn windings which are connected in series with each other and in series with two similar windings on the rotor. All these in series are connected between the antenna and ground. The motion of the rotor within the stator as controlled by the Clarifier Dial controls the coupling of the receiver to the antenna and is in effect a selectivity control. When the rotor is set so that the field of the two small windings are aiding the coupling to the antenna is at a maximum and the receiver tunes less sharply. When the two coils oppose each other the coupling to the antenna is zero except for the insignificant amount of static coupling which may exist between the grid coil and the antenna coils. Any value midway of these extremes may be selected at will by a suitable setting of the left hand dial. With this dial set at 100 the coupling to the average antenna has been designed to fall just above the point of maximum signal strength for the amount of amplification which the selector affords.

With any radio frequency amplifying receiver a definite amount of coupling will be found, above which the signal strength will fall off. The selection of this peak for all wavelengths is done by means of the clarifying selector. With zero setting the receiver is so sharp that it is an easy matter to pass stations without hearing them at all, unless the variable condenser is turned very slowly. For this reason the variable condenser is equipped with a fine mechanical vernier dial. In accordance with the rest of the receiver the variable condenser is of low loss design. It should have a maximum capacity of .0005 mfd. and a low minimum. The clarifying selector used

(Continued on page 70)

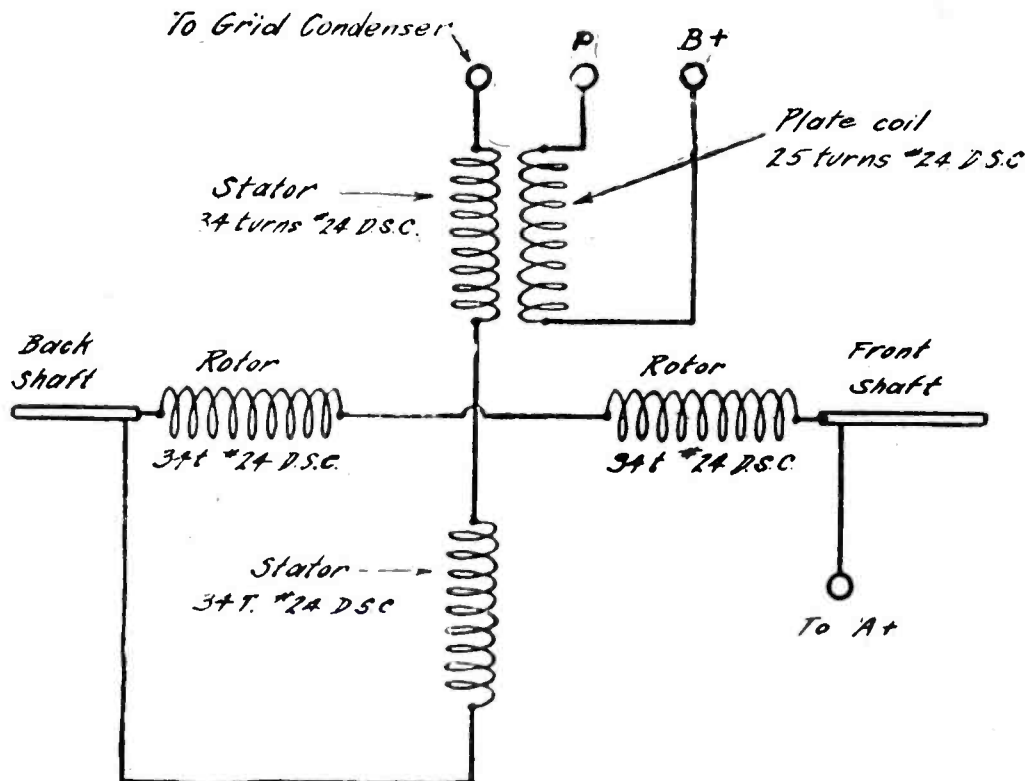

Fig. 7. Diagram of variotransformer connections.

proceeding. Cover the wire with lengths of spaghetti as you proceed. Don't hurry the wiring. This practice in building radio sets usually results in an improperly wired instrument which will not function. Then follows a mountain of trouble in locating the fault and a lot of shifting and changing which a little more time and a little more care would have obviated. There's nothing to be gained by hurrying, so let's not do it.

Wire your set from Fig. 4.

Beginning with the wire attached to the post on the potentiometer marked 1 continue on to posts marked, 2, 3, 4 and 5, in this order. Spaghetti should be cut to the proper lengths and slipped over the wire as you proceed.

The next piece of wire begins at post 6, continuing on to 7, 8 (movable plates of variable condenser) and 9.

Another piece of wire should connect points 10, 11, 12, 13, 14, 15 and 16.

Now run a wire from 12 to the A positive and B negative posts.

Join with a single piece of wire, 17, 18 (fixed plates of variable condenser) and 19. Join 2 and 20. Join 21 and 22. Join 23 with A negative and C positive posts.

With separate pieces of wire connect 24 to 25, 26 to 27, 28 to 29, 30 to 31, 32 to 33, 34 to 35.

Connect 36 to 37 and continue to 38. Connect 39 to 40, and continue to DET positive post.

With single pieces of wire join 41 to

construction to those illustrated in Fig. 4.

Connect 48 to 49; 50 to 51; 52 to 53; 54 to speaker negative post; 55 to speaker positive post; 56 to 57; 58 to 59.

Join with a single piece of wire 60, 61 and C negative post. Connect 62 to antenna post, and 63 to ground post. This completes the wiring of the set.

The concert selector will operate under extremely adverse conditions as regards antenna and ground when using the large tubes. With tubes of the UV-199 class a long antenna and a good ground connection are necessary. A good antenna and ground is of course desirable with the larger tubes, although the writer has had excellent success with a 25 foot wire for an antenna and a nondescript ground on a heating system, bringing in stations 1,000 miles or more away. It is recommended that an antenna 75 to 100 ft. long between supports be used with as good a ground as can be made. We regard with suspicion grounds to radiators, drain pipes and the like. The cold water pipe is usually the best bet.

Thousands of receivers of this type are now in use in New England. Excellent reports are being received daily on their performance. Stations as far away as Rome, Italy, IRO, have been received and this reception confirmed. Another user has written to OAZ, Lima, Peru, for confirmation of his reception. We hold these two tempting

A Four-Tube DX Receiver

A Practical Set Allowing Smooth Control of Regeneration Over the Entire Broadcast Band

WRITING in *Radio World*, New York, Herbert E. Hayden describes a somewhat radical version of the popular combination of tuned, radio frequency with regenerative detector and the conventional audio stages. Mr. Hayden has torn a page from a book that is given all too little consideration—the Weagant regeneration method. Adaptation of this arrangement to use with a single stage of tuned, radio frequency amplification and the customary two audio stages, has resulted in a well-balanced receiver that can be depended on to do its full duty throughout the entire wavelength band. Mr. Hayden describes the circuit as follows:

The use of the Weagant method of obtaining regeneration, which is based on the Hartley system of oscillation, affords smooth regeneration control. Hence, while it is as effective as the tickler coil method, it simplifies tuning, the regeneration setting being spread over a much larger part of the dial. Indeed, the regeneration control may be logged, the same as the wavelength control. In Fig. 1 the wavelength control is shown by the two variable condensers connecting from grid to filament of the radio-frequency and detector input coils, respectively. There are three controls, as must needs be the case in a regenerative set that has also a tuned RF amplifier, using condensers of the single tuning type, with steady filament lighting.

The third control is the regeneration condenser, shown in Fig. 1 to the left top of the first audio-frequency transformer. The rotor is connected to filament, the stator to one terminal of the plate coil, L5, the other terminal of that coil going to the plate of the detector tube. Hence the detector, rather than the RF stage, is regenerated, which is the better practice, since the tendency towards overloading the RF tube is thus avoided.

What the Set Does

The set is remarkably selective and sensitive. It can be operated on an indoor antenna consisting of about 40 feet of wire, with ground connection to the cold water pipe or even to a radiator. Hence it is easily used in the hotel rooms or under other circumstances where an outdoor aerial is impractical. But if an outdoor antenna is employed results will be much better, signals will be louder, and distant stations (known

in radio as DX) can be received readily. Under good conditions the set, using an outdoor aerial 65 feet long, with a 30-foot lead-in and a 20-foot wire from

LIST OF PARTS

- One RF transformer, L1L2.
- One interstage coupler, with feedback coil, L3L4L5.
- One 6-ohm rheostat.
- One 20-ohm rheostat.
- One A battery switch, S.
- One double-circuit jack, J.
- Three 4-in. dials, with three dial pointers.
- One filament-control jack, 4 prongs, FCJ.
- Four sockets.
- Three .0005 mfd. variable condensers.
- One .00025 mfd. fixed grid condenser.
- One 5-megohm fixed grid leak, cartridge type.
- Two audio-frequency transformers.
- Accessories: One 22½-volt. B battery, three 45-volt B batteries, one 4½-volt C battery, four UV201A, C301A or DV2 tubes, one 6-volt storage battery, 100 ampere-hours or more, 65-foot outdoor aerial lead-in wire, ground clamp, lightning arrester, internal connecting wire, one headset, one speaker, one jack plug, two right angles for coil mounting; hardware.

ground to set, consistently brought in stations on the speaker 800 to 1,000 miles away, and quite often made it

Ultra Selectivity

The problem of reception when one lives within a mile or so of one or more powerful broadcasting stations can be solved, to some extent, by leaving off the ground connection when the stations that are so nearby are on the air. In that manner you will be able to tune in and out all the local stations, possibly up to 50 miles distant, maybe more. The selectivity, of course, is greatly increased by the omission of the ground connection, while the sensitivity is somewhat decreased and the volume drops just a little, too. When the stations nearby are off the air restore the ground connection and go after your DX stations to your heart's content.

The set is very stable and dependable. It is economical both in point of initial cost and in upkeep, when measured by the results obtained. The RF tube helps only a little on local stations, but may as well be kept burning when listening to these. When it comes to DX work, that is where the RF tube more than justifies its presence.

The Divided Circuit

The method of feedback is the most interesting point regarding this circuit. There is, of course, a little inductive feedback, since the plate coil L5 is in

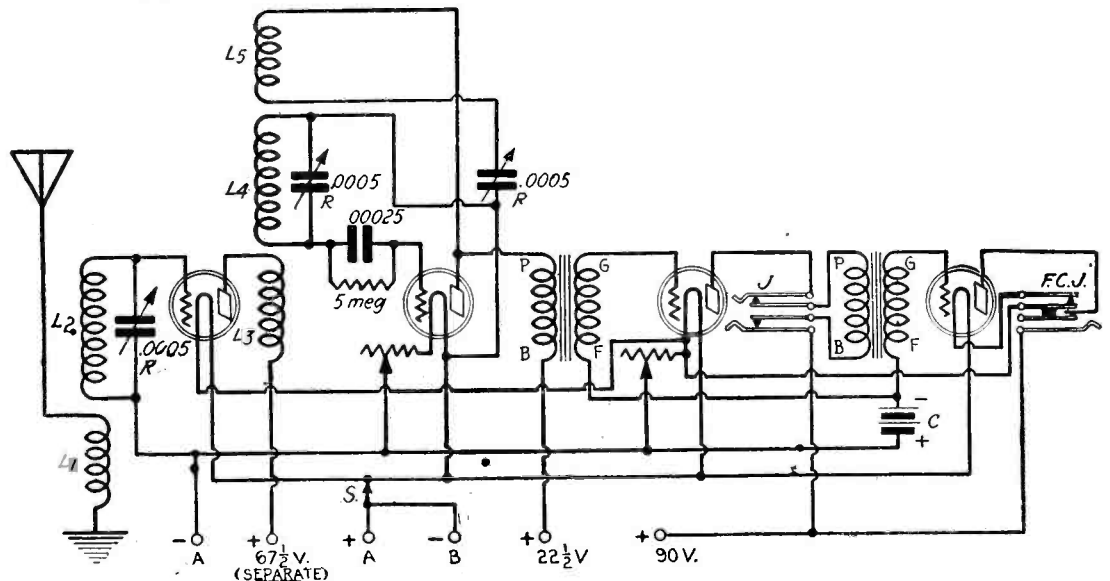

Fig. 1, the wiring diagram of the Divided Circuit. There is one stage of tuned RF, regenerative detector and two stages of transformer-coupled AF.

possible to hear stations 1,500 miles away, when the point of reception was in New York City. The 1,500-mile reception occasionally was loud enough to be heard on the speaker with moderate volume. As for selectivity, the set meets present needs very well, even in congested areas.

close proximity to the secondary L4, which is in the detector grid circuit. This, however, is trifling, and besides this much of the feedback is always at a rate below that required for satisfaction at resonance even on the lowest waves in the range of the broadcast belt. However, as the end of the plate

coil is connected to one side of a variable condenser, the other side of which goes to positive filament, the radio current from the plate is thus returned to the detector grid coil, L4. The plate charges the condenser and the discharge is made into the grid coil. The secondary L4 and the plate coil have a

if you use dowel sticks of $\frac{1}{4}$ in. diameter you will not split the wood when drilling.

The hub is just like the hub of a wheel and the dowels are inserted so that they protrude radially, just like the spokes of a wheel. In other words, the dowels are inserted at right angles to

ference you may desire for radio coil construction. That template holds good for basket-weave as well as for diamond-weave coils.

Lay the piece of paper on the hub you have obtained or made, right near the outside edge of the hub, and with pocketknife or centerpunch make 15 marks. Then drill the holes in the direction toward the center of the hub at the 15 points on the circumference just under the marks you have made.

Use No. 22 single silk covered wire throughout. The RF transformer in the aerial circuit, L1L2 in Fig. 1, consists of 10 feet of wire, while the secondary L2 consists of 47 feet of wire. Hence it is well to remove about 12 feet of wire from the spool, cutting the wire at this point, affording the 10 feet for the actual winding and 1 foot extra at each end as excess wire, to be used for internal set connection, instead of bus bar for that particular purpose. Of course in wiring the set, if 1 foot of wire is too much, cut the wire, so that the lead will be no longer than absolutely necessary. The same rule applies as to the secondary, L2, hence cut off 49 feet of wire. A convenient way of measuring the wire is to mark off one yard on a table and measure 16 such lengths for the secondary, and 1 foot extra, the wire, of course, being continuous.

Simultaneous Winding

In actual winding it will be found convenient to put on 6 turns of the secondary first, then pick up the primary (12-foot length) and wind that alongside of the continuation of the secondary, and at the same time that the secondary is wound. The wire is passed over one turn and under the next. The odd number of spokes or dowels makes each complete alternative winding "over" at those points where the previous, and even succeeding, winding is "under." This will be clear to you when you look at the completed coil.

After the winding is finished the dowel sticks may be pulled out and grocer's twine interspersed in the windings to keep them together. The cord may be one continuous piece, passed through an aperture formerly occupied by a dowel, then in the opposite direction through the adjoining aperture, knotted, and then wound in succeeding spaces. Any other convenient method of applying the cord binder may be employed.

The same form may be used over and over again.

The same directions given for the RF transformer L1, L2 apply to the interstage coupler and feedback unit, L3, L4, L5. Here L3 corresponds to L1 and is likewise an aperiodic primary. L4, the secondary, corresponds to the secondary of L2. Measure off 10 feet of wire, leaving 1 foot excess at each end, or 8 feet actual winding.

(Continued on page 80)

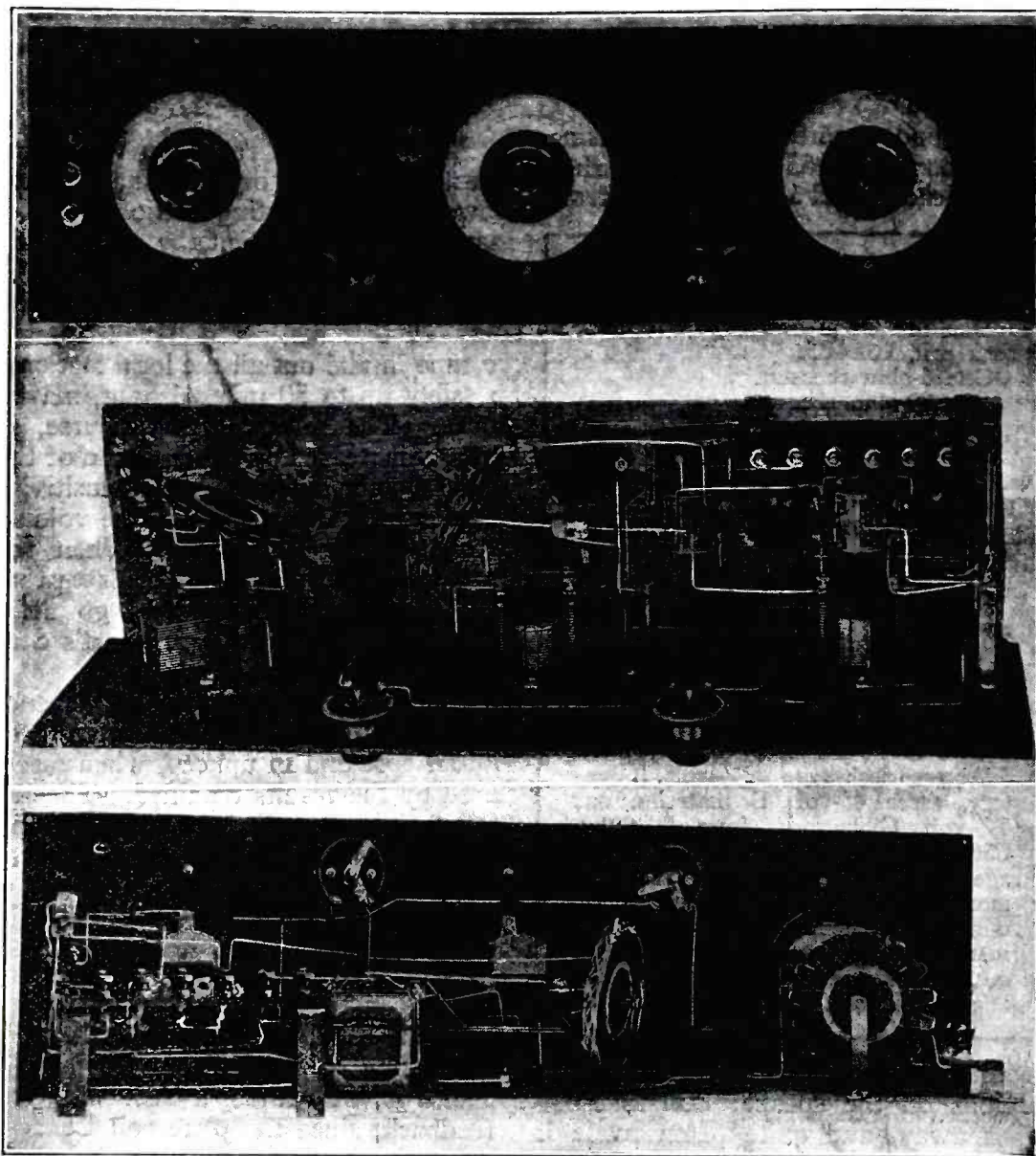

Fig. 1A (top) shows the panel layout. The knob at left of the central dial is a variable grid leak, but a fixed one may be used instead. Fig. 2 is the top view. Fig. 3 (bottom) is the rear view. Note rightangle coil mounting.

grid and plate return to the same low potential point, A plus. The coils are divided as to input, however. The regeneration is obtained by varied capacity coupling.

The Coils For the Set

The coils used in the set are of the diamond-weave type. These are somewhat in the nature of spider-web coils, except that the arms of the form on which they are wound are not triangular in shape, but simply round dowel sticks, usually $\frac{1}{4}$ in. in diameter. These should be about $2\frac{1}{2}$ in. long. The dowels are purchasable in a hardware store and usually come in about 3-ft. lengths. Hence you may saw them down to size.

The hub or central base for the form may be 3 in. diameter. If no circular form is handy, use a 3-in. square and cut away the corners, smoothing out the circumference as well as you can. The hub should be wood at least $\frac{1}{2}$ in. thick, and preferably 1 in. thick, so that

the thickness of the wood, not at right angles to the flat plane of the hub, or just the opposite to the method used in making a form for winding basket-weave coils.

Preparing the Coil Form

There are fifteen arms or spokes, hence cut up 15 dowels. The drill used on the edge of the circumference should be of the same diameter as that of the dowels or rods. To establish the 15 points most readily, describe a circle 3 in. in diameter on a piece of paper of considerably larger size, then measure off straight-line distances inside but along the circumference, $\frac{5}{8}$ in. each. This is the linear measurement of the chord subtended by the arc of 24 degrees (360 degrees divided by 15). The 15 points on the circumference then are joined to the center of the circle by 15 straight lines. These lines may be extended to the edges of the paper and you will have a template for obtaining 15 equi-distant points on any circum-

A New Non-Radiating Receiver

Full Efficiency Is Obtained by Employing Feed-back to Prevent Oscillation

IN the July issue of *RADIO REVIEW*, a new circuit was presented to our readers which was called the Monophase circuit. This circuit employed the principle of negative feed-back to stabilize the system and to prevent self-oscillation. It is an efficient receiver, as it can be constructed very readily without using extra resistance to prevent it from oscillating. Once it is adjusted, as near the point of oscillation as possible on the short wavelengths, it will not squeal at any wavelength within its range.

Laboratory staff of *Radio News*. The description of the new non-radiating set as given in *Radio News* follows:

The general arrangement is shown in the wiring diagram in Fig. 1. There is nothing out of the ordinary in the general arrangement of the circuits, with the exception of the coils A and B. The coil A is the feed-back coil and the coil B is the absorbing coil. The latter consists of three turns of wire wound on a short tube and short-circuited. The two coils are fastened on the same shaft, so that the adjustment is made

It is possible so to adjust the two coils with respect to each other that the pair can be rotated together, by means of the shaft, into the position giving maximum response from the receiver. The advantage of this method of stabilizing is that the absorbing coil, being composed of so few turns, can be adjusted very accurately. For this reason the set continually operates very close to the critical point; that is, to the point of self-oscillation, where the amplification is greatest.

It may be well to present to our

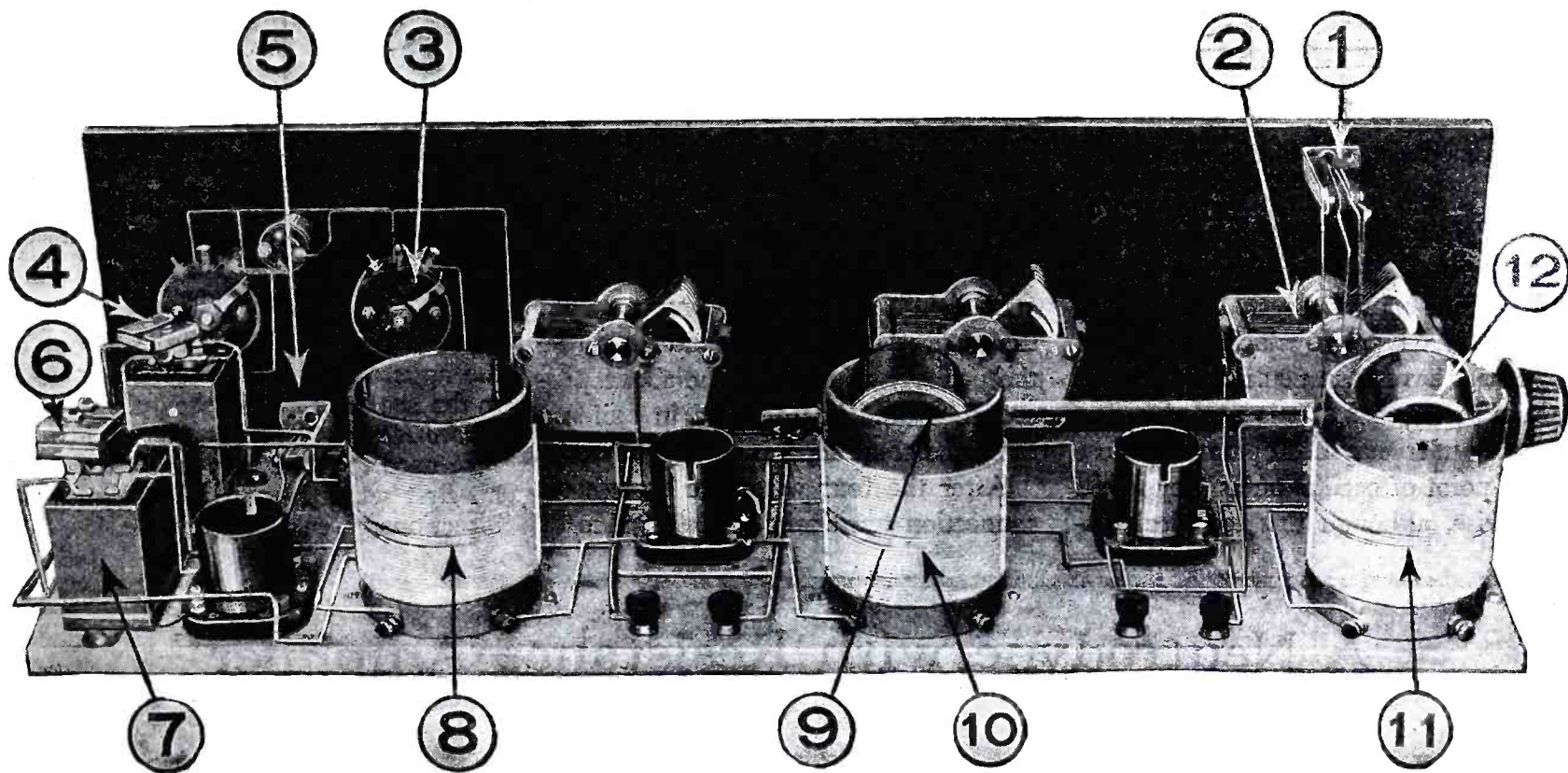

Illustrations by Courtesy of *Radio News* (New York)

Complete set: 1, antenna jack; 2, tuning condenser; 3, rheostat; 4, by-pass condenser; 5, telephone jack; 6, by-pass condensers; 7, audio frequency transformer; 8, detector inductance; 9, feed-back coil; 10 and 11, R.F. coils.

We have, in this circuit, which has recently been described in *Radio News*, New York, two exactly opposite types of radio frequency amplifiers which will not squeal. The first—the Monophase—is constructed with a large number of turns on the primaries of the tuned R.F. transformers, and the stabilizing is done by negative feed-back. In the circuit of this article there are comparatively few turns on the transformer primaries; this renders the circuit inherently inefficient. But in this case *positive* feed-back is employed, and, by this agency, the efficiency of the system made equal to that of the Monophase.

Both the Monophase and the set described herewith were developed by the

simultaneously. The absorbing coil is so fastened to the shaft that it can be set at any position on the shaft with reference to the other coil.

The method of adjusting the coils is as follows: Holding the absorbing coil B at right angles to the transformer coils, marked C on Fig. 1, the shaft is turned, coil A turning at the same time, until the set begins to howl. This is done while receiving signals from a long wave station. Holding the feed-back coil A (which is fastened rigidly to the shaft) so that it cannot move, gradually turn coil B until the howling disappears. Once this adjustment is made properly, the set will not howl on any wave-length, and the efficiency at all times will be very high.

readers a new classification of radio frequency amplifiers which may assist materially in clearing the atmosphere about five-tube sets.

1. *The inefficient type.* This class includes all receivers which employ resistance to afford stability to the set.

2. *The inefficient type with positive feed-back.* This is a considerable improvement over sets in the first type, for although the coupling between the stages is very loose and the transfer of energy between stages relatively small, the efficiency of the tubes has been raised by the feed-back.

3. *The efficient type with negative feed-back.* These circuits are built efficiently and have considerably more turns on the R.F. transformer pri-

maries than the first two types, and are inherently good squealers. The squealing is stopped by means of the negative feed-back.

4. *The efficient type with absorption circuits.* This type is built efficiently, but the squealing is prevented by absorption circuits coupled to the tuned circuits. The adjustment must be made on the short wave-lengths, so that will

advantage is far outweighed by the greater efficiency of the circuits.

The first step is the construction of the radio frequency transformers. Each transformer employs a cardboard tube 3 inches in diameter and 4 inches long. One-half inch from one end a winding of 32 turns of No. 24 D.C.C. wire is begun and a space of 1/4 inch is left open, whereupon another wind-

the tube, the three transformers are mounted on the baseboard at a distance of 8 inches between centers. The first is equipped with a small rotor 1 1/2 inches long and 1 7/8 inches in diameter upon which is wound four turns of wire. The second transformer is likewise equipped with a similar coil whose ends are connected, thus forming a closed circuit. The third transformer is complete as it is.

A 12-inch length of fibre rod, which has a small knob fitted to it at one end, is passed through the top section of the first and second transformers and is the means of mounting the stabilizing coils. The position of the coils on this rod will have to be determined from experiment and, when once adjusted,

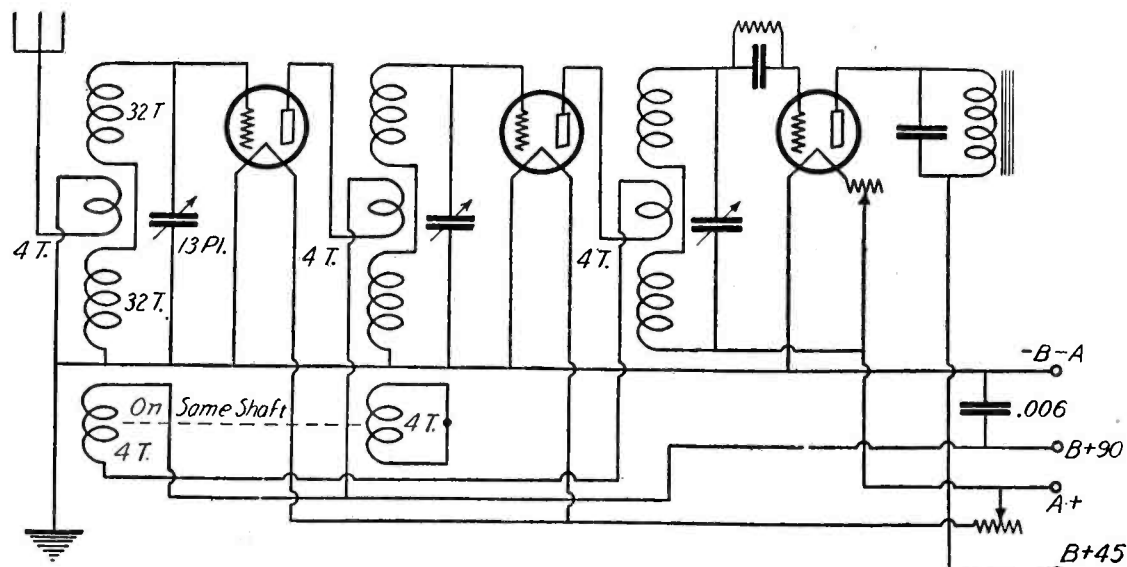

Fig. 1. Circuit diagram of the two stages of radio frequency amplification and detector. The audio frequency amplifiers are connected in the conventional manner.

give slightly less amplification on the long waves.

5. *The efficient type neutralized.* This is the type in which the circuit capacities have been neutralized by one means or another. It is probable that these circuits may not operate as close to the point of oscillation as they might otherwise, although this technical dis-

ing of 32 turns, in the same direction, completes the secondary. In the space at the middle of the coil four turns of the same wire are placed and constitute the primary winding. The above procedure should be followed in building the three coupling transformers.

After the four wires are brought to connection terminals on the bottom of

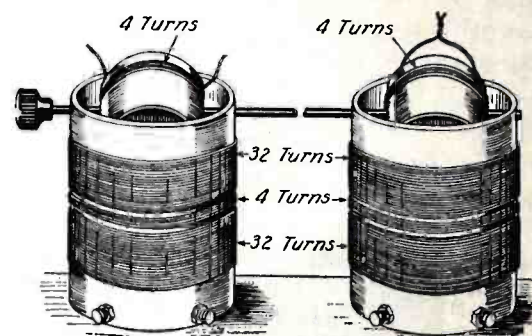

Fig. 2. Two of the radio frequency transformers' constructional diagram, both rotors being mounted on the same shaft.

will need no further attention. As can be seen from the photo, the layout of the apparatus is the same as was used in the set described in the July issue of *Radio Review*. The builder will therefore need to make very few changes in his first set, if he carefully follows the directions given in this article.

A Neutrodyne with Resistance Amplifier

(Continued from page 52)

from Fig. 3. Room may be found for two of these under the same two radio-frequency transformers, next to the 50,000-ohm resistances. The first of the C-5 condensers should be mounted to the right of sockets 3 or 4 or near condenser C-3. The two jacks are also omitted from the baseboard layout in Fig. 3. These are placed under and slightly to the side of the rheostat and socket No. 3. In order that this may be done the panel type mounting should be used for this socket, and it should be placed high enough to admit the jacks. This way of mounting the socket will also give more room for the first blocking condenser C-5.

The method of mounting the condensers and the radio-frequency tuned transformers is the same as that used

in the standard neutrodynes; that is, they are placed with their axes inclined from the horizontal by an angle of about 5 degrees. While this is not absolutely necessary on account of the great distance between the coils, it is a help in preventing stray feed-back and it gives the set a much neater appearance.

List of Parts

Equipment needed for the construction of the set: Three radio-frequency coupling transformers as described; three tuning condensers, .00035 microfarad; one grid condenser, .00025 microfarad; one by-pass condenser, .001 microfarad; three large blocking condensers, .1 microfarad; two neutralizing condensers; one grid leak, two megohms, with mounting; three 50,000

ohm coupling resistances, with mountings; three 500,000-ohm grid-leak resistances, with mountings; five fixed filament resistances, about 4 ohms each; one rheostat, about 10 ohms; one double circuit jack; one single circuit jack; two "C" batteries, about 4.5 volts; one storage battery, 6 volts and about 90 ampere-hours; one "B" battery, 120 volts or higher; six binding posts, mounted at rear of panel on sub-panel; six standard tube sockets; six UV201-A or C201-A vacuum tubes; three 3-in. or 4-in. dials; one panel, 7x26x3/16 in. hard rubber or bakelite; one baseboard, 8x25.5x.75 in.; one shield, 6x22 in.; one cabinet to match the panel and baseboard; one loud speaker with plug and cord; one headset with plug and cord.

An Impedance-Coupled Amplifier

This Amplifier Has Advantages Over Resistance-Coupled System and Gives Equally Good Reproduction

IN this article the editor of the *N. Y. Herald Tribune Radio Magazine* gives data for an efficient impedance-coupled amplifier. An amplifier of this type performs similarly to a resistance-coupled amplifier and has the advantage of not requiring as much "B" battery voltage, as the voltage drop through the choke coils is not nearly as much as through the resistances used in the resistance-coupled amplifier. The amplification per stage obtainable from this amplifier when operating at maximum efficiency is approximately equal to the amplification constant of the vacuum tube used. This amplification is equal to that obtainable from a resistance coupled amplifier, but slightly less than is usually obtained from the transformer coupled amplifier.

Three stages of impedance coupled amplification will usually produce the same results as a two-stage transformer coupled amplifier and the quality of reproduction will be much better.

The article as given in the *N. Y. Herald Tribune Radio Magazine* by the editor of that newspaper radio section is as follows:

The radio fan to-day craves for distortionless reproduction of music and speech. With the advent of cone type loud speakers, and transformers giving fairly flat amplification characteristic, we are nearing the ultimate. Resistance amplification has gained ground in many quarters, while in the writer's opinion the best system of all has been partly overlooked. I refer to the choke, or impedance, method of coupling.

The most important claim against resistance amplification is the necessity for a high plate voltage, generally in the neighborhood of 135 to 150 volts. This is due to the high resistance elements which appear in series between the applied potential and the plates of the amplifier tubes and serve greatly to reduce the effective voltage impressed on the plate. The amplification obtained from this type of circuit is much less per tube than that obtained with transformer amplification, the value of course being in the improved quality due to uniform amplification over all tone frequencies.

90 per cent of the radio transformers in use to-day do not amplify so well at the lower frequencies as at the medium and higher frequencies. At 200 cycles per second a transformer might give a voltage amplification of, say, 1. At

500 cycles it would give an amplification figure of perhaps 3, and at 1,000 cycles 6 or more times the input or applied voltage.

Reproduction in most types of loud speakers is similarly affected. There is no obvious solution to the loud speaker problem, but a greater amount of satisfaction may be obtained by using a choke amplifier, a description of which is given here.

Referring to diagram it will be seen that a choke amplifier is somewhat similar to the resistance method. The

capacity should be fairly large in order to handle high and low frequencies simultaneously. A capacity as large as 1 mfd. may be used, but the writer has found that .1 mfd. is quite satisfactory.

It must be borne in mind that at times the grids of the tubes become charged excessively negative, and for this reason a "leak" or resistance of about 50,000 ohms is connected to the negative leg of the tube as a return for these charges. Without this leak the grid at times would become so negative that the plate current would fall to zero

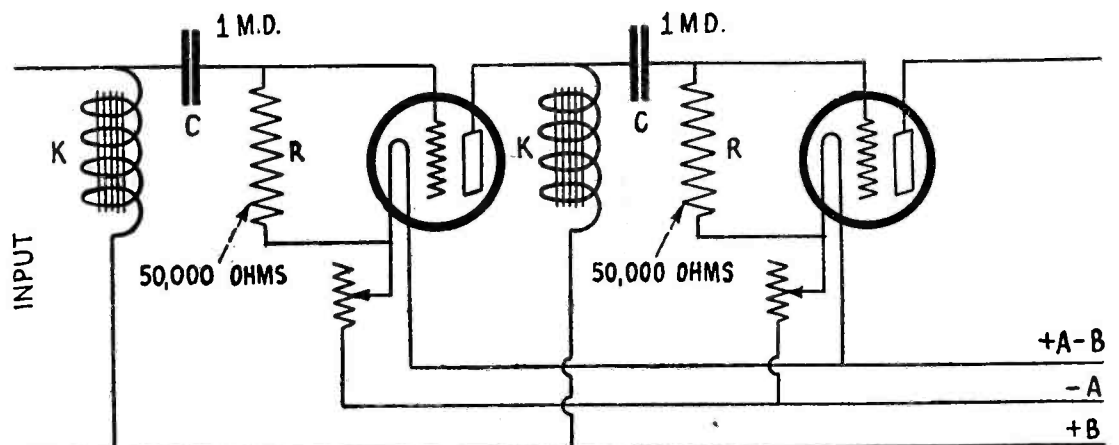

Illustration by Courtesy of The N. Y. Herald Tribune

The above is the wiring diagram of two-stage impedance-coupled audio amplifier described by the editor of the *N. Y. Herald Tribune Radio Magazine* section. The loud speaker is connected to the output or the plate of the last tube and positive lead of the "B" battery.

chokes K and K¹ may be the secondary of an audio transformer having a high impedance value, or they may be the primary (the high resistance winding) of a bell ringing transformer such as is used on the 110-volt A. C. lighting circuit. The condensers C and C¹ should be about 1 mfd. The resistances R and R¹ have a value of approximately 50,000 ohms. These are connected to the negative filament lead of the tube.

The theory of impedance amplification is perhaps out of the scope of this article, but a few words regarding the elementary principles of its operation would perhaps not be out of place:

The current variations present in the choke circuit of the first amplifier tube are due to the impressed voltage variations applied to the grid circuit of that tube. The condensers C and C¹ act as a direct current split between the plate of the first tube and grid of the second tube. They pass, however, the voltage variations present in the plate or choke circuit to the grid of the following tube. The exact value of this condenser is open to great discussion. Theoretically, the capacity of this condenser is governed by the average audio frequencies imposed upon it; hence, the

and the tube cease to function properly.

The voltage amplification obtained with choke coupling is much higher than that obtained with the resistance method, though, of course, not giving the voltage amplification of a transformer. The quality of reproduction, however, stands well above that obtained with the average transformer.

The experimenter who wishes to use the choke method can easily convert his transformer and coupled amplifier by the addition of the two resistances and the two condensers.

This method of amplification is described by many as an "audio filter," and as a last stage amplifier it certainly has great claim to that name.

Many fans desire more volume than is furnished by the regular receivers using two stages of transformer coupled audio amplification. If another stage of conventional amplification is used the volume will certainly be great, providing the distortion can be held down, and that is often extremely difficult or impossible. The value of the method here described is therefore, that it furnishes substantial volume without the effect of distortion of signals. It is well worth trying.

Data On "B" Battery Eliminators

Complete Details on Several Types which Give Good Results

THE subject of "B" battery eliminators is one which we know interests all our readers. In response to hundreds of queries regarding these

any eliminator. All rectifiers deliver a pulsating direct current which, if connected directly to the set, would cause considerable noise in the loud speaker

fixed condensers. The details of a choke coil suitable for use with almost any "B" eliminator unit are given at A in Fig. 1. The core is thin strips of silicon steel and an air gap is provided by inserting a piece of cardboard 1/32d of an inch thick in the position shown. All other corners of the core are overlapped and the entire core may be clamped in any convenient manner. The condensers used in the filter system are of the paraffin paper and tinfoil type.

The "B" eliminators shown in Figs. 1 and 2 use electrolytic rectifiers consisting of lead and aluminum rods or strips of the dimensions indicated, placed in a saturated solution of borax and water. Be sure that you use pure aluminum.

Dissolve the borax in warm water and allow to stand for 24 hours. Pour off the clear top liquid and use in the rectifier. A layer of oil 1/4 of an inch thick floating on top of the electrolyte will prevent evaporation of the liquid. In the type of rectifier shown in Fig. 2, 6 jars are used and are supplied with current by means of a transformer, the details and dimensions of which are given. An eliminator of this type will supply sufficient voltage for the largest of receiving sets, whereas the one shown in Fig. 1 is for use on smaller sets. When putting one of these elimi-

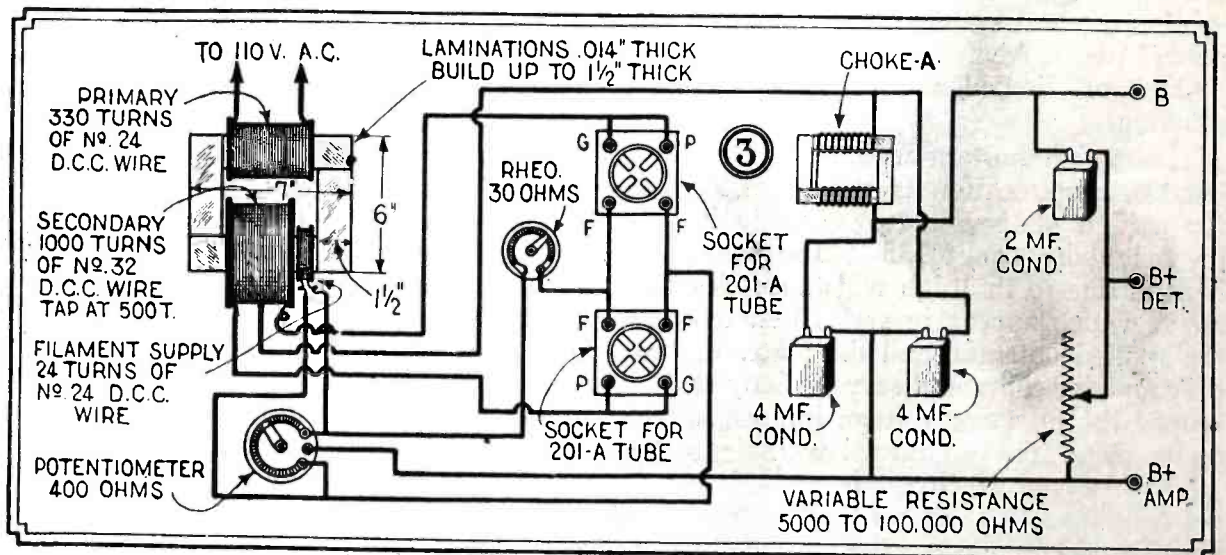
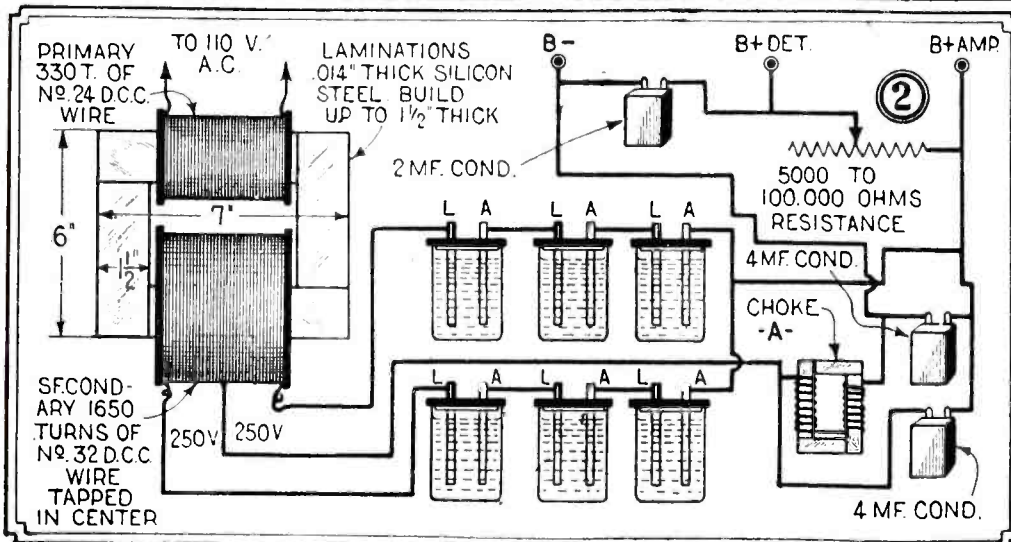
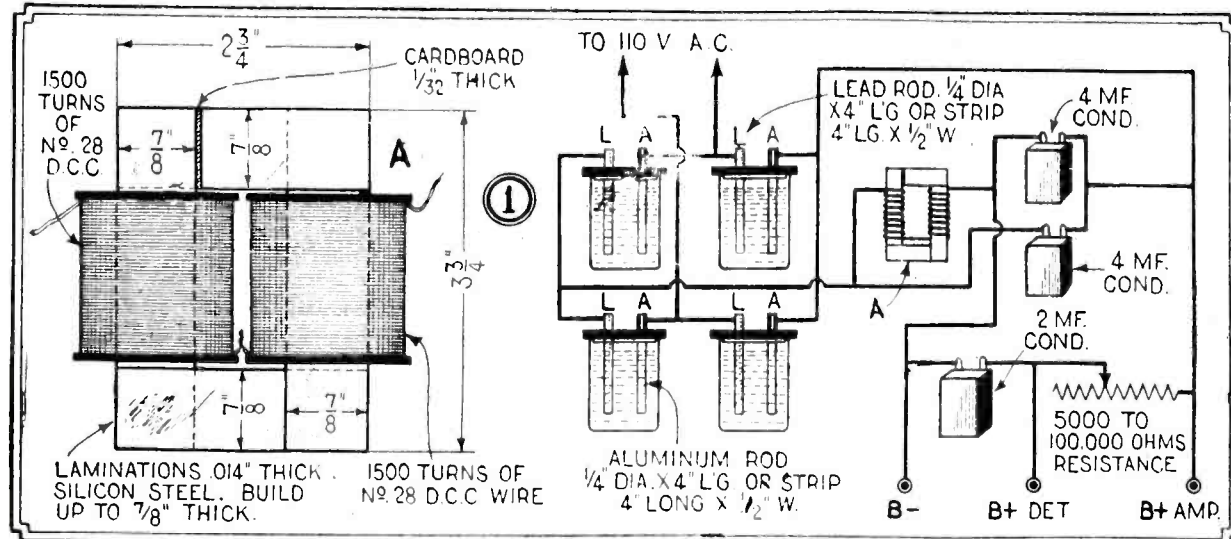

units, we are presenting here with sufficient data to enable anyone to build one of them. Different types are shown from the simplest and cheapest to the more complex and expensive. The choice of the type that you will build will rest entirely with yourself. The eliminators illustrated in Figs. 1 to 5 inclusive were designed by Moe Joffe, while others are designed by W. M. Cummings and Max Kuhne. These "B" battery eliminators were recently described in *Science and Invention*, New York, as follows:

In Fig. 1 is shown one of the simplest and least expensive types of rectifiers to be used for the purpose of eliminating "B" batteries. This makes use of what is known as an electrolytic rectifier and a filter system. The latter is probably the most important part of

or head-phones. Therefore, it is necessary to smooth out this current so that it is what is commonly known as pure D.C. and this is done by means of the filter. Generally speaking, a filter consists of a large choke coil made of many turns of wire wound on an iron core and one or more large capacity

eliminators into use, it will be found that the aluminum plates must be formed. To do this, hook up the entire unit as illustrated and close the A.C. circuit momentarily. Open the circuit and repeat the process several times, never leaving it closed for more than two seconds at any one time. When this

has been done for 5 or 10 minutes, the plates will be formed and ready for use.

The eliminators shown in Figs. 3 and 4 use vacuum tubes of the same type that you employ in your receiving set and use them to rectify the A.C. This type of rectifier does not have some of the drawbacks that are found in the electrolytic style, but, on the other hand, the vacuum tube rectifier is more expensive to build. Specially designed

as three choke coils are used. They may be wound on small audio frequency amplifying transformer cores and are all identical in construction. The electrolytic condensers can be purchased on the market and are far superior to the usual paraffin paper and tinfoil type. They are known as self-healing and if they break down under an abnormal strain they immediately regain their usefulness automatically.

handle. The further the core is inserted into the spool, the lower will be the voltage delivered by the eliminator. This instrument may be used with any type of rectifier by connecting it in series with one side of the A.C. line. It matters not whether a transformer is used.—*IV. M. Cummings.*

Here we have a very simple home-made type of "B" eliminator constructed by *Max Kuhne* from standard

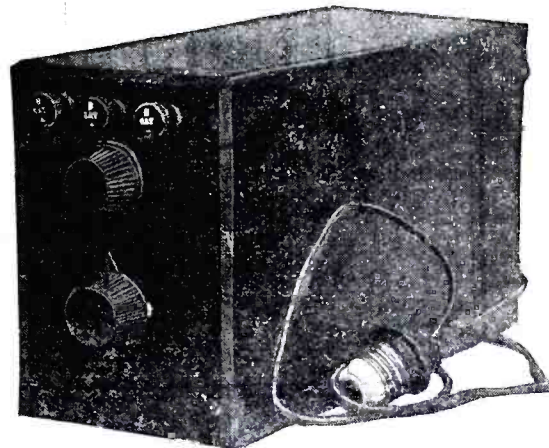
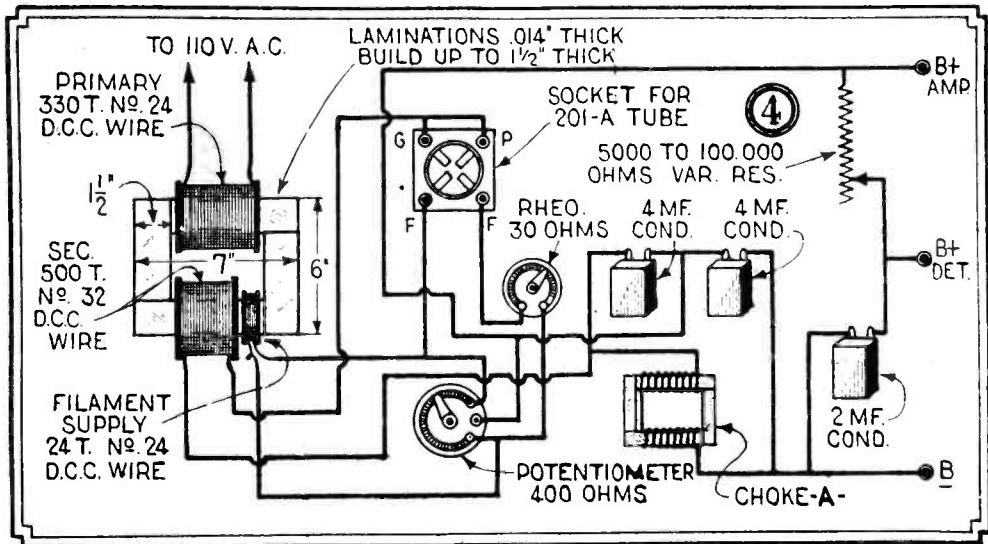

Illustrations by Courtesy of Science and Invention (New York)

The "B" eliminator described by Mr. Kuhne mounted in a cabinet and ready for use.

transformers, the details of which are given on the drawing, are used with these rectifiers and supply both the current for lighting the filaments of the tubes and the voltage that is to be rectified and filtered and eventually used for operating the receiving set. A potentiometer aids considerably in producing pure D.C. at the receiving set and should by all means be included and adjusted to best results.

In the two vacuum tube rectifiers or eliminators illustrated in Figs. 3 and 4 on the opposite page, the same choke coil illustrated at A, in Fig. 1, is employed in the filter.

In Fig. 5 is shown another type of tube rectifier employing what is known as an "S" tube, which does not have a heated filament. Therefore, the

"B" Eliminator Controller

An excellent method of controlling the output of a "B" eliminator is by placing a variable reactance in the pri-

parts that can be obtained almost anywhere. Mr. Kuhne makes use of the primary of an audio frequency amplifying transformer for a choke coil and uses two 2-mf. condensers in connec-

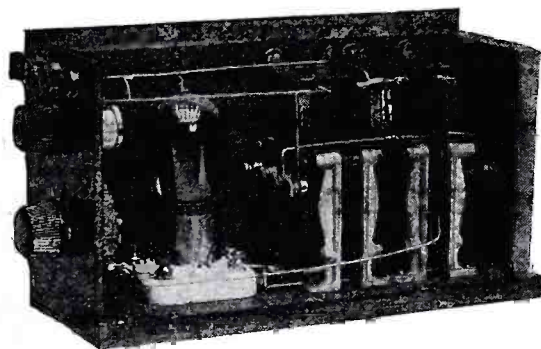
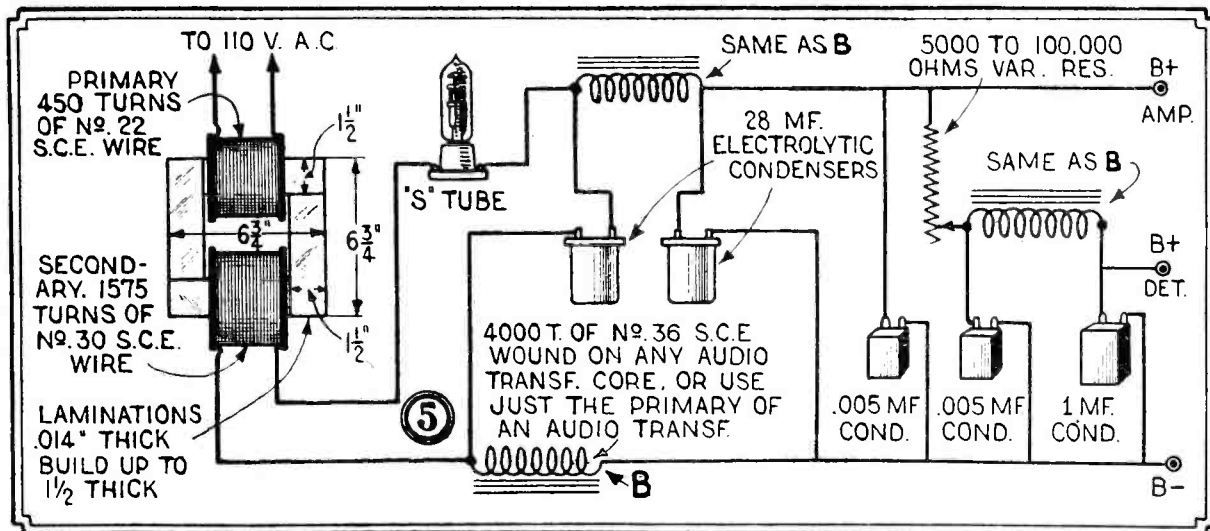

A view of the interior of Mr. Kuhne's "B" eliminator is shown directly above. The filter condensers are mounted over the two audio frequency amplifying transformers.

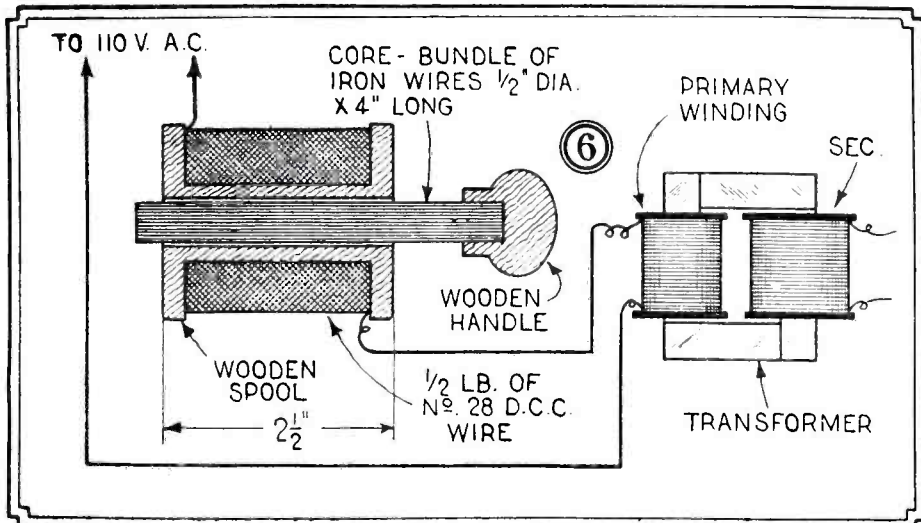

transformer used with this device needs only one secondary winding and all of the details are given. The filter system that we illustrate in connection with this device is different from those shown on the opposite page, inasmuch

as the primary circuit as in Fig. 6. This is a very simple instrument consisting merely of one-half pound of No. 28 D.C.C. wire, wound on a suitable spool. The core is made up of a bundle of iron wires bound together and provided with a

connection with it for the filter system. If you do not get good results with this instrument, try a larger filter condenser in place of the one that is connected from the B+ side of the audio frequency transformer to the filament

binding post on the tube socket. A second audio frequency amplifying transformer provides the current to be rectified and also the filament potential

primary of an audio frequency amplifying transformer is connected directly to the 110-volt A.C. line. The secondary, therefore, furnishes the high voltage

taking off the leg of the core opposite the winding. On this core a quantity of No. 28 S.C.C. wire is to be wound. The exact amount will depend upon the other windings of the transformer used. We would suggest that you wind about 200 turns, replace the leg, and hook up the transformer. Measure the voltage across this new winding. If it is not at least six volts, wind on more turns. If it is more than six volts, remove turns until the voltage is correct. This winding supplies the filament of the rectifying tube.

It may be that you will have a little trouble in eliminating all of the hum with this unit. In such a case, try connecting a potentiometer across the filament supply secondary and connecting the wire which leads from the common connection between the two condensers to the filament, to the center post of that instrument. Adjusting this potentiometer will probably aid considerably in smoothing out the current supplied to the set.

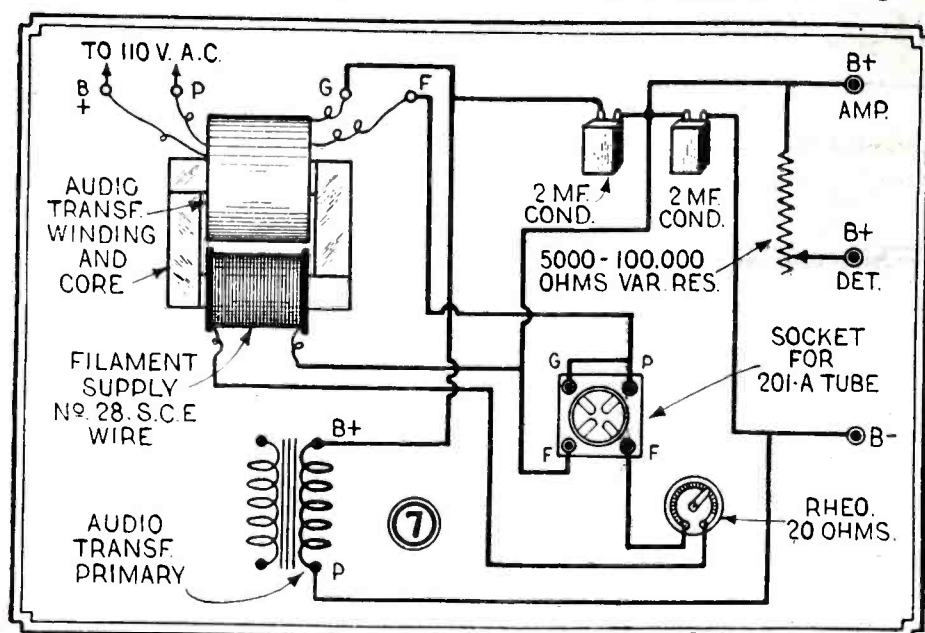

for the rectifying tube. It is reconstructed as described below.

In connection with this unit, the pri-

mary which is to be rectified by the single vacuum tube. This transformer is first taken apart by unbolting the frame and

Receiving without an Antenna or Loop

(Continued from page 55)

noises will appear, notably one similar to that of boiling water. Here you will perhaps become disgusted and manifest a desire to consider me a bluffer and to halt the attempt to operate the set. Don't give up at this stage. By means of your condenser (tickler capacity) and by virtue of much patience, come back to a less turbulent zone. That is to say, turn back until the noise is less annoying. Then you should have nothing but a whistle to contend with. You must make up your mind not to allow the receiver to remain in the danger zone because the amplification is enormous and all parasitic disturbances are consequently increased beyond reasonable bounds. Obviously these noises if allowed to persist will effectively drown out signals.

Conclusion

Operate the receiver exclusively in the first or "super" zone. This zone will be distinguishable by the second click referred to before. The zone exists up to the point where the noise as of boiling water commences. As long as the whistle remains weak and the pitch high you are in the proper zone for operation.

As shown in the foregoing tables there are two zones for reception. They correspond to two different positions or settings of the condenser across the reaction or tickler coil. In order to review the above in complete form I thought it well to present two tables giving the characteristic actions and disturbances of the tube for each period or zone.

The results of reception with this receiver, including English concerts and the following miscellaneous stations, were verified by numerous witnesses. Over 760 different amateur stations, including French, English, Belgian, Italian, Dutch, Swiss, Danish, Finnish and some American stations, have been picked up in a period of eighty hours with the receiver operating with no collective agency and in a rather poor location (first floor of six-story building near the powerful Eiffel Tower station.)

The Editors of *Radio Review* will be glad to hear from readers detailing their experiences and observations in operation of such a receiver.

The Greene Concert Selector

(Continued from page 62)

with such a condenser will cover the range from 170 to approximately 570 meters.

The clarifying selector stator has 50 turns of No. 24 D.S.C. on the inside (25 turns on each half) and 8 turns on the outside (4 turns on each half). The stator form has the same dimensions as the variotransformer stator. The rotor has 4 turns on each side

wound near the edges directly under the same turns as the stator. The diameter of the rotor is the same as that for the variotransformer, but is $1\frac{3}{8}$ in. thick instead of $2\frac{1}{2}$ in. The method of connecting is shown in Fig. 5.

The variotransformer dimensions are shown in Fig. 6 and method of connection in Fig. 7. The plate coil con-

sists of 25 turns bank-wound on the outside of the stator form directly over that half of the stator which connects to the grid of the detector tube. This winding is slightly in excess of $\frac{3}{8}$ in. in width and placed $\frac{1}{2}$ in. from the edge of the form as shown in Fig. 6.

The stator winding consists of 68 turns (34 on each half). The rotor has the same number of turns,

A Two-Tube Power Amplifier

An Excellent Amplifier for Either Crystal Receiver or Single Tube Set

THE superior tone quality obtained by using a crystal detector is well known, but crystal receivers have become very nearly obsolete in these days of reflex and multi-tube reception. Quite possibly the fact that it is a comparatively simple matter to amplify the signals received by a crystal set suffi-

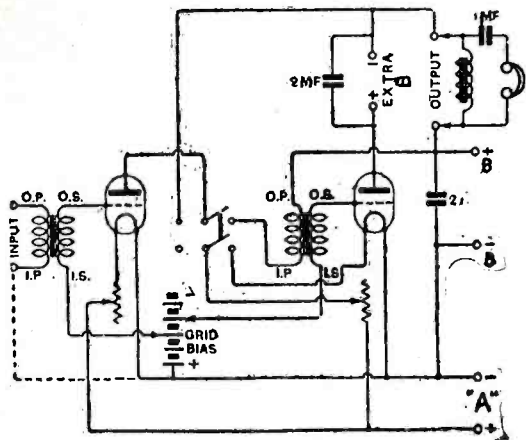

Fig. 1.—The circuit of the amplifier, giving details of the switching arrangement.

ciently to operate a loud speaker has been overlooked by the majority of fans. Writing in *Wireless World*, London, England, G. M. Jones describes a two-tube power amplifier which can be used to operate with a crystal receiver or a tube set.

In this article and data on the construction of such an amplifier unit, Mr. Jones has happily stepped away for a moment from the commonplace and injected some features of a rather novel nature. Considerable attention has been paid to detail—the little things that amount to much in the aggregate. Following are the essentials of the article:

Although primarily designed to operate in conjunction with a crystal set, this instrument is one of general utility and will well repay the trouble spent in constructing it. It is capable of giving enormous power and really good quality reproduction from the loud speaker.

The circuit, Fig. 1, is conventional with the exception, perhaps, that the method of supplying voltage to the plates of the tubes by means of a switch which also cuts in or out one of the tubes is unique and uncommon. Provision is made for a common B voltage for both tubes, whilst it is possible to provide an additional potential to the second tube when considered necessary. The switch when used to cut out the last tube automatically throws out of circuit the "extra B volt-

age," thus avoiding excessive voltage on the first tube.

When two different types of power tubes are in use, and the amplifier is called upon to handle very great volume, it is particularly convenient to be able to apply the necessary additional plate voltage and thereby avoid overloading the tubes. As an illustration, if the amplifier is in use with a tube detector or R. F. amplifier and very strong signals are being received, the second power tube may be overloaded when worked at its normal plate potential of 100 volts. It would be necessary, therefore, to increase the plate voltage of this tube.

Transformer Ratios

As low impedance tubes are generally used in power amplifiers, the transformers must match such tubes. The first (input) transformer, being connected in the crystal circuit or the plate circuit of a detector tube, should have

transformer should, therefore, have a high step-up ratio.

The ratio of the input transformer is 3—1 and may be any good type of this ratio. The second has a ratio of

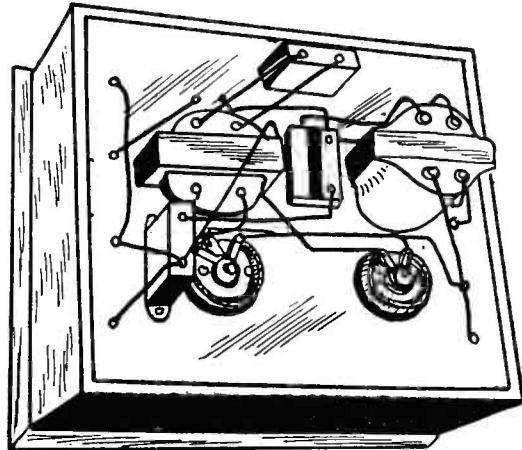
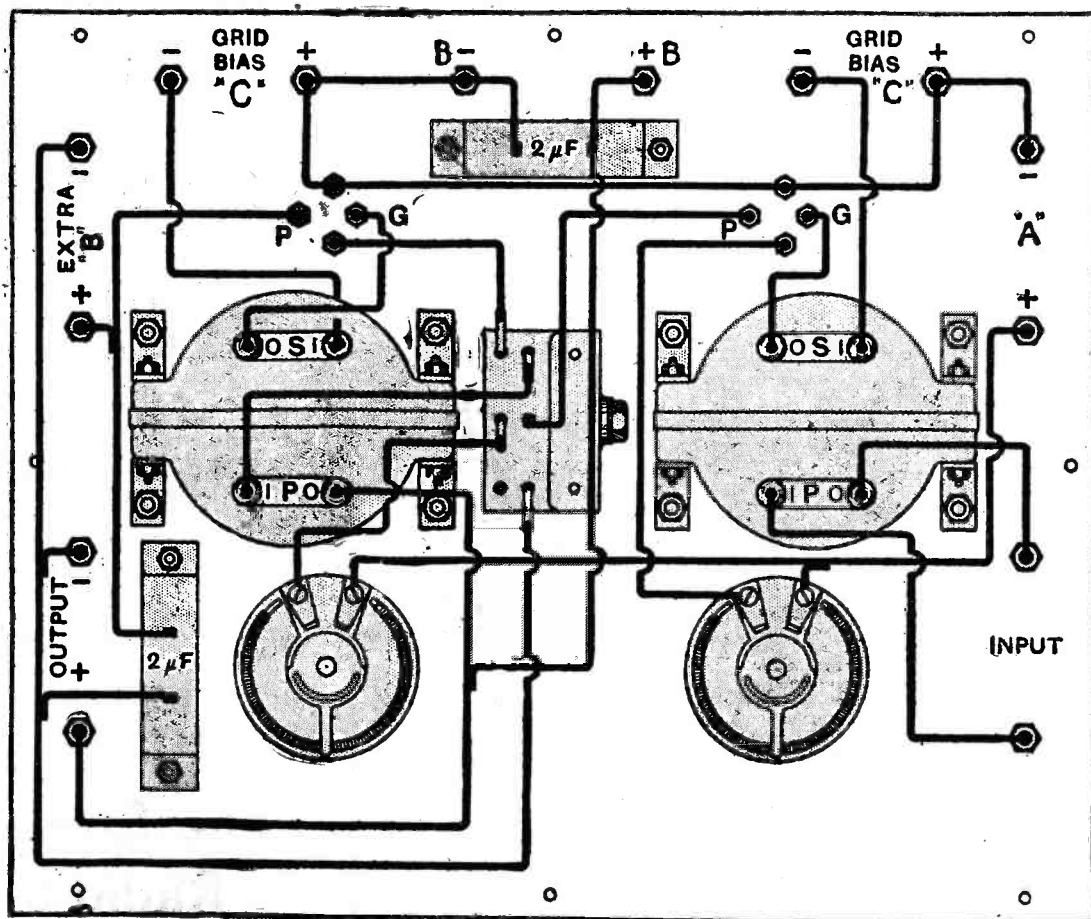

Fig. 2.—The wiring of the underside of the panel made neat and straightforward. In this instrument the types of transformer used are Western Electric and Radio Corporation, but other types of suitable ratios may be substituted if desired.

4—1, matching the moderately low impedance of the 216A or VT2 tubes.



Illustrations by Courtesy of *Wireless World* (London, England)

Fig. 3.—A diagram which will facilitate the wiring of the panel. The provision of a switch so that one or two tubes may be used at will is a point which adds greatly to the value of the amplifier without elaborating the wiring to any appreciable extent.

a high impedance and also a low ratio. The second transformer is connected in the plate circuit of the first power tube, which has a low impedance; the

The materials required are as follows:

- 1 Bakelite panel, 12 x 10 x 1/4.
- 2 6-ohm rheostats.

- 1 D P D T switch.
- 2 good transformers. Ratios 3—1 and 4—1.
- 2 2-mfd. condensers.
- 2 sockets.
- 12 binding posts.

The panel, after being squared up to the required size, should be rubbed down to produce a shell finish.

The mounting holes in panel must of course depend on the type of parts used. Engraving should be done before mounting the components. Care should be taken to mount the transformers with their grid terminals nearest to the grid leads of the tube sockets, thus keeping all grid leads short and direct.

Wiring is straightforward, and the connections are given in Fig 3. It is carried out with No. 14 tinned copper wire, spaghetti-covered. This method enables all connecting wires to be kept short, avoiding angles and long wires.

A fixed condenser of about .001 mfd. should be connected across the primary winding of the first transformer, but this in most cases will be

found across the telephone terminals of the set used as a detector, and is therefore not shown connected in the amplifier.

It is not advisable to shunt the loud-speaker with a fixed condenser when low impedance tubes are used, but if the loud-speaker requires one to correct acoustic faults it is best applied externally to the amplifier. UV 201A or C 301A tubes are useless with this instrument unless they are employed to amplify one frequency only, such as supplying power to a Morse recording instrument. It may be found necessary to ground the filament battery when the amplifier is connected up to a crystal receiver; this is particularly necessary when extended leads for loud-speakers are in use.

Great power is rarely required by the average individual, but it is there if wanted. In the summer evenings, on the lawn or the tennis court, such a reserve of power is very useful. Under ordinary circumstances where the receiver is located reasonably near to a broadcasting station it will seldom be necessary to use more than one tube.

In conclusion, it might be mentioned that as the plate current of the tubes is high, the B battery must be of generous capacity. The ordinary type is quite useless for the purpose, and would give rise to "cracklings" in a very short time. Several manufacturers turn out batteries which are suitable and, although high in cost initially, they are really very economical. Incidentally, these batteries are recommended for any multitube set, as a "dead" background of silence cannot be obtained when ordinary B batteries have been in use for a few weeks, even when large by-pass condensers are used.

A word of warning. Ordinary telephone receivers must not be connected to this amplifier when power tubes are in use. The current flowing in the plate circuit is much too heavy for the windings. A 1 to 1 in the case of high resistance phones, and 10 to 1 telephone transformer with 120-ohm phones, should be used, or, alternately, a choke filter circuit consisting of an iron core choke wound to about 25 henries and a 1 mfd. fixed condenser.

WIRELESS COURSE in 20 LESSONS

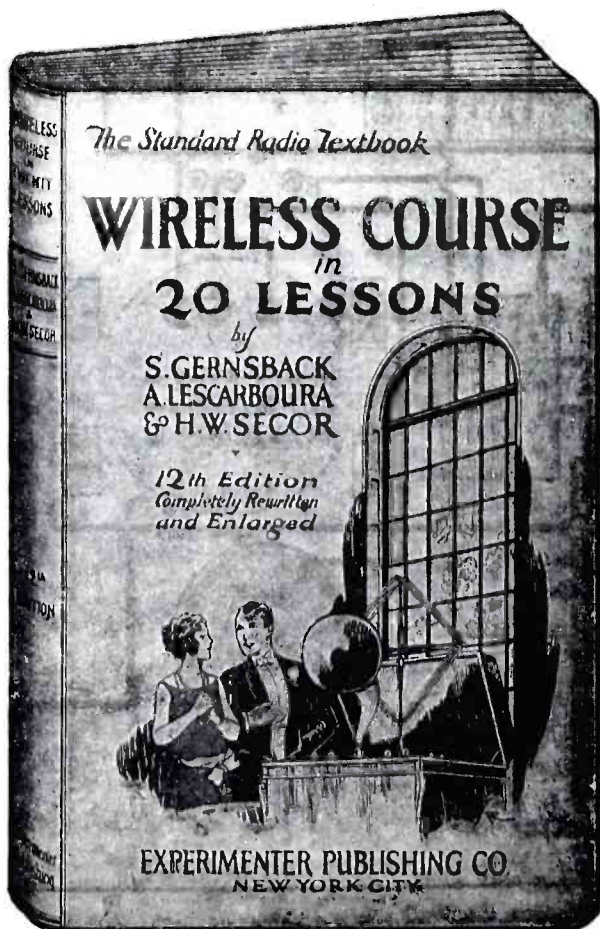

PRICE \$2.00 POSTPAID

by

S. GERNSBACK
A. LESCARBOURA
H. W. SECOR

*Radio's Standard
Textbook*

12th EDITION

The finest, most complete
Radio textbook on the
market

Experimenter Publishing Co., Inc.

53 Park Place, New York, N. Y.

Single Tube Regenerative Hookups

Various Arrangements of Regenerative Circuits Easily Made with Multi-Unit Hookup Board

FOR the ardent fan who is desirous of making comparisons as to the sensitivity of various types and arrangements of regenerative circuits, a compact assembly of the units necessary will prove very convenient. By a few changes of connections, the single circuit becomes a three circuit and the relative values can be easily determined. Such an assembly can be mounted on a hookup board which is described by A. J. Gelula in *The Experimenter*, New York. The author's description and general explanation is as follows:

We shall consider the straight regenerative circuit utilizing one tube only. Without doubt, regeneration properly applied results in an ultra-selective as well as a very sensitive circuit.

It often requires much consideration on the part of the experimenter or novice to determine whether radio frequency, regeneration, or audio frequency should be used for a given number of tubes. Before attempting to build a complete set, always give thought to the requirements involved and to external receiving conditions.

Of course, audio frequency amplification should be placed, if possible, at the output of every receiving set. Audio frequency amplification increases the practical receiving range of the set as well as the volume.

If volume is preferable to distance reception, radio frequency amplification would not do, as this type of amplification will boost only the energy intercepted by the aerial. Radio frequency amplification amplifies the signal before rectification, while audio frequency amplification amplifies it after rectification.

Considering the question whether a given number of tubes are to be used for the audio side, we must ask ourselves the above questions as well as give thought to other factors.

Radio frequency amplification may be added to the circuits given on the next page by merely placing one tube ahead of it, the primary and secondary coils acting as the inter-stage coupling.

Regeneration is equal to a little over one stage of tuned radio frequency. Therefore, by the addition of regeneration plus R.F. and with the conventional two stages of audio, this type of set might be considered ideal.

The circuits given on the opposite page are of the one tube regenerative type. The hook-up board as shown in the illustration contains two vario-

LIST OF PARTS

- 2 Atwater-Kent Variometers
- 1 Hammarlund 43-plate Condenser
- 1 Shamrock 3 Circuit Coupler
- 1 Soft Wood Board, 20x10x1/2"
- 1 Na-Ald Tube Socket
- 1 Rasco 30 ohm Filament Rheostat
- 8 Double Spring Binding Posts
- 5 Single Spring Binding Posts
- 18 Rasco Test Clips
- 12 Rasco Test Points
- 1 Grid Condenser (.00025 mfd.)
- 1 Grid Leak (2 meg.)

meters, one variocoupler, a variable condenser (.001), a socket and a rheostat. They are connected together ac-

the variometer in the circuit be capable of tuning throughout the wave-length range of 200 to 600 meters.

Fig. 2 shows how a three control set may be built by using two variometers and a variable condenser. As stated in the preceding paragraph, the variometers must tune throughout the entire broadcast wave band. The variable condenser is of a .001 mfd. capacity (43 plates approximately). The grid leak may be connected across the grid condenser rather than from grid to filament. It will be found that the regeneration will be slightly difficult to control if a dry cell tube is used. By

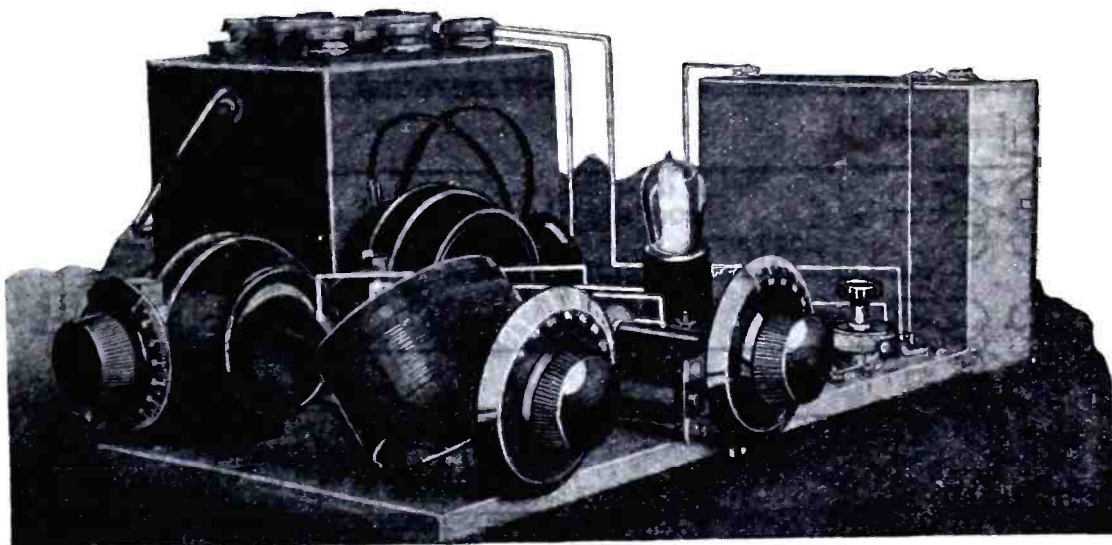

Illustrations by Courtesy of *The Experimenter* (New York)

The layout for the experimental test-board. Note the arrangement of the apparatus. All dials are easily accessible for variation of wave-length and regeneration. This layout, besides being used for single-tube regenerative circuits, may be, with the addition of another tube, a test-board for radio frequency amplification tests. If the addition of another tube is disagreeable, the apparatus may be used for building one stage of R. F. and connecting the output into any standard radio receiving set.

cording to the desired diagram. Clips or cord tips were used for the making of rapid connections.

The experimenter will find that a board of this type, left assembled, will be invaluable in general experimentation. Variometers may be used in many points of the circuit other than grid and plate leads. The variometer may be used very successfully for inter-stage radio frequency transformers, primary or secondary tuning devices or for general wave-length control.

We shall now consider the one-tube regenerative circuits, presenting on the next page ten tested, one-tube regenerative hookups for the test board.

Fig. 1 is the usual variocoupler, two-variometer circuit. A soft tube is preferable for detection, with a low voltage on the plate. The aperiodic primary is wound directly over the secondary. It is very important that

the use of a soft tube the regeneration may be controlled with the aid of the rheostat.

Fig. 3 shows the tickler feed-back method of regeneration control. The primary is aperiodic, wound over or directly beneath the secondary. The tickler is variable. The primary, secondary and tickler comprise a three-circuit coupler, and with the secondary tuning condenser, which is of a .0005 mfd. capacity, the set operates very efficiently despite the fact that there are but two controls.

Fig. 4 is a split variometer circuit. A two-circuit tuner may be used in place of the single circuit affair shown in this diagram. This circuit operates very efficiently on broadcast wave-lengths and is comparatively easy to tune. It will be found to be a simple matter to "split" the variometer. The variometer is composed of the rotary and stationary coil connected in series.

Experimental One-Tube Regenerative Circuits

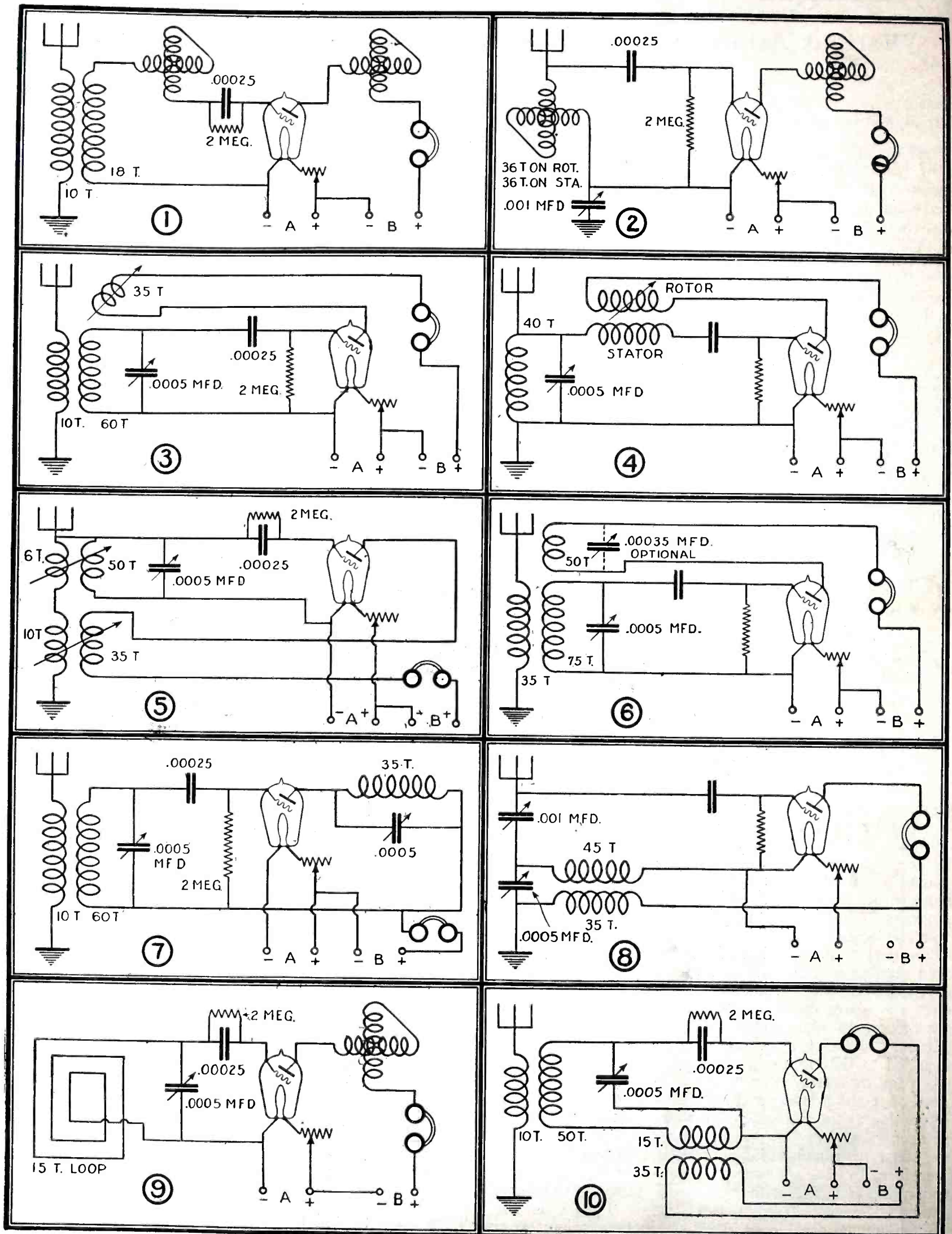

Fig. 1 is a straight variocoupler, two variometer regenerative circuit; Fig. 2 indicates how two variometers and a variable condenser are connected for a one-tube regenerator; Fig. 3 is a tickler feed-back system, while Fig. 4 shows a similar method using the split-variometer; Fig. 5 is to a certain degree a freak circuit, but presents good meat for the experimenter; Fig. 6 gives a honeycomb regenerative circuit, the variable condenser in the tickler coil being optional; Fig. 7 is similar to Fig. 1 except that the condenser replaces the variometer; Fig. 8 is a capacity-coupled regenerative circuit; Fig. 9, for short distance reception and for the radio man desiring the extreme in selectivity, is ideal; Fig. 10 is another method of tickler feed-back.

In order to split the variometer it is necessary to sever this series connection. The connection is usually made either through the end plates or directly on the shaft of the rotor. It is very important that the rotor of the variometer be connected in the plate circuit, and the stator in the grid.

Fig. 5 makes a very interesting experimental layout. We have our two-circuit tuning arrangement in the aerial coil and secondary. The ground coil and tickler are in inductive relationship. It was found that the ground and tickler coil should be out of the inductive field of the primary and secondary coils. For the radio man who enjoys experimenting with freak circuits, Fig. 5 certainly fills the bill.

Referring to Fig. 6, we may be led to believe, at first glance, that it is a duplicate of Fig. 3. This is not the case, however, for this circuit is designed for use in connection with the

honeycomb type of coil. The variable condenser in the plate coil is optional. However, should the coils be mounted within the cabinet in fixed inductive relation, this condenser becomes vital. If the three condensers are used, it will not be necessary to touch the coils after they are once adjusted, as the tuning is entirely controlled by the three condensers.

Fig. 7 is a well known ultra-audion circuit using a condenser-tuned plate. The volume is very good, but for the amateur DX receiver, it is doubtful whether this circuit would be suitable. The fixed condenser must not be connected across the grid condenser, for the tube is easily paralyzed.

Fig. 8 gives the schematic diagram for a capacitively-coupled circuit. The two coils are in inductive relationship, the plate coil being variable. This circuit will be found very selective and capable of producing good tone and

volume. However, for DX many of the other circuits shown on the page surpass or equal it.

If you live within one mile of a broadcasting station, the circuit shown in Fig. 9 will be found to produce good volume, and is especially useful in vicinities where broadcasting stations are numerous, because it is ultra-selective. The loop to be used with this set should be as large as possible. The 15 turns indicated in the diagram were computed on the basis of a loop two feet square. Of course, if the loop is larger, the number of turns becomes smaller.

In Fig. 10 we have another circuit utilizing the tickler feed-back system. The two inductive coils in the feed-back system of this circuit may be a split variometer, if the experimenter so desires. Note that the variable condenser tuning the secondary, connects to the filament side of the secondary.

Get this beautiful binder for your Radio Encyclopedia

Price
\$2.00

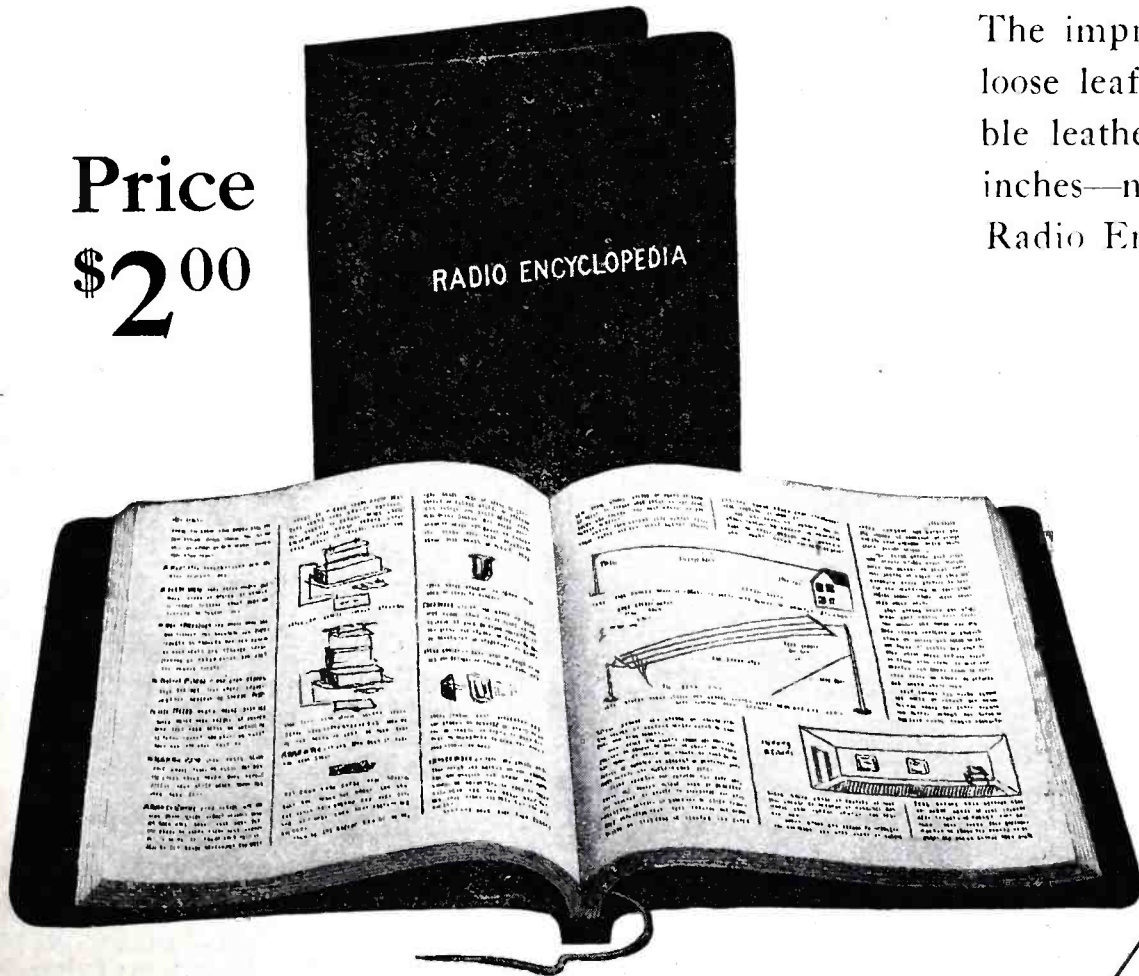

The improved "Emerson" patent loose leaf binder—made of flexible leatherette. Size 10 by 12½ inches—made specially for the Radio Encyclopedia.

Gold Stamped

**JUST TEAR OFF
THIS COUPON
AND MAIL
TODAY**

**ALL
BINDERS
SHIPPED
POSTPAID**

CONSRAD CO., 233 Fulton St., New York, N. Y.
Gentlemen: Kindly send me at once one leatherette binder as described for which I am enclosing \$2.

Name.....
Address.....
City.....
State.....

Crystal Sets for the Experimenter

An Explanation of Various Crystal Circuits which Give Most Satisfactory Results

"WHENEVER 'a selective crystal set' is mentioned radio engineers smile or laugh. Is there any such thing, or can there be? Yes. There is a limit in the selectivity line, in regard to simple crystal sets, due to the stubbornness of the crystal itself

"While with tube receivers it is possible to utilize circuit designs applicable to general demands and needs, regardless of location of the receiver, with the loggable crystal sets it was found advisable to make them to fit the locality."

Here, the author, *Herman Bernard*, writing in *Radio World*, New York, asks a question concerning a much neglected matter. It is an important one, however, as far as users of crystal receivers are concerned, and they are fortunate in being able to read a very interesting and instructive answer by the same author. Much credit is due Mr. Bernard, not only for bringing up the subject, but for his excellent treatment of the proposition and the lucid explanation of a number of practical solutions. Mr. Bernard continues in his explanation of various crystal circuits as follows.

A 3-Station Range Set

Fig. 1 shows the wiring of a simple crystal set, having three controls, and which is very good for a locality where three stations may be within the constant receiving range. To increase the selectivity slightly a somewhat disproportionately large reduction in volume had to be suffered, due to the electro-

once. If not, then both C2 and C3 may be set to tune out the one interfering broadcaster, or if only one is used for a trap, the other circuit may be tuned to any frequency other than that of the incoming signal.

A great many persons live in localities in the United States that are within crystal range of three stations or less and to them this circuit will prove attractive. However, the first

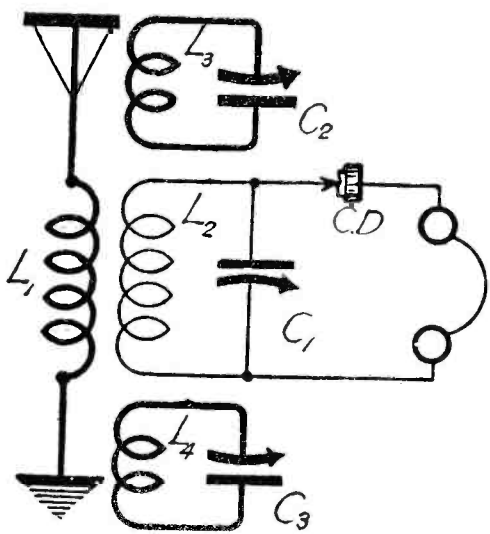

Fig. 1. A selective crystal set for a point of reception that has a 3-station range. Any one of the three stations may be tuned in by C1, the two others tuned out by the wave-traps, L3C2 and L4C3. As the primary L1 is not tuned there is no compensating effect and the set may be logged.

in resisting attempts to introduce it into very select society. A crystal set can be made sufficiently selective to be useful in most localities. With any of the circuits, even the most selective, trouble may be expected in congested areas, such as New York City and Chicago. If the set owner lives near a powerful broadcaster he is bound to hear that station virtually all over the dial and can not tune it out to bring in a station farther away that is of the same power. The only other trouble with the best designs in simple crystal receivers is that at least four controls, often even five or six, are used. Also, they can not be logged."

"Hence, you can have a selective crystal set, if there is no objection to more than four controls. These sets invariably use tap switches, and the introduction of such devices destroys the possibility of logging. It is conceded that there is no great advantage in having a simple crystal set loggable, since only a few stations will be within the range of the receiver at all, but the loggability feature and the limitation of controls to three were taken as a basis experimentally. No set having less than three controls was found to be worth much.

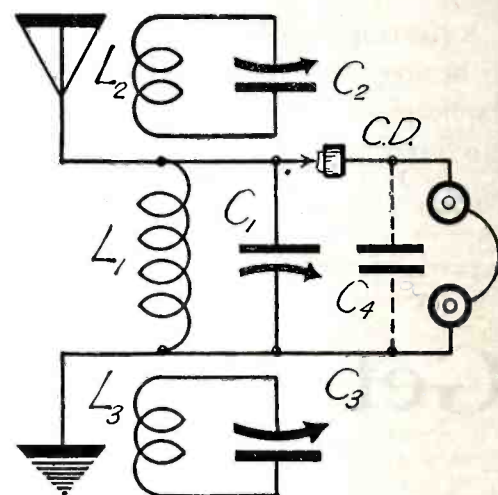
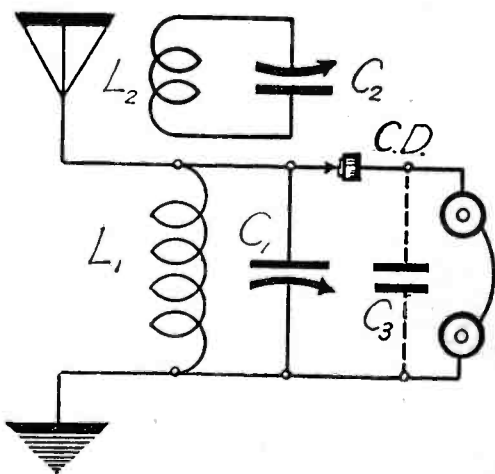

Fig. 2. A tuned impedance primary gives more volume than the inductive coupling method shown in Fig. 1, but the set suffers in selectivity. Under certain conditions, explained in the text, this hook-up is very good.

question to determine is how many stations really are within range. For this purpose hook up the receiver shown in Fig. 2, omitting L3C3 and L2C2. This is about the broadest tuning circuit possible to make. Any station that you can hear fairly well may be expected to come in at any setting of the condenser, although the volume will be more or less, depending on how near you set C1 to that ample sweep of dial degrees that represent theoretical resonance with the incoming signal. A station nearby may be very loud and another, further away, will be weaker, or not heard at all, under the circumstances, due to the drowning effect caused by the other. However, a fair idea is obtained of those stations you may expect to hear. If there are three, then the hookup shown in Fig. 1 will be serviceable.

Coupling the Wave-traps

The wave-traps are loosely coupled to the secondary. Have the coupling as loose as is consistent with effectiveness of the traps. If the coupling is too loose there will be no effect; if too tight there will be no trapping, only compensated tuning. With tight coup-



Illustrations by Courtesy of *Radio World* (New York)
Fig. 3. Instead of two wave-traps one may be used, but that is efficient only if the receiver has a 2-station range.

magnetic method of coupling the antenna circuit to the tuned secondary L2. The two tuned closed oscillatory circuits, C2L3 and C3L4, are wave-traps. Thus C1 is set to tune in the station desired to be heard, while C2 is tuned so as to trap out one interfering station and C3 tuned to trap out the other. It is assumed that the three stations within range are on the air at

ling, if you add capacity by further engaging the plates of one of the condensers you will have to reduce the capacity of the other by unmeshing its plates. There will be no selectivity gain from such compensated tuning.

The operation of the wave-trap is on the theory of parallel inductive closed circuits. These are known as rejectors, because their only use is to keep out signals that are not wanted. If the wave-trap is set so that its frequency is the same as that of the receiving circuit, then theoretically the trap will absorb the energy and no sound will be heard in the phones. This is more or less true of more strenuously oscillating circuits—where tubes are employed—but it is not quite so of crystal hookups, for in most cases if the incoming signal is of any good degree of strength the resonant trap will absorb most of the energy, not all of it. If the station is heard rather weakly under best conditions, then even in the crystal hookup the trap may monopolize the signal. This might argue against the effectiveness of the traps when used for their intended purpose, and it might be so, were it not for the drowning effect of the accepted signals.

The opposite method is that of series connection, where one end of

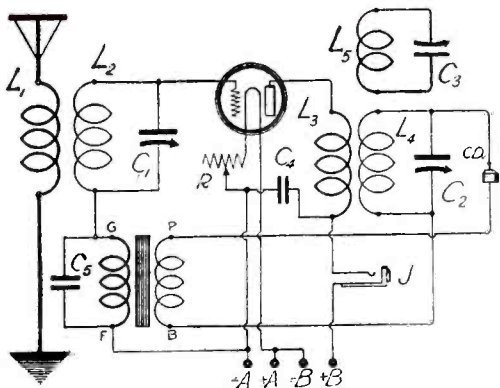

Fig. 4. The wave-trap idea embodied in a 1-tube reflex. This circuit is good for ear-phone reception even in congested areas.

the coil (L2 in Fig. 3) would be connected to the antenna side and the other end of the erstwhile trap to the receiver side. This is the acceptor method, and tuning such a circuit to resonance aids the set in receiving the desired signals, instead of hampering or preventing this end. But the help is not such as to constitute a gain in selectivity. The coil L2 could be connected, say to the antenna in Fig. 3, the other side of the coil to one side of C2, and the other side of C2 to the receiver, e.g., to the crystal input. That, too, is series connection, only capacitive coupling is used instead of tuned conductive coupling. Only compensated tuning would result. In fact, by this method of connection for series purposes the coil could be omitted entirely, to represent the idea. The coil across the condenser preserves conductive coupling. Capacitive coupling causes a severe volume drop in crystal sets. Inductive coupling is much bet-

ter. Greatest volume results from conductive coupling.

The Question of Frequency Range

Fig. 2 shows a conductively coupled circuit. Here the antenna is tuned by

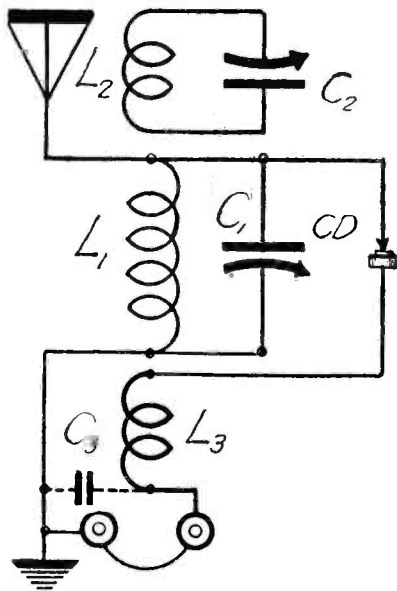

Fig. 3A. How a 3-circuit tuning coil may be employed in a wave-trap crystal hookup. L1 is the rotary coil. L2 is the secondary (large stator winding, used for trap). L3 is the otherwise aperiodic primary. The rotary coil L1 is loosely coupled and left that way.

C1. L1 is the impedance coil. If the wave-traps are properly distant from the impedance coil L1, so that no compensated tuning results, it would be impossible to cover the broadcast range with any untapped coil in combination with any condenser in general use by fans today. However, it is rarely necessary to cover the whole band, since only a few stations can be received, anyway, and these are assumed not to have such a disparity of wavelengths as to require a greater range than this combination affords.

The reason why the wavelength or

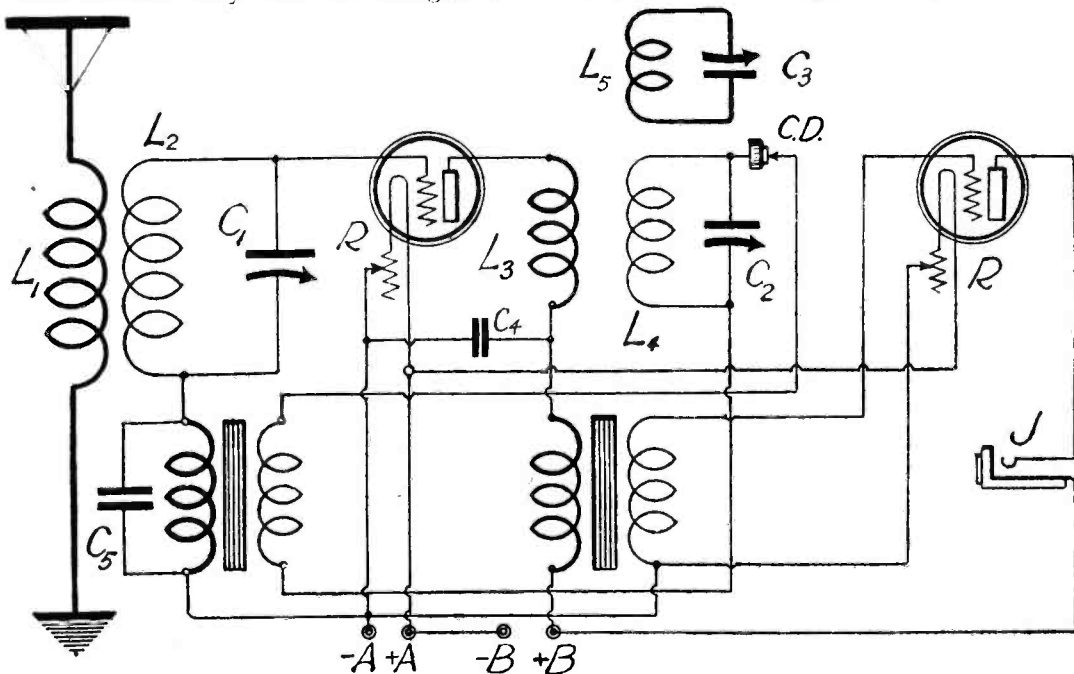

Fig. 5. One step farther and we have a reflex set that works a loud speaker and which is selective. The wave-trap idea is retained. This is the same as Fig. 4, except that a second stage of audio (this one not reflexed) is added.

frequency range could not be covered, say even in the case of a tube hookup embodying this plan, is due to the introduction of the actual resistance and, more particularly, the capacity of the

antenna system into the tuned circuit. A condenser is able to cover the range with a suitable inductance, e.g., L4C2 in Fig. 4, only because the distributed capacity of the coil, part of the plate capacity of the tube, and the capacity of some of the associated wiring and parts are added to the minimum capacity of the condenser. All these additions are not ratable factors, even in comparison with the minimum capacity of good condensers. Thus, broadly speaking, about the same ratio of minimum to maximum capacity of the condenser is maintained as when the condenser is considered alone and apart from any circuit. The maximum capacity must be at least a certain number of times greater than the minimum capacity. This relationship constitutes the ratio. Because the wavelength varies as the square of the capacity, there must be enough difference in capacity between the maximum and the minimum to enable the square of the lowest to bring in the lowest-wave station and the square of the highest to bring in the highest wave station, in conjunction with a coil of proper inductance.

Therefore if you add the aerial capacity to any coil you add that capacity to any condenser connected in parallel with the aerial system. The capacity of different aerials differs greatly. Many aerial systems in use for broadcast reception have a capacity as high as .0005 mfd., some even have .001 mfd. and more, while between .00025 mfd. and .0005 mfd. may be assumed to represent the capacity of the majority of antenna systems used for reception of programs. Add .00025 mfd., for instance, to a condenser that has a minimum of .00005 mfd. and a maximum of .0005 mfd., in other

words, 50 to 500 micro-mfd., or 1-to-10. The minimum that was .00005 mfd. (50 micro-mfd.) is increased by .00025 mfd., hence is .0003 mfd., while the maximum is .0005 mfd. + .00025

infd., or .00075. Is .0003:00075:: 1:2½?

Is 1:2½ a 1:10?

The ratio is only one-fourth of what it was before, and not enough to cover the range.

What might seem to be an exception

Fig. 1, and the coupling is close, then part of the aerial capacity, etc., are added to that of the tuned receiving circuit, although to a much smaller degree than by the conductive method. Granting there is a substantial number of turns on the aperiodic primary L1,

receiver was that shown in Fig. 3 (2-station range). No other receivable station was on the air. WNYC, 526 meters, was using 1,500 watts output, WEAJ, 492 meters, 3,500 watts. This is far greater power than that used by 90 per cent. of the stations in the United States and Canada. It is far greater than the power used on stations tuned in usually in testing crystal receivers. To be very certain of the result, four stages of audio-frequency amplification were added to the receiver. These consisted of one transformer-coupled audio stage and three resistance-coupled steps. The reason for all this AF was that sometimes stations can not be heard on ear-phones, although within theoretical receiving range, the silence being due to absence of sufficient power to actuate the phones. The result of the test was that by turning the wavetraps C2, either one of the two stations could be tuned in and the other tuned out. The success of the experiment was complete and beyond doubt. There was no signal interference whatsoever. Also, the trap functioned as selectively as a 1-tube regenerative set.

It will be noticed that the wavetraps was used not really for tuning but for detuning. As there was a difference of only 34 meters between stations, and the power output of both was high, naturally the receiving circuit, which, as has been mentioned, is one of the broadest tuners you can possibly have,

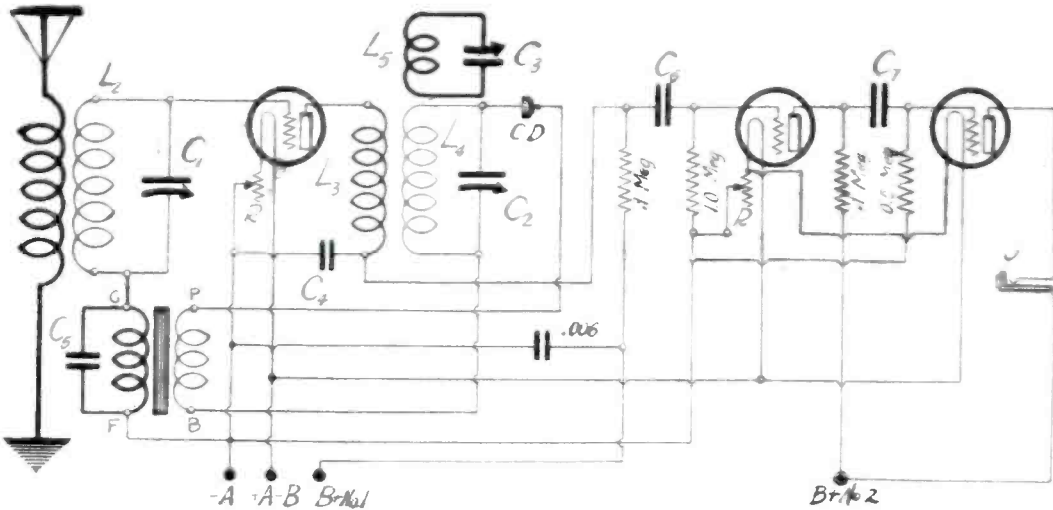

Fig. 6. The same fundamental hook-up as is shown in Fig. 5 is presented above, except that the second audio stage is replaced by two stages of resistance-coupled AF for better quality.

to this method of reasoning will be found when the lowest wavelength station and the highest wavelength station, granting both are within receiving range, are heard even with the impedance crystal hookup. That would be due to the broad tuning of the circuit enabling signals to crowd through, although on waves above and below those to which the circuit itself is responsive. In other words, the inherent broadness of the crystal causes this

say 20 or more, this effect may be very noticeable. But as the coil is moved farther away from the secondary the effect diminishes and almost completely disappears. In this case, of course, some account must be paid to the inductive effect, some of the increased period being due to that. This would be well represented were L1 made variable in respect to L2 in Fig. 1. But it has been demonstrated experimentally that the inductive ex-

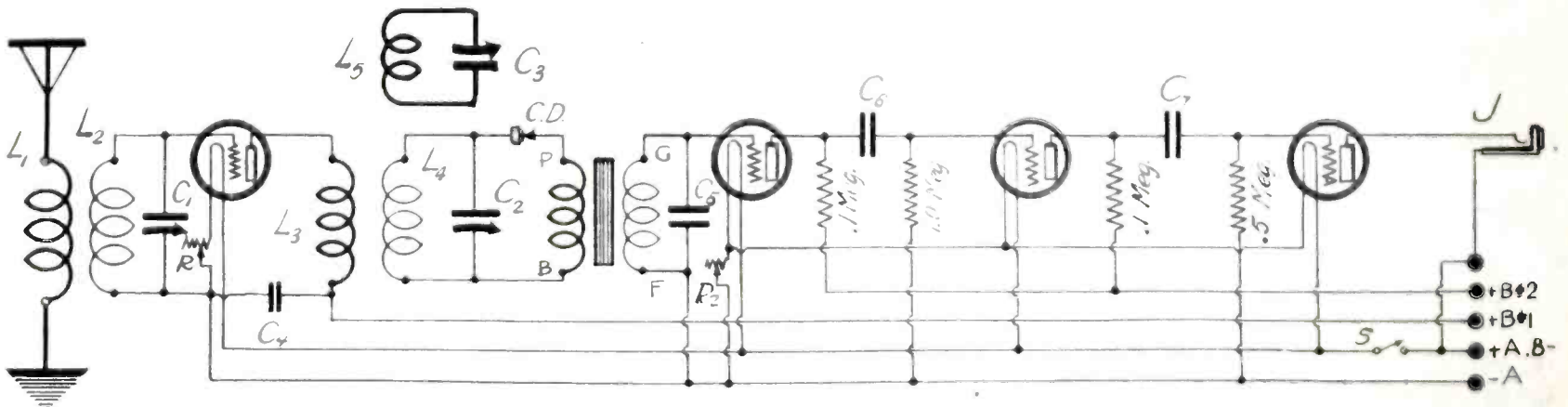

Fig. 7. The same circuit as shown in Fig. 6, except that the first audio stage is not reflexed.

phenomenon, which may be regarded as defiant of wavelength, a forcible entry, rather than tuned reception.

The hookup shown in Fig. 3 uses the conductive coupling method, too, with the impedance coil. If a variable series condenser were used here or in Fig. 2 the range could be covered, the desired ratio being re-established by the series condenser's sharp reduction of the minimum capacity present in the tuned receiving circuit. Fig. 3 is good to use if only two stations are within range. A likely plan would be to build this one and then, if another interferer is found, to incorporate the second trap (Fig. 2).

In all cases conductive coupling for crystal receivers will give more volume than any other method.

If an untuned primary is used, as in

planation is not complete, by any means, since even if relatively few turns are used on L1 and the coupling made as tight as possible, the wavelength increase resulting is far greater than what could be ascribed merely to the inductive addition. In other words, tighter coupling tends to create the effect of parallel capacity while loose coupling establishes independent capacity. The observations are restricted to simple crystal sets.

Test of the Trap

Some question may arise in the minds of those who have not used wavetraps in conjunction with crystal hookups as to how effective they are. Citing experimental proof, WNYC and WEAJ were each five miles distant from the point of reception. The

made them both audible together at any point from 0 to 100 on the dial. This cross-talk was eliminated by setting the condenser C2 at 65 to eliminate WEAJ, permitting WNYC to perform a "solo," and at 78 to eliminate WNYC and bring in WEAJ.

A 1-Control Set

The ineffectiveness of C1 under these circumstances will naturally give rise to the idea of constructing a 1-control receiver for meeting a condition similar to this one. Why tune the input circuit at all? Why not simply have a trap, in inductive-relationship to an untuned coil which has a natural peak say at 500 meters, this being a good compromise point? Why not either wind the requisite number of turns, or use about 25 turns, shunted

by a .001 mfd. fixed condenser? This is indeed practical.

All Trap Detuning

Pursuing the idea a little farther, if there are three stations within receiving range, and the highest no more than about 200 meters removed from the lowest, why not use 15 turns, shunted by a .001 mfd. fixed condenser, for L1C1 in Fig. 2, and have two wave-traps, one to eliminate one of the interferers, the other to block the entry of the other cross-talker. That gives two controls. Also, as one extra wave-trap is needed to eliminate each additional station that causes interference, why not three wave-traps where four stations are within receiving range? That gives a 3-control set. All this is feasible, but of course disparity of volume may be expected, especially where some receivable stations are on the lower waves, where the permanent inclusion of much extra capacity (the fixed condenser) operates tremendously against the possibility of passing enough of the signal to give volume. Fans should try this method, however, if they are interested in the development of workable crystal receivers.

Data on Coils and Condensers

All the variable condensers used in the circuits are presumed to be .0005 mfd. maximum capacity and the inductances were calculated accordingly. If smaller capacity condensers are used, add more turns.

The coils are of three kinds:

- (1) Radio-frequency transformer, with exception (a).
- (2) Wave-trap inductance.
- (3) Impedance coil.

All the radio-frequency transformers are wound alike, with the exception (a) of L1L2 in Fig. 1. All the wave-trap inductances are wound alike. The impedance coils will vary, according to antenna conditions (capacity, resistance, etc.).

(1) **RADIO-FREQUENCY TRANSFORMERS.**—These are wound on a tubing $3\frac{1}{2}$ " diameter, 4" high, with No. 22 single cotton covered wire. The primary will consist of 10 turns, the terminals being anchored in pinholes punched in the form. Leave $\frac{1}{4}$ " space and wind 45 turns for the secondary. The terminals of the secondary similarly are secured. The exception (a) is that

L1L2, Fig. 1, consists of using 22 turns (instead of 10) for the primary L1, leaving $\frac{3}{4}$ " space, or a little more, if experience shows that the circuit will stand it (instead of only $\frac{1}{4}$ "), then winding the regulation secondary, 45 turns.

(2) **WAVE-TRAP INDUCTANCE.**—This consists of 52 turns of No. 22 single cotton covered wire on a $3\frac{1}{2}$ " diameter tubing at least 3" high.

(3) **IMPEDANCE COIL.**—This is used conductively coupled to the antenna system. As antennas vary greatly as to capacity, some being as high as .001, others as low as .0001, this capacity is added to the condenser capacity, hence the coil will have to be wound to suit particular conditions. It is good practice to start with 40 turns and remove turns, under test, until satisfactory tuning conditions prevail. The same kind of wire and the same diameter tubing are used.

Those having other wire types on hand may employ what they have. Finer wire necessitates a slight reduction in the number of turns, provided the insulation used is the same as that specified above. If the same kind of wire, No. 22, is used with heavier insulation, such as double cotton covered or silk over cotton, then a few more turns will have to be incorporated.

Coil Key to Diagrams

Fig. 1, L1L2, the exception (1a) noted above; L3 and L4 are in class (2).

Fig. 2, L1 is in class (3) while L2 and L3 are under (2).

Fig. 3, L1L2 and L3L4 under class (1). L5, class (2).

Fig. 4, same as Fig. 3.

Fig. 5, same as Figs. 3 and 4.

Fig. 6, same as Figs. 3, 4 and 5.

Fixed Condenser Key

C4 is .001 mfd. C5 is .0001 mfd. These values are not critical and may be changed, if you have higher or lower capacities on hand.

Where a condenser is shown across the phones it may be .002 mfd. but is not critical, either. Experience will show whether the phone condenser is necessary. Usually it is connected with one side to one of the phone tips, or equivalent detector output, and the other side to the other output post of the detector. In Fig. 6 the equivalent condenser is shown across the second-

ary of the first AFT where it worked better, and this supplants the normal position across the AFT primary. The .006 mfd. fixed condenser across the batteries in Fig. 5 is entirely optional.

In all cases in testing out crystal detector receivers where tubes are employed, whether for AF or RF or a combination of both, always ground the minus A battery lead experimentally. If volume increases leave the grounding of minus A as a permanent part of the hookup.

Use of Tubes

Once you include a stage of RF ahead of a crystal detector you have a tube set, not a crystal set. But such inclusion gives you a receiver that is altogether out of the experimental stage, so far as general adaptability to standard use and needs is concerned. Fig. 4 shows a 1-tube reflex, using a wave-trap, a good set to tune out a powerful station near the receiver, and which station otherwise would cause a great deal of trouble. The station, by the way, may be sending code, rather than programs, although this is usually harder to tune out for several reasons. It is not guaranteed, however, that a wave-trap will cut out all powerful stations close by the point of reception. If the set is sensitive enough to work without ground connection, and the trap is included, good results may be expected.

To operate a speaker two stages of transformer-coupled audio are needed, and Fig. 5 shows the same hookup as Fig. 4, but with the speaker power, i.e., a second but unreflexed stage of transformer-coupled audio included.

Fig. 6 affords somewhat better quality, but no more volume than Fig. 5, since two resistance-coupled stages are added to the reflexed audio stage, instead of a second transformer-coupled stage. Note that one extra tube is required. This set works a cone type speaker that is very sensitive to distortion and works it with marvelous sweetness.

In Fig. 7 the same circuit is presented as in Fig. 6, with the same RF, detection and AF, but without resort to reflexing. Thus one extra tube is required, four in all, but for those who possess musical ears and a fine sense of appreciation of quality it is a circuit of great allurements. The B battery voltage for the RF in these hookups may be 45 to $67\frac{1}{2}$, while up to 135 on the resistance-coupled stages will lend further richness to the tone.

RADIO FOR ALL

By H. GERNSBACK

Editor "Radio News," "Science and
Invention" and "The Experimenter"

With over 130 illustrations and diagrams, and 12
photographs, 300 pages, size 8¼" x 5½".

What the novice in radio needs is a book in which he can get all the information necessary for him to understand radio telephony and telegraphy, to make or buy a receiving set suitable to his means, to know how to operate his set, and after he has an understanding of the radio art, information that will enable him to advance and get the most out of his outfit. All this must ordinarily be dug out of text-books, pamphlets and government publications, but the aim of this book is to have all the data and information that the beginner will need from the time that he takes up radio. It is a permanent, comprehensive reference book for the dyed-in-the-wool dabbler in Radio.

For the Beginner

The theory of radio carefully explained with drawings.
Description of and instruction for operating instruments of receiving and sending sets, with all picture diagrams of the wiring of the apparatus.
How to make your own receiving set, costing from \$3.00 to \$50.00.
How to read diagrams; for every picture diagram there is a corresponding technical diagram using the symbols instead of drawings.
How to tune sharply and eliminate interference from other stations.
How to protect your set from lightning and the laws regarding installation.
Explanation of time and weather signals.

For the More Experienced Amateur

How to make a practical vacuum tube detector, two stage amplifier set costing less than \$50.00 that will work.
How the radio compass works.
All about underground aeriels, loop aeriels and directional aeriels.
Formulae for finding wave length; miscellaneous formulae for finding capacity of condenser and other instruments. Tables of wire resistances, wave lengths and their corresponding frequencies, approximate wave lengths for different aeriels, tuning coil data, and much more invaluable information.

Special Features

Lists of all the broadcasting stations in the United States and Canada for concerts; time signals, weather reports, press, stock market reports, etc., with their call, wave length and time of sending.
Detailed description of Washington weather signals and their translations.
Description of a modern broadcasting station and its operation.
Large map showing location of all U. S. radio telephone broadcasting stations suitable for hanging up in radio room.
Collection of miscellaneous radio information for the amateur.

For Sale by

The Experimenter Publishing Company, Inc.
53 PARK PLACE
NEW YORK, N. Y.

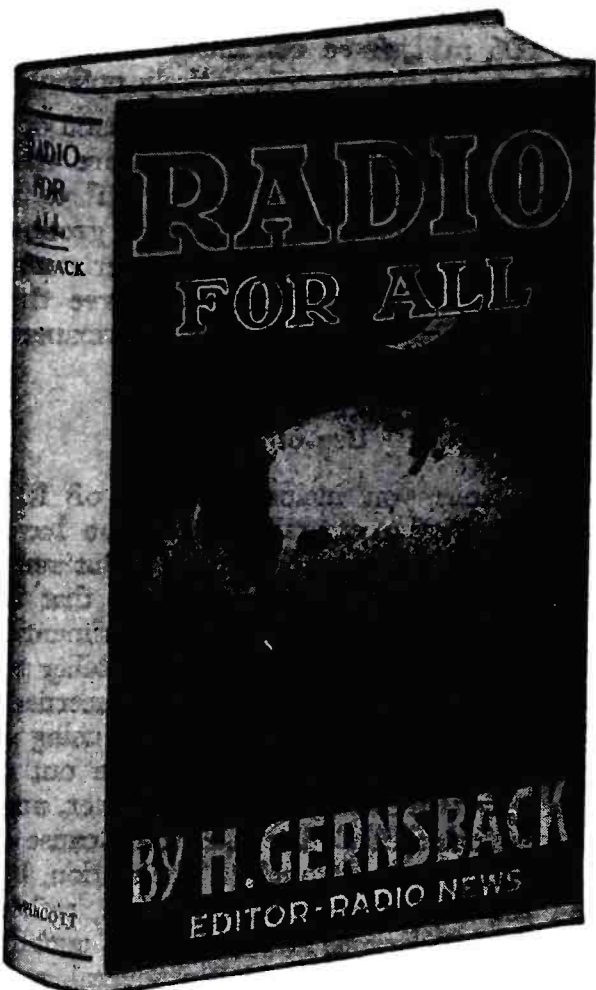

PRICE \$2.00 Postpaid

A Four-Tube DX Receiver

(Continued from page 64)

for L5, the feedback coil, and put this winding near the outside end of the secondary, just as the aperiodic primary was put near the inside terminal of that secondary (L4).

By following the methods outlined it will be unnecessary to count the number of turns.

The relative positions of the actual connections are not shown uniformly in Fig. 1, since that is a schematic diagram and is not intended to give polarities. Note that the aerial seems to be next to the grid return of the RF tube. Such is not the practice. Connect the outside terminal of L2, secondary, to grid, the hub end of L2 to A minus. The terminal of L1 which is nearer the hub connects to ground and the other end of L1 to aerial. In the interstage coil the same system is followed. The plate lead of L3 and the grid lead of L4 are as close together as the windings permit, and the terminals of L4 and L5 that go to A plus (in one case across a variable condenser) are those nearer together. The outside terminal of L4 goes to one side of the grid condenser, the hub end of L4 to A plus. The end of L3 nearer the hub goes to B battery and the other L3 terminal to the plate of the RF tube. The out-

side terminal of L5 (nearer the grid end of L4) is joined to the plate of the detector tube, the remaining end of L5 to the stator plates of the variable condenser at right in Fig. 1. In all cases connect the battery side of a variable condenser to the rotary plates. In two cases that will compel the connection of the stator plates direct to grid and (in the detector stage) to one side of the grid condenser. In the other case, while the rotor goes to A plus, the stator goes to one end of L5, the feedback coil.

Be sure that the condenser in the plate circuit, used for feedback control, is not short-circuited. Test the plates with a pair of phones and a small battery. If that condenser is shorted the B battery current will be fed into the filament, and you know what that may mean.

Two jacks are used, one for listening on the first audio stage, for earphone use, the other for working the speaker from the final output. The last audio jack is of the filament-control variety. Study the diagram. Note that the plate and B plus are connected to adjoining springs of FCJ. Thus when the speaker plug is inserted the plate spring, which is insulated from its top neighboring

spring, pushes up that neighbor, making the top and second from top springs close together. As these two springs interrupt the negative filament lead, when they are united the circuit is completed and the tube lights. Also the amplifier rheostat is put into service. It governs the RF and first audio tubes always, when the set is in use, and the final audio tube when the speaker plug is inserted. The detector has its own rheostat 20 ohms, whereas the other rheostat is 6 ohms.

The switch S will turn three tubes on and off as a unit, and also turn on the last audio tube if the speaker plug is inserted. Persons often leave the speaker plug in the jack, hence the last tube would be burning all the time, were it not for the switch.

The set was found to work best with a separate B battery of 67½ volts for the RF plate. This is emphasized in Fig. 1. Hence the batteries needed are one 45-volt and one 22½-volt for the RF tube alone, and two 45-volt batteries for the audio, the detector voltage being tapped off the audio battery at 22½.

A C battery of 4½ volts is included, to cut down the drain on the B battery and somewhat improve the signals.

Oct.

1925

S. Gernsback's Radio Encyclopedia

Radio Review

PART TWO

4th Installment

COUPLING
DEGREE

to

EDISON, THOMAS A.

PREVIOUS INSTALLMENTS



- FIRST INSTALLMENT** Consisting of definitions from "A" BATTERY to ARC OSCILLATOR contained in May 1925 issue of Radio Review, Vol. 1, No. 1.
- SECOND INSTALLMENT** Consisting of definitions from ARC SPARK to CAPACITY OF CONDENSERS IN PARALLEL contained in July 1925 issue of Radio Review, Vol. 1, No. 2.
- THIRD INSTALLMENT** Consisting of definitions from CAPACITY OF CONDENSERS IN SERIES to COUPLING COEFFICIENT contained in September 1925 issue of Radio Review, Vol. 1, No. 3.

ERRATUM

On page 87 of the September issue of *Radio Review* the formula for calculation of inductance of an iron core choke coil should read as follows:

$$L = \frac{1.257 \times \mu \times A \times N^2 \times 10^{-8}}{l}$$

Copyright by The Consrad Co., Inc., 1925. All rights reserved, including that of translation into foreign languages, including the Scandinavian.

Printed in the United States of America.

COUPLING, DEGREE OF—The extent of relationship between coupled circuits. In a great number of circuits the coupling is arranged so that it may be adjusted either close or loose, as the requirements of the reception may be. Variable coupling may be obtained either by varying the distance between the two coils of a *loose coupler*, or by changing the angle between the coils of a *variocoupler*. (See *Coupling*.)

COUPLING TRANSFORMER—(OSCILLATION TRANSFORMER)

This is the "tuner" of the transmitting circuit. It consists of primary and secondary windings usually of flat strips of copper, or copper ribbon, instead of wire, in order to reduce losses due to *skin effect* (q.v.). The primary coil receives the energy in the form of alternating currents from the generating device; these currents set up lines of force which interlink with the windings of the secondary coil connected in series with the antenna system, and in this manner the energy of the oscillation (alternating) current is transferred to the radiating system (aerial and ground) and thence into space. The purpose of the oscillation transformer is to produce a sharp wave which is readily tuned at the receiving end and causes a minimum of interference. The greater the distance between the primary and secondary coils the more sharp the wave becomes.

A device serving the same purpose in a receiving set, i.e. to enable the receiver to separate sharply the received signals, is sometimes called a receiving transformer, although commonly known as a tuner, coupler, vario-coupler, etc.

C. Q.—Abbreviation of inquiry made in code by a radio telegraph station desiring to communicate with another station. (See *Abbreviations*.)

C. Q. D.—The original Distress Signal (q.v.) established in 1904 by the Marconi Company. The origin of this signal is said to have developed from the use by telegraphers on land lines sending the C. Q. call when they wished everyone on their circuit to listen to the message being transmitted.

The signal C. Q. D. is now obsolete, having been replaced by S. O. S. at the International Radio Telegraph Convention held at Berlin, Germany, in July, 1908.

CRITICAL—A term often used in reference to the tuning qualities of a radio set, and, less frequently, to indicate a *vacuum tube* that *oscillates* too freely. If a receiving set is not critical in adjustment it is said to tune broadly, that is to say, not sharp in tuning. A critical set has a very narrow margin of control in tuning—the particular signals being receivable within only a very few points on either side of their true wave setting on the tuning dials. If a set is difficult to tune it is termed "too critical". This means that it tunes too sharply and it is difficult to get proper results, due to the possibility of passing by signals unnoticed when turning the dials. Obviously there is a middle point wherein a set may be selective and yet not too difficult to tune. If a vacuum tube goes into *self-oscillation* (q.v.) too readily it is said to be critical. This effect is not desired in a tube except in rare instances. (See *Resonance*, *Tuning*, *Broad*, etc.)

CRITICAL CURRENT—The current required to bring about some particular effect in an electrical circuit. In radio use, a common example is the exact amount of current needed by the

filament of a vacuum tube to bring it close to the *oscillating point* (q.v.) without actually going into oscillation. (See *Critical*.)

CRITICAL POINT OF CURVE—The peak or point of maximum value in a curve showing the relation of any varying values. The illustration shows

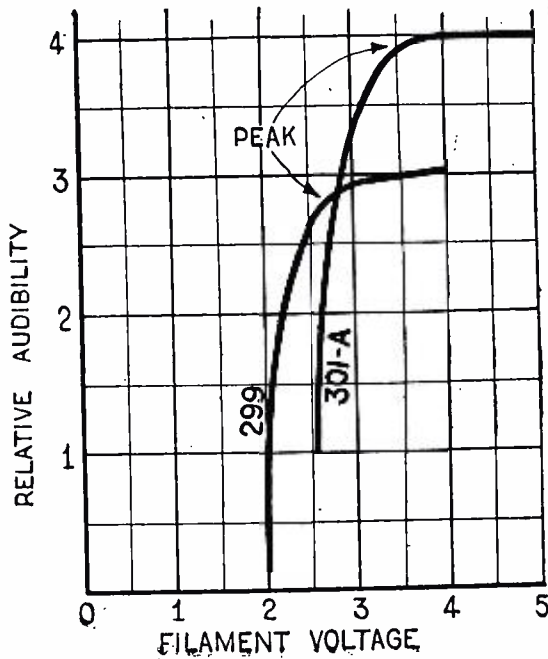

Illustration showing peaks or critical points of curve.

the curve indicating relation between voltage and signal strength in two types of vacuum tubes. The points marked "Peak" in each curve represent the critical points of the curves at which maximum audibility is obtained, any further increase in voltage not increasing the audibility. (See *Characteristic Curve*, also *Curve*.)

CROOKES, SIR WILLIAM (1832-1919)—English chemist and physicist. Born in London June 17th, 1832, Crookes was educated at the Royal College of Chemistry and afterwards became as-



Sir William Crookes.

sistant in the meteorological department of the Radcliffe Observatory, Oxford. In 1855 he obtained a chemical post at Chester.

Crookes early began that series of brilliant researches which has left its mark on the scientific progress of the nineteenth century. In 1861 he isolated the new element *thallium*, during the investigation of the atomic weight of which he made the discovery of his *radiometer*. This led to his researches

on the phenomena of electric discharges through highly exhausted tubes, or *Crookes tubes*. The illustration shows such a tube. When a current is passed through it, cathode particles travel along it. His discoveries on these phenomena led directly to the development by Sir J. J. Thomson of the now generally accepted *electron theory*. (q.v.) In 1883 he began his study of the rare earths, and in 1892 he forecast Radio telegraphy on the strength of Lodge's and Hughes' experiments.

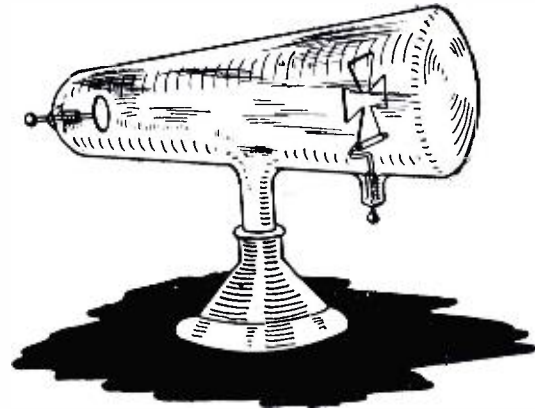

Crookes' tube.

Knighthood in 1897, Crookes was awarded the Royal medal in 1875, the Davy medal in 1880, and the Copley medal of the Royal Society in 1904, and the O.M., in 1910. He died in London, April 4th, 1919.

CRYSTAL—A general radio term for a mineral used as a *detector* (q.v.) of radio signals. The Physicist F. Braun noted in 1874 that certain pairs of crystals when arranged so that only a small area of surface was in contact, offered high resistance to the passage of currents in one direction while permitting them to pass readily in the other. This was really the birth of the crystal detector, although radio was not then developed. There are a great many different minerals that will act as detectors for radio signals, some of which operate with a wire, or other metallic contact, others which require a combination of minerals, one in contact with the other. There are also numerous *synthetic crystals* such as *carborundum*. Then again some of the more common natural crystals are subjected to treatment by heat, or other means, to change their nature or to make them more sensitive.

The following crystals are most used in radio reception: *galena*, *silicon*, *molybdenum*, *carborundum*, *zincite*, *bornite*, *chalcopyrite*, and *cerusite*. All of these are taken up under their respective headings. (See *Crystal Detector*, also *Combination Detector*.)

CRYSTAL DETECTOR—A combination of a *crystal rectifier* with contact and supports, used to detect radio

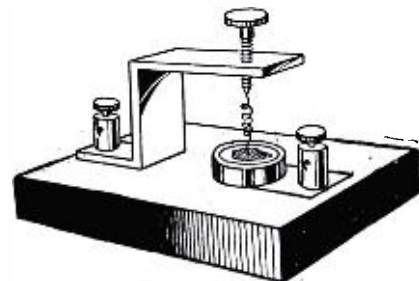

Fig. 1. Crystal detector using contact wire, or "cat-whisker."

frequency oscillations. Detectors of this nature are made in a great variety of styles, and use various kinds of crystals. In the more widespread form

the crystal detector consists of a crystal with rectifying properties, held in a cup or spring grip and arranged with a contact wire as shown in the illustration Fig. 1. This may be

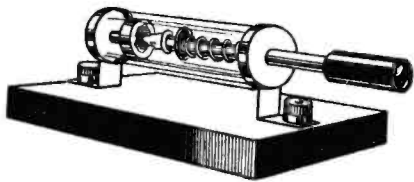

Fig. 2. Combination crystal detector.

elaborated upon by supplying a series of flat springs to obtain very fine adjustment of the contact. Fig. 2. shows a combination detector, using two crystals, in contact with each other. This form has several advantages over the wire or *cat-whisker* (as the contact



Fig. 3. Fixed crystal detector.

wire is called) type, chief among them the fact that it will withstand severe shocks without losing its adjustment. Fig. 3 illustrates a popular form of fixed crystal detector, in which the contact seldom requires adjustment. This type is of advantage providing it can be made sufficiently sensitive. (See *Carborundum, Vacuum Tube, also Crystal Receivers.*)

CRYSTAL DETECTOR—THEORY OF OPERATION—Theory of operation of a device used to detect radio waves, usually comprising a crystal in combination with a metallic contact, or, in some cases, two crystals arranged to rest against each other. In action this device serves to rectify the incoming signals, that is to say, it changes their nature from an alternating current to pulsating direct current. The incoming waves or signals consist of a series of alternations, the current flowing first in one direction, then reversing and flowing in the opposite direction along the circuit of the receiver. The changes of direction take place many times each second and would not be audible in the head phones in their original state. The crystal, as used in radio reception, has the peculiar property of furnishing a ready path for the flow of current in one direction while offering high resistance to its passage in the other. Now an *alternation* (q.v.) is a rise in current from minimum to maximum in one direction and back to minimum or zero, repeating the process in the other direction. Two of these alternations, one in a positive direction and the other in the negative direction constitute a *cycle*. (q.v.) If the crystal will permit the passage of current in one direction only, it is apparent that only half of each cycle can pass through; the other half of each cycle being lost or blocked out by the action of the crystal.

The illustration "A" gives a graphic representation of the *radio frequency oscillations* as they move over the aerial circuit. The curves above the line show the current in a positive direction while those below the line show it in the opposite or negative direction. If the signals or waves in this state were sent through a telephone receiver or head phone in a radio receiving set no sounds would be reproduced. Then again if the incoming oscillations were continuous, of unvarying strength, the rectified current would merely act on the diaphragm of

the phone and hold it in a certain position as long as the signal persisted. This of course would not create any audible or intelligible sounds. If, however, the incoming oscillations are in the forms of groups or trains of waves, in any one of which the successive oscillations were less than the previous

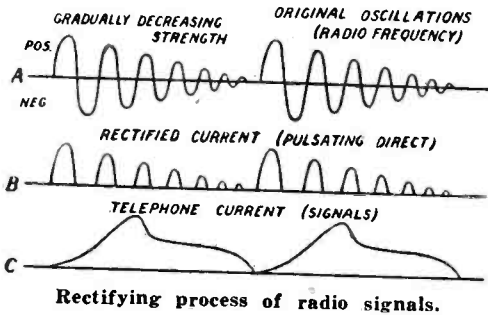

Fig. 1. Simple crystal set with single slide tuner.

arrangement. In its simplest form it may be merely a crystal detector, coil of wire and phones as in Fig. 1.

Fig. 2 shows a more efficient form, using a two slide tuning coil. This

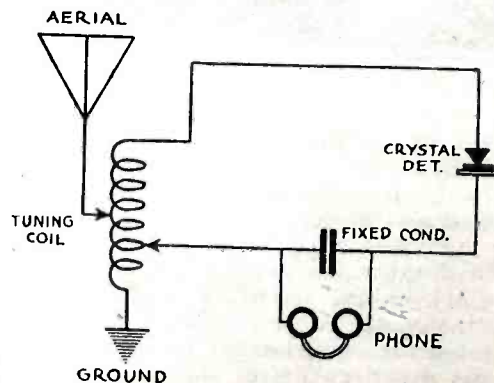

Fig. 2. Crystal receiver using double slide tuner.

ones, the current would be rectified as shown in B and the result would be a series of pulses in the phone as indicated in C. These pulses would occur as often as the trains of oscillations occur (for more complete explanation of the difference between continuous and damped waves, see *Damped Waves, also Continuous Waves*). It will therefore appear that a *crystal detector* can only be used to receive *damped waves*. When the rectified portion of a damped wave train reaches the phones, the *diaphragm* is depressed and held until the train has died out, at which point the diaphragm is released until another train reaches it. This creates the audible signals and the number of trains occurring each second will determine the number of depressions of the diaphragm and hence the pitch of the audible signals. (See *Crystal Receiver, Crystal Detectors, also Tickler.*)

CRYSTAL RECEIVERS—A crystal receiver is the complete set of apparatus for receiving broadcast programs or *spark transmission* (signals), employing a crystal as the *detector* or *rectifier*. The set comprises a crystal detector, tuning device and phones, together with the usual aerial and ground ar-

method permits closer adjustment of the receiver to the particular signals desired. A still more efficient form is the *inductively coupled* type shown in Fig. 3. This method allows a very close adjustment and considerably reduces interference. The kind of detector to be used in any of the above types of receiver is immaterial as long as it is sufficiently sensitive. Such an

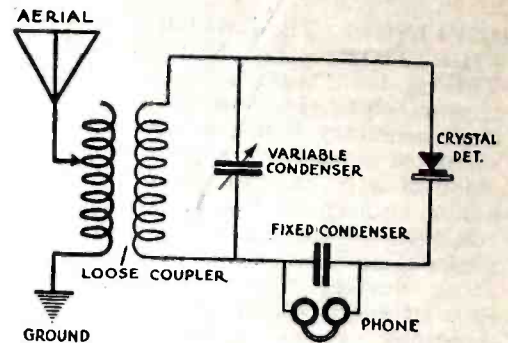

Fig. 3. Selective crystal receiver with loose coupler for tuning.

arrangement as shown in Fig. 3 is very inexpensive to construct and when used within ten to twenty miles of the broadcasting station gives excellent results. A very simple arrangement for

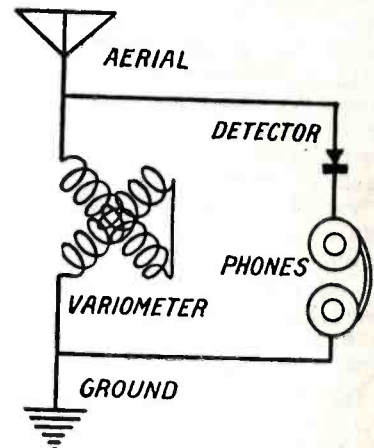

Fig. 4. A variometer is used as the tuning element in this crystal set.

use with a crystal detector is shown in Fig. 4. This circuit uses a standard *variometer* and eliminates the necessity for a *condenser*, thus having only one control in addition to the adjustment of the crystal.

CRYSTAL RECTIFIER—A device for changing an alternating current in a radio receiver into a pulsating direct current. This action is fully explained in "*Crystal Detectors (Theory of Operation).*"

CURRENT—A term used in electrical practise to signify the rate at which electricity flows from point to point in a circuit. The current in a circuit may be likened to the water flowing in a pipe. In this case the water would represent the electricity, the force or pressure represents the voltage, the pipe can be compared to the conductor or wire through which the electricity flows, and the current can be likened to the discharge from the pipe over a given period of time, that is the cubic feet of water per second. For practical purposes the unit of current is considered as the *Ampere*. This is the rate of flow of electricity when one *coulomb* (q.v.) passes a given point in the circuit each second. It will thus be apparent that while the ampere is often considered as the amount of current in a circuit, in reality it is the rate of flow of the electricity, the *coulomb* being the definite unit of quantity. Electric current is of course invisible. The only means of determin-

ing when there is current in a circuit is by observing its effect and it is always apparent by one or more of a number of effects. For example, if current is flowing in a wire or other conductor and a compass is placed near the conductor in such a position that the axis on which the needle revolves is parallel to the axis of the wire, the needle will be deflected. If the current reverses and flows in the opposite direction in the wire, the needle will be deflected in the opposite direction. The effect of current is also apparent by reason of the heat which it generates in passing through a wire conductor. If the wire is comparatively small and the current correspondingly large, the heat may be sufficient to be noticeable by placing the hand on the conductor. When the current is small, it can be detected by means of delicate instruments. This heating effect is made use of in various types of *ammeters*. The effect of current may also be noted in an incandescent lamp. In this case the current is made to flow through a fine wire inside a globe from which the air has been extracted, and the heat generated by the passing current causes the filament, or fine wire, to glow.

It is a well-known fact that heat causes expansion and this expansion of a fine wire is the principle on which one type of current measuring device operates.

Current is divided broadly into two divisions, *direct* and *alternating*. These two classes may again be separated into several further groups such as *high* and *low frequency alternating*, *continuous* and *pulsating*. Each phase or characteristic of current is taken up more in detail under its particular heading in this encyclopedia. (See *Current, Direction of Flow*, also *Current, Production of*.)

CURRENT, ALTERNATING—A current which does not flow steadily in one direction but changes its direction in the circuit periodically. (See *Alternating Current*.)

CURRENT CARRYING CAPACITY OF WIRE—The amount of current which a wire or other metallic conductor will carry without over-heating. Whenever current flows through a conductor, heat is generated. The amount of heat will be directly proportional to the resistance of the conductor and the square of the current in it. Now the resistance of a conductor depends on its cross-sectional area, length, and also its nature. It is therefore correct to state that the heating will depend on the amount of current flowing and the cross section and length of the wire. Obviously, a large wire will carry more current without over-heating, than will a small wire. Thus, it is necessary when choosing wire for a conductor to carry a certain amount of current, to select a wire of a cross section sufficient to carry the desired amount of current without undue heating.

The following formula for determining the current carrying capacity of various sizes and kinds of wire uses a certain factor T, which is the permissible rise in temperature above surrounding medium—such as air, earth or water. Where d is the diameter of the conductor in inches, T—the permissible temperature rise in degrees centigrade, N the resistance of conductor in ohms per mil-foot at final temperature, and I the current in amperes, then for solid conductors:

$$I = \frac{K \sqrt{Td^3}}{r} \text{ and for stranded conductors: } I = 0.85 K \sqrt{\frac{Td^3}{r}}$$

K is a constant (q.v.) depending upon the condition of the surface of the wire and upon the amount of heat convection due to air currents. Values of the constant K for air differ according to different authorities from 800 to 1000, the former referring to still air and the latter to open air.

Table of current carrying capacities follows:

Wires and Cables, Insulated: Carrying Capacities, in Amperes, allowed by The Regulations of The National Board of Fire Underwriters for Interior Copper Conductors.

(For Aluminum 84 Per Cent of These Currents is allowed.)

Single Conductor Cables or Each Conductor of Multiple Conductor Cables.

A. W. G.	Area in Circular Mils	Table A. Rubber Insulation	Table B Varnished cloth	Table C. other insulation
18	1,624	3	5
16	2,583	6	10
14	4,107	15	(18)	20
12	6,530	20	(25)	25
10	10,380	25	(30)	30
8	16,510	35	(40)	50
6	26,250	50	60	70
5	33,100	55	65	80
4	41,740	70	85	90
3	52,630	80	95	100
2	66,370	90	110	125
1	83,690	100	120	150
0	105,500	125	150	200
00	133,100	150	180	225
000	167,800	175	210	275
	200,000	200	240	300
0000	211,600	225	270	325
	250,000	250	300	350
	300,000	275	330	400
	400,000	325	390	500
	500,000	400	480	600
	600,000	450	540	680
	700,000	500	600	760
	800,000	550	660	840
	900,000	600	720	920
	1,000,000	650	780	1000
	1,100,000	690	830	1080
	1,200,000	730	880	1150
	1,300,000	770	920	1220
	1,400,000	810	970	1290
	1,500,000	850	1020	1360
	1,600,000	890	1070	1430
	1,700,000	930	1120	1490
	1,800,000	970	1160	1550
	1,900,000	1010	1210	1610
	2,000,000	1050	1260	1670

Varnished cloth smaller than No. 6 may be used by special permission only.

CURRENT, CONVECTION—See *Convection Current*.

CURRENT, CRITICAL—See *Critical Current*.

CURRENT DENSITY—The number of amperes passing through a wire conductor per square inch of area of the conductor. For example, if a conductor is a wire or bar of copper having a cross section of one square inch and ten amperes are passed through it, the current density will be ten amperes per square inch.

CURRENT, DIRECT—Current that flows steadily, and only in one direction. (See *Direct Current*.)

CURRENT, DIRECTION OF FLOW (ASSUMED)—In electrical practice the *assumed direction of flow* of current is often referred to. This refers to the fact that direct current is assumed to flow from the *positive pole* of a battery, or other source of electrical energy, to the *negative pole* and thence back through the battery from negative to positive. This assumed action is shown in the illustration Fig. 1, where the arrows indicate the assumed direction of flow. Now while the cur-

rent is stated as flowing from positive to negative outside the source, it is the generally accepted theory that the electron stream moves in the opposite direction, or from negative to positive. In other words, the current as we use

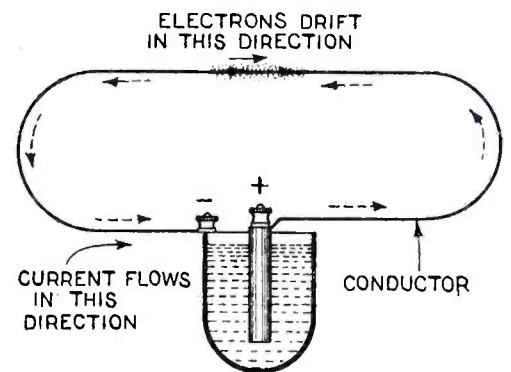

Fig. 2. Showing reverse action of current and electrons.

the term, flows backward along the path of electrons. (See *Electron Flow*.) This reverse action of current and electrons is shown by the illustration Fig. 2. This apparent anomaly

can be likened to a salmon swimming up a rapid. The movement of electrons can be compared to that of the fish actually swim against the stream, and the electric current flows against

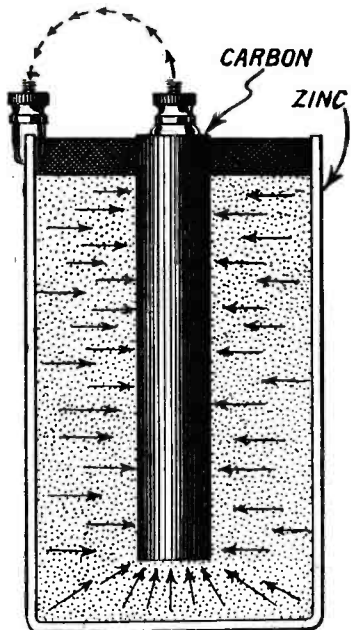

Fig. 1. Illustration showing the assumed direction of current flow in a dry battery.

the electron flow, the water and the electron stream nevertheless furnish the path of motion in each instance. The reason for the contradiction lies in the unfortunate arbitrary choice of positive and negative poles long before electrons were known. (See *Electron*.)

CURRENT, EDDY—See *Eddy Currents*.

CURRENT, HIGH FREQUENCY—A current that changes direction many times each second. In radio usage, currents having a frequency over ten thousand cycles per second are considered as *high frequency* or *radio frequency currents*. (See *Frequency*, *Radio Frequency* also *Low Frequency*.)

CURRENT, HIGH TENSION—Alternate term *High Pressure*. When the voltage, tension or pressure, in a circuit is comparatively low, the current is said to be a low pressure or *low tension current*. When the voltage is high, the current is said to be of high tension or pressure. Thus, as applied to radio usage, a dry cell or storage battery giving, respectively, one and a half and six volts for a certain type, are said to produce low tension or low pressure current. A "B" battery (q.v.) giving from 22½ to 45 volts (the usual value) furnishes *high tension* or *high pressure current*. While there is not a very great difference in voltage between a small "B" battery and an "A" type storage battery, the ratio of voltage to current in a "B" battery is far greater than in the ordinary case of the "A" battery and this must be taken into consideration. In general electrical practice the terms are not so arbitrary, and high tension currents might be taken as those above a pressure of several thousand volts.

CURRENT, LOW FREQUENCY—An alternating current that changes its direction of flow a comparatively few times per second. In commercial electrical work any frequency up to about 500 cycles per second is considered as low frequency current. In radio phraseology *audio frequency* (q.v.) currents are termed low frequency. For ordinary radio practice low frequency may be considered as any frequency below

about 10,000 cycles. (See *Oscillation* also *Oscillatory current*.)

CURRENT, OSCILLATORY—See *Oscillatory Current*.

CURRENT, PRIMARY—A current which flows directly from its source, such as a cell or generator. The current obtained from any source through a direct conductive circuit is termed a primary current. (See *Secondary Current*, also *Induced Current*.)

CURRENT, NATURE OF ELECTRIC

—As explained under the heading *Current*, electric current is manifest or understood by its effects. It may be apparent through the production of heat or light, by producing mechanical action such as required to operate a bell or move an electric motor, or, again, by producing chemical changes (See *Electrolysis*), and still further in its disastrous effects on the human body when the current has sufficient intensity. Without any actual or visible form of manifestation it can best be understood from the *electron* basis. It will be understood that an *electron* (q.v.) small as it is, contains a charge of electricity. When a sufficient number of electrons are in motion in a conductor (Note: current consists of electrons in motion) the current becomes large enough to be measured. As an instance of this fact a current of one ampere intensity (one coulomb per second) requires that about 10^{19} electrons flow past a given point in the circuit each second. When the electrons are not progressing along a conductor, no current flows in the circuit. If no current is being carried by the conductor, the electrons may move about, but they do not progress along the conductor.

CURRENT, PRODUCTION OF ELECTRIC

—An electric current is produced in a conductor by applying an *electro-motive force* (voltage) at points of the conductor or by maintaining a difference of *potential* (q.v.) between two points. In the first example we can assume a metal ring or closed coil of wire through which a magnet is pushed or perhaps in the core of which a magnet is being excited, or in the general sense any complete circuit through which the number of magnetic lines of force are being varied. In the second instance the difference of potential may be due to a *primary cell* (q.v.). Thus, the first case can be understood as referring to any mechanical means of producing current, such as *generators*. The other general method is by use of a *voltaic cell*, that is, by chemical action. There are four important methods of producing an *electro-motive force*. The first is by friction, the apparatus used in this connection being termed a static machine; the second is by chemical action, as a primary or secondary cell; third, by mechanical motion, i.e., *dynamo*s and *generators*, and fourth, by thermal action—known as a *thermo-junction* which is the wiring of two unlike metals in a conductive circuit so that by heating one of the points of joining an electric current will be set up in the circuit. (See *Static Electricity*, *Generator*, *Thermo Couple*, also *Current* and *Electro-Motive Force*.)

CURRENT, PULSATING DIRECT—

When an alternating current is rectified by means of any device which permits current to pass only in one direction, the resultant current will move only in one direction, hence it is known as a *direct current* but unless both

negative and positive halves of the *cycle* (q.v.) are rectified or changed to direct current, the resultant current will appear as a series of pulses in one direction. The most common application of this is found in the case of a *crystal rectifier*, or *detector* as used for receiving radio signals or broadcasting.

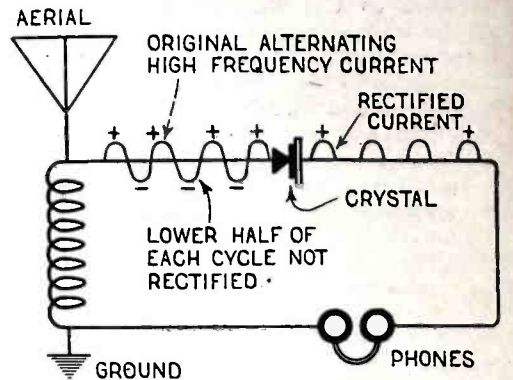

Diagram showing how crystal detector converts alternating high frequency current into pulsating direct current.

When the incoming waves, or high frequency *oscillations* (Q.v.), are impressed on the detector, due to its peculiar properties they can only pass through it in one direction. In other words, granting that the incoming signal, or current, reverses its direction a great many times each second, it will be obvious that at any instant in the *cycle* (q.v.) current is moving in a certain definite direction, as from positive to negative, or vice versa, as stated, due to the peculiar properties of the detector the incoming signal current can only pass through the detector when the current is flowing in the correct direction. This means that only half of the *wave* (q.v.) is passed through and rectified. The result is a series of direct current surges through the balance of the circuit, each surge of current being followed by a space or time interval while the opposite half of the *cycle* or opposite *alternation* (q.v.) is blocked by the uni-directional nature of the crystal. These surges are then audible in the *head phones*, as they will actuate the *diaphragm* (q.v.) whereas a high frequency alternating current such as the original impulse from the broadcasting station would be inaudible. For a more complete explanation of this action see *Rectifying action of crystal detector*. (See also, *Rectifier*, *Full Wave Rectification* and *Rectifying Tube*.)

CURRENT, SECONDARY—A current produced by a *primary current* (q.v.) acting on a *secondary circuit* which does not receive its energy by direct connection with the primary source. The illustration shows both primary and secondary currents and the man-

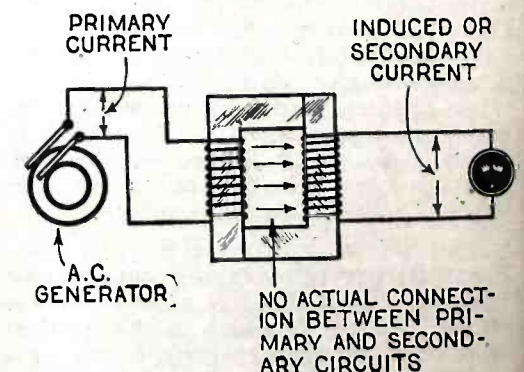

Illustration showing primary and secondary currents and method of production.

ner of production. It will be understood that the primary current in this case must be a varying current. (See *Induced Current*, also *Inductive Coupling*.)

CURRENT, THEORY OF ELECTRIC

—Under Electromotive force it will be explained that voltage or pressure is the result of a difference of potential (the power possessed by a charge of electricity for doing work) between two points in a conductor. Electric current will flow from the point of higher pressure or *voltage* to the point of lower pressure, the flow continuing as long as the difference is maintained. This action is the same as with water, which will always seek to move from a high point to a lower point. The flow of current is thus an effort to equalize the two potentials. (See *Current, Assumed Direction of Flow, also Pressure and Voltage.*)

CURVE—A straight or curved line showing the relation between various electrical phenomena or the characteristics (relation of changing values) of an electrical instrument. (See *Characteristic Curve, also Sine Wave.*)

CURVE OF SINES—A curved line representing the vibration of a body

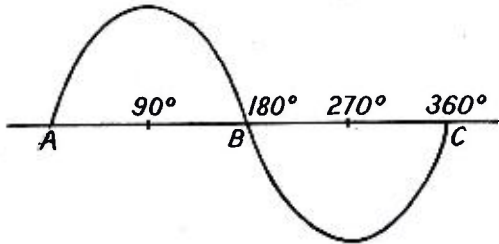

Sine curve.

that oscillates like a pendulum. The illustration shows a curve of sines which may be used to represent an alternating current. (See *Alternating Current, also Sine Wave and Simple Harmonic Vibration.*)

CUT OUT—An electrical device to interrupt the flow of current through any particular piece of apparatus or instrument, either automatically or by hand; a switch.

CYCLE—In electricity, a period of time during which certain changes take place in an *alternating current*, (q.v.) the same changes occurring again in each successive cycle. We can imagine an alternating current as travelling along a wire in the form of a wave, one half of the wave being in one direction and the other half being in the opposite direction. That is to say, the current flows from positive to negative for one half of the cycle and then in effect, flows from negative to positive the other half of the cycle.

D—The symbol of *electric displacement* (q.v.); also occasionally used as a symbol for diameter in electrical calculations.

DAMPED OSCILLATIONS—Electrical oscillations which die away, each succeeding oscillation in a group having lesser *amplitude* (q.v.) or strength than the preceding one. (See *Damped Waves.*)

DAMPED WAVES—Radio waves in the form of successive trains or groups, in each of which the amplitude or strength decreases with each successive wave. When electrical oscillations are caused by a single impulse, they do not continue indefinitely, but decrease in amplitude or die away. Thus, if oscillations are created in an antenna or other circuit by a discharge from a *condenser* (see spark discharge), each electric spark creates a train of oscillations which die away more or less

(It will be understood that actually current always flows in the same

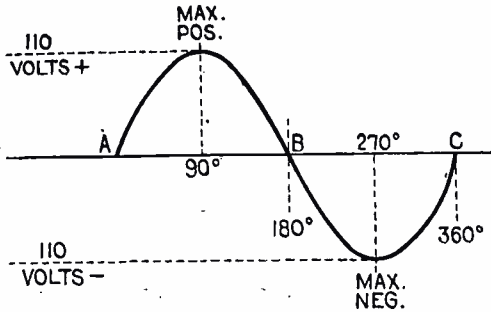

Curve showing action of 110 volts alternating current during one cycle.

direction, but the action of alternating current is due to a reversal of polarity at the source.) The difference between direct and alternating current is that, in the case of direct, the polarity always remains the same at the source and hence the direction of flow of the current is always in one direction, whereas with alternating current, the polarity changes twice each cycle due to changes at the source, and thus it flows in one direction for a certain fixed period, then reverses and flows in the opposite direction. In the illustration the current is shown as a *sine wave*. (q.v.) We assume that this represents an alternating current of 110 volts pressure such as in the average house lighting system. Now we consider the wave as a circle. The current flows in a positive direction toward its maximum value and at the 90 degrees it has reached the positive maximum. It then falls back to zero at 180 degrees and reverses, rising to maximum on the negative side, which it reaches at 270 degrees. It then falls back to zero at 360 degrees having completed a cycle or two alternations. The operation is repeated over and over a certain number of times each second. Thus, the rise and fall from A to B or 180 degrees is one *alternation*, the rise and fall from B to C is another alternation, the two alternations, one positive and one negative making a complete cycle. If sixty of these cycles occur each second we say that the frequency (q.v.) is sixty cycles. (See *Alternating Current, Phase, Sine Wave.*)

CYMOMETER—The name given a type of *wave-meter* designed by Dr. J. A. Fleming. It is used to measure the wave-length of oscillatory (vibrating) circuits. (See *Wave-Meter.*)

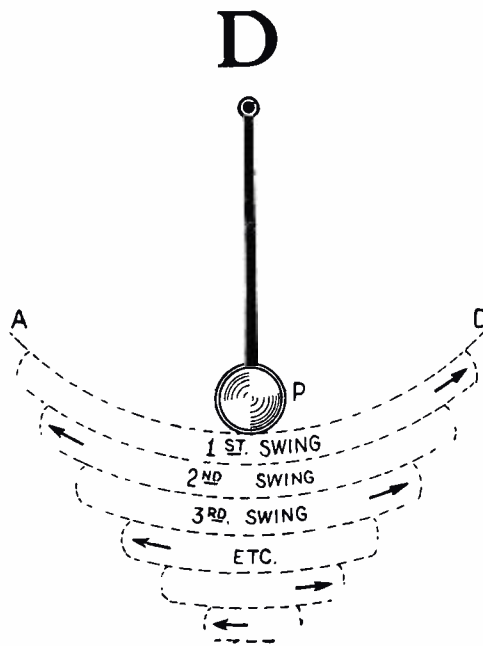

Fig. 1. Pendulum coming to rest after being given a momentary impulse.

CYMOSCOPE—A term used to designate any instrument which enables one to see the effect of electrical waves or to detect their presence. The original form was merely a loop of wire

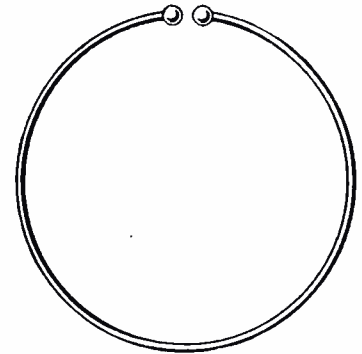

Fig. 1. Early type of cymoscope used to indicate resonance in a circuit.

not completely closed as shown in Fig. 1. When held close to a transmitter of short waves a small spark will pass between the ends of the loop providing the *wave-length* is properly adjusted. This was the form used by Hertz (the discoverer of electro-magnetic waves which form the basis of radio telegraphy and telephony) in his early experiments. The more modern form is shown in Fig. 2 where a small

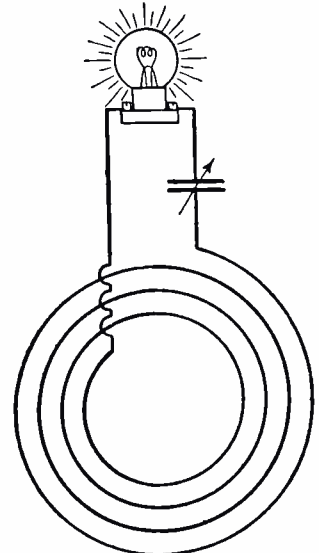

Fig. 2. More modern form of cymoscope.

lamp is made to light by holding the loop close to the transmitter. A complicated arrangement used to actually see the waves and study their form is called the *Oscillograph*. (See *Oscillograph, also Cathode Ray Tube.*)

gradually. Fig. 1 shows a pendulum which is given a momentary impulse. Now as this source of power is only momentary the pendulum will not

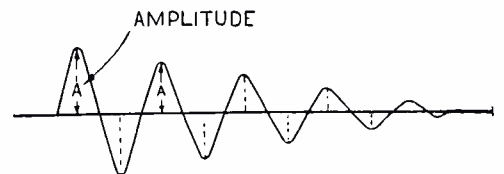

Fig. 2. Train of damped waves.

swing from A to D indefinitely. If the first swing under the impulse carries the pendulum the entire distance A to D, the next swing will cover a lesser arc and so on until the movement has died out altogether.

Now in Fig. 2, the graphic illustration of a train of *damped waves* shows that each crest is a little lower than the one preceding it and after a short period the waves have died out alto-

gether. These curved lines may be considered as an illustration of the path taken by the pendulum in its motion as shown in Fig. 1. The decrease in amplitude of one crest over that preceding is known as the damping, and the neperian logarithm of the ratio of amplitude of any oscillation to the one preceding it is known as the *logarithmic decrement*.

If the impulse of force causing the oscillations is steady—not intermittent—the result will be a sustained series of oscillations that will continue at constant strength or amplitude until the exciting force is withdrawn. Thus, in the case of the pendulum, we can very easily keep exciting it by an evenly exerted force and so insure that the swings will continue without diminishing, as in the case of a momentary impulse. Oscillations or waves that have constant amplitude are known as *Continuous Waves, Undamped Waves or Sustained Waves*. (q.v.) (See also *Decrement, Logarithmic*; also *Neperian Base*.)

DAMPING—A progressive decrease in amplitude or strength. (See *Damped Waves, Damping in Instruments*.)

DAMPING COILS—Short circuited (q.v.) coils used in electrical apparatus for the purpose of causing damping (i. e., decrease in the intensity of electrical oscillations). The reaction of induced currents in the shorted coil creates the damping effect. (See *Damping*.)

DAMPING DECUMENT—See *Decrement, Logarithmic*.

DAMPING FACTOR—The product of the *logarithmic decrement* (q.v.) and the frequency (rate of alternation) of a damped alternating current. (See *Decrement, also Amplitude*.)

DAMPING IN INSTRUMENTS—The term damping is applied in a mechanical sense as in the case of the needle of a measuring instrument such as a *galvanometer*. (q.v.)

In a delicate instrument for measuring current the needle is controlled by the current through the instrument, and when this current is withdrawn the needle is brought back to the neutral position by a fine spring. Now, unless some precaution is taken the needle will have a tendency to swing or vibrate when measurement is being taken. Various devices are used to bring the needle quickly to rest without undue vibration. If the needle comes to rest almost immediately it is said to be a highly damped or *dead beat instrument*, because the oscillations or vibrations die out rapidly the same as in the case of damped waves.

There are two principal methods of damping instruments. When the instrument is of the moving coil type, the coil is generally wound on a light aluminum frame which is mounted between the poles of a permanent magnet. A soft iron core fills the gap between the two poles, allowing space for free movement of the coil. The result is that the metal frame carrying the coil moves through a very strong *magnetic field* and *Eddy currents* (q.v.) are set up in the frame and serve to damp its motion. The other common method is to have a light metallic vane carried by the pointer in its motion and moving in an air chamber to stop vibration. While damping is highly essential in a measuring instrument, too high a degree of damping is not advisable. If there is a very slight tendency on the part of the needle to vibrate, it permits the operator to de-

termine whether it is swinging freely. (See *Voltmeter, Wattmeter*.)

DAMPING MEASUREMENT—See *Decrement, Logarithmic*.

DAMPING WAVES—Term commonly used to denote the gradual decrease in amplitude of a train of oscillations as in radio transmission. If the oscillations persist at constant amplitude or strength, each oscillation being equal in amplitude to the one preceding, there is no damping. When the amplitude of each successive oscillation is less than that of the preceding one there is said to be damping and the oscillations will die out entirely, at a rate dependent on the degree of damping. If the oscillations die out very rapidly they are said to be highly damped; if they die out slowly the damping is said to be feeble.

DANIELL'S CELL—A two fluid *voltic cell* containing a zinc plate immersed in dilute sulphuric acid, and a copper plate in a saturated solution of copper sulphate; the two solutions being separated by a porous cup. This cell has a constant voltage and shows only slight polarization. Was formerly much used in telegraph work.

D'ARSONVAL GALVANOMETER—A type of galvanometer in which a coil carrying the current to be measured is suspended in a *fixed magnetic field*. (See *Galvanometer*.)

DASH—The long stroke used in *Morse and Continental Code*. It is considered as equivalent in length to three dots. (See *Code*.)

D. C. C.—The customary abbreviation for double cotton covered wire.

D. C.—The abbreviation commonly used for *direct current*. (q.v.)

"D" COIL—Occasionally known as Figure Eight coil. A form of inductance, used particularly in tuned radio frequency circuits. The windings are in the shape of a figure eight, either in pancake form (flat wound) or wound on a slotted tube. Owing to the peculiar arrangement of the windings these coils have very little external field and thus can be used in radio frequency amplifiers without the usual oscillating due to conflicting fields. (See *Field, Inductance, Radio Frequency Coils*.)

DEAD BEAT INSTRUMENT—A measuring instrument arranged so that the needle comes quickly to rest with little or no vibration is said to be *dead beat* or highly damped. (See *Damping in Instruments*.)

DEAD CELL—A cell which has been discharged. (See *Cell*.)

DEAD CRYSTAL—A crystal used in a *crystal detector* (q.v.) that has lost its sensitivity. Very often a crystal becomes dirty or oily from contact with the fingers. In some cases they can be brought back to usefulness by cleaning with alcohol, or if the crystal is dead through causes other than dirt on its surface, it may be broken to present a new surface and thus find a new sensitive spot.

DEAD END EFFECT—The effect on a receiving circuit (oscillatory circuit) resulting from unused turns of wire in a coil. In the customary tuning coil or tapped coil a certain portion of the wire is not in use and this idle section, being in metallic connection with the main portion, but not actually in use, acts as a miniature oscillatory circuit. This tends to reduce the efficiency of the tuning unit as a whole. Dead end effect may be eliminated by using the entire coil at all times, doing the tuning solely by the variable condenser, or it may be reduced by the

use of a *dead end switch* (q.v.). (See *Tuning Coil*.)

DEAD END SWITCH—A switch used to cut out unwanted turns of wire in a coil in order to eliminate or reduce the *dead end effect* (q.v.). Such a switch is generally arranged so that

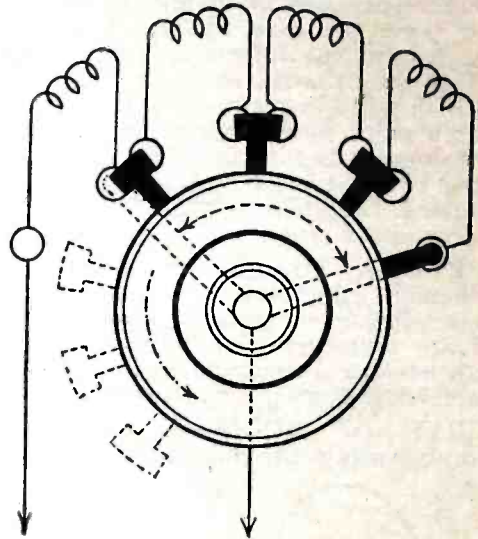

Dead end switch.

instead of taps being taken from various points on the coil, the winding is actually in sections and the switch blade connects into the circuit the desired number of sections.

DEAD SPACE—In the case of *beat heterodyne* reception if the two frequencies are brought together or the difference is very slight there will be no beat. This space where the two frequencies are identical, or very nearly so, is known as the *dead space*. (See *Beats, also Heterodyne*.) The beat resulting from the superposition of two waves differing in frequency is the difference or the sum of the two frequencies. For instance, if two waves are present in the same circuit, of 1,000 and 1,005 kilocycles respectively, the two beat frequencies will be 5 and 2,005 kilocycles. If, however, the two frequencies are made identical, the difference between the two will be zero, and the sum of the two will be twice the original frequency. In the one case, where we take the difference of the frequencies, the beat note is zero, or there is no beat note at all; in the other case, where we add the two frequencies, the resulting frequency is the *harmonic* (q.v.) of the original frequencies, which is the same as an octave in music. In the present instance, this note will not be heard at all as it is above the range of audibility.

DECADENT WAVE—A damped wave. A wave, or oscillation, in a train of *damped waves* (q.v.) which is of lesser amplitude or strength than the one preceding it. (See *Damped Waves, also Undamped Waves*.)

DECAY OF CURRENT—The gradual dying out of current in an *inductive circuit* (q.v.) after the *impressed potential* has been removed. The presence of inductance in a circuit causes the current to lag in time behind the voltage producing it. As a result, when a highly inductive circuit is broken by opening a switch or by other means, the current still tends to flow for a short interval, and the *induced voltage* in the circuit may become very high. This is the reason why a spark often occurs when the switch in a highly inductive circuit is opened. As a result the current decays gradually

after the impressed voltage is removed.

It will be noted that the *decrement* (q.v.) or the rate of decay of the oscillations directly affects the number of oscillations in the wave train that will be useful in transmitting signals. For instance, if a certain oscillation in the figure should represent the smallest voltage that will operate a detector, it is evident that all oscillations in the wave train that have smaller amplitudes will be useless. Consequently, the lower the decrement of the wave, the greater will be the number of oscillations before the amplitude becomes too small for useful purposes. This likewise means that a greater amount of the energy in the wave can be utilized.

DECOHERER—In the type of detector, now obsolete, known as the *coherer*, the incoming signals caused the particles of nickel and silver filings in the glass tube of the device to cohere or cling together. (See *Coherer*.) In order to place the coherer in its original state after each impulse, it was necessary to have some means of separating the particles. These were known as *decoherers* and were in many different forms, some as separate attachments, others as a part of the detector or coherer. (See *Detector*.)

DECOMPOSITION, ELECTROLYTIC—The decomposition of chemicals taking place in a cell due to the action of the electrolyte. (See *Cell*, also *Electrolyte*.)

DECREMENT—A term used to indicate the rate of decay or dying out of an electrical oscillation that is subject to *damping*. (q.v.) In the illustration is shown a series of damped waves. It will be noted that the distance from zero to the crest of wave (C-2) is less than the one preceding it (C-1). This distance represents the amplitude and the ratio of any amplitude to the one preceding it is constant, that is the decay or decrease in amplitude is constant. The *Naperian Logarithm* (q.v.) of the ratio—of one wave to the one preceding it—is called the *logarithmic decrement*. The damping of a train of waves is an important consideration as it affects the tuning qualities to a great extent. This is covered by a U. S. Government Statute Concerning Transmitting Stations, decreeing that the logarithmic decrement per complete oscillation must not exceed 0.2, which

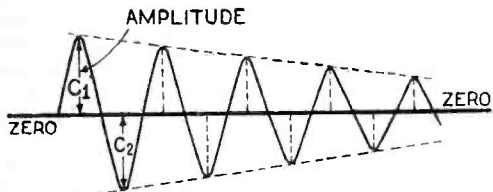

Damped waves gradually dying out.

means that for each single spark discharge from the transmitter there must be not less than 24 complete oscillations in the *antenna system*. (See *Oscillations*, *Damping*, *Naperian Logarithm*, *Sharp Wave*.)

DECREMETER—An instrument used to measure the *decrement* or degree of damping in an oscillatory current. Such meters are made in several different forms. Some types are direct reading in terms of the logarithmic decrement, while others require mathematical reduction from the readings of a dial. All decimeters operate on the basis of comparison of the resonance current in a tuned circuit with that in a circuit out of tune by a known or

unknown percentage. (See *Logarithmic Decrement*, also *Damping*.)

DE FOREST, DR. LEE—Electrical engineer; b. Council Bluffs, Ia., Aug. 26, 1873. Grad. Yale (Sheffield Scientific), Ph. B., 1896; Ph. D., 1899. Inventor De Forest system wireless telegraphy and founder Am. De Forest Wireless Telegraph Co.; system originally adopted largely by U. S. Govt.; demonstrated to the British, Danish, German,



Dr. Lee De Forest.

Russian and Indian Govts., first used by the U. S. Signal Corps in the war manoeuvres and inst. in Alaska. 1905 invented the Audion or three-electrode vacuum tube. 1906-09 was the pioneer

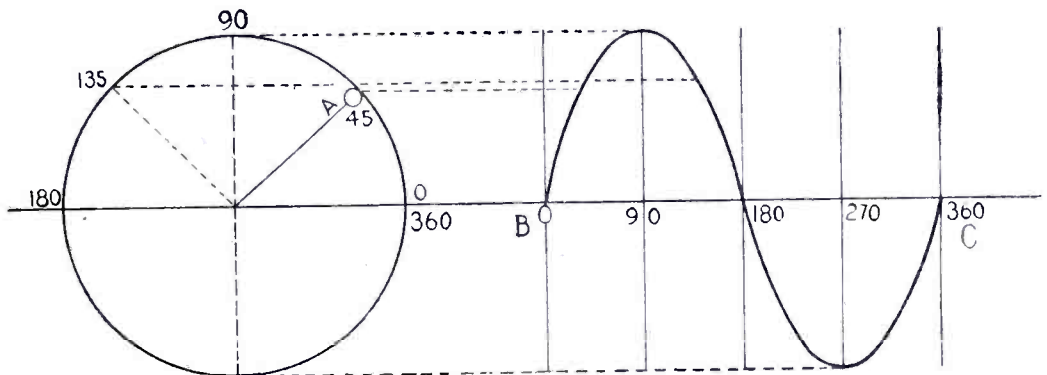

Curve representing current variation during one revolution of the armature of a generator.

in Radio Telephony. First to broadcast music and opera. 1908 equipped the 24 battleships and destroyers of Admiral Evans for their historic round-the-world cruise. 1913 incorporated De Forest Radio Tel. & Tel. Co., which developed the audion amplifier and oscillator for commercial purposes. These De Forest devices completely revolutionized the radio art and made possible the Bell Tel. Transcontinental System. He was the father of radio broadcasting and all radio broadcasting apparatus is built upon his audion inventions. Since 1919 he has devoted his attention to the phonofilm, photographing sound waves directly on motion picture film. Pres. of the De Forest Phonofilms, Inc.; Dir. of De Forest Phonofilms, Ltd., London. 1921, Awarded Cross of Legion of Honor by the French Govt. in appreciation rendered by audion to the Allies during the war. 1922 awarded Elliott Cresson

medal by Franklin Inst. 1922 awarded medal by Inst. of Radio Engineers. Fellow American Inst. of Elec. Engineers. Fellow Inst. of Radio Engineers. Mem. of N. Y. Elec. Society; mem. of Nat. Geog. Soc.

DE FOREST COILS—A type of coil named after *Lee De Forest* (q.v.). The wires are wound in a diamond shaped pattern in such manner that the turns of one layer cross the turns of the preceding layer at an angle, thus making the *distributed capacity* (q.v.) very small compared with the capacity of other types of coils. (See *Honeycomb Coils*.)

DEGREES, ELECTRICAL—In an alternating current curve each complete oscillation or cycle is shown as two loops, one above the line representing time, and the other below it, the entire cycle being considered as 360 *electrical degrees*. It is possible in this manner to show relations between current and voltage phases, amplitude at any point, etc. (See *Alternating Current*, also *Sine Wave*.)

The idea of electrical degrees comes originally from the *elementary electric generator*, with two-slip-rings taking off the alternating current, and having only two poles. During one-half revolution of the armature turns, the current increases from zero to a maximum and then back to zero again. During the other half revolution the current increases in an opposite direction from a zero value to maximum and then back to zero again. The curve shown in the figure represents the current variation during the complete revolution, a cross-section of the rotating armature wire being shown at A. The angles indicated on the line BC are laid off to any convenient scale, and the intersection of the ordinates from these points with horizontals drawn from the circle as shown, give the points on the curve.

The same ideas hold when the generator has more than two poles; in this case a full 360 electrical degrees is taken to represent the armature motion from across two adjacent pairs of poles, so that a complete cycle of voltage or current is generated. In a four pole machine, therefore, a full revolution of the armature could be represented by 2 x 360 or 720 electrical degrees. This corresponds to 2 complete cycles. Or, looking at it the other way, 360 electrical degrees would represent a half revolution of the armature wire.

DEIONIZATION—The action of returning a mass of gas that has become *ionized* (breaking up of the atoms of gas into positive and negative ions, being the elements to which and to whose motion, under the action of electric forces, is supposed to be due their electric conductivity) to its orig-

inal state. In the case of a *spark gap* (q.v.) the ionization creates a conductive path which remains after the actual spark has passed, thus preventing sharply defined oscillations. There are various methods of deionization, including cooling, absorption, air-blast or magnetic field, all tending to deionize or place the spark gap in its previous condition to prevent an arc from following the discharge. This action is also known as *quenching*. (See *Quenched Gap*.)

DELTA—The fourth letter in the Greek alphabet. The capital letter delta (Δ) is used as a symbol for delta connection of *three phase alternating current generators or transformers*. The small or lower case delta (δ) is used as a symbol for *Logarithmic decrement*. (See *Decrement*, also *Delta Connection*.)

DELTA CONNECTION— Δ In a three phase *alternating current generator*, where three coils are mounted symmetrically around a shaft rotating in a *magnetic field*, the connection or grouping of the windings is called

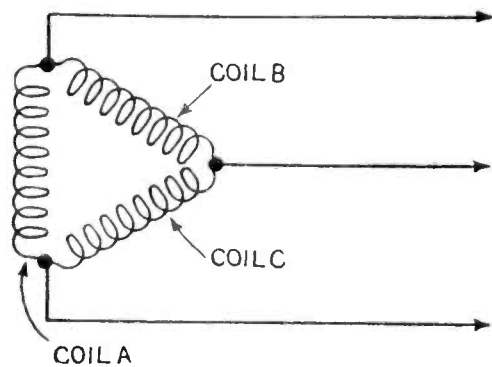

Delta grouping in a three phase system.

delta after the Greek letter which the grouping somewhat resembles. The illustration shows delta grouping in a three phase system. The sum of the instantaneous Electromotive Forces of the three coils is zero, or in other words the sum of the Electromotive Forces of any two coils is equal and opposite to that of the other coil, the *line voltage* thus being equal to the *phase voltage*. (See *Alternator*, *Poly-phase*.)

DEMAGNETIZATION—The act of returning a body to an unmagnetized state or of reducing the degree of *magnetization*. In the case of phones used in radio reception the permanent magnets are often weakened or *demagnetized* by connecting them in the *electron-tube circuits* in the wrong way. (See *Magnetization*, also *Telephone Receiver*.)

DENSITY, CURRENT—See *Current Density*.

DENSITY, FLUX—See *Flux Density*.

DENSITY OF ELECTROSTATIC CHARGE—The *electrostatic charge* per unit area. (See *Electrostatic Charge*, also *Condenser*.)

DEPOLARIZATION—In an electric cell hydrogen bubbles form on the surface of the positive electrode and unless some arrangement is made to counteract this effect, the usefulness of the cell will soon be impaired due to the insulating action caused by this film of gas, known as *polarization*. Usually some means of oxidizing is employed to act upon the hydrogen as fast as it is produced on the positive electrode, thus preventing or reducing the effect of

polarization. (See *Cell*, also *Polarization*, and *Depolarizer*.)

DEPOLARIZER—The oxidizing agent or other means used in a cell to counteract the effect of polarization. Bichromate of potash or peroxide of manganese is commonly used for this purpose. (See *Dry Battery*, also *Polarization*.)

DETECTOR—A device for converting oscillating currents of high frequency (radio waves) into a form suitable for operating a telephone receiver or sensitive measuring instrument. It is often referred to as a *rectifier*, because it serves to change the incoming currents from *alternating to pulsating direct currents*. Detectors vary in type and efficiency, ranging from the now obsolete *coherer*, to the modern sensitive *regenerative vacuum tube*. The different types of detectors are taken up under their various headings. (See *Crystal Detector*, *Vacuum Tubes*, *Electrolytic Detector*.)

DETECTOR CIRCUIT—That part of the circuit in a radio receiver which contains the *detector* (q.v.). The *detector circuit* may be closely coupled to the balance of the receiving circuit by means of a tuning coil or it may be inductively coupled by using a *vario-coupler* or *loose coupler*. (See *Coupling*.)

DETECTOR, DAMPED WAVE—Any special type of detector, such as a crystal, etc., used for reception of *damped waves*. (q.v.). (See *Ticker*, also *Heterodyne*, and *Vacuum Tube*.)

DETECTOR, VACUUM TUBE—The *vacuum tube* used as a *detector of radio frequency (high frequency) oscillations*. A vacuum tube may be used to change or rectify the high frequency alternating currents received at the aerial to *pulsating direct currents* (q.v.) capable of operating a telephone receiver or recording device. Formerly vacuum tubes were made for an

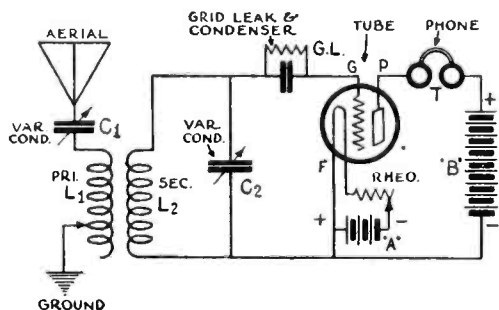

Fig 1. Non-regenerative vacuum tube circuit.

individual purpose, such as *radio frequency amplifier*, *audio frequency amplifier*, or *detector*, the amplifier tubes being highly exhausted and the detector tube having a low vacuum and requiring critical filament adjustment. Of late tubes have been developed to such an extent that no special tube is necessary for the detector circuit, all being adaptable for almost any purpose. Fig. 1 shows the ordinary circuit for a vacuum tube detector. This method is not much used now since the advent of regeneration, except where stages of radio frequency amplification are used ahead of the detector to amplify the incoming signals. In this case incoming signals are impressed on the grid "G" and the slight variations of potential at this point control comparatively large currents at the plate "P," actuating the telephone "T." (See *Vacuum Tube*, *Theory of Detector Action*.)

Used in this manner the tube is a considerable improvement over the crystal detector in point of sensitivity. However, by means of regeneration, the sensitivity may be increased many times. Fig. 2 shows a simple *regenerative circuit*. Here the unrectified currents passed through to the plate of the vacuum tube are fed back by means of the coil L2 and by being impressed again on the grid, further amplification can be attained. (For com-

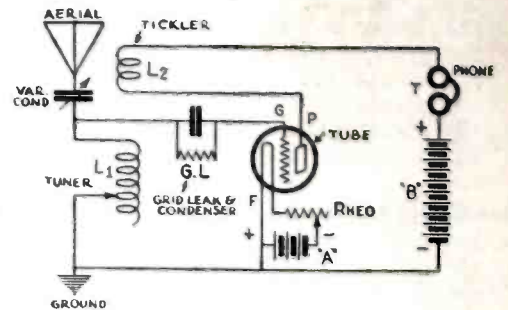

Fig. 2. Simple regenerative circuit.

plete explanation see *Regenerative*, *Theory of Operation of Vacuum Tube*, *Detector*, *Pulsating Direct Current*, also *Crystal Detector*.)

DETUNING—The opposite of *tuning* (q.v.) The process of varying the effective inductance or capacity or both, to throw the radio receiver out of resonance with the particular signals to which it is tuned. This may be done to decrease the volume of the signals or it may be employed to eliminate or reduce interference from some undesired signals. For example, a station operating with a wavelength of 400 meters might interfere with reception of a station operating on 360 meters, providing it has sufficient power, or the receiver is not particularly selective. If the radio receiver is detuned slightly below 360 meters, the desired signals will still come in, though at lesser volume, but the interfering signals will be lost entirely. Tuning is the act of *producing resonance* and detuning is the act of *destroying resonance*. In the case of a *heterodyne receiver* (q.v.) the heterodyne circuit is slightly detuned from the incoming oscillations, thus producing a difference in frequency or *beat frequency* (q.v.). (See *Resonance*, also *Dead-space*.)

DIAGRAM—A system of lines drawn to represent the circuit or connections for radio receivers or transmitters or associated apparatus, etc. Diagrams may be in any of several forms, the two common methods being known as *schematic* and *perspective*. In the

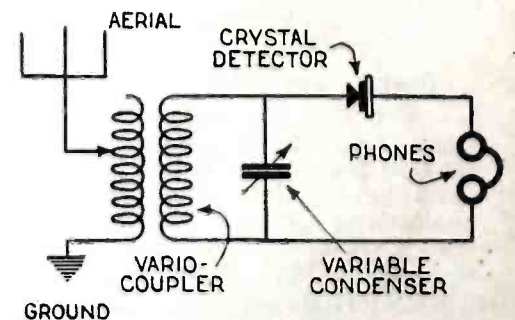

Fig. 1. Schematic diagram of a simple crystal receiver.

schematic form, symbols are generally used to represent the various pieces of apparatus, whereas in the perspective form, drawings of the apparatus are used. Fig. 1 illustrates a typical schematic diagram of a simple crystal receiver. Here the tuning coils, de-

tector, phones and so on, are shown in the form of symbols. Fig. 2 shows the same circuit in perspective form, with the tuning coil and other parts actually pictured. Diagrams may be used

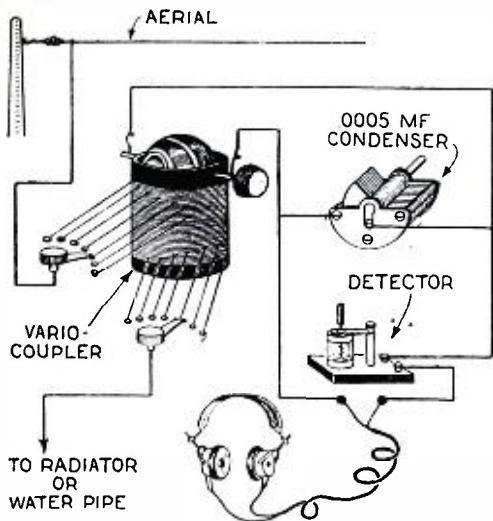
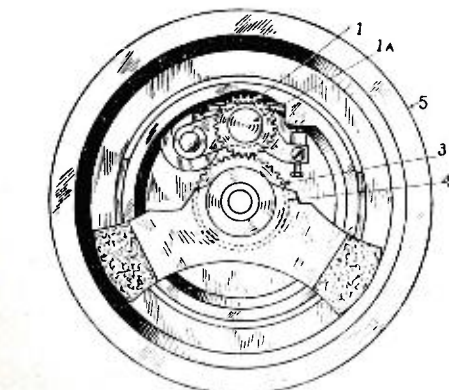
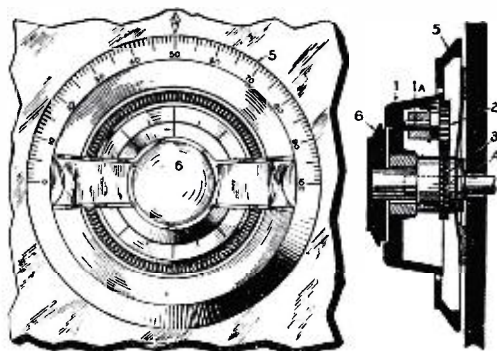

Fig. 2. Showing in perspective form the circuit given in Fig. 1.

to show connections for any electrical or radio circuits or for individual parts of instruments. (See *Hookup*.)

DIAL—Devices used to control the movement of condensers or other moving parts of radio apparatus. Most dials are made of a composition such as Bakelite or hard rubber; some are made of metal. The periphery is generally spaced off in numbers from 0 to 100 or 180, for purposes of keeping a record of the positions at which the various stations are received. Dials may be arranged to have the readings refer to definite values by means of *calibration* (q.v.). (See *Dial Vernier*. See *Log*.)

DIAL, VERNIER—A term incorrectly applied to a dial arranged with slow-



This dial utilizes the slip tooth principle. 5 is the main dial. 6 turns the slip gears (3) and (4), which cause 2 to turn. 2 is mounted on the shaft (1A) fastened in the main dial (1). 5 is the scale, fastened to the condenser shaft.

motion linkage in order to permit very fine adjustment. The illustrations show two types of vernier dials. Ver-

nier dials are generally used on *variable condensers* and occasionally on other instruments, where close adjustment is necessary. They are particu-

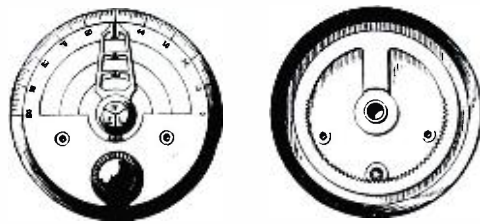

A simple vernier dial using a pinion and internal rack.

larly useful in the case of a *Super-Heterodyne receiver*, the oscillator control being critical, and the wavelength control as well, in certain cases. (See *Dial*, also *Critical*.)

DIAMAGNETIC MATERIAL—Substances not readily susceptible to *magnetism*. If a substance does not pass magnetic lines of force, but rather is repelled by a magnetic pole, it is said to be *diamagnetic*; its permeability, or ability to permit magnetism to pass through it, is considered negative or less than unity (air). Diamagnetic substances are apparently repelled from the poles of a magnet. If placed in a magnetic field they have a tendency to diminish the *magnetic induction* (q.v.). (See *Paramagnetic*, also *Permeability*.)

DIAPHRAGM—A thin disk, generally of soft iron used in *telephone receivers* and *microphones* (q.v.) to either produce or detect electrical pulsations by means of vibrations caused by an *electromagnet*. Variations in the current through the electromagnet cause corresponding vibrations in the diaphragm. While the common type of diaphragm is made of soft iron, there are numerous other materials used. Certain alloys have higher permeability, and therefore are more responsive to the attraction of the magnet. In one type of telephone receiver that is particularly sensitive, there are two diaphragms—one that is actuated directly by the electromagnet under the influence of a varying current and another of thin mica, coupled to it by a fine wire. Another type employs a small iron armature suspended on a pivot, and attached to a mica diaphragm by means of a delicate lever, at right angles to the armature. The vibrations of the armature in the magnetic field of the magnets are communicated to the diaphragm by means of this lever. (See *Baldwin Receiver*.) Another type is of metal with fine corrugations and still another is a mica or parchment disk with a piece of soft iron in the center. (See *Microphone*, *Telephone Receivers*.)

DIAPHRAGM, CARBON—A phone diaphragm in the form of a thin carbon disc. (See *Diaphragm*.)

DIELECTRIC—This term is rather broadly used in electrical work to indicate a non-conductor or *insulator*. A dielectric may be a solid, liquid or gas and is generally employed to separate two conducting surfaces. The most common instance of the application of a *dielectric* is in the case of a condenser. Here the plates are separated by a dielectric material, the nature of this material depending on the particular type and purpose of condenser. A *variable condenser* for receiving purposes generally employs air as the

dielectric. That is, the two sets of plates are kept from actual contact while one is being rotated, by an air space. In *fixed condensers* the dielectric is usually waxed paper, mica, glass, oil or compressed air, depending on the purpose for which the condenser is to be used and the dielectric strength necessary. While we refer to a dielectric as a non-conductor or insulator, there is actually no dividing line between conductors and insulators, practically any dielectric permitting passage of a certain amount of current under the proper conditions. If a substance is a very good insulator it is said to have good dielectric properties, while one that is a poor insulator and permits leakage of current is a correspondingly poor dielectric. (See *Insulator*, *Conductor*, *Resistance*, also *Dielectric Coefficient and Constant*.)

DIELECTRIC ABSORPTION—The tendency of the dielectric in a condenser to apparently absorb a certain amount of the power applied to it. When a condenser is charged by a direct current source such as a battery, the instantaneous charge is often followed by a small charge or flow of current that steadily decreases as it flows into the condenser. This additional charge is in effect absorbed by the dielectric of the condenser. The reverse effect is obtained when the condenser is discharged, the instantaneous discharge being followed by a steadily decreasing additional discharge. It will be apparent, then, that if the condenser is charged from an *alternating current* source, such as by *radio frequency currents*, the dielectric will show a tendency to withhold a certain part of the charge, and as the charging and discharging goes on rapidly due to the rapid reversals of the current (see *High Frequency Alternating Current*), the dielectric will continue to hold back this portion of the power as long as the charging and discharging process persists.

This loss, due to the absorption in the dielectric, must not be confused with the losses due to faulty dielectric materials, wherein a certain portion of the current is allowed to leak away by conductance through or on the surface of the insulator. *Dielectric absorption* is often referred to as *dielectric viscosity* or *hysteresis* because of its similarity to viscosity in liquids. Viscosity is the property possessed by liquids to resist deformation. The usual method of measuring viscosities is by measuring the time taken by a known volume of the liquid, at a known temperature, in flowing through an aperture of known form and dimensions under a known pressure. Thus tested, water will flow rapidly, while cylinder oil is very sluggish, and hence is said to possess great viscosity. (See *Condenser*, also *Dielectric*.)

DIELECTRIC COEFFICIENT and CONSTANT—The specific *inductive capacity* of a dielectric. Generally speaking, its properties to act as a *dielectric*. In the *Centimeter Gram Second system* (q.v.) the *inductive capacity* and the *dielectric constant* are numerically equal, the constant being the dielectric value of the material as compared with air at ordinary pressure taken as the standard (1). The table of constants for the more important dielectric materials follows.

It will be seen that glass, oils and mica have the highest values, for which reason they are widely used. (See *Specific Inductive Capacity*, *Dielectric*, also *C. G. S.*)

Dielectric	Constant
Air at ordinary Pressure (Taken as the Standard)	1.000
Manila Paper	1.50
Celluloid	1.555
Parrafine (clear)	1.68 to 2.32
Beeswax	1.86
Parrafine Wax	1.9936 to 2.32
Parrafined Paper	3.65
Hard Rubber (Ebonite)	2.05 to 3.15
India Rubber (pure)	2.22 to 2.50
Gutta Percha	2.46 to 4.20
Shellac	2.74 to 3.60
Olive Oil	3.00 to 3.16
Glass (Low Frequency value)	3.25 to 4.00
Glass (High Frequency value)	4.21
Mica (Pure Sheet)	4.00 to 8.00
Porcelain	4.38
Castor Oil	4.80
Flint Glass, very light	6.57
Flint Glass, light	6.85
Flint Glass, very dense	7.40
Flint Glass, double extra dense	10.10

DIELECTRIC CONSTANTS—See *Table of Constants* under "Dielectric Coefficient and Constants."

DIELECTRIC HYSTERESIS—When the electric field in a dielectric material is varied rapidly, as when the condenser is charged by high frequency currents, heat may be generated. This is due to dielectric hysteresis which is synonymous with dielectric absorption (q.v.)

DIELECTRIC STRENGTH—When an electric field is established in a dielectric, that is to say, a charge is applied to a condenser, and the field attains a certain intensity, the dielectric ceases to be an insulator and becomes, in effect, a conductor. This condition generally is accompanied by a puncturing of the dielectric material. When the charge applied to a condenser is too high the spark will burn through the dielectric and the condenser is then said to have broken down. In some cases the condenser may be permanently ruined by this action, and in others, the dielectric may be conductive at a certain voltage, while remaining effective as long as the voltage is held below the safety point. The particular voltage (critical voltage) or field intensity at which the breakdown of the dielectric occurs is called the dielectric strength of the material. (See *Dielectric*, also *Table of Dielectric Strength*.)

DIFFERENCE FREQUENCY—The frequency of oscillations produced by superposing oscillations of one frequency on oscillations of a different frequency. In Super-heterodyne receivers the action is based on the production of a difference or beat frequency. If the incoming oscillations from the antenna are combined with oscillations of a different frequency produced locally in the receiver, a new series of oscillations will be produced, these oscillations having a frequency numerically equal to the difference in frequency between the other two sets of oscillations. (See *Beat Frequency*, also *Super-Heterodyne*.)

DIODE—A thermionic vacuum tube having only two electrodes, namely filament and plate. The original vacuum tubes were known as Fleming Valves and contained a hot filament and cold plate but no grid as found in the three element vacuum tube now in general use. Several types of diode are still in use as detectors, their chief value lying in the fact that they require no careful adjustments as in the case of a crystal detector. (See *Triode*, *Vacuum Tube*, also *Fleming Valve*.)

DIPLEX RECEPTION OR TRANSMISSION—The simultaneous reception or transmission of two series of signals by or from a single operating station. The systems are so arranged that two messages may be sent or received at the same time without interfering with each other. (See *Duplex Signalling*.)

DIRECT CONDUCTIVE CIRCUIT—Any circuit having a direct conductive path and not depending on capacity or electromagnetic coupling. A metallic, conducting circuit.

DIRECT COUPLING—The coupling or relation between two or more coils or circuits, wherein the connection is metallic. In the illustration Fig. 1 is

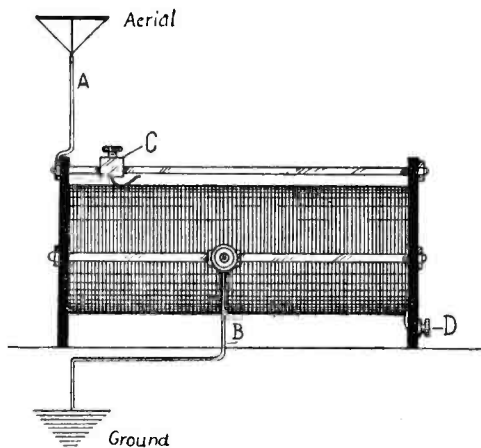

Fig. 1. Double slide tuner which affords direct coupling between the primary and secondary circuits.

shown a two slide tuning coil. In this case A-B is the primary or aerial circuit and C-D the secondary or detector circuit. The two circuits are joined together by metallic connection.

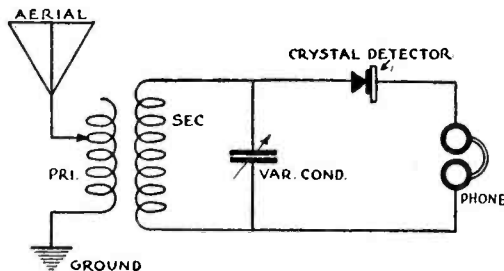

Fig. 2. Circuit in which primary and secondary are inductively coupled.

The illustration Fig. 2 shows essentially the same circuit, except that the primary and secondary are two separate coils. Here the two coils or circuits are joined by inductive coupling.

DIRECT COUPLED—Circuit in which primary and secondary circuits are metallically connected. Generally permits little selectivity. For this reason, inductive coupling is more generally used to permit close tuning or selectivity (q.v.). (See *Coupling*, *Inductive Coupling*.)

DIRECT CURRENT—See *Current*, *Direct*.

DIRECT READING—A term applied to various measuring or recording instruments which are so arranged as to show values directly without requiring mathematical reduction. Voltmeters, Ammeters and such instruments, used widely for showing the voltage, current, etc., of batteries or cells, are direct reading, showing the values directly in volts or amperes. A decrementer or wavemeter very often shows a reading that requires application of a formula to produce the desired quantity. (See *Calibration*.)

DIRECTION FINDER—See *Radio Compass*.

DIRECTIONAL—The effect of an aerial wherein waves are transmitted better, or entirely, in a certain direction, or received from a certain direction, depending upon the type and direction of aerial. (See *Transmitting Aerial*, also *Receiving Aerial*.)

DIRECTIONAL EFFECT OF ANTENNA—An effect of an antenna (aerial) for reception or transmission wherein signals from a certain direction are more readily received than from another direction, or in the case of transmission, the range being greater in a certain direction.

DISCHARGE—Generally speaking, a comparatively sudden passage of electricity. The term however, as applied to a storage battery will mean merely the effect of releasing the electrical charge stored up in it, in this case the discharge not being necessarily rapid. A condenser has the ability to hold charges of electrical energy and to release them suddenly when the proper

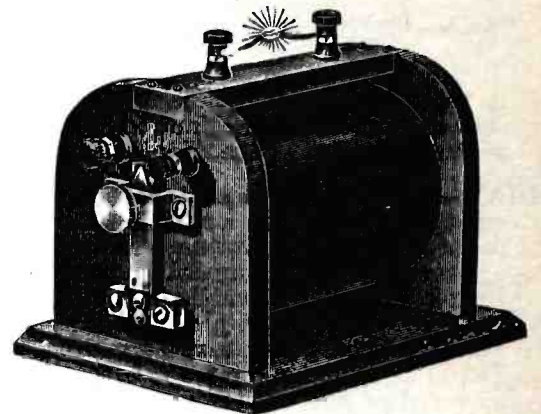

Discharge from a spark coil.

contact is made. The term "discharge" as applied to a transmitter indicates the passage, usually in the form of a spark or succession of sparks, of the electrical energy across a gap between electrodes. The illustration shows spark discharge from spark coil. (See *Spark Discharge*, *Storage Battery*, also *Discharger*.)

DISCHARGER—Any device allowing a path for an electrical discharge. The term may be considered roughly a synonym for spark gap. Usually two or more electrodes, either stationary or rotary, spaced a short distance apart to permit the released electrical energy to bridge the space and thus complete an oscillatory circuit. (See *Disc Discharger Rotary Gap*.)

DISC DISCHARGER—A form of discharger employing one or two rotating discs carrying the sparking surfaces. With the advent of modern undamped transmission methods, these dischargers are gradually passing out. (See *Synchronous Discharger*.)

DISPLACEMENT CURRENT—A current which flows for a short interval in an insulating material or dielectric when an electromotive force is impressed across it, or when the intensity of the electromotive force impressed across it is increased or decreased. This displacement current will flow only when the impressed electromotive force is altered in intensity. After the initial current due to the sudden change in the electromotive force being impressed across the material, the dielectric material or insulating material will remain in a state of strain as long as the charging force persists without further change in intensity, and no further displacement current will flow. (See *Current*, also *Dielectric*.)

DISPLACEMENT, PHASE—See *Phase Displacement*, also *Phase Angle*.

DISRUPTIVE VOLTAGE—The voltage sufficient to disrupt or break down a sample of *dielectric* material under given conditions. Known also as *breakdown potential*. For example, if a *condenser* will stand an impressed potential or voltage of 500 volts without injury, but will be punctured by a potential of 1000 volts minimum, the disruptive voltage is said to be 1000. (See *Break Down Potential*.)

DISSOCIATION THEORY—A theory advanced by Arrhenius in 1887, explaining *electrolytic conduction* by the assumption that a substance in solution is dissociated or separated into *positive and negative ions*, these ions carrying their respective charges in opposite directions. (See *Electrolytic Action*.)

DISSONANCE—"Discord; disagreement"—Webster. The antonym of *resonance*. A term broadly applied in radio to indicate lack of resonance, or coordination of signals or impulses. When an alternating current is superimposed on another alternating current of different frequency, the resulting lack of resonance—*dissonance*—is known as a *beat*. (See *Distortion*.)

DISTORTION—Lack of purity or faithfulness in the reproduction of a vibration or series of vibrations. The most common application of the term in broadcast reception is in the case of reproduction by a loud-speaker. It will very often be found that music or speech is not perfectly reproduced, due to any of a variety of causes. Vacuum tubes may themselves cause distortion; too high potential applied to the plate of a tube may result in distortion; many transformers used in audio frequency amplifier circuits may distort notes of certain frequencies, or it may be due to *self-oscillation* or *regeneration* in the receiving set. This effect is also caused by inefficient transmitting (broadcasting) apparatus, or by lack of careful adjustment. The transformation of speech or music into electrical impulses and its subsequent transmission and reception are attended by many difficulties.

The control of wave form in broadcasting is known as *modulation*. (q.v.) If the transformation of speech or music into electrical impulses and its propagation into space is accomplished without materially changing or distorting the wave form from the original voice or music vibrations, the problem of accurate reproduction is entirely dependent on the receiving apparatus. Distortion may often be traced to the diaphragm of the loud-speaker, certain types being more efficient in this respect than others. (See *Loud-speakers*.) If the ordinary type of disc diaphragm is used, it may become bent and thus cause inequalities in the vibrations, producing distortion of the music or speech being reproduced. (See *Wave Form, Modulation, also Amplifier*.)

DISTRESS SIGNAL—At the International Radio Telegraph convention held at Berlin, Germany, in July, 1908, the call letters C Q D, established by the Marconi Co. in February, 1904, as the official distress call, were superseded by the letters S O S as the Marine distress signal.

S O S is the International distress call for ships and airships requiring assistance. The letters have no particular significance, being chosen mainly for their distinctive sound. In the

International Morse code, S O S is composed of three dots, three dashes and three dots, thus: . . . — — — . . . an unusual combination which permits easy recognition among other messages and calls. When distress signals are heard, the nearest government transmitting station generally sends out immediate notification to all broadcasting stations in the vicinity to suspend operations until the ship has been located and assistance rendered.

DISTRIBUTED CAPACITY—The condenser effect in a coil of wire. Any coil of wire possesses *inherent capacity* to a certain extent, depending on its particular shape, size, etc. In the case of a coil of wire wound on a cylindrical form as indicated in the illustration

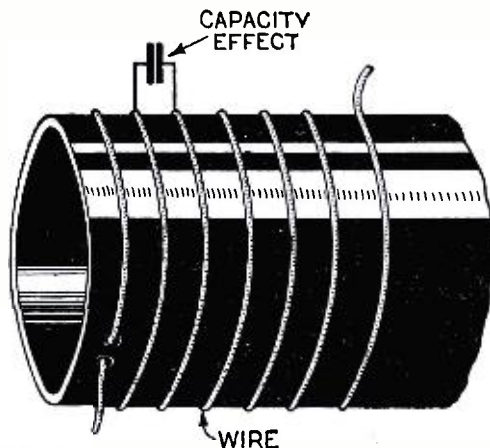
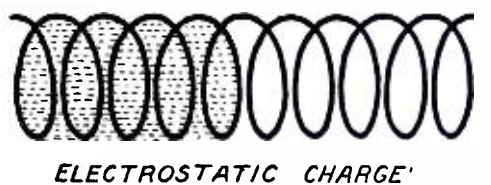

Fig. 1. Coil showing effect of distributed capacity between winding.

Fig. 1, the passage of current through the coil sets up a *local magnetic field*, but also an *electrostatic field*, the latter being in the form of lines of force perpendicular to the conductor. Thus in effect, each two adjacent turns of wire act as a miniature condenser (Fig. 2).



ELECTROSTATIC CHARGE ACTS AS SMALL CONDENSER ACROSS COILS
Fig. 2.

There are numerous methods and forms for winding coils in order to do away as much as possible with this effect. (See *Low-Loss Coils*.)

DISTRIBUTED INDUCTANCE—In a long cable or any great length of wire used for electrical purposes, additional inductance (wire) distributed throughout the entire length to compensate for the inherent capacity of the line. (See *Distributed Capacity*.)

DOT—The short signal in the International Morse Code. (See *Code*.)

DOUBLE AMPLIFICATION CIRCUIT—Also known as *dual amplification circuit*. The arrangement whereby a vacuum tube or several tubes may be made to do double duty, acting as both *radio frequency* and *audio frequency amplifiers*. (See *Reflex*.)

DOUBLE COTTON COVERED WIRE—Abbreviation D. C. C.—Cotton covered copper wire widely used in radio work for coils and all forms of inductances. The insulating covering is composed of two distinct layers of cotton, wound on in opposite directions to prevent loosening. Such wire is obtainable in a variety of sizes according to the standard gauges. (See *Wire Gauge*.)

DOUBLE FREQUENCY OSCILLATIONS—Sometimes referred to as a *double humped wave*. An irregular

wave resulting from two frequencies, generally due to too close coupling of the *oscillation transformer*. When the coupling between the open and *closed oscillatory circuits* is too tight, the *open circuit* very often oscillates at two frequencies, resulting in the radiation of an irregular or *impure wave*. The illustration Fig. 1 shows in graphic form, such an irregular wave. The two peaks of resonance explain the term *double humped wave*. Fig. 2 shows another curve illustrating two frequencies.

In this case however, the amplitude of the second wave is considerably less than that of the first or main wave. According to U. S. Government regulations, if the amplitude of the lesser wave is not more than 0.1 of the am-

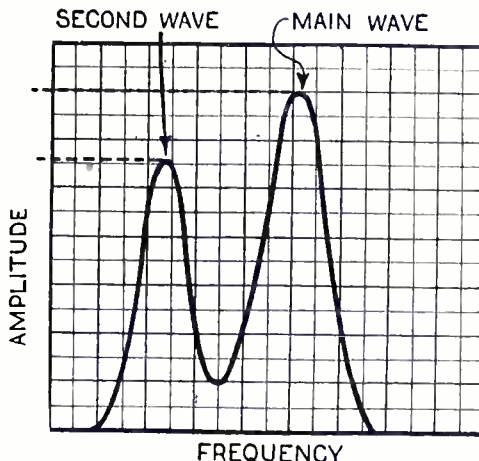

Fig. 1. Resonance curve showing second wave of interfering nature.

plitude of the main wave, it is said to be pure. In other words, where there are two frequencies, but the strength of one less than one tenth that of the

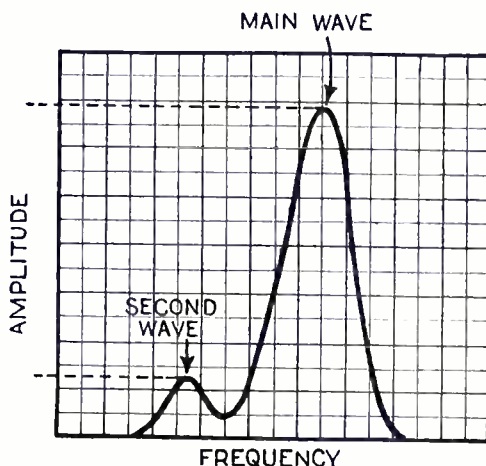

Fig. 2. Resonance curve showing second wave of negligible proportion.

other, it is considered negligible as it cannot be expected to cause any appreciable interference. (See *Resonance, Amplitude, Decrement, etc.*)

DOUBLE GRID TUBE—A vacuum tube having two distinct *grid* members in addition to the usual *filament* and *plate* elements. Such a tube is used in circuits where the customary "B" battery is not employed, the extra grid acting as a booster for the electron flow, the "A" battery furnishing a small positive potential to the plate. (See *Solodyne, also Theory of Vacuum Tubes*.)

DOUBLE MODULATION—Successive modulation of a *radio frequency alternating current* at two lower frequencies. The *intermediate frequency* is usually above *audio frequency* and the lowest frequency is customarily within audio limits or a combination of audio frequencies, as in the case of *radio*

Double Pole Switch

telephony (broadcast). (See *Modulation*.)

DOUBLE POLE SWITCH—A switch used in electrical practice and in radio installations having two poles or connections, thus permitting both sides of a circuit to be opened or closed simultaneously.

DOUBLE RANGE METERS—Meters used for electrical measurements, arranged to read to two scales. As an example, the voltmeter shown has two scale readings, one in fine degrees for a maximum of 7.5 volts, the other a coarser scale to a maximum of 150 volts. Three binding post connectors are furnished, one being a common positive for both scales. A meter for almost any measurement might be made to have double range, although such instruments are generally confined to measurement of current in

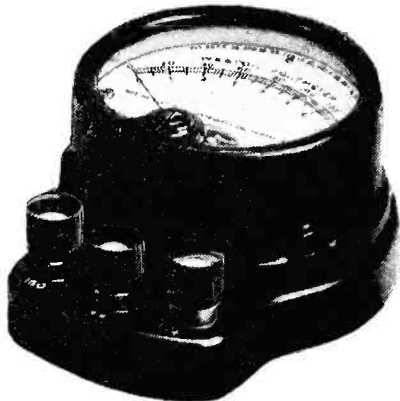
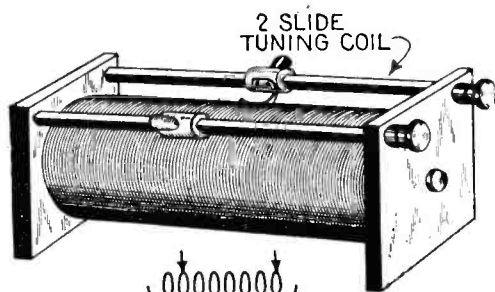

Photo by Courtesy of
Weston Electrical Instrument Co.

Double range meter, one range to 7½ volts, higher range to 150 volts maximum.

amperes and pressure in volts—i. e., ammeters and voltmeters. (See *Meter*.)

DOUBLE SLIDE TUNER—A tuning coil provided with two sliding contacts, generally used in crystal receivers.



2 SLIDE
TUNING COIL
SYMBOL

Two-slide tuner.

The illustration shows a common type of two slide tuner. (See *Coupling Crystal Receiver*, also *Tuning*.)

DOUBLE THROW SWITCH—A switch so arranged that a circuit or a certain instrument is connected in either of two different positions by throwing the

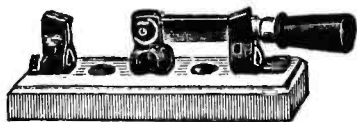

Double throw single pole switch.

switch lever. The illustration shows a single pole double throw switch. (See *Switch*.)

DOWN LEAD—More commonly known as *lead-in*. The wire running from the aerial to the receiving or transmitting apparatus, whereby the signal energy is either collected from, or fed to, the aerial. The illustration shows a typical down lead or lead-in for a receiving set. Obviously the chief difference between such a lead for receiving purposes and for connecting a transmitter to the antenna is the matter of insula-

RADIO REVIEW

tion. The comparatively feeble impulses received or collected by the aerial when receiving require only ordinary care, whereas the high volt-

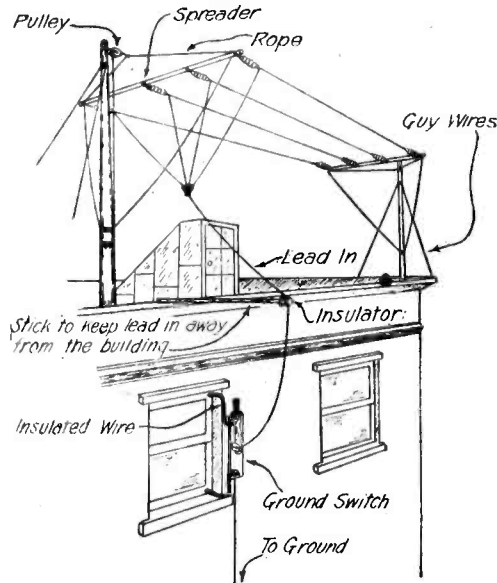

A typical 4-wire aerial showing lead in and method of installing lightning switch.

ages used in transmitting require careful insulation and much heavier apparatus all around. (For more complete details regarding insulation, etc., see *Aerial*.)

DRIFT, AVERAGE ELECTRON—The assumed rate of flow or drift of electrons under average or specific conditions. (See *Electronic Flow*, also *Current, Assumed Direction of Flow*.)

DRIVER—A term broadly used to denote any system used to produce oscillations (vibrations) of a local nature. More specifically any means of producing oscillatory currents as used to test or make measurements in radio circuits. A buzzer connected inductively to a circuit to produce oscillations in that circuit for the purpose of making measurements of *capacity*, *wavelength*, etc. Another means might be a circuit involving a vacuum tube and the necessary apparatus to make it oscillate at a given or variable frequency. The term may be used to signify the tube circuit used to produce local oscillations in the case of a *super-heterodyne* (q.v.). Here the driver produces a series of oscillations of a frequency different from the incoming oscillations, the difference between the two being known as the *beat frequency*. (See *Heterodyne*, *Local Oscillations*, *Buzzer*, *Excitor*.)

DRIVER CIRCUIT—The circuit of the apparatus used to produce oscillations for purposes of test or measurement, or, in the case of a super-heterodyne, to produce a beat effect. (See *Driver*.)

DRUM ARMATURE—A form of armature winding in the approximate shape of a drum. (See *Armature*.)

DRY BATTERY—A battery or group of cells not employing a liquid electrolyte, the cell being filled with a mixture of carbon, manganese dioxide and sawdust (or other absorbent) saturated with a solution of sal ammoniac, these forming a paste, as distinguished from Wet Battery. (See *Battery*, also *Cell* and *B Battery*.)

DRY CELL—See *Dry Battery*.

D. S. C.—The abbreviation for "Double Silk Covered" as applied to copper wire having two distinct layers of silk, wound generally in opposite directions. This wire is furnished in standard sizes according to the various wire gauges. (See *Brown & Sharpe Gauge*.)

DUAL AMPLIFICATION—The process of obtaining both *radio frequency* and *audio frequency amplification* from the same tube instead of using two separate tubes. (See *Double Amplification Circuit*, also *Reflex*.)

DUBILIER, WILLIAM—President and technical director; born, New York, July 25, 1888. Educated New York Schools, Technical Inst. and Cooper Union; Chief Engineer of Continental Wireless Tel. & Tel. Co.; 1910 President of Com. Wireless Tel. Co.; at present Technical Director of Dubilier Condenser and Radio Corp. of New York, The Dubilier Condenser Company Ltd. of London, The Deutsche Dubilier Kondensator Gesellschaft in Berlin, La Protection Electrique Capart-Dubilier in Paris. Has obtained over three hundred patents and applications of electrical devices, which have been purchased or licensed by many companies. Member American Institute Electrical Engineers, Inst. of Radio Engineers, Honorary Member of Societe Academique D'Historie Internationale. Member of Royal Society of Arts.

DUCON—Trade name of a device which can be fitted to any electric light socket and made to serve in place of the usual outdoor aerial. This attachment consists essentially of two condensers, so arranged as to prevent the passage of any direct current or low frequency alternating current from the lighting main to the receiving set, but at the same time to permit passage of the incoming radio signals, the electric light line acting, therefore, as an aerial. (See *Adapter*, *Aerial*.)

DUDELL SINGING ARC—Also called *Musical arc*. An arc actuated by a source of direct current through a *resistance* and shunted by a *condenser* and *inductance* in series. An *oscillat-*

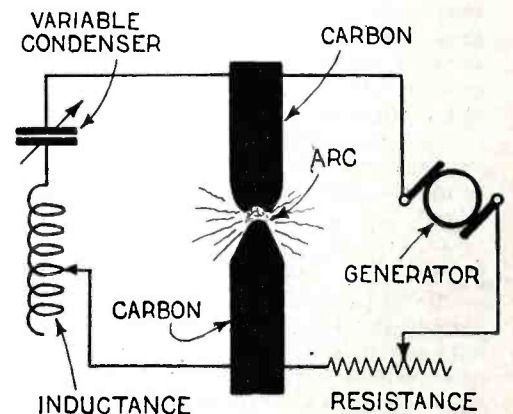

Schematic arrangement for operation of Duddell singing arc.

ing current is thus produced in the condenser circuit, the result being a singing note corresponding in pitch to the frequency of the oscillations in the condenser circuit. The schematic arrangement is shown by the illustration. (See *Arc Generator*.)

DULL EMITTER—The English term for vacuum tubes having *thoriated filaments* and operating with low current consumption. While the term is generally used to denote the tubes requiring only one or two dry cells to operate, it may apply as well to storage battery tubes where the current requirements are low. (See *Filament*, *Thoriated*.)

DUOLATERAL COILS—An alternate term for *honey-comb coils*; inductances wound in diamond-shaped layers to reduce the distributed capacity effect. (See *Honey-Comb Coils*.)

DUPLEX SIGNALLING or DUPLEX TELEGRAPHY OR TELEPHONY—The simultaneous transmission of signals or telephony in both directions between two stations. (See *Duplex Reception or Transmission*, also *Telephony*.)

DUST CORE—A form of core for certain types of transformers, employing iron filings or dust in place of the customary iron wire or laminations. Iron dust is used occasionally where simplicity of construction is desired, the assembly of such a core being obviously much easier than with wire or laminated types. (See *Core*.)

DX—The popular term for long distance; referring to the transmission to or reception from distant points of radio signals or broadcasting.

DYNAMIC CHARACTERISTIC—The curves obtained by impressing an alternating E. M. F. (electromotive force) on the grid of a vacuum tube, as distinguished from the curves obtained by application of a steady direct potential. When alternating potentials such as incoming signals are impressed on the grid of a tube, the curve resulting is apt to take an entirely different form from that of the curve showing *static characteristics* (q.v.). (See *Vacuum Tube characteristics*.)

DYNAMIC CONDENSER—A term occasionally applied to a *synchronous motor* used to improve power factor (in alternating current circuits, the ratio of the electric power in *watts* to the apparent power in *volt amperes* is known as the power factor). Used in this manner the motor has the effect of advancing the current phase in a manner similar to that of a condenser. (See *Angle of Lead or Lag*.)

DYNAMIC ELECTRICITY—A term sometimes used for electric currents to distinguish them from *static electricity* (q.v.).

DYNAMO—A machine for converting mechanical energy into electrical energy. Is also known as *generator*, but usually confined to machines for generating *direct current*. The action of a dynamo is based on the production of an *electromotive force* in a conductor moving in a magnetic field. Fundamentally a dynamo is a machine that generates alternating current, but instead of collecting this current by means of rings, which would cause alternating current to flow in the external circuit, a device known as an *armature* is employed in such a manner that the current collected by brushes and delivered to the external circuit is direct—that is, it flows more or less steadily in one direction. Thus the kind of current delivered for use depends on the method used to collect the currents generated. (For more complete explanation of the production of alternating current see *Alternating Current, Theory of Production*.) In the case of a dynamo, the essential parts are the *field magnets*, the *arma-*

ture and the *commutator*. Now in the case of an *alternator*, each end of the

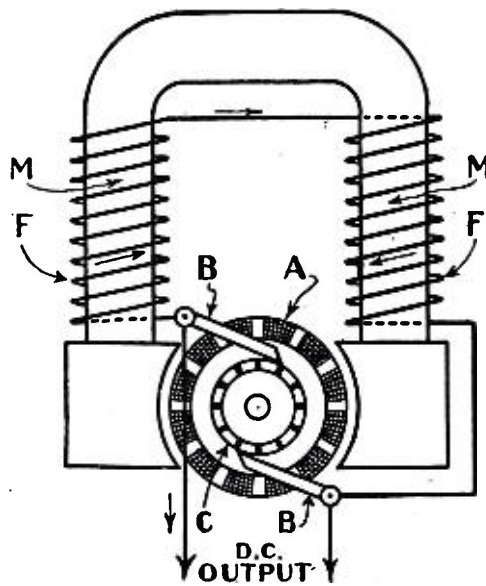

Shunt wound dynamo.

loop or armature is connected by a brush bearing against a collector ring and the end of each loop is always connected to the same brush. This results in an external current that changes its direction with each reversal of direction of the induced electromotive force. If the external current is to be direct it is necessary to have some means of collecting the current through one brush at the positive instant and the other at the negative instant. This is done by means of an armature, which is in effect a switching arrangement, so designed that it will reverse the connections of the external circuit at the instant of each reversal of current in the armature. The illustration shows a *shunt wound dynamo*. MM are the field magnets, FF the field windings, BB the brushes, A the armature and C the commutator. (See *Alternator, Armature, Generator*.)

DYNAMOMETER—A delicate and accurate instrument for the measurement of currents and voltages or both. Such instruments depend upon the action of a circuit carrying current upon another carrying the same current. Essentially it comprises two coils, one fixed and the other movable. This system of measurement is used in a *wattmeter*, where it is necessary to measure the instantaneous current and voltage, i.e., power. (See *Wattmeter*, also *Electro Dynamometer*.)

DYNAMOTOR—A direct current machine which acts either as a *motor* or *dynamo*. It has an armature with two separate windings and two separate commutators, one at each end of the armature. Either winding may be used as a motor and the other as the generator winding. Such a machine is used to convert high voltage direct current into low voltage direct current or vice versa, thus performing the same function with direct current as a

power transformer performs for alternating current. (See *Converter*.)

DYNATRON—A form of vacuum tube generally used for producing oscillations as in radio telephony, wherein the phenomena of "secondary electron emission" is used. In this form of tube the electrons traveling at high speed from the hot filament or cathode

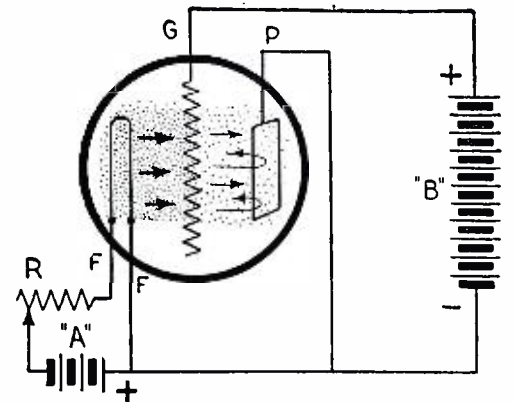

Showing how a standard vacuum tube can be connected to act as a dynatron.

are made to collide with a metallic surface. The collision of these electrons on the surface of the interposed element has the effect, under proper conditions, of jarring other electrons out of the metal. The secondary emission thus obtained depends upon the speed of the original electrons which collide with the metal surface. Normally, these secondary electrons will immediately re-enter the surface from which they were emitted, but if another electrode of higher potential is in the vicinity they will travel toward it in the same manner as the electrons are attracted to the plate of an ordinary three element tube. A standard tube can be connected as shown in the illustration to act as a dynatron. Here the filament F emits electrons, some of which pass through the grid G and collide with the plate P. This collision with the plate P may jar loose from the surface additional electrons, which normally would immediately re-enter P. However, as the grid G is held at a higher potential (higher positive voltage) than P, the electrons will be drawn toward it. A tube arranged in this manner may be used for practically any of the purposes of the standard tube, such as regenerative detector, detector of continuous waves or as a generator of high frequency oscillations, but it has not been shown to have any advantages in this respect, being used mainly as an *oscillator* (q.v.). (See *Electron Emission, Vacuum Tube*, etc.)

DYNE—The unit of force in the absolute or CGS system of units. It is defined as the force which, acting on a mass of one gram for one second, will impart to the mass a velocity of one centimeter per second. (See *CGS System*, also *Force*.)

E

E—Common symbol for *Electromotive force* (q.v.).

EAR CUSHION—Pads or cushions of soft rubber used in conjunction with head-phones to prevent unpleasant pressure against the ears and also to exclude outside sounds when listening in.

EARTH—An alternate term for *ground*, where the earth or any metallic connection thereto is used as a return in transmission or reception of *electromagnetic waves*. (See *Ground*.)

EARTH CURRENTS—See *Ground Currents*.

EARTH, DEAD—See *Ground*.

EARTH DETECTOR—See *Ground Detector*.

EBONITE—See *Insulating Materials*.

EBURIN—An insulating compound used for *strain insulators* (q.v.). (See *Insulating Materials*.)

EDDY CURRENT LOSS—The portion

of the total loss in electrical apparatus due to *Eddy Currents* (q.v.).

EDDY CURRENTS—Currents induced in the mass of a solid conductor due to the action of a varying magnetic field. The most common example of eddy currents will be found in the case of a dynamo or generator. Here the useful current generated in the armature is produced by the motion of the armature in the magnetic field. At the same time currents are generated in the iron core due to its motion in the magnetic field. As all currents generated in an electrical machine are produced at the expense of a certain amount of energy, and since the Eddy currents cannot be gathered or put to useful account in this case, they represent a loss. This loss usually is apparent in the form of heat. If the core is made up of solid metal it will be obvious that a good closed path is offered for eddy currents produced. Now if the core is composed of a number of sheets or laminations, insulated by thin layers of paper or by an insulating scale (see *Transformer Steel*) the path for the eddy currents is partially broken and the effect is reduced. Eddy currents are produced in the core of a transformer due to the same action—the variation of the magnetic field in which the core is located. In order to reduce the effect, laminated cores are employed as in the case of many generating machines. Eddy current loss is often given as the loss in watts per pound of core material at 10,000 gaussses (q.v.) and 60 cycles for a sheet 0.0141 inch or 0.0358 centimeter thick. While eddy currents are usually productive of losses they are put to useful account in certain types of instruments. For example, the eddy currents produced in the metal frame of a moving coil meter may be employed to damp or retard the free oscillations of the needle. (See *Damping of Instruments*.) Eddy currents are also used in a form of speed indicator where the reaction of eddy currents created in a moving disk are made to deflect a pivoted, spring controlled, magnetic needle. (See *Core Loss, Hysteresis, also Foucault Currents*.)

EDDY CURRENT COEFFICIENT—The coefficient or numerical multiplier, generally termed K_1 , used in calculations of eddy current loss. Its numerical value depends upon the specific resistance (q.v.) of the iron used in the core of the machine in question, the character or wave shape of the induced voltage, the distribution of magnetic flux (q.v.) in the core material, the degree of insulation between sheets, where laminations are used, and upon the flux distribution (q.v.) due to the shape of the magnetic circuit. Its value will also vary according to the units used in the computation.

EDDY CURRENT LOSS, FORMULA FOR CALCULATING—A common formula for calculation of eddy current loss is the following: $P_e = eV(xfB)^2$. Here the loss is expressed in watts as P_e , V is the volume of core metal in cubic centimeters, x the thickness of the sheets in centimeters, f the frequency in cycles per second, B the flux density (q.v.) in gaussses and e the eddy current coefficient.

EDGE EFFECT—The effect on the capacity of a condenser due to the curving of the lines of stress at the edge of the plates. This effect is not very pronounced where there is considerable

dielectric surface (insulating material) extending beyond the edge of the plates. (See *Distributed Capacity*.)

EDISON BATTERY—A number of Edison cells grouped together in one case to supply various currents and voltages as in radio. The illustration shows an Edison "B" battery, used to supply potential to the plates of

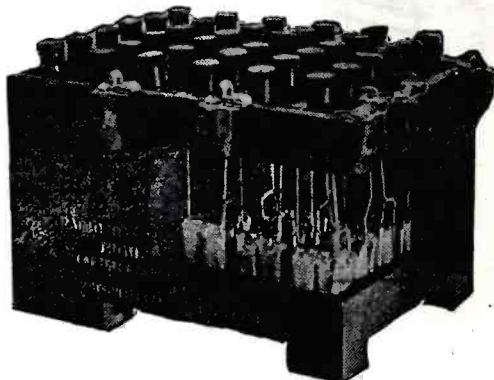

Photo by Courtesy of Edison Storage Battery Co.
Edison "B" battery with portion of case removed to show interior construction.

vacuum tubes. (See "A" Battery, "B" Battery, Plate, Filament, also Storage Battery.)

EDISON CELL—A storage cell employing electrodes of nickeled steel and a solution of potassium hydrate for the electrolyte as distinguished from the usual type of storage cell using lead plates and dilute sulphuric acid as the electrolyte. The chief point of superiority of this type of cell is its comparative ruggedness, due partially to steel construction and also to freedom

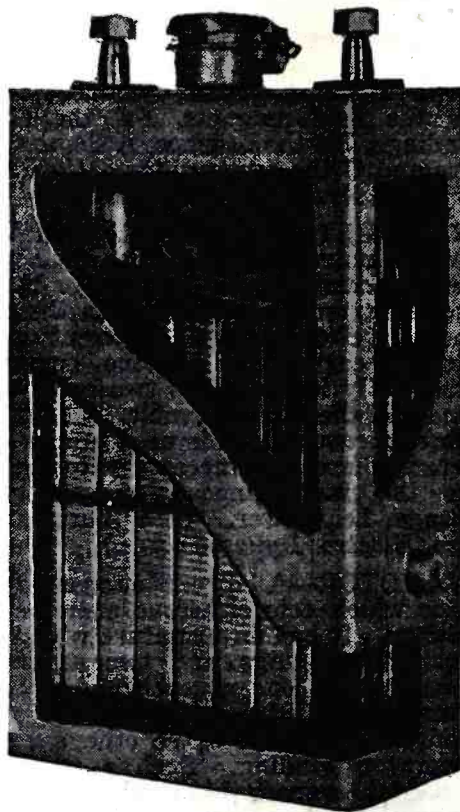
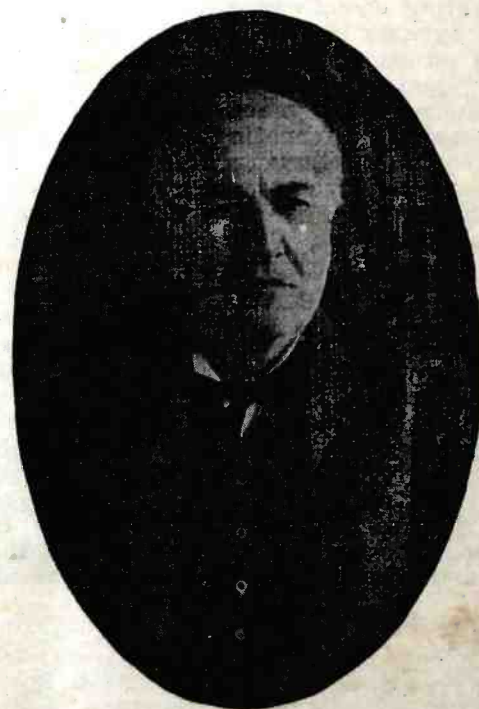

Photo by Courtesy of Edison Storage Battery Co.
Edison cell with part of case cut away to show how constructed.

from the usual ills of cells employing acids and lead plates. The positive electrode in the Edison cell is made by tamping nickel hydrate and alternate layers of pure flake nickel into perforated steel tubes under pressure. The negative electrode is made by pressing iron oxide into flat perforated steel pockets. A number of these pockets are forced into a steel grid to form the complete negative plate. (Note: The negative electrode connection on the outside of the cell is re-

ferred to as the positive pole because it is positive in its relation to the external circuit. Similarly the positive electrode connection will be known as the negative pole.) The potassium hydrate or hydroxide which takes the place of the acid solution used in the lead plate type of cell acts as a preservative of the steel elements. This naturally means greater life; in fact, it is not subject to the chemical deterioration of other cells. The illustration shows a cell with part of the sides cut away to show the interior construction. (See *Edison Battery*.)

EDISON, THOMAS ALVA—Born 1847. An inventor famous for his experiments in applied electricity. He began life with newspaper work which he soon abandoned for telegraphy, making many original inventions in duplex systems of operation. After a varied experience in that line he came to New York in 1871, where his talents were recognized and he had opportunity to profitably develop his ideas. The duplex telegraph was made a success the following year, and two years later the quadruplex; and thereupon he began manufacturing on a large scale for the Western Union Telegraph Co. In 1876 he gave up his factory, and established his experimental station at Menlo Park, N. J., where for several years he worked upon the problem of the incandescent electric light, exhibiting a successful bamboo filament lamp in Paris in 1881. He invented the phonograph in 1878. He superintended the construction of the first incandescent lighting station in New York in 1882. Moving his laboratory to Orange, N. J., he established there a large plant for electrical experiment and invention and as a result of his labors there he has taken out 400 patents. Among his inventions may be further named: a type of dynamo, a microphone, the chemical electrical meter, an electric pen, the mimeo-



Thomas A. Edison

graph, the magnetic ore separator, dead beat galvanometer, the electric torpedo, a telephone transmitter, and a storage battery. His chief fame rests with his development of the telegraph, his invention of the incandescent lamp and the phonograph.

RADIO

If you want to know radio from beginning to end or if you want to know what is going on in radio designing, manufacturing and broadcasting from day to day—you will need these magazines.

They are written for the radio Beginner, Amateur, Professional or Broadcast Listener with pages of stories, articles, hookups and data for everybody who owns or uses a radio receiver or transmitter.

RADIO NEWS

Radio's Greatest and Biggest Magazine

The largest radio magazine published. It is the outstanding authority in the radio field carrying more new developments, more hookups and more news than any other radio magazine.

RADIO NEWS carries in every issue more than a dozen separate departments that cover every angle of the great industry from the beginner to the professional broadcaster or ship operator.

RADIO NEWS has been radio's greatest magazine since the very beginning of radio broadcasting.

Ask your local newsdealer to let you see a copy today.

SCIENCE AND INVENTION

Beginner's Radio

The radio beginner's magazine in which you get the sound, practical fundamentals of radio in a simple, easy pictorial way.

Each month, various principles of radio are carefully and completely explained and simplified so that anyone can understand them.

SCIENCE AND INVENTION also covers all the principal, interesting events of the scientific or inventive world that occur from day to day the world over.

SCIENCE AND INVENTION can be obtained on all newsstands. Ask your dealer to let you see a copy.

THE EXPERIMENTER

Radio for the "Radio Tinker"

THE EXPERIMENTER concentrates its entire radio section to the problems of the radio "Tinker," covering the real practical problems of the day that affect the receiving apparatus of the Amateur station.

THE EXPERIMENTER covers the three great branches of modern research, Electricity, Radio and Chemistry. It is one of the most interesting, most instructive, and most comprehensive magazines published.

Your newsdealer can show you a copy today. 72 pages of experiments and drawings.

12 pages of radio in every issue.

At all Newsstands and Radio Dealers 25c per Copy
Subscriptions, \$2.50 the Year

Published and Distributed by

THE EXPERIMENTER PUBLISHING CO., Inc.

53 Park Place

New York City

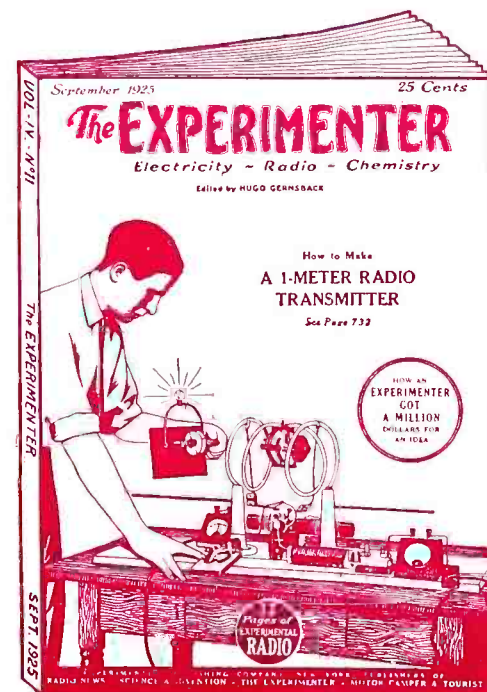
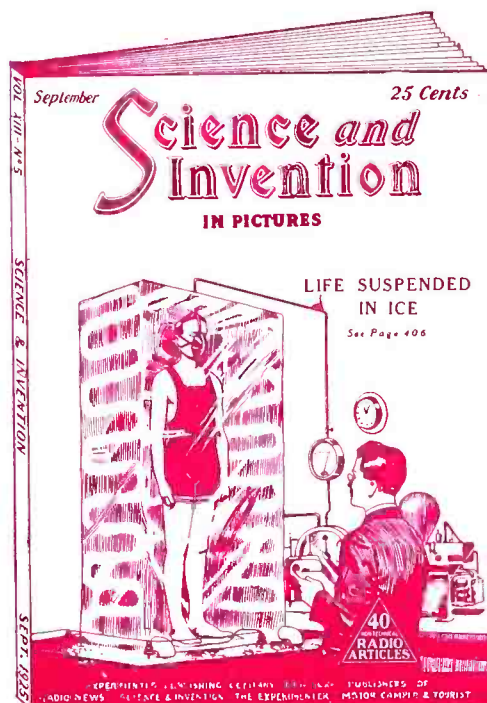

RADIO LISTENERS' GUIDE and CALL BOOK

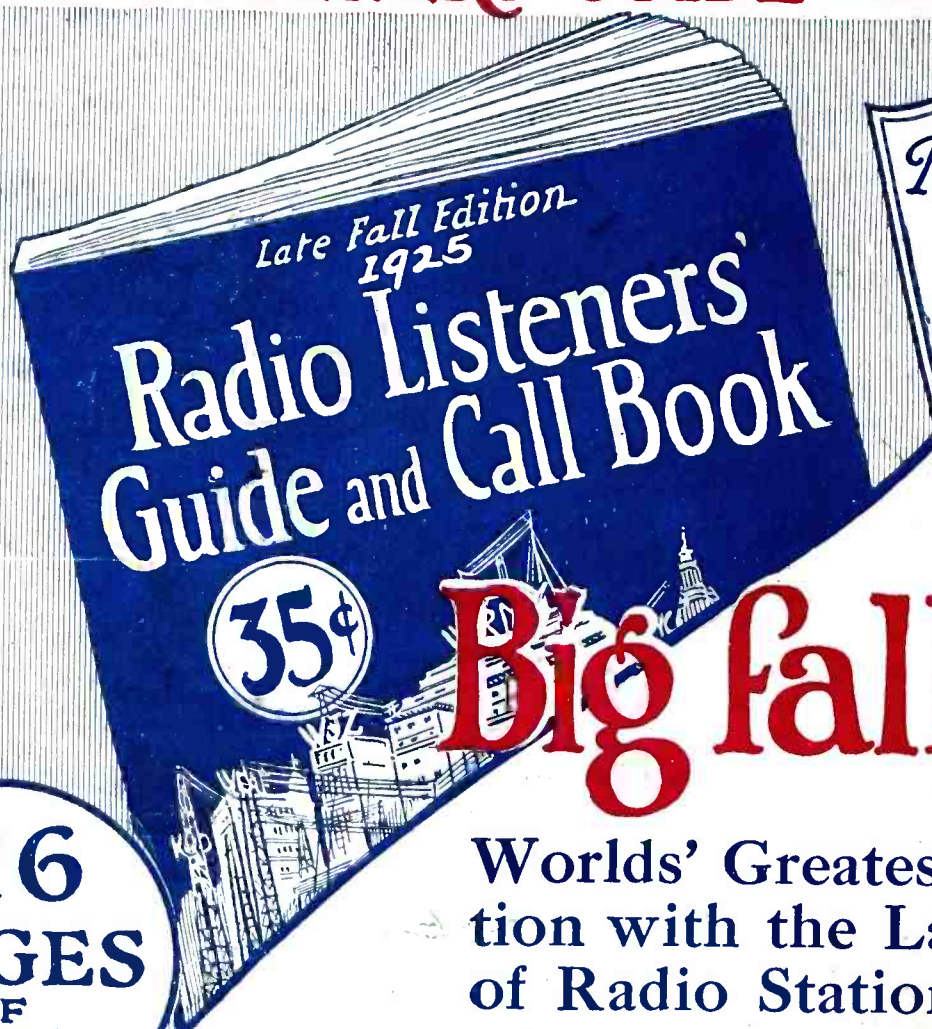

The
Radio Set Owners'
Book
of
Information

Big fall Issue

116
PAGES
OF
RADIO

Worlds' Greatest Book of Information with the Latest Complete List of Radio Stations and Call Letters

Here is the latest and greatest radio book of its kind published for the Broadcast Listener. It is a National Radio Guide Book of the United States in that it gives you, completely and comprehensively, the location of radio stations on the air. It lists all stations of the United States, both Broadcast and Amateur, giving size and location of each station, its wave-length, etc., with ample space for tabling and logging those you receive. Then just as an Automobile Guide Book tells you how to care for your car, this book explains the complete care of your radio set by explaining the fundamental operation of all principal parts. And also it gives foreign radio stations, time signals and a multitude of similar, valuable listings.

116 pages filled to the brim with valuable data.

PARTIAL LIST OF CONTENTS

Selecting a Radio Receiving Set.	Radio Broadcast Stations of the U. S., by States.
Reaching the Shorter Wavelengths.	Radio Broadcast Stations of Canada.
How Broadcast Stations Operate.	Special Land and Experimental Radio Stations of the U. S.
Locating and Eliminating Trouble in Radio Sets.	Foreign Radio Broadcast Stations, by Countries.
All About Radiologs.	American Radio Relay League and Directory.
The Function and Care of Vacuum Tubes.	Amateur Radio Stations of the U. S., by Districts.
Loud Speakers—How to Select Them.	Foreign Amateur Radio Stations.
Fundamental Principals of Radio.	Table for Making Time Transitions.
The Care and Operation of Storage Batteries.	Radio Broadcast Maps of the United States and Canada.
Basic and Modern Radio Circuits.	Time in All Parts of the World.
Aerials, Loops, Ground and Lightning Arresters.	
How to Understand Radio Circuits.	
Radio Broadcast Stations of the U. S., by Call Letters.	

35c the Copy

Sold at all Newsdealers and Radio Stores, or if your local dealer cannot supply you, write direct, inclosing Full Price.

Published and Distributed by

THE CONSRAD CO., INC., 233 Fulton Street, New York, N. Y.

Consrad

RADIO'S FOREMOST PUBLISHERS—Everything in Books, Patterns and Diagrams