

THE  
**RADIO CONSTRUCTOR**

VOL. 22 NO. 5

**DECEMBER 1968**

**3/-**

A DATA PUBLICATION

**RADIO · TELEVISION · ELECTRONICS · AUDIO**

**SOLID -STATE**

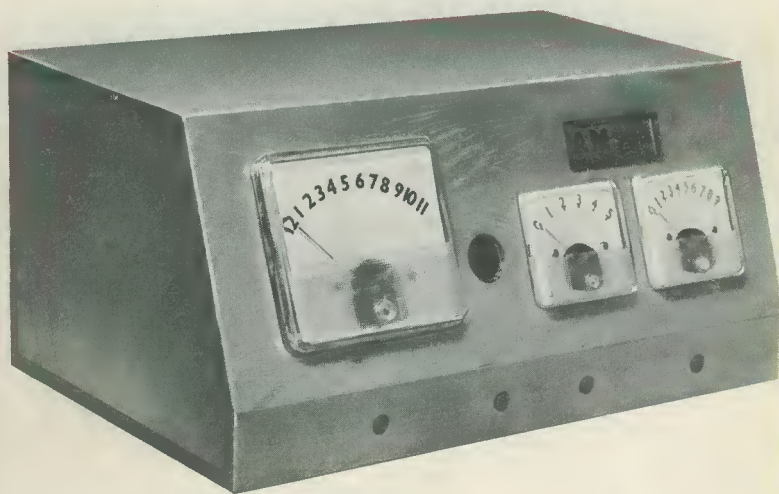

**DIGITAL CLOCK**



*Also featured*

**3-Band  
Preselector**



**Thyristor  
Alarm Switch**



**Christmas  
Water Fountain**

# Scottish Insurance Corporation Ltd

66-67 CORNHILL · LONDON · EC3



**TELEVISION  
SETS,  
RECEIVERS  
AND  
TRANSMITTERS**

Television Sets, Receivers and Short Wave Transmitters are expensive to acquire and you no doubt highly prize your installation. Apart from the value of your Set, you might be held responsible should injury be caused by a fault in the Set, or injury or damage by your Aerial collapsing.

A "Scottish" special policy for Television Sets, Receivers and Short Wave Transmitters provides the following cover:

- (a) Loss or damage to installation (including in the case of Television Sets the Cathode Ray Tube) by Fire, Explosion, Lightning, Theft or Accidental External Means at any private dwelling-house.
- (b) (i) Legal Liability for bodily injury to Third Parties or damage to their property arising out of the breakage or collapse of the Aerial Fittings or Mast, or through any defect in the Set. Indemnity £10,000 any one accident.
- (ii) Damage to your property or that of your landlord arising out of the breakage or collapse of the Aerial Fittings or Mast, but not exceeding £500.

Why not BE PRUDENT AND INSURE your installation—it is well worthwhile AT THE VERY LOW COST INVOLVED. If you write to the Corporation's Office a proposal will be submitted for completion.

---

Write for full details, quoting reference 5304, to:—

**THE MANAGER  
SCOTTISH INSURANCE CORPORATION LTD.,  
66-67 CORNHILL, LONDON E.C.3**

---

# FOLLOW THE LEADERS

## KING SIZE QUALITY-TESTED PAKS

2	Drift Trans.	2N1225 Germ. PNP	10/-
1	100 Mc/s.	100 Mc/s.	10/-
6	Matched Trans.	OC45/81/81D	10/-
20	Red Spot AF Trans.	PNP	10/-
16	White Spot RF Trans.	PNP	10/-
5	Silicon Rects.	3 A 100-400 PIV	10/-
2	10 A Silicon Rects.	100 PIV	10/-
2	OC140 Trans.	NPN Switching	10/-
1	12 A SCR	100 PIV	10/-
3	811 Trans.	2S303 PNP	10/-
4	Zener Diodes	260mW 3-12V	10/-
3	200Mc/s. Sil. Trans.	NPN BS226/27	10/-
3	Zener Diodes	400mW 38V 5% Tol.	10/-
4	High Current Trans.	OC42 Eqty.	10/-
2	Power Transistors	1 OC291 1 OC355	10/-
5	Silicon Rects.	400 PIV 250mA	10/-
4	OC75 Transistors	Mullard Type	10/-
1	Power Trans.	OC20 100V	10/-
10	OA502 Sil. Diodes	Sub-min. Marked	10/-
2	Low Noise Trans.	NPN 2N929/30	10/-
1	Sil. Trans.	NPN VCB 100 ZTR66	10/-
4	OA81 Diodes	100 PIV	10/-
4	OC72 Transistors	Mullard Type	10/-
4	OC77 Transistors	Mullard Type	10/-
4	Sil. Rects.	400 PIV 100mA	10/-
5	GET834 Trans.	Eqvt. OC44	10/-
6	GET833 Trans.	Eqvt. OC44	10/-
2	2N708 Sil. Trans.	300Mc/s. NPN	10/-
5	GT41/46 Germ. Trans.	PNP	10/-
3	GT31 LF Low Noise	PNP Trans.	10/-
6	IN914 Sil. Diodes	75 PIV 70mA	10/-
8	OA95 Germ. Diodes	Sub-min. IN69	10/-
3	NPN Germ. Trans.	NK1773	10/-
2	OC22 Power Trans.	Germ.	10/-
2	OC25 Power Trans.	Germ.	10/-
4	OC72 Mullard Trans.		10/-
4	AC128 Trans.	PNP High Gain	10/-
2	AC127/128 Comp. pair	PNP/NPN	10/-
3	2N1307 PNP Switching	Trans.	10/-
10	CG92H Germ. Diodes	Eqvt. OA71	10/-
3	AF116 Mullard Type	Trans.	10/-

**FREE** One 10/- Pack of your own choice free with orders value 44 or over.

12	Assorted Germ. Diodes	Marked	10/-
4	AC126 Germ. PNP		10/-
4	Silicon Rects.	100 PIV 750mA	10/-
3	AF117 Trans.	Mullard Type	10/-
7	OC81 Type Trans.		10/-
3	OC171 Trans.	Mullard Type	10/-
5	2N2926 Sil. Epoxy	Trans.	10/-
7	OC71 Type Trans.		10/-
25	Trans. Heatinks fit TO18, 8012, etc.		10/-
2	2S701 Sil. Trans.	Texas NPN	10/-
3	12V Zener	400mW	10/-
2	1CA 600 PIV Sil. Rects.	1S45R	10/-
3	BC108 Sil. NPN High Gain	Trans.	15/-
1	2N910 NPN Sil. Trans.	VCB100	15/-
3	1000 PIV Sil. Rect.	1.5A R3310 AF	15/-
3	BSY95A Sil. Trans.	NPN 200Mc/s.	15/-
3	OC200 Sil. Trans.	Mullard	10/-
2	Sil. Power Rects.	BYZ13	15/-
1	Sil. Power Trans.	NPN 100Mc/s.	15/-
1	TK201A		15/-
6	Zener Diodes	3-12V Sub-min.	15/-
1	2N132 PNP Epitaxial	Planar Sil.	15/-
3	2N897 Epitaxial	Planar Trans. Sil.	15/-
4	Germ. Power Trans.	Eqvt. OC16	15/-
1	Unijunction Trans.	2N2646	15/-
2	Sil. Trans.	200Mc/s. 60Vcb ZTR3/84	15/-
1	Sil. Planar Trans.	NPN 100Mc/s.	15/-
3	BSY25		15/-
1	Unijunction Trans.	2N2180 TO-5	15/-
2	Sil. Rects.	5A 600 PIV Stud Type	15/-
2	Germ. Power Trans.	OC28/29	15/-
1	10A Sil. Stud React.	800 PIV	15/-
1	Tunnel Diode	ABY11 1050Mc/s.	15/-
2	2N2712 Sil. Epoxy Planar	HFE225	15/-
8	EX 100 Type Sil. Rects.		20/-
25	Sil. and Germ. Trans.	Mixed, all marked, New	30/-
2	GET880 Low Noise	Germ. Trans.	10/-
1	AD139 NPN High Freq.	Trans.	10/-
3	NPN Trans.	1 BT141 & 2 ST140	10/-
4	Mad's 2 MAT100 & 2 MAT120		10/-
3	Mad's 2 MAT'01 & 1 MAT121		10/-
4	OC44 Germ. Trans.	AF	10/-
3	AC127 NPN Germ. Trans.		10/-
1	2N3906 Sil. PNP Trans.	Motorola	10/-

### CADMIUM CELLS ORP12 ORP12 MANY NEW PAK ITEMS

FULL RANGE OF ZENER DIODES	
VOLTAGE RANGE 2-16V.	
400mW (DO-7 Case)	2/8 each
1.5W (Top-Hat)	3/8 each
10W (SO-10 Stud)	5/- each
All fully tested 5% tol. and marked. Please state voltage required. Full range eqvt. to OAZ Mullard Type Z. Range of NTC, T.R. Texas and IN types.	

**TRANSISTOR EQVT. BOOK**  
52 pages of cross references for trans. and diodes, types include British, European, American and Japanese. Specially imported by BI-PAK 10/- each

## ANOTHER CROWNING SUCCESS— THIS MONTH'S BARGAIN PAKS ALL FULLY TESTED AND GUARANTEED SATISFACTION

Pak No.	Qty.	Description	Price
S1	10	Gold Bonded Diodes eqvt. OA47	10/-
S2	10	2N3707 NPN Planar Transistors	10/-
S3	5	BC108 NPN Sil. Transistors	10/-
S4	8	Zeners 400mW 2-18V Mixed	10/-
S5	8	2N3702 PNP Planar Transistors	10/-
S6	4	3A 600PIV Sil. Rects. Stud	10/-
S7	5	PNP Sil. Planar Trans. 2N2904	10/-
S8	5	2N606 NPN Sil. Trans.	10/-
N9	10	OC44 Type Trans. Gen. P. RF	10/-
K10	10	Sil. Diodes 60PIV 250mA MSI, Gen. P.	10/-

EACH MONTH FOR ONE MONTH ONLY WE OFFER SPECIAL BARGAIN PAKS AVAILABLE AT THIS SPECIAL PRICE. TAKE FULL ADVANTAGE AND SAVE EVEN MORE ON YOUR BI-PAK BARGAINS.

## KING OF THE PAKS Unequaled Value and Quality SUPER PAKS BRAND NEW—UNTESTED SEMICONDUCTORS

Satisfaction GUARANTEED in Every Pak, or money back.

Pak No.	Description	Price
U1	120 Glass Sub-min. General Purpose Germanium Diodes	10/-
U2	60 Mixed Germanium Transistors AF/RF	10/-
U3	75 Germanium Gold Bonded Diodes sim. OA5, PA47	10/-
U4	40 Germanium Transistors like OC81, AC128	10/-
U5	60 200mA Sub-min. Sil. Diodes	10/-
U6	40 Silicon Planar Transistors NPN sim. BSY95A, 2N706	10/-
U7	16 Silicon Rectifiers Top-Hat 750mA up to 1000V	10/-
U8	50 Sil. Planar Diodes 250mA OA/200/292	10/-
U9	20 Mixed Volts 1 watt Zener Diodes	10/-
U11	30 PNP Silicon Planar Transistors TO-5 sim. 2N1132	10/-
U12	12 Silicon Rectifiers EPOXY 500mA up to 800 PIV	10/-
U13	30 PNP-NPN Sil. Transistors OC200 & 2S104	10/-
U14	160 Mixed Silicon and Germanium Diodes	10/-
U15	30 NPN Silicon Planar Transistors TO-5 sim. 2N697	10/-
U16	10 3-Amp Silicon Rectifiers Stud Type up to 1000 PIV	10/-
U17	30 Germanium PNP AF Transistors TO-5 like AGY 17-22	10/-
U18	8 6-Amp Silicon Rectifiers BYZ13 Type up to 600 PIV	10/-
U19	30 Silicon NPN Transistors like BC108	10/-
U20	12 1.5-amp Silicon Rectifiers Top-Hat up to 1,000 PIV	10/-
U21	30 A.F. Germanium alloy Transistors 2G300 Series & OC71	10/-
U22	10 1-amp Glass Min. Silicon Rectifiers High Volts	10/-
U23	30 Mad's like MAT Series PNP Transistors	10/-
U24	20 Germanium 1-amp Rectifiers GJM up to 350 PIV	10/-
U25	25 300Mc/s NPN Silicon Transistors 2N708, BSY27	10/-
U26	30 Fast Switching Silicon Diodes like IN914 Micro-min	10/-
U28	Experimenters' Assortment of Integrated Circuits, untested. (Gates, Flip-Flops, Registers, etc., 8 Assorted Pieces)	20/-
U29	10 1 amp SCR's TO-5 can up to 600 PIV CR81/25-600	20/-
U30	15 Plastic Silicon Planar Trans. NPN 2N2924-2N2926	10/-
U31	20 Sil Planar NPN Trans. low noise Amp 2N3707	10/-
U32	25 Zener diodes 400mW D07 case mixed Volts. 3-18	10/-
U33	15 Plastic case 1 amp silicon rectifiers 1N4000 series	10/-

Code Nos. mentioned above are given as a guide to the type of device in the Pak. The devices themselves are normally unmarked

**ADI61 NPN ADI62 PNP** HIGH POWER SILICON PLANAR TRANSISTORS. TEXAS 2S034. NPN TO-3.

MATCHED COMPLEMENTARY PAIRS OF GERM. POWER TRANSISTORS. VCB100 1c 4A 1T. 15M/cs. VCE100 Ptot. 40W. VEB8 hFE(min.) 60 Price 15/- each

For mains driven output stages of Amplifiers and Radio receivers. OUR LOWEST PRICE OF 12/6 PER PAIR

NEW SILICON RECTIFIERS TESTED				
PIV	400mA	750mA	1.5A	3A
50	10d 1/	1/5	2/9	4/3
100	1/1	1/3	2/3	4/3
200	1/8	1/9	2/6	4/1
300	2/3	3/9	4/6	6/8
400	2/2	2/6	4/1	5/6
500	3/1	3/1	6/1	8/6
600	2/9	3/3	4/3	6/9
800	3/1	3/6	4/9	7/6
1,000	5/1	6/1	9/3	12/6
1,200	6/1	6/6	7/6	11/6

SCR's LOWEST PRICE LARGEST RANGE		
PIV	1A	7A
30A	1A	7A
50	7/6	8/6
100	8/6	10/15
200	12/6	15/20
300	15/20	25/30
400	17/6	25/35
500	30/40	45/95
600	40/50	50/100

**PLEASE NOTE.** To avoid any further increased Postal Charges to our Customers and enable us to keep our "By Return Postal service" which is second to none, we have re-organized and streamlined our Despatch Order Department and we now request you to send all your orders together with your remittance, direct to our Warehouse and Despatch Department, postal address: BI-PAK SEMICONDUCTORS, Despatch Dept., P.O. BOX 6, WARE, HERTS. Postage and packing still 1/- per order. Minimum order 10/-.



**FET'S**

2N 3819	10/-
2N 3820	25/-
MPF105	5/-
OCF71	8/6

**UNIUNCTION**  
Eqvt. 2N2846, Eqvt. T1843, BEN3000  
**7/6 EACH**  
25-99 5/- 100 UP 4/-

**INTEGRATED CIRCUITS**  
I.C. Operational Amplifier with Zener output. Type 701C. Ideal for P.E. Projects. 8 Lead TO-5 case. Full data.  
Our price 12/6 each  
5 off 11/- each. Large Qty. Prices quoted for.

**FAIRCHILD EPOXY TO-5**  
8 Lead I.C.  
μL800 Buffer 10/6  
μL914 Dual Gate 10/6  
μL923 J.K. Flip-Flop 14/-  
I.C. Data Circuits, etc. 1/6

**MULLARD I.C. AMPLIFIERS**  
TAA243 ORP. Amp. 70/-  
TAA263 Min AF Amp. 18/6  
TAA293 G.P. Amp. 26/-  
RCA CA3020 Audio Amp. 30/-

**PRINTED CIRCUITS EX-COMPUTER**  
Packed with semiconductors and components, 10 boards give a guaranteed 30 trans and 30 diodes. Our price 10 boards 10/- Plus 2/- P. & P.

**SOLID STATE DIGITAL CLOCK**  
Price List of Components available FREE on request. S.A.E. PLEASE.

**SIL. G.P. DIODES**  
500mW 30 10/-  
25PIV (Min.) 100 25/-  
Sub-Min. 500 25/-  
Fully Tested 1,000 29/-  
Ideal for Organ Builders.



500 Chesham Hse.,  
150 Regent Street,  
LONDON W.1.

# KING OF THE PAKS BI-PAK GUARANTEE SATISFACTION OR MONEY BACK

VALUE ALL THE WAY

BI-PAK Semiconductors

## NEW! PORTABLE SOLID-STATE VOM

A thousand and one uses . . . plus lowest cost  
IM-17 Kit £13.12.0 pp.6/-



Solid state circuitry FET input. 4 Silicon transistor, 1 diode. 4 A.C. voltage ranges. 4 d.c. voltage ranges. 4 ohm ranges. 11M ohm input d.c. 1M ohm input on a.c. 4½ in. 200µA meter. Battery powered. Rugged Polypropylene case, self cover and handle. Space for storage of test leads. Easy circuit board construction.

Just right for the householder, hobbyist, boaters, model builders. Amateur radio den and TV service engineer.

## LATEST! PORTABLE STEREO RECORD PLAYER, SRP-1

Kit £28.6.0 incl. P.T. p.p. 10/6

Ready-to-Use £35.4.0 incl. P.T. p.p. 10/6



Automatic playing of 16, 33, 45 and 78 rpm records. All transistor—cool instant operation. Dual LP/78 stylus. Plays mono or stereo records. Suitcase portability. Detachable speaker enclosure for best stereo effect. Two 8in x 5in. special loudspeakers. For 220-250V a.c. mains operation. Overall cabinet size 15½ x 3½ x 10½in.

Compact, economical stereo and mono record playing for the whole Family—plays anything from the Beatles to Bartok. All solid-state circuitry gives room filling volume.

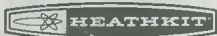

## ENJOY YOURSELF AND SAVE MONEY HEATHKIT for Britain's Best in Electronic kits

### INSTRUMENTS

**3" LOW-PRICED SERVICE OSCILLOSCOPE.** Model OS-2. Compact size 5" x 7¾" x 12" deep. Wt. only 9½lb. "Y" bandwidth 2Hz-3MHz ±3dB. Sensitivity 100mV/cm. T/B 20Hz-200kHz in four ranges, fitted mu-metal CRT Shield. Modern functional styling.

Kit £24.18.0 Ready-to-Use £32.18.0 p.p. 9/-

**5" GEN-PURPOSE OSCILLOSCOPE.** Model 10-12U. An outstanding model with professional specification and styling. "Y" bandwidth 3Hz-4.5 MHz ±3dB. T/B 10 Hz-500 kHz.

Kit £36.18.0 Ready-to-Use £46.16.0 p.p. 10/6

**DE LUXE LARGE-SCALE VALVE VOLT-METER.** Model IM-13U. Circuit and specification based on the well-known model V-7A but with many worth-while refinements. 6" Ernest Turner meter. Unique gimbal bracket allows operation of instrument in many positions. Modern styling.

Kit £22.8.0 Ready-to-Use £29.10.0 p.p. 7/6

**AUDIO SIGNAL GENERATOR.** Model AG-9U. 10 Hz to 100 kHz, switch selected. Distortion less than 0.1%, 10V sine wave output metered in volts and dB's.

Kit £28.0.0 Ready-to-Use £36.0.0 p.p. 7/6

**VALVE VOLTMETER.** Model V-7AU. 7 voltage ranges d.c. volts to 1,500. A.c. to 1,500 r.m.s. and 4,000 peak to peak. Resistance 0.1Ω to 1,000MΩ with internal battery. D.c. input resistance 11MΩ. dB measurement, has centre-zero scale. Complete with test prods, leads and standardising battery. Kit £14.16.0 Ready-to-Use £19.18.0 p.p. 4/6

**MULTIMETER.** Model MM-1U. Ranges 0-1.5V to 1,500V a.c. and d.c.; 150µA to 15A d.c.; 0.2Ω to 20MΩ. 4½" 50µA meter.

Kit £12.18.0 Ready-to-Use £18.12.0 p.p. 4/6

**R.F. SIGNAL GENERATOR Model RF-1U.** Up to 100 MHz fundamental and and 200 MHz on harmonics. Up to 100mV output.

Kit £13.18.0 Rdy-to-Use £20.8.0 p.p. 6/-

**SINE/SQUARE GENERATOR Model IG-82U.** Freq. range 20 Hz-1 MHz in 5 bands less than 0.5% sine wave dist. less than 0.15µ sec. sq. wave rise time.

Kit £25.16.0 Rdy-to-Use £37.16.0 p.p. 10/6

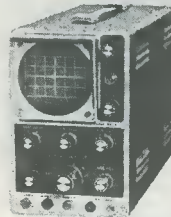

OS-2



IM-13U



V-7A



RF-1U

### Complete your motoring pleasure with this outstanding CAR RADIO, Model CR-1



pp. 4/6 8" x 5"

Will give you superb LW and MW entertainment wherever you drive. Tastefully styled to harmonise with any car colour scheme. Available for your convenience in two separate parts, RF Amp. Kit £11.15.0 incl. P.T. IF/AF Amp. Kit £11.3.6.

Total Price Kit (inc. Loudspeaker) £14.12.0 incl. P.T.

### TRANSISTOR RADIOS

**OXFORD LUXURY PORTABLE.** Model UXR-2. Specially designed for use as a domestic or personal portable receiver. Covers L. and M. Wave bands. 7 transistor, 3 diode, circuit. 7" x 4" loudspeaker for big set sound. Heathkit now offer choice of Brown or Black real leather case. Excellent value at only Kit £15.10.0 inc. P.T. p.p. 6/-

**TRANSISTOR PORTABLE, Model UXR-1.** Now available in modern colours or real leather case. 6 Transistor, 1 diode circuit for reliability. Pre-aligned I.F. transformers. Covers L.W. and M. Wave bands. 7" x 4" loudspeaker for generous sound. Case available in colours Navy Blue, Coral Pink, Lime Green or Brown Real Leather. Please state second choice. Kit £12.8.0 Colour incl. P.T. p.p. 4/6.

Kit £13.8.0 Real leather incl. P.T. p.p. 4/6.



UXR-2



UXR-1

### STEREO TRANSISTOR FM TUNER

(Mono version also available)

14 transistor, 5 diode circuit. Tuning range 88-108 MHz. Designed to match the AA-22U Amplifier. Available in separate units, can be built for a total price.

TFM-IS Kit (Stereo) £27.10.0 incl. P.T. p.p. 6/-



Cabinet extra £3.16.0

FM Tuner

### SEE HOW EASY-IT-IS TO BUILD ANY HEATHKIT MODEL YOURSELF

Full details of manual only purchase scheme in latest catalogue. Remember all Heathkit models are fully guaranteed.

### VISIT THE HEATHKIT CENTRES

GLOUCESTER Bristol Road Tel. 29451

LONDON 233 Tottenham Ct. Rd. Tel. 01-636 7349

BIRMINGHAM 17-18 St. Martin Hse, Bull Ring Tel. 021-643 4386

## LATEST! STEREO AMPLIFIER, TSA-12

12 x 12 watts output.

Kit **£32.16.0** less cabinet p.p. 10/6

Cabinet **£3.16.0** extra

Ready-to-Use **£39.10.0** less cabinet p.p. 10/6

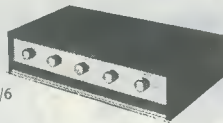

### FOR THIS SPECIFICATION

● 17 transistors, 6 diode circuit ●  $\pm 1$ dB, 16 to 50,000 Hz at 12 watts per channel into 8 ohms ● Output suitable for 8 or 15 ohm loudspeakers ● 3 stereo inputs for Gram, Radio and Aux. ● Modern low silhouette styling ● Attractive aluminium, golden anodised front panel ● Handsome assembled and finished walnut veneered cabinet available ● Matches Heathkit models TFM-1 and AFM-2 transistor tuners.

Full range power . . . over extremely wide frequency range. Special transformerless output circuitry. Adequately heat-sinked power transistors for cool operation—long life. 6 position source switch.

FULL SPECIFICATION SHEET AVAILABLE

## LATEST! STEREO TAPE RECORDER, STR-1

Fully portable—own speakers

Kit **£58.0.0** incl. P.T. p.p. 10/6

Ready-to-Use **£72.0.0** incl. P.T. p.p. 10/6

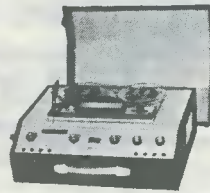

### FOR THIS SPECIFICATION

●  $\frac{1}{4}$  track stereo or mono record and playback at 7 $\frac{1}{2}$ , 3 $\frac{1}{2}$  and 1 $\frac{1}{2}$  ips ● Sound-on-sound and sound-with-sound capabilities ● Stereo record, stereo playback, mono record and playback on either channel ● 18 transistor circuit for cool, instant and dependable operation ● Moving coil record level indicator ● Digital counter with thumbwheel zero reset ● Stereo microphone and auxiliary inputs and controls, speaker/headphone and external amplifier outputs . . . front panel mounted for easy access ● Push-button controls for operational modes ● Built-in stereo power amplifier giving 4 watts rms per channel ● Two high efficiency 8" x 5" speakers ● Operates on 230V a.c. supply.

Versatile recording facilities. So easy to build—so easy to use.

FULL SPECIFICATION SHEET AVAILABLE

# WORLD LEADER IN QUALITY KITSETS

The instruction manual shows you how to build the model.



## SHORTWAVE 4 BAND RECEIVER, GR-64

Offers you the exciting world of Shortwave Covers 550 kHz to 30 MHz

incl. broadcast plus 3 SW bands. 4 valve superhet circuit plus 2 silicon rectifiers. Own 5" speaker. Illuminated 7" slide-rule dial with logging scale. Signal strength indicator.

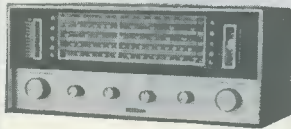

Variable BFO control. Built in AM rod antenna. Circuit Board construction. Headphone jack. Attractive charcoal grey cabinet with black dial panel with green/white markings. Assemble in a few hours. Hear live broadcasts from around the Globe.

Kit **£22.8.0** pp 9/- Ready to use **£29.8.0** pp 9/-

## "AMATEUR" EQUIPMENT

**THE "MOHICAN" GENERAL COVERAGE RECEIVER. Model GC-1U.** With 4 piezo-electric transfilters, variable tuned B.F.O. and Zener diode stabiliser, this is an excellent fully transistorised general purpose receiver for Amateur and Short wave listeners. Printed circuits, telescopic aerial, tuning meter and large slide-rule dial. Kit **£38.8.0** Ready-to-Use **£46.8.0** p.p. 10/6

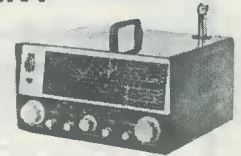

GC-1U

**AMATEUR BANDS RECEIVER. Model RA-1.** To cover all the Amateur Bands from 160-10 metres. Many special features, including: half-lattice crystal filter; 8 valves; signal strength "S" meter; tuned R.F. Amp. stage. Kit **£39.16.0** Ready-to-Use **£53.0.0** p.p. 9/-



RA-1

**160-10M TRANSMITTER. Model DX-100U.** Careful design has achieved high performance and stability. Completely self-contained. Kit **£95.0.0** Ready-to-Use **£120.0.0** p.p. 19/6

**COMMUNICATIONS TYPE RECEIVER. Model RG-1.** A high performance, low cost receiver for the discriminating listener. Frequency coverage: 600 kHz 1.5 MHz and 1.7 MHz-32 MHz.

Kit **£39.16.0** Ready-to-Use **£53.0.0** pp. 9/-

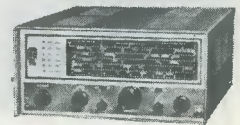

RG-1

## SPEAKER SYSTEMS

**HI-FI SPEAKER SYSTEM, Model SSU-1**  
Ducted-port bass reflex cabinet in the white: Two speakers, vertical or horizontal models with legs, Kit **£13.4.0** p.p. 7/6 without legs.

Set of 4 legs 7" or 15" (Please state length required) **16/-**, pp. 4/6.



SSU-1

## AVON MINI SPEAKER SYSTEM

6 $\frac{1}{2}$ " Bass, 3 $\frac{1}{2}$ " Treble speakers and crossover unit. Kit **£6.0.0** incl. P.T. Beautiful Walnut veneered fully-finished cabinet, **£9.8.0** Total price Kit **£15.8.0** incl. P.T. p.p. 10/6 Ready to use pp. 10/6

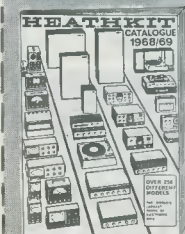
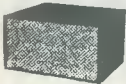

## FREE! NEW CATALOGUE

Describes these and many more kits and ready-to-use models for Stereo/Hi-Fi, Domestic Radio, Record Players, Tape Recorder, Amateur Radio, Shortwave, Test, Educational, Home and Hobby. Save money with Heathkit models. Mail coupon or write to Daystrom Ltd., Gloucester. Tel: 29451.

DAYSTROM LTD., Dept. RC 12  
GLOUCESTER Tel. 29451

Enclosed is £ \_\_\_\_\_, plus packing and carriage.

Please send model (s) \_\_\_\_\_

Please send FREE Heathkit Catalogue.

Name \_\_\_\_\_

(Please Print)

Address \_\_\_\_\_

City \_\_\_\_\_

Prices and specifications subject to change without notice.



# PACK BARGAINS

- 4 **FST3/8 STC** Sil. Rectifiers New & Marked 800piv 1½ Amp. Good substitute for BY100 etc. **13/-**
  - 4 **RAS310AF STC** Avalanche Rectifiers New & Marked 1200piv 1½ Amp 5A Surge rated. **20/-**
  - 6 **GJ4M** New & Marked AEL Germanium Rectifiers 50piv 1 Amp **10/-**
  - 4 **GP297/1** Sub. Miniature power transistors Texas New & Marked. **10/-**
  - 3 **ZF16 STC** New & Marked 16v 300mW Zener Diodes. **10/-**
  - 1 Pair of **AD161/AD162 NPN/PNP** Power Complementary Pair. **15/-**
  - 1 Pair of **AC128/AC176 NPN/PNP** Driver Complementary Pair. **10/-**
  - 1 Set **OC82D + 2 x OC82** Matched Pair New Mullard Marked. **10/-**
  - 4 **BSY95A STC** New & Marked Planar Transistors. **10/-**
  - 4 **BC108** Mullard Latest type Low noise planars New & Marked. **10/-**
  - 6 **NKT276** New & Marked Newmarket Audio General purpose transistor. **10/-**
  - 32 Square inches of "15" Matrix Veroboard—the most popular pack of all—only from LST. **10/-**
  - 4 **NKT162** New & Marked Newmarket Switching transistor. **10/-**
  - 2 **OC19** New & Marked Mullard Power Transistors. **10/-**
  - 5 **BA115** New & Marked Mullard Colour Television Diodes. **10/-**
  - 4 **2G371B** New & Marked Texas Audio Transistors. **10/-**
  - 4 **BYX38/600** Mullard New & Marked Power Studs 600piv 2½ Amp. **16/-**
  - 1 "Designers Guide to British Transistors" New data book with over 1000 types listed—Computer selected substitution chart. Just out from Publishers (Add 2/6d. this item post). **25/-**
- Postage and Packing by First Class Mail now 1/- minimum per order

**TIS43A**  
Equivalent  
2N3646 RE N3000  
**UNI-JUNCTION 6/9d**  
including data

**2N3819**  
Texas Field  
Effect Transistor  
**10/-**

**FAIRCHILD uLogic**  
1 6 7 12 12-  
uL900 Buffer 11 9 6 4 4  
uL914 Dual Gate 11 9 6 4 4  
uL923 JK Flip Flop 14 12 6 11 8  
5 Page data sheets 7 6d.

**TAA263** Linear  
Regulator  
1C **19/-**

**SCR1+2pc1S113**  
For P.C. Units  
Controller  
(July Issue) **10/5ct**

**BC107/8/9 2/9d**

**TD716** Tunnel  
Diode **12/-**

**SILICON RECT'S**  
FULLY TESTED  
GUARANTEED

PIV 200mA 750mA 2A 10A	
50 Ed. — 2/3 —	
100 Ed. 1/6 2/3 4 4	
200 1/3 2/3 — 2/8 8/	
400 2 2 8 4 8 8	
600 3 — 4 8 9 4	
800 — 3 8 8/ 11 2	
1,000 — — 8 14	

Post and Packing 8d  
Free Export Catalogues

## LOOKING FOR QUALITY, VALUE & SERVICE? Write for our catalogue price 1/6d



2N2925	6	AF116	4.8	GE113	6	OC82D	3/
2N2926	2.6	AF116	4.4	GE114	4/	OC83	4
2N2927	5/	AF117	4.4	GE116	4/	OC84	4
2N3703	5/	AF124	6/-	OA5	3 8	OC123	7
2N3704	5/	AF127	4/-	OA7	1 6	OC139	8
2N3705	5/	AF139	15/	OA70	1 6	OC150	12/
2N3706	4/6	AF239	12	OA79	1 6	OC169	6
2N3707	3/9	AF188	12/	2OA79M	4 6	OC170	4
2N3708	4/	AE211	10 8	OA81	1 6	OC211	6 6
2N3710	5/	AE12	11 9	OA85	1 6	OC200	6/
2N3711	5/	ASV27	5 8	OA90	1 6	OC201	10/
2N3953	4/	ASV28	4 4	OA91	1 6	OC202	18 4
2N3955	22/	ASV26	5 8	OA95	1 6	OC203	8/
2N3820	23/	ASV29	4 4	OA200	2	OC204	8/
2G301	4 9	ASZ21	11	OA202	2	OC205	8/
2G302	3 9	AT10	30/	OA210	6 4	OC206	10 6
2G306	6 9	AU110	39 6	OA211	9/	OC207	7 6
2G308	6 9	BA115	2 8	OA220	3 6	ORP12	3 6
2G309	10/	BC108	3	OA202	3	ORP80	8
2G328A	5/	BCY30	7/	OA208	2 8	ORP81	8
2G348B	3/	BCY31	8/	OA207	7/	ORP82	8/
2G371B	4/	BCY32	16/	OA208	3 6	ORP93	18/
2G374B	5/	BCY33	4 8	OA221	3 6	SK831	2 7/
2G382	6/-	BCY34	8 4	OA242	3 6	SK838	10 8
2S002	6/	BCY38	8	OA243	6	SK838	12/-
2S017	8/	BCY39	27 4	OA244	3 6	SK831	2 7/
2S018	8 6	BCY40	13 4	OA269	3 6	SZ200	18/
2S024	45/	BCY54	15 2	OA270	3 6	SV1	6/
2S027	28/	BCY70	4 4	OC19	3 6	VA05A	9 3
2S102	15/	BCY71	8/	OC20	33/	VC401	5/
2N697	8/	AAV11	10 8	OC22	13/	VC402	5/
2N706	4/	AAV11	10 8	OC23	13/	VC402	5/
2N706A	6 6	AAV30	2/	BD21	28 8	VC402	5/
2N711	7 8	AC126	6 6	BF13	14 6	VC402	5/
2N1131	9 6	AC127	6 6	BF184	2 6	VC402	5/
2N1132	7 6	AC128	6 6	BF184	2 6	VC402	5/
2N1303	5/	AL197	12/	BF184	2 6	VC402	5/
2N1304	5/	AL197	12/	BF184	2 6	VC402	5/
2N1305	5/	AL197	12/	BF184	2 6	VC402	5/
2N1306	5/	AL197	12/	BF184	2 6	VC402	5/
2N1307	5/	AL197	12/	BF184	2 6	VC402	5/
2N1308	10 6	ACV20	3 6	BF184	2 6	VC402	5/
2N1613	12/	ACV22	2 4	BF184	2 6	VC402	5/
2N2368	8 6	AD140	12 8	BF184	2 6	VC402	5/
2N2369	5 8	AD149	11 8	BF184	2 6	VC402	5/
2N2368A	10	AD181	7 6	BF184	2 6	VC402	5/
2N2447	17	AD211	21/	BF184	2 6	VC402	5/
2N2448	12/	AD212	23 4	BF184	2 6	VC402	5/
2N2100	14 9	AF102	18/	BF184	2 6	VC402	5/
		AF114	4 6	GE103	4 6	OC82	4 6

**LST COMPONENTS**  
7 COPTFOLD ROAD  
BRENTWOOD ESSEX  
BRENTWOOD 7904  
24 HOUR POSTAL SERVICE

PLEASE SEND 1968 CATALOGUE TO:  
(Block Capitals)  
I ENCLOSE 1/6 STAMPS  
NAME \_\_\_\_\_  
ADDRESS \_\_\_\_\_  
\_\_\_\_\_ (RC4)

## A BRILLIANT NEW HI-FI MONO/STEREO TUNER FROM TRS



This advanced design FM tuner comes in easy-to-assemble prefabricated units engineered to the highest standards of efficiency and performance. Valuable refinements include switchable A.F.C., automatic noise suppression, flywheel tuning, excellent audio response. Sensitivity better than 5 microvolts. Stereo can be added as required. Gorrer I.F. amplifier. Styled to match the TRS Stereo 4-4. S.A.E. brings full details.  
Kit to make MONO tuner inc. chassis and tuning assembly. **15 gns.** (p. & p. 3/6)

Add-on T.R.S. Stereo Multiplex Unit for mounting within cabinet and indicating light **10 gns.** (p. & p. 2/6). T.R.S. Power Unit for incorporating within cabinet **£2.50** (p. & p. 2/6). T.R.S. Simplex Cabinet to house Tuner Assembly as required **£1.17 6** (p. & p. 2/6). Total price (for mains operation) **£29.10.0** (carr. 10/-)



### TRS Stereo 4-4

Based on newest Mullard Modules, with BC.108 pre-amp, this well designed product of T.R.S. offers excellent kit value with good appearance and performance. Suitable for speakers from 3 to 15 ohms. Bass and treble cut/boost. Response—60 to 14KHz ±3dB. Requires only wiring between controls and modules. Complete with metal chassis and simplex teak-ended cabinet for instant assembly. Stereo/Mono and Radio/P.U. switches. Styled to match TRS FM Tuner described in this ad. **£19.80** (p. & p. 3/6).

T.R.S. Power Unit **£2.50** (p. & p. 2/6). T.R.S. Simplex Cabinet **£1.17 6** (p. & p. 2/6). 4 prs DIN plugs and sockets if purchased separately **15/-**. Complete kit inc. cabinet/power pak/DIN plugs and sockets **£12.10.0** (post free).

### Make a bookshelf speaker

Matched speaker assembly comprising special 5 in. base unit, cross-over and 2½ in. tweeter. Loads easily up to 6 watts. Response 80-20,000 Her Complete **79/6** (P. & P. 5/-).

**ORDERING**—Send cash with order. Post and packing where not stated add 1/- per ½ lb.; 1/9 1 lb.; 3/6 2 lb.; 5/- 6 lb.; 6/6 10 lb.; 8/- 14 lb.; over 10/- S.A.E. with enquiries please.

**LISTS**—Eight large printed pages packed with bargain offers. Send 6d. for latest copy.

## PLAYING UNITS

LM3000 Record Player with 9T.A. Stereo Cartridge. **£10.5.0**

AT.60 Mk. II De-Luxe Auto-changer die-cast turntable. Less cartridge. **£13.5.0**

SP.25 De-Luxe single record player, die-cast turntable. Less cartridge. **£11.9.6**

Brand new in makers' carton. Packing and carriage paid on any one of above 7/6.

GARRARD PLINTH WB.1. In fine Teak for any of above units. (Packing and carriage 5/-). 65/- GARRARD clear-view rigid perspex cover (carriage 4/6). 62/6.

CARTRIDGE FOR ABOVE Stereo Sonotone 9TA/HC Ceramic with diamond 49/6; Decca Deram with diamond 82/6; Mono Acos GP91-1 21/-; Goldring MX2M 26/6.

EMI 4 speed single player. 10½ in. T/table with separate arm and T/O cartridge 69/6 (p. & p. 5/-).

## TRS-MULLARD VALVE AMPS

Stereo 10+10 Passive control network, tapped O/P transformer, phase switch etc. etc. Built **£21.0.0** Kit, complete, **£17.10.0** (p. & p. either model 7/6); 2 + 2 Stereo Pre-amp Built 13 gns. (p. & p. 7/6).

3 + 3 Mono amp Ready built **£9.19.6** Kit **£7.12.6** (p. & p. either model 7/6).

5-10 Mono amp Basic kit **£9.19.6** With control panel **£11.19.6** Built **£14.19.6** Pre-amp for basic 5-10 kit **£6.12.6** Built **£8.10.0** (p. & p. any of above, each 7/6).

Always in stock—full ranges of resistors and capacitors, all types, accessories, transistors, valves, materials etc., etc. See latest list.

## TAPE OPPORTUNITY

With each reel of this professional quality full frequency tape with metallised leader/stop foils we give a full library wallet in simulated leather to hold 2 reels. 7 in. reel 1800 ft. with wallet. **22/6**  
5 in. reel 9000 ft. with wallet. **12/6**  
5½ in. reel 1200 ft. or 7 in. reel 1200 ft. with wallet. **17/6** P. & P. 1/6 per reel

## TRS RADIO COMPONENT SPECIALISTS

EST. 1946

70 BRIGSTOCK ROAD, THORNTON HEATH, SURREY  
Telephone: 9 a.m.—6 p.m. daily A few doors from Thornton  
01—684 2188 1 p.m. Weds. Heath Stn. (S.R. Victoria Section)

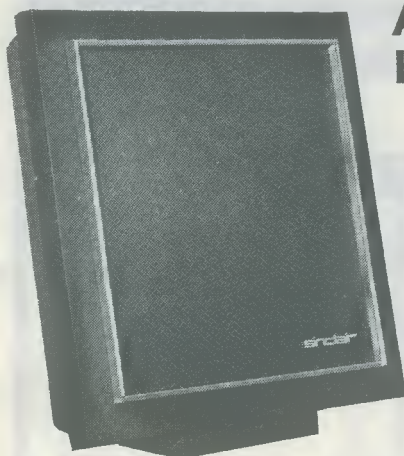

## A NO-COMPROMISE HIGH-FIDELITY LOUDSPEAKER

Listen to a Q.14. Hear it in your own home. It is the result of long and thorough investigation into speaker design in order to produce one which would outperform anything within pounds of its price. How far we have succeeded can be seen from the independently taken test report which compares excellently with loudspeakers over four times the price. The Sinclair Q.14 is uncommonly versatile, too. It can serve as a free-standing unit for bookshelf, etc., as a corner radiator, or be flush mounted in a multi-unit assembly. Power handling capacity is in excess of 14 Watts with remarkably smooth response between 60 and 16,000 c/s. Size  $9\frac{3}{8}$ " square x  $4\frac{3}{8}$ " deep. In black matt finish with solid aluminium bar embellishment and detachable plinth base. Impedance—8 ohms.

**SINCLAIR**  
**Q.14**

TRY IT IN YOUR OWN HOME—MONEY (INC. POSTAGE) REFUNDED IF NOT SATISFIED

**£7.19.6**



## SINCLAIR MICROMATIC PRICE REDUCED

With sales and export orders for the Sinclair Micromatic breaking all records, we have changed over to new production methods to meet the ever-increasing demand for the world's smallest radio set. This has enabled us to effect dramatic economies in production costs. At the same time, we have appreciably improved the set's quality by supplying a magnetic earpiece with it, and what was superb performance before, now sounds better than ever. At the new prices, everyone is going to want the Micromatic. Order yours now for prompt delivery.

Kit complete with magnetic earpiece, solder and instructions, originally 59/6, now

**49'6**

Post Paid

Ready built with magnetic earpiece, originally 79/6 now

**59'6**

Post Paid

2 Mercury Cell long life batteries for either of above, each, 2/9d.

- $1\frac{4}{5} \times 1\frac{3}{10} \times \frac{1}{2}$ "
- Plays anywhere
- M.W., A.G.C. and Bandpass
- Kit or Built

## SINCLAIR Z.12 12 WATT INTEGRATED HI-FI AMPLIFIER AND PRE-AMP

- Size  $3" \times 1\frac{3}{8}" \times 1\frac{1}{8}"$ .
- 8 special HF transistors.
- Ultra-linear class B output and generous neg. feedback.
- Response—15 to 50,000 c/s  $\pm 1$ dB.
- Output suitable for 3, 7.5 and 15 ohm loads. Two 3 ohm speakers may be used in parallel.
- Input—2mV into 2K ohms.
- Signal to noise ratio—better than 60dB.

USE IT FOR HI-FI, RADIO, MUSICAL INSTRUMENTS, INTERCOM, P.A., etc.

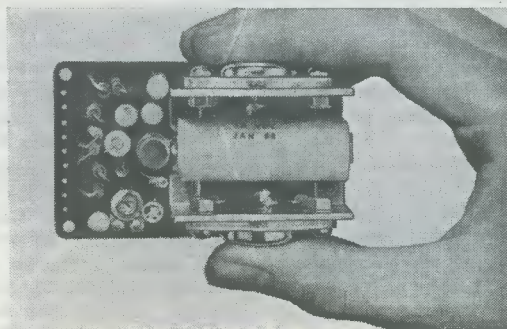

## SINCLAIR STEREO 25

Pre-amp/Control Unit for two Z.12s in stereo, built.

**£9.19.6**

## SINCLAIR PZ.4

Stabilised Heavy Duty Mains Power Unit. Delivers 18V. d.c. at 1.5 amp.

**99/6**

Ready built, tested & guaranteed with Z.12 manual

**89'6**

- 12 watt RMS continuous sine wave
- Ideal for battery operation

**GUARANTEE** If you are not completely satisfied when you receive your purchase from us, your money will be refunded at once, in full and without question.

SINCLAIR RADIONICS LTD., 22 NEWMARKET ROAD, CAMBRIDGE

Please send

NAME

ADDRESS

for which I enclose cash/cheque/money order value £.....s.....d.....

RC12

**sinclair**

**SINCLAIR RADIONICS LIMITED**  
22 NEWMARKET RD., CAMBRIDGE

Telephone OCA3 52996

# DENCO (CLACTON) LIMITED.

355-7-9 OLD ROAD, CLACTON-ON-SEA, ESSEX

Our components are chosen by Technical Authors and Constructors throughout the World for their performance and reliability, every coil being inspected twice, plus a final test and near spot-on alignment as a final check.

Our General Catalogue showing full product range	..	..	..	2s. 6d.
DTB4 Transistor & Valve circuitry for D.P. Coils	..	..	..	2s. 6d.
DTB9 Valve Type Coil Pack Application circuitry	..	..	..	2s. 6d.
MD.1 Decoder Circuitry for Stereo Reception	..	..	..	4s. 0d.

All post paid, but please enclose S.A.E. with all other requests in the interests of retaining lowest possible prices to actual consumers.

## THE MODERN BOOK CO

**Television Engineers' Pocket Book.** By J. P. Hawker and J. A. Reddihough. **21s.** *Postage 1s.*

**ABC's of Electrical Soldering.** By L. M. Dezettel. **18s.** *Postage 1s.*

**The Electronic Musical Instrument Manual.** By A. Douglas. **55s.** *Postage 1s. 6d.*

**Solution of Problems in Electronics and Telecommunication.** By C. S. Henson. **38s.** *Postage 2s.*

**Elementary Telecommunication Principles.** By R. N. Renton. **30s.** *Postage 2s.*

**FET Circuits.** By R. P. Turner. **25s.** *Postage 1s.*

**RCA Hobby Circuits Manual.** **17s. 6d.** *Postage 1s.*

**Q and A Radio and Television.** By R. W. Hellyer. **8s. 6d.** *Postage 9d.*

**Electronics Pocket Book.** By J. P. Hawker and J. A. Reddihough. **21s.** *Postage 1s.*

**Radio Valve Data.** Compiled "WW" 8th Ed. **9s. 6d.** *Postage 1s.*

**Transistor Substitution Handbook No. 8.** **16s.** *Postage 1s.*

**Electrical and Electronic Signs and Symbols.** By R. G. Middleton. **30s.** *Postage 1s.*

**Hi-Fi in the Home.** By J. Crabbe. **40s.** *Postage 2s.*

**The Radio Amateur's V.H.F. Manual.** **28s. 6d.** *Postage 2s.*

**The A.R.R.L. Antenna Book.** **28s. 6d.** *Postage 2s.*

**Outline of Radio and Television.** By J. P. Hawker. **30s.** *Postage 2s. 6d.*

**Mathematics for Radio and Electronics Technicians.** By Dr. Inf F. Bergtold. **50s.** *Postage 2s.*

**Inter G.E.C. Transistor Manual 7th Ed.** **21s.** *Postage 2s.*

**T.V. Fault Finding 405/625 lines.** A Data Pub. No. 5. **8s. 6d.** *Postage 9d.*

**Understanding Digital Computers.** By R. M. Benrey. **16s.** *Postage 1s.*

New Catalogue 2s. 0d.

We have the Finest Selection of English and American Radio Books in the Country

**19-21 PRAED STREET (Dept RC) LONDON W2**

Telephone PADdington 4185



# BI-PRE-PAK LIMITED

## TRANSISTORS PRICE

AC107	3/-	OC170	3/-
AC126	2/4	OC171	4/-
AC127	2/4	OC200	3/6
AC128	2/4	OC201	7/-
ACY17	3/-	2G301	2/6
AF114	4/-	2G303	2/6
AF115	3/6	2N711	10/-
AF116	3/6	2N1302-3	4/-
AF117	3/6	2N1304-5	5/-
AF118	3/6	2N1306-7	6/-
AF186	10/-	2N1308-9	8/-
AF139	10/-	2N3844A	5/-
AF239	12/6	<b>Power Transistors</b>	
BFY50	4/-	OC20	10/-
BSY25	7/6	OC23	10/-
BSY26	3/-	OC25	8/-
BSY27	3/-	OC26	5/-
BSY28	3/-	OC28	7/6
BSY29	3/-	OC35	5/-
BSY95A	2/6	OC36	7/6
OC41	2/6	AD149	10/-
OC44	1/11	AUY10	30/-
OC45	1/9	<b>Diodes</b>	
OC71	2/6	AAV42	2/-
OC72	2/6	OA95	2/-
OC73	3/6	OA70	1/9
OC81	2/6	OA79	1/9
OC81D	2/6	OA81	1/9
OC83	2/6	OA73	2/-
OC139	2/6	IN914	1/6
OC140	3/6		

## SPECIAL OFFER!!

Exclusive to *Radio Constructor* readers

### ELECTRONIC DIGITAL CLOCK PAK CL1

This pack is approved by the author of the project, in this issue.

This pack consists of all the Semi-conductors needed to build the Digital Clock.

Contents:

- 110 Silicon Transistors
- 1 OC36 Power Transistor
- 132 Silicon Diodes
- 1 Zener Diode

*All the Components are tested and fully guaranteed*

**PAK CL.1. All this for only**

N.B.—Please add 1/- post and packing with order. We very much regret that the "Free Choice" offer is suspended with this pak.

## PRE-PAKS

Selection from our lists

No.	Description	Price
B1	50 Unmarked Trans. Untested	- 10/-
B2	4 Photo Cells Inc. Book of Instructions	- 10/-
B6	17 Red Spot AF Transistors	- 10/-
B6A	17 White Spot RF Transistors	- 10/-
B9	1 ORP 12 Light Sensitive Cell	- 9/-
B53	25 Sil. Trans. 400 Mc/s Brand New	- 10/-
B54	40 " " NPN to 5 Trans Voltage	- 10/-
B55	" " NPNT to 18 & Gain Fallouts	- 10/-
B56	" " NPN/PNP All Tested	- 10/-
B68	10 Top Hat Recs. 750 M/A 100-800 PIV	- 10/-
B69	20 Diodes. Gld-Bnd. Germ Sil. Planer	- 10/-
B74	5 Gld-Bnd. Diodes. 2-OA9, 3-OA5	- 10/-
B75	3 Comp. Set. 2G371, 2G381, 2G339A	- 10/-
C2	1 Unijunction Transistor 2N2160	- 15/-
C32	6 Top Hat Recs. IS100 Type	- 15/-
C35	3 Unijunction Trans. = to 2N2160	- 15/-
A1	7 Silicon Rectifiers BY100 Type	- 20/-
A3	25 Mixed Marked and Tested Transistors	- 20/-
A21	5 Power Transistors 1-AD149/1-OC26 and 3 others	- 20/-

AND MANY MORE

# FREE!

PACKS OF YOUR OWN CHOICE UP TO THE VALUE OF 10/- WITH ORDERS OVER £4

## TRANSISTORS ONLY 1/- EACH

SILICON • PLANAR • N.P.N. • P.N.P.

All these types available

2N929 2N706 2S131 2S103 2N696 2N1613 2S733 BFY10  
 2S501 2N706A 2S512 2S104 2N697 2N1711 2N726 2S731  
 BC108 2N3011 2S102 2N2220 2N1507 2N1893 2N2484 2S732

All tested and guaranteed transistors—unmarked.  
 Manufacturers over runs for the new PRE-PAK range.

### NEW UNMARKED UNTESTED PAKS

25	BSY95A NPN Silicon	TRANSISTORS 10/-
10	OC45—OC81 Mull. Glass Type	TRANSISTORS 10/-
25	BSY26-27 NPN Silicon	TRANSISTORS 10/-
10	10 Watt Silicon All Voltages	ZENERS 10/-
25	BFY50-1-2 NPN Silicon	TRANSISTORS 10/-
10	4 amp. Stud. Silicon	RECTIFIERS 10/-
25	BC107-8-9 NPN Silicon	TRANSISTORS 10/-
40	1N914-6 OA200/202 Sub. Min. Silicon	DIODES 10/-
150	Min. Germ. High Quality	DIODES 10/-
25	2N706 A NPN Silicon	TRANSISTORS 10/-

PRE-PAK. N.605 POWER TRANSISTOR EQUIVALENT TO NKT301-2-3-4 **5/- each**

COMPLEMENTARY SET NPN/PNP GERM. TRANS. **pair 2/6**

## BRAND NEW PAK !!! JUST RELEASED !!!

REPLACES OUR VERY POPULAR B39 PAK  
 Short Lead Components, all Brand New and Factory Marked, mounted on Printed Circuit Panels.

Approximately:

80 TRANSISTORS AND DIODES **10/-**  
 50 HIGH TOLERANCE RESISTORS  
 20 VARIOUS CAPACITORS

Please state when ordering Pak. P.1. 2/6 Post and Packing with this pak.

Make a Rev. Counter for your Car. The "TACHO BLOCK". This encapsulated block will turn any 0-1mA meter into a perfectly linear and accurate rev. counter for any car. State 4 or 6 cylinder. **20/- each**

FREE CATALOGUE AND LISTS for:—

ZENER DIODES  
 TRANSISTORS, RECTIFIERS  
 FULL PRE-PAK LISTS  
 & SUBSTITUTION CHART

MINIMUM ORDER 10/- CASH WITH ORDER PLEASE. Add 1/- post and packing per order. OVERSEAS ADD EXTRA FOR AIRMAIL.

THERE IS ONLY ONE  
**BI-PRE-PAK LTD**  
 BEWARE OF IMITATIONS

**FIRST EVER LOGIC KITS**

Learn for yourself how computers work, even make one for yourself. Full instructions for a noughts and crosses machine, binary counters, timers, etc. L1 5gns. L2 10gns. Introducing the Norkit range. Norkit Junior £8. Norkit Senior £16.

**Details Free**  
 Free Paks suspended with Logic Kit Orders.

FREE! A WRITTEN GUARANTEE WITH ALL OUR SEMICONDUCTORS

**BI-PRE-PAK LTD** DEPT. A, 222-224 WEST ROAD, WESTCLIFF-ON-SEA, ESSEX  
 TELEPHONE: SOUTHEND (0702) 46344

# STEAM OR SOLID STATE

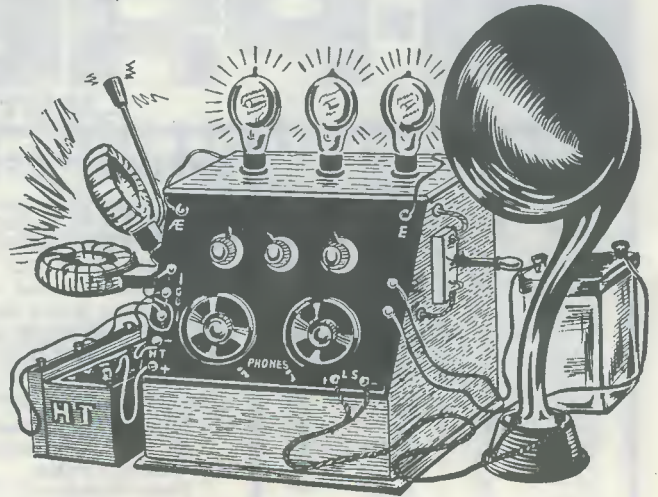

*you  
need the*

## HOME RADIO CATALOGUE

If your interest lies in *last* year's gear, or *next* year's... if you go for transmitting, receiving, reproducing, or the lot... if you're working on a tight budget, or an elastic one... the HOME RADIO Components Catalogue is a MUST! In its 256 pages, listing over 7,000 items (more than 1,300 of them illustrated) you can track down any component you're ever likely to need. At 7s. 6d., plus 3s. p. and p., it's the best ever bumper book... and every copy contains 5 vouchers, each worth a shilling when used as directed. Send the coupon now with your cheque or P.O. for 10s. 6d. *It'll be the best Christmas gift you've ever given yourself.*

**A Merry  
Christmas**  
*to all our  
Readers !*

*Please write your Name and Address in block capitals*

NAME .....

ADDRESS .....

Home Radio (Mitcham) Ltd., Dept. RC, 187 London Rd.,  
Mitcham CR4 2YQ



Vol. 22 No. 5

Published Monthly (1st of Month)  
First Published 1947

Editorial and Advertising Offices  
57 MAIDA VALE LONDON W9

Telephone CUNningham 6141  
Telegrams Databux, London

© Data Publications Ltd., 1968. Contents may only be reproduced after obtaining prior permission from the Editor. Short abstracts or references are allowable provided acknowledgement of source is given.

**Annual Subscription** 42s. (U.S.A. and Canada \$5) including postage. Remittances should be made payable to "Data Publications Ltd". Overseas readers please pay by cheque or International Money Order.

**Queries.** We regret that we are unable to answer queries other than those arising from articles appearing in this magazine nor can we advise on modifications to equipment described. Queries should be submitted in writing and accompanied by a stamped addressed envelope for reply.

**Correspondence** should be addressed to the Editor, Advertising Manager, Subscription Manager or the Publishers as appropriate.

**Opinions** expressed by contributors are not necessarily those of the Editor or proprietors.

**Production.**—Lithography.

The *Radio Constructor* is printed by Allens Printers (Wales) Ltd., Apex Works, Pontywindy Industrial Estate, Caerphilly in conjunction with Godfrey Lang Ltd. London Office: Cliffords Inn, Fleet Street, London EC4

DECEMBER 1968

3-Band Self-Powered Preselector	282
<i>by L. Saxham</i>	
Thyristor Alarm Switch	289
(Suggested Circuit No. 217)	
<i>by G. A. French</i>	
News and Comment	292
Wideband A.C. Millivoltmeter	294
<i>by C. Crosbie</i>	
Radio Constructor Data Sheet No. 18	297
(Wire Resistance and Current Table)	
Radio Constructors Data Sheet Index 1968	298
Can Anyone Help?	301
Reflex-3 Portable Receiver	302
<i>by Arman Sapciyan</i>	
Christmas Water Fountain	304
<i>by D. P. Newton</i>	
Crossword	305
<i>by W. M. Fraser</i>	
Solid-State Digital Clock, Part 1	306
<i>by A. J. Ewins</i>	
Crossword Solution	312
Wide-Band Oscilloscope Amplifier	313
<i>by G. Sowersby</i>	
Suggestions For Your 'Easy -View' Diary	314
The Radio Constructor's 'Easy-View' Diary	315
(First Quarter 1969)	
150 Watt Amateur Bands Transmitter, Part 2	318
<i>by F. G. Rayer, G3OGR</i>	
Understanding Radio	322
(Superhet Detector and A.G.C.)	
<i>by W. G. Morley</i>	
In Your Workshop	326
Radio Topics	331
<i>by Recorder</i>	
	281



## 3-BAND SELF-POWERED PRESELECTOR

by L. SAXHAM

**This is the latest article in the series we have been publishing describing the construction of communication receiver ancillary equipment housed in Eddystone Diecast boxes. Previous articles in the series were "Aerial Tuner Unit" (August 1968) and "Q Multiplier" (September 1968)**

**T**HE PRESELECTOR UNIT ABOUT TO BE DESCRIBED WAS designed and constructed to match the other receiver ancillary equipments as mentioned in the introduction to this article and to function with a Trio 9R-59D communications receiver. The unit will, however, operate satisfactorily with any communications receiver and the circuit design is fairly standard, having no frills or "trick" circuitry.

As may be seen from the illustrations, the layout is quite compact. Because of this, construction of the preselector is not recommended for the beginner unless he is confident of undertaking the rather "close" work that is involved, both when dealing with the drilling and physical measurements and the wiring-up of the components. A slightly wrong measurement, or an untidy or wrongly

routed wire, could result in a short-circuit to the outer metal casing. Nevertheless, provided the instructions are closely followed no trouble will be experienced by the average constructor.

A self-powered design was decided upon as it was considered unwise, in the writer's circumstances, to run the unit from the receiver supplies—the Q-Multiplier described in a previous article being already supplied in this manner. In order not to run the receiver power supply near its maximum it was necessary therefore to include a power supply as an integral part of the preselector. Where adequate power supplies are available from the receiver, or a separate power supply is available, the beginner could well undertake the construction of the tuned r.f. stage part only, the design then being less compact and easier to assemble.

**Resistors**

(All fixed values 10%)

- R<sub>1</sub> 33kΩ ½ watt
- R<sub>2</sub> 5.6kΩ 1 watt
- R<sub>3</sub> 10kΩ 2 watt
- R<sub>4</sub> 47Ω ¼ watt
- R<sub>5</sub> 5kΩ pot. lin
- R<sub>6</sub> 5.6kΩ ¼ watt
- R<sub>7</sub> 6.8kΩ 2 watt

**Valve**

EF183 (Mullard)

**Valveholder**

B9A (ceramic with centre spigot)

**Chassis**

6½ x 2¼ x 1½ in  
(L-shaped, front apron only)  
(H. L. Smith & Co. Ltd.)

**Knobs**

Spun aluminium  
(H. L. Smith & Co. Ltd.)

**Dial and Drive**

6:1 Slow Motion Drive, Part No. 4489, Jackson Bros. Ltd. (Home Radio Ltd. Cat No. DL3A)

**Capacitors**

(All fixed capacitors 350V wkg.)

- C<sub>1</sub> 365pF variable, Jackson Bros. type 01, (H. L. Smith & Co. Ltd.)
- C<sub>2</sub> 0.1μF, tubular
- C<sub>3</sub> 0.1μF, tubular
- C<sub>4</sub> 100pF silver mica
- C<sub>5</sub> 0.01μF, tubular
- C<sub>6</sub> 100pF silver mica

C<sub>7</sub> 16μF, electrolytic, TCC type CE118LC, Home Radio Cat. No. 2CK13

C<sub>8</sub> 8μF, electrolytic, TCC type CE112LC, Home Radio Cat. No. 2CK07

**Tagstrips**

See text

**Metal Rectifier**

Contact-cooled, 250V, 50mA

**Mains Transformer**

250V, 60mA; 6.3V, 1.5A. Type 6BR10, (H. L. Smith & Co. Ltd.)

**Panel Lamp Assembly**

Type LES (Red), 6.5V, 0.15A (H. L. Smith & Co. Ltd.)

**R.F. Choke**

2.5mH type CH1 (H. L. Smith & Co. Ltd.)

**Coils**

Miniature Dual-Purpose Blue (Denco Ltd.)

Range 5 (32 to 10.2 Mc/s)

Range 4 (15.5 to 3.5 Mc/s) see text

Range 3 (4.6 to 1.25 Mc/s) re coverage

**Switches**

S<sub>1</sub> 1-pole 3-way, rotary

S<sub>2(a)·(b)</sub> 2-pole 3-way, miniature rotary

**Die-Cast Box**

Eddystone, type 6357P (Home Radio Cat. No. E903)

**Miscellaneous**

4BA and 6BA nuts and bolts, 6 off ⅜ in rubber grommets, solder, wire, coaxial cable (75Ω), Panel Sign transfers Set No. 3.

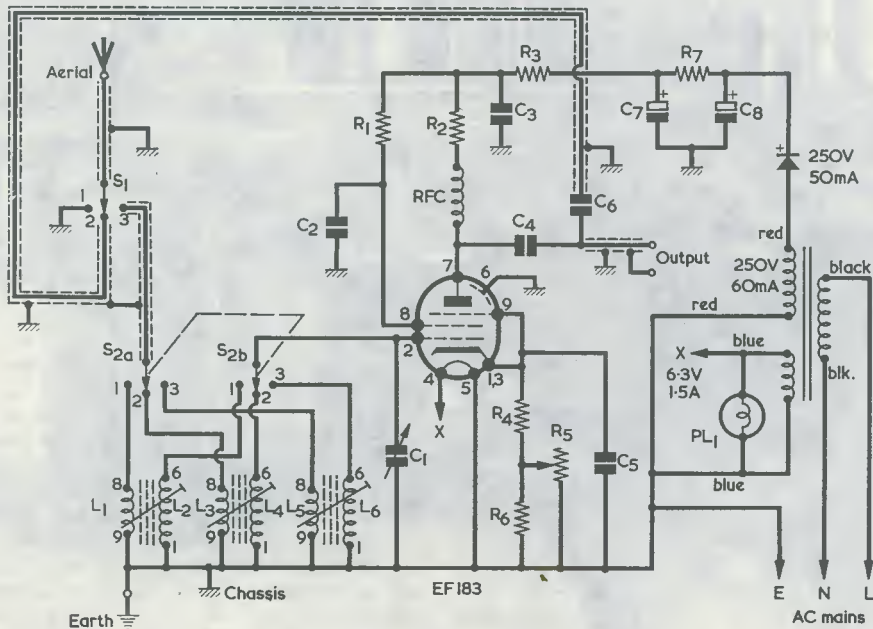

Fig. 1. Circuit of the 3-Band self-powered Preselector

As shown, the pre-selector incorporates three bands although this could be subject to some variation according to individual preferences. In the prototype, Band 1 covers from 32 to 10.2 Mc/s; Band 2 from 15.5 to 3.5 Mc/s and Band 3 from 4.6 to 1.25 Mc/s. It will be seen that there is quite a degree of frequency overlap between bands, which the writer prefers. This overlap is occasioned by the fact that a 365pF variable capacitor is used in conjunction with the Denco Miniature Dual Purpose coils (Blue, Ranges 3, 4 and 5) whilst the recommended variable capacitor for the coil is 300pF nominal. The resultant frequency coverage in each band is therefore larger, by virtue of the additional 65pF, than that specified by the manufacturer. The coil inductances have an average frequency variation of  $\pm 15\%$  obtainable by core adjustment and constructors may therefore vary the coverage, within these limits, according to individual requirements.

#### CIRCUIT

The circuit diagram is shown in Fig. 1 and, in this, it will be seen that the aerial input is fed direct to the arm of switch  $S_1$ . The inclusion of this switch enables the operator to (1) short-circuit the aerial to chassis—this being a useful facility when using a crystal standard; (2) bypass the preselector and feed the aerial input direct to the receiver input terminals via  $C_6$ ; and (3) feed the aerial directly into the preselector circuit.

Where a crystal frequency standard is in use, its output should be fed to tags 2 and 3 of the switch. With  $S_1$  set to position 1, it will be found that the markers from the standard are extremely easy to locate due to the elimination

of signals from the aerial which otherwise cause heterodyne beats, particularly when the b.f.o. is also in use for the purpose of locating the frequency marker points. Where the marker points are weakest, usually towards the 30 Mc/s end, the preselector may be employed to boost the marker output.

When checking these points with the prototype, the crystal marker output was temporarily clipped to tags 2 and 3 of  $S_1$ , as appropriate. If a more permanent method of connection is required, screened leads may be run from tags 2 and 3 and coupled externally to the crystal marker output when required. It is important to note that stray capacitive coupling between any wiring from tags 2 and 3 must be kept to a minimum as there will otherwise be feedback from output to input when the preselector function is switched in.

Selecting position 2 of  $S_1$  enables the aerial to be fed direct to the receiver without amplification by the preselector. This position may be used when the receiver is operating at frequencies other than those covered by the preselector and its availability obviates the continual connection and disconnection of aerial and preselector plugs at the back of the receiver which would otherwise be required. It is sometimes beneficial, also, to select position 2 when receiving strong signals within the preselector coverage, as can occur on the 80 and 160 metres amateur bands.

Screened leads (coaxial cable is suitable) *must* be used for the connections to tags 2 and 3 of  $S_1$ . The braiding of these leads must be earthed at both ends. The aerial input lead is screened and its braiding must be earthed at  $S_1$ .

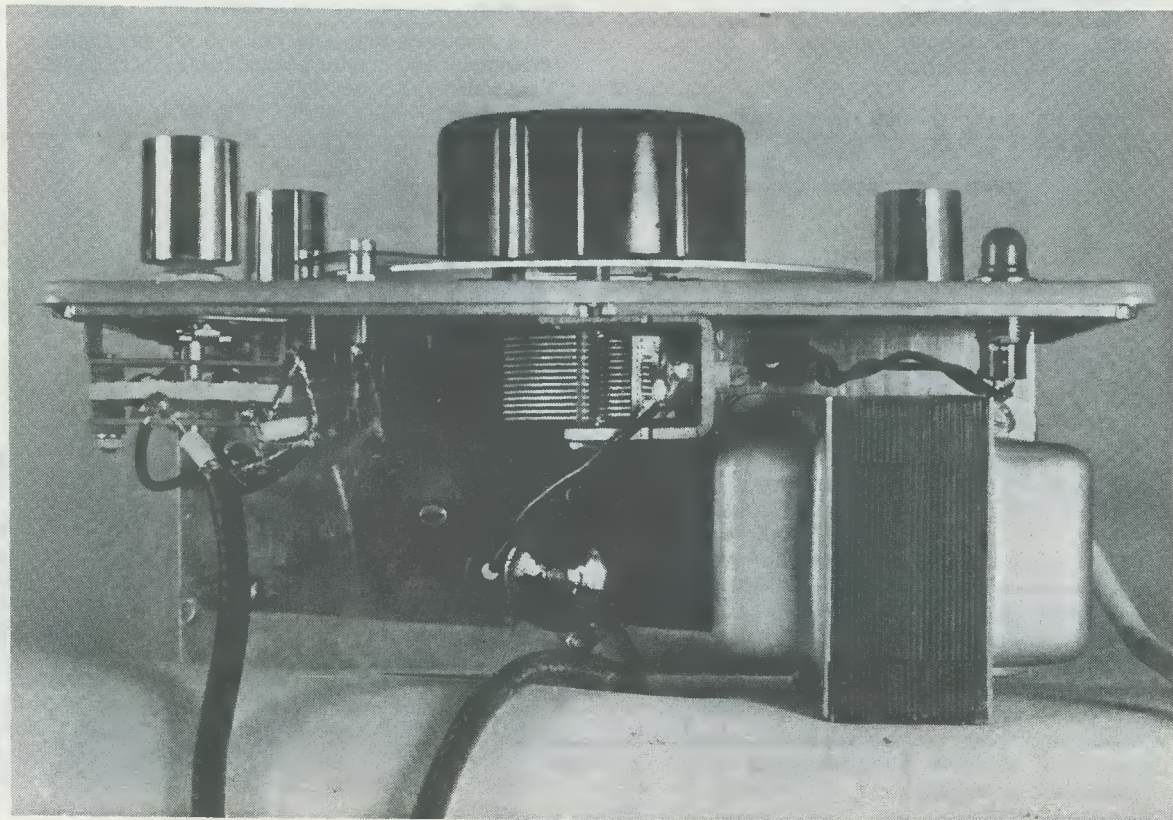

Above-chassis view of the pre-selector. Note the positioning of the variable capacitor  $C_1$

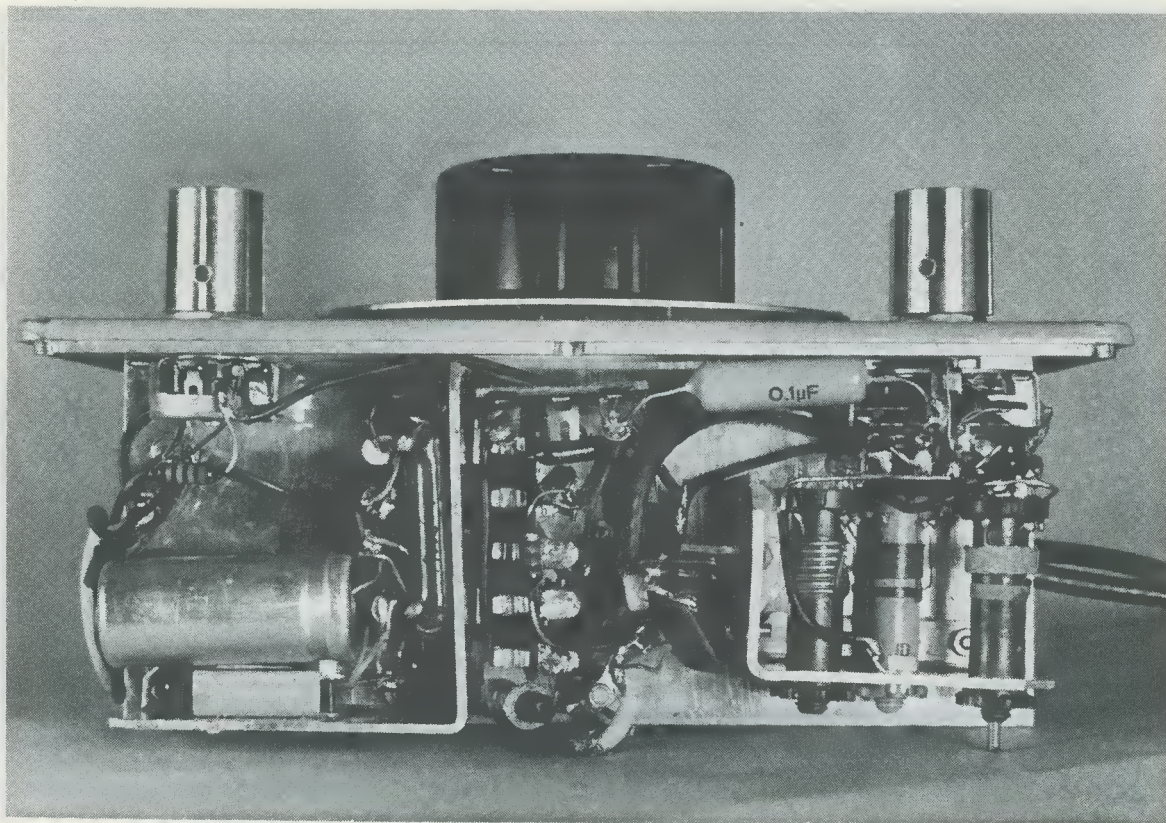

*Below-chassis view of the completed unit. The positioning of the coil and power supply sub-chassis is clearly shown. Note that  $C_7$  is mounted into position directly above  $C_8$*

The output lead (from  $C_4$ ) is also screened, its braiding being earthed at an adjacent chassis point.  $C_6$  should be close to  $C_4$ , with both capacitor lead-outs which connect to the output lead being as short as possible. Both the aerial input and the output screened leads pass through holes in the back of the case.

With  $S_1$  in position 3, the aerial input is applied, via section  $S_{2(a)}$  of the wavechange switch, to coupling windings  $L_1$ ,  $L_3$  or  $L_5$  of the three coils. The remaining section of the wavechange switch,  $S_{2(b)}$ , selects the corresponding tuned windings,  $L_2$ ,  $L_4$  or  $L_6$ .  $L_1$  and  $L_2$  form the Range 5 Denco coil (32 to 10.2 Mc/s),  $L_3$  and  $L_4$  the Range 4 coil (15.5 to 3.5 Mc/s), and  $L_5$  and  $L_6$  the Range 3 coil (4.6 to 1.25 Mc/s). Variable capacitor  $C_1$  tunes whichever tuned winding is selected by  $S_{2(b)}$ .

The valve chosen for this design is the EF183 variable-mu frame grid r.f. pentode, this type exhibiting a high gain factor which is eminently suitable for preselection applications. The values of the components used in this circuit have been selected after much experiment, and quality components should be used throughout. Positive h.t. potential is supplied to the screen grid (pin 8) via  $R_1$ , capacitor  $C_2$  being the bypass component. The anode (pin 7) is supplied via  $R_2$  and the r.f. choke. The function of resistor  $R_3$  is to reduce the h.t. potential to that required for optimum operation of the circuit and to isolate the valve circuit from the power supply and thus provide additional smoothing. The tuned and amplified r.f. signal at the anode is fed, via capacitor  $C_4$ , to the output

of the unit, this being then connected to the receiver aerial and earth input terminals.

The internal screen of the valve, pin 6, must be connected direct to chassis. The suppressor grid (pin 9) is connected to both pins 1 and 3 (cathode).

The cathode components  $R_4$ ,  $R_5$ ,  $R_6$  and  $C_5$  provide the required variable cathode bias voltage,  $R_5$  being the panel-mounted gain control. As originally developed, the cathode circuit consisted of  $R_4$ ,  $R_5$  and  $C_5$  only but it was found that with this arrangement, the setting of  $R_5$  for maximum gain was apt to be critical and difficult to adjust. Tests showed that this condition was eased if resistor  $R_6$  was included in the circuit in parallel with  $R_5$ .

One side of the heater supply is connected to chassis, the 6.3V winding of the mains transformer feeding the red pilot lamp  $PL_1$  as well as the valve heater. The rectified d.c. voltage from the contact-cooled rectifier is fed to the smoothing circuit  $R_7$ ,  $C_7$  and  $C_8$ . It should be noted that  $C_7$  and  $C_8$  are separate components and not the more usual twin-capacitor within a single can. This was necessary in order to contain these components within the small space available.

#### CONSTRUCTION

Fig. 2 (a) shows the drilling details of the die-cast box lid, which now becomes the front panel of the preselector unit. Holes A, B, C, D and E should be drilled  $\frac{7}{16}$ in, A being later used for the panel lamp  $PL_1$ , B for switch  $S_1$ , C for variable capacitor  $C_1$ , D for gain control  $R_5$  and E for wavechange switch  $S_{2(a)(b)}$ .

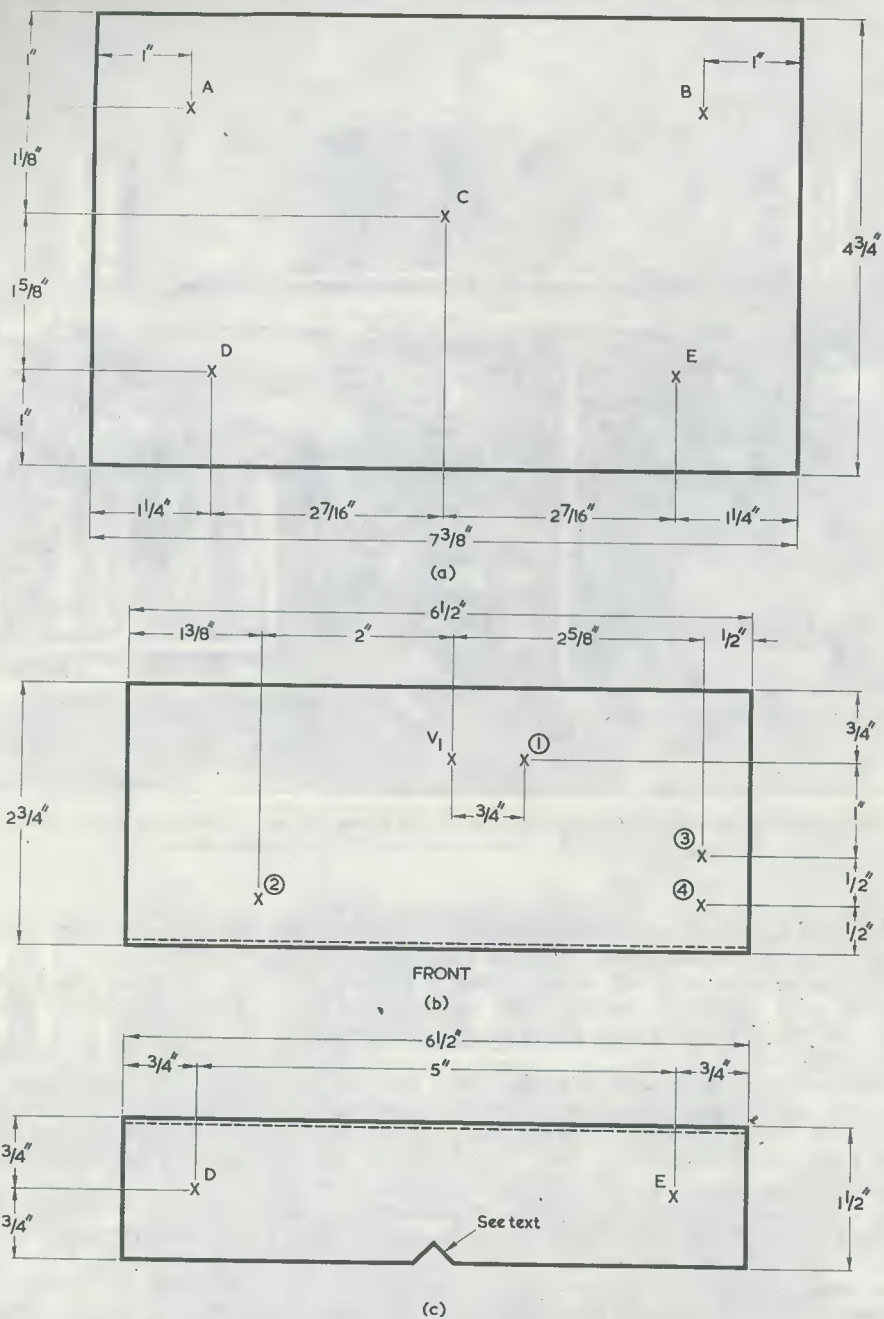

Fig. 2 (a). Front panel dimensions and drilling details, (b) plan view of the chassis deck with drilling details and (c) chassis front apron drilling details

Fig. 2 (b) is the plan view of the chassis deck. The position for the EF183 is shown as V<sub>1</sub>, whilst holes 1, 2, 3 and 4 are of  $\frac{1}{4}$ " diameter to which rubber grommets are later fitted. The hole for V<sub>1</sub> should be  $\frac{3}{4}$ " diameter to take the B9A valveholder.\* Hole 1 is required for the lead from the grid of V<sub>1</sub> to the variable capacitor C<sub>1</sub>, hole 2 for the leads to PL<sub>1</sub>, hole 3 for the output coaxial cable from C<sub>4</sub>

and hole 4 for the coaxial cable from tag 3 of S<sub>1</sub> to the arm of S<sub>2(a)</sub>.

Fig. 2 (c) shows the front apron of the chassis, holes D and E corresponding to D and E of Fig. 2 (a). It should be noted here that the chassis, when viewed from the side, is L-shaped, the only apron being that at the front. Also, it will be seen from Fig. 2 (c) that an inverted V-shaped cut-out must be made in the chassis apron in the central position so that the lower edge of the apron does not foul

\* A B9A ( $\frac{3}{4}$ " in) chassis cutter is available from Home Radio Ltd., under Catalogue Number TL 10, the required Allen key being listed under Catalogue Number TL 12.



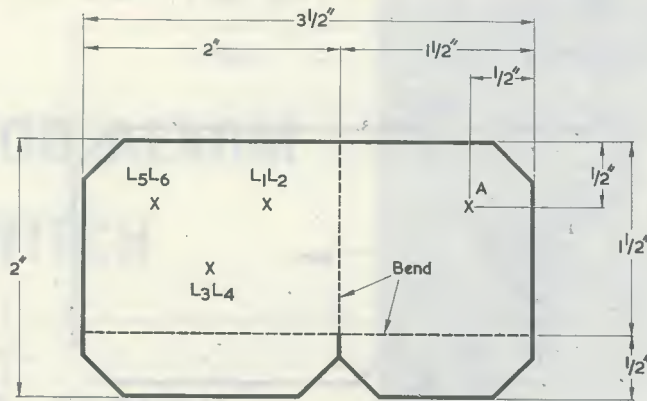

Fig. 3. Dimensions of the coil mounting sub-chassis

the lower central fixing bolt extrusion on the front panel rear.

From the illustration of the below-chassis view, it will be noted that two small sub-chassis are used. The first of these (see Fig. 3) is for the mounting of the three inductors, the positions of which are shown. The dashed lines indicate where bends should be made. The three coils should be mounted into position on the sub-assembly prior to securing this to the underside of the chassis. This assembly is later secured to the underside of the chassis by means of two 6BA nuts and bolts, one in each lower flange. Prior to this however, a further hole should be drilled at a position midway between  $L_1L_2$  and  $L_5L_6$  and fitted with a 6BA nut, bolt and solder tag. This tag provides the chassis connection for the coils. A further 6BA hole ("A" in Fig. 3) is drilled in the smaller side to which is secured a small 3-way tagstrip (one tag earthed). This tagstrip accommodates  $C_6$  and the earthed braiding of its coaxial cable. The coil assembly should be positioned on the chassis directly behind the wavechange switch  $S_{2(a)(b)}$  and rather nearer the rear of the chassis than is shown in the photograph. The dust core threaded sections of the inductors can then protrude through suitably sized and positioned holes drilled in the rear panel of the box, thereby allowing for adjustment of the frequency coverage with the whole unit completely assembled. The outside dimensions of the box are quoted here.

Fig. 4 shows the dimensions and drilling details of the second sub-chassis, the bend lines being shown dashed. To the rear section of this sub-chassis (see the photograph) should be secured the contact-cooled rectifier. To the side section are fitted two tagstrips, one in either side of the section, by means of two 6BA nuts and bolts. In the prototype, the power supply side of the apron is fitted with a 4-way tagstrip (2 tags earthed) and the other side with a 5-way tagstrip (2 tags earthed). In the course of development, two of the tags in the 5-way tagstrip have become unused, although they could well be pressed into service by constructors wiring up the circuit to their own preferences. To the tag of the 5-way tagstrip nearest the

front panel is soldered the central fixing tag of a 3-way tagstrip. This later provides a support for resistor  $R_3$ .  $R_3$  could alternatively be soldered to the two unused tags just mentioned.

It will be noted that both these small sub-chassis not only act as suitable mountings for the various components but also perform the necessary function of screening both the coils and the power supply from each other, and from the valveholder with its associated components.

The small mains transformer should be secured to the chassis by means of four 4BA nuts and bolts, the component itself acting as a template for these hole positions. Additionally, two 1/4in holes must be drilled in the chassis deck, and fitted with rubber grommets, to take the transformers leads down through the deck. These holes are not shown in Fig. 2 (b). To the mains transformer mounting bolt nearest gain control  $R_5$  should be fitted a 3-way tagstrip (end tag earthed). These tags accommodate the 3-way mains cord, care being taken to ensure that the earth lead in this cord connects correctly to the tag which is in contact with the chassis. (No mains on-off switch is incorporated in the preselector itself).

The electrolytic capacitor visible in the under-chassis view is  $C_7$ .  $C_8$  is immediately below this capacitor.

From the above-chassis illustration it will be seen that variable capacitor  $C_1$  is mounted to the front panel such that the moving vanes are furthest from the mains transformer. The capacitor is secured to the front panel by means of three short 4BA bolts, ensuring that these do not pass through far enough to foul the rotor vanes.

Turning to the front panel illustration it may be noted that the dial cursor is secured to the panel in the 45° position, it being impossible to mount this in the more normal 0° (or 360°!) position with the size of dial employed (4in diameter). When fitting the completed assembly into the box, it will be found that the top central mounting bolt cannot be used, as its hole is behind the top of the dial. Omission of this screw does not detract from the final appearance of the preselector as the blank hole is obscured by the dial.

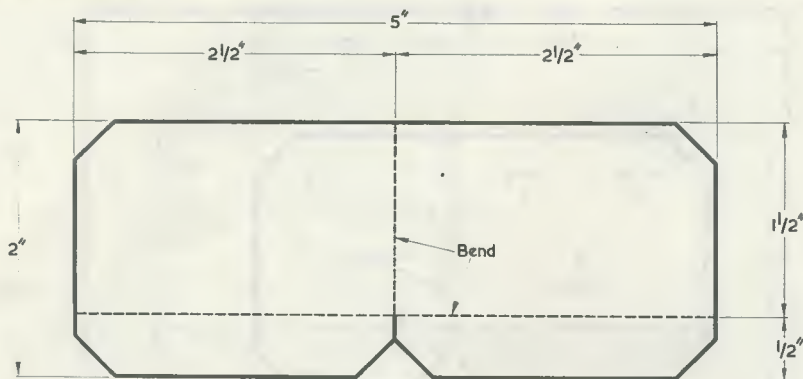

Fig. 4. Measurement details of the power supply sub-chassis

In practice, it will be found that a good slow-motion dial and drive assembly is of paramount importance if the preselector is to be capable of being tuned "on the nose" and in line with the receiver.

Dealing with the remainder of the box, as distinct from the front panel, it will be found necessary to drill three  $\frac{7}{16}$ in holes along the top of the rear panel for ventilation purposes. One hole should be drilled in a central position and the remaining two approximately 2in on either side of this central hole. The three holes for the coil iron-dust core threaded spindles have already been mentioned. In addition, a further three holes must be drilled for the mains input, aerial input and preselector output leads. Each of these should be fitted with a suitably sized rubber grommet.

#### WIRING-UP

It is not proposed here to describe the wiring-up process in any detail, it being left to the individual constructor to adopt his own methods. All wiring should, of course, be as short and direct as possible and great care should be taken to ensure that no short-circuits will be made with the metalwork once the unit is secured within the box. Pay particular attention here to the power supply of the unit, making sure that no part of this can possibly touch the metal box interior once the unit is completed and assembled.

A voltage Table is given and this shows the typical readings that may be obtained at the various points designated, with  $R_5$  set to the *minimum* gain position (where it inserts maximum resistance into circuit). As is to be expected, anode and screen-grid voltages will drop by a considerable amount when  $R_5$  is adjusted to the maximum

TABLE

Position	Volts
Junction $R_7, C_8$	345
Junction $R_7, C_7$	315
Anode (pin 7)	250
Screen grid (pin 8)	230
Cathode (pins 1, 3)	12.2

$R_5$  at minimum gain position

gain position. Due to component tolerances and different mains voltages, variations on the readings in the Table up to some 10% or so may be encountered, and such variations do not necessarily indicate a fault.

#### FINAL DETAILS

In use the preselector is operated in the normal manner, it being kept approximately "in step" with the tuning of the main receiver, then finally adjusted for maximum signal strength when a desired signal is located.

It is possible that the preselector may go into oscillation on parts of one or more of the bands when  $R_5$  approaches the maximum gain position. This does not detract from its performance and the added regeneration enhances the sharpness of its tuning.

To provide the completed unit with eye-appeal, the prototype was sprayed with Yukon Self-Spray enamel (light blue in the present instance)—see advertisement at the rear of this magazine—and then marked up with Panel Signs transfers (set No. 3). The four rubber feet are secured to the box with Parker-Kalon self-tapping screws.

#### RECEIVER ANCILLARY EQUIPMENTS

In the present series of articles by L. Saxham—describing the construction of various units within Eddystone diecast boxes—(of which the above is the latest example)—a further four equipments are undergoing construction or design. These will be published in due course.

# THYRISTOR ALARM SWITCH

by G. A. FRENCH

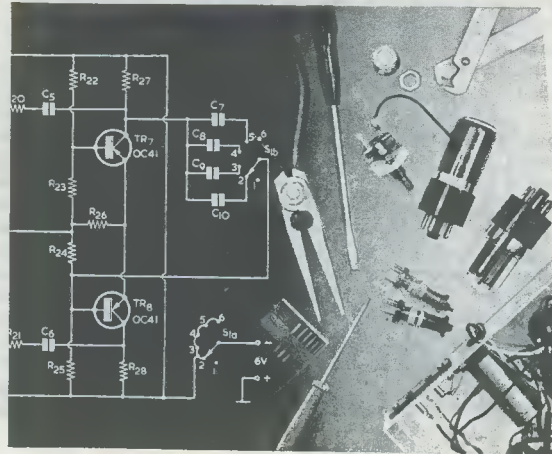

**A**N ATTRACTIVE APPLICATION FOR A transistor radio consists of coupling its battery circuit to some form of time switch so that it functions as a "radio alarm" in the morning. The sleeper can then be awakened by broadcast music instead of by the raucous clangour of an alarm clock bell.

Unfortunately, time switches are not always inexpensive or easy to obtain, whereupon the constructor may find it necessary to modify a standard alarm clock so that it completes a circuit at a preselected time and thereby switches on the radio. If a conventional spring-wound alarm clock is examined, for instance, it will be found that a metal disc which is concentric with the spindle on which the set alarm hand is mounted moves forward and releases the striker escapement at the preselected alarm time. A reasonably skilful constructor should find it possible to add a contact to the clock mechanism which enables a circuit to be completed when this disc moves forward. Since, as will shortly be explained, only a momentary connection is required at the time when the radio is to be switched on, it does not matter if the circuit completed by the added contact in the clock is a little intermittent in character, or is otherwise not as good as would be provided by proper switch contacts. The fact that only a momentary connection is needed also makes it possible to use an alternative and perhaps easier scheme, in which the added contact is positioned so that a circuit is made when the striker arm is set into operation. The general idea is shown in Figs. 1 (a) and (b) and it will be seen that in both cases the alarm circuit is completed by way of the clock chassis. The contact added to the clock mechanism is, of course, mounted on a small piece of suitable insulating material. With a non-alarm clock, it should even be possible, given care and skill, to add a contact to the clock face itself, this contact completing a circuit

via the hour hand when the latter passes the point at which it would normally be desired to awaken.

This month's article in the "Suggested Circuit" series describes a simple method of reliably switching on a battery transistor radio by means of an external switching circuit, and is capable of operation even when the completed external circuit is intermittent in character. It is primarily intended for use with radios powered by a 9 volt battery, and all that is required is a momentary closure of the external circuit for the transistor receiver to be triggered on and to remain playing indefinitely. This switching method is, in consequence, satisfactory for use with

modified alarm clocks of the type just described where the closure of the external circuit may not be as continual or as reliable as would be given by a standard switch. It may also be employed with any other external circuit of like character and a number of novelty applications can be visualised here. again, the switching method enables a transistor radio (or transistorised equipment working at around the same current and voltage as a transistor radio) to be turned on by pushing one press-button, and to be turned off by pressing another.

## THYRISTOR OPERATION

The most obvious component for a

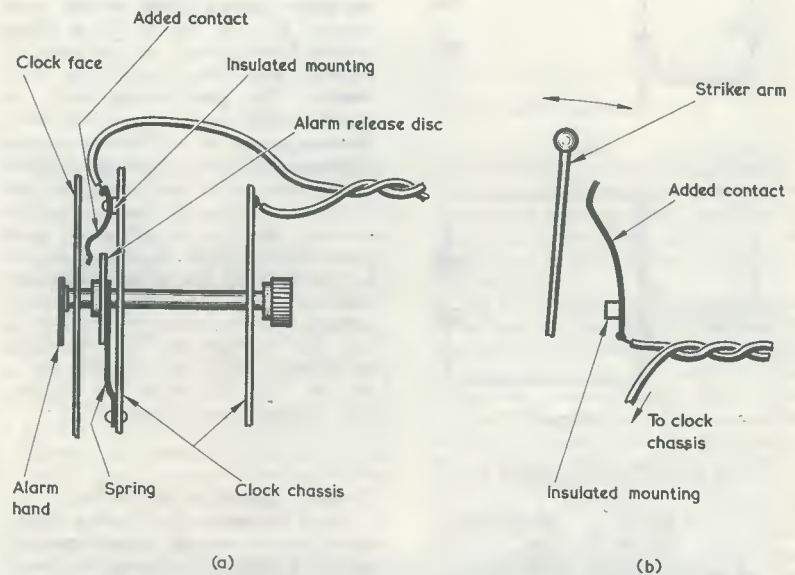
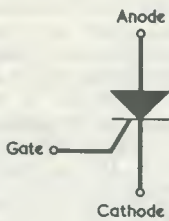

Fig. 1 (a). Adding a contact to an alarm clock. At alarm time, the alarm release disc moves forward and completes a circuit to the added contact (b) An alternative approach to adding a contact to the clock. The striker arm touches the added contact as it swings back and forth

switching function of this nature is a thyristor, or "silicon controlled rectifier". Small thyristors capable of controlling battery powered transistor radios are readily available at low cost. The thyristor recommended for the present "Suggested Circuit" is, for example, housed in a TO-5 can and retails at around five shillings.

Fig. 2 (a) shows the circuit symbol for a thyristor and identifies its electrodes. Until it is triggered, the thyristor passes leakage current only. When it has been triggered the thyristor passes conventional current (positive to negative) from anode to cathode in a similar manner to a standard rectifier. The thyristor is triggered by applying a firing current to the gate in the direction which causes conventional current to flow from gate to cathode.

Fig. 2 (b) shows a typical thyristor circuit for an application of the type under discussion. Here,  $R_1$  is the "load" (and could be a transistor radio) whilst



(a)

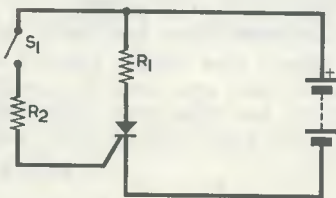

(b)

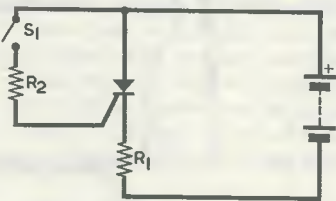

(c)

Fig. 2 (a). The electrodes of a thyristor

(b). A typical d.c. application for the thyristor

(c). An improved circuit which reduces battery current and simplifies wiring for the application described in the text

$R_2$  is a resistor which limits gate firing current.  $S_1$  is a switch which may, like the alarm clock contacts just discussed, close momentarily or intermittently only.

Before  $S_1$  is closed, the only current flowing through load resistor  $R_1$  is leakage current in the thyristor. As soon as  $S_1$  is closed a firing current flows in the gate circuit and the thyristor becomes conductive. Current from the battery then flows through  $R_1$ , being limited only by the value of  $R_1$  itself (together with a small forward resistance in the conducting thyristor). Regardless of whether  $S_1$  is opened again or not the thyristor remains conductive, and may only be returned to its non-conducting state by disconnecting the battery or by short-circuiting its anode and cathode together.

The circuit of Fig. 2 (b) clearly illustrates thyristor operation and could be employed in practice for the radio alarm application which forms the subject of this article, the transistor radio being connected in place of load resistor  $R_1$ . It suffers, however, from the disadvantage that connection has to be made to both terminals of the battery as well as to the load, thereby making it necessary for three connections to be made to the transistor radio when this is to be the load. Also, gate current continues to flow whenever  $S_1$  is closed. This gate current is not negligible, being of the order of 10mA or more for a small thyristor.

A better circuit, which was especially checked out by the writer for the present application, appears in Fig. 2 (c). When, in this diagram, the thyristor is non-conductive, its cathode assumes virtually the same potential as the negative terminal of the battery. This is because negligible current flows in the load resistor  $R_1$ . On closing  $S_1$  a firing current flows through the gate-cathode junction and then through the load resistor. This gate current fires the thyristor which then becomes conductive, allowing nearly the full battery voltage to appear across  $R_1$ . Since the cathode of the thyristor is now nearly at the same potential as the positive battery terminal there is no additional gate current drawn from the battery should  $S_1$  remain closed. All the battery current now flows in the load. A further advantage of the circuit of Fig. 2 (c) is that the thyristor and its associated components may be coupled to a transistor receiver (when this replaces  $R_1$ ) by two connections only.

#### RADIO ALARM CIRCUIT

Fig. 3 illustrates the thyristor circuit as applied to a normal battery-operated transistor radio. (It should be noted, incidentally, that resistor numbering in Fig. 3 does not correspond to that in Figs. 2 (b) and (c)). The radio is modified by having a non-reversible 2-way socket

fitted to its case, this being connected in series with the lead to the positive terminal of its battery. All the components of the radio, including its on-off switch, are within the block at the left of the diagram. For normal use the 2-way socket connections are short-circuited, whereupon the radio functions in its usual manner.

When the alarm facility is required the radio is initially tuned to a station and set to the desired volume level, its on-off switch being left in the "on" position. The short-circuit is then taken off the 2-way socket and a plug from the thyristor switching circuit inserted instead. Apart from resistor  $R_1$  (which is included merely to limit switch-on surge current) the circuit which results is then the same as that of Fig. 2 (c). Before the external alarm contacts close the thyristor passes leakage current only and the transistor radio does not operate. As soon as the external contacts close, the thyristor fires and switches the radio on. This then plays continually. Should the radio be turned off by its own on-off switch the thyristor reverts to its non-conductive state. If the radio is next switched on again it will not operate unless the external alarm contacts are closed or unless the alarm circuit is removed and the 2-way socket short-circuited again.

Thus, the radio is switched on by the external alarm contact circuit, even if the latter closes momentarily or intermittently only, and the required alarm function has been achieved.

#### COMPONENTS

As has already been mentioned, resistor  $R_1$  of Fig. 3 is included to limit switch-on surge current. Such a resistor is desirable as the receiver will have a high value electrolytic bypass capacitor across its supply lines and this will be discharged when the thyristor starts to conduct. The 10Ω resistor specified for  $R_1$  keeps surge current well within the maximum peak value for the thyristor employed.

Resistor  $R_2$  is the gate current limiting resistor. It enables the gate firing current to be comfortably above the 10mA minimum firing current rating of the thyristor. Both  $R_1$  and  $R_2$  may be  $\frac{1}{4}$  watt 20% types.

The thyristor itself is an S.T.C. CRS1/05, available from Henry's Radio Ltd. It is encapsulated in a TO-5 can and, in consequence, takes up very little space. It is probable that the thyristor, together with  $R_1$  and  $R_2$ , could be fitted inside the alarm clock, whereupon this could be coupled to the receiver via a convenient length of 2-core flex terminated in a plug. The external metalwork on some transistor radios (decorative metal finishes, telescopic aerials, etc.) is frequently connected to one of the supply lines in the receiver, and care should be taken to prevent this metalwork coming into contact

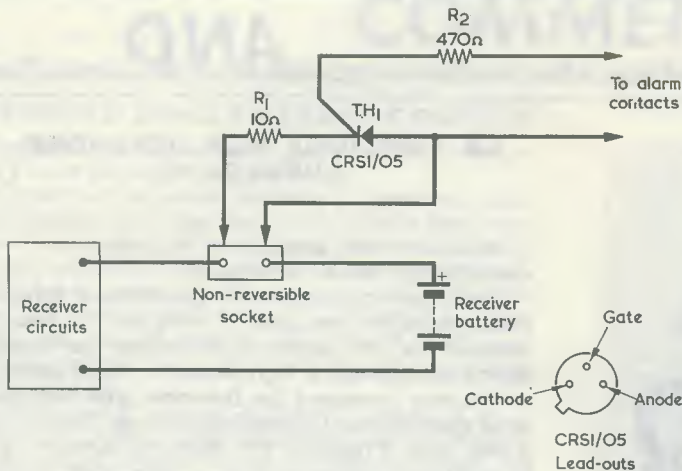

Fig. 3. The radio alarm. The external circuit comprising  $R_1$ ,  $R_2$  and  $TH_1$  is plugged in when the alarm facility is required

with the metal case of the alarm clock as battery short-circuits, or even damage to components, could then result.

Fig. 3 shows a non-reversible plug and socket for the connection from the thyristor external contact circuit to the receiver. An excellent choice here would be given by a miniature closed-circuit jack and plug, the jack being fitted to the receiver. A closed-circuit jack automatically short-circuits its contacts when its plug is removed, whereupon the receiver may be changed automatically from normal to alarm operation, or vice versa, merely by inserting or withdrawing the jack plug. The jack socket can be fitted at any convenient point on the receiver cabinet and it has, of course, merely to be wired in series with the internal lead to the positive battery terminal.

A helpful approach, during assembly of the alarm switch circuit, is to leave the fitting of the alarm contact until last. The switching circuit may then be wired up, coupled to the receiver, and operation checked by momentarily short-circuiting the connections which will later couple to the alarm contacts. When satisfied that all is correct up to this stage, the alarm contacts may then be fitted and wired in.

As already stated, to use the alarm switch the receiver is initially tuned to the desired station and the alarm switching circuit plugged in. The receiver will then commence to play as soon as the thyristor fires. A point to bear in mind is that about 0.7 volts is dropped across the thyristor and  $R_1$ . Should the receiver battery be nearly exhausted and provide only enough voltage to keep the local oscillator running when the receiver is used under normal

conditions, the 0.7 volt dropped across the thyristor and  $R_1$  may be sufficient to prevent the oscillator operating when the thyristor fires. In consequence, if the receiver battery voltage is very low the receiver may not provide the requisite alarm when the alarm contacts close.

#### RESULTS WITH THE PROTOTYPE

A prototype assembly was made up to the circuit of Fig. 3, employing a standard medium and long wave transistor superhet running from a 9 volt battery. The thyristor fired and turned on the receiver even when the external contacts were closed for an instant only. About 0.7 volt was dropped across the thyristor and  $R_1$  at normal volume levels, this increasing slightly at higher volume peaks.

Although the circuit is primarily intended for use with receivers working from a 9 volt battery, operation was

checked with a 6 volt battery. The prototype functioned satisfactorily at this voltage. It is possible, however, that thyristor operation would not be so reliable with a partly run-down 6 volt battery as with a partly run-down 9 volt battery, and its use with a 9 volt radio is preferred. It may also be employed with a radio using a 12 volt supply.

Leakage current through the thyristor in the prototype assembly was of the order of  $20\mu\text{A}$ . The maximum leakage current rating of the CRS1/05 is 1mA at a case temperature of  $125^\circ\text{C}$ , and leakage current at normal ambient temperatures will be very much lower than this figure.

#### PUSH BUTTON CIRCUIT

A push button on-off circuit utilising the thyristor is given in Fig. 4. This is intended for equipment running from a 9 or 12 volt battery, with a current requirement similar to that of a transistor radio. When push button  $S_2$  is pressed

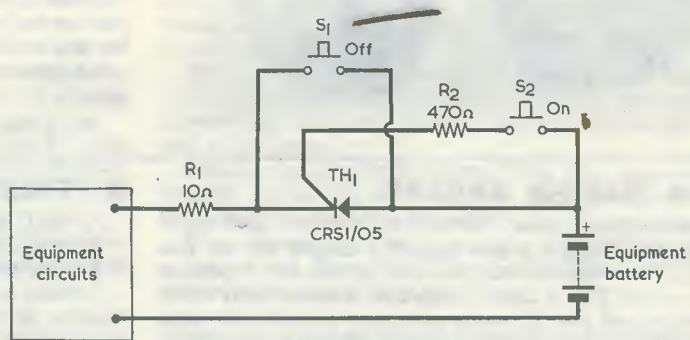

Fig. 4. Using the thyristor in an on-off switching circuit incorporating two press-buttons

the thyristor fires and the equipment is switched on. When  $S_1$  is pressed the thyristor is short-circuited and becomes non-conductive. The supply to the equipment is then broken when  $S_1$  is released.

Fig. 4 is included in this article because some readers may find it attractive for certain applications. When compared with an ordinary on-off switch, it suffers from the disadvantages that a low voltage is dropped across the conducting thyristor and its series limiter resistor, whereupon a small amount of battery power is wasted, and that in the "off" condition a small leakage current still flows via the thyristor. Whilst these disadvantages are of minor importance with the radio alarm application, they acquire somewhat greater significance if the thyristor switching circuit is to be permanently installed instead of a conventional on-off switch.



### AN AMPLIVOX EAR DEFENDER— AURALGARD

Amplivox have announced the release of a new ear defender called "Auralgard".

The growing awareness of the effect of dangerous noise levels on personnel in industry has created a demand for an economically priced ear defender which will provide a high degree of noise reduction.

The new Auralgard Ear Defender is comfortable to wear and has many interesting features. These include a new type of hygienic soft foam ear cushion, which is practically indestructible, a new style attractive headband rest which is easy to clean and a robust headband. All of these parts simply "snap" into position which eliminates any serious servicing problem as all components are easily replaceable without the use of tools.

Auralgard has an attractive colour scheme of bronze for headrest and ear cushions, and light brown for the ear shells. Auralgard is going into immediate production and will be available from stock very shortly.

We show a photograph of this new product.

### NEW MARINE RADARS

Decca marine radar—already an acknowledged world leader—now offers a new facility available for the first time on commercial marine radar in the less expensive price range. This is called Interscan—a line of light which can be moved over the radar picture to get accurate range and bearing details of ships and other objects in the picture. As Richard Oliver explained in a BBC broadcast, without Interscan this is a slow process either involving calculation, or a wait of several seconds on each radar "target". Interscan gives the answer instantly—and in this case it is particularly important because these details are the very ones that a ship's navigator needs to know to avoid collisions. Hitherto Interscan has been available only on the more expensive radars. Its introduction by Decca in the "Group 7 range" brings it within the reach of more modest installations.

### BACKHANDER

'A compliment I shall always remember being paid was from my seven-year-old daughter. I was in bed recovering from a nasty stomach upset, when she crept into my room. "Mummy," she said earnestly, "you must be feeling better. Just now you looked 70, but now you only look 50." I'm 32.'

Listener's letter to BBC 'Woman's Hour', after a broadcast about compliments.

### CHANGE OF ADDRESS

The Radio Society of Great Britain have now moved into their own headquarters building, 35 Doughty Street, London, W.C.1.

### A "FIRST" FOR EUROPE

A "first" for Europe is a "first" for Manchester!

In October Group 70 Limited became the first company in Europe to operate deep-sea colour television.

Limited underwater colour TV has been possible in shallow water but on a very limited scale. The new development of the Manchester-based company make it possible for them to take underwater TV pictures in the ocean-depths and not just in shallow rivers.

Mr. Richard Young, the Chairman of the company, declared: "This puts Manchester first in Europe in Underwater TV as well as football!"

For further information, please contact:

Mr. Richard A. E. Young, Chairman, Group 70 Limited, St. Ann's Square, Manchester.



"finished—do you like it?"

# COMMENT

## IMPROVED SINGLE DECADE COUNTER

Radiatron Limited announce a major improvement to their ELMA B4 Single Decade Counter.

In order to give greater flexibility in operation, wider safety margins, and higher ratings, the ELMA B4 counter has been re-designed in several parts, whilst maintaining the same overall size and appearance. The indexing drum profile has considerably less operating drag; the coil rating has been uprated by 70%; a modified armature mechanism provides more positive "snap" action, and new zero reset and carry pulse contacts reduce reset time and transfer drag.

The B4 counts electrical impulses at speeds of up to 25 i.p.s. and provides visual and electrical decimal readout. In addition, a contact closure is provided which can operate at any number preset on the rotary switch mounted on the front panel.

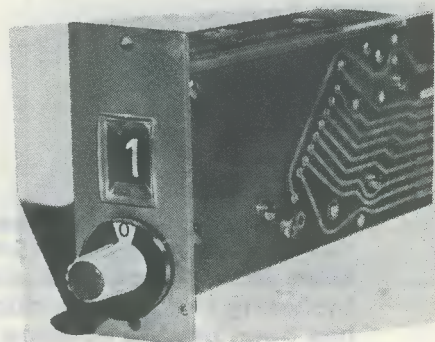

## FUTURE PUBLICATIONS

*Audio Amplifiers* is the title of our next publication, number 18 in our Data Book series.

This Data Book will be published early in January and contains no fewer than 16 transistor and valve designs for the home constructor, especially selected from articles published in this magazine.

All the authors are well known to our readers for their expertise and reliability. The book, which contains 124 pages, has been edited by J. R. Davies. For fuller details see our advertisement pages.

Stocks of the Tenth Revised Edition of that ever popular book, *The Radio Amateur Operator's Handbook*, are now exhausted.

The next edition will be available in mid-January. This mine of information for the radio amateur has been brought up to date and full details will be given in next month's issue.

Binders (wording on the spine) and therefore suitable for binding other journals of the same format as *The Radio Constructor*, are now available in two colours, rich maroon and bright green.

Finally, readers will observe that this magazine is steadily improving, as forecast in these notes when we completed 21 years of publication.

The contents list of this issue contains 19 items including a Data Sheet, Easy-View Diary, and the discreet use of colour on a number of pages.

## MINIATURISING HI-FI

A most recent development in magnetic cone loudspeakers for use with hi-fi systems and equipment is the new P.20 speaker unit from the Oakland Trading Company of London.

The unit has an excellent response value within a frequency range of 40 c/s to 20 kc/s, but what is surprising is that the P.20, complete in a solid teak waterproof cabinet is only 2½ inches deep. This will certainly enable the enthusiast to miniaturise his installation.

Apart from being a stylish piece of furniture the specification available with each unit shows that it does the job and will compliment any hi-fi system.

It has sensitivity rating of 85 dB/M for 1 watt and a power capability of 20 watts peak (10 watts r.m.s.).

Measuring 18 inches high by 14 inches wide, the P.20 provides a combination of characteristics not available from conventional cone speakers.

Further details from The Oakland Trading Company 68, Lupus Street, London, S.W.1.

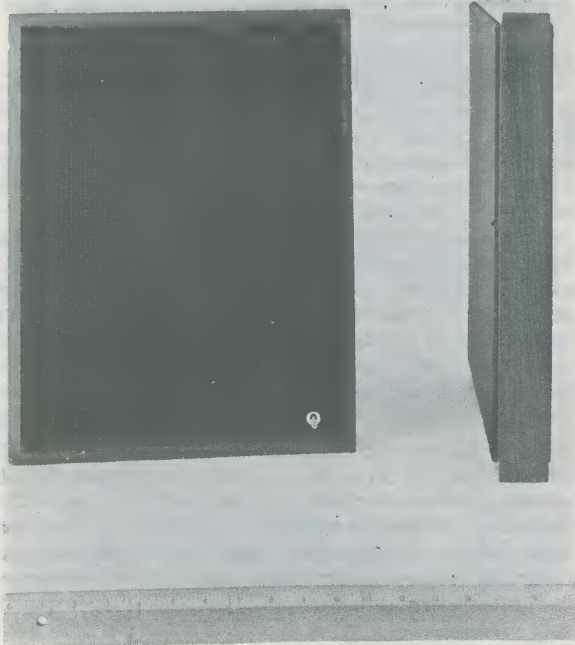

# WIDEBAND A.C. MILLIVOLTMETER

by  
C. CROSBIE

This ingeniously designed millivoltmeter has high input impedance, a frequency range from 15 c/s to 1 M/c and provides readings from 5mV to 500V in X10 intervals with a separate X2 multiplier. All components, including the semiconductors, are readily available. Particular attention has been paid to keeping costs low, and the millivoltmeter is presented as a general-purpose instrument for the service engineer and the experimenter

**T**HE WIDEBAND A.C. MILLIVOLTMETER WHICH FORMS THE subject of this article has the following specifications.

*Ranges:* 50mV to 500V r.m.s. in X10 intervals, with X2 multiplier and separate 5mV r.m.s. input.

*Input impedance:* 1M $\Omega$  and 10pF in parallel from 50mV to 500V; 100k $\Omega$  and 100pF in parallel at 5mV.

*Frequency range:* 15 c/s to 1 Mc/s.

*Power supply:* 7mA at 18V.

*Meter movement:* 0–50 $\mu$ A moving-coil.

## GENERAL POINTS

The instrument uses 3 transistors and 2 diodes to achieve a high input impedance and a linear scale. Two small 9V batteries provide a long-lived power supply. Negative feedback is employed to increase bandwidth and stability. Cost has been kept to a minimum and easily obtainable commercial components are specified throughout.

To enable the operation of the circuit to be more readily appreciated this will be described in four stages. The final stage is described first, then the stage immediately preceding this, and so on. The author has found that this form of explanation is of considerable help in promoting the understanding of a circuit of this nature.

## RECTIFIER CIRCUIT

The forward parts of germanium diode characteristics exhibit what can be described as a "turnover" voltage, below which the diode has a high forward resistance. A representative example is shown in Fig. 1 (a). The "turnover" voltage is around 0.3V depending upon the type of diode. Because of this characteristic, the forward resistance/forward current curve takes up the form shown in Fig. 1 (b), where the change of resistance with current is very evident. The effect of this change in resistance is to produce a non-linear scale in rectifier-fed meters.

The disadvantage is overcome in the present design by including a resistor in series with the rectifier circuit, as illustrated in Fig. 2, the series resistor being large enough to make changes in diode resistance insignificant by comparison. More voltage is needed to drive the rectifier circuit, but this can be obtained from a preceding amplifier.

The voltage-doubler rectifier circuit shown in Fig. 2 gives best linearity for small voltage inputs. The circuit includes smoothing capacitor C<sub>16</sub> and the d.c. blocking capacitor C<sub>15</sub>. The high series resistance just mentioned is given by VR<sub>1</sub>, this also being employed to set up the calibration after the millivoltmeter has been constructed. The design is such that the final value in VR<sub>1</sub> is sufficiently high for it to counteract the effect of changing forward resistance in the diodes.

VR<sub>2</sub>, another preset variable resistor, is the X2 multiplier. It is set up such that the meter gives half its previous indication when VR<sub>2</sub> is switched into circuit. Thus, when "X2" is selected, the 0–50mV range becomes 0–100mV, and so on. This facility is useful for expanding the low ends of the ranges and saves the expense of further input attenuator arms to provide intermediate ranges between the X10 intervals.

## MAIN AMPLIFIER

The circuit of the main amplifier appears in Fig. 3, this being preceded by an emitter follower, TR<sub>1</sub>, which is shown later in the complete circuit.

The function of the main amplifier is to supply some 2 to 3V r.m.s. to the rectifier circuit whilst being fed with a signal a little less than 5mV. Thus, a gain of over 500 is required. For this purpose a 2-transistor feedback amplifier, given by TR<sub>2</sub> and TR<sub>3</sub>, is used. Each transistor appears in a conventional common emitter stage. Negative feedback is taken from the output to the emitter of TR<sub>2</sub>



via  $C_{13}$  and  $R_{15}$ . The feedback ratio is  $R_{12}/R_{15}$ .  $C_{13}$  is a d.c. blocking capacitor which has been made small enough in value to reduce the level of feedback at low frequencies, and it compensates for the low frequency performance of the coupling capacitors.  $C_{12}$  bypasses some of the high frequency feedback, thus compensating for the effect of stray capacitances.

Since  $TR_3$  must be able to supply some 3V r.m.s. to the rectifier circuit, its collector must be capable of swinging at a total of about 8V peak-to-peak, without the transistor cutting off or bottoming. It is this consideration which leads to the use of an 18V power supply, for then the collector of  $TR_3$  may be between  $-7V$  and  $-12V$  d.c. under no-signal conditions.

$R_{14}$  and  $C_{10}$  decouple  $TR_2$  and the preceding emitter follower,  $TR_1$ , from any a.c. content in the supply voltage due to  $TR_3$ .  $TR_2$  and  $TR_3$  may be AF114, AF115 or AF116.

The main amplifier runs direct from the 18V battery, and it was decided that it would be wasteful to incorporate a stabilising circuit in an instrument of this nature. In any event, as will be shown in the complete circuit diagram, a battery check facility is provided, and the battery can be discarded after its voltage has dropped to 17V or so.  $C_{17}$ , across the 18V supply, is a bypass capacitor.

#### HIGH IMPEDANCE INPUT STAGE

For the remainder of the stages we turn to the main circuit diagram, given in Fig. 4. The high impedance input stage is provided by  $TR_1$  and it will be seen that its emitter couples to  $C_8$  of the main amplifier of Fig. 3.

$TR_1$  is an emitter follower, obtaining its input from the

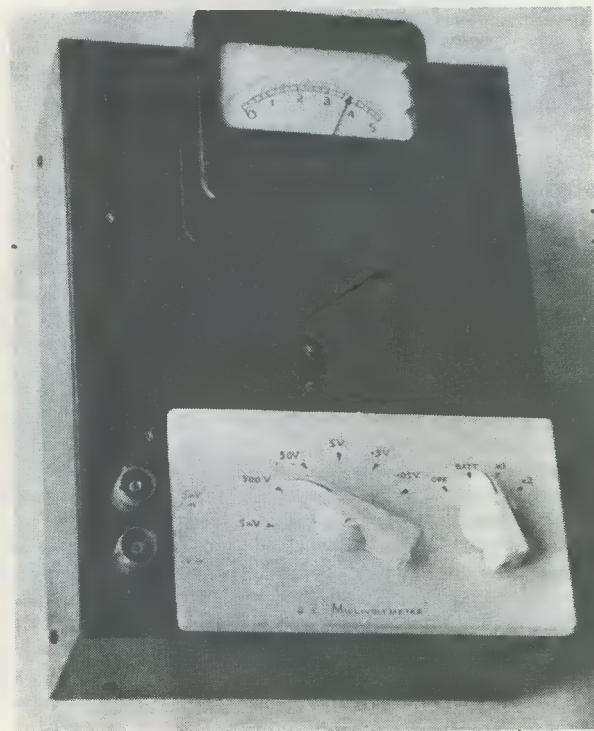

Front view of the millivoltmeter. The  $50\mu A$  meter used in the prototype is a surplus component, but any standard  $50\mu A$  meter may be employed in its place

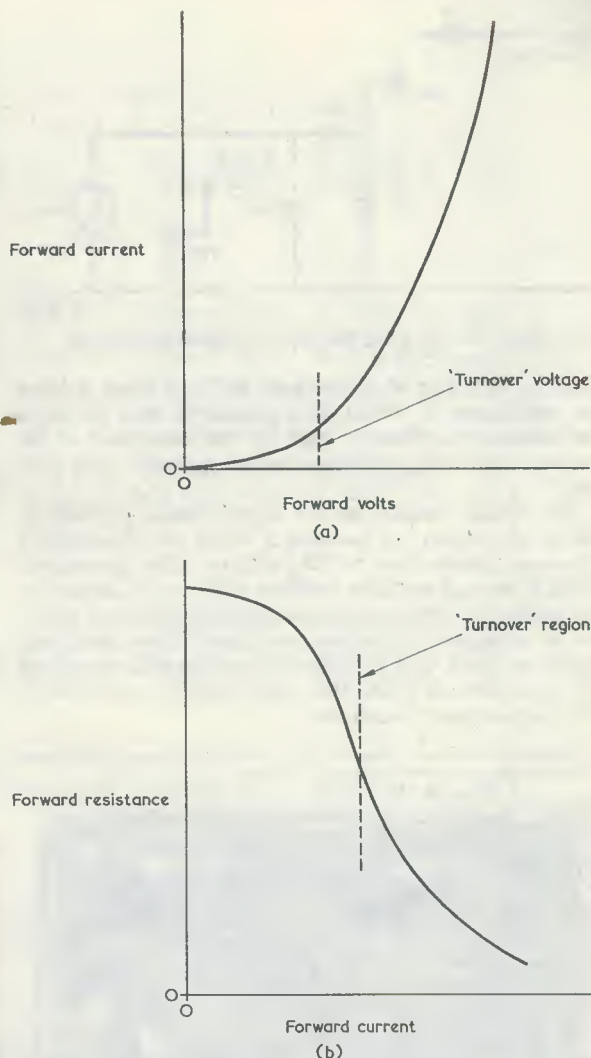

Fig. 1 (a). Typical forward voltage/forward current curve for a germanium diode  
(b). The curve of (a) re-plotted in terms of forward resistance

attenuator circuit via  $C_7$ . Its input impedance is approximately equal to the total impedance presented to the emitter multiplied by  $h_{fe}$ , this being reduced by  $R_1$ . An actual input impedance of some  $250k\Omega$  can be anticipated.  $C_7$  is a d.c. blocking capacitor, to protect  $TR_1$  from any high d.c. voltages in the signal being measured and also to prevent bias resistor  $R_8$  being shunted by the input attenuator. An OC44 is chosen for  $TR_1$ , partly on account of its noise performance.

#### INPUT ATTENUATOR

The input attenuator is provided by  $R_1$  to  $R_6$ ,  $C_1$  to  $C_6$  and  $S_1$ . It is based on a high value resistor,  $R_1$ , placed in series with the input stage, the latter being shunted by successive resistors appropriate to the range selected by  $S_1$ . This method is preferred to that of adding series resistance, since the 50V range would then require  $1,000M\Omega$ ! The value for  $R_2$  is found experimentally during calibration,

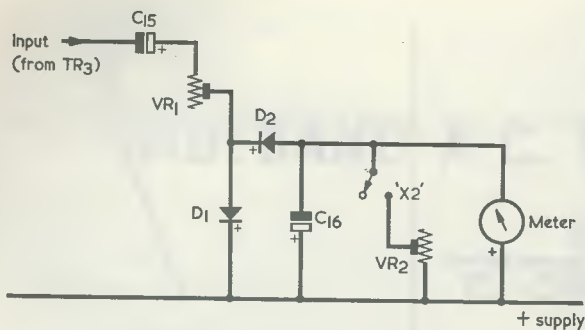
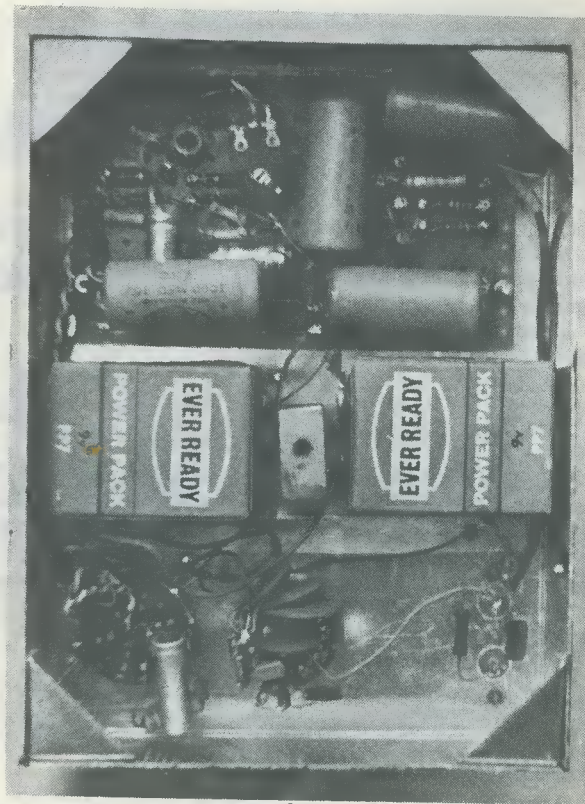

Fig. 2. The diode rectifier circuit of the millivoltmeter

it being such that, in parallel with the input stage, it offers an impedance of  $100k\Omega$ . It is considered that the input impedance is sufficiently high for the remainder of the resistors,  $R_3$  to  $R_6$ , to follow the progression  $10k\Omega$ ,  $1k\Omega$ , etc.\*

To obtain readings on the 0–5mV range,  $S_1$  may be either at position 1 or position 2. When it is at position 1 the input passes direct to  $TR_1$  with no other connection. With  $S_1$  at position 2 the addition of  $R_2$  and  $C_2$  causes an impedance of  $100k\Omega$  with a parallel capacitance of  $100pF$  to be presented to the input terminals. Many users will prefer to work with the known input impedance offered by  $S_1$  in position 2, and this is the impedance specified at the beginning of this article.

\* If a high level of accuracy is required on Range 3,  $R_3$  could, however, be determined experimentally in the same manner as  $R_2$ .—EDITOR.



Bottom view, showing component layout. Note how the batteries are fitted between the switches and the amplifier

It was found that stray capacitances introduced errors at the higher frequencies, and parallel capacitors were included in the attenuator to counteract this effect.

#### THE FULL CIRCUIT

The full circuit diagram of Fig. 4 takes in the points that have already been explained, and includes some further incidental details.

Switch  $S_2$  is a 3-pole 4-way component which carries out the following functions. On position 1 it switches off the instrument completely, switching it on at positions 2, 3 and 4. On positions 3 and 4  $S_{2(a)}$  couples the meter to the rectifiers  $D_1$  and  $D_2$ , thereby allowing the instrument to function as a millivoltmeter. On position 4  $S_{2(c)}$  switches  $VR_2$  across the meter, thereby selecting the  $\times 2$  facility previously illustrated in Fig. 2. In position 1 (Off)  $S_{2(c)}$  also short-circuits the meter. This damps its coil and reduces any tendency for excessive movement in the needle when the instrument is being moved around.

At position 2,  $S_{2(a)}$  couples the meter to the negative supply line via  $R_{20}$ , enabling it to check battery voltage.  $R_{20}$  is specified as  $390k\Omega$  10% in the Components List, whereupon a supply of 18V will result in a reading of  $46\mu A$  at the same tolerance. A note on the front panel may then be added to indicate the reading which corresponds to the minimum usable battery voltage of 17. If a more positive indication is required,  $R_{20}$  may be changed to  $500k\Omega$  close tolerance. A battery voltage of 18 will then be indicated as 36 on the meter scale, and one of 17 as 34.

Switch  $S_1$  is specified as single-pole 6-way. It will

(continued on page 299)

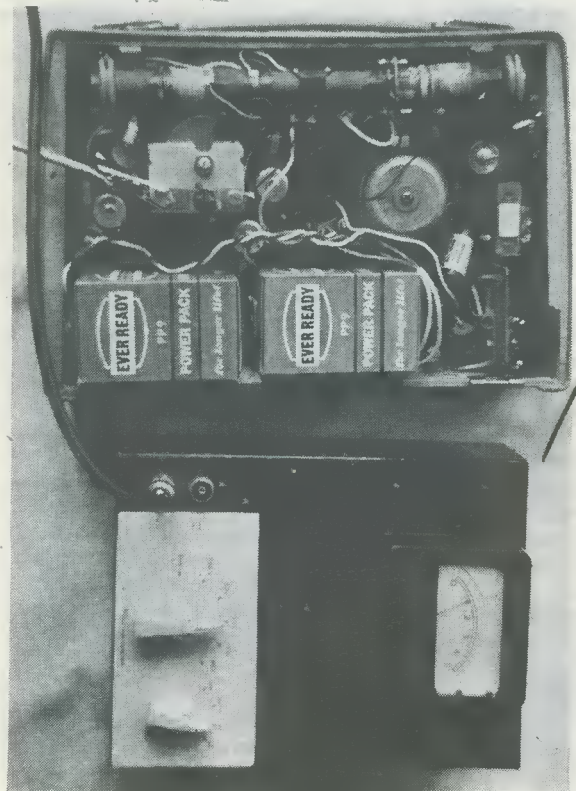

The millivoltmeter in use. Here it is measuring local oscillator voltage in a transistor portable receiver

# RADIO CONSTRUCTORS DATA SHEET

# 18

## WIRE RESISTANCE AND CURRENT TABLE

The Table gives nominal diameter (in and mm), resistance per 1,000 yds (at 20°C) and current rating (to 2 significant figures) for copper wires from 10 to 40 s.w.g. The diameter figures apply to the bare copper before the addition of enamel insulation or other coverings. The current ratings are based on 1,000A per sq. in section, and represent conservatively safe maximum ratings for wire used in mains transformers and similar power-handling components of conventional design.

S.W.G.	Nominal dia. (in)	Nominal dia. (mm)	Resistance per 1,000 yds (Ω)	Current rating (A)	S.W.G.	Nominal dia. (in)	Nominal dia. (mm)	Resistance per 1,000 yds (Ω)	Current rating (A)
10	0.128	3.251	1.899	13	25	0.020	0.5080	77.78	0.31
11	0.116	2.946	2.312	11	26	0.018	0.4572	96.03	0.25
12	0.104	2.642	2.877	8.5	27	0.0164	0.4166	115.68	0.21
13	0.092	2.337	3.676	6.6	28	0.0148	0.3759	142.05	0.17
14	0.080	2.032	4.862	5.0	29	0.0136	0.3454	168.22	0.15
15	0.072	1.829	6.002	4.1	30	0.0124	0.3150	202.4	0.12
16	0.064	1.626	7.596	3.2	31	0.0116	0.2946	231.2	0.11
17	0.056	1.422	9.921	2.5	32	0.0108	0.2743	266.7	0.092
18	0.048	1.219	13.504	1.8	33	0.0100	0.2540	311.1	0.078
19	0.040	1.016	19.446	1.3	34	0.0092	0.2337	367.6	0.066
20	0.036	0.9144	24.01	1.0	35	0.0084	0.2134	441.0	0.055
21	0.032	0.8128	30.38	0.80	36	0.0076	0.1930	538.7	0.045
22	0.028	0.7112	39.69	0.62	37	0.0068	0.1727	672.9	0.036
23	0.024	0.6096	54.02	0.45	38	0.0060	0.1524	864.3	0.028
24	0.022	0.5588	64.28	0.38	39	0.0052	0.1321	1150.7	0.021
					40	0.0048	0.1219	1350.4	0.018

**JANUARY**—ANOTHER FEATURE PACKED ISSUE!



**SLIDE  
PROJECTOR  
SYNCHRONISER**

## **RADIO CONSTRUCTOR**

**PLUS**  
**DATA SHEETS**  
**19 AND 20**

- **High Gain A.F. Amplifier**
- **Variable Voltage Power Supply**
- **Looking into Europe**

## **INDEX**

### **RADIO CONSTRUCTORS DATA SHEET**

(January to December 1968)

DATA SHEET 1	Reference Formulae (Ohms Law etc.)	iii	January
2	Decibel Table	ii	February
3	Frequency/Wavelength Conversion Chart	473	March
4	International Morse Code, Nato Telephony Code	491	March,
5	Capacitive Reactance—Audio Frequencies	541	April
6	Capacitive Reactance—Radio Frequencies	559	April
7	Inductive Reactance—Audio Frequencies	609	May
8	Inductive Reactance—Radio Frequencies	627	May
9	Eureka Resistance Wire Table	695	June
10	U.K. Amateur (Sound) Frequency Bands	iii	July
11	Temperature Conversion Chart	25	August
12	Metric Conversion Table	43	August.
13	Parallel-R, Series-C Table	93	September
14	Multivibrator C-R Values	161	October
15	Winding Temperature Table	179	October
16	Binary-Decimal Conversion Tables	229	November
17	Speaker Transformer Ratio Table	247	November
18	Wire Resistance and Current Table	297	December

# WIDEBAND A.C. MILLIVOLTMETER

(continued from page 296)

probably be more convenient to obtain a 2-pole 6-way switch and use one pole only.

The 18V battery is made up of two 9V batteries, a good compromise between small size and long life being given by two PP7 batteries. If both batteries are purchased new

for a 5mV input up to 100 kc/s, after which there is an increase of sensitivity. At 1 Mc/s, f.s.d. corresponds to 4.25mV input and, above this frequency, the sensitivity begins to fall off.

## CONSTRUCTION

The instrument must be completely screened, and it is convenient to mount the components in an aluminium ready-made chassis having dimensions of 6 by 8 by 2½ in, and which is fitted with a metal base plate. There is then sufficient space for the two PP7 batteries.

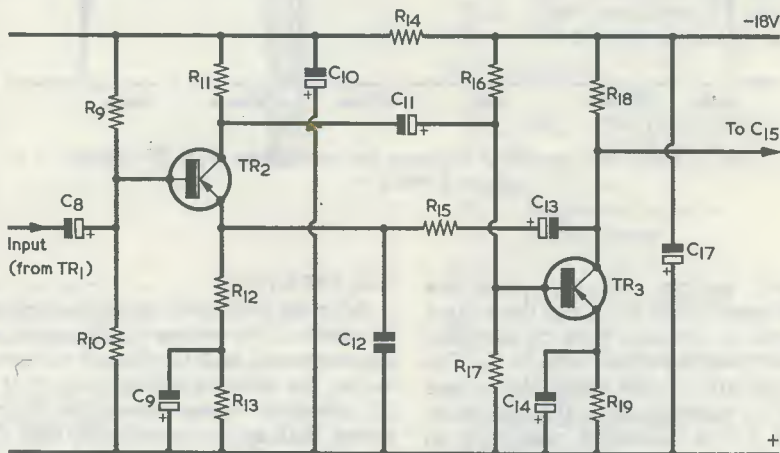

Fig. 3. The main amplifier circuit around TR<sub>2</sub> and TR<sub>3</sub>

at the same time, they should run down together at about the same rate.

Fig. 5 shows the performance of the prototype over the range 20 c/s to 2.5 Mc/s. A correct f.s.d. reading is given

Coaxial input sockets are best, and these enable a convenient test lead to be made from a length of coaxial cable, a coaxial plug and two crocodile clips.

Resistor R<sub>1</sub> and capacitor C<sub>1</sub> may be wired directly

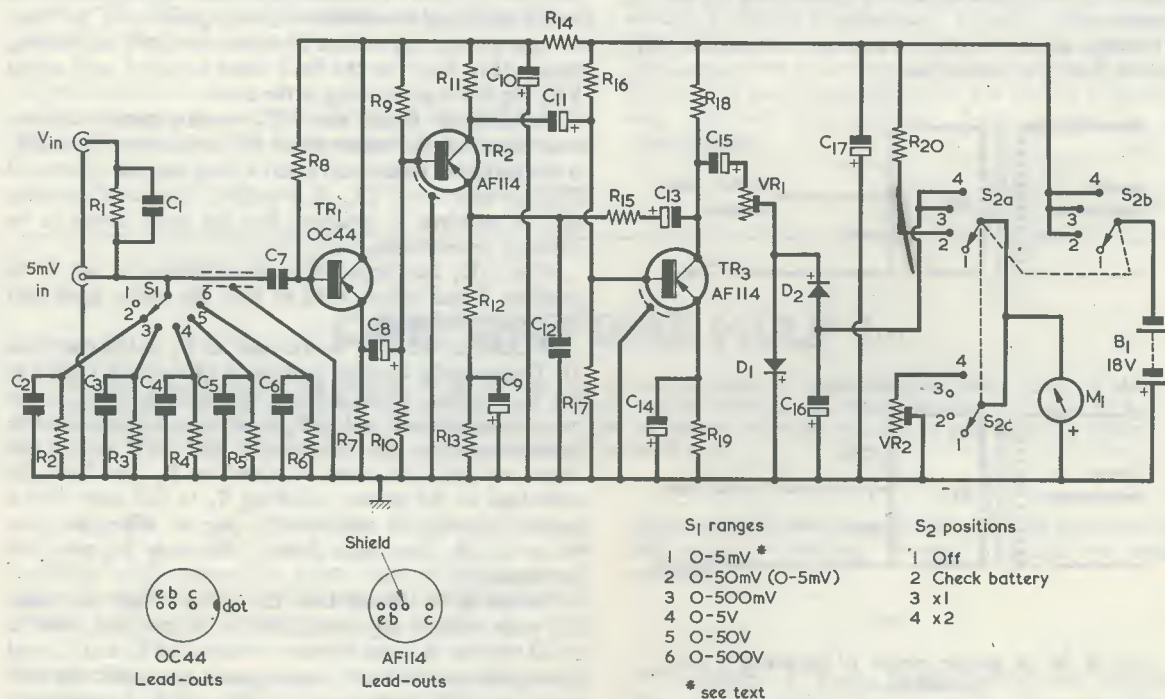

Fig. 4. Complete circuit diagram for the millivoltmeter

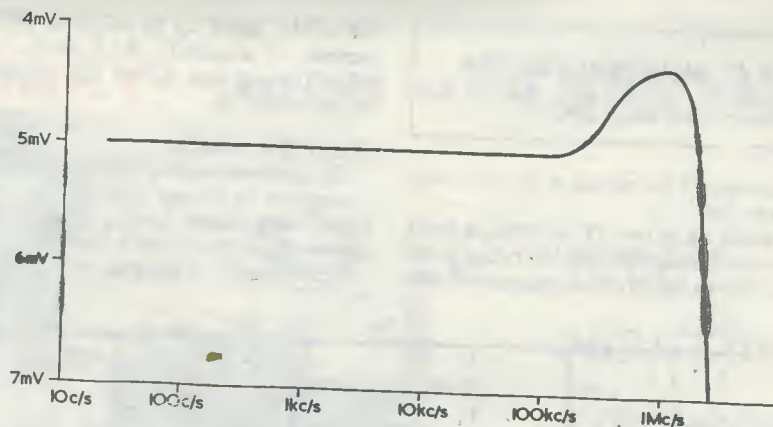
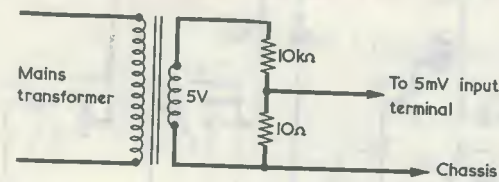

Fig. 5. Measured sensitivity response for frequencies from 20 c/s to 1 Mc/s

across the two input sockets. All the attenuator components should be wired direct to  $S_1$ , and this section of the instrument should be screened from the amplifier section. A screened lead couples the arm of  $S_1$  to  $C_7$ . The output wiring at  $C_{16}$  and after carries negligible a.c. and such wiring need not be screened from the attenuator components, although it is a reasonable precaution to keep it fairly well spaced away. This point makes it possible to mount  $S_1$  and  $S_2$  alongside each on the front panel, if desired.

The amplifier components proper may be wired up on a sheet of Paxolin fitted with turret tags, but any other similar means of assembly would be equally satisfactory. The  $TR_1$  stage should be screened from  $TR_3$  and this was done in the prototype by suitably positioning  $C_9$  and  $C_{14}$  between them.

It should be noted that no component is fitted in the  $R_2$  position during construction.



(a)

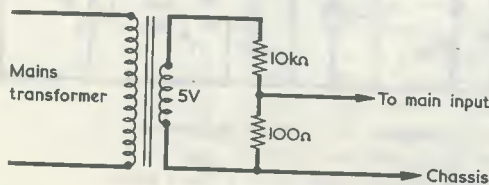

(b)

Fig. 6 (a). A simple means of obtaining a 5mV calibrating source  
(b). The same approach is employed for a calibrating source of 50mV

### CALIBRATION

After the instrument has been completed a check should be made of the voltage at  $TR_3$  collector. This should be approximately half the battery voltage above chassis. At worst, the collector voltage may be at plus 3V or minus 2V of half the battery voltage but, in general, it should be closer. If all appears satisfactory here, the calibration may be commenced.

Two millivolt sources are required, these being at 5mV and 50mV, and they may be obtained very simply from a mains transformer having a 5V secondary, as shown in Figs. 6 (a) and (b). The resistors used here should, of course, be close tolerance types.

Adjust  $VR_1$  to insert maximum resistance and set  $S_2$  to position 3. Ensure that there is no deflection in the meter under no-signal conditions for any position of  $S_1$ , then set this switch to position 2. Apply the 5mV calibrating source (Fig. 6 (a)) to the 5mV input terminal, and adjust  $VR_1$  for full-scale reading in the meter.

Should it be found that  $VR_1$  cannot insert sufficient resistance (i.e. the meter reads full-scale even when  $VR_1$  is at maximum resistance) insert a fixed resistor of around 27kΩ in series with  $VR_1$ . It is unlikely that such a resistor will be required in practice, but the point needs to be covered, nevertheless.

After  $VR_1$  has been adjusted satisfactorily, set  $S_2$  to position 4 and adjust  $VR_2$  so that the meter gives half full-scale deflection.

Disconnect the 5mV source and set  $S_2$  to Off (position 1). Temporarily connect a resistor of around 150kΩ in the  $R_2$  position, apply a 50mV source (Fig. 6 (b)) to the main input terminal and set  $S_2$  to position 3. Then proceed, by trial and error and starting with the 150kΩ resistor just fitted, to find the value required in  $R_2$  for full-scale deflection in the meter, switching  $S_2$  to Off each time a resistor is removed and another put in. When the final value for  $R_2$  has been found, this may be wired in permanently.

Should it be found that the meter reads less than full-scale without any resistor in the  $R_2$  position, insert a 33kΩ resistor in series between the arms of  $S_1$  and  $C_7$  and recommence calibration, starting once more with the 5mV input. As with the previous modification just mentioned, it is unlikely that this change will be required in practice,

# COMPONENTS

## Resistors

(All fixed values  $\frac{1}{4}$  watt 10% unless otherwise stated)

R <sub>1</sub>	1M $\Omega$ 2% hi-stab
R <sub>2</sub>	(see text)
R <sub>3</sub>	10k $\Omega$ 2% hi-stab
R <sub>4</sub>	1k $\Omega$ 2% hi-stab
R <sub>5</sub>	100 $\Omega$ 2% hi-stab
R <sub>6</sub>	10 $\Omega$ 2% hi-stab
R <sub>7</sub>	15k $\Omega$
R <sub>8</sub>	560k $\Omega$
R <sub>9</sub>	68k $\Omega$
R <sub>10</sub>	15k $\Omega$
R <sub>11</sub>	6.8k $\Omega$
R <sub>12</sub>	100 $\Omega$ 5% hi-stab
R <sub>13</sub>	2.7k $\Omega$
R <sub>14</sub>	8.2k $\Omega$
R <sub>15</sub>	100k $\Omega$ 5% hi-stab
R <sub>16</sub>	33k $\Omega$
R <sub>17</sub>	2.7k $\Omega$
R <sub>18</sub>	2.7k $\Omega$
R <sub>19</sub>	330 $\Omega$
R <sub>20</sub>	390k $\Omega$ (see text)
VR <sub>1</sub>	50k $\Omega$ skeleton preset
VR <sub>2</sub>	5k $\Omega$ skeleton preset

## Capacitors

C <sub>1</sub>	10pF silver-mica
C <sub>2</sub>	100pF silver-mica
C <sub>3</sub>	silver-mica
C <sub>4</sub>	0.01 $\mu$ F paper or plastic foil
C <sub>5</sub>	0.1 $\mu$ F paper or plastic foil

C <sub>6</sub>	1 $\mu$ F paper or plastic foil
C <sub>7</sub>	0.22 $\mu$ F paper or plastic foil, 1,000V wkg.
C <sub>8</sub>	2 $\mu$ F electrolytic, 15V wkg.
C <sub>9</sub>	250 $\mu$ F electrolytic, 6V wkg.
C <sub>10</sub>	50 $\mu$ F electrolytic, 15V wkg.
C <sub>11</sub>	8 $\mu$ F electrolytic, 15V wkg.
C <sub>12</sub>	330pF silver-mica
C <sub>13</sub>	1 $\mu$ F electrolytic, 25V wkg.
C <sub>14</sub>	250 $\mu$ F electrolytic, 6V wkg.
C <sub>15</sub>	2 $\mu$ F electrolytic, 25V wkg.
C <sub>16</sub>	50 $\mu$ F electrolytic, 6V wkg.
C <sub>17</sub>	500 $\mu$ F electrolytic 25V wkg.

## Semiconductors

TR <sub>1</sub>	OC44
TR <sub>2</sub> , TR <sub>3</sub>	AF114 (or AF115, AF116)
D <sub>1</sub> , D <sub>2</sub>	OA70 (or OA79, OA81)

## Switches

S <sub>1</sub>	Single-pole, 6-way
S <sub>2</sub>	3-pole, 4-way

## Meter

M <sub>1</sub>	0-50 $\mu$ A moving-coil
----------------	--------------------------

## Battery

B <sub>1</sub>	18-volt battery (two 9-volt in series)
----------------	--

## Miscellaneous

2 coaxial input sockets
2 pointer knobs
Metal case
Coaxial lead, coaxial plug and crocodile clips

but it still has to be mentioned here.

After VR<sub>1</sub>, VR<sub>2</sub> and R<sub>2</sub> have been set up, calibration is complete. The instrument is then ready for use.

## CONCLUSION

In conclusion, the writer would like to mention that the millivoltmeter described in this article is intended as an

economic general purpose instrument which employs readily available components. Considerable stress has been placed on economy, if necessary at the expense of a slight reduction in accuracy. The millivoltmeter will be a particularly useful instrument for the service engineer, as well as for the amateur home-constructor and experimenter. 

## CAN ANYONE HELP ?

Requests for information are inserted in this feature free of charge, subject to space being available. Users of this service undertake to acknowledge all letters, etc., received and to reimburse all reasonable expenses incurred by correspondents. Circuits, manuals, service sheets, etc., lent by readers must be returned in good condition within a reasonable period of time

**High-Quality Stereo.**—G. Miller, 95 Mayfield Road, Edinburgh, — loan or purchase any circuits of 15 + 15W amplifier with inputs for gram, tape deck, tuner and microphone (5mV into 1-100 $\Omega$  approx.), stabilised power supply, 15 $\Omega$  output. Prompt return of circuit.

**TV/Oscilloscope Conversion.**—M. J. Davies, Beechcroft, Northwood, Wem, Shropshire, — any information on converting TV receivers into an oscilloscope.

**Hallicrafter S27 Receiver.**—G. Hooper, 24 Bramble Close, Durrington, Worthing, Sussex, — circuit or manual required.

**B40 Receiver.**—P. Tarry, 38 Birchfield Road, Northampton, — circuit, manual or any information, purchase or loan.

# REFLEX-3 PORTABLE RECEIVER

by  
**ARMAN SAPCIYAN**

IT IS QUITE EASY TO OBTAIN GOOD RESULTS FROM A SIMPLE receiver using 3 transistors only. The set to be described employs 3 transistors in an inexpensive and reliable circuit design, and it readily falls into this category. Like other home-constructor designs of similar type, however, it has one or two tricky points which affect the overall performance; but if these are properly catered for construction raises few difficulties.

## REFLEX CIRCUIT

The circuit of the receiver appears in the accompanying diagram. In this,  $L_1$  is a medium wave ferrite aerial, with a coupling coil which feeds the base of  $TR_1$ . The aerial coil is tuned by  $C_1$ .

$TR_1$ , in conjunction with diodes  $D_1$  and  $D_2$ , functions as a reflex amplifier. It first amplifies the r.f. signal applied from the ferrite aerial to its base, the amplified signal appearing at its collector. The choke  $RFC_1$  prevents this signal passing to the second stage and it is applied instead, via  $C_3$ , to the voltage doubler diode circuit given by  $D_1$  and  $D_2$ . These detect the signal which is then re-applied, as a.f., to the base of  $TR_1$  for further amplification. The amplified a.f. signal now passes through  $RFC_1$  and is next fed via  $C_6$  to the volume control  $R_5$ . Capacitor  $C_5$  bypasses any residual r.f. that may still be present after  $RFC_1$ , whilst  $R_4$  and  $C_4$  decouple the  $TR_1$  stage from the rest of the receiver.

Resistors  $R_1$  and  $R_2$  in series provide base bias current for  $TR_1$ , and it will be found that if this current is increased above a certain point the transistor oscillates.  $R_1$  is in consequence adjusted so that  $TR_1$  is just below the oscillation point over most of the band received, whereupon the resultant regeneration considerably improves the overall selectivity and sensitivity of the receiver. In some previously published designs using this type of reflex circuit it has been common practice to specify a single fixed resistor in place of  $R_1$  and  $R_2$ , the constructor being advised to find the best value by experiment. Such an approach is time-wasting and can lead to the accidental damage of other components whilst different values of resistor are being soldered in. The present circuit is much simpler and enables the receiver to be set up without difficulty.

One of the incidental advantages given by this class of reflex circuit is that  $R_1$  and  $R_2$  provide a small forward bias for diodes  $D_1$  and  $D_2$ , with the result that their detection efficiency is enhanced. Again, the rectified output from  $D_1$  is positive-going, so that strong signals cause the base of  $TR_1$  to go slightly positive whereupon its gain is reduced and it becomes partly removed from the state where it is just short of oscillation. The circuit therefore

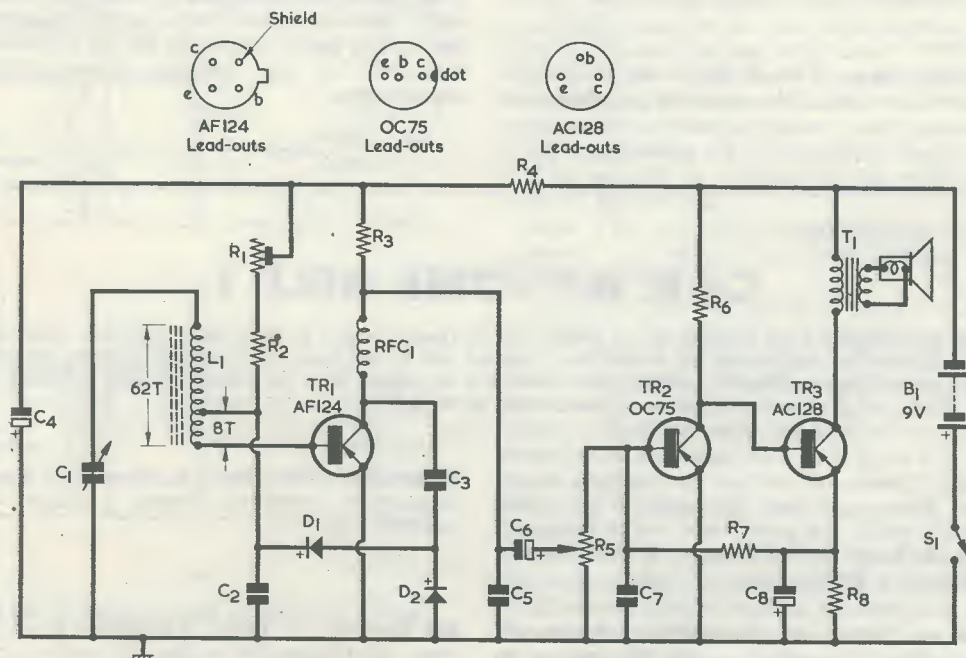

The circuit of the Reflex-3 Portable receiver



provides a degree of a.g.c. action and ensures that greatest regeneration is reserved for weaker signals.

The TR<sub>1</sub> stage is sufficiently sensitive to operate a pair of high resistance headphones connected across R<sub>3</sub>.

#### A.F. STAGES

A.F. amplification is provided by TR<sub>2</sub> and TR<sub>3</sub>. Direct coupling is employed from the volume control R<sub>5</sub> right through to the speaker transformer primary, thereby enabling a good performance to be obtained with a minimum of components. R<sub>7</sub> provides d.c. feedback and keeps the two stages stabilised. Capacitor C<sub>7</sub> functions as a bypass for the higher audio frequencies and, as is described later, may require adjustment to suit the particular speaker employed.

If a high impedance speaker, of around 150Ω, is available, this can be connected directly in place of T<sub>1</sub> primary, whereupon this transformer is not required. For lower impedance speakers, T<sub>1</sub> should present a primary impedance of around 150 to 250Ω to the collector of TR<sub>3</sub>. (A suitable component for T<sub>1</sub> is the Radiospares Transistor Transformer type T/T4. This will match TR<sub>3</sub> to a 3Ω loudspeaker. The T/T4 transformer is readily available from component mail order houses.—*Editor*.)

#### TRANSISTORS

The transistor specified for the first stage is an AF124, which is intended for v.h.f. operation. Alternative choices

N.B. Some of the components listed below may require adjustment. Details are given in the text.

##### Resistors

(All fixed values  $\frac{1}{4}$  watt 10%)

- R<sub>1</sub> 250kΩ variable, skeleton preset
- R<sub>2</sub> 100kΩ
- R<sub>3</sub> 4.7kΩ
- R<sub>4</sub> 1kΩ
- R<sub>5</sub> 10kΩ potentiometer, log, with switch
- R<sub>6</sub> 4.7kΩ
- R<sub>7</sub> 33kΩ
- R<sub>8</sub> 150Ω

##### Capacitors

- C<sub>1</sub> 365pF, variable
- C<sub>2</sub> 0.01μF, paper or plastic foil
- C<sub>3</sub> 330pF, ceramic
- C<sub>4</sub> 30μF, electrolytic, 10V wkg.
- C<sub>5</sub> 0.005μF, paper or plastic foil
- C<sub>6</sub> 5μF, electrolytic, 10V wkg.
- C<sub>7</sub> 0.05μF, paper or plastic foil
- C<sub>8</sub> 100μF, electrolytic, 6V wkg.

##### Inductors

All inductors are described in the text.

##### Semiconductors

- TR<sub>1</sub> AF124
- TR<sub>2</sub> OC75
- TR<sub>3</sub> AC128
- D<sub>1</sub>, D<sub>2</sub> OA70

##### Switch

- S<sub>1</sub> s.p.s.t., part of R<sub>5</sub>

##### Battery

- B<sub>1</sub> 9 volt battery

##### Loudspeaker

See text

### COMPONENTS

for TR<sub>1</sub> are AF126 or AF127, but the writer found that these did not provide quite as much gain as the AF124. When compared with a medium wave transistor like the OC44, the AF124 is much to be preferred. Its shield lead-out is ignored, and is *not* connected to chassis.

TR<sub>2</sub> is not very critical and a number of high gain a.f. types were tried with roughly equivalent results. An OC75 functioned well and this is specified in the Components List.

The output transistor, TR<sub>3</sub>, should preferably be a high gain type also, although fairly adequate results would be obtained even with an OC72 or similar. (The author tried both an AC153K and an AC117, with equal results, in the prototype. These are not readily available in the U.K., and an AC128—"comparable" with the AC117—is quoted in the Components List.—*Editor*.)

The diodes D<sub>1</sub> and D<sub>2</sub> were OA70's in the prototype. Other germanium diodes should be satisfactory, but they may require changes in the value of R<sub>2</sub>.

#### INDUCTORS

The aerial coil, L<sub>1</sub>, is wound on a ferrite slab 3in long,  $\frac{3}{4}$ in wide and  $\frac{1}{8}$ in thick, and the total number of turns is 62, with the earthy tap 8 turns from the end which connects to TR<sub>1</sub> base. The coil should be close-wound on a paper sleeve which permits it to be slid along the slab for the required frequency coverage. Slabs of approximately the same dimensions as that used by the author (such as the  $4\frac{5}{8}$  by  $\frac{1}{2}$  by  $\frac{5}{32}$ in slab available from Henry's Radio.—*Editor*) will be satisfactory, although it may be necessary to add, or take off, several turns at the end which connects to C<sub>1</sub> to provide the requisite range. The wire is 26 s.w.g. enamelled copper.

In the prototype, choke RFC<sub>1</sub> consisted of the primary of a miniature transistor i.f. transformer with its internal parallel capacitor (200pF) disconnected. (Any internal capacitor across the secondary should also be disconnected.) The secondary winding and any taps in the primary are ignored, no connections being made to these. Some advantage was provided by the fact that the dust core position could be adjusted for best regeneration. The can was earthed to the positive supply line. However, the use of an i.f. transformer in this manner is put forward as an experimental approach only, and constructors may employ a standard r.f. choke instead. (A 2.5mH choke such as the Repanco CH1 would be satisfactory.—*Editor*.) A home-wound choke could also be made up by winding about 450 turns of 36 s.w.g. single rayon covered enamelled wire on a 1 watt 20% resistor of 1MΩ or more, the ends of the winding being soldered to the resistor lead-outs.

#### ADJUSTMENT AND OPERATION

With the prototype, current consumption was 10mA from the 9V battery, and the output power from the speaker was of the order of 50mW. A PP3 battery is satisfactory for running the receiver under these conditions. Output power may be increased by reducing the value of R<sub>8</sub> to 100Ω, whereupon the total current rises to 17mA. A PP3 battery is not recommended for this higher current since its life will be reduced by more than half, and a larger battery should be used.

The function of C<sub>7</sub> is to remove distortion at the higher audio frequencies, such distortion being most noticeable with small diameter speakers. With some speakers, it may be preferable to use 0.02μF or 0.03μF in the C<sub>7</sub> position or, even, to omit the capacitor altogether. The reader is advised to build the receiver and bring it up to working

order with  $C_7$  at  $0.05\mu\text{F}$ . The value of  $C_7$  may then be changed experimentally, if necessary, to suit the particular speaker employed.

When the receiver has been completed it is first of all necessary to set up  $R_1$ . A new battery should be fitted for this process. Initially adjust  $R_1$  such that the receiver is just below oscillation point over most of the band covered. If oscillation cannot be obtained, reduce  $R_2$  to  $68\text{k}\Omega$ . With the prototype it was found that the  $100\text{k}\Omega$  value specified for  $R_2$  was satisfactory for a wide range of transistors in the  $\text{TR}_1$  position. Remember that if  $\text{RFC}_1$  is unshielded the onset of oscillation will depend to some extent upon any inductive coupling it may have to the ferrite aerial coil.  $\text{RFC}_1$  should be mounted several inches away from  $L_1$  and with its axis at right angles to that of  $L_1$ . Some control of the oscillation point may then be given by orientating it relative to the ferrite aerial coil, and this factor may be helpful in some cases. After  $R_1$  has been

initially set up it does not need to be touched again.

A suggested alternative method of using  $R_1$  is to fit it to the front panel as a normal  $250\text{k}\Omega$  linear potentiometer and employ it as a sensitivity control. It may then be adjusted for optimum sensitivity on each received station. In this instance,  $R_5$  is not required in variable form and may be replaced by a fixed resistor of the same value, with  $C_6$  connecting direct to its upper end. The on-off switch may then be provided by a separate slide or toggle switch. However, this alternative scheme is offered as a suggestion only, since the circuit gives excellent results as it stands.

As a final point there is a very slight risk of inductive a.f. feedback coupling between the output transformer and the ferrite aerial. If this occurs the connections to the output transformer primary should be reversed. There was no trouble on this score at all with the prototype, and it is only mentioned in case the constructor encounters the snag and does not know how to deal with it. ✱



## CHRISTMAS WATER FOUNTAIN

by  
D. P. NEWTON

**Add a distinctive touch to your Christmas decorations by including this ornamental fountain, which functions also as a humidifier. The simple electrics involved will make a pleasant holiday break from more complex projects!**

CENTRAL HEATING, THOUGH VERY CONVENIENT, PRESENTS the problem of dry air which can cause discomfort, since it irritates the membranes of the eyes, nose and throat. A water fountain is an efficient and interesting way of overcoming this and one may be easily built, as is described in this article. Its construction offers a very pleasant Christmas holiday task.

The bowl should be as large as possible, e.g. a big bowl of glass or strong plastic of at least twelve inches diameter.

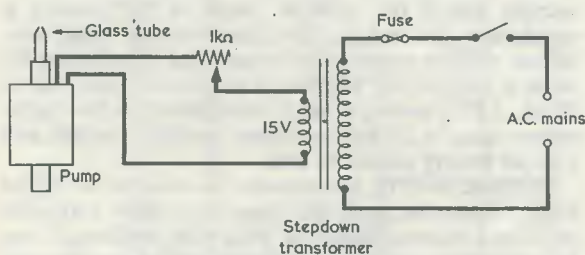

Fig. 1. How the pump and transformers are wired to the mains supply

A miniature water pump and a suitable transformer are needed, the whole circuit being as in Fig. 1.

### MODIFIED PUMP JET

It is necessary to modify the pump jet by making a smaller outlet, so that a fine, high spray can be produced. This is done by heating the central portion of a length of glass tubing in a gas flame until it is soft and then drawing it out as in Fig. 2. (The glass tubing may be obtained at a chemist's and should be of such a diameter as to fit into the polythene outlet of the pump.) Break the tube along the line AB and insert the end C into the existing outlet.

### COMPONENTS

- 1 miniature submersible water pump. (See text)
- 1 15V output stepdown transformer. (See text)
- 1  $1\text{k}\Omega$  variable resistor, linear, 2 watts wirewound
- 1 fuseholder and fuse, 1A
- 1 s.p.s.t. switch, toggle
- Bowl
- Glass tubing

The 1kΩ variable resistor controls the voltage drop across the pump and hence the height of the spray. The spray can therefore be confined within the limits of the bowl. Reducing the voltage across the pump also reduces the noise level considerably.

The pump should be mounted in the bowl so that the intake is clear of the bottom, and the glass outlet is above the surface of the water. Floating plastic flowers will eliminate any tendency to splash, and will disguise the body of the pump and its wires.

When completed, the fountain has an attractive appearance and can provide a particularly distinctive addition to the Christmas scene. The miniature submersible pump operates from 8 to 20 volts a.c. whilst the stepdown transformer has an output of 15 volts at 200mA and is

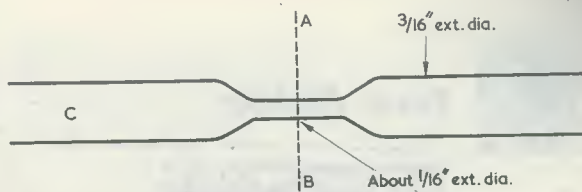

Fig. 2. Preparing the modified pump jet

specifically intended for driving the pump. The pump and transformer are available from Proops Brothers Ltd., 52 Tottenham Court Road, London, W.1. The remaining components are, of course, standard radio parts. \*

### ACROSS

1. An example of axial directivity (3, 4, 5)
8. First stage parameter in cascode amplifier (3, 4)
9. Reactive components (3, 4)
11. A nuisance when replacing valve bases (6)
14. A feature of moist magnetrons (6)
15. Covered by Fenbridge guards (7)
16. It is this feature of 3 down that the trap exploits (4)
17. Attenuated, but amplifies (4)
18. Vertically built connectors (7)
19. Has been a sideproduct of 23 across (1, 3)
21. Can be replaced by the reactance valve (4)
23. Pronounced (and spelt!) electronic success in the U.S. (5, 1, 1)
25. Associated with 1 down, but bounces (1, 1, 4)
26. Suez defines the scarcity of military electronics (4, 2)
29. The input impedance of a second stage is a prime example (7)
30. Cadmium plate or this (7)
31. Inharmonious (12)

### DOWN

1. Fills the void between sound and light (1, 1, 5)
2. Compiles the specification for initial perusal (6)
3. They make noise measurements possible, and necessary (4)
4. The frequency of d.c. perhaps (4)
5. Not a feature of magslips (6)
6. Scene of circuit design activity, perhaps (7)
7. Responsible in a way for 1 down (5, 7)
10. Copes with large blocks of interference (3, 9)
12. To be found in a J-type indicator (4, 3)
13. Fence-sitter, electrically (7)
14. Two ones make a one (3, 4)

## CROSSWORD

Check your knowledge against this crossword puzzle, which embraces all aspects of electronics from automation to radar. Be warned—some of the answers are not too easy! The solution is given on page 312

20. Hazard to Santa Claus (7)
22. Point of discharge (7)
23. Victorian light source (6)
24. Splendid for running up the high tension (6)
27. One cycle perhaps (4)
28. Microwave device minus means of access (4)

by

W.M. FRASER

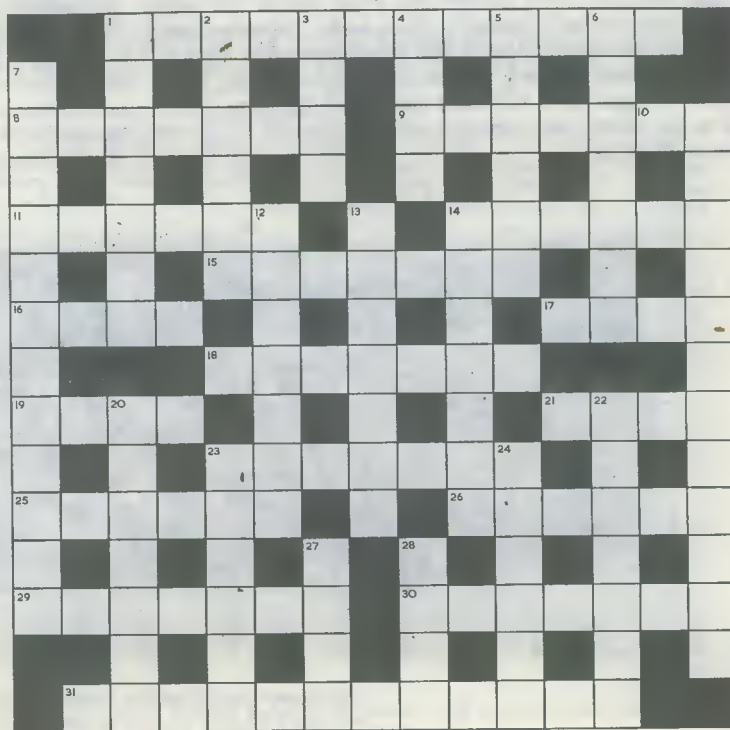

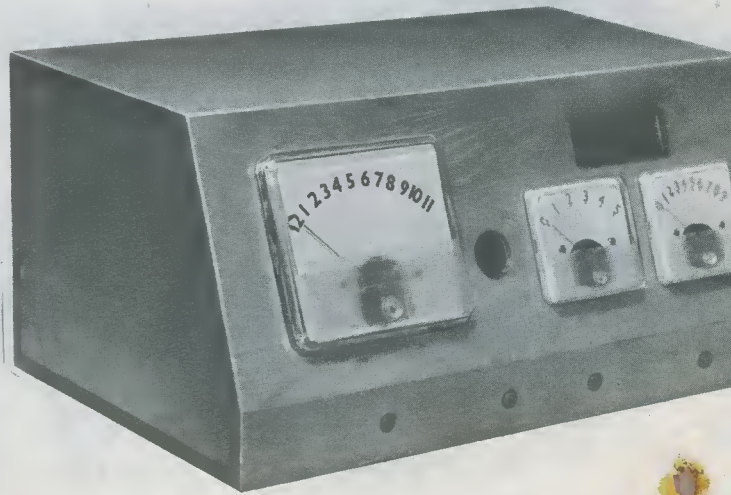

This is the first of a 4-part series which describes the design and assembly of an electronic clock providing read-out on four 1mA meters. The clock, which is time-controlled by the 50 c/s a.c. mains, uses computer techniques throughout, and even includes an indicator to distinguish between a.m. and p.m. as well as a circuit which sounds appropriate "chimes" at each hour. Presented primarily for those who wish to obtain practical experience with computer techniques, this project is intended for readers who are able to design their own Veroboard stage layouts from circuit diagram and textual information

Whilst the writer agrees that the design represents a complicated and expensive way of building a clock, he would nevertheless point out that the building of a clock was not the sole object of the exercise. The main object is to construct and become acquainted with the operation of a number of logic circuits such as are encountered in digital computers, whereupon a digital clock represents a reasonable end product.

In this first article we will introduce the main operational circuits and, in succeeding articles, describe individual stages and general construction. It would be impossible to attempt to reproduce complete wiring layout diagrams in a magazine series of reasonable length and the reader has, to some extent, to devise individual stage layouts himself. However, the writer feels that, in any event, part of the pleasure of construction lies in simple design work of this nature.

Also given this month is an overall Components List for the electronic components. A later article will describe the construction of a suitable cabinet, but the materials required for this are not included in the Components List given this month.

THE CLOCK TO BE DESCRIBED IN THIS SERIES OF ARTICLES is really a practical exercise in logic circuits such as are encountered in digital computers. It incorporates 250 diodes and transistors, but very nearly all of these are the very cheap surplus silicon devices which are available for around 3d each. Had it not been for the availability of such semiconductor devices the clock would not have been economically feasible. Even with the very cheap devices incorporated it is still more expensive than an ordinary electric clock and its design is, of course, much more complicated. The total cost of all the components less the meters and cabinet is of the order of £14 at the time of writing.

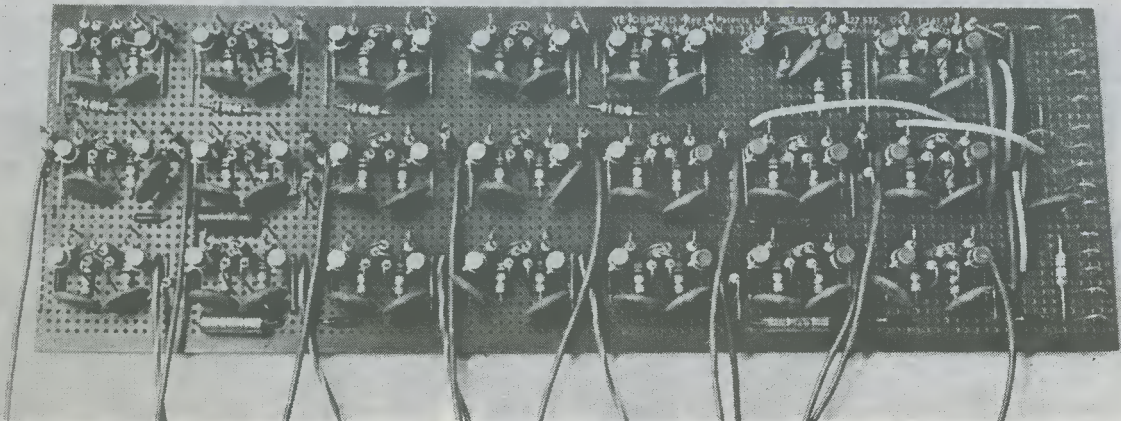

This board carries all the stages of Fig. 1 except binaries B21 to B25, and is identified as Board 1



# SOLID - STATE DIGITAL CLOCK

## Part 1

by A. J. EWINS

### COMPONENTS

- 25 bistable dividers
  - 1 reset monostable
  - 18 silicon diodes ( $D_1$ - $D_{18}$ )
  - 4  $10k\Omega$  resistors
  - 17  $100k\Omega$  resistors
  - 2  $820k\Omega$  resistors
  - 1  $0.01\mu F$  capacitor (disc ceramic, as small as possible)
  - 5  $0.02\mu F$  capacitors (disc ceramic, as small as possible)
  - 1 switch, s.p.s.t. toggle ( $S_1$ )
  - 4 push-button switches, closed when pressed ( $S_2$ - $S_5$ )
- (N.B. Separate Components Lists for the bistable dividers and reset monostable are given later).

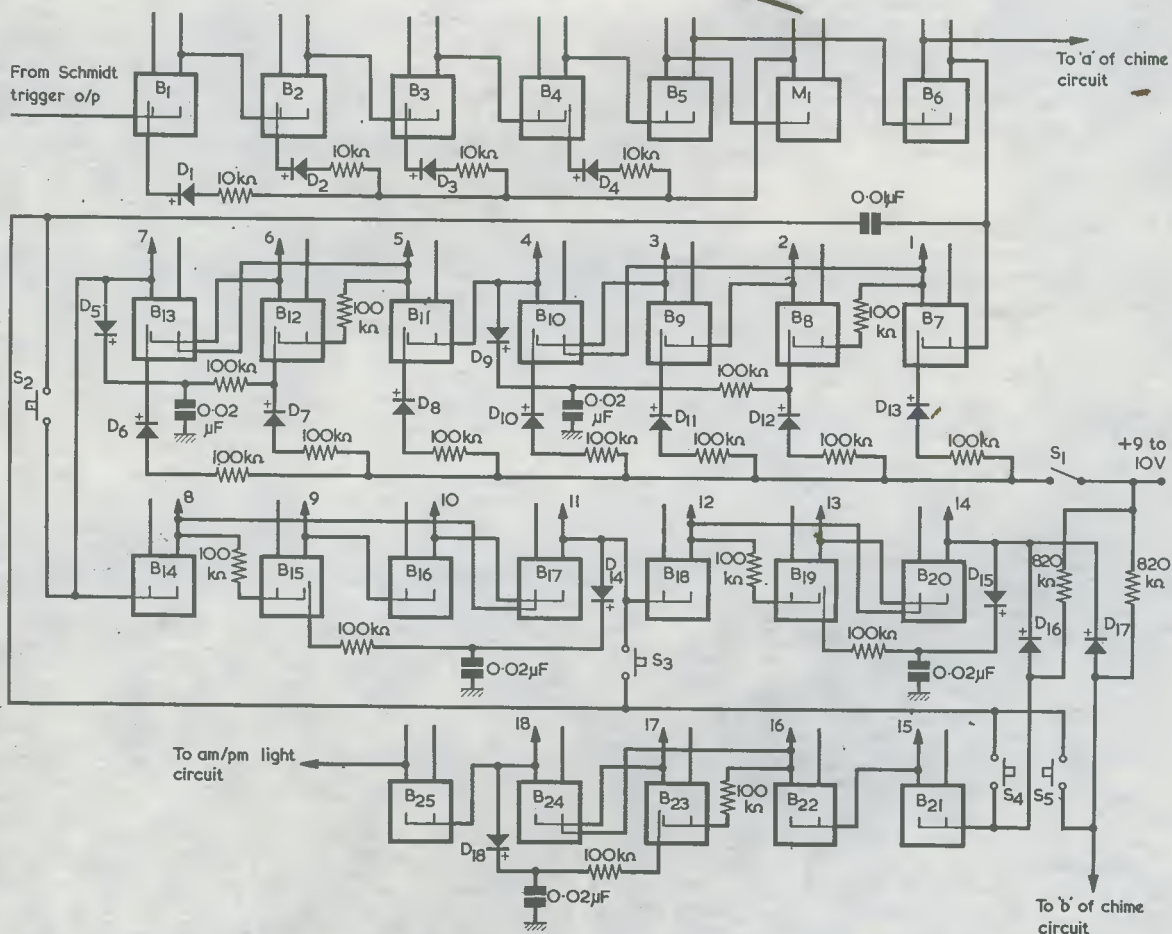

Fig. 1. The complete circuit of the time-keeping section of the clock. Circuit diagrams and descriptions of the bistables and monostables are given in next month's issue

The photograph of a completed version of the clock appears in one of the accompanying illustrations. In this photograph the left hand meter indicates hours, the centre meter tens-of-minutes and the right hand meter minutes. The circuit includes electronics for a meter to indicate seconds but this meter was not included in the particular cabinet shown. Cabinet dimensions are not critical and the meters are standard 0-1mA types, whereupon it is readily possible to incorporate the seconds meter in an alternative design. Above the two right hand meters is an illuminated panel having two separate sections identified as "AM" and "PM". Either of these sections is illuminated according to whether the time indicated is a.m. or p.m. respectively. Fitted to the small round aperture between the hours and tens-of-minutes meters is a moving-coil microphone insert which sound "chimes" at each hour, the number of "chimes" indicating the hour itself.

There are four small push-button switches in the lower part of the front panel. These are used for circuit reset and other requirements, as are described later.

Test instruments required for construction of this clock are a voltmeter with a sensitivity of 20,000 $\Omega$  per volt and, preferably, a simple oscilloscope. The latter is not, however, essential. Also required, if the transistors obtained are of the untested variety, is a simple  $h_{fe}$  checker. A suitable instrument is described this month.

So far as drawings and photographs are concerned, it will be necessary in succeeding parts to refer to drawings and illustrations which have appeared in earlier issues. All the issues should, in consequence, be retained, so that such references may be properly followed.

We shall now proceed to a description of circuit operation.

## THE BASIC CIRCUIT

The basic circuit of the digital clock is shown in Fig. 1. The Bistable Dividers (hereafter referred to as "binaries") and the Monostable are shown in block diagrammatic form only (they are shown in detail in later diagrams). The circuit of Fig. 1 can be described in five sections.

The first section divides the 50 c/s mains frequency output from the Schmitt trigger by 50, producing 1 second pulses at the output from binary B6. The binaries B1 to B6 and the reset monostable M1 form the building blocks of this section. Six binaries connected in series would normally divide by  $2^6=64$ . The introduction of the reset monostable enables the six binaries to skip 14 pulses in the following manner. If one considers that the outputs of all six binaries initially read zero, then after 15 pulses the six binaries will read, B1 to B6 respectively, 1, 1, 1, 1, 0, 0. On the sixteenth pulse, if the reset monostable is not connected, they will read 0, 0, 0, 0, 1, 0. However, with the reset monostable connected to the inverse output of B5 it is triggered on for approximately 10 msec as the state of B5 is changed over. The positive d.c. potential output from the monostable presets the binaries B1 to B4 with the result that after the sixteenth pulse has been fed into B1 the binaries B1 to B6 will read 1, 1, 1, 0, 1, 0. It now requires only a further nine pulses to be fed into B1 before the six binaries will read 0, 0, 0, 0, 0, 1. A further 25 pulses returns all outputs from the six binaries to zero with the result that a negative going pulse is obtained from the output of B6 for every 50 that are fed into B1. If a mains frequency of 50 c/s is fed into B1 then a negative going pulse is obtained every 1 second at the output of B6.

The output from B6 is fed into B7, which together with

the binaries B8 to B13 form the building blocks of the second section. This section divides by 60 to provide a negative going pulse every 1 minute from the output of B13, and provides outputs from the seven binaries, B7 to B13, which, when added together in a suitable manner, can "count", and provide a read-out for, 0-59 seconds. (As the read-out circuits are described in a later section, only the divide by 60 principle is discussed at this point.). The second section can be split up into two sub-sections, B7 to B10 and B11 to B13. The four binaries B7 to B10 divide by 10 and the three binaries B11 to B13 divide by 6. Considering the binaries B7 to B10 and ignoring the reset diodes  $D_{10}$  to  $D_{13}$  it will be seen that the four binaries are connected together in series but with some additional feedforward and feedback connections. The trigger inputs to the transistor bases of binary B10 are also kept separate instead of being connected together (this point is discussed later, when the binary dividers are described in detail). Consider initially that the outputs from the four binaries B7 to B10 all read zero, in other words, all four outputs are down at ground potential. After eight pulses have entered B7 the four binaries will read, from B7 to B10 respectively, 0, 0, 0, 1 (an output pulse from B7 does not affect B10 unless its output is "up", i.e. reading 1). After the ninth pulse the binaries will read 1, 0, 0, 1. On the tenth pulse the output from B7 returns the output of B10 to a zero and also tries to change the state of B8's output. However, the diode, capacitor, resistor feedback network from the output of B10 holds the output of B8 "down" at a zero. The 100k $\Omega$  resistor between the output of B7 and the input of B8 weakens the pulse from B7 in order that it should not over-ride the capacitor, diode, resistor feedback network from B10. It is also important that the time constant of the feedback network is larger than the time constant of the trigger input pulse, which is 1 msec (see later description of binary dividers). The capacitor of the feedback network is given a value of 0.02 $\mu$ F, giving a time constant of 2 msec with a feedback resistor value of 100k $\Omega$ .

The binaries B11 to B13 are made to divide by 6 in precisely the same manner as the binaries B7 to B10 are made to divide by 10. A similar feedback network holds down the output of B12 at the zero level during the sixth pulse so that all three binaries read zero after six pulses.

The diodes  $D_6$  to  $D_{13}$  and their associated 100k $\Omega$  resistors reset the outputs of the binaries B7 to B13 to zero when the switch  $S_1$  is closed. This provides a means of resetting the 0-59 seconds read-out to zero and of stopping the clock.

The output from B13 is fed into the third section of the clock which consists of binaries B14 to B20. These binaries, in addition to dividing by 60, provide outputs which when added together count and give read-outs for 0-9 minutes and 0-5 tens-of-minutes. B14 to B17 divide by 10 and provide the read-out for 0-9 minutes and B18 to B20 divide by 6, providing the read-out for 0-5 tens-of-minutes. An output pulse is obtained every hour from B20.

The output from B20 is fed into B21, which, together with the binaries B22 to B24, form the fourth section of the digital clock. These binaries count and provide a read-out for 0-11 hours (12 o'clock being the same as 0). B21 divides by 2 and B22 to B24 divide by 6, providing an overall division by 12. The output from B24, which is a pulse every half-day, operates the binary B25 which in turn operates the AM/PM light circuit. This part of the

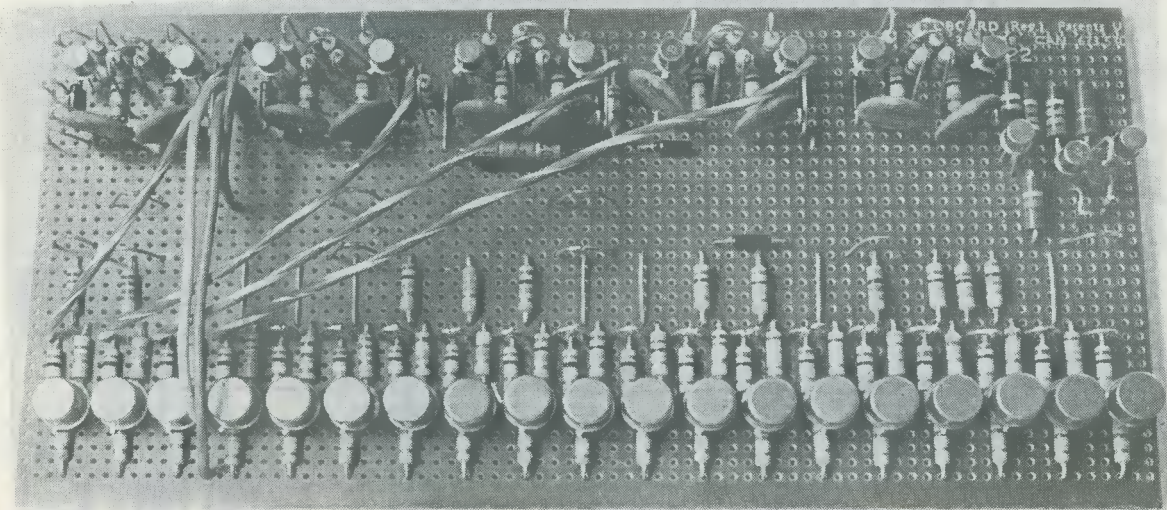

*Board 2. On this board are assembled binaries B21 to B25 and the AM/PM light circuit. The row of transistors at the bottom are in the digital to analogue read-out circuit*

circuit (described in detail later) indicates by means of two lit panels whether it is a.m. or p.m.

The push-button switches,  $S_2$  to  $S_4$ , enable the minutes, tens-of-minutes and the hours binaries to be connected to the 1-second pulses from the output of binary B6. With the switch  $S_1$  closed, (this stopping the clock and resetting the seconds read-out to zero but still allowing 1-second pulses to be obtained from B6) each of the push-button switches is depressed in turn, starting with  $S_2$ , so that the clock may be set to the right time. Switch  $S_5$  sets the Chime circuit to the right hour. Upon opening switch  $S_1$ , the clock is restarted.

The diodes  $D_{16}$  and  $D_{17}$  are necessary in order that any resetting of the hours does not interfere with the resetting of the chime circuit, and vice-versa. The  $820k\Omega$  resistors associated with  $D_{16}$  and  $D_{17}$  enable the input sides of the capacitors of the binaries B21 and BC1 (in the chime circuit) to return to a positive potential when the output of B20 reads 1, as would have been the case had they been connected directly to the output of B20.

#### THE CHIME CIRCUIT

Before describing the chime circuit (shown in Fig. 2) the task that it has to carry out must first be clearly understood. Basically the chime circuit must be able to store the time in hours and on receipt of a pulse, on the hour, count the hours that it holds stored, operating the oscillator (which acts as the chime) as it counts, and, finally, switch itself off when it has finished counting.

The binaries BH1 to BH4 count the hours in precisely the same way that binaries B21 to B24 of the basic circuit of Fig. 1 do. (In fact, the outputs from the binaries B21 to B24 of the basic circuit could possibly be used instead of the outputs from binaries BH1 to BH4 if an economy on components or space were to be effected). The binaries BS1 to BS4 count 0-11, as do BH1 to BH4, on receipt of one second pulses. The four comparators C1 to C4 compare the outputs of the four pairs of binaries BH1 and BS1, BH2 and BS2, BH3 and BS3, and BH4 and BS4.

The output from a comparator is zero when the outputs from the two binaries it is comparing are the same.

To understand the operation of the chime circuit let us consider that initially the time stored by the binaries BH1 to BH4 is, say, 6 o'clock, in which case the output from BH1 to BH4 will read 0, 1, 1, 0 respectively. Initially the output from BC1 is zero and the outputs from BC2 and the NAND gate are one. The outputs from the four binaries, BS1 to BS4 are also all zeros.

An output pulse, on the hour, from B20 of Fig. 1 changes the output of BC1 from 0 to 1, and the binaries BH1 to BH4 now store 7 o'clock, reading 1, 1, 1, 0 respectively. Simultaneously with a negative going "hour" pulse arriving at the inputs to binaries BC1 and BH1 a positive going "second" pulse arrives at the input to the NAND gate. As both inputs to the NAND gate are now one the output from the NAND goes down to zero, transmitting a negative going pulse to the inputs of BS1, BC2 and the oscillator. So long as the output from BC1 is a one the NAND gate is controlled by incoming "second" pulses, the output being zero when the input "second" pulse is positive, a one. Thus negative going pulses are transmitted to BS1 for as long as the output from BC1 is a one. The binaries BS1 to BS4 now proceed to store and count the number of "second" pulses fed into BS1. Simultaneously the oscillator is pulsed on and off for each "second" pulse that passes through the NAND gate. After seven pulses the binaries BS1 to BS4 will read the same as the binaries BH1 to BH4, thus the outputs from all four comparators will be zero. The output from BC2 is also zero, having been changed from a one to a zero when the first "second" pulse passed through the NAND gate. Hence five inputs to the OR gate now read zero and on the positive going "second" pulse returning to zero the output from the OR gate will go down to zero, triggering the monostable MC with a negative going pulse. MC in turn transmits a negative going pulse to BC1 and BC2, returning the output of BC1 to zero and the output of BC2 to a one. The

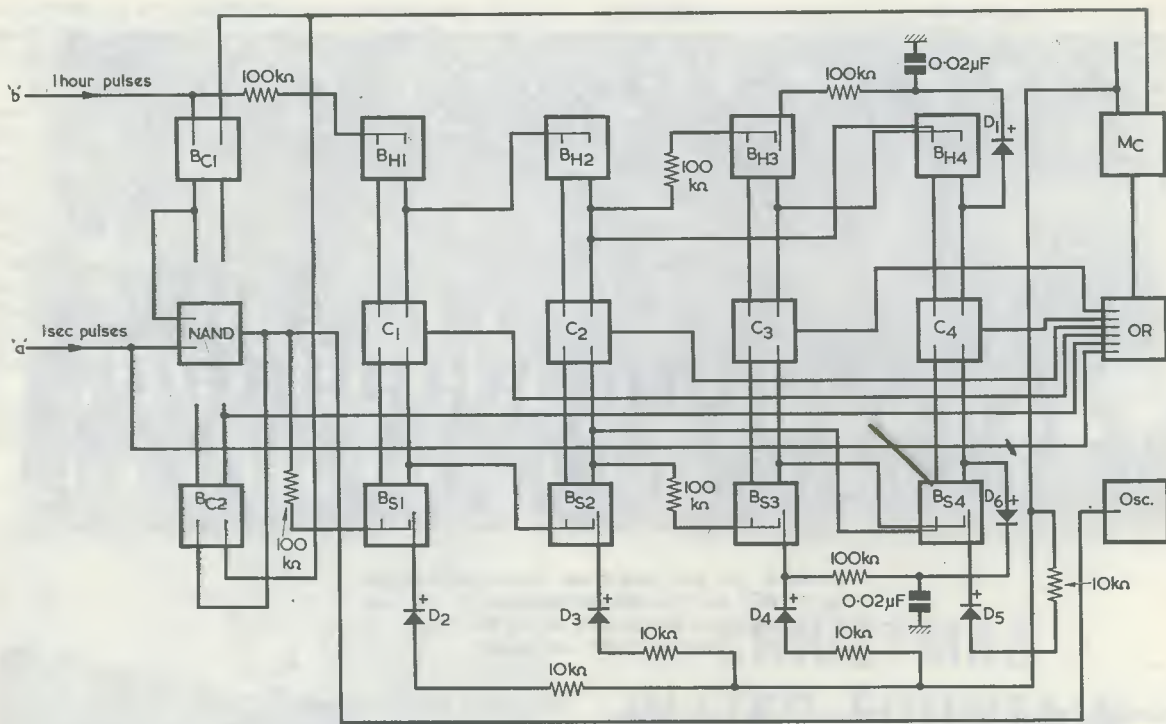

Fig. 2. The chime circuit. Again, block representation is used for the individual stages. These are described in detail in succeeding issues

zero output from BC1 prevents any further "second" pulses from passing through the NAND gate and thus shuts the chime circuit off until a further "hour" pulse is received at the input to binary BC1 and BH1. MC also transmits positive going pulses to the four binaries BS1 to BS4, which resets their outputs to zero's.

The reason for the inclusion of BC2 is to prevent the chime circuit from counting zero chimes for 12 o'clock. For the clock to read 12 o'clock all the binaries BH1 to BH4 must read zero. Thus, without BC2, the circuit would immediately switch itself off after being switched on, counting no chimes at all, since the binaries BS1 to BS4 also read zero initially. The output from BC2 is designed not to read zero until one "second" pulse has

entered the circuit, by which time the binaries BS1 to BS4 will have advanced from their zero positions. An additional eleven pulses is therefore necessary before they can again read zero.

Adding the positive "second" pulses to the inputs of the OR gate prevents the chime circuit from switching itself off immediately after the beginning of the last pulse, cutting short the last chime of the oscillator.

It is quite possible that as the positive "second" pulse arrives at the OR gate fractionally ahead of an "hour" pulse at BC1 and BH1 that the binary BC2 is made redundant, since the binaries BS1 to BS4 must read more than zero before the "second" pulse returns to zero. However, the binary BC2 was included in the circuit before it was realised that the addition of the positive "second" pulse to the OR gate input was necessary. The author, therefore, suggests that binary BC2 be included as a precautionary measure.

## COMPONENTS

- 10 bistable dividers
- 1 reset monostable
- 4 comparators
- 1 six-input OR gate
- 1 two-input NAND gate
- 1 oscillator

N.B. Separate Components Lists for the items above are given later).

- 4 10kΩ resistors
- 6 100kΩ resistors
- 2 0.02μF capacitors (disc ceramic, as small as possible)
- 6 silicon diodes (D<sub>1</sub>-D<sub>6</sub>)

## NOTES ON COMPONENTS

A master Components List for all the electronic items required for the clock accompanies this article. Also given, with each circuit diagram, is a Components List applying to that diagram only. These individual Components Lists are all part of the master Components List.

A very large number of semiconductors are required for the clock. Dealing first with the diodes, unless otherwise specified these are all silicon planar types obtainable as surplus components from firms specialising in this particular market and advertising in *The Radio Constructor*. At the time of writing these diodes were available, untested, at 40 for 10s. A total of 126 of these



diodes is required for the clock, and they are referred to, in the individual Components Lists, as "silicon diodes". They should be tested before use, and should offer a

## COMPONENTS

Master list

(N.B. See text for details on components listed below.)

### Resistors

1	150 $\Omega$	1	22k $\Omega$
1	680 $\Omega$	3	24k $\Omega$
1	820 $\Omega$	1	27k $\Omega$
1	1k $\Omega$	3	33k $\Omega$
1	1.5k $\Omega$	1	43k $\Omega$
1	2k $\Omega$	16	47k $\Omega$
1	2.2k $\Omega$	1	62k $\Omega$
2	2.7k $\Omega$	1	91k $\Omega$
1	3k $\Omega$	197	100k $\Omega$
2	3.3k $\Omega$	1	130k $\Omega$
1	4.3k $\Omega$	1	240k $\Omega$
2	4.7k $\Omega$	5	330k $\Omega$
3	5.1k $\Omega$	1	510k $\Omega$
2	5.6k $\Omega$	95	820k $\Omega$
1	8.2k $\Omega$	1	2k $\Omega$ potentiometer, pre-set, linear
98	10k $\Omega$		
1	11k $\Omega$		
1	12k $\Omega$		
1	13k $\Omega$		
1	15k $\Omega$		
5	20k $\Omega$		

### Capacitors

73	0.01 $\mu$ F disc ceramic (as small as possible)
10	0.02 $\mu$ F disc ceramic (as small as possible)
2	0.1 $\mu$ F (as small as possible)
1	0.47 $\mu$ F
3	10 $\mu$ F electrolytic, 12V wkg.
2	25 $\mu$ F electrolytic, 12V wkg.
1	500 $\mu$ F electrolytic, 20V wkg.

### Transistors

104	n.p.n. silicon planar, $h_{fe}$ greater than 20
2	n.p.n. silicon planar, $h_{fe}$ greater than 60
3	n.p.n. silicon planar, $h_{fe}$ greater than 100
1	p.n.p. OC200
1	p.n.p. OC36

### Diodes

126	silicon planar diodes
6	silicon rectifier diodes, 250mA, p.i.v. greater than 40V (e.g. Lucas DD000)
1	zener diode, 6.2 volts, 250mW

### Miscellaneous

4	push-to-make press-buttons
1	single pole toggle switch
4	0-1mA meters
2	6V 0.04A bulbs
2	bulb-holders, m.e.s., clip-on
1	moving coil microphone insert (See text)
1	Mains transformer, Douglas MT112AT, G. W. Smith & Co., 3 Lisle Street, London, W.C.2.
2	sheets Veroboard, 0.1in matrix, 17.9 x 3 $\frac{3}{4}$ in. Copper strips parallel with longer side. (See text)

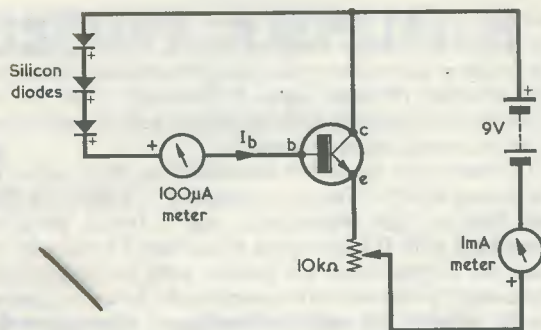

Fig. 3. A simple test circuit for n.p.n. transistors. The 10k $\Omega$  variable resistor should be set to maximum resistance before inserting a transistor

reverse current of very much less than 1 $\mu$ A when checked with a voltage not less than 10 volts.

Except where specified, the transistors used throughout were surplus n.p.n. silicon planar types of the TO-18 or TO-5 variety, available from the same retail source as the diodes. Untested ones were also available at about the same price. The clock employs 104 of these transistors, and the circuits in which they are used are designed to give satisfactory operation with transistors having a minimum  $h_{fe}$  of 20 at 1mA. They should also have an  $I_{ceo}$  of very much less than 1 $\mu$ A at a voltage not less than 10 volts. In the individual Components Lists these transistors are referred to as "silicon planar transistors". A point to bear in mind is that some transistors in this category have the metal can common to one of the electrodes, and that it is, in consequence, necessary to take the appropriate precautions against short-circuits during wiring.

Also required are 2 n.p.n. silicon planar transistors with an  $h_{fe}$  greater than 60. These may be BC168 or equivalent. 3 further silicon planar transistors with  $h_{fe}$  greater than 100 are needed, and they can also be BC168 or equivalent. The two remaining transistors in the clock are OC36 and OC200.

A suitable test circuit for the transistors is given in Fig. 3, the 10k $\Omega$  variable resistor being set up for an emitter current reading of 1mA. The gain of the transistor under test is then given by  $(1mA/I_b)-1$ .

All the resistors used in the prototype were  $\frac{1}{4}$  watt 5% carbon film types.

The majority of the capacitors were disc ceramics of about  $\frac{3}{8}$ in diameter. As a large quantity of these is required it is possible that some retailers may be prepared to give some kind of discount.

If any difficulty is experienced in obtaining the 6V 0.04A lamps, these are usually available at Woolworth's stores. They are normally used as rear lamps in bicycle dynamo systems.

The master Components List includes four 1mA moving-coil meters, these providing the read-out facility. At this stage, it is difficult to quote specific components by make and type number because of varying dimensions, which will have considerable effect upon final cabinet design. Also, some constructors may prefer to use three meters only, one of these doubling both for hours and

seconds read-out. Since these points are fully discussed in the later parts in this series of articles, including Part 4, the reader is advised to read these parts before making his final selection of meter types. Fortunately, there are no difficulties in obtaining suitable meters with the minimum of delay through normal channels.

The prototype clock was assembled on three pieces of Veroboard with 0.1in matrix measuring 11 x 3 $\frac{3}{4}$ in, 7 $\frac{1}{2}$  x 3 $\frac{3}{4}$ in and 10 $\frac{1}{8}$ in x 3 $\frac{3}{4}$ in respectively, and a fourth piece of Veroboard with 0.15in matrix measuring 2 x 6 $\frac{1}{2}$ in. In all cases, the copper strips are parallel with the longer side. The assembly on the fourth board could, however, just as readily be made up on 0.1in Veroboard, whereupon the whole Veroboard requirements for the clock can be provided by two large boards of 0.1in matrix measuring 17.9 x 3 $\frac{3}{4}$ in. These may be obtained from Service Trading Co., 9 Little Newport Street, London, W.C.2.

The microphone insert specified in the Components List is used as a miniature loudspeaker to reproduce the output of the chime oscillator. It is available in impedances of 50Ω or 100Ω (either is satisfactory) from West End

Electronics Co., 14 Lisle Street, London, W.C.2. Although not checked by the writer, a miniature 80Ω speaker should serve equally well.

As a final point, several extra resistors will be required to provide "trimming" in the read-out circuit and, perhaps, the power supply circuit. Their values have to be found experimentally and so they cannot be quoted in the Components List.

#### Kit Suppliers

There are two retailers providing kits for this project: Messrs. Bi-Pak Semiconductors, 500 Chesham House, 150 Regent Street, London, W.1. Bi-Pre-Pak Ltd., 222-224 West Road, Westcliff-on-Sea, Essex.

Details will be found on pages 273 and 279 respectively.

#### NEXT MONTH

A technical description of the individual stages will be given in Part 2, to be published next month.

(To be continued)

### "AUDIO DIARY 69"

A useful diary for the audiophile is the "Audio Diary 69" now published by Link House Publications Ltd., Link House, Dingwall Avenue, Croydon, CR9 2TA. With a page size of 2 $\frac{1}{2}$  by 4 in., this provides 68 pages of information on hi-fi topics in addition to the normal facilities provided by a diary (Underground map, etc.) The wide range of contents include an index of composers, note/frequency tables, speaker cross-over network values, tape equalisation curves and a glossary of audio terms. The "Audio Diary 69" is available at 8/6d. post-free direct from the publishers.

CROSSWORD

SOLUTION

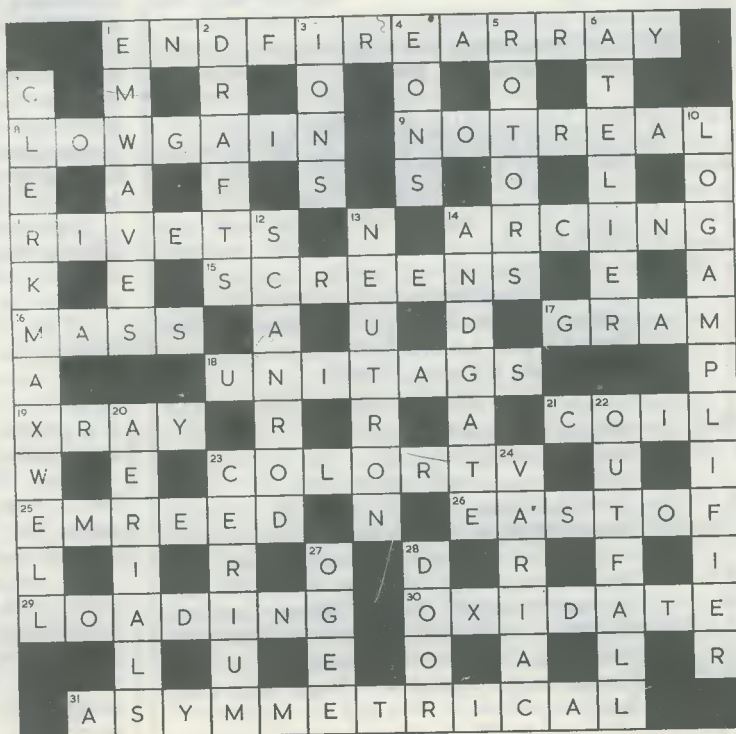

# WIDE-BAND OSCILLOSCOPE AMPLIFIER

by  
**G. SOWERSBY**

**Extend the sensitivity and high frequency performance of your oscilloscope with this simple low-cost amplifier, which can be set up to provide a gain of 100 or more. A particularly attractive feature is the use of an f.e.t. in the first stage to provide high input impedance**

**M**ANY LOW PRICED OSCILLOSCOPES ARE AVAILABLE with a reasonable bandwidth of some 3 to 5 Mc/s and gains up to, say, 100mV/cm. With higher gains (if provided) the bandwidth is often reduced, sometimes to as low as 100 kc/s. Where it is necessary to look at low amplitude high frequency signals, for example in radio r.f. and i.f. amplifiers, such oscilloscopes are useless; whilst the oscilloscopes which can carry out these functions adequately are usually quite expensive.

There are many people who already possess a low gain oscilloscope, such as radio enthusiasts and school groups, etc. The addition of the amplifier to be described here can convert an oscilloscope of this type into a much more versatile instrument.

## DESIGN REQUIREMENTS

The prototype amplifier was designed to have a

bandwidth of 50 c/s to 5 Mc/s  $\pm$  1dB, and a gain of 100. It was intended to feed into an oscilloscope having a maximum gain of 100mV/cm, thus increasing the overall gain to 1mV/cm. A separate transistor amplifier was envisaged, this being battery powered to eliminate hum pick-up troubles. Since a small PP3 battery will last a long time when used with the amplifier, a mains supply, with its attendant problems, is not necessary.

The first stage of the amplifier, whose circuit is given in the accompanying diagram, employs a cheap field effect transistor type 2N3819 which is easily obtainable at low cost. This is employed as a source follower to give a high impedance low capacitance input, and to act as an impedance converter to feed into the following transistor.

The next two stages use OC171 transistors with low impedance collector loads and negative feedback in the form of a variable 3k $\Omega$  resistor, R<sub>7</sub>, strapped across the two collectors. R<sub>7</sub> controls the gain of these two stages

(continued on page 317)

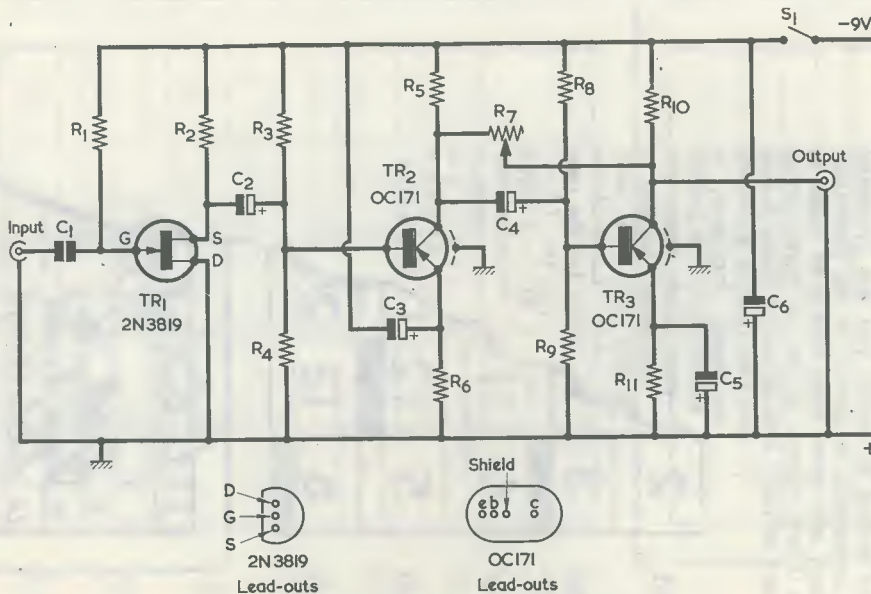

The circuit of the wide-band oscilloscope amplifier

## HOW TO MAKE FULL USE OF YOUR DIARY

Underline the dates of both personal and radio events in which you are interested or concerned, as shown in the illustration below, and enter brief details of these in the Diary Notes. A list of forthcoming events of radio interest taking place during the first quarter (January to March inclusive) is shown alongside. Detach your Diary from the magazine and affix to the workshop wall.

An Easy-View diary for the next quarter (April to June 1969 inclusive) will be published in the March issue.

Tues	2					
Wed	3					
Thur	4	11				
Fri	5	12				
Sat	6	13	20			

3	4 <sup>th</sup> Birthday 21
6	R.S.B. Feb 24
7	Band contest
12	Labels A.C.H.
14	Mobile Rally 28 March

## SUGGESTIONS FOR YOUR EASY-VIEW DIARY

### JANUARY

- 5 \* Top Band Trans-Atlantic Test. 0500-0730 GMT.
- 11 / Top Band Trans-Pacific Test. 1330-1600 GMT.
- 12 \* Top Band Trans-Atlantic Test. 0500-0730 GMT.
- 18-19 Louisiana (USA) OSO Party
- 24-26 Old Timers (USA) OSO Party
- 25-26 REF CW Contest
- 25-26 CQ WW 160 CW Contest

### FEBRUARY

- 1 / Top Band Trans-Pacific Test. 1330-1600 GMT.
- 2 \* Top Band Trans-Atlantic Test. 0500-0730 GMT.
- 15 / Top Band Trans-Pacific Test. 1330-1600 GMT.
- 16 \* Top Band Trans-Atlantic Test. 0500-0730 GMT.
- 22-23 REF Phone Contest

### MARCH

- 2 \* Top Band Trans-Atlantic Test. 0500-0730 GMT.

### Tests arranged by W1BB

**\*Top Band Trans-Atlantic Tests.** Frequencies—1800-1820 kc/s (E. Coast/W/VE); 1975-2000 kc/s (W. coast W/VE); 1823-1830 kc/s and 1851-1861 kc/s European stations. Call "CQ DX Test" alternate 5 minute periods—W's 1st, 3rd, 5th, 7th etc. Europeans 2nd, 4th, 6th periods. 2nd February Test is for "First Timer's" (European) and 5th January, 2nd March is for American "First Timer's".

**Top Band Trans-Pacific Tests.** Frequencies additional to the above are—1907.5-1912.5 kc/s for JA's; around 1876 kc/s for ZL's and around 1802 kc/s for VK's. Time periods as previous with W/VE's calling first.





We wish  
all our  
readers  
a  
very Happy  
Christmas  
and  
a Prosperous  
New  
Year—Editor

... must remember to be careful here. This is where that electronic kid lives with his perishing early warning system!

- ★ Set 3 Wording—WHITE
- ★ Set 4 Wording—BLACK
- 6 Sheets, over 1,000 words etc.
- ★ Set 5 DIALS—clear background
- ★ Set 6 DIALS—black background

**YOUR FINISHED ASSEMBLY  
DESERVES A REALLY  
PROFESSIONAL FINISH  
-USE 'CONSTRUCTOR'  
PANEL SIGNS  
PERMANENT PAINT  
TRANSFERS**

4/6 per set (postage 3d)

Send to:  
DATA PUBLICATIONS LTD., 57 MAIDA VALE, LONDON, W.9

## WIDEBAND OSCILLOSCOPE AMPLIFIER

(continued from page 313)

and can be either preset or a normal variable component. In the original it was preset, and was adjusted to give an overall gain of 100. The emitter decoupling from TR<sub>2</sub> is returned to the negative supply rail to make the amplifier as stable as possible. With the gain turned fully up there is no tendency to self-oscillation.

2 x 2 x 6in steel conduit box with detachable rear. This gave ample room, also, for the battery and on-off switch. Layout is not critical, and the only point to be careful about is to keep the input and output leads as far apart as is convenient. The terminations used were coaxial sockets bolted to the steel box. The gain control, R<sub>7</sub>, can be a potentiometer mounted on the box with an external knob or a slider preset soldered on the Veroboard and enclosed.

As tested with various OC171's, the minimum gain was 130. The trace thickness (caused by transistor noise) with the worst transistors tried, and with the input open-circuit, was no more than approximately 1mm, which is quite reasonable.

### COMPONENTS

#### Resistors

(All fixed values  $\frac{1}{4}$  watt 10%)

R <sub>1</sub>	1M $\Omega$
R <sub>2</sub>	1k $\Omega$
R <sub>3</sub>	56k $\Omega$
R <sub>4</sub>	10k $\Omega$
R <sub>5</sub>	680 $\Omega$
R <sub>6</sub>	680 $\Omega$
R <sub>7</sub>	3k $\Omega$ potentiometer, linear (see text)
R <sub>8</sub>	56k $\Omega$
R <sub>9</sub>	15k $\Omega$
R <sub>10</sub>	680 $\Omega$
R <sub>11</sub>	680 $\Omega$

#### Capacitors

C <sub>1</sub>	0.1 $\mu$ F
C <sub>2</sub>	100 $\mu$ F electrolytic, 9V wkg.
C <sub>3</sub>	1,000 $\mu$ F electrolytic, 9V wkg.
C <sub>4</sub>	100 $\mu$ F electrolytic, 9V wkg.
C <sub>5</sub>	1,000 $\mu$ F electrolytic, 6V wkg.
C <sub>6</sub>	2,000 $\mu$ F electrolytic, 9V wkg.

#### Transistors

TR <sub>1</sub>	2N3819
TR <sub>2</sub>	OC171
TR <sub>3</sub>	OC171

#### Switch

S <sub>1</sub>	s.p.s.t., on-off
----------------	------------------

#### Miscellaneous

	2 coaxial sockets
	9-volt battery

An isolating capacitor is not provided in the output as the oscilloscope to which the amplifier couples is set to the a.c. input position. If isolation is required, a 0.25 $\mu$ F capacitor can be inserted between the collector of TR<sub>3</sub> and the output socket.

The prototype was built on Veroboard and mounted in a

Apart from an occasional battery change the original has given good service for over a year with no faults or deterioration in performance, even though it has had some rough usage.



### HEATHKIT CATALOGUE for 1968/69

Now available from Daystrom Ltd. is the new Heathkit catalogue for 1968/69. Published in a larger format (8 $\frac{1}{4}$  x 11 $\frac{3}{4}$ in.) than previous editions, the catalogue is in full colour and has 36 pages. Listed are many new editions to the well established existing Heathkit range of kits for assembly at home or in the school or laboratory, and a very wide range of user requirements is catered for.

Listed under General Products are such items as communications receivers, a car radio, a stereo tape recorder and a guitar amplifier. A section devoted to high fidelity reproduction includes everything for a hi-fi installation from turntables, cartridges and tuners to loudspeaker systems. Among the test equipment available are multimeters, signal generators and oscilloscopes, whilst the amateur radio section embraces all that an amateur would normally need, from an electronic keyer through transmitters and receivers to s.w.r. bridges. Sophisticated laboratory and educational equipment is also listed and it is possible to obtain kits for a pH meter, an educational analogue computer and many other items of like application.

The 1968/69 Heathkit Catalogue will be forwarded, free, to any reader of *The Radio Constructor* who writes to Daystrom Ltd. at Gloucester.

# 150 WATT AMATEUR BANDSTRANSMITTER

## Part 2

by

F. G. RAYER, G3OGR

In this second article, our contributor describes the v.f.o. and buffer section of this very successful design. Next month's concluding article will discuss suitable modulator units

**T**HOUGH THE VARIABLE FREQUENCY OSCILLATOR WHICH forms the subject of this month's article was originally intended for use with the 150 watt driver/p.a. described last month, it is suitable for most other driver/p.a. stages in the 3.5–28 Mc/s range as well.

Fig. 1 shows the circuit. In this,  $L_1$  tunes from 1.75–1.9 Mc/s, for the 3.5–3.8 Mc/s band.  $L_2$  covers 7.0–7.2 Mc/s, for the 7.0–7.1 Mc/s band, and also 14.0–14.4 Mc/s for the 14.0–14.35 Mc/s band by doubling. (The circuit is also satisfactory for 21 Mc/s and 28 Mc/s bands, though coverage on the latter is limited to 28–28.8 Mc/s.)

H.T. to the v.f.o. stage is regulated by the VR150/30, and switched off by  $S_2$  for optional crystal control. The latter was provided to allow frequency checking, but can be excluded if wished by omitting  $C_{10}$ ,  $C_{11}$ , RFC<sub>2</sub> and the 2-pole 2-way switch,  $S_2$ . The cathode of  $V_3$  then connects direct to chassis. If crystals are used, the crystal oscillator ( $V_3$ ) anode may be tuned to the fundamental or harmonics

of the crystal frequency.

$L_3$  is in use for 7 Mc/s and 14 Mc/s bands, and is resonant at about 7.1 Mc/s.  $L_4$  is resonant at about 1.8 Mc/s, for 80m, with doubling in the driver of the driver/p.a. unit.

### VALVE TYPES

The 6AG7 used for  $V_3$  is particularly suitable for r.f. and doubler circuits, whilst audio valves such as the 6V6 are unsatisfactory. The 6AG7 is not difficult to obtain. The same circuit has proved to be satisfactory using miniature valves—a 6C4 (in a screening can) for the v.f.o. and a 5763 for buffer.

A 400 to 500V supply is shown as this was used, but a lower voltage is satisfactory, and 300V will be adequate.  $R_2$  can then be reduced to 10k $\Omega$  3 watt, and  $R_3$  to 1k $\Omega$  or 470 $\Omega$  1 watt.

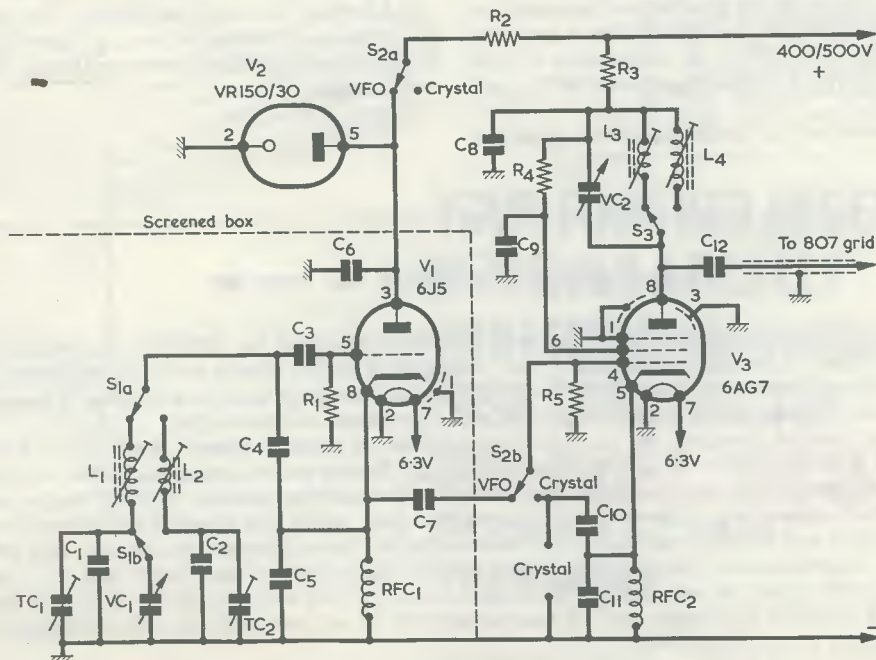

Fig. 1. Circuit of the 2-band v.f.o. for 80, 40 and 20 metres



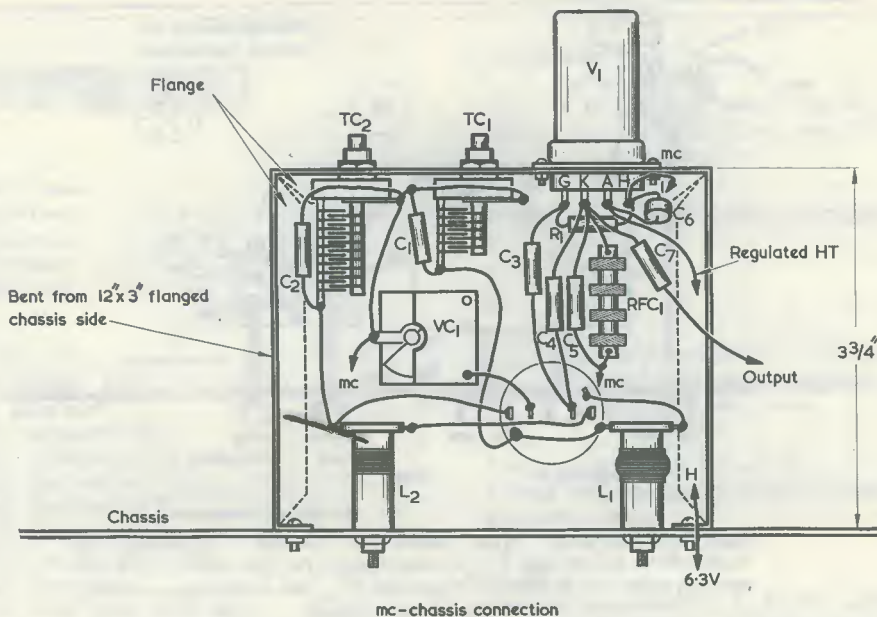

Fig. 2. Layout and wiring in the v.f.o. box as seen from rear. Pin connections to  $V_1$  should be as shown in Fig. 1

The 6AG7 may be used on its own, if desired, as crystal oscillator, and will give output on the crystal frequency, or 2x, 3x and 4x this. Given crystals can then allow more working frequencies than when using the 807 of the driver p.a. unit as crystal oscillator. A crystal also allows a quick check on receiver calibration or on v.f.o. tuning, by leaving the receiver untouched and switching from crystal to v.f.o.

#### COILS

$L_1$  consists of 55 turns of 32 s.w.g. enamelled wire, in a pile  $\frac{1}{4}$ in wide on a  $\frac{1}{2}$ in diameter former. The turns are doped after winding.  $L_2$  has 12 turns close-wound of 24 s.w.g. enamelled wire, on a similar former. A little adhesive is applied before winding. Other coils adjusted for similar coverage would do. Both  $L_1$  and  $L_2$  are fitted with adjustable iron dust cores.

$TC_1$  and  $TC_2$  are small short wave air spaced variable capacitors of the type shown in Fig. 2. The values of  $TC_1$  plus  $C_1$ , or  $TC_2$  plus  $C_2$ , can be changed slightly if alternative components are to hand, provided that the combined capacitance in each case gives satisfactory band coverage.

$L_3$  can be any small coil resonant around 7.1 Mc/s. That used by the author had 28 turns of 26 s.w.g. enamelled wire close-wound on a  $\frac{1}{2}$ in diameter former with adjustable core.  $L_4$  is a medium wave tuning coil, with unwanted coupling windings removed and its core screwed out a little to give resonance around 160m.

*Internal view of the components inside the v.f.o. box*

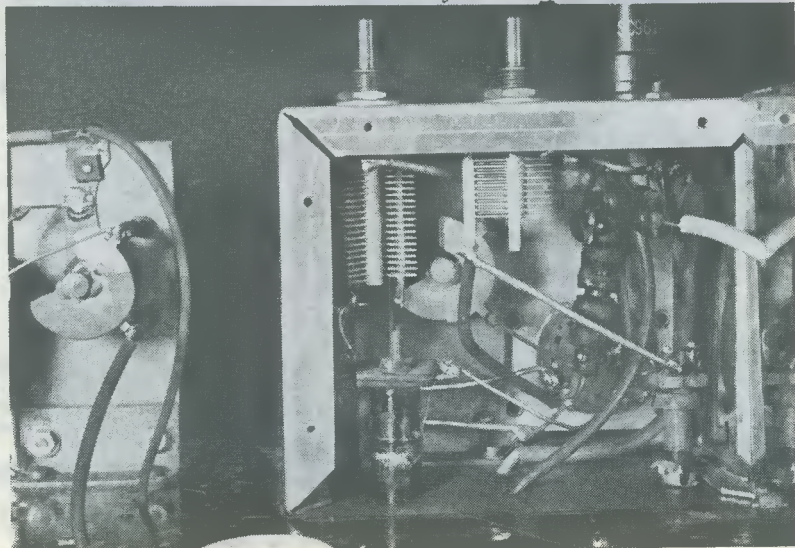

coupling windings removed and its core screwed out a little to give resonance around 160m.

When construction is finished calibration of the v.f.o. is easily carried out by beating its output against harmonics of a 100 kc/s crystal marker, tuning in the wanted 100 kc/s harmonic on a receiver. By adjusting  $L_1$  core and  $TC_1$ , suitable band coverage is obtained for 3.5-3.8 Mc/s.  $L_2$  and  $TC_2$  are similarly adjusted for the higher frequency bands.

The cores of  $L_3$  and  $L_4$  are set for maximum grid current in the p.a. stage, with  $VC_2$  nearly open, whereupon little further adjustment of  $VC_2$  will be needed.

#### POINTS ON CONSTRUCTION

All components in the v.f.o. stage (excluding the valve) are in a screened box  $3\frac{1}{2}$ in high,  $4\frac{1}{2}$ in wide and 3in deep. This was easily made by taking a 12 by 3in Universal

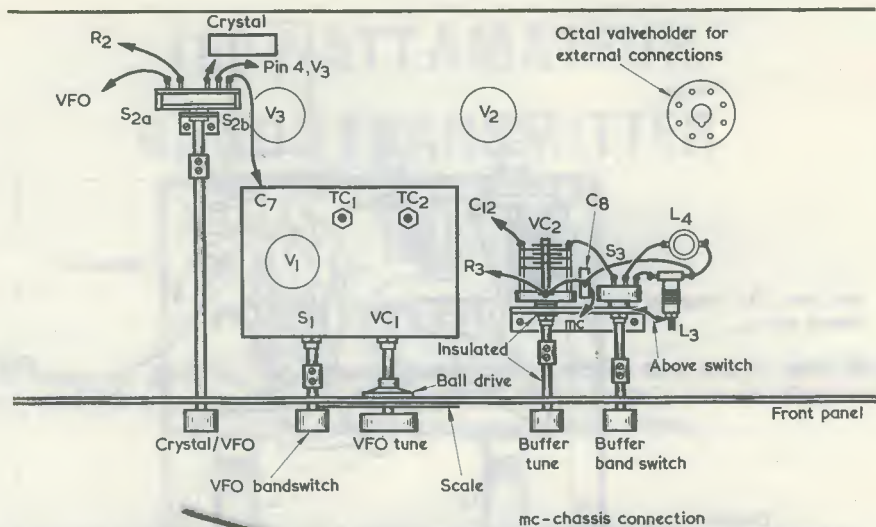

Fig. 3. Component layout above the chassis. Connections to components below (see Fig. 4) and in the v.f.o. box should be taken through adequate grommets. Note that  $VC_2$  has its spindle and bush insulated from chassis

Chassis flanged side (Home Radio Cat. No. CU152) and cutting 90-degree sections out of the flanges  $3\frac{3}{4}$ in from each end. The member is then bent to produce the  $3\frac{3}{4}$ in high sides and  $4\frac{1}{2}$ in top of the box, as may be seen from Fig. 2. Front and back are later closed with flat metal plates, each  $3\frac{3}{4}$ in by  $4\frac{1}{2}$ in. The manner in which the v.f.o. screened box is mounted on the chassis, relative to the front panel of the v.f.o. section of the transmitter, may be seen in Fig. 3.

The v.f.o. valve is a "metal" type, and it stands on top of the v.f.o. box to keep heat away from the v.f.o. components. Its metal shell, pin 1, is earthed to chassis. If a glass 6J5 is used, it must be provided with a screening can. The v.f.o. is assembled and wired without the back plate and before the box is mounted on the chassis.

A ball drive, with pointer for calibration, is employed with  $VC_1$ , and an extension spindle will probably be required on the bandswitch,  $S_1$ . Leads are all short and stout.  $L_1$  and  $L_2$  are positioned so as to fix to the chassis

when the box is mounted.

The box is finally bolted in place by its flanges, and leads run out for anode,  $C_7$ , and heater connections. The back plate is secured with self-tapping screws.

#### V.F.O. BUFFER CHASSIS

Fig. 3 gives the layout used on top of the chassis. The v.f.o. box is spaced back a little from the panel.

The crystal v.f.o. switching and buffer anode switching are very straightforward, and involve no wiring problems.  $L_3$  was positioned immediately over switch  $S_3$ .  $VC_2$  is insulated from the chassis, and employs  $\frac{1}{4}$ in diameter insulated rod as extension spindle.

An octal valveholder accepts an octal plug and this provides h.t. and other connections, including the screened coaxial lead from  $C_{12}$  to the grid of the 807 in the driver/p.a. unit. This valveholder could, alternatively, be on the rear of a chassis or cabinet.

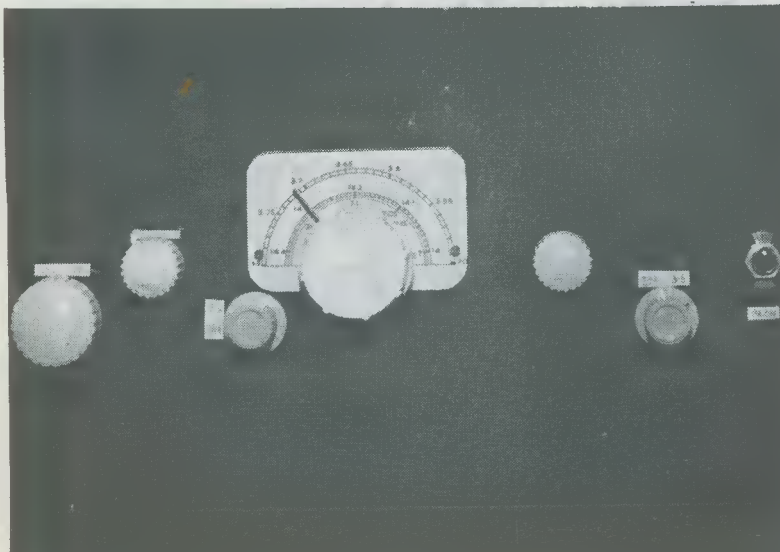

A  $2\frac{1}{2}$ in by  $3\frac{3}{4}$ in card scale was placed behind the ball drive pointer and calibrated as described. Perspex of similar size was then cut to go over the card, and secured with two 8BA countersunk bolts.

Components under the chassis are positioned as in Fig. 4. The crystal v.f.o. switch section  $S_2^{(a)}$  applies h.t. to the v.f.o. when this function is selected. Tag 6 of the VR150/30 valveholder is an anchor point for leads running to the h.t. contacts of  $S_2^{(a)}$ .

#### PANEL LAYOUT

The front panel layout can be seen in the accompanying photo-

Layout of the panel controls for the v.f.o./buffer section

## COMPONENTS

### Resistors

(All 10%)

R <sub>1</sub>	100kΩ 1 watt
R <sub>2</sub>	15kΩ 10 watt
R <sub>3</sub>	4.7kΩ 5 watt
R <sub>4</sub>	47kΩ 1 watt
R <sub>5</sub>	82kΩ 1 watt

### Capacitors

(All fixed capacitors 250V wkg. unless otherwise stated)

C <sub>1</sub>	100pF silver-mica 2%
C <sub>2</sub>	300pF silver-mica 2%
C <sub>3</sub>	100pF silver-mica
C <sub>4</sub>	470pF silver-mica 1%
C <sub>5</sub>	470pF silver-mica 1%
C <sub>6</sub>	0.01μF ceramic 500V wkg.
C <sub>7</sub>	100pF silver-mica
C <sub>8</sub>	0.01μF silver-mica 500V wkg.
C <sub>9</sub>	0.01μF silver-mica 500V wkg.
C <sub>10</sub>	20pF silver-mica (optional)
C <sub>11</sub>	200pF silver-mica (optional)
C <sub>12</sub>	100pF silver-mica 500V wkg.
TC <sub>1</sub>	75pF air-spaced, trimmer
TC <sub>2</sub>	100pF air-spaced, trimmer
VC <sub>1</sub>	75pF air-spaced, variable
VC <sub>2</sub>	25pF air-spaced, variable

### Inductors

L <sub>1</sub> , L <sub>2</sub> , L <sub>3</sub> , L <sub>4</sub>	see text
RFC <sub>1</sub>	2.6mH 100mA type RFC5 (Denco)
RFC <sub>2</sub>	2.6mH 100mA type RFC5 (Denco) (optional)

### Valves

(V <sub>1</sub> and V <sub>3</sub> should, preferably, be "metal" types)	
V <sub>1</sub>	6J5
V <sub>2</sub>	VR150/30
V <sub>3</sub>	6AG7

### Switches

S <sub>1(a)(b)</sub>	2-pole 2-way rotary
S <sub>2(a)(b)</sub>	2-pole 2-way rotary (optional)
S <sub>3</sub>	Single pole 2-way rotary

### Sockets

3 octal valveholders (for valves)	
1 octal valveholder (for external connections) or alternative socket	
1 crystal holder (optional)	

### Miscellaneous

4 spindle couplers (VC <sub>2</sub> , S <sub>1</sub> , S <sub>2</sub> , S <sub>3</sub> —see text)	
3 extension spindles and bushes (S <sub>1</sub> , S <sub>2</sub> , S <sub>3</sub> —see text)	
1 insulated extension spindle and bush (VC <sub>2</sub> )	
Insulated mounting washers (VC <sub>2</sub> )	
Knobs for controls (as required)	
Ball drive with cursor mount, Cat. No. 4511/F (Jackson Bros.)	
Metalwork, gommets, etc., as required	

graphs. From left to right, the controls appear in the following order: Transmit/Receive control (operating the Transmit/Receive switch at the rear of the transmitter above, by way of a crank and link), switch S<sub>2</sub>, switch S<sub>1</sub>, VC<sub>1</sub> (with calibrated scale), VC<sub>2</sub>, S<sub>3</sub>, and an on-off toggle switch which applies the mains to the p.a. h.t. transformer primary (see Fig. 7 of last month's article). To the right of this switch, and visible in the photograph showing the meter panel, is VR<sub>1</sub> of the driver/p.a. circuit, which varies the screen-grid voltage for the 807. Of the five meters on the meter panel, four carry out the functions of M<sub>1</sub> to M<sub>4</sub>

inclusive, as described last month. The fifth is optional and merely monitors the high voltage h.t. supply for the p.a. anode and screen-grid.

### NOTES ON WORKING

If the Transmit/Receive control circuit shown in Fig. 7 last month is employed, h.t. can be applied to the v.f.o., buffer and driver only, whilst tuning to a selected frequency and adjusting p.a. grid current. If an alternative driver/p.a. unit is used, a switch should be fitted so that p.a. anode and screen-grid voltages can be removed for tuning up.

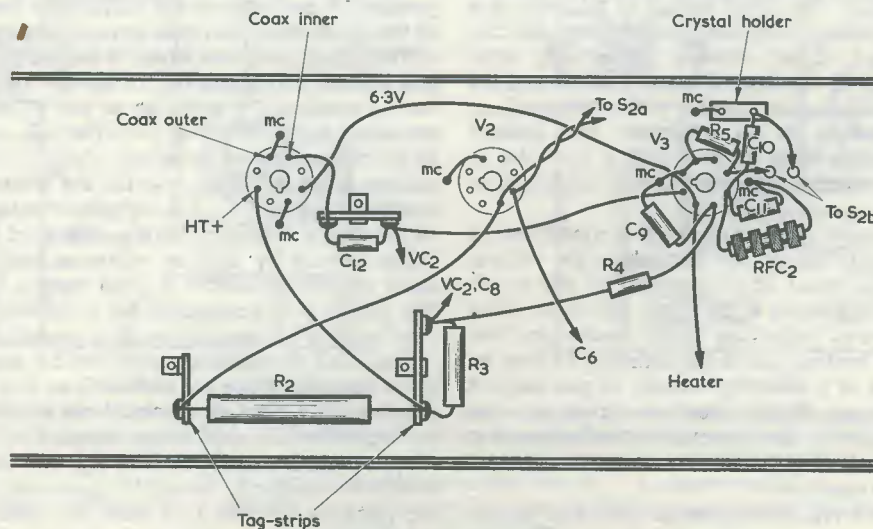

Fig. 4. Wiring and components below the chassis

The v.f.o., buffer and driver in the writer's transmitter were designed to provide the large grid current required by the 813. A p.a. consisting of a single 807 or 6146, or a pair of these valves, could be substituted. For a single 807

or 6146, about 2.5mA grid current will be usual, so a 250V receiver type h.t. supply would then easily prove adequate for the v.f.o., buffer and driver stages.

(To be concluded)

# UNDERSTANDING RADIO

## DETECTOR AND A.G.C.

$$f = \frac{1}{2\pi\sqrt{LC}}$$





by W. G. Morley

IN LAST MONTH'S ISSUE WE COMPLETED OUR DESCRIPTION of the i.f. amplifier then turned our attention to the superhet a.m. detector. We discussed a number of important basic points concerning this section of the receiver, including the positioning of the a.f. volume control when this appears in the detector circuit, and the necessity of keeping the detector d.c. and a.c. loads close to each other in value in order to prevent distortion.

We will next complete our examination of the detector, after which we shall consider automatic gain control.

### THE DOUBLE DIODE TRIODE

In the article published last month we saw how superhet a.m. detection could be carried out with the aid of a single diode. In valve superhets it is, however, uneconomic to use a single diode valve on its own for this function, since amplifying valves have been developed which incorporate one or more diodes in the same envelope as well. Typical of these is the double diode triode, whose circuit symbol is given in Fig. 1 (a). The triode section of this valve is a conventional a.f. voltage amplifier, and it is intended that it amplify the a.f. signal obtained immediately after detection. The two diodes share the same cathode and are intended for signal detection together with, as we shall see shortly, the provision of an automatic gain control voltage. For the time being we shall look at the valve in terms of signal detection and a.f. voltage amplification only.

So far as the double diode triode itself is concerned, its construction is quite simple. The cathode in the valve is mounted vertically, most of it appearing in the triode section, which is positioned at the upper end of the valve assembly. Two small cylindrical diode anodes are then fitted around the bottom end of the cathode. As may be imagined, the use of a common cathode in this manner enables a simple and effective electrode structure to be made up. Fortunately, the common cathode does not involve any difficulties so far as standard a.m. detector circuit design is concerned.

Fig. 1 (b) shows a typical superhet detector and voltage amplifier circuit incorporating a double diode triode. The

cathode is at chassis potential, whereupon the two diodes function in the same manner as did the single detector diode we saw last month. Incidentally, it is not necessary for *both* the diode anodes in Fig. 1 (b) to be connected together; a single diode anode on its own would function just as well in the detector circuit, whereupon the remaining anode would be unused and could be connected direct to chassis to prevent any unwanted static voltages appearing on it.

The detected a.f. voltage appears across volume control  $R_2$  and is then applied via  $C_3$  (which has negligible reactance at a.f.) to the grid of the triode. An amplified a.f. signal is produced at the anode and this is passed to the succeeding a.f. amplifier stage or stages in the receiver. In Fig. 1 (b) the triode is biased by grid current bias (dealt with in "Understanding Radio" in the October 1965 issue) whereupon its grid resistor  $R_3$  requires a high value, of the order of  $10M\Omega$  or more.

It should be noted that, if an a.f. volume control is to be inserted in the circuit of Fig. 1 (b), it *must* be in the  $R_2$  position. It cannot be in the  $R_3$  position because the grid of the triode would not then have the requisite high value of resistance to chassis which is needed to maintain the grid current bias condition. To have a volume control in the  $R_3$  position it is necessary to add a further blocking capacitor, as shown in Fig. 1 (c). Here,  $R_2$  and  $R_3$  appear in the detector circuit as before, whilst  $R_4$  is a high value resistor offering current bias for the triode. The second blocking capacitor,  $C_4$ , has negligible reactance at a.f. and its function is to prevent the bias voltage at the triode grid being reduced by the low resistance path between the slider of volume control  $R_3$  and chassis. The circuit of Fig. 1 (c) is quite practicable, but it suffers from the slight disadvantage of requiring an extra capacitor and resistor.

Fig. 1 (d) shows the detector and a.f. amplifier circuit given when the triode has cathode bias. It is interesting to note here that, since the double diode triode cathode now has a positive potential above chassis due to the voltage dropped across cathode resistor  $R_5$ , the lower end of the diode load resistor  $R_2$  cannot be connected to chassis as in the previous circuits. If it were the diode would only conduct when the positive half-cycles passed to its anode

from the i.f. transformer secondary exceeded the voltage on the diode cathode, with the results that detection could only occur with high amplitude signals and that the detected a.f. signal produced would, in any case, be heavily distorted. The lower end of  $R_2$  is, therefore, connected to the cathode of the double diode triode. A standard diode detector circuit is thus obtained, the only difference with what we have seen previously being that the diode cathode (which is bypassed to chassis for i.f. and a.f. signals by  $C_3$ ) happens to be a volt or so positive of the chassis. Detection takes place as before, the detected a.f. signal appearing across  $R_2$  and being passed on to the triode amplifier grid via  $C_3$ . In Fig. 1 (d), either  $R_2$  or  $R_3$  may be a volume control because it is not now necessary for the grid of the triode to have a high value of external resistance coupling it to chassis.

The circuits of Figs. 1 (b) to (d) represent those most commonly employed for a.m. detection using a double diode triode. An alternative type of amplifier valve incorporating diodes is the double diode pentode, in which two diodes and a pentode share a common cathode inside a single envelope. It is usual for the pentode to be employed as the i.f. amplifier feeding the last i.f. transformer primary, whilst the diode circuit is similar to those we have

just examined. Alternatively, the pentode may be employed as an a.f. voltage amplifier, whereupon it replaces the triode of the double diode triode. Because triode pentode valves incorporating an a.f. voltage amplifier triode and output pentode in a single envelope are available, an attractive proposition from the economic point of view is to have the pentode of the double diode pentode function as i.f. amplifier, giving thereby the *three-valve* superhet "line-up" shown in Fig. 2. As may be seen, this allows a complete superhet capable of meeting domestic requirements to be made up using three valves only. Quite a number of commercially made a.m. receivers using this "line-up" have been manufactured, with acceptable performance. Care has to be taken with component and wiring layout when the detector diodes appear in the same envelope as a pentode employed as i.f. amplifier. This is because it is necessary to keep stray capacitive couplings between the diode and pentode control grid circuits at a minimum as, since the diode circuits carry the i.f. signal at an amplified level, instability may otherwise occur.

#### VARIABLE-MU VALVES

When (in the March 1967 issue) we were dealing with

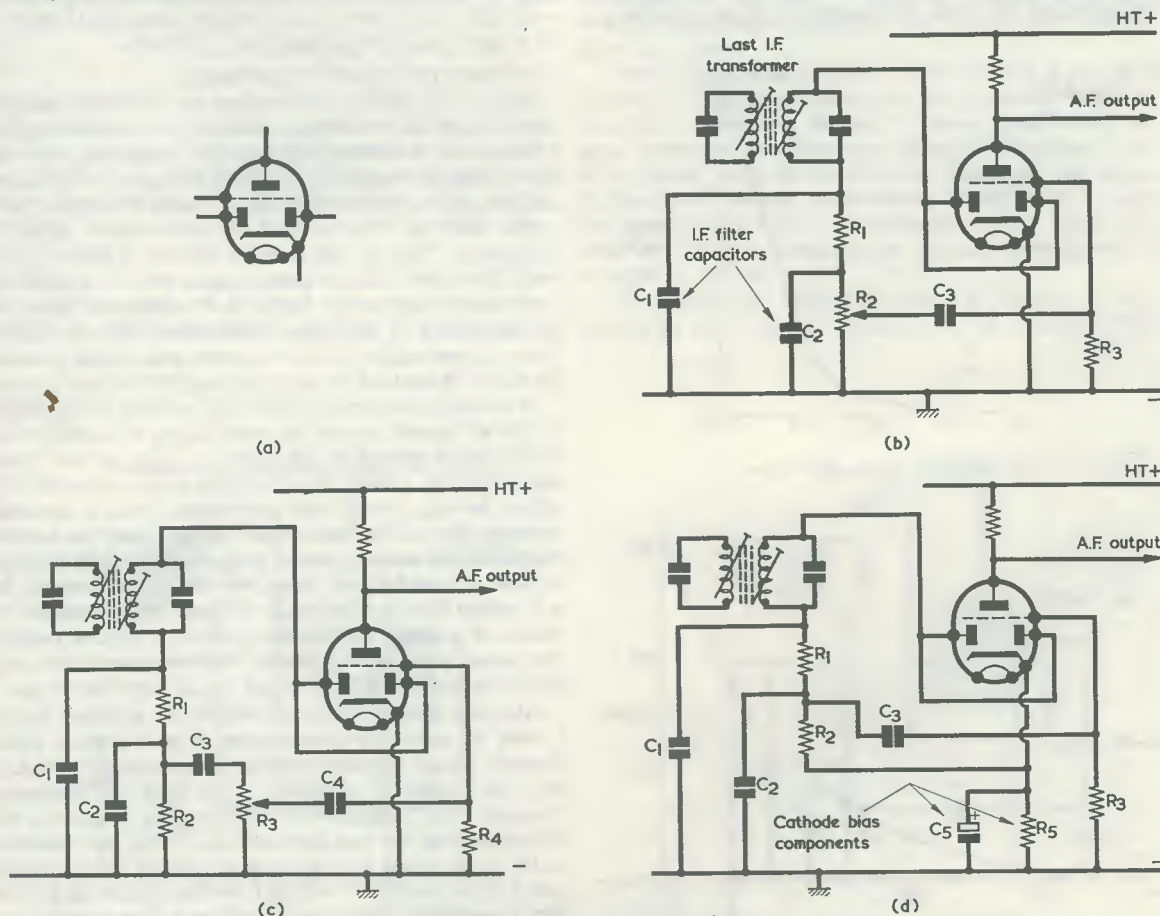
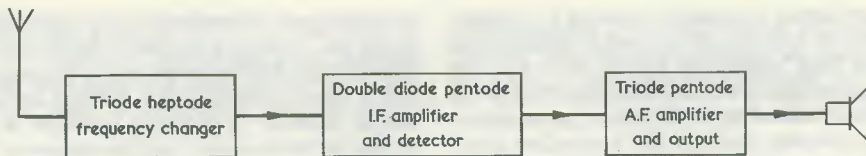

Fig. 1 (a). The circuit symbol for a double diode triode. In the symbol, the two diode anodes appear on either side of the cathode, with the triode section above  
 (b). A typical a.m. detector and a.f. amplifier circuit incorporating a double diode triode  
 (c). The circuit modifications required when  $R_3$  is a volume control  
 (d). A detector and amplifier circuit which can be used when the triode section has cathode bias. Either  $R_2$  or  $R_3$  may be a volume control



M621

Fig. 2. Stage line-up for a three valve a.m. superhet

voltage amplifier pentodes, we introduced what are described as *variable-mu* valves. We saw that these valves have variations in the spacing between the control grid wires along the length of the control grid assembly which makes it possible to control mutual conductance very readily by varying grid bias voltage. Fig. 3 (a) shows a typical  $I_a V_g$  characteristic for a normal r.f. pentode and Fig. 3 (b) that for a variable-mu r.f. pentode. It will be noted that the slope of the characteristic (and hence the mutual conductance) varies much more "smoothly" with change in grid voltage in Fig. 3 (b) than it does in Fig. 3 (a) and, also, that the grid cut-off point in Fig. 3 (b) is at a much greater negative potential than it is in Fig. 3 (a). As is demonstrated by these characteristics it is possible to

control mutual conductance by way of control grid bias voltage much more effectively with a variable-mu pentode than it is with a normal pentode.\*

As we shall see very shortly, variable-mu pentodes offer a particular advantage when used in a.m. superhets.

It is desirable, in a.m. valve superhets, for the frequency changer to be similarly capable of having its gain controlled by way of control-grid bias voltage. In this case the mixer section of the valve is designed such that a smoothly-changing variation in *conversion conductance* is given as the grid bias voltage is varied. In the ECH81, for instance, conversion conductance changes smoothly from about  $700\mu\text{A}$  per volt at a signal grid bias potential of  $-2$  volts (with respect to cathode) to around  $1\mu\text{A}$  per volt at a signal grid bias potential of  $-40$  volts.

#### AUTOMATIC GAIN CONTROL

The a.m. superhet, as described up to now, consists of an optional a.f. amplifier, a frequency changer stage, an i.f. amplifier, a detector stage, an a.f. voltage amplifier and the a.f. output stage. It offers a high degree of selectivity and sensitivity, but it suffers from several shortcomings.

The first of these is that no provision is made to counteract "fading" of received signals. Fading occurs with the more distant transmitters, whose signals are "reflected" back to the Earth by the refractive action of ionised layers in the upper atmosphere. The activity of these ionised regions is not constant and signals received by way of them tend to vary in strength from time to time.

A second shortcoming of the superhet as so far envisaged is that all signals receive the same degree of amplification before being passed to the detector. Thus, as the tuning dial is turned, a weak signal is liable to be succeeded by a signal having a very high amplitude. With a domestic receiver this can be particularly trying, since the audible output at the loudspeaker is proportional to the strength of each received signal. Also, it is difficult to control the a.f. output from a wide range of signal input strengths by means of a single a.f. volume control. A further point is that some of the more powerful received signals may have sufficient amplitude to overload the i.f. amplifier stage.

All these difficulties are overcome by a circuit device known as *automatic gain control*. Fig. 4 gives a block diagram illustrating how automatic gain control (or a.g.c.) may be applied in a superhet. We have the frequency changer and i.f. amplifier as before but, in addition to the detector diode, we now have an a.g.c. diode. The function of the a.g.c. diode is to develop a negative direct voltage which is proportional to the i.f. voltage passed to it from the i.f. amplifier. This negative voltage is then applied, as a

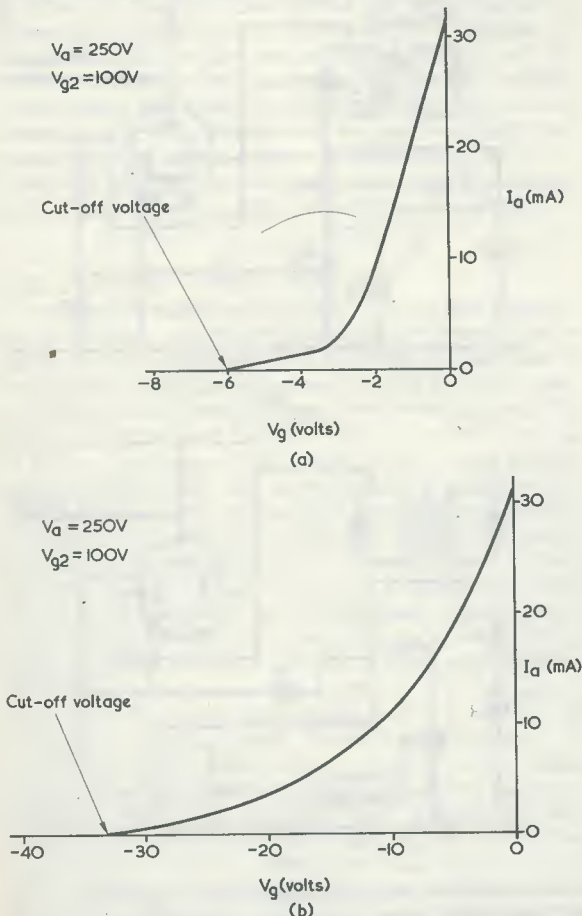

Fig. 3 (a). The  $I_a V_g$  characteristic of a normal r.f. pentode  
(b). The characteristic given by a variable-mu r.f. pentode

\*Another important point here is that, although the  $I_a V_g$  characteristic of the variable-mu valve is always slightly curved along its length, it does not exhibit as great a curvature as, at some points, does the characteristic for the normal pentode. Thus, the variable-mu pentode is less likely to suffer from cross-modulation effects than is a normal pentode operated at a highly curved portion of its  $I_a V_g$  characteristic. (Cross-modulation occurs when two signals are applied to a non-linear amplifier. Due to the non-linearity, each tends to modulate the other.)

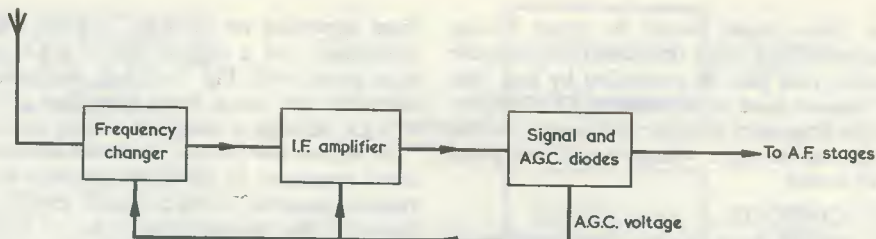

Fig. 4. Block diagram illustrating how an a.g.c. voltage obtained from an a.g.c. diode may be applied to preceding stages to control their gain

grid bias voltage, to the preceding valves, which in Fig. 4 are the frequency changer and i.f. amplifier. What now occurs is that if, say, a weak signal is received, the a.g.c. diode develops a small negative bias voltage only and the frequency changer and i.f. amplifier stages consequently offer very nearly the full gain of which they are capable. When, on the other hand, a strong signal is received, the a.g.c. detector applies a correspondingly high negative bias voltage to the preceding stages and decreases their gain considerably, thereby reducing the amplitude of the i.f. signal passed to the detector diode. It will be apparent that a state of equilibrium is achieved according to the amplitude of each signal received. Should a signal be suddenly applied to the receiver, the action of the a.g.c. circuit causes the output of the i.f. amplifier to be reduced and, hence, the amplitude of the i.f. signal passed to the a.g.c. diode itself. The system stabilises when the bias voltage from the a.g.c. diode maintains the gain of the preceding stages at the level which provides the corresponding i.f. output to the diode.

It follows that an a.g.c. system of the type shown in Fig. 4 cannot cause all received signals to produce a standard i.f. output amplitude. Instead, it regulates the

gain of the stages preceding the a.g.c. diode in such a manner that strong signals provide a much lower i.f. output than would otherwise be the case. It is possible, by using rather complex a.g.c. systems incorporating an amplifier, to obtain a receiver performance where all signals are reproduced at the same level, and such systems have been used fairly extensively in the past. They are not often encountered in more modern receivers, however, as the simple a.g.c. system shown in block form in Fig. 4 can, when properly designed, regulate i.f. output amplitude within quite narrow limits for a very wide range of input signal strengths.

Turning to the reasons for incorporating a.g.c. in a receiver, it may now be seen that the regulating action of the a.g.c. counteracts fading. When a signal fades, the a.g.c. system causes the stages preceding the detector to offer greater amplification for it. Similarly, the a.g.c. system causes signals consecutively tuned in by turning the tuning control to be reproduced at very nearly the same level despite considerable variance in their signal strength at the aerial.

In Fig. 4, the bias voltage from the a.g.c. diode is shown applied to the frequency-changer and i.f. amplifier. The

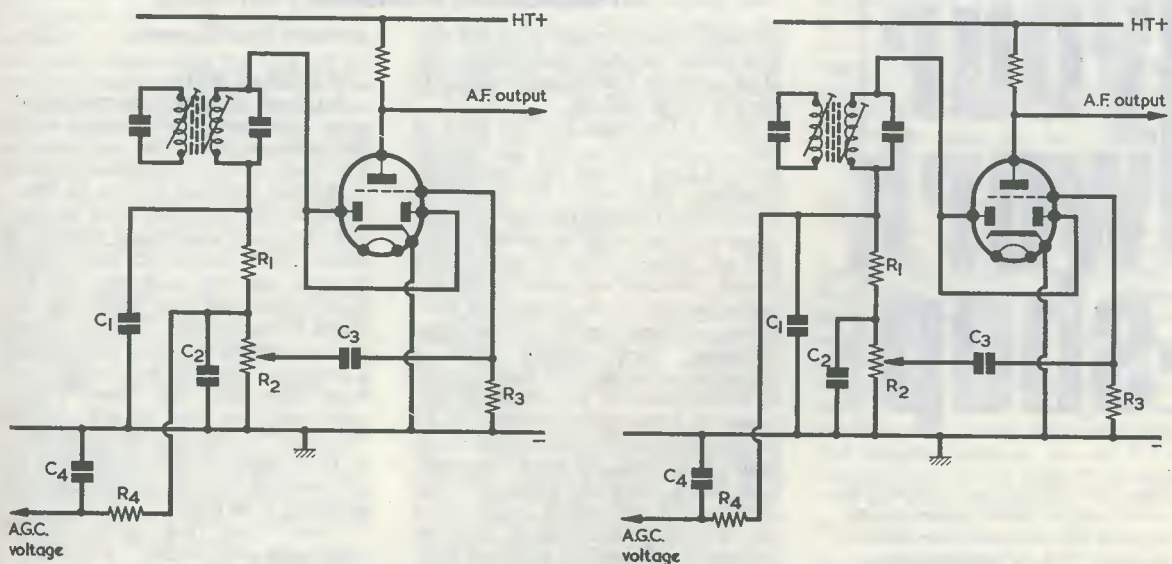

Fig. 5 (a). Obtaining an automatic gain control voltage from the circuit of Fig. 1 (b) (b). A slightly higher a.g.c. voltage is available at the upper end of resistor  $R_1$

valves fitted in these stages would be types having variable-mu characteristics, since these are more suitable when it is intended that gain be controlled by grid bias voltage. If the receiver were fitted with an r.f. amplifier stage preceding the frequency changer, this would also be a variable-mu type and the a.g.c. voltage would be applied as bias to its grid as well.

#### A.G.C. DIODE CIRCUITS

An extremely simple a.g.c. circuit incorporating a double diode triode is illustrated in Fig. 5 (a). In this circuit a single diode performs the functions of *both* the detector and the a.g.c. diode. Fig. 5 (a) is the same as Fig. 1 (b) with the exception that the components  $R_4$  and  $C_4$  have been added, and it takes advantage of the fact that a direct voltage nearly equal to the peak value of the rectified i.f. half-cycles appears across  $C_1$ . As we saw last month, the polarity of this voltage is such that the upper plate of  $C_1$  is negative with respect to chassis. Nearly all the voltage across  $C_1$  appears across the load resistor  $R_2$  and an automatic gain control voltage for the preceding stages is taken from the upper end of this resistor. Resistors  $R_4$  and  $C_4$  form a filter which prevents the detected a.f. signal appearing on the a.g.c. voltage. There is, therefore, a direct voltage only across  $C_4$ , this being proportional to the amplitude of the i.f. signal from the i.f. transformer secondary. Obviously, the control voltage on the lower plate of  $C_4$  goes negative as the amplitude of the i.f. signal increases, whereupon it meets the requirements for an a.g.c. system.

A slight modification to the circuit of Fig. 5 (a) is given in Fig. 5 (b). Here, the a.g.c. control voltage is taken from the upper plate of  $C_1$ , whereupon the filter given by  $R_4$  and  $C_4$  also prevents the i.f. content of the detected signal

from appearing on the a.g.c. voltage. Fig. 5 (b) has the advantage that a slightly higher a.g.c. voltage is given than occurs with Fig. 5 (a) but, since the value of  $R_1$  is normally very much lower than that of  $R_2$ , the increase in a.g.c. voltage is marginal only.

As we saw last month, it is desirable for the a.c. and d.c. loads presented to the detector diode to be as close in value as possible. The d.c. load is given by  $R_2$  on its own (ignoring the relatively low value of  $R_1$ ) whilst the a.c. load is given by  $R_2$  in parallel with any load coupled to it by a capacitor which offers low reactance at audio frequencies. In Fig. 5 (a) and (b) we have added another resistor which is effectively in parallel with  $R_2$  at a.f. This new resistor is  $R_4$ , and it is coupled across  $R_2$  via  $C_4$ . The latter capacitor has, of course, to have a low reactance at a.f., or the filter it forms with  $R_4$  would not be effective. To prevent the a.c. load being excessively different from the d.c. load,  $R_4$  requires a value considerably higher than  $R_2$ . Typical practical values would be given by having  $R_2$  equal to 250k $\Omega$  and  $R_4$  equal to 1M $\Omega$ . Capacitor  $C_4$  may, typically, have a value of the order of 0.05 $\mu$ F. A further point to be introduced at this point is the *time constant* of the a.g.c. system. In Figs. 5 (a) and (b) this time constant is partly provided by  $R_4$  and  $C_4$  and it controls the speed at which the a.g.c. system operates. We shall be referring to the question of time constant in greater detail later, after we have examined the manner in which the a.g.c. voltage is applied to the grids of the controlled valves.

#### NEXT MONTH

In next month's article we shall consider other a.g.c. detector circuits. 

**As usual, Christmas brings its load of extra work for Smity the Serviceman and his able assistant, Dick. This year, fortunately, the pair are able to finish their labours by the late afternoon of Christmas Eve, and there is still time for Smity to give Dick an exercise in elementary servicing**

opening stanza in the tale of the boy who died rather than relinquish that banner of his provides a fitting introduction to our tale for this month.

For it is Christmas Eve and when we join the Serviceman and his faithful assistant Dick we find that, outside the rime-laden windows of the Workshop, the shades of night are falling fast indeed. There is, as well, evidence of much snow and ice, some of the former having actually found its way inside by way of a dodgy section of the Workshop roof. Again, of strange devices there is a great profusion, these ranging from a precarious soldering iron stand created by Smity from the wire of an old coat hanger to a beautifully finished grid-dip oscillator lovingly constructed three years ago by Dick and never since used. And, finally, the bright and garish trade calendars for 1969 which already grace the Workshop walls show that the concept of the hard sell is just as much in evidence today as it was with that 19th century youth when he pursued his dedicated promotion campaign for

American packing material.

#### CHRISTMAS BET

But (as we slip gratefully into the past tense) there were other features in the Workshop on this particular Christmas Eve which could not have been conceived by the poet, however inspired his Muse. There was the Workshop floor, spangled with the many star-shaped splashes of solder which betokened that mighty industry with the soldering iron had taken place that day; there was the spares cupboard with its doors gaping unaccustomedly wide after withstanding a continual rush on its contents; and there were the "For Repair" racks now completely clear of sets and the "Repaired" racks filled to overflowing as Dick triumphantly carried over the last serviced receiver for the day and deposited it on them.

"Gosh," said Dick, as he returned and flopped onto his stool, "what a *day!*"

"It has certainly," agreed Smity, mopping his brow, "been something of a shocker."

THE RADIO CONSTRUCTOR

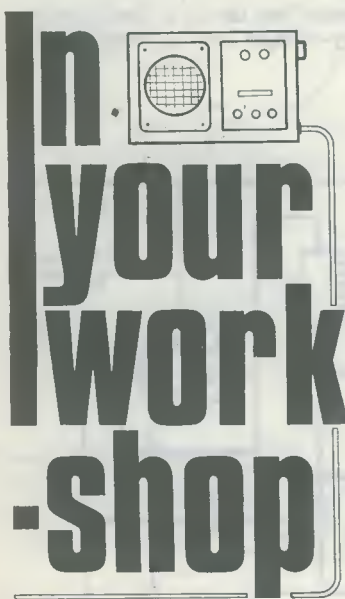

*The shades of night were falling fast,  
As through an Alpine village passed  
A youth who bore, mid snow and ice,  
A banner with the strange device,  
Excelsior!*

Thus, from that past, speaks Henry Wadsworth Longfellow, and this



"It's always the same at Christmas," grumbled Dick. "Every flaming set in the neighbourhood goes up the wall from December the 20th onwards!"

"True enough," confirmed Smithy.

The pair rested and gazed with pride at the sets they had repaired.

"Well, there's one thing," remarked Dick smugly. "I fixed a lot more sets today than you did."

"Of course you did," returned Smithy, a little irritably. "The scheme we'd arranged beforehand was that you'd do all the easy ones whilst I did all the hard ones."

"Some of the ones I did," boasted Dick, "were still pretty tough, nevertheless. What this Christmas Eve has really proved is that youngsters such as me have got a real edge over you old fuddy-duddies when it comes to getting the work done quickly!"

"How on earth," snorted Smithy, "you manage to get that great head of yours through the Workshop door each morning completely baffles me. Well, if that's how you feel, and seeing that it's Christmas, I'll have a wager with you if only to find out whether I can deflate you a little. I'll get a transistor portable off those shelves, put a simple fault on it and see how long you take to find it. You can have the service manual in front of you and if you fix the set within twenty minutes you win the bet. O.K.?"

"How much?"

"Ten bob."

"Done!"

The impending conflict aroused the pair from the lethargy which had followed their exertions, and it was with alacrity that Smithy walked towards the "Repaired" racks and selected a small medium and long wave transistor radio. Returning, he called out its make and type number to Dick who briskly searched in the filing cabinet for its service manual. Whilst Dick was thus occupied, Smithy took the back off the receiver, busied himself mysteriously in its interior, then carefully replaced the back again. At that instant, Dick returned from the filing cabinet with the service sheet in his hand.

"It's ten to five," remarked Smithy, glancing at the Workshop clock. "If you get this set going by ten past, you've won the bet."

"Fair enough," said Dick seating himself at Smithy's bench. "You've put the fault on?"

"I have."

"Right," replied Dick. "Then I'll begin."

He switched on the receiver and adjusted the volume and tuning controls. Its loudspeaker was completely silent for all settings of these controls, both on medium and on long waves. Dick switched the set off again.

"I am now," he pronounced pompously, "going to start by making a test which doesn't even necessitate taking

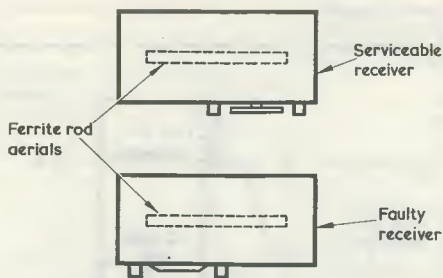

Fig. 1. Checking the oscillator of a transistor radio by picking up the oscillation on a second radio. The receivers should be positioned so that their ferrite aerial rods are parallel and close together

the back off the set!"

"Aren't you going to check the battery voltage first?"

"In this case," replied Dick airily, "I'm assuming that you wouldn't have tried so corny a gag as to put a run-down battery in that set. And so I'll risk that the battery is O.K. Instead, I'm going to check that the oscillator is running."

"Blimey," said Smithy. "This is going to be the easiest ten bob I've picked up for a long time! You know, Dick, there are quite a few other things you should check before you start testing the oscillator."

"Who," retorted Dick rudely, "is doing this job, you or me? Anyway, we're wasting valuable time."

Dick strode purposefully to the "Repaired" racks and picked up another transistor radio.

"What I'm going to do," he announced, "is to carry out a pretty well-known dodge for checking whether the oscillator of a transistor radio is working without actually opening up its cabinet."

Whilst Smithy settled down to watch him, Dick switched on the second radio and tuned it to a weak station at the high frequency end of the medium wave band. He then placed the faulty receiver close to it, switched this on as well and set it to the medium wave band. (Fig. 1). He then carefully adjusted its tuning control. As he did so a heterodyne became audible from the speaker of the serviceable receiver. Dick continued adjusting the tuning control of the faulty set and was rewarded with heterodynes at several other tuning positions.

"There we are," he remarked with satisfaction as he switched off both the sets. "That shows that the oscillator in this receiver is working on the medium wave band!"

"I'll agree with you on that, at any rate," remarked Smithy with grudging approval. "And I'll agree also that what you've just done is quite a good method of checking the oscillator of a faulty set. What's happening, of course, is that some of the oscillator signal in the faulty receiver is finding its way to the ferrite frame aerial, whereupon it's being

radiated at sufficient strength to be picked up by the ferrite frame aerial of the other set. I've used that method of testing quite a bit myself and the theoretical idea is that you tune the good set to a frequency about 460 kc/s or so higher than the frequency you tune the faulty set to. Since the oscillator in the faulty set is running some 460 kc/s above the frequency indicated on its dial you should then get its heterodyne on the good set as you adjust the tuning of the bad set around the appropriate frequency. You must, of course, tune in a signal on the good set first."

"I usually find," said Dick, who had now started to remove the back from the faulty receiver, "that you get several heterodynes as you adjust the tuning of the suspect receiver. There are others in addition to the one where the tuning of the two receivers is spaced about 460 kc/s apart."

"True enough," agreed Smithy. "You've got a fair number of oscillator harmonics knocking around in both receivers and these will give you the other heterodynes. Still, they're nothing to worry about. This heterodyne test is, of course, capable of being carried out on the medium wave band because this band has a top frequency of about 1,550 kc/s and a bottom frequency of around 600 kc/s. It's easy to get two dial frequencies with 460 kc/s difference between them on a range as wide as that."

"Often," remarked Dick, looking inside the cabinet of the faulty radio, "the heterodynes sound fairly weak."

"They are, with some sets," confirmed Smithy. "Still, all you're carrying out is a rough and ready test for oscillator operation on medium waves, and so you can't expect exactly the same results with different sets. So long as you get a heterodyne, you know that the oscillator in the faulty set is running. My own experience, by the way, is that you get the best coupling between the sets if you position them so that their ferrite aerial rods are close together and parallel to each other."

#### A.G.C. VOLTAGE TEST

"That," agreed Dick, "is what I've found, too."

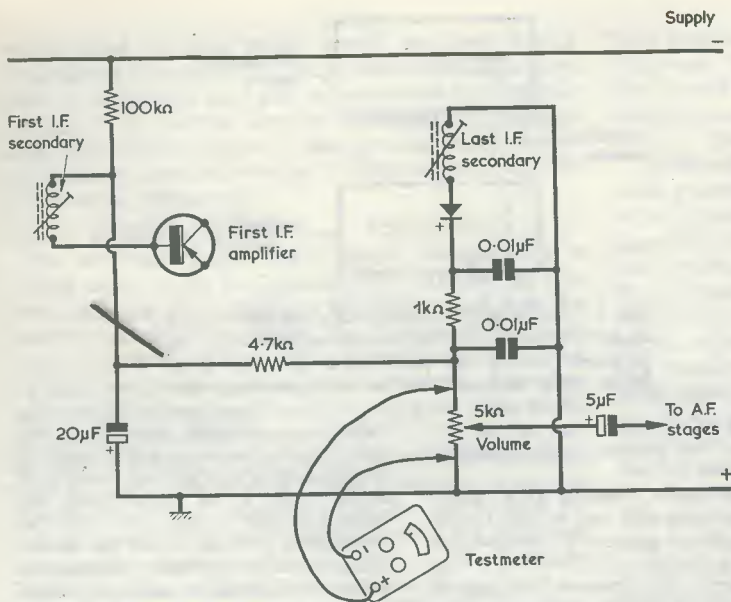

Fig. 2. A typical detector and a.g.c. circuit in a transistor a.m. portable radio. In this example a.g.c. is applied to the first i.f. transistor only. The testmeter measures detected signal voltage across the volume control

He pulled his testmeter towards him, selected a low voltage range and carefully clipped its test leads to two tags inside the unserviceable receiver.

"What," asked Smithy, "are you doing now?"

"Checking for a.g.c. voltage," replied Dick confidently. "This is a servicing dodge you told me about yourself a

couple of years ago."

"Once more," remonstrated Smithy, "you're carrying out a useful and sensible check. But you're still doing these tests in the wrong order."

"What should I be doing, then?"

Smithy opened his mouth, then remembered the ten shillings wager.

"I'll tell you later," he added hastily.

"After ten past five."

"As you like," replied Dick cheerfully.

"Well now, what I'm doing here is clipping the testmeter leads across the volume control track. In nearly all these a.m. portables the volume control is also the diode d.c. load, which means that

the a.g.c. voltage is built up across it. (Fig. 2). Thus, if I can get a voltage reading as I turn the tuning dial it indicates that a signal is finding its way through to the detector."

"Fair enough," replied Smithy, relinquishing for the moment any further attempt to convince his assistant that he was proceeding with his tests in the wrong order. "That a.g.c. test is a jolly useful one for a.m. portables, particularly if you're working on an unfamiliar set. Even with the most crowded printed circuit layouts, it's still very easy to locate the volume control tags. It's also very easy, by turning the control, to judge which tag is set at the earthy end of the track. With a conventional set using p.n.p. transistors, you connect the negative meter terminal to the earthy end of the track."

"I've just finished doing that," announced Dick. "Let's turn on the set."

He did so, and his meter needle travelled, in a reverse direction, towards the end stop at the zero voltage end of the range. Dick turned the receiver dial experimentally, whereupon there was a sudden positive deflection of the meter needle. Dick adjusted the tuning control for maximum deflection.

"I don't know what the station I've tuned in is," he remarked, pleased, "but it's causing the detector to bash out a good 0.6 volts of a.g.c.!"

"Then," remarked Smithy, "the receiver is serviceable up to the diode stage at least."

"I wonder," mused Dick, switching off the set again and removing his test clips, "why, with this test, I always get a reverse voltage reading in the meter at first."

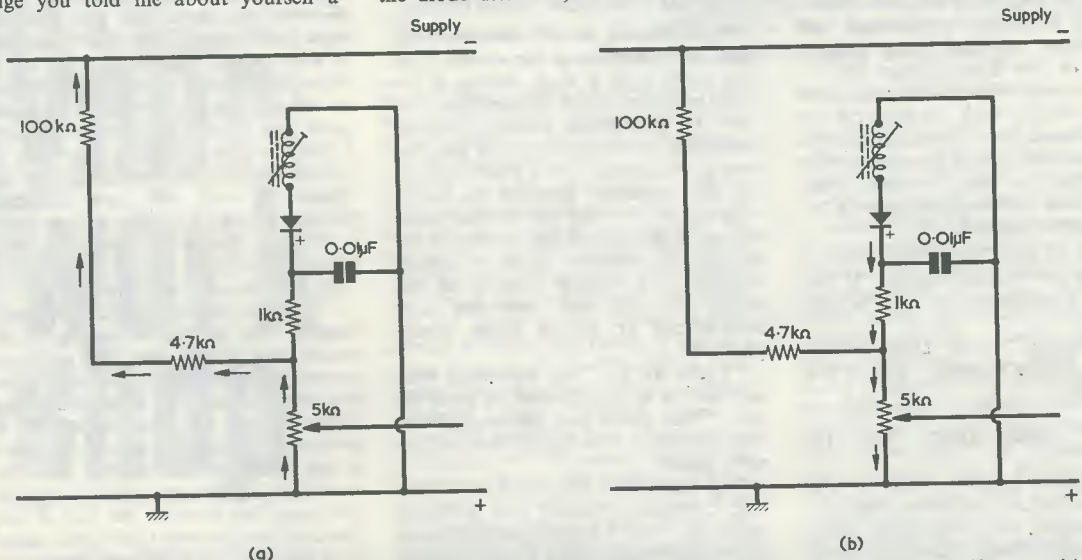

Fig. 3 (a). D.C. circuit conditions in Fig. 2 when no signal is being received. Conventional current (from positive to negative) flows in the direction indicated, causing the upper end of the volume control to be negative with respect to chassis and the diode to be forward-biased

(b). On receipt of a signal, conventional current from the diode flows through the volume control as shown. The upper end of the volume control goes positive (as also does the junction of the 4.7kΩ and 100kΩ resistors)

"That's because of the a.g.c. circuit," replied Smyth. "The normal form with these sets is that current in the emitter bias potentiometer for the a.g.c. controlled transistor or transistors flows through the volume control. This means that, in the absence of signal, the upper end of the volume control track is negative and the detector diode is forward-biased (Fig. 3 (a)). When a signal comes along, the diode causes the upper end of the volume control track to go positive and provide a positive a.g.c. voltage for the controlled transistor or transistors. (Fig. 3 (b)). Because of the initial reverse reading in the meter it's a good plan to start off with it switched to read, say, 10 volts full-scale, since this will prevent too much reverse movement of the needle. You can still see the positive deflection as you tune in a station, and you can then go down to a lower voltage range if you want to."

### BATTERY CURRENT

Dick glanced up at the clock.

"Gosh," he remarked, "it's just gone five! I'd better get weaving if I'm going to win this Christmas bet of ours."

"What's your next move?"

"To check battery current."

"The heavens," pronounced Smyth devoutly, "preserve us!"

But Dick had no time for Smyth's comments and he hastily set his testmeter to its 100mA range, removed one of the battery clips, and inserted the meter in series with this clip and the battery (Fig. 4). He switched on the receiver, turning the volume control to full.

The meter needle rose initially to indicate 30mA then danced continually between this figure and 15mA. Suddenly, it fell to 7mA and remained steady at this reading for a few seconds, after which it advanced again and resumed its jiggling motion between 15 and 30mA.

Nonplussed, Dick stared at the quivering needle.

"Blimey, Smyth," he wailed. "I've got an intermittent fault in this set."

Smyth could contain his impatience no longer.

"You thundering great twirp," he exploded. "Of course it isn't an intermittent! What I find even more infuriating is the fact that this is one of the tests you should have carried out right at the beginning."

"But it *must* be an intermittent," protested Dick, sticking doggedly to his theme. "Just look at the way that meter needle's wobbling about!"

"Ye gods," snorted Smyth. "Haven't you learnt *anything* during the years that you've been in this Workshop?"

Completely at a loss, the confused Dick turned the volume control of the receiver back to minimum. The vibration of his testmeter needle at once ceased, and it sank back to indicate a sedate 7mA. Puzzled, Dick turned up the volume control again, whereupon the

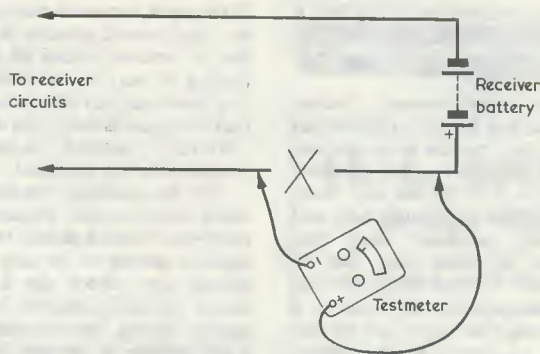

Fig. 4. Inserting a testmeter in series with the receiver battery to measure supply current

meter needle once more commenced its erratic motion between 15 and 30mA.

"Of course, of course," exclaimed Dick suddenly, smiting his forehead. "Why the dickens didn't I realise it first of all?"

He quickly examined the circuit diagram showing the output stage of the receiver (Fig. 5), then returned to the set and peered inside.

"Blow me," he remarked elegantly. "You crafty old devil!"

With trembling fingers he picked up a pair of long-nosed pliers and applied them to the inside of the receiver. As he removed the pliers, gripping a small piece of paper between their jaws, the receiver came to life and the sound of Bing Crosby singing "I'm Dreaming of a White Christmas" filled the Workshop.

Both Dick and Smyth looked at the clock. It indicated precisely ten minutes past five.

### LOGICAL SERVICING

"I've won," Dick cried out exultantly. "I've won!"

"You jolly well didn't deserve to," returned Smyth ungraciously. "You should have located that fault ages ago."

"At any event, I found it in the end," said Dick triumphantly. "But you know, Smyth, you really are cunning. The fault you put on that set represented a touch of genius."

"I have my moments, I suppose," conceded Smyth modestly. "But what I was really trying to bring home to you was the fact that even *you* aren't as hot at this servicing game as you fondly imagine you are. All I did to that set was to slip a bit of paper between the closed-circuit contacts of the receiver earphone socket (Fig. 6) with the result that the set worked perfectly all the way up to the speaker transformer secondary, but there was no circuit from that secondary to the speaker itself. That was why the set was completely dead."

"I wasn't half foxed for a moment," commented Dick ruefully, "when that meter needle started shaking around after I'd put it in series with the battery. What the meter was reading, of course, was the current drawn by the Class B output stage, and the needle was actually joggling about in time with the broadcast music. As soon as I turned the volume control down and the meter reading dropped to the quiescent value for the

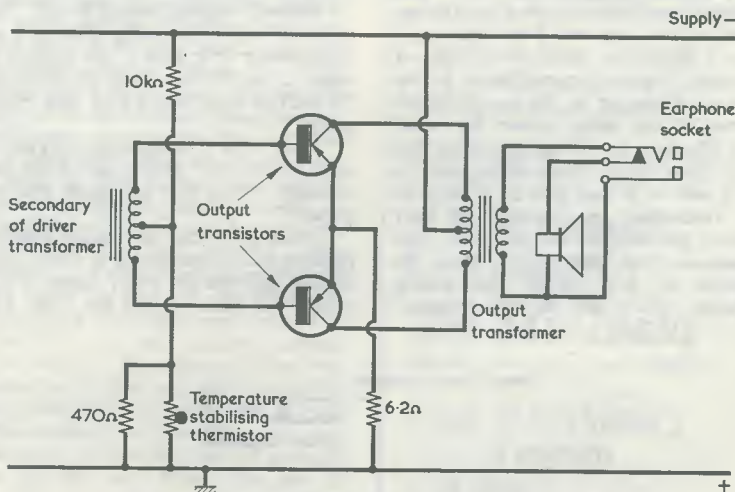

Fig. 5. The output stage of the transistor radio repaired by Dick

set, I suddenly realised that the Class B output stage must be working all right and that the fault must lie between that stage and the speaker."

"With the consequence," Smithy broke in, "that you looked at the circuit diagram and saw that the most obvious place was at the short-circuit contacts of the earphone jack. By the way, these closed-circuit jacks do go open now and again, so my artificial snag was representative of what you find in practice. It was a good thing for you that the set happened to be tuned to a station following your a.g.c. test, so that you had an a.f. input to the output stage. Otherwise, you'd never have got it working within twenty minutes."

"I did though, didn't I?" grinned Dick. "Ten shillings, please!"

"In a moment," replied Smithy heavily. "What I next want to say is that you *should* have located that fault in five minutes, not twenty minutes."

"How come?"

"By carrying out the tests you did in the proper orders," continued Smithy, frowning. "When confronted with any faulty transistor radio, the first thing to do is to measure battery voltage with the set switched on. However, I'll agree that, in this case, the voltage of the battery in the set would have been O.K. because the set had already been through our hands earlier. With a set that is completely dead, like this one was, the second thing to do is to give its works a quick visual check for something *obviously* wrong. Such a check might well have enabled you to see that little bit of paper I popped in, and you could have cleared the fault there and then. The next thing to do with a completely dead set is the test you carried out last of all—check the battery current!"

"But," queried Dick, "what other things could a battery current test show up? Apart, that is, from the particular snag I had myself."

"A battery current check," said Smithy, "can indicate quite a lot of things with a dead receiver. For instance, if there's no current at all there's almost certainly a simple open-circuit in the battery wiring or in the on-off switch circuit. If the meter shows the usual 7 to 12mA or so quiescent current that these transistor portables draw, then it's fairly safe to assume that all or most of the transistors are running at their correct current. If the set is in this condition, you should then turn the volume to full, adjust the tuning capacitor slowly, and see what happens.

If the same increased current effect that you experienced appears, then you know that a received signal of some sort is finding its way to the output stage. If you don't get that effect then you know that the signal is being lost earlier on."

Smithy settled himself more comfortably on his stool.

"If," he resumed, "the battery current check indicates that quiescent current is pretty well what it should be and that no signal is getting to the output stage, you should next check for a.g.c. voltage across the diode detector load, which is nearly always the volume control. If a.g.c. voltage is present here, then the fault is in the a.f. circuits following the volume control. If a.g.c. voltage is not present you will next want to know whether the oscillator is running, whereupon you can check for heterodynes with another receiver in the same manner as you did yourself. All these checks are very simple and they soon enable you to isolate the section of the receiver in which the fault actually exists."

#### DEBT ACKNOWLEDGED

"Oh, well," admitted Dick, "perhaps I *could* have done these tests of mine in a more logical order. Nevertheless, I still won the bet and you still owe me ten bob!"

"All right," agreed Smithy grudgingly. "I suppose I'd better see what I can do for you. Ten shillings, eh?"

The Serviceman drew out a bulging wallet and, after a careful search, extracted some of its contents. He next dug into his trouser pockets and withdrew a number of coins. He carefully arranged all these items on his bench, checked and double-checked them, then turned gravely to Dick.

"There you are," he remarked. "Ten shillings."

"Don't tell me," said Dick incredulously, "that *that* pile of junk represents ten bob."

"Unless," replied Smithy firmly, "my calculations are in error, what you so ungratefully refer to as a 'pile of junk' is equal to slightly *more* than ten shillings. To start off with, here's a 10 New Pence piece."

"Well, that's something, anyway," remarked Dick. "That's *two* of the ten shillings. What are all those bits of paper?"

"These two bits," continued Smithy, handing two coupons over to Dick, "are 4d-Off coupons for Fairy Snow. Your grocer will allow you 8d for these. I'm

also giving you no less than 54 Green Shield stamps. These are worth 0.075 pence each, so that's another 4.05 pence."

"Don't you ever," asked Dick bitterly, "believe in paying your debts with real money? What's this?"

"This," explained Smithy, "is a 2s. 6d. coupon cut out from a radio component mail order catalogue. And here's a two shilling piece to go with it."

"It's an *Irish* two shilling piece!"

"They'll change it at the bank," replied Smithy cheerfully.

Dick pulled a piece of paper towards him and started to tot up some figures.

"Up to know," he announced, "I make it seven shillings and sixpence you've given me."

"Seven shillings," Smithy corrected him, "and 6.05 pence. Well, here's the remainder of what I owe you."

The Serviceman passed five metal discs over to his assistant.

"What on earth are these?" grunted Dick sarcastically. "Devalued piastres from Outer Mongolia or something?"

"Nothing of the sort," replied Smithy. "They're sixpenny tokens from the one-armed bandit in my local pub!"

"Corluvaduk," grumbled Dick resignedly. "I must have seen everything now. I suppose I'll *have* to take all this stuff if I'm ever to get anything representing payment from a tight-wad like you."

#### CHRISTMAS SPIRIT

"Tight-wad?" repeated Smithy, shocked. "When I'm actually giving you 0.05 of a penny more than I need do? That's a fine thought for Christmas, I must say!"

Suddenly, Dick chuckled.

"Oh, well," he laughed, "I suppose I must admit I've been lucky to pick up even this lot. I suggest that from now on we forget all about work and debts, and start thinking about Christmas instead!"

"No sooner said," remarked Smithy, opening a drawer in his bench and extracting some objects that produced the pleasant tinkle of glass on bottle, "than done, my lad!"

"Now this," remarked Dick, a few seconds later, as he sipped appreciatively at the golden liquid in the charged glass that Smithy had handed him, "is a bit of the *real* Christmas spirit."

"Indeed it is," responded Smithy warmly, "and let me take this opportunity to wish you a very Merry Christmas, Dick."

"The same to you, Smithy."

The pair stood and held up their glasses.

"We must also," announced Smithy, "wish a very Merry Christmas to all the readers who've put up with the two of us over the last twelve months. A really Happy and Merry Christmas to you all!"

"And," chimed in Dick, "let's finally end this year as we have ended so many previous years, by saying 'God Bless Us, Every One!'"

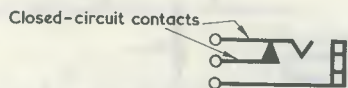

Fig. 6. Identifying the closed-circuit contacts of the earphone jack

# Radio

# Topics

## By Recorder

**E**VERY ART FORM TENDS TO TAKE advantage of the mechanics existing in the process which links the artist to his audience.

Typical examples occur, for instance, in the field of literature. A writer can convey impression not only by his words but also by their appearance when they are set up on the printed page, the most common stratagem with prose being the use of the paragraph. Humorous uses of the technique are very common, and I recall that P. G. Wodehouse once wrote a wildly inane dialogue between two burglars, one of whom expressed his opinion by stating, simply: "R". In poetry, the positioning of the start of each line adds much to the effect of the words themselves.

Where the linking process is complicated and highly technical, its mechanics are purposely used to constitute a part of the whole presentation. The most obvious instance here is given by the motion picture film. The final impression given by a film owes nearly as much to skill in the cutting room as it does to the actors and the writer of the script.

### POP MUSIC

We have now reached the stage at which we accept the fact that a similar reliance on technical artistry contributes as much to the production of a gramophone record as it does in the case of the film. This state of affairs exists mainly in the world of pop music, and the greatest exponents of the

techniques are, I would suggest, our old friends the Beatles.

I have been reading a description of a typical recording session in "The Beatles", by Hunter Davies, which was published at the end of September by Heinemann. Quite a standard Beatles approach is to get the instrumental backing for a number safely on the tape before attempting the vocal. The latter is then sung (without Ringo in the example described by Hunter Davies) whilst wearing headphones reproducing the backing track. A great deal of hard work goes into these recording sessions and the number is played, or sung, very many times before the Beatles consider themselves satisfied. Finally, the tracks which have been recorded are blended together to produce the final version, which then goes onto the disc.

It could be said that the record which is sold to the public represents a performance which could not possibly be produced by the artists if they were to appear on stage and perform under normal stage conditions, and some might even doubt the ethics of this approach to recording. But to my mind the Beatles' technique is not only perfectly ethical but is also to be applauded, for the simple reason that they make no secret of the fact that the whole idea behind their recording and composing sessions is the production of the disc and nothing else but the disc. Where the use of recording methods of this type tends to shimmer a little at the edges so far as ethics are concerned is when it is *not*

## Your Local Supplier

LONDON

Established 1910

### H. L. SMITH & CO. LTD.

Comprehensive stocks of components  
by all leading makers.

287-9 EDGWARE ROAD  
LONDON W.2  
Tel: 01-723 5891

### TELERADIO ELECTRONICS

For Radio Control Devices, Miniature components, Special Transistors, Circuits and data on boat and aircraft control.

QUOTATIONS GLADLY FOR PARTS USED IN  
MAGAZINE ARTICLES

(S.A.E. Enquiries REF. D/P)

325/7 FORE STREET,  
EDMONTON (3719)  
LONDON, N.9.

### THE MODERN BOOK CO.

Largest selection of English and  
American radio and technical books  
in the country.

19-21 PRAED STREET,  
LONDON, W.2  
Tel: PADDington 4185/2926

### ELECTRONICS GALORE!

in the NEW

### dca CATALOGUE

Send 1/6 now for your copy  
to: DEPT. R/C

### dca ELECTRONICS LIMITED

28 UXBRIDGE ROAD,  
EALING, W.5

## Your Local Supplier

LONDON

### ST. HELEN'S RADIO

Hi-Fi Equipment  
Tape Recorders  
Radio Receivers  
Television

SPECIALISTS IN RADIO  
& ELECTRONIC TEXTBOOKS

ST. HELEN'S GARDENS  
LONDON W.10  
Tel: 01-969 3657

ESSEX

### ELECTRONIC COMPONENTS

Valves, transistors, capacitors,  
transformers, amplifiers,  
tuners, etc., etc.

335 GREEN LANE,  
SEVEN KINGS,  
ILFORD, ESSEX.

Telephone: 599-1826

### MARKET CENTRE

For Semiconductors

Prompt, efficient mail order service for Mullard, Newmarket, Texas, Sinclair, S.T.C., Fairchild Semiconductors. We also offer a comprehensive selection of miniature components for transistor circuitry. Catalogue 1s.

### L.S.T COMPONENTS

23 New Rd., Brentwood, Essex

HAMPSHIRE

### BOURNEMOUTH

LARGEST HI-FI AND  
RADIO COMPONENT  
STORE IN THE SOUTH

FORRESTERS NATIONAL  
RADIO SUPPLIES LTD.

70-72 Holdenhurst Road  
Bournemouth  
Telephone 25232

made known to the public, who might then reasonably expect the same performance from a group when working live as has been offered on their recordings.

Thus, we now have the case where the production of music via the gramophone record is provided partly by the composer, partly by the performer and partly by the recording engineer. Just as with the motion picture film.

#### LES PAUL AND MARY FORD

Older readers may recall that this state of affairs is by no means new. Cast your mind back to the early 50's and bring to mind the records produced by Les Paul and Mary Ford, who would have topped the pop music charts of those days if we'd called it pop music then and if charts, as we know them today, had been started.

Les Paul not only played a competent guitar, he was also a highly skilled electronic engineer. His technique was to produce multiple sound on a record by continually adding parts played by himself to a basic recording until the final result consisted of as many as a dozen combined guitar parts. The result, as anyone who has heard a Les Paul record will confirm, was a very pleasant and enjoyable composition which owed its entire existence to the use of electronic recording techniques, and which was accepted by the public as such. Incidentally, Les Paul had no need for a recording engineer, as he handled all the technical work himself. To give an idea of what was involved, it is interesting to note that all the tracks for the very popular "Lover" were combined on *disc* and not on tape. Also, the disc-cutter employed was a home-made job constructed by Les Paul himself! Later, Les Paul went over to tape because this was so obviously more convenient for multiple recordings.

The vocals on a Les Paul recording were provided by Mary Ford. Much use was made of acoustics to provide a particular effect, and of electronic filters and a Les Paul "special"—decaying echo.

And so the modern recording methods used for pop music discs are not perhaps so revolutionary (no pun intended) as they may appear. Personally, I think that quite a lot of pop music, whilst often brash and naive, still has a lot to commend it, and that there is nothing wrong with the use of recording gimmickry in its production provided that the existence of such gimmickry is made known.

Incidentally, I turned to a ten year old issue of the American magazine *Radio-Electronics* to refresh my memory concerning Les Paul and Mary Ford, and must give acknowledgement to Eric Leslie, whose article "Les Paul, Technician and Musician" appeared in the October 1958 issue of that journal.

#### PLUG-IN TRANSISTORS

I have always thought that, provided they are treated with reasonable respect, transistors are as reliable as the resistors and capacitors which share their circuits. A transistor cannot "wear out" in the sense that a valve with falling cathode emission can wear out, whereupon it becomes a sensible approach to solder transistors directly into circuit.

I am rather surprised to learn, therefore, that the latest range of Sylvania transistorised colour-TV sets manufactured in America employs plug-in transistors. Each transistor has its own socket and may be pulled out for testing or for temporary replacement if it is thought that it may be faulty.

So far as servicing is concerned this idea has its advantages, I suppose, when used in a complex piece of equipment such as a colour television receiver because, apart from being able to remove a suspect transistor, one can also render individual stages inoperative for fault tracing. At the same time, though, one of the older American servicing gags concerns the set-owner who arrives at a radio store with a bag full of valves taken from his TV set, for checking on the stores valve tester. The modern equivalent will be given by the set-owner who similarly arrives at the store, but this time with several dozen transistors taken from his colour TV.

On reflection, I think it preferable that transistors in television equipment remain fairly and securely soldered in position!

#### LUCKY 37

You can play some interesting little tricks with numbers. Take, for example, the number 37. If you multiply this by any number lower than 10, then multiply the result by 3, you get quite a surprising answer. To show you what I mean, let's first multiply 37 by 7, giving us 259. That number, when further multiplied by 3, gives 777. You'll get a similar result if you choose any other number lower than 10 for the initial multiplication. If, for instance, you choose 4, then the final answer is 444.

There's a very simple reason for this apparent phenomenon and I should imagine that most of you have already spotted it. For those who haven't, I'll pass on the appropriate information in next month's issue.

#### MORE NUMBERS

Talking about numbers, my comments on mnemonics for  $\pi$  in the last May and September issues seem to have caused quite a little interest.

I initially introduced the mnemonic "May I have a large container of coffee," which gives the first 8 figures of  $\pi$ . The number of letters in each word in this sentence represents, in order, these first 8 figures.

I then quoted from the 7th edition of M. G. Scroggie's *Radio and Electronic*

THE RADIO CONSTRUCTOR

Laboratory Handbook (Iliffe), stating that  $\pi$  to ten decimal places is 3.1415926535 . . . -

Whereupon I remarked that the final word in the mnemonic, which stands for 6, should really be replaced by one which stands for 7, as is given when the expression is corrected to seven decimal places.

Mr. Scroggie has since written to me to point out that the final 6 represented by the mnemonic is correct, because the rule for 5 is to round off to an even number. This rule is justified statistically and is, indeed, mentioned in his book.

Mr. Scroggie states also that the 8th edition of his *Radio and Electronic Laboratory Handbook* should be appearing shortly (if it is not already in

print by the time these notes appear) and that it has been thoroughly revised and is very different from the 7th. This is a work which I, for one, will warmly welcome for my bookshelves.

#### DECEMBER ONCE MORE

Yet another year has shot by, and I see that we are once again at December. So let me first of all wish all readers a very Merry Christmas and a truly Happy New Year.

It's going to be an exciting New Year too, so far as *The Radio Constructor* is concerned. We have plenty of fascinating new projects in hand, as you'll be discovering during the next twelve months.

See you in 1969!



## Your Local Supplier

SURREY

### Portable Transistor Amplifier



Many uses, Inter-coms, Baby Alarms, Guitar Practice, Telephone or Record Player Amplifier. ONE WATT OUTPUT. Wooden cabinet 12 x 9 x 4in. Rexine covered two tone grey. Four transistors, 7 x 4in. speaker. Volume control: Jack socket. Uses PP9 battery.

Worth double our price

79/6

Post 5/6

### Radio Component Specialists

337, WHITEHORSE ROAD,  
WEST CROYDON, SURREY.  
Phone 01-684-1665 FULL LIST 1/-

SUSSEX

## TWO NEW HEATH MODELS

Two new models recently introduced from Heath are the Universal Digital Instrument EU-805 Series and the Analogue Digital Designer, model EU-801-A.

The Heath "805" Universal Digital Instrument is the ideal multi-purpose instrument capable of many high-accuracy standard measurements and has the adaptability and versatility required of modern research instrumentation. It incorporates a unique modular design based on 16 plug-in cards using TTL Integrated Circuits. This concept enables card addition of new functions to the instrument and protects it against obsolescence. In both academic and industrial laboratories it is a logical companion to the Heath Analogue Digital Designer EU-801-A.

The Heath Analogue Digital Designer, model EU-801-A is an exceptionally versatile device for teaching digital logic and instrumentation in academic laboratories. It can also be used by engineers and scientists in research and development as an experimentation system as well as a permanent or semi-permanent instrument, in a particular configuration. It has everything necessary to investigate digital circuitry, design one's own circuits or "customise" functions to perform as a discreet digital instrument.

For further details, please write to Daystrom Limited, Bristol Road, Gloucester GL2 6EE.

## SOLID STATE WINDSCREEN WIPER DELAY UNIT

We have been informed that there is a risk of excessive battery current flow if the windscreen wiper delay unit described on page 116 of the last September issue is employed with modern vehicles having a wiper motor with permanent magnet field. In such systems the motor armature is short-circuited to provide dynamic braking during the parking operation, and the circuit employed is not compatible with that of the delay unit. If in doubt, insert a fuse rated at 10 amps in series with the non-earthly supply lead to the wiper circuit whilst initially checking the delay circuit.

DECEMBER 1968

## E. JEFFRIES

For your new television set, tape recorder, transistor radio, and hi-fi equipment.

PHILIPS, ULTRA, INVICTA, DANSETTE, MASTERADIO, PERDIO, MARCONI, PHILCO, FIDELITY.

6A Albert Parade,  
Victoria Drive,  
EASTBOURNE SUSSEX

WORCESTERSHIRE

Dept. C1, 176 HAGLEY ROAD  
**HALESOWEN**  
021-550 3210 WORCS.

Hi-Fi Equipment  
Transistors and  
Radio Components  
Public Address Amplifiers

**MARLISON**  
Electronics

EIRE

## PEATS for PARTS

ELECTRONIC COMPONENTS  
RADIO & TELEVISION

For the convenience of IRISH enthusiasts we supply:

The Radio Constructor,  
Data Books and  
Panel-Signs Transfers

Also a postal service

Wm. B. PEAT & Co. Ltd.  
28 PARNELL STREET  
DUBLIN 1

# Opportunity of a lifetime!

## Big price reductions on top quality knights-kits

Easy to build. Designed to highest specifications. Unbeatable quality and superb performance guaranteed.



### KG980 Solid-State Stereo FM Receiver Kit

Silicon transistors. Control facilities for phono and tape. Extra-wide power bandwidth and response. 240V, 50Hz A.C. Kit £55. 3. 6. Teak case extra £5. 15. 6. (inc. P.T.) Tuning heart extra £7. 19. 0. (inc. P.T.) Postage 10s 0d. complete kit, 5s 0d. case.



### KG765A Solid-State Stereo FM-AM Tuner

Frequency response 1dB, 20-20,000 Hz. Hum and noise (f.m.) 55dB down. Outstanding in weak signal areas. Kit £34. 14. 2. Teak case extra £5 (inc. P.T.) Tuning heart extra £10. 15. 4. (inc. P.T.) Postage 10s 0d. complete kit, 5s 0d. case.



### KG795 Stereo Tuner

F.M.  $\pm$  1dB, 30-15,000 Hz. Hum and noise better than -50dB. Tuning range 88-108 MHz. Channel separation 30dB or more at 1kHz. Kit £34. 14. 2. Teak case extra £5. 7. 6. (inc. P.T.) Tuning heart extra £6. 16. 0. (inc. P.T.) Postage 10s 0d. complete kit, 5s 0d. case.



### KG854 Stereo Amplifier

Advanced design. 14 transistors. 2 silicon diodes. Full controls. Response  $\pm$  1dB, 20-25,000 Hz. Kit £42. 9. 0. Teak case extra £5 (inc. P.T.) Postage 10s 0d. complete kit, 5s 0d. case.

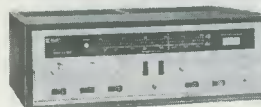

### KG964 Stereo FM-AM Receiver

For the perfectionist. Powerful 64-Watt IHF Amplifiers. 46 semi-conductors. Full controls. Factory assembled FM Front-end, FM-AM IF Circuits, transformers and coils. Response  $\pm$  1dB, 20-20,000 Hz. Hum and noise 55dB. Kit £62. 8. 4. Teak case extra £8. 12. 7. (inc. P.T.) Tuning heart extra £20. 1. 4. (inc. P.T.) Postage 10s 0d. complete kit, 5s 0d. case.



### KG790 Stereo AM-FM Tuner

22 Transistors. 14 diodes. Response  $\pm$  2dB, 50 Hz to 15 kHz. Hum and noise -60dB. Range 87.5 to 108.5 MHz. Kit £55. 18. 2. Teak case extra £8. 9. 6. (inc. P.T.) Tuning heart extra £20. 1. 4. (inc. P.T.) Postage 10s 0d. complete kit, 5s 0d. case.

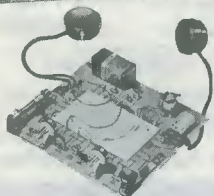

### 21 Circuit Transistor Lab. Kit

Complete with headphones and photocell. Great fun and instructive. Enables you to broadcast through any nearby radio; turn electric equipment on and off just by speaking! Kit £7. 19. 6. (inc. P.T.) Postage 7s 6d.



### KG275A CdS Exposure Meter Kit

Takes accurate readings even in moonlight. Covers ASA Speed Ratings 6 to 12,000; shutter settings 1/4,000 second to 30 minutes. Cine settings 4 to 128 frames per sec. Incident or reflected light readings. Kit £10. 7. 6. (inc. P.T.) Hard case £2. 8. 3. (inc. P.T.) extra. Soft case £1. 6. 5. (inc. P.T.) extra. Postage 4s 0d.

Easy credit facilities available, ask for details.

## New 960 page Hobbies Manual 12 Hobbies Sections - over 12,000 units & components for dozens of Hobbies 16/6

Please send me: Free Knight-Kits brochure   
The new Electronics Hobbies Manual. (16/6)   
Enclosed is a cheque/postal order for 16/6 (which includes the 5/- pp) made payable to Electronics (Prop. STC) Ltd.

Name.....

Address.....

**knight-kit** Quality built-in, built up by you.

Electronics (Prop. STC) Ltd.,  
Edinburgh Way, Harlow, Essex.

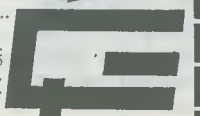

electronics

# PEAK SOUND

aids to economical hi-fi

## Peak Sound ES.10-15 BAXANDALL SPEAKER



"Rolls-Royce standards"

says  
RALPH WEST  
*Hi-Fi News Oct.*

"The immediate impression was of a thoroughbred speaker, smooth and effortless... voices were uncannily real... Once again we see the possibility of Rolls-Royce standards from comparatively cheap components... when you know how." *Hi-Fi News* Test Report, Pages 1208/1211. Oct. 1968.

## A Revolutionary Advance in Design Logic

THE PEAK SOUND ES/10-15 is the designer-approved kit of the sensational loudspeaker designed and described by P.J. Baxandall in *Wireless World* (Aug. & Sept. 68). Frequency response extends from 60-14,000 Hz. (100-10,000 Hz.  $\pm$  3dB). Everything supplied to specification—the 18" x 12" x 10" afro-mossia teak cabinet is cut and drilled for simple assembly; the equalising circuitry is ready for immediate installation. See what *Hi-Fi News* says in full in their October issue. It is hard to believe so modestly priced a speaker could get so glowing a report.

Equaliser assembly  
—36/- Speaker Unit  
—38/- Pur. Tax—  
8/1d.; Cabinet parts  
(complete) £6.15.0  
**Total Cost**  
**£10.17.1**  
Cover for additional  
bass unit—22/6d.—  
(carr. paid).

6 5 . 0

## a new Peak Sound hi-fi power amplifier

THE PEAK SOUND PA/12-15 is a new power amplifier of excellent design and performance. Class B output of 12 watts R.M.S. into 15 ohms; 43dB neg. feedback frequency response from 10Hz to 45 KHz  $\pm$  0.5dB; distortion less than 0.1% input sensitivity—400mV; power requirement 45V D.C. Size 5" x 3 $\frac{1}{2}$ " x 1 $\frac{3}{8}$ ". Selected high gain closely matched transistors are used throughout. Full instructions are provided. Pre amp details are available. Peak Sound heavy duty power unit £55.0.

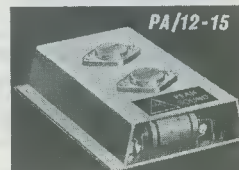

Built and tested **£5.19.6**

Kit, less heat sink (price 6/-) and base board **79/6**

From dealers or sent direct in case of difficulty. POST FREE.  
**PEAK SOUND (HARROW) LTD.**

32 St. Judes Road, Englefield Green, Egham, Surrey. Egham 5316



## TAKE FIVE

Save money with our new discounts and price reductions. You can now buy ANY FIVE or more transistors, one type or MIXED, at the '5-up' (in brackets) prices. Example: set of 6 transistors and diode for the 'R.C.' 3V TRF (October, p. 160). Old price £1-0-9. New price: 17/8. Quality unchanged: new, first grade and guaranteed to specification. Send stamp for data/price list (free with orders). Orders over 10/- post paid. EXTRA DISCOUNT: 10% over £5, 15% over £10.

AD161/2pr	15/6 (12/8)	GET693	1/6 (1/3)	2N3707	5/- (4/3)
AF239	10/- (8/6)	HK041	2/6 (2/3)	2N3983	6/11 (5/8)
B-5000	12/6 (10/-)	HK101	2/- (1/9)	2N4058	5/6 (4/7)
BD121	23/- (21/-)	HK301	2/- (1/9)	2N4285	2/10 (2/6)
BC107B	3/- (2/8)	HK601	2/6 (2/3)	2N4292	2/10 (2/6)
BC109C	4/- (3/6)	SF115	2/10 (2/6)	2N706	3/4 (2/7)
BC168B	2/3 (2/-)	TI3028	19/9 (16/7)	2SB187	2/6 (2/-)
BC168C	2/3 (2/-)	TIS18	8/6 (7/-)	2SB405	6/- (5/-)
BC169C	2/6 (2/3)	TIS60M	5/10 (4/8)	2SD72	6/- (5/-)
BF224	5/- (4/-)	TIS61M	5/11 (4/11)	3N140	20/- (18/-)
BF225	5/- (4/-)	2N2926G	3/- (2/6)	3N141	15/8 (14/-)
BFY51	4/9 (4/-)	2N3055	20/- (17/-)	IS557	3/6 (3/-)

### 'R.C.' 3V TRF (October, p160)

Wound MW aerial rod for 300pF tuning 5/7. Blank 4 1/2" x 3/8" rod in NW25, 2/-, J.B. Dilemin capacitor, 300pF, 10/-, Battery Holder BH2, with clip connector, 2/6. Transistors (see above) 17/8. We can supply all parts except 32 speaker. Send stamp for list and circuit.

### HOOKED ON GE?

Are you a 'negative up', germanium transistor addict? Worried by all those new silicon npns? Break yourself gently of the Ge habit. Our new silicon npns work in the familiar germanium circuits. 2N4285 is similar to old friends like OC71, OC72, etc. 2N4289 is a high gain type for r.f. and a.f., not far removed from OC44, AF117, etc. Both tiny, robust, and cheap: 2/10 (2/6). Send 6d. stamp for our new hint-sheet 'CHANGING TO SILICON', with many useful circuits.

### WHO ARE AMATRONIX?

Amatronix (You guessed! It's short for 'Amateur Electronics') Ltd. is a small family firm. We specialise in mail-order supply to constructors, and we really do take an interest in our customers. Our service is quick, our prices are reasonable, and we don't sell rubbish. We know your problems: we're constructors ourselves. (You may have seen articles by G. W. Short in 'R.C.' He's one of our directors, and a lifelong radio enthusiast).

## AMATRONIX LTD. (RC)

396 Selsdon Road, South Croydon, Surrey, CR2 0DE.

# S-DeC BREADBOARDING

- \* Fast, reliable, solderless circuit assembly
- \* Contacts last indefinitely
- \* Use ordinary components again and again
- \* Test *all* the circuits in the magazines

This breadboard is used professionally by development engineers throughout the world. Over 80% of current production is exported. A booklet of projects is included with each kit giving construction details for a variety of circuits such as amplifiers, oscillators, VHF transmitter, radio, etc.

**S-DeC Kit:** One S-DeC with Control Panel, Jig and Accessories for solderless connections to controls, etc., with booklet 'S-DeC Projects' giving construction details for a variety of circuits. 29/6d retail.

**4-DeC Kit:** Four S-DeCs with two Control Panels, Jigs and Accessories and the booklet 'S-DeC Projects' all contained in a strong attractive plastic case. Ideal for the professional user. £5-17-6d retail.

### AVAILABLE FROM LEADING SUPPLIERS

*or in case of difficulty from*

## S.D.C. PRODUCTS (Electronics) LTD.

THE CORN EXCHANGE, CHELMSFORD, ESSEX.  
Telephone: Chelmsford (OCH 5) 56215

(Please add 1/- P.&P. for S-Decs, and 3/- P.&P. for 2 and 4-Dec Kits)



## MARCONI INSTRUMENTS LIMITED ST. ALBANS & LUTON

**ARE YOU A SKILLED AND EXPERIENCED ELECTRONICS TECHNICIAN?  
HAVE YOU BEEN A WIRELESS OR RADAR FITTER IN THE ARMED FORCES?  
CAN YOU DO A PROFESSIONAL REPAIR JOB ON A T.V.?**

If you can answer "YES" to at least one of these questions, then we should like to hear from you.

We need test and calibration engineers both at our Government Service Unit at Luton Airport and at our Production Units in St. Albans to work on a wide range of telecommunications measuring instruments, which includes F.M. and A.M. Signal Generators, R.F. Power Meters, Valve Voltmeters, Radar Test Sets, Digital Counters, Deviation Meters, Spectrum Analysers and White Noise Test Sets.

The work requires the understanding of the most modern and varied circuit techniques and embraces all frequencies up to U.H.F.

This is an opportunity to work for an expanding company with a world-wide reputation for technical progress in the design of test equipment. The posts are permanent and pensionable; they offer first-class conditions of service in a key export company of English Electric, including substantial superannuation and life assurance benefits. Financial assistance may be given with re-location expenses.



Write in confidence, stating briefly age, experience, qualifications and present salary, to:—

**The Recruitment Manager, Marconi Instruments Limited,  
c/o Directorate of Personnel (RC 2890 H),  
English Electric House, Strand, London, W.C.2.**

COMING SHORTLY . . .

# AUDIO AMPLIFIERS



**16 Transistor and Valve Designs for the Home Constructor**

*Amplifiers for Tuner Units, Record Players, Tape Recorders, Public Address, etc., etc.*

Includes contributions by such well know authors as A. S. Carpenter, A. Kinloch, E. Govier, G. A. French, F. G. Rayer, P. F. Bretherick, K. Jones, D. Aldous, R. Murray-Shelley, C. Swires, G. A. Stevens and V. E. Holley.

*Specially selected from The Radio Constructor*

Edited by J. R. Davies

**PRICE 10s. 6d.**

124 pages

Postage 8d.

Available January 1969

**TO DATA PUBLICATIONS LTD 57 Maida Vale London W9**

Please supply.....copy(ies) of "Audio Amplifiers," Data Book No. 18

I enclose cheque/crossed postal order for.....

NAME .....

ADDRESS .....

.....

.....

.....

**BLOCK LETTERS PLEASE**

# SMALL ADVERTISEMENTS

Rate: 9d. per word. Minimum charge 12/-.  
Box No. 2/- extra.

Advertisements must be prepaid and all copy must be received by the 4th of the month for insertion in the following month's issue. The Publishers cannot be held liable in any way for printing errors or omissions, nor can they accept responsibility for the bona fides of advertisers. (Replies to Box numbers should be addressed to: Box No.—, The Radio Constructor, 57 Maida Vale, London, W.9.)

**SERVICE SHEETS.** Radio, Television, Tape Recorders 1925-1968, by return post, from 1s. with free fault-finding guide. Catalogue 6,000 models 2s. 6d. S.A.E. enquiries.—Hamilton Radio, 54c London Road, Bexhill, Sussex.

**ILLUSTRATED CATALOGUE No. 17.** Manufacturers Surplus and New Electronic Components including Semiconductors. 3/- Post Free. Arthur Sallis Ltd., 28 Gardner Street, Brighton.

**RESISTORS.** Low noise (0.3 micro V. per V.) 1/2W. 10% carbon film. 1/6d. each 13/- per 100. Transistor mounting pads 1/4d. each. Post and packing plus 5%. Stuart Fyfe (Components). 11 Rosedene Avenue, Croydon, Surrey. CRO. 3DN.

**WHY PAY MORE!!** PM Loudspeakers, all shapes & sizes. Ideal for room to room extensions, car radios, etc. Ex-equipment. Tested & Guaranteed. 10/6d., 15/6d., or 23/- Well packed. 4/6d. postage. E. & J. Wild (Loudspeakers). Square Street, Ramsbottom, Lancs.

**RCĀ LINEAR I.C.'s.** CA3011 1 s., CA3020 28s., CA3028A 20s. P. & P. 1s. per order. L.F.H. Electronics, 65 Flanders Mansions, Flanders Road, London, W.4.

**PRINTED CIRCUITS MADE TO YOUR NEGATIVES** or transparent master positives. 1 board to 250 boards. We will produce master to your circuit diagram if required. Bideford Graphic Arts, Torridge Hill, Bideford, North Devon. Telephone: Bideford 4991.

**WHY BUILD A POWER SUPPLY,** when you can buy one for only 25/-, plus 2/6d p. and p. Mains input 230V a.c. 250V, 100mA d.c. out. Fused. 6.3V at 3 amp. 7.3V at 3 amp. ISHERWOODS ELECTRONICS, 98/100 Northgate, Blackburn, Lancs.

**BRIGHTEN UP YOUR ADVERTISING!** Break the ice with a cartoon, "tailor made" for your product. Reasonable charges.—Box No. F294.

**5 TON FACTORY CLEARANCE.** Radio, T.V., elec. components in 27s. 6d. mixed parcels. Post free. Example: resistors, condensers, pots, speakers, coax, coils, fibre washers, valves, over a dozen different types, tuning knobs, grommets, sleeving, IFS, Paxalin, wire, rectifiers. Lots of other items. Pot Luck. Postal orders to: P. L. Newton, 16 Shallcross Crescent, Hatfield, Herts.

**BOOKS FOR SALE.** Alfred Nobel E. Bergengren £1, *Radio-isotope Laboratory Techniques* R. A. Faïres, 10s. *Atomic Medicine* Behrens, £1. *Medical Radiation Biology* Ellinger, 30s. *Physics in Medical Radiology* Russ, Clark & Pelc, 7s. 6d. *Disease & its Conquest* Hollis, 7s. 6d. *Earth's Envelope* T. Lobsack, 15s. *The Atomic Submarine* C. Blair, 7s. 6d. *Astro-and exploration* D. R. Bates, £1. *Once round the Sun* Story of the I.G.Y., Fraser, 10s. *Earth Satellite* P. Moore, 7s. 6d. *Frontier to Space* E. Burgess, 5s.—Box No. F316.

**FOR SALE:** 1 cwt. electronic components, chassis, (resistors, capacitors, pots, etc.). View London W.2. £3. Buyer collects. Telephone: Mr. Fowler, 01-723-9584. 9 a.m. to 6 p.m.

DECEMBER 1968

# BENTLEY ACOUSTIC CORPORATION LTD.

38 Chalcot Road, Chalk Farm, The Old Police Station  
LONDON, N.W.1. Gloucester Road  
PRImrose 9090 LITTLEHAMPTON, Sussex  
PHONE 6743

Please forward all mail orders to Littlehampton

5Z4G	6/9	ECC85	5/-	PC88	9/6	UB01	17/6	AF116	3/-	GET896	4/6
GAT6	4/-	ECC88	7/-	PC95	8/3	U4020	6/9	AF117	2/9	GET897	4/6
6/30L2	12/6	ECC189	9/6	PC97	7/9	UABCB0	5/9	AF119	3/6	OA81	1/9
6F1	8/9	ECF80	6/6	PC900	8/3	UBC81	7/-	AF125	3/6	OA95	1/9
6F23	12/3	ECF82	6/6	PCCB4	6/6	UBF80	5/9	AF127	3/6	OA182	2/-
6L6GT	7/9	ECF86	9/-	PCCB5	6/6	UBF89	6/9	AF139	11/-	OA200	11/-
10F1	15/-	ECH42	9/6	PCCB8	9/6	UC92	5/6	AF180	9/6	OC22	5/-
10P13	12/-	ECH81	5/3	PCCB9	9/6	UC84	8/-	AF212	5/-	OC23	5/-
20D1	13/-	ECH83	8/-	PCC189	9/6	UC85	6/6	ASY29	10/-	OC24	5/-
20L1	13/-	ECH84	7/-	PCF80	6/6	UCF80	8/3	BA115	2/8	OC25	5/-
20P4	18/6	EGL80	6/6	PCF82	6/6	UCH21	9/-	BA129	2/6	OC26	5/-
30C15	13/6	ECL82	6/-	PCF84	8/3	UCH42	9/3	BA130	2/-	OC28	5/-
30C17	13/-	ECL83	9/-	PCF85	8/6	UCH81	6/6	BC107	4/6	OC30	5/-
30C18	8/9	ECL86	8/-	PCF801	7/-	UCL82	7/6	BC108	3/6	OC35	5/-
30F5	11/9	EF22	12/6	PCF802	9/-	UCL83	9/3	BC109	4/3	OC36	7/6
30FL1	5/-	EF37A	7/-	PCL82	7/-	UF41	9/6	BCY10	5/6	OC38	11/6
30FL12	16/-	EF41	9/-	PCL83	8/9	UF42	9/6	BCY12	5/6	OC41	10/-
30PL14	12/6	EF80	4/6	PCL84	7/6	UF80	6/9	BCY33	5/6	OC44	2/-
30L15	13/9	EF85	5/3	PCL85	8/3	UF85	6/9	BCY34	4/6	OC45	1/9
30L17	13/-	EF86	6/6	PCL86	8/6	UF86	6/9	BCY38	5/6	OC46	3/6
30P4	12/-	EF89	4/9	PFL200	12/6	UF89	6/9	BCY39	4/6	OC70	2/3
30P4MR	17/6	EF91	3/3	PL36	9/6	UL41	9/6	BFY50	4/6	OC71	2/6
30P12	13/-	EF183	5/9	PL81	7/3	UL84	6/6	BFY51	4/6	OC72	2/6
30P19	12/-	EF184	5/9	PL82	6/6	UM80	5/6	BFY52	4/6	OC75	2/6
30PL1	15/-	EH90	6/6	PL83	7/3	UY41	6/9	BF163	4/6	OC76	2/6
30PL13	15/-	EL33	11/6	PL84	8/3	UY85	5/6	BY100	3/6	OC77	2/6
30PL14	15/-	EL41	9/3	PL500	12/3	2N404	6/6	BY126	6/6	OC78	3/6
CL33	18/6	EL84	4/6	PL504	13/-	2N2297	4/6	BY234	4/6	OC78D	3/6
CY31	7/6	EL95	5/-	PY32	9/6	2N2369A	4/3	BY236	4/6	OC81	2/-
DY87	5/9	EM80	5/9	PY33	9/6	2N3866	20/-	BY238	4/6	OC82	2/3
EB8CC	12/-	EM81	6/9	PY81	5/3	AAZ13	3/6	BY211	5/6	OC83	2/6
EABC80	6/6	EM84	8/-	PY82	5/6	AC107	3/6	BY212	5/6	OC84	3/6
EF42	8/3	EM85	11/6	PY83	5/6	AC113	5/6	BY213	5/6	OC85	2/6
EB91	2/3	EM87	7/3	PY88	6/3	AC126	2/6	GET103	4/6	OC123	4/6
EBCA1	8/6	EY51	6/9	PY800	6/6	AC127	2/6	GET113	4/6	OC169	3/6
EBCB1	5/9	EY86	6/-	PY801	6/6	AC128	2/6	GET116	6/6	OC170	2/6
EBF80	5/9	EY87	6/-	U25	13/-	AC154	5/6	GET119	4/6	OC171	3/4
EBF83	8/-	EZ40	7/3	U26	11/9	AC156	4/6	GET573	7/6	OC172	4/6
EBF89	6/3	EZ80	4/3	U33	29/6	AC157	5/6	GET587	8/6	OC200	4/6
EC92	4/6	EZ81	4/6	U45	15/6	AD140	8/6	GET873	3/6	OC203	4/6
ECC51	3/9	KT88	29/-	U191	12/6	AD149	8/6	GET887	4/6	OC205	7/6
ECC82	4/6	KTW62	10/-	U251	16/6	AD162	9/6	AF115	3/6	GET890	4/6
ECC83	4/6	PABC80	7/3	U301	11/6	AF114	4/6				
ECC84	5/6	PC86	9/6	U404	7/6	AF115	3/6				

Terms of business: Cash with order only. No C.O.D. Post/Packing 6d. per item. Orders over £5 post free. All orders despatched same day as received. Complete catalogue including transistor section and components with terms of business 6d. Any parcel insured against damage in transit for 6d. extra. Business hours: 9 a.m.-5.30 p.m. Saturdays 9 a.m.-1 p.m.

# FREE TO AMBITIOUS ENGINEERS

—THE LATEST EDITION OF ENGINEERING OPPORTUNITIES

**Have you sent for your copy?** ENGINEERING OPPORTUNITIES is a highly informative 132 page guide to the best paid engineering posts. It tells you how you can quickly prepare at home for a recognised engineering qualification and outlines a wonderful range of modern Home Study Courses in all branches of Engineering. This unique book also gives full details of the Practical Radio & Electronic Courses, administered by our Specialist Electronics Training Division — explains the benefits of our Appointments Dept. and shows you how to qualify for five years promotion in one year.

**"Satisfaction or refund of fee" terms**  
Whatever your age or experience you cannot afford to miss reading this famous book. If you are earning less than £30 a week send for your copy of "ENGINEERING OPPORTUNITIES" today — FREE.

**Practical Equipment including Tools**  
The specialist Electronics Division of B.I.E.T. NOW offers you a real laboratory training at home with practical equipment.

Basic Practice and Theoretical Courses for beginners in Radio, T.V.; Electronics, etc. Ask for details.

**Which is your pet subject**  
A.M.I.E.R.E. City & Guilds  Radio Amateur's Exam.  R.T.E.B. Certificate P.M.G. Certificate  Practical Radio  Radio & Television Servicing  Practical Electronics  Electronics Engineering  Automation  
The B.I.E.T. is the leading institute of its kind in the world.

Please send Free Books and Full Information

## British Institute of Engineering Technology

NAME.....  
ADDRESS.....  
.....  
Subject of Interest.....Age.....



ALDERMASTON COURT, Dept. 480D. Aldermaston, Berks.

# NEW STYLE SELF-BINDER for "The Radio Constructor"

The "CORDEX" Patent Self-Binding Case will keep your issues in mint condition. Copies can be inserted or removed with the greatest of ease. Rich maroon finish, gold lettering on spine.

Specially constructed Binding Cords are made from Super Linen of great strength, very hard twisted and twice doubled. They are attached to strong RUSTLESS Springs under tension, and the method adopted ensures PERMANENT RESILIENCE of the Cords. Any slack that may develop is immediately compensated for, and the Cords will always remain taut and strong. It is impossible to overstretch the springs, as a safety check-device is fitted to each.

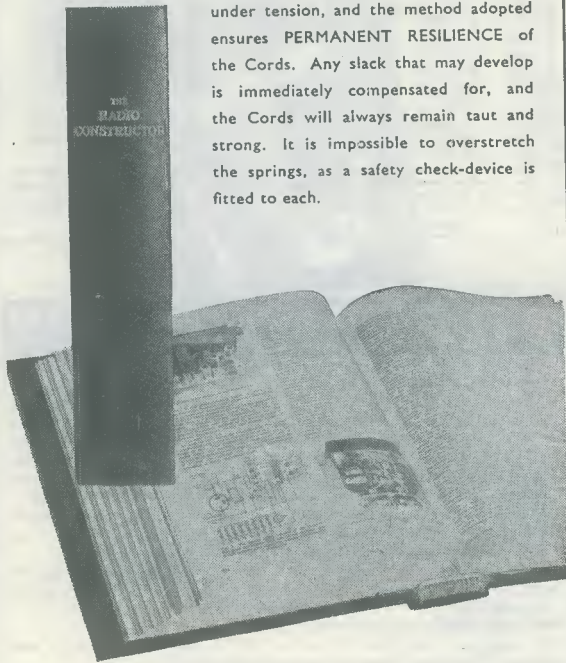

PRICE **14/-**

Postage 1/6

Available only from:—

**Data Publications Ltd.**  
**57 Maida Vale London W9**

## SMALL ADVERTISEMENTS

*continued from page*

**ARE YOU A MOTORING ENTHUSIAST?** The Seven Fifty Motor Club caters for all types of motor sport—racing, rallies, hill climbs, etc. Monthly Bulletin free to members. For full details write to: The General Secretary, Colin Peck, "Dancer's End," St. Winifred's Road, Biggin Hill, Kent.

**JOIN THE INTERNATIONAL S.W. LEAGUE.** Free Services to members including Q.S.L. Bureau. Amateur and Broadcast Translation. Technical and Identification Dept.—both Broadcast and Fixed Stations, DX Certificates, contests and activities for the SWL and transmitting members. Monthly magazine, *Monitor*, containing articles of general interest to Broadcast and Amateur SWLs, Transmitter Section and League affairs, etc. League supplies such as badges, headed notepaper and envelopes. QSL cards, etc., are available at reasonable cost. Send for League particulars. Membership including monthly magazine, etc. 35s. per annum.—Secretary, ISWL, 60 White Street, Derby.

**BARGAIN TRANSISTORS.** Good Audio types. 5 for 5/-, 10 for 8/-. All new, tested. Post 6d. J. Blacker, 32A Mill Hill, Vicarage Lane, Leicester.

**TECHNICAL DRAWINGS, Artwork, etc.** Electronic and Radio Circuits a speciality. Moderate charges.—B. P. Meaney, 43 Forest Road, Worthing, Sussex.

**"MEDIUM WAVE NEWS"** Monthly during DX season—Details from: K. Brownless, 7 The Avenue, Clifton, York.

**WANTED TO PURCHASE.** Set of 6 coils for Jason Everest-7 receiver kit. 43 Ashbrook Road, Old Windsor, Berkshire.

**FOR SALE: MORSE OSCILLATOR SET.** Transistorised, type D, key, on base 8½ in. x 9½ in., with headphones. £3. Box No. F347.

**BOOK BARGAINS TO CLEAR.** "The Yachtman's Bedside Book", Snoxell, 25/-. "The Story of Atomic Energy", Soddy, 12/6d. "Invitation to Skiing", Iselin and Sectorsky, 20/-. "The Upper Atmosphere", Massey and Boyd, 50/-. "Outlook"—simple weather forecasting, White, 7/6d. "Basic Principles of Marine Navigation", Moore, 7/6d. "Telegraphy", Freebody, 60/-. "The Book about Weather", Mee, 7/6d. Box No. F348.

**FOR SALE: Radio Constructor** Sept. 1967 to October 1968. *Practical Wireless* 1955 to 1961. *Bulletin* 1959 to 1968. Offers for any year. Some bound. L. Tarr, 11 Oakwood Avenue, Wilmslow, Cheshire.

**POSTAL ADVERTISING?** This is the Holborn Service. Mailing lists, addressing, enclosing, wrapping, facsimile letters, automatic typing, copy service campaign planning, design and artwork, printing and stationery. Please ask for price list.—The Holborn Direct Mail Company, Capacity House, 2-6 Rothsay Street, Tower Bridge Road, London, S.E.1. Telephone: 01-407-1495.

**WORLD DX CLUB** covers all aspects of SWLing on Amateur and Broadcast Bands through its monthly bulletin "Contact". Membership costs 25s. a year. Enquiries to Secretary, WDXC, 17 Taunton Road, Bridgwater, Somerset.

**FOR SALE.** Golay Lever Escapement Navigation watch, with external, rotatable, navigation ring, graduated to 360°. In wooden case, 4 in. x 3½ in. x 2½ in. £10. Box No. F350.

**PROPERTIES** for sale and to let in London and suburbs. Apply to Maggs & Stephens, Estate Agents, 229 Maida Vale, London, W.9. MAIDA VALE 8123.

*(continued on page*

## SMALL ADVERTISEMENTS

continued from page

**TO CLEAR.** 3000V d.c. 0.5 $\mu$ F capacitors, 2 $\frac{1}{2}$ in. x 1 $\frac{1}{8}$ in. x 6in. with porcelain insulators, 3/6d. each. 88Htoroid coils, new, wax covered, 5/- each. Heathkit Balun Coil set, B-1U, assembled, £5. Box No. F352.

**ESSEX GARDENERS.** Buy your bedding and rock plants, shrubs, etc., also cacti from May's Nurseries, 608 Rayleigh Road, Hutton, Brentwood, Essex. Callers only. Monday to Saturday.

**RADIO HAMS.** For sale, R.107 set, Good condition, £30 or nearest; Single and twin Tannoy speakers; power generator (converter) S.E.R.70; 2 converter units type S454B; carbon microphones; radio receiver VC 453B; Offers? Box No. F353.

**FOR SALE:** Unbound copies of "The Radio Constructor", 1955/1960/1962/1963/1964/1966. Complete. 40s. per year, post paid. Other years available, not complete. Enquire with s.a.e. first. Box No. F354.

**VALVES FOR SALE TO CLEAR.** Early radio valves, would suit collector. LS5, P625, DE5, DEL610, Cossor 41MP, HP4106, HL610, HL8, ACS2/PEN, Mullard TDD4, 1W4/350. All at 3/6d. each. Wartime types: VT62, U14, 6B4G, VT136, CV1075, 801-A, VR91. All at 2/6d. each. EF40, EL91, EB91, DL92, DK81, 3ML, IS5, 6AG5. All at 5/- each. 5B/254M, 10/-, Box No. F355.

**RECITALS OF RECORDED MUSIC.** The second Saturday evening of each winter month. Next recital: 14th December, 1968, 8 p.m. Woodford Green United Free Church, Woodford Green, Essex. Bus routes 20, 20A, 38A and 179—alight at "The Castle" stop. Programme includes works by Pergolesi, Bach, Handel & Gabrieli.

**FOR SALE:** 88mH toroid coils, 5/- each. Cover for Siemens Teleprinter, 50/-, Ink rollers for Creed type 3 teleprinter, 5/- per bottle. EMI Fisk Solariscope, 7/6d. Prices include p. & p. Box No. F356.

**FOR SALE:** *The Radio Constructor*. January 1954 to February 1968, most as new, all indexed. Half price, minimum one volume. Box No. F357.

**INNOVATION IN DX CLUBS ANNOUNCED!** Formed in October, 1965, the Radio New York Worldwide Listeners Club now has 3,600 members in 86 countries! A unique club offering shortwave listeners monthly magazines containing listening tips and technical features, numbered wallet-sized membership cards and gold 8 $\frac{1}{2}$ in. by 11in. membership certificates. Multi-lingual report forms available for cost of postage. "We must be doing something right!" Find out... join now!" Send 7s. 2d. (crossed domestic money order) for one year's membership to: The Radio New York Worldwide Listeners Club, 485 Madison Avenue, New York 10022, U.S.A.

### SITUATIONS VACANT



We have Vacancies for Four Experienced Test Engineers in our Production Test Department. Applicants are preferred who have Experience of Fault Finding and Testing of Mobile VHF and UHF Mobile Equipment. Excellent Opportunities for promotion due to Expansion Programme.

Please apply to Personnel Manager,  
**Pye Telecommunications Ltd.,**  
Cambridge Works, Haig Road, Cambridge.  
Tel. Cambridge 51351, Extn, 327.

# PLAIN-BACKED NEW STYLE SELF-BINDERS

## for your other magazines

(max. format 7 $\frac{1}{2}$ " x 9 $\frac{1}{2}$ " )



The "CORDEX" Patent Self-Binding Case will keep your copies in mint condition. Issues can be inserted or removed with the greatest of ease. Specially constructed Binding cords are made from Super Linen of great strength, very hard twisted and twice doubled. They are attached to strong RUSTLESS Springs under tension, and the method adopted ensures PERMANENT RESILIENCE of the Cords. Any slack that may develop is immediately compensated for, and the Cords will always remain taut and strong. It is impossible to overstretch the springs, as a safety check-device is fitted to each.

**COLOURS : MAROON OR GREEN**

(Please state choice)

**PRICE 13/6** Postage 1/6

Available only from:—

**Data Publications Ltd.**  
**57 Maida Vale London W9**

# CHASSIS and CASES by



**H. L. SMITH & CO. LTD.**  
287/9 Edgware Road  
London W2  
TEL: 01-723 5891

## BLANK CHASSIS—Same day Service

Of over 20 different forms made up to YOUR SIZE.  
(Maximum length 35", depth 5".)

SEND FOR ILLUSTRATED LEAFLETS or order straight away, working out total area of material required (including waste) and referring to table below which is for four-sided chassis in 16 s.w.g. aluminium.

48 sq. in.	5/-	176 sq. in.	10/4	304 sq. in.	15/8
80 sq. in.	6/4	208 sq. in.	11/8	336 sq. in.	17/-
112 sq. in.	7/9	240 sq. in.	13/-	368 sq. in.	18/4
144 sq. in.	9/-	272 sq. in.	14/4	and pro rata	
	P. & P. 3/-		P. & P. 3/6		P. & P. 4/6

Discounts for quantities. More than 20 different sizes kept in stock for callers.

**FLANGES** (1/4" or 3/8"). 6d. per bend.

**STRENGTHENED CORNERS, 1/- each corner. PANELS**

Any size up to 3ft at 6/- sq. ft. 16 s.w.g. (18 s.w.g. 5/3).  
Plus postage and packing

CASES		ALUMINIUM, SILVER HAMMERED FINISH		Type N	
Type	Size	Price	Type	Size	Price
N	8 x 6 x 2"	18/-	W	12 x 7 x 7"	37/6
N	6 x 6 x 3"	17/6	W	15 x 9 x 8"	48/6
N	4 x 4 x 2"	11/-	Y	8 x 6 x 6"	29/-
U	4 x 4 x 4"	11/-	Y	12 x 7 x 7"	45/-
U	5 1/2 x 4 1/2 x 4 1/2"	17/-	Y	13 x 7 x 9"	50/6
U	8 x 6 x 6"	23/-	Y	15 x 9 x 7"	53/6
U	9 1/2 x 7 1/2 x 3 1/2"	24/-	Z	17 x 10 x 9"	72/6
U	15 x 9 x 9"	49/-	Z	19 x 10 x 8 1/2"	78/-
W	8 x 6 x 6"	23/-			

Type N has removable bottom, Type U removable bottom or back, Type W removable front, Type Y all screwed construction, Type Z removable back and front.

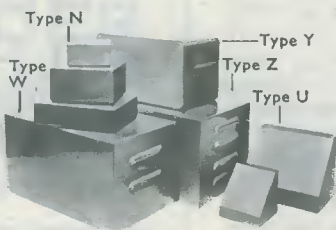

## HIGH GLOSS METALLIC HAMMERED ENAMEL

'Makes fantastic difference to Panels' so say

hundreds of enthusiastic users. 'Crackle' pattern appears like magic. Dries hard glossy finish. Scratch-proof, resists heat and liquid. Simply brush-on. No undercoat. Air dries 15-mins. Lt. & Dk. Blue; Bronze; Silver; Green; Black. Send for details or send 8/- (plus 1/9 post.) for 1/2 pt. Trial Tin, colour samples and instructions.

FINNIGAN SPECIALITY PAINT MANUFACTURERS,  
DEPT. RC, STOCKSFIELD, NORTHUMBERLAND. Tel. 2280.



BRUSH  
OR SPRAY-ON  
QUICK DRYING

## "V" NOTCHES

G.P.O.  
TYPE  
RELAY  
CONTACT  
SPRINGS



## WANTED

Contact springs as shown

BEST PRICES PAID

S.a.e. to "Lanco", 76 Sedgemoor Road,  
Willenhall, Coventry, Warwickshire

## 20 Suggested Circuits

by G. A. FRENCH

48 pages  
Price 3/6d. Data Book Series No. 15  
Postage 5d.

This book contains the first 20 circuits to be published in the very popular series of the same name appearing in *The Radio Constructor*.

The Contents include: simple and inexpensive two-valve capacity bridge, short wave regeneration preselector, one-valve speech operated switching circuit, transformer ratio analyser, series noise limiter, receiver remote mains on-off control, and many others; covering subjects ranging from electronic laboratory equipment to a simple 2-Stage Gram Amplifier.

DATA PUBLICATIONS LTD., 57 MAIDA VALE, LONDON, W.9.

# NOW AVAILABLE ... BOUND VOLUME No. 21

of "The Radio Constructor"

AUGUST 1967 to JULY 1968

Comprising 792 pages plus index

# FOR YOUR LIBRARY

PRICE 35' - Postage 4/6

## Special discount of 10/- for regular readers

As a further service to regular readers, it is no longer necessary to return the complete issues making up a volume, to qualify for the special discount.

Just cut the heading from each month's contents page, including title and month of issue, and this will be sufficient evidence of readership to qualify for the discount.

Thus regular readers will still retain their old copies for workbench use, while having a splendid bound volume containing issues in mint condition.

PRICE 25/- Postage 4/6

Limited Number of Volume 20 (August 1966-July 1967) still available. Price: 32/6, postage 4/6.

Available only from:

**DATA PUBLICATIONS LTD., 57 MAIDA VALE, LONDON, W9**

# THE RADIO CONSTRUCTOR

Price 3/- each, postage 6d.

Annual Subscription 42/-, post free.

Bound Volumes Vol. 20 August 1966 to July 1967 32/6, postage 4/6.

Vol. 21 August 1967 to July 1968 35/-, postage 4/6.

Cordex Self-Binders With title "The Radio Constructor" on spine, maroon, 14/-, postage 1/6.

With no title on spine, maroon or green, 13/6, postage 1/6.

## DATA BOOK SERIES

**DB5 TV FAULT FINDING**

124 pages. Price 8/6, postage 8d.

**DB6 THE RADIO AMATEUR OPERATOR'S HANDBOOK**

64 pages. Price 5/-, postage 5d. New edition available mid-January 1969

**DB14 SHORT WAVE RECEIVERS FOR THE BEGINNER**

72 pages. Price 6/-, postage 6d.

**DB15 TWENTY SUGGESTED CIRCUITS**

48 pages. Price 3/6, postage 5d.

**DB16 RADIO CONTROL FOR MODELS**

192 pages. Price 15/-, postage 1/-.

**DB17 UNDERSTANDING TELEVISION**

512 pages. Price 37/6, postage 3/-

## PANEL-SIGNS TRANSFERS

Six sheets in each set

**Set 3: WORDING—White**

**Set 4: WORDING—Black**

**Set 5: DIALS—Control Panels have a clear background**

**Set 6: DIALS—Control Panels have a black background**

Price per set 4/6, postage 4d.

I enclose Postal Order/Cheque for.....in payment for.....

NAME .....

ADDRESS .....

(Please use Block Capitals for both name and address)

Postal Orders should be crossed and made payable to Data Publications Ltd.

Overseas customers please pay by International Money Order

All publications are obtainable from your local bookseller

Data Publications Ltd., 57 Maida Vale, London W.9

# ENGLANDS LEADING COMPONENT & EQUIPMENT CENTRES

## SOLID STATE-HIGH FIDELITY AUDIO EQUIPMENT

Audio Equipment developed from Dinsdale Mk. II—each unit or system will compare favourably with other professional equipment selling at much higher prices.

COMPLETE SYSTEMS FROM **£15.5.0**

THE FINEST VALUE IN HIGH FIDELITY—CHOOSE A SYSTEM TO SUIT YOUR NEEDS AND SAVE POUNDS

All units available separately.

SEND FOR 16 PAGE BROCHURE (No. 21) TODAY!  
DEMONSTRATIONS DAILY AT '303' EDGWARE ROAD

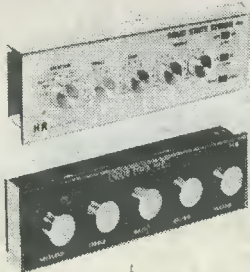

## Acclaimed by everyone THE MAYFAIR ELECTRONIC ORGAN

A completely new development in portable electronic musical instruments and a new field for the home constructor. The 'MAYFAIR' produces a multitude of the most pleasing sounds with a wide range of tone colours suitable for classic or popular music. The organ is fully polyphonic, that is full chords can be played over the entire keyboard. Supplied as a kit of parts which includes 165 transistors, printed circuit panels, special fully sprung and depth of touch adjusted keyboard, attractive wynnair covered cabinet with carry handle. A complete detailed and illustrated construction manual is provided with circuits and full parts list. Cost can be spread by purchasing the components packet by packet. All parts supplied are fully guaranteed. Full after sales service.



A new source of construction for the keen electronics fan either amateur or professional. Once built the 'MAYFAIR' will then provide years of enjoyable entertainment. **TOTAL COST 99 Gns.**

ORGAN COMPONENTS We carry a comprehensive stock of organ components for TRANSISTOR AND VALVE FREE PHASE designs. Ask for BROCHURE 9

Deferred terms available. COMPLETE KIT - Deposit £29.19.0. 12 monthly payments of £7. TOTAL £113.19.0.

BUILT AND TESTED Deposit £38.8.0 & 12 monthly payments of £8. Total £144.8.0. EXPORT ENQUIRIES INVITED

Call in. See it and play it yourself.

## TRANSISTOR AMPLIFIER

INTEGRATED 7 WATT AMPLIFIER & PREAMPLIFIER MA7 With full Bass Treble and Volume Controls

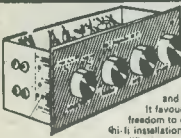

A brilliant new design suitable for home or portable installations. For use with magnetic and crystal/ceramic cartridges, radio tuners, microphones, tape head replay and auxiliary inputs. Output is for 3 to 16 ohm speakers. It favours the user in so many ways—with fantastic power, with far greater adaptability, with freedom to operate it from batteries or mains power supply unit (the new PS.20 is ideal for this). High in installations, electronic guitars and organs, P.A. installations, intercom, systems, etc. This true watt amplifier is supplied ready built, tested and guaranteed.

For complete listening satisfaction. FOR ONLY £8/10/0 P.P. 4/-

(OPTIONAL MAINS UNIT PS.20 62/2, P.P. 3/-). Illustrated Brochure No. 12.

## BRITISH MADE CAR RADIOS

A fine precision engineered car radio that's a perfect company for long hours on the road. So easy to install and operate—and the price is exactly right. Has quick push-button operation for immediate station selection and choice of Medium or Long wave frequency. Manual tuning facilities. Push button control. Output of 31 watts ensures crisp, top quality sound even at high motoring speeds. Price includes 7" x 4" speaker, full accessories and installation.

POSITIVE OR NEGATIVE EARTH EASI-TUNE £12.12.0. pp. 4/6

AUTOBAHN MANUAL as the EASI-TUNE, but with a single MW/LW Push Button. £10.10.0. pp. 4/6

CAR AERIALS \* 3 Section Single Hole Wing or Boot Mounting 19/6 Brochure 15  
Multi Section fully disappearing type with locking device, single hole mounting 35/- Post free with Car Radio or 2/6 separately.

## BUILD THESE PRACTICAL DESIGNS

	LIST
I.C.F.M. TUNER	£5.2.8. 40B
Switched F.M. Tuner	£3.17.6. 39B
Fluorescent Camping Light	£3.2.6. 43

Let us have your enquiries for parts for current PW and PE designs. S.A.E. PLEASE.



## NEW MODELS NOMBREX TRANSISTORISED Test Equipment

MODEL	PRICE Leaflet
22 Power Supply	£ s. d. No. 14 0 0 22
30 Audio Generator	19 10 0 24
31 R.F. Generator	12 10 0 25
32 C.R. Bridge	10 10 0 26
33 Inductance Bridge	20 0 0 29

Send for descriptive illustrated Brochure.

## DO IT YOURSELF MW/LW PORTABLE

New printed circuit design with full power output. Fully tunable on both mw/lw bands. 7 transistors plus diode, push-pull circuit. Fitted 5 inch speaker, large ferrite aerial and Mullard transistors. Easy to build with terrific results. All local and Continental.

TOTAL COST £6.19.6. P.P. 4/6  
TO BUILD Send for Brochure 1



## MULLARD 1 WATT AMPLIFIER WITH VOLUME CONTROL

Suitable 7x4 inch 3 ohm speaker 17/8  
Ideal for Portable Record Players, Inter-Comms. Baby Alarms etc. Brochure 15  
For 9 Volts operation. **45/- 3/6d.**

## ITS SO EASY TO BUILD TO PROFESSIONAL STANDARDS

To get the best out of your MAGNAVOX STUDIOMATIC DECK Type 363, you need a MARTIN RECORDART. This comprises a special high quality 8 valve amplifier and pre-amplifier which comes to you assembled on its printed circuit board, together with necessary transformers, switches, control knobs—in fact everything needed down to the last screw. FOR MAKING A SUPERB TAPE RECORDER, which, when built, will compare favourably with instruments costing twice as much, yet you need no experience or technical skill to bring this about. THE INSTRUCTIONS MANUAL MAKES BUILDING EASY AND SUCCESS ASSURED.

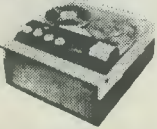

TWO TRACK Deck, Amplifier, Cabinet and Speaker. Complete kits with MICROPHONE 7 in 1,200 ft. tape, spare spool. Today's value £55. OUR PRICE 36 gns.  
FOUR TRACK Deck, Amplifier, Cabinet and speaker. Complete kits with MICROPHONE 7 in 1,200 ft. tape, spare spool. Today's Value £60 OUR PRICE 39 gns.  
P.P. 22/6  
ALL UNITS AVAILABLE SEPARATELY. Both models ASK FOR BROCHURE 6.

## VHF FM SUPERHET TUNER MKII

\* 5 MULLARD TRANSISTORS & 4 DIODES - 300 kc/s BANDWIDTH \* PRINTED CIRCUIT CONSTRUCTION \* HIGH FIDELITY REPRODUCTION MONO AND STEREO \* MATCHES AUDIO MK II EQUIPMENT  
A popular VHF FM Tuner now used throughout the country for quality reception of monophonic and, with the decoder stereophonic broadcast. There is no doubt about it—VHF FM gives the real sound. Excellent stability, economically priced.  
TOTAL COST £6.19.6. DECODER £6.19.6. (CABINET 20/- EXTRA) ASK FOR LEAFLET 3.

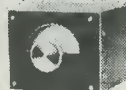

TRANSISTORS, RECTIFIERS, ZENERS, SCR's TUNNEL DIODES, FIELD EFFECT TYPES, VALVES, CRYSTALS  
New 1968 32-page Booklet Price 1/- Post Paid  
Circuits with Data, Details and Prices of over 2000 different types  
This booklet is a must for every enthusiast. MANUFACTURERS — DISTRIBUTORS. We also publish a QUANTITY SEMI-CONDUCTOR BULLETIN. Please write to us for your copy.

## NEW — MALLORY LONG LIFE MERCURY BATTERIES

50% OFF LIST PRICES  
\* RM12 1.35 volts 3600 m/ah OUR PRICE 6/- each size 2 1/2 dia.  
\* RM625 10.35 volts 350 m/ah Pack of 8 Size 2 1/2 x 1 1/2 dia. OUR PRICE 10/- each  
Easily splits into eight 1.35v cells. These cells are ideal for any application where SMALL SIZE, HIGH CAPACITY and LONG LIFE are required. QUANTITY QUOTATIONS WRITE OR PHONE EXTN. 2.



## GARRARD DECKS



BRAND NEW All below list price

	£ s. d.
2025 Mono/Stereo	18 0 0
300 LW with STATIC	18 0 0
SP25 MK II	12 12 0
LAB80 MK II	10 10 0
AT60	10 10 0
AT60 MK II	13 10 0
40 MK II	11 10 0
3500 Mono/Stereo	14 10 0
401	27 10 0
AP75	21 10 0
SL55	16 10 0
SL65	16 10 0
SL75	28 10 0
SL85	38 10 0
AT70 MK II	13 10 0

Send for illustrated brochures 18, 17.  
Complete range of accessories available

## TRANSISTORS — SEMICONDUCTORS

COMPLETELY NEW 1968 LIST OF 1000 types available from stock. Send for your FREE COPY TODAY. (List No. 36)  
S.C.R.'s from 5/-  
Field Effect Transistors from 9/6  
Power Transistors from 5/-  
Diodes and Rectifiers from 1/6

## Hi-Fi equipment to suit EVERY POCKET

Ask for Hi-Fi- Stock List Leaflet 16.17  
VISIT OUR NEW HI-FI CENTRE at 309 EDGWARE RD.

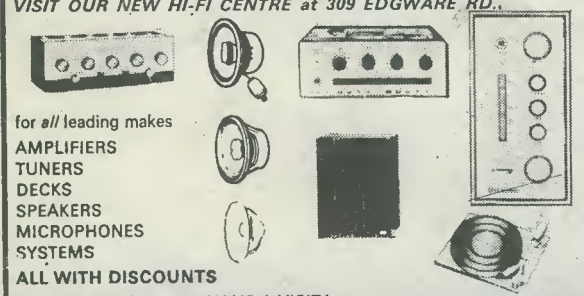

for all leading makes  
AMPLIFIERS  
TUNERS  
DECKS  
SPEAKERS  
MICROPHONES  
SYSTEMS  
ALL WITH DISCOUNTS  
IT WILL PAY YOU TO PAY US A VISIT!

## Fully Illustrated CATALOGUE

COMPLETELY NEW 9th EDITION (1968)  
The most COMPREHENSIVE—CONCISE—CLEAR —COMPONENTS CATALOGUE  
Complete with 10/- worth discount vouchers FREE WITH EVERY COPY.  
\* 32 pages of transistors and semi-conductor devices, valves and crystals.  
\* 200 pages of components and equipment.  
\* 65 pages of microphones, decks and Hi-Fi equipment.  
**6,500 ITEMS**  
**300 BIG PAGES**  
**Send today 8'6** Post Paid

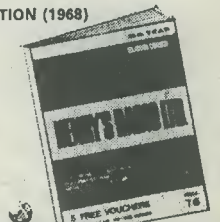

# HENRY'S RADIO LTD



OPEN MON-SAT, 9 a.m.-6 p.m. THURS, 9 a.m.-1 p.m.

303 Edgware Road, London, W.2. Mail Order Dept all types of Components. Organ Dept (01) 723-1008 9  
309 Edgware Road, London, W.2. High Fidelity Sales: P.A. and Test Equipment Record Decks (01) 723 6963