

THE Radio Constructor

RADIO
TELEVISION
AUDIO
ELECTRONICS

VOLUME 15 NUMBER 6

A DATA PUBLICATION

PRICE TWO SHILLINGS

January 1962

Printed Circuit Matchbox Receiver

Temperature Operated Switch ● Experimental Transistor VHF Receiver for the Aircraft Bands ● Simple Musical Instrument ● Small High Quality Amplifier ● Interpretation of Valve Data ● Resistors and Capacitors as Mains Droppers ● Emitter Follower Circuits, Part 1 ● Improving Radio Luxembourg Reception ● Radio Astronomy, Part 4 ● Understanding Radio, Part 5

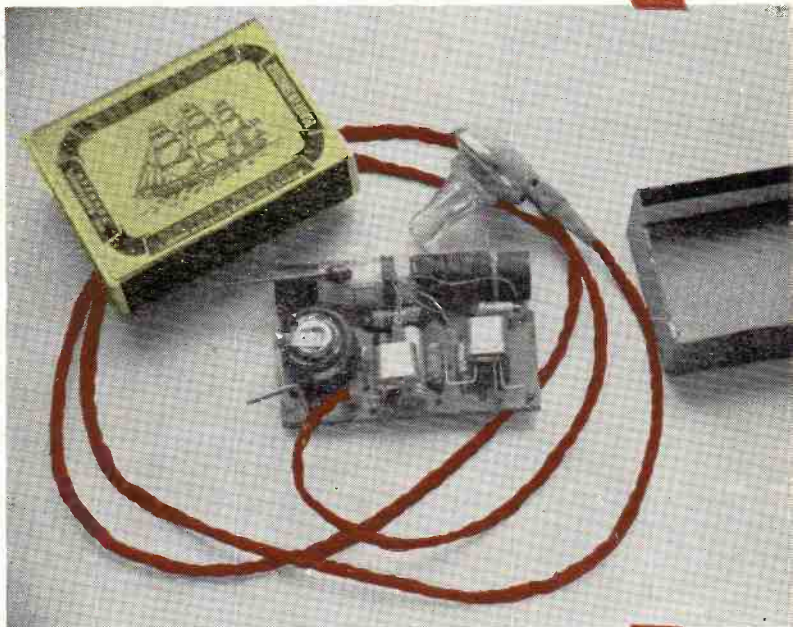

HARVERSON SURPLUS CO. LTD

2-BAND SUPERHET CHASSIS WITH SPEAKER ONLY £4.19.6

Plus 6/6 post and packing

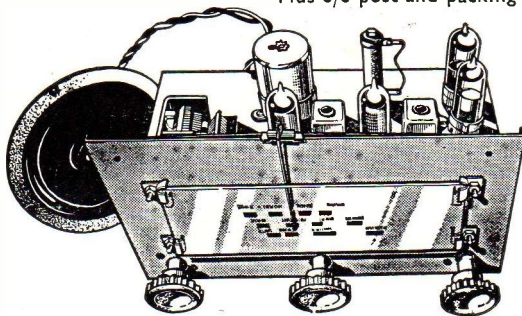

A quality 4 valve AC/DC superhet chassis made by a world famous manufacturer. Long and Medium wave coverage. Fitted with a cord and drum reduction tuning drive and attractive illuminated glass dial (size 6½" x 2½"). Controls: volume on/off, tuning and wave change. The receiver is self-powered, employing a mains dropper and a valve rectifier. Chassis dimensions 6½" x 9" x 5½" high. Supplied complete with a good quality 5" loudspeaker, valves (UCH42, UAF42, UL41, UY41), AC/DC mains input lead, ivory knobs, etc. **DON'T HESITATE, ORDER NOW!** This unbeatable bargain is bound to sell out quickly at only £4.19.6, plus 6/6 post and packing.

4-STATION PRESET CHASSIS ONLY £4.17.6 WITH SPEAKER

Plus 6/6 post and packing

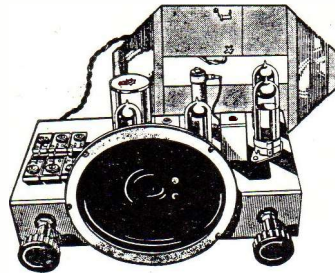

A compact, 4-station preset mains transportable receiver for operation from AC/DC mains. Two simple controls, volume on/off and 4-position station selector. The latter is set to Light Programme (Long Wave), Third

Programme, Home Service and Light Programme (Medium Wave), but may of course be adjusted to alternative selections if required. A frame aerial with throw-out extension is supplied, making this receiver ideal as a general purpose transportable set for the home. A fully smoothed power supply is provided from AC/DC mains input by a mains dropper and a valve rectifier. The good tonal qualities are assisted by the provision of a quality 5" speaker, which is ready-mounted on the chassis (this is easily detachable if alternative positioning is required). Valve line-up: UCH42, UAF42, UL41, UY41. This chassis (size 9" x 6½" x 5½" high) is supplied complete with valves, knobs, mains lead, aerial, etc. It is beautifully made by a famous maker, and is a first-class buy at the rock bottom price of only £4.17.6 plus 6/6 post and packing.

AM RADIOGRAM CHASSIS

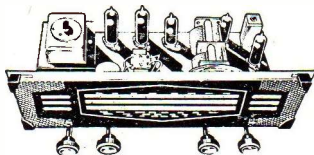

A chassis of distinction by a famous maker. Covering Long, Med. and Short waves, plus gram position, this chassis (size 15½" x 7" x 6½" high) incorporates the latest circuitry, using fully delayed a.v.c. and negative feedback. Controls: tone, volume on/off, wave-change (L.M.S. and gram), tuning. Tapped input 200-250V a.c. only. An attractive brown and gold illuminated dial with matching knobs make this one of the most handsome, in addition to being one of the best performing, chassis yet offered. Complete with valves (ECH81, EF89, EBC81, EL84, EZ81), knobs, output transformer, leads, etc. **OUR PRICE ONLY £9.19.6** plus 4/6 post & packing

HARVERSON'S FM TUNER

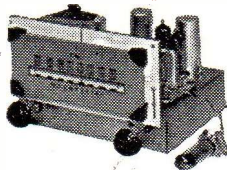

At last a quality FM Tuner Kit at a price you can afford. Just look at these fine features, which are usually associated with equipment at twice the price!

NOW AVAILABLE

A robust cabinet made from heavy gauge metal which has been specially designed to house the above F.M. Tuner. Beautifully finished in a choice of glossy hammer green, or hammer grey enamel, or black crackle. The front panel (illustrated) has holes for control spindles, and apertures for tuning dial and magic eye. **PRICE 25/- P & P. 1/9.** (Front panel only, 10/6 P. & P. 9d.)

- ★ FM tuning head by famous maker.
- ★ Guaranteed non-drift. ★ Permeability tuning. ★ Frequency coverage 88-100 Mc/s. ★ OAB1 balanced diode output.
- ★ Two i.f. stages and discriminator.
- ★ Attractive maroon and gold glass dial (7" x 3").
- ★ Self powered, using a good quality mains transformer and valve rectifier. ★ Valves used ECC85, two EF80s and EZ80 (rectifier). ★ Fully drilled chassis. ★ Everything supplied, down to the last nut and bolt. ★ Size of completed tuner 8" x 6" x 5½". ★ All parts sold separately.

£4.19.6 Plus 8/6 P.P. & Ins.
Circuit diagram and illustrations, 1/6 post free.

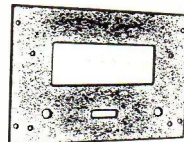

★ SPECIAL BARGAIN ★

MIDGET 2 GANG TUNING CONDENSERS

Polystyrene cased with built-in trimmers. Size 1" x 1" x 7/8". Not used, but removed from printed circuit boards. **UNBEATABLE VALUE AT ONLY**

9/- for TWO plus 1/- P.P.

MINIATURE EARPHONE WITH CORD, SUB-MINIATURE PLUG AND SOCKET

A deaf aid type earpiece of top grade quality. Gives an exceptionally crisp reproduction of both speech and music. Brand new and fully guaranteed. Two types available. CR-5 high impedance crystal, MR-4 low impedance magnetic. **Plus 1/- Either type ONLY 7/6 P. & P.**

MAINS PORTABLE SOLDERING IRON

Probably one of the most outstanding soldering instruments yet produced, this iron has a detachable handle which can be placed over the bit and barrel, enabling it to be carried in complete safety even when hot. The provision of an extremely stable 30W element makes this ideal for transistor and all similar lightweight applications. Brand new in P.V.C. bag, with lead and plug. **ONLY 18/9,** plus 1/3 P. & P.

FM TUNER HEAD



A permeability tuned tuner head by a famous maker, supplied without valve (ECC85).

18/6 plus 1/9 P. & P.
Valve 8/6 extra

83 High St. Merton SW19 **CHerrywood**
3985/6

PLEASE TURN
OVER FOR
MORE BARGAINS

14 Watt Hi-Fi Amplifier Kit

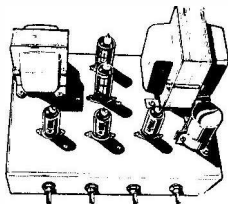

A kit designed to meet the exacting requirements of the audio enthusiast, yet remain within the price range of the average constructor. A stylishly finished monaural

amplifier with an output of 14 watts from 2 EL84s in push pull. Super reproduction of both music and speech. (Frequency response $\pm 3\text{db}$ c/s-60 kc/s with negligible hum). Separate inputs for mike and gram allow records and announcements to follow each other and make this amplifier ideal for small halls, youth clubs, etc. Fully shrouded Linear output transformer (to match 3-15 Ω speaker), and fully shrouded mains transformer (these alone are worth over £3.10.0). 2 independent volume controls, and separate Bass and Treble controls are provided, giving good lift and Cut. Valve line up 2 EL84s, ECC83, EF86 and EZ80 rectifier. All parts down to the last nut and bolt, including valves, heavy gauge metal chassis finished in glossy hammer green enamel (mains and output transformers finished to match.)

ONLY **£6.19.6** P.P. 6/6 (simple instruction booklet 1/6. Free with kit).

Super Table Radio Cabinet

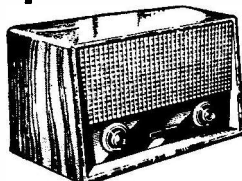

A very fortunate purchase allows us to offer this quality table radio cabinet for only 18/6 (this cabinet cost the manufacturers 35/- each to make). The positions of the controls make it ideal for housing our

6 TRANSISTOR SUPERHET KIT described opposite. Beautifully finished in walnut and tygan. OUR PRICE ONLY **18/6** plus 1/6 P. & P. and ins.

QUALITY RECORD PLAYER AMPLIFIER KIT

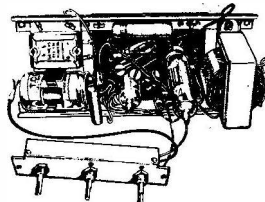

A top quality record player amplifier in kit form. This amplifier (which is used in a 29 gn. record player) has a printed circuit and has an internal fully smoothed power supply (input AC/DC Mains) using a mains dropper and contact cooled rectifier. A flying panel is supplied accommodating BASS, and TREBLE and VOL-ON/OFF controls. 2 valves UL84 and UF89) and linear output transformer give crisp reproduction from all records at 4 WATTS. Our price for the complete kit of parts

(including valves) only **59/6** plus P. & P. 6/6
Simple instructions 1/6. (Free with kit)

Super Stereo Kit Mark II

A kit of ready-built units only requiring inter-connection. Comprising two midget 3W amplifiers, push-button switch, transformer, control unit (bass, treble and vol.), power pack, two speakers, indicator light, valves (ECL82, EZ80 range), and comprehensive instruction.

£3.19.6
Plus 6/6 P. & P.

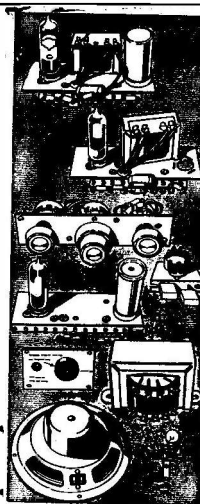

VALVES

WE HAVE 20,000 IN STOCK—ALL AT BARGAIN PRICES. See our list in November "Radio Constructor", write, phone or call for your requirements.

E.M.I. 4-SPEED PLAYER AND P.U.



Heavy 8 $\frac{1}{2}$ " metal turntable. Low flutter performance 200/250V shaded motor with tap at 80V for amplifier valve filament if required. Turnover LP/78 head. Price **89/6**. Plus 4/6 P. & P.

SPECIAL OFFER...

6 TRANSISTOR RADIO IN KIT FORM

Limited quantity only of new ex-manufacturers parts to make a 6 transistor 2 wave band superhet chassis. Ideal for portable or table radio. All parts including transistors, ferrite aerial, printed circuit etc., but EXCLUDING speaker and cabinet. Few only, **£4.19.6**, plus 2/6 P. & P. Simple instructions 1/6. (Free with kit).

SPECIAL OFFER

54" wide loudspeaker silk. Heavily woven in ivory and gold. Original price 35/- per yard lengths. OUR BARGAIN PRICE **13/6** per yd. length P. & P. 1/6.

TAPE DECKS

B.S.R. Monardeck (single speed) 3 $\frac{1}{2}$ " per sec., simple control, uses 5 $\frac{1}{2}$ " spools, **£7.5.0** plus 5/6 carr. and ins. (tapes extra)
COLLARO STUDIO DECK **£10** plus 5/6 carr. and ins. (tapes extra)

CRYSTAL MIKES

T.S.L. Stick Mike ... **22/6**
ACOS (latest model) ... **18/6**

PLESSEY SPEAKER

8" x 5" 3 Ω speaker, large pot, **12/6**, 1/6 P. & P.

HI-FI STEREO MONAURAL AMPLIFIER

A 5 valve hi-fi amplifier with switched stereo/monaural operation. Output 3 watts per channel, provision for bass and treble speakers on each. Volume and tone controls fitted both channels. All housed in stylish blue/grey metal case, with gold finished knobs and trimmings.

£9.19.6 Plus 4/6 P. & P.

3-PUSH BUTTON SWITCH

A really attractive 3-push button switch, ideal for putting that "professional finish" to your transistor radio. Each button is approx. 1" long and the following functions are provided: On/Off, Medium Wave, and Long Wave. In addition the underside of the switch carries a rack for mounting a ferrite rod aerial. Easily 15/- value.

ONLY **5/6** P & P. 1/-.

HARVERSON SURPLUS CO. LTD

Introducing . .

HARVERSON'S Monaural Amplifier Kit

39/6

In response to numerous requests from delighted purchasers of our "SUPER STEREO KIT" we have produced a "MONAURAL AMPLIFIER" on similar lines.

★ A UCL82 valve provides a triode amplifying stage, and a pentode output stage (3 watts), enabling good amplification and sparkling reproduction to be combined with physical compactness (amplifier size 7" x 3½" x 6½" high).

★ Modern circuitry design, good quality o.p. transformer (to match 3Ω) keep hum and distortion to a low level.

★ The controls, volume on/off and tone, are complete with attractive cream and gold knobs.

★ The amplifier has a built-in fully smoothed power supply, using a good quality mains transformer (a.c. mains only) and metal rectifier.

★ All you need is supplied including easy to follow instructions which guarantee good results for the beginner and expert. All components, leads, chassis, valve, knobs, etc., are first grade items by prominent manufacturers.

OUR PRICE **39/6**
Plus 4/6 Post and Packing

5" LOUDSPEAKER TO SUIT, 14/6 EXTRA



BARGAIN MONTH FOR TRANSISTORS

POWER			
OC36	10/-	GET15	9/-
OC44	9/-	GET15 (matched pair)	16/6
OC45	8/-	GET102	7/6
OC71	5/-	XA103	8/6
OC75	6/6	PXA101	9/6
OC76	6/6	PXA102	9/6
OC78	6/6		
OC78D	6/6	DIODE	
		OA81	3/-

Please add 6d. postage for each transistor.

TRANSISTOR SPEAKER

Weston Electric 3Ω or 80Ω speaker. Size 2½" x 1½" deep. 12/6 P.P. 1/-

SUPERHET CHASSIS — LESS VALVES & CABINET

Modern AC/DC chassis with printed circuit and ferrite rod aerial. Although not completely built, the main components are mounted. L. & M. wave coverage, 4 valves (UBF89, UCL83, UCH81, UY85). Everything supplied except valves and cabinet. With simple instructions. **£3.6.6** Plus 3/6 P. & P.

COIL AND TRANSFORMER SET FOR TRANSISTOR SUPERHET

3 I.F. Transformers, one oscillator coil, one driver transformer, and wound ferrite aerial (Med., Long and aerial coupling) 28/6 complete, post 1/- . 6 transistor printed circuit board to match 8/6. post 9d. Circuit diagram 1/6 extra.

CONDENSER/RESISTOR PARCEL

50 mixed pF Condensers and 50 mixed Resistors. An assortment of useful values. All popular sizes—all new—a must for the serviceman and constructor. **ONLY 10/-** P. & P. 1/-

THE HARVERSON 6 TRANSISTOR PLUS DIODE SUPERHET KIT

A first class 2 waveband transistor superhet in kit form.

- ★ Printed circuit panel (size 8½" x 2¾")
- ★ 3 Pre-aligned I.F. Transformers
- ★ Output Transformer
- ★ 5" 5Ω Speaker
- ★ High gain Ferrite rod aerial
- ★ Car aerial socket
- ★ First grade G.E.C. transistors
- ★ Push-Pull output

All parts down to the minutest item with simple instructions.

ONLY **£6.19.6** Plus 2/6 P. & P.

Cabinet to Suit (if available) 15/- extra.

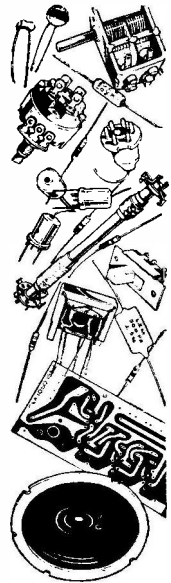

THE HARVERSON COMPLETE FM/VHF RECEIVER KIT

£6.19.6

At last! A complete FM Receiver in kit form.

Specially designed with the home constructor in mind, this kit enables the construction of a completely self-contained VHF receiver at a fraction of the normal cost of comparable equipment. This is basically a quality self-powered FM tuner plus 2 separate audio amplifier stages and output transformer and speaker.

- ★ FM tuning head by famous maker
- ★ Guaranteed non-drift
- ★ Permeability tuning
- ★ Frequency coverage 88-100 Mc/s
- ★ OA81 balanced diode output
- ★ Two i.f. stages and discriminator
- ★ Self-powered, using a good quality mains transformer and valve rectifier
- ★ Valves used: ECC85, two EF80s, ECL82 and EZ80 (rectifier)
- ★ Fully drilled chassis
- ★ Good quality speaker
- ★ Well designed output transformer
- ★ Attractive maroon and gold glass dial
- ★ Two output stages (using ECL82 valve)
- ★ Everything supplied, down to the last nut and bolt
- ★ Compact size
- ★ All parts sold separately

OUR PRICE **£6.19.6** Plus 4/6 P. & P.

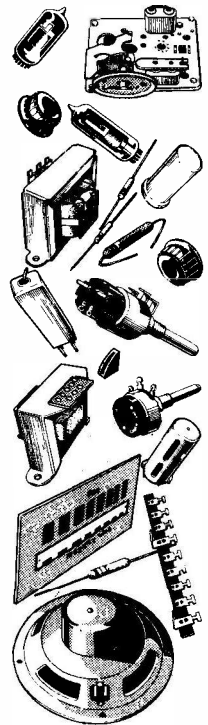

designed for

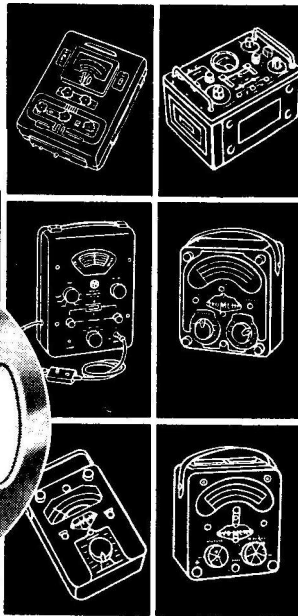
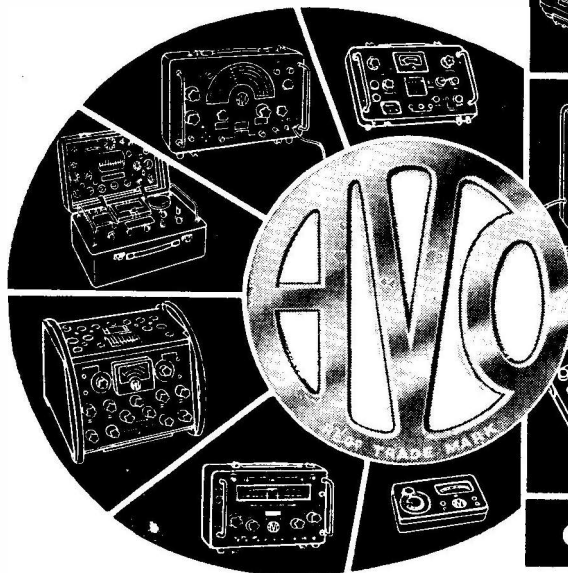

dependability

The new "AVO" Mk. IV Valve Characteristic Meter is typical of the ingenuity of design and high standard of workmanship that exemplify all of the multi-range instruments in the wide "Avo" range.

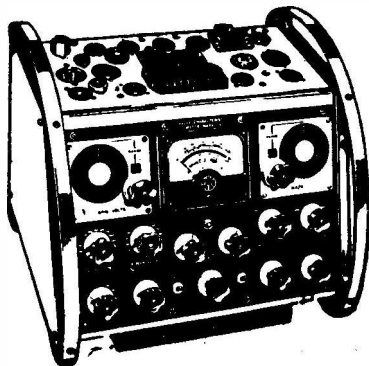

It is a compact and comprehensive meter that will test quickly any standard receiving valve or small transmitting valve on any of its normal characteristics under conditions corresponding to a wide range of DC electrode voltages. The method of measuring mutual conductance ensures that the meter can deal adequately with modern TV receiver valves. It does many useful jobs too numerous to mention here, but a comprehensive pamphlet is available on application.

List Price **£92** complete with Instruction Book and Valve Data Manual

AVO LTD

AVOCET HOUSE . 92-96 VAUXHALL BRIDGE ROAD . LONDON S.W.1.

VICTORIA 3404
(12 lines)



A MEMBER OF THE METAL INDUSTRIES GROUP OF COMPANIES

TECHNICAL
TRAINING
in radio
television
and
electronic
engineering
with

The decision is YOURS. To be a success in your chosen career; to qualify for the highest paid job . . . to control a profitable business of your own. ICS home-study courses put your plans on a practical basis; teach you theory and practice; give you the knowledge and experience to take you, at your own pace, to the top.

Choose the **RIGHT** course.

RADIO & TELEVISION
 ENGINEERING . INDUSTRIAL
 TELEVISION . RADIO AND TV
 SERVICING . RADIO SERVICE
 AND SALES . ELECTRONICS .
 COMPUTERS AND PROGRAMMING

ICS provides thorough coaching for professional examinations: A M BRIT. I R E, City and Guilds Telecommunications, C. & G. Radio and TV Servicing, C. & G. Radio Amateurs.

LEARN AS YOU BUILD

Practical Radio Course

Gain a sound up-to-professional-standards knowledge of Radio and Television as you build YOUR own 4 valve T R F and 5 valve superhet radio receivers, signal generator and high-quality multi-meter. At the end of the course you have three pieces of permanent and practical equipment and a fund of personal knowledge and skill . . . ICS Practical Radio courses open a new world to the keen radio amateur.

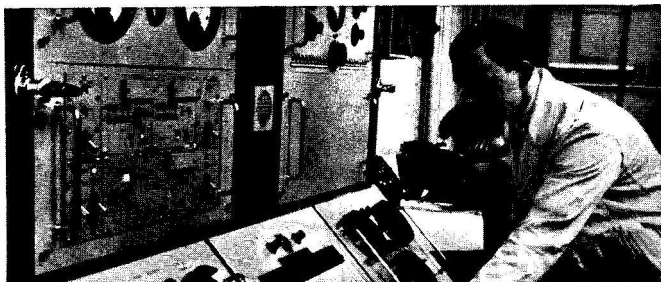

THERE ARE ICS COURSES TO MEET YOUR NEEDS AT EVERY STAGE OF YOUR CAREER.

Post this coupon today: In return you will receive the FREE 60-page ICS Prospectus listing technical examinations and their appropriate ICS courses PLUS details of over 150 specialised subjects.

Other ICS courses include:

MECHANICAL, MOTOR, FIRE, CHEMICAL, ELECTRICAL AND CIVIL ENGINEERING, ETC. SELLING AND MANAGEMENT, ARCHITECTURE, WOODWORKING, FARMING, GARDENING, ART, PHOTOGRAPHY.

Please state subject in which you are interested on coupon.



INTERNATIONAL CORRESPONDENCE SCHOOLS
 (Dept. 248) Intertext House Parkgate Road London SW11

NAME.....

ADDRESS

.....

OCCUPATION..... AGE.....

SUBJECT..... 1.62

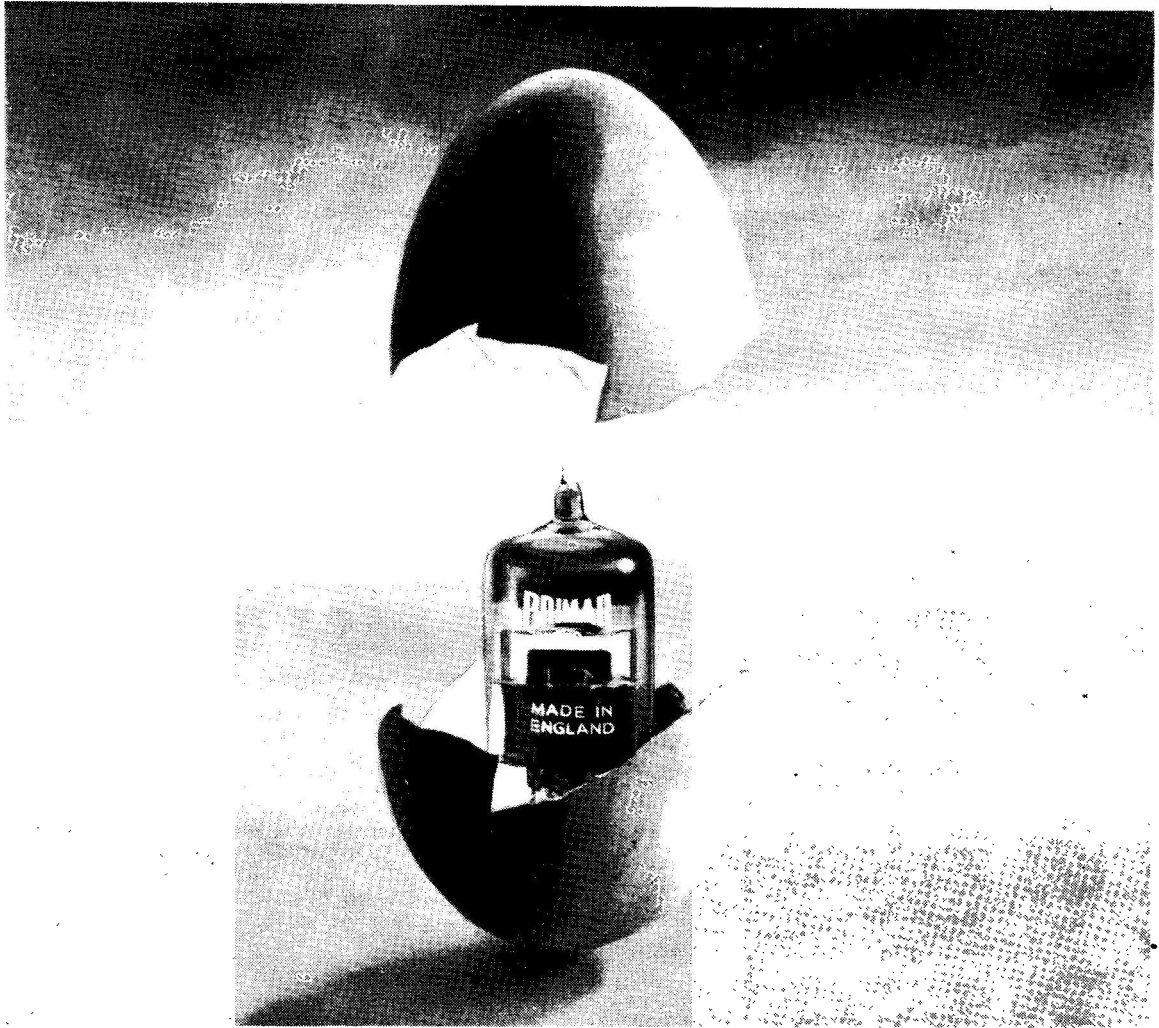

The shell of an egg contains the secret of reproduction.
So too, in a different sense, does a Brimar valve. For
true-to-life reproduction and consistent reliability,

better make it **BRIMAR**

Brimar Commercial Division

THORN—AEI RADIO VALVES & TUBES LIMITED · ROCHESTER · KENT TEL: CHATHAM 44411





THE FINEST ELECTRONIC KITS IN THE WORLD



RSW-1

4-WAVEBAND TRANSISTORISED PORTABLE RECEIVER, Model RSW-1. This possesses Medium, Trawler and two Short-wave bands and is mid-way between the domestic broadcasting and professional general communications receiver. Ideal and inexpensive for those who wish to listen to world broadcasts, shipping and aviation communications. It is not the set to buy if you wish only to enjoy domestic broadcasting. In a handsome leather case, it has retractable whip aerial and socket for car radio use.

£22.10.0

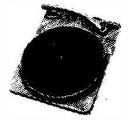

GL-58

TRANSCRIPTION RECORD PLAYER (STEREO). Manufactured by Goldring-Lenco. This 4-speed unit is fitted with a G60 pick-up arm. Infinitely variable speed adjustment from 33½ to 80 r.p.m. Fixed speed of 16 r.p.m. Its balanced turntable (3½ lb) reduces rumble, wow and flutter to very low level. The unique lowering device fitted provides absolutely safe means of placing pick-up on record

£20.12.2



TA-1M

5in OSCILLOSCOPE KIT, Model O-12U. Has wide-band amplifiers, essential for TV servicing, FM alignment, etc. Vertical frequency response 3 c/s to over 5 Mc/s, without extra switching T/B covers 10 c/s to 500 kc/s in 5 ranges.

£36.10.0



O-12U

DECADE CAPACITOR KIT, Model DC-1 Capacity values 100µF to 1.011µF in 100µF steps.

£6.5.6

AUDIO SIGNAL GENERATOR KIT, Model AG-9U. 10 c/s to 100 kc/s, switch selected. Distortion less than 0.1%, 10V sine wave output metered in volts and dB's.

£19.19.6



DC-1

HI-FI SINGLE CHANNEL AMPLIFIER KIT, Model MA-12. 12W output, wide freq. range, low distortion.

£10.19.6

RESISTANCE CAPACITANCE BRIDGE KIT, Model C-3U. Measures capacity 10pF to 1,000µF, resistance 100Ω to 5MΩ and power factor. 5-450V test voltages. With safety switch.

£8.6.6



AG-9U

BALUN COIL UNIT KIT, Model B-1U. Will match unbalanced co-axial lines to balanced lines of either 75 or 300Ω impedance.

£4.9.6

AUDIO WATTMETER KIT, Model AW-1U. Up to 25W continuous, 50W intermittent.

£14.14.0



MA-12

MATCHED HI-FI STEREO KIT
We offer as a "packaged deal" the following matched Hi-Fi Stereo Equipment:

4-speed Record Player (RP-1U) ...	£12.16. 4
6W Amplifier (S-33) ...	£12. 8. 6
Twin Speaker Systems (SSU-1) ...	£21.15. 0
Cost of Units ...	£46.19.10
At an "all in" price of ...	£44.19. 4
Pedestal Speaker legs ...	£2.2.0 optional extra.

AMATEUR TRANSMITTER, Model DX-100U. Covers all amateur bands from 160 to 10 metres. Self-contained, with Power Supply, Modulator and V.F.O. 150 watts D.C. input.

£81.10.0



DX-100U

HI-FI FM TUNER. This model is available as two units which, for your convenience, are sold separately: the R.F. Tuning Unit, model FMT-4U (£3.5.0 incl. P.T.) with I.F. output of 10.7 Mc/s, and the Amplifier Unit, with power supply, valves, and attractive cabinet, model FMA-4U (£11.11.0) total ...

£14.16.0



FM Tuner

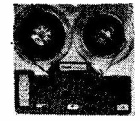

Truvox Mk. 6

TRUVOX TD-1 Mk. 6 TAPE DECK. Mono/stereo tape deck of semi-professional standard. Two tracks with safety gap. Limited quantity available at the greatly reduced price of

£29.15.0

THE BEST QUALITY

TAPE-RECORDING AND REPLAY HI-FI AMPLIFIER

Mono, model TA-1M, Stereo model TA-1S
For use with most tape decks. Thermometer type recording indicators, press-button speed compensation and input selection, 3-position bias level and printed circuit construction

TA-1M	£18	2	6
TA-1M and Collaro "STUDIO"	£30	10	0
TA-1M and TRUVOX Mk. 6	£46	17	6
TA-1S	£23	6	0
TA-1S and Collaro "STUDIO"	£35	14	0
TA-1S and TRUVOX Mk. 6	£52	1	0

HI-FI EQUIPMENT CABINETS

Our four equipment cabinets meet the wide variety of tastes and requirements: the "CHEPSTOW" was designed for those who have little floor space, the contemporary "MALVERN" for the Tape and Gram. enthusiast, and the "GLOUCESTER" Mk. I and II for those with traditional tastes. All parts are pre-cut and drilled for easy assembly, and left "in the white". Prices from £11.5.6 to £17.18.6.

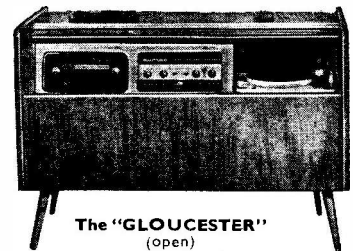

The "GLOUCESTER"
(open)

available from **DAYSTROM Ltd** Dept. RC1, Gloucester, England



GD-1U

GRID-DIP METER KIT. Model GD-1U. Functions as oscillator or absorption wave meter. With plug-in coils for continuous frequency coverage from 2 Mc/s to 250 Mc/s. **£10.9.6**

Two Additional Plug-in Coils Model 34-1U extend coverage down to 350 kc/s. With dial correlation curves. **15/-**

TRANSISTORISED VERSION. Model XGD-1. Similar to GD-1U. Fully transistorised with a frequency range of 1.75 to 45 Mc/s. **£10.8.6**



DX-40U

AMATEUR TRANSMITTER KIT. Model DX-40U. From 80-10m Power input 75W. C.W., 60W peak controlled carrier phone. Output 40W to aerial. Provision for V.F.O. **£32.10.0**



S-33

6-W STEREO AMPLIFIER KIT. Model S-33. 3 watts per channel, 0.3% distortion at 2.5 w/chnl., 20dB N.F.B. Inputs for Radio (or Tape) and Gram., Stereo or Monaural, ganged controls. Sensitivity 100mV. **£12.8.6**



"STUDIO"

COLLARO "STUDIO" TAPE DECK. The finest buy in its price range. May be converted to stereo. Two tracks. "Wow" and "flutter" not greater than 0.15% at 7½" p.s. Long Term Speed Stability better than 0.5%. **£17.10.0**

VARIABLE FREQUENCY OSCILLATOR KIT. Model VF-1U. From 160-10 m. Ideal for our DX-40U and similar transmitters. Price less valves **£8.19.6** **£11.2.0**

TRANSISTOR PORTABLE RADIO KIT. Model UXR-1. Pre-aligned I.F. transformers, printed circuit and a 7" x 4" high-flux speaker. Real hide case. **£14.18.6**

HI-FI STEREO AMPLIFIER KIT. Model S-88. 16W output, 10mV basic sensitivity (4mV available, 7/6 extra). Ganged controls. Stereo/Monaural gram., radio and tape recorder inputs. Push-button selection. Two-tone grey metal cabinet. **£26.12.6**

HI-FI SPEAKER SYSTEM KIT. Model SSU-1. Ducted-port bass reflex cabinet "in the white". Twin speakers. With legs **£11.18.6** **£10.17.6**

2½in. SERVICE 'SCOPE KIT. Model OS-1. Light, compact portable for service engineers. Dim. 5" x 8" x 14½" long. Wt. 10½lb. **£19.10.0**

VALVE VOLTMETER KIT. Model V-7A. 7 voltage ranges d.c. volts to 1,500 a.c. to 1,500 r.m.s. and 4,000 peak to peak. Resistance 0.1Ω to 1,000MΩ with internal battery. D.C. input impedance 11MΩ. dB measurement has centre-zero scale. Complete with test prods, lead and standardising battery. **£13.0.0**

ELECTRONIC SWITCH KIT. Model S-3U. (Oscilloscope Trace Doubler.) Enables a single beam oscilloscope to give simultaneous traces of two separate and independent signals. Switching rates approx. 150, 500, 1,500, 5,000 and 15,000 c/s. Sig. freq. response 0-100 kc/s. ± 1dB. Separate gain controls and sync. output. Sig. input range 0.1-1.8V r.m.s. **£10.15.6**

CAPACITANCE METER KIT. Model CM-1U Direct-reading 4½" scale. Full-scale ranges 0-100µµF, 0-1,000µµF, 0-0.01µF and 0-0.1µF. **£14.15.0**

POWER SUPPLY UNIT KIT. Model MPG-1. Input 100/120V 200/250V, 40-60 c/s. Output 6.3V, 2.5A A.C.; 200, 250, 270V, 120mA max. D.C. **£4.16.6**

MULTIMETER KIT. Model MM-1U. Ranges 0-1.5V to 1,500V A.C. and D.C.; 150µA to 15A D.C.; 0.2Ω to 20MΩ. 4½" 50µA meter. **£11.18.6**

THE "MOHICAN" GENERAL COVERAGE RECEIVER. Model GC-1U. With 4 piezo-electric transmitters, variable tuned B.F.O. and Zener diode stabiliser, this is an excellent fully transistorised portable or fixed station receiver for Amateur and Short wave listeners. Printed circuit boards, telescopic whip antenna, tuning meter and large slide-rule dial, 10 transistors. **£38.15.0**



VF-1U



UXR-1



S-88



SSU-1



OS-1



V-7A



GC-1U

AT LOWEST PRICES

MONEY-SAVING "PACKAGED DEALS"

For the benefit of customers wishing to purchase several units of their Hi-Fi equipment at the same time, useful price reductions are offered. Such "Packaged Deals" may include RECORD PLAYERS and TAPE DECKS of your preference, not necessarily featured in our catalogue. Two money-saving examples are given below and quotations for your own special requirements will gladly be sent on request.

GL-58 Transcription Unit	£20.12.2	TA-1M	£18. 2.6
S-33 Stereo Amp.	£12. 8.6	Collaro "STUDIO"	£17.10.0
Twin SSU-1 Speakers		USC-1	£18.18.6
(Bookcase Type)	£21.15.0	MA-12	£10.19.6

£54.15.8

Packaged £50.19.0

£65.10.6

Packaged £59.10.0

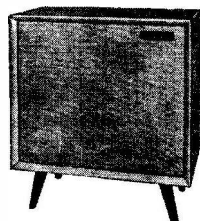

THE "COTSWOLD"

THE "COTSWOLD". This is an acoustically designed enclosure 26" x 23" x 15½" housing a 12" bass speaker with 2" speech coil, elliptical middle speaker together with a pressure unit to cover the full frequency range of 32-20,000 c/s. Capable of doing justice to the finest programme source, its polar distribution makes it ideal for really Hi-Fi Stereo. Delivered complete with speakers, crossover unit, level control, Tygan grille cloth, etc. All parts pre-cut and drilled for ease of assembly and left "in the white" for finish to personal taste. **£21.19.0**

All prices include free delivery U.K.
Deferred terms available over £10.

★ SEND THIS COUPON NOW FOR FURTHER INFORMATION

(Please write in BLOCK CAPITALS)

NAME

ADDRESS

Without obligation please send me

(Tick here)

BRITISH HEATHKIT CATALOGUE.....

FULL DETAILS OF MODEL(S).....

DAYSTROM LTD DEPT RC1 GLOUCESTER • ENGLAND

A member of the Daystrom Group, manufacturers of the
WORLD'S LARGEST-SELLING ELECTRONIC KITS

ARMSTRONG AF 208 AM/FM RADIOGRAM CHASSIS

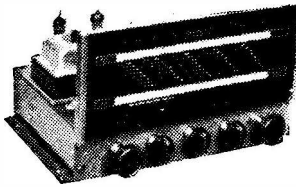

★ Full VHF Band (87-108 Mc's.) and Medium Band, 187-570M. ★ 7 Valves ★ 5 Watts Output ★ 15dB Negative Feedback ★ Separate wide range Bass and Treble Controls ★ 2 Compensated Pick-up Inputs ★ Frequency Response 30-22,000 c.p.s. ★ 2dB ★ Tape Record and Playback Facilities ★ Continental Reception of Good Programme Value ★ For 3, 7, and 15 ohm speakers. Send S.A.E. for leaflet.

Price **22 Guineas** Carr. Free

LATEST "E.M.I." 4 SPEED SINGLE RECORD PLAYER

Acos Hi-Fi Pick-up for LP, and or 78, 7", 10" and 12" records. Silent motor, heavy turntable, auto stop. Completely assembled on base plate.

Special offer **£6.5.0** post free

Or with Stereo Monaural Pick-up **£6.19.6**

SINGLE PLAYER BARGAIN

Ready built complete with B.S.R. TU9 4-speed Gram Pick-up unit. Handsome portable case. 3-watt amplifier with 2 valves and speaker.

List Price **£12. 12. 0.** Our Price **£9. 9. 0.**

Post 4/-. Fully guaranteed. In manufacturer's sealed cartons.

I.F. TRANSFORMERS 7.6 pair

465 kc/s Slug Tuning Miniature Can. 1 1/2" x 1" x 1". High Q and good band width. Data sheet supplied.

New boxed VALVES 90-day Guarantee

1R5	7 616K8G	7 61EA50	1 61EZ80	7 6
1S5	7 616L6G	10 61EABC80	8 611A4B	7 6
1T4	6 619NM	6 61EB91	6 61HABC80	12 6
2X2	3 616Q7G	8 61EBC33	8 61HVR2A	6 6
354	7 616S4T	6 61EBC41	8 61MU14	9 -
3V4	7 616S17M	6 61EBF80	10 - P61	3 6
5U4	7 616S7R	6 61ECC84	9 61PCC84	9 6
5Y3	7 616V6G	6 61ECF80	9 61PCF80	9 6
5Z4	9 616X4	7 61ECH42	10 61PCL82	11 6
6AM6	5 616X5	6 61ECL80	10 61PEN25	6 6
6B8	5 12A6	7 61ECL82	10 61PL81	12 6
6BE6	7 612AT7	8 61EF39	5 61PL82	10 6
6BH6	9 612AU7	8 61EF41	9 61PY80	7 6
6BW6	9 612AX7	8 61EF50	5 61PY81	9 6
6D6	6 12BE6	8 61EP80	8 61PY82	7 6
6F6	7 612K7	6 61EPR6	12 61SP61	3 6
6H6	3 612Q7	6 61EP92	5 61UBC41	9 6
6J5	5 6135L6	9 61EL32	5 61UCH42	9 6
6J6	5 6135Z4	7 61EL41	9 61UF41	9 6
6J7G	6 6180	9 61EL84	8 61UL41	9 6
6K6GT	6 61807	5 61EY51	9 61UY41	8 -
6K7G	5 61954	1 61EZ40	7 61U22	8 -

DK96, DP96, DAF96, DL96, 8 6 each or 30 - set

NEW ELECTROLYTICS FAMOUS MAKES

TUBULAR	TUBULAR	CAN TYPES	
1/350v.	2 - 50 350v.	5 616 450v.	5 -
2.350v.	2 3100 25v.	3 - 32 350v.	4 -
4.450v.	2 1250 25v.	3 - 100 370v.	4 6
8.450v.	2 3500 12v.	3 - 2,000 6v.	4 -
8.500v.	2 9 8 - 8 450v.	3 6 5,000 6v.	5 -
16.450v.	3 1 - 8 500v.	5 - 32 - 32 350v.	5 -
16.500v.	4 8 - 16 450v.	3 9 32 - 32 450v.	6 -
32.450v.	3 9 8 - 16 500v.	5 6 32 - 32 350v.	7 -
25 25v.	1 9 16 - 16 450v.	4 3 50 30 350v.	7 -
50 25v.	2 16 - 16 500v.	6 64 - 120 350v.	11 6
50 50v.	2 32 - 32 350v.	4 6 100 - 200 275v.	12 6

C.R.T. BOOSTER TRANSFORMERS

For Cathode Ray Tubes having heater cathode short circuit and for C.R. Tubes with falling emission, full instructions supplied.

TYPE A. LOW LEAKAGE WINDINGS. OPTIONAL 25% and 50% BOOST ON SECONDARY: 2 V. OR 4 V. OR 6.3 V. OR 10.3 V. OR 13.3 V. WITH MAINS PRI-MARIES: 12 6.

OUR LATEST SUPERIOR PRODUCT. MAINS INPUT TYPE A2. HIGH QUALITY LOW CAPACITY 10-15 pF. OPTIONAL BOOST 25%, 50%, 75%. 16 6 each.

TYPE B. MAINS INPUT. LOW CAPACITY. MULTI OUTPUT 2, 4, 6.3, 10 and 13 V. BOOST 25% AND 50%. THIS TRANSFORMER IS SUITABLE FOR ALL TV TUBES. 21 - each.

MAINS TRANSFORMERS

200/250 AC Post 2/- each

STANDARD 250-0-250, 80 mA.	6.3 v. tapped 4 v. 4 a., Rectifier 6.3 v. 1 a. tapped 5 v. 2 a. and 4 v. 2 a.	22 6
Ditto 350-0-350		29 6
MINIATURE, 200 v. 20 mA.	6.3 v. 1 a.	10 6
MIDGET, 220 v. 45 mA.	6.3 v. 2 a.	15 6
SMALL, 220-0-220 v. 50 mA.	6.3 v. 2 a.	17 6
STANDARD, 250-0-250	65 mA.	
	6.3 v. 3.5 a.	17 6
HEATER TRANS., 6.3 v. 1 1/2 a.		7 6
Ditto 6.3 v. 3 a.		10 6
Ditto 1.4, 2, 3, 4, 5, 6.3 v. 1 1/2 a.		8 6
MULLARD '510' OSRAM '912', 300-0-300, 120 mA, 6.3 v. 4 a. c.t.c.	6.3 v. 2 a. tapped 5 v.	38 6
GENERAL PURPOSE LOW VOLTAGE Outputs 3, 4, 5, 6, 8, 9, 10, 12, 15, 18, 24 and 30 v. at 2 a.		22 6
AUTO. TRANS. 150 w., 0, 10, 120, 200, 230, 250 v.		22 6
AUTO. TRANS. 500 w., 0, 115, 200, 230, 250 v.		82 6

O.P. TRANSFORMERS. Heavy duty 50 mA. 4/6. Miniature 3V4, etc., 4/6. Small, pentode, 4/6. Multi-ratio push-pull, 7/6. Multi-ratio push-pull 10 w., 15 6. Goodmans heavy duty 10 20 v. 6K push-pull, 30--.

L.F. CHOKES 15 10 H. 60/65 mA. 5/-; 10 H. 85 mA. 10 6; 10 H. 120 mA. 12 6; 10 H. 150 mA. 14 -

TELEVISION REPLACEMENTS

Line Output Transformers

from 45 - each, NEV Stock and other timebase components. Most makes available. S.A.E. with all enquiries

FULL WAVE BRIDGE CHARGER RECTIFIERS. 2, 6 or 12 v. 1 1/2 a.; 8/9; 2 a.; 11/3; 4 a., 17/6. Free charger circuit.

CHARGER TRANSFORMERS. Tapped input 200 250 v. for charging at 2, 6 or 12 v. 1 1/2 a.; 15/6; 2 a., 17 6; 4 a., 22 6.

4 AMP. CAR BATTERY CHARGER with amp meter Leads, Fuse Case, etc., for 6 v. or 12 v., 69 6

BOOKS (List S.A.E.)

40 Circuits for Germanium Diodes	3/-
"W/W" Radio Valve Data	6/-
High Fidelity Speaker Enclosures	5/-
Valve and TV Tube Equivalents	9/6
TV Fault Finding	5/-
Quality Amplifiers	4/6
Radio Valve Guide. Books 1, 2, 3 or 4.	5/- each
Transistor Superhet Receivers	7/6
Practical Radio for Beginners	3/6
Master Colour Code	1/6

TINNED COPPER WIRE 16 to 22 swg. 1/2 lb. 3/-
COPPER ENAMEL WIRE 1/2 lb. 16 to 22 s.w.g. 2/9, 24 to 30 s.w.g. 3/6, 32 to 40 s.w.g. 4/6

CRYSTAL MIKE INSERT by Acos 8/6 Precision engineered. Size only 1 1/2" dia. x 1"

ACOS CRYSTAL MIKE 40	25/-
ACOS STICK MIKE 39-1	35/-
T.S.L. DE LUXE STICK MIKE	35/-

BAKER SELHURST LOUDSPEAKERS

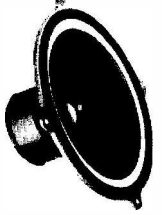

12" Baker 15W Stalwart 3 or 15Ω, 45-13,000 c.p.s. 90/-
12" Baker ditto, foam suspension, 15Ω, 40-13,000 c.p.s. £6
12" Stereo 12W, 35-16,000 c.p.s. £8
12" Baker Ultra Twelve, 20 c.p.s. to 25 kc/s £17.10.0
15" Auditorium, Bass Mk II 35W £15

LOUDSPEAKERS P.M. 3 OHM. 2 1/2in. 3in. 4in. 19/6; 5in. Rola, 17/6; 7in. x 4in., 18/6; 4in. Hi-Fi Tweeter, 25/-; 8in. Plessey, 19/6; 6in. Goodmans, 18/6; 10in. R.A., 30/-; 12in. Plessey, 30/-; 10in. x 6in. E.M.I. 27/6; E.M.I. 13 1/2" x 8" 45/-; Stentorian HF1012 10in., 95/-; HF1016, £8

CRYSTAL DIODES. G.E.C., 2/-; GEX34, 4/-; OA81, 3--

40 CIRCUITS FOR GERMANIUM DIODES, 3 - . H.R. HEADPHONES, 4,000 ohms, brand new, 15 - pair. Low resistance phones, BA5, 7 6 pair. SWITCH CLEANER FLUID, squirt spout, 4 3 tin.

COMPLETE RADIO CHASSIS

£4.19.6 post free

4 Mullard valves, 5" speaker, frame aerial. 4 pre-set stations. 1 long, 3 med. wave.

Superhet Circuit.

Size 9" x 6" x 5 1/2" high. Tested ready for use.

200/250V A.C.-D.C. Mains.

TWIN GANG CONDENSERS. Miniature transistor gang 208 and 176 pf, 10/6 each; 365 pf, miniature, 1 1/2in. x 1 1/2in., 10/-; 500 pf standard with trimmers, 9/-; midget, 7/6; midget with trimmers, 9 -

SHORT WAVE. Single 25pF, 50 pf, 75 pf, 100 pf, 160 pf, 5/6 each.

TUNING AND REACTION CONDENSERS. 100 pf, 300 pf, 500 pf, 3/6 each, solid dielectric. **CONDENSERS.** 0.001 mfd. 7kv T.C.C., 5/6; ditto 20 kv, 9/6; 0.1 mfd. 7 kv, 9 6; 100 pf to 500 pf Micas, 6d.; Tubular 500 v., 0.001 to 0.05, 9d.; 0.1, 1/-; 0.25, 1/6; 0.1350 v., 9d.; 0.5/500 v., 1/9; 0.01/2,000 v., 1/9; 0.1/2,000 v., 3 6.

CERAMIC CONDENSERS. 500 v. 0.3 pf to 0.1 mfd., 9d. 0.1/30v., 1/3.

SILVER MICA. 10% 5 pf to 500 pf, 1/-; 600 pf to 3,000 pf, 1 3; close tolerance (plus or minus 1 pf), 1.5 pf to 47 pf, 1/6; ditto 1% 50 pf to 815 pf, 1/9; 1,000 pf to 5,000 pf, 2/-.

465 Kc/s. SIGNAL GENERATOR.

Total cost 15/- . Uses B.F.O. Unit ZA 30038 ready made. **POCKET SIZE** 2 1/2in. x 4 1/2in. x 1in. Slight modifications required, full instructions supplied. Battery 7/6 extra 69 v. - 1 1/2 v. Details S.A.E.

WAVECHANGE SWITCHES

2 p. 2-way, 3 p. 2-way, short spindle ... 2 6
8 p. 4-way 2-wafer, long spindle ... 6 6
2 p. 6-way, 4 p. 2-way, 4 p. 3-way, long spindle ... 3 6
3 p. 4-way, 1 p. 2-way, long spindle ... 3 6
Wavechange "MAKITS". Wafers available: 1 p. 12 wafer, 2 p. 6 wafer, 3 p. 4 wafer, 4 p. 3 wafer, 6 p. 2 wafer. 1 wafer, 8/6; 2 wafers, 12/6; 3 wafers, 16--. Additional wafers up to 14, 3/6 each extra.

TOGGLE SWITCHES. s.p., 2/-; d.p., 3/6; d.p.d.t., 4--.

JACKS. English open-circuit 2/6, closed-circuit 4/6, Grundig-type 3-pin 1/3

JACK-PLUGS. English 3/-, Grundig 3-pin 3/6

JASON F.M. TUNER COIL SET, 29 -

H.F. coil, aerial coil, oscillator coil, two i.f. transformers, 107 Mc/s. detector transformer and heater choke. Circuit and component book using four 6AM6, 2/6. Complete Jason FMTI kit, Jason chassis with calibrated dial, components and 4 valves, £6.5.0.

VALVEHOLDERS. Pax. int. oct., 4 d. EA50, 6d. B12A, CRT, 1/3. Eng. and Amer. 4, 5, 6 and 7 pin, 1 - . **Moulded MAZDA** and int. Oct., 6d.: BTG, B8A, B8C, B9A, 9d. BTG with can, 1 6. B9A with can, 1/9. Ceramic, EF50, B7G, B9A, Int. Oct., 1 - . B7G, B9A cans, 1/- each.

RADIO COMPONENT

Our written guarantee with every purchase. Buses 133 or 68 pass door. S.R. Stn. Selhurst.

VOLUME CONTROLS

Long spindles, Midget 5K ohms to 2 Meg.
No. sw. D.P. Sw 3/-
Linear or Log Tracks.

80 ohm Coax CABLE

Semi-air spaced 3in. Stranded core, 6d. yd. 40 yds. 17/6; 60 yds. 25/-
Fringe Quality, Air Spaced 1/- yd.

EXTENSION SPKR. CONTROL 10 Ohm 3/-

RESISTORS. Preferred values, 10 ohms to 10 meg. 1/2 w., 4d.; 1 w., 4d.; 1 w. 6d.; 1 1/2 w. 8d.; 2 w. 1/-
HIGH STABILITY. 1/2 w. 19/6, 2/- Preferred values, 10 ohms to 10 meg. Ditto 50%, 100 ohms to 5 meg. 9d.
WIRE-WOUND RESISTORS (1/3 10 watt) 25 ohms-10,000 ohms (1/6 15 watt) 25 ohms-10,000 ohms (2/- 12.5K to 50K 10 w 3/-

WIRE-WOUND POTS, 3 WATT

Pre-set Min. TV Type. All values 10 ohms to 25K, 3/- ea.; 30K, 50K, 4/- (Carbon 30K to 2 meg., 3/-)

WIRE-WOUND 4 WATT POTS

Long Spindle, Values, 50 ohms to 50K, 6/6; 100K, 7/6.

TRIPLEXERS, Bands I, II, III, 12/6
COAXIAL PLUGS, 1/-, **PANEL SOCKETS, 1/-**
LEAD SOCKET, 2/-, **OUTLET BOXES, 4/6**
BALANCED TWIN FEEDER, per yd. 6d., 80 ohms or 300 ohms.
TWIN SCREENED BALANCED FEEDER, 1/6 yd. 80 ohms.
TRIMMERS, Ceramic 30, 50, 70 pF. 9d.; 100 pF. 150 pF. 1/3; 250 pF. 1/6; 600 pF. 750 pF. 1/9; Philips, 30 pF. 1/- each.

PYE STEREOGRAPHIC PLAYER DECK

Complete with walnut cabinet
Quality stereo amplifier
Garrard TA Mk. II pick-up.
14 1/2" wide, x 17" deep, x 8 1/2" high.
PRICE £12.10.0. Carr. and Ins. 10/-
Requires any two 3-ohm speakers.

BLACK CRACKLE PAINT, Air drying, 3/- tin.
NEON MAINS TESTER SCREWDRIVER, 5/-
SOLDER RADIOGRADE, 4d. yd., 1 lb. 9/6.

HIGH GAIN TV PRE-AMPLIFIERS

BAND I B.C.C.
Tunable channels 1 to 5. Gain 18 dB. ECC84 valve. Kit price 29/6 or 49/6 with power pack. Details 6d. (PCC84 valves if preferred.)
BAND III I.T.A.—Same prices
Tunable channels 8 to 13. Gain 17 dB.

PAXOLIN PANELS, 10in. x 8in., 1/6.
MINIATURE CONTACT COOLED RECTIFIERS. 250 v. 50 mA, 7/6; 250 v. 60 mA, 8/6; 250 v. 85 mA, 9/6. 200 mA, 21/-; 300 mA, 27/6.
SELENIUM RECT. 300 v. 85 mA. 7/6.
COILS. Wearite "P" type, 3/- each. Osmor Midget "Q" type, adj. dust core from 4/- each. All ranges.
TELETRON D.W.R. L. & Med. T.R.F. with reaction, 3/6.
FERRITE ROD AERIALS. M.W., 8/9; M. & L., 12/6.
FERRITE ROD AERIALS. L & M. for transistor circuits, 10/- each.
FERRITE RODS 8in. x 3in., 2/6.
H.F. CHOKES, 2/6. Osmor QCI 6/9.
T.R.F. COILS A/HF, 7/- pair; HAX, 3/-, DRR2, 4/-.

ALUMINIUM CHASSIS. 18 s.w.g. Plain, undrilled. 4 sides, riveted corners, lattice fixing holes. 2 1/2in. sides. 7in. x 4in., 4/6; 9in. x 7in., 5/9; 11in. x 7in., 6/9; 13in. x 9in., 8/6; 14in. x 11in., 10/6; 15in. x 14in., 17/6; 18in. x 16in. x 3in., 16/6.
ALUMINIUM PANELS. 18 s.w.g., 12in. 12in. 4/6; 14in. x 9in., 4/-; 12in. x 8in., 3/-; 10in. x 7in., 2/3. 8in. x 6in. 2/-.

ALADDIN FORMERS and cores. 3in. 8d., 3in. 10d. 0.3in. **FORMERS** 5937 or 8 and cans TV1 or 2, 3in. sq. x 2 1/2in. or 3in. sq. x 1 1/2in., 2/- with cores.
SLOW MOTION DRIVES. Epicyclic ratio 6-1, 2/3.
SOLENOID IRON, 25 w., 200 v. or 230 v. 24/-.
PRECISION Sub-miniature Iron. 200 or 240 v. 29/6;
MAINS DROPPERS. 3in. x 1 1/2in. With adj. sliders, 0.3A, 1,000 ohms, 4/3; 0.2A 1,000 ohms, 4/3.
LINE CORD. 0.3 A 60 ohms per foot, 0.2 A 100 ohms per foot, 2-way, 1/- per foot; 3-way 1/- per foot.
MIKE TRANS. 50:1, 3/9; 100:1 potted, 10/6.
P.V.C. CONN. WIRE, 8 colours, single or stranded, 2d. yd.
SLEEVING, 1 or 2 mm, 2d.; 4 mm, 3d.; 6 mm, 5d. yd.
SPEAKER FRET. Gold cloth, 17in. x 25in., 5/-; 25in. x 35in., 10/- **TYGAN,** 52in. wide, 10/-; 26in. wide 5/- ft. Samples S.A.E. Expanded Metal, Gold, 12in. x 12in., 6/-.

AMERICAN "BRAND FIVE" PLASTIC RECORDING TAPE

Double Play 7" reel, 2,400 ft.	60/-	Spare Plastic Reels	
5" reel, 1,200 ft.	37/6	3" 1/6	
Long Play 7" reel, 1,800 ft.	35/-	4" 2/-	
5 1/2" reel, 1,200 ft.	23/6	5" 2/-	
5" reel, 900 ft.	18/6	5 1/2" 2/-	
Standard 7" reel, 1,200 ft.	25/-	7" 2/6	
5" reel, 600 ft.	16/-		

"Instant" Bulk Tape Eraser and Head Defluxer, 200/250V A.C. 27/6. Leaflet S.A.E.

QMAX CHASSIS CUTTER

The cutter consists of three parts: a die, a punch and an Allen screw.

Sizes	Price	Key
3in.	12/9	1/-
3 1/2in.	12/9	1/-
4in.	13/9	1/-
4 1/2in.	13/9	1/-
5in.	16/-	1/6
5 1/2in.	16/-	1/6
6in.	18/-	1/6
6 1/2in.	18/-	1/6
7in.	20/6	1/6
7 1/2in.	30/-	2/3
8in.	33/6	2/3
8 1/2in.	38/6	2/3
9in. square hole	29/-	1/6

"REGENT" 4 VALVE

"96" RANGE VALVES
Kit Price £6.6.0
carr. 4/-



PRINTED CIRCUIT BATTERY PORTABLE KIT

Medium and long wave. Powerful 7 x 4 in. high Flux Speaker. T.C.C. Printed Circuit and condensers. Components of finest quality clearly identified with assembly instructions. Osmor Ferrite Aerial Coils. Rexine covered attache case cabinet. Size 12 in x 8 in. x 4 in. Batteries used B126 (L5512) and AD35 (L5040), 10/- extra. Instructions 9d. (free with kit), Mains Unit ready made for above 39/6. Sold separately. Details free.

MODEL U.A.8 £6.18.0

POST 2/-



MONARCH RECORD PLAYER
BUILD IT YOURSELF using 4-SPEED BSR MONARCH AUTOCHANGER READY BUILT 3W AMPLIFIER, HANDSOME PORTABLE CASE, HIGH FLUX LOUDSPEAKER. FULL INSTRUCTIONS SUPPLIED

Total Price £12.10.0
Carr. and ins. 5/-

RECORD PLAYER BARGAINS

4 Speed Autochangers: POST 2/- each
BSR, U.A.14.....£7.10.0
BSR, U.A.12 Stereo.....£8.5.0
Collaro Autochanger.....£7.19.6
Garrard Autoslim.....£8.17.6
Garrard RC 210.....£10.10.0
4 Speed Single Players:
Garrard TA Mk. II.....£8.0.0
Garrard 4 HF Transcription.....£17.19.6
Garrard Stereo Heads £2 extra.
All Sapphire Stylus available from 6/-.
All Crystal Cartridges available from 21/-
AUTOCHANGER ACCESSORIES
Amplifier player cabinets with cut boards, 63/-.
2-valve amplifier and 6 1/2" speaker for above, ready mounted on baffle, 12in. x 7in., 3in. deep, Wired and tested ready for use. £4.15.0.

ARDENTE TRANSISTOR TRANSFORMERS

Type D3035, 7.3 CT:1 Push Pull to 3 ohms for OC72, etc. 1in. x 3in. x 3in., 9/6.
Type 3034, 1.75:1 CT. Push Pull Driver for OC72, etc. 1in. x 3in. x 3in., 9/6.
Type D3058, 11.5:1 Output to 3 ohms for OC72, etc., 1in. x 3in. x 3in., 9/6.
Type D167, 18.2:1 Output to 3 ohms for OC72 etc., 3in. x 3in. x 3in., 12/-.
Type D339, 4.5:1 Driver Transformer, 3in. x 3in. x 3in., 10/-
Type D240, 8.5:1 Driver Transformer, 3in. x 3in. x 3in., 10/-
ARDENTE TRANSISTOR VOLUME CONTROLS. Type VC1545, 5K with switch, 9in., 8/-.
Type VC1760, 5K with switch, dia. 7in., 10/6.
DEAF AID EARPIECE Xtal or magnetic 7/6.

WEYRAD

COILS AND TRANSFORMERS FOR A 2-WAVE TRANSISTOR SUPERHET WITH PRINTED CIRCUIT AND FERRITE ROD AERIAL AND

Long and Medium Wave Aerial—RA2W. On 6in. rod, 2in. diameter, 208 pF. tuning, 12/6.
Oscillator Coil P501AC. Medium wave. For 176 pF. tuning, 5/4.
1st and 2nd I.F. Transformer—P50/2CC. 470 kc/s, 1 1/2in. diameter by 3in. high, 5/7.
3rd I.F. Transformer—P50/3CC, to feed diode detector, 6/-.
Driver Transformer—LFDT2, 1 1/2in. x 3in. x 1 1/2in., 9/6.
Printed Circuit—PCAI. Size 2 1/2in. x 8 1/2in. Ready, drilled and printed with component positions, 9/6.
7in. x 4in., 35 ohm Speaker, 25/-.
Wavechange Switch 3/6.
These components are approved by transistor makers and performance is guaranteed. Constructor's Booklet with full details, 2/-.

NEW MULLARD TRANSISTORS

Audio OC71 ... 6/- R.F. OC44 ... 10/6
OC72 ... 7/6 OC45 ... 9/6
Sub-miniature Electrolytics (15 V). 1 mfd., 2 mfd., 4 mfd., 5 mfd., 8 mfd., 25 mfd., 100 mfd., 2/6. Diodes OA71, OA81, 3/-; GEX 34 4/-.

B.B.C. Pocket 2 Transistor. M.W. and L.W. Radio Kit, 32/6. Phones 7/6 or deaf aid earpiece, 7/6.

"P.W." Pocket 6. Transistor kit. All parts, printed circuit and cabinet. Osmor Designed Kit, £8.15.0. Mk. II all the latest modifications.

SPECIALISTS

337 WHITEHORSE ROAD WEST CROYDON Telephone THO 1665

P. & P. charge 1/-, over £3 post free. C.O.D. 2/- (Export welcome. Send remittance and extra postage)

TEST EQUIPMENT OF EXCEPTIONAL QUALITY

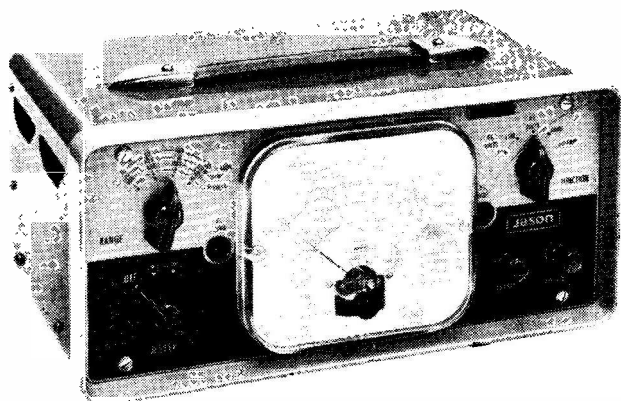

by

Jason

in

KIT FORM

A number of positive advantages stem out of presenting Jason Electronic Test Equipment in kit form. There is naturally a high degree of satisfaction to be obtained from building first-class equipment of this kind for yourself. You benefit too from using instruments of a standard which would otherwise cost very much more than the equivalent Jason Kit. Jason Instruments are in regular use in laboratories and test departments throughout the world. As Kits, they provide excellent opportunities for training in electronics. Built, they provide accuracy of exceptionally high order together with reliability and welcome robustness.

● TEST EQUIPMENT

● VALVE VOLTMETER (illus.)

4-valve Bridge Circuit. 23 ranges inc. D.C. Kit inc. valves, 4½" sq. meter and case. £23.0.0
High voltage probes £3 extra.

● OSCILLOSCOPE OG.10 (illus.)

Sensitivity of 10 mV/cm. with bandwidth 2 c/s. to 2 Mc/s. Push/pull amps. on X and Y plates. With 2½" tube, valves and case. £22.10.0

● AUDIO GENERATOR A.G.10

Tunes from 10 c/s to 100 Kc/s with output constant within 1dB. Square wave rise time better than 2 microseconds. With valves and case. £15.19.0

● AUDIO ATTENUATOR AA.10.

Nine steps by switches from 1dB to 40 dB. £7.15.0

● WOBBULATOR W.11

For all IF and RF alignment. Complete kit. £14.19.0

● CRYSTAL CONTROLLED CALIBRATOR C.C.10.

For use in 10 Kc/s to 250 Mc/s range with 0.01% basic accuracy. £19.19.0

Literature on all Jason items gladly sent on request. S.A.E. please

● New Argus Transistor Radio Tuner for Recorder and Amp. £7.10.0

● NEW STEREO/MONO DE LUXE TAPE UNIT JTL

In Kit Form, complete with Valves and Instructions 20 gns.

Ready Built 29 gns.

AMPLIFIERS • TUNERS

(Built).

J.2-10. Mk. III Stereo/Mono Amp. £40.19.0

J.10 Mono Amp., 10 watt £24.0.0

FMT.4 FM Fringe Tuner £23.6.9

(inc. £6.15.7 P.T.)

JTV/2. Switched FM and TV Sound Tuner (inc. £6.15.7 P.T.) £25.19.7

Monitor—as JTV/2 but for cabinet mounting (inc. £5.4.1. P.T.) £19.19.1



Jason

**ELECTRONIC TEST EQUIPMENT
HIGH FIDELITY EQUIPMENT**

JASON ELECTRONIC DESIGNS LIMITED, 2(RR) KIMBERLEY GARDENS, LONDON N.4. Telephone STA 5477

CHECK with these

BARGAINS

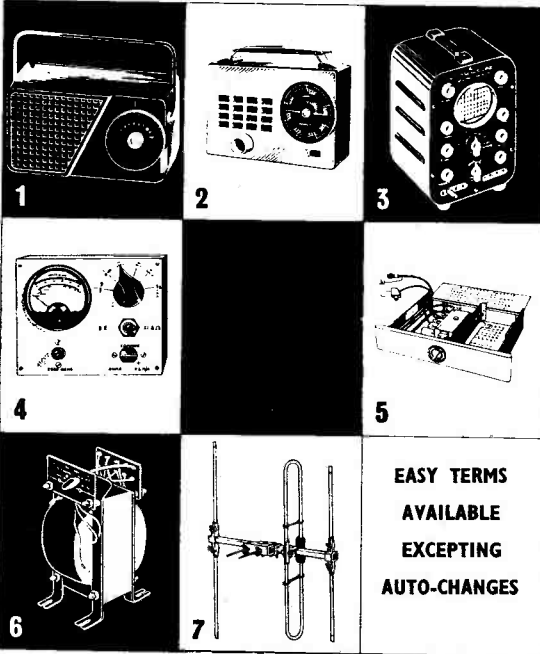

**EASY TERMS
AVAILABLE
EXCEPTING
AUTO-CHANGES**

- 3-TRANSISTOR POCKET RADIO** with miniature **SPEAKER FERRITE ROD**, and 2 **GERMANIUM DIODES**. The only 3-transistor radio available at the price. Build it in 1 evening! Tunable over M/L waves. Complete with easy-to-follow instructions and all components (less batteries obtainable anywhere 1/3). 27/6. P. & P. 2/6. (All parts available separately.)
- 5-TRANSISTOR POCKET RADIO**. Size 4½" x 3½" x 1½". Output 200 m/W. Five first quality transistors. Push-pull output. Fitted 2" high-flux moving coil speaker. Medium and long wave. Internal high gain ferrox aerial. Twin coloured case in red and black. All parts available separately. Circuit-diagram 1/6. Free with parts. No aerial or earth required. 59/6. P. & P. 3/6.
- OSCILLOSCOPE FOR D.C. and A.C. APPLICATIONS**. A high gain, extremely stable differential T-amplifier (30 mV/CM.). Provides ample sensitivity with A.C. or D.C. inputs. Especially suitable for measurements of transistor operating conditions where maintenance of D.C. levels is of paramount importance. Push-pull X amplifier; Fly-back suppression; Internal Time-base Scan Waveform available for external use; pulse output available for checking TV line O/P Transformers, etc. Provision for external—/P and CRT Brightness Modulation. A.C. mains 200/250V £15.15/0. P. & P. 8/- or 30/- deposit; plus P. & P. 8/- and 12 monthly payments of 26/6. FULL 12 MONTHS' GUARANTEE INCLUDING VALVES AND TUBE
- A.C./D.C. POCKET MULTI-METER KIT**. 2" moving coil meter, scale calibrated in A.C./D.C. volts, ohms, and milliamps. Voltage range A.C./D.C. 0-50, 0-100, 0-250, 0-500. Milliamps 0-10, 0-100. Ohms range 0-10,000. Front panel, range switch, wirewound pot (for ohms zero setting), toggle switch, resistor and rectifier. 19/6. P. & P. 2/- Wiring diagram 1/- free with parts.
- CHANNEL TUNER** Will tune to all Band I and Band III stations. Complete with P.C.C.84 and P.C.F.80 valves (in series) I.F. 16-19 or 33-38. Can be modified as an aerial converter (instructions supplied). 32/6, plus 4/- P. & P. **HEATER TRANSFORMER** to suit above, 200-250V, 6/-, plus 4/- P. & P.
- MAINS TRANSFORMERS**. All with tapped primaries. 250-250V 70mA, 6.3V 2A, 10/6. P. & P. 3/6. 280-0-280 70mA, 6.3V 2A, 6.3V 1A, 10/6. P. & P. 3/6. 280-0-280 120mA, 6.3V 2A, 6.3V 3A, 17/6. P. & P. 3/6.
- WOLSEY 3-ELEMENT FOLDED DIPOLE**. I.T.V. Aerial less mounting bracket for external use, complete with 12 yards coaxial cable, 15/-, P. & P. 4/-.

- SIGNAL GENERATORS**. Cash £6.19.6. or 25/- deposit and 6 monthly payments of 21/6. P. & P. 5/6. Coverage 100 kc/s to 100 Mc/s on fundamentals and 100 Mc/s to 200 Mc/s on harmonics. Case 10" x 6½" x 5½". Three miniature valves and Metal Rectifier. A.C. mains 200/250V. Internal modulation of 400 c.p.s. to a depth of 30 per cent; Modulated or unmodulated R.F. output continuously variable 100 millivolts. CW. and mod. switch, variable A.F. output. Magic eye as output indicator. Accuracy ± 2%.
- SIGNAL GENERATORS**. Cash £4.19.6. P. & P. 5/6. Coverage 120 kc/s to 84 Mc/s. Case 10" x 6½" x 4½". Size of scale 6½" x 3½". 2 valves and rectifier. A.C. mains 230-250V. Internal modulation of 400 c.p.s. to a depth of 30 per cent modulated or unmodulated R.F. output continuously variable 100 millivolts. CW. and mod. switch variable A.F. output and moving coil output meter. Accuracy ± 2%.
- BATTERY RECORD PLAYER AND AMPLIFIER**. 45 r.p.m. "Star" motor "Acos" crystal pick-up, 3 transistor, push-pull amplifier complete with transistors. Output 500 milliwatts, 49/6. P. & P. 4/-.
- 8-watt PUSH-PULL 5 VALVE AMPLIFIER**. A.C. mains 200-250V. Size 10½" x 6½" x 2½". 5 valves. For use with all makes and type of pick-up and mike. Negative feedback. Two inputs, mike and gram. and controls for same. Separate controls for Bass and Treble lift. Response flat from 40 cycles to 15 kc/s, ± 2dB; 4db down to 20 kc/s. Output 8 watts at 5 per cent total distortion. Noise level 40 db down all hum. Output transformer tapped for 3 and 15 ohms speech coils. For use with Std. or LP. records; musical instruments such as guitars, etc. Suitable for small halls. £3.19.6. P. & P. 7/- Crystal mike to suit 15/-, P. & P. 2/-, 8" P.M. Speaker to suit, 12/6. P. & P. 2/-.
- B.S.R. MONARCH U88 WITH FUL-FI HEAD**. 4-speed, plays 10 records, 12", 10" or 7" at 16, 33, 45 or 78 r.p.m. Intermixes 7", 10" and 12" records of the same speed. Has manual play position: colour brown. Dimensions: 12½" x 10½". Space required above baseboard 4½" below baseboard 2½". Fitted with Ful-Fi turnover crystal head, £6.19.6. P. & P. 5/-. With Stereo Head £7.19.6. P. & P. 5/6.
- TRANSISTOR TESTER**. For both P.N.P. and N.P.N. transistors incorporating moving coil meter. In metal case size 4½" x 3½" x 1½". Scale marked in gain and leakage. 19/6. P. & P. 3/-.
- PUSH-PULL OUTPUT STAGE** inclusive of transistors with input and output transformers to match 3 ohms speech coil, suitable for use with the POCKET RADIO. Kit of parts, including transistors, 19/6. P. & P. 2/- Wiring diagram 1/6, free with parts.
- PORTABLE AMPLIFIER**. On printed circuit for A.C. Mains 200/250V. Size 4" x 3" with tone and volume control. Complete with valves: ECL82 and EZ80. Output 2 watts. 39/6. P. & P. 3/-.

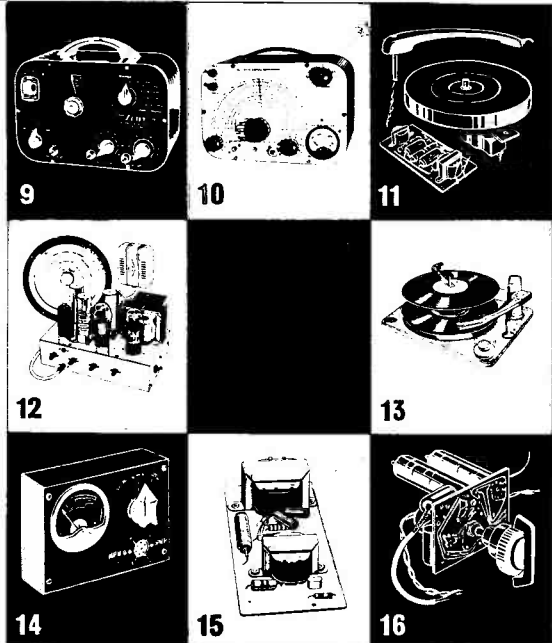

**RADIO & T.V. COMPONENTS
(Acton) LTD.**

**23d HIGH STREET, ACTON,
LONDON, W.3.**

ALL ENQUIRIES S.A.E.
GOODS NOT DISPATCHED OUTSIDE U.K.

HOME RADIO OF MITCHAM

Dept. AC, 187 London Road, Mitcham, Surrey. MIT 3282. Shop hours: 9.0 to 6.30 p.m. (Weds. 1.0 p.m.)

NEW MINIATURE TUNING CONDENSERS

Jackson "Dilemin" condensers. Measuring only $\frac{7}{8}$ " x $\frac{7}{8}$ " x $\frac{1}{2}$ " and available in 300pf 500pf single gangs. High grade insulation end plates and dielectric. Standard $\frac{1}{4}$ " dia. spindle. Really excellent for miniature receivers, etc. Delivery from stock. Brand new and boxed. **PRICE 7/6** each. Post 9d.

JASON ARGUS TUNER



Superhet three transistor AM tuner for Medium and Long wave with self-contained high efficiency ferrite rod aerial giving excellent reception of the main Continental stations. Complete in neat wooden case. Size 9" x 4" x 2 $\frac{1}{2}$ ". Ideal for use with tape recorder or Hi-Fi equipment. **PRICE OF KIT £7.10.0.** post 1/6.

ALL OTHER JASON MANUAL AND SWITCH TUNED FM KITS IN STOCK. CONSTRUCTIONAL DATA IN DB12 **PRICE 2/6d.** post 6d.

MULLARD DESIGNS

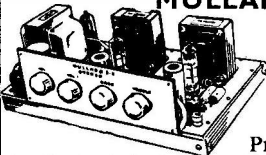

"CIRCUITS FOR AUDIO AMPLIFIERS" 8/6

Prepared by Mullard's technical laboratories, this exciting book on audio design is now regarded as a standard reference book on all aspects of quality reproduction. In addition to the theory of reproduction and distortion there are practical designs for twelve different popular circuits. All parts are standard and available from stock and detailed price lists are available on request. Prices shown are average figures for sets of parts exactly as specified by Mullards.

20 watt amplifier	£27.10.0.
10 watt amplifier	£15.0.0.
3 watt amplifier	£9.9.0.
7 watt DC/AC amplifier	£11.10.0.
2 valve pre-amplifier	£6.9.6.
3 valve pre-amplifier	£12.0.0.
4 channel mixing pre-amp	£7.15.0.
3 watt tape amplifier	£13.12.6.
Tape pre-amplifier	£14.17.6.
7 watt stereo amplifier	£18.0.0.
3 valve stereo amplifier	£13.10.0.
Stereophonic pre-amplifier	£13.0.0.

Price list being prepared for the new ECL86 amplifier.

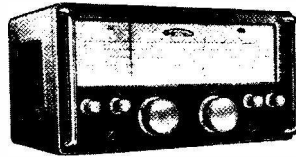

NEW EDDYSTONE 840C

The latest EDDYSTONE communications receiver now available from stock. Advanced design, rugged construction, and highest grade components used throughout. Modern smart streamlined appearance and a delight to operate. Precision

made gear driven slow-motion drive and full width dial for easy tuning. Five ranges covering 480 kc/s to 30 Mc/s. **PRICE £58.0.0.** Delivery free U.K. Overseas shipping quoted on request.

EDDYSTONE 898 SLOW-MOTION DIAL

The finest slow motion dial assembly available. Essential for really high grade receivers, tuners, test gear, transmitters, etc. Precision cut gears give velvet smooth 110 to 1 reduction and the vernier logging scale gives exact position. Size 9 $\frac{1}{2}$ " x 5 $\frac{3}{4}$ ". **PRICE £3.11.4.** post 1/6 (Overseas post 7/6).



JOHNSON SHORT-WAVE RECEIVER KITS

GLOBE KING 100

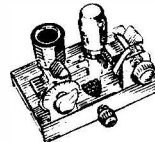

This amazing little one valve battery receiver gives really long distance reception at a minimum cost. Short wave radio operates 24 hours a day: start today and join the happy band of short wave listeners. KIT with three plug-in coils **£3.19.6.** Extra add-on one valve amplifier **2/6.** Add 1/6 postage.

SR2 METRES

A simple but very effective one valve super-regenerative receiver for the new 2 metre band. Explore this new medium on VHF and listen in to aircraft and amateurs, etc. **KIT FOR RECEIVER 39/6,** post 1/6. Power supply unit **30/-** post 1/6.

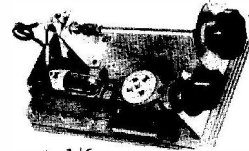

WE ARE ACTUAL STOCKISTS FOR THE FAMOUS HEATHKITS

HI-FI EQUIPMENT
We are stockists for LEAK, QUAD, PYE, H.M.V., ARMSTRONG, GOODMAN, WHARFEDALE, STENTORIAN, GARRARD, COLLARO, DECCA, etc.

NEW TEST METER BARGAIN

Wonderful value in this new CABY pocket multi-range test meter. Large scale moving coil movement, 9 separate ranges covering AC and DC voltages from 6 to 1,200 volts. DC current 30 and 300 mA, also resistance in ohms up to over 100,000. Size 4" x 3" x 1 $\frac{1}{2}$ " and supplied complete with leads and prods. **AMAZING PRICE OF ONLY £2.14.0.** post paid.

SUPER 170 PAGE ILLUSTRATED CATALOGUE
2/-, post 1/-

TRANSISTORS

Don't risk inferior results with "surplus" transistors when you can obtain brand new boxed Mullard at these low prices. OC44 11/-, OC45 10/-, OC70 6/6, OC71 6/6, OC72 8/-, OC75 8/-, OC76 8/-, OC78 8/-, OC81 8/-, OC170 13/6, OC171 14/6, OC35 25/6, OA70, OA79, OA81, all at 3/- each. Matched pairs of output transistors and OA79 diodes available.

PLEASE ADD 6d. POSTAGE TO ORDER

4-SPEED BATTERY GRAMOPHONE UNIT

The Goldring Cygnet is designed to play all sizes of records up to 12" and speeds of 16, 33, 45, and 78 rpm. Low current consumption from 6 or 9 volt battery. Dimensions 11" x 9" and 2 $\frac{1}{2}$ " below deck. Ideal for making portable record player. Price of deck complete with pick-up **£6.13.8.**, post 2/6.

THE **Radio Constructor**

Incorporating **THE RADIO AMATEUR**

JANUARY 1962

	Suggested Circuits No. 134: A Temperature-operated Switch, <i>by G. A. French</i>	414
	An Experimental Transistor VHF Receiver for the Aircraft Bands, <i>by D. T. Bradford, VQ4EV</i>	417
	Can Anyone Help ?	420
	A Simple Musical Instrument, <i>by R. C. Marshall, M.A., Grad.I.E.E.</i>	421
	A Small High Quality Amplifier, <i>by Peter J. L. Binns, M.Sc.</i>	422
	Trade Review, New Oryx Micro-Miniature Soldering Tweezers	425
	Understanding Radio, Part 6, <i>by W. G. Morley</i>	426
	In Your Workshop	432
	Interpretation of Valve Data, <i>by F. E. Ash</i>	437
	News and Comment	442
	A Printed Circuit Matchbox Receiver, <i>by R. Davis</i>	443
	Radio Astronomy, Part 4, <i>by Frank W. Hyde, F.R.S.A., F.R.A.S.</i>	446
	The JR1/JTL Stereo Tape Recorder Unit, Part 4, <i>by G. Blundell</i>	453
	Radio Topics, <i>by Recorder</i>	454
	A Constructor's Wife, <i>by Mrs. J. Anderson</i>	457
	Resistors and Capacitors as Mains Droppers, <i>by J. B. Dance, M.Sc.</i>	458
	Emitter Follower Circuits, Part 1, <i>by Peter Williams, B.Sc.(Hons.), Grad.Inst.P., Grad.I.E.E.</i>	461
	Improving Radio Luxembourg Reception, <i>by Gordon J. King, M.I.P.R.E.</i>	463
	A Constructor Visits the 1961 International Radio Hobbies Exhibition	466

© *Data Publications Ltd, 1962*

CONTENTS may only be reproduced after obtaining prior permission from the Editor. Short abstracts or references are allowable provided acknowledgment of source is given.

CONTRIBUTIONS on constructional matters are invited, especially when they describe the construction of particular items of equipment. Articles should be written on one side of the sheet only and should preferably be typewritten, diagrams being on separate sheets. Whether hand-written or typewritten, lines should be double spaced. Diagrams need not be large or perfectly drawn, as our draughtsmen will redraw in most cases, but all relevant information should be included. Photographs should be clear and accompanied by negatives. Details of topical ideas and techniques are also welcomed and, if the contributor so wishes, will be re-written by our staff into article form. All contributions must be accompanied by a stamped addressed envelope for reply or return, and should bear the sender's name and address. Payment is made for all material published.

OPINIONS expressed by contributors are not necessarily those of the Editor or the proprietors.

TRADE NEWS. Manufacturers, publishers, etc., are invited to submit samples or information of new products for review in this section.

TECHNICAL QUERIES must be submitted in writing. We regret that we are unable to answer queries, other than those arising from articles appearing in this magazine; nor can we advise on modifications to the equipment described in these articles.

CORRESPONDENCE should be addressed to the Editor, Advertising Manager, Subscription Manager or the Publishers, as appropriate.

REMITTANCES should be made payable to "DATA PUBLICATIONS LTD."

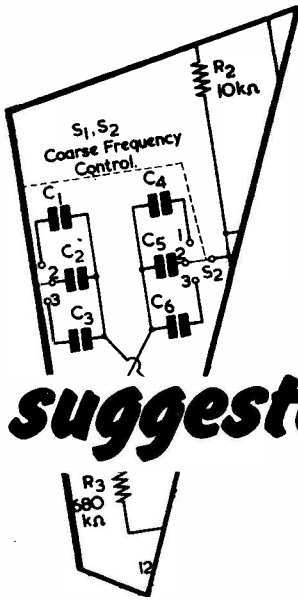

suggested circuits

No. 134

A TEMPERATURE-OPERATED SWITCH

THE CIRCUIT DESCRIBED THIS month employs a simple two-transistor amplifier to operate a relay when a heat sensitive device is raised or lowered to a pre-determined temperature. The heat sensitive device is a small and inexpensive thermistor whose resistance variations with temperature change cause corresponding changes in input current to the amplifier. The writer visualises the most useful application of the switching unit as that of providing a warning of overheating in any equipment to which the thermistor is coupled. Such equipment could consist of electronic apparatus, engine cooling systems, and the like; and it would, in many cases, also be possible for the unit to switch off the equipment if temperature reached an undesirable level. A further application would be that of employing the switch to give warning of fire, in which case the warning system could be tested from time to time by momentarily holding a lighted match below the thermistor.¹ The switching unit could also be used for the temperature control of ovens, but it must be pointed out that change of thermistor resistance with temperature is too low to permit a very close degree of control to be obtained.

The switching unit, as described in this article, allows relay operation to occur at temperatures within the range of some 40° to 120° C. It

can, in consequence, provide warning or protection for most types of overheating. A method of enabling the switching unit to operate outside this range is suggested, but it must be pointed out that maximum operating temperature for the thermistor is of the order of 200° C. Since the thermistor is a filament protection device, a minimum operating temperature is not quoted in the manufacturer's literature, but there

seems little reason why it could not be employed below 0° C.

A meter capable of measuring the current flowing through the relay coil (or the voltage dropped across it) is required during the setting-up of the unit.

The Circuit

The circuit of the switching unit appears in Fig. 1. The CZ10 thermistor is connected between a

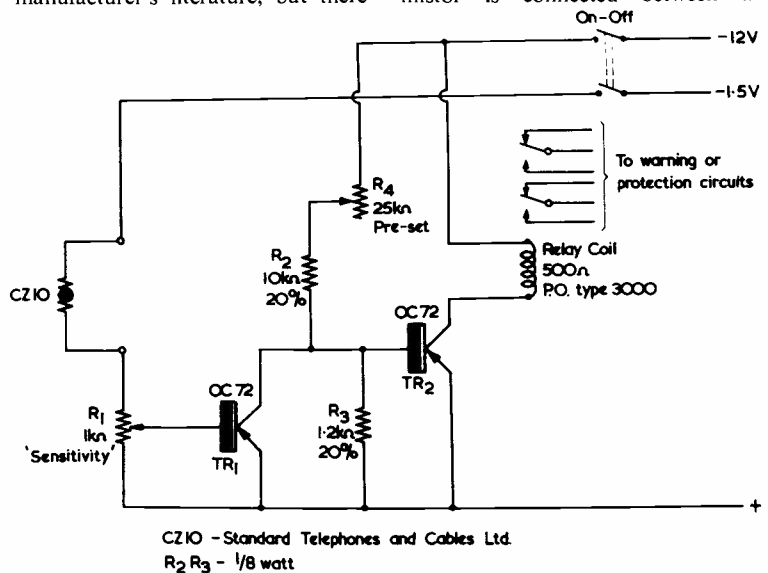

M212

Fig. 1. The circuit of the temperature operated switch

¹ The match should be applied for a short time only, as is discussed later.

negative source of 1.5 volts and the $1k\Omega$ potentiometer, R_1 . Since the thermistor has a negative temperature coefficient its resistance drops as temperature increases. In consequence, an increase in temperature in the thermistor causes increased current to flow through it and, also, through the base-emitter circuit of TR_1 .

TR_1 collector current passes through R_2 and R_4 in series and is normally of a low level, thereby allowing a relatively high base-emitter current to flow in TR_2 . The base-emitter current in TR_2 is sufficiently high to enable the collector current of this transistor to energise the relay.

When the resistance of the thermistor falls, due to increasing temperature, the increased base-emitter current in TR_1 causes a corresponding increase in its collector current. This, flowing through R_2 and R_4 , causes a reduced base-emitter current in TR_2 , and a consequent reduction in TR_2 collector current. The relay then de-energises.

If the switching unit is intended to detect a *fall* in temperature to a pre-determined level the relay normally remains de-energised. When the temperature is sufficiently low, the increase in thermistor resistance causes a decrease in TR_1 current, a corresponding increase in TR_2 current, and the energising of the relay.

The relay specified may be fitted with two sets of contacts, these being used to operate warning circuits or to switch the equipment whose temperature is being monitored.

The "sensitivity" control, R_1 , functions in an extremely simple manner, since it merely regulates the change in TR_1 base-emitter current brought about by changes in thermistor resistance. Adjusting R_1 varies the temperature at which the relay operates. The variable resistor R_4 is used to bring TR_2 on to its correct operating point.

Design Features

A CZ10 was employed as the temperature sensitive device in the switching unit because it has a high initial resistance (i.e. resistance at ambient temperature). Most thermistors exhibit approximately the same *ratio* of resistance change with change in temperature, and a high initial resistance enables this change in ratio to be sensed by the first transistor in the amplifier without the necessity of drawing a heavy energising current from the power supply. The CZ10 has the further advantage of being small in physical size, its dimensions being $\frac{1}{8}$ " in long by $\frac{3}{16}$ " in diameter. The thermistor

may, therefore, be readily fitted in equipment where space is limited.

The potentiometer R_1 offers an extremely simple means of controlling sensitivity, but its use incurs the disadvantage that the rate of change of relay current for temperature change reduces as the slider moves towards the lower end of the track, whereupon variations in relay performance become more liable to vary the temperature at which external circuits are switched. However, results with the prototype indicated that the simple sensitivity circuit given by R_1 was adequate in practice, especially if the device was merely intended to give protection against excessive temperatures.

No tests were made for repeatability of operation, and this point can only be ascertained by experience. One of the performance curves obtained with the prototype was determined from two sets of readings, and these tallied with each other satisfactorily. If the device is to be used to check a temperature having a fixed maximum level (such as a water cooling system, whose maximum level would be 100°C .) it might be advisable, until repeatability had been reliably ascertained, to set the switching device such that it operated at a minimum of some 10 to 15°C . below the maximum temperature. This procedure should give reasonable protection against any long-term shifts in performance which might occur.

It will be noted that a separate 1.5 volt supply is required for the thermistor. If desired, this could be obtained from a potentiometer connected across the 12 volt supply, the upper arm consisting of a 390Ω $\frac{1}{2}\text{W}$ resistor and the lower arm of a 56Ω $\frac{1}{2}\text{W}$ resistor. Such a potentiometer would draw a standing current of some 27mA, and both resistors should preferably be $\pm 5\%$. If the 1.5 volt cell is retained it will need to supply less than 1mA energising current for temperatures of up to 100°C . The resistance of the thermistor at maximum operating temperature (200 – 250°C .) is 148Ω , with the result that the maximum current liable to be required from the cell (assuming zero base-emitter resistance in TR_1) is 10mA. (This figure falls comfortably within the maximum base current rating for the OC72 of 20mA.)

If it is desired to have the switching unit operate at temperatures outside the range 40 to 120°C ., this could be achieved by varying the energising voltage applied to the thermistor. Lower temperatures could be accommodated by increasing the voltage, and higher temperatures by decreas-

ing it. Performance at such temperatures has not been checked by the writer.

The relay circuit employed with the switching unit employs a transistor and relay combination which offers extremely reliable results and which has been used in previous circuits in this series. Brief details of relay operation are given at the end of this article. It is not necessary to connect a protective diode across the relay coil (to prevent the formation of high reverse voltages on the sudden cessation of energising current) because, in this circuit, changes in relay current should take place relatively slowly.

Setting-up and Operation

After the unit has been completed it needs to be set up. For this process it is necessary to connect a milliammeter capable of reading 20mA in series with the relay coil (or a voltmeter capable of reading 10 volts across it).

Initially, R_4 should be adjusted to insert maximum resistance and the 12 volt supply only should be applied. When the unit is switched on under this condition, TR_2 should be capable of passing maximum collector current. Pre-set resistor R_4 should now be adjusted until the relay coil current is 20mA (or until 10 volts appears across the 500Ω coil). Currents in excess of 23mA should be avoided.

The 1.5 volt supply should now be applied and R_1 adjusted for maximum sensitivity. The maximum sensitivity setting of R_1 may cause a slight reduction in relay current, this effect indicating that the current in the base-emitter circuit of TR_1 at maximum sensitivity is sufficiently high to affect TR_2 current. The thermistor may now be held between thumb and forefinger, whereupon the heat imparted to it should cause a noticeable drop in relay coil current. (Some of this drop may be caused by leakage across the surface of the thumb and finger.) A more positive check is given by *momentarily* holding a lighted match several inches under the thermistor. This should cause the relay coil current to drop to a negligible value and the relay to de-energise. The match should not be held too long under the thermistor or it may cause damage.

In use the thermistor will, of course, be mounted away from the remainder of the circuit by means of extension leads, the transistors and their associated components being kept at normal ambient temperature. Great care must be taken when positioning the thermistor to ensure

that its terminals are not short-circuited. If such a short-circuit were to occur, TR₁ could pass an excess base-emitter current and be irreparably damaged.

Results with the Prototype

Several temperature runs were taken with the prototype, the results obtained being illustrated in Fig. 2. Fig. 2 (a) shows the results given at full sensitivity and, as may be seen, the slope of the temperature/current curve about the relay operating points is comfortably steep, despite the simplicity of the switching unit circuit. Readings for the curve of Fig. 2 (a) were taken on two separate occasions and tallied satisfactorily.

Fig. 2 (b) gives the curve given for a reduced sensitivity setting. In this case the slope at the relay operating points is not as steep, but it is still adequate for the applications envisaged by the writer.

The current consumed by the prototype from the 12 volt supply was approximately 21mA when the relay was energised, and 1mA when it was de-energised.

The Relay Circuit

The circuit around TR₂ is designed to allow this transistor to control the robust relay specified in an efficient manner, and the constructor is strongly recommended to employ a relay of the same type. That specified is a Post Office type 3,000 unit with a coil resistance of 500Ω. More than two contact sets should not be used, as energising current would become excessive. Under no circumstances should a relay having

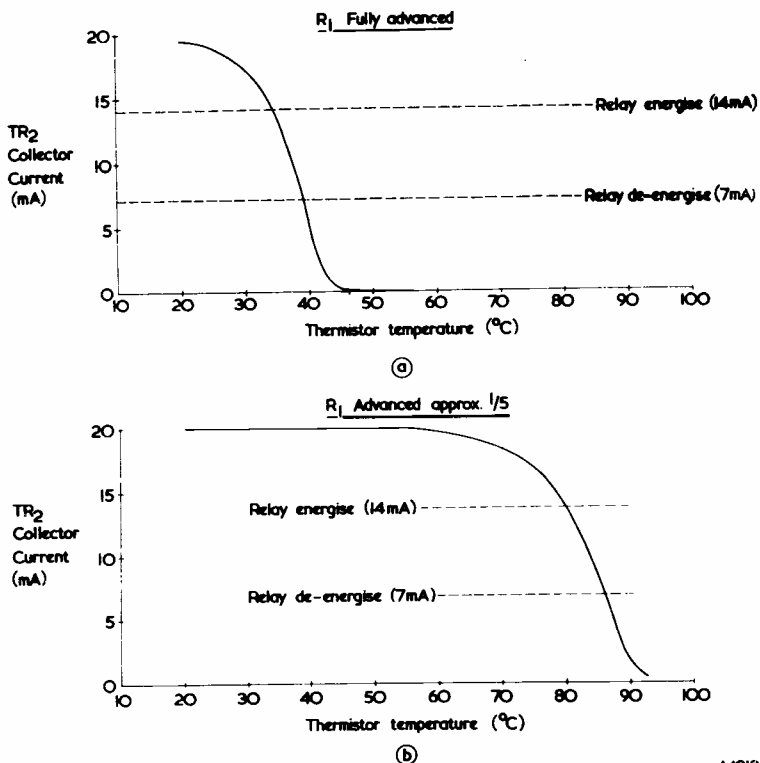

Fig. 2. Curves showing TR₂ collector current for temperatures in the range 20 to 95° C, as given by the prototype. The relay employed had two sets of changeover contacts

a coil resistance less than 500Ω be employed.²

Although not essential, it would

² A suitable relay, fitted with two sets of changeover contacts, is available from H. L. Smith & Co. Ltd., 287 Edgware Road, London, W.2.

be preferable to clamp TR₂ to a heat sink, the latter having the minimum dimensions of 1½ in square. The supply voltage should be reasonably well regulated, a desirable figure being better than ±2 volts on 12 volts.

Two-Tone Alarm Generator

Marconi Marine Radiotelephony Alarm Signal Generator

The two-tone radiotelephony alarm signal generator now being fitted in many British fishing vessels and small craft by The Marconi International Marine Communication Co., Ltd., has been type-approved by the British General Post Office and fulfils all the requirements of the C.C.I.R. (International Radio Consultative Committee) recommendations.

Although there will be some delay before all the authorities concerned bring appropriate regulations into force, the British Ministry of Transport has already made a strong recommendation that all United Kingdom ships carrying radiotelephony apparatus should be fitted with alarm generating equipment by 1st January, 1962.

Marconi Marine's alarm generator has been designed for speed and simplicity in operation: the operator starts up the associated transmitter, tuned to the international radiotelephone distress frequency of 2182 kc/s, switches on the alarm generator with the telephone handset clipped on to it, and pulls the alarm knob. The two-tone signal—alternating tones of 1,300 c/s and 2,200 c/s, each tone lasting for 250 milliseconds—is transmitted for approximately 30 to 60 seconds and the verbal distress message can then be transmitted by simply disengaging the handset and speaking into it.

The distinctive two-tone alarm signal is the result of exhaustive tests designed to discover a signal which will be heard through the normal traffic noise and atmospheric interference of intermediate frequency radiotelephony and above the normal noises of a ship's bridge.

The alarm generator unit is powered by the vessel's 24 volt battery supply and delivers twelve milliwatts into a 300 ohm loudspeaker which feeds the signal into the microphone of the handset and, at the same time, enables the signal to be monitored while transmission is taking place.

An Experimental

TRANSISTOR VHF RECEIVER

for the Aircraft Bands

By D. T. Bradford, VQ4EV

THERE HAS FOR SOME TIME BEEN A NEED FOR light weight v.h.f. equipment in some of the older aircraft, as are sometimes used by private flying enthusiasts. These aircraft are particularly mentioned because of their popularity, due to relatively low cost, and because there is usually a complete absence of storage battery electrical facilities and/or radio installation.

With an aged Leopard Moth in mind, the author set out to investigate the possibilities of useful transistorised equipment which could improve the safety of flying in the vicinity of crowded aerodromes. The fairly strong signals to be expected encouraged experiments using transistors alone. While the resultant receiver as it stands does not offer immediate applications for amateurs, a description is given as it is felt that the circuits used, and difficulties involved, may well prove of interest to those working in the 70 or 144 Mc/s bands.

The only transistors available at the time of these experiments which appeared to be suitable for use up to 120 Mc/s were the Ediswan type XA131 and four of these were purchased. These transistors are normally only recommended for use as amplifiers up to 100 Mc/s but it was resolved to attempt to squeeze them past this limit if at all possible. Very little other data could be found on these semi-conductors and all of the results have been achieved by pure experiment without manufacturer's data. Crystal control of the oscillator was considered essential because of the possible vibration, etc., to which any final model would be subjected.

Front End Circuit

As may be seen from the circuit diagram, an XA131 is arranged in a grounded base circuit amplifying at the signal frequency. The aerial is coupled into the input tuned circuit L_2 , C_3 , C_4 using a series tuned link L_1 , C_1 , C_2 , the signal frequency tuned circuit feeding the XA131 emitter via a bias-blocking capacitor C_5 from a low impedance tap in the coil.

C_3 is merely a small piece of tinfoil approximately $\frac{1}{4}$ by $\frac{3}{8}$ in soldered to a short supporting wire from the top of C_4 . The proximity of this small capacitance to chassis is sufficient to provide final adjustment to resonance of the input circuit, which in this case was required to give a reasonably broad response across the range 118.1 to 119.7 Mc/s.

The collector circuit of this first stage is also broad tuned by means of L_3 which is "squeeze tuned" to resonance in the centre of the required band. This coil feeds the following XA131 mixer via a blocking capacitor, C_8 , and a low impedance tapping. Bias for the XA131 mixer is fed from the usual potential divider through a series v.h.f. choke RFC₁ to minimise losses.

Local oscillator injection is fed into the mixer emitter from the multiplier chain, again using an r.f. choke, RFC₂, in series with the resistor R₇. Care should be taken to avoid stray coupling between the two r.f. chokes in this stage. The value of the emitter resistor was found to be quite critical, and reducing this much below the stated value of 4.7k Ω was found to increase the output at i.f. considerably, amplifying breakthrough, etc., but causing a serious drop into the noise level of the wanted converted signal.

Crystal controlled oscillator injection is obtained from a 23 Mc/s overtone crystal (chosen because it happened to be available!) using yet another XA131. A conventional tuned circuit in the collector of this stage feeds the base via a pair of capacitors, C_{19} and C_{20} , in an "impedance dividing" circuit to provide the necessary feedback at low impedance. The crystal is in series with this path and was found to oscillate readily on the overtone frequency. Several small plated crystals in the range 21 to 24 Mc/s were tried in this circuit, and all worked well as soon as the coil was resonated, there being no noticeable attempt to self-oscillate on detuning. Off resonance the crystal merely stops working after a very slight frequency pulling.

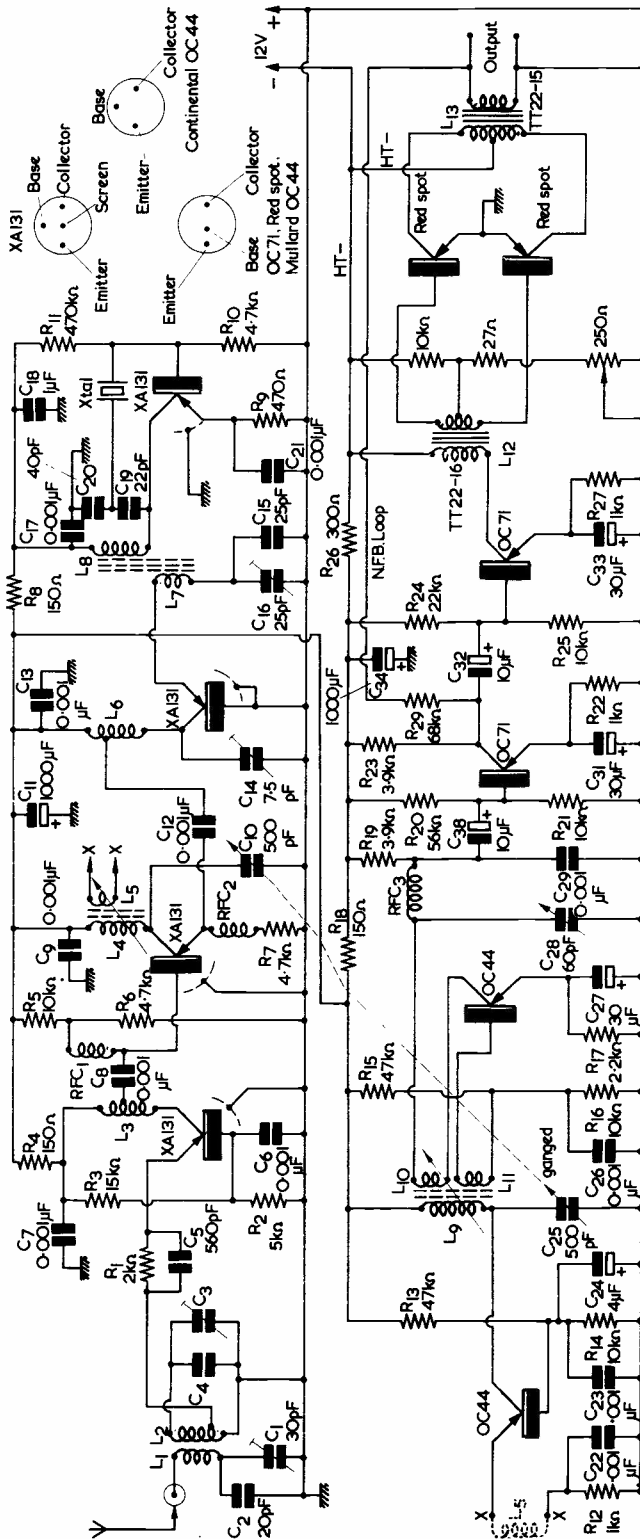

Circuit of the transistor v.h.f. receiver. The value of R₁₇ should be as high as possible consistent with sufficient feedback enabling the stage to gently oscillate over the tuning range

Brief attempts to use 5 Mc/s 10X crystals on their 5th overtone and FT.243 7 Mc/s units on their 3rd overtone proved fruitless, although no very serious efforts have so far been made to press them into use owing to their clumsy size for the present purpose.

The 23 Mc/s output from the overtone oscillator circuit is taken via a series tuned winding consisting of 5 turns of plastic covered wirewound on top of the oscillator winding, and tuned to chassis with a variable capacitor C₁₆ with C₁₅ as a padder. The 5th harmonic generating stage is operated in the grounded base Class C condition and gives best output at 115 Mc/s with no base bias whatsoever! Attempts to bias the base of this stage only reduced the output. The latter is taken from a low impedance tapping on a conventional tuned circuit L₆, C₁₄ via a blocking capacitor C₁₂, to the mixer emitter. Variable capacitance is used in this tuned circuit in order to reduce the amount of unwanted harmonics present, for to have a broad band characteristic here would only cause trouble.

The tuned circuit in the collector of the mixer is conventional and is tuned by a 500pF section of the two-gang variable capacitor, C₁₀. A low impedance winding on this coil, L₅, provides output for the next stage. All original experiments were carried out by feeding this low impedance output into the aerial terminals of an Eddystone S750 receiver, using the front-end as a crystal controlled converter only. When properly aligned, this "converter" circuit puts S9-plus signals into the S750 with the i.f. gain control set at minimum, the r.f. gain advanced by about one-third and audio gain at maximum. With these rough settings the background noise was just audible with the "converter" switched on.

The I.F./A.F. Section

Having obtained a "converter" capable of resolving signals of well below 10μV, the next step was to build some sort of receiver into which it could be fed. In the

interests of low consumption, sensitivity, and above all, cheapness, a t.r.f. circuit using a regenerative detector with a fair amount of audio amplification was selected. The high audio output is a requirement peculiar to aircraft use and is possibly unnecessary for an amateur portable application.

With an injection frequency of approximately 115 Mc/s, the Nairobi Approach frequency of 119.7 Mc/s appears at 4.7 Mc/s on the receiver, while the Tower frequency of 118.1, at 3.1 Mc/s, represented the lowest channel needed. Therefore a range of say 3–5 Mc/s would conveniently cover the required i.f. when using a 23 Mc/s crystal.

This section of the overall receiver consists of an OC44 grounded base amplifier following the XA131 v.h.f. mixer, and is fed on its emitter by the coupling coil L₅ which was previously used to couple into the S750. A suitable resistor and bypass capacitor is inserted at the earthy end of this coil. The output from the amplifier stage is taken, via a conventional tuned circuit using L₉ and the other half of the two-gang capacitor, C₂₅, to an OC44 functioning as a regenerative detector. This stage is operated in the grounded-emitter condition and signals are fed to its base via a low impedance coil, L₁₁. The collector of the detector stage is connected to L₁₀, which provides feedback controlled by C₂₈, a 60pF trimmer. RFC₃ and C₂₉ filter out any radio frequency signals which would otherwise reach the first OC71 audio amplifier. This feeds a second OC71 acting as a driver stage which in turn feeds a conventional transformer-coupled Class B audio amplifier using a pair of surplus red spot transistors. Negative feedback has been included from the loudspeaker output transformer winding, although for speech purposes this is probably an unnecessary embellishment.

Alignment and Adjustments

As mentioned earlier, the front-end is best tested first, on its own. Output from L₅ (X–X) is taken to the aerial terminals of a receiver covering the intermediate and oscillator frequencies. The receiver is tuned to the crystal oscillator frequency of 23 Mc/s and L₈ is adjusted for maximum stable output. This should sound S9 in the receiver with only the coupling as above.

After this the receiver is tuned to the intermediate frequency for the required channel (oscillator injection frequency being 115 Mc/s) and noise is peaked by adjusting L₄, C₁₀ to resonance. A fairly strong signal should be injected into the aerial socket to L₁ at the required signal frequency, and the following trimmers adjusted for maximum signal in this order:

C₁₄, C₁₆ are adjusted, followed by touching up L₈ and C₁₆ again for maximum signal.

L₃ is "squeeze-tuned" to resonance, also L₂ in

conjunction with C₃ and C₁. All are adjusted for maximum signal. By this time the front-end should sound lively and car ignition and/or aircraft signals should be audible when an aerial is connected in place of the signal generator.

Having ascertained that the front end is operating correctly, the i.f./a.f. section should be connected in place of the receiver. C₂₅, L₉, and regeneration control C₂₈ are now all adjusted for maximum signal on the wanted channel. The regeneration control will be found to cause some frequency pulling of the detector and final adjustments are best made on noise from a fluorescent lamp or other broad band source rather than from a signal generator.

Coil Winding Data

- L₁ 1 Turn 22 s.w.g. plastic covered introduced into earthy end of L₂ (same dia.).
- L₂ 7½ Turns 22 s.w.g. tinned copper. Self supporting 1 cm. long, 8 mm. i.d. (Tapped 1T from chassis.)
- L₃ 12 Turns 22 s.w.g. tinned copper. Self supporting 1.5 cm. long, 8 mm. i.d.
- L₄ 50 Turns 32 s.w.g. enam. copper on 7 mm. miniature Aladdin D.1 cored former.
- L₅ 9 Turns 32 s.w.g. enam. copper wound on top of L₄.
- L₆ 9 Turns 22 s.w.g. tinned copper. Self supporting 2.3 cm. long, 8 mm. i.d. (Tapped 2T from h.t.)
- L₇ 5 Turns 22 s.w.g. plastic covered on top of L₈.
- L₈* 10 Turns (approx.) on 7 mm. miniature Aladdin D.1 cored former. Close wound 32 s.w.g. enam. copper.
- L₉ 50 Turns on 7 mm. miniature Aladdin D.1 cored former. Close wound 32 s.w.g. enam. copper.
- L₁₀ 30 Turns 32 s.w.g. enam. copper on top of L₉.
- L₁₁ 9 Turns 32 s.w.g. enam. copper on top of L₉ and L₁₀.
- R.F.C._{1, 2} 27 inches 32 s.w.g. enam. copper close wound on body of any convenient resistor over 100kΩ.
- R.F.C.₃ 1.5mH single pi dust iron cored.

* The size of this coil was found to vary a few turns either way among the XA131's used. This coil will also of course depend on the crystal frequency being 23 Mc/s, and on small differences in the values of C₁₉ and C₂₀. In most cases the dust iron core should compensate sufficiently for such changes.

Because of this pulling effect it is recommended that at this stage all trimmers and coils are re-adjusted for maximum signal *several* times to ensure best results.

Points to Watch

The use of a preset regeneration control was found

to be unsatisfactory as the required amount of feedback varied considerably from channel to channel and a larger variable would be needed on anything other than a prototype model. Regeneration was found to be quite smooth provided that the emitter bias resistor R_{17} was not too low in value.

Insufficient bypassing of the h.t. supply to the early audio stages can cause modulation of the supply by the output transistors. This produces feedback, and a form of motor-boating can also occur. The latter seems to be due to frequency modulation

effects on the detector when the h.t. voltage swings as above, and is noticeable on very strong signals. Some form of a.g.c. would perhaps help with this trouble, but increasing the values of C_{11} and C_{34} to $1,000\mu\text{F}$ each also minimised this effect. It is important to remember that transistors are, by valve comparisons, very low impedance devices, and as such require equally low impedance power supply sources. The use of old batteries whose internal resistance has risen too far can cause endless trouble and the author has used "lantern" cells or "bell" cells for all test purposes to good effect.

CAN ANYONE HELP?

Requests for information are inserted in this feature free of charge, subject to space being available. Users of this service undertake to acknowledge all letters, etc., received and to reimburse all reasonable expenses incurred by correspondents. Circuits, manuals, service sheets, etc., lent by readers must be returned in good condition within a reasonable period of time

Transistorised DF Circuit.—W. N. Perioli, 22 Perch Meadow, R.A.F., Halton, Bucks, requires circuit of this loop or ferrite rod DF receiver.

* * *

Radio Altimeter, type RT-40/APN.IX.—A. L. Wakeman, 29 Islington Road, Southville, Bristol 3, has recently acquired this unit and is in need of the circuit diagram. Has any reader any conversion details for the 430 Mc/s amateur band or any other use?

* * *

R1155A Receiver.—R. Mouat, 22 Norfolk Road, Thornton Heath, Surrey, would appreciate any advice on this receiver.

* * *

Jason FM Tuner.—D. Byrne, G3KPO, Jersey House, Eye, Peterborough, Northants, would appreciate circuit and details of the Jason FM Tuner (original kit), and the T1131 VHF Transmitter.

* * *

Combination Tester Model No. 104 (?SC7051.A).—W. B. Glayzer, 126 Trenchard Avenue, R.A.F. Halton, Aylesbury, Bucks, wishes to buy, borrow or purchase any information concerning this tester and the meter, this latter being missing. The tester was manufactured by Espey Mfg. Co. Inc., of U.S.A.

* * *

The Radio Amateur's Handbook 1961.—J. Langford, 20 Eastlake Avenue, Parkstone, Dorset, would like to borrow this manual for two weeks only. Postage, carriage and hiring fee to instructions received.

* * *

Receiver type RL85.—4019253, Cpl. Peyton, W., Signals Workshop, R.A.F. Driffield, Yorks, is in need of the circuit diagram or any other information of the r.f. section of this receiver.

Bendix Receiver Unit type BC624.—J. A. Taylor, 16 Springfield Gardens, Lowestoft, Suffolk, wants to convert this unit to cover the 2 metre band and would appreciate any details from readers.

* * *

Original Senior HRO Receiver.—A. W. Mann, 62 Costa Street, Middlesbrough, wishes to purchase, or obtain on loan, the instruction manual or drawing of under-chassis showing values of components.

* * *

Ex-R.A.F. Indicator Unit Ref. AB/414.—P. J. Horn, 81 Brockley Rise, London, S.E.23, wishes to know if any reader can supply the circuit or service manual of this equipment, also any modifications to convert to general purpose oscilloscope. Willing to purchase information if necessary.

* * *

Wavemeter W1191A and AR88D Receiver.—J. Hudson, 68 Glebe Street, Great Harwood, Blackburn, Lancs, wishes to obtain any technical information on these equipments.

* * *

Ekco TU211 TV.—R. S. Waite, 17 Southdown Road, London, S.W.20, would like to borrow the service sheet or manual for this television receiver.

* * *

Philco Stereo Record Player Model 62.—J. Goodworth, 29 Chestnut Avenue, Oswestry, Salop, urgently requires the circuit diagram of this player.

* * *

R1147 Receiver.—P. W. Ellis, 354 North Road, Hull, requests tuning coil/capacitor modifications to cover any useful waveband.

* * *

R107 and R110 Receivers.—F. J. Lubbock, 12 Derwent Close, Cambridge, would like to receive the circuit diagrams and any other data concerning these two receivers.

A SIMPLE

Musical Instrument

By R. C. MARSHALL, M.A., Grad.I.E.E.

THIS ARTICLE DESCRIBES AN OSCILLATOR THAT WAS built as a child's toy, but has proved a useful musical instrument. It will play only one note at a time, but cannot produce a discord if two keys are pressed simultaneously. The keyboard covers the scale from middle B to top F. The basic instrument only consumes power from its battery when a key is pressed. If the vibrato oscillator is fitted, the consumption rises to about 10mA and an on/off switch is desirable.

oscillator is determined by the potential at point "A". Normally this is positive to the emitters and both transistors are cut off. Pressing a key connects the appropriate portion of the resistor chain, raising the potential as required, and oscillation commences.

The lowest frequency is obtained with "A" about 2½ volts negative to the emitter. At lower voltages the oscillator ceases to work as a multivibrator and produces a sinewave of higher frequency. Above this voltage, frequency is proportional to voltage,

Fig. 1. Circuit of the Simple Musical Instrument described by the author. The capacitors C₁ and C₂ should be adjusted on test (see text). All resistors are rated at ½ watt ±10%.

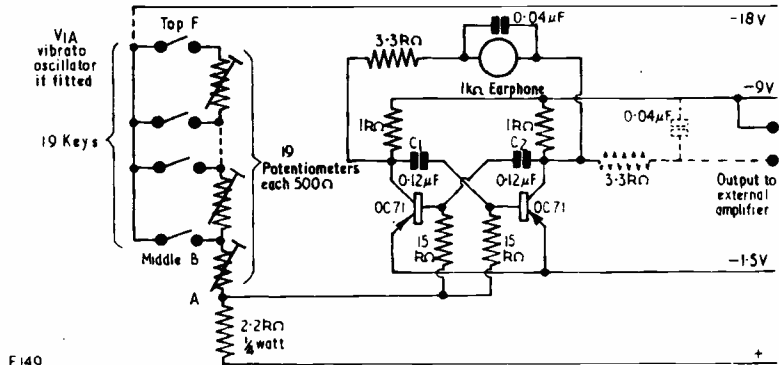

E149

The basic circuit, Fig. 1, is that of a multivibrator using two OC71 transistors. The output is connected to an earphone via a resistor-capacitor filter that reduces the harshness of the square waveform. To feed an external power amplifier, connection can be made between one collector and the -9 volt line as shown dotted in Fig. 1. The frequency of the

and is limited only by the battery voltage available. If it is desired to extend the keyboard beyond 19 notes a higher voltage is needed. Alternatively a switch can be arranged to double or halve the values of C₁ and C₂, to give a scale an octave lower or higher than the basic one. Frequency stability is good, as frequency depends largely on the ratio between the 9 volt and 18 volt supplies, which will not vary during the life of the battery. The use of transistors of lower leakage current, and a higher minimum voltage at "A", would improve the stability further.

The realism of the sound can be improved by adding vibrato, that is, modulation of the frequency or amplitude at about 10 c/s. A suitable oscillator is shown in Fig. 2. It is a "Twin T" oscillator using the transistor in grounded base, and frequency modulates the main oscillator by supplying a fluctuating voltage to the keyboard. The components shown give a frequency of about 12 c/s. This may be varied by changing C₃, C₄ and C₅, keeping their ratio constant. An OC72 is used as the output is

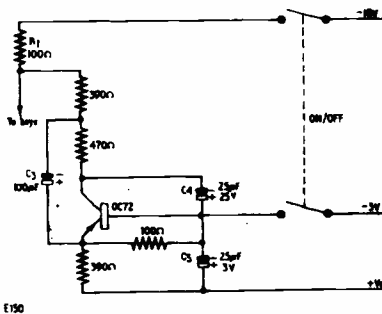

E150

Fig. 2. Circuit of the vibrato "Twin-T" oscillator. All resistors are rated at ½ watt ±10%.

"A Novel Single Transistor Oscillator" by E. T. Emms, *Electronic Engineering*, August 1960.

required at a fairly low output impedance. Variation of the 100Ω resistor R_1 will control vibrato amplitude, but as it affects pitch also, the potentiometer corresponding to the highest note must be reset.

The photograph shows the construction of the

meters. Longer bolts are used for the black notes, with nuts above and below so that the heads nearly reach the upper tier of springs. The heads of the bolts need cleaning occasionally. A proper keyboard from an old piano and a pair of relay contacts

View of the simple musical instrument constructed by the author

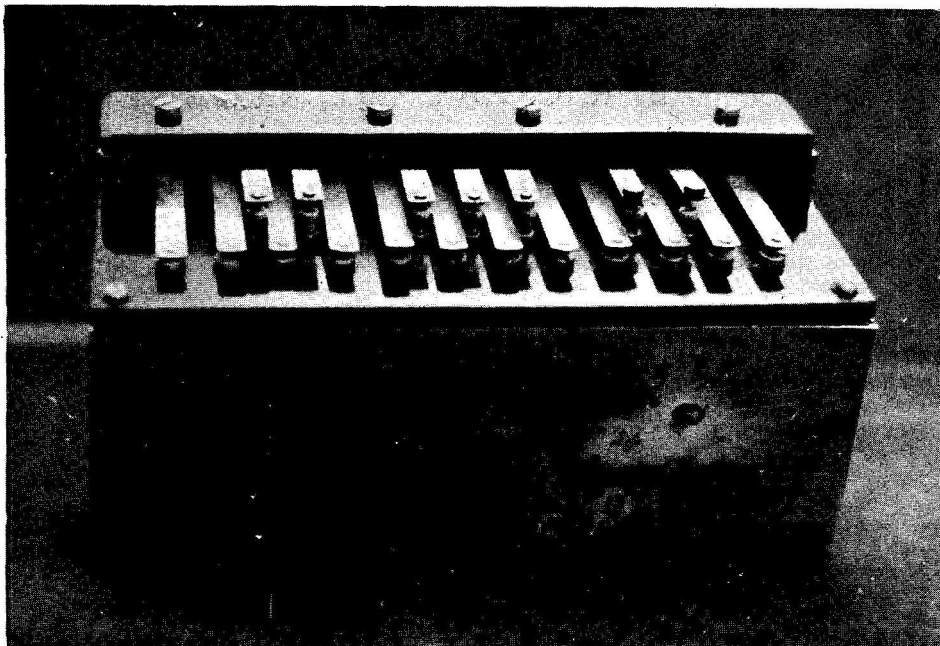

author's instrument, which, being intended for a small boy, is "narrow gauge". The keys are dismantled springsets from post office type relays, and they are clamped between strips of paxolin in two tiers, with the black notes on the upper tier. Two strips of tinfoil link all the keys together and thus to the 18 volt line or the vibrato oscillator. The baseboard is also of paxolin and carries cheese-headed bolts, with heads above, and solder tags and nuts below: These bolts act as fixed contacts for each key, and are connected to the preset potentiometer

for each note would be much better.

The adjustment procedure is as follows. Capacitors C_1 and C_2 are adjusted to bring the highest note within the range of its potentiometer, and then each lower note may be set in turn. This sequence is essential, as each potentiometer affects all lower notes. The vibrato oscillator can be stopped by disconnecting one of the capacitors. The frequencies can be set against an accurate oscillator, or they can be set approximately with an oscillator and adjusted into tune with a piano.

A Small High Quality Amplifier

By PETER J. L. BINNS, M.Sc.

THE AUDIO OUTPUT IN WATTS WHICH IS NEEDED to reproduce music realistically in a normal living room is a subject for argument. Many people will maintain that a minimum of 10-12 watts is necessary with ordinary moving coil loudspeakers, and the writer is inclined to agree with this view: but nevertheless the results which can be obtained with an output of only 4 watts are fre-

quently surprisingly good, provided that this 4 watts is delivered with very low distortion. The present amplifier design is suggested as fulfilling this requirement and is also both sensitive and economical. A pair of these small amplifiers for stereo use, employing a common power supply, can be built for a price not much greater than that needed for a conventional 10 watt monophonic push-pull amplifier

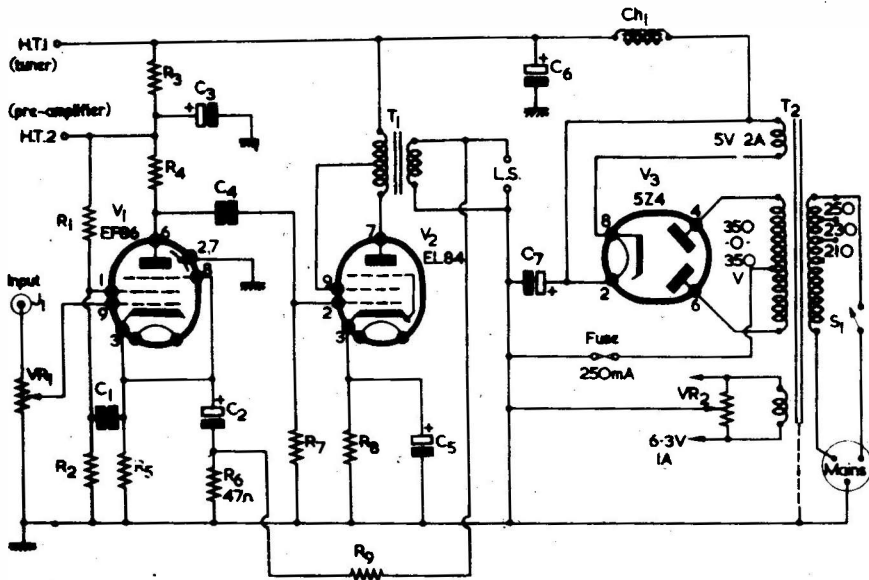

Fig. 1. The circuit of the amplifier

M216

The Output Transformer

The one component on which the quality of the amplifier depends is, as usual, the output transformer, and it is advisable not to try to economise on this. A nominal rating of 10 watts is suggested: the prototype amplifier used a 20 watt "C core" push-pull triode transformer (still quite small), and the excellent performance is no doubt related to this. There must, however, be many readers who have good quality output transformers rated at 10 watts or more, designed for push-pull triode operation but without the tapings necessary for ultra-linear circuits. Such transformers are excellent for the amplifier here described, as the centre tapping on the primary winding approximates closely to the 43% tap preferred for the ultra-linear operation of a single-ended output stage.

The writer has used the prototype amplifier in direct comparison with a Mullard 20 watt ultra-linear design using push-pull KT66 valves and giving a distortion of 0.05% and a damping factor of 50. The tests were conducted in a room roughly 18 x 12 x 10ft (i.e. not by any means the smallest of modern living rooms), and at full realistic listening volume the small amplifier was almost indistinguishable from the larger when both were operating a large three-speaker system. On exceptionally heavy passages of organ music, the deep bass occasionally lacked the clarity provided by the 20 watt amplifier, but this only at a volume level which even an organist described as "excessive"!

A perusal of the circuit diagram (Fig. 1) shows it to be fairly conventional. A low noise pentode V_1 is RC coupled to the output stage V_2 , the screen grid of the latter being fed from the centre-tap (ideally at 43% from the anode) to provide ultra-linear operation. Negative feedback is applied from

Components List

Resistors

(All $\frac{1}{2}$ watt unless otherwise specified)

- R_1 1M Ω
- R_2 1M Ω
- R_3 10k Ω 1 watt
- R_4 330k Ω high stability
- R_5 2.2k Ω
- R_6 47 Ω
- R_7 470k Ω
- R_8 150 Ω
- R_9 4.7k Ω
- VR_1 500k Ω log.
- VR_2 200 Ω wirewound, pre-set

Fuse

Cartridge, 250mA

Capacitors

- C_1 0.5 μ F 350 w.v. paper
- C_2 50 μ F 12 w.v. electrolytic
- C_3 16 μ F 450 w.v. electrolytic
- C_4 0.1 μ F 350 w.v. paper
- C_5 50 μ F 25 w.v. electrolytic
- C_6 16 μ F 450 w.v. electrolytic
- C_7 8 μ F 450 w.v. electrolytic

Valves

- V_1 EF86
- V_2 EL84
- V_3 5Z4

Transformers

- T_1 Output transformer (see text)
- T_2 Mains transformer 350-0-350V, 60mA, 5V at 2A, 6.3V at 1A

Choke

- CH_1 Approx. 20H at 60mA

the secondary of the output transformer to the cathode of V_1 , and the cathodes of both valves are bypassed to keep the overall gain as high as possible. The power supply uses a full-wave rectifier, and a smoothing choke is employed to keep hum to a minimum without needing large values of capacitances, though no doubt RC smoothing would also prove satisfactory. Provision is made for supplying power to both a preamplifier and an f.m. tuner, though if this is not required the size of the mains transformer can be correspondingly reduced. With the values given in the components list sensitivity is approximately 200mV for 4 watts output.

fixed to a small metal sub-chassis screwed to the wooden shell adjacent to the input jack and potentiometer VR_1 . The position of the remaining small components will be clear from the foregoing: small tagboards or strips are easily screwed to the wooden shell to support them as necessary.

A further unexpected virtue of this method of construction results from there being no definite metal chassis, and hence no opportunity to make indiscriminate earth connections to it! Instead, an earth bus-bar is run round the amplifier, starting at the input jack and extending finally to the mains input socket earth connection, and all other earth

Fig. 2. Diagram showing layout and position of the larger components. (See also text.) V_1 is mounted vertically on a small aluminium bracket, which also supports C_1 . V_2 is mounted below VR_2 on an aluminium bracket held between the output transformer and the choke. C_4 is not shown, being below C_2 and C_5

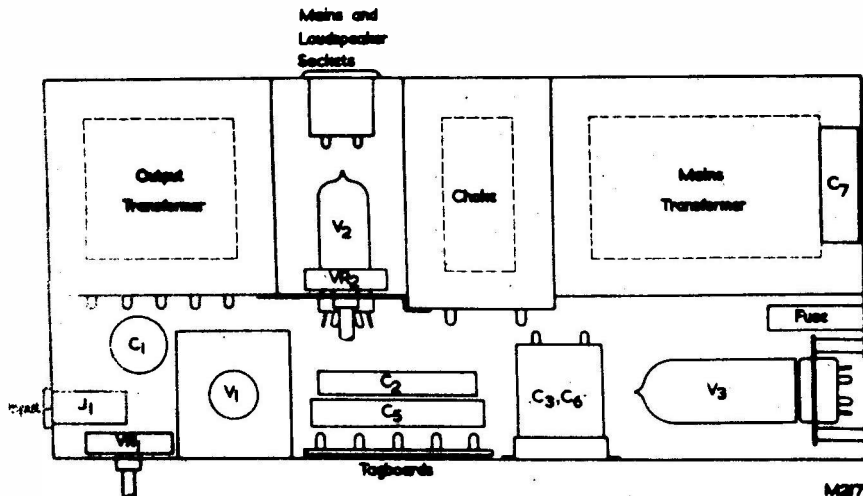

Layout

The layout of the prototype amplifier is somewhat unusual but has proved very satisfactory, being surprisingly compact and well protected. A conventional metal chassis is not used: instead, a rectangular wooden shell, open top and bottom, is used as the main framework (Fig. 2). On the rear wall are placed the three heavy components—mains transformer, smoothing choke, and output transformer, with a small gap between the latter two for the mains input and loudspeaker sockets. Also in this space are mounted horizontally the output valve and the “humdinger” potentiometer, VR_1 . The valveholder and potentiometer are fixed to a small metal subchassis, which is in turn secured to the “top” of the choke and output transformer.

The rectifier valve is also mounted horizontally, with the valveholder fixed to the shell with wood screws but spaced from it by means of spacers. There can be sufficient room to employ a large rectifier of the international octal class as is used in the prototype. A miniature of the EZ80 type could alternatively be used. It is advisable to solder the leads to the valveholder before mounting it in position. Above the valveholder is the reservoir capacitor C_7 (unless mounted as shown in Fig. 2). The EF86 (V_1) is mounted vertically, its base being

connections are made to this. To keep hum down to a minimum, only one earth connection is made to ancillary equipment (preamplifier, tuner, etc.) and this will normally be via the shielding of the coaxial input cable.

One word of repetition. To realise the full potentiality of this small amplifier, it is essential to use an output transformer of the highest quality, preferably rated at a minimum of 10 watts. After all, the design is still considerably simpler and cheaper than a genuine 10 watt amplifier! And it provides an admirable use for any available “push-pull triode” transformer without the ultra-linearappings.

Stereo Version

The design of a stereo version calls for no special comment: the circuitry of V_1 and V_2 will be duplicated, and the ratings of the power supply components increased accordingly. It is important that the output transformers are similar, and also that critical components such as anode load and bias resistors are closely matched. It is suggested that the input potentiometers be made concentric, but with separate operating spindles: in this way, an additional balance control becomes unnecessary. Other refinements such as channel reverse and

speaker phasing switches can be added if required, though it seems to the author that these things should be settled once and for all at the time of initial setting up, and then left alone!

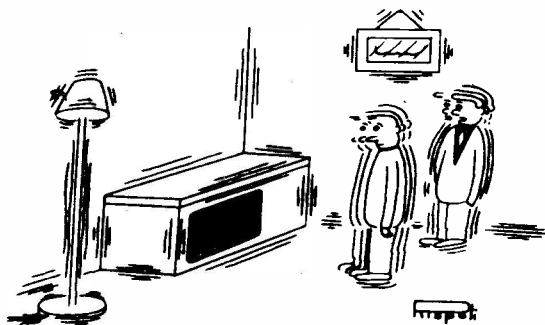

"That's some amplifier you've got there!"

In conclusion, do not be misled by the simplicity of the circuit. If you still think that 10 watts of undistorted sound are essential for real "hi-fi" reproduction, build this amplifier and see for yourself. You may be surprised!

NOTE: It should be pointed out that a single-ended output transformer normally has butt-jointed laminations (e.g. all the E's on one side and all the I's on the other) with spacing at the joint to prevent the formation of a complete magnetic circuit. The iron is thus less driven towards saturation by the constant d.c. in the primary. Push-pull transformers, on the other hand, normally have interleaved laminations (e.g. alternate E's and I's down the stack) because the steady d.c. currents in the primary cancel each other out. This fact also necessitates the use of a relatively large push-pull transformer in the single-ended circuit discussed here.

The output transformer ratio is experimental, but we would suggest a reflected anode load of some 4 to 5k Ω . The value of R_o may, also, require adjustment according to speaker impedance.—Editor.

TRADE REVIEW . . .

New Oryx Micro-miniature Soldering Tweezers

A revolutionary type of soldering instrument has been developed to meet the need for precision soldering in laboratories and on production lines with micro-miniature circuit modules, diodes, transistors, other semi-conductors, relays, etc.

Designed, developed and manufactured in the U.K. by Oryx Electrical Laboratories Ltd., the instrument is in the form of a pair of tweezers having $\frac{1}{32}$ in tips and separate heating elements to both tips. The quality long-life elements are as provided for the popular range of Oryx standard miniature soldering instruments and operate at up to 554° F. tip temperature from a 6 volt supply.

Incredibly light to handle and requiring only minimum finger pressure, these tweezers provide unobstructed view at all times for close precision soldering. An operator can hold work and give simultaneous heating on both sides of a circuit module with only one hand. It is claimed that heating times are considerably reduced and cold joints are virtually eliminated.

World-wide patents have been applied for and the introduction of these instruments in America

has been well received by the electronic, radio and television, electrical, jewellery and fancy goods industries where precision soldering of miniature and micro-miniature components is carried out.

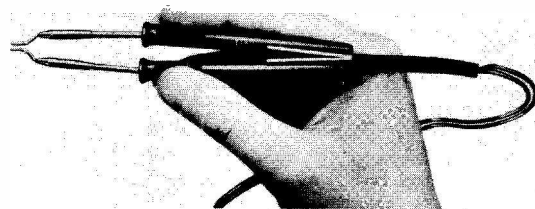

These soldering tweezers are being added to the standard Oryx range and are marketed in the U.K. by W. Greenwood Electronic Ltd., 677 Finchley Road, London, N.W.2.

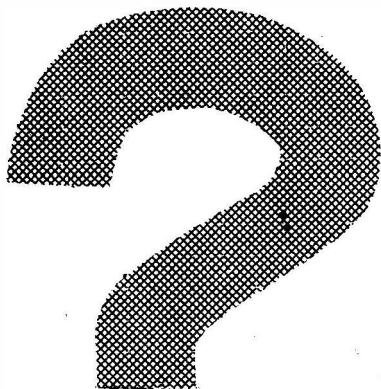

The sixth in a series of articles which, starting from first principles, describes the basic theory and practice of radio

part 6

understanding radio

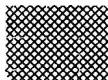

By W. G. MORLEY

IN LAST MONTH'S ISSUE, WE DISCUSSED THE RESISTOR colour code and introduced the subject of variable resistors. We shall now carry on to a further discussion of these components.

Mounting Arrangements

It is normally necessary for a variable resistor to be securely mounted on a chassis, a means being provided for rotating the shaft. The most frequently encountered mounting method employs a threaded bush and nut, as in Fig. 17 (a). The threaded bush is passed through a hole in a panel and is secured by a nut and shake-proof washer, as shown, or by a specially designed nut which has shake-proof properties of its own. A locating lug on the variable resistor fits into a second hole in the panel and prevents the whole assembly from being rotated out of position if excessive torque is applied to the shaft after it has reached the end of its travel.

An alternative method of mounting is shown in Fig. 17 (b). In this case the variable resistor is secured by two screws on either side of the shaft, these fitting into tapped holes in the housing. In some instances the holes may not be tapped, whereupon the housing is secured by self-tapping screws, or by normal BA (or similar) screws cutting their own thread in the material. Untapped holes of this type are encountered in plastic housings and normally have square sections, the corners of which offer space for the material cut away by the screw.

The bush mounting method shown in Fig. 17 (a) is employed generally with carbon-track variable resistors and with some wirewound variable resistors, whilst that of Fig. 17 (b) is employed most commonly with wirewound components.

Variable resistors of the type shown in Figs. 17 (a) and (b) usually have shaft diameters with a nominal dimension of 0.25 in. A knob may be fitted to such shafts with the aid of a grub screw, as in Fig. 17 (c). To ensure a more positive mechanical coupling between knob and shaft, it is normal to provide a *flat* on the shaft, as illustrated in Fig. 17 (d). The grub screw then tightens down on to this flat. When a flat is provided the knob may be affixed to the shaft by an inexpensive spring device instead of by a grub screw. Many present-day variable resistors are miniaturised (for use in transistor radios and the like) whereupon shaft diameters tend to be smaller than the nominal 0.25 in. just mentioned.

Some variable resistors need occasional adjustment only, and they may then be fitted with a slotted shaft, as in Fig. 17 (e). No knob is fitted, and the shaft is rotated by a screwdriver. Such components are described as *pre-set* variable resistors, (or *pre-set* potentiometers). Another variation is shown in Fig. 17 (f), in which a variable resistor having two-screw mounting is fitted with an integral knob. The latter may also have a screwdriver slot at the end, whereupon adjustments can be carried out either with the fingers or by screwdriver. Integral knob designs are normally

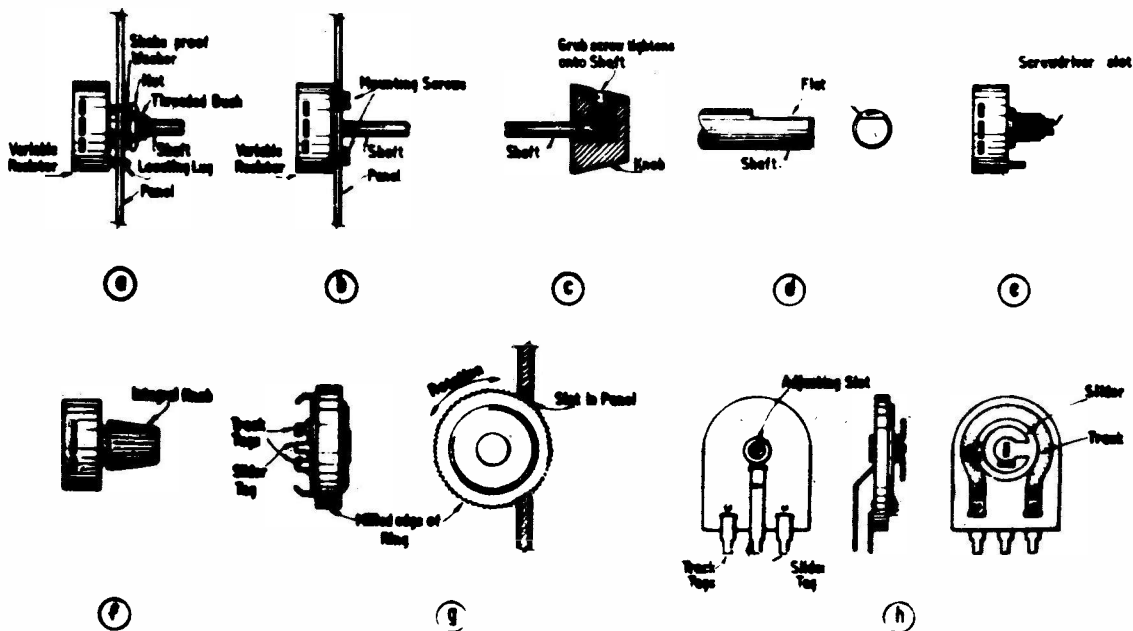

Fig. 17 (a). Variable resistors are commonly mounted by means of a threaded bush and nut
 (b). An alternative method using two screws
 (c). A knob may be secured to the shaft with a grub screw
 (d). Normally, the shaft is provided with a flat (e). A preset variable resistor
 (f). Some variable resistors have integral knobs, which may also have a screwdriver slot
 (g). A miniature variable resistor, which is adjusted through a slot in the front panel of the associated equipment.
 The whole ring, which forms the housing, rotates
 (h). A miniature variable resistor of the pre-set type

encountered with wirewound resistors only.

A miniature variable resistor of a type commonly fitted to transistor radios is shown in Fig. 17 (g). This component is mounted by its tags, these being soldered into position on a printed circuit board. The milled edge of the assembly protrudes through a slot in the case of the radio to enable adjustments to be made.

Another miniaturised variable resistor commonly encountered in this country and on the Continent is illustrated in basic form in Fig. 17 (h). This is again mounted by its tags, and it is a pre-set component.

The Slide-Wire

Some circuits need a variable resistor having an extremely low value of resistance. This requirement may be met by employing a track which consists, quite simply, of a length of resistance wire. Such a component is known as a *slide-wire*. Slide-wires are not used in conventional radio receivers, but are employed in measuring equipment.¹

¹ Apart from its low resistance, the slide-wire has the important advantage of having a low inductance (especially when compared with wirewound components), and this latter point may furnish the major reason for its being used in some equipment. We have not discussed inductance yet, but when we do so the reason for the low inductance of the slide-wire will become self-evident.

Tapered Tracks

A variable resistor may be manufactured such that the resistance between the slider and one end of the resistance element varies in direct proportion to the rotation of the shaft. Such a component is described as being a *linear* variable resistor, or *linear* potentiometer, or (in the case of carbon-track components) as having a *linear* track.

However, a large number of radio applications require that the resistance between the slider and one end of the element does not vary in direct proportion with shaft rotation. A typical instance would be given if the resistance between the slider and the starting end varied as the *logarithm* of rotation as the shaft was turned clockwise. Variable resistors in which resistance does not vary in direct proportion with shaft rotation are described as being *tapered*, or as having *tapered* tracks. The relationship between resistance and rotation is then referred to as the *law*, or *taper*, of the variable resistor. In practice, a large number of different laws are available, these having been designed for particular applications. That most frequently encountered in elementary radio work in this country is the *logarithmic* law which, in practical variable resistors, corresponds approximately to

the logarithmic relationship just referred to. Frequently, the abbreviation "log" would be used.

Tapered variable resistors are usually of the carbon-track type. Tapered wirewound variable resistors may also be encountered.²

Taps and Combinations

For certain circuit requirements, a variable resistor may have one or more taps made into the resistance element. Such taps are brought out to solder tags to enable external connection to be made.

Two (or more) variable resistors may be coupled together as in Fig. 18 (a) and (b). In Fig. 18 (a) the two resistors share a common shaft, so that both sliders rotate in unison as this is turned. The two variable resistors can then be described as being *ganged*. In Fig. 18 (b) the two variable resistors are not ganged because the sliders operate independently by means of concentric shafts. The outside shaft controls the forward variable resistor, and the centre shaft the rear variable resistor. Combinations of this nature have the advantage of allowing two variable resistors to occupy the same panel space as would normally be required by one. A very common combination is shown in Fig. 18 (c), in which a switch is fitted at the rear of a variable resistor. The switch is operated when the slider is at one end of the track.

² The word "linear", as applied to a variable resistor, defines a different characteristic than in the case of a "linear resistor" which follows Ohm's Law. See "Understanding Radio", part 3, October 1961 issue. The two usages are, of course, quite separate and would be obvious from their context.

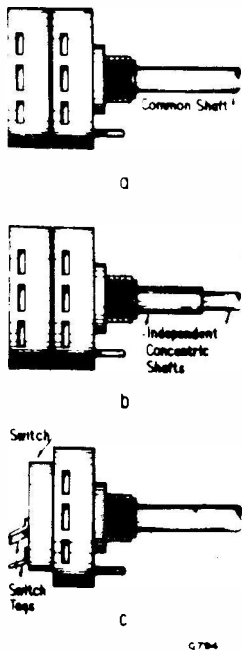

Fig. 18. Common variable resistor combinations. A ganged double variable resistor is shown at (a), and a dual combination with independent shafts in (b). In (c) a switch is combined with the variable resistor

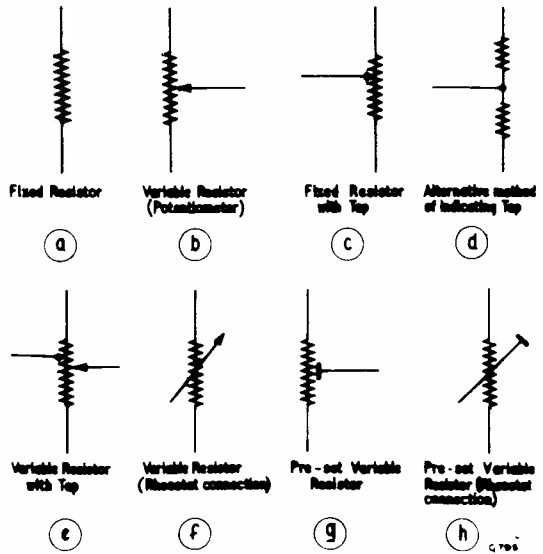

Fig. 19. Resistor circuit symbols. These are discussed in the text

Resistor Symbols

As we already know, a cell is shown in a circuit diagram by means of a symbol. So, also, are resistors. A fixed resistor is represented by the symbol shown in Fig. 19 (a), and a variable resistor by the symbol illustrated in Fig. 19 (b). In the latter diagram the arrow in the centre represents the slider, which could then move up and down the resistance element. If a fixed resistor has a tap this may be represented as in Fig. 19 (c). Alternatively, if the tap is fixed, two separate resistors may be drawn about the tapping point, as in Fig. 19 (d). A tap into the resistance element in a variable resistor is illustrated as shown in Fig. 19 (e). If a variable resistor is employed as a rheostat (i.e. with the slider and one end of the resistance element only in circuit) it may sometimes be presented as in Fig. 19 (f), the arrow drawn through the component indicating "variable". Pre-set variable resistors may be drawn as in Figs. 19 (b), (e) or (f), the fact that they are pre-set being indicated on the drawing or in the accompanying text; or they can be illustrated as in Fig. 19 (g). Occasionally, the symbol of Fig. 19 (h) for a pre-set variable resistor employed as a rheostat may be encountered.

It will be noted from Figs. 19 (g) and (h) that a change of function from "variable" to "pre-set" is indicated by replacing the arrow which indicates "variable" with a T-shaped symbol. As we shall see later when we come to consider other components, this is a general practice in circuit diagram presentation.

Individual resistors in a circuit diagram are normally identified by the letter R with a number suffix. A circuit with three resistors would, therefore, identify these as R₁, R₂ and R₃. The letter R may be applied to fixed and variable resistors alike,

although the latter are sometimes identified by the letters VR, also with a number suffix. Occasionally, variable resistors are identified by the letter P (for potentiometer).

Resistor Circuits

We have seen³ that when we connect two wires of equal resistance in series, the total resistance is doubled. In other words, the total resistance is equal to the sum of the two individual resistances. If we were to add another wire of equal resistance in series we would obtain three times the initial resistance, because the total resistance is now equal to the sum of the three individual resistances. This rule applies to all resistors connected in series: the total resistance is the sum of the individual resistances.

Fig. 20 (a) illustrates a 10Ω resistor in series with a 22Ω resistor. The total resistance is 32Ω. Fig. 20 (b) shows three resistors in series, these having values of 100kΩ, 220kΩ and 820kΩ. Once more, the total resistance is the sum of these, and it is equal to 1,140kΩ, or 1.14MΩ.

At the same time that we examined the effect of connecting two wires of equal resistance in series we also looked at the result of connecting them in parallel. In this case the total resistance is one half the resistance of each wire. If we connect a third wire of equal resistance in parallel, the total resistance becomes one third. This relationship is easy to understand if we consider it in terms of

the expression $R = \frac{E}{I}$. Obviously, three wires of

equal resistance in parallel allow three times as much current to flow as does a single wire. If E in the expression remains constant, multiplying I by three reduces R to one third of its initial value.

The formula for determining the total resistance of resistors in parallel is:

$$\frac{1}{R} = \frac{1}{R_1} + \frac{1}{R_2} + \frac{1}{R_3} + \dots$$

where R represents the total resistance, and R_1 , R_2 , R_3 , etc., the individual resistors.

³ In "Understanding Radio", part 2, September 1961 issue.

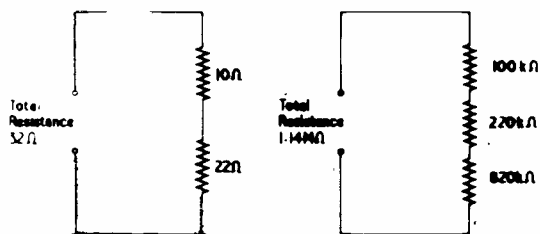
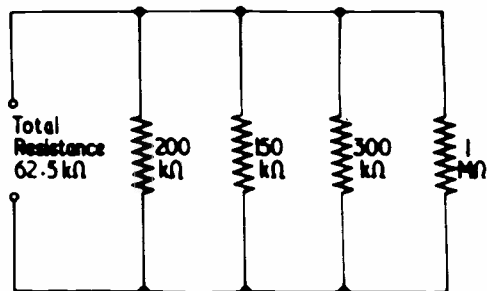
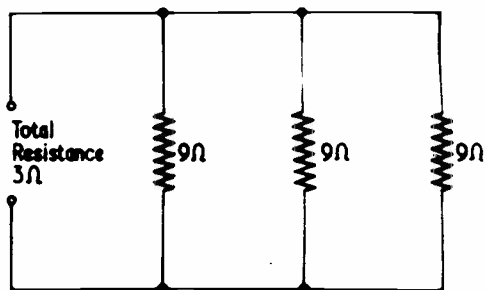

Fig. 20. Two series resistor combinations, showing also the total resistance



C 797

Fig. 21 (a) illustrates three 9Ω resistors in parallel. From our formula:

$$\begin{aligned} \frac{1}{R} &= \frac{1}{9} + \frac{1}{9} + \frac{1}{9} \\ &= \frac{3}{9} \\ \therefore R &= \frac{9}{3} \\ &= 3\Omega. \end{aligned}$$

As we would expect, the total resistance is a third of the individual equal resistances.

In Fig. 21 (b) we have four resistors in parallel, these having unequal values. In this case, and working in units of kΩ, we have:

$$\begin{aligned} \frac{1}{R} &= \frac{1}{200} + \frac{1}{150} + \frac{1}{300} + \frac{1}{1000} \\ &= \frac{15 + 20 + 10 + 3}{3000} \\ &= \frac{48}{3000} \\ \therefore R &= \frac{3000}{48} \\ &= 62.5k\Omega. \end{aligned}$$

The total resistance is 62.5kΩ.

The formula we have just considered may also be expressed as:

$$R = \frac{1}{\frac{1}{R_1} + \frac{1}{R_2} + \frac{1}{R_3} + \dots}$$

which is merely another way of saying the same thing.

If only two resistors are connected in parallel, the formula may be simplified to:

$$R = \frac{R_1 R_2}{R_1 + R_2}$$

Most beginners will probably find it convenient to work to the formula for parallel resistors given first, as this is easiest to remember and covers all cases.

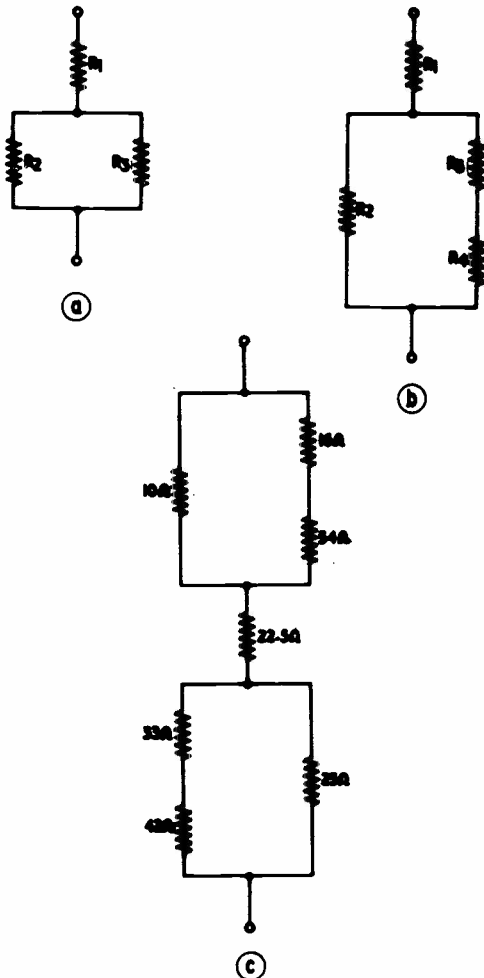

Fig. 22 (a) and (b). Two series-parallel resistor combinations

(c). A series-parallel combination, the total resistance of which is 50Ω

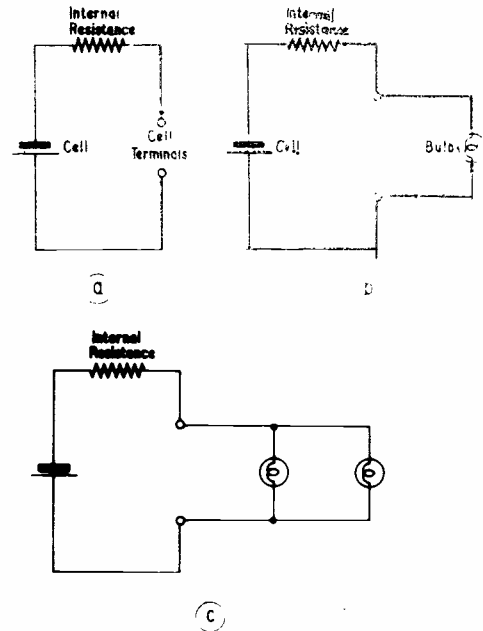

Fig. 23 (a). The internal resistance of a cell may be shown as a separate resistor (b) and (c). Showing the effect of increasing the current flowing through the internal resistance of a cell

Series-Parallel Combinations

Combinations of resistors in series and parallel are frequently encountered in radio work, typical examples being given in Figs. 22 (a) and (b). To find the total resistance of such combinations it is necessary to work in separate steps. Thus, in Fig. 22 (a), the total resistance of R_2 and R_3 in parallel must first be determined, this then being added to the resistance of R_1 . In Fig. 22 (b) there are three steps. First, the total resistance of R_3 and R_4 in series must be calculated. This total resistance is then considered as a single resistance in parallel with R_2 , whereupon the combined resistance of the parallel combination is determined. This last figure is then added to the resistance of R_1 to give the total resistance.

Fig. 22 (c) gives a series-parallel combination of resistors, with values, the total resistance of which readers may care to calculate on their own. This total resistance is 50Ω .

Internal Resistance

We have up to now looked upon cells, and batteries made up of cells, simply as devices which are capable of providing an e.m.f. This does not, however, provide a full picture.

When we apply a source of electromotive force to a conductor there is a flow of electric current. Electrons leave the negative terminal of the source of electromotive force and a similar quantity enter at its positive terminal. Thus there is a flow of current through the source itself. In practice,

we might employ a cell as the source of electro-motive force, whereupon we would find that this cell offered a resistance to the flow of electric current. Resistance is present in just the same manner as it is present in any conductor: it is impossible to have a perfect conductor of electricity.

The resistance in a cell is known as its *internal resistance*, and it may be represented in a circuit diagram as a separate resistor in series with the cell as in Fig. 23 (a), the cell itself now being assumed perfect. Because of the presence of internal resistance, the e.m.f. on the terminals of a cell drops as the current which flows increases. This is an effect which can be easily verified. If we connect a flash-light bulb to the terminals of a small partly exhausted flash-light battery (dry Leclanché) the bulb will light up in normal manner. See Fig. 23 (b). If we add a second similar bulb in parallel to the first, as in Fig. 23 (c), the brightness of the first bulb will noticeably drop. This is because the additional current flowing through the internal resistance of the battery causes a larger e.m.f. to appear across it, and a smaller e.m.f. to be available for the bulb. This particular effect is especially noticeable with a small partly exhausted dry Leclanché battery because, in general, the internal resistance of such a battery increases as its size decreases; also the internal resistance of a dry battery of this type tends to increase as it becomes exhausted.

It was stated earlier⁴ that cells are not normally connected in parallel to increase current capability unless they are identical, or nearly identical, in electrical performance. The reason for this now becomes apparent. Fig. 24 (a) illustrates three cells in parallel, each having its own internal resistance. If all the internal resistances are equal each cell is capable of providing its fair share of current to an external circuit. If, however, the internal resistance of one cell is higher than the others it will not be capable of providing the same current, and an unfair burden of the total current is carried by the remaining two cells. When cells are connected in series, as in Fig. 24 (b), the situation is somewhat different. In this case all the individual internal resistances add up to a single overall resistance (Fig. 24 (c)), which can then be described as the internal resistance of the

battery. In this case all cells must provide the same current and dissimilarities in internal resistance (provided they are not exceptionally great) do not detract from the overall performance of the battery.

Sources of e.m.f. other than cells and batteries also have unavoidable internal resistances, and these may similarly be expressed in the form of series resistors.

Two new points of terminology may now be introduced. Fig. 23 (a) shows a cell with its internal resistance in series with the terminals. The e.m.f. at these points is known as the *terminal e.m.f.* Obviously, terminal e.m.f. falls as current increases.

It was stated just now with reference to Fig. 23

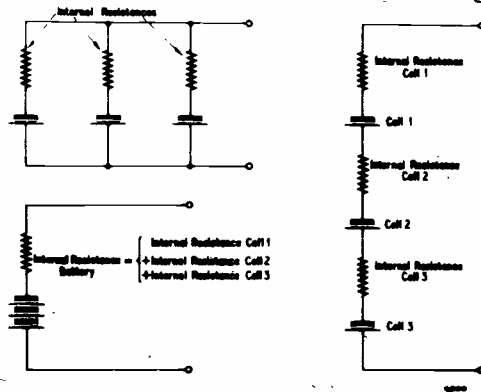

Fig. 24. Illustrating individual internal resistances when cells are connected in series or parallel. The effect of the internal resistances is discussed in the text

that increased current flowing through the internal resistance caused a larger e.m.f. to appear across it, and a smaller e.m.f. to be available for the external circuit (in this case a bulb). This statement could have been condensed by saying that the increased current caused a larger *voltage drop* across the series internal resistance, the fact that less voltage was available for the external circuit being then understood. The term "voltage drop" may be applied to any form of resistance which performs the same function.

Next Month

In next month's issue we shall deal briefly with a few remaining aspects of resistance, and shall then carry on to capacitance.

⁴ In "Understanding Radio", part 2.

THIRD PYE I.L.S. FOR CZECHOSLOVAKIA

Pye Telecommunications Limited of Cambridge, England, announce that a Pye Instrument Landing System has been ordered by the Czechoslovakian Government for installation at Bratislava International Airport.

The Instrument Landing System will be the third supplied by Pye to Czechoslovakia, the previous two installations being at Prague International Airport.

This Pye contract brings the value of I.L.S. and ancillary equipment supplied by the Company to Czechoslovakia to over £100,000.

The latest contract covers additionally the supply of transistorised radiotelephones for use on Czechoslovak airfields.



This month Smithy the Serviceman and his able assistant Dick tackle their first job for 1962. They also experience their first taste of the rigours of winter!

"A HAPPY," CALLED OUT DICK, as he entered the Workshop, "and preposterous New Year to you, Smithy!"

Smithy the Serviceman looked up, and Dick was surprised to see that he was sporting a full day's stubble on his normally immaculate chin.

"Blimey," remarked Dick, regarding the Serviceman closely. "You must have had a session last night!"

"Nothing of the sort," replied Smithy indignantly. "I had a very quiet and sedate New Year's Eve."

"Well, why the beard?" persisted Dick. "Are you trying to wangle a staff job on the Committee of 100?"

"The reasons why I haven't shaved this morning," said Smithy, with dignity, "are twofold. If I were superstitious, I might add that they augur ill for the coming year. When I woke up this morning I found, firstly, that my electric razor had broken down. Secondly, when I got the old cut-throat out, I found that our pipes had frozen!"

"Already?"

"Our pipes, Dick," said Smithy wearily, "are the most sensitive pipes in the British Isles. It only needs a touch of frost and they freeze up solid."

"Yours doesn't sound a very desirable residence to me," commented Dick.

"It isn't a bad old dump, really," conceded Smithy, "but it just wasn't meant to be left out in the open. If, for instance, we have

what other people would look upon as a gentle breeze, our roof is immediately denuded of slates. They come off one after the other, just like peas out of the pod."

"There *have* been some gales recently," commented Dick, suspecting this statement. "How many slates did you actually lose?"

Smithy chuckled.

"Perhaps I'm exaggerating a little," he said. "But we did find one in the gutter and another one ready to go. Anyway, we'd better get on with a little work right now, and I'll have a shave later on over at the sink. Perhaps you could put the kettle on."

Dick looked a little hurt.

Haven't you forgotten something?"

"Forgotten something?" questioned Smithy, frowning. "I don't think so. Oh yes, I have too! A happy New Year to you as well, Dick."

F.M. Receiver

Satisfied, Dick walked over and filled the kettle whilst Smithy started work on his first receiver for 1962. The Workshop soon settled into its normal industrious rhythm, with Smithy and Dick quietly occupied with their respective tasks.

But not for long.

"Well, that's queer."

Smithy, wise with the years, let Dick's remark go unheeded.

"Yes, that's a very queer thing."

Smithy ignored this further comment, and concentrated on his own

receiver.

"This is a *most* queer effect."

Smithy sighed and looked at his watch. If matters pursued their normal course, Dick should be finally calling out for assistance within five seconds.

"Smithy!"

"Four seconds," muttered Smithy to himself with sombre satisfaction. He liked his predictions to come out accurately.

"What did you say?" called out Dick suspiciously.

"Oh nothing," said Smithy, hastily. "What do you want, anyway?"

"There's something queer happening with this f.m. receiver I've got here" replied Dick. "Could you come and have a look at it?"

"What's the trouble?" asked Smithy, as he wandered over to Dick's bench.

"It's an f.m. set, and it's responding to a.m!"

"More details please."

"Well, I'm pumping an amplitude modulated signal into the i.f. strip at 10.7 Mc/s," stated Dick, "and it's coming out of the speaker!"

Smithy glanced at the signal generator Dick had coupled to his receiver.

"Even if the receiver were in perfect order," he remarked, "I wouldn't be too surprised at an effect like that. You happen to be using a relatively inexpensive a.m.-only signal generator, and quite a few of these give a small amount of frequency modulation as well. So you might well hear a weak tone from the speaker."

Dick looked disappointed.

"Then that particular effect won't have anything to do with the trouble I'm experiencing," he remarked moodily. "I suppose I'll have to look somewhere else now!"

"What is the trouble anyway?"

"This set came in as 'weak reception,'" replied Dick. "And, when I tried it out I could only just get our two local stations with the volume turned fully up. Even so, there was quite a lot of background hiss behind them. I then thought that the set wasn't limiting properly, and that my experience with the a.m. signal genny had confirmed this."

"I shouldn't be too sure about diagnoses like that," commented Smithy. "When the signal is as weak as that, it may well mean that the only circuit which can do any effective limiting is the ratio detector itself. If there is a limiting i.f. amplifier it probably wouldn't have enough signal to limit on."

Dick looked puzzled.

"Why do you refer to the presence of a ratio detector so confidently? This set could just as easily have a phase detector or any other f.m. detector."

"Not in this country, it couldn't," replied Smithy firmly. "Ratio detectors are just about standard equipment in domestic f.m. receivers."

"I suppose you're right," conceded Dick. "At any rate there's an electrolytic capacitor sitting in the detector wiring, and ratio detectors need electrolytics if they're going to work."

"We'll go into that at a later date," said Smithy. "What have you done up to now?"

"One of the first things I did," said Dick, "was to insert my finger into the works, applying it, therein, to the a.f. triode grid. I was rewarded with a good loud 'um from the speaker."

"And then?"

"I next followed," said Dick, "some advice which has been given much publicity recently. I pulled my finger out!"

"Which is," approved Smithy, "a good servicing gambit. So we can now say that the a.f. stages seem to be in pretty reasonable shape."

"That's right," said Dick. "I next turned my attention to the i.f. stages, whereupon I encountered the queer business with the a.m. and f.m. we've just been talking about."

Smithy frowned.

"Have you checked the valves?" he asked. "It would be foolish to start serious work without swapping

bottles."

"Oh I've done that," said Dick. "None of the new valves gave any improvement, and so I've left all the old ones in."

"Good show," approved Smithy. "It's always a sensible thing to do the easy tests first, even if it's unlikely that they'll reveal the cause of the trouble. What about voltage tests?"

"I haven't done any yet."

"Well," said Smithy, "I think that these are the next thing to do, rather than start playing around with the signal genny. Have you got the service manual out?"

Dick looked uncomfortable.

"I was just getting around to that."

Smithy frowned.

I.F. Stages

Dick quickly obtained the manual and passed it over to the Serviceman. As usually occurred, the latter had become completely absorbed in Dick's fault; and he was now firmly seated on Dick's stool with test prods at the ready. Smithy opened up the manual and laid it on the bench so that they could both look at the circuit of the receiver.

"Ah," he said, "it seems nice and straightforward. A double triode r.f. amplifier and mixer in a separate tuner unit to handle the signal frequencies; after which we get a two-pentode i.f. amplifier and a triple diode triode ratio detector and a.f. amplifier (Fig. 1). Nothing much to be scared of

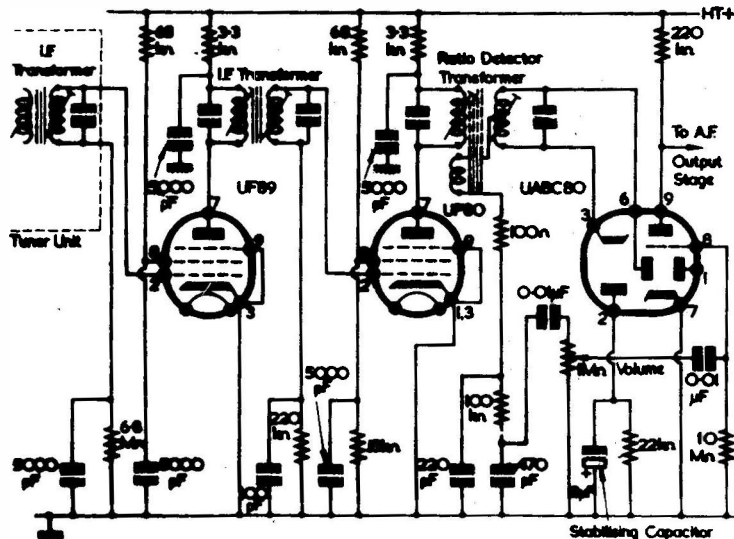

Fig. 1. The i.f. and detector circuits in the f.m.-only receiver serviced by Dick and Smithy. Component values are representative of commercial practice

"I can appreciate," he remarked, "your pressing on with a.f. grid tests and valve changing without the manual, but I can't see much sense in proceeding further. You've already been guessing about the ratio detector, and without the manual you'll be guessing also about any other tests you carry out."

"We don't have manuals for all the sets we service," protested Dick.

"I know we don't," replied Smithy, "and that often means that we have to spend longer on them. Anyway, I'm certain we've got a manual for this set, so let's have a look at it."

here."

Smithy applied his test prods.

"Tuner unit anode voltage seem to be O.K.," he remarked, "so let's tackle the i.f. amplifier. The h.t. rail voltage is around 180, and the first i.f. anode is reading 155 volts. There's a 3.3k Ohm anode decoupling resistor, so this means that the anode's drawing some 7 or 8mA. Which is quite a reasonable figure."

"That's a pretty quick mental calculation for the current, isn't it?" commented Dick. "Dash it!

all, I have to start with $R = \frac{E}{I}$ before

I can even think of current. And

even then I need a bit of paper to get the I over to the left-hand side!"

Smithy looked surprised.

"Oh, I never bother with that sort of thing when working out currents from voltage and resistance," he said. "All you have to remember is that 1 volt across $1k\Omega$ gives you $1mA$. Here we have 25 volts dropped across an anode decoupling resistor of $3.3k\Omega$. Now, 25 volts across $1k\Omega$ is obviously $25mA$; and across $3.3k\Omega$ it would be slightly less than a third of this figure. My guess was some 7 to $8mA$. And that's near enough for the present job."

"What's the anode voltage on the second i.f. pentode?"

Smithy applied his test prods.

"It's 165 volts," he announced.

"That's 15 volts dropped across another $3.3k\Omega$ resistor," announced Dick. "Let's see now! 1 volt across $1k\Omega$ is $1mA$, 15 volts across $1k\Omega$ is $15mA$, so 15 volts across $3.3k\Omega$ would be slightly less than a third of $15mA$. Would the anode current be around $4mA$?"

"Near enough," confirmed Smithy.

Dick thought for a moment and then a sudden gleam came into his eye.

"Well, there it is," he exclaimed.

"What?"

"Why, the fault of course," said Dick excitedly. "We have two pentodes, and one draws only half the anode current of the other."

"So?"

"They've both got $3.3k\Omega$ anode dropping resistors," continued Dick impatiently, "and if you look at the circuit you'll see that both cathodes go straight down to deck."

"Go on."

"Well, it's obvious!" rushed on Dick. "Something in the circuit is causing the second pentode to draw less anode current."

"You're perfectly right there."

Dick examined the circuit in greater detail.

"Both grids go to chassis via parallel resistors and capacitors," he continued, "so they're the same. Both suppressors are tied to cathode. And," concluded Dick triumphantly, "both screen-grids go up to h.t. plus via $68k\Omega$ droppers."

"You have forgotten to point out," concluded Smithy gently, "that the screen-grid of the second pentode goes to chassis via a $15k\Omega$ resistor."

Dick looked more closely at the circuit, and his finger traced the connections from the screen-grids down to the chassis line. There was silence for a moment.

"Well," he said eventually, "I

suppose you *could* say that the screen-grid voltage on the second pentode must be lower than that on the first, and I suppose you *could* say that this would make the second pentode anode current less."

"I like the way you say you *could* say these things," protested Smithy. "You jolly well *should* say them, because they happen to be true! I'll measure the screen-grid voltages right now just to see what they really are. The first one is 80 volts and the second one is 30 volts. Does that satisfy you?"

"O.K. Smithy," said Dick, looking slightly abashed. "I was rather jumping the gun, I suppose."

"I'll say you were," confirmed Smithy.

He stroked his chin absent-mindedly, and suddenly realised that it was covered with stubble.

"Dash it all," he remarked, "I haven't had my shave. Is that kettle boiling yet?"

"I'd forgotten all about it," confessed Dick.

He walked over to the battered Workshop kettle, which was now giving off steam furiously and picked it up. Its weight caused him to open the lid and look inside, whereupon he turned a somewhat doleful face to the Serviceman.

"Sorry Smithy," he remarked. "But it's nearly boiled dry. I'll have to fill it up again."

Limiting

Smithy shrugged.

"Not to worry, lad," he remarked.

"It's just in the nature of things today. My main hope is that our pipes at home will have got unfrozen by the time I get back tonight. It's most inconvenient being without water. Particularly on a Monday."

"What's so special about Monday?"

"Monday's my bath-night."

"Do you only have one bath a week, then?" asked Dick, interestedly.

"Of course not," said Smithy defensively. "I have another one on Thursdays as well."

"I suppose that's all right," commented Dick critically.

"Of course it's all right," said Smithy irritably, "What's wrong with having two baths a week?"

"Nothing really," said Dick. "After all you don't do a *dirty* job, do you?"

"I wish you'd stop discussing my personal hygiene in this way," said Smithy, vexedly. "I have two baths a week and that's that."

"O.K. Smithy."

"But I will admit it's a darned

nuisance if I have to go without one tonight."

"You can always," suggested Dick, "dust yourself down with D.D.T."

Smithy turned a furious glance on his assistant.

"I shall dust *you* down in a minute," he glowered. "Now let's change the conversation."

"Fair enough, Smithy," said Dick equably.

There was quiet for a long moment whilst Smithy's ire slowly evaporated. Dick maintained his innocent expression throughout this period. But only just.

"Where were we?" growled Smithy.

"We'd realised that the second pentode anode current was lower than the first because it had a lower screen-grid voltage."

"You'd realised, you mean," grunted Smithy. "Oh well, I suppose I might as well get on and finish off this job. I'll check the voltages on the control grids next. This is not because I have much certainty that there's anything wrong there but because I've got the test prods handy."

Smithy applied the test prods and noted the meter readings.

"As I thought," he nodded.

"They're both reading slightly negative of chassis, which is to be expected because they are both connected to chassis via high resistances. The negative voltage is, of course, contact potential."

"*Might* there have been some other voltage on those grids?"

"It's conceivable," said Smithy, "zero volts would have indicated a possible short between grid and chassis, and a positive voltage might have indicated a leak to h.t. via, say, the previous i.f. transformer. If there'd been a high negative voltage it could mean that a high level of r.f. was getting to the grid because of oscillation somewhere, whereupon the grid would bias itself back by leaky-grid action. All these possibilities are a bit far-fetched but they could happen nevertheless. And it only took a second to measure the grid voltages anyway."

"Where do you get the leaky-grid action from?" asked Dick. "There are no grid leaks or grid capacitors."

"Yes, there are," replied Smithy. "They're the ones on the other side of the i.f. secondaries."

He scribbled a circuit on Dick's pad.

"Now the normal leaky-grid circuit," said Smithy, "is like this (Fig. 2 (a)), whilst the pentode grid circuits in our receiver are like this (Fig. 2 (b)). If you re-draw

the latter you'll see that the grid and cathode rectify in familiar manner. (Fig. 2 (c)). The diode given by the grid and cathode rectifies the r.f. from the coil, causing the capacitor plate connected to cathode

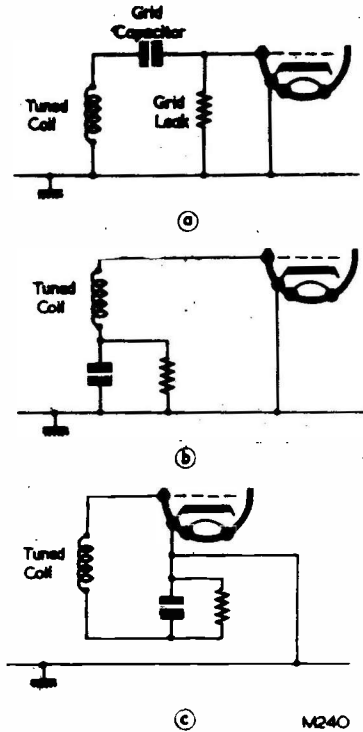

Fig. 2 (a). A conventional leaky-grid circuit

(b). In this diagram, the resistor and capacitor are transferred to the chassis end of the coil

(c). The components of (b) rearranged. The grid and cathode form a diode, and the capacitor charges to the peak value of the r.f. voltage appearing across the tuned coil. The upper plate of the capacitor is positive

to go positive. The other plate goes negative and therefore biases back the grid by a voltage equal to the peak value of the applied r.f."

"Oh, I see," remarked Dick. "It's just the same effect as if they were connected in the more usual circuit. Why do both valves use this circuit anyway?"

"The second pentode," explained Smithy, "is a limiter. It has a short grid base—that is, the valve cuts off at a low negative grid voltage—by reason of the reduced

screen-grid voltage which we have already discussed. High amplitude i.f. signals applied to the grid cause this to bias back so much that only the peaks affect anode current (Fig. 3 (a)). This biasing back is affected by the 220kΩ resistor and the 100pF capacitor sitting at the chassis end of the i.f. transformer secondary as we've just seen. The tuned circuit between anode and h.t. positive now responds only to the peaks. Since the pentode grid is fed with peaks it is not concerned with input amplitude, and amplitude modulation cannot therefore affect the tuned circuit in the anode. You may note that the time constant of the 220kΩ resistor and 100pF capacitor is only 22 microseconds, so that these two components will keep the input

peaks at the pentode grid in their proper place for amplitude changes up to several hundred microseconds at least."

Dick threw an admiring glance at the Serviceman.

"You are in form today on the mental arithmetic," he remarked. "Where do you get the 22 microseconds and the 'several hundred' microseconds from?"

"Well, I've used a few short cuts again," said Smithy. "First of all, the time constant in seconds of a C R circuit is microfarads multiplied by Megohms. A picofarad is a millionth of a microfarad, so Megohms times picofarads gives you time constant in microseconds. In this case the resistance is 220kΩ, which is 0.22MΩ; so that the time constant is 0.22 times 100. That

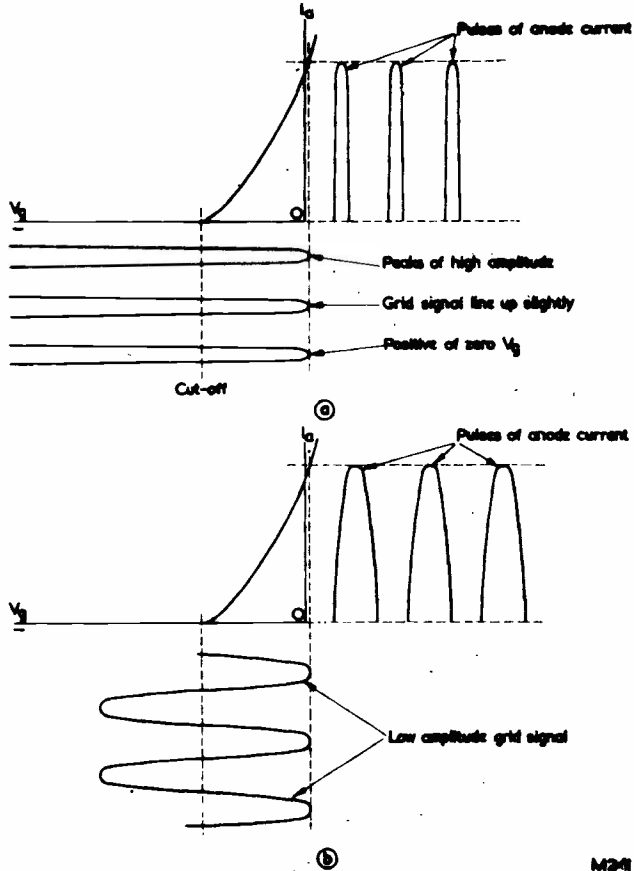

Fig. 3 (a). Limiting action. Most of the input signal is outside cut-off and only the most positive part causes anode current to flow
(b). Reducing input signal level causes the width of the anode current pulses to increase

is, 22 microseconds."

"What about the 'several hundred' microseconds?" persisted Dick.

"That's a guess," admitted Smythy. "Time constant defines the time the capacitor takes to charge to 63% of the applied voltage, or to discharge to 37%. It should have gone a good way towards completing its charge or discharge when ten times the time constant has passed."

"Several hundred' microseconds," mused Dick. "That corresponds to a frequency of 5 kc/s, doesn't it?"

"You're on the ball too," chuckled Smythy, "And you're quite right as well. One cycle at 5 kc/s would take up 200 microseconds. In this case, however, we would be asking the resistor and capacitor to follow half cycles within 200 microseconds. So, working from this figure, the circuit should be capable of limiting amplitude modulation up to 10 kc/s."

"Well, I'm dashed," exclaimed Dick. "That's knobby, isn't it? Limiting is effective over the whole audio spectrum."

"You've got it," said Smythy. "But we're only talking in very round figures here. One point that needs making is that the limiter isn't perfect, and that it is at its least effective if amplitude modulation causes the input voltage to be heavily reduced. (Fig. 3 (b)). You still get peaks in the anode circuit, but they're much fatter peaks than in the previous case (Fig. 3 (a)), and they can cause a greater current to flow in the anode coil. Nevertheless, the limiting provided by the second pentode in our i.f. amplifier is not to be sneezed at and it will augment the further limiting given by the ratio detector."

"Is the first i.f. pentode a limiter too?" asked Dick. "It has a resistor and capacitor in the grid circuit in just the same way."

"It's not really a limiter," replied Smythy. "The main purpose of the resistor and capacitor is to bias back the valve if a really hefty signal comes along. There's no point in passing fantastically large signals to the second i.f. pentode, and so you could say that the resistor and capacitor offer a rudimentary form of a.g.c. With really heavy signals they will ensure also that a fairly constant signal is passed to the limiter."

"What happens if you get a weak signal?" asked Dick. "The first valve will then be working without bias."

"That's all right," said Smythy. "The particular valve employed in this circuit is capable of working

without external bias, provided it has a high resistance down to chassis. Just like those a.f. triodes you see without bias."

Alignment

Smythy looked at his watch and started.

"Phew," he said, "I'm gassing too much. 'We'll never get anything done today if we go on like this. Let's get on to the next stage in clearing up this receiver.'"

"What's that, Smythy?"

"I think we'd better carry on to what you were doing just now," replied Smythy, "which is to check the alignment of the i.f. trannies. There's a test point on the tuner unit, so we can inject our 10.7 Mc/s into this."

"How are you going to check output—listen to the speaker?"

"Well," said Smythy, thoughtfully, "that's not entirely a bad thing. But to do so, you need a proper frequency modulated signal generator and you have to attenuate it such that you can just about comfortably hear the output when the receiver volume control is set to full. You shouldn't try the loudspeaker scheme with an a.m. signal genny because you'd need a lot of carrier from this to enable what accidental f.m. exists in it to be heard. My own favourite method of alignment consists of popping a meter across the stabilising capacitor and trimming for maximum voltage."

"The stabilising capacitor being the electrolytic in the ratio detector circuit?"

"That's right," said Smythy. "You can line up all the i.f. cores except the ratio transformer secondary with the aid of a meter connected across it."

"I still don't quite understand the detector circuit in this receiver," said Dick. "You'll have to explain it to me some time."

"We'll have to go into that later," said Smythy hastily. "For the time being, I'll just pop the testmeter on to the stabilising capacitor and see what happens as I tune the signal genny around 10.7 Mc/s."

Smythy adjusted the signal generator frequency to his satisfaction and reduced its attenuator setting.

"We don't need a lot of input here," he remarked. "An input sufficient to give us three or four volts across the stabilising capacitor is more than adequate."

Smythy swung the signal generator frequency on either side of 10.7 Mc/s and watched the meter connected to the stabilising capacitor.

"Well," he remarked, "the response looks fairish. It's reason-

ably flat on either side of 10.7 Mc/s for 50 kc/s or so, and it then begins to fall off. I must admit it falls off rather slowly though and that there's rather an accentuated peak at 10.7 Mc/s, so we might have alignment trouble after all."

"Can't you check sensitivity from the signal genny attenuator reading?" asked Dick. "That would tell you if our loss of gain was in the i.f. strip."

"If I knew what the figure should be," replied Smythy, "I would agree with you. But unfortunately I don't. I haven't done an i.f. alignment with this particular receiver model for ages, and so I just don't know what sort of i.f. sensitivity it should have in terms of signal generator attenuator readings."

Smythy returned the signal generator to 10.7 Mc/s.

"I'm now," he announced, "going to check each core in the i.f. strip for alignment. Since the overall response looked fair, I'll merely turn each to see it it's tuning approximately on its peak, then return it to its previous position. Let's try the i.f. tranny in the tuner unit."

Smythy checked the cores in the tuner unit i.f. transformer.

"There's nothing wrong that I can see here," he pronounced, "both cores tune perfectly."

Smythy next applied his trimming tool to the i.f. transformer in the anode circuit of the first pentode.

"Well," he remarked. "The top core seems O.K. as well. It's tuning a bit sharp, though. Let's try the bottom core. Ah! we're on to something here."

"What's happening?"

"Nothing!" replied Smythy cheerfully. "The meter reading stays constant however much I move the core. Apart, that is, from a slight increase in reading when I screw the core right in; but that's probably because it's then merely increasing the mutual between primary and secondary windings. So that's your fault!"

"Where?"

"In the bottom coil of this i.f.," said Smythy. "We're still getting a fair amount of joy through it, and so I would guess that the parallel capacitor has gone open-circuit or something like that."

"Okey doke," said Dick. "Leave it to me, and I'll get the tranny out and have a shuffti at it."

Decision

Smythy stood up and allowed Dick to sit at his bench. Absent-mindedly, he watched his assistant

for a moment as he started to remove the i.f. transformer from the printed circuit board.

"Isn't it easier to get the can off?" asked the Serviceman. "Quite a few cans are held by clips only, and it's much simpler to take them off and leave the innards still fixed to the board than it is to unsolder all those connections."

"Right you are, Smithy," said Dick. "And you're right about the clip-on can, too. This is one of the clip-on type."

Dick removed the can and examined the coil assembly. At the same instant Smithy gave a sudden start.

"Dash it all," he exclaimed. "I've forgotten the kettle again."

He walked over to the sink and picked up the kettle which was now almost hidden in a cloud of steam.

"Drat it," said the Serviceman. "It's boiled dry again."

Smithy put the kettle under the tap and proceeded to fill it once more. At the exact moment when

the kettle was full, the tap gave a gurgle and no further water flowed.

"It was a poor joint," called out Dick from his bench.

"What was?" asked Smithy, tearing his attention away from the tap.

"The fault in that i.f. transformer," replied Dick. "One end of the capacitor was almost completely adrift. I've soldered it in properly now."

Defly, Dick replaced the can on the transformer and switched on the receiver again. As soon as it warmed up the needle on the meter connected across the stabilising capacitor swung hard against its end stop. Hastily, Dick further attenuated the output of the signal generator until a satisfactory reading was given in the meter. He then re-aligned the bottom core of the i.f. transformer for peak voltage.

"I think we're on the last leg now, Smithy," he called out. jubilantly.

Dick quickly disconnected the signal generator and meter and tried

the receiver out on its own internal aerial. It functioned perfectly.

"Well, that's *something* good that's happened today," commented Smithy, grumpily.

"Why, what's wrong?" said Dick, turning round.

"We're frozen up in the Workshop now!" said Smithy. "I've just managed to get the last kettleful of water out of the tap for my shave."

"You *can't* waste that water on a shave!" said Dick, scandalised. "What about our tea?"

Smithy pondered. "I'd forgotten about tea," he remarked. "Oh well, I'll have to make a big decision and forego my shave. It'll have to wait until later."

"I'd like to have a talk about that ratio detector circuit later, as well," commented Dick. "I've got stacks of queries about it."

"That particular talk," said Smithy firmly, "will be *much* later. In fact, I think we'd better leave it till our next little session together!"

Interpretation of Valve Data

By F. E. ASH

THE MAJORITY OF VALVE MANUFACTURERS PUBLISH their valve data in a form which is understandable to engineers, but may not be entirely clear to the home constructor. It is hoped therefore that the following notes may be of some assistance in interpreting such data.

In general the data may be divided into the following main headings: limiting values, characteristics and operating conditions, it being important to distinguish between these three subdivisions.

Limiting Values

These values must not be exceeded. For normal receiving types, the values given are *design centre ratings*. This means that an allowance is made, in the data, for normal variations of mains voltage and component tolerances, so that if a valve has a maximum anode voltage of 250V for instance, it can be used in a design where the working anode voltage is 250V when the mains supply is at its nominal value. A temporary increase of 5% in the mains voltage may cause the anode voltage to rise above 250V, but the valve manufacturer has already allowed for such variations in determining the ratings, this not harming the valve in any way.

Some special purpose and industrial valves are rated not on *design centre*, but *absolute ratings*. This means that the maximum values quoted must never be exceeded, whether due to mains fluctuation

or other causes, and the equipment designer must make due allowances for these. Where a valve is rated on the "absolute" system, this will be stated in the data.

For a pentode valve, the limiting values given will probably include the maximum anode voltage (V_a max.), the maximum screen-grid voltage (V_{g2} max.), the maximum dissipation of these two electrodes (p_a and p_{g2} max.) and the maximum cathode current (I_k max.). It may be found that at the maximum anode and screen-grid voltages, the maximum cathode current cannot be attained, the limit being the dissipation. The "working area" of such a valve is illustrated in Fig. 1, which shows that voltage, current and power ratings are all important.

The $V_{a(b)}$ maximum is sometimes quoted in valve data. This is the maximum voltage which can appear on the anode when the valve is not passing current, and must not be confused with V_a maximum, this being the maximum voltage which can appear at the anode during normal operation.

If a pentode is to be triode connected, it will be realised that the maximum voltage which can be applied to the "anode" will be limited by either the maximum screen or maximum anode voltage, whichever is the lower. It must not be assumed that the maximum dissipation is p_a max + p_{g2} max. This will depend on the ratio of anode to screen current, and which of these electrodes first reaches its

maximum dissipation.

The V_{h-k} maximum is often quoted in the limiting values, particularly in the case of valves for series operation where the heater-to-cathode voltage is likely to be quite high.

Very often, particularly in the case of power output valves, a maximum value for the grid resistor (R_{g1-k} maximum) is given under fixed bias and self bias conditions. This is a very real limit although the reason may not be immediately obvious. In power valves, the grid becomes heated due to its proximity to the cathode, tending to emit electrons. This leaves the grid with a slightly positive charge and it therefore attracts electrons from the cathode. Providing R_{g-k} is not too large, this state of affairs will reach equilibrium, but if R_{g-k} is large, the charge on the grid becomes accumulative, the cathode current rises, the anode dissipation rises, the grid emission increases, and this state of affairs can lead to the destruction of the valve.

Characteristics

The characteristics quoted in the manufacturer's data are normally measured under static conditions. In the case of r.f. pentodes and output pentodes these correspond fairly closely to the operating conditions, the main difference being that whereas characteristics are usually measured with fixed bias, the operating conditions refer to operation with cathode bias, unless otherwise stated.

For voltage amplifying triodes and pentodes, however, there is a wide difference between the two. The characteristics are given with fixed anode (and screen-grid) voltages, whilst in normal use a resistance is used in the anode setting a limit to the anode current which will flow.

For many of the older type triodes, the characteristics are given at $V_a=100V$, $V_g=0V$. It may even be found that under these conditions either the maximum cathode current or maximum anode dissipation is exceeded. This indicates that the characteristics cannot be measured under d.c. conditions, but only under pulsed conditions.

Line output valves, which are normally biased well back, also have their characteristics quoted under pulsed conditions, and this is also true of the triode sections of some frequency changers.

The three main parameters, g_m , μ and r_a are probably already well known to constructors. For triodes, all three are normally quoted, but if only two are given the third can be calculated from $\mu = g_m r_a$ where μ is the amplification factor. g_m is the mutual conductance (in mA/V) r_a is the anode impedance (in k Ω)

For r.f. pentodes, g_m is the most important of these parameters, since the gain of a stage having a tuned circuit with an impedance Z as load, is given by: Gain = $g_m Z$

The r_a is also important, this effectively being in parallel with the load and, unless it is fairly high compared with Z , will reduce the stage gain.

It is not usual to quote μ for a pentode, since it is rarely used; the value is exceedingly high, being several thousand. The parameter μ_{g1-g2} is often

quoted for pentodes. This is known as the *inner- μ* or amplification factor between the control-grid and screen-grid. It has several practical uses, and can be regarded as the μ of the valve when triode connected.

The most useful parameter for a voltage amplifying triode is μ , since this gives some indication of the voltage gain which can be obtained from the valve.

Since the voltage gain is given by: Gain = $\frac{\mu R_a}{r_a + R_a}$

(where r_a is the anode impedance of the valve, and R_a is the load) the gain can never in fact reach μ , but if for example R_a is made equal to $3r_a$, the gain will equal 75% of μ .

For frequency changers the important parameter is g_c , the conversion conductance. This is rather similar to g_m in the case of a pentode, being the relation between a change in grid voltage and the consequent change in anode current. In this case, however, it is not a d.c. measurement, and is carried out with the oscillator section working. A known voltage is applied to the signal grid at one frequency, and the corresponding anode current variation—at the intermediate frequency (i.e. difference between signal and oscillator frequencies) is measured. Thus the value of g_c given corresponds to the operating conditions. The characteristics of the triode section may be given either under static conditions ($V_g=0$) or under working conditions, in which case g_m (effective) is given and the value of R_{g-k} and I_g quoted. The bias due to the grid current is equal to $V_g = I_g \times R_{g-k}$.

Operating Conditions

As already mentioned, the operating conditions for frequency changers, r.f. pentodes and output valves in class "A" will correspond with the characteristics. In the case of output valves, however, a few additional figures are required. These include R_a (the optimum load, not to be confused with r_a), the power output which can be obtained (P_{out}), the drive required to give this output (V_{in} (r.m.s.)), and the total harmonic distortion (D_{tot}).

The distortion sets a limit to the amount of power which can be obtained from the valve, and it is usual to limit the distortion to 10%.

If the input voltage required for full output is not given, it can be easily calculated, since $P_{out} = (V_{in} \text{ (r.m.s.)} \times g_m)^2 \times R_L$.

$$\text{Hence } V_{in} \text{ (r.m.s.)} = \frac{1}{g_m} \sqrt{\frac{P_{out}}{R_L}}$$

With cathode bias, the value of g_m is slightly lower than that obtained with fixed bias, and allowance should be made for this factor when calculating V_{in} . For push-pull operation, the bias can be obtained either by a common cathode bias resistor or separate resistors for each valve. The data will usually state which method is used but if in doubt, a quick check can be made by multiplying the total cathode current (under no-signal conditions) by the cathode bias resistor, thereby calculating the bias

voltage. Valves in push-pull are usually biased back slightly from the class "A" operating point, and operated under class "AB" conditions. Some textbooks recommend that for push-pull working the anode-to-anode load should be twice that for a single valve, although in practice this is rarely found to be the case. The reason is that with single valve operation, the load is chosen to give the maximum output with 10% total distortion. This distortion is made up of 2nd, 3rd and higher order harmonics.

When two valves are used in push-pull, the even harmonics cancel, therefore with twice the normal load, twice the output is obtained with less than 10% distortion. By biasing the valve back slightly and reducing the load, more than twice the output can be obtained for 10% distortion, and there is also a reduction in the standing anode current of the two valves.

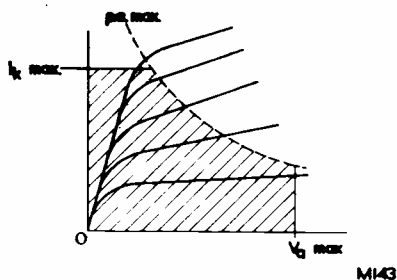

Fig. 1. Voltage, current and power limitations

For class "B" output stages cathode bias cannot be used, and the fixed grid voltage required is given. It is quite usual for the grids of class "B" stages to be driven positive during operation. Since the valve will take grid current under these conditions the impedance of the driver stage must be kept low or distortion will result. If the peak value of the input voltage ($=1.4 \times V_{in} \text{ (r.m.s.)}$) exceeds the bias voltage, the grid will go positive. With both class "AB" and class "B" output stages, the anode current increases with the output power. This is indicated in the data by $I_a \text{ (o)}$ (no-signal current) and $I_a \text{ (max. sig.)}$. When considering rectifier requirements, the latter figure must be used.

R.F. Pentodes

In addition to the information given under characteristics, several other figures may be quoted. The grid voltage for a 100:1 reduction in g_m may be given. This indicates that the valve has a variable-mu characteristic.

R_{in} and R_{eq} are sometimes given, particularly in the case of valves intended for use at v.h.f. R_{eq} , the equivalent noise resistance, is a measure of the noise introduced by the valve. It is given as a resistance since the noise from a resistance is a constant value, depending on the value of the resistance (temperature and bandwidth assumed constant). If a valve has an R_{eq} of $1k\Omega$, it means that a resistor of $1k\Omega$ connected between grid and

cathode would produce as much noise as the valve itself.

The input impedance R_{in} is usually several times larger than R_{eq} . At low frequencies, the input impedance of a valve is very high, but at frequencies of the order of 30 Mc/s it begins to fall. This is due to the transit time of electrons between grid and cathode. R_{in} is usually quoted at 50 Mc/s. The value at any other frequency can be calculated from:

$$R_{in}(f) = R_{in}(o) \times \left(\frac{f_o}{f}\right)$$

Where $R_{in}(o)$ is the input impedance at frequency f_o and

$R_{in}(f)$ is the input impedance at frequency f .

Thus if $R_{in} = 4k\Omega$ at 50 Mc/s it will fall to 250Ω at 200 Mc/s.

Inter-electrode Capacitances

The capacitances between various electrodes are often given on data sheets. These are important when the valve is used at r.f. The three most common capacitances quoted are c_{in} , c_{out} , and c_{a-g} .

The input capacitance, c_{in} , is the capacitance between the grid and all other electrodes except the output (i.e. the anode). If a tuned circuit is used in the grid circuit of a valve, c_{in} will be in parallel with it and will contribute to the total capacitance in the circuit.

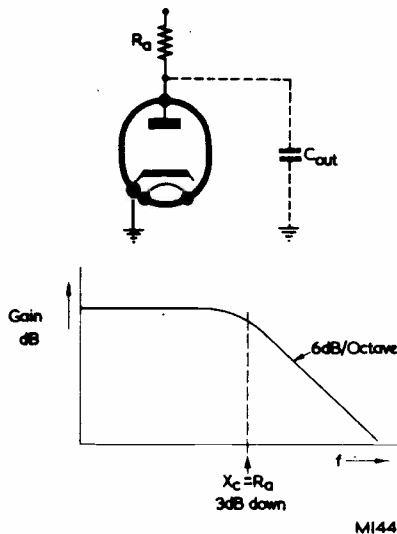

Fig. 2. Effect of C_{out} on frequency response

The output capacitance, c_{out} , is measured between the anode (output electrode) and all other electrodes except the grid, it having a similar effect on a tuned circuit connected in the anode. When a valve is used as a video amplifier with a resistive load (R_a), the combination of R_a and c_{out} will form a top-cut circuit. (See Fig. 2.) The gain of the stage will fall by 3dB (to 70.7% of its value) when

$Xc_{out}=R_a$. Thus the value of R_a must be kept low if the frequency response is to be maintained up to 3 Mc/s. Since the gain= $g_m R_a$, g_m must be as large as possible.

These requirements have resulted in the derivation of a "figure of merit" for wide band amplifying

pentodes which is given by $\frac{g_m}{c_{in}+c_{out}}$.

This is a useful factor when comparing different pentodes for their relative merit as wide-band amplifiers.

The capacitance between the output and input, c_{a-g} , can be used to calculate the amount of feedback, providing sufficient information is known about the input and output circuits.

Voltage Amplifying Stages

Tables showing the values of R_a , R_k and stage gain, together with the appropriate electrode currents are normally given in the manufacturer's data sheets. The current taken by such stages is usually very low—only 1 or 2mA. It is also normal to quote the grid resistor of the following valve in these tables, since this reduces the effective value of the load. This should therefore be large compared with the load—if possible, at least five times as large. There will, of course, be a maximum value for the grid resistor of the next valve, as explained above.

Operating conditions are sometimes quoted for grid current biasing. In this case no cathode bias resistor is required, but a large grid resistor (10M Ω) is employed.

Rectifiers

The two most important ratings for rectifiers, the maximum r.m.s. input voltage (V_a (r.m.s.) max.), and the maximum output current (I_{out} max.) are fairly self explanatory.

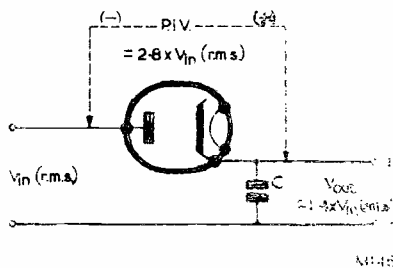

Fig. 3. Rectifier ratings

The maximum peak inverse voltage may not be quite so clear. If an input voltage of 200V r.m.s. is applied to the anode of a half-wave rectifier and a capacitor is connected from the cathode to earth, the rectifier will conduct on positive half cycles, the capacitor charging up to the peak value of the input voltage, in this case $1.4 \times 200 = 280V$. The cathode potential will therefore be +280V with respect to earth. This condition is illustrated in Fig. 3.

On negative half cycles the anode will reach 280V with respect to earth, and the total peak inverse voltage across the valve will be $2 \times 280 = 560V$ or $2.8 \times V_{in}$ (r.m.s.). This is the worst possible case: in practice the load on the circuit will prevent the capacitor from attaining its full charge, and in the case of a choke input filter the P.I.V. will be much lower (approx. $2.4 \times V_{in}$ (r.m.s.)).

The peak anode current of a rectifier may at first seem irrelevant, but a consideration of how the rectifier operates, however, will show that the rectifier does not in fact pass a steady current, but a series of pulses—one pulse every time the anode goes more positive than the cathode.

When the circuit is first connected, the reservoir capacitor must charge up, the charging current passing through the rectifier. The current will be limited by the resistance of the circuit, and the time for which it flows by the CR time constant. It is for this reason that a maximum value of reservoir capacitor is given (C max.) and also a minimum value for the limiting resistor to be used with this capacitor (R_{lim} min.).

Incidentally, strapping the anodes of a full wave rectifier valve and using it as a half wave rectifier does *not* double its mean current rating as some constructors might hope!

Base and Connections

There are various methods of showing base connections. Some manufacturers prefer to tabulate them, whilst others give a sketch of the valve base with the abbreviations for the electrodes written in.

The most common of these are:

- a* —anode
- f* —filament
- g* —grid
- h* —heater
- k* —cathode
- M*—Metallising
- s* —internal shield
- t* —target (tuning indicators)
- x,y*—deflection plates (electrostatic cathode ray tubes)

In valves having more than one grid, such as an r.f. pentode for instance, the grids are distinguished by numbers, g_1 being the grid nearest to the cathode (control grid), g_3 the second grid (or screen-grid) and g_4 the final grid (or suppressor). The same system is used in cathode ray tubes having more than one anode.

When more than one electrode structure is included in one envelope, such as in the case of a triode-pentode, the electrodes are distinguished by the subscript letters *t* and *p*. These are only used where confusion is likely to arise: in a triode-pentode a_t is the triode anode, and a_p the pentode anode. The triode grid is g_t , but the various grids of the pentode are denoted by g_1, g_2, g_3 , without a subscript *p* since these obviously cannot refer to the triode.

Other subscripts which are sometimes used in this way include

- d*—diode

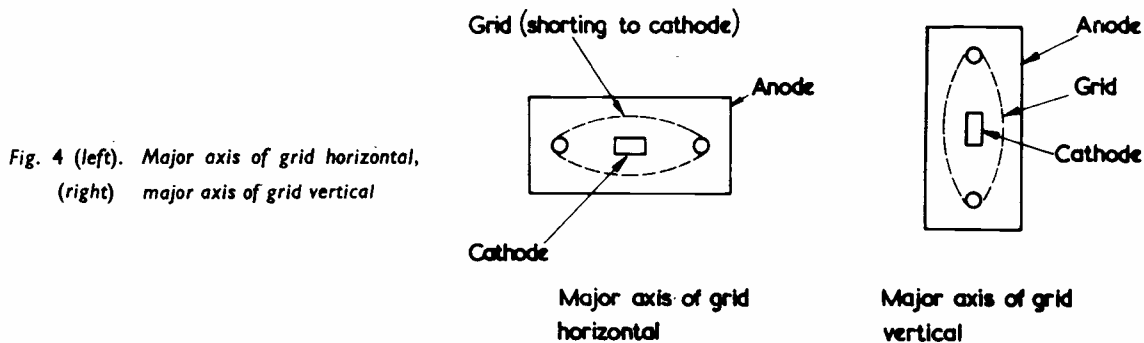

Fig. 4 (left). Major axis of grid horizontal,
(right) major axis of grid vertical

MI46

h—heptode, hexode or octode

q—tetrode

Valves which have two similar electrode structures in the same envelope (e.g. double triodes) use a system of “primes” to distinguish between sections. *a'*, *g'*, *k'*, make up one triode whilst the other consists of *a''*, *g''*, *k''*.

In the old days, when the British 4 and 5 pin bases were in vogue, it was usual for all the pins to be occupied. The introduction of multi-electrode valves brought in its train, side terminals, top caps, the British 7-pin base and the British 9-pin base, before an attempt was made to standardise and use the octal base.

With rectifiers and some other types, there were, of course, more pins than required and the unwanted pins could either be left blank or omitted from the base. The abbreviation “NP” is used to denote no pin whilst “NC” is used when the pin is present but not connected to an electrode.

With the introduction of miniature valves of the “A” construction using “all-glass” bases, the problem of electrode supports came into the picture.

With the old “pinch” type valves, the anode was supported by two rods mounted in the glass pinch. An electrical connection was taken out from one of these. The miniature valves do not use a pinch, and supporting rods can only be connected down to the base pins. It is sometimes necessary to provide an additional support for the electrode structure. This support may not make good electrical contact with any electrode, and the pin to which it is connected should therefore not be used for electrical connections. The pin will be marked “IC” on the base diagram and must be left blank.

Most small valves can be mounted in any position, although it is as well to consult the valve data to ensure that there is no restriction. In the case of power valves having a high *gm*, horizontal mounting is only permissible if the major axis of the grid is kept vertical. This is because the grids of power valves run quite hot and are liable to sag. If the grid to cathode spacing is small—in order to obtain a high *gm*—there would be a danger of the grid touching the cathode if the major axis was horizontal. (See Fig. 4.)

Evo-Stik ‘Impact’ Adhesive 528 used for a variety of do-it-yourself radio construction jobs

If you are a radio constructor you will have used a variety of adhesives for various jobs. Evo-Stik “Impact” Adhesive 528 has proved one of the most useful and efficient adhesives for this work.

Mr. A. H. Oliver, radio enthusiast, of 105 Walsworth Road, Hitchin, Herts., gives an account of a selection of uses he has put the adhesive to.

One of the first jobs Evo-Stik “Impact” Adhesive 528 was used for was the repairing of a large bakelite radio cabinet which dropped and shattered in 20 pieces. The adhesive made a most successful repair and the joins are barely visible. In fact the cabinet is now as good as new.

It often happens that the top cap of a valve seating becomes loose. A drop of Evo-Stik under and round the edge of the cap will permanently fix this, with no further fear of it loosening. Also, if a small amount is spread round the glass base where it joins the seating, this will create a permanent fixture.

It is sometimes necessary to wind a new coil from an old disused one. If the coil is one of the old, large diameter, solenoids, the job is not simple, for as soon as the wire is unanchored it becomes a large, loose spring and if care is not taken it can become completely tangled. If a smear of Evo-Stik is applied with the tip of the finger down the side of the coil and allowed to dry, this will effectively hold the turns while the new coil is wound.

If at any time it is required to leave the coil during winding, a dab of Evo-Stik will anchor the loose end of the wire safely until the job is ready to proceed with.

Evo-Stik has also proved useful for filling holes in bakelite or other brittle material where strip-threading has taken place. The hole should be filled in and the Evo-Stik allowed to partly dry, then the screw can be re-applied. It will hold firmly when the adhesive has dried.

Evo-Stik can be used for fixing components such as large capacity capacitors to the chassis which frequently have no other means for attachment.

NEWS AND COMMENT . . .

ALTHOUGH MOST OF US, PARTICULARLY those who are middle-aged, think of radio as a relatively recent invention the number, one almost might say spate, of jubilees connected with radio during the last few months remind us that, to the younger generation, radio and TV are just part of the natural order of things. The one freshest in most minds will be the Silver Jubilee of B.B.C. television transmissions.

Appeal

We mentioned in our November issue that the London Wireless Club, which became the Radio Society of Great Britain, was founded in 1913. Therefore the Society will be celebrating its Golden Jubilee next year.

To note this milestone in Amateur Radio the President of the R.S.G.B., Major-General E. S. Cole, has launched a Headquarters Fund Appeal.

The object of the Fund is to assist in financing the purchase of a permanent headquarters which would not only provide office accommodation but also a technical library and rendezvous for British and Overseas amateurs.

Recently the opportunity for purchasing suitable premises had to be turned down because of lack of funds. It is the first time that the society has made such an appeal, and although it has only been launched a short time well over £1,000 has been donated.

This is, perhaps, a suitable occasion to commend membership of the R.S.G.B. to our readers. Corporate membership is open to those engaged in radio research experimentation or communication, and Associate membership to those, under 21 years of age, who are interested in radio. Associate membership can be invaluable to beginners as the society has branches all over the country and old-timers are only too glad to assist newcomers. Applications for membership must be supported by two corporate members, or by two references from people of standing. Details may be obtained from the General Secretary at New Ruskin House, Little Russell Street, London, W.C.1.

Exhibition

Also following from our opening remarks, we would draw attention to the exhibition to be held at the Science Museum, South Kensington, London, S.W.7, from Wednesday 13th December, 1961, to Thursday 25th January, 1962, to celebrate the diamond jubilee of Transatlantic Radio. On the 12th December, 1901, Guglielmo Marconi became the first to send a radio signal across the Atlantic. This remarkable achievement with primitive equipment marked the birth of world-wide communication.

The museum is open from 10 a.m. to 6 p.m. on weekdays and from 2.30 p.m. until 6 p.m. on Sundays.

Time Check

For over 100 years the Royal Greenwich Observatory has been responsible for providing exact time signals for a wide variety of users both at home and abroad. In recent years this service has become increasingly important in various fields of scientific research where extreme accuracy is essential.

In order to provide the various users with more frequent opportunities for checking the time, the present twice daily transmissions from Rugby are being increased to four as from 1st December. This will mean that the transmissions on the low frequency of 16 kc/s, now radiated at 10 a.m. and 6 p.m., will be superseded by signals at 3 a.m., 9 a.m., 3 p.m., and 9 p.m. There will, however be no change in the form of the signals. The 9 a.m. and 9 p.m. signals will also be transmitted on short-waves.

As long ago as 1833 the Royal Greenwich Observatory provided hourly time signals for the operation of "time balls", i.e. devices consisting of a large ball secured to the top of a mast and released by a special catch at a precise time. One such ball is still in use in the grounds of the old Observatory at Greenwich.

Rights

It may not be long before the

symbol (P) on gramophone records will be as familiar as the copyright symbol seen on the contents page of this magazine—the capital "C" enclosed in a circle.

The draft of an International Convention protecting the so-called "neighbouring" rights of interpreters of broadcast or recorded musical, dramatic and literary works and of broadcasting stations and manufacturers of records was submitted to a recent diplomatic conference.

The text is based on the same principles as those underlying the Universal Copyright Convention, in which contracting states pledge themselves to accord the same rights to authors of other countries as they accord to their own nationals. The new Convention would guarantee the rights of performing artists, stations and manufacturers, who will be able to prevent unauthorised recording or broadcasts of their work in foreign countries, and who will be entitled to remuneration whenever reproduction is authorised.

Radio Australia

The "VL" call signs, which have been associated with Radio Australia broadcasts since the inception of the service, have been discontinued and are no longer heard in station identification announcements. However, the various other identifications have been retained, including "Radio Australia, The Overseas Service of the Australian Broadcasting Commission", together with full details of frequencies and wavelengths; the station tuning and interval signal "Waltzing Matilda"; the laugh of the kookaburra and the chimes of the Melbourne Post Office clock.

Television in Ships

According to *The Times* a transatlantic liner soon to be built will probably be equipped to receive television programmes from satellites. The ship-owners are confident that by the time the liner enters service in 1963 TV programmes will be rediffused over large areas through special satellites.

Cover Feature

A Printed Circuit Matchbox Receiver

By R. DAVIS

THIS TRANSISTOR SET STARTED OFF AS LITTLE MORE than a printed circuit "doodle", but such good results were obtained that a serious attempt was made to develop a really useful receiver on the same lines.

General Description

The final result of a number of experiments is a portable receiver so small that it fits snugly into an ordinary matchbox. Its small size, together with its neat and robust construction, is made possible by the use of a printed circuit. The printed circuit panel acts as the chassis, and accommodates all the components except the aerial, which is a piece of ferrite rod $\frac{3}{8}$ in diameter by $1\frac{1}{8}$ in long, wound with the tuning and reaction coils. The detector is permeability tuned, and so its range is limited to the reception of one of the main broadcasting stations only, the local Home Service being chosen in the original model. The tuning coil can, however, be modified for the reception of any other reasonably strong Medium wave station. The sensitivity of the set is such that the Home Service is good and loud at a distance of 50 miles from the transmitter (on 330 metres); it is also possible to tune in a few Continental stations late at night. Distant stations can be made a good deal louder by adding an aerial of a few feet of wire, but this spoils the portability of the set, and defeats its purpose.

Constructing the Receiver

The first step in building the set is to prepare the printed circuit panel. A rectangle of copper-clad laminate measuring $1\frac{1}{8}$ in by $\frac{1}{8}$ in is required. Since matchbox trays are not all the same length, it may prove necessary to alter the length of the panel slightly to obtain a good tight fit in the box. A semi-circular section is cut from one corner of the panel to make room for the mercury cell which powers the receiver. (Fig. 2.)

Fig. 2 also shows the positions of the holes which are drilled through the panel after etching the printed circuit. At this stage the holes are only marked lightly with a centre punch on the copper side of the panel. The copper side of the laminate is then cleaned and polished very thoroughly to remove any grease which will prevent etching being carried out properly. The parts of the copper which

have to be left on the board to form the printed circuit are protected by painting them over very carefully with coloured aircraft dope or nail-varnish. (Fig. 2.) Great care is needed to avoid rough or careless work at this stage, since a mistake in the

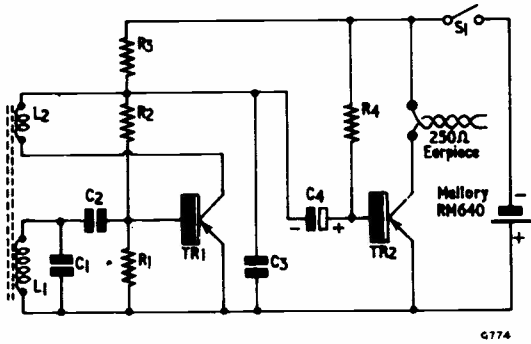

Fig. 1. Circuit diagram of the matchbox receiver

Components List

- Resistors*
 R₁ 15kΩ $\frac{1}{8}$ watt 10%
 R₂ 56kΩ $\frac{1}{8}$ watt 10%
 R₃ 4.7kΩ $\frac{1}{8}$ watt 10%
 R₄ 47kΩ $\frac{1}{8}$ watt 10%
- Transistors*
 TR₁ V6/R4
 TR₂ V10/50B
- Earpiece*
 250Ω impedance with 3ft cord
- Capacitors*
 C₁ 100pF subminiature polystyrene
 C₂ 0.01μF 150V (Hunts)
 C₃ 0.001μF 350V (Hunts)
 C₄ 4μF 6V electrolytic (Hunts)
 S₁ See text
- Mercury Cell*
 Mallory RM640

painting means a mistake in the printed circuit itself. After the dope has dried the printed circuit is ready for etching.

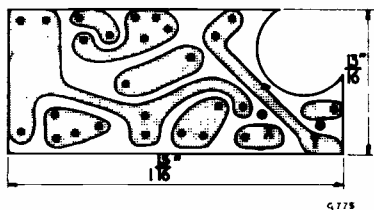

Fig. 2. Underside of the printed circuit, shaded areas to be painted. Connect phone leads to X and Y

Ferric chloride solution is the etchant used. It can be obtained easily at most chemists; 2 fl. oz. should be sufficient. Enough to cover the printed circuit panel to a depth of at least $\frac{1}{4}$ in is poured into a saucer, and the panel is immersed, copper face upwards. The dish should be rocked slowly to and fro during the process, which will be completed after about half an hour. The solution is very corrosive to fabrics and due care must be taken when handling it, all traces being washed away after etching the printed circuit. The dope is removed with acetone, leaving the printed circuit exposed. The insulation between the sections of the circuit should be tested at this stage, since even a small leakage may prevent the set from functioning correctly.

The final work on the printed circuit is to drill the holes through which the connections will be made. A $\frac{3}{32}$ in drill is used for all the holes except those for the on/off switch and the earpiece lead, which are drilled $\frac{1}{8}$ in and $\frac{3}{16}$ in diameter respectively. Drilling is started at the punch-marks previously made in the copper. A good finish is obtained if the holes are lightly countersunk with a $\frac{1}{16}$ in drill on the other side of the panel. This completes the printed circuit, leaving it ready for soldering in the components, as shown in Fig. 3.

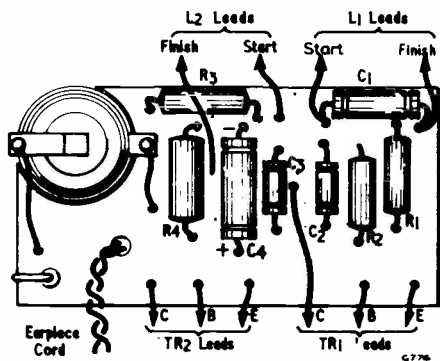

Fig. 3. Upper side of the printed circuit board showing the layout of components

Fitting the Components

The resistors are the first components to be mounted (Fig. 4 (a)), $\frac{1}{8}$ watt $\pm 10\%$ types being used. C_2 and C_3 are too large to fit on the panel as obtained, and the material covering them has to be removed. It can be softened by heating in a match flame, when it will peel off cleanly, leaving the capacitor itself exposed. The capacitors are easily damaged in this state, and must be handled very carefully.

The earpiece lead (Fig. 4 (b)) and the mercury

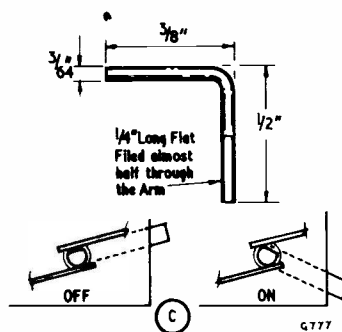
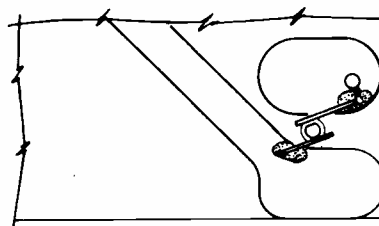
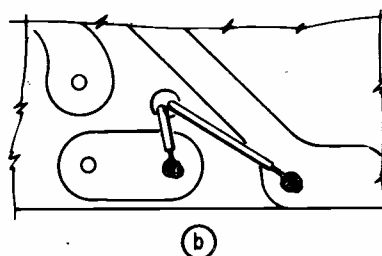

Fig. 4 (a). Cross section through the printed circuit showing the correct method of soldering the components

(b). Details of the phone lead connections (identify with Fig. 2)

(c). Details of the switch contacts (identify with Fig. 2) mounted on the printed circuit (centre) details of the switch arm and (below) showing the switch in the on and off positions

battery (Fig. 3) are the next to be soldered in. The on/off switch presented a bit of a problem at first. Finally, the design shown in Fig. 4 (c) was used. The switch contacts are $\frac{1}{16}$ in lengths of hard drawn brass wire $\frac{1}{16}$ in in diameter, and contact is made between them by another piece of brass wire $\frac{1}{16}$ in in diameter, the details of which are shown in Fig. 4 (c). The transistors are the last components to be mounted on the printed circuit panel. Since the leads have to be cut very short to enable the transistors to fit neatly into the set, great care must be taken during soldering to prevent any heat from entering and possibly damaging the transistors.

The choice of transistors may seem a little unusual, but the performance of the set using a white spot type for TR₁ and a red spot type for TR₂ is very poor

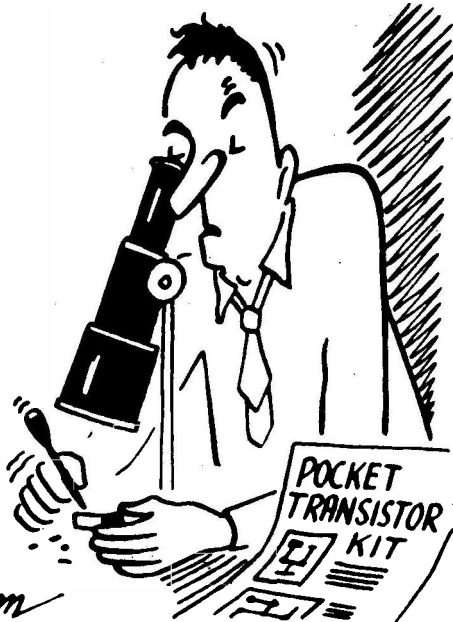

indeed; the two transistors specified give easily the best performance of all the combinations which were tried.

Ferrite Rod Coils

All that remains now is to wind and connect up the tuning and reaction coils. The coil formers are made from cartridge paper; L₁ former is $1\frac{3}{8}$ in long and free to slide over the ferrite rod, whilst L₂ former is $\frac{3}{8}$ in long and free to slide over L₁ former. This arrangement is used so that the tuning and

reaction coils can be moved together over the ferrite rod when tuning the set, since their relative position does not need changing once it has been set for optimum performance.

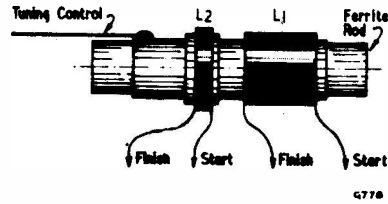

Fig. 5. Ferrite rod aerial assembly

L₁ is wound with 40 turns of 9/47 litz wire, close wound at one end of its former in a single layer. L₂ is similarly wound, but has only 6 turns. (Fig. 5.)

The leads from the coils are soldered in position and the ferrite rod is inserted in L₁ former. The receiver is now finished and ready for operation.

Adjusting and Operating the Receiver

To make sure that there are no serious faults in the circuitry, connect a 5mA f.s.d. moving coil meter across the switch contacts. If all is well, a current of about 2mA should flow. An indication that the set will work can be obtained by temporarily connecting a 0.01 μ F capacitor between TR₁ base and TR₂ collector, when a loud tone should be heard in the earpiece. It is not advisable to wear the earpiece at this stage! This being so, after removing the capacitor and meter, the earpiece may be safely worn. The switch should now be inserted in its hole, and rotated until a loud click, followed by a faint hissing, is heard.

L₂ is then slid along L₁ former, towards L₁ until the receiver starts to oscillate. It is then moved slowly away from L₁ until the oscillation just ceases (If no oscillations can be heard, reversing the connections to L₂ should effect a cure.) The whole coil assembly is then slid along the ferrite rod until the Home Service can be heard. L₁ may be modified as required at this stage by adding or removing turns. A rudimentary tuning control may be fixed to L₁ former after placing the set in its matchbox. (Fig. 5.) This control is to enable slight tuning drift caused by changes in the ambient temperature of the transistors to be covered.

The quality obtained with this set is noticeably better than that normally expected from transistors, this being due to the large value of C₄, and to the careful choice of transistors.

New Ceramic-Cased Tunnel Diodes from S.T.C.

The operating frequency of tunnel diodes has been raised by a technique of miniature ceramic encapsulation developed by Standard Telephones and Cables Limited.

The extremely small size (5.6mm diameter less tabs) of these new devices and their tab-ended configuration have reduced their inductance to such an extent that a typical limiting frequency of oscillation of 900 Mc/s is now attainable.

A single version, known as the JK30A, is now in production. It is being followed by a new version incorporating a matched pair of tunnel diodes and forming a single integral unit having three tabs. These units are matched for peak current and capacitance and are intended for applications in the computer field. They may be used in high speed logic and counting circuits or as the threshold amplifier/gate at the input of a pulse amplifier.

Advance data sheets are available.

Radio Astronomy

PART 4

by

FRANK W. HYDE
F.R.S.A., F.R.A.S.



THE LAST ARTICLE DEALT WITH THE CONSTRUCTION of the aerial system and we now come to a consideration of the receiver and ancillary gear. We will deal first with equipment that may be on hand or can be obtained from the surplus market.

Noise Factor

The basic units of the receiver are a radio frequency section, an intermediate frequency section and an a.f. and recording section. The radio frequency section is the most important for it is here that we must combine the highest possible sensitivity with the lowest internal noise. Internal noise emanates from two main sources, the input circuit and the first valve. Neglecting the noise which is generated by the aerial, the main source of noise in the first circuit will be due to the components. When a current flows through a conductor the electrons are agitated, a voltage is built up across that particular section of conductor or across a component such as a resistor, energy is dissipated and there is therefore, a temperature rise. This agitates the molecules of the conductor and results in what is termed thermal agitation noise. There is a formula for the calculation of this quantity which is as follows:

$$4KT\Delta F$$

$$2I_N^2 = \frac{R}{R}$$

I_N^2 = mean squared noise current (amperes²)

K = Boltzman's constant (Joules per degree Kelvin) = 1.37×10^{-23}

T = Temperature degrees Kelvin

ΔF = Bandwidth in cycles per second

R = Resistance in ohms

Since all noise currents and voltages are random and occupy the whole of the band of frequencies in the electro-magnetic spectrum, it is usual to speak of the average noise power. This may be expressed as mean squared noise current or mean squared noise voltage.

It will be clear now why the term ΔF relating to

bandwidth appears in the formula. There are certain precautions which we must observe to keep this first circuit noise within as low a limit as possible.

All soldered joints should be mechanically sound, care should be taken to see that there are no dry joints; resistors should be of ample rating and have plenty of ventilation in order that the temperature rise shall be kept to a minimum. The chassis of the r.f. unit should be of heavy material capable of dissipating most of the temperature rise.

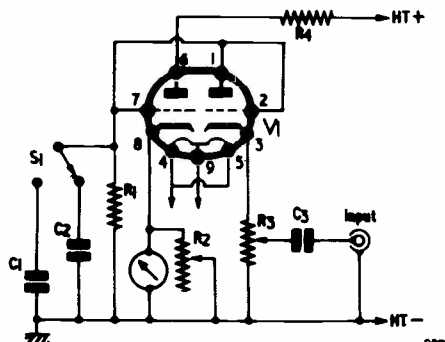
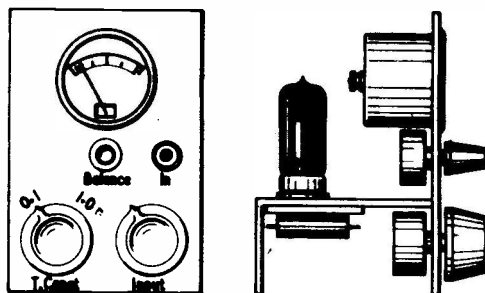
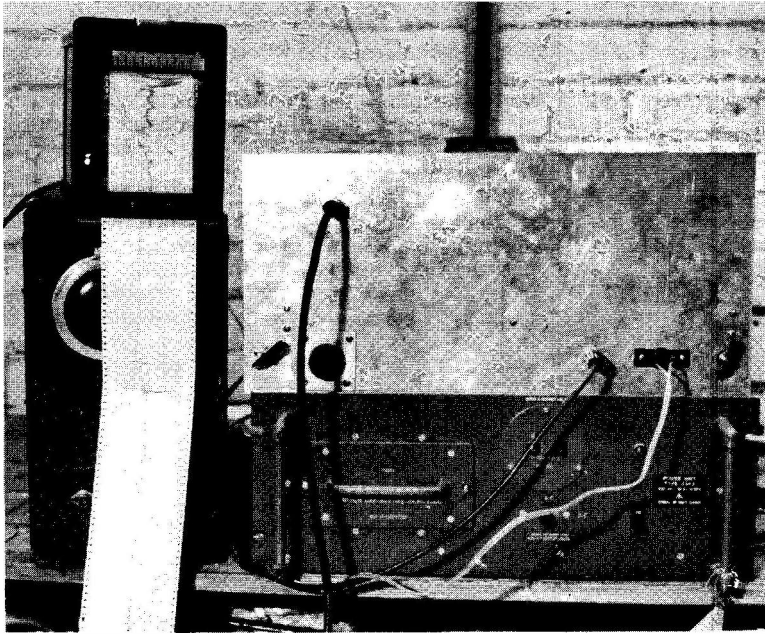

Fig. 23. Layout and circuit of the translator unit



View of the receiver with power unit (below) and recorder. The receiver controls are—extreme bottom, left to right, r.f. gain; tuning; a.f. output; pen recorder or meter output sockets and, extreme right, the zero adjustment

The author has arranged with Denco (Clacton) Ltd., of 357/9 Old Road, Clacton-on-Sea, Essex, that the coils specified for the units featured in this issue be manufactured and supplied direct to interested readers. Those readers who would prefer to obtain the coils ready made should therefore contact Denco (Clacton) Ltd. direct.—Editor.

Components List (Translator)

Resistors

- R₁ 1M Ω
- R₂ 500 Ω pot.
- R₃ 25k Ω pot.
- R₄ 100k Ω

Capacitors

- C₁ 0.1 μ F
- C₂ 1.0 μ F
- C₃ 0.25 μ F

Switch

- S₁ Single pole, 2 way

Valve

- V₁ 12AX7/ECC83

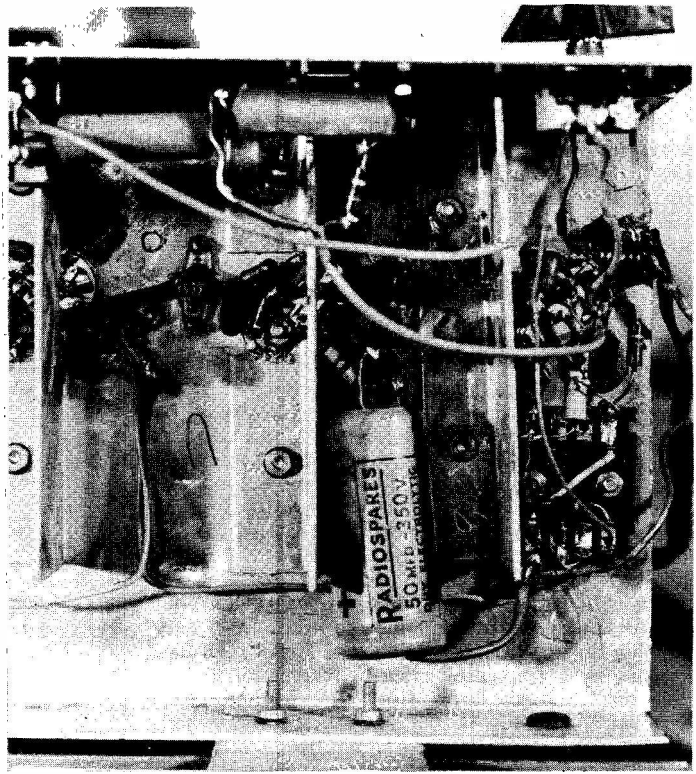

The detector and recording section layout

The next contributor to the noise in the first part of the circuit is the valve itself. This valve is important and there are a number of low noise valves available on the market at the present time. A good deal has been written on this subject and a number of manufacturers issue pamphlets dealing with it very comprehensively. Calculations of the total input noise are referred to the grid of the first valve. Each of the sources of noise must be calculated and referred to this reference point. As has already been stated, noise is a random effect and is calculated on a power basis.

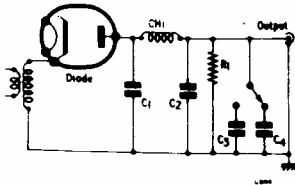

Fig. 24. Modification of Pye i.f. strip for use with the pen recorder d.c. amplifier

Components List

(Detector modification of Pye Strip)

Resistor

R₁ 1MΩ

Capacitors

C₁ 50pF

C₂ 50pF

C₃ 1.0μF

C₄ 0.1μF

To sum up the various noise voltages that must be referred to the first grid are, (i) thermal agitation noise of the tuned grid circuit, (ii) shot noise of the input valve, (iii) induced grid noise of the input valve, and (iv) the following stages of grid circuit noise referred back to the first grid.

R.F. units are available in the surplus market, some of these are single tuned and others, such as the many turret tuners available, cover a wide range of frequencies in the television bands. As was stated in an earlier article, one of the principal receivers used by the writer consists of first, a modified turret tuner, second, an i.f. strip (the familiar Pye strip), and finally an audio output and recorder section. The intermediate amplifier can be, as just stated, an i.f. strip or it can be a communications receiver set to a particular frequency. Among the receivers that would be suitable are the R1155, the AR88, the CR100, the R208, the S27, the CR150, and the National HRO. Each of the communication receivers will, of course, have its own audio output. We may use this directly to record on tape for subsequent analysis by a translator described herewith, or we may use the translator direct for instantaneous observations. This is the simple method which can be put into immediate operation. The tape recorder can make a permanent record but, even at the slowest speed of say $\frac{1}{18}$ in per second, observa-

tions would be limited by the length of tape available. However, at this slow speed it would be possible to cover the whole period of the passage of the Sun through the aerial, or of the Milky Way containing the constellation Cygnus where one of the most powerful radio sources is located.

Pen Recorder

The most desirable part of the equipment is, of course, the pen recorder. Such a piece of apparatus enables us to make permanent records of everything received at the aerial. The speed at which the records are made depends largely upon the observation to be carried out, and all

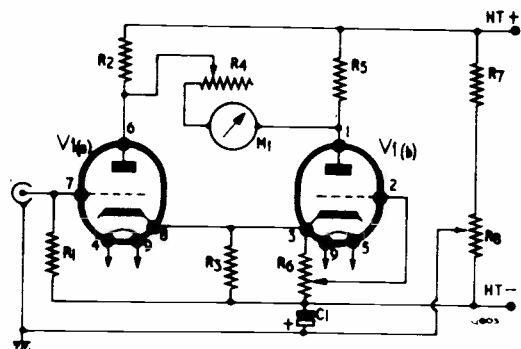
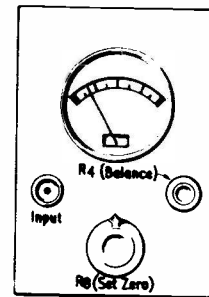

Fig. 25. Layout and circuit of the pen recorder d.c. amplifier

Components List

(D.C. Amplifier for Pen Recorder)

Resistors

R₁ 20MΩ

R₂ 5kΩ

R₃ 500Ω

R₄ 20kΩ pot.

R₅ 5kΩ

R₆ 25kΩ pot.

R₇ 47kΩ

R₈ 5kΩ pot.

Meter

M₁ 1mA f.s.d.

V₁(a), (b) 12AX7/ECC83

Capacitor

C₁ 12μF 50vV

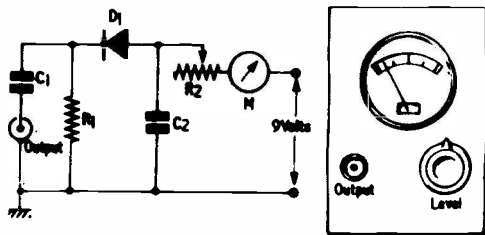

Fig. 26. Front panel layout and circuit of the noise generator

speeds are available from, say, $\frac{1}{2}$ in per hour to 24 in per hour. For special observations very much higher speeds are sometimes used. From the amateur's point of view the two most useful speeds are 1 in and 6 in per hour. At 1 in per hour a steady examination of the whole of the galactic system may be made. This is accomplished by setting the angle of the aerial at a different position for each sweep. Such a process would mean that a complete map of the radio sky could be built up in, say, seven or eight successive runs of 24 hours each. This, of course, represents the ideal, but it should not be thought that the lack of a pen recorder will preclude any work of a useful nature being done. The use of the tape recorder

Components List (Receiver RF Section)

Resistors

- R₁ 4.7k Ω
- R₂ 47k Ω
- R₃ 1k Ω
- R₄ 47 Ω
- R₅ 5k Ω pot. (linear)
- R₆ 150k Ω 5%
- R₇ 150k Ω 5%
- R₈ 100k Ω
- R₉ 2.7k Ω
- R₁₀ 3.3k Ω Hi-Stab
- R₁₁ 3.3k Ω Hi-Stab
- R₁₂ 10k Ω

Valves

- V₁ PCC89
- V₂ ECC81

Capacitors

- C₁ 3.3pF
- C₂ 2pF
- C₃ 2pF
- C₄ 1000pF
- C₅ 4.7pF
- C₆ 1000pF
- C₇ 5pF
- C₈ 1000pF
- C₉ 3pF (or suitable value to tune L₅)
- C₁₀ 1000pF
- C₁₁ 25pF
- C₁₂ 2000pF
- C₁₃ 10pF
- C₁₄ 10pF
- C₁₅ 5pF
- C₁₆ 3-30pF variable

Components List (Noise Generator)

Resistors

- R₁ 75 Ω
- R₂ 25k Ω pot.

Capacitors

- C₁ 1000pF
- C₂ 1000pF

Diode

- D₁ Silicon

and subsequently the translator, or the translator direct (though somewhat slow and laborious), will still enable the observer to complete quite useful records. If the translator is used direct the presence of the observer is, of course, required at the time that observations are made. As previously mentioned, the cost of the equipment including the pen recorder is no more expensive than that of many other hobbies such as ciné or even amateur radio. Indeed, the purpose of these articles is to enable any amateur with the available equipment to enter into and enjoy this fascinating section of electronics combined with astronomy. The translator will be described next since it becomes the only additional apparatus to that already discussed.

Translator Unit

The circuit of the translator unit is shown in Fig. 23. It will be seen that this is quite straightforward, receiving its audio via the 0.25 μ F capacitor C₃ to an adjustable input. The first section of the double-triode is strapped as a diode and feeds into the other triode. The grid circuit of this second triode has a time constant which can be set to different values. This is necessary because

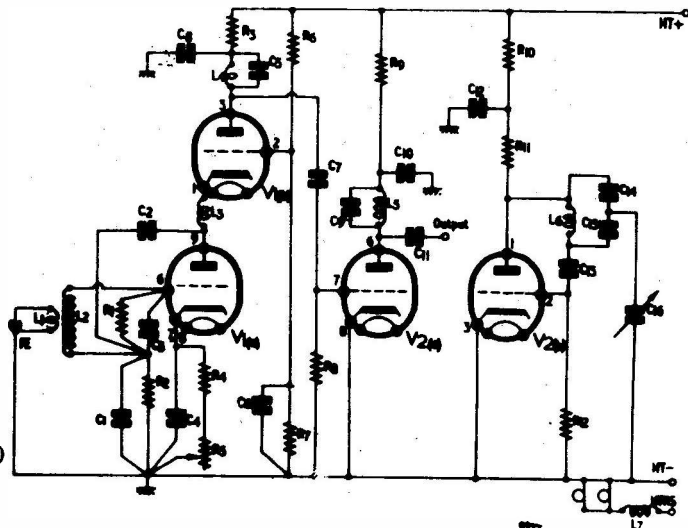

Fig. 27. Circuit of the r.f. section of the receiver. Note that V₁ has 6.3V applied to the heater and not 7.5V, this assisting in the reduction of receiver noise. For coil winding details see Table 1. All coils are dust-core tuned.

TABLE 1

L ₁	1½ turns	22 s.w.g. (p.v.c.)
L ₂	3½ turns	22 s.w.g. (p.v.c.)
L ₃	4 turns	18 s.w.g. (p.v.c.)
L ₄	1 turn	14 s.w.g. (p.v.c.)
L ₅	7 turns	26 s.w.g.
L ₆	2 turns	14 s.w.g.
L ₇	4 turns	18 s.w.g. (p.v.c.)

if observations are being made of rapidly fluctuating sources a short time constant may be useful in order to record these sudden fluctuations. On the other hand, when observing long period variations a longer time constant is more satisfactory. The values shown in Fig. 23 are arbitrary and will in fact give time constants of one-tenth of a second and of one second. For some work which will be described later it may be necessary to use a time constant of several seconds. When using communications receivers, this unit can obviously be incorporated in the receiver using the existing power

supply. A suitable meter would be one having a full scale deflection of 1mA, although this is not absolutely necessary. The requirements are that the meter shall be sufficiently sensitive to enable accurate measurements to be recorded in action by direct observation. It would, of course, be used as a guide point when plotting a graph with readings taken say every half or one second, or even longer. This will enable a graph to be plotted against time. If the translator is used with a tape recorder it will be necessary to arrange for the output of the recorder to be at a sufficiently high level to be fed into the unit. Where long periods of observations have been made with the tape recorder, much of the time may show little variation in level. The time taken to reduce this to graph form can be reduced by speeding up the tape on replay, the record given will be quite valid provided the time shown on the graph is corrected. The amplitude of the variations will not, of course, be affected by the change of speed.

Those who propose to use a turret tuner and the Pye i.f. strip will find that modification of the output at the detector is required. The circuit for feeding a pen recorder from the Pye strip is shown in Fig. 24, this also having the variable time constant. For use with the translator, the Pye strip could

**Components List
(Receiver IF Section)**

Resistors

R ₁	33kΩ
R ₂	47kΩ
R ₃	2.2kΩ
R ₄	180Ω
R ₅	22kΩ
R ₆	33Ω
R ₇	68Ω
R ₈	2.2kΩ
R ₉	22kΩ
R ₁₀	2.2kΩ
R ₁₁	33Ω
R ₁₂	68Ω
R ₁₃	22kΩ
R ₁₄	100Ω
R ₁₅	2.2kΩ
R ₁₆	22kΩ
R ₁₇	150Ω
R ₁₈	470Ω

Valves

V ₁	6AK5
V ₂	6BW7
V ₃	6BW7
V ₄	6BW7
V ₅	6BW7

Capacitors

C ₁	1000pF
C ₂	1000pF
C ₃	1000pF
C ₄	8μF 350wV
C ₅	2000pF
C ₆	2000pF
C ₇	1000pF
C ₈	2000pF
C ₉	1000pF
C ₁₀	2000pF
C ₁₁	1000pF
C ₁₂	2000pF

C ₁₃	1000pF
C ₁₄	2000pF
C ₁₅	1000pF
C ₁₆	3000pF
C ₁₇	1000pF
C ₁₈	2000pF
C ₁₉	1000pF
C ₂₀	3000pF

TABLE 2

L ₁	9 turns tapped at 3 turns	26 s.w.g.
L ₂	"	"
L ₃	"	"
L ₄	"	"
L ₅	12 turns	26 s.w.g.
L ₆	7 turns	26 s.w.g.

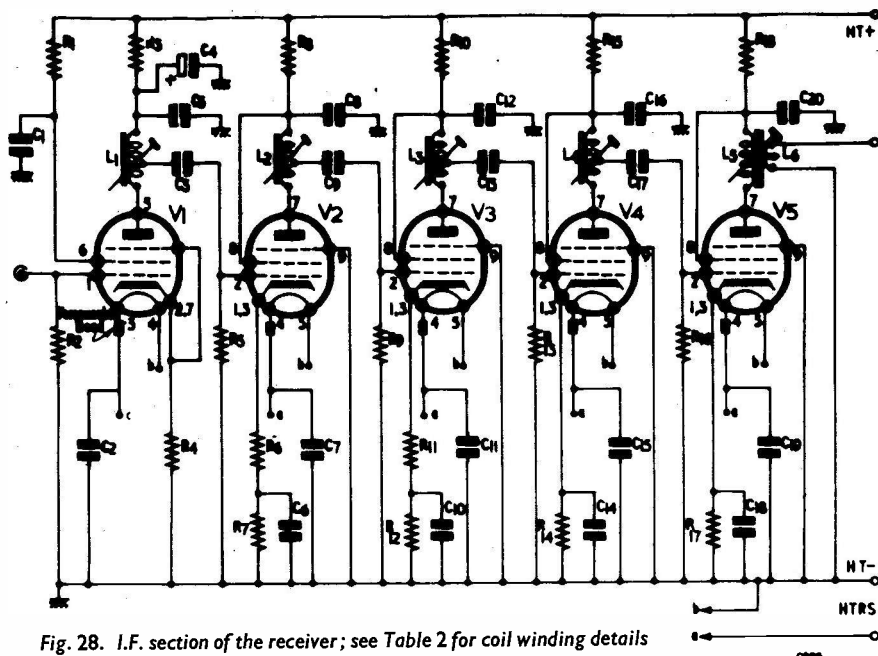

Fig. 28. I.F. section of the receiver; see Table 2 for coil winding details

have the conventional audio frequency stage after the diode, this then being followed by the translator. It is important to have an audio stage to which a loudspeaker is connected, thus enabling the observer to listen to the various changes in level. Indeed, when working in the workshop with the loudspeaker switched on, any sudden change or special phenomena which takes place will be immediately apparent. Attention can then be turned to the apparatus directly and, if necessary, plots made from the translator while the phenomena is in progress. This is particularly interesting in the case of the active Sun, for sometimes the sudden increase in noise is of such an amplitude that the audio stages may even become overloaded.

Pen Recorder D.C. Amplifier

For the sake of completeness in dealing with

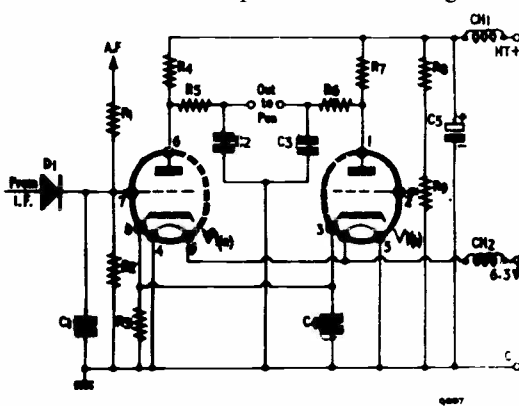

Fig. 29. Circuit of the pen recorder unit

Components List (Pen Recorder Unit)

Resistors

- R₁ 220kΩ
- R₂ 1MΩ
- R₃ 500Ω
- R₄ 22kΩ
- R₅ 3.3kΩ
- R₆ 3.3kΩ
- R₇ 22kΩ
- R₈ 100kΩ
- R₉ 25kΩ pot.

Valve

- V_{1(a), (b)} 12AU7/ECC82

Capacitors

- C₁ 50pF
- C₂ 0.02μF
- C₃ 0.02μF
- C₄ 5000pF
- C₅ 50μF 350wV

Chokes

- CH₁ Interference suppressor choke (1A)
- CH₂ 4 turns 18 s.w.g. insulated

Diode

- D₁ Germanium Diode

existing apparatus a d.c. amplifier for the pen recorder is included. This is shown in Fig. 25. The amplifier is again quite a straightforward piece of apparatus and may be used by the more ambitious in place of the translator. In this case, of course, it will have to follow a circuit containing a time constant. Referring back to Fig. 24 it will be seen that it may be either added to the Pye strip or the diode section of the communications receiver, (the latter being then modified). This unit requires a stable source of h.t. supply and it should perhaps be noted that stability of the supply is very important. Should there be any doubt about this aspect of the apparatus, steps must be taken to ensure that reasonable voltage stability is obtained.

Noise Generator

The apparatus so far described forms now, with the aerial, the complete radio telescope. It is however necessary to make a calibration of the noise level and this can best be done with the use of a noise generator. Fig. 26 shows the circuit of a simple piece of apparatus containing a silicon diode and a meter. The control R₂ sets the level. The noise generator is used as a comparator. The noise input is fed into the aerial terminal of the receiver and the level of output noted. The generator is then disconnected and the aerial itself connected to the receiver, this should produce a rise in reading. The position of the control on the noise generator should be noted, for this will now become the reference point. In cases where the extra-terrestrial radiations are near to, or possibly even less than, that of the noise generator, comparison of the two inputs will show whether or not there has been a change in the level for, having established the setting on the noise generator, comparison of the two positions will show to what extent it has been changed. It is advisable to check the receiver once at the beginning and once at the end of the period of observation if these are short, or once a day if long-term observations are being made. The noise generator will be found to be an extremely useful piece of apparatus for it provides an immediate check on the condition of the receiving system. It is of more value for our purpose than the standard type of signal generator which deals with a particular frequency only. It must be remembered that, although our receiver is set to the middle of the band, it was noted earlier that noise voltages received by the aerial cover an infinite band of frequencies. The output of a noise generator corresponds more nearly to the energy received by the aerial than does the ordinary signal generator modulated with an audio frequency source.

The Receiver

We next discuss a particular receiver which was developed for the purpose of these articles. It is a modification of a receiver originally designed for use between 200 and 240 Mc/s and the first prototype was in fact demonstrated to the Duke

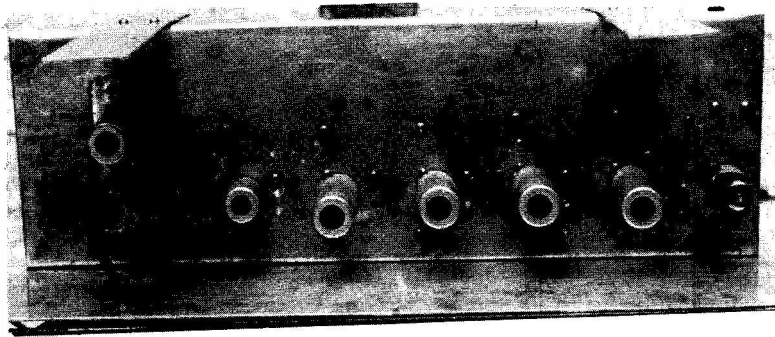

View of the top of the receiver chassis showing the valve line-up

of Edinburgh on the occasion of the opening of Crawley Technical College, where there had been installed a portable radio telescope of the author's design. The majority of the development work on this receiver has been directed to making it simple in design and easy to build. The circuit has been broken down into three sections for the sake of clarity. These three sections are shown in Figs. 27, 28 and 29. The input from the aerial is fed into the transformer, L_1 , L_2 , and from thence to the grid of one-half of V_1 (a) which is cascode coupled to the other half, V_1 (b). From there it is fed to the double-triode frequency changer. It will be observed that this follows conventional practice. The layout is important and details of this can be seen in the accompanying illustration¹. The output from the r.f. section is fed into the i.f. stages, which again are conventional although considerable development work was necessary to provide stability with high gain. The layout will be apparent from the photograph. The output section includes the diode and the pen recorder unit with provision for a.f. monitoring.

This receiver has been designed nominally for operation for 210 to 220 Mc/s but modification of the r.f. section is all that is required to make it suitable for the other frequencies for which the aerial was designed. Within the limits of space available the individual amateur can choose his own frequency at any point between 60 and 240 Mc/s. The power supply chosen for this receiver is one of the many which are available on the surplus market at a reasonable price. That employed by the writer is the ex-R.A.F. unit type 234A

The complete receiver with pen recorder and power unit is shown in the illustrations. For the sake of completeness in this part of the series, it is necessary to show what the receiver actually does and a further illustration shows two of the recordings made during tests in the past seven weeks.² One trace shows the Sun passing through the beam of the aerial and the other shows a section

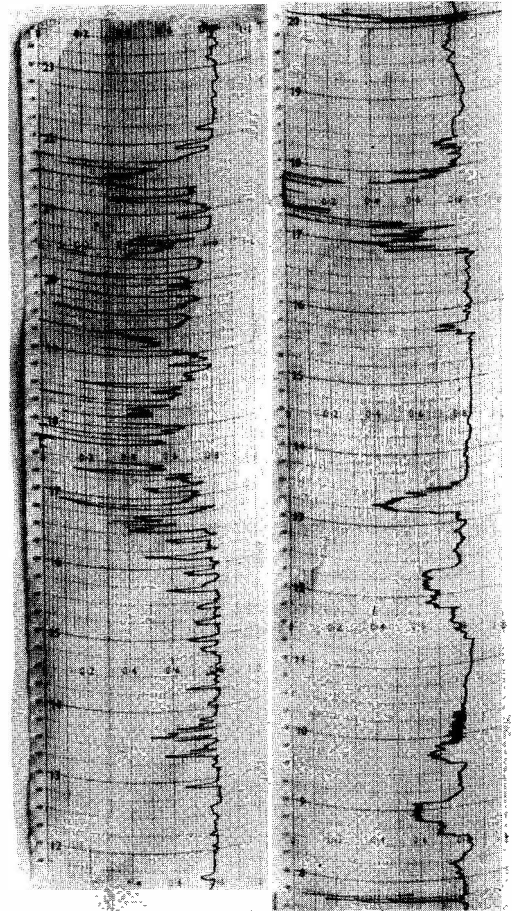

Pen recordings showing (at top) passage of the Sun through the aerial beam and (below) part of the Milky Way (Sagittarius-Area) passing through the beam.

of the Milky Way. The difference between the types of radiation received are clearly visible on these charts and the amplitude of the variations can be readily seen. Those amateurs who enter this field will find that the interpretation of these results is, indeed, a fascinating pursuit.

(To be continued)

¹ In the photograph L_1 , L_2 are farthest away from the variable capacitor. L_4 is between the valveholders and L_6 is below the variable capacitor. L_5 is close to the screen, through which the output lead to the i.f. section passes. Oscillator coupling to the mixer is by way of stray capacitive and inductive couplings.—EDITOR

² Up to November 10th 1961.—EDITOR

The JR1/JTL Stereo Tape Recorder Unit

PART 4. By G. BLUNDELL

The JR1 JTL Stereo Tape Recording Unit offers stereophonic record and playback facilities, together with instantaneous tape monitoring. It is employed with a stereo amplifier. The unit can also allow all tape tracks to be recorded and played back in conjunction with a monaural amplifier or amplifiers, the instantaneous monitoring facilities still being retained for this application

THE JTL TAPE LINK HAS BEEN PRIMARILY DESIGNED to use with the Jason J2-10 Stereo Amplifier, but equally successful results have been obtained with other amplifiers, after a few minor modifications have been made. Notes on converting a Leak Varislope Stereo pre-amplifier were made in conjunction with Teleradio (1943) Ltd., of 189 Edgware Road, London, W.1., who have co-operated throughout and who would carry out these modifications for a nominal fee. While these modifications to the Varislope Stereo have been discussed with Messrs H. J. Leak & Co. Ltd., it can be readily understood that they can in no way be responsible for any modifications so made or the results obtained.

The object of these modifications is to separate the first stage of the pre-amplifier from the final stages, so that, as explained elsewhere, the first stage can correct the signal which is being applied to the tape, whilst the tone controls are being used on playback. Switching off the JTL then leaves the amplifier operating as though the tape unit were not connected.

Varislope Stereo

- (1) Remove top and bottom covers.
- (2) Remove two leads connecting the "Extra" sockets to the gain switch, which is mounted immediately below.
- (3) Remove two leads connecting the "Record" L and R sockets to the volume control (P₄₁ and P₄₂) at the extreme right of the front panel.
- (4) Refer to the layout diagram on page 5 and the circuit diagram page 6 (of the Varislope manual) and locate the junction of C_{14R} and C_{15R}. Trace the lead from this junction to C_{17R} and R_{30R} on top of the tagboard. Disconnect this lead at the junction of C_{17R} and R_{30R} and reconnect to the "Record R" socket. If the lead is re-routed it may be long enough, otherwise replace with a longer wire.
- (5) Again, refer to diagrams and locate C_{14L} and C_{15L}. Disconnect C_{17L} from the tagstrip. Disconnect R_{30L} from the tagstrip. Reposition R_{30L} pointing towards C_{17L}. Join a length of tinned copper wire to R_{30L} and cover with 2in

of sleeving. Join the other end of this wire to C_{17L} and from this joint a further length of wire is connected to the "Extra L" socket.

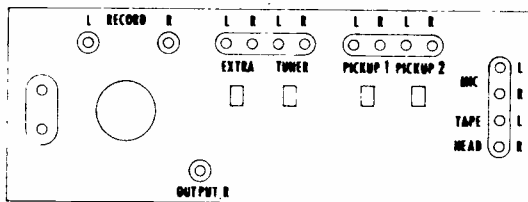

Rear view of the Leak Varislope Preamplifier

(6) Find the junction of R_{30R} and C_{17R} with the unit upside down and the front facing away. This junction is on the 9th tag from the left on the edge of the board nearest the controls. Connect this junction to the socket. ("Extra R".)

(7) Find the junction of C_{14L} and C_{15L}, which is on the 8th tag from the left. Connect this junction to the "Record L" socket.

(8) Find the junction of C_{14R} and C_{15R} and connect a 10MΩ resistor from this point to tag 3, which is connected to chassis.

(9) From the junction C_{14L} and C_{15L}, which is tag 8 as previously mentioned, connect a 10MΩ resistor to tag 3, from the left, on the front row. These last two resistors are required to prevent a charge building up on capacitors C₁₄ and C₁₅ when the monitor switch is operated. Normally the connection to the tone control circuit through R₃₀ prevents this voltage appearing.

(10) If the Leak pre-amplifier is to be used before the JTL is obtained, the sockets must now be joined together externally otherwise there will be no output. Two 6in lengths of screened wire are required with the appropriate plugs at each end. With these leads, join "Extra R" to "Record R" and "Extra L" to "Record L". With these leads in position the performance of the Varislope pre-amplifier will be in no way altered from the original specification.

If the Leak pre-amplifier was manufactured before September 1960, it may be necessary to carry out a further modification. Referring again

to the layout and circuit diagram, find the junction of R_{9R} and R_{8R} and see whether this is connected to C_{3R} . If C_{3R} exists, it should be short-circuited so that the above junction connects directly to R_{7R} . The same modification is required on the other channel and if C_{3L} exists, it should also be short-circuited.

This modification is required because with C_3 connected, operation of the monitor switch results in clicks being recorded on the tape, due to the discharge of C_3 . It should be emphasised again that deliveries since September 1960 of the Leak pre-amplifier already have this modification included.

(Conclusion)



By RECORDER

THE PHOTOGRAPH ON THIS PAGE is a visual presentation of sound. We have to reproduce it here in black and white, of course,

but it would appear in practice in one or more colours. The pattern is obtained by electronic means on the screen of a cathode ray tube, and it represents just one of an infinite variety of figures which can depict sounds in abstract form. It is a simple example, in fact, of what is offered by very recent developments in the art of Chromasonics.¹

¹ "Chromasonics" is a Registered Name.

Chromasonics

Mr. F. C. Judd is well known in audio and home-constructor circles as a protagonist in the field of electronic music and *musique concrète*², and I am indebted to him for the details he has passed on to me concerning Chromasonics.

The term Chromasonics was coined to segregate abstract visual presentation of sound in colour from normal colour films having their own sound tracks. In the latter case there is complete co-ordination of aural and visual impressions because it is the primary function of the sound track to provide sound which is synchronised with the actions and speech of the film characters (live or cartoon), and which stresses the changing emotions dictated by the plot. With Chromasonics the visual display is still directly related to the sound but, in this instance, its purpose is to provide abstract aesthetic impressions to further emphasise the character of the sound reproduced. Chromasonics can enhance enjoyment by creating patterns and colours which move and change to the mood of different kinds of music; an obvious instance being given by rhythmic movements with rhythmic sound.

What could be described as a crude form of abstract visual presentation is given when displays of coloured lighting, in conjunction

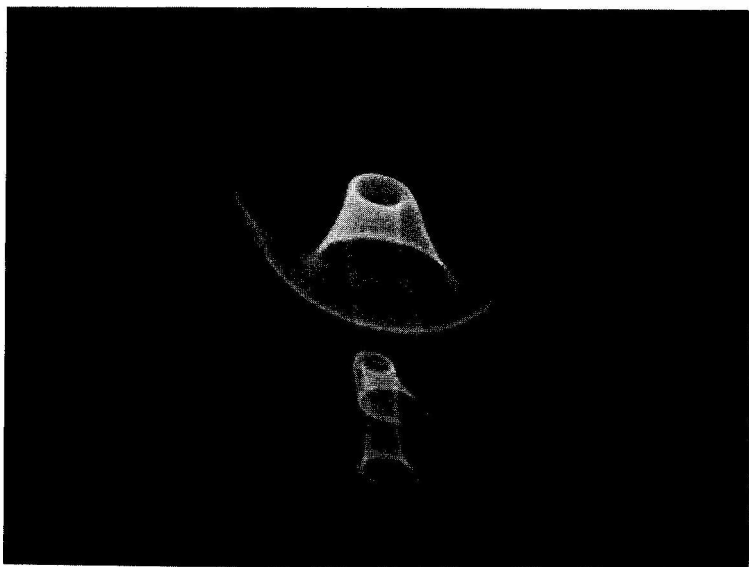

Chromasonics: sound in the abstract

² See for instance Mr. Judd's articles: "Electronic Music", *Wireless World*, September 1961; and "A Console Recorder For *Musique Concrète* and Electronic Music" *The Radio Constructor*, August 1960.

with music, are employed to create pleasing effects at exhibition displays or in the cinema during intervals. On a much more impressive scale are the Vortex concerts of electronic music held annually in U.S.A., these being invariably presented

up a long, medium and short-wave job and he bumped into a snag which baffled him completely. Although the cause of the fault is an "oldie", it is still not generally known. So I shall relate what happened in this case.

Fig. 1 shows the oscillator circuit employed, and Fig. 2 (a) the neat way in which my friend had laid out the coils. (Knowledgeable readers may now skip the rest and carry on at the next sub-heading!) After one look I tuned the receiver to 450 metres with the signal generator connected, and increased the capacitance of the long-wave trimmer. As I adjusted the trimmer medium-wave sensitivity rose at once, and after I had given the adjusting screw a turn or two the receiver worked perfectly over the entire medium-wave band, with no peculiar hops in frequency or anything like that at all.

The trouble, of course, was absorption. When it was switched out of circuit the long-wave coil still had the trimmer connected across it. This now provided the only parallel capacitance and resulted in the long-wave oscillator grid coil resonating at the oscillator frequency which corresponded to 450 metres on the dial. In consequence it formed an absorption tuned circuit which took a considerable amount of energy out of the medium-wave oscillator coil at this point, as well as causing the queer

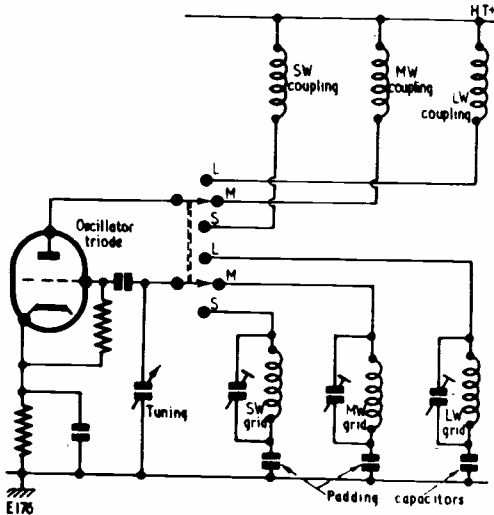

Fig. 1. A simple oscillator circuit, which gave peculiar results on the medium-wave band circuit

with coloured illumination, together with moving coloured patterns of light and projected coloured abstract or geometric shapes.

The pattern illustrated here represents a significant breakthrough from these other forms of Chromasonics, and it is made possible by sophisticated techniques which have been recently developed. These techniques are employed in two different display systems. The first of these consists of presentation on a cathode ray tube by the use of low frequency signals and mechanically scanned colour systems, recording and complete synchronisation (between sound and visual display) being given by way of magnetic tape running at slow speed. The second is direct projection on to a large screen of pulsed light controlled by sound recorded on magnetic tape, with colour and images produced by mechanical scanning.³

It will be interesting to watch future progress in this new and unusual off-shoot of electronics.

Absorption Effects

Despite the introduction of v.h.f. sound transmissions, home-constructors are still very interested in broadcast band receivers. A friend of mine has, indeed, just knocked

³ Both these systems are the subject of patent application by Mr. F. C. Judd.

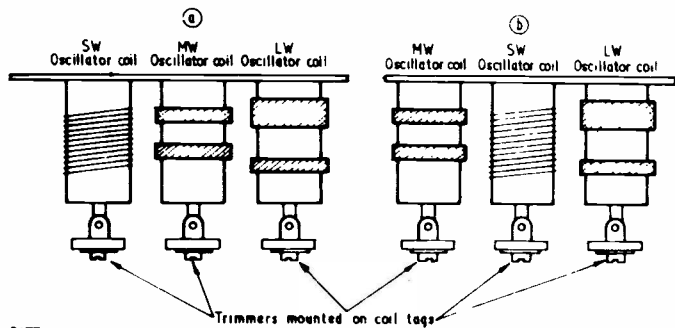

Fig. 2 (a). The coil layout originally employed for the oscillator (b). The revised coil layout

The receiver, which was a superhet, worked excellently on long and short waves, as well as over the high frequency end of the medium-wave band. Round about 450 metres, however, sensitivity dropped. When my friend tried the medium-wave range with a signal generator, the dial calibration held accurately enough until the mysterious 450 metre region was approached. The set tuning then hopped several kc/s at that point. Obviously, there was trouble in the oscillator circuit.

hop in frequency. The cure was to change the layout to that of Fig. 2 (b), whereupon the medium- and long-wave coils were spaced further apart from each other, a useful bit of screening being provided by the short-wave coil in between.

If you're surprised at the fact that a long-wave oscillator coil can ascend to the heights of the medium-wave band, a look at some typical facts and figures may be of interest. Assuming a medium-wave range of 500 to 1,500 kc/s (600 to 200 metres), the medium-

wave oscillator covers (with 465 kc/s i.f. transformers) 965 to 1,965 kc/s. The corresponding long-wave oscillator frequency range (assuming a dial coverage of 2,000 to 800 metres, or 150 to 375 kc/s) is 615 to 840 kc/s. If the long-wave oscillator trimmer is set to a fairly low capacitance, it is pretty easy to imagine that switching the long-wave coil out of circuit (with the consequent disconnection of stray wiring capacitances, valve capacitances, and minimum tuning gang capacitance) can easily cause the grid coil to jump up from a top frequency of 840 kc/s to 965 kc/s or more.

In the past, this effect has been one of the main reasons why many coil-packs have the short-wave oscillator coil mounted between the medium- and long-wave oscillator coils. In the absence of a short-wave coil, the trouble can of course be avoided by adequate spacing between

An Interesting Discharge Circuit

Mr. D. E. Launchbury, of Leamington Spa, has sent in details of an interesting discharge circuit. The circuit appears in Fig. 3 and, as may be seen, it consists for the most part of a fairly conventional tape recording level indicator arrangement. The a.f. voltage fed to the record head is applied also, via R_1 , to diode $V_1(a)$, this rectifying and causing an appropriate negative potential to be applied to the grid of the Magic-Eye, V_2 . The latter then offers a display corresponding to the peak level of the applied a.f. It is normal to have a capacitor and resistor in parallel connected between the Magic-Eye control grid and chassis in order to provide a relatively slow decay in the display, and time constants here for commercial recorders are usually of the order of 0.2 to 0.3 seconds. Such time constants necessitate a relatively large value in the capacitor

of the circuit. An arbitrary indication of discharge time (given by the Magic-Eye display) was used, and this was probably significantly longer than the time constant of a capacitor and parallel resistor.

Discharge time with $V_1(b)$ and C_3 disconnected was 60 seconds. In this instance C_2 discharged via circuit leakage paths.

Discharge time with $V_1(b)$ and C_3 in circuit as in the diagram was 15 seconds. Since $V_1(b)$ anode was coupled to one side of a centre-tapped heater line it received an a.c. potential of 3.15 volts relative to chassis.

Discharge time with $V_1(b)$ anode connected to chassis was 25 seconds, whilst discharge time with $V_1(b)$ anode connected to 6.3 volts a.c. relative to chassis was 13 seconds.

From these results it would appear that C_2 discharges more rapidly when the a.c. voltage applied to V_2 anode is increased. Also, the combination of 30pF capacitor and diode (particularly with a.c. on its anode) would appear to cause a marked decrease in discharge time when they are initially applied. Incidentally, capacitor C_3 has been thoroughly checked and appears to be 100% both for capacitance and leakage.

Technical News

That well known speaker fabric "Tygan" (manufactured by Fothergill & Harvey Ltd., Littleborough, Lancs.) has exceptionally low sound absorption because it employs polyvinylidene chloride yarn. Tests have shown that such yarns, used in speaker fabrics, can even give a 2% increase in sound. This is because they do not absorb the sound but reflect it back into the speaker.

Do you remember those miniature metal-cased Sprague 0.1 and 0.01 μ F capacitors that appeared in such large numbers after the war? You may well be seeing quite a few more Sprague products in the future, as the result of an agreement between Sprague Electric Company and the Telegraph Condenser Company. By means of the agreement, Sprague and T.C.C. now share their research facilities, manufacturing experience and know-how; also T.C.C. are the sole distributors for Sprague products in the U.K. Sprague Electric Company is the largest manufacturer of capacitors and electrical components in America.

Seen at the recent Engineering Materials and Design Exhibition at Earls Court—knitted "armour" suits for protection against injury from micro-waves in radar stations.

Fig. 3. A discharge circuit whose operation is discussed in the text

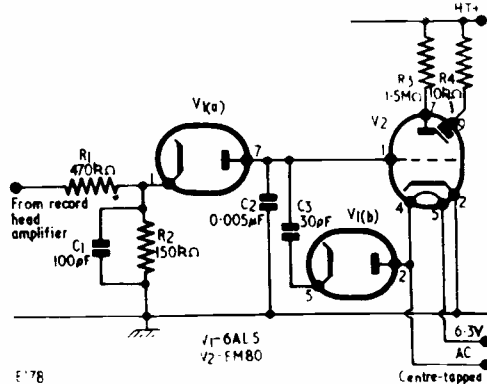

the two coils or by mounting them at right angles.

Hitting The Jackpot

Talking of "oldies" reminds me that this is how colleague W. Holmes referred to one of his "Gadgets For Your Christmas Party" in last month's issue. The gadget consisted of a metal ring which was moved along a bar. When the ring touched the bar a bell sounded.

Those of our readers who watch the I.T.V. programme "Sunday Night At The London Palladium" will, of course, have seen the self-same gadget employed in the Jackpot Prize contest. This particular Jackpot series commenced after W. Holmes' article was written and set up, and we note that the London Palladium version of the bar sported considerably more bends and turns than did ours!

if the parallel resistor is not to have a value greater than the maximum Rg-k permissible with the Magic-Eye.

It was desired to obtain a long time constant without increasing the value of the storage capacitor since, to maintain the same charge time, such an increase would have necessitated a lower value of series diode resistance with the risk of loading on recording peaks. In consequence, the arrangement shown in the diagram was devised. In this a second diode, $V_1(b)$, in series with a 30pF capacitor, C_3 , is connected across C_2 which has the relatively low value of 0.005 μ F. And this is where the interesting part begins, because C_2 discharges more rapidly when the 30pF capacitor and $V_1(b)$ are applied than when they are disconnected.

The following discharge times were recorded for different arrange-

The suits are very flexible and light in weight, and are made of a mesh of silver-copper material.

The largest international exhibition ever to be staged in Britain is planned for April 23rd to May 2nd, 1963. This will be known as The London International Engineering Exhibition, it will occupy *both* Olympia and Earls Court, and it will cater for every type of engineering product from the largest items of capital equipment to the smallest component.

Rechargeable portable TV bat-

teries are now available in this country from G. A. Stanley Palmer and Co. Ltd., Maxwell House, Arundel Street, W.C.2. These are DEAC units, 6 volt versions of which are available in either 4 amp-hour or 6 amp-hour capacity. The batteries can provide 2 and 3 amp outputs respectively for five hours of continuous use, recharging being accomplished via inbuilt circuitry when the associated TV receiver is plugged into the mains. The DEAC batteries can be operated in any position, and they are entirely

free from gassing, swelling, fumes and corrosion. They are guaranteed for a year or 300 recharges, whichever is the less.

Signing Off

And, now, let me end this month with the wish that all readers have a truly happy and prosperous New Year, with all equipment working immediately after the last solder joint has been made and with television tubes and transistors down to a tanner each.

All the best for 1962!

A Constructor's Wife . . .

a warning to constructors and to any girls considering marrying one

By MRS. J. ANDERSON

Mr. J. A. Anderson, who is one of our regular contributors, tells us that he has been more or less ordered to send this article on to us. (And asks us to make the cheque payable to him.)

—Editor.

AT THIS TIME OF YEAR MANY GIRLS ARE THINKING of getting married, and I am sure that quite a high percentage of them have no idea what they are in for if their future husband is keen on electronics, especially as this is sometimes concealed from them.

I thought that my husband must be very clever, being able to understand radios and things, and that he would be very useful in the house. Now, I'm not so sure about this . . .

We have a "house phone", so that I can tell my husband when a meal is ready if he is working in his workshop. A good idea? If you had only seen the floorboards that were up, the dirt that came out of them! To be quietly working in the kitchen and suddenly he startled by a loud and decidedly unmelodious buzzing, and then, perhaps having interrupted some particularly delicate cooking operation to answer it, be greeted by a request as to whether I have seen some tool or other which I've never even heard of, is not funny any more.

About once every two months, some small and inconspicuous plug appears on the skirting board. When there are more than five or six of them in several rooms, it becomes a little trying, especially when I forget which one is for the vacuum and which for the radio extension.

We had a thing for answering the front door electrically, so that from the kitchen I could ask who was there through a microphone or something: apart from the fact that I never could remember which button to press to speak, we nearly had to go to court when something went wrong and a sheet of flame blew the milkman's eyebrows into a new shape!

There was another thing for ringing a bell when

it began to rain, so that I wouldn't have to keep one eye on the weather on Mondays . . . What my husband didn't say was that the bell was an ex-government alarm gong which nearly gave me a heart attack when it went off: and the first time it did so, I couldn't turn it off, it had a "locking relay" in it so that if I was upstairs it would still be on when I came down to the kitchen. I had to phone him, 300 miles away, to ask him how to stop it.

Only a week ago, I woke up at about three in the morning, and thought my husband was having an epileptic fit and wandering about the house hurting himself, there was such a strange bubbling and gurgling coming from downstairs and he wasn't in bed. On going to see what was wrong, I found him sitting with his radios, trying to "get Australia" . . . the noise was interference! Often I have been called away from the phone, or from the oven, or even from a guest, because "Old Bill in Honolulu wants to say hello." The majority of our friends seem to live in a heap of grey steel boxes; we certainly haven't got as many as we used to have locally, because even after the time when the steel poles which hold up the aeriels fell down and broke some rose trees and a fence or two, the steady procession of people on a Saturday afternoon didn't stop . . . "Hello, Mrs. Anderson. Is your husband in? I was watching the Test Match and all of a sudden the television went funny, voices and things and a sort of snowstorm on the screen." Oh, dear me.

One day last year I wanted to go to a garden party, but we had to get the car out and go miles and miles, with an incredible stock of food, for a "Field Day". This wasn't much fun either . . . I sat all

day in a car listening to whizzing noises from the boot and everywhere else, whilst we dashed from place to place meeting cheery men with headphones and handlebar moustaches who called my husband by an unspeakable nickname which he apparently picked up at college . . . Then when I said I was bored I was given a little dial to watch, and I had to say "UP" when the pointer got to the highest point: that gave me a headache.

About the middle of 1960, my husband advertised some gadget he had made to work off the mains, because he didn't want it any more. He *said* he had put "callers only", but I spent most of the day answering the phone; we even had two telegrams: the thing was sold by eleven in the morning to one of the innumerable men who thundered at the front door!

If you aren't discouraged yet, then buy a book on first-aid. Several years ago, when we lived in London, I was sitting enjoying a cup of coffee and reading the paper one morning, when there was a sort of scraping at the back door; I opened it, and my eldest son CRAWLED in on his hands and knees,

as white as a sheet, and shaking all over. He gasped something about electricity, and collapsed. The doctor, who was one of these awful radio people as well, roared with laughter and said that a few free electrons in the body isn't as bad as people think: I don't know what that means, but I've always remembered it because it annoyed me so much! My husband has a scar on his chin, a mark which is all that is left of a hole *straight through his thumb*, and at this moment a wad of bandages conceals his right arm from wrist to elbow: and he's a dentist, that hole in his thumb could have lost him a job. . . . Although then perhaps he wouldn't have been able to afford all these radios and things!

Now, think about that lot, you girls who are being blinded with science. Our television is in pieces at the moment, there are more knobs on the radio, which *was* a beautiful wedding present, than I know what to do with, we're losing our friends, my sons have got the disease, the kitchen table has a soldering-iron burn on it, my husband is still trying to disable himself, and I can't even get a decent sleep nowadays.

And, men, take this as a warning!

Resistors and Capacitors as Mains Droppers

By J. B. DANCE, M.Sc.

IN ORDER TO AVOID THE COST, BULK and weight of a mains transformer, it is common practice to supply valve heaters from the mains with the use of a series resistor to drop the mains voltage to the required value. It is not so well known, however, that if the mains supply is a.c., a series capacitor can be used instead of a resistor to drop the mains voltage. The advantages

and disadvantages of the two methods will be discussed in this article and graphs are given which will enable the required value of the dropping resistor or capacitor to be quickly found for most practical cases.

Series Resistor Circuits

A circuit employing a series resistor, R , to drop the mains

voltage for valve heaters is shown in Fig. 1. The same current passes through each of the valve heaters in the circuit shown and it is therefore necessary that they shall all have the same current rating, I .

Let the total voltage across all of the valve heaters = V_v , and the voltage across the series resistor $R = V_R$. The current and voltage are in phase (as the circuit is purely resistive) and therefore the mains voltage, V_M , must be equal to $R R + V_v$. The value of the series resistor, R , which is required can be calculated from Ohm's Law:

$$R = \frac{V_R}{I} = \frac{V_M - V_v}{I}$$

If it is assumed that the mains voltage is 240, the value of R required can be found immediately from the graphs of Fig. 2 (which are based on the above equation) provided that the valves used require one of the four values of heater current shown in the graphs. Almost all modern valves require a heater current equal to one of the values shown.

Example

Suppose it was desired to con-

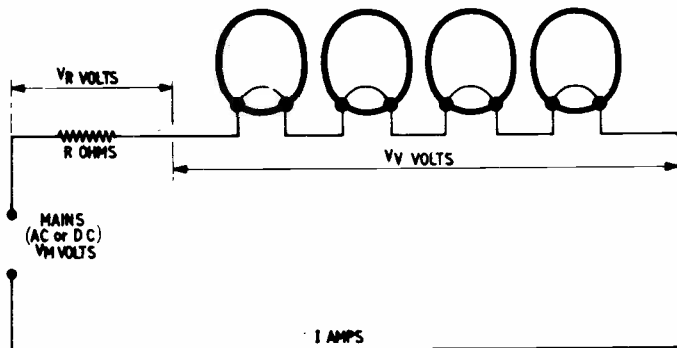

Fig. 1. A series connected resistor as a mains voltage dropper

struct a piece of equipment containing a PCF80, a PCC84 and a PY80 rectifier. The heaters of these valves are rated at 9, 7 and 19 volts respectively, but as they are all rated to pass 300mA heater current, they can be connected in series. Let us imagine that a 6 volt 300mA dial light is to be connected in series with the valves to indicate when the apparatus is working. The total voltage, V_v , across all the valve heaters and the dial light is 41 volts. Using the 300mA line of Fig. 2, it can be seen that the resistor value required for R is about 667Ω . The preferred value of 680Ω would be quite satisfactory, but the resistor would have to be capable of dissipating 60 watts or more.

If one of the valves in a series heater chain requires a smaller heater current than the others, this can be achieved by placing a resistor in parallel with the heater of that particular valve. The resistor must have such a value that it passes the excess current when the voltage across it is equal to the rated voltage of the valve heater.

Series Capacitors

A capacitor can be used to drop the voltage of a.c. (but not d.c.) mains in a similar way to a resistor; a typical circuit is shown in Fig. 3. A resistor of about $680k\Omega$ should be connected across the capacitor so that it will discharge when the mains voltage is switched off, this preventing a shock from the capacitor should the mains plug pins be touched for some reason after the apparatus has been switched off and the plug withdrawn from the socket. A fuse should be incorporated in the circuit to prevent damage to the valve heaters in the event of the capacitor developing a short circuit. Under no circumstances should the use of an electrolytic capacitor be contemplated. A good quality paper capacitor rated at 250 volts a.c. working or more must be used.

Let the total voltage across all of the valve heaters be V_v as before (see Fig. 3) and the voltage across the capacitor be V_c . These voltages are not in phase with the mains voltage V_M . We can write:

$$V_c = \sqrt{V_M^2 - V_v^2}$$

$$V_c = I X_c$$

where X_c is the reactance of the capacitor. The following expression for C can be derived from these equations:

$$C = \frac{I}{2\pi f \sqrt{V_M^2 - V_v^2}}$$

where f = the mains frequency.

It is most convenient to express this equation in the form of the graphs shown in Fig. 4. This can only be done if definite values are assigned to the mains voltage and frequency. The graphs shown in Fig. 4 are for a 240 volt 50 c/s mains supply; graphs for four of the most common values of heater current are shown.

Example

Let us suppose it is required to

use two ECC81 (12AT7) valves in some apparatus. The heaters of the two sections of each valve can be connected in two ways (series or parallel) in order to provide a heater rating for the whole of each valve of either 12.6 volts at 0.15 amp or 6.3 volts at 0.3 amp. For use with a series capacitor, it is usually advisable to use the method of connection requiring the lower current, a smaller value of capacitor then being used. If the two valves are connected in

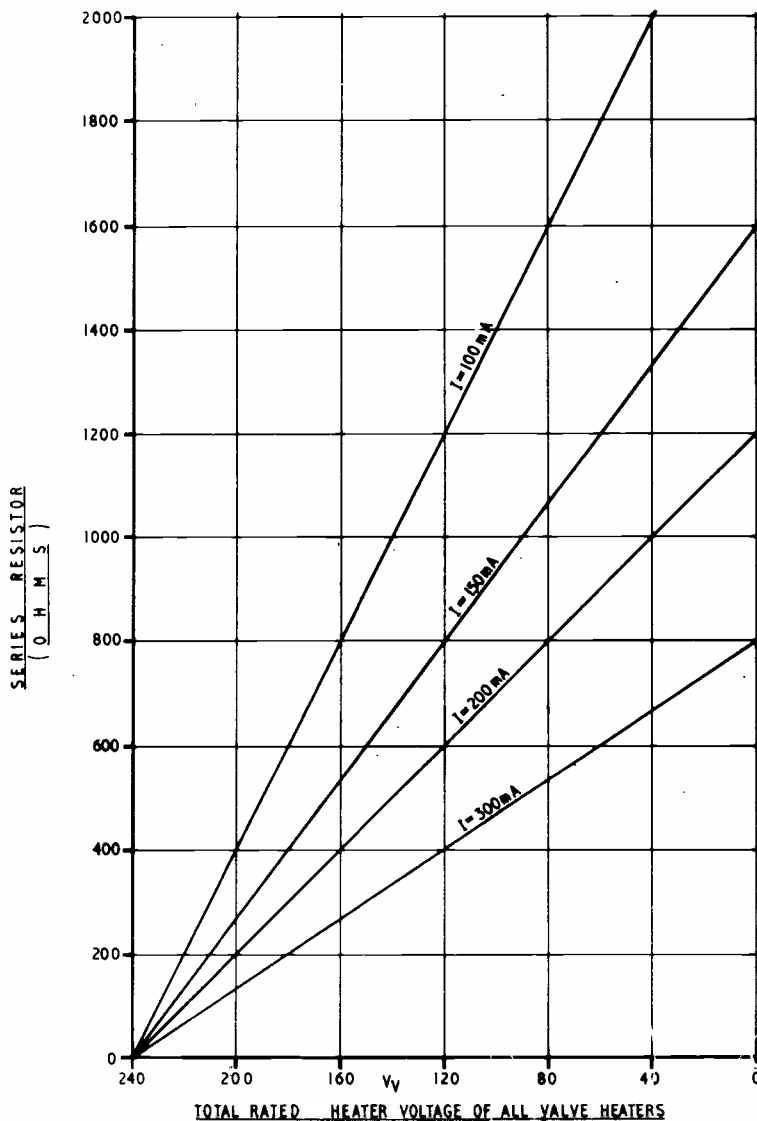

Fig. 2. These graphs enable the value of the series resistor to be found for 240V 50 c/s mains operation

series, the total heater rating will be 25.2 volts at 0.15 amp. Assuming the mains voltage is 240 volts, 50 c/s, the value of the series capacitor required can be found from the Fig. 4 graph; it is about $2\mu\text{F}$.

If the heaters of each valve had been connected so that they each required 6.3 volts at 0.3 amp, the value of the capacitor required would have been doubled.

Advantages and Disadvantages

The use of a capacitor instead of a resistor enables voltage dropping to be accomplished without any wastage of power. Circuits which employ resistors may have an efficiency of less than 20%. Voltage dropping resistors must be fairly large in order to dissipate the heat evolved. This heat may help to cause frequency drift in oscillators, etc. Whilst capacitors do not radiate any

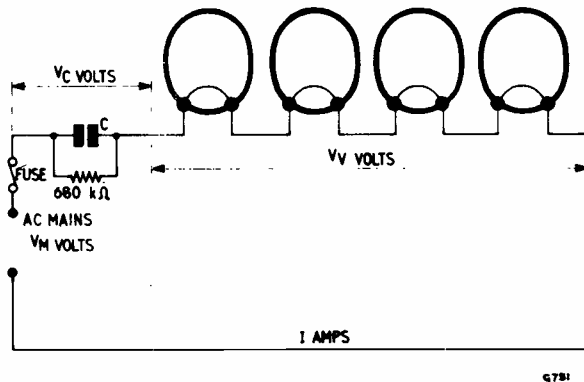

Fig. 3. A series connected capacitor may be used to drop the a.c. mains voltage

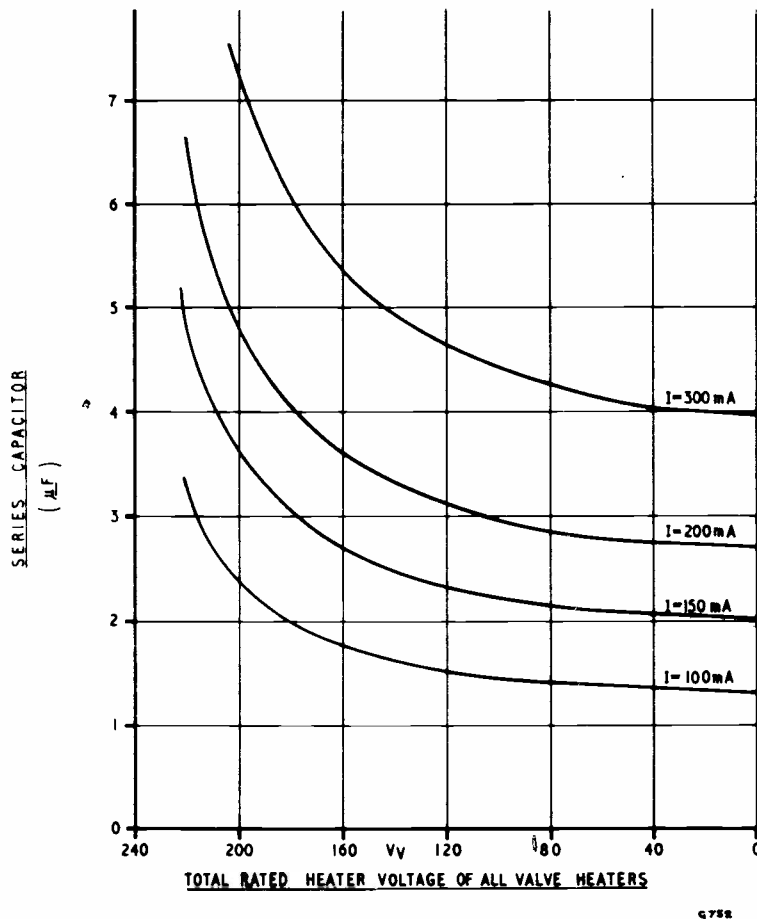

Fig. 4. Graphs showing the value of series capacitor required for 240V 50 c/s mains operation

heat when used as voltage droppers, it has already been mentioned that they cannot be used when the mains supply is d.c.

The use of a series capacitor enables the current during the warming up period to be kept at approximately the same value as the normal heater current. If dropping resistors are used, the low initial resistance of the valve heaters can lead to large heater currents during the warming up period. Whilst these large currents may enable the apparatus to warm up more quickly, it may result in shorter valve and dial light life.

Stability

A change of resistance of one of the valve heaters will cause a slight change in the total current passing through the heater chain. This change will be much smaller, however, if a capacitor is used as a voltage dropper instead of a resistor. This can be deduced from the fact that the slope of the graphs of Fig. 4 is much less than those of Fig. 2. A small change in the total voltage required by the valve heaters (V_v) when a capacitor is used causes a negligible change in the value of the capacitor required providing that V_v is fairly small. The use of a voltage dropping capacitor thus helps to preserve stability, especially when the total heater voltage is much smaller than the mains voltage.

Another advantage associated with the use of a series dropping capacitor is that an extra valve can be inserted in a heater chain without the necessity of changing the value of the capacitor, provided that the total heater voltage is less than half of the mains voltage. This would not be advisable in apparatus in which a series resistor is used.

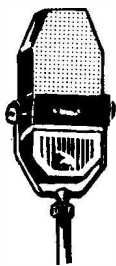

Emitter Follower Circuits

Part 1

LOW IMPEDANCE MICROPHONE PREAMPLIFIER

By **PETER WILLIAMS,**

B.Sc.(Hons.), Grad.Inst. P., Grad.I.E.E.

This is the first of a series of four articles, each of which describes a particular application employing emitter follower transistor circuits. A special feature of the series is that a standard set of components may be employed, if desired, to construct all the devices discussed. Despite this, the circuits are extremely non-critical so far as component tolerances are concerned, and alternative values are dealt with fully.

Of particular interest are the d.c. coupling and negative feedback arrangements employed by the writer, these not only reducing the number of components required but also permitting excellent stability to be maintained, together with flexibility in component values.

The devices described can provide a valuable introduction for the newcomer to transistor theory, and have the advantage of being somewhat more sophisticated than the "beginners' circuits" which are normally published.

BECAUSE OF THE HIGHER GAIN AVAILABLE, THE transistor is used most frequently in the common emitter configuration, i.e. with input between base and emitter, and output taken from collector to emitter. When coupling several such stages together, the loading effect on each stage of the previous one considerably reduces the gain, and this loss is further accentuated by the presence of bias and stabilising components.

By using the other configurations sensibly, matching input and output impedances, it is often possible to produce results as good as those of cascaded grounded emitter stages and at the same time reduce the number of components. The designs that follow make use of direct coupling of the first stage into the high impedance of an emitter follower second stage, and by d.c. feedback eliminating several of the stabilising resistors usually required.

D.C. Stability

The d.c. stability of the circuit used (Fig. 1) can be understood when it is realised that the emitter and base of TR₂ are at the same potential as the collector of TR₁ (ignoring the small potential drop across the junction as it is a diode biased in the forward direction). If now the collector current of TR₁ increases, due either to temperature rise or substitution of another transistor, then more voltage is lost across R_c and the base and emitter of TR₂ are brought closer to the positive supply line. Since the bias current of the first transistor is provided, through R_b, by the emitter voltage of the second transistor, this bias current will fall too, reducing the collector current to something near its original value. Similarly, if the collector current of the second transistor increases, the increased voltage across R_e drives more bias into the first transistor, causing the collector current to rise and lowering the collector potential. This in turn returns the

base and emitter of TR₂ to a lower value. Each transistor thus provides the bias for the other, and the combination can cope with more widely varying conditions than if biased separately.

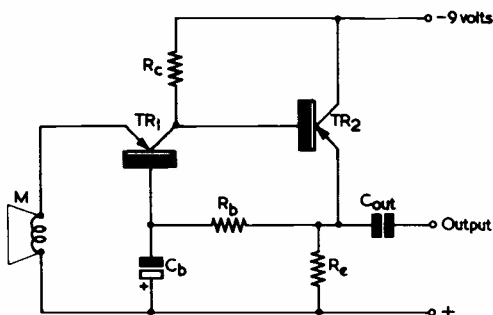

R_c = 22k Ω

R_b = 330k Ω

R_e = 4.7k Ω

C_b = 16 μ F

C_{out} = 0.1 μ F

TR₁, TR₂ = Audio Transistors (Red-spot, OC71's etc.)

M = Low Impedance Earphone

M214

Fig. 1. Circuit diagram of low impedance microphone preamplifier

A.C. Operation

When we consider the a.c. operation of the circuit, we see that the base of TR₁ is earthed via C_b. This prevents loss of gain through signal negative feedback without disturbing the d.c. feed-

back described above. The signal voltage across R_e will be only slightly less than that across R_c because of the low junction impedance. At first sight it might seem from this that the second transistor is serving no useful purpose other than to establish the d.c. operating conditions. In fact, it also acts as a buffer and prevents much of the gain of the grounded base stage from being thrown away.

A practical example will illustrate this quite clearly. Since the emitter and collector currents of TR_1 are almost equal, the input current in this arrangement must also flow through the load resistance. This makes the voltage output directly proportional to the load and

$$\text{Voltage gain} = \frac{\text{Load resistance}}{\text{Input resistance}}$$

With the designed collector current of 0.3mA and collector resistance of 22k Ω , the input impedance is in the region of 80 Ω . Inserting these values, Voltage

$$\text{gain} = \frac{22k\Omega}{80\Omega} = 275$$

If the second stage is a grounded emitter stage with an input impedance of about 1k Ω , this appears in parallel with the load and the gain is very much

$$\text{reduced, Voltage gain} = \frac{1k\Omega}{80\Omega} = 12.5$$

The action of the second stage can be described in this case as an impedance transformer since its current gain of, say, 50, enables it to provide a specified output to the emitter resistor while drawing only 1/50th of this current from the previous stage. Reducing the current at a fixed voltage implies an increased impedance, and the first stage now "sees" an impedance of $50 \times R_e$ in parallel with its collector load. This value is sufficiently high to prevent any loading, with the associated loss of gain, even when working into external loads as low as one or two kilohms.

We can summarise the working of the circuit as follows. The current injected into the emitter of TR_1 reappears in the collector load. This, being very much larger than the input impedance, has a proportionately larger voltage developed across it. Finally the voltage appears across the emitter resistor of TR_2 , very little reduced by the slight shunting effect of the high input impedance of the second stage, and by the small loss across the emitter-base diode.

"Pick Any Resistor"

This particular circuit has been amongst the most flexible and versatile that the author has tried, and the operating conditions were varied as widely as possible to try to find its limits of operation. So wide have these proved that the following section could almost be entitled "Pick Any Resistor".

Satisfactory operation was in fact obtained with the following range of values, subject only to permissible dissipation: at one end of the scale and bottoming due to leakage current at the other.

Supply voltage	3-20 volts
R_c	5-40k Ω
R_b	150-1,000k Ω
R_e	2-5k Ω
C_b	0.5-16 μ F
α_1	20-100
α_2	20-100

At the extreme ends of the scale, of course, both gain and undistorted output will fall. Provided the constructor avoids the obvious pitfalls of high voltage together with low resistance and vice versa, he need only keep his eye on the usual limiting values specified by the manufacturer. These precautions apply only to large variations from the recommended values as these will be safe with all transistors.

To enable the constructor to select the conditions most suited to his own needs, a series of curves has been drawn up from the results, showing the gain available for various collector loads over a wide range of supply voltage. (Fig. 2.)

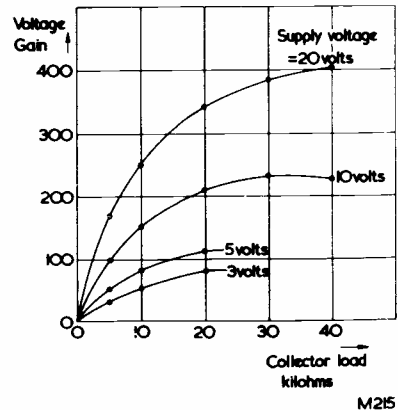

Fig. 2. Measurements taken with transistors of current gain = 20, $R_e = 4.7k\Omega$, $R_b = 330k\Omega$

Since one of the fundamentals laws of electronics is that "No result derived from theory or laboratory measurements works when put into practice," the final test was to insert a microphone into the emitter lead and monitor the output.

A surplus moving iron earphone of about 50 Ω impedance was used and the output checked while singing and whistling at various distances from it. Singing a few inches from the "microphone" produced inputs to the preamplifier of 1 or 2mV, which after amplification gave outputs of the order of one-third of a volt. Outputs as high as 3 or 4 volts could be obtained by whistling across the microphone with it coupled to the highest gain arrangement, and this would be sufficient to drive an output valve to very nearly its full power.

Finally it is suggested that the values shown in Fig. 1 be used, since further articles in the series will make use of exactly the same components. They will include a medium impedance preamplifier and an emitter coupled multivibrator.

(To be continued)

Improving Radio Luxembourg Reception

By GORDON J. KING, M.I.P.R.E.

WHILST BEING ONE OF THE MOST POPULAR stations, Radio Luxembourg suffers from disconcerting fading and distortion troubles when received in most parts of Great Britain. Numerous tests have revealed that the trouble is caused essentially by random changes in the polarisation and phase of the received signal, these being due to ionospheric refraction and bending of the sky wave over the medium-distant path at the rather susceptible wavelength of 208 metres.

Luxembourg Interference Pattern

The severe fading and bad quality are caused because Radio Luxembourg is received in the main towards dusk and during the night, when the sky wave and ground wave in this country approach equal intensity. In effect, the received signals represent the vector sum of the two waves that have travelled along different paths. At some locations these waves add, while at others they subtract. This causes a Radio Luxembourg interference reception pattern over most of Great Britain, particularly at night, since it is only after dark that the sky wave really comes into play.

During the daytime the ground wave contributes most of the signal received, and it is for this reason that the daytime Luxembourg signal is relatively poor, though less disturbed by fading.

The reception pattern is rarely consistent for any length of time, since slight changes in the ionosphere result in a change in length of the sky wave path. This modifies the interference from an addition to a subtraction, and vice versa, and thereby causes the typical Luxembourg fading which alternates with progressive increases in signal strength.

Distortion due to Selective Fading

The Luxembourg interference pattern is also somewhat sensitive to frequency because even a small alteration in frequency under these conditions is sufficient to change the relative path lengths by an appreciable fraction of a wavelength. This means, then, that the carrier and the sidebands of the Luxembourg signal are likely to occur out of phase or out of step at the receiver. For example, some frequency components will tend to cancel while others will tend to add, and the resulting distortion, which is commonly so severe as to destroy the entertainment value of the signal, is in this context known as "selective fading" or "selective distortion".

Sideband Suppression

It was required by the author to reduce this effect as inexpensively and as much as possible. Several methods were tried, including the reception of only one of the sidebands of the signal. This improved matters somewhat for it was discovered that when a fade occurred, one sideband was affected far more than the other.

This is because the worst quality distortion is invariably caused by the carrier fading, or reducing considerably in amplitude, while leaving the sideband frequencies almost unaffected. In order to receive just a single sideband, the receiver itself is called upon to supply the missing carrier, and this was accomplished by the use of a separate oscillator. This oscillator was arranged to heterodyne with the component frequencies of one of the sidebands, and the difference frequencies produced after detection corresponded to the original modulation signal. These were then amplified audio-wise in the ordinary way.

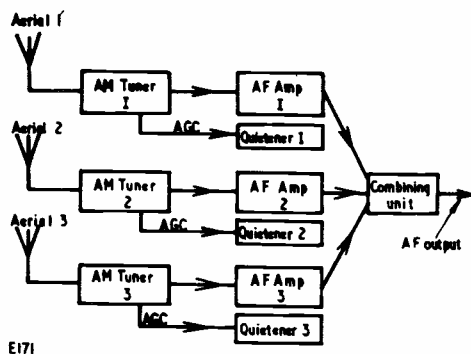

Fig. 1. In this diversity arrangement only the tuner producing the strongest signal contributed to the a.f. output signal

There are several problems to this method, one of which is that to secure reasonable quality the carrier oscillator must be held within a few cycles of the correct frequency. This can be achieved by the use of a crystal oscillator or by filtering the sideband signals from the carrier and then using that to control the frequency of the locally manufactured carrier. The latter idea is sometimes called "carrier reconditioning".

Ultimately, a method was devised for switching

from one sideband to the other, depending on which gave the best reception, but this made life rather difficult and by now the expense was going way up.

Diversity Reception

The exercise continued with the use of a diversity receiving system. Here three receivers were used and each was fed from its own aerial which was removed from the other two aerials by approximately 300 yards. This required a lot of room, and because there was insufficient area to space the aerials adequately the system was not wholly successful in relation to its cost. Nevertheless, it would be interesting to relate.

It was hoped to take advantage of the fact that it is unlikely for signals of the same transmission to fade simultaneously when picked up on separate aerials spaced from each other. It usually happens that when the signal fades in one aerial it fades less in another aerial and may possibly rise in a third. With this in mind the arrangement of Fig. 1 was adopted.

Basically, three a.m. tuners were used, and each of these was fed from its own aerial through 75Ω coaxial cable. The detector output of each tuner fed an associated a.f. amplifier, and the outputs of the amplifiers were mixed in a combining network, giving a single a.f. output signal.

After taking care of various phasing factors, this arrangement appeared to work adequately, apart from the introduction of noise due to those tuners which were receiving little or no signal as the result of a fade in their aerials. The effect was reduced by including at each a.f. amplifier a quieting arrangement operated by the a.g.c. systems of the tuners. The result was that the outputs of the two a.f. amplifiers with the least signal at their detectors were considerably suppressed, and the majority of the signal was supplied by the tuner receiver at any

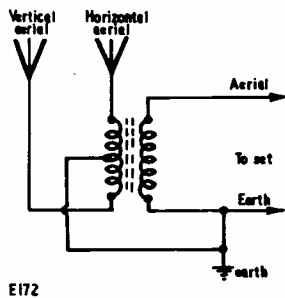

Fig. 2. A simple transformer coupling for two aerials—horizontal and vertical

time the strongest signal. In this way the signal-to-noise ratio of the system as a whole was improved.

Nevertheless, a degree of fading persisted, and this was possibly due to insufficient spacing between the aerials, for it would seem from subsequent experiments that the aerials would need to be spaced by at least ten wavelengths for optimum

results. Ten wavelengths at 208 metres is over one mile, and this kind of reception can hardly be called inexpensive!

Two Aerials

Finally, the diversity reception idea just described was abandoned and two aerials were erected fairly

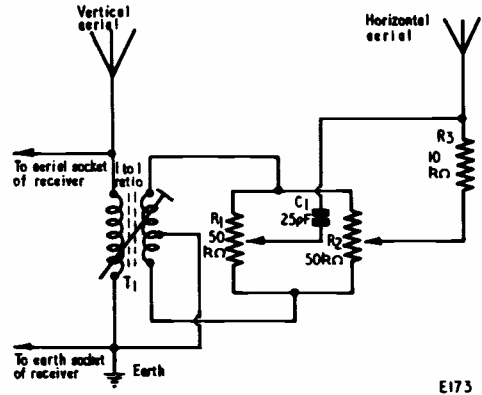

Fig. 3. A phasing circuit for the horizontal signal

close together, one vertical and the other horizontal. These were coupled to the two tuners in a semi-diversity arrangement, similar to that in Fig. 1. Surprisingly, the results were as good, if not slightly better, than the costly and complicated three-aerial system.

One Tuner—Two Aerials

It was next decided to try just one tuner and couple the horizontal and vertical aerials to it through a coupling transformer with a centre-tapped primary, as shown in Fig. 2. This was not very successful at first, but after attention was given to the aerials, mainly in terms of length, an outstanding improvement was observed.

As a test, the vertical aerial was disconnected and the signal monitored using the horizontal aerial only. At the instant of a deep fade, the vertical aerial was connected. This improved the signal strength considerably and almost eliminated the selective distortion which was present with just the horizontal aerial.

The same experiment was carried out by first using the vertical aerial only, and when the horizontal aerial was connected during a deep fade the results were almost identical to those of the first test.

These tests proved fairly conclusively that the Luxembourg fade and distortion are caused not only by the phase of the received signal altering but also by a change in the polarisation. It should be noted that the fading and distortion were not completely removed, but the improvement was well worth the small expense of an extra aerial and coupling unit. The set-up appeared to be somewhat critical in terms of aerial length, but a little over 50ft of wire for each aerial, including the down-lead

of the horizontal aerial, was found to work quite well in practice.

Phasing Unit

Finally, it was decided to try to improve on the simple aerial coupling transformer. After some experimenting, the circuit shown in Fig. 3 was

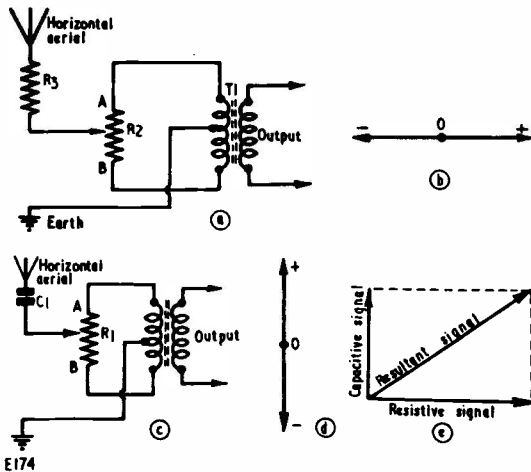

Fig. 4. The circuit producing the "resistive" component of the horizontal signal (a) and the vector representation of the signal at (b). The circuit producing the "reactive" component of the horizontal signal (c) and the vector representation of the signal at (d). At (e) is shown resultant signal due to the two signals (b) and (d). It will be seen that the amplitude and phase of the resultant signal depends on the vectorial sum of the resistive and capacitive signals

evolved. Here the vertical signal is connected direct to the aerial socket of the set, while the horizontal aerial is connected through the phasing network comprising R_1 , R_2 , R_3 and C_1 , and the transformer T_1 . This serves to permit adjustment of both the amplitude and phase of the horizontal signal in relation to the amplitude and phase of the vertical signal. Optimum balance may thus be achieved simply by adjusting R_1 and R_2 .

How this happens is shown in Fig. 4. At (a) the horizontal signal is applied to the potentiometer R_2 via resistor R_3 . Now since R_2 is connected across the centre-tapped primary of T_1 , it follows that when R_2 is at the centre of its travel there exists, in effect, a balanced bridge arrangement and no signal appears across the secondary winding.

However, when the slider of R_2 is set towards position A signal currents circulate in the top section of the primary and a signal voltage is induced across the secondary. Similarly, when the slider is set towards position B signal currents circulate in the bottom section of the primary and a voltage, equal though of opposite phase to that in the former case, is induced across the secondary. From this description it can be realised that a horizontal signal is

available at the secondary which can easily be adjusted from positive through zero to negative, as shown in Fig. 4 (b).

Adding a Reactive Component

At (c) is shown the other section of the circuit. This is identical to that at (a) except that the signal is applied through C_1 to R_1 . This capacitor produces a reactive component which can also be adjusted from a positive value through zero to a negative value, but this time 90 degrees out of phase with the signal produced via the resistor, as shown at (d). This phase shift, of course, is attributable to the action of the capacitor.

It may now be seen how the two actions are combined in the complete circuit of Fig. 3. Clearly, the two potentiometers can be used to provide a horizontal signal which has any amplitude (being limited by the amplitude of the aerial signal itself) and any phase angle, as shown in Fig. 4 (e).

It is interesting to note that a circuit of a similar nature was evolved by Spencer-West some years ago as a means of eliminating pattern interference from Band III conversions.

The phasing unit almost completed the exercise, and Radio Luxembourg was received far better than hitherto with very little extra expense. The transformer was produced from an old medium-wave aerial coil to start with but, as it was found difficult to locate a good centre-tap a special coil was produced which gave improved coupling and far better balance. The transformer requires an overall 1-to-1 turns ratio and an inductance of about 150 microhenries at each winding. A suggested method of construction is shown in Fig. 5.

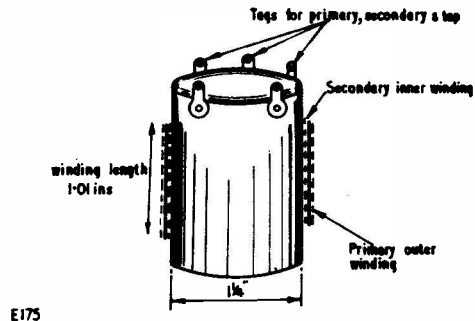

Fig. 5. Suggested transformer. Primary and secondary 84 turns, close-wound 32 s.w.g. enamelled wire on 1.25in former. Spacing between primary and secondary by thin card. Primary centre-tapped

Initial adjustment was accomplished by removing the horizontal aerial until a severe fade occurred. It was then reconnected and the potentiometers carefully adjusted to obtain the best results. It was found necessary to carry through this procedure several times for optimum results, especially during periods of fairly rapid fading.

A Constructor Visits the 1961 International Radio Hobbies Exhibition

IN HIS OPENING ADDRESS TO THE 1961 International Radio Hobbies Exhibition, held at the Royal Horticultural Hall from 22nd to 25th November, Mr. Henry Loomis, Director of "Voice of America", stressed the points of similarity between the professional and the amateur electronic communications engineer.

In an extremely informative address in which the problems involved in putting over the "Voice of America" were fully detailed, Mr. Loomis made the observation that "whereas you amateurs are experts communicating with experts, we are experts communicating with an audience possessed of only enough technical know-how, in the main, to turn a set on and off and do some tuning." Mr. Loomis concluded with the statement that "we are all of us working for mutual understanding," a sentiment with which every amateur will be in complete agreement.

After the opening ceremony, the exhibition got away to an excellent start, and the writer was pleased to observe the high attendance.

Club and Society Stands

Prominent on the R.S.G.B. stand were beautifully constructed equipments including 2 and 4 metre transmitters by G3KMD, an s.s.b. exciter unit by GM3FYB, a home-built transmitter by GM3IAA, and a transistorised receiver by G3HBW. This last item was awarded the 1961 Silver Trophy for outstanding home constructed equipment.

The British Amateur Television Club staged an impressive display of colour television, reproduction being given by monitors with shadow mask tubes. During the writer's visit reproduction from a colour bar generator was shown, whilst at other times B.B.C. pictures on the 405 line N.T.S.C. system were displayed. A further colour monitor used a rotating colour filter and was employed as a viewfinder for the B.A.T.C. colour camera, the latter having a similar filter in conjunction with a 3 in. image orthicon tube. This camera was built by J. Tanner especially for the Exhibition.

Another spectacular and imaginative presentation was evident on the Royal Air Force stand. This consisted of equipment used by the Royal Air Force Amateur Radio Society in their recent expedition to the island of Kamaran in the Red Sea, 200 miles north of Aden. The gear was mounted inside a tent on a table improvised from packing cases, and the whole floor area was covered

with some six inches of very authentic-looking sand. Members of the expedition were present on the stand, and defied the rigours of London's November by being dressed in khaki drill.

Amateur radio astronomy was well to the fore, with an exhibit by G. A. Frampton, G3LRH. This consisted of a receiver, the input to which consisted of alternate bursts of noise from an aerial system and from a matched load at a known temperature. The difference in power between the two sources was then indicated on a valve voltmeter driving a pen recorder. The equipment was described as an experimental system to determine the performance likely to be obtained in an amateur system, and is the first of a series of projects undertaken for the British Astronomical Association.

Trade Stands

For the youngster or beginner, Daystrom Ltd. exhibited their newly introduced Electronic Workshops Kit, Model EW-1. This comprises an insulated board holding a number of easily recognisable and well identified components, each being coupled to spring connectors which enable wiring to be fitted quickly and without soldering. It is possible to wire up twenty different electronics set-ups with this kit, these including amplifiers, three transistor radios and voice operated relays. The kit includes a loudspeaker. Also evident on the Daystrom stand were samples from the well-known range of Heathkit equipment, including the DX-100U and DX-40U transmitters and the fully transistorised general coverage receiver type GC-1U. Announced by Daystrom Ltd. at the Exhibition was the new transistor intercom kit consisting of Model XI-IU (master) and XI-RU (slave station). This new kit should be available in early January.

Radiostructor were well in evidence and displayed some of the equipment built up as part of their courses. These included a multi-testmeter, a signal generator, an oscilloscope, and a comprehensive a.m./f.m. receiver.

A wide range of cabinets, chassis panels and racks was shown by E. J. Philpott's Metalworks Ltd., these being available in a number of colours. Products in the Philpott's range are available in any size to meet customers' specifications and appear in a large number of basic designs. Especially attractive was this Company's well-tried and popular "S" line style of presentation, this consisting basically of "wrap around" cabinets with up to 11 ins in the front to back dimension. Ventilation is available by perforated panel or louvres according to requirements.

Once again, dimensions can be to users' specification.

Copp Communications and Electronics (Felixstowe) Ltd. displayed samples of high quality inductors. The wide range exhibited included over 100 different types of "Stabcoils", these consisting of coils with built-in adjustable capacitance trimmers, cores and temperature compensation components. Also displayed were high-Q i.f. transformers covering 85kc/s to 1.6Mc/s. These transformers feature high selectivity and give bandwidths, for 6dB down, of 2kc/s at 85kc/s and 9kc/s at 1.6Mc/s. Another interesting exhibit on the Electroniques stand was a series of "Qoilpax", these comprising a complete chassis assembly for coils, tuning capacitor, range switch and the associated valve or valves. Careful layout and clean design were very evident in these. Electroniques specialise in a wide range of components which are not generally available, and these include 6mm dust cores for varying frequency ranges, miniature ceramic trimmers, plastic fixing nuts and insulated nylon lead throughs.

Sound Vision Service (Electrical) showed a number of aerial masts having particular value for the amateur. The main exhibit was the S.V.S. 45ft. telescopic mast which is completely portable, can be erected in minutes by one person, and which carries a full rotary head. Also exhibited was the 36ft. model incorporating a patent guy ring which enables the complete mast to be rotated regardless of strain on the guy ropes. This mast can be installed to heights up to 80ft. An innovation was the S.V.S. Automatic Rotator which offers rotation through 360 degrees for aerials up to 150lbs in weight. This device is remotely controlled, and functions from 50c/s a.c. mains. An indicator installed at the control position shows orientation relative to north on a fully calibrated circular scale.

Of interest on the stand of Avo Limited was the new model 9SX AvoMeter. This is a fully tropicalised instrument designed primarily for Service use and has sensitivities of 20,000 ohms per volt on d.c. and 1,000 ohms per volt on a.c. The meter will measure current up to 10 amp a.c. or d.c., potential up to 3,000 volt a.c. or d.c., and resistance up to 2M Ω . To meet the heavy climatic demands for which the instrument has been designed, the front panel, case and some of the internal components are moulded in a special phenolic material which not only reduces tracking and leakage but also inhibits fungus growth

NOW! YOU can MASTER ELECTRONICS!

BRITAIN'S MOST COMPREHENSIVE PRACTICAL
COURSE IN RADIO
ELECTRONICS • TELEVISION!

THESE SPECIAL TRAINING
KITS — YOURS TO KEEP



Multi-Range
TEST METER

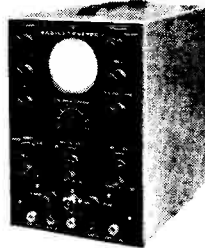

CATHODE RAY
OSCILLOSCOPE

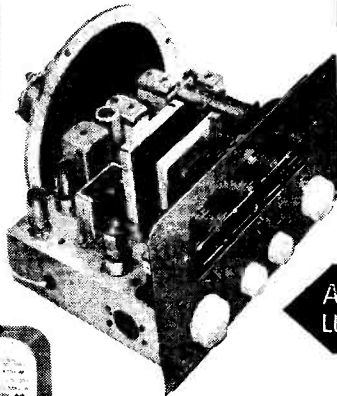

AM and VHF/FM
LUXURY RECEIVER

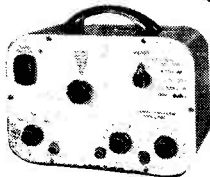

SIGNAL GENERATOR



Complete set of
Picture Way books and
Experimental Manuals

LEARN BY BUILDING
NOW for your
CAREER • HOBBY
OWN BUSINESS

YOU RECEIVE

- Complete kits of equipment as illustrated.
- Complete set of experimental manuals.
- Complete set of "picture-way" theory books.
- Modern test-yourself examination sheets.
- Study programme.
- Unlimited consultation with Tutors.

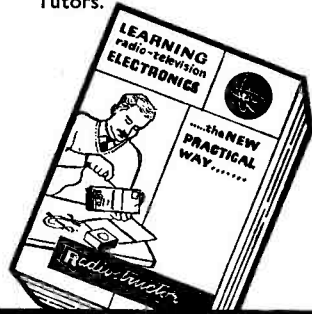

FREE
BROCHURE

POST NOW

RADIOSTRUCTOR

TO RADIOSTRUCTOR (DEPT. M.31)
READING, BERKS.

Name.....
Address.....
.....
.....

BLOCK
CAPS
PLEASE

(We do not employ representatives)

1.62

RETURN-OF-POST SERVICE

We offer a really efficient Mail Order Service on all items stocked. All cash orders are dealt with on the day of receipt. Hire purchase orders are subject to slight delay but this is kept to the absolute minimum

● LOUDSPEAKERS

GOODMANS: Axiom 110 10" £5.20; Axiom 112 10" £8.14.0; Axiette 8" £6.15.0; Axiom 300 12" £11.5.9; Axiom 400 12" £16.1.0; Audiom 60 Bass, 12" £9.12.9; Trebax Tweeter £6.4.0; CX5000 Cross-over unit £1.19.0.

WHITELEY: HF1016 10" £8.4.0; HF1012 10" £5.2.6; HF816 8" £7.0.9; T816 8" £6.10.0; T10 Tweeter £4.8.3; T359 Tweeter £1.15.10; CX3000 Cross-over unit £1.11.6; CX1500 Cross-over unit £2.0.0. H.P. Terms available.

● TRANSISTORS

MULLARD. Reduced prices. Current production types, not rejects. All in makers' boxes. OC44 11/-; OC45 10/-; OC70 and OC71 6/6; OC72 8/-; OC72 Matched Pairs 16/-; OC78 8/-; OC81 8/-; OC170 13/6; OC171 14/6. Postage 3d. on each transistor.

● AMPLIFIER KITS

We have full stocks of all components for the Mullard 510, Mullard 3-3, Mullard 2 and 3 Valve Pre-amp, Mullard Stereo, Mullard Mixer, G.E.C. 912 Plus. Fully detailed list on any of these sent upon request. Instruction Manuals: All Mullard Audio Circuits in "Circuits for Audio Amplifiers" 9/5. G.E.C. 912 4/6. All post free.

● STEREO COMPONENTS

Morganite ganged potentiometers as specified for the Mullard circuits. ● Log/Anti-Log, 500k, 1 meg, 2 meg. ● Log/Log, 50k, 250k, 1 meg, 2 meg. ● Lin/Lin, 250k, 500k, 1 meg, 2 meg. All 10/6 each. Pick-up cartridges. B.S.R. TC8S £2.5.11. Turn-over type for Stereo, L.P. and 78 records. List of all components for Mullard Stereo Designs is available.

● "P.W. TUTOR"

Everything in stock. Stage 1, including brand-new light-weight headphones, 39/6. Less headphones 23/6. Stage 2, 19/- Stage 3, 21/6. Stage 4, 11/6. All Stages 1 to 4, £4.8.6. Less headphones, £3.13.6. All post free. Please note that the hardboard, wood, Terry clips and cement not included. All items available separately—send for list.

● "P.W. MINI-AMP"

Complete kit for Amplifier £4.2.6. Whiteley speaker P2.585 £1.4.0. Greencoat Gramophone unit £5.8.0. All parts available separately—send for list.

● "P.W. CITIZEN TUNER UNIT"

Kit for R.F. Unit 57/-; Kit for I.F. Unit 54/-; Both kits together £5.7.6. ALL POST FREE. Separate components available. Send for list.

● GRAMOPHONE EQUIPMENT

ALL LATEST MODELS
ALL POST FREE

	Cash Price	Deposit	Hire Purchase Mthly Pmts.
RECORD CHANGERS			
GARRARD			
AUTOSLIM (GC8 PU)	£8. 5.0	£1.13.0	12 of 12/8
COLLARO C60 (GP67 PU)	£8. 5.0	£1.13.0	12 of 12/8
GARRARD RC210 (GC8 PU)	£10. 6.0	£2. 2.0	12 of 15/4
B.S.R. UA14 (TC8 PU)	£7.19.6	£1.12.6	12 of 12/3
B.S.R. UA14 Monarch (TC8S Stereo/LP/78)	£8.19.6	£1.16.6	12 of 13/7

SINGLE RECORD PLAYERS

GARRARD TA (GC8 PU)	£8.10.0	£1.14.0	12 of 13/-
B.S.R. TU12 (TC8 PU)	£4.10.0	£1. 5.0	3 of £1.5.0
E.M.I. (Acos Stereo/Mono PU)	£6.15.0	£1. 7.0	12 of 10/6

TRANSCRIPTION UNITS

GARRARD 4HF (GC8 PU)	£18.18.0	£3.16.0	12 of £1.7.8
PHILIPS AG1016	£14. 3.6	£2.17.6	12 of £1.0.9

Many of the above can be supplied for stereo working. See our Gramophone Equipment List for details.

● OUTPUT TRANSFORMERS

GILSON: W0696A, W0696B 50/6, post 2/6. W0710, W0710/8K 55/6, post 2/6. W0892 £2.3, post free. W0767 27/-, post 1/6. W01796A 57/6, post 2/6.

PARTRIDGE: P3667 52/6, post 2/6. P4014 98/6, post free. P4131 60/-, post free. P3591A 99/-, post free. P5202, P5203 95/-, post free. **PARMEKO:** P2641 28/-, post 2/-.

● ILLUSTRATED LISTS

Illustrated lists are available on LOUDSPEAKERS, TAPE DECKS, TEST GEAR, RECORDING TAPES, GRAMOPHONE EQUIPMENT or AMPLIFIERS. Any will be sent free upon request.

● TERMS OF BUSINESS

Cash with order or C.O.D. We charge C.O.D. orders as follows. Up to £3, minimum of 3/2. Over £3 and under £5, 1/6. Over £5 and under £10, 1/8. Over £10, no charge. Postage extra on CASH orders under £3 except where stated. Postage extra on Overseas orders irrespective of price.

● JASON FM TUNER KITS

We supply kits for all the Jason FM Tuners. Fully detailed lists available. Kits are complete with all valves and instruction manuals—definitely nothing else to buy. **FMT1 Standard Tuner** with ext. power supply £6.19.6. Power pack kit £2.12.6 extra. **FMT2 Standard Tuner** with internal power supply £10.9.6. Less power supply £8.9.6. **FMT3 Fringe Tuner** with internal power supply £12.7.6. Less power supply £10.9.6. **Mercury 2 FM/TV Sound Switched Tuner.** External power supply. £11.7.6. Power pack kit £2.12.6 extra. **JTV2 FM/TV Sound Switched Tuner.** Internal power supply. £15.17.6. **IMPORTANT.** Please state TV channels required when ordering Mercury and JTV Kits. **INSTRUCTION MANUALS.** Booklet for FMT1, 2 and 3, 2/10; Mercury 2, 3/10; JTV2 3/10. All post free. **HIRE PURCHASE** terms available on any kit.

● TRANSISTORISE YOUR CRYSTAL SET

We have two new designs for transistor amplifiers which can be used to greatly improve the signal from any crystal set. Leaflet available. **RLD4 Kit.** One stage, 12/- post free. **RLD5 Kit.** Two stage 21/- post free. The kits are easy to build and very detailed instructions are supplied.

● MULLARD CATHODE RAY TUBES

ALL AT THE NEW REDUCED PRICES
We supply both Mullard Radiant Screen (brand new, factory fresh) and Mullard Lunenar (rebuilt by Mullard with reclaimed bulbs—all other parts brand new). List of types available with prices and hire purchase terms.

● LATEST TEST METERS

	Cash Price	Deposit	Hire Purchase Mthly Pmts.
AVO Model 8 Mark II	£24. 0.0	£4.16.0	12 of £1.15. 2
AVO Model 8 with leather carrying case	£27.18.0	£5.12.0	12 of £2. 0.11
AVO Model 7 Mark II	£21. 0.0	£4. 4.0	12 of £1.10.10
AVO Multiminor	£9.10.0	£1.18.0	12 of 14/4
AVO Multiminor with leather carrying case	£11. 9.0	£2. 5.0	12 of 17/-
TAYLOR Model 127A	£10. 0.0	£2. 0.0	12 of 15/-
CABY A-10	£4.17.6	£1. 7.6	3 of £1. 6.8
CABY B20	£6.10.0	£2. 0.0	3 of £1.13.4

Full details of any of the above supplied free on request. The AVO Models 7 and 8 are both latest models from current production—not to be confused with Government Surplus.

● "BRAND FIVE" RECORDING TAPE

Standard Play: 600 ft (5") 16/-; 1,200 ft (7") 25/-; Long Play: 900 ft (5") 18/6; 1,200 ft (5 1/2") 23/6; 1,800 ft (7") 35/-; Double Play: 1,200 ft (5") 37/6; 2,400 ft (7") 60/- (All Post Free!)

● B.A.S.F. RECORDING TAPE

Long Play: 210 ft (3") 9/-; 900 ft (5") 28/-; 1,200 ft (5 1/2") 35/-; 1,800 ft (7") 50/-; Double Play: 300 ft (3") 14/-; 600 ft (4") 25/-; 1,200 ft (5") 42/-; 1,800 ft (5 1/2") 58/-; 2,400 ft (7") 77/6. All post free.

● TAPE RECORDING EQUIPMENT

	Cash Price	Deposit	Hire Purchase Mthly Pmts.
TAPE DECKS			
ALL CARRIAGE FREE			
B.S.R. TD2	£8.19.6	£1.16.6	12 of 13/7
LATEST COLLARO Studio	£12.19.6	£2.12.6	12 of 19/-

We now stock the **Martin Recorder Kits.** These are partly assembled kits for complete tape recorders. The Amplifier Printed Circuit panels are completely wired, but the assembly of this and external components is left to the constructor. Very complete instructions are supplied. Send for leaflet.

MODEL C for Collaro Studio Deck, £11.11.0.
MODEL B for BSR TD2 Deck, £8.8.0.

CARRYING CASES. Smart carrying cases are available to take the above amplifiers and decks. Fitted with speaker. For Model C Amplifier and Collaro Deck £5.5.0. For Model B Amplifier and BSR Deck £4.4.0.

H.P. terms available for amplifiers, cases and decks.

● TAPE PRE-AMPLIFIERS

ARMSTRONG PABO-3. This is a ready made version of the Mullard Tape C Pre-amplifier. Price £16.16.0. Hire Purchase: Deposit £3.8.0 and 12 monthly payments of £1.4.7.

MULLARD TAPE C PRE-AMPLIFIER. We stock complete kits and all components. Send for list.

MARTIN KIT for Collaro Studio deck, £8.8.0.

● HIRE PURCHASE TERMS
are available on any item. Repayments may be spread over 3, 6 or 12 months. Details as follows: Three months: Deposit 6/- in the £. Service charge 5 per cent but minimum charge of 10/-; Six and twelve months: Deposit 4/- in the £. Service charge 10-per cent, but minimum charge 20/-.

WATTS RADIO 54 CHURCH STREET WEYBRIDGE SURREY
(MAIL ORDER) LTD. Telephone: Weybridge 4556
Please note: Postal business only from this address

EVERYTHING FOR THE ENTHUSIAST

HEADPHONES. DHR5B (very sensitive), 2,000 ohms 22/6. P. & P. 2/-

NATIONAL H.R.O. CRYSTAL FILTER UNITS. 455 kc/s with crystal. Sel. and phasing controls. New boxed. ONLY 19/6. P. & P. 1/6.

MULTI-WAY CABLE. 3-core screened 1/- yd.; 12-core screened 2/- yd. First grade Mike Cable 9d. yd. P. & P. 2/-.

10-WAY CABLE (5 pairs), screened and plastic covered. Any length cut, 1/8 per yd. P. & P. 1/6 min.

TOUGH POLYTHENE LINE. Type ML1 (100 lb) 2d. per yd. or 12/6 per 100 yds. Type ML2 (220 lb) 4d. per yd. or 25/- per 100 yds. Post free.

ABSORPTION WAVE-METERS. 3.00 to 35.00 Mc/s in 3 switched bands, 3.5, 7, 14, 21 and 28 Mc/s ham bands marked on scale. Complete with indicator bulb. A MUST for any hamshack. ONLY 22/6. Post free.

SPECIAL OFFER

Bumper Bargain Parcels of Resistors, Condensers and Pots. 10/- and 5/- Post Free

GELOSO V.F.O. UNITS. 4/102 with new dial and escutcheon. Outputs on 80, 40, 20, 15 and 10. For 2-807 or 6146 tubes. Only £8.5.0. 3 valves to suit, 24/-, All post free.

ROTARY CONVERTERS 6V input, 250mA output. Only 5½" x 3" x 3". 17/6 each. P. & P. 3/-.

12V MINIATURE ROTARIES. Only 4½" x 2½" overall. Output 360V, 30mA or 310V, 70mA. NEW LOW PRICE 12/6 each or 22/6 for 2. P. & P. 2/-.

SUPER BANDCHECKER AND MONITOR. This new, sensitive, absorption wavemeter is fitted with 0-500 microammeter and is also a most useful phone monitor. Covers 3.5-35 Mc/s in 3 switched bands, only 3 gns.

RACK MOUNTING PANELS. 9" x 5½", 7", 8½" or 10½" black crackle finish. 5/9, 6/6, 7/6 and 9/- respectively, postage and packing 2/-.

PLUG IN NOISE LIMITERS. 3 Position Limiting. No Wiring Required. Ideal on HRO or H.R. Output for PHONES 8/6. P. & P. 2/-.

CERAMIC COIL FORMERS. 2½" x 1½". IDEAL FOR VFO or P.A. on Mobiles. 1/9 each or 17/6 doz.

BTX. 3½" x 1½" with 32 Grooves for P. Tanks 6/- ea.

TFX. 2½" Dia. 5" WINDING SPACE. Ideal Hi Power Lin. Amps 8/6.

MOSLEY TRI-BAND BEAMS
T33, JR, 3 EL ... £24.15.0
TA32 JR, 2 EL ... £17.10.0
V3 JR, Vertical 3 Band £7.10.0
PLACE YOUR ORDER EARLY

AERIAL EQUIPMENT

COPPER WIRE. 14g. h.d.: 140' 17/-; 70' 8/6; 7/25 stranded. 140' 10/-; 70' 5/-, plus 2/- P. & P.

RIBBED GLASS INSULATORS. 3" 1/9 each. P. & P. 1/6 up to 12.

TWIN FEEDER. 300 ohm twin ribbon feeder, similar K25, 6d. per yd. K358 Telcon (round) 1/6 per yd. Post on above feeder and cable 1/6 any length.

SUPER AERIAL CABLE 1/8 per yd. P. & P. 2/-.

CERAMIC FEEDER SPREADERS. Type F.S. 6" 10d. each. P. & P. 2/- up to 12.

CERAMIC "T" PIECES. Type AT for centre of dipoles, 1/6 each. P. & P. 1/-.

NEW MOSLEY POWER BEAMS. Write for details. 300 watt, 50 ohm COAX, ½" dia., very low loss. 1/9 yd. P. & P. 2/-.

CHAS H. YOUNG LTD (Dept. R)

110 DALE END BIRMINGHAM 4

(Tel. all departments) CEN 1635

All components for the improved "PIMPERNEL"

5 Transistor Radio

that works really well!

ONLY 69/6

Postage and Insurance 2/6
Battery 2/-

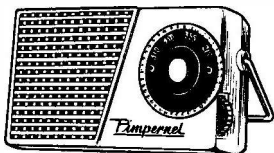

This remarkable little receiver uses 5 transistors and 2 diodes, 3" moving coil speaker, tuning condenser, volume control with on/off switch, latest type circuitry giving excellent station separation and ample volume at good tone. Push-pull output circuit ensures long life from PP4 battery.

All components included for Medium wave operation in handsome plastic case with carrying handle as illustrated.

Demonstrations at all branches.

Circuit diagram Free with parts or separately, 2/-

OPTIONAL EXTRAS

All components and switch for Long waves 8/6
Motif "Pimpernel" 2/-

Agents wanted to build up our "Companion Receivers". Send addressed envelope for full particulars.

The "GOOD COMPANION"

CAR RADIO & PORTABLE

One of the finest of its kind available. The design is the combined efforts of our technicians and those of several of the leading manufacturers in the country, and the resulting set has a performance as good as if not superior to those selling at £20 and more. It has the eight transistor set performance. Features include American Philco R.F. transistors and Mullard A.F. transistors—Q.P.P. output giving 750mW—full coverage on Medium and Long—very fine tuning arrangement—excellent reception of difficult stations like 208—variable feed-back control—full tonal qualities—really superior looking cabinet size 11" x 8" x 3" approximately—car aerial attachment—several months' operation from battery costing only 3/6. Circuit employs six transistors and two diodes, it incorporates all latest refinements, and oscillator I.F. transformers are pre-aligned so no instruments are necessary. Anyone who can solder competently can make this set. The instructions are fully comprehensive with plenty of illustrations. Service is available in the unlikely event of your getting into difficulties. All components fully guaranteed. Price of all components and original cabinet.

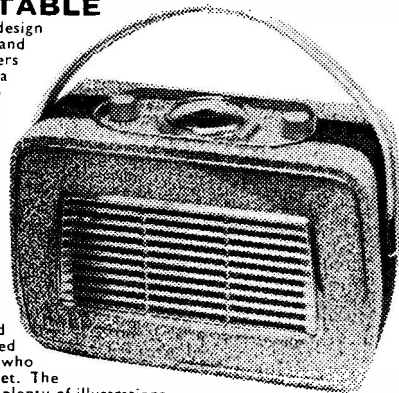

£9.19.6 Post and Insurance 5/-
Battery 3/6 extra.

or, with new cabinet as illustrated, £1 extra.

Mk. 2 uses latest ceramic transistors in place of the normal i.f. transformers. This saves alignment problems and improves performance. Price 10/- extra

POCKET COMPANION is now ready for constructors. Constructional details 2/6, or all parts complete. Post and insurance 2/6
£6.15.0 Battery 2/-

ELECTRONIC PRECISION EQUIPMENT LTD

★ Orders received by post are despatched from our warehouse, Dept. 34, 66 Grove Road, Eastbourne, and to save time, please post your order to this address. Please include enough for postage. Callers, however, should use one of the following addresses:

520 High Street North
Manor Park, E.12

42-46 Windmill Hill
Ruislip, Mddx.

266 London Road
Croydon

29 Stroud Green Road
Finsbury Park, N.4

246 High Street
Harlesden, N.W.10

NEW!

**MICROMINIATURE
SOLDERING
TWEEZERS**

**HOLD
IT
AS
YOU
SOLDER
IT**

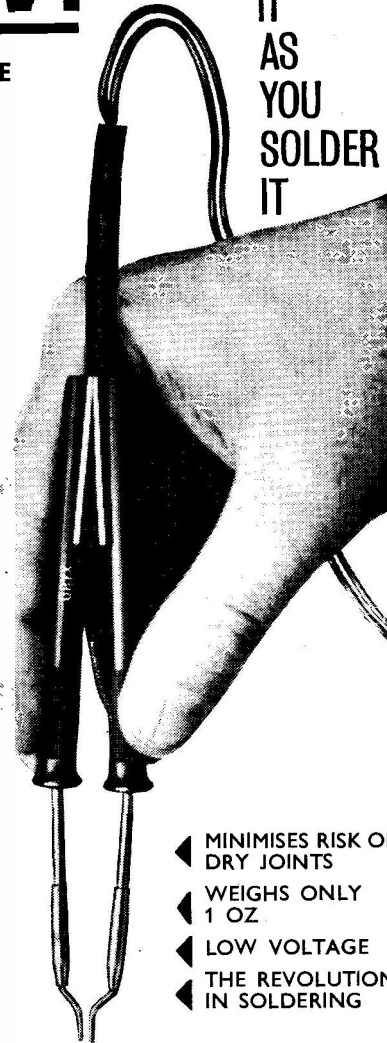

▶ ONE-HAND
OPERATION
▶ HEATS BOTH
SIDES AT
ONCE
▶ MAXIMUM
VISIBILITY

◀ MINIMISES RISK OF
DRY JOINTS
◀ WEIGHS ONLY
1 OZ.
◀ LOW VOLTAGE
◀ THE REVOLUTION
IN SOLDERING

ORYX

MICROMINIATURE SOLDERING TWEEZERS

For the first time, one-hand operation can hold the circuit module and apply direct heat to both sides simultaneously, thus virtually eliminating dry joints and reducing heating times. At your local store or write for free leaflet to:

WG
W GREENWOOD
ELECTRONIC LTD

677 FINCHLEY ROAD
LONDON N.W.2
Tel: SW1as Cottage 3383/4

JACKSON

the big name in PRECISION components

Precision built radio components are an important contribution to the communications industry. Be sure of the best and buy Jackson Precision Built Components

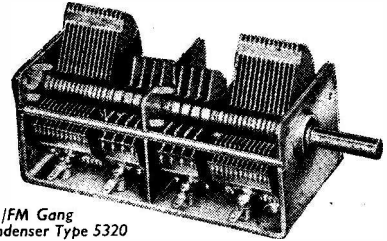

AM/FM Gang
Condenser Type 5320

JACKSON BROS. (LONDON) LTD
KINGSWAY, WADDEN, SURREY

Telephone Croydon 2754-5
Telegrams Walfico, Souphone, London

REPANCO

MINI-4 POCKET SUPERHET TRANSISTOR RECEIVER

(As reviewed last month)

Envelope of easy wiring plans
and instructions with detailed price list

1/6 post 3d

Radio Experimental Products Ltd

33 MUCH PARK ST COVENTRY

Telephone 27114

7 VALVE AM/FM RADIOGRAM CHASSIS

Valve Line-up: ECC85, ECH81, EF89, EABC80, EL84, EM81, EZ80.

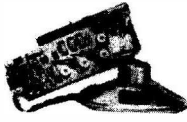

Three Waveband and Switched Gram positions Med. 200-500 mm., Long 1,000-2,000 m., VHF/FM 88-95 Mc/s. Philips Continental Tuning insert with permeability tuning on FM and combined AM/FM I.F. transformers, 460 kc/s and 10.7 Mc/s. Dust core tuning all coils. Latest circuitry including AVC and Neg. Feedback. Three watt output. Sensitivity and reproduction of a very high standard. Chassis size 13½" x 6½". Height 7½". Edge Illuminated glass dial 11½" x 3½". Vertical pointer. Horizontal station names. Gold on brown background. A.C. 200/250V operation. Magic-eye tuning.

Aligned and tested ready for use. £13.10 Carr. & Ins. 5/-. Complete with 4 knobs—walnut or ivory to choice. Indoor FM aerial 3/6 extra.

3 ohm P.M. Speaker only required. Recommended Quality Speakers 10" H/DUTY PLESSEY 30/-, 8" H/DUTY ROLA 25/-, P. & p. 2/6.

New Boxed		All Valves Guaranteed		Electrolytics All Types New Stk.							
1R5	1S5	3S4	3V4	DAF96	DP96	DK96	DL96	ECC81	ECC82	EM81	U25
6/-	7/6	7/6	7/6	9/-	9/-	9/-	9/-	8/-	8/-	9/6	9/6
25/25V	50/12V	50/50V	100/25V	8/450V	4/350V	16+16/450V	32+32/450V	25/25V	50/12V	50/50V	100/25V
1/9	1/9	2/-	2/-	2/3	2/3	5/6	5/6	1/9	1/9	1/9	1/9
8+8/450V	16+16/450V	32+32/275V	50+50/350V	60+250/275V	100+200/275V			8+8/450V	16+16/450V	32+32/275V	50+50/350V
4/6	5/6	4/6	6/6	12/6	12/6			4/6	5/6	4/6	4/6

RECORDING TAPE—BARGAIN PRICES
Famous American Columbia (CBS) Premier Quality Tape at **NEW REDUCED PRICES.** A genuine recommended Quality Tape —TRY IT! Brand new, boxed and fully guaranteed. Fitted with leader and stop foils.

Standard	Long Play	Double Play
5" 600ft, 15/-	900ft, 19/6	1,200ft, 31/6
5½" 900ft, 16/6	1,200ft, 22/6	1,800ft, 39/6
7" 1,200ft, 21/-	1,800ft, 32/6	2,400ft, 47/6

Post and Packing, per reel, 1/-, plus 6d. each for additional reels.
SPECIAL OFFER—3" mfrs. surplus tape, 225ft, 5/6. P. & P. per reel 6d. Plastic Tape Reels, 3" 2/6, 5" 3/-, 5½" 3/3, 7" 3/6.

Volume Controls—5K-2 Meg. ohms, 3" Spindles Morganite Midget Type. 1½" diam. Guar. 1 year. LOG or LIN ratios less Sw. 3/-. DP. Sw. 4/6. Twin Stereo less Sw. 6/6. D.P. Sw. 8/-.

COAX 80 OHM CABLE
High grade low loss Cellular air spaced Polythene—½" diameter. Stranded cond. Famous mfrs. Now only 6d. per yard. Bargain Prices—Special lengths 20 yds. 9/-, P. & P. 1/6. 40 yds. 17/6. P. & P. 2/-, 60 yds. 25/-, P. & P. 3/-. Coax Plugs 1/-, Sockets 1/-. Couplers 1/3. Outlet Boxes 4/6.

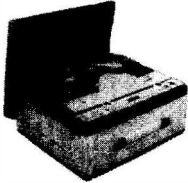

Tape Recorder Kit Special Offer
Latest 5 valve circuit based on Mullard's design. Magic eye and tone controls. Printed circuit already wired. A sensitive quality recorder **BSR Amp Kit 95/-, B.S.R. Tape Deck £8.10.0. Collaro Amp. Kit £6.5.0. Collaro Tape Deck £12.10.0. Set of 5 valves 45/-, Special Unit Kit Prices—Send stamp for detailed list. Construction and circuit details 2/6. Bargain Complete Kit £16/10/0 Carriage 4/6.**

Condensers—Silver Mica. All values, 2pF to 1,000pF, 6d. each. Ditto, Ceramics 9d. Tub. 450V T.C.C., etc. .001 mfd., .01 and .1/350V, 9d. .02-.1/500V 1/-. .25 Hunts 1/6. 5 T.C.C. 1/9, etc., etc. **Close Tol. S/Micas—10% 5pF-50pF 8d. 600-5,000pF 1/-. 1% 2pF-100pF 9d. 100pF-500pF 11d. 575pF-5,000pF 1/6. Resistors—Full Range 10 ohms-10 megohms 20% ± and ½W 3d., ¼W 5d. (Midget type modern rating) 1W 6d., 2W 9d. Hi-Stab 10% ¼W 5d., ¼W 7d., 5% ¼W 9d., 1% ¼W 1/6. **W/W Resistors** 25 ohms to 10K 5W 1/3, 10W 1/6, 15W 2/-. Pre-set 7/V Pots, W/W 25 ohms-50 K 3/-. 50 K-2 Meg. (Carbon) 3/-.
JASON FM TUNER UNITS
Designer-approved kits of parts:
FMT1, 5 gns. 4 valves, 20/-
FMT2, £7. 5 valves, 37/6.
JTV MERCURY 10 gns.
JTV2 £13.19.6. 4 valves, 32/6.
NEW JASON FM HANDBOOK, 2/6. 48 hr. Alignment Service 7/6. P. & P. 2/6.**

Speakers P.M.—3 ohms 2½" Elac 17/6. Goodmans 18/6. 5" Rola 17/6. 6" Elac 18/6. 7" x 4" Goodmans 18/6. 8" Rola 20/-. 10" R. x A. 25/-, 9" x 6" Goodmans 25/-, E.M.I. Tweeter 29/6.

Speaker Fret—Expanded bronze anodised metal 8" x 8" 2/3, 12" x 8" 3/-. 12" x 12" 4/6, 12" x 16" 6/-. 24" x 12" 9/-. 36" x 12" 13/6, etc. etc.

TYGAN FRET (contemp. pat.)
12" x 12" 2/-. 12" x 18" 3/-.
12" x 24" 4/-.

BARGAINS 4-SPEED PLAYER UNITS

Single Players	carr. 3/6
Garrard 4 S.P.	£6.19.6
Garrard TA Mk. 2	£7.15.6
Collaro "Junior"	75/-
B.S.R. (TU9)	79/6
E.M.I. Junior	89/6
Auto-Changers	carr. 5/-
Garrard RC210	£10.10.0
Collaro "Conquest"	£7.15.0
B.S.R. (UAB)	£6.19.0
B.S.R. (UAB Stereo)	£7.10.0
B.S.R. (UA14)	£7.15.0

SINGLE SCREENED LEAD— Standard size, 8d. yd.; Ditto Lightweight for Pick-up, etc., 7d. yd.; ditto lightweight for PVC sheathed, 9d. yd.; Twin screened sheathed, 1/-. yd.

VALVE HOLDERS—Paxolin: Int. Oct., 6d. Moulded: 88G, 9d. each; Nylon or Moulded Ceramic: 87G, 89A unskirted, 9d. each; 87G, 89A skirted, 1/-. each; B7G with Can, 1/6 each; B9A with Can, 1/9 each; EF50, B7G, 1/-. each; B9A ditto, 1/3 each.

ENAMELLED COPPER WIRE— ¼lb reels: 14g-20g, 2/6; 22g-28g, 3/-. 30g-40g, 3/9. Other gauges quoted for.

PVC CONNECTING WIRE
—10 colours (for chassis wiring, etc.)—Single or stranded conductor, per yd., 2d.

SPECIAL BARGAIN OFFER! Record Player Kits

Auto Changer Kit. Comprising three units. Contemp. styled cabinet size 17" x 14½" x 8½". 2 valve 2 watt amp. and 7" x 4" quality speaker. Variable tone and volume controls with feedback circuit and B.S.R. 4-speed 10 record mixer auto. changer unit.

BGN. PRICE only £12.10.0. Carr. 7/6.
Send for detailed leaflet 3d. stamp.

Single Player Kit. Similar spec. to auto. changer kit except player is 4-speed B.S.R. T.U.9 single record player unit. Attractive contemp. styled cabinet. Size 13½" x 13" x 6" with splendid volume and reproduction.

BGN. PRICE only £8.19.6. Carr. 5/-.
Send for detailed leaflet 3d. stamp.

All units record wired, simple screw-driver, assembly only Full Satisfaction Refund Guar.

TRANSISTOR COMPONENTS

Midget I.F.'s—465 Kc/s ⅝" diam.	5/6
Osc. Coil—⅝" diam. M/WV.	5/3
M. & L.W.	5/9
Midget Driver Trans. 3.5-1	6/9
Midget O/Put Trans. Push-pull to 3 ohms.	6/9
Elect. Condensers—Midget Type 1mfd-100mfd, ea. 1/9. 6V/12V wk. Ferrite Aerial—M. & L.W. with car aerial coupling coil 9/3	
Condensers—150v. wkg. .01 mfd., .03 mfd. 9d. .05 mfd., 1 mfd. 1/-. .25 mfd. 1/3. 5 mfd. 1/6. Etc.	
Vol Controls—Midget Type with edge Control Knob. 5K, 47K, 1 M/ohm, ea. 2/6.	
Speakers P.M.—2½" EMI 3 ohms 17/6. 7" x 4" Plessey 35 ohm 23/6.	
Ear Plug Phones—Min. Continental type, 3ft lead, jack plug and socket. High Imp. 8/-. Low Imp. 7/6.	

SLEEVING—Various Colours 1mm, 2mm, 2d. yd.; 3mm, 4mm, 3d. yd.; 6mm, 5d. yd.

FUSES—Cartridge Type. Standard 1½". All standard values 6mA-10mA, 4d. each.

KNOBS—Modern Continental types: Brown or Ivory with Gold Centre, 1" dia, 9d. each; 1½" 1/-. each; Brown or Ivory with Gold Centre, 1" dia., 10d. each; 1½" 1/3 each. **LARGE SELECTION AVAILABLE.**

METAL RECTIFIERS, STC Types—RM1, 4/9; RM2, 5/6; RM3, 7/6; RM4, 16/-; RM5, 21/-; RM4B, 17/6.

STC RECTIFIERS—E.H.T. Type Fly-back Voltages: K3/25, 2kV, 5/-; K3/40, 3.2kV, 6/9; K3/50, 4kV, 7/9; etc.

SIEMENS TYPES—Contact Cooled: 250V, 50mA, 7/6; 250V, 85mA, 10/-; 250V, 125mA, 15/-; 250V, 300mA, 26/6.



Send for detailed bargain lists, 3d. stamp.
We manufacture all types Radio Mains Transf. Chokes, Quality O/P Trans., etc. Enquiries invited for Specials, Prototypes for small production runs. Quotation by return.
RADIO COMPONENT SPECIALISTS
70 Brigstock Rd Thornton Heath Surrey Hours: 9 a.m.-6 p.m., 1 p.m. Wed. THO 2188
Terms C.W.O. or C.O.D. Post and Packing up to ½lb, 7d.; 1lb, 1/1; 3lb, 1/6; 5lb, 2/-; 10lb, 2/9

INTRODUCING THE NEW . . .

We proudly claim that this highly efficient and compact signal generator is the finest value in instruments anywhere in the world.

Designed after months of research in our own laboratory, and custom-built to the highest standards in our own factory, it is the ideal instrument for radio service engineers, radio enthusiasts, and for technical training colleges.

NOTE THESE STAR FEATURES

- ★ Compact and portable—only 6½" x 4½"
- ★ Truly lightweight—under 2lb weight
- ★ Operates from standard 9V transistor battery
- ★ Fully transistorised—negligible consumption
- ★ 8 ranges fully covering 200 kc/s–220 Mc/s
- ★ Printed circuit for absolute reliability
- ★ Accuracy better than 2% (average 1%)
- ★ Modulated or unmodulated R.F. output, 100mW
- ★ Audio output, sine wave, approx. 1,000 c/s

COMPLETE WITH OUTPUT PLUG ONLY

SEND YOUR ORDER IN **NOW** FOR
EARLIEST POSSIBLE DELIVERY

S.A.E. FOR FULL
TECHNICAL LEAFLET

NOMBREX Transistorised Wide-Range SIGNAL GENERATOR 27

200 kc/s to 220 Mc/s

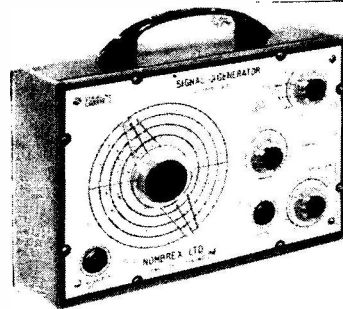

RETAIL **£7.10.0** Post and Ins. 3/6
Battery 2/-

CASH WITH ORDER. REGRET NO C.O.D.
DELIVERIES COMMENCE 10th JANUARY
ALL ORDERS IN STRICT ROTATION

Trade and Export Enquiries Invited

NOMBREX LTD

INSTRUMENTS
DIVISION 21

ESTUARY HOUSE
EXMOUTH

CAMPERDOWN TERRACE
DEVON
Telephone 3515

PANEL-SIGNS TRANSFERS

For a really professional finish

Set No. 1: Receivers and Amplifiers

Five sheets 8½" x 5½" containing one large scale, twelve control panels (clear backgrounds) and white wording. 3s. 6d. postage 3d.

Set No. 2: Test Equipment

Five sheets 8½" x 5½" containing two medium scales, twelve control panels (clear backgrounds) and white wording. 3s. 6d. postage 3d.

Set No. 3: Wording

Wording for Receivers, Amplifiers, Transmitters, Test Equipment and other Radio Apparatus, and Station Names. Five sheets, over 750 words and symbols. White. 3s. 6d. postage 3d.

Set No. 4: Wording

As set No. 3, but in black. 3s. 6d. postage 3d.

20 SUGGESTED CIRCUITS

by G. A. FRENCH

No. 15 in our Data Book Series. This book contains the first 20 circuits to be published in the very popular series of the same name appearing in *The Radio Constructor*.

The contents include: simple and inexpensive two-valve capacity bridge, short wave regeneration preselector, one-valve speech operated switching circuit, transformer ratio analyser, series noise limiter, receiver remote mains on-off control, and many others; covering subjects ranging from electronic laboratory equipment to a simple 2-Stage Gram Amplifier.

PRICE 3s. 6d. Postage 4d. 48 pages

DATA PUBLICATIONS LTD

57 MAIDA VALE · LONDON W9

No. 39. LOOK! NOW YOU CAN TAKE A COURSE IN RADIO AND ELECTRONICS FOR ONE TENTH THE USUAL COST!

By special arrangement we are able to offer for the first time a new comprehensive course consisting of 35 lessons bound into a manual size 8 in. x 11 in. Each page is divided into two colours. A wide column features the usual text, while a narrow column has the instructor's comments, helpful suggestions, additional pictures and remarks to simplify the difficult parts. We feel that many readers of Radio Constructor who require a basic course of instruction will find this manual of considerable assistance in their studies. 216 pages. Paper covers. Cash price 36/-, Time payment price 10 - cash with order and two monthly payments of 13/9.

No. 19. REFRIGERATION SERVICE MANUAL. H. P. Manly, Jr. Learn Refrigeration! This manual is a course in itself. Packed solid with information to enable you to do that repair job yourself. Used by many leading refrigeration firms as a standard reference. Features 364 pages together with 157 illustrations bound in cloth. An excellent buy at only 24/-, plus postage.

No. 7. TRANSISTOR CIRCUIT HANDBOOK. Louis E. Garner, Jr. Coyne.

A practical Transistor Circuit Reference Handbook by the eminently qualified Louis E. Garner, Jr., one of the greatest writers on transistor applications. Covers Transistor Circuitry, Basic Circuits, Circuit Applications and General Reference Material. Dozens of how-to-do-it illustrations with more than 200 circuit diagrams. Over 400 pages. Vinyl cloth covers. 39/6. (When ordering this book please be sure to clip the coupon.)



**No. 9
Pin-point
Transistor troubles
in 12 minutes (Coyne)**

Trouble-Shoot every type of circuit in ALL transistorised equipment! 525 pages; hundreds of illustrations; 120 check charts. Includes portable transistor Wireless Sets, Preamplifiers, Hearing Aids, Amplifiers, Car Radios, TV Sets and special types of equipment. Test procedures, trouble shooting charts and much useful reference data. Price 47/6

LIMITED OFFER! ACT NOW!

Just mail coupon for free trial. After 7 days send only low price or return books and pay nothing. If you keep more than one book, send £1 after 7 days and £1 each month until completed (maximum three books value not exceeding £5.0.0.) To buy one book send one-half in 7 days, and one-half in 30 days.

No.1 SPECIAL OFFER! COYNE ELEMENTARY PRACTICAL RADIO-TELEVISION SET OF THREE VOLUMES, total 1,038 pages, sturdy Vinyl washable covers. £3.12.6 the set!

These three volumes present the principles of construction, operation and testing of radio and television equipment in a SIMPLE, EASY TO FOLLOW manner.

One very important way in which these books differ from many other radio and television books is that the publishers did not try to assume the "extent of technical knowledge" of the reader. Every subject is explained COMPLETELY—while at the same time keeping it brief and to the point.

You will find hundreds of photos, charts, diagrams, etc., in these books. These have been provided to make it easier to understand the explanations. To get this special offer, send no money now, then 12/6, after free examination, and 20/- per month.

No. 8

COYNE'S NEW PIN-POINT TV TROUBLES TAKES HEADACHES OUT OF ALL SERVICING PROBLEMS

Your most useful on-the-job "tool"! Quickly and easily pin-points the exact trouble in any TV set. Covers 70 symptoms, 700 trouble spots. Over 340 cross-indexed pages; 50 time-saving Check-Charts; 290 diagrams and photos; explanation of circuits and designs. SIMPLE CHECK-CHART SYSTEM SAVES TIME

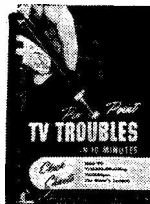

This amazingly practical handbook shows you how to find the trouble in any TV circuit FAST! Simple cross-index tells you in what section you'll find cause of trouble. Handy Check-Charts then help you accurately locate the EXACT trouble spot. Cut waste time, eliminate hours of aggravation, get right to the heart of the trouble in minutes. Price 31/6.

To SIM-TECH BOOK COMPANY (U.K.)
Mail Order Division, DEPT. RC9, Gaters Mill, West-End, Southampton, Hants.

RUSH (Insert Book number here) () () ()
 Tick here if enclosing full price, we pay postage (Coyne Books only). Same 7-day money-back guarantee.

NAME
ADDRESS
City County
Postage charges: Orders under £3 allow 1/6. £3 or over allow 2/- extra.

THE MODERN BOOK CO

Radio Control Manual. By E. L. Safford Jr. 25s Postage 1s.

Transistors. How to Test Them. Gernsback Lib. 16s. Postage 9d.

Records & Gramophone Equipment. By E. N. Bradley. 8s. 6d. Postage 6d.

Guide to Broadcasting Stations. Compiled by "WW". 3s. 6d. Postage 6d.

Service Valve Equivalents. An R.S.G.B. Pub: 2s.. Postage 4d.

Valve & Teletube Manual. No. 9. Brimar. 6s. Postage 1s.

Radio Valve Data. 7th ed. Compiled by "WW". 6s. Postage 10d.

Short Wave Receivers for the Beginner. A Data Pub: 6s. Postage 4d.

Telecommunications. By W. T. Perkins. 21s. Postage 9d.

TV Fault Finding. A Data Publication. 5s. Postage 6d.

The All In One Tape Recorder Book. By J. M. Lloyd. 12s. 6d. Postage 6d.

Principles of Semiconductors. By M. G. Scroggie. 21s. Postage 1s.

Handbook for Radio Operators. G.P.O. 6s. Postage 1s.

A Guide to Amateur Radio. An S.S.G.B. Publication. 3s. 6d. Postage 6d.





We have the Finest Selection of British and American Radio Books in the Country

Complete catalogue 1s.

19-21 PRAED STREET (Dept RC) LONDON W2

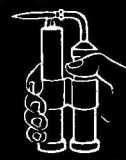
Telephone PADdington 4185

With a VALTOCK AUTOMATIC BLOWLAMP

	<p>The "2000." Ideal for model makers, hobbyists and service engineers for fine delicate work, soft soldering, glass bending, etc.</p> <p>PRICE 14/7</p>		<p>The "Major." A larger version of the "2000" fitted with flame shield to give large flame; for most big soldering jobs about the house.</p> <p>PRICE 30/-</p>
<p>The "No. 3." The D.I.Y. man's best friend. Full size, powerful. For paint stripping, heavy soldering and all big plumbing jobs.</p> <p>PRICE 63/-</p>		<p>Soldering Iron attachment. Fits the "Major" and "2000". Gives you a soldering iron anywhere—away from electrical supplies.</p> <p>PRICE 5/-</p>	

**YOU CAN DO
SO MANY
JOBS
SO WELL**

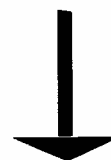

and the **SLOTGRIP** torsion Screwdriver
POSITIVELY GRIPS SCREWS ON THE END OF ITS BLADE

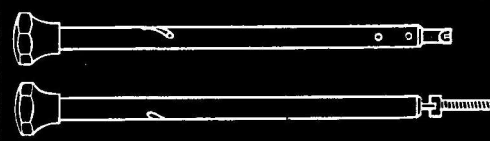
	<p>For putting screws in awkward places. Automatic action. Push—it grips. Pull—it's released.</p> <p>PRICE 5" 7/6 10" 12/-</p>
---	--

Get them at your local hardware shop or send to us for name of nearest stockist.

VALTOCK LTD. Regency House 1-4 Warwick St. London W1 Telephone GERRARD 1667

BUILD A BETTER RECORDER WITH A MARTIN RECORDAKIT

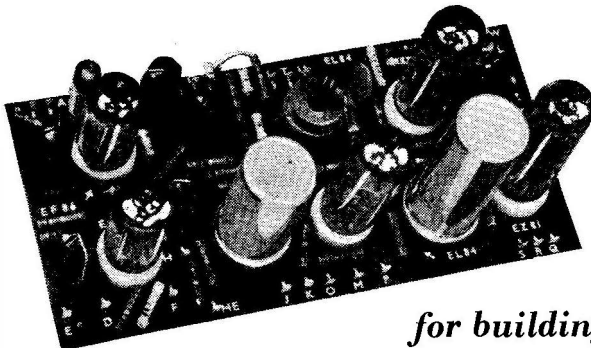

- HI-FI QUALITY PRINTED CIRCUIT AMPLIFIERS
- SIMPLIFIED BUILDING—PROFESSIONAL STANDARDS

for building into two and four track models

- COMPLETE WITH VALVES DOWN TO WIRE CUT TO LENGTH
- BETTER PERFORMANCE—LESS OUTLAY

Produced by the makers of amplifiers for some of today's best known recorders, the specially designed kits offered here set brilliant standards of performance and styling. Amplifiers, case and speaker assemblies and kits complete with decks are available. Well presented instructions are included. All equipment guaranteed. Instructions are easy to follow and success is assured. From radio dealers, or in cases of difficulty please write direct.

All amplifiers supplied assembled on printed circuit boards with valves. Case and Speaker assemblies available.

AMPLIFIER "C" for Collaro Studio Deck	11 gns.
KIT "C" with Deck, Case and Speaker	28½ gns.
AMPLIFIER "A" (4-TRACK) for BSR Monardeck	9 gns.
AMPLIFIER "B" (2-TRACK) for BSR Monardeck	8 gns.
KIT "A" with Deck, Case and Speaker	24 gns.
KIT "B" with Deck, Case and Speaker	21 gns.

MARTIN ELECTRONICS LIMITED
155 HIGH STREET BRENTFORD MIDD
 Leaflet on Martin Recordakits please. (Write in Block Letters)

NAME

ADDRESS

R.1

FREE TO AMBITIOUS ENGINEERS

— THE LATEST EDITION OF ENGINEERING OPPORTUNITIES

Have you sent for your copy?

ENGINEERING OPPORTUNITIES is a highly informative 156-page guide to the best paid engineering posts. It tells you how you can quickly prepare at home for a recognised engineering qualification and outlines a wonderful range of modern Home Study Courses in all branches of Engineering. This unique book also gives full details of the Practical Radio & Electronics Courses, administered by our Specialist Electronics Training Division—the *B.I.E.T. School of Electronics*, explains the benefits of our Employment Dept. and shows you how to qualify for five years promotion in one year.

We definitely Guarantee "NO PASS — NO FEE"

Whatever your age or experience, you cannot afford to miss reading this famous book. If you are earning less than £20 a week, send for your copy of "ENGINEERING OPPORTUNITIES" today—FREE.

**BRITISH INSTITUTE OF ENGINEERING
TECHNOLOGY** (Incorporating E.M.I. Institutes)
(Dept. SE/23), 29 Wright's Lane, London, W.8

THE B.I.E.T. IS THE LEADING ORGANISATION OF ITS KIND IN THE WORLD

WHICH IS YOUR PET SUBJECT?

Mechanical Eng.,
Electrical Eng.,
Civil Engineering,
Radio Engineering,
Automobile Eng.,
Aeronautical Eng.,
Production Eng.,
Building, Plastics,
Draughtsmanship,
Television, etc.

GET SOME LETTERS AFTER YOUR NAME!

A.M.I. Mech.E.
A.M.I.G.E.
A.M.I. Prod.E.
A.M.I.M.I.
L.I.O.B.
A.F.R.Ae.S.
B.Sc.
A.M. Brit. I.R.E.
City & Guilds
Gen. Cert. of Education
Etc., etc.

PRACTICAL EQUIPMENT

Basic Practical and Theoretic Courses for beginners in Radio, T.V. Electronics, Etc., A.M. Brit. I.R.E. City & Guilds Radio Amateurs' Exam. R.T.E.B. Certificate P.M.G. Certificate Practical Radio Radio & Television Servicing Practical Electronics Electronics Engineering Automation

INCLUDING TOOLS!

The specialist Electronics Division of B.I.E.T. (Incorporating E.M.I. Institutes) NOW offers you a real laboratory training at home with practical equipment. Ask for details.

B.I.E.T. SCHOOL OF ELECTRONICS

POST COUPON NOW!

Please send me your FREE 156-page "ENGINEERING OPPORTUNITIES" (Write if you prefer not to cut page)

NAME.....

ADDRESS.....

SUBJECT OR EXAM THAT INTERESTS ME.....



Premier RADIO

23 Tottenham Court Road London W1 Telephone MUSeum 3451/2 and 309 Edgware Road London W2 Telephone PADdington 6963

4-TRANSISTOR PORTABLE RADIO

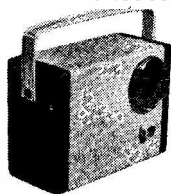

MAY BE BUILT FOR **95/-**
Plus 3/6 P. & P.

PP7 Battery Extra 3/3
A 4-transistor and 1-diode portable receiver ideally suited for the young enthusiast, having full medium waveband coverage and internal ferrite rod aerial. It incorporates a pre-tagged circuit chassis ensuring ease of construction, a hi-flux 5" speaker is used and the receiver is housed in an attractive two-tone rexine-covered cabinet.

incorporates a pre-tagged circuit chassis ensuring ease of construction, a hi-flux 5" speaker is used and the receiver is housed in an attractive two-tone rexine-covered cabinet.

The "Petite" PORTABLE



MAY BE BUILT FOR **£7.7.0** plus 5/- P. & P.

Batteries extra

HT 10/- (Type B126) or equiv.
LT 1/6 (Type AD35) or equiv.

- ★ Size only 8" x 8" x 4 1/2"
- ★ Instruction book 1/6

Battery Eliminator, available in component form price 37/6 plus 2/- P. & P.

BARGAIN OFFER



A COMPLETE SELF-POWERED

FM TUNER

MAY BE BUILT FOR **£4.19.6** plus 5/- P. & P.

STAR FEATURES

- ★ Self-powered
- ★ Permeability tuning
- ★ Philips FM tuning unit
- ★ Absolutely no drift
- ★ Frequency coverage: 88-100 Mc/s
- ★ Two IF stages and discriminator
- ★ OA81 balanced diode output
- ★ Valve line-up: ECC85, two EF80, EZ80 rectifier

Attractive full vision maroon and gold glass dial size 7" x 3". Overall dimensions of tuner 8" x 7 1/2" x 5 1/2"

Introducing THE TELEFUNKEN STEREO

HI-FI AMPLIFIER



For only **£7.19.6**
P. & P. 5/-

Brief specifications:

- Power Output 5 Watts total (2 1/2 watts per channel).
- ★ Frequency Response 30 c/s to 40 Kc/s 2dB, 45 c/s to 30 Kc/s 1/2dB.
- ★ Sensitivity sufficient for all normal inputs from Tape Recorders, Pick-ups, Microphones, Radios.
- ★ Power Requirements 110, 125, 150, 220, 240 volts A.C. ★ Piano key selecting.
- ★ Preselected tone control.
- ★ Size 12" wide x 9" deep x 2" high.
- ★ Finish: Hammered enamel in grey/green with gold trimmings, Controls and press buttons in cream with black, blue and red lettering.



THE "MID-FI" A NEW DESIGN

4 1/2 W AMPLIFIER KIT
MAY BE BUILT FOR **95/-** plus 3/- P. & P.

A new circuit for the home constructor requiring a good quality med. powered amplifier for reproduction of records or i.m. broadcasts. Technical spec.: sep. bass and treble controls. Valves: EF86, EL84, EZ80. Voltage adjustment for a.c. mains from 200/250V, 3 or 15Ω imp. Neg. feedback. Size 7" x 5" x 2", overall ht. 5". Silver hammered finished chassis.

D & B TELEVISION

Telephone Cherrywood 3955
Dept. D.1 131 & 131a KINGSTON ROAD
SOUTH WIMBLEDON LONDON SW19
"Compare our prices with any others"

For the **FINEST, FASTEST SERVICE** in the COUNTRY. We are open from 10 a.m. until midnight (1 p.m. Wednesday). For any information or problems you have, call or phone. We are always pleased to help.

NEW! SEND FOR OUR COMPREHENSIVE L.O.P.T. Scan Coil L.B.O., F.B.O., F.O.P.T. LIST. Prices of nearly all makes and models, 2/6 post 6d. Invaluable as a service aid. The finest list ever compiled.

HUGE PURCHASE ENABLES US TO SELL TRANSISTORS AT THESE ASTONISHING PRICES
Mullard: OC44 9/-, OC45 8/-, OC70 6/-, OC71 5/-, *OC72 6/-, OC76 7/-, OC78 7/-, *OC81 7/-, OC81D 6/-,
G.E.C.: GET874 8/-, GET873 7/6, *GET114 5/-,
*Available in matched pairs at 1/- extra

Mullard Diodes: OA70 2/9, OA79 2/9, OA81 2/9, OA91 3/6.
G.E.C.: GEX34 3/3.
TURRET TUNERS, various makes: 10, 16, 38 Mc/s. 40/-

EXAMPLE OF TRANSFORMER LIST

	L.O.T.		SCAN COILS	
	(New)	(Used)	(New)	(Used)
FERGUSON				
103T, 105T ...	69/9	35/-	60/-	35/-
992/4/6/8 ...	69/9	35/-	60/-	35/-
PYE				
V4, V4, V7 ...	52/6	35/-	55/-	35/-
V77, CTM4 ...	52/6	35/-	55/-	35/-
MURPHY				
V214, V240, V250 ...	60/6	35/-	45/-	45/-

REGUNNED CATHODE RAY TUBES
all with 12 months' Guarantee
ALL MAKES: 12" £3.15.0, 14" £4.5.0, 17" £4.15.0.
ADD: 10/- for 90°, 15/- for 110°, 5/- for Electrostatic Types.
SECONDS, with 12-month Guarantee—ALL MAKES: 12" £2.15.0, 14" £3.5.0, 17" £3.15.0.
SECONDS, no Guarantee—ALL MAKES: 12" £1.5.0, 14" £1.15.0, 17" £2.15.0.

10/- allowance on old tube if in good condition
HUGE PURCHASE! Again passed on to you
T.V. or coffee tables, veneered in walnut. Complete with four screw-on legs. Many other uses. Size 15" x 18½". Amazing offer at only 14/6. P.P. 3/-.
SPECIALLY made cabinets for the REPANCO JOURNEYMAN KIT, complete with 3 ohm speaker, dial and knobs. Well made in wood and covered in Vynide. Colours: Yellow, White, Red. State second choice. 30/- each. P.P. 3/-.
HURRY WHILE STOCKS LAST!

ALL VALVES ARE SOLD SUBJECT TO FULL GUARANTEE

CURRENT VALVE LIST

AZ31 8/6	ECC83 6/3	KT33C 6/-	SP41 2/3	UL46 7/-	6U4 10/-
B36 5/6	ECC84 7/9	KT36 8/6	SP61 2/3	UL44 10/9	7C5 6/9
CBL31 19/-	ECC85 7/6	KT61 8/3	U22 6/6	UL84 7/3	7C6 7/-
CCH33	ECH21 12/3	KT63 6/3	U24 10/-	U08 14/6	7S7 8/9
	ECH35 9/-	KTW61 5/9	U25 12/-	UU9 6/3	7Y4 6/9
CL33 10/-	ECH42 7/6	KTW63 5/9	U26 9/6	UY41 6/-	10F1 4/6
D77 3/-	ECH81 7/6	L63 2/9	U31- 7/-	UY85 6/6	10C1 10/-
DAF91 4/6	ECL80 6/9	PCC84 7/-	U37 18/9	W77 4/-	10C2 13/-
DAF96 6/6	ECL82 9/3	PCC89 8/9	U50 5/6	Z77 3/-	10P13 8/9
DF91 3/3	ECL83 11/9	PCF80 7/-	U52 5/-	U04 4/9	10P14 8/9
DH63 6/9	EF39 4/3	PCF82 7/9	U191 9/-	SV4 8/9	12A76 7/3
DH63 6/9	EF50 1/3	PCF86 14/6	U281 9/-	SY3 5/9	12A77 4/6
DH77 4/6	EF80 4/6	PCL82 7/-	U282 14/6	SZ4 10/-	12A07 5/6
DK91 5/6	EP91 3/-	PCL83 9/9	U301 17/6	GAL5 3/-	12AX7 6/3
DK92 7/-	EP92 4/-	PCL84 7/-	U801 22/-	GAM6 3/-	19B6G 14/6
DK96 6/9	EP85 6/3	PCL85 15/-	UABC80 6AT6	5/6	20F2 8/3
DL91 7/9	EP86 8/9	PL33 8/-	8/6	6BG6 12/-	20L1 12/6
DL92 5/9	EP89 6/6	PL36 9/9	UAF42 8/-	6BV6 7/6	20P1 9/6
DL94 6/6	EL33 7/6	PL38 14/6	UB41 7/9	6CD6 25/6	20P3 12/6
DL96 6/6	EL38 12/-	PL81 8/6	UBF89 7/9	6D2 3/-	20P4 16/6
EABC80	EL41 7/9	PL82 6/6	UBF89 7/9	6F1 4/6	20P5 14/6
	EL84 6/9	PL83 6/6	UCC84 6F12	3/-	27S5 14/-
EAF42 7/9	EM80 8/6	PL84 8/9	12/6	6F13 6/6	30C1 7/3
EB41 6/6	EM81 8/6	PY31 7/-	UCC85 7/9	6F14 9/-	30FL1 9/3
EB91 3/-	EM84 9/6	PY32 10/-	UCF80 14/6	6F15 9/-	30L1 7/9
EBC33 4/6	EY51 7/9	PY80 6/6	UCH21 6F33	6/3	30P4 10/-
EBC41 7/6	EY86 7/6	PY81 6/-	12/3	6L1 12/-	30P12 7/6
EBF80 7/6	EZ40 6/3	PY82 6/-	UCH42 7/-	6L6 9/9	52KU 10/6
EBF89 8/3	EZ41 6/9	PY83 8/-	UCH81 8/3	6V6 5/-	53KU 10/-
EBL31 20/-	EZ80 6/-	PY88 12/-	UCL83 12/6	6L8 8/-	54KU 8/6
ECC81 4/6	GZ32 8/9	PZ30 8/-	UF42 3/9	6L19 12/-	185BT 14/-
ECC82 5/6	GZ34 12/6	R18 10/-	UL41 7/-	6SN7 4/6	

These are only examples of our valves; if you do not see what you require send stamped addressed envelope for special quotation

We pride ourselves that we can obtain and supply any TV spare
OUR GIGANTIC STOCKS INCLUDE: Line, Frame and Sound Output, Line and Frame Blocking, Osc., Trans., and Scan Coils for any make or model television. Please ask us for ANY components you require; we are almost certain to have them.

TERMS: S.A.E. all enquiries.
Postage on Valves, 6d. each
SATISFACTION ASSURED.

C.W.O. or C.O.D. 3/- extra
C.R.T.s 12/6 inc. insurance
RETURN POST SERVICE

TRANSISTOR POCKET RADIOS

BULK PURCHASE ENABLES US TO MAKE THIS FANTASTIC OFFER AND WITH MONEY BACK GUARANTEE!

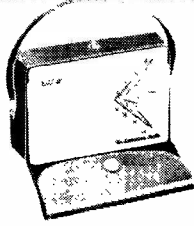

The "SAN REMO" . . .
only 32/6 No more so tuned that it brings the voices of star entertainers and vocalists dramatically to life—in your home, office, etc. . . . Only 4¼" x 2⅞" x 1¼" fits easily into your pocket or handbag. **Works for months off 8d. battery.** Should last a lifetime. Anyone can assemble it in an hour or two with our easy plan. Complete set of parts including miniature speaker, carrying case—everything only 32/6 plus 2/6 P. & P. C.O.D. 2/6 extra. (Parts can be bought separately.) **Limited period—so order before it's too late.**

DEMONSTRATIONS DAILY
CONCORD ELECTRONICS (DEPT. RC4)
210 Church Road Hove Sussex

EX-RENTAL SETS **ILFord 6001/3** **REPLACEMENT REGUNNED TV TUBES**

17 inch £11.10.0 **14 inch TV TUBES**

Excellent Table Models. ITA/BBC. Famous manufacturer. 12 months guarantee on tube, 3 months on chassis and valves. Ins., carr. 25/- (Regret some delay).

21" 99/6 17" 90/-
15" 14", 12" 70/-
£1 extra without old bowl, refundable if same received within 14 days.

14 inch TV TUBES
14KP4 and 36/24
Due to large purchase of Rental replacement stocks. Carr. 5/-.

14 inch £17.10.0
ITA/BBC. Identical to 17" TV. Ideal for Caravans, Weekend Bungalows, Chalets, etc. Carr. 20/-.

DE LUXE TAPE RECORDER CABINET 79/6 **TAPE RECORDER AMPLIFIER £7.19.6**

Beautifully styled rexine covered cabinet in red or Beige. Size 14½" x 13" x 9½".
Storage comp. in lid for tapes and mike.
Easily adapted to Record Player Cabinet. Carr. 5/-

Compact well designed 5 valve amplifier. O.P. 3.5 watts. Input for mike, radio and gram. Size 8½" x 3" x 4½". Carr. 5/-
EXTRAS: Knobs 2/6 per set. Beautiful perspex dial plate, complete with sockets for mike, Radio & superimposed switch 3/6.

DUKE & CO. (London) LTD 621/3 ROMFORD RD MANOR PARK E12

SMALL ADVERTISEMENTS

Private: 3d. per word, including address.
Minimum charge 2/6.
Use of Box Number, 2/- extra.

Trade: 9d. per word. Minimum charge 12/-.
Terms: Cash with order.

All copy must be received by the 6th of the month for insertion in the following month's issue. The Publishers cannot be held liable in any way for printing errors or omissions, nor can they accept responsibility for the *bona fides* of advertisers.

PRIVATE

FOR SALE. No. 5 Indicator timebase sets containing 8-VR91, 1-6V6G, 2-VR92 and a wealth of potentiometers, capacitors, resistors, transformers, c.r.t. holder, etc. All high grade components. Brand new, £1. Potentiometers, 4/-. Post Free. Howdle, 52 Braithwell Road, Ravenfield, Rotherham, Yorks.

FOR SALE. Collaro Mark 4 tape deck, £8. Collaro Studio pick-up with stereo cartridge, £2. Champion self-powered f.m. tuner, £7. Buyer collects. 32 Chigwell Road, South Woodford, London, E.18.

WANTED. Signal Generator. Accurate and in good order Reasonable. A.C. preferred. Box No. F138.

FOR SALE. Alan Douglas organ parts. R.C.O. pedalboard, 2 manual keyboard, power pack, valves, chokes, etc. S.A.E. for list. Also 2 manual reed organ. P. Anderson, 8 Leybourne Road, Strood, Kent.

FOR SALE. First class v.h.f. receiver type 1392, unmodified and complete with 15 valves, "S" meter, etc. Covers 95 to 150 Mc/s., £3. 10s. Carriage paid. Beadle, 6 Chapel Cottages, Thearne, Nr. Beverley, E. Yorks.

TRADE

LEARN RADIO AND ELECTRONICS the NEW Practical way. Very latest system of experimenting with and building radio apparatus—"as you learn"—FREE Brochure from: Dept. RC10 Radiostructor, Reading, Berks.

PANL, recognised for many years as the unique one-coat black crackle finish. Brush applied, no baking. Available by post in eighth-pint cans at 3s. 9d. from G. A. Miller, 255 Nether Street, London, N.3.

THE INCORPORATED PRACTITIONERS IN RADIO AND ELECTRONICS (I.P.R.E.) LTD. Membership conditions booklet 1s. Sample copy of I.P.R.E. Official Journal 2s. post free.—Secretary, 20 Fairfield Road, London, N.8.

"AMPLIFIERS AND FEEDERS." Covers the construction of direct-coupled amplifiers and an assortment of radio feeders. Price 3s. 6d.—High Fidelity Co., 18 Melville Road, Birmingham 16.

CATALOGUE No. 14. Government surplus and model radio control, over 500 illustrated items, 2s. 6d. (refunded on purchase of £2) post free.—Arthur Sallis Radio Control Ltd., 95 North Road, Brighton.

FIND TV SET TROUBLES IN MINUTES from that great book *The Principles of TV Receiver Servicing*, 10s. 6d., all book houses and radio wholesalers. If not in stock, from Secretary, I.P.R.E., 20 Fairfield Road, London, N.8.

JOIN THE INTERNATIONAL S.W. LEAGUE. Free Services to members including Q.S.L. Bureau, Amateur and Broadcast Translation, Technical and Identification Dept.—both Broadcast and Fixed Stations, DX Certificates, contests and activities for the SWL and transmitting members. Monthly magazine, "MONITOR", containing articles of general interest to Broadcast and Amateur SWLs, Transmitter Section and League affairs, etc. League supplies such as badges, headed notepaper and envelopes. QSL cards, etc., are available at reasonable cost. Send for League particulars. Membership including monthly magazine, etc., 21s. per annum.—Secretary ISWL, 12 Gladwell Road, London, N.8.

SERVICE SHEETS (1930-1962) from 1s. Catalogue 6,000 models, 1s. 6d. S.A.E. enquiries.—Hamilton Radio, 13 Western Road, St. Leonards, Sussex.

continued on page 479

SMITH'S of Edgware Road BLANK CHASSIS

Precision made in our own works from commercial quality half-hard Aluminium. Two, three or four sided.

SAME DAY SERVICE
of over 20 different forms made up to YOUR SIZE. Order EXACT size you require to nearest $\frac{1}{16}$ " (maximum length 35", depth 4").

SPECIALS DEALT WITH PROMPTLY

SEND FOR ILLUSTRATED LEAFLET

Or order straight away, working out total area of material required and referring to table below, which is for four-sided chassis in 18 s.w.g. (for 16 s.w.g. add 10%)

48 sq. in.	4/-	176 sq. in.	8/-	304 sq. in.	12/-
80 sq. in.	5/-	208 sq. in.	9/-	336 sq. in.	13/-
112 sq. in.	6/-	240 sq. in.	10/-	368 sq. in.	14/-
144 sq. in.	7/-	272 sq. in.	11/-	and pro rata	
P. & P. 2/- (2/6)		P. & P. 2/6 (2/9)		P. & P. 2/9 (3/-)	

Discount for quantities. Trade enquiries invited. Spray finish arranged for quantities of 25 or over.

FLANGES ($\frac{1}{4}$ ", $\frac{3}{8}$ " or $\frac{1}{2}$ ") 6d. per bend.

STRENGTHENED CORNERS, 6d. each corner.
PANELS. The same material can be supplied for panels, screens, etc. Any size up to 3ft at 4/6 sq. ft. (16 s.w.g. 5/-). P. & P., up to 72 sq. in. 1/-(1/3), 108 sq. in. 1/9 (2/), 144 sq. in. 2/- (2/6), 432 sq. in. 2/6 (2/9), 576 sq. in. 2/9 (3/3).

Prices in brackets are for P. & P. on 16 s.w.g.

H. L. SMITH & CO. LTD

287/289 EDGWARE ROAD LONDON W2
Telephone PAD 5891/7595

REPANCO

Transistor Amplifier and Feeder Unit Circuits

Envelope of theoretical and practical layout diagrams for:

350/500 milliwatt Transistor Amplifier

Simple TRF Band Pass Feeder Unit

Medium wave TRF Feeder Unit with R.F. Stage

Medium and Long wave Unit with R.F. Stage

Medium and Long wave Superhet Feeder Unit

Microphone Pre-amplifier

Send now 2/- (post free) for envelope

RADIO EXPERIMENTAL PRODUCTS LTD
33 MUCH PARK STREET · COVENTRY

POCKET RADIO—OUTSTANDING RESULTS

Covers Medium and Long waves. No aerial or earth required. Very compact. Personal earphone.

ALL PARTS 59/6. Plus post 2/-

Write for details (3d. stamp) before you buy elsewhere

Red Spot Transistor 2/3; White Spot 2/3; Yell/Gr. 3/3; Ediswan XA102 (Mixer Stage) 9/-; XA104 (I.F.s) 8/-; XA103 (I.F.s) 8/-; XB104 (A.F.) 6/-; Mullard OC71 6/-; OC72 7/6; OC44 9/6; OC45 9/-; Bargain sets 6 transistors plus Diode, Ediswan 39/6; Mullard 47/6. P.V. Superhet complete Kit £8.5. (Mullard transistors). Diodes 1/-, 2/-, 3/-; Sub. Min. Electrolytics 1, 2, 4, 8, 10, 16µF 2/- each. Ardent Trans. D239 8/6; D240 8/6; D131 10/-. Silicon Rectifier 70 p.i.v. ½A 3/3; Westalite Contact Rectifier 250V 60mA 7/6; Transformer 250-0-250V, 6V and 5V 15/-. Garrard Record Player Motor (45-r.p.m.) and Pick-up for Transistor Amplifier 70/-; Meter 200mA M.C. F.M. 2½" 12/6; 5A R.F. (2mA) 8/6; Hearing Aid Mike 31/6; Super Coax. 75 ohms 6d. yd; Valves 6X5 5/6, 6V6 5/6, 1L4 5/6; Speaker 18/6; Electrolytics: 8µF 500V 2/3; 8+16µF 3/3; 100+100 (375V) 3/9; V. Cond. 0.0005 T. Gang, Trimmers and Slow M. 9/6; Resistor Holders 1/-; Resistors 10% col. 4d.; 5% col. 9d. Tannoy Mike 5/-. Crystal Inserts (new) 7/6. Gorler Units, 1 watt Amplifier 92/6; I.F. Amplifier (460 kc/s pre-aligned) 92/6; 3 waveband Converter 90/3. Manual No. 167 describing and circuits 2/9 post free. Earphone Hi-imped 10/-; 4 mfd Block 600V. 3/6; T.S.L. Speakers CMS50. 2½" 17/11; Sub-min. Jack and Socket 3/- pr; Min. Slide Switches 2/6; V15/10P Transistors 15/-; V30/20P 28/6; Crystal Mike Input Transf. 12/-.

Terms—Cash with order. Post extra, excess refunded. Our Reflex Rx, best 2-transistor Receiver. Send 10d. stamps for notes.

MOORE'S EXPERIMENTAL SUPPLIES

8 & 10 GRANVILLE ST. SHEFFIELD 2

Telephone 27461

EDDY'S (NOTTM) LTD.

Dept. RC

116 ALFRETON ROAD • NOTTINGHAM

NEW OR SURPLUS VALVES. GUARANTEED AND TESTED. BY RETURN POST.

AC2/PENDD	EF91	3/6	U26	10/11	6F13	6/11	6SN7GT	4/3
	EF92	4/6	1D5	7/6	6F15	8/6	6X5G	5/6
CY31	EL32	6/11	1L4	3/6	6F33	6/6	7C5	6/11
EB91	EL91	4/6	1R5	5/6	6J5G	2/9	10F1	6/6
ECC81	GTIC	4/11	1S5	4/9	6J7G	5/-	10P13	9/6
ECC85	KT33C	6/6	1T4	3/6	6K7G	1/11	12A6	5/-
ECH42	HL23DD7	1/11	3A4	4/11	6K8G	5/6	12AT6	7/6
ECL82	MU14	7/-	5U4G	4/9	6P25	9/11	20D1	8/6
EF36	OZ4	5/11	5Z4G	7/6	6Q7G	5/11	20P1	9/6
EF39	PL36	13/6	6AC7	4/-	6SA7M	5/9	20P3	12/6
EF40	PY82	6/3	6AC5	3/11	6SG7M	4/9	25A6G	8/-
EF41	PZ30	9/11	6C4	3/6	6SJ7M	5/9	80	6/11
EF42	PEN36C	8/-	6CH6	8/-	6SL7GT	6/6	954	1/6
EF50	TDD4	7/6	6C5	4/9	6V6G	4/9	955	3/6
EF86	VP23	6/6	6F1	6/11	6J6	4/-	956	2/6

POCKET RADIO 2 Transistor with miniature speaker. Complete with all parts, wiring diagram and full instructions 27/6. Batteries 1/- P. & P. 2/-.

CAR RADIO 7 Transistors, Long and Medium. 2 watts output. R.F. Stage and auto gain control. Size 7½" x 7½" x 2½" 6 or 12v. (state which) supplied with full instructions. 10½gns. Speaker extra 17/11. P. & P. 5/6.

NIFE ACCUMULATORS 1.25v. size 3" x 2½" x ¾" 7 amp. hrs. Weight 13oz. 3/6 ea. P. & P. 2/- one only add 9d. per cell.

THROAT MIKES 2/- each. Post 10d. Could be used for electrifying musical instruments etc.

GERMANIUM DIODES 9d. each. 7/- Dozen. Post 6d.

CRYSTAL SETS complete 2 wave bands high gain, 19/11 also with transistor amplifier extra 9/11. P. & P. 2/6.

HEADPHONES high res. to suit above crystal sets. Good quality 13/11 Pr. P. & P. 1/6.

VIBRATORS 12 v. 4 pin 4/11. 6v 4 pin 9/11 P. 1/6

ALL ABOVE ARE NEW AND GUARANTEED

Any parcel insured against damage in transit for only 6d. extra per order. All uninsured parcels at customers risk. Post and Packing 6d. per valve extra C.W.O. or C.O.D. only. C.O.D. charge 3/- extra. S.A.E. with enquiries.

"BUILD IT YOURSELF" WITH R.C.S!

5 STAGE SUPER SENSITIVE
TRANSISTOR PORTABLE

THE "BOBETTE"

★ Simple to Build.

★ All first grade components.

A truly portable transistor radio giving full medium wave reception. Incorporates 5" High Flux Speaker, push pull output, first grade transistors, High-Q ferrite aerial, socket for car aerial, pre-tagged circuit board for easy construction. Attractive two-tone case.

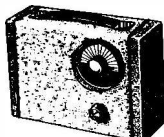

Total Building Costs
£5.2.6 P. & P. 2/6

All parts sold separately. Send 1/6 for itemised price list and full assembly instructions (free with order).

EXPLORE THE WORLD ON THIS 1-VALVE SHORT WAVE RADIO

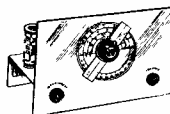

Total Building Costs only
35/-
P. & P. 2/-

- ★ Receives speech and music from all over the world.
 - ★ Construction price includes valve and one coil covering 40-100 metres.
 - ★ Can be extended to cover 10-100 metres.
 - ★ Can be converted to 2 or 3 valve.
- Send 2/- for wiring diagram and components price list.

THE "PIRETTE"

TWO-TRANSISTOR SET DESIGNED FOR PERSONAL LISTENING

An amazing little set with built-in ferrite rod aerial bringing in medium wave at wonderful volume. Sturdy case, size 4" x 3" x 1½", fits into palm of the hand. Drilled chassis colour-coded for easy assembly. Two top grade transistors plus diode. Supplied with earpiece.

Total building **50/-** P.P. 2/-
Costs
Wiring diagram, etc., 1/6 (free with order)



R.C.S. PRODUCTS (Radio) LTD

11 Oliver Road • London • E17

(Mail Order Only)

P.W. POCKET SUPERHET

TRANSISTORISED PRINTED BOARD

A-Z CONSTRUCTIONAL BOOKLET 1/6 including "BLOWN-UP" DIAGRAM

SIMPLE BOOST MODIFICATIONS

PHOTO—ILLUSTRATION.
NEW CONTEMPORARY CASE

Some Osmor Stockists

Henry's Radio Ltd., 5 Harrow Road, London, W.2
Clyne Radio Ltd., 162 Holloway Road, London, N.7
Surbiton Park Radio Ltd., 48 Surbiton Rd., Kingston, Surrey
Radio Component Specialists, 337 Whitehorse Road, West Croydon, Surrey

Norcol Ltd., Castle Road, Camberley, Surrey
Sound Reproducers Ltd., 7 Jepson Road, Forest Gate, London, E.7

Ask your Dealer or write for Illustrated Price List and Free Information

OSMOR RADIO PRODUCTS LTD

418 BRIGHTON ROAD SOUTH CROYDON SURREY

Telephone CRO 5148/9

SMALL ADVERTISEMENTS

continued from 477

WANTED. Instrument Speedometers: ex R.A.F. Type AM 1940 ref. 50698. Made by Hasler Telegraph Works. These are speedometers apparently designed for measuring instrument shaft revolutions and would be very useful for checking teleprinter shaft speeds. A number required for resale to British Amateur Radio Teleprinting Group members: c/o Hon. Sec. B.A.R.T.G., "East Keal", Romany Road, Oulton Broad, Lowestoft, Suffolk.

"MEDIUM WAVE NEWS." Monthly during DX season.—Details from B. J. C. Brown, 196 Abbey Street, Derby.

THE INTERNATIONAL HAM HOP CLUB is a non-profit making organisation open to RADIO AMATEURS AND SHORT WAVE LISTENERS. OBJECT: To improve international relationships through an organised system of hospitality. MEMBERS offer overnight hospitality to visiting members, subscription 10s. per annum. ASSOCIATE MEMBERS invite radio amateurs to visit their stations. Associate membership 5s. per annum. FAMILY EXCHANGE holidays arranged, also FRIENDSHIP LINKS between radio clubs. The Club's official journal is free to both Full and Associate members.—Hon. Gen. Secretary: G. A. Partridge, G3CED, 17 Ethel Road, Broadstairs, Kent.

"MEDICINE". For home, factory or first aid post. The book that everyone should have on hand. Price 3s. 6d.—Eggbaston Electro-Medical Laboratories, 18 Melville Road, Birmingham 16.

METALWORK. All types chassis and panels made to own specification. Quick service. T. Ellis, 106 Clough Street, Morley, Leeds.

SITUATION VACANT

UNIVERSITY OF GLASGOW. Biological Electronics Technician wanted to construct research equipment. Experience with valve and transistor amplifiers and/or pulse equipment desirable. Salary within the range of £490-£675 p.a. Applications should be sent to the Head of the Physiology Department, The University, Glasgow, W.2.

15/- TUBES. 31/74, 124, 153. EX-SERVICE STOCK, CARR. 5/6.

35/- 14KP4, 36/24. EX-RENTAL REPLACEMENT, CARR. 5/6.

★ **SPEAKER BARGAINS**, 8/9 each. 6", 8" and 7" x 4". Ex-manufacturers. Money back, guaranteed. P. & P. 3/3.

P. P. COMPONENTS LTD. c/o 623 Romford Rd. Manor Pk. E12
Regret Mail Order Only, Stamp for Free List



RADIO and T.V. SPARES

SEND NOW FOR OUR

FREE 1962

CATALOGUE

OVER 2,000 VALVE TYPES AVAILABLE FROM STOCK

ALPHA RADIO SUPPLY CO

103 LEEDS TERRACE, WINTOUN ST., LEEDS 7
Telephone 25187



3-TRANSISTOR POCKET RADIO

WITH MINIATURE LOUDSPEAKER

Absolutely NO soldering

39/6 Superb appearance. Simple instructions. Built in an evening. No drilling. Complete in every detail. Receives entire broadcast band. Aerial required in certain areas. Pocket size 4 1/2" x 2 1/2" x 1 1/2".



Or the more powerful **SAVOY SUPER-3**: 3 transistors and 2 diodes in a 5-stage reflex circuit. Dimensions as above.

55/6

Battery 1/- extra P. & P. 2/- ALL PARTS SOLD SEPARATELY

Savoy Electronics Ltd 15 Maiden Lane, London WC2 (Back of Adelphi Theatre)

★ VALVES New Tested & Guaranteed

1R5 6/6	6X4 7/6	DK96 8/-	EZ40 6/6
1S5 6/6	6X5GT 6/6	DL92 6/9	EZ80 6/6
1T4 4/6	12AT7 6/-	DL94 7/6	EZ81 7/-
354 6/9	12AU7 6/-	DL96 8/-	GZ32 10/6
3V4 7/6	12AX7 7/6	EBC1 4/6	KT66 15/-
5U4G 6/-	12BH7 10/6	ECC81 9/6	PL81 13/6
5Y3GT 7/6	12K7G 8/6	ECC82 6/-	PL82 10/6
5Z4G 9/-	12K8GT 13/6	ECC83 7/6	PY81 8/-
6AK6 6/6	12Q7GT 6/6	ECC85 7/6	PY82 7/6
6AL5 4/6	25A6G 10/6	ECC85 8/6	PCC84 9/-
6AM6 4/-	25L6GT 9/-	ECC85 8/6	PCF80 9/-
6AT6 7/6	35Z4GT 8/6	ECC82 7/6	PCF82 11/-
6BA6 8/6	35L6GT 9/6	ECH81 10/6	PCL82 7/6
6BE6 7/6	5763 10/6	ECH42 8/6	R19 12/6
6BR7 10/6	DAF91 6/6	EL80 9/6	U26 10/6
6BW6 8/6	DAF96 8/-	EF41 8/6	U76 8/6
6I7GT 8/6	DF91 4/6	EF80 8/-	UBC41 10/-
6K7G 7/6	DF96 8/-	EF86 9/6	UCH42 10/6
6Q7G 7/6	DH76 8/6	EF91 4/-	UF41 10/-
6SL7GT 8/-	DH77 7/6	EL41 9/-	UL41 8/-
6SN7GT 8/6	DK91 6/6	EL84 8/-	UY41 8/-
6V6G 7/6	DK92 7/6	EY51 7/6	W76 8/6

MATCHED PAIRS. EL84, 17/-; EL85, 25/-; 6V6G, 17/-; 6BW6, 18/-; KT33C, 19/6; 807 14/6 pair; KT66, 32/6.

SETS OF VALVES

DK96, DF96, DAF96, DL96 "REGENT"	29/6 per set
DK91, DF91, DAF91, DL92, or DL94	21/- per set
1R5, 1T4, 1S5, 354, or 3V4	21/- per set
6K8, 6K7, 6Q7, 6V6, 5Z4, "G" Types	27/6 per set
12K8, 12K7, 12Q7, 35L6, 35Z4, "GT" Types	35/- per set
ECH42, EF41, EBC41, EL41, EZ40	37/6 per set
UCH42, UF41, UBC41, UL41, UY41	35/- per set

P.P. OP. TRANSFORMERS. MR 3-15 ohms for EL84, 6V6, 6BW6, etc., 18/6; Op. Pen. 50mA, 5/6; 30mA, 4/6.

P. & P. 6d., over £1 post paid. C.O.D. 3/-

R. COOPER G8BX 32 SOUTH END CROYDON SURREY CROYDON 9186

The NEW "SAVOY" 4-TRANSISTOR POCKET RADIO

WITH MOVING COIL SPEAKER
Absolutely NO Soldering : NO Drilling

NO Aerial Required

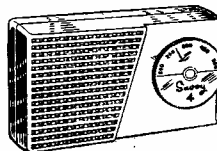

4 transistors and 2 diodes; 5-stage reflex circuit; push-pull output; size 5 1/2" x 3" x 1 1/2"; full medium wave; simple instructions and assembly tool provided. All parts sold separately.

95/- plus battery 2/- extra postage and packing 3/-

(RC) **Savoy Electronics Ltd** 15 Maiden Lane, London, WC2 (Back of Adelphi Theatre)

MODEL TP55

A.C./D.C. voltage up to 1,000 in 5 ranges. D.C. current 4 ranges up to 500 mA. 4 range resistance to 10 meg. Capacity, dB scales, etc.

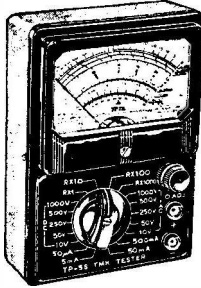

20,000 ohms/volt
Size 5 1/4" x 3 1/2" x 1 1/2"

£5.19.6 P.P. 1/6.
With Test Leads, Battery and Instructions

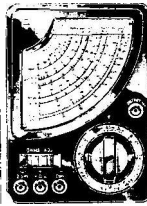

MODEL 200H

20,000 ohms per volt

£6.19.6 P.P. 1/6.

With Test Leads, Battery and Instructions.

6 Ranges D.C. voltage to 2 1/2 kV.
5 Ranges A.C. voltage to 1 kV.
3 Ranges D.C. current to 250 mA.
Resistance to 6 meg. Capacity and dB ranges

ALSO MODEL TE10

10,000 ohms/volt version of above, identical in appearance. £5.19.6 P.P. 1/6. Fully Guaranteed.



AVO-7

Famous Multi-meter. Reconditioned and fully guaranteed. Full A.C./D.C. voltage and current, resistance, dB, power, etc., etc. Supplied with Batteries, Leads and Instructions.

£11.10.0 Regd. Post 5/-.
(Normal Price £19.10.0.)

LEATHER CASE 30/- EXTRA

MODEL TP10

A.C./D.C. voltage up to 1 kV. in 4 ranges. D.C. current up to 500 mA in 2 ranges. 2 Range resistance to 1 meg. Capacitance, dB ranges, etc.

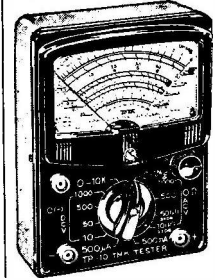

2,000 ohms/volt.
Size 5" x 3 1/2" x 1 1/2"

79/6 P.P. 1/6

With Test Leads, Battery and Instructions.

TRANSISTOR INTERCOMM

★ Two-way Inter-comm. with clear reproduction. Incorporates unique buzzing system. 2 speakers, volume control. Cabinet sizes about 3 3/4 x 1 1/2 x 3 1/2 in. Ready to use. Fully guaranteed.

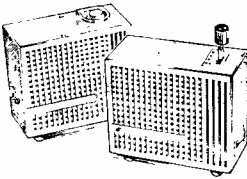

★ Printed Circuit Amplifier.

SUPPLIED IN PRESENTATION BOX WITH BATTERY AND 60ft WIRE.

10 gns.

"BAIRD" RECORD PLAYER AMPLIFIER

★ 2-watt output.
★ Ready built with valves and 8" x 5" speaker, tone and volume controls. Printed circuit.

75/- P.P. 2/-

Ideal for Portable Record Player.

★ UAB 4-speed Record Changer, ideal for above. £6.19.6. P.P. 3/6.

SUB-MINIATURE JACK PLUGS AND SOCKETS, 3/6 pair.

1 KΩ DYNAMIC MICROPHONE

Hand held or desk stand, complete with screened cable. Excellent response. 49/6. P.P. 1/-.

★600Ω PERSONAL EARPHONE

with jack plug and socket. 10/6. P.P. 1/-.

MINIATURE PANEL METERS (D.C.)

0/50 microamp	39/6
0/500 microamp	32/6
0/1 milliamp	27/6
Vu meter	42/6
"S" meter	35/-

BRAND NEW

TELEPHONE ADAPTOR

★ Ideal for recording telephone conversations. Supplied with screened cable. Fitted rubber sucker. 14/- P.P. 9d.

LOW IMPEDANCE HEADPHONES, 6/- P.P. 1/3.

★ RANGER 2 ★



PERSONAL POCKET RADIO

● Two Transistor Two Diode, fully tunable over Medium waves. Good reception of Radio Luxembourg. Size 4 3/8 x 3 x 1 1/2 in.

All Parts 59/6 No extras to buy.

● PICTORIAL PLANS AND DETAILS FREE ON REQUEST



CRYSTAL MICROPHONES

ACOS 39-1. Stick Microphone with screened cable and stand (list 5 gns), 32/6. P.P. 1/6.

ACOS 40. Desk Microphone with screened cable and built-in stand (list 50/-), 15/- P.P. 1/6.

ACOS 45. Hand Microphone with screened lead, very sensitive, 25/- P.P. 1/6.

100C STICK MICROPHONE with muting switch, detachable table stand, neckcord, screened lead, 39/6. P.P. 1/6.

★ Brand New—Fully Guaranteed ★

1 WATT TRANSISTOR AMPLIFIER

● EMI 4-Transistor Amplifier with speaker, tone and volume controls. Ready assembled. For use with crystal pick-ups. 6-9 volt operated. 89/6 P.P. 1/6.



BATTERY RECORD PLAYER

● 6-7 1/2 volt Garrard turntable with crystal pick-up. Plays 45 r.p.m. Ideal for above amplifier.

65/- P.P. 1/6.

TUBULAR LOUDSPEAKER UNIT

Extension portable speaker unit to give big set performance from any transistor pocket radio. Fitted 2 sizes of jack plug. Just plug into earphone socket. 57/6. P.P. 1/6.

★ CRYSTAL LAPEL MICROPHONE
Ideal for tape recording.

Very sensitive. 17/6 P.P. 1/-.

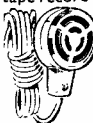

★ LIGHT-WEIGHT 4,000 OHM HEADPHONES,



12/6 P.P. 1/-.

Transistors



We stock a transistor for every need from 3/6 each.

SEND FOR LATEST PRICE LIST

● 1st Grade Fully Guaranteed ●

★ WE CAN SUPPLY MOST OF THE COMPONENTS USED ON CIRCUITS PUBLISHED IN THIS AND OTHER MAGAZINES QUOTATIONS BY RETURN ★

PORTABLE LOUD HAILER

★ Pistol grip action. Special shape horn. Built-in batteries and detachable microphone. Made of lightweight materials. Weight 4 lb. £14.10.0.

CRYSTAL MIC. INSERTS

★ ACOS 43-2 2 1/2" round, 12/6. P.P. 6d.

★ ACOS 1 1/2" round, 7/6. P.P. 6d.

★ 3/4" square, 3/6. P.P. 6d.

TAPE HEADS.

Wright and Wearite Record and Erase Heads, Type FE7 and FR7. Brand new, 19/6 pair. P.P. 2/-.

★ TRANSISTOR STANDARD AND MINIATURE COMPONENTS

We stock the largest range of components in the country for the home constructor.



PRACTICAL TRANSISTOR CIRCUITS

3/6 Post Free. Contains easy to follow plans of 40 all transistor units, including light operated switches, amplifiers, transmitters, receivers, test oscillators, signal tracers, hearing aids, radio control, etc. All parts available separately. ● Designed for the Home Constructor

★ STEREO AMPLIFIER ★

BARGAIN OFFER

● 2 watts per channel.
● Full tone, balance and volume controls.
● Complete with sockets, dials, etc.

97/6 P.P. 2/6.

Suitable Speakers, 8" x 5", 49/6 pair. UA14 Stereo Deck, £8.19.6. P.P. 2/6.

BATTERY ELIMINATOR AND CHARGER

9 volt charger for pocket transistor radios. Charges PP3 or equivalent to give 5 times life. Also runs radio from 200/250 volt mains. Price 29/6. P.P. 1/-

Henry's Radio Ltd PLEASE

PADddington 1008/9

5 HARROW ROAD LONDON W2 TURN

Open Monday to Sat. 9-6, Thurs. 1 o'clock PAGE

Send 1/- stamp for New Illustrated Price List

★

NYLON P.T.F.E.

ROD BAR SHEET TUBE STRIP WIRE
No quantity too small List on application
BRASS COPPER BRONZE ALUMINIUM LIGHT ALLOYS

H. ROLLET & CO LTD

6 CHESHAM PLACE, LONDON, SW1 BELGRAVIA 4300
Also at Liverpool, Birmingham, Manchester, Leeds

Quality Components FOR CONSTRUCTORS

capacitors, resistors, coils, valves, diodes, controls, chassis, transformers, speakers, pick-ups, cartridges, styli, and all types of components in stock.

PRICE LISTS AVAILABLE ON REQUEST

J. T. FILMER

82 DARTFORD ROAD
DARTFORD KENT
Telephone Dartford 24057

H.A.C. THE ORIGINAL SUPPLIERS OF SHORT-WAVE KITS

One valve Super Sensitive All-dry Short-wave Receiver, Model "K". Complete kit including valve and chassis, 77/- (Other S.W. kits from 25/-) Before ordering call and inspect a demonstration receiver, or send stamped envelope for full specification, catalogue and order form.

H.A.C. SHORT-WAVE PRODUCTS (DEPT. R)
44 OLD BOND STREET LONDON W1

The thrills of VHF can now be yours for only 39/6d, complete kit! Tunable 150-100 Mc/s, simplified construction, write today for leaflet. Also, if a newcomer to Amateur Radio, ask for free copy of the world famous "Globe-King" kits and receivers, stamp please to cover postage:

Johnsons (Radio) St. Martin's Gate Worcester

BETTER BRIGHTER PICTURE TUBES BRAND NEW THROUGHOUT

excepting glass

12"	...	£4.10.0	New Silver Screen and
14"	...	£5. 5.0	Aluminising. All makes:
15"-17"	...	£5.15.0	Mullard, Mazda, Emiscope,
21"	...	£7.15.0	Cossor, Brimar, Emitron, etc.

REBUILT MULLARD AND MAZDA TUBES

12"	...	£3. 0.0	All Tubes FULLY
14"	...	£4. 0.0	GUARANTEED 12 MONTHS.
15"-17"	...	£4.10.0	Dispatch same day.
21"	...	£6.10.0	Cash with order.

Carriage and Insurance 10/-

S.T.S. LTD. 35 Pound Street Carshalton Surrey
Telephone Wallington 9665

LEARN RADIO & TV SERVICING

For your own business / hobby

by a new exciting no maths system, using practical equipment recently introduced to this country

FREE BROCHURE FROM

RADIOSTRUCTOR
DEPT. G103 · READING · BERKS.

1.62

RECORD CHANGERS AND PLAYERS

Garrard RC210 £9.8.6 each

New Garrard Autoslim £8.0.0 each

B.S.R. UA14 £7.15.0 each

In Makers Sealed Cartons

B.S.R. TU9 £4.5.6 each

Large stocks of Valves, Transistors and other Components

NEW LIST NOW READY

H. F. JAMES 21 Claremont Road Twickenham Middx
Telephone POEsgrave 3579

G2ACC offers you . . .

A proven dependable service

We have been established 27 years and are one of the original pre-war mail order businesses.

- All the best makes from one source.
- Aluminium chassis, paxolin and ceramic rotary switches made to individual design.
- A 56 page illustrated catalogue No. 12 Your buying guide for short wave, broadcast and transmitting components. 9d. post free (refundable on first order). U.K. and H.M. Forces anywhere.

SOUTHERN RADIO & ELECTRICAL SUPPLIES

So-Rad Works Redlynch Salisbury Wiltshire
Telephone Downton 207

SPARES, VALVES, TUBES 1930-1960

Guaranteed perfect, set tested, ex-working equipment

5U4	4/6	10P13	4/6	ECH42	4/6	PL33	4/6	U25	10/-
5Z4	4/6	12AT7	3/-	EAF42	4/6	PL81	4/6	U35	4/6
6AQ5	4/6	12AU7	3/-	EL33	4/6	PL82	4/6	U37	10/-
6AU6	4/6	12AX7	3/-	EL38	4/6	PL83	4/6	U107	10/-
6BA6	4/6	12BH7	4/6	EL41	4/6	PY31	4/6	U191	7/6
6BE6	4/6	20L1	4/6	EL90	4/6	PY80	4/6	U403	7/6
6CH6	4/6	20P1	4/6	KT36	4/6	UU8	6/-	UAF42	4/6
6U4	6/-	20P3	6/-	KT66	7/6	PY82	4/6	UCH22	6/-
6X4	4/6	185BT	12/6	KT67	7/6	PZ30	4/6	UL41	4/6
7S7	4/6	B36	4/6	N37	4/6	U14	5/-	UL44	6/-
7C5	4/6	ECC85	4/6	PCC84	4/6	U22	4/6	UL46	4/6
10F1	3/-	ECC80	4/6	PCF80	4/6	U24	7/6	UY41	4/6

Most pre-war 4, 5, 7, 9-pin valves 5/- each. P. & P. 6d. per valve
VALVE PARCEL. 12 assorted, all different, 8/6. Postage 1/6.

CONSTRUCTOR'S PARCEL. 2 lb mixed resistors, condensers pots, valveholders, electrolytics, etc. 7/6, postage 2/6.
Send S.A.E. with enquiries or for list of 1,000 valves

ST. JOHN'S RADIO 3 Jews Row, SW18 Tel. VAN 8822

SURPLUS RADIO SUPPLIES

2 LAING'S CORNER MITCHAM SURREY

OUR CATALOGUE CONTAINS OVER

400 BARGAINS

AT PRICES BELOW MANUFACTURERS' COSTS
SEND FOR IT TODAY, PRICE 1/6

Crystal Deaf Aid Earpieces. Suitable for Crystal Sets 5/-. Complete with Jack Plug and Socket 7/6. 1/6 Postage.

Published in Great Britain by the Proprietors and Publishers Data Publications Ltd. 57 Maida Vale London W9

Printed by A. Quick & Co. (Printers) Ltd. Oxford Road Clacton-on-Sea England

Obtainable abroad through the following Collectors Subscription Service Continental Publishers & Distributors Ltd. William Dawson & Sons Ltd. Australia and New Zealand Gordon & Gotch Ltd. Electronics Publications (Australia) South Africa Central News Agency Holland "Radio Electronica" Registered for transmission by Magazine Post to Canada (including Newfoundland)

ANNOUNCING A COMPLETELY NEW 6-TRANSISTOR
POCKET SUPERHET RADIO

THE
"CAPRI"
POCKET
SIX

Size only
4½" x 2½" x 1½"

REALLY
POCKET
SIZE!



- ★ Full medium wave tuning—preset light on long wave.
- ★ 6 Mullard transistors and diode.
- ★ Push-pull output.
- ★ Printed circuit construction.
- ★ High flux speaker.
- ★ Fitted earphone/record socket.
- ★ Moulded two-tone cabinet with mesh grille.

A REMARKABLE EASY TO BUILD POCKET
RADIO GIVING OUTSTANDING RESULTS

● Fully Descriptive Leaflet on Request ●

TOTAL COST OF ALL PARTS **£7.10.0.** P.P. Battery 2/- 2/6 Extra

"QUINTET" (As described in
Dec. edition)
MEDIUM AND LONG WAVE
POCKET LOUDSPEAKER
RADIO

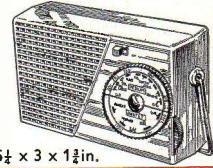

Size 5½ x 3 x 1½in.

TOTAL COST OF ALL PARTS
£5.10.0 P.P. 2/-
NO EXTRAS TO BUY.

- 250mW Push-Pull Output.
- Plainly marked Printed Circuit Board.
- 5 Mullard Transistors.
- Carded Components.

A new design, fully tunable on both wavebands. Guaranteed reception of Continental and local stations, including Luxembourg, anywhere with full station separation. Fitted Car Aerial and Earpiece Sockets.

VERY EASY TO BUILD AND USE
You will be amazed by the performance

● Illustrated Instructions FREE ON REQUEST ●

3 TRANSISTOR AND DIODE
PERSONAL POCKET RADIO



Quality Output on
Personal Earphone.

A simple to build local station with personal earphone output. Built-in Ferrite Aerial and Battery lasting 9 months.

Size 4½ x 3 x 1½in.

ALL PARTS **37/6** P.P. 1/6

¾ WATT 4 TRANSISTOR
AMPLIFIER

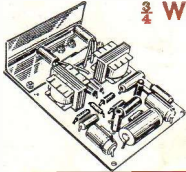

1 watt peak output.
±3dB 70 c/s to 12 kc/s.
Output to 3 ohm speaker.
9 volt operated.

Details on request.

Built and Tested
69/6 P.P. 1/6.

2-OC81 Transistors. Ideal for Intercomm., Record Player, Tuner Amplifier or any application requiring a quality and reliable amplifier.

"TRANSFIVE" PORTABLE
MEDIUM & LONG
WAVE PORTABLE
RADIO

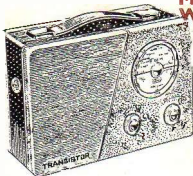

325mW Push-Pull Output on 5" Speaker. Fully illustrated Plans. Easy to Build Printed Circuit. Carded Components. 5 Mullard Transistors.

Size 8½ x 6½ x 3½in.

After Sales Service and Fully Guaranteed

TOTAL COST OF ALL PARTS
£6.19.6 P.P. 2/6.
NO EXTRAS TO BUY

● Full coverage on Medium and Long wavebands. Excellent quality with full station separation. Car aerial socket.

● BUILDING PLANS AND PRICES
FREE ON REQUEST ●

PLEASE Henry's Radio Ltd

PADdington 1008/9
5 HARROW ROAD, LONDON W2
Open Monday to Sat. 9-6, Thurs. 1 o'clock
Send 1/- Stamps for New Illustrated Price Lists

"CONTESSA"
6 TRANSISTOR MEDIUM AND
LONG WAVE SUPERHET
TERRIFIC SENSITIVITY
UNBEATABLE IN PERFORMANCE AND
APPEARANCE
COMBINED PORTABLE AND
CAR RADIO

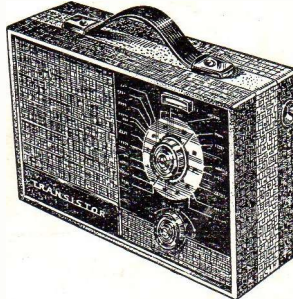

Employs the latest techniques. Double tuned IFS, AVC and first-grade components are standard features. Excellent tone, sensitivity and selectivity on both wavebands.

Descriptive Leaflet on Request.

- ★ 425mW Push-Pull Output.
- ★ 6 "Top-Grade" Ediswan Transistors.
- ★ New Type Printed Circuit with all Components marked.
- ★ Full Medium and Long Wave Tuning.
- ★ High "Q" Internal Ferrite Aerial.
- ★ Car Radio Adaptation and AVC.
- ★ Slow Motion Fingertip Tuning with Station Names clearly marked.
- ★ "Hi-Fi" Quality Speaker.
- ★ Attractive Rexine Covered Cabinet, Red/White or Blue/White.

TOTAL COST OF ALL PARTS
£10.19.6 P.P. 3/6

★ NO EXTRAS TO BUY ★

WITHOUT DOUBT THE "CONTESSA" IS THE FINEST PORTABLE AVAILABLE TO THE HOME CONSTRUCTOR. GOOD LOOKS, QUALITY OUTPUT, AMAZING SENSITIVITY, EASE OF CONSTRUCTION. SIZE 10½ x 8 x 3½ ins.

POCKET IRON

- Pocket Soldering Iron, 220/250V A.C./D.C. 30 watts, complete with mains plug, case, etc. Handle unscrews to cover element enabling iron to be carried in pocket, 18/6. P.P. 1/-.

Now available. The new improved "P.W." Pocket Superhet £8.10.0 P. & P. 2/6. Send for details.

ALL-TRANSISTOR
TIME SAVER

OFFICE OR HOME TELEPHONE
PICK-UP AMPLIFIER

- ★ No more "holding on" wasting time waiting for your call to come through. When it does the amplifier can be switched off if required. No connections, just press the pick-up coil to back of phone as below. Fully Guaranteed.
- ★ 3 months battery life. 400mW output.

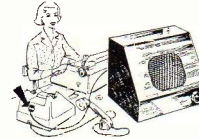

BUILT,
TESTED,
READY TO
USE

£5.10.0

P.P. 2/6

ALSO ALL-TRANSISTOR BABY OR
INVALID ALARM **£5.10.0** P.P. 2/6

★ RANGER 3 ★

NO EXTERNAL
AERIAL OR EARTH—
3-TRANSISTOR and
2 DIODES



Size 4½ x 3 x 1½in.

ALL COMPONENTS

79/6 P.P. 1/6

NO EXTRAS
TO BUY

Everything Supplied

Personal Pocket Radio with 5 stages giving clear reception on medium wave, amateur top band and shipping.

● Easy to follow instructions with pictorial layout.

● Reception of Radio Luxembourg guaranteed (most areas). Free Instructions and Price List on request. Easy to build.

TRANSISTOR TAPE RECORDER

IDEAL FOR HOME, OFFICE OR TRAVEL

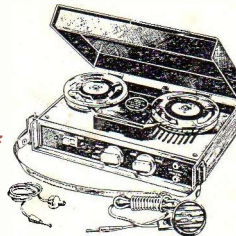

- ★ Built-in Quality Speaker.
- ★ Fast Rewind.
- ★ Over 1 hour Play/Record.
- ★ Volume Control.
- ★ Size 6" x 8½" x 2½".
- ★ Weight 2½lb.
- ★ Two Tone case with carry strap

SUPPLIED COMPLETE WITH MICROPHONE, TAPE, BATTERIES AND PERSONAL PHONE (cuts out speaker). **12 GNS** FULLY GUARANTEED.