

84 m... ..

THE Radio Constructor

RADIO
TELEVISION
AUDIO
ELECTRONICS

VOLUME 15 NUMBER 2
A DATA PUBLICATION
PRICE TWO SHILLINGS

September 1961

The JR1 Stereo Tape Recorder Unit — design details

- Pocket Audio Injection Probe
- Unusual 2-Valve Superhet
- Microphone Pre-amplifiers, Attenuators and Mixers
- Transistor Shorted Turns Tester
- Magnetic Guitar Pick-up and Transistorised Tone Control Pre-amplifiers
- The "Finger-Tip Five" Receiver
- Understanding Radio, Pt. 2
- Resistance Measurement

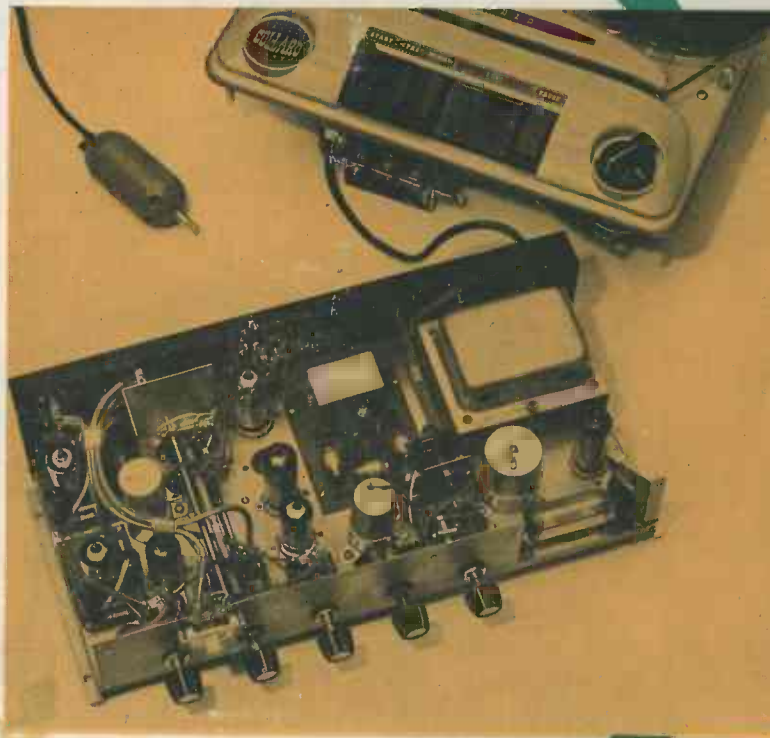

HARVERSON SURPLUS CO. LTD

2-BAND SUPERHET CHASSIS WITH SPEAKER ONLY £5.17.6

Plus 6/6 post and packing

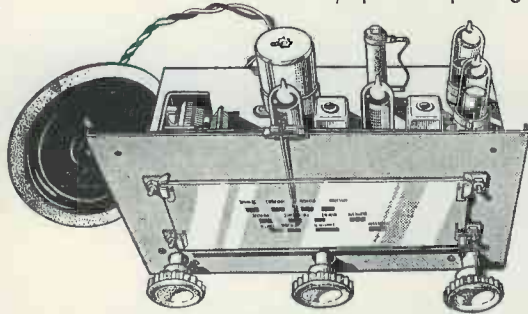

A quality 4 valve AC/DC superhet chassis made by a world famous manufacturer. Long and Medium wave coverage. Fitted with a cord and drum reduction tuning drive and attractive illuminated glass dial (size 6½" x 2½"). Controls: volume on/off, tuning and wave change. The receiver is self-powered, employing a mains dropper and a valve rectifier. Chassis dimensions 6½" x 9" x 5½" high. Supplied complete with a good quality 5" loudspeaker, valves (UCH42, UAF42, UL41, UY41), AC/DC mains input lead, ivory knobs, etc. **Don't hesitate, Order Now!** This unbeatable bargain is bound to sell out quickly at only £5.17.6, plus 6/6 post and packing.

4-STATION PRESET CHASSIS ONLY £4.17.6 WITH SPEAKER

Plus 6/6 post and packing

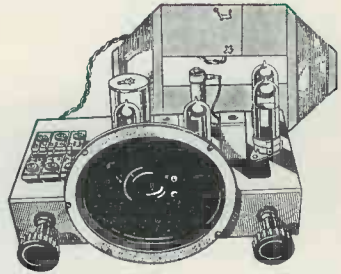

A compact, 4 station preset mains transportable receiver, for operation from AC/DC mains. Two simple controls, volume on/off and 4 position station selector. The latter is set to Light programme (Long wave), Third programme, Home service and Light programme (Medium wave), but may of course be adjusted to alternative selections if required. A frame aerial with throw-out extension is supplied, making this receiver ideal as a general purpose transportable set for the home. A fully smoothed power supply is provided from AC/DC mains input by a mains dropper and a valve rectifier. The good tonal qualities are assisted by the provision of a quality 5" speaker, which is ready-mounted on the chassis (this is easily detachable if alternative positioning is required). Valve line-up: UCH42, UAF42, UL41, UY41. This chassis (size 9" x 6½" x 5½" high) is supplied complete with valves, knobs, mains lead, aerial, etc. It is beautifully made by a famous maker, and is a first-class buy at the rock bottom price of £4.17.6.

AM RADIOGRAM CHASSIS

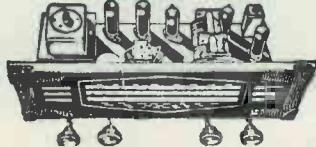

A chassis of distinction by a famous maker. Covering Long, Med. and Short waves, plus gram position, this chassis (size 15½" x 7" x 6½" high) incorporates the latest circuitry, using fully delayed a.v.c. and negative feedback. Controls: tone, volume on/off, wave-change (L.M.S. and gram), tuning. Tapped input 200-250V a.c. only. An attractive brown and gold illuminated dial with matching knobs make this one of the most handsome, in addition to being one of the best performing, chassis yet offered. Complete with valves (ECH81, EF89, EBC81, EL84, EZ81), knobs, output transformer, leads, etc. **OUR PRICE ONLY £9.19.6** plus 4/6 post & packing

THE WORLD FAMOUS E.M.I. ANGEL TRANSCRIPTION P.U. (Model 17A)



A Pick-up for the connoisseur originally priced at £17.10.0. The last remaining few offered at **£4.10.0** Plus P. & P. 5/-

OUTPUT STAGE AND SPEAKER FOR FM TUNER UNIT

All parts including speaker, ECL82 valve and simple instructions to make two-stage output unit, for converting f.m. tuner into f.m. receiver. **ONLY 45/-** plus 4/6 P. & P.

E.M.I. 4-SPEED RECORD TURNTABLE AND PICK-UP

Heavy 8½" metal turntable. Low flutter performance, 200/250V shaded motor with tap at 80V for amplifier valve filament if required. Turnover LP/78 head. **89/6 COMPLETE** Plus 4/6 P. & P.



SUPER STEREO KIT MARK II

A kit of ready-built units only requiring inter-connection. Comprising two midget 3W amplifiers, push-button switch, transformer, control unit (bass, treble and vol.), power pack, two speakers, indicator light, valves (ECL82, EZ80 range), and comprehensive instructions. **£39.6** plus 6/6 P. & P.

FM TUNER HEAD

A permeability tuned tuner head by a famous maker, supplied without valve (ECC85). **18/6** plus 1/9 P. & P.



Valve 8/6 extra

HARVERSON'S FM TUNER KIT

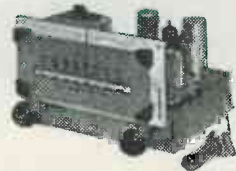

At last a quality FM Tuner Kit at a price you can afford. Just look at these fine features, which are usually associated with equipment at twice the price!

- ★ FM tuning head by famous maker.
- ★ Guaranteed non-drift.
- ★ Permeability tuning.
- ★ Frequency coverage 88-100 Mc/s.
- ★ OAB1 balanced diode output.
- ★ Two i.f. stages and discriminator.
- ★ Attractive maroon and gold glass dial (7" x 3").
- ★ Self powered, using a good quality mains transformer and valve rectifier.
- ★ Valves used ECC85, two EF80s and EZ80 (rectifier).
- ★ Fully drilled chassis.
- ★ Everything supplied, down to the last nut and bolt.
- ★ Size of completed tuner 8" x 6" x 5½".
- ★ All parts sold separately.

£4.19.6 Plus 8/6 P.P. & Ins.

Circuit diagram and illustrations, 1/6 post free.

WESTERN ELECTRIC TRANSISTOR SPEAKER

Size 2½" x 1½" deep. 3 ohm impedance. **11/9** P. & P. 1/6

Introducing . . .

HARVERSON'S Monaural Amplifier Kit

39/6

In response to numerous requests from delighted purchasers of our "SUPER STEREO KIT" we have produced a "MONAURAL AMPLIFIER" on similar lines.

★ A UCL82 valve provides a triode amplifying stage, and a pentode output stage (3 watts), enabling good amplification and sparkling reproduction to be combined with physical compactness (amplifier size 7" x 3½" x 6½" high).

★ Modern circuitry design, good quality o.p. transformer (to match 3Ω) keep hum and distortion to a low level.

★ The controls, volume on/off and tone, are complete with attractive cream and gold knobs.

★ The amplifier has a built-in fully smoothed power supply, using a good quality mains transformer (a.c. mains only) and metal rectifier.

★ All you need is supplied including easy to follow instructions which guarantee good results for the beginner and expert. All components, leads, chassis, valve, knobs, etc., are first grade items by prominent manufacturers.

OUR PRICE 39/6
Plus 4/6 Post and Packing

5" LOUDSPEAKER TO SUIT, 14/6 EXTRA



CHILD'S NURSERY LAMP

A child's night light of unusual design. Contemporary styled lampholder of robust construction finished in either red or yellow. Entirely safe (bulb socket shielded from "prying fingers") complete with flex and a push-button switch. 200/250 volts a.c. only. The low-consumption bulb element is made in the shape of either flowers or angel fish, and when switched on, glows in fluorescent colours (the flowers pink with green leaves, or the fish green with purple weed). Made by a famous manufacturer and originally priced at 29/6.

Please state lampholder colour preference and whether fish or flower element is required.

OUR BARGAIN PRICE ONLY 10/9
plus 9d. post and packing



SUPERHET CHASSIS — LESS VALVES & CABINET

Modern AC/DC chassis with printed circuit and ferrite rod aerial. Although not completely built, the main components are mounted. L. & M. wave coverage, 4 valves (UBF89, UCL83, UCH81, UY85). Everything supplied except valves and cabinet. With simple instructions.

£3.6.6 Plus 3/6 P. & P.

TRANSISTOR AMPLIFIER KIT

A complete kit of parts to build a compact 4-transistor amplifier, with tone and volume controls. Two GT3 driver transistors, transformer coupled. Output 1 watt from matched pair GT15. Complete with output transformer to matched 3 ohm speaker, transistors and attractive dial plate.

OUR PRICE 59/6 P. & P. 4/6

CONDENSER/RESISTOR PARCEL

50 mixed pF Condensers and 50 mixed Resistors. An assortment of useful values. All popular sizes—all new—a must for the serviceman and constructor.

ONLY 10/-
P. & P. 1/-

AT ½ PRICE WHILE THEY LAST!
GOLDRING MU-METAL CASED CARTRIDGES

Sapphire styli. Brand new and boxed

OUR PRICE £2.15.0 Plus P.P. 1/6 inc. ins.

BARGAIN MONTH FOR TRANSISTORS

POWER			
OC36	10/-	GET102	7/6
OC44	9/-	XA103	8/6
OC45	8/-	PXA101	9/6
OC71	5/-	PXA102	9/6
OC75	6/6	AMERICAN	
OC76	6/6	2N388	6/6
OC78	6/6	2N1485	6/6
OC78D	6/6	25712	7/6
GET15	9/-	DIODE	
GET15 (matched pair)	16/6	OA81	3/-

Postage 6d. each

THE HARVERSON COMPLETE FM/VHF RECEIVER KIT £6.19.6

At last! A complete FM Receiver in kit form.

Specially designed with the home constructor in mind, this kit enables the construction of a completely self-contained VHF receiver at a fraction of the normal cost of comparable equipment. This is basically a quality self-powered FM tuner plus 2 audio amplifier stages and output transformer & speaker.

- ★ FM tuning head by famous maker
- ★ Guaranteed non-drift
- ★ Permeability tuning
- ★ Frequency coverage 88-100 Mc/s
- ★ OA81 balanced diode output
- ★ Two i.f. stages and discriminator
- ★ Self-powered, using a good quality mains transformer and valve rectifier
- ★ Valves used: ECC85, two EF80s and EZ80 (rectifier)
- ★ Fully drilled chassis
- ★ A good quality speaker
- ★ Well designed output transformer
- ★ Attractive maroon and gold glass dial
- ★ Two output stages (using ECL82 valve)
- ★ Everything supplied, down to the last nut and bolt
- ★ Compact size
- ★ All parts sold separately

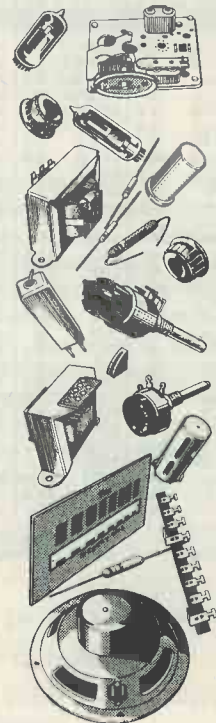

OUR PRICE £6.19.6 Plus 4/6 P. & P.

HARVERSON SURPLUS CO. LTD

★ HARVERSONS UNEQUALLED VALVE SERVICE ★

OA2 17/6	6F6G 7/-	10F1 26/6	35Z4GT 6/-	DH76 5/-	EF40 15/-	HN309 24/7	PL84 12/8	UABC80 9/-	XFY34 17/6
OB2 17/6	6F11 17/3	10F9 11/6	35Z5GT 9/-	DH77 7/-	EF41 9/-	HVR2 20/-	PL820 18/8	UAF42 9/6	XH(1.5) 6/6
OZ4 5/-	6F12 4/6	10LD11 15/11	43 10/-	DK32 12/-	EF42 10/6	HVR2A 6/-	PM84 17/7	UB41 12/-	XSG(1.5) 6/6
1A7GT 12/-	6F13 11/6	10P13 15/-	50C5 10/-	DK91 6/6	EF50(A) 7/-	KF35 8/6	PX4 10/6	UBC41 8/6	Y63 7/6
1C5 12/6	6F23 10/6	10P14 19/3	50CD6G 6/-	DK92 9/6	EF50(E) 5/-	KL35 8/6	PY31 16/7	UBC81 11/4	Z63 7/6
1D6 10/6	6F24 12/6	12AC6 15/3	50L6GT 9/6	DK96 8/6	EF54 5/-	KLL32 24/7	PY32 12/6	UBF80 9/6	Z66 17/6
1G6 17/6	6F32 10/6	12AD6 17/3	53KU 19/11	DL33 9/6	EF73 10/6	KT2 5/-	PY80 7/6	UBF89 9/6	Z77 4/6
1HSGT 10/6	6F33 7/6	12AE6 13/11	78 8/-	DL66 17/6	EF80 6/-	KT33C 10/-	PY81 8/6	UBL21 23/3	Z719 6/-
1L4 3/6	6G6 6/6	12AH7 8/-	77 8/-	DL68 15/-	EF85 6/-	KT36 29/10	PY82 7/-	UCC84 14/7	
1LD5 5/-	6H6 3/-	12AH8 12/6	80 9/-	DL72 15/-	EF86 10/6	KT41 23/3	PY83 8/6	UCC85 9/-	Transistors
1LNS 5/-	6J5 5/-	12AT6 7/6	83 15/-	DL92 7/-	EF89 9/-	KT44 12/6	PY88 13/3	UCF80 16/7	and diodes
1NSGT 10/6	6J6 5/6	12AT7 6/-	85A2 16/-	DL94 7/6	EF91 4/6	KT61 12/6	PZ30 19/11	UCH21 23/3	CG1C 7/6
1R5 6/6	6J7G 10/6	12AU6 23/3	90AG 67/6	DL96 8/6	EF92 4/6	KT63 7/-	QP21 7/-	UCH42 9/6	CG4E 7/6
1S4 9/-	6K7G 5/-	12AU7 6/6	90C1 16/-	DM70 7/6	EF97 13/3	KT66 15/-	QP25 14/6	UCH81 9/6	CG6E 7/6
1T4 3/6	6K8GT 10/6	12AX7 7/6	90CG 37/6	E80F 30/-	EF98 13/3	KT88 24/-	QS150/15	UCL82 11/6	CG7E 7/6
1U5 6/6	6K8GT 10/6	12BA6 8/-	101 13/6	E83F 30/-	EF183 18/7	KTW61 6/6	R12 10/6	UCL83 19/3	CG10E 7/6
2D21 15/-	6K8G 6/6	12BE6 9/6	150B2 18/-	EAS0 2/-	EF184 12/6	KTW62 7/6	R18 14/-	UF41 9/-	GD3, 4, 5,
2P 26/6	6K25 19/11	12BH7 21/3	161 10/6	EAT6 9/6	EK32 8/6	KTW63 6/6	R19 19/11	UF42 12/6	6, 8 4/-
2X2 4/6	6L1 23/3	12E1 30/-	185BT 33/2	EABC80 9/-	EL32 5/-	KTZ41 8/-	RG1 19/11	UF80 10/6	OA70 3/-
3A4 6/6	6L6G 8/-	12E5GT 4/6	304 10/6	EAC91 4/6	EL33 12/6	KTZ63 7/6	R19/240A	UF85 9/6	OA73 3/-
3A5 10/6	6L6M 9/6	12I7GT 9/6	305 10/6	EAF42 9/-	EL34 15/-	L63 6/6	RK34 7/6	UF86 17/11	OA79 3/-
3B7 12/6	6L7GT 7/6	12K5 17/11	807 7/6	EB34 2/6	EL38 26/6	MHL4 7/6	S130 22/6	UF89 9/6	OA81 3/-
3D6 5/-	6L8 13/-	12K7GT 5/6	956 3/-	EB41 8/6	EL41 9/-	MHL4 12/6	SP40 14/6	UL41 9/6	OA86 4/-
3Q4 7/6	6L19 23/3	12K8GT14/-	1821 16/7	EB91 4/-	EL42 10/6	ML4 8/6	SP42 12/6	UL44 26/6	OA91 3/6
3Q5GT 9/6	6LD20 15/11	12Q7GT 5/-	4033L 12/6	EB3C 23/3	EL81 16/7	MS4B 23/3	SP61 3/6	UL46 14/6	OA95 3/6
3S4 7/6	6N7 8/-	12SA7 8/6	5763 12/6	EBC33 5/-	EL83 19/11	MU12/14 8/-	SU25 26/6	UL84 8/6	OA210 11/-
3V4 7/6	6P26 19/11	12SG7 8/6	7193 5/-	EBC41 8/6	EL84 7/6	N37 23/3	T41 9/-	UM4 17/3	OA211 20/-
5R4GY 17/6	6P28 26/6	12SG7 7/6	7475 7/6	EBC81 8/-	EL85 13/11	N78 19/11	TD4 9/-	UM34 17/3	OC16 48/-
5U4G 10/6	6Q7G 6/6	12SH7 8/6	9002 5/6	EBF80 9/-	EL86 17/3	N108 23/3	TD4 9/-	UM80 15/3	OC19 48/-
5V4G 6/6	6Q7GT 11/-	12SJ7 8/6	AC/PEN	EBF83 13/11	EL91 5/-	N308 20/7	TH41 26/6	UR1C 18/7	OC23 87/-
5Y3 6/6	6R7G 10/6	12SK7 6/-	5-pin 23/3	EBF89 9/6	EL95 10/6	N339 15/-	TH41 26/6	UJ6 19/11	OC26 25/-
5Z3 19/11	6SA7GT 8/6	12SQ7 11/6	7-pin 15/-	EBL1 29/6	EL820 18/7	P61 3/6	TH233 33/2	UU7 16/7	OC28 25/-
5Z4G 9/6	6SC7 7/6	12SR7 8/6	AC2PEN	EBL21 23/3	EL822 19/-	PABC80	TP22 15/-	UU8 26/6	OC35 25/6
6A7 10/6	6SG7GT 8/-	12TA 10/6	DD 12/6	EBL31 23/3	EM34 9/6		TP25 15/-	UJ9 7/6	OC44 11/-
6A8 9/-	6SH7GT 8/-	1457 27/10	AC6PEN 7/6	EC52 5/6	EM71 23/3	PCC84 8/-	TP2620 33/2	UY1N 18/7	OC45 10/-
6AC7 4/-	6SJ7GT 8/-	19AQS 10/6	AC/TP 33/2	EC54 6/-	EM80 9/-	PCC85 9/6	TY86F 13/3	UY21 16/7	OC65 22/6
6AG5 5/6	6SK7GT 6/6	19H1 10/-	ATP4 5/-	EC70 12/6	EM81 9/-	PCC88 18/-	U12/14 8/6	UY41 7/6	OC66 25/-
6AG7 7/6	6SL7GT 6/6	20D1 15/3	AZ1 18/7	EC92 13/3	EM84 10/6	PCC89 11/6	U16 10/6	UY85 7/6	OC70 6/6
6KA5 8/-	6SN7GT 5/6	20F2 26/6	AZ31 10/-	ECC32 5/6	EM85 17/3	PCF80 8/6	U18/20 8/6	VMP4G 15/-	OC71 6/6
6AL5 4/-	6SQ7GT 9/6	20L1 26/6	AZ41 13/11	ECC33 8/6	EN31 53/-	PCF82 10/6	U19 36/-	VMS4B 15/-	OC72 8/-
6AMS 4/6	6SS7GT 8/-	20P1 26/6	B36 15/-	ECC34 24/7	EY51 9/-	PCF84 16/7	U22 8/-	VP2 12/6	OC73 16/-
6AQ5 7/6	6U4GT 12/6	20P3 23/3	BL63 7/6	ECC35 8/6	EY83 16/7	PCF86 15/-	U24 29/10	VP2B 14/6	OC75 8/-
6AT6 7/-	6U5G 7/6	20P4 26/6	C1 12/6	ECC40 23/3	EY84 14/-	PCL82 10/-	U25 17/11	VP4 15/-	OC77 15/-
6AU6 10/6	6U7G 8/6	20P5 23/3	C1C 12/6	ECC81 6/-	EY86 9/-	PCL83 10/-	U26 10/-	VP4B 23/3	OC78 8/-
6AV6 12/8	6V6G 7/6	25A6G 10/6	CB1 26/6	ECC82 6/6	EZ35 6/-	PCL84 12/6	U31 9/6	VP13C 7/6	OC81 8/-
6B8 5/-	6V6GTG 8/-	25L6GT 10/6	CB131 23/3	ECC83 7/6	EZ40 7/-	PCL85 16/7	U33 26/6	VP23 6/6	OC170 13/6
6BA6 7/6	6X4 5/-	25Y5G 10/-	CCH35 23/3	ECC84 9/-	EZ41 7/-	PCL86 16/7	U35 26/6	VP41 6/-	OC171 14/6
6BE6 6/-	6X5GT 6/-	25Z4G 9/6	CK506 6/6	ECC85 8/6	EZ80 7/-	PEN4A 23/3	U37 26/6	VR105 8/-	OC200 16/6
6BG6G 23/3	6/30L2 10/6	25Z5 9/6	CL33 19/3	ECC88 18/-	EZ81 7/-	PEN4B 26/6	U43 9/-	VR150 7/6	OC203 24/6
6BH6 8/-	7A7 12/6	25Z6G 10/-	CV63 10/6	ECC91 5/6	FC4 15/-	PEN4DD	U45 9/-	VT61A 5/6	OCP71 29/6
6BJ6 6/-	7B6 21/3	27SU 19/11	CY1 18/7	ECF80 10/6	FW4/5000 8/6	PEN25 26/6	U50 6/6	VT501 5/-	TJ1 40/-
6BQ7A 15/-	7B7 8/6	28D7 7/-	CY31 11/-	ECF82 10/6	FW4/8000 8/6	PEN25 4/6	U52 6/6	W76 5/6	TJ2 45/-
6BR7 12/6	7C5 8/-	30C1 8/-	D1 3/-	ECF86 19/11	GU50 27/6	PEN40DD	U54 19/11	W81M 6/6	TJ3 50/-
6BS7 25/-	7C6 8/-	30F5 6/-	D15 10/6	ECH3 26/6	GZ30 9/-		U76 6/-	W107 18/7	TP1 40/-
6BW6 8/6	7H7 8/-	30FL1 10/-	D77 4/-	ECH21 23/3	GZ32 10/-	PEN44 26/6	U78 5/-	W229 19/11	TP2 40/-
6BW7 6/-	7R7 12/6	30L1 8/-	DAC32 10/6	ECH35 6/6	GZ33 19/11	PEN45 19/6	U107 16/7	X724M 24/7	TS1 10/-
6C4 5/-	7S7 9/6	30L15 11/6	DAF91 6/-	ECH42 9/-	GZ34 14/-	PEN46 7/6	U191 16/7	X41 15/-	TS2 12/6
6C5 6/6	7V7 8/6	30P4 12/-	DAF96 8/6	ECH81 9/-	GZ37 19/11	PEN383 23/3	U201 16/7	X61(C) 12/6	TS3 15/-
6C6 6/6	7Y4 7/6	30P12 7/6	DD41 13/11	ECH83 13/11	H63 12/6	PEN453DD	U251 14/-	X63 9/-	TS4 24/6
6C9 13/6	8D2 3/6	30P19 12/-	DET25 7/6	ECL80 9/-	HABC80		U281 19/11	X65 12/6	V30/10P 28/-
6C10 9/-	8D3 4/6	30P11 10/6	DF33 10/6	ECL82 10/6		PEN/DD	U282 22/7	X66 12/6	XA101 23/-
6CD6G 36/6	9BW6 15/3	30PL13 16/6	DF66 15/-	ECL83 19/3	HL2 7/6	4020 33/2	U301 23/3	X76M 14/-	XA102 26/-
6CH6 9/-	9D2 4/-	35A5 21/3	DF91 3/6	ECL86 16/7	HL23 15/3	PL33 19/3	U329 14/-	X78 23/3	XA103 15/-
6D6 6/6	10C1 13/-	35L6GT 9/6	DF96 8/6	EF9 23/3	HL23DD 7/6	PL36 12/-	U339 16/7	X79 23/3	XA104 18/-
6E5 12/6	10C2 26/6	35W4 7/6	DF97 9/-	EF22 14/-	HL41DD	PL38 26/6	U403 16/7	X109 17/3	XB102 10/-
6F1 26/6	10D2 12/-	35Z3 10/6	DH63 6/6	EF36 4/-	HL42DD	PL81 10/6	U404 8/6	XD(1.5) 6/6	XB103 14/-
				EF37A 8/-		PL82 7/6	U801 29/10	XFG1 18/-	XB104 10/-
				EF39 5/6		PL83 9/-	U4020 16/7	XFY12 9/6	XC101 16/-

SPECIAL OFFER ! ONE DOZEN 6K7G £1 Plus 2/6 p. & p.

The above list supercedes all previous issues

WE SPECIALIZE IN OBSOLETE VALVES - IF YOU DON'T SEE IT ABOVE, WRITE AND ASK

BRAND NEW COSSOR 10" TUBES 108K OR 75K 18/6 plus p. & p. 6/6.

REGUNNED TUBES - ANY TYPE! - ANY SIZE SUPPLIED! WRITE FOR LIST!

OSCILLATOR COIL FOR ANY TAPE DECK 5/6. p. & p. 9d.

Designed for



Dependability

The new "AVO" Mk. IV Valve Characteristic Meter is typical of the ingenuity of design and high standard of workmanship that exemplify all of the multi-range instruments in the wide "Avo" range.



It is a compact and comprehensive meter that will test quickly any standard receiving valve or small transmitting valve on any of its normal characteristics under conditions corresponding to a wide range of DC electrode voltages. The method of measuring mutual conductance ensures that the meter can deal adequately with modern TV receiver valves. It does many useful jobs too numerous to mention here, but a comprehensive pamphlet is available on application.

List Price **£92** complete with Instruction Book and Valve Data Manual

AVO LTD

AVOCET HOUSE . 92-96 VAUXHALL BRIDGE ROAD . LONDON S.W.1.

VICTORIA 3404
(12 lines)



A MEMBER OF THE METAL INDUSTRIES GROUP OF COMPANIES

TECHNICAL

TRAINING

in radio

television

and

electronic

engineering

with

The decision is YOURS. To be a success in your chosen career; to qualify for the highest paid job . . . to control a profitable business of your own. ICS home-study courses put your plans on a practical basis; teach you theory and practice; give you the knowledge and experience to take you, at your own pace, to the top.

Choose the RIGHT course.

RADIO & TELEVISION
ENGINEERING . INDUSTRIAL
TELEVISION . RADIO AND TV
SERVICING . RADIO SERVICE
AND SALES . ELECTRONICS .
COMPUTERS AND PROGRAMMING

ICS provides thorough coaching for professional examinations: A M B R I T I R E, City and Guilds Telecommunications. C. & G. Radio and TV Servicing, C. & G. Radio Amateurs.

LEARN AS YOU BUILD

Practical Radio Course

Gain a sound up-to-professional-standards knowledge of Radio and Television as you build YOUR own 4 valve T R F and 5 valve superhet radio receivers, signal generator and high-quality multimeter. At the end of the course you have three pieces of permanent and practical equipment and a fund of personal knowledge and skill . . . ICS Practical Radio courses open a new world to the keen radio amateur.



THERE ARE ICS COURSES TO MEET YOUR NEEDS AT EVERY STAGE OF YOUR CAREER.

Post this coupon today: In return you will receive the FREE 60-page ICS Prospectus listing technical examinations and their appropriate ICS courses PLUS details of over 150 specialised subjects.

Other ICS courses include:

MECHANICAL, MOTOR, FIRE, CHEMICAL, ELECTRICAL AND CIVIL ENGINEERING, ETC. SELLING AND MANAGEMENT, ARCHITECTURE, WOODWORKING, FARMING, GARDENING, ART, PHOTOGRAPHY.

Please state subject in which you are interested on coupon.



INTERNATIONAL CORRESPONDENCE SCHOOL
(Dept. 248) Intertext House Parkgate Road London SW11

NAME.....

ADDRESS

.....

OCCUPATION..... AGE.....

SUBJECT..... 9.61



TRIPLE CRYSTAL UNITS for Frequency Control of F.M. Tuners

The STC quartz crystal assembly Type 4434 comprises a trio of quartz elements mounted in a single B7G based glass envelope. The three elements each work on their 5th overtone at 10.7 Mc/s below the radiated frequencies of the three F.M. transmissions in each area of the United Kingdom. Improved manufacturing techniques and quantity production of crystal units designed specifically for F.M. application enables STC to offer the units at less than a quarter of the normal cost.

F.M. radio is by nature a "local station" service and variable tuning is unnecessary. Switched tuning, instead of variable tuning by dials, is a saving and an attraction to the user.



Hermetically sealed B7G STC 4434

STC CRYSTAL	BBC TRANSMITTERS	STC TRIPLE CRYSTAL FREQUENCIES M/CS		
		LIGHT	THIRD	HOME
4434/A	Wrotham	78.4	80.6	82.8
4434/B	Peterborough	79.4	81.6	83.8
4434/C	Rosemarkie	78.9	81.1	83.3
4434/D	N.H. Tor	77.4	79.6	81.8
4434/E	Sutton Coldfield	77.6	79.8	82.0
4434/F	Pontop Pike	77.8	80.0	82.2
4434/G	Meldrum	78.0	80.2	82.4
4434/G	Blaen Plwyf	78.0	80.2	82.4
4434/H	Holme Moss	78.6	80.8	83.0
4434/F	Rowridge	77.8	80.0	82.2
4434/B	Divis	79.4	81.6	83.8
4434/J	Douglas	77.7	80.9	82.1
4434/K	Kirk O'Shots	79.2	81.4	83.6
4434/C	Llanddona	78.9	81.1	83.3
4434/L	Llangollen	78.2	80.4	82.6

The List Price of all the above items is £3.15.0d each.
For circuit diagrams and further information ask for leaflet MQ/104.

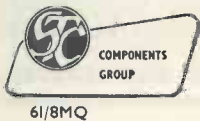

Standard Telephones and Cables Limited
QUARTZ CRYSTAL DIVISION: HARLOW · ESSEX

THE WORLD-FAMOUS



RANGE OF EQUIPMENT

For the Discerning who require
THE BEST PERFORMANCE AT MINIMUM PRICE



HI-FI FM TUNER

This model is available as two units which, for your convenience, are sold separately. They comprise an R.F. Tuning Unit, Model FMT-4U (£35.0 including purchase tax) with I.F. output of 10.7 Mc/s, and an Amplifier Unit complete with attractively styled cabinet, also power supply and valves. Model FMA-4U (£111.11.0) making a total cost for the equipment of £14.16.0

AMATEUR TRANSMITTER Model DX-100U



This is the most popular Amateur transmitter in the world and requires no introduction to "Hams" the world over. Covers all bands from 160-10 metres. Self-contained, including power supply, Modulator and V.F.O. 150 W. D.C. input. £81.10.0



THE "MOHICAN" GENERAL COVERAGE RECEIVER Model GC-1U

In the forefront of design with 4 piezo-electric transfilters, variable tuned B.F.O. and Zener diode stabiliser, this is an excellent fully transistorised portable or fixed station receiver for both "Ham" and Short wave listeners. Other features include printed circuit boards, telescopic whip antenna, tuning meter and large slide-rule dial of approximately 70". Uses 10 transistors. £38.15.0

4-WAVEBAND TRANSISTORISED PORTABLE RECEIVER, Model RSW-1

This possesses Medium, Trawler and two Short-wave bands and is mid-way between the domestic broadcasting and professional general communications receiver. Ideal and inexpensive for those who wish to listen to world broadcasts, shipping and aviation communications, etc. It is not the set to buy if you wish only to enjoy domestic broadcasting. In a handsome solid leather case, it has retractable whip aerial and socket for car radio use. £22.10.6



MONEY-SAVING "PACKAGED DEALS"

For the benefit of customers wishing to purchase several units of their Hi-Fi equipment at the same time, useful price reductions are offered. Such "Packaged Deals" may include RECORD PLAYERS and TAPE DECKS of your personal preference, not necessarily featured in our catalogue. Two money-saving examples are given below and quotations for your own special requirements will gladly be sent on request.

GL-58 Transcription Unit	£20.12.2	TA-1M	£18. 2.6
S-33 Stereo Amp.	£12. 8.6	Collaro "STUDIO"	£17.10.0
Twin SSU-1 Speakers (Bookcase Type)	£21.15.0	USC-1	£18.18.6
		MA-12	£10.19.6
	£54.15.8		£65.10.6
Packaged	£51.10.0	Packaged	£59.10.0

PRICE OF TAPE DECK PURCHASES WITH AMPLIFIERS

	Separate	Together
TA-1M with Collaro "STUDIO"	£35.12.6	£30.10.0
TA-1S with Collaro "STUDIO"	£40.16.0	£35.14.0
TA-1M with TRUVOX Mk.6	£54.17.6	£48. 5.0
TA-1S with TRUVOX Mk. 6	£60. 1.0	£53. 7.0

All prices include free delivery U.K.
Deferred terms available over £10.



THE "COTSWOLD"

THE "COTSWOLD". This is an acoustically designed enclosure 26" x 23" x 15½" housing a 12" bass speaker with 2" speech coil, elliptical middle speaker together with a pressure unit to cover the full frequency range of 32-20,000 c/s. Capable of doing justice to the finest programme source, its polar distribution makes it ideal for really Hi-Fi Stereo. Delivered complete with speakers, cross-over unit, level control, Tygan grille cloth, etc. All parts pre-cut and drilled for ease of assembly and left "in the white" for finish to personal taste. £21.19.0

HI-FI EQUIPMENT CABINETS



The "GLOUCESTER"
(open)

left "in the white" for finish to personal taste. range. Prices from £11.5.6 to £17.18.6. Send for details of whole

Available direct from

DAYSTROM LTD

DEPT. RC9 GLOUCESTER

Easily-built Equipment of excellent quality AT MUCH LOWER COST



TA-1M



O-12U



DC-1U



S-33



DX-40U



AG-9U



UJR-1



MA-12

TAPE RECORDING/REPLAY AMPLIFIERS, Models TA-1M and TA-15. Available both monophonic (TA-1M) and stereophonic (TA-15) and the former can be modified later to stereo with modification kit TA-1C. Special features include bias level control, thermometer type recording level indicators, press-button control. Housed in attractive metal case. TA-1M £18.2.6 TA-15 £23.6.0

GRID DIP METER, Model GD-1U. A very handy instrument for the lab., the "Ham" of Service Engineers. Complete set of plug-in coils provided covering 1.8 Mc/s to 250 Mc/s. Additional plug-in coils at 15/- 500 micro-amp panel meter used. £10.9.6

TRANSISTORISED version of above, model XGD-1, 1.75 Mc/s to 45 Mc/s £10.8.6
5" OSCILLOSCOPE: O-12U. "Y" sensitivity 10mV/cm, 3 c/s to over 5 Mc/s. Rise time, 0.08 µsecs or less. Sweep, 10 c/s to 500 kc/s. Electronically stabilised. £36.10.0

2½" PORTABLE SERVICE OSCILLOSCOPE: OS-1. Ideal instrument for service and portable use. Size 5" x 8" x 14". Wt. 10½lb. £19.10.0

DECADE CAPACITANCE BOX: DC 1U. Provides capacity values from 100 mmf to 0.111 mfd in 100 mmf steps. Ideal for experimental development and design work. £6.5.6

VALVE VOLTMETER: V-7A. The world's largest-selling VVM. Measures volts to 1,500 (DC & RMS) and 4,000 pk. to pk.; resistance 0.1Ω to 1,000MΩ DC. D.C. input impedance 11 Megohms. £13.0.0

HI-FI STEREO 6 WATT AMPLIFIER: S-33. Low-priced but high quality; less than 0.3% distn. at 2½ watts per channel. £12.8.6

HI-FI STEREO 16 WATT AMPLIFIER: S-88. Superb reproduction for the man who wants the best in Hi-Fi. Only 0.1% distortion at 6 W/chnl. Many special features. £26.12.6

AMATEUR TRANSMITTER: DX-40U. 75W CWV; 60W pk. c/c phone; 40W into Aerial. £32.10.0

HI-FI SPEAKER SYSTEM: SSU-1. Ideal twin speaker/ducted-reflex cabinet for stereo/mono in average room (left "in the white"). Legs £1.1.0 extra. £10.17.6

AUDIO GENERATOR: AG-9U. 10 volts, 10 c/s to 100 kc/s pure sine-wave. Switch-selected frequency and attenuator. £19.19.6

JUNIOR TRANSISTOR RADIO: UJR-1. Youngsters are not excluded from our kit programme. This special single transistor set is an excellent introduction to radio and an instructive present. £2.16.6

TRANSISTOR PORTABLE RADIO UXR-1 In elegant solid hide case, with golden relief. Six transistors, dual-wave, fine reproduction, very easy to build. £14.18.6

SINGLE CHANNEL 12 WATT HI-FI AMPLIFIER: MA-12. Ideal for stereo conversions, etc. Generous auxiliary power provided. £10.19.6

COLLARO "STUDIO" TAPE DECK. This extremely attractive and compact 3-speed monaural tape deck features: digital counter, pause control and piano-key switches. £17.10.0

(Following models not illustrated)

MULTIMETER, Model MM-1U. Sensitivity 20,000 ohms per volt D.C. .5000 ohms A.C. Ranges 0-1.5, 5, 15, 50, 150, 500 and 1500V. AC and DC. Current 0-150 micro-amps to 0-15 amps in 5 ranges. Resistance ranges RX1(15 ohm centre scale) RX100 and RX10,000. 4½" 50 micro-amp meter. £11.18.6

CAPACITANCE/RESISTANCE BRIDGE: C-3U. Measures capacity 10pF to 1,000µF. Resistance 100Ω to 5MΩ; Pwr. factor. £8.6.6

VARIABLE FREQUENCY OSCILLATOR: VF-1U. 10V output; covers 10 to 160 metres. £11.2.0

AUDIO WATTMETER: AW-1U. Up to 25W continuous, 50W intermittent. £14.14.0

AUDIO VALVE-MILLIVOLTMETER: AV-3U. 1mV to 300V AC. 10 c/s to 400 kc/s. £13.18.6

ELECTRONIC SWITCH: S-3U. This extremely useful device extends your single-beam "scope" for double-beam uses. £10.15.6

DIRECT READING CAPACITANCE METER: CM-1U. Full-scale ranges of 0-100 mmf, 1,000 mmf, 0.01 mfd and 0.1 mfd. £14.15.0

AUDIO SINE-SQUARE WAVE GENERATOR. Model AO-1U. Inexpensive generator covering 20 c/s to 150 kc/s and square waves to 50 kc/s in four ranges. Maximum output 10V., distortion less than 1 per cent. £12.18.6

R.F. SIGNAL GENERATOR, Model RF-1U. Up to 100 Mc/s fundamental and 200 Mc/s on harmonics and up to 100mV output on all bands. £11.18.0

GOLDRING-LENCO TRANSCRIPTION RECORD PLAYER, Model GL-58. This four-Speed Unit is offered for those who want a domestic unit which is of transcription quality. Fitted with G60 pick-up arm it has infinitely variable speed adjustment between 33½ and 80 r.p.m. as well as fixed speed of 16 r.p.m. Balanced turntable (3½ lb). Unique p/u lowering device. £20.12.2

All prices include free delivery in U.K. Deferred terms available on orders above £10



GD-1U and XGD-1



OS-1



V-7A



S-88



SSU-1



UXR-1



"STUDIO"

★ SEND THIS COUPON NOW FOR FURTHER INFORMATION

(Please write in BLOCK CAPITALS)

NAME _____

ADDRESS _____

Without obligation please send me

(Tick here)

BRITISH HEATHKIT CATALOGUE

FULL DETAILS OF MODEL(S) _____

DAYSTROM LTD DEPT. RC9 GLOUCESTER ENGLAND

A member of the Daystrom Group, manufacturers of the
WORLD'S LARGEST-SELLING ELECTRONIC KITS

ARMSTRONG AF 208 AM/FM RADIOGRAM CHASSIS

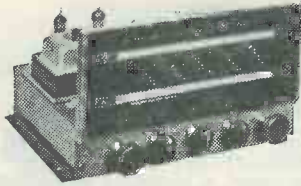

★ Full VHF Band (87-108 Mc/s.) and Medium Band, 187-570M. ★ 7 Valves ★ 5 Watts Output ★ 15db Negative Feedback ★ Separate wide range Bass and Treble Controls ★ 2 Compensated Pick-up Inputs ★ Frequency Response 30-22,000 c.p.s. ★ 2dB ★ Tape Record and Playback Facilities ★ Continental Reception of Good Programme Value ★ For 3, 7½ and 15 ohm speakers. Send S.A.E. for leaflet.

Price **22 Guineas** Carr. Free

LATEST "E.M.I." 4 SPEED SINGLE RECORD PLAYER

Acos 73 Hi-Fi Pick-up for LP, and/or 78, 7", 10" and 12" records. Silent motor, heavy turntable, auto stop. Special offer **£6.5.0** post free Stereo/Monaural **£6.19.6**

BUILD THIS REPRODUCER BARGAIN SPECIAL SINGLE PLAYER KIT

B.S.R. TU9 4-speed Gram Pick-up Unit **£4.5.0**
Handsome portable case 13" x 11" x 6 1/2" **£2.5.0**
Ready-built 3-watt, printed circuit, amplifier with two valves and speaker **£3.12.6**
or **£9. 9. 0** complete kit, post free

I.F. TRANSFORMERS 7/6 pair

465 kc/s Slug Tuning Miniature Can. 1 1/2" x 1" x 1/2". High Q and good band width. By Pye Radio. Data sheet supplied.

New boxed VALVES 90-day Guarantee

1RS	7/6	6K8G	7/6	EAS0	1/6	EZ80	7/6
1S5	7/6	6L6C	10/6	EAC80	8/6	E1148	1/6
1T4	6/1	6N7M	6/6	EB91	6/1	HABC80	12/6
2X2	3/6	6Q7G	8/6	EBC33	8/6	HVR2A	6/6
3S4	7/6	6SA7	6/1	EBC41	8/6	MU14	9/1
3V4	7/6	6SU7M	6/6	EBF80	10/1	PG1	3/6
5U4	7/6	6SN7	6/6	ECC84	9/6	PCC84	9/6
5Y3	7/6	6V6G	6/6	ECC80	9/6	PCF80	9/6
5Z4	9/6	6X4	7/6	ECH42	10/6	PCL82	11/6
6AM6	5/1	6X5	6/6	ECL80	10/6	PEN25	6/6
6B8	5/1	12A6	7/6	ECL82	10/6	PL81	12/6
6BE6	7/6	12AT7	8/1	EF39	5/6	PL82	10/6
6BH6	9/6	12AU7	8/1	EF41	9/6	PY80	7/6
6BV6	9/6	12AX7	8/1	EF50	5/6	PY81	9/6
6D6	6/1	12BE6	8/6	EF80	8/1	PY82	7/6
6F6	7/6	12K7	6/6	EP86	12/6	SP61	3/6
6H6	3/6	12Q7	6/6	EP92	5/6	UBC41	9/6
6J5	5/6	35L6	9/6	EL32	5/6	UCH42	9/6
6J6	5/6	35Z4	7/6	EL41	9/6	UF41	9/6
6J7G	6/6	80	9/6	EL84	8/6	UL41	9/6
6K6GT	6/6	807	5/6	EY51	9/6	UY41	8/1
6K7G	5/1	95A	1/6	EZ40	7/6	UZ2	8/1

DK96, DF96, DA96, DL96, 8/6 each or 30/- set

NEW ELECTROLYTICS FAMOUS MAKES

TUBULAR	TUBULAR	CAN TYPES
1/350v.	2/-	50/350v. 5/6
2/350v.	2/3	100/350v. 4/-
4/450v.	2/3	250/25v. 5/6
8/450v.	2/3	500/12v. 3/-
8/500v.	2/9	8+8/450v. 3/6
16/450v.	3/-	8+8/500v. 5/-
16/500v.	4/-	8+16/450v. 3/9
32/450v.	3/8	16+16/500v. 5/6
25/25v.	1/9	16+16/450v. 4/3
50/25v.	2/-	16+16/500v. 6/-
50/50v.	2/-	32+32/350v. 4/6

C.R.T. BOOSTER TRANSFORMERS

For Cathode Ray Tubes having heater cathode short circuit and for C.R. Tubes with falling emission, full instructions supplied.

TYPE A. LOW LEAKAGE WINDINGS. OPTIONAL 25% and 50% BOOST ON SECONDARY: 2 V. OR 4 V. OR 6.3 V. OR 10.3 V. OR 13.3 V. WITH MAINS PRIMARIES. 12/6.

OUR LATEST SUPERIOR PRODUCT. MAINS INPUT TYPE A2. HIGH QUALITY LOW CAPACITY 10-15 pF. OPTIONAL BOOST 25%, 50%, 75%. 16/6 each.

TYPE B. MAINS INPUT. LOW CAPACITY. MULTI OUTPUT 2, 4, 6.3, 10 and 13 V. BOOST 25% AND 50%. THIS TRANSFORMER IS SUITABLE FOR ALL TV TUBES. 21/- each.

MAINS TRANSFORMERS 200/250 AC

STANDARD 250-0-250, 80 mA., 6.3 v. tapped 4 v., 4 a., Rectifier 6.3 v. 1 a. tapped 5 v. 2 a. and 4 v. 2 a. ... 22/6
Ditto 350-0-350 ... 22/6
MINIATURE, 200 v. 20 mA., 6.3 v. 1 a. 10/6
MIDGET, 220 v., 45 mA., 6.3 v. 2 a. ... 15/6
SMALL, 220-0-220 v. 30 mA., 6.3 v. 2 a. ... 17/6
STANDARD, 250-0-250 65 mA., 6.3 v. 3.5 a. ... 17/6
HEATER TRANS., 6.3 v. 1 1/2 a. ... 7/6
3 a. ... 10/6
Ditto 1, 4, 2, 3, 4, 5, 6.3 v. 1 1/2 a. ... 8/6
L.L. LARD "1010" OSRAM "912", 300-0-300, 120 mA., 6.3 v. a. c. t., 6.3 v. 2 a. tapped 5 v. ... 38/6
GENERAL PURPOSE LOW VOLTAGE. Outputs 3, 4, 5, 6, 8, 9, 10, 12, 15, 18, 24 and 30 v. at 2 a. ... 22/6
AUTO. TRANS. 150 w., 0, 10, 120, 200, 230, 250 v. ... 22/6
AUTO. TRANS. 500 w., 0, 115, 200, 230, 250 v. ... 82/6

O.P. TRANSFORMERS. Heavy duty 50 mA, 4/6. Miniature 3V4, etc., 4/6. Small, pentode, 4/6. Multi-ratio push-pull, 7/6. Multi-ratio push-pull 10 w., 15/6. Goodmans heavy duty 10/20 v. 6K push-pull, 30/-.

L.F. CHOKES 15/10 H. 60/65 mA, 5/-; 10 H. 85 mA, 10/6; 10 H. 120 mA, 12/6; 10 H. 150 mA, 14/-.

TELEVISION REPLACEMENTS

Line Output Transformers from 45/- each, NEW Stock and other timebase components Most makes available. S.A.E. with all enquiries

FULL WAVE BRIDGE SELENIUM RECTIFIERS. 2, 6 or 12 v. 1 1/2 a., 8/9; 2 a., 11/3; 4 a., 17/6. Free charger circuit.

CHARGER TRANSFORMERS. Tapped input 200/250 v. for charging at 2, 6 or 12 v. 1 1/2 a., 15/6; 2 a., 17/6; 4 a., 22/6.

4 AMP. CAR BATTERY CHARGER with amp. meter Leads, Fuse Case, etc., for 6 v. or 12 v., 69/6

BOOKS

Valve and TV Tube Equivalents ... 9/6
TV Fault Finding ... 5/-
Quality Amplifiers ... 4/6
Radio Valve Guide. Books 1, 2, 3 or 4 each 5/-
Transistor Superhet Receivers ... 7/6

CRYSTAL MIKE INSERT by Acos 8/6
Precision engineered. Size only 1 1/8" dia. x 1/2"
ACOS CRYSTAL MIKE 40 ... 25/-

BAKER SELHURST LOUDSPEAKERS

12in. Baker 15w. Stalwart, 3 or 15 ohms ... 90/-
12in. Baker ditto, foam suspension, 15 ohms ... £6
12in. Baker Ultra Twelve, 20 c.p.s. to 25 kc/s £17.10.0
15in. Auditorium, 35 w., £15



LOUDSPEAKERS P.M. 3 OHM. 5in. Rola, 17/6; 7in. x 4in., 18/6; 4in. Hi-Fi Tweeter, 25/-; 8in. Plessey, 19/6; 6in. Goodmans, 18/6; 10in. R.A., 30/-; 12in. Plessey, 30/-; 10in. x 6in. R.A., 27/6; 12in. Baker 15 w. 3 ohm or 15 ohm models, 90/-; Stentorian HF1012 10in., 95/-; HF1016, 48.

CRYSTAL DIODES. G.E.C., 2/-; GEX34, 4/-; OA81, 3/-.

40 CIRCUITS FOR GERMANIUM DIODES, 3/-.

H.R. HEADPHONES, 4,000 ohms, brand new, 15/- pair. Low resistance phones, BA5, 7/6 pair.

SWITCH CLEANER FLUID, squirt spout, 4/3 cin.

TWIN GANG CONDENSERS. Miniature transistor gang 208 and 176 pF, 10/6 each; 365 pF; miniature, 1 1/2in. x 1 1/2in. x 1 1/2in., 10/-; 500 pF standard with trimmers, 9/-; midget, 7/6; midget with trimmers, 9/-.

SHORT WAVE. Single 50 pF, 75 pF, 100 pF, 160 pF, 5/6 each.

TUNING AND REACTION CONDENSERS. 100 pF, 300 pF, 500 pF, 3/6 each, solid dielectric.

CONDENSERS. 0.001 mfd, 7kV T.C.C., 5/6; ditto 20 kV., 9/6; 0.1 mfd, 7 kV., 9/6; 100 pF to 500 pF Micas, 6d; Tubular 500 v. 0.001 to 0.05, 9d.; 0.1, 1/-; 0.25, 1/6; 0.1/350 v., 9d.; 0.5/500 v., 1/9; 0.01/2,000 v., 1/9; 0.1/2,000 v., 3/6.

CERAMIC CONDENSERS. 500 v. 0.3 pF to 0.01 mfd., 9d.

SILVER MICA. 10% 5 pF to 500 pF, 1/-; 600 pF to 3,000 pF, 1/3; close tolerance (plus or minus 1 pF), 15 pF to 47 pF, 1/6; ditto 1% 50 pF to 815 pF, 1/9; 1,000 pF to 5,000 pF, 2/-.

465 K/c/s. SIGNAL GENERATOR Total cost 15/-.. Uses B.F.O. Unit ZA 3005B ready made. POCKET SIZE 2 1/2in. x 4 1/2in. x 1 1/2in. Slight modifications required, full instructions supplied. Battery 7/6 extra 69 v. + 1 1/2 v. Details S.A.E.

WAVECHANGE SWITCHES
2 p. 2-way, 3 p. 2-way, short spindle ... 2/6
6 p. 4-way 2 wafer, long spindle ... 6/6
2 p. 6-way, 4 p. 2-way, 4 p. 3-way, long spindle ... 3/6
3 p. 4-way, 1 p. 2-way, long spindle ... 3/6
Wavechange "MAKITS". Wafers available: 1 p. 12 wafer, 2 p. 6 wafer, 3 p. 4 wafer, 4 p. 3 wafer, 6 p. 2 wafer, 1 wafer, 8/6; 2 wafer, 12/6; 3 wafer, 16/-.. Additional wafers up to 14, 3/6 each extra.

TOGGLE SWITCHES, s.p., 2/-; d.p., 3/6; d.p.d.t. 4/-.

JASON F.M. TUNER COIL SET, 29/-.. H.F. coil, aerial coil, oscillator coil, two i.f. transformers 10.7 Mc/s., detector transformer and heater choke. Circuit and component book using four 6AM6, 2/6. Complete Jason FM TI kit, Jason chassis with calibrated dial, components and 4 valves, £6.5.0.

VALVEHOLDERS. Pax. int. oct., 4d. EA50, 6d. B12A, CRT, 1/3. Eng. and Amer. 4, 5, 6, and 7 pin, 1/-.. MOUNTED MAZDA and int. Oct., 6d.; B7G, B8G, B9A, 9d.; B7G with can, 1/6. B9A with can, 1/9. Ceramic, EF50, B7G, B9A, int. Oct., 1/-.. B7G, B9A cans, 1/- each.

RADIO COMPONENTS

Our written guarantee with every purchase. Buses 133 or 68 pass door. S.R. Stn. Selhurst

VOLUME CONTROLS

Long spindles. Midget 5K ohms to 2 Meg.
No. sw. D.P. Sw 3/- 4/6
Linear or Log Tracks.

80 ohm Coax CABLE

Semi-air spaced 2in. Stranded core, 6d. yd. 40 yds. 17/6; 60 yds. 25/-
Fringe Quality, Air Spaced 1/- yd.

RESISTORS. Preferred values. 10 ohms to 10 meg. 1/2 w., 4d.; 1 w., 4d.; 1 w. 6d.; 1 1/2 w. 8d.; 2 w. 1/-

HIGH STABILITY. 1/2 w. 1/6, 2/-, Preferred values. 10 ohms to 10 meg. Disto 5%, 100 ohms to 5 meg. 9d.

WIRE-WOUND RESISTORS
5 watt 25 ohms-10,000 ohms. 1/3
10 watt 25 ohms-10,000 ohms. 1/6
15 watt 25 ohms-10,000 ohms. 2/-
12.5K to 50K 10 w. 3/-

WIRE-WOUND POTS. 3 WATT. Pre-set Min. TV Type. All values 10 ohms to 25K, 3/- ea.; 30K, 50K, 4/- (Carbon 30K to 2 meg., 3/-)

4 WATT POTS. Long Spindle, Values, 50 ohms to 50K, 6/6; 100K, 7/6.

COAXIAL PLUGS, 1/-. PANEL SOCKETS, 1/-

LEAD SOCKET, 2/-. OUTLET BOXES, 4/6

BALANCED TWIN FEEDER, per yd. 6d., 80 ohms or 300 ohms.

TWIN SCREENED BALANCED FEEDER, 1/6 yd. 80 ohms.

TRIMMERS. Ceramic 30, 50, 70 pF. 9d.; 100 pF. 150 pF. 1/3; 250 pF. 1/6; 600 pF. 750 pF. 1/9; Philips, 30 pF. 1/- each.

BLACK CRACKLE PAINT. Air drying, 3/- tin.

NEON MAINS TESTER SCREWDRIVER, 5/-

SOLDER RADIOGRADE, 4d. yd., 1 lb. 5/-, 1 lb. 9/-.

HIGH GAIN TV PRE-AMPLIFIERS
BAND I B.B.C.
Tunable channels 1 to 5. Gain 18 dB. ECC84 valve. Kit price 29/6 or 49/6 with power pack. Details 6d. (PCC84 valves if preferred.)
BAND III I.T.A.—Same prices
Tunable channels 8 to 13. Gain 17 dB.

PAXOLIN PANELS, 10in. x 8in., 1/6.

MINIATURE CONTACT COOLED RECTIFIERS. 250 v. 50 mA, 7/6; 250 v. 60 mA, 8/6; 250 v. 85 mA, 9/6.

SELENIUM RECT. 300 v. 85 mA. 1/6.

COILS. Wearite "P" type, 3/- each. Osrom Midget "Q" type, adj. dust core from 4/- each. All ranges.

TELETRON D.W.R. L. & Med. T.R.F. with reaction, 3/6.

FERRITE ROD AERIALS. M.W., 8/9; M. & L., 12/6.

FERRITE ROD AERIALS. L & M. for trapistor circuits, 10/- each.

FERRITE RODS 8in. x 2in., 2/6.

H.F. CHOKES, 2/6.

T.R.F. COILS A/HF, 7/- pair; HAX, 3/-, DRR2, 4/-.

ALUMINIUM CHASSIS. 18 s.w.g. Plain, undrilled, 4 sides, riveted corners, lattice fixing holes, 2 1/2in. sides. 7in. x 4in., 4/6; 9in. x 7in., 5/9; 11in. x 7in., 6/9; 13in. x 9in., 8/6; 14in. x 11in., 10/6; 15in. x 14in., 17/6; 18in. x 16in. x 3in., 16/6.

ALUMINIUM PANELS. 18 s.w.g., 12in. 12in. 4/6; 14in. x 9in., 4/-; 12in. x 8in., 3/-; 10in. x 7in., 2/3.

AUTOCHANGER ACCESSORIES
Suitable player cabinets (uncut boards), 49/6. Amplifier player cabinets with cut boards, 63/-, 2-valve amplifier and 6 1/2 speaker for above, ready mounted on baffle, 12in. x 7in., 3in. deep, 79/6. Wired and tested ready for use.

QUALITY 2-STAGE HI-FI AMPLIFIER. A.C. only, 200-250 v. Valves ECL82 and EZ80. 3 watt quality output. Mullard tone circuits, bass boost, treble and volume controls. Separate engraved Perspex front-panel with de-luxe finish. Heavy duty output transformer 3 ohm. Shrouded mains transformer. Stove enamelled chassis size 6in. x 5in. x 3in. Bargain price £4.10.0. Circuit supplied.

ALADDIN FORMERS and cores. 2in. 8d., 2in. 10d.

0.3in. FORMERS 5937 or 8 and cans TV1 or 2, 1in. sq. x 2 1/2in. or 2in. sq. x 1 1/2in., 2/- with cores.

SLOW MOTION DRIVES. Epicyclic ratio 6-1, 2/3.

SOLON IRON, 25 w., 200 v. or 230 v. 24/-.

MAINS DROPPERS. 3in. x 1 1/2in. With adj. sliders, 0.3A, 1,000 ohms, 4/3; 0.2A 1,000 ohms, 4/3.

LINE CORD. 0.3 A 60 ohms per foot, 0.2 A 100 ohms per foot, 2-way, 1/- per foot; 3-way 1/- per foot.

MIKE TRANS. 50:1, 3/9; 100:1 potted, 10/6.

P.V.C. CONN. WIRE, 8 colours, single or stranded, 2d. yd. Sleeving, 1.2 mm, 2d.; 4 mm, 3d.; 6 mm, 5d. yd.

SPEAKER FRET. Gold cloth, 17in. x 25in., 5/-; 25in. x 35in., 10/- TYGAN, 52in. wide, 10/-; 26in. wide 5/- ft. Samples S.A.E. Expanded Metal, Gold, 12in. x 12in., 6/-.

AMERICAN BRAND "FIVE" FERRO-DYNAMICS RECORDING TAPE

Long Play	7in. reel, 1,800 ft.	35/-
	5 1/2in. reel, 1,200 ft.	23/6
	5in. reel, 900 ft.	18/6
Standard Play	7in. reel, 1,200 ft.	25/-
	5in. reel, 600 ft.	16/-
Double play	7in. 2,400 ft., 60/-; 5in. 1,200 ft., 37/6; Spare Reels, 3in. 1/6; 4in., 5in., 5 1/2in. 2/- 0 7in. 2/6. "Instant" Bulk Tape Eraser and Head Defluxer, 200/250 v. a.c., 27/6. Leaflet S.A.E.	

QMAX CHASSIS CUTTER

The cutter consists of three parts: a die, a punch and an Allen screw.

Sizes	Price	Key
1/2in.	12/9	1/-
3/4in.	12/9	1/-
1in.	13/9	1/-
1 1/4in.	13/9	1/-
1 1/2in.	16/-	1/6
1 3/4in.	16/-	1/6
2in.	18/-	1/6
2 1/4in.	18/-	1/6
2 1/2in.	20/6	1/6
2 3/4in.	30/-	2/3
3in.	33/6	2/3
3 1/2in.	38/6	2/3
4in. square hole	29/-	1/6

"REGENT" 4 VALVE

"96" RANGE VALVES

Kit Price
£6. 6. 0
carr. 4/-



PRINTED CIRCUIT BATTERY PORTABLE KIT

Medium and long wave. Powerful 7 x 4 in. high Flux Speaker. T.C.C. Printed Circuit and condensers. Components of finest quality clearly identified with assembly instructions. Osrom Ferrite Aerial Coils. Rexine covered attache case binnet. Size 12 in x 8 in. x 4 in. Batteries used B126 (LS512) and AD35 (LS040), 10/- extra. Instructions 9d. (free with kit), Mains Unit ready made for above 39/6. Sold separately. Details free.



The Brilliantly Successful **Monarch** World's finest shaped Autochanger

BRAND NEW & BOXED

with Cabinet, Amplifier & Speaker

£12.10.0 CABR. 5/-

RECORD PLAYER BARGAINS

4 Speed Autochangers:

BSR, U.A.14.....	£7.10.0
Collaro Autochanger.....	£7.19.6
Garrard RC209.....	£9.9.0
Garrard RC 210.....	£10.10.0

4 Speed Single Players:

Garrard TA Mk. II.....	£8.0.0
Garrard 4 HF Transcription.....	£17.19.6
Garrard Stereo Heads £2 extra.	
All Sapphire Styli available from 6/-.	

ARDENTE TRANSISTOR TRANSFORMERS

Type D3035, 7.3 CT:1 Push Pull to 3 ohms for OC72, etc., 1in. x 2in. x 2in., 9/6.
Type 3034, 1.75:1 CT. Push Pull Driver for OC72, etc., 1in. x 2in. x 2in., 9/6.
Type D3058, 11.5:1 Output to 3 ohms for OC72, etc., 1in. x 2in. x 2in., 9/6.
Type D167, 18.2:1 Output to 3 ohms for OC72 etc., 2in. x 2in. x 2in., 12/-.
Type D239, 4.5:1 Driver Transformer, 2in. x 2in. x 2in., 10/-.
Type D240, 8.5:1 Driver Transformer, 2in. x 2in. x 2in., 10/-.

ARDENTE TRANSISTOR VOLUME CONTROLS. Type VC1545, 5K with switch, dia. .9in., 8/-.
Type VC1760, 5K with switch, dia. .7in., 10/6.

WEYRAD

COILS AND TRANSFORMERS FOR A 2-WAVE TRANSISTOR SUPERHET WITH PRINTED CIRCUIT AND FERRITE ROD AERIAL

Long and Medium Wave Aerial—RA2W. On 6in. rod, 1 1/2in. diameter, 208 pF. tuning, 12/6. Oscillator Coil P50/1AC. Medium wave. For 176 pF. tuning, 5/4.
1st and 2nd I.F. Transformer—P50/2CC. 470 kc/s, 1 1/2in. diameter by 2in. high, 5/7.
3rd I.F. Transformer—P50/3CC, to feed diode detector, 6/-.
Driver Transformer—LFDT2, 1 1/2in. x 2in. x 1 1/2in., 9/6.
Printed Circuit—PCAL. Size 2 1/2in. x 8in. Ready drilled and printed with component positions, 9/6.
7in. x 4in., 35 ohm Speaker, 25/-.
These components are approved by transistor makers and performance is guaranteed. Constructor's Booklet with full details, 2/-.

NEW MULLARD TRANSISTORS

Audio OC72 ... 6/- R.F. OC44 ... 10/6
OC72 ... 8/6 OC45 ... 9/6
Sub-miniature Electrolytics (15 V.) 1 mfd. 2 mfd., 4 mfd., 5 mfd., 8 mfd., 25 mfd., 100 mfd., 2/6.
B.B.C. Pocket 2 Transistor. M.W. and L.W. Radio Kit, 32/6. Phones 7/6 or deaf aid earpiece, 12/6.

"PW" ROADFARER AM/FM RADIO KIT Transistorised throughout. Advanced design, operated from internal batteries or direct from mains. Four Sections all on printed circuit: AM Tuner, FM Tuner, Audio Amplifier, Mains Supply Unit. Attractive Plastic Cabinet. Ferrite Rod, Aerial for AM, Telescopic Aerial for FM. Order Form now. Lowest price £15.

"P.W." Pocket 6. Transistor kit. All parts, printed circuit and cabinet. Osrom Designed Kit, £8.15.0.

SPECIALISTS 337 WHITEHORSE ROAD WEST CROYDON Telephone THO 1665

P. charge 1/-, over £2 post free. C.O.D. 1/6. (Export welcome. Send remittance and extra postage)

TEST EQUIPMENT OF EXCEPTIONAL QUALITY

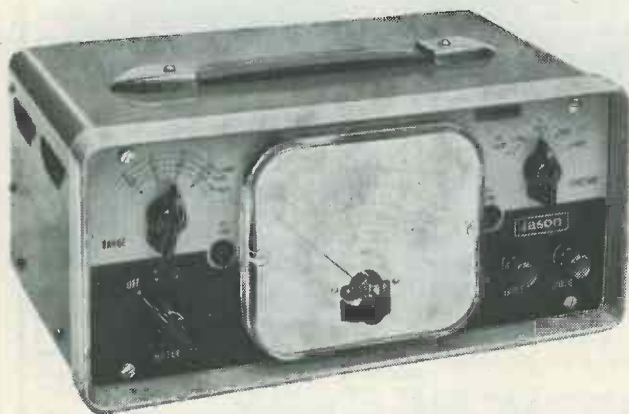

by

Jason

in

KIT FORM

A number of positive advantages stem out of presenting Jason Electronic Test Equipment in kit form. There is naturally a high degree of satisfaction to be obtained from building first-class equipment of this kind for yourself. You benefit too from using instruments of a standard which would otherwise cost very much more than the equivalent Jason Kit. Jason Instruments are in regular use in laboratories and test departments throughout the world. As Kits, they provide excellent opportunities for training in electronics. Built, they provide accuracy of exceptionally high order together with reliability and welcome robustness.

• TEST EQUIPMENT

● VALVE VOLTMETER (illus.)

4-valve Bridge Circuit. 23 ranges inc. D.C. Kit inc. valves, 4½" sq. meter and case. £23.0.0 High voltage probes £3 extra.

● OSCILLOSCOPE OG.10 (illus.)

Sensitivity of 10 mV/cm. with bandwidth 2 c/s. to 2 Mc/s. Push/pull amps. on X and Y plates. With 2½" tube, valves and case. £22.10.0

● AUDIO GENERATOR A.G.10

Tunes from 10 c/s to 100 Kc/s with output constant within 1dB. Square wave rise time better than 2 microseconds. With valves and case. £15.19.0

● AUDIO ATTENUATOR AA.10.

Nine steps by switches from 1dB to 40 dB. £7.15.0

● WOBBULATOR W.11

For all IF and RF alignment. Complete kit. £14.19.0

● CRYSTAL CONTROLLED CALIBRATOR C.C.10.

For use in 10 Kc/s to 250 Mc/s range with 0.01% basic accuracy. £19.19.0

Literature on all Jason items gladly sent on request.

● New Argus Transistor Radio Tuner for Recorder and Amp. £7.10.0

● NEW STEREO/MONO DE LUXE TAPE UNIT JTL

FOR RELEASE SHORTLY. DETAILS ON REQUEST.

AMPLIFIERS • TUNERS

(Built).

J.2-10. Mk. III Stereo/Mono Amp. £40.19.0

J.10 Mono Amp., 10 watt £24.0.0

FMT.4 FM Fringe Tuner £23.6.9

(inc. £6.15.7 P.T.)

JTV/2. Switched FM and TV Sound Tuner (inc. £6.15.7 P.T.) £25.19.7

Monitor—as JTV/2 but for cabinet mounting (inc. £5.4.1. P.T.) £19.19.1



Jason

ELECTRONIC TEST EQUIPMENT HIGH FIDELITY TEST EQUIPMENT

JASON ELECTRONIC DESIGNS LIMITED, KIMBERLEY GARDENS, LONDON N.4.

Telephone STA 5477

JACKSON

the big name in PRECISION components

Precision built radio components are an important contribution to the radio and communications industry. Be sure of the best and buy Jackson Precision Built Components

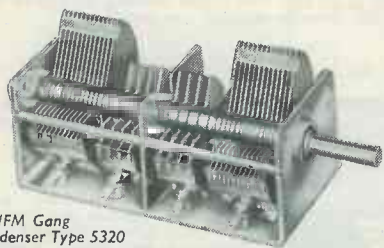

AM/FM Gang
Condenser Type 5320

JACKSON BROS. (LONDON) LTD
KINGSWAY, WADDEN, SURREY

Telephone Croydon 2754-5
Telegrams Walfico, Souphone, London

SO SENSITIVE...
but not temperamental!

from Salford - the NEW
minitest
POCKET-SIZED MULTIRANGE TEST SET



Only recently introduced, this instrument is proving an outstanding success. Its high sensitivity makes it ideal for testing and fault location in all types of electrical and electronic circuits. The instrument is well built and economically priced. Each instrument supplied with test leads. (Leather carrying case available as an extra.)

RANGES:	A.C. Volts.	2.5, 10, 25, 100, 250, 1000.
	D.C. Volts.	2.5, 10, 25, 100, 250, 1000.
	D.C. Amps.	50 μ A, 1mA, 10mA, 100mA, 1A. Ohms. 2000 200,000 20 M Ω
ACCURACY:	D.C. Volts & Amps.	\pm 2% of full scale deflection
	A.C. Volts	\pm 3% of full scale deflection
		\pm 5% at centre scale.

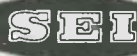

Send for leaflet MIN 6009/R.C.

SALFORD ELECTRICAL INSTRUMENTS LIMITED
PEEL WORKS · SILK ST · SALFORD 3 · LANCs · TEL · BLACKFRIARS 6888
London Sales Office · Magnet House · Kingsway, W.C.2. Temple Bar 4658
A SUBSIDIARY OF THE GENERAL ELECTRIC CO. LTD. OF ENGLAND

SMITH'S of Edgware Road BLANK CHASSIS

Precision made in our own works from commercial quality half-hard Aluminium. Two, three or four sided.

SAME DAY SERVICE

of over 20 different forms made up to YOUR SIZE. Order EXACT size you require to nearest $\frac{1}{16}$ " (maximum length 35", depth 4").

SPECIALS DEALT WITH PROMPTLY

SEND FOR ILLUSTRATED LEAFLET

Or order straight away, working out total area of material required and referring to table below, which is for four-sided chassis in 16 s.w.g.:

48 sq. in.	4/-	176 sq. in.	8/-	304 sq. in.	12/-
80 sq. in.	5/-	208 sq. in.	9/-	336 sq. in.	13/-
112 sq. in.	6/-	240 sq. in.	10/-	368 sq. in.	14/-
144 sq. in.	7/-	272 sq. in.	11/-	and pro rata	

Post 1/3 Post 1/6 Post 1/9

Discount for quantities. Trade enquiries invited. Spray finish arranged for quantities of 25 or over.

FLANGES ($\frac{1}{4}$ ", $\frac{3}{8}$ " or $\frac{1}{2}$ ") 6d. per bend.

STRENGTHENED CORNERS, 6d. each corner.

PANELS. The same material can be supplied for panels, screens, etc. Any size up to 3ft at 4/6 sq. ft. (sq. in. x $\frac{3}{8}$ d.). Post, up to 72 sq. in. 9d., 108 sq. in. 1/3, 144 sq. in. 1/6, 432 sq. in. 1/9, 576 sq. in. 2/-.

H. L. SMITH & CO. LTD
287/289 EDGWARE ROAD LONDON W2
Telephone PAD 5891/7595

HOME RADIO OF MITCHAM

Dept AC, 187 London Road, Mitcham, Surrey. MIT 3282. Shop hours: 9.0 to 6.30 p.m. (Weds. 1.0 p.m.)

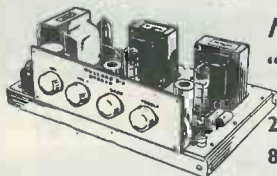

MULLARD'S
"Circuits for Audio Amplifiers"
 2nd. edition 136 pages
 8/6 plus 1/- post

The second edition of this exciting book on Audio design is now available. Prepared by Mullard's technical laboratories, it is now regarded as a standard text book on all aspects of High Fidelity reproduction and Audio design. In addition to sections dealing with the theory of reproduction and distortion there are practical designs for twelve different popular circuits. Detailed price lists are available for the components for these designs which are listed below. The prices shown are average figures for the exact parts as specified by Mullard's.

20 Watt Amplifier	£27.10.0
10 Watt Amplifier	£15. 0.0
3 Watt Amplifier	£ 9. 9.0
7 Watt DC/AC Amplifier	£11.10.0
2 Valve Pre-Amplifier	£ 6. 9.6
3 Valve Pre-Amplifier	£12. 0.0
4 Channel Mixing Pre-Amplifier	£ 7.15.0
3 Watt Tape Amplifier	£13.12.6
Tape Pre-Amplifier	£14.17.6
7 Watt Stereo Amplifier	£18. 0.0
3 Valve Stereo Amplifier	£13.10.0
Stereophonic Pre-Amplifier	£13. 0.0

NEW EDDYSTONE 840C

This smart streamlined communication receiver is a worthy successor to the original 840A. Advanced design, rugged construction, and high quality components used throughout. Designed for continuous operation under all conditions. High-grade, gear-driven, slow-motion drive and full width dial. Five ranges covering 480 kc/s to 30 Mc/s. PRICE £58.0.0 (Overseas shipping arranged).



EDDYSTONE 898 SLOW - MOTION DIAL

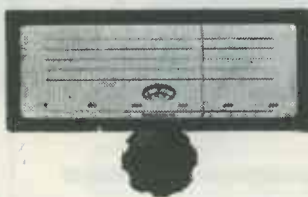

The finest slow-motion dial assembly available. Essential for really high-grade receivers, tuners, test gear, transmitters, etc. Precision cut gears give smooth 110 to 1 reduction and vernier scale gives exact logging positions. Size 9 1/4" x 5 1/2". PRICE £3.11.4, post 1/6 (Overseas post 7/6).

TRANSISTORS

Sensational Price Reduction by Mullard's OC44 11/-, OC45 10/-, OC70 6/6, OC71 6/6, OC72 8/-, OC75 8/-, OC76 8/-, OC78 8/-, OC81 8/-, OC170 13/6, OC171 14/6. Matched pairs of output transistors available.

SUB-MINIATURE RESISTORS

We now stock the range of LAB type LX in 10% tolerance. Rated at 1/8 watt and size 1/8" long and 1/16" diameter. PRICE 8d. each.

MINIATURE SPEAKER OFFER

Brand new miniature PM speaker 2 3/4" diameter and only 1/2" deep, 3 ohms impedance. Ideal for portables, transistor sets, intercoms, etc. LIMITED QUANTITY ONLY at special price of 12/6, post 6d.

WE ARE ACTUAL STOCKISTS FOR THE FAMOUS HEATHKITS

ANTEX "PRECISION" SOLDERING IRON



A wonderful iron for the constructor. Five different sizes of bits available. All voltages from 6 to 240 volts in stock. Model as illustrated, PRICE 29/6, post paid. Leaflet on request. Please state voltage.

CELESTION P44 12" LOUD-SPEAKER

This popular High Fidelity speaker is available again in 3 and 15 ohms. 12" unit with heavy-duty magnet and suitable for high quality domestic use or public address and dance halls, etc. PRICE £3.15.0, post 2/6

ARMSTRONG STEREO 12—MK II

The most complete radio and Hi-Fi chassis ever produced. Everything you want on one compact streamlined chassis. AM, VHF/FM, push-pull Hi-Fi Stereo, Pre-amp tone control unit, facilities for tape. PRICE 42 gns. All other Armstrong models in stock. AF208 22 gns. JUBILEE 29 gns, STEREO 55 32 gns.

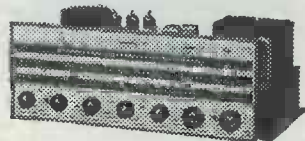

Dark evenings ahead—have fun on Short Waves with the "GLOBE-KING"

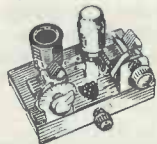

You can explore the world from the comfort of your own armchair and enjoy relaxation from a day's work. Build this truly amazing little one-valver, which gives really long distance reception at a minimum cost. Extra stage can be added later. Learn morse and listen in to shipping and amateurs, etc. 100/A kit with 3 coils covering 10 to 100 metres, PRICE £3.19.6, plus 1/6 post. Leaflet on request.

STEREOPHONIC PICK-UPS

ACOS "Hi-Light" Stereo pick-up £17.17.0
 Decca FFSS Stereo Pick-up £21.0.0
 Garrard TPA.12 Stereo pick-up £7.0.0

HI-FI EQUIPMENT

We are stockists for LEAK, QUAD, PYE, W.B., GOODMAN, WHARFEDALE.

AVO MULTIMINOR



A well-designed, simple to use rectifier/moving-coil test meter of pocket size and sturdy construction, complete with moulded rubber test leads and clips. 19 different ranges covering AC and DC voltage, DC current and resistance up to 2 megohms. Full details on request. PRICE £9.10.0, post 1/6.

NEW BOOKS

STEREO HANDBOOK by Briggs, 146 pages 10/6
 EXTRA EQUIPMENT FOR TAPE RECORDERS 6/-
 LATEST VALVE DATA MANUAL 6/-
 Please add 1/- packing and post.

HAVE YOU HAD OUR SUPER CATALOGUE

2/- plus 9d. post

VALVE DATA MANUAL

Seventh edition of this book has 156 pages and lists 4,800 valves, transistors, C.R.T.'s with base connections and most equivalents. PRICE 6/-, post 1/-.

The

Radio Constructor

Incorporating THE RADIO AMATEUR



SEPTEMBER 1961

Vol. 15, No. 2
Published Monthly

Annual Subscription 29/-
(including postage)

Editorial and
Advertising Offices
57 MAIDA VALE LONDON W9

Telephone
CUNningham 6141
(2 lines)

Telegrams
Databux, London

Suggested Circuits No. 130: A Pocket Audio Injection Probe, <i>by G. A. French</i>	94
Can Anyone Help?	95
An Unusual 2-Valve Superhet, <i>by V. C. Jackson and R. A. Ord</i>	96
An Impulse-operated Motor Speed Control Mechanism, <i>by R. J. Hawkins</i>	98
Resistance Measurement, <i>by J. B. Dance, M.Sc.</i>	100
A Crystal-Controlled Oscillator for FM, Part 2, <i>by Sir John Holder, Bt.</i>	101
Understanding Radio, Part 2, <i>by W. G. Morley</i>	105
In Your Workshop	111
Microphone Pre-amplifiers, Attenuators and Mixers, <i>by F. C. Judd, A.Inst.E.</i>	117
The JR1 Stereo Tape Recorder Unit, Part 1, <i>by G. Blundell</i>	121
Book Review	129
The "Finger-tip Five", <i>by A. S. Carpenter</i>	130
Radio Topics, <i>by Recorder</i>	134
A Constructor's Oscilloscope—A Construction of the Mullard Design, Part 3, <i>by D. Noble, G3MAW, and D. M. Pratt, G3KEP</i>	138
News and Comment	141
Transistor Shorted Turns Tester, <i>by M. D. Roberts</i>	142
A Magnetic Guitar Pick-up and Transistorised Tone Control Pre-amplifier, <i>by D. E. Maynard</i>	145

© Data Publications Ltd, 1961

CONTENTS may only be reproduced after obtaining prior permission from the Editor. Short abstracts or references are allowable provided acknowledgment of source is given.

CONTRIBUTIONS on constructional matters are invited, especially when they describe the construction of particular items of equipment. Articles should be written on one side of the sheet only and should preferably be typewritten, diagrams being on separate sheets. Whether hand-written or typewritten, lines should be double spaced. Diagrams need not be large or perfectly drawn, as our draughtsmen will redraw in most cases, but all relevant information should be included. Photographs should be clear and accompanied by negatives. Details of topical ideas and techniques are also welcomed and, if the contributor so wishes, will be re-written by our staff into article form. All contributions must be accompanied by a stamped addressed envelope for reply or return, and should bear the sender's name and address. Payment is made for all material published.

OPINIONS expressed by contributors are not necessarily those of the Editor or the proprietors.

TRADE NEWS. Manufacturers, publishers, etc., are invited to submit samples or information of new products for review in this section.

TECHNICAL QUERIES must be submitted in writing. We regret that we are unable to answer queries, other than those arising from articles appearing in this magazine; nor can we advise on modifications to the equipment described in these articles.

CORRESPONDENCE should be addressed to the Editor, Advertising Manager, Subscription Manager or the Publishers, as appropriate.

REMITTANCES should be made payable to "DATA PUBLICATIONS LTD."

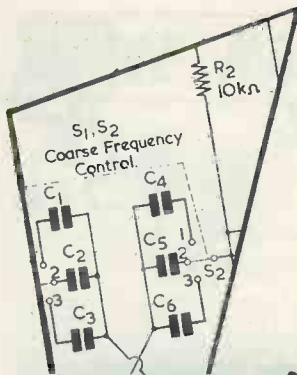

The Circuits presented in this series have been designed by G. A. FRENCH, specially for the enthusiast who needs only the circuit and essential data

suggested circuits



No. 130 A POCKET AUDIO INJECTION PROBE

A SIMPLE AUDIO OSCILLATOR is always a useful item and it may be employed for many jobs including, especially, trouble-shooting in the audio stages of faulty equipment.

This month's circuit is for an audio oscillator which employs very few components and which is intended to operate from a single 1.5 volt cell. Due to the small volume taken up by the components and cell, the oscillator is capable of being built into a completely self-contained probe, whereupon it becomes readily available for service work in the field as well as in the workshop.

The output of the probe is at high impedance, although the oscillator continues to function (with reduced output) if the probe is applied to impedances as low as 100Ω. When applied to the primary of a standard valve speaker transformer, the resultant tone in the speaker is at adequate level for fault-finding purposes. Thus, the probe may be used for trouble-shooting a.f. amplifier stages from the speaker transformer primary back.

The oscillator transformer specified in the circuit has been used in an a.f. oscillator previously described in *The Radio Constructor*¹, and the present circuit is similar in many respects to that given in the earlier issue. In this instance, however, the supply potential required is 1.5 volts

¹ D. J. French, GRAD.I.E.E.: "A Transistor Audio Signal Generator", *The Radio Constructor*, August 1959.

only, and the output is taken from the oscillator in a different manner.

The Circuit

The circuit of the oscillator accompanies this article and, as may be seen, very few components are required. The collector of the transistor feeds into winding 1-2 of the transformer, feedback being applied to the base via winding 3-4. Winding 5-6 is not used, and no connection is made to its terminals. Resistors R₁ and R₂ provide bias for the transistor and also limit the a.f.

current flowing in the base-emitter circuit. Condenser C₂, connected across winding 1-2, modifies the frequency of the oscillator note and reduces its tendency to squeg.

An output is taken from the collector of the transistor via the 0.01μF condenser C₁. When the probe is used for fault-finding, the flying chassis lead is clipped to the chassis of the equipment under test, whereupon the probe is applied to successive a.f. injection points as required.

Points of Design

Most of the work on the prototype was concerned with the selection of oscillator components capable of giving a reliable a.f. output of good amplitude for the relatively low supply voltage of 1.5. The oscillator tends to squeg, and this tendency is of advantage here since it enables the transistor to offer a higher output than would be given if it were employed as a pure sine wave oscillator. In this case a compromise has been reached, condenser C₂ sufficiently reducing the tendency to squeg to enable an acceptable tone to be generated at good amplitude. Resistors R₁ and R₂ also have an effect on the quality of the tone. Apart from providing a bias circuit they reduce the a.f. level fed to the base by winding 3-4 of the transformer. R₁ and R₂ may be considered as inserting a series resistor in the base-emitter circuit, the resistor having the same value as R₁ and R₂ in parallel.

As may be gathered from the last paragraph, the quality of the tone

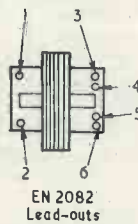

EN 2082 Lead-outs

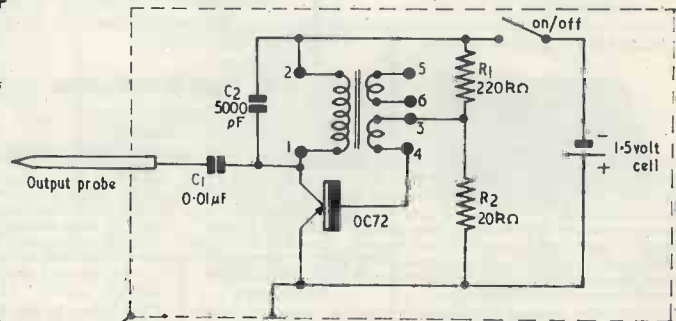

Transformer: Audio Transformer EN 2082 (Henry's Radio Ltd)
Resistors 1/8 watt 20%

E112

generated by the oscillator is not a pure sine wave. It is, however, sufficiently acceptable in quality to be satisfactory for fault-finding and servicing work.

The frequency of the tone varies slightly with load, but this effect is not great. The supply potential has a considerable bearing on frequency, and the component values given here are applicable to supply potentials around 1.5 volts only.

A possible risk with the circuit is that if the probe is applied to an injection point carrying a high d.c. potential, a high voltage may momentarily appear across the transistor whilst C_1 charges. The transistor is, however, effectively shunted (via the 1.5 volts cell) by winding 1-2 of the transformer, the low resistance of which (approximately 150Ω) prevents damage to the transistor from this cause. Nevertheless, winding 1-2 is only connected effectively across the transistor when the oscillator is switched on, with the result that the probe should not be applied to a circuit under test when

switched off. If desired, an electrolytic condenser of some $10\mu\text{F}$ or more could be connected across the supply rails after the on-off switch: such a condenser would ensure that winding 1-2 was effectively shunted across the transistor at all times, regardless of whether the oscillator were switched on or not. Similarly to protect the transistor, C_1 should be a good quality component having a high leakage resistance, and care should be taken to prevent the probe being accidentally applied to points carrying high a.c. potentials.

The transformer specified for the oscillator is a small component whose windings offer a convenient ratio for the present application. It is readily available through normal home-constructor channels.

Construction

The construction of the probe should raise few difficulties, layout not being important. When completed, the probe should be checked by connecting its output to an a.f.

amplifier or to the primary of a speaker transformer. If desired, variations to the frequency and quality of the note obtained can be obtained by adjusting the value of R_1 , or C_2 . However, experience with the prototype did not indicate that any of the component values were so critical as to necessitate adjustment.

Results with the Prototype

It was found, with the prototype, that an audible note at adequate level was obtained when the output was applied to the primary of a valve speaker transformer. Obviously, louder tones were given when it was applied to the output and preceding grids of the associated amplifier. The oscillator continued to work reliably (at a reduced output level) when a 100Ω resistor was connected across its output.

The peak value of the output voltage, when connected to a $250k\Omega$ load, was approximately 0.4 volts. Current consumption, for a supply voltage of 1.5, was 0.4mA.

CAN ANYONE HELP?

Requests for information are inserted in this feature free of charge, subject to space being available. Users of this service undertake to acknowledge all letters, etc., received and to reimburse all reasonable expenses incurred by correspondents. Circuits, manuals, service sheets, etc., lent by readers must be returned in good condition within a reasonable period of time

Hamcrafters SX24 Receiver.—L. Orbach, 131 Clarence Gate Gardens, London, N.W.1, urgently requires the manual or circuit diagram for this receiver—will purchase if necessary.

* * *

BC348, Model JN8Q.—J. Robertson, Aukengill, Wick, Caithness, Scotland, wishes to borrow or purchase the manual.

* * *

Ex-Government Receiver Type ZC8931.—R. W. Hilton, 8 Hogshell Lane, Cobham, Surrey, is in urgent need of information and circuit details for this 1.5 metre receiver and also, if possible, modifications for 2 metre working.

* * *

T1131 or 75C Transmitter.—P. M. Beecham, 2 Fyfield Road, Enfield, Middlesex, requires to borrow or purchase the manual or circuit diagram.

* * *

RF27 Unit.—P. M. Griffiths, 5 Hulbert Street, Bury, Lancs, would like to receive details on converting this unit for use on 2 metres.

* * *

Timebase Unit No. 4 ZC24694.—D. Howdle, 52 Braithwell Road, Revenfield, Rotherham, wishes to know the actual timebase and whether suitable for an oscilloscope.

Valve Types.—A. Lee, 77 Yew Tree Lane, Manchester 23, has obtained a civilian wartime receiver and requires to know the base connections of the following valves: BVA types 273/4/5/6/7, 243 or 246, 264/5/6, 211 and 214/5/6.

* * *

Channel RC Bridge and Signal Generator.—P. D. Webb, 139 Bromyard Road, Sparkhill, Birmingham 11, would like to obtain the service manuals of these and other Channel products.

* * *

Admiralty Type Receiver R/T Pattern 4660.—J. C. Henson, North Dhuloch, By Dunfermline, Fife, wishes to acquire the service manual of this receiver (marked Model No. 850).

* * *

G.E.C. Super 10 Autogram Cat. No. BC3918H.—R. Turner, "Bowmore", Dedworth Road, Windsor, Berks, is in urgent need of the circuit, willing to purchase if necessary—this appeal is his last hope!

* * *

Marconiphone Radio, Model T32A.—A. G. Ariyoh, 19 Dempster Road, London, S.W.18, requires the service manual or circuit—or any other information available—on this receiver.

An Unusual 2-Valve Superhet

by V. C. Jackson and R. A. Ord

THE REQUIREMENT WHICH LED TO THE DESIGN OF the receiver described here was for a small radio to be used in a kitchen. Consequently, provision was only made for reception of the Medium waveband, and switched tuning provided for quick (and accurate) station selection of the Home and Light programmes. Additionally, only a very small shelf area was available, so the receiver had to fit into a fairly small cabinet. The actual cabinet dimensions were $6\frac{1}{2} \times 5\frac{1}{2} \times 4$ in.

Circuit Design

The circuit is shown in Fig. 1. L_1 is a ferrite rod aerial and the rest of the circuit around V_1 is of a fairly conventional mixer/oscillator stage. The i.f. output from V_1 is coupled, via L_4 and L_5 , to the grid of V_2 .

V_2 performs a dual function, namely i.f. amplifier and audio output stage; and its action is as follows: i.f. signals are amplified by V_2 and fed via L_6 and L_7 to the crystal detector D_1 . L_6 and L_7 constitute a modified i.f. transformer. About two-thirds of the windings of L_7 are removed together with the associated tuning condenser, the remaining one-third being pushed close to the L_6 winding. The i.f. component is filtered from the audio signals by C_{11} and R_6 , the detected audio signal appearing across the diode load R_7 , the filtered signal appearing across the volume control R_3 . From the volume control, audio signals are fed via L_5 back to the grid of V_2 , which now acts as a conventional output stage.

As was to be expected in a circuit of this description, one of the most important problems to be overcome was preventing V_2 from breaking into oscillation. Due to the very high gain obtained at 465 kc/s with a high slope valve, the anode grid capacity becomes troublesome.

In Fig. 1 the circuit is stabilised by balancing the valve inter-electrode capacities in a bridge circuit.

This bridge is shown in Fig. 2. Balance is achieved by feeding h.t. to the screen-grid of V_2 via the 330Ω resistor R_4 , and decoupling this electrode with the $0.001\mu\text{F}$ condenser C_{14} . It is C_{14} which neutralises the circuit by balancing the bridge.

We were unable to find the anode load impedance of an EF91 when used as an audio output stage, and a suitable ratio had to be found by experiment. In the prototype, T_1 matches $15\text{k}\Omega$ to 3Ω , and therefore has a ratio of approximately 70:1. The loudspeaker employed has a diameter of 4 in.

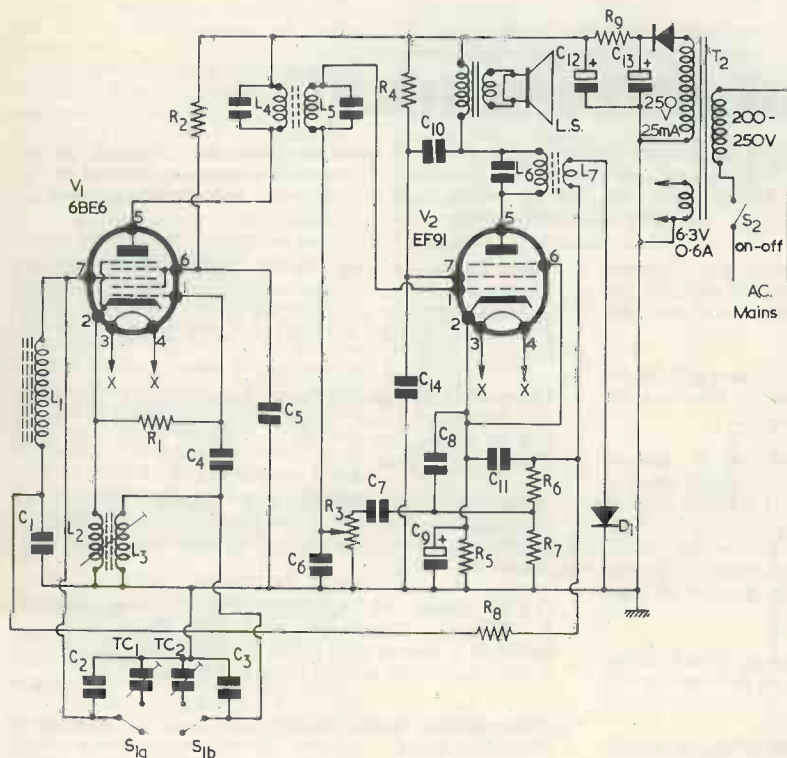

Fig. 1. Circuit diagram of the Unusual 2-Valve Superhet. S_1 (a), (b) is the station selector switch, position 1 being that of the Light programme and position 2 that of the London Home service

M127

In the interests of safety, a transformer is fitted to provide h.t. and l.t. supplies, the type used in Band I converters being ideal for the purpose, together with a contact-cooled rectifier. The current consumption of the receiver (h.t.) is 20mA at 250V.

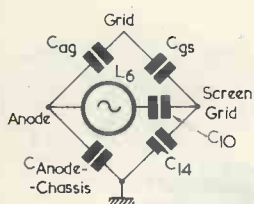

Fig. 2. Equivalent bridge circuit of V_2 interelectrode capacitances

MI28

The chassis employed with the prototype measured 5 x 3 x 1 in deep. Fig. 3 illustrates the layout of the major components both above and below the chassis.

Alignment

Provided that pre-aligned i.f. transformers are used, alignment will be found to be a very simple matter.

Switch to the Light programme; that is, with trimmers TC_1 and TC_2 out of circuit. Now adjust the core of L_2L_3 and the position of L_1 on the ferrite rod for maximum signal. Following this, adjust the core of L_6L_7 for optimum results.

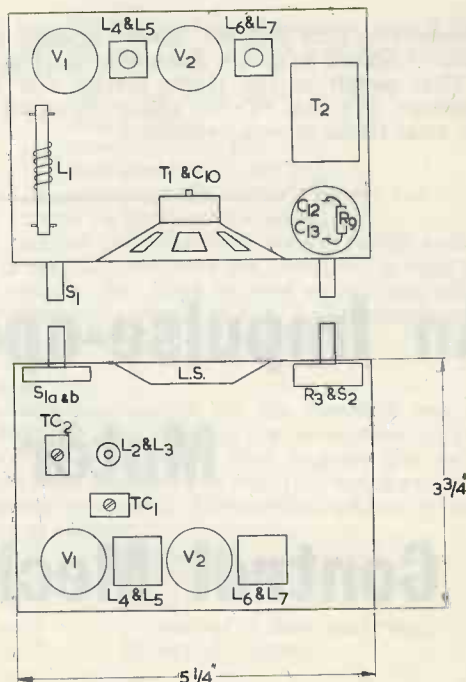

MI29

Fig. 3. Top: above-chassis main component layout; below: under-chassis main component layout

Components List

Resistors

- R_1 22k Ω 1/4 watt $\pm 20\%$
- R_2 22k Ω 1/4 watt $\pm 20\%$
- R_3 500k Ω pot, log, SPST switch
- R_4 330 Ω 1/4 watt $\pm 20\%$
- R_5 220 Ω 1/4 watt $\pm 20\%$
- R_6 47k Ω 1/4 watt $\pm 20\%$
- R_7 220k Ω 1/4 watt $\pm 20\%$
- R_8 1M Ω 1/4 watt $\pm 20\%$
- R_9 1k Ω 1 watt $\pm 20\%$

Valves

- V_1 6BE6 (X77, EK90, X727)
- V_2 EF91 (Z77, 6F12, 6AM6, 8D3)

Coils

- L_1 Ferrite rod aerial (MW)
- L_2L_3 Oscillator (MW)
- L_4L_5 465 kc/s i.f.
- L_6L_7 465 kc/s i.f. modified (see text)

Transformers

- T_1 Output 70:1
- T_2 Mains: Primary 200-250V, Sec: 250V, 25mA; 6.3V, 0.6A

Condensers

- C_1 0.05 μ F mica
- C_2 120pF mica (see text)
- C_3 120pF mica (see text)
- C_4 100pF mica or ceramic
- C_5 0.05 μ F paper
- C_6 560pF mica or ceramic
- C_7 0.05 μ F paper
- C_8 100pF mica or ceramic
- C_9 25 μ F, 12V, electrolytic
- C_{10} 0.005 μ F paper
- C_{11} 100pF mica or ceramic
- C_{12} } 16 + 16 μ F, 350V, electrolytic
- C_{13} }
- C_{14} 0.001 μ F paper
- TC_1 100pF max
- TC_2 100pF max.

Switches

- S_1 d.p.s.t. toggle or rotary
- S_2 s.p.s.t. ganged with R_3

Rectifier

- Contact-cooled 250V, 25mA

Miscellaneous

- D_1 GEX34 or similar
- Speaker, cabinet, B7G valveholder, chassis etc.

Incidentally, note that the "inner" position of this latter is needed to ensure maximum coupling.

Next switch to the Home service and adjust trimmers TC₁ and TC₂ for maximum signal from the local Home service transmitter.

The values of TC₁, TC₂, C₂ and C₃ apply to reception of the Medium wave Light programme and London Home service. When other stations are required these components may need to be altered accordingly.

An Impulse-operated Motor Speed Control Mechanism



By R. J. HAWKINS

THIS UNIT IS A MODIFICATION OF A SURPLUS electromagnetically operated switch, Ref. 5D/609. As purchased it consists of five sets of contacts which are sequentially operated by rotating cams, these being turned by a magnetically-driven 12 tooth ratchet. A pair of contacts situated above the electromagnet allows the mechanism to motor, while the magnet winding is in two sections, one part being switched to operate the unit and the other being permanently energised. All connections are brought to a 10-way terminal block.

The suppliers of the unit recommended it for radio control as it stood, but the author decided

that it was rather inflexible in its original condition, and therefore set about modifying it. The requirement was that the resulting unit should produce the following speed-sequence: full ahead, half ahead, stop, half astern, stop, half ahead. Half speed is obtained by connecting the motor field and armature in series (these being in parallel for full speed), while reversing is brought about by changing the polarity of the field supply.

When it is modified the unit is approximately 3½ x 3½ x 2½ in high. The two electromagnet coils are connected in parallel, whereupon energising current is 0.7A for a 12V supply. A boat containing the equipment should be at least 2.5ft long, although this would also depend to a great extent on the size and weight of motor and power supply, as well as on the ratio of width to length. The unit could also be used in a wheeled vehicle with a length of about 1.5 to 2ft.

The unit is designed to operate with a shunt-wound motor which will consume at least 1A at full speed. In consequence the power supply would be some sort of accumulator, such as a battery of miniature lead-acid, NiFe alkaline, or silver-zinc cells. The unit itself, however, takes little power, the action of the electromagnet being practically instantaneous. Two relays, each consuming some 0.02A, are fitted to the modified unit, but these are only operational for part of the time.

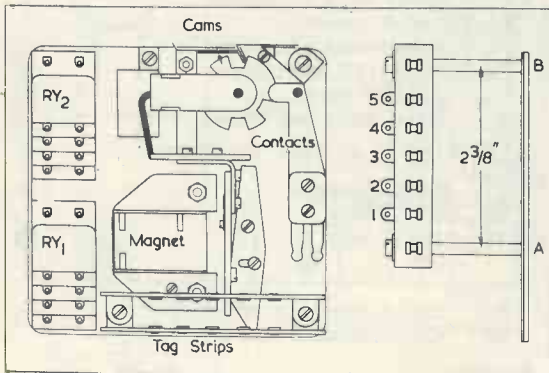

Fig. 1. Plan view of unit and details of tagstrip. The tags should be re-arranged if necessary by unclenching fixing lugs with pliers. Holes A and B countersunk ¼ in (B is already drilled)

MI24

The Modification

The items required for the modification are as follows:

- 5 1/16 in Paxolin washers, 3/4-7/8 in dia. with 1/8 in hole;

- 2 miniature 12-24 volt relays with double-pole changeover contacts;
- 2 spacing pillars $1\frac{1}{4}$ in long, tapped 6BA both ends;
- Tagstrip, wire, sleeving, 6BA bolts.

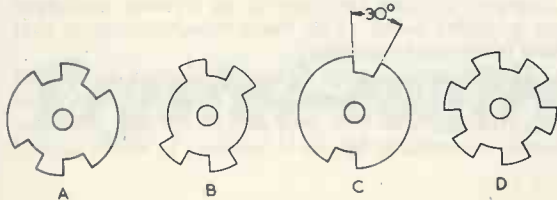

MI25

Fig. 2. Patterns of cams A, B, C, and D. Spaces must be cut to a diameter of $\frac{3}{16}$ in. (Diagram not to scale)

All wiring is removed from the magnet, motoring contacts, and terminal block, the latter two components then being removed. (A little methylated spirits may be necessary to loosen the varnish here.) To detach the motoring contacts striker arm it will be necessary to remove the magnet armature, taking care to replace the small spacing strips and to re-align the pivot correctly.

The relays are fixed to the baseplate at the point previously occupied by the terminal block, as shown in Fig. 1. Those used by the author had two 6BA holes in the base. The tagstrip is used to provide easy connection to the unit, the old terminal-block being somewhat too bulky. The tagstrip employed by the writer had every third tag supporting brackets.

Fig. 3. Circuit diagram of the motor speed control unit. All relays are shown in the de-energized position

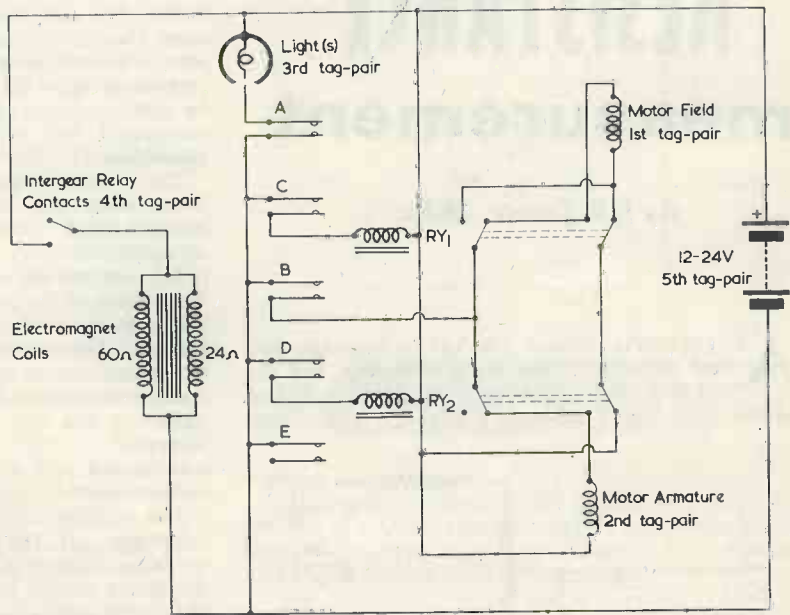

MI26

This tagstrip was cut and the tags rearranged (by removing with pliers and re-clinching in alternative positions) to give two strips of seven, the two end tags being inverted brackets having the parts to which the wire is soldered removed. The strips are mounted by means of the spacing pillars, as shown in Fig. 1.

The bracket which supports the cam-spindle is unscrewed and the cams removed. New cams are then made from the Paxolin washers as in Fig. 2.

Cam A controls the top pair of contacts, cam B the second, and so on. The functions of the various cams are as follows:

- A ... lights (on when motor is off)
- B ... motor on/off.
- C ... reversing relay (Ry 1).
- D ... half-speed relay (Ry 2).
- E ... unused in the author's model, but may be cut to suit various requirements.

The original cams have hexagonal centre holes, but it is sufficient to make the new ones a tight fit on the spindle; they must be fixed so that they take up the orientation shown in Fig. 2. This completes the mechanical part of the modification.

Wiring-up

The theoretical circuit for the complete unit is given in Fig. 3, this showing the connections to the battery, light and motor. This diagram also indicates the tags, numbered in Fig. 1 to which external connections are made. The services offered by the tags are as follows:

- Pair 1 ... motor field.
- Pair 2 ... motor armature.
- Pair 3 ... lights.
- Pair 4 ... to receiver or inter-gear relay.
- Pair 5 ... 12-24V d.c. input.

Motoring Contacts

The author considered that difficulties in operation might arise if the motoring contacts were left in circuit, since it is almost impossible to judge exactly when to cut off the supply to the electromagnet.

This is particularly true when the unit is incorporated in a boat, where a change in motor revolutions is not immediately obvious from the speed of the model. Nevertheless, the circuit may be altered, if desired, to give provision for motoring. If it is found that sparking between the relay contacts gives rise to instability in the receiver it may be suppressed by connecting a 22Ω resistor in series with a $0.01\mu\text{F}$ condenser across them.

Weight and Mounting

When purchased, some units are contained in a die-cast case; removing this reduces the weight considerably. The weight of the author's unit after modification was about 20 oz. As the original fixing holes in the corners of the baseplate are no longer usable, one being used to hold the tagstrip pillar and the other being covered by a relay, it will be necessary to drill new ones. They should be about $\frac{1}{8}$ to $\frac{1}{4}$ in diameter, and spaced to suit the support available.

and, generally, the accuracy of the instrument will not be as great as that which might be expected from methods in which a linear scale can be employed.

The circuit described (shown in the accompanying diagram) enables resistors to be quickly measured on a linear scale. The main disadvantage is that two meters are required.

The battery voltage (about 15 volts) is applied across the $1\text{k}\Omega$ potentiometer and the portion of this voltage which is tapped off by the potentiometer is measured by the voltmeter, V, which should

TABLE

Current	Factor
$100\mu\text{A}$	10,000
1mA	1,000
10mA	100
100mA	10

RESISTANCE measurement

By J. B. Dance, M.Sc.

AN EXPENSIVE BRIDGE CIRCUIT IS PERHAPS THE best method of measuring resistance, but the use of a multi-range meter is undoubtedly one of the most rapid methods available. Apart from

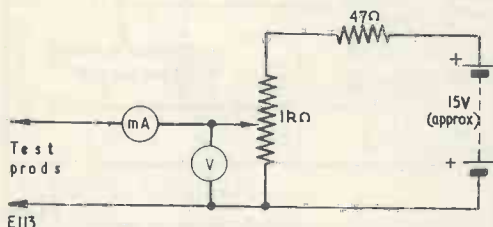

the necessity of adjusting the zero reading fairly frequently (in order to correct for any changes in the voltage or resistance of the internal battery), the multi-range meter method suffers from the disadvantage that the scale is non-linear. The resistance scale must therefore be specially calibrated

have a full scale deflection of between 10 and 15 volts. The milliammeter (or microammeter) measures the current passing through the resistor under test; it should have a number of ranges. The 47Ω resistor protects the battery if the test prods should be short-circuited with the full voltage across them.

Operation

The unknown resistor is connected across the test prods with the milliammeter set to its highest current range. The range is then altered until the milliammeter gives a reasonable deflection with the potentiometer set at about the centre of its range. The setting of the potentiometer is then altered until the reading is exactly $100\mu\text{A}$, 1mA, 10mA, or 100mA. The current should be chosen from one of these four values so that it passes when there is a reasonable deflection of the voltmeter, e.g. if $100\mu\text{A}$ passes at less than 1 volt, the current should be increased to 1mA. Each measurement should be commenced with a large current range so that the milliammeter is not damaged.

The resistance is found from the reading of the voltmeter. If the current passing through the unknown resistor is 10mA, the voltage indicated by the meter should be multiplied by 100 in order to obtain the resistance value in ohms. The factors by which the voltmeter reading must be multiplied for various other currents are shown in the table.

If it is desired to make a permanent piece of equipment employing this method for measurement of resistance, it would be convenient to employ a pointer knob to operate the milliammeter range switch so that it points directly to the range factor (as shown in the table), the factors being marked on the panel around the knob.

A

Crystal-controlled Oscillator

for F.M.

by Sir John Holder, Bt.

Part 2

A DESIGN FOR A CRYSTAL CONTROLLED FRONT-END which can be adapted to any f.m. receiver appears, at first sight, to be rather a tall order. However, a little experiment indicates that the second of the two circuit applications described in Part 1 of this series was so "docile" and "pliable" that, provided the constructor fulfilled certain requirements, he could twist it round in any reasonable way and still retain an adequate chance of success. These requirements are:

Requirements

1. The circuit given in this article must be used in its entirety, together with the specified oscillator valve and coils.
2. No connecting wire carrying high frequency current must be more than 1in long. Preferably a wire should be of the order of a $\frac{1}{4}$ in long.
3. The layout may be twisted and turned around in any way provided that the sequence of circuits shown in the block diagram of Fig. 1 is maintained, except that there must be no crossing over of the "flow" arrows shown in Fig. 1.
4. The relative positions of the coils is also important. L_1 must be $1\frac{1}{2}$ in or more away from L_2 or L_3 , whilst L_2 and L_3 must be separated by exactly $\frac{1}{2}$ in, this spacing giving the required mutual coupling.

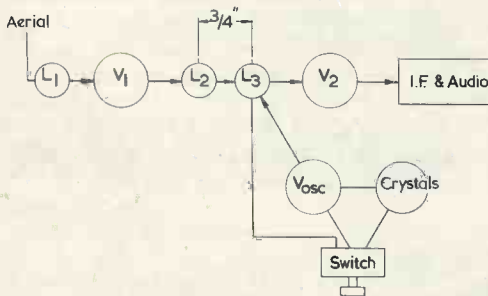

M117

Fig. 1. Front-end block diagram

5. The crystal must be closely adjacent to the switch tags and V_{osc} must be closely adjacent to the crystal. Any undue lengthening of the wiring associated with the crystal will almost certainly cause the crystal to lose control. Further wires associated with the "switch side" of the crystals should, if possible, not be parallel to the common wire joining the crystals to the cathode of V_{osc} .

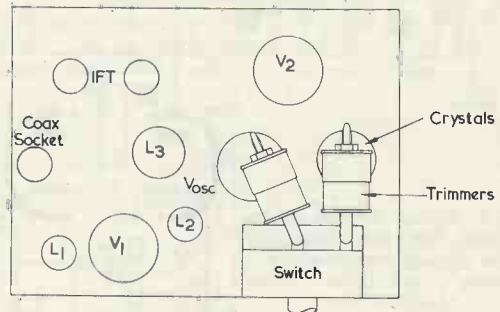

M118

Fig. 2. The Jason "Jupiter" conversion. The existing coils, valves and switch are retained, the latter having the rear wafer removed. The trimmer side-tags should be soldered direct to the switch tags

Cutting Large Holes

Existing components on the chassis may preclude the use of a Q-Max cutter. In this case, large holes may be cut quite easily with the aid of an Arborfile (a kind of fretsaw for cutting metal).

Left to Right and Backward Arrangement

The first application tried was an adaptation of the Jason "Jupiter" tuner. For this purpose, the back wafer of the switch was removed, an oscillator valve and crystal added and the wiring altered as necessary. The original coils were retained but the top end of the ribbon coils was used as the "hot" end instead of the bottom end. The layout is shown in Fig. 2. The pentode portion of the original oscillator was retained as a mixer. All that was necessary was to ground pins 1, 9 and 8 to the

- (ii) Add C_1 , C_2 , C_5 , C_6 , C_8 , also R_1 , R_3 , R_4 , R_5 , R_6 and R_7 , all lying flat close to the chassis.
- (iii) Add R_2 and R_8 .
- (iv) Connect common side of crystals to pin 8 of the ECC85.
- (v) Add coils and connect up. Add C_7 and C_3 .
- (vi) Add the switch and connect to crystals and coil former. These connections should be very short.
- (vii) Fix the trimmers and remaining condensers in place and connect up.

The centre spindle of the trimmers should be rigidly connected to chassis via earth tags or thick bare wire.

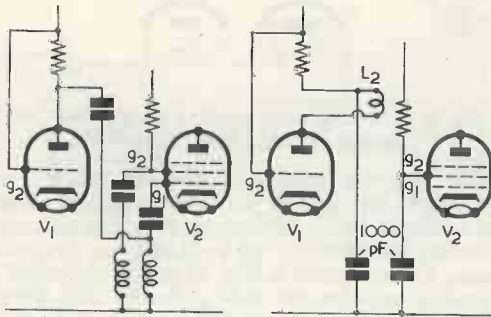

MI23

Fig. 7. Showing alterations to existing tuner unit enabling original V_1 and V_2 to be utilised. Left, before conversion; right, after conversion (inter-valve-coupling as in Fig. 3)

Right to Left Arrangement

As was stated earlier, provided certain requirements are fulfilled, the whole arrangement may be changed around in order to conform to adaptation requirements and the next example illustrates the conversion to crystal control of what was formerly a vintage variable condenser type tuner.

Fig 6 shows the layout. The variable condenser and original coils were removed and a switch fitted together with the same type of coils as in the previous example and the same type of switch. Note that the new components have been interchanged as compared with the previous example. Also, as the chassis was rather shallow, the trimmer had to be mounted alongside the switch instead of above it. The original V_1 and V_2 (both Z77's) were retained.

A slight alteration to the connections of V_1 was necessary in this case. Formerly, the output from V_1 was shunt fed to V_2 . In order to alter it to series

feed, the anode load resistance was "lifted" from the anode pin of V_1 and the primary of L_2 interposed, the original coupling condenser being replaced by a 1,000pF condenser connected to chassis. Similarly, as V_2 formerly oscillated between screen-grid and control-grid, the back coupling condenser originally connected to the screen-grid was replaced by a 1,000pF bypass condenser to chassis. Fig. 7 shows these details "before and after".

Adjustment

Part 1 of this article gave details for recognising the correct adjustment. A few further remarks may be helpful.

First set L_2 slug about three-quarters of the way in and the programme switch to "Home". (In Fig. 3 this switches in C_9 .) Screw in L_3 slug until the position is found where the Home programme can be heard over a few degrees of slug rotation and a voltmeter connected between the automatic volume control line and chassis shows no variation. Carefully find the mean slug setting for this.

Now change the switch to "Light" and repeat the process using the appropriate trimmer instead of the slug.

Next find the position for L_2 slug which gives the same a.g.c. voltage for Light and Home programmes.

Alteration of L_2 may necessitate a slight alteration of the setting of L_3 slug and "Light" trimmer. Finally, change to "Third" and adjust the remaining trimmer. If L_3 slug is altered for any reason, a corresponding alteration of both trimmers will be necessary.

If desired, a more "open" trimmer adjustment can be obtained by using 8pF max. trimmers shunted by 4.7pF fixed condensers.

Having adjusted the front-end, the i.f. part of the receiver can be checked in the usual way, using the 10.7 Mc/s signal furnished by the front-end in conjunction with one of the B.B.C. programmes.

Conclusion

These three examples should be sufficient to show the reader how to adapt the scheme to his particular needs, but for success, he *must* comply with the rules given, especially must he keep the wiring associated with the crystals and cathodes *very short*.

Indication that some part of the wiring is too long will be the hearing of one of the programmes when the switch is in the "off" position. If the fault is not too serious it may still be possible to achieve crystal control in the proper manner, and the offending programme in the "off" position, can be silenced by connecting the open contact of $S_{1(a)}$ to pin 6 of V_{osc} .

CHANGE OF ADDRESS

Jason Electronic Designs Limited, manufacturers of high fidelity audio equipment and electronic test equipment, announce their removal from Gt. Chapel Street, Oxford Street, W.1, to Kimberley Gardens, Harringay, N.4 (Telephone STAmford Hill 5477).

The move has been necessitated by increasing home and export trade and the consequent need for larger factory space.



The second in a series of articles which, starting from first principles, describes the basic theory and practice of radio

part 2

understanding radio

By W. G. MORLEY

IN LAST MONTH'S ISSUE WE DISCUSSED THE MOLECULE and the atom, pointing out that the latter consists of a nucleus around which one or more electrons may orbit. By applying an electromotive force, or e.m.f., to an electric conductor there is a general movement of electrons in one direction, and this constitutes an electric current. The basic unit for e.m.f. is the volt, and the basic unit of current is the ampere.

Cells and Batteries

It will be helpful at this stage to introduce some practical sources of electromotive force with which we are all familiar. A commonly encountered source of electromotive force is the *cell*. Cells are employed (usually in twos or threes) in electric torches, and may have the appearance shown in Fig. 3 (a). The cell shown here (known as a dry Leclanché cell) has a zinc outer container and a central carbon rod fitted with a brass cap. Both zinc and brass are conductors, and the e.m.f. given by the cell is taken from the zinc container and the brass cap, the former providing the *negative terminal* and the latter the *positive terminal*. The e.m.f. is produced by the action of the chemicals enclosed in the zinc container and, in this instance, is of the order of 1.5 volts. Often, a sleeve of specially treated cardboard or paper is passed over the zinc container to provide insulation, whereupon connection to the cell terminals may be made at the top and bottom.

It is usual to use two or more cells in an electric torch, and these are connected together *in series*, as shown in the typical example of Fig. 3 (b). In

this diagram the brass cap (positive terminal) of the lower cell connects to the zinc container (negative terminal) of the upper cell, the e.m.f. required by the torch bulb being taken from the upper brass cap and the lower zinc container. If two 1.5 volt cells are connected together in series in this manner, the total e.m.f. at the outer terminals is 3 volts.

Fig. 3 (c) shows three cells connected together in series. In this case the cells are mounted side by side, and the connections from one cell to the next are made by wires soldered to the zinc containers and brass caps. Once more the total e.m.f., appearing this time across two pieces of springy brass strip, is taken from the zinc container (negative terminal) at one end of the series arrangement, and the brass cap (positive terminal) at the other end. When three 1.5-volt cells are connected together in series the e.m.f. available at the outer terminals is 4.5 volts.

A series combination of two or more cells is known as a *battery*. As has already been inferred, the total e.m.f. produced by a number of cells connected together in series is equal to the sum of the individual e.m.f.'s. If we wished to construct a battery offering an e.m.f. of 90 volts (as would be used in a portable valve receiver) we could connect together, in series, 60 cells offering 1.5 volts each.

If we wish to do so, we may also connect two or more 1.5-volt cells together in *parallel*, as in Fig. 3 (d). In this case all the positive terminals are connected together, as are all the negative terminals. The e.m.f. available from this parallel combination is, however, only 1.5 volts; that is, the e.m.f. offered by any of the cells so connected. Whilst the

parallel combination of cells does not cause an increase in e.m.f., it can cause an increase in the current which may be drawn. Let us assume that a single 1.5 volt cell is capable, under certain conditions, of causing a current of, say, 0.1 amp to flow when it is connected to an external circuit. Two such cells, connected in parallel, could then be capable of causing 0.2 amps to flow; three could be capable of causing 0.3 amps to flow; and so on. Thus, it may be said that connecting cells in parallel causes the total current capability to be the sum of the individual current capabilities.

However, this point, which is intended to demonstrate the result of connecting cells in parallel, must not be considered as necessarily representing a sound practical technique. For reasons which will become apparent later, cells are not normally connected in parallel to increase current capability unless they are identical, or nearly identical, in

Dry Leclanché cells of the type used in electric torches are not capable of being re-charged, and are discarded when they are exhausted. Cells of the type employed in car batteries may, on the other hand, be re-charged by passing an electric current through them. Cells which cannot be re-charged are known as *primary cells*, and those which can be re-charged as *secondary cells*. A number of other cells fall into these two categories. A typical example is the mercury cell. This is a primary cell offering an e.m.f. of some 1.3 volts which, because it has a relatively long life and can be given small physical dimensions, is especially useful for hearing aids, transistor receivers and other miniaturised equipment. Alternative secondary cells are the nickel-iron NiFe cell (1.3 volts nominal and a very robust type with applications in electrically powered vehicles), the nickel-cadmium alkaline cell (1.2 volts nominal), and the Verner silver-zinc cell (1.5 volts nominal). The latter two cells may be given small

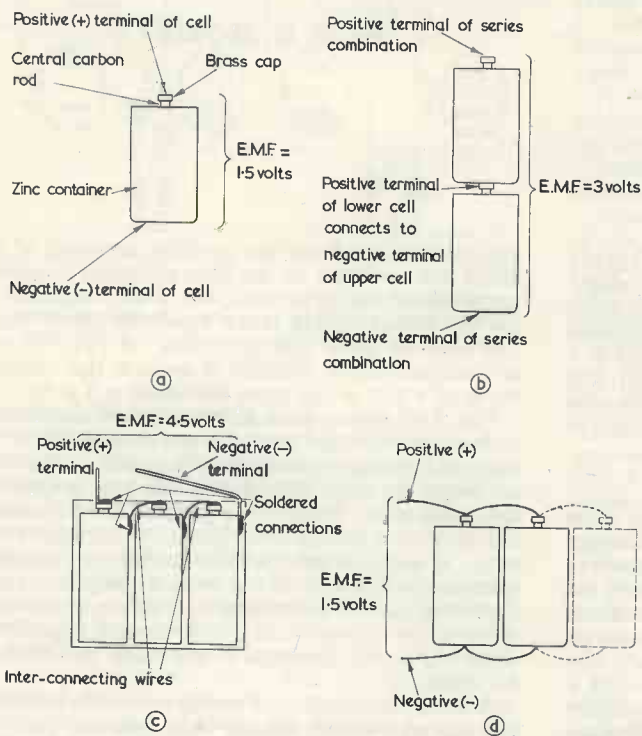

Fig. 3 (a). A dry Leclanché cell. Nominal e.m.f. is 1.5 volts, connection being made to the central brass cap and the zinc container

(b). Two dry cells in series, giving a total e.m.f. of 3 volts. An insulating cardboard sleeve may be fitted over the two cells shown here

(c). A familiar type of series cell arrangement employed in electric torches. In this instance the connections between cells are made with wire

(d). If two, or more, cells are connected in parallel, the total e.m.f. is still the same as for a single cell

electrical performance.

Another type of cell with which we are familiar is the lead-acid cell employed in car batteries. The nominal e.m.f. provided by a lead-acid cell is 2 volts, and three such cells may be connected together in series to form a 6 volt car battery, or six cells connected together in series to form a 12 volt car battery. In a car battery the series connections from one cell to the next are normally made by heavy copper straps covered with lead to provide protection against corrosion. (See Fig. 4.)

dimensions and can be employed in small-size equipment and powered models or vehicles, etc.

Two points of terminology need to be mentioned before proceeding further. A term fairly commonly used in place of "in parallel" is "in shunt". Thus, the cells of Fig. 3 (d) are *in shunt*. If a cell is connected in parallel with a second cell, it may be described as being *shunted* across the second cell. The term *accumulator* is frequently used to describe secondary cells, or to describe batteries made up from secondary cells.

MI47

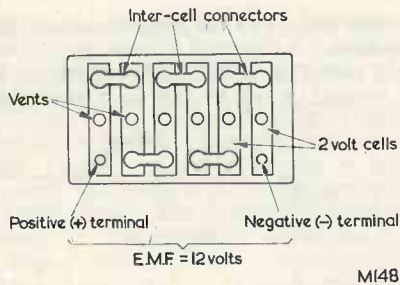

Fig. 4. A 12-volt car battery, consisting of six 2-volt cells connected in series

Circuit Symbols

It would, of course, be wasteful of time to reproduce actual cells when drawing up a circuit diagram, and so a readily recognisable symbol is employed instead. The circuit symbol for a cell is given in Fig. 5 (a), this consisting of a short thick line drawn parallel to a long thin line. The long line represents the positive terminal of the cell, and the short line represents the negative terminal.¹ Two cells connected in series may be represented as shown in Fig. 5 (b) and three cells in series as shown in Fig. 5 (c); but it is more usual to depict a battery (of any number of cells) in the manner shown in Fig. 5 (d), the total e.m.f. normally being indicated at an adjacent part of the diagram.

Potential

A very useful concept in radio and electrical engineering is that of potential difference.² Fig. 6 (a)

¹ A useful mnemonic here is to remember that a + sign (positive) has a longer "length of line" than a - sign (negative).

² Judging from the correspondence received when the "Understanding Television" series was published in *The Radio Constructor*, some readers have difficulty in visualising the concept of potential. In consequence, potential and potential difference are dealt with here at some length.

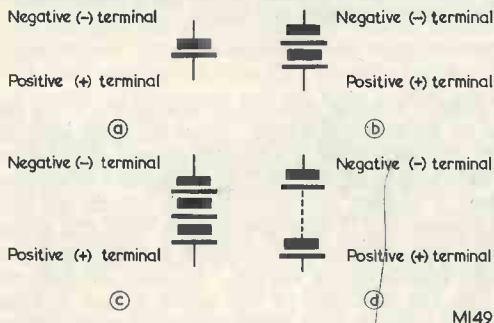

Fig. 5. Circuit symbols. That at (a) is for a single cell, and those at (b) and (c) for two and three cell batteries respectively. The symbol at (d) is for a battery with any number of cells, the total e.m.f. usually being indicated in the circuit diagram at an adjacent point

illustrates a battery having an e.m.f. of 6 volts. It may then be said that there is a potential difference of 6 volts between the two terminals of the battery. It is usual to consider the earth as having zero potential and, if we connect the negative terminal of our battery to earth, as in Fig. 6 (b), we may then say that its positive terminal has a "positive potential of 6 volts with respect to earth". Reversing the battery, as in Fig. 6 (c), causes its negative terminal to have a "negative potential of 6 volts with respect to earth". The terms "above" and "below" are sometimes employed to qualify potential, and they correspond to "positive" and "negative" respectively. Thus, the positive terminal of Fig. 6 (b) may be described as being "6 volts above earth potential", and the negative terminal of Fig. 6 (c) as being "6 volts below earth potential". Most electronic equipment is built on a metal chassis, and it is common to assume that the chassis has zero potential in just the same way as the earth (even though the chassis may not be connected to the earth). We may then encounter such expressions as "6 volts above chassis potential", and so on.

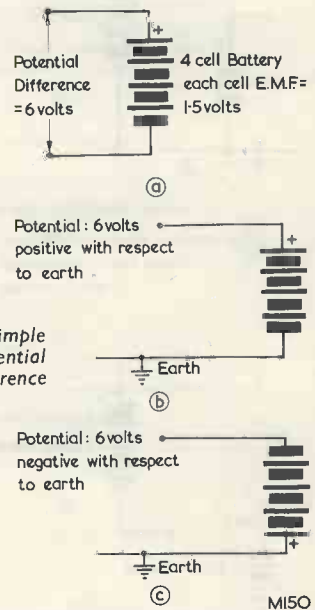

Fig. 6. Three simple illustrations of potential and potential difference

It is useful to make an analogy between potential and height. If we have a cliff 60 feet high with a ledge 30 feet below (Fig. 7 (a)), and there are stones on the cliff top and on the ledge, these stones possess potential energy. A stone capable of falling from the 30 feet ledge to earth level would have a potential energy which corresponded to a height of 30 feet. Similarly, a stone capable of falling from the cliff top to earth level would have a potential energy corresponding to a height of 60 feet. However, a stone on the cliff top capable of falling to the

ledge would have a potential energy corresponding to a height of 30 feet only. Fig. 7 (b) shows a 6 volt battery having its negative terminal connected to earth and a connection made into it at the 3 volt

terminal, with respect to the centre terminal, is only 3 volts positive.

Fig. 7 (c) shows the 60 feet cliff without the ledge. There is, instead, a hill 30 feet high alongside the

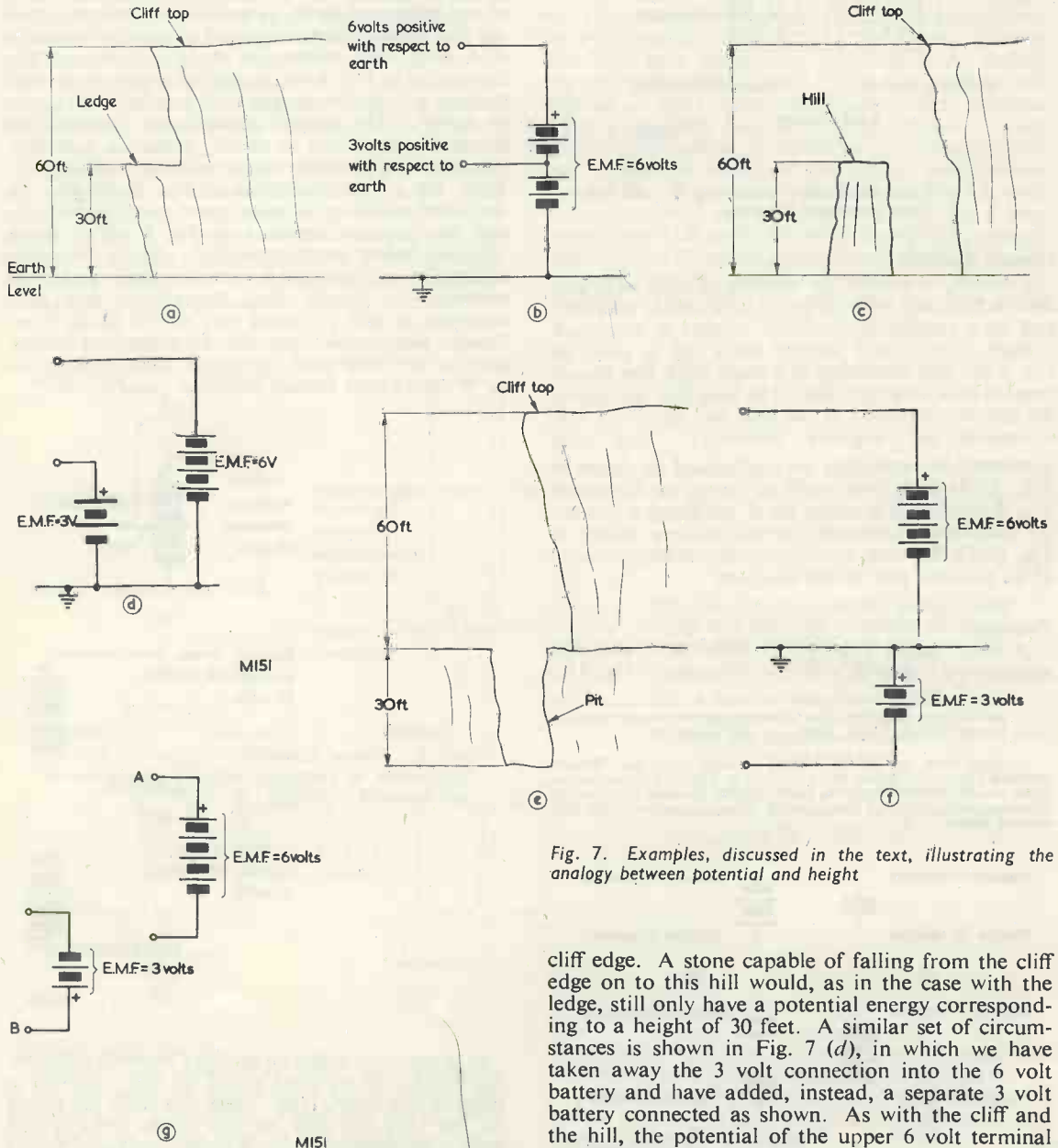

Fig. 7. Examples, discussed in the text, illustrating the analogy between potential and height

cliff edge. A stone capable of falling from the cliff edge on to this hill would, as in the case with the ledge, still only have a potential energy corresponding to a height of 30 feet. A similar set of circumstances is shown in Fig. 7 (d), in which we have taken away the 3 volt connection into the 6 volt battery and have added, instead, a separate 3 volt battery connected as shown. As with the cliff and the hill, the potential of the upper 6 volt terminal is 3 volts positive with respect to the upper terminal of the 3 volt battery.

Let us next add a pit 30 feet deep at the bottom of our 60 feet cliff. (Fig. 7 (e).) A stone capable of falling from the top of the cliff to the bottom of this pit now has a potential energy corresponding to a height of 90 feet. In Fig. 7 (f) we add a 3 volt

point. Just like the stones at the 30 and 60 feet levels, the potentials at the middle and top terminals are 3 and 6 volts positive respectively with respect to earth. And just like the stone which could only fall half way down the cliff, the potential of the top

battery in a similar manner. The potential of the upper 6 volt battery terminal is now 9 volts positive with respect to the lower terminal of the 3 volt battery.

The exercises of Figs. 7 (a) to (f) should help to show the concept of potential and potential difference. Practical examples similar in basic principle to those described will be frequently encountered in radio work. The beginner should pay especial attention to the manner in which the 3 volt battery of Figs. 7 (d) and (f) is connected to the 6 volt battery. In Fig. 7 (d) its negative terminal is connected to the negative terminal of the 6 volt battery whilst, in Fig. 7 (f), it is its positive terminal which is so connected.

As a final example, let us examine the two batteries of Fig. 7 (g). What is the potential difference between terminals A and B? The answer is that no potential difference exists between these two terminals. This is because the batteries are not connected together at any point, and they become, in consequence, completely separate.

The term potential difference may be abbreviated to p.d., and it is expressed in volts in just the same manner as e.m.f. Frequently, the term is omitted altogether, whereupon the upper 6 volt battery terminal in Fig. 7 (b), (d) and (f) would be described as being "6 volts positive of earth". Again, the term *voltage* may be used, whereupon this terminal could be described as having "a positive voltage, above earth, of 6".³

We have introduced the term "earth" when discussing potential and potential difference. The fact that the earth may be considered as being at zero potential will be explained in a later article. We have also, in Figs. 6 and 7, introduced the circuit symbol for "earth".⁴

Resistance

If an e.m.f. is applied across a conductor, the current which flows will depend, amongst other things, on the material with which the conductor is made. We have seen⁵ that the flow of electric current through a material is given by the flow of free electrons in the direction dictated by the *polarity* of the applied e.m.f. (Polarity refers, here, to the distinction between positive and negative terminals of the source of e.m.f.) Obviously, an infinite number of electrons cannot flow in the conductor. There must be a limiting factor, and this will in fact be given by the number of free electrons available and the ease with which they can pass through the material. Some materials allow the flow of electric current more readily than others, and they can be said to have a greater *conductance*. In radio work it is generally much easier to work with a reciprocal quality (i.e. one which decreases as the other increases, and vice versa) and so we refer to the *resistance* offered by conductors rather than to their

conductance. Resistance is the opposition of a material to the flow of electric current.

The resistance of a conductor varies according to its dimensions. Let us assume that we have two equal-length wires having a square cross-section of the same area, as shown in Fig. 8 (a). Both wires are made of the same material and we can make connection to their ends. If we were to measure their resistance individually we would find them to be identical. In Fig. 8 (b) we connect the two wires in parallel.⁶ If we were to measure the resistance

⁶ In just the same way as we connected the cells of Fig. 3 (d) in parallel, except that there is no necessity here to consider polarity.

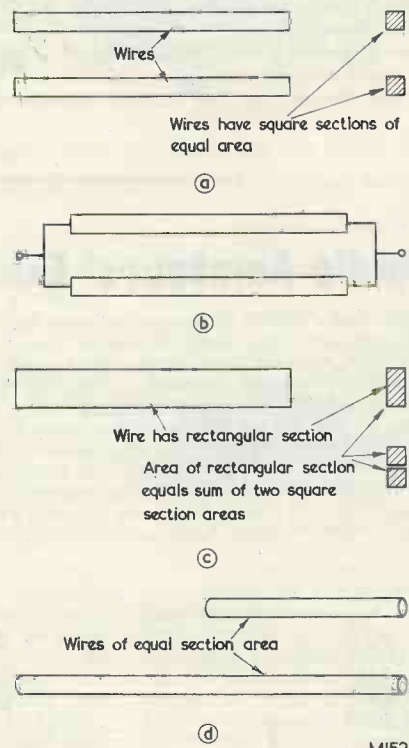

Fig. 8 (a). Two wires made of the same material, and having the same length and area of cross section. Both wires have the same resistance

(b). If the two wires are connected together in parallel, the total resistance is half that of either wire

(c). Another wire, having the same length but twice the cross-section area of the wires of (a) and (b), also has half the resistance

(d). The two wires shown here are made of the same material and have the same cross-section area. The lower wire is twice as long as the upper wire, and has twice the resistance

³ The term voltage may also be encountered in place of e.m.f. Thus: "a battery has a voltage of 3".

⁴ American terminology uses the word "ground" instead of "earth".

⁵ In last month's article.

of this parallel combination we would find it to be exactly half that of either wire on its own. The reason for this is obvious enough: we now have, in the same length as before, twice as many free electrons to provide the current. Fig. 8 (c) shows a single wire having a rectangular cross section whose area is equal to the sum of the two square section areas of Fig. 8 (a) and (b). The resistance of this wire is the same as the parallel combination of Fig. 8 (b) because, once again, we have twice as many free electrons for the same length of wire. Comparing Fig. 8 (c) with Fig. 8 (a) we can see that by doubling the cross-sectional area of the wire we have halved its resistance. It could be shown by similar means that if we trebled the cross-sectional area we would reduce the resistance to a third of its original value, and so on. Summing up, it may be said that the resistance of a wire varies inversely as its cross-sectional area. For reasons of simplicity, we used wires with square cross-sections in Figs. 8 (a) to (c) but the relationship between resistance and

cross-sectional area will obviously also hold true for wires with round cross-sections, or cross-sections of any other shape as well.

Fig. 8 (d) illustrates two wires of the same material and cross-sectional area. One wire, however, is twice as long as the other. Opposition to the flow of current in the longer wire will be two times greater because an e.m.f. applied to its ends will have to modify the movement of twice as many free electrons along its length. In consequence, the resistance of the longer wire will be twice that of the shorter wire. The same reasoning may be applied for other length ratios, and we can sum up by saying that, assuming constant cross-sectional area, the resistance of a conductor varies directly as its length.

Next Month

In next month's issue we shall carry on with resistance, introducing practical examples and covering Ohm's Law and power dissipation.

Radio Amateurs' Examination and Morse Classes

Grafton Radio Society announce that they have again made arrangements with Holloway L.C.C. Evening Institutes for official courses in the Radio Amateurs' Examination and Morse (both for beginners) to be held this winter at Montem School, Hornsey Road, Holloway, London, N.7. The classes will meet on Mondays, with repeat lectures on Tuesdays and Wednesdays, commencing Monday 25th September—R.A.E. at 7-9 p.m. (instructors S. Iles (G3BWQ) and P. Bernal (G3KQZ)), followed by Morse 9-10 p.m. (instructors L. Barber and A. Ralph). The fee for either course will be 20s., or 22s. 6d. for the two. Enrolment will be at the school any evening (7-9 p.m.) Monday to Friday during the week 18th-22nd September, but application in the first instance should be made to the Grafton Radio Society Hon. Secretary, A. W. H. Wennell (G2CJN), 145 Uxendon Hill, Wembley Park, Middlesex, so that a place may be assured. Of the 30 who sat the May City & Guilds examination, 23 passed making a grand total of 157 in eight years. In addition to the above, the club meet in the same room on Friday evenings for the usual club activity, including two transmitters and a monthly SWL meeting, commencing Friday 8th September, new members and visitors being especially welcome.



"THE DEPARTMENT IS VERY INTERESTED IN CIRCUITS, JONES, BUT NOT THE ONE AT GOODWOOD!"

In your Workshop

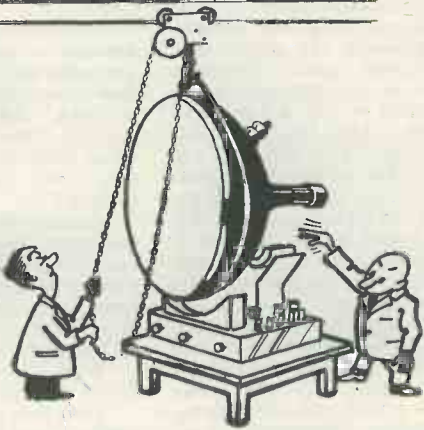

This month Smithy the Serviceman, and his able assistant Dick, discuss a subject which has been requested by a number of readers, that of bringing old sound receivers back into service

"SN'T IT FUNNY," REMARKED DICK, as he reached for his packet of lunch-time sandwiches, "the way the t.v. sets drop off at the end of the Summer?"

Smithy looked round the Workshop. The racks, which normally carried a full complement of television sets in for repair now held a few only, these being interspersed with record players and transistor radios. Several venerable broadcast receivers stood sedately on one of the shelves, their sober wooden cabinets contrasting strongly against the gay and brightly coloured plastic cases of their successors.

"We've got some really *antediluvian* jobs in as well," continued Smithy's assistant. "Just look at that old-timer over there!"

Dick pointed with scorn at a battered receiver which must have seen at least two decades of service.

"I suppose," said Smithy, referring to Dick's first point, "that t.v. repairs have eased off because the Summer weather has kept the insides of the sets nice and dry. Anyway, it's time we started our lunch. Have a sandwich!"

Old A.M. Receivers

Dick looked suspiciously at the sandwich offered by Smithy.

"What sort is it?"

"Corned beef," said Smithy heartily, "and full of vitamins."

The Serviceman glanced at Dick's lunch package, and a momentary gleam of cupidity shone in his eyes.

"I see you've got tinned salmon sandwiches today," he continued casually. "I'll swap this for one of yours!"

Very unwillingly, Dick took Smithy's sandwich and handed one of his own back in return. Smithy attacked it with great gusto.

"Why *do* we fix these old sets, anyway," queried Dick, as he bit listlessly into Smithy's corned beef sandwich. "There are quite a few service establishments which won't even look at them, you know."

"That's true enough," replied Smithy, his mouth full. "But don't forget that we don't always repair them ourselves, either. If we think the set is beyond economic repair we tell the customer accordingly."

Silence descended on the pair for a moment as they sprawled comfortably in the battered Workshop chairs and enjoyed the lunch-time lull in their labours.

"We've got an old Medium and Long wave set at home," volunteered Dick ruminatively, after a moment's deep thought. "It packed in about five years ago and we just stowed it away in the attic. I wonder if it would be worthwhile getting it out again and see if it can be repaired. After all, we could always use it as a standby set, or hitch it up in somebody's bedroom if they became ill."

"It mightn't be a bad idea," replied Smithy. "Very often all that goes wrong with these older sets is a single simple fault. But, because they've attained the dignity of years,

people look upon them as being 'worn out' and just sling them away."

"So our old set at home," pursued Dick, his interest aroused, "could quite possibly have little more wrong with it than, say, a broken down condenser or something like that?"

"That's right."

Dick digested this information.

"There must be quite a number of people," he commented, "with old radios of this type which could possibly be fixed up quite easily. How would you set about the job?"

"Well," replied Smithy. "Before you started you would need to be quite clear in your own mind exactly what it is you want to do. A common-sense approach would be to say that if the old radio can be made good enough to bring in the Home and Light programmes reliably then it would make a useful standby set for the sickroom or, perhaps, the kitchen. Incidentally I would, personally, only tackle mains superhets and I would, even then, make certain reservations. Given an acceptable mains superhet, it shouldn't in fact be asking too much to expect fairly reasonable reception of, say, Radio Luxembourg as well as the Home and the Light. And I would suggest that some three to four hours for repairs would represent a sensible maximum time. However, that last point depends on the views of the individual carrying out the repair."

"It seems fair enough to me," said Dick, his enthusiasm mounting, "considering that you are getting a

reasonable standby radio as a result of the work. What's the next step?"

"The next step," replied Smithy, "is the very important one of examining the old set and seeing whether it's worth the trouble of getting it to work again. The first thing is that, in my opinion, it's *got* to be a superhet or you're just wasting your time. Also, the i.f. should be in the range 455 to 475 kc/s. I must admit that some old supers with 126.5 kc/s are still, believe it or not, giving good service. If you feel like having a bash at any of these I wish you luck, but don't ask me where you're going to get replacement i.f. transformers!"

"After ensuring that it's a superhet, check the valve line-up. Apart from the rectifier, you should have a frequency-changer, i.f. pentode, double-diode-triode, and output pentode or tetrode. Sometimes, you may get a single diode instead of the double diode, and it might just possibly be tucked away in the i.f. pentode. You might even have a Westector diode, this being normally replaceable, with advantage, by a crystal diode. If you haven't got the four amplifying valves, plus the diode or diodes, I would personally advise against proceeding further if you're interested in a quick economic repair. You just won't have the gain to play with."

"That's narrowing the field a bit, isn't it?" queried Dick.

"Not really," replied Smithy. "Many sets produced in the late 30's had this valve line-up and so did practically all post-war sets."

"What about an r.f. stage?"

"Not very common in this country."

"Is the valve line-up the only thing you need to check?"

"Good heavens, no!" replied Smithy. "There are lots of other things you have to look out for as well. Valve heater voltages are the next point. If these are connected in parallel they should be 6.3 volts. If they're not, I should think twice before tackling the set. Incidentally, would you like another sandwich?"

Dick, suddenly jolted from his thoughts of bringing his old receiver at home back to life again, looked at the Serviceman with suspicion.

"What is it this time?"

"Cheese," said Smithy brightly.

"Just cheese?"

"Yes," replied Smithy firmly.

"Don't say you want another of my tinned salmon ones!"

"That's a nice friendly spirit, I must say," complained Smithy.

"The world's come to a pretty bad pass if two people who work to-

gether can't share their lunch in an egalitarian, comradely and unselfish spirit!"

Reluctantly, Dick handed over another of his salmon sandwiches and regarded that given him by the Serviceman with marked distaste.

"Why," he asked, attacking it gingerly, "don't you think it's worthwhile bothering with parallel-wired sets which don't have 6.3 volt heaters?"

"Because there are no modern replacement types," replied Smithy, munching cheerfully. "If the set has a series heater string rather the same applies. An 0.3 amp string is the most attractive, followed by an 0.15 amp string."

"What about 0.2 amp strings? Plenty of English sets had these."

"Yes, they're O.K. too," agreed Smithy, "and there are still plenty of 0.2 amp valves in the surplus market which may help out here as well."

"The next thing to check," continued Smithy, "is the valveholder type. If the valveholders are side-contact or a similar obsolete type you can take a risk that the valves currently fitted are O.K., but you must first ensure that the layout allows you to swap over to International Octal whenever you want to fit a replacement valve. That's a decision you can make yourself easily enough, of course."

Push-Button Tuning

"Anything else to keep an eye open for?"

Smith thought for a moment.

"An important feature," he remarked, "is the tuning arrangement. If this consists of a nice simple cord reduction drive, you won't have much trouble here. On the other hand, if the tuning arrangement employs one of those fantastic combinations of cord, cogwheels and Bowden cable which used to be so popular in the old days it would probably be better to give the set a miss and return it to the cobwebs. Again, the decision is up to you. Rather the same applies if the set had push-button tuning. Before you start, you want to check the button mechanism to see that it's not worn out, and that the contacts haven't become too heavily oxydised over the years. It's just a waste of time trying to repair an old set if the push-button tuning mechanism, for which spares will not be available, is past its useful life."

"All that seems sensible enough," commented Dick. "Where do we go from there?"

"There's nothing much else to do in the preliminary examination," said Smithy, "except to have a look at the cabinet and, also, to make certain that the set hasn't been stored in too damp a place, with the result that the chassis is a fruitful source of verdigris and plant life."

Checking Out

"I'm with this so far," said Dick.

"We've dug out the old set and given it a preliminary butcher's which shows that it might be worth the trouble of putting it into working order. What's the next job?"

"I would next get the works out," replied Smithy, "and give them a good old blow-out to clear the fluff and grime away. After which you can get down to real business. First of all, look over the chassis for obvious burn-ups. If there are any, you trace the faults causing them in the normal manner. After that, you can quickly check the h.t. positive line to chassis for shorts, apply the mains and switch on. If the set is *very* old and hasn't been used for a long time I wouldn't stand too close for the first few moments."

"Hey?"

"I'm quite serious," grinned Smithy. "There's just a faint risk of the electrolytics going pop when they first get h.t. on them! It's extremely improbable, incidentally, but the risk exists. After switching on you're on your own, and you follow normal servicing practice. If the valves light up you know that the heater chain or the primary and heater windings of the mains transformer, as the case may be, are O.K. Next, check to see whether there's any h.t., what sort of noise is coming out of the speaker, whether the h.t. is getting through to the anodes and screen-grids, and so on. In other words you carry out pretty well the same tests you make on any Medium and Long wave receiver which comes in for repair."

"Are there any general points to watch out for when servicing these old receivers?" asked Dick, surreptitiously reaching for another sandwich.

"Have another of mine," said Smithy genially.

Dick examined the proffered sandwich with an expression of revulsion.

"There's a big red stain on it."

"That's because it's a jam sandwich."

"Jam?"

"Raspberry jam," explained Smithy, coaxingly.

"You certainly go in," commented Dick, "for *grisly* lunches."

"Nonsense," said the Serviceman,

taking, with a masterful and adroit gesture, a further salmon sandwich from his protesting assistant. "It's just that I like a little variety in my food, that's all."

Dick frowned darkly at the jam sandwich which had appeared in his hand, but made no comment.

new condensers should of course have approximately the same capacity as is marked on the case of those they replace. You want to watch out for working voltage, incidentally, especially in the reservoir condenser. Some of the old sets had energised speakers (Fig. 1), the

smoothed h.t. line. Another point is that it is inadvisable to replace reservoir condensers with new components having much larger values. The increased reservoir capacity could cause the rectifier to pass higher charging currents than it was designed for.

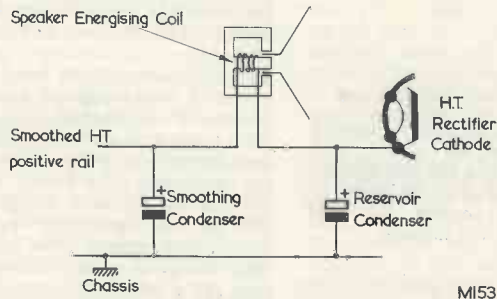

Fig. 1. In some early sound receivers the speaker energising coil also served as an h.t. smoothing choke. Because of its relatively high resistance this could necessitate a high working voltage for the reservoir condenser

General Points

"You asked me just now," said Smithy, chewing happily, "whether there are any general points to look out for when servicing these earlier receivers. As a matter of fact, there are.

"The first thing to look out for is electrolytic condensers. I said just now that there's a very slight risk of their going pop when they first get h.t. on them. At the same time,

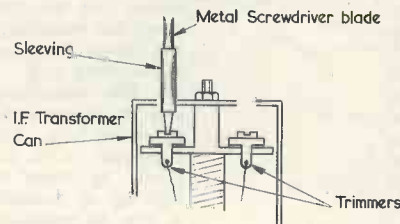

Fig. 3. I.F. transformers in old receivers had capacitive trimmers whose adjusting screws might be "live" to one end of the winding they tuned. A piece of sleeving slipped over a metal adjusting screwdriver blade prevents short-circuits to the can

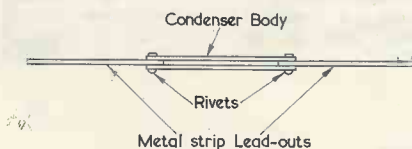

Fig. 2. In early mica condensers lead-out connections were made with the aid of rivets, as shown here. Such connections occasionally became intermittent, particularly when the condensers were varnish impregnated and had little physical protection in consequence

it's much more possible for them to lose their capacity with the passage of the years. When the set is really ancient it's not a bad idea to replace the h.t. electrolytics as a matter of routine; and you may find that this automatically clears a lot of other troubles in the receiver as well. The

energising coil acting as an h.t. smoothing choke. The resistance of such a coil is usually much greater than that of a choke, with the result that the voltage on the cathode of the rectifier and, hence, that applied to the reservoir condenser, would be quite a lot higher than that on the

the trimmer screws have to be reached through holes in the can, they should be adjusted with screwdrivers made of insulating material. If the screws are so tight you *have* to use a metal screwdriver, I should pop some sleeving over the shaft to prevent shorts to the can (Fig. 3). If the i.f. transformers had dust cores with an integral screwdriver slot you should proceed with great caution, because the cores may have become brittle over the years and any core-locking compound that was used may have hardened up. Use an insulated screwdriver that really fits the slots in the cores."

"Is it worth swapping i.f. transformers on spec," asked Dick, "like the h.t. electrolytics?"

"Oh no," replied Smithy. "You only want to change i.f. transformers if they have a definite snag. Most of the transformers employed in these old sets had really high Q's."

"Are there any other things to look out for whilst lining them up?"

"Not really," replied Smithy. "Just line them up like you would a modern receiver. There were one or two smaller receivers, however, which needed a little extra treatment. These had the tuning condenser fitted directly to the chassis without rubber

them severely alone, apart from trimming, if they appear to be working reasonably well. And don't expect too much from any Short wave bands that may be fitted, because these were a bit of a joke in some receivers. In any case the whole point of the repair is to obtain a standby set capable of picking up the

tion away from Smithy's actions.

"Not normally," replied the Serviceman. "But you might get quite a lot of trouble with i.f. instability. You see, it's at the intermediate frequency that most amplification in an a.m. sound receiver takes place. This holds true for modern sets as well, of course. With the old sets there was a very common cause of i.f. instability which I should tell you about. The i.f. valve was frequently covered with metallising to provide a screen, this metallising being connected to a wire wrapped around the bottom of the glass envelope. If the glass came unstuck from its base, the metallising would break away from the earthing wire (Fig. 5 (a)). The cure for this was to stick the glass back into the base again and wrap tinned copper wire several times around the metallising at the bottom. You then ran a lead down the side of the valve base to the pin the metallising normally connected to, and soldered

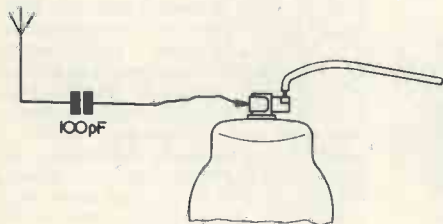

Fig. 4. Early frequency-changers usually had the signal grid brought out to a top cap connection. This enabled an aerial to be readily coupled into the receiver for test purposes

M156

mountings. If you got the i.f.'s in these sets spot on frequency there was a tendency to go into audio oscillation when you tuned in a station. The reason was that the i.f. response was too sharp and you were getting feedback from the speaker back to the tuning condenser."

"I know the effect," chimed in Dick. "The sound from the speaker gets back to the tuning condenser, vibrates the vanes and frequency modulates the signal. The resultant f.m. is changed to a.m. on the skirts of the i.f. response and is applied to the speaker."

"That's the idea," confirmed Smithy. "The whole arrangement gives you a positive feedback loop. Anyway, if you get this effect after lining-up it's best to slacken off the alignment a little. You can easily rock your signal genny when you're doing this, to see if you're still getting a decent response."

Smithy took a sandwich from the packet at his side, and looked at it with interest.

"What happens if you haven't got a signal genny?" asked Dick, his eyes glued to Smithy's movements.

"Tune in a station and rock the receiver tuning condenser across it," replied Smithy. "This'll give you a fair idea of what the response is like."

The R.F. Stages

"What about the r.f. circuits in these old sets?"

"Well," replied Smithy, "these tended to be pretty complicated in some cases, with bandpass coupling and all manner of things like that. The best thing to do here is to leave

Fig. 5 (a). A common fault with metallised valves. In this diagram the metallising has broken away from the earthing wire.

(b) The metallising may be re-connected as shown here. The connection to the pin should be made as high up as possible. It may be necessary to file off the plating on the pin at the point of connection to enable a reliable solder joint to be made

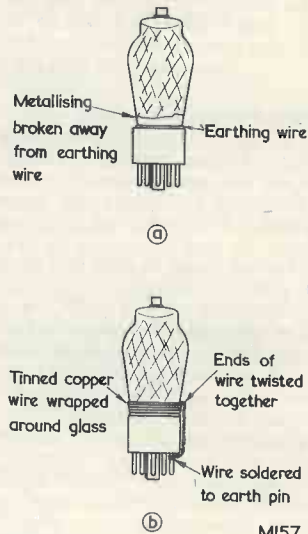

M157

Home and Light programmes. Don't forget that, provided the oscillator is working, you can always get some sort of signal into the i.f. and a.f. stages merely by applying a short aerial to the signal grid of the frequency-changer via a 100 pF condenser (Fig. 4), and this can be jolly useful for test purposes. Since the signal grid often appeared as a top cap in early frequency-changers, the process of applying the aerial can be quite a simple operation."

Smithy looked fondly at his sandwich, but made no attempt to eat it.

"Could r.f. instability be a problem?" asked Dick, tearing his atten-

tion at this pin (Fig. 5 (b)). This cure earthed the metallising and cleared the i.f. instability."

Smithy paused reflectively and looked down at his hands.

"Dear me," he said, in a nostalgic tone of voice, "I wish I had as many pounds as I've cleared i.f. instability that way!"

Dick's mind, however, was not on the past but on the immediate present.

"I do wish you'd do something with that sandwich you're holding," he remarked irritably. "It's getting on my nerves your looking at it all the time."

"Ah," said Smithy, "this one's special. I want to savour it."

"Yes, but what's in it?"

"I would prefer not to tell you at this stage," replied Smithy equably. Dick sighed.

"Well," he said resignedly. "I shall have to give way in the end, I suppose, if only to satisfy my curiosity. Pass it over!"

Smithy obeyed with alacrity, and two further sandwiches changed hands.

"This," remarked Dick, after an incredulous examination of Smithy's offering, "is just about the end! Until this moment I never even realised that you could have a dripping sandwich."

"I thought you'd like it," said Smithy. "Dripping is a very rich source of protein and carbohydrates. And it's absolutely crawling with calories."

Smithy's assistant gave a violent shudder.

"Well," he remarked, "you've wolfed all my tinned salmon sandwiches, so I suppose I'll just have to eat this horrible thing. What it will do to my stomach I hesitate to think."

"It'll do it the world of good," said Smithy, smacking his lips. "Give the old digestive juices something to really work on."

"Perhaps you're right," said Dick. He thought for a moment.

"Anyway," he continued darkly, "it's better than ptomaine poisoning."

Smithy looked suspiciously at his assistant.

"What did you say?"

"Just a thought," said Dick hastily.

"Anyway, let's get back to these old receivers. What about speakers, for instance? I should imagine that these would be one of the first things to replace."

Loudspeakers

"Funnily enough," replied Smithy, "that's not entirely true. If the set has been stored reasonably well you will often find that the speaker gives quite adequate reproduction. Not hi-fi, of course, but certainly good enough for a Medium and Long wave receiver which is only intended to be a standby anyway. You would be surprised, in fact, to hear how good some of those old sets sound. Should the speaker seem a bit scratchy it may need re-centring, but that isn't too hard a task if you're careful about it."

"How would you set about it yourself?"

"There are several ways of doing it," replied Smithy, "but what I've always done with cheaper speakers is to centre them by eye. You first of all place the speaker, magnet downwards, on the bench and very lightly hold the cone on either side of the centre with your two hands. (Fig. 6 (a)). You have your thumbs on the top and your fingers, passed through the gaps in the metal frame, on the back of the cone. Then you carefully raise and lower the cone, allowing its own suspension to guide it and keeping pressure exactly the same on both sides, and listen and feel for any interference between the coil and the pole-pieces. If there is, you loosen the centre-screw of the flexible 'spider' in the middle of the cone (Fig. 6 (b)) and carefully re-set the cone so that it looks central. Tighten up the centre-screw again and test once more for interference. It may be necessary to carry out this operation several times, because the final turn of the centre-screw some-

I must add, though, that this technique is intended for old receiver loudspeakers with central 'spiders' only, and is most definitely *not* recommended for expensive high fidelity units, or anything of that order. In the latter case you must follow the manufacturer's instructions. With modern television and radio speakers, of course, no centring adjustment is normally available, as they are pre-set at the factory."

Smithy paused and lit a cigarette.

"I like a smoke after my lunch," he pronounced grandly. "By the way, what was that you said just now about poisoning?"

"I was referring to ptomaine poisoning," replied Dick carelessly. "It's a loose term for the poisoning you get from food that's gone bad. Like tinned food."

"Yes," said Smithy, thoughtfully. "I thought you mentioned something like that. But why raise the matter now?"

"Oh, it was a little thing I just

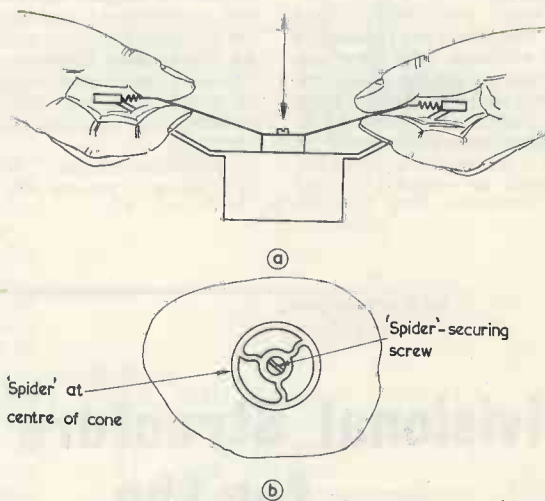

Fig. 6 (a). Part of the process of centring a loudspeaker, as described by Smithy

(b). The "spider" at the centre of the speaker cone. The spider-securing screw fits to the centre pole-piece of the magnet assembly

times shifts the 'spider' slightly. The process sounds a bit fiddling but it's pretty easy in practice once you've got the knack. The important thing is to treat the cone as gently as possible."

"It sounds a bit hit-and-miss to me," remarked Dick.

"I don't know," replied Smithy. "It's worked well for me in the past.

remembered," said Dick, in an off-hand tone. "About tins bulging."

"Bulging?"

"Before you open them. Apparently, if the ends of a tin of food bulge outwards it means that the contents have gone bad and have released a lot of gas. Gone putrid, in fact."

Smithy looked uncomfortable and

stuffed out his cigarette.

"It seems a funny sort of subject to bring up," he remarked eventually.

"Perhaps so," said Dick artlessly. "Anyway, we're getting off the point. I suppose you've got to replace the speaker in these old sets sometimes."

"Oh, yes," replied Smithy, returning thankfully to the subject of old receivers. "Such replacements would be most frequent in sets with small cabinets which dissipated a lot of heat. This heat could, with time, dry out the cone and voice coil former, causing them to be distorted out of shape and brittle."

"What happens if it was an energised speaker?" asked Dick. "You don't get energised speakers nowadays."

"You just replace it with an ordinary permanent magnet speaker."

"Yes," insisted Dick, "but what about the energising coil itself? You said just now that this may act as a smoothing choke. But you can't replace it with a choke directly because the latter would have a much lower resistance."

"I see what you mean," said Smithy. "Well, there are three ways out of this problem. An easy way consists of unscrewing the energising coil, complete with pole-pieces, from the speaker frame and mounting it in a convenient place in the cabinet. It will still act as a smoothing choke but it won't now be coupled to the

speaker. The second way out of the trouble consists of replacing the energising coil by an ordinary choke in series with a resistor which brings the total resistance up to that of the original coil. The third method if you can get away with it, consists of simply replacing the energising coil with a resistor of the same resistance. If this results in hum you then have to try and remove it by increasing the value of the smoothing condenser—not the reservoir condenser—after the resistor. You should be able to get hum-free reproduction in most cases with this technique.

"You may find, by the way, that energised speakers had hum-bucking coils connected in series with the voice coil. These coils were mounted inside the energising coil assembly, and their purpose was to apply a current to the voice coil which cancelled out the small variations in magnetic field produced by the energising coil acting as a choke. You simply forget about hum-bucking coils when you fit a replacement permanent magnet speaker and connect the speaker transformer secondary direct to the voice coil."

An Unanswered Question

"And that," concluded Smithy, "is pretty well the whole story on bringing old receivers back to life again."

"Thanks, Smithy," said Dick. "I'm going to get out that old set of

ours tonight and see if it's worth having a go at."

There was silence for a moment. Dick waited expectantly.

"I suppose," Smithy started, then relapsed into silence.

"Yes?" said Dick brightly.

Smithy swallowed, and tried another approach.

"Well," he remarked. "You had some of those tinned salmon sandwiches, didn't you?"

"I did not," replied Dick aggrievedly. "You scoffed the lot." Smithy looked unhappy, and Dick decided to relent.

"I was just pulling your leg," he said, "about the salmon being bad."

"Thank goodness for that," said Smithy in a relieved tone. "It would have been terrible if we'd both been off sick together."

"Together?"

"Yes," said the Serviceman innocently. "Didn't you notice anything funny about that dripping?"

"Oh, come off it," said Dick indignantly, "don't try the same trick on me!"

"Well," replied Smithy, shrugging his shoulders. "I only thought I'd mention it."

Dick sighed. He knew it would take a good half-hour to get Smithy to admit there was nothing wrong with the dripping. But what can you do with a gov'nor who insists on getting the last word?

A Divisional Structure for the Institution of Electrical Engineers

Much of the scientific work of the Institution has been for many years conducted by four Specialised Sections (Electronics and Communications, Measurement and Control, Supply, and Utilisation).

The Council have decided that it will be advantageous for the four Sections to be replaced by three Divisions, two of which will represent "Electronics" and "Power" interests, while the third, a "General" Division, will cover activities of common interest to all electrical engineers, such as basic measurement and technological education.

Each of the Divisions will comprise a number of Technical Groups designed to cover the specialisations within its field, and the scheme provides for speedy readjustment and creation of these Technical Groups which will increase the flexibility which is now more than ever necessary to reflect the rapid developments of electrical science and engineering.

In setting up a divisional structure the Council also recognise the increasing importance of electronics in electrical engineering, and the part being played by electronics engineers in the work of the Institution which has resulted in its present position as the professional home of electronics engineers.

Minor bye-law changes will be required, mainly of terminology, and these will be put to the membership at a Special General Meeting in due course.

Microphone Pre-amplifiers

Attenuators and Mixers

by F. C. JUDD, A.Inst.E.

Microphone Pre-amplifiers

A PRE-AMPLIFIER IS REALLY A *voltage* AMPLIFIER suitable for operation from very low level input sources, but with output characteristics suitable for matching to an amplifier having provision for high level input only. It is commonly used with most low level microphones and some types of gramophone pick-up in order to build up the signal from these sources to approximately 1 volt r.m.s. across a high impedance. This allows a volume control or attenuator to be placed between the pre-amplifier and the main amplifier. In some cases, however, the volume control may be included in the pre-amplifier itself and between stages if more than one valve is used. It is not good practice to have a variable attenuator at the *input* to a high gain pre-amplifier unless the input signal is very large. If the signal must be limited, it is better to incorporate a fixed attenuator in the grid circuit and use a variable attenuator *after* the first amplifier. The pre-amplifier requires the same design consideration as any other voltage amplifier and particular attention must be paid to hum pick-up, noise and microphony (ringing effects from the valves), all of which present their special problems.

Random noise includes both thermal agitation and valve noise, much of the energy of this noise being distributed uniformly over the whole of the frequency spectrum. Noise also comes from circuit components such as resistors, and this will be added to that from thermal agitation, etc. Most of the noise in a low level amplifier is due to three principal causes; noise from the anode load resistor, valve noise, and noise in the grid (input) circuit. Other, smaller, contributions may come from the screen and cathode circuits. Much of the noise may, however, be reduced by the use of high stability cracked carbon resistors and by limiting the pre-amplifier h.t. supply to between 100 and 200V.

Valve noise may be reduced somewhat by using triode valves, but at the expense of losing gain and the possible introduction of hum. Practice generally is to use a low noise pentode valve such as the Mullard EF86 which has been specially designed as a high gain, low microphony, low noise amplifier valve. There are other sources of noise; namely, leakage in the valve itself between the grid and other

electrodes or from resistive paths likely to be found in poor quality valveholders and from reversed grid current.

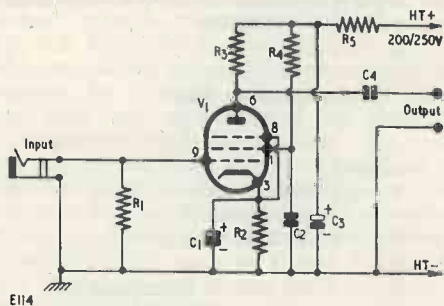

Fig. 1. Circuit of the high gain microphone pre-amplifier

Components List (Fig. 1)

Resistors

- R₁ 5M Ω Hi-Stab
- R₂ 2.2k Ω Hi-Stab
- R₃ 100k Ω Hi-Stab
- R₄ 390k Ω Hi-Stab
- R₅ 47k Ω carbon (composition)

Condensers

- C₁ 50 μ F electrolytic
- C₂ 0.25 μ F paper
- C₃ 16 μ F electrolytic
- C₄ 0.1 μ F paper

Valve

- V₁ EF86 Mullard

If the output source is of low impedance and coupled to the grid by means of a step-up transformer, it is not always necessary to design for minimum valve noise. In this case the input circuit should be arranged so that the microphone impedance reflected into the grid is at least twice, but better, four times that of the valve noise resistance.

This may be accomplished by using a transformer secondary impedance of 25 to 40K Ω in which case valve noise will have a very small effect on the total noise. This allows a more satisfactory use of high mu triodes and pentodes.

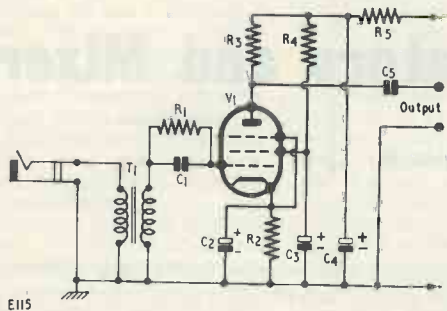

Fig. 2. Circuit of a pre-amplifier for a low impedance microphone

Components List (Fig. 2)

Resistors

- R₁ 1M Ω Hi-Stab
- R₂ 2.2k Ω Hi-Stab
- R₃ 100k Ω Hi-Stab
- R₄ 390k Ω Hi-Stab
- R₅ 47k Ω carbon (composition)

Condensers

- C₁ 0.05 μ F paper
- C₂ 50 μ F electrolytic
- C₃ 16 μ F electrolytic
- C₄ 16 μ F electrolytic
- C₅ 0.1 μ F paper

Valve

- V₁ EF86 Mullard

Transformer

- T₁ Microphone, 100:1

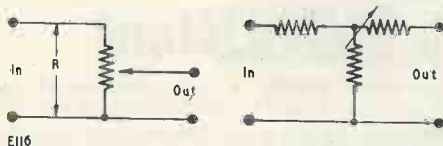

Fig. 3 (left). Continuously variable volume control (attenuator). Fig. 4. Constant impedance attenuator (T type)

Hum

In a pre-amplifier the permissible hum voltage present at the grid of the first valve depends somewhat on the maximum available signal input. If a

matching transformer with a high ratio and a reflected secondary impedance of 25K Ω or more is used, the signal level will be high and an extremely low hum level is not quite so necessary. If, however, a low level microphone or pick-up is directly connected into the grid circuit without a transformer, considerable care will be needed in preventing the circulation of hum currents and their introduction into the grid itself. The following precautions should be taken when considering design and construction:

- (1) The amplifier valve, associated wiring and components must be carefully screened.
- (2) Matching transformers must be electromagnetically shielded from stray 50 c/s fields. This can only be successfully accomplished by the use of mu-metal screens, orientation of the transformer and for exceptionally low level hum, by the use of hum-bucking coils.
- (3) Care must be taken over all "earth" connections. Hum loops can be formed even by external cables. These loops will often induce currents into the grid and cathode circuits of the valve itself.
- (4) Heater wiring should be twisted and taken by a suitable route in order to avoid coupling with other leads and components.
- (5) Valves should be mounted away from mains supply transformers and electrostatically screened.
- (6) If exceptionally high gain is required it may be necessary to drive the amplifier from pure d.c. supplies, e.g. batteries.
- (7) D.C. h.t. supplies derived from 50 c/s mains must be well smoothed and decoupled.

In practice the limit on amplification is set by the noise level due to thermal agitation in the grid circuit of the first valve, plus some of the noise generated by the valve itself. For a bandwidth of about 15,000 c/s noise due to thermal agitation may be about -129dBm.¹ If the effective microphone level is taken as, say, -60dBm with an unloaded microphone, the maximum possible signal to noise ratio will be about 72dB. The figure would be reduced to around 68 to 69dB for a loaded microphone. In actual practice, and because of other contributing factors such as hum fields, overall noise may be considered satisfactory if it is within 10dB of the thermal noise.

When crystal microphones are used, almost the whole of the microphone noise emanates from the grid resistance, the signal to noise ratio being poorest for values around 100K Ω . Improvement is gained if the grid resistance is made smaller but this, however, will affect the frequency response of the microphone. The alternative is to make the grid resistor very much larger, a value as high as 50M Ω being indicated for very low noise. In practice, a value around 5M Ω is used and this is a good compromise for a noise voltage of 4 μ V or so (this equals approximately -108dBv ref: 0dB=1V). The noise resistance of a pentode is negligible by comparison

¹ dBm indicates power expressed in decibels with 0dB=1mW.

and thus permits a signal to noise ratio of at least 60dB with diaphragm and sound cell types of microphone.

A Signal Stage Microphone Pre-amplifier

The circuit of Fig. 1 shows a simple pre-amplifier, suitable for a crystal microphone of the diaphragm type with a sound pressure of around 10 dynes/cm². It is an amplifier suitable for recording purposes and for use in a combination mixer circuit where two or more inputs may be fed into an attenuator network like that of Fig. 6. A recommended valve is the Mullard EF86 for which the anode, grid and screen resistors should be high stability cracked carbon types.

For low impedance ribbon and moving coil microphones the circuit of Fig. 2 should be used. This employs the same valve but requires a step-up transformer to obtain a correct grid impedance match between the microphone and grid circuit.

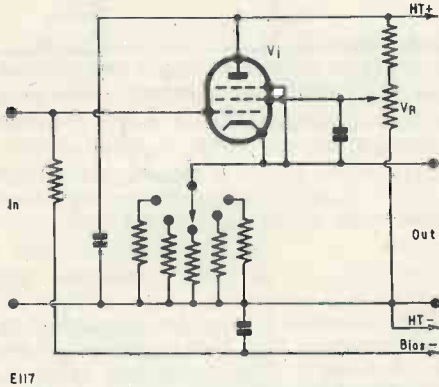

Fig. 5. Electronic attenuator (basic circuit)

Attenuators and Simple Mixers

The continuously variable volume control is commonly used in tape recorders, simple valve microphone mixers, radio receivers, and amplifiers. Its uses as an attenuator are limited because the voltage ratio is proportional to the resistance ratio only when the load at the output terminal is very much greater than the total resistance (R) of the attenuator. (See Fig. 3.) Logarithmic and linear characteristics are used, the former being adopted mainly for volume control purposes. Although this type of control has certain disadvantages as an attenuator, its low cost and otherwise reasonably noiseless operation makes it suitable for even high fidelity amplifying equipment. It would, however, be quite unsuitable for high grade studio recording equipment, which would be more likely to employ a constant impedance device for fading and mixing as shown in Fig. 4.

For some purposes an electronic attenuator may be advantageous and a possible arrangement is one utilising a cathode follower in which the screen voltage of the valve may be varied by VR, together

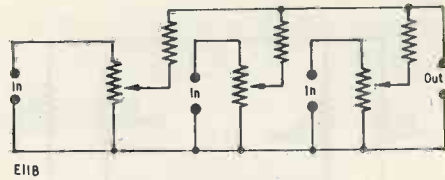

Fig. 6. Parallel mixing network

with the cathode resistors as in the circuit of Fig. 5. Any pentode type valve with a sharp cut-off is suitable although a valve with a high mutual conductance would limit the maximum attenuation.

Non-Constant Impedance Mixers

This type of mixer employs the simple "volume control" type of variable resistor which is commonly used for most domestic type amplifying equipment and radio receivers. Various combinations employing these simple controls can be used with or without valves but it must be emphasised that a combination as shown in Fig. 6 for example, is quite unsuitable for high impedance crystal microphones because of attenuation by loading, the possibility of hum pick-up, and noisy operation of the sliders. The insertion attenuation is about 10dB. The arrangement is suitable for direct mixing of high level signal sources such as the output from a radio receiver or gramophone pick-up. It can be combined with valve amplifiers for mixing microphones and, when used with pre-amplifiers such as those shown in the circuits of Figs. 1 and 2, provides the basis of a multi-channel mixing unit.

Another widely used mixing circuit is one employing a valve, or valves, with a common anode load as in Fig. 7. When two valves, such as a double triode, are used in this type of circuit the anode resistance of each valve acts as a shunt across the other thereby reducing the gain. With pentodes this loss of gain is negligible, however, and may be ignored.

Design for a Mixer

Combining the parallel network mixer circuit with high gain microphone pre-amplifiers, provides the

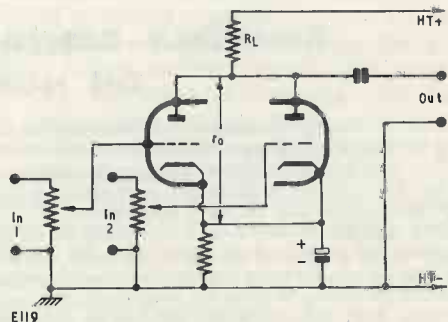

Fig. 7. Simple mixer using a twin triode with a common anode load

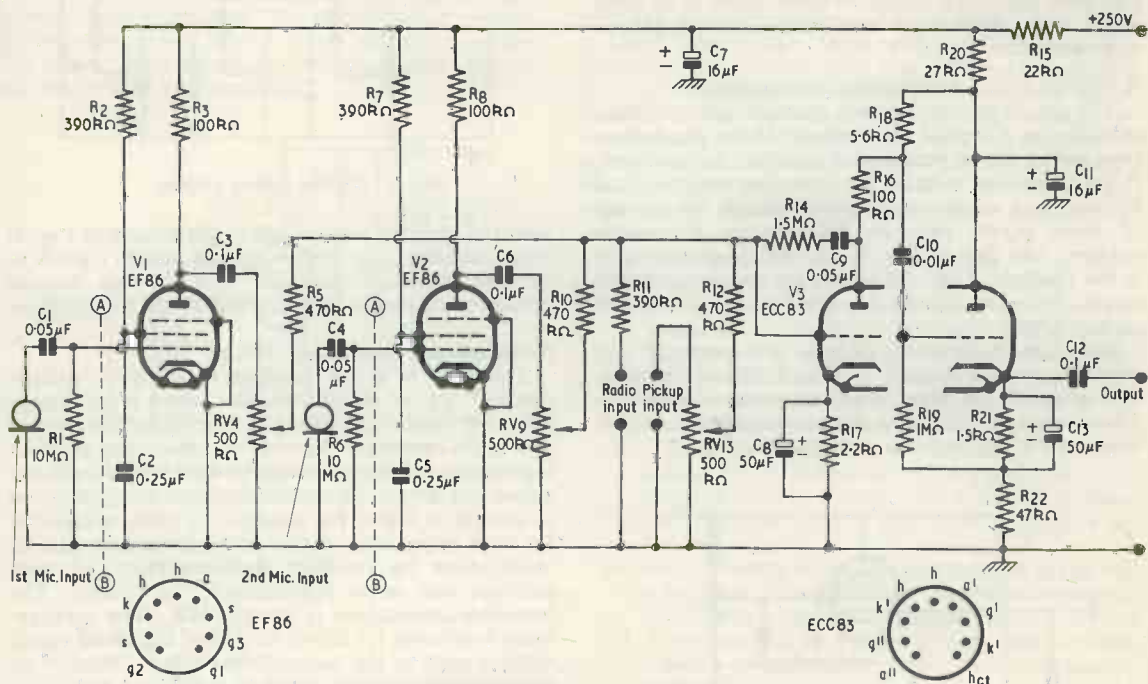

Fig. 8. Four channel signal and microphone mixer (circuit by permission of Mullard Ltd.)

basis for a very efficient multi-channel microphone and signal mixer as shown in Fig. 8, which was developed by the Mullard Research Staff.² The circuit employs the EF86 low noise amplifier with high value grid resistors and utilises a four channel parallel mixing network. This is followed by an intermediate amplifier with negative feedback from which the signals are taken via a cathode follower to the output terminal, which has an impedance of approximately 600 ohms. This makes the mixer

suitable for connection to a high impedance input of a tape recorder or high level amplifier and allows the use of a fairly long connecting cable if so required. The frequency response of the mixer is flat from 20 to 20,000 c/s and the noise level is -50dB at full gain.

² The circuit given in Fig. 8 is taken from Chapter 10 of *Mullard Circuits for Audio Amplifiers*, and is reproduced by permission of Mullard Ltd.

REMOTELY CONTROLLED TELEVISION STATION ON NORWEGIAN ISLAND

The Norwegian Telegraph Administration is building a television station on the island of Bokn in Stavanger Fiord and is to operate it by remote control from the mainland by means of a v.h.f. radio link.

The transmitters selected for this purpose—two 4kW vision and two 1kW sound—are of Marconi manufacture and are suitable for unattended operation. In addition to the transmitters, Marconi's are to supply and install programme input and ancillary equipment.

The equipment will operate in Band III to 625 line C.C.I.R. standards. The two vision transmitters are to be connected for parallel working, as also will the f.m. television sound equipments. Remote control facilities over the v.h.f. link will include the independent on-off switching of all four transmitters; the control of blanking level (including the on-off switching of blanking level feedback), and the control of video and audio gain. An indication of power output at normal, high and low levels will also be provided over the link. It is intended that adjustments to the controls will be made in conjunction with a waveform display derived from a high-grade receiver and oscilloscope sited at the remote control position on the mainland.

The order was obtained through the Marconi agents in Norway, Norsk Marconikompani A/S.

The JR1 Stereo Tape Recorder Unit

PART I. By G. BLUNDELL

This article outlines in detail the theoretical factors which were considered during the development of the Jason JR1 Stereo Tape Recorder Unit. Constructional details will commence in next month's issue.—Editor.

IN THIS DESCRIPTION OF A HIGH QUALITY TAPE recorder the emphasis will be on electronics, a later section showing how to obtain the optimum performance with a number of popular tape decks. The various parts of the circuit are described here so that the constructor will have an understanding of the design considerations involved.

A tape recorder requires a tape deck, playback and recording amplifier. In the cheaper type of tape recorder, the same amplifier circuit is switched to be used for record or playback, only two heads being required on the tape deck, i.e. a combined record/playback head and an erase head.

In the Jason Stereo Tape Recorder Unit three heads are used, and a typical arrangement of these is shown in Fig. 1. The tape is pulled from one reel to the other by the capstan and pinch roller, and is held accurately in line with the heads by the guides. A recording may be played back a fraction of a second later as the tape passes from the record to the playback head and the quality of the recorded signal may be immediately judged and compared with the original programme. Although this feature slightly increases the cost of the unit, it is invaluable when there is only one opportunity to make a particular recording which has to be right first time.

The circuits of the Jason tape unit are duplicated for stereo, and the switching is so arranged that the two stereo tracks may be recorded independently; thus the playing time of the tape is doubled when stereo is not required. In addition, all the measure-

ments have been made with quarter track heads, which allow two stereo, or four single tracks on the standard $\frac{1}{4}$ in tape.

No wild claims for frequency response will be made—a recent directory showed that some cheaper tape recorders claimed a wider frequency response than the professional and studio types. In practice,

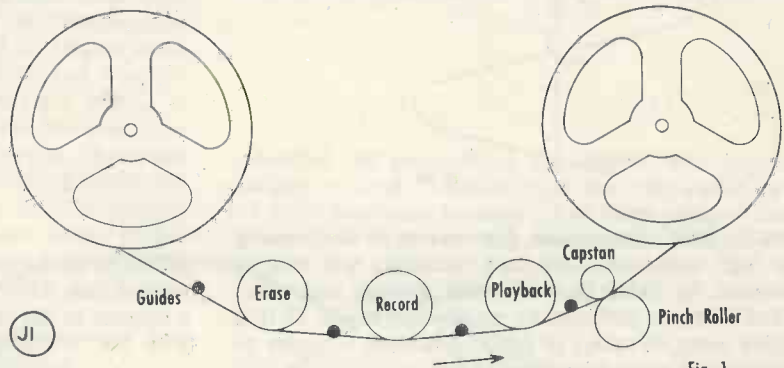

Fig. 1

careful judgment is required in relation to this question of frequency response, because distortion and background noise are also of importance and these three factors are inter-related. The technique of boosting the playback response with tuned chokes may result in an excellent frequency characteristic but it also increases background noise and transient distortion. This kind of circuit must be rejected. The aim is to produce an acceptable frequency response at $7\frac{1}{2}$ in per second (i.e. reasonably flat to 15 kc/s), and we can expect the quality and surface noise to be at least equal to the best gramophone records available.

To continue this point a little further, a recent 12in stereo disc is almost silent between the recorded items, the "surface noise" which then appears being

in fact tape recorder noise recorded on to the disc. The gramophone disc is not dead yet and seems unlikely to become obsolete while it can be mass-produced so easily. Therefore, in saying that our tape recorder is to produce results which are as good

the tape running at 15in per second; now we can achieve this at 3½in per second with greater output.

Range of Frequencies to be Recorded

The character of a musical instrument is given by the overtones or harmonics and these extend in frequency out of the range of human hearing. Some people can hear frequencies up to 20 kc/s, while others, often older people, can only hear up to 10 kc/s. A good compromise is that the frequency response should be flat to 15 kc/s and then gently fall away. The piano and organ probably cover the widest ranges of frequencies, since the fundamental notes or tones extend from 25 c/s to 4,000 c/s. A violin extends from 200 c/s to 3,300 c/s, and a man's voice from 100 c/s to 200 c/s. To those fundamental notes must be added the harmonics which provide the character of the sound.

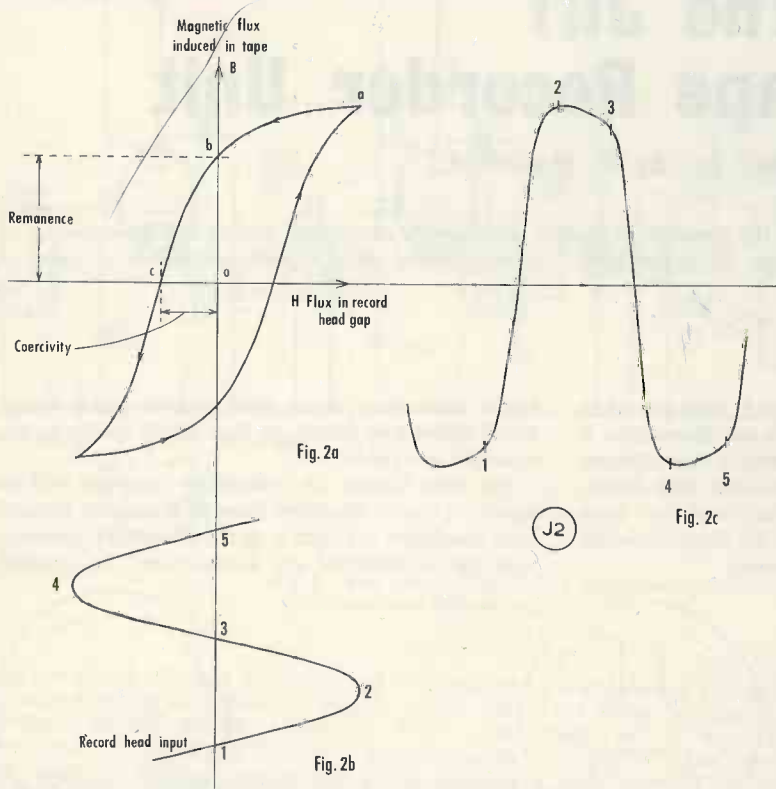

as the best gramophone disc we are, in fact, setting a high standard. Our tape recording will not, of course, be liable to mechanical damage and wear, but it can be damaged by magnetised heads, so that care must be taken in other directions in order to preserve a good recording.

History of Tape Recording

The first magnetic recordings were made over fifty years ago, and before the war the B.B.C. were using steel tape running at 60in per second. Before the invention could become practical two further ideas were required, these being high frequency biasing (first used in 1921) and plastic based magnetic tape, which could be easily handled. During the war, the Germans developed magnetic recording to a fine art and, since then, the major advances have been improved magnetic powder on the tape, which allows better frequency response and greater output, and fine gap playback heads, which have improved the overall frequency response. At the end of the war a 10 kc/s response required

The Recording Process

The recording tape is coated with a material such as ferric oxide, which is capable of being magnetised. The behaviour of this material is shown by the hysteresis loop in Fig. 2 (a). From this we find that, if the tape is magnetised to point "a" by a current in the head which rises and then falls to zero, the magnetic field in the tape will fall only

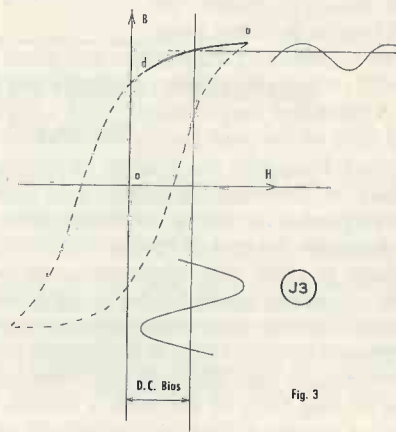

to "b". This level is known as the remanance of the tape and is a measure of the strength of the signal which may be recorded on the tape. If the current is reversed, a signal amplitude OC will be required to bring the tape magnetic field to zero. This amplitude OC represents the coercivity of the tape, and offers a measure of how well and how long the tape is capable of storing a recording.

We can find from the hysteresis loop what will happen to the tape when we feed a signal (Fig. 2 (b)) into the record head. Fig. 2 (c) shows the resulting magnetic field in the tape. The figures on Fig. 2 (b) represent intervals of time. If we begin at 2 we can read from the hysteresis loop that the field in the tape will be as shown in Fig. 2 (c). At time 3 the record signal has returned to zero, but the field in the tape has not. The curve which we would see on an oscilloscope connected to the playback head would, in fact, show a steeper front and the peak at 2 would be more pronounced. The pronounced peak is due, as is explained later, to the fact that the output from the head depends on the rate of change of the field, and this has the effect of increasing the distortion. As can be seen, Fig. 2 (c) bears little resemblance to our initial sine wave input to the head winding and represents very considerable distortion. D.C. biasing added to the signal input was first attempted to overcome this distortion. Fig. 3 shows that, with d.c. bias, the excursions of the input signal never take the field in the tape away from the top of the hysteresis loop, and that the resulting output, as shown on the right of Fig. 3, is low. Distortion is still present but the sine wave shape is now recognisable in the output. Although this biasing is an advance, the resulting distortion and low output signal make it a suitable method only for dictation machines. Much better results

are given by high frequency biasing. By adding a bias frequency of approximately 70 kc/s to the programme signal the distortion shown in Fig. 2 can be overcome. The problem in Fig. 2 is that the tape behaves as though the particles have a magnetic friction which prevents the field in the tape following the field in the head immediately. The high frequency biasing acts as a magnetic lubricant by

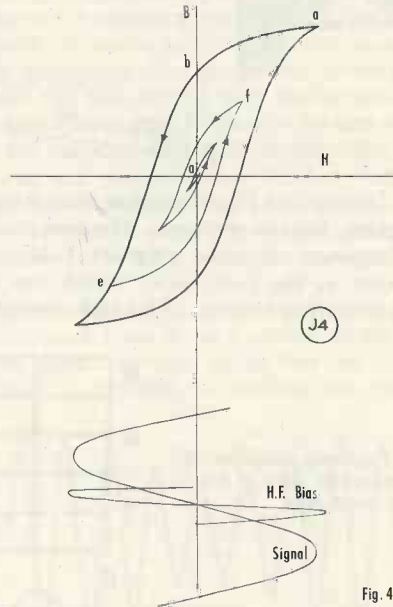

Fig. 4

subjecting the particles of the tape to very rapid changes of field. Imagine now that the signal in the head has been increased and then reduced to zero and the tape has been magnetised to the level

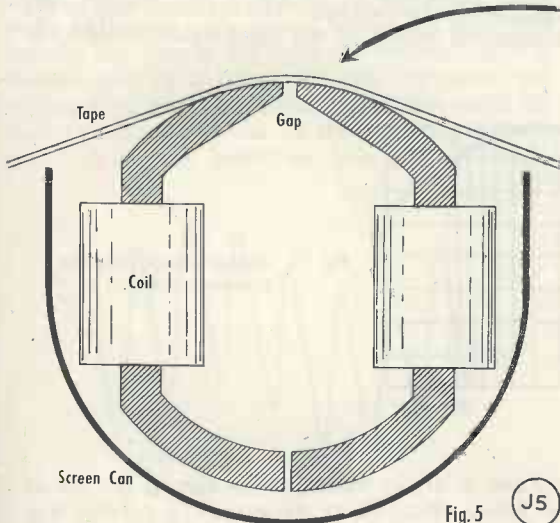

Fig. 5

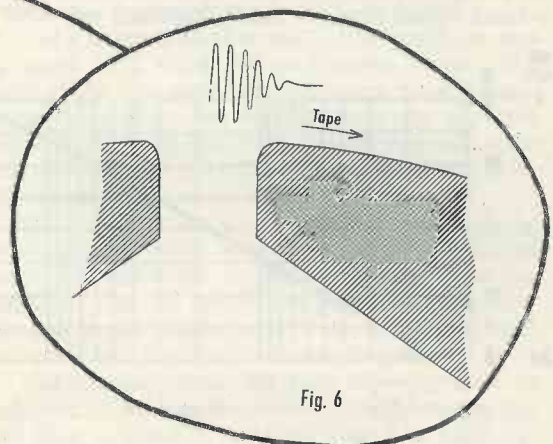
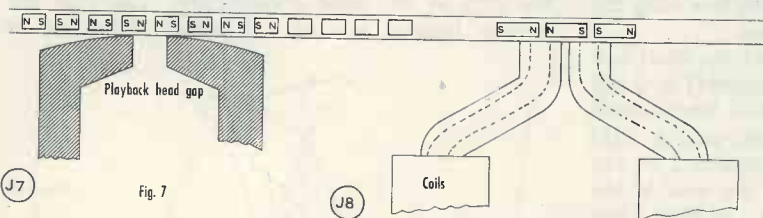

Fig. 6

Ob as shown in Fig. 4. Although the biasing frequency has been operating all this time let us now consider what is happening at the instant when the record head signal has become zero. As this particular portion of the tape is leaving the record head it is subjected to decreasing cycles of the bias



(J7)

Fig. 7

(J8)

Fig. 8

frequency. Shown on Fig. 4 is what then happens to the magnetic field in the tape. The first cycle of the bias frequency takes the magnetic field in the tape to point e, the next cycle, which has now reduced in amplitude because of the tape movement,

trailing edge of the recording head gap, as is shown in Fig. 6 and the signals to be recorded all undergo this treatment. The magnetic tape is, therefore, continuously cycled through the reducing hysteresis loops so that, at the moment of leaving the recording head, it is magnetised exactly in proportion to the programme input. The application of this idea of high frequency biasing represented a considerable step forward in the history of magnetic recording.

Wire or Tape Recording

Wire is never used now for recording except perhaps for dictation purposes because it is not very suitable. Should the wire rotate on playback, the high frequency response will vary. Also, it is difficult to join when breakage occurs and, being solid steel, h.f. biasing is not so effective in reducing distortion and increasing the output.

Wire is never used now for recording except perhaps for dictation purposes because it is not very suitable. Should the wire rotate on playback, the high frequency response will vary. Also, it is difficult to join when breakage occurs and, being solid steel, h.f. biasing is not so effective in reducing distortion and increasing the output.

Fig. 9. Frequency response of single lamination type of playback head

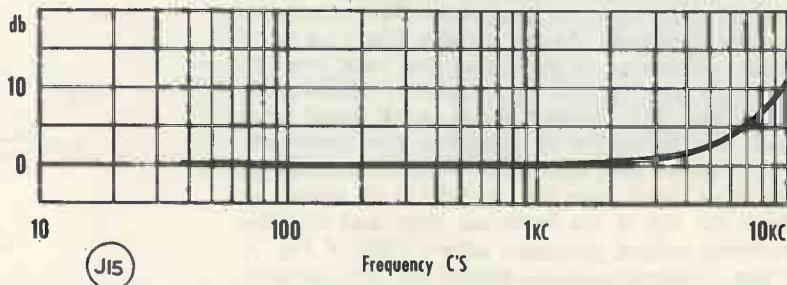

(J15)

brings the field to point f, and eventually the field in the tape finishes at the point o. The field in the tape has therefore been returned to zero when the recording current is zero. Because the bias frequency is much higher than the signal frequency very little

The Recording Head

A typical head, as shown in Fig. 5, has two sets of laminations, two coils, gaps at the front and rear, and a screening can. The magnetic field in the laminations caused by the input signal, bridges the

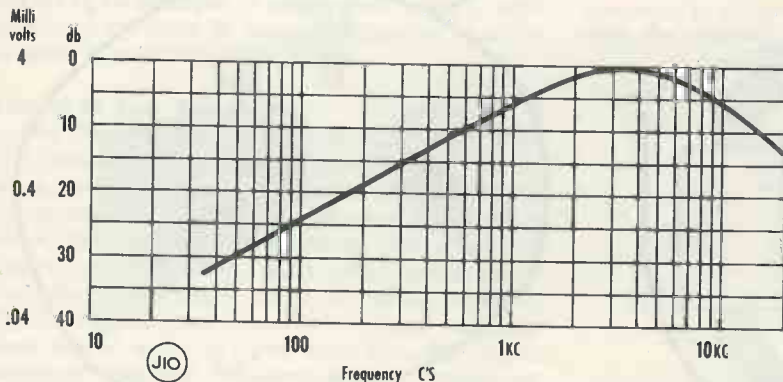

(J10)

Fig. 10. Output voltage from the playback head

change in the programme signal has occurred during these cycles of the bias frequency. This cycling of the bias frequency is occurring continuously at the

gap and is largely wasted, except for the portion at the front, which enters the tape. To prevent this loss the gap is made as shallow as possible (i.e. from

front to rear), allowance being made for head wear by the tape. A reasonable compromise reduces the depth from front to rear of this gap to 10 thousandths of an inch. It follows that when the head

although identical heads are often used for record and playback.

The Erase Head

The amplitude of high frequency voltage fed to the erase head is sufficient to magnetically saturate the tape. As the tape leaves the head this voltage decreases gradually as shown in Fig. 6 and the tape is left in a magnetically neutral state ready for re-recording. A typical gap width is 15 thousandths of an inch. A permanent magnet can be used to erase by saturating the tape in one direction, but this leaves the tape with a high background noise. The concept of magnetic friction in the tape suggests that all the particles cannot be magnetically neutral unless they are magnetised through a number of cycles of the hysteresis loop. Any particle which is out of step produces an unwanted output, and this can be heard as noise added to the output signal.

The Playback Head

The playback head is very similar to the record head, the main difference being that the front gap is as small as possible to improve the frequency

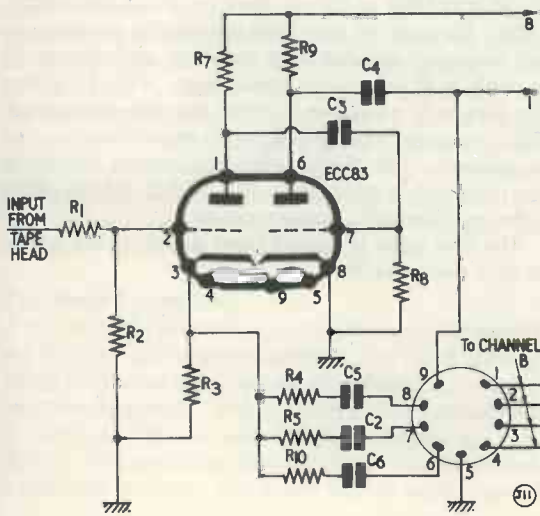

Fig. 11. The playback amplifier employed in the JR1 Stereo Unit

wears its efficiency improves. The pole pieces tips, shown enlarged in Fig. 6, have been drawn slightly rounded because magnetically this is how they behave. The wave form at the top of Fig. 6 represents the high frequency bias, which is shown falling gradually to zero because the pole piece is not magnetically sharp, and it is this variation of the magnetic field in the tape at the bias frequency which enables the recording to be made. The width of the gap in the record head is not important because the tape is left with the magnetic field it receives just as it leaves the gap. However, the trailing edge must be reasonably well defined or the high frequency response of the recording will be poor. A typical width for this gap is 0.001in

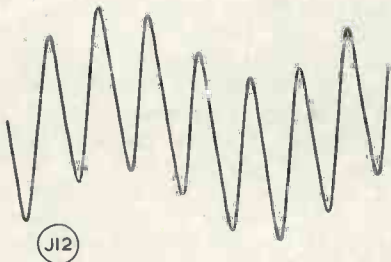

Fig. 12. Addition of the signal and bias frequencies in the recording head

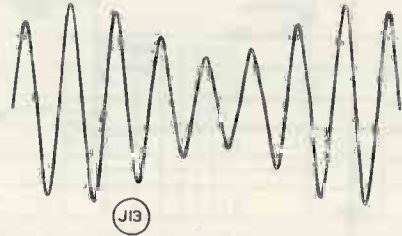

Fig. 13. Multiplication of two frequencies as occurs in the frequency-changer of a normal radio receiver

response. A typical gap width is 0.0002in, i.e. 2/10 of a thousandth of an inch. Effectively, the gap is about 20% wider due to fringing effects. The limit of the frequency response occurs when the gap width is equal to one wavelength of the recorded signal as shown in Fig. 7. Two south magnetic poles are shown at the end of the gap so that there is no flux in the head and no output from the coils.

The high frequency response will suffer if the heads are not truly vertical. Even $\frac{1}{4}$ of a degree error will halve the output at 15 kc/s. It is not sufficient that the record and playback heads have parallel gaps, the gaps must be vertical so that tapes recorded on other machines may be played.

The playback head will have as many turns as possible to achieve maximum voltage output, but the limit is about 4 millivolts output at 1,000 c/s. More turns increase both the inductance and self-capacity of the head and cause a resonance within the audio range, which must be avoided.

The screening can around the playback should be made from mu-metal, a form of magnetic steel having a very low magnetic impedance. This short-circuits any interfering a.c. fields from the motor and nearby transformers. Even steel $\frac{1}{8}$ in thick is useless in comparison with $\frac{1}{8}$ in mu-metal. The balanced arrangement of the laminations and coils also helps to reduce trouble from a.c. fields.

The stacked lamination type of playback head easily reproduces frequencies down to 20 c/s., whilst an alternative method of head manufacture, using a single lamination, causes a poor low frequency response below 100 c/s. The wider pole face of the lamination effectively short-circuits the immediately adjacent recording, while the narrow pole face of the single lamination, shown in Fig. 8,

tional to the rate of change of flux in the head. This is a nuisance because it means that the lower the frequency the lower the output from the head, as shown in Fig. 10. The playback amplifier must have the opposite characteristic, and thus the sensitivity of the amplifier at 50 c/s must be about 100 microvolts. Because of this high sensitivity precautions are necessary against hum troubles, and this point is dealt with in greater detail later. Fig. 11 shows the playback amplifier used in the full-stereo unit, this meeting the sensitivity requirements just mentioned. The 9-way plug and socket shown in this diagram is connected to a switch which offers differing playback characteristics..

The first valve is heated from d.c. to avoid heater to grid hum troubles.

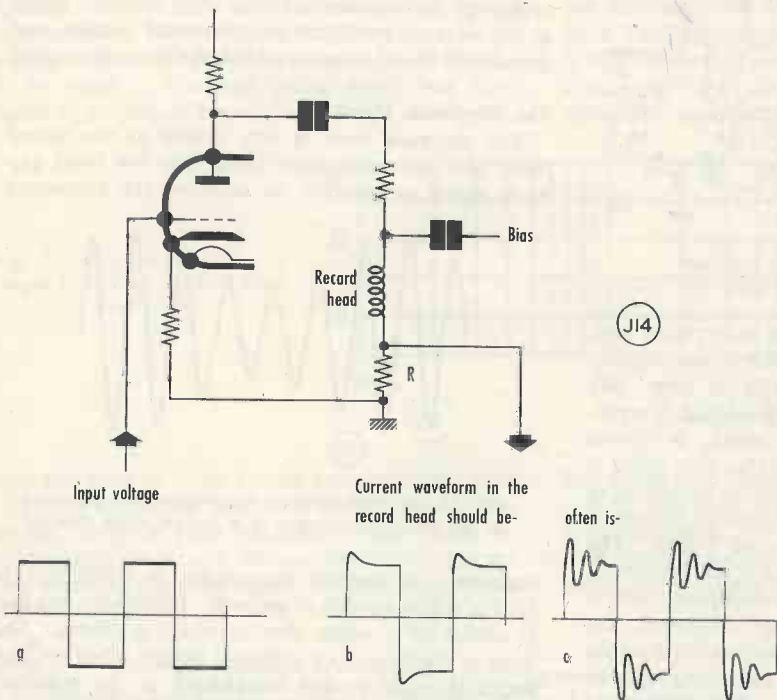

Fig. 14. Resistance R is added to the record head circuit so that the current in this head may be shown on an oscilloscope. At "a" is shown a 1 kc square wave input whilst at "b" the peaks illustrate the treble boost required to overcome the head losses. The treble boost often results in ringing ("c") and care in design of the circuit is necessary to avoid this effect

allows adjacent signals to increase the output at some frequencies and reduce it at others, resulting in the response shown in Fig. 9. This type of head can be recognised by the thin vertical steel pole in the centre of the head.

Pressure pads may be used to ensure good tape contact with the head although this can be achieved by wrapping tape around the head for $\frac{3}{16}$ in either side of the gap as shown in Fig. 1. If this contact is not maintained the high frequency output will vary.

The Playback Amplifier

The output from the playback head is propor-

Valve noise may be a problem and therefore a triode has been chosen for the first stage. A pentode is normally used because it also embodies extra shielding to prevent heater/grid hum, but since we are using d.c. heating, this problem is avoided and we take advantage of the lower noise of the triode.

The amplifier playback response characteristic which we shall use conforms to the standard C.C.I.R. characteristic. This states that the field in the tape shall produce an output, from an ideal playback head, which is constant when the amplifier has a 100 microsecond time constant correction. Both record and playback heads have losses and therefore some treble boost will be required in both

the record and playback amplifiers to compensate for these losses. In some designs all the compensation has been made in the recording amplifier. This has the advantage that less treble boost is required on playback and, therefore, the background noise is lower. However, the losses in the playback head may not be known if the tape is to be played on another machine and therefore the results would be variable. A further disadvantage is that with all the boost on the recording side there is a real danger of tape overload. The Americans have a compromise (NARTB response) whereby the top is given a small extra boost on the recording over and above that required to compensate the head losses, and this gains a few dB signal to noise ratio.

The Record Amplifier

A constant current is required through the recording head whatever the frequency. The head, through being an inductance, has an impedance which rises with the frequency. The impedance of a typical head is 100Ω at 100 c/s and $10k\Omega$ at 10,000 c/s, and despite this variation, our amplifier has to provide a constant current. The usual way of achieving this

from the playback head just begins to fall. The bias is then just beginning to erase the signal, and this sets an upper limit on bias level.

The treble boost circuit have been carefully chosen to avoid "ringing" troubles. This can be seen graphically by connecting an oscilloscope to a small resistance, R_1 , in series with the recording head (see Fig. 14) when a 1 kc/s square wave is fed into the input. It is extremely difficult to achieve a current in the record head which resembles the input voltage if large amounts of treble boost are used, and this is a further argument against attempts to achieve wide frequency responses by excessive record or playback boost. The same argument also applies if the playback head gap is too wide. One has to tolerate the resulting poor top response because attempts to compensate in the circuit will result in transient distortion as shown by the "ring" on the square wave. The treble boost offered in the Jason unit is shown in Fig. 15.

The Oscillator

A push-pull oscillator (see Fig. 16) is used in the Jason unit so that the output will be balanced and

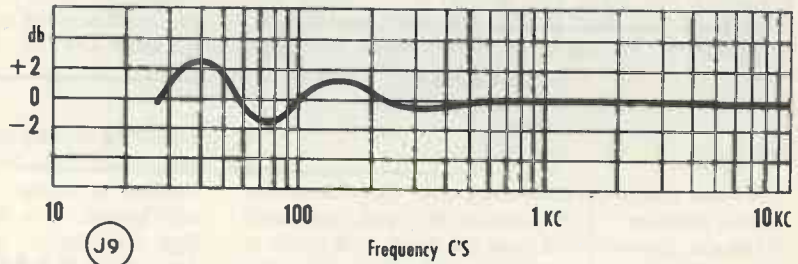

Fig. 15. Treble boost required to overcome record head losses

is to insert a high resistance in series with the head so that the total load of the resistance plus head does not alter so greatly, this combination being fed from a normal amplifier. An alternative method uses the head as a load for a pentode. The current at the anode of a pentode is largely independent of the voltage and the changing voltage across the head will not, therefore, affect the current through it.

As explained earlier, high frequency biasing is added at this point and the combined signal and bias waveform is shown in Fig 12. This addition of the signals, which occurs in the recording head, should not be confused with a radio receiver frequency-changer, wherein the signals are multiplied as in Fig. 13. Minimum distortion of the recording occurs at a particular bias level. This level should be found with a distortion meter because it depends on many variables. As the amateur cannot usually perform this measurement, an alternative method is to increase the bias until the output at 10 kc/s

free from second harmonic distortion. Any unbalance of the oscillator causes residual magnetism to be left in the heads, and this, if left in either the erase or record heads, will increase the background noise of any tape played. Distortion of the recorded signal is also increased if the bias waveform is not pure. To further lower the distortion the oscillator coil uses a ferrite core, which increases the "Q" of the circuit. This increase in "Q" can be imagined as a flywheel, which helps the waveform of the voltage output to be sinusoidal and ignore the effect of its own grid current drive, which is one of the main sources of distortion.

Demagnetisation of the Heads

Despite care with the bias waveform it is still possible to magnetise the heads and thus affect any tapes played. This can happen in a number of ways:

- (1) Switching off the mains without the heads shorted.

- (2) Switching a nearby transformer.
- (3) Using a magnetised screwdriver when making an adjustment.

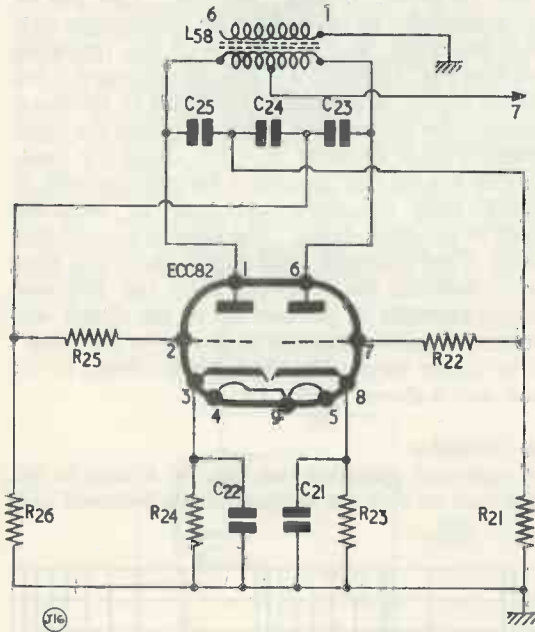

Fig. 16. The tape oscillator circuit

A keen recording enthusiast will, therefore, have a head defluxer. This consists of a coil connected to the a.c. mains placed near the head, and which is then switched on and drawn gradually away. The coil subjects the head to a number of cycles of demagnetisation in a similar way to h.f. biasing described earlier and leaves it magnetically neutral.

The Record Level Indicator

Thought was given to the record level indicator before deciding between a Magic Eye and a meter. A meter has a scale and apparently gives a more accurate indication. The question is, though—what

signal. A meter should be able to follow a signal with a one millisecond rise time, but, to do this, it needs to be driven by a 10 watt amplifier. The normal meter circuits fed from a triode are quite inadequate in this respect. A Magic Eye, on the other hand, has no moving parts and is capable of

TABLE 1

Playing Time in Minutes Per Track

The figures should be doubled if two quarter track stereo recordings are made on one tape, or multiplied by four if four separate quarter tracks are recorded.

Tape Length	3½ in per second	7½ in per second
150	8	4
200	10	5
300	16	8
400	21	10
600	32	16
850	45	22
900	48	24
1,200	64	32
1,700	90	45
1,800	96	48
2,400	128	64
3,400	180	90

following rapidly rising signals. Therefore, although not so accurate to read, it will nevertheless give a reading in some circumstances which the meter will ignore. On the balance, therefore, the Magic Eye was chosen as the best compromise for the present application. Since the Jason unit is intended for stereo two Magic Eyes are employed, these being mounted side by side to enable comparisons to be made of the level in either channel.

The Recording Tape

A recording tape should be strong enough to avoid physical damage during normal use, but not so stiff that it will not lie flat against the head. Unless intimate contact is maintained with the head,

Fig. 17. Standard track widths

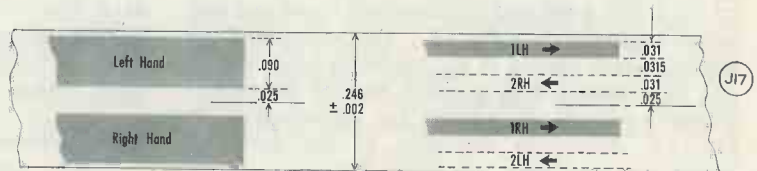

are we expecting to read? Obviously, if the signal is rising too quickly the meter will be unable to follow and it may in fact ignore a rapidly increasing

the output voltage will vary considerably, particularly at the higher frequencies. The tape which satisfies these requirements best is known as "long

play tape", which allows a playing time of 96 minutes, with two separate stereo recordings on a 7in reel carrying 1,800ft of tape. Tests show also

TABLE 2

Tape Length in Feet on Various Spool Sizes

Spool Size	Standard Tape	Long Play	Double Play
3	150	200	300
4	300	450	600
4½	—	600	—
5	600	900	1,200
5½	900	1,200	1,800
7	1,200	1,800	2,400
8½	1,700	2,400	3,400

that this tape suffers less from the phenomena known as "drop-out" caused by variations in the magnetic coating, and which is more prominent when the track width is narrow.

The standard tape is thicker and only 1,200ft can be accommodated on a 7in reel. The double play tape with 2,400ft on a 7in reel gives the advantage of extra playing time, but is more difficult to handle and may be stretched by the braking mechanism of some decks.

A good recording tape should have a high remanence (see Fig. 2 (a)), which means that it can retain a stronger magnetic field and thus give a greater output. A high coercivity, which is a measure of the ability of the tape to resist magnetisation, is also necessary. At high frequencies, the effective magnets recorded on to the tape become so short that they are able to demagnetise each other and thus result in a poor high frequency response. A further possible trouble, which is worse when the coercivity is low, is "print through". This is caused by the magnetic field of a recording impressing itself on an adjacent turn of tape and giving an unwanted echo.

Originally, only one track was recorded on a ½in tape, but later it was found that two tracks, and then four, could be satisfactorily accommodated. To prevent interference between tracks, portions of the tape must be left unused to act as guard tracks. It is advisable also not to record to the edges of the tape, because any mechanical damage is likely to show itself there.

Fig. 17 shows the usual arrangement of recording and guard tracks, and the positions of the channels when recording stereo. The erase head is made a little longer, 0.1in for the twin track and 0.04in for the quarter track, to ensure that any tape deck alignment errors do not leave part of the recording on the tape. *(To be continued)*

Book Review . . .

FUNDAMENTALS OF RADIO RECEIVER SERVICING. By E. M. Squire. 172 pages 152 diagrams. Published by Pitman. Price 15s. net.

This is, on the whole, a well-written and useful little book, but it is first necessary to make clear, in view of its title, that it is mainly a description of the way in which a receiver and its component parts work. Many of the servicing notes are really secondary to this, and are often of a rather general nature.

Thus the home constructor, new to the field, but ambitiously building his first 7 valve all-wave receiver, will not find here instructions on how to cure the howls, whistles or plain dead silence that may at first greet his efforts. What he will find is a clear description of how the circuits ought to work, written at a fairly elementary level and in a practical way. With the servicing notes, he should then be able to apply intelligently the detailed instructions in servicing manuals.

After an introductory survey of the field, in which such basic terms as current, frequency and gain are defined, the author devotes about a third of the book to components. These chapters contain both theory and constructional details, and include an account of printed circuits and their manufacture, and material on transistors. Surprisingly, there is no discussion of component tolerances—a matter which can be of some importance in servicing. The way in which components are used in typical receiver circuits—both valve and transistor operated—is then described, including such refinements as dual-purpose circuits in a.m./f.m. sets. The chapter on power supplies is particularly comprehensive and useful, with that difficult point, the development of grid bias in battery sets, clearly explained.

After some notes on the radio-gramophone, the book concludes with two chapters on the use and care of common servicing equipment, and some advice to the novice on setting about the first servicing job.

P.R.S.

The "Finger-tip Five"

by A. S. CARPENTER

HERE IS AN EASILY BUILT LITTLE receiver capable of providing many hours of enjoyment despite its simplicity which will tune continuously from 10-2,000 metres. Although the receiver can tune the Medium and Long wavebands it has been especially designed for the Short wavebands where much of interest is transmitted.

The receiver is self-powered and is intended for use with an a.c. mains supply. The chassis is completely safe to handle due to the inclusion of an isolating mains transformer.

When headphones are plugged into the output socket a self-contained receiver results, whilst if a coaxial lead is taken from the same output socket and fed into the "gram" sockets of a broadcast receiver or to an amplifier it becomes a tuner. The unit occupies little

space, its chassis measuring 8 x 4 x 2 in and its front panel 8½ x 5½ in. A modern triode-pentode valve is used and this ensures both space economy and efficiency.

The Detector

One of the simplest and least expensive ways of exploring the Short wavebands is to use a leaky grid detector coupled to an aerial via a tuned circuit. Positive feedback, or reaction, is also required to increase sensitivity and sharpen the tuning. Whilst a great deal of fun can be obtained from simple apparatus of this nature one or two unpleasant features soon become evident, one of these being the occurrence of "dead spots", i.e. sections of the band over which it is impossible to obtain effective reaction. Such dead spots are often

caused by the aerial and occur more frequently where coupling to the tuned circuit is tight. Loosening the coupling may cure the dead spots but signal pick-up may become impaired.

In an attempt to obtain optimum results with such a receiver, the aerial is some times coupled to the tuned circuit via a small value variable condenser. Although this works fairly well it means that an extra control is needed on the panel, thereby adding a further complication to the tuning of the receiver.

Another unpleasant feature of such simple receivers is their ability to radiate when reaction is too far advanced, since there is no buffer between the detector and the aerial. Even the most careful user is certain at some time or other to advance the reaction control too far and therefore cause annoyance to others.

The unpleasant features just described can be very largely avoided by employing an r.f. stage prior to the detector, and such a stage may be untuned. It might be argued that the inclusion of an untuned r.f. stage is a waste of a valve but, when it is considered that such a stage ensures that the aerial constants in no way affect either the operation or the tuning calibration plus the fact that it forms an effective buffer against radiation, most of the argument becomes void—and, after all, a certain small amount of gain is likely to result.

Circuit Details

Fig. 1 shows the circuit of the receiver, and it will be seen that it includes a mains transformer, and the triode and pentode sections of an ECF80. The pentode is used as the untuned r.f. stage previously referred to, whilst the triode operates as a leaky grid detector-cum-audio-amplifier, with controllable positive feedback (reaction) added for "pepping up" purposes.

Resistor R₄ serves partly to make the grid bias effective for the pentode section and partly to allow the development of sufficient r.f. for effective operation. Resistors R₁ and R₂ are merely screen-grid and anode feeds respectively for V_{1A}, whilst R₅ provides cathode bias. Condensers C₁ and C₂ are decoupling components.

R.F., amplified to some extent, appears at the pentode anode, and is conveyed to the tuned circuit and the grid of V_{1B} by condenser C₅.

At this point it should be noted that the desired waveband is obtained not by switching but by the plug-in coil method, the Denco

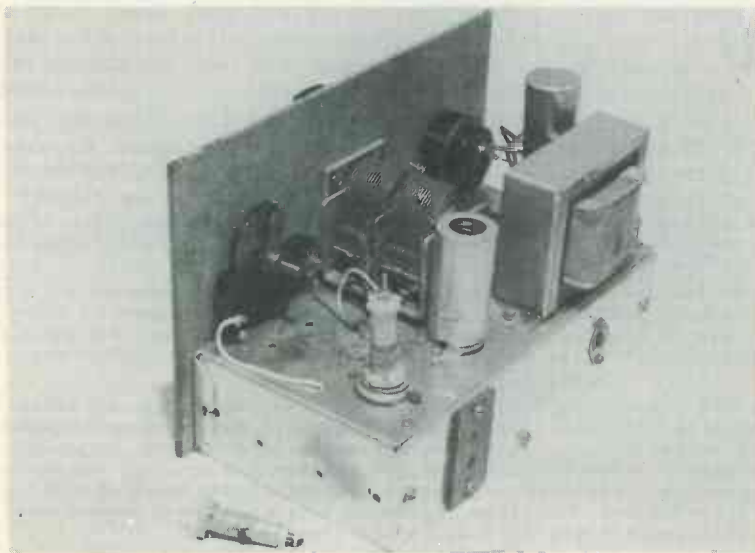

A rear view of the receiver

range of miniature inductors being chosen since these conveniently fit a standard Noval (B9A) valve base. A Noval base is in fact used for this purpose and the circled figures shown on the diagram adjacent to L₁ indicate the correct tags; e.g. tag 6 on the valve base used as an inductor holder is wired to the chassis.

Note that the method of connecting the particular inductor in use permits the use of its primary winding for reaction purposes.

The triode section of the valve functions in conventional fashion, demodulating and amplifying the signal and passing the resultant audio to the output socket via C₄ and the volume control, C₉. The reaction control, C₃, is used in conjunction with the primary winding of L₁, R₆ being included to ensure successful operation.

Individual Inductor Ranges

These are given in the Table and are those published by the manufacturers, a parallel connected condenser of 310pF being assumed for tuning. As no trimming condenser is needed and as the inductors are fitted with dust iron cores which give up to 15% variation in most cases, the ranges are likely to vary a little as used here.

Some intending constructors will already possess a variable tuning condenser of 500pF and this can be used for C₇ if a 1,000pF fixed value silver-mica condenser is wired in series with it to reduce the maximum capacity. If a twin-gang condenser of good quality is to hand already this may be utilised for tuning purposes by using one section only. A twin-gang condenser was in fact used in the prototype, as can be seen from the photograph accompanying this article.

Bandspredding

Instead of fitting a bandspread condenser across C₇ a good quality slow motion drive is employed, as

it is felt that this aids simplicity of operation. The drive mechanism is actually a Muirhead type and was taken from one of those excellent little RF27 ex-W.D. units. These drives are available from advertisers from time to time and, although the precise type is unimportant from the point of view of appearance, it is essential that any alternative make should be rigid in operation and permit of no backlash. An excellent

Table Showing Inductor Ranges

Range	Mc/s	Metres
1	0.150-0.400	750-2000
2	0.515-1.55	195-580
3	1.670-5.3	57-180
4	5.0-15	20-60
5	10.5-31.5	9.5-28

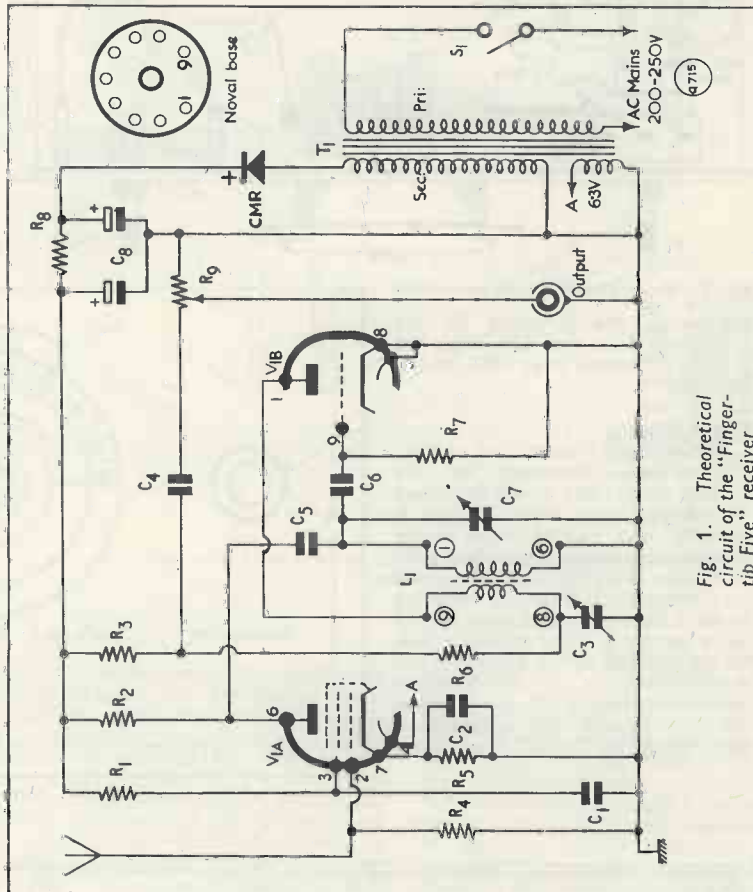

Fig. 1. Theoretical circuit of the "Finger-tip Five" receiver

Components List

Resistors

- R1 47kΩ ½ watt
- R2 10kΩ ½ watt
- R3 68kΩ ½ watt
- R4 1MΩ ½ watt
- R5 470Ω ½ watt
- R6 20kΩ ½ watt
- R7 4.7MΩ ½ watt
- R8 3.3kΩ 1 watt
- R9 250kΩ pot. and switch

Condensers

- C1 0.01μF
- C2 0.01μF
- C3 500pF solid dielectric variable (reaction)
- C4 0.01μF
- C5 47pF
- C6 47pF
- C7 310pF (see text)
- C8 16 x 16μF electrolytic, 350V working

Miscellaneous

- T1 Mains transformer Primary—Mains input, Secondary—200-250V at 25mA, 6.3V at 0.45A min. (Elstone MT11 or similar)
- L1 Denco Miniature Dual-purpose coils—Yellow Range (see Table)
- CMR miniature contact cooled rectifier—250V at 50mA
- V1A, B Mullard ECF80
- Chassis—Universal, 8 x 4 x 2in (Home Radio (Mitcham) Ltd.)
- Dial—Muirhead or Eddystone (see text)
- Two control knobs
- One coaxial plug and socket.
- Two Noval (B9A) valve bases with centre spigots
- One 5-way tagstrip (end tags earthed)
- One aerial/earth panel and sockets
- One pair headphones (2,000Ω per phone)
- Mains lead and plug, solder, wire, wood for cabinet, etc.

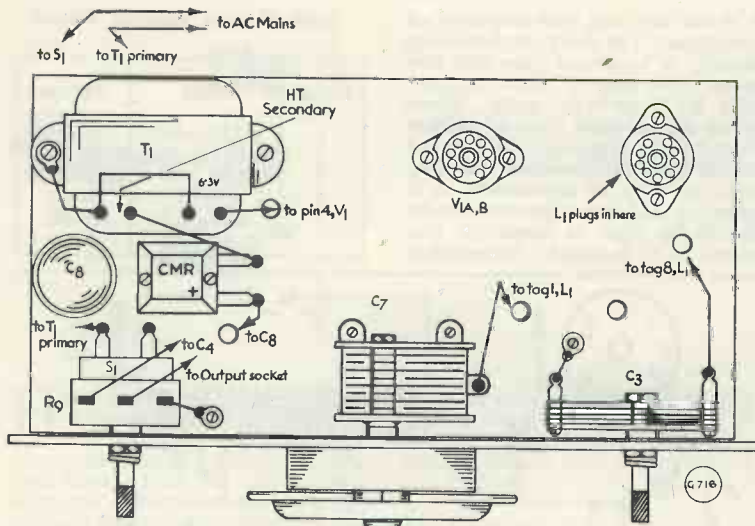

Fig. 2. Above-chassis layout and wiring

alternative choice would be the Eddystone drive type 843 which has a scale calibrated over 180° in 100 divisions.

Power Supply

The modest voltage and current requirements demanded by the ECF80 mean that a self-contained and simple power supply section is possible, and various small mains transformers designed specifically for half-wave working are obtainable very cheaply. It might be tempting to use a filament transformer for the valve heaters in order to save a little on the cost but such a method is not recommended as the chassis would necessarily become live to the mains via its h.t. circuit, this being especially dangerous when headphones

were used. A mains transformer with isolated h.t. and heater secondaries must be employed.

Used in conjunction with the mains isolating transformer, T₁, is a midge contact cooled metal rectifier, CMR. This is approximately 1 x 1 x ½ in only in size, and it utilises the chassis as a heat sink. The a.c. supply, after being converted to d.c. by the rectifier, is smoothed by R₈ and C₈ and fed to the h.t. rail, some 180–240 volts appearing at this point.

Constructional Notes

Due to the use of a "Universal" sectional chassis, construction is greatly facilitated. The aluminium parts for these chassis are obtainable separately so that one may order a top plate and four sides, all of which bolt together to form a very rigid construction. One great advantage

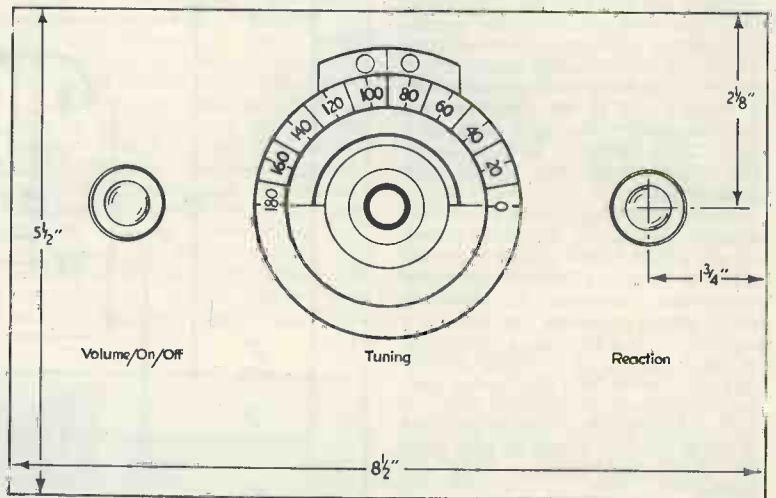

Fig. 4. Front panel details

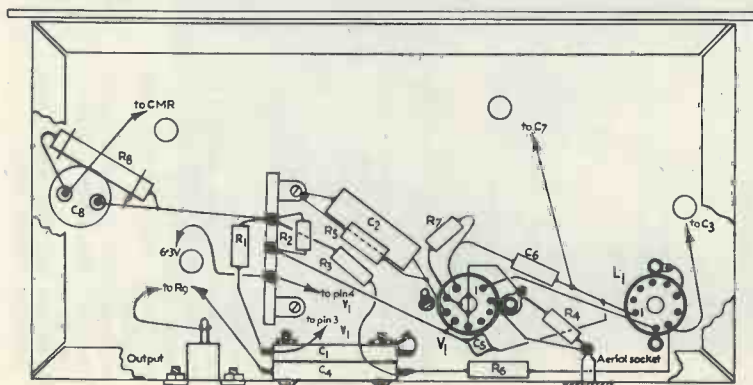

Fig. 3. Below-chassis layout and wiring

is that drilling is considerably eased since each piece can be handled independently of the others. Furthermore, should a particular joint be difficult to reach with the soldering iron during wiring up, then a section of the chassis can be removed!

To the front flange of the 8 x 4 x 2 in chassis specified a panel ½ in thick is bolted, this being made 8½ in wide to allow a simple case made from ½ in plywood to fit snugly. (See Fig. 4.) This case will be described briefly later. For the front panel hardboard may be used as any hand-capacity effects evident during operation may easily be removed by gluing metal foil to the inside of the panel and connecting it to the chassis. Upon this panel the various

controls are arranged in a neat symmetrical manner.

The rear flange of the chassis carries the aerial and earth sockets and also the coaxial output socket for the headphones. In the prototype the rear flange is also used to mount two of the fixed condensers. Full above- and below-chassis layouts with point-to-point wiring plans are given in Figs. 2 and 3, from which it will be observed that ample space exists and that no cramping occurs. A single tagstrip is sufficient to anchor the h.t. and l.t. feed points, the majority of the other small components being suspended in the wiring. Care should be taken to orient the valve bases as shown, so that short and direct wiring is made possible. A reliable connection must be made between the tuning condenser frame and chassis.

Operating the Receiver

On completion of the wiring a thorough check should be made to ensure that no short circuit exists between the h.t. rail and the chassis whereupon if all is in order an aerial may be plugged in as well as the headphones, the valve and one of the inductors. The receiver should now be switched on and an attempt made to tune in transmissions with the aid of the main tuning control, at the same time adjusting the reaction control gently to bring the valve to the verge of oscillation. Provided that the volume control is sufficiently far advanced no difficulty should be experienced in picking up signals, and the set should act in a very lively manner indeed. Should it be impossible to stop the receiver from oscillating at any setting of the reaction control, switch off and either change R_3 for a resistor slightly larger in value or, alternatively, connect a condenser of approximately 500pF from pin 1 of the valve to the chassis. But remember that the inductor core setting may affect the reaction effect to a certain extent as it can modify the coupling between the two windings.

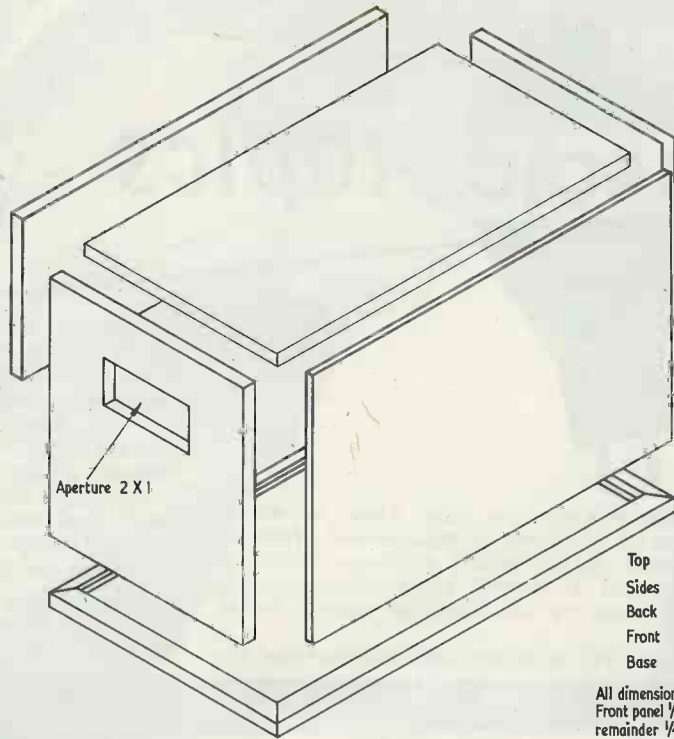

Top	$8\frac{1}{2} \times 4\frac{1}{2}$
Sides	$5\frac{1}{4} \times 4\frac{1}{2}$
Back	$8\frac{1}{2} \times 3\frac{1}{4}$
Front	$8\frac{1}{2} \times 5\frac{1}{2}$
Base	$9\frac{1}{4} \times 5\frac{7}{8}$

All dimensions are in inches.
Front panel $\frac{1}{8}$ thickness —
remainder $\frac{1}{4}$

(6719)

Fig. 5. Details and dimensions of the woodwork required for the suggested cabinet

The Case

A suitable housing for the receiver can be made from plywood as stated earlier. Band changing necessitates a removable type of cabinet and this can be achieved by adopting the principle shown in Fig. 5 which shows all the woodwork needed for the receiver, with the exception of reinforcement strips for holding it together without the aid of joints. Since the author professes no skill in woodworking the design is very elementary and simple, and can doubtless be improved upon con-

siderably.

The idea is to secure the chassis and front panel to a baseboard to which is glued $\frac{3}{8}$ in moulding or quadrant as shown. Slots cut in the sides of the box assist ventilation and also permit it to be removed when it is required to change an inductor. When the case is replaced it fits into the well provided by the moulding or quadrant and is thus kept in position. Four rubber feet may be fitted to the underside of the baseboard and the whole either lacquered or French polished, or treated in whatever style is preferred.

Loudspeaker Enclosures

In the article entitled "A Small Bass Reflex Enclosure suitable for the 'Axiette' Loudspeaker" by M. J. Pitcher, B.Sc., featured on page 40 of the last issue (August), the author wrote a very clear and interesting account of the business of cabinet construction. For the benefit of readers who are interested in speaker enclosure construction and who wish to obtain still further information, we should like to point out that a free book entitled "High Fidelity Loudspeaker Manual" is available from the manufacturers of the "Axiette". In this book, details of an enclosure both for the "Axiette" and other speakers are featured. The publication is available direct from Goodmans Industries Ltd., Axion Works, Wembley, Middlesex.



RADIO topics

By **RECORDER**

THE PHOTOGRAPH ON THIS PAGE SHOWS A colourful newcomer to the crowded streets of London. In this picture a driver-operator in one of the fleet of Welbeck Minicabs contacts his headquarters via the radiotelephone installed in his cab.

As readers will be aware, Minicabs may not ply

for hire in the same manner as a conventional taxi-cab. They must, instead, receive their instructions via radio, and this imposes particularly stringent requirements on the equipment employed. This fact should be combined with the statement that the current Minicab system, put into service for Welbeck Motors by Pye Telecommunications Ltd., is the largest radiotelephone system in Europe. At the time of writing there are 200 Welbeck Minicabs and it is expected that these will increase to 800 by the end of the year.

Cab Installation

Welbeck Minicabs are Renault Dauphins which have been adapted for use as radio-taxis by having





their 6 volt electrical systems (the standard voltage on the Continent) converted to 12 volts. Considered overall, the cab installation is extremely simple, consisting of a self-contained simplex transmitter-receiver with self-contained speaker, and a quarter-wave whip aerial. A microphone with an integral push-to-transmit button is coupled via expanding cable to the transmitter-receiver and fits in a special clip when not required. If desired, this microphone may be replaced by a telephone handset incorporating a pressel push-to-transmit switch. The second photograph shows an engineer fitting a transmitter-receiver under the dashboard of a Minicab.

The transmitter-receiver is a Pye equipment type PTC 2007, and is known as the *Transistor Ranger*. However, apart from a transistorised h.t. power unit, all r.f. and a.f. circuits employ valves. The transmitter section has a 6BH6 crystal oscillator; 6BH6 multiplier (for 68-174 Mc/s only); QQV03-10 (6360) multiplier; and QQV03-10 (6360) power amplifier. The a.f. section of the transmitter, following a moving-coil mike, is ECC83 (12AX7) voltage amplifier; ECC83 (12AX7) phase splitter; and two EL90 (6AQ5) a.m. modulators. R.F.

output is 4 to 6 watts according to operating frequency.

The receiver employs a single superhet circuit for the 25-68 Mc/s band, and a double superhet for the 68-174 Mc/s band. On 25-68 Mc/s there are three r.f. stages, an overtone oscillator mixer, three i.f. amplifier stages at 2 Mc/s, a demodulator, a.g.c. rectifier and a.f. amplifier, a noise limiter, and the a.f. output stage. On 68-174 Mc/s there are two r.f. stages followed by a crystal oscillator and multiplier, the first mixer (converting to 10.7 Mc/s), and the second mixer and crystal oscillator. After this the 2 Mc/s i.f. stages proceed as with the 68-174 Mc/s circuit. Valve line-up is two EC91 (6AQ4) r.f. amplifiers; EC91 (6AQ4) r.f. amplifier (low band) or first mixer (high band); ECF80 (6BL8) mixer (low band) or second mixer-oscillator (high band); two 6BJ6 2 Mc/s i.f. amplifiers; 6CB6 third 2 Mc/s i.f. amplifier; EBC90 (6AT6) demodulator, a.g.c. rectifier and a.f. amplifier; EL90 (6AQ5) a.f. output; 6BH6 low band overtone oscillator; ECF80 (6BL8) high band oscillator/multiplier; and OA200 silicon diode noise limiter. After a row of bottles as impressive as this some sort of noise

ought to come out of the speaker. And indeed it does: typical sensitivity figures for an input of $2\mu\text{V}$ only are 1 watt a.f. output with 14dB signal to noise ratio at 72 Mc/s, and 1 watt a.f. output with 11dB signal to noise ratio at 160 Mc/s. The a.g.c. control range is similarly impressive, there being less than 8dB change in a.f. output for inputs ranging from $4\mu\text{V}$ to 20mV .

The h.t. power supply unit employs two OC35's in a multivibrator circuit running at approximately 4 kc/s, the output being rectified by a pair of silicon junction rectifiers connected as voltage doublers. An interesting feature of the power supply is that the decorative front panel also provides a radiating heat sink for the power unit transistors.

The overall unit is capable of working in the two bands 25–68 Mc/s and 68–174 Mc/s just mentioned (i.e. overall range is 25–174 Mc/s), and those fitted in the Welbeck Minicabs have six switch-selected channels. The front panel controls are On-Off, Transmitter Off/Stand-by (which switches the transmitter filaments), and a.f. volume. A squelch level control, which silences background in the absence of a signal, may also be fitted. Under an inspection cover on the front panel are controls which include transmitter aerial trimmers and receiver crystal trimmer. There is also a test meter outlet socket. The power consumption of the unit is 36 watts on Receive, 58 watts on Standby, and 105 watts on Transmit.

The Complete System

The complete Pye installation includes transmitting stations based at Hampstead and Forest Hill, and these are connected by G.P.O. land lines to the Control Room. The given radius of operation from the transmitters is 20 to 25 miles but, with good line of sight conditions, the actual range may be considerably increased. At the Control Room, initially installed with 20 G.P.O. lines, a conveyer-belt system is fitted which can handle calls at the rate of one every two seconds.

Quite a set-up, isn't it? And something to ponder over, perhaps, if and when you next ring for a Minicab whilst in the Smoke!

Russia at Earls Court

I was able to make a flying visit to the U.S.S.R. Industrial Exhibition held in London on the 7th to the 29th July. I arrived at Earls Court to find that the familiar Exhibition Hall, on whose concrete floors I have travelled many foot-weary miles during successive radio shows, had been transformed completely by the Russians. Apart from the Fashion Theatre only the ground floor was in use; but the individual sections on that floor, which all merged one into the next, had been given very high false roofs that completely obliterated the somewhat unsightly upper section of the building. The layout seemed at first sight to be a little haphazard, but a glance at the programme soon showed that a definite route could be followed which enabled all the exhibits to be examined without re-crossing one's steps and without leaving anything out.

Personally, I preferred the change from the usual geometric Exhibition layout.

Much of the emphasis was, quite frankly, on Soviet achievements; and the centrepiece of the Exhibition was contained in a circular section having a high blacked-out dome in the shape of a planetarium. A model of the world revolved slowly near the apex of this dome, being surrounded by orbits of various shapes traced out in neon tubing. This section also held models of the various Russian satellites including that in which Major Yuri Gagarin carried out his epoch-making flight into space.

Most of the purely electronic equipment on display was of a standard and solidly-made variety, and my eye was not caught, during my short visit, by any outstandingly new development. A small section was devoted to domestic radio and television receivers and my immediate reaction to the latter was that, judging by the depths of the cabinets, the Russians have not yet gone over to 110° picture tubes. The television receivers were on a closed-circuit hook-up, allowing visitors to see themselves via a camera in the centre of the stand. The radio sets were, so far as I could judge, pretty standard also, with conventional cabinet styling and not too much flashy trim.

The educational section showed some simple electronic demonstration boards employing actual components mounted in such a manner that their circuit could be easily followed. These demonstration boards included a two-triode a.f. amplifier and a two-triode balanced v.h.f. oscillator working directly into a dipole of some 3-metre wavelength. There was also a do-it-yourself kit for an electric motor in a shallow cardboard box complete with a lovely garish picture on the top of the completed job. Just the sort of thing that I used to lap up when I was a kid! A neat gadget in this section displayed a sine wave by means of a series of white buttons sliding on vertical black rods against a black background. By rotating a wheel at the rear, cords pulled the buttons to different positions, thereby changing the shape of the "wave".

I was at the Exhibition during the visit of Major Yuri Gagarin, but any hopes I may have had of seeing the astronaut were dashed because of the fantastic and enthusiastic crowds who waited for him and surrounded him as soon as he appeared.

A fond memory of the Exhibition was occasioned by a public address call for three missing schoolboys. The call asked these boys "to report to Section Four, Outer Space, immediately". This was perfectly in keeping with the idiom of the Exhibition and capped my visit very nicely.

Electroluminescent Clock Dial

Smiths Clocks and Watches Ltd. will shortly be releasing the *Callglow* electric clock. This clock, which operates from 200–250 volts a.c. synchronous mains, caused considerable comment when it was exhibited at the Tenth Electrical Engineers' Exhibition at Earls Court last March, and it is of special

interest here in that it will be available with an electroluminescent dial. The light intensity of the dial is controllable and, obviously, the latter can be read very easily in the dark.

The phenomenon of electroluminescence has been the subject of research work for many years, but it is only recently that development has enabled electroluminescent light sources to become available at low manufacturing costs. Basically an electroluminescent lamp consists of a flat panel, which can be made in sizes up to 12 x 9in, containing a layer of phosphors sandwiched between two conducting layers. The back conducting layer may be opaque and the front conducting layer transparent, whereupon the application of an e.m.f. to the two causes light from the excited phosphors to pass through the front layer. As may be gathered, the light is radiated from the whole area of the panel, as opposed to the "point" light source of filament lamps and the "linear" source of fluorescent tubes.

Apart from the unique ability to radiate light from an "area" source, electroluminescent lamps have a very high efficiency. Negligible heat is dissipated, and practically all the applied electrical energy is converted directly to light. A typical lamp running from a 250 volts supply would consume a current of some 0.2 to 0.3mA per square inch only.

The Smiths *Callglow* clock will be available in illuminated and non-illuminated versions, the former having the electroluminescent dial. In this, the a.c. mains voltage is applied to the conducting layers of the electroluminescent element via a fixed limiting resistor and a variable resistor which controls the brightness. The *Callglow* clock also contains the normal alarm circuit.

Points from Letters

Last month's Radio Topics included a report of t.v. Dx reception by Mr. R. J. Ringrose of Ipswich Suffolk. Mr. Ringrose has sent me some further information, this arriving just too late to appear last month. He has now changed his receiver to negative modulation by reversing the video detector and he found that he also had to halve the value of his video output cathode resistor to obtain sufficient brightness. On his Channel 1 vertical dipole he has received Belgian and Spanish transmissions on 48.25 Mc/s, at times so strongly that contrast had

to be turned fully back. He has also received the Russian test card on 49.75 Mc/s on five occasions, once so strongly that contrast had, again, to be turned fully back. Going back to positive modulation he has received Caen weakly on 52.4 Mc/s and Lille on 185.25 Mc/s, the latter being picked up at such strength that a test card was resolved with only a 10in piece of wire in the aerial socket of the receiver! Incidentally, I guessed last month that unidentified 185.25 Mc/s transmissions might be from Eiffel Tower, but it looks as though I was wrong. Both Lille and Eiffel Tower share the same channel, and both have the same power.

Mr. I. C. Beckett of Buckingham, whose feats of Dx reception formed the basis of the "Long Distance TV" article in our November 1960 issue, is still pulling them in. As of the beginning of July his total of countries received this year is 11, excluding France and Belgium. The last two must be locals to Mr. Beckett! Included in Mr. Beckett's haul is the identification card for the *Osterreichischer Rundfunk* service introduced in Austria some years ago. All Mr. Beckett's Dx is on Band I.

The way things are going, I'm expecting a report any day now on the reception of *Transatlantic* t.v.! A set successfully adapted for 625 line negative modulation shouldn't have much difficulty in resolving a 525 line signal as used in the States. The 525 line signal has a line frequency of 15,750 c/s, which is only very slightly removed from the 15,625 c/s of the 625 line signal. The field frequency is 60 per second, as opposed to 50 per second, but this shouldn't be beyond the capabilities of most vertical timebases.

Another letter describes the experiences of a reader, Mr. R. Goodsell of Margate, after he had inserted a request for information on an electronic metronome in the "Can Anyone Help?" column in our March issue. Mr. Goodsell writes: "... I received replies from Germany, Australia and New Zealand, apart from about two dozen or so from various parts of this country. I really had no idea that *The Radio Constructor* got around so much."

The "Can Anyone Help?" column certainly seems to be giving considerable assistance to those who take advantage of it. And it also proves, of course, that the old friendly spirit in the hobby of radio is still with us, and that it remains as strong as ever.

Lead Consumption Rises

Consumption of lead in batteries in the U.K. has been rising steadily in recent years and in 1960 the battery industry took some 75,000 tons of lead as metal and oxides—some 20 per cent of all lead consumed.

In order to assist in the development of this important market the Lead Development Association announces that Mr. P. C. Fryer, B.A. Cantab., has been appointed to the staff. Mr. Fryer is a metallurgist and prior to joining the L.D.A. was on the staff of the Morgan Crucible Company. He will be principally engaged in development work for the lead industry in the battery field.

A Constructor's Oscilloscope

—A Construction of the Mullard Design

Part 3

by D. NOBLE, G3MAW and D. M. PRATT, G3KEP

I. High Impedance Attenuator Probe

THE VERY SIMPLE CIRCUIT OF THIS, TOGETHER WITH constructional sketches, is shown in Figs. 7 and 8. The small trimmer is provided to balance the capacity of the coaxial lead, which should be of the specified length. In the prototype, this trimmer was made from a miniature air-spaced type with rotary moving-vanes, and consisted of one fixed and one moving vane.

Construction

The probe is built around standard Neosid coil components. Firstly, the central portion of the coil former is filed away leaving a piece of semi-circular cross-section supporting the top end, in which a $\frac{1}{8}$ in hole is drilled as shown. A standard brass core is drilled through its axis to take the prod of $\frac{1}{16}$ in

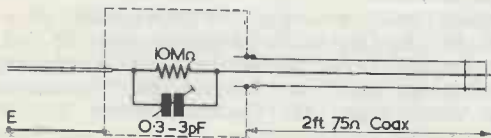

M98

Fig. 7. High impedance attenuator probe

Components List

(High Impedance Attenuator Probe)

- 1 10MΩ resistor 10% $\frac{1}{4}$ watt
- 1 Trimmer 0.3-3pF (see text)
- 1 Former assembly, Neosid 5000B, complete with insulated top plate
- 1 Brass core (to fit former assembly)
- 1 Crocodile clip (Bulgin)
- 1 Coaxial plug (Belling-Lee L734/P)
- 75Ω Coaxial cable (2ft)
- $\frac{1}{16}$ in brass rod, screws, etc.

brass rod, which may either be sweated in or made a tight fit. A radial hole in the core is drilled and tapped 6BA such that, with the core screwed flush

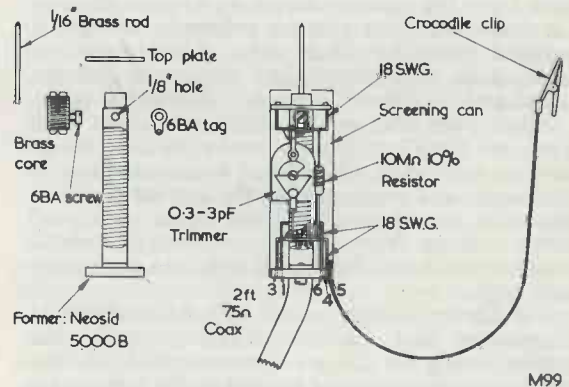
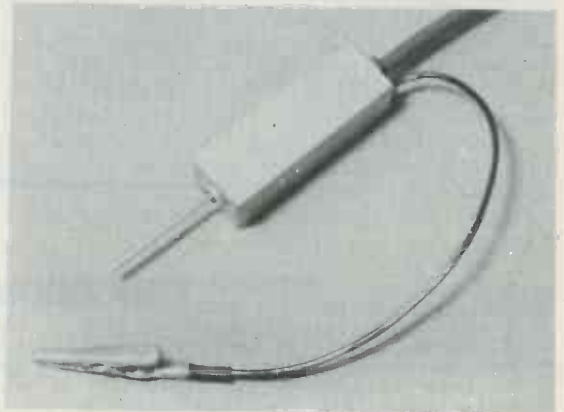

Fig. 8. Construction details of the high impedance attenuator probe (see text)

with the end of the former, a 6BA screw may be fitted through the former to retain it, a solder tag being provided for the electrical connection.

The top plate is fitted in position and three pieces of 18 s.w.g. tinned copper wire are bent and fitted into the spill holes of the top plate and base as shown.



The high impedance attenuator probe

The components may then be soldered in position. An earth lead fitted with a crocodile clip is taken from the earth spill through one of the spare spill holes. The coil can be earthed by means of a piece of copper foil, cut to a suitable shape, which is soldered to the earth spill and bent under the former

Components List (High Gain Probe)

Resistors

R ₁	470kΩ	¼W	10%
R ₂	47kΩ	¼W	10%
R ₃	470kΩ	¼W	10%
R ₄	1.5kΩ	¼W	10%
R ₅	120kΩ	¼W	10%
R ₆	470kΩ	¼W	10%

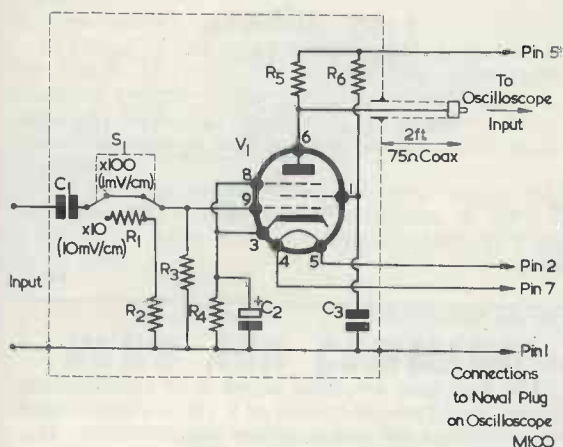

Fig. 9. Circuit diagram of the high-gain probe

Condensers

C ₁	0.1μF	350V	paper
C ₂	100μF	6V	electrolytic
C ₃	0.1μF	350V	paper

Miscellaneous

S ₁	Double-pole changeover toggle switch, N.S.F. Type 8373/K7
V ₁	Mullard EF86

Also required—

- 1 Noval valve base (McMurdo) Type BM9/U
- 1 Noval plug (McMurdo Type BLM9/USP1 with No. 22 cover)
- 2ft of 75Ω coaxial cable
- 1 Coaxial plug (Belling-Lee L.734/P)
- 2ft 4 way p.v.c. cable
- 1 crocodile clip (Bulgin)
- Prod assembly (see Fig. 11)
- Chassis and box (see Fig. 10)
- 1 Tagstrip, Bulgin Type T19 with R.H. tag removed

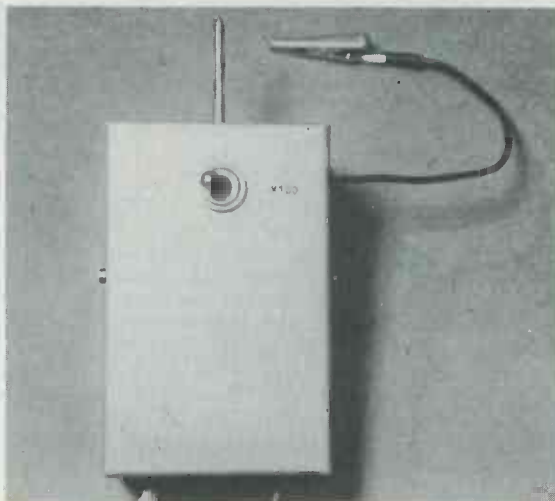

External view of the high-gain probe

base. Upon fitting the can one of the fixing lugs is clamped to the copper foil by means of its 6BA fixing screw.

As can be seen the coaxial lead is fed up the centre of the former. It will be found a tight fit, and will necessitate being tapered and screwed in. To enable the trimmer to be adjusted when the probe is assembled, a hole is drilled in the side of the can.

Checking

As explained earlier, the purpose of the trimmer is to make the whole circuit (including all stray capacity) aperiodic. Alignment of this condenser can be achieved by connecting the input of the high impedance attenuator probe from the oscilloscope to the cathode of the tube in a television receiver.

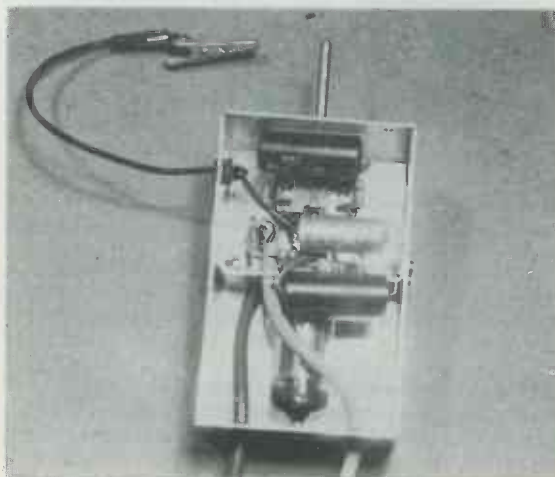

Rear view of the high-gain probe unit with back plate removed

With maximum Y-gain, a display of 1 cm. amplitude should be obtained with an input of 1mV on the x 100 switch position. If the specified length of coaxial cable is used, the response should be found to be flat to within 3dB up to about 20 kc/s.

Conclusion

The writers have found this Mullard circuit to give very pleasing results in a unit which compares favourably in size with the average commercial kit, and they wish to express their appreciation and thanks to Mullard Ltd. for their kind co-operation, without which this article could not have been produced.

References

1. *Mullard Technical Communications*, Vol. 4, No. 32, "Circuit for a Simple Oscilloscope", pages 33-38. (Based on a report prepared by L. S. Brown of the Mullard Applications Research Laboratory).
2. *Scope for Service*. Mullard Publication No. TP374.

ERRATA

A Constructor's Oscilloscope—Part 1

In Part 1 of this series condenser C_1 is shown, in the circuit on page 923 of the July issue, with incorrect polarity. The condenser should have its negative terminal connected to rectifier MR_1 , otherwise damage may result when the mains input is applied.

The table on page 921 did not show clearly that response, with Direct Input or "Probe X 10", is 2 c/s to 2.5 Mc/s and, with Pre-amplifier, is 5 c/s to 20 kc/s.

NEWS AND COMMENT

Interference

A correspondent to *The Times* has recently suggested, presumably not too seriously, that 4-star hotels should lose a star or two if television or radio are installed in the only comfortable lounge. Such a comment underlines the difficulty, in a heavily populated country, of how to allow freedom to one type of person without depriving another. A current difficulty is with transistor portables. Complaints of annoyance have been made when these have been used on motor bus and beach. This latter can readily be appreciated as these words are being written at a spot where normally one can only hear the sound of waves breaking on the seashore, but today some holiday-makers are listening (?) to programmes on their portable and the rest of us perforce . . .

This matter has been pinpointed by a statement issued by the Town Clerk of Eastbourne, attention being drawn to the fact that there is a bye-law which makes it an offence to operate radio sets, record players or other amplifying equipment in streets and public places. Offenders can be fined up to £5. The statement was put out after complaints of annoyance had been received from holiday-makers on the beaches and promenades. For the same reason London Transport has reminded its staff that the use of portable radios on buses contravenes

regulations. A possibly more serious misuse is the monitoring of police messages by criminals to warn them of the approach of the law.

However, probably every great discovery has been misused by someone, and, when the novelty has worn off, we do not expect to hear so much about this kind of interference.

Viewing

According to figures issued by the B.B.C. in respect of the period April to June, 2 million more people watched t.v. compared with the same period a year before. It is estimated that 32 million sets are switched on during the average day! The B.B.C. compute that commercial programmes are tuned into more frequently than their own to the extent of 63% to 37%; the exception being the Saturday afternoon "Grandstand".

The number of current t.v. receiving licences issued in England and Wales is now comfortably in excess of 10 million, and in Scotland over 1 million. Taking Great Britain and Northern Ireland together the numbers are likely soon to reach 11½ million. (Sound only licences are just short of 4 million of which nearly ¼ million are for car radios.)

The Home Secretary, Mr. R. A. Butler, speaking at a British Medical Association conference dinner, referred to irresponsibility among young people and mentioned, among other things, the immaturity and irresponsibility of many television programmes. One method of achieving a more responsible attitude might be to follow the somewhat facetious advice given on one of our office calendars "instead of standing them in a corner, children nowadays are best corrected by standing them with their backs to the television".

Wired Sound and Television

The chairman's statement issued with the accounts of Rediffusion Ltd., reveal the considerable overseas use of wired sound and television broadcasts. In references to a subsidiary's activities in Western Nigeria, it was stated that the majority of the world's population live in scattered communities, without power supply or radio and that anyone finding a successful means of bringing them information and entertainment will have almost limitless opportunities.

Wired sound and television was, naturally, dealt with in some detail. It was mentioned that regional agreements had been made with branches of the R.T.R.A. for co-operation with the general radio trade. It was interesting to note that Rediffusion hope to persuade manufacturers to incorporate modifications in television receivers so that viewers may receive signals from either aerial or land-line.

In Brief

● The B.B.C. estimate that an average audience of 15 million people had watched "*The Valiant Years*" each week, 10 million in the first and 5 million in the second showing. These figures were issued just before the conclusion of the series.

(continued on page 144)

Transistor Shorted Turns Tester

By M. D. ROBERTS

In our August 1960 issue, we published details of "A High Sensitivity Shorted Turns Tester" designed by M. D. Roberts. This unit employed a 12AT7 valve and required a mains h.t. and heater supply. Our contributor has now developed a self-contained transistorised version of the shorted turns tester, and this is described herewith

THE TRANSISTORISED SHORTED turns tester was designed for compactness and, since it is completely self-contained, it can be carried anywhere and used in any situation. The appearance of the unit can be seen from Fig. 1. The meter is a 0-1mA moving coil instrument, the size of this determining the size of the complete unit. The batteries are housed within the case and should have a life of many months. The case must be made of wood or other insulating material to prevent damping effects on the test probe.

There being no valves to warm up, when the tester is switched on it is ready for use immediately; therefore the unit need not be switched on until the moment it is needed, with

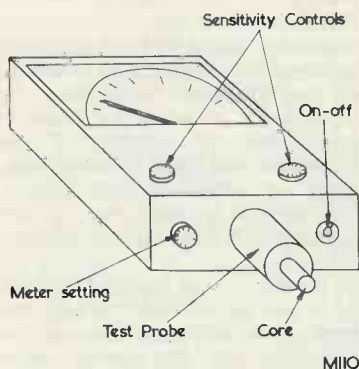

Fig. 1. The external layout of the shorted turns tester

a consequent saving in battery consumption. The core of the test probe is a piece of Ferroxcube taken from an old ferrite aerial; it is protected by being mounted in a Paxolin tube.

The Circuit

The circuit, which is shown in

Fig. 2, employs two Newmarket audio transistors type V10/30A. One transistor, TR₁, is used as a

conventional oscillator with a nominal frequency of 1 kc, and the other, TR₂, as an amplifier controlled by the amplitude of oscillations from TR₁.

TR₁ constitutes a Colpitts oscillator in conjunction with L₁ and its associated components. R₁R₂ set up the bias conditions for the oscillator, whilst R₄ allows variation of the bias point and thereby serves as a sensitivity control. C₄ decouples the emitter to the positive supply line and prevents negative feedback in the oscillator. The oscillations built up across R₃ are passed to TR₂ via the d.c. blocking condenser C₅. The signal passed by C₅ controls the current flowing through TR₂, this current being monitored by meter M₁. R₆ controls the bias point on TR₂ and is adjusted for maximum sensitivity of this

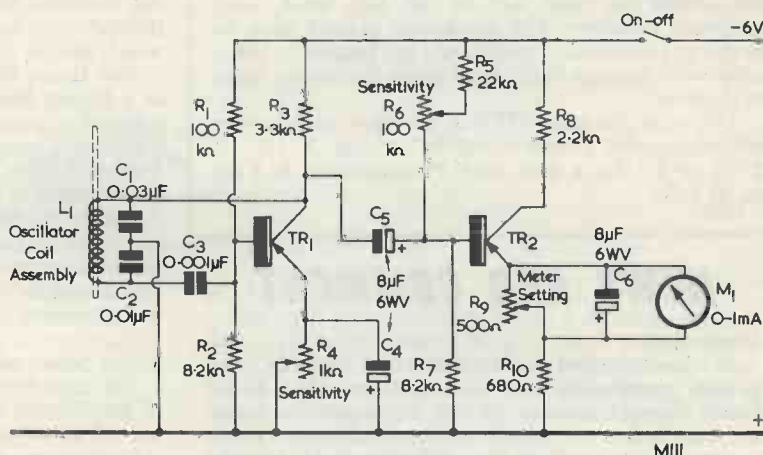

Fig. 2. Circuit diagram of the tester

Components List

Resistors

- R₁ 100kΩ $\frac{1}{8}$ watt
- R₂ 8.2kΩ $\frac{1}{8}$ watt
- R₃ 3.3kΩ $\frac{1}{8}$ watt
- R₄ 1kΩ potentiometer
- R₅ 22kΩ $\frac{1}{8}$ watt
- R₆ 100kΩ potentiometer
- R₇ 8.2kΩ $\frac{1}{8}$ watt
- R₈ 2.2kΩ $\frac{1}{8}$ watt
- R₉ 500Ω potentiometer
- R₁₀ 680Ω $\frac{1}{8}$ watt

Transistors

- TR₁ V10/30A Newmarket
- TR₂ V10/30A Newmarket

Meter

- 0-1mA f.s.d.

Condensers

- C₁ 0.03µF paper
- C₂ 0.01µF paper
- C₃ 0.001µF paper
- C₄ 8µF, 6 w.v. electrolytic
- C₅ 8µF, 6 w.v. electrolytic
- C₆ 8µF, 6 w.v. electrolytic

Miscellaneous

- On/off switch
- 6V battery (two 3V units in series, or to suit individual requirements)
- Ferrite rod (see text)
- Paxolin tubing, etc., etc.

stage. R_9 varies the current flowing through M_1 , and is set to prevent the meter being overloaded. C_6 decouples any oscillations present across the meter.

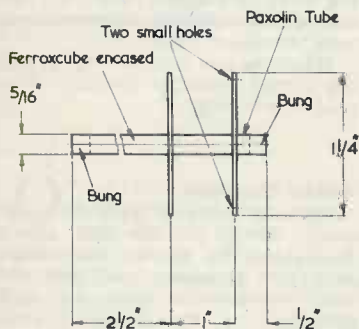

M112

Fig. 3. The manner in which the oscillator coil assembly is constructed before winding

Testing for Shorted Turns

With the aid of this unit, coils without cores can be checked to ascertain if there are any shorted turns within the winding.

Referring to Fig. 2, it will be seen that L_1 has a core which extends beyond the actual oscillator coil. If a winding with a shorted turn is passed over this core extension the oscillator coil becomes damped. The

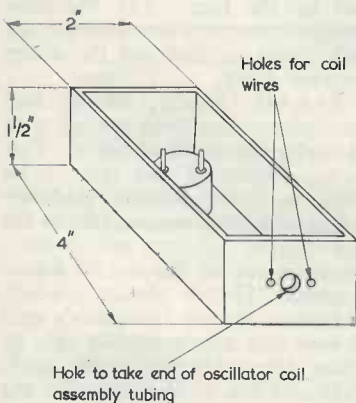

M113

Fig. 4. The case dimensions employed in the prototype

result is a considerable reduction or, even, a complete collapse of oscillator amplitude. The reduced signal passed to TR_2 then causes this transistor to pass more current and

the presence of the shorted turn is indicated by an increased reading in M_1 . If a coil without a shorted turn is passed over the oscillator core extension there is no increase in the M_1 reading.

Construction of the Oscillator Coil

The construction of the oscillator

coil is shown in Fig. 3. Obtain a Ferroxcube rod about $3\frac{1}{2}$ in long and completely enclose the Ferroxcube and hold it rigidly in position. Make up two Paxolin discs $1\frac{1}{4}$ in in diameter with a hole in the centre of each allowing them to slide over the Paxolin tube. One of the discs requires two small holes near its periphery for lead-out wires from the coil. Cement the discs into position, as shown in Fig. 3, remembering that the disc with the two small holes



Checking the transistorised shorted turns tester by passing a closed loop of wire over the oscillator core extension. This causes an increase in meter reading. (The unit illustrated here is an experimental model built to the circuit of Fig. 2 but employing a layout differing from that in Figs. 1, 4 and 5)

coil is shown in Fig. 3. Obtain a Ferroxcube rod about $3\frac{1}{2}$ in long and

¹ It should be remembered that, in the presence of oscillations from TR_1 , there will be a rectifying action between the base and emitter of TR_2 . This would cause C_5 to charge in such a manner that the base of TR_2 will tend to go positive, the positive excursion being limited by R_5 and R_6 . Reduction of oscillation amplitude results in reduced charge in C_5 , and would explain the increase in TR_2 current referred to in the text.—Ed.

completely enclose the Ferroxcube and hold it rigidly in position. Make up two Paxolin discs $1\frac{1}{4}$ in in diameter with a hole in the centre of each allowing them to slide over the Paxolin tube. One of the discs requires two small holes near its periphery for lead-out wires from the coil. Cement the discs into position, as shown in Fig. 3, remembering that the disc with the two small holes

should be nearer the end of the Ferroxcube.

Next, wind 2,000 turns of 32 s.w.g. enamelled copper wire in several layers between the two discs. Lead the two ends of the coil wire through the two small holes in the Paxolin disc and cement the coil firmly into place. The coil is now ready for assembly to the case.

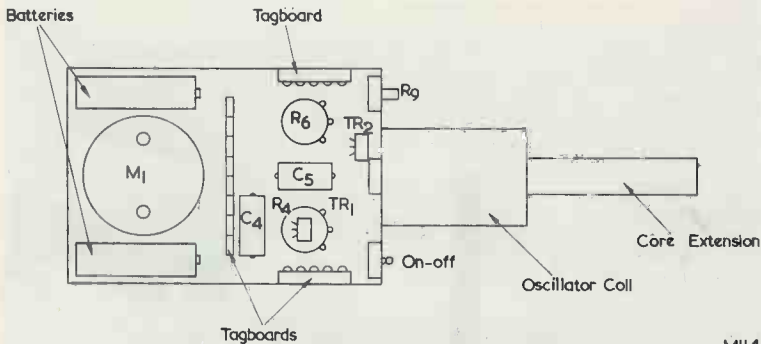

Fig. 5. Illustrating the layout of the major components

Construction of Case

The size of the case depends mainly on meter dimensions. In the writer's instance, the meter was 2 x 2 x 1½ in deep, and the dimensions of a box to house such a meter are given in Fig. 4.

Special attention is drawn to the relatively large diameter hole at the end of the case, and the two small holes on either side. The large hole takes the end of the oscillator coil tubing, and the two small holes allow the leads from the coil to be fed into the case. The rear disc on the coil can then be cemented to the end of the box with the tubing

protruding through. If desired, a Paxolin sleeve 1 in long and with an internal diameter of 1½ in can be glued over the coil on the two discs to completely seal the coil and make a neater unit.

After this, the layout of the com-

ponents has to be decided. The layout diagram given in Fig. 5 will serve as a though guide.

The layout of components is not critical, but if the size of the unit is to be kept small, component positioning must be planned carefully. All components used in the prototype were miniature types.

When the unit has been wired, and the circuit carefully checked, it is ready for testing.

Testing Procedure

Make a tin loop with 20 s.w.g. wire. Switch on the unit, adjust R₄, R₆ and R₉ so that they insert maximum resistance and pass the loop momentarily over the core extension of the oscillator coil. Watch the meter for results. Advance R₄ a fraction and pass the loop over the core again. Repeat this process until a position is found where the meter indicates the most deflection when the loop is passed over the core. Then proceed to R₆ and adjust this for maximum sensitivity in the same way, adjusting R₉ to prevent the meter being overloaded.

Continue minor adjustments to all three controls until the unit is at its most sensitive setting. The shorted turns tester is then ready for use.

NEWS AND COMMENT *(continued from page 141)*

● The Amateur Radio Mobile Society at their second Annual General Meeting reported an increase in membership and that they now have quite a number of members abroad. It was announced that a ruling had been obtained from the Post Office allowing separate log books to be kept for mobile contacts.

● According to the *London Evening Standard*, Mr. Charles Orr Stanley's Pye Radio and Television group is linking up with the Ling-Temco Electronics of Texas to form a new joint company to be called Pye-Ling. The new firm will market vibration test equipment which is used for testing missiles and space rockets. Initially the new firm will be comparatively small, starting with a capital of £160,000.

● In order to survey a busy intersection at Southend airport which is not visible from the control tower, a Marconi closed circuit television camera channel has been installed.

● Marconi will also be supplying underwater television cameras to be used for salvage operations by a fleet of seven Russian tugs, following an order for t.v. equipment placed by the Finnish shipbuilding firm Valmet Oy. Seven Marconi-Siebe, Gorman cameras and monitors are to be delivered to the Pansio Shipyard, Turku, for installation on board the diesel-driven salvage tugs now being built for

V/O Sudoimport of Moscow. Diving equipment, and underwater cutting and electric arc welding devices, are carried by the tugs. The Marconi-Siebe, Gorman television cameras will enable salvage experts to see work being carried out by divers using pressure air-driven tools.

● An order for SARAH (Search, Rescue and Homing) marine equipment has been placed with Ultra Electronics Ltd. by the Swedish Navy. This is the first marine equipment of this type to be ordered from Sweden. An initial order for SARAH aircraft equipment has also been received from the Swedish Army.

● The first turf has been cut on the site of a new building—to be named "Elettra House"—which will house all the Marconi Marine Company's staff in the Chelmsford area and approximately fifty of the Company's East Ham central stores staff. Clearing of the three-acre site at Westway, on the Widford industrial estate, Chelmsford, has now begun and the building is expected to be ready for occupation by the end of next summer. The name of the new headquarters has a historic significance within the Marconi Group of Companies. Marchese Marconi named his famous experimental yacht *Elettra*, one of his daughters was also called *Elettra*, and the Marconi Company's present experimental yacht is named *Elettra II*.

A Magnetic Guitar Pick-up and Transistorised Tone Control Pre-amplifier

BY D. E. MAYNARD

ONE OFTEN SEES ARTICLES DESCRIBING GUITAR pick-ups, but they nearly all seem to use a crystal mike insert or similar device. Quite good results are obtainable in this way but such methods are subject to one or more of the following disadvantages:

- (1) Pick-up of extraneous noises such as the rubbing of clothing on the guitar.
- (2) Feedback if played too close to the loud-speaker system.
- (3) High impedance output necessitating the use of considerable lengths of screened cable.

The method described here is subject to none of these disadvantages. However, it can only be used with a steel stringed guitar.

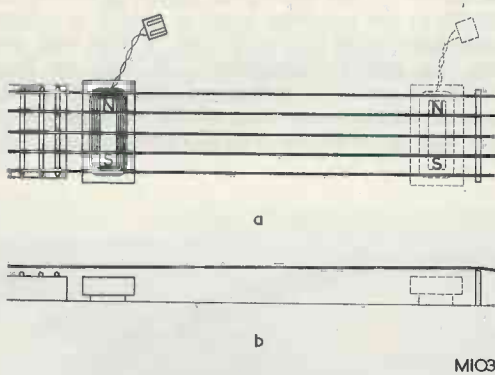

Fig. 1. Two positions for the guitar pick-up

Pick-up Construction

A bar magnet slightly shorter than the span of the strings and thin enough to pass between them and the guitar body is needed. Around this a



Fig. 2. The pick-up former

former of thin Paxolin or ivory or any other stout insulating material is built up as shown in Fig. 2

so that it is a tight fit over the magnet. Then, with the magnet inserted, about 180 turns of 32 s.w.g. enamelled wire are wound on to the former and terminated in a two-pin socket which is fixed to the guitar. It should be pointed out here that the number of turns and gauge of wire required need not necessarily be the same as those just given.

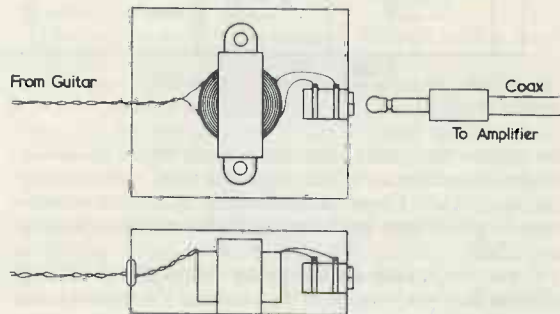

Fig. 3. Matching the pick-up to the amplifier

Experience with experimental models has shown that, whilst it is preferable to fill the former with a large number of turns of fine wire rather than a small number of turns of thick wire, the difference in output resulting is not great. A pick-up wound with 40 turns of 24 s.w.g. enamelled wire gave only slightly less output than that wound with 180 turns of 32 s.w.g. wire.

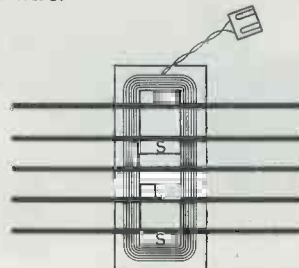

Fig. 4. An alternative method of constructing the pick-up using two magnets

The pick-up is positioned on the guitar body as in Fig. 1, it being mounted as close to the strings as

is permissible after allowing for the depression of the strings on high notes. Fig. 1 shows two alternative positions for the pick-up. The steel strings of

veniently be a miniature "battery pentode" output transformer mounted in a small box as shown in Fig. 3. From here, about one yard of coaxial cable

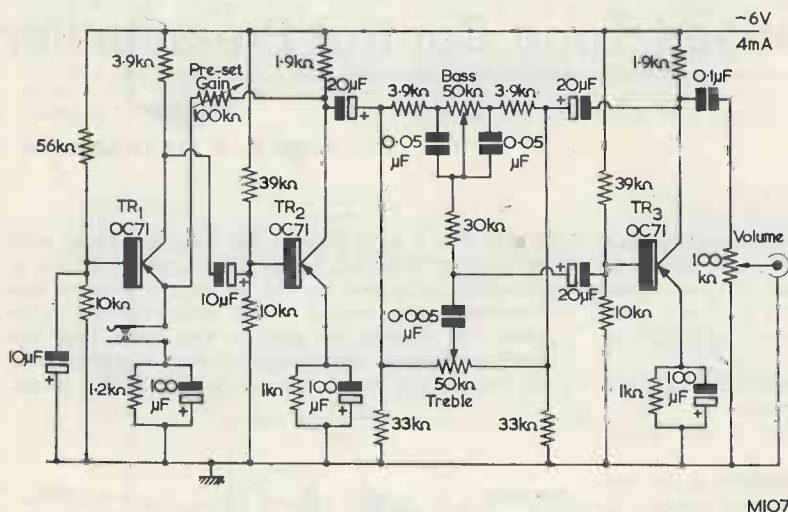
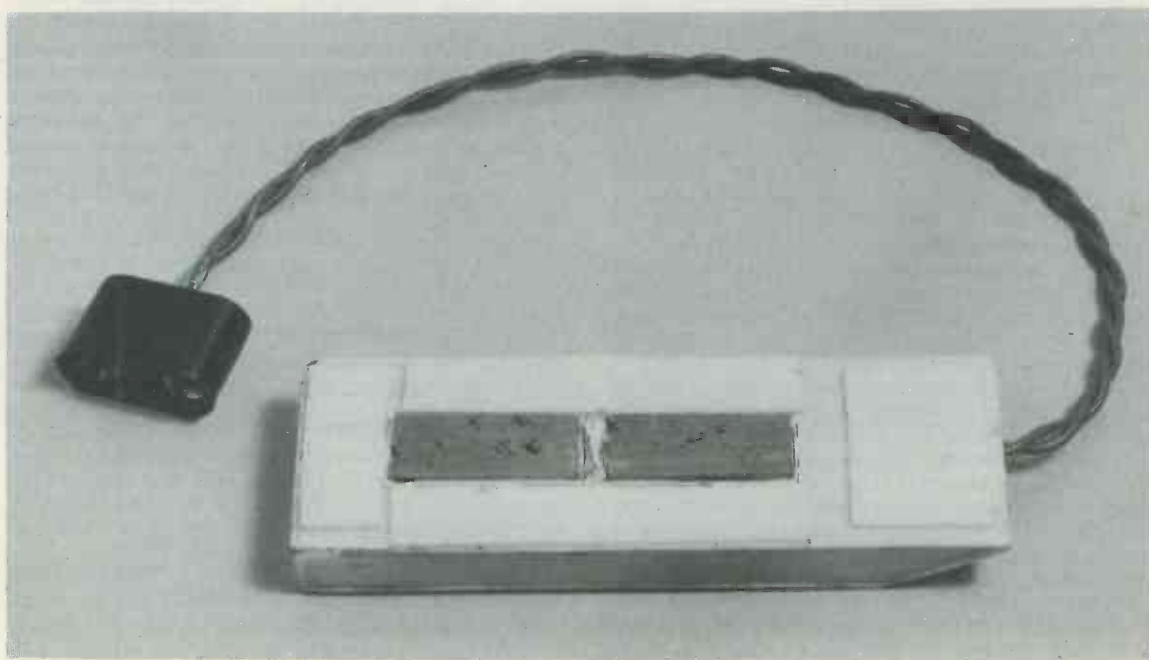

Fig. 5. A transistorised tone control pre-amplifier for the pick-up, offering a high impedance output

the guitar become magnetised and, when plucked, create disturbances in the magnetic field surrounding the magnet. These disturbances produce corresponding voltages in the coil which are subsequently amplified.

From the socket on the guitar up to about 20 feet of twin flex may be used to connect the pick-up to the matching transformer. The latter can con-

is used to connect to the input of a suitable amplifier. The reason for not having the matching transformer actually at the amplifier input is that it is sensitive to magnetic fields and thus must be kept well away from the mains transformer. It may be found helpful, in order to reduce r.f. breakthrough and hum, to connect one lead of the twin flex to the outer conductor of the coaxial cable.



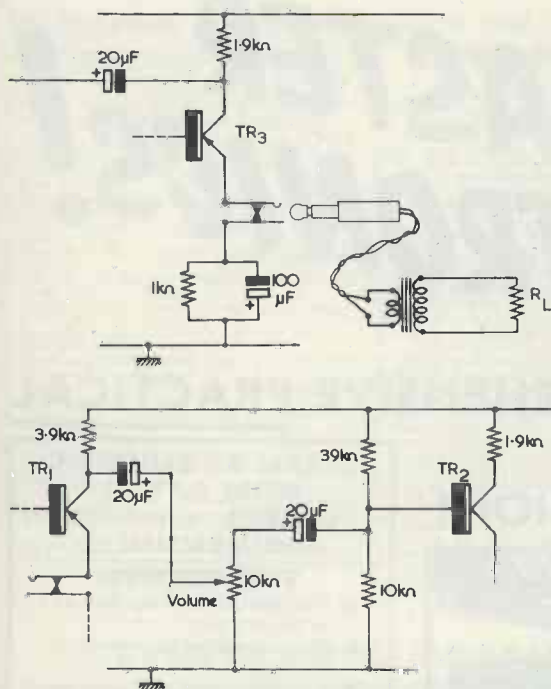

Fig. 6 (a) (above). Modifying the output stage of the pre-amplifier to low impedance (b). The low impedance output necessitates re-positioning the volume control between TR₁ and TR₂ and deleting the pre-set gain control of Fig. 5

With the pick-up shown in Fig. 1, bass and treble boost is automatically provided; this is because the magnetic flux is more concentrated near the poles of the magnet, and consequently the outer strings produce a greater effect than the inner ones. If the constructor considers this undesirable, and cannot compensate for it in his amplifier, the effect can be greatly reduced by using two magnets as shown in Fig. 4. This arrangement provides a more even distribution of magnetic flux through the strings.

The tone of the output can be varied greatly by placing the pick-up in different positions on the guitar. If placed next to the bridge the pick-up reproduces several harmonics giving a "twangy" sound; if placed near to the finger board a more mellow sound is produced. However, the method of attaching the pick-up is best left to the constructor since guitar shapes and sizes vary so greatly.

The maximum output of the pick-up is approximately 10mV after the matching transformer.

A Tone Control Pre-amplifier

In order to provide greater flexibility, the writer has designed a pre-amplifier for use between the pick-up and the main amplifier.

The circuit of the pre-amplifier is shown in Fig. 5. As can be seen it has one grounded base stage and two common emitter stages. The pick-up used with this pre-amplifier consisted of 180 turns of 32 s.w.g. enamelled wire on a two magnet core (although,

here again, the number of turns and wire gauge was not critical) and was connected directly into the emitter circuit of the first stage. About 10 feet of twin flex can be used between the pick-up and the pre-amplifier without any noticeable hum.

The first stage is a low noise amplifier providing a small amount of gain, and this is coupled to a common emitter stage TR₂, which provides the main amplification. A variable 100kΩ feedback resistor is included so that the gain of these two stages can be limited, if necessary.

The tone control circuit utilises negative feedback which is fed in with the incoming signal in varying proportions in order to provide bass and treble left and cut. It may be necessary to alter the components of the tone control circuit if the pre-amplifier is to be put to other uses, since the characteristics were chosen primarily to be of use in the frequency range of a normal guitar.

As shown, the circuit has a reasonably high output impedance and can be connected directly to a normal valve amplifier.

The output covers the range 0-800mV with a level of about 300mV for normal playing.

For use with a low impedance output, either an emitter follower stage is added or the output is taken from the emitter circuit of the present last stage as shown in Fig. 6 (a). In this case the output is matched at the main amplifier by means of a transformer with a suitable turns ratio. Upwards of 10 feet of twin flex can be used here without any noticeable hum pick-up. In this configuration the volume control of Fig. 5 must be discarded and one fitted between the first two stages as shown in Fig. 6 (b) (in which the pre-set gain control is also deleted). Alternatively, the pre-set gain control can be used as a volume control.

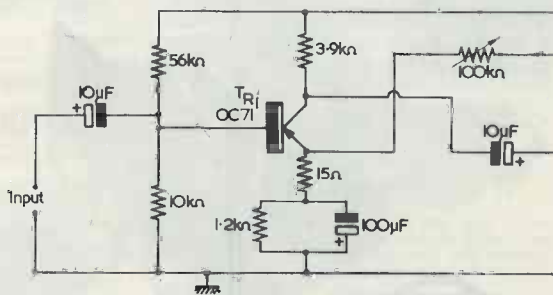

Fig. 7. Converting the first stage of the pre-amplifier to grounded emitter

If an emitter follower stage is added, the matching at the main amplifier can be effected by a grounded base transistor although this greatly increases the cost.

For use in other applications the input stage is easily converted into a grounded emitter configuration as shown in Fig. 7. The output for 1mV is then 300mV with the tone controls in a neutral position.

The consumption of the pre-amplifier is 4mA at 6 volts.

NOW YOU can MASTER ELECTRONICS!

**BRITAIN'S MOST COMPREHENSIVE PRACTICAL
COURSE IN RADIO
ELECTRONICS • TELEVISION!**

**THESE SPECIAL TRAINING
KITS — YOURS TO KEEP**



**Multi-Range
TEST METER**



**CATHODE RAY
OSCILLOSCOPE**

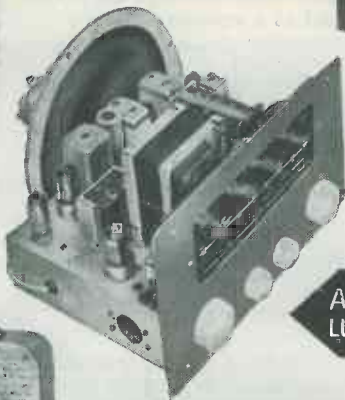

**AM and VHF/FM
LUXURY RECEIVER**



SIGNAL GENERATOR



**Complete set of
Picture Way books and
Experimental Manuals**

**LEARN BY BUILDING
NOW for your
CAREER • HOBBY
OWN BUSINESS**

YOU RECEIVE

- Complete kits of equipment as illustrated.
- Complete set of experimental manuals.
- Complete set of "picture-way" theory books,
- Modern test-yourself examination sheets.
- Study programme.
- Unlimited consultation with Tutors.

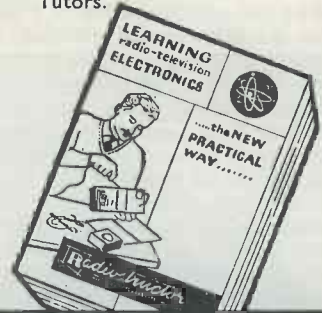

**FREE
BROCHURE
POST NOW**

RADIOSTRUCTOR

TO RADIOSTRUCTOR (DEPT. M.31)
READING, BERKS.

Name.....

Address.....

**BLOCK
CAPS
PLEASE**

(We do not employ representatives)

9.61

SUB-MINIATURE COMPONENTS

1. Ferrite aerial with Long and Medium Wave Coils 4 1/2" long for pocket superhet, complete with circuit showing component values etc. 22/6d.
2. Ferrite aerial as above, but 1 1/2" diameter, 8" long for table model receiver or portable. 10/6d.
3. Three I.F. Transformers with oscillator coil and circuit details to work with item 1. 19/6d.
4. Three I.F. Coils and oscillator to work with item 2. 22/6d.
5. Smallest possible electrolytics, 1MFD, 2MFD, 4MFD, 5MFD, 6MFD, 8MFD, 10MFD, 20MFD, 30MFD, 50MFD, 100MFD, 200MFD all 1/9d. each.
6. Smallest \downarrow watt resistors all 10% values 5d. each.
7. Miniature condenser 1 1/10d., .5, .04, .02, .01 all 8d. values below this 7d.
8. Miniature slide switch double pole change over 2/6d.
9. Edgewise volume controls 2K, 5K, 10K and 20K 2/6d. each.
10. Small edgewise controls with switch 2K, 5K, 10K and 20K 4/9d. each.
11. Red Spot Transistors tested and suitable all A.F. applications 2/6d.
12. White Spot Transistors tested and suitable as I.F. or mixer 3/6d.
13. Set of six transistors for superhet Mullards in original packets, fully guaranteed, comprising OC44, OC45, OC45, OC81D and matched pair OC81. £2 the set.

SPECIAL SNIP FOR THIS MONTH

The Pocket "6" as described alongside but fully made up ready to work.

£5.15.0 plus 2/6 post and insurance.

NOW THE MARK IV

Read these Testimonials

- D. A. Hilton, Leigh, Lancs.**
 "I received 'Pocket 4' on Christmas Day. I made it up on Boxing Day and I am very pleased with the results. It brings in local stations and many foreign stations including Luxembourg at good strength. I am 13 years old."
- Mr. J. Bell, Wolverhampton.**
 "I am writing to express my satisfaction at the standard of your kit for your Pocket 4 Transistor set and also to state that it has come up to my expectations in regard to performance."
- Mr. R. Belt, Newcastle-on-Tyne.**
 "I have built your Pocket 4 Transistor set, I am very pleased with it."
- Mr. F. Jackson, Ickenham, Middx.**
 "I have built the Pocket 4 and, am more than pleased with the results."
- Mr. G. Bamford, Ramsgate.**
 "I find this set even better than you claim it to be and most certainly up to your usual standard of quality. I feel that nobody could fail to build it and get results. Even the first-time-ever novice, as your circuit diagrams and instructions are so clear and precise."
- Mr. A. J. Simmonds, Welling, Kent.**
 "I purchased from you a week ago the Pocket 4 Transistor Kit, I put it together last night in 1 1/2 hours, on switching on the set I was right on Radio Luxembourg. I must say thank you because not only has the set a very attractive appearance, it also behaves fantastically."
- *****

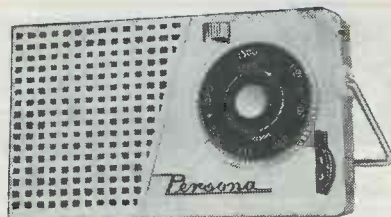

Our famous Pocket "5" which is doing yeoman service all over the country has been modified and improved to make it an even better receiver. The new features include:—

- New elegant dial graduated for Long and Medium Waves.
- Switched Long and Medium Waves.
- Slide switch on/off control.
- Printed circuit.
- Ferrite Rod Aerial.
- Improved reaction circuit.
- Positive spindle coupling to tuner.
- Battery containers.

The Pocket "5" of course retains its original r.f. circuit which means still no aerial or earth needed.

The Pocket "5" Mark IV uses 4 transistors, crystal diode, miniature loud speaker and has all the above refinements, complete in case as illustrated (less motif) 52/6, battery 10d., post and insurance 2/6. Motif 2/-.

Pocket "6" as Pocket "5" but with Moving Coil Speaker and Q.P.P. output stage, 95/-.

Seven days' approval. Order in confidence. We allow you seven days to decide whether or not to make the set, you may return the parcel as received within this time and your money will be refunded in full.

Read some of the testimonials, over 1,000 of which have been received about our Pocket Receivers.

ELECTRONIC PRECISION EQUIPMENT LTD

* Orders received by post are despatched from our warehouse, Dept. 34, 66 Grove Road, Eastbourne, and to save time, please post your order to this address. Please include enough for postage. Callers, however, should use one of the following addresses:

520 High Street North
Manor Park, E.12

42-46 Windmill Hill
Ruislip, Mddx.

266 London Road
Croydon

29 Stroud Green Road
Finsbury Park, N.4

246 High Street
Harlesden, N.W.10

Premier RADIO

23 Tottenham Court Road London W1 Telephone MUSeum 3451/2 and 309 Edgware Road London W2 Telephone PADdington 6963

THE WALTER
Battery/Mains Transistorised Portable

TAPE RECORDER

Original price 55 gns.
NOW ONLY 27 GNS.
Plus P. & P. 20/-

No longer need you be restricted to in-door recordings for with this machine you can record and playback wherever and whenever you wish. Recordings made with the machine on battery operation maintains the Hi-Fi quality when played back on mains. These machines are supplied complete with Microphone, Mains Lead and all necessary accessories, they are brand new in manufacturers' original cartons. **Star Features**—★ 7 stage built-in Amplifier with separate bias oscillator and record level indicator. Push-pull output stage with negative feedback. Also separate feedback equalisation. ★ Full size, 3-watts undistorted output. ★ 7" x 4" High Flux Elliptical Speaker. ★ Large 5 1/2" sp 5 1/2" Spools. ★ 3 1/2" i.p.s. Tape Speed. ★ Revolution Counter. ★ Mixing facilities. ★ Super-impose facilities. ★ Safety device on record (preventing accidental erasure). ★ Volume on/off and Tone controls. ★ Magic Eye Tuning Indicator.



Summer Bargain Offer

"THE CLARION"

Transistorised Battery Tape Recorder

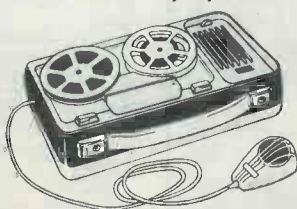

Now only 16 1/2 gns

Batteries Extra 3/4 P. & P. 6/-
Original Price 25 gns.

Brief specifications—Constant governed speed of 3 1/2 i.p.s. Completely transistorised circuit. Recordings inter-changeable with other Recorders. Remarkable reproduction on both speech and music. Complete with Microphone, Tape and Spare Spool. Full range of accessories available.

Send for full descriptive literature

Introducing THE TELEFUNKEN STEREO

HI-FI AMPLIFIER

For only £9.19.6
P. & P. 5/-



At last perfection is now within the reach of all. This unique Amplifier has been designed to revolutionary standards, both in appearance and technical design and backed by the full technical resources of Telefunken.

Brief specifications:

- Power Output 5 Watts total (2 1/2 watts per channel).
- ★ Frequency Response 30 c/s to 40 Kc/s 2dB. 45 c/s to 30 Kc/s 1dB.
- ★ Total harmonic distortion less than 1% at 1 watt output.
- ★ Sensitivity sufficient for all normal inputs from Tape Recorders, Pick-ups, Microphones Radios.
- ★ Power Requirements 110, 125, 150, 220, 240 volts A.C.
- ★ Piano key selecting.
- ★ Preselected tone control.
- ★ Size 12" wide x 9" deep x 2" high.
- ★ Weighs 9 lbs.
- ★ Finish: Hammered enamel in grey/green with gold trimmings, Controls and press buttons in cream with black, blue and red lettering. Specially designed output transformers have been used having an extremely high transfer efficiency therefore delivering a far greater output to the speakers.

THIS MONTH'S BARGAINS

HEADPHONES. DHR58 (very sensitive), 2,000 ohms 18/6. P. & P. 1/6. DLR1 (low res.) 7/6. P. & P. 1/6.

NATIONAL H.R.O. CRYSTAL FILTER UNITS. 455 kc/s with crystal. Sel. and phasing controls. New boxed. ONLY 19/6. P. & P. 1/6.

MULTI-WAY CABLE. 3-core screened 1/- yd.; 12-core screened 2/- yd. First grade Mike Cable 9d. yd. or 6/- doz. yds. P. & P. 1/6.

10-WAY CABLE (5 pairs), screened and plastic covered. Any length cut, 1/8 per yd. P. & P. 1/6 min.

TOUGH POLYTHENE LINE. Type ML1 (100 lb) 2d. per yd. or 12/6 per 100 yds. Type ML2 (220 lb) 4d. per yd. or 25/- per 100 yds. Post free.

ABSORPTION WAVE-METERS. 3.00 to 35.00 Mc/s in 3 switched bands, 3.5, 7, 14, 21 and 28 Mc/s ham bands marked on scale. Complete with indicator bulb. A MUST for any hamshack. ONLY 22/6. Post free.

SPECIAL OFFER

Bumper Bargain Parcels of Resistors, Condensers and Pots. 10/- and 5/- Post Free

GELOSO V.F.O. UNITS. 4/102 with new dial and escutcheon. Outputs on 80, 40, 20, 15 and 10. For 2-807 or 6146 tubes. Only £8.5.0. 3 valves to suit, 24/- All post free.

ROTARY CONVERTERS 6V input, 250mA output. Only 5½" x 3" x 3". 17/6 each. P. & P. 3/-.

12V MINIATURE ROTARIES. Only 4½" x 2½" overall. Output 360V, 30mA or 310V, 70mA. NEW LOW PRICE 12/6 each or 22/6 for 2. P. & P. 1/6.

SUPER BANDCHECKER AND MONITOR. This new, sensitive, absorption wavemeter is fitted with 0-500 microammeter and is also a most useful phone monitor. Covers 3.5-35 Mc/s in 3 switched bands. only 3 gns.

RACK MOUNTING PANELS. 9" x 5½", 7", 8½" or 10½" black crackle finish, 5/9, 6/6, 7/6 and 9/- respectively, postage and packing 2/-.

PLUG IN NOISE LIMITERS. 3 Position Limiting. No Wiring Required. Ideal on HRO or H.R. Output for PHONES 8/6. P. & P. 1/6.

CERAMIC COIL FORMERS. 2½" x 1¼". IDEAL FOR VFO or P.A. on Mobiles, 1/9 each or 17/6 doz.

BTX. 3½" x 1½" with 32 Grooves for P. Tanks 6/- ea.

TFX. 2½" Dia. 5" WINDING SPACE. Ideal Hi Power Lin. Amps 8/6.

MOSLEY TRI-BAND BEAMS

T33, JR, 3 EL ... £24.15.0
TA32 JR, 2 EL ... £17.10.0
V3 JR, Vertical 3 Band ... £7.10.0

PLACE YOUR ORDER EARLY

AERIAL EQUIPMENT

COPPER WIRE. 14g. h.d.: 140' 17/-; 70' 8/6; 7/25 stranded: 140' 10/-; 70' 5/-, plus 2/- P. & P.

RIBBED GLASS INSULATORS. 3" 1/6 each. P. & P. 1/6.

TWIN FEEDER. 300 ohm twin ribbon feeder, similar K25, 6d. per yd. K358 Telcon (round) 1/6 per yd. Post on above feeder and cable 1/6 any length.

SUPER AERIAL CABLE 1/8 per yd. P. & P. 1/6.

CERAMIC FEEDER SPREADERS. Type F.S. 6" 10d. each or 9/- doz. P. & P. 2/-.

CERAMIC "T" PIECES. Type AT for centre of dipoles, 1/6 each. P. & P. 1/-.

NEW MOSLEY POWER BEAMS. Write for details. 300 watt, 50 ohm COAX, ½" dia., very low loss, 1/6 yd. P. & P. 1/9.

CHAS H. YOUNG LTD (Dept. R)

110 DALE END BIRMINGHAM 4
(Tel. all departments) CEN 1635

REPANCO TRANSFORMERS FOR 10 WATT TRANSISTOR AMPLIFIERS

Type TT23 Interstage Transformer Ratio 4:1+1
Secondary Resistance 2+2 ohms **22/6**
Primary Resistance 3.5 ohms (P.P. 1/6)
Secondary Bifilar Wound

Type TT24 Output Transformer Ratio 1.3+1.3:1+1
Secondary Resistance 0.2+0.2 ohms **22/6**
Primary Resistance 0.6+0.6 ohms (P.P. 1/6)
Primary Bifilar Wound. 15 ohm or 3.5 ohm output

Stack Size of Both Types 2¾" x 2½" x 7⁄8"
Boxed Complete with 10 watt Amplifier Circuit

MAIL ORDER and TRADE
RADIO EXPERIMENTAL PRODUCTS LIMITED

33 Much Park Street Coventry
Telephone 27114

WHOLESALE and EXPORT
REPANCO LTD

O'Brien's Buildings
203-269 Foleshill Rd. Coventry
Telephone 24224

ILFord 6001/3



REPLACEMENT REBUILT T.V. TUBES

H.P. Terms Available

21" 99/6 17" 90/-

15", 14", 12" 70/-
Ins. carr. 15/6

12 months guarantee

£1 extra without old bowl, refundable if same received within 14 days

14" TV TUBES

14KP4 35/- 36/24

Due to purchase of renter's replacement stocks. Carriage 5/-

17 inch £11.10.0

Excellent table models. ITA/BBC. Famous manufacturer. 12 months guarantee. Terms available. Personal collection advised or delivery rate by arrangement up to 50 miles, or despatched in 3 parcels for easy assembly. Carr. 25/-

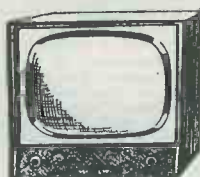

Ex-RENTAL SETS

14 inch £7.10.0

ITA/BBC. As 17" Ideal for caravans, chalets, weekend bungalows, etc. Personal collection advised. Special delivery rate by arrangement up to 50 miles, or despatched in 3 parcels for easy assembly. Carr. and Ins. 20/-

DUKE & CO. (London) LTD 621/3 ROMFORD RD MANOR PARK E12

TAPE AMPLIFIER £7.19.6



Compact well designed 5 valve amplifier. Output 3.5W. Input for microphone, gram and radio. Size 8½" x 3" x 4½". Ins. Carr. 4/6. 12 months guarantee. Dial plate 3/6. Knobs 2/6 per set.

SCOTCH BOY TAPES

5½" 19/9 7" 25/-
Post Free

CHECK *with these*

BARGAINS

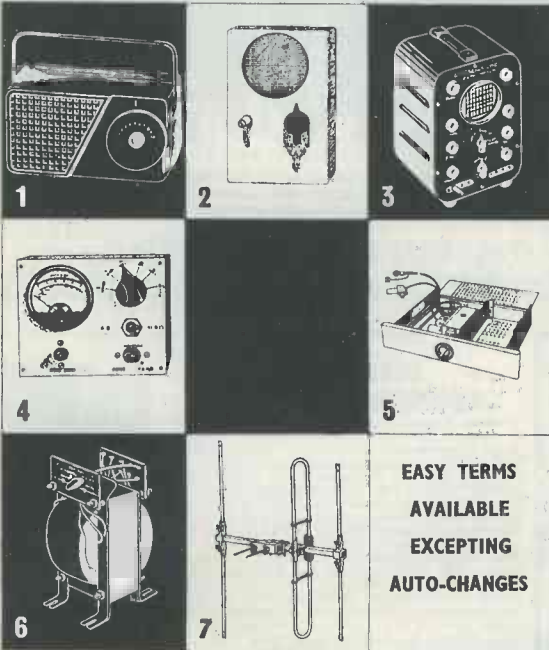

**EASY TERMS
AVAILABLE
EXCEPTING
AUTO-CHANGES**

- 9 **SIGNAL GENERATORS.** Cash £6.19.6 or 25/- deposit and 6 monthly payments of 21/6. P. & P. 5/-. Coverage 100 kc/s to 100 Mc/s on fundamentals and 100 Mc/s to 200 Mc/s on harmonics. Case 10" x 6 1/2" x 5 1/2". Three miniature valves and Metal Rectifier. A.C. mains 200/250V. Internal modulation of 400 c.p.s. to a depth of 30 per cent; Modulated or unmodulated R.F. output continuously variable 100 millivolts. CW. and mod. switch, variable A.F. output. Magic eye as output indicator. Accuracy ± 2 per cent.
- 10 **SIGNAL GENERATORS.** Cash £4.19.6 or 25/- deposit and 4 monthly payments of 21/6. P. & P. 5/-. Coverage 120 kc/s to 84 Mc/s. Case 10" x 6 1/2" x 4 1/2". Size of scale 6 1/2" x 3 1/2". 2 valves and rectifier. A.C. mains 230-250V. Internal modulation of 400 c.p.s. to a depth of 30 per cent modulated or unmodulated R.F. output continuously variable 100 millivolts. C.W. and mod. switch variable A.F. output and moving coil output meter. Accuracy ± 2 per cent.
- 11 **BATTERY RECORD PLAYER AND AMPLIFIER.** 45 r.p.m. "Star" motor "Acos" crystal pick-up, 3 transistor, push-pull amplifier complete with transistors. Output 500 milli watts, 49/6. P. & P. 3/6.
- 12 **8-watt PUSH-PULL 5 VALVE AMPLIFIER.** A.C. mains 200-250V Size 10 1/2" x 6 1/2" x 2 1/2". 5 valves. For use with all makes and type of pick-up and mike. Negative feedback. Two inputs, mike and gram, and controls for same. Separate controls for Bass and Treble lift. Response flat from 40 cycles to 15 kc/s. ± 2 dB; 4db down to 20 kc/s. Output 8 watts at 5 per cent total distortion. Noise level 40 db down all hum. Output transformer tapped for 3 and 15 ohms speech coils. For use with Std. or L.P. records, musical instruments such as guitars, etc. Suitable for small halls, £3.19.6. P. & P. 6/6. Crystal mike to suit 15/-, P. & P. 1/6. 8" P.M. Speaker to suit, 12/6. P. & P. 1/6.
- 13 **B.S.R. MONARCH UAS WITH FULL-FI HEAD.** 4-speed, plays 10 records, 12", 10" or 7" at 16, 33, 45 or 78 r.p.m. Intermixes 7", 10" and 12" records of the same speed. Has manual play position; colour, brown. Dimensions: 12 1/2" x 10 1/2". Space required above baseboard 4 1/2" below baseboard 2 1/2". Fitted with Full-Fi turnover crystal head, £6.19.6. P. & P. 5/-. With Stereo Head £7.19.6. P. & P. 5/-.
- 14 **TRANSISTOR TESTER.** For both P.N.P. and N.P.N. transistors incorporating moving coil meter. In metal case, size 4 1/2" x 3 1/2" x 1 1/2". Scale marked in gain and leakage, 19/6. P. & P. 2/6.
- 15 **PUSH-PULL OUTPUT STAGE** inclusive of transistors with input and output transformers to match 3 ohm speech coil, suitable for use with the POCKET RADIO. Kit of parts, including transistors, 19/6. P. & P. 1/6. Wiring diagram 1/6, free with kit.
- 16 **PORTABLE AMPLIFIER.** On printed circuit for A.C. Mains 200/250V. Size 4" x 3" with tone and volume control. Valves: ECL82 and E280. 39/6. P. & P. 2/6.

- 1 **3-TRANSISTOR POCKET RADIO** with miniature SPEAKER, FERRITE ROD, and 2 GERMANIUM DIODES. The only 3-transistor radio available at the price. Build it in 1 evening! Tunable over M/L waves. Complete with easy-to-follow instructions and all components (less batteries obtainable anywhere 1/3). 27/6. P. & P. 2/-. (All parts available separately.)
- 2 **3-TRANSISTOR SUPER RADIO** with MINIATURE SPEAKER. Plus Germanium Diode and Printed Circuit. Size 3 1/2" x 4" x 1 1/2". Ferrite Rod Aerial. Two Surface Barrier Transistors and one Audio. Tunable over medium and long waves. To build yourself 39/6. P. & P. 1/6. Circuit diagram 1/6, free with kit. All parts of items 1 and 2 sold separately.
- 3 **OSCILLOSCOPE** for D.C. and A.C. APPLICATIONS. A high gain, extremely stable differential Y-amplifier (30 mV/C.M.). Provide ample sensitivity with A.C. or D.C. inputs. Especially suitable for measurements of transistor operating conditions where maintenance of D.C. levels is of paramount importance. Push-pull X amplifier; Fly-back suppression; Internal Time-base Scan Waveform available for external use; pulse output available for checking TV line O/P Transformers, etc. Provision for external -I/P and CRT Brightness Modulation. A.C. mains 200/250V £15.15.0. P. & P. 7/6 or 30/- deposit; plus P. & P. 7/6 and 12 monthly payments of 24/6. FULL 12 MONTHS GUARANTEE INCLUDING VALVES and TUBE.
- 4 **A.C./D.C. POCKET MULTI-METER KIT.** 2" moving coil meter, scale calibrated in A.C./D.C. volts, ohms and milliamms. Voltage range A.C./D.C. 0-50, 0-100, 0-250, 0-500. Milliamms 0-10, 0-100. Ohms range 0-10,000. Front panel, range switch, wirewound pot (for ohms zero setting), toggle switch, resistor and rectifier. 19/6. P. & P. 1/6. Wiring diagram 1/- free with kit.
- 5 **CHANNEL TUNER.** Will tune to all Band I and Band III stations. Complete with P.C.C.84 and P.C.F.80 valves (in series) 1.F. 16-19 or 33-38. Can be modified as an aerial converter (instructions supplied). 32/6, plus 3/6 P. & P. HEATER TRANSFORMER to suit above, 200-250V, 6/-, plus 3/6 P. & P.
- 6 **MAINS TRANSFORMERS.** All with tapped primaries, 200-250V, 0-160 180, 200V, 60 mA, 6.3V 2 amps, 10/6. 350-0-350V, 70mA, 6.3V. 1 amp, 6.3V 2 amp, 10/6. 250-250V 70mA, 6.3V 2 amp, 10/6. P. & P. 3/-, 280-0-280 70mA 6.3V, 2 amp 6.3V, 1 amp, 10/6. P. & P. 3/-. 280-0-280 120mA, 6.3V, 2 amp 6.3V, 3 amp, 17/6. P. & P. 3/-.
- 7 **WOLSEY 3-ELEMENT FOLDED DIPOLE.** I.T.V. Aerial less mounting bracket for external use, complete with 12 yds. of coaxial cable, 15/-, P. & P. 3/6.

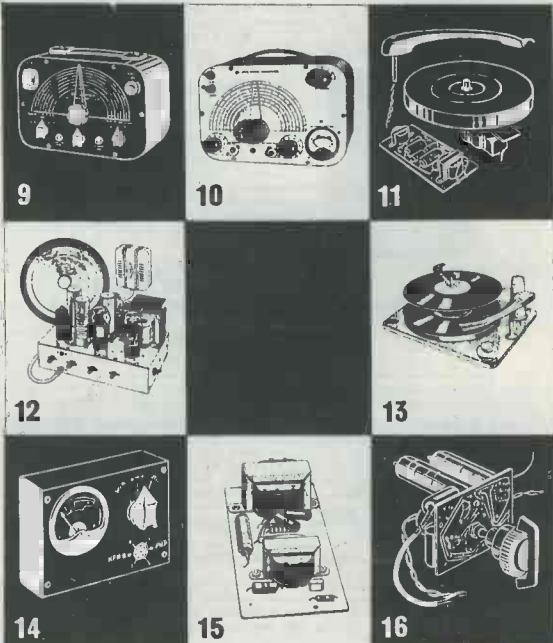

**RADIO & T.V. COMPONENTS
(Acton) LTD.**

**23d HIGH STREET, ACTON,
LONDON, W.3.**

ALL ENQUIRIES S.A.E.
GOODS NOT DISPATCHED OUTSIDE U.K.

FREE TRIAL OFFER!

COYNE'S

NEW JOB TRAINING BOOKS

Put Money-Making Time Saving Know-how at your fingertips!



Shows you the way to easier TV—Radio repair—time saving practical working knowledge that helps you to repair sets faster! How to install service and align ALL radio and TV sets even colour-TV UHF FM and transistorized equipment. New photo-instruction shows you what makes equipment "tick." No complicated maths or theory—just practical facts you can put to use immediately right in the shop or for ready reference at home.

TRY ANY THREE BOOKS ON NO RISK FREE TRIAL

Look over the list of books and select the first three books you would like to examine. Circle the book numbers on the coupon. Additional books you would like to see may be entered on a separate piece of paper and these will be sent to you after completion of the first transaction.

SPECIAL OFFER COYNE ELEMENTARY PRACTICAL RADIO-TELEVISION SET OF THREE VOLUMES total 1,038 pages, sturdy Vinyl washable covers. £3 12s. 6d. the set!

These three volumes present the principles of construction, operation and testing of radio and television equipment in a SIMPLE, EASY TO FOLLOW manner. By using NEW & DIFFERENT methods of explanation these books clearly explain the direct relation between the various parts of sets. This information is especially helpful in repair work where many times a burned out valve, resistor or transformer is actually caused by some other defective part of a circuit. Until the cause of the trouble is removed the parts would continue to burn out. For this reason, each part of the radio or television unit is explained, thus, making the material especially helpful to the experienced radioman, as well as the amateur.

One very important way in which these books differ from many other radio and television books is that the publishers did not try to assume the "extent of technical knowledge" of the reader. Every subject is explained COMPLETELY—while at the same time keeping it brief and to the point.

You will find hundreds of photos, charts, diagrams, etc., in these books. These have been provided to make it easier to understand the explanations. To get this special offer, send no money now, then 12/6d. plus postage, after free examination, and 20/- per month.

No. 9

Pin-point

Transistor troubles in 12 minutes



In this extremely practical handbook, the famous Coyne Check-Chart Trouble-Shooting Method is applied to Transistorized Equipment and includes such subjects as Pre-amplifiers and Hearing Aids; Audio Amplifiers, Portable Sets, and Special Types of equipment. Hundreds of photos, illustrations, diagrams and Check-Charts; Valuable reference, sections. 525 pages. Spiral Binding. Price 47/6. (Please send coupon with order).

No. 4. LATEST INSTRUMENT FOR SERVICING RADIO AND TELEVISION. Coyne.

This up-to-the-minute book tells all about modern radio, TV and electrical testing equipment and how to use it. Money-making short cuts on trouble-shooting, servicing, construction, and other jobs. Over 350 pages, 220 photos and diagrams. Covers Multimeters, Resistors, Ohmmeters, Oscilloscopes and many others. All data has been pre-tested in the Coyne radio shops. Vinyl cloth covers. 26/-

No. 5. PRACTICAL TELEVISION SERVICING AND TROUBLE SHOOTING MANUAL. Coyne.

A book of fast time saving methods for servicing TV receivers. Includes dozens of new testing ideas all of which have been proven on the job. This book shows how radio knowledge can be applied to help solve television problems. Contents include TV servicing methods, TV Servicing Instruments, Tuners, Video I.F., Amplifiers, alignment, etc., with 200 crystal clear photos and diagrams. 437 pages. Washable vinyl cloth covers. Price 34/-.

No. 6. COYNE TELEVISION SERVICING CYCLOPEDIA. Harold P. Manly, Coyne.

Quick and concise answers to TV problems in alphabetical order, cross indexed, fully illustrated, covers hundreds of questions involving radio, TV, electronics operation and repair. 450 illustrations; photos, diagrams, charts, test patterns, etc., 860 pages. Vinyl cloth covers. Price 47/6.

No. 13. TELEVISION EXPLAINED. Miller and Spreadbury.

In simple terms and non-mathematical language gives step-by-step survey of modern television receivers and aerial systems, including AGC and Flywheel Synchronising. 184 pages. 12/6.

No. 8.

COYNE'S NEW

PIN-POINT TV TROUBLES

TAKES HEADACHES OUT OF ALL SERVICING PROBLEMS

Your most useful on-the-job "too"! Quickly and easily pin-points the exact trouble in any TV set. Covers 70 symptoms, 700 trouble spots. Over 340 cross-indexed pages; 50 time-saving Check-Charts; 290 diagrams and photos; explanation of circuits and designs. **SIMPLE CHECK-CHART SYSTEM SAVES TIME**



This amazingly practical handbook shows you how to find the trouble in any TV circuit FAST! Simple cross-index tells you in what section you'll find cause of trouble. Handy Check-Charts then help you accurately locate the EXACT trouble spot. Cut waste time, eliminate hours of aggravation, get right to the heart of the trouble in minutes.

USE THIS BOOK RIGHT ON THE JOB—NO NEED TO MEMORIZE!

This pin-point book was designed especially for on-the-job trouble-shooting. You simply turn to the indexed section, locate the circuit description and Check-Chart, and in minutes you have the trouble spot located and ready for repair. No complicated theory or mathematics. Down-to-earth, practical circuit description, service methods and trouble-shooting techniques. Published by the famous Coyne Electrical School and approved by leading authorities in the field. Price 31/6.

No. 7. TRANSISTOR CIRCUIT HANDBOOK. Louis E. Garner, Jr. Coyne.

A practical Transistor Circuit Reference Handbook by the eminently qualified Louis E. Garner, Jr., one of the greatest writers on transistor applications. Covers Transistor Circuitry, Basic Circuits, Circuit Applications and General Reference Material. Dozens of how-to-do-it illustrations with more than 200 circuit diagrams. Over 400 pages. Vinyl cloth covers. 39/6. (When ordering this book please be sure to clip the coupon).

No. 19. REFRIGERATION SERVICE MANUAL. H. P. Manly.

This manual is primarily an instruction book on accepted methods of servicing and repairing electric refrigerators and refrigeration systems. It covers every operation in field service, performed where the equipment is installed, and also the shop operations which may be performed with the simpler kinds of equipment. 157 illustrations, 343 pages, cloth Price 24/-

NOTE

Any Iiffe or Coyne book is available on time payment plan! Send name of title required.

Just mail coupon for free trial. After 7 days send only low price or return books and pay nothing. If you keep more than one book, send £1 after 7 days and £1 each month until completed (maximum three books). To buy one book send one-half in 7 days, and one-half in 30 days.

LIMITED OFFER! ACT NOW!

To SIM-TECH BOOK COMPANY (U.K.)
Mail Order Division, DEPT. RC5, Gaters Mill, West-End, Southampton, Hants.

Please send me the special Elementary Radio TV Set as per special offer.

Rush the books circled below for 7-day FREE TRIAL as per offer.

9. 4. 5. 6. 13. 8. 7. 19.

Tick here if enclosed full price. Same 7-day money back guarantee

Name

Address

City..... County.....

Postage 1/6, orders under £3. 2/- orders over £3.

"6 plus 1" TRANSISTOR RADIO KIT

UNBEATABLE VALUE!

MANUFACTURERS' CURRENT PRODUCTION OFFER.—A fortunate bulk purchase enables us to offer one of the season's most outstanding bargains in Portable Transistor Radio Kits. This kit is a modern sensitive quality circuit Receiver Unit with all the latest features. Six BVA transistors and 1 diode, printed circuit, Med. and Long waves. Ferrite aerial, car radio input 500mW, push-pull output into 3 ohm speaker, calibrated dial and slow-motion tuning, etc. Size approx. 8" x 2 1/2".



KIT of Parts including 5 gns. printed circuit, Set of 6 Transistors and 1 Diode 45/- P. & P. 2/6. 3 ohm Speaker 7" x 3 1/2"—ONLY 15/6. P. & P. 1/6. Send 3d stamp for full details. Circuit and Instructions 1/6. Cabinets 25/- extra.

BARGAIN OFFER Complete Kit £6/19/6 less Speaker Carr. 2/6

New Boxed	VALUES	All Guaranteed	Electrolytics	All Types New Stk.
1R4	6/-	ECC83 8/-	PCC84 9/6	25/25V 1/9
1R5	7/6	ECL82 10/6	PCF80 9/6	50/12V 1/9
1S5	7/6	ECL80 10/6	PCF83 12/6	50/50V 2/-
354	7/6	EF80 8/-	PCL84 12/6	100/25V 2/-
3V4	7/6	EF86 12/6	PL81 12/6	8/450V 2/3
DAF96	9/-	EL84 8/6	PL82 9/6	4/350V 2/3
DF96	9/-	EY51 9/6	PL83 10/6	16+16/450V 5/6
DK96	9/-	EY86 10/6	PY32 12/6	32+32/450V 6/6
DL96	9/-	EZ81 7/6	PY81 9/6	60+250/ 275V 12/6
ECC81	8/-	GZ32 12/6	PY82 7/6	Ersin Multicore Solder 60/40 3d.
ECC82	8/-	EM81 9/6	U25 12/6	per yard. 1/6. 2/6, etc.

RECORDING TAPE—BARGAIN PRICES
Famous American Columbia (CBS) Premier Quality Tape at **NEW REDUCED PRICES.** A genuine recommended Quality Tape —TRY IT! Brand new, boxed and fully guaranteed. Fitted with leader and stop foils.

Standard	Long Play	Double Play
5" 600ft, 15/-	900ft, 19/6	1,200ft, 31/6
5 1/2" 900ft, 16/6	1,200ft, 22/6	1,800ft, 39/6
7" 1,200ft, 21/-	1,800ft, 32/6	2,400ft, 47/6

Post and Packing, per reel, 1/-, plus 6d. each for additional reels.
SPECIAL OFFER—3" mfrs. surplus tape, 225ft, 5/6. P. & P. per reel 6d. Plastic Tape Reels, 3" 2/6, 5" 3/-, 5 1/2" 3/3, 7" 3/6.

Volume Controls—5K-2 Meg-ohms, 3" Spindles Morganite Midget Type. 1 1/2" diam. Guar. 1 year. LOG or LIN ratios less Sw. 3/-. DP. Sw. 4/6. Twin Stereo less Sw. 6/6. D.P. Sw. 8/-.

COAX 80 OHM CABLE
High grade low loss Cellular air spaced Polythene—1/4" diameter. Stranded cond. Famous mfrs. Now only 6d. per yard. Bargain Prices—Special lengths 20 yds. 9/- P. & P. 1/6. 40 yds. 17/6. P. & P. 2/-. 60 yds. 25/- P. & P. 3/-. Coax plugs 1/-. Sockets 1/-. Couplers 1/3. Outlet Boxes 4/6.



Tape Recorder Kit Special Offer
Latest 5 valve circuit based on Mullard's design. Magic eye and tone controls. Printed circuit already wired. A sensitive quality recorder. **B.S.R. Amp. Kit 95/-**. **B.S.R. Tape Deck £8.10.0**. **Collaro Amp. Kit £6.5.0**. **Collaro Tape Deck £12.10.0**. Set of 5 valves 45/- Special Unit Kit Prices—Send stamp for detailed list. Construction and circuit details 2/6. Bargain Complete Kit £16/10/0 Carriage 4/6.

Condensers—Silver /Mica. All values, 2pF to 1,000pF, 6d. each. Ditto, Ceramics 9d. Tub. 450V T.C.C., etc. .001 mfd., .01 and .1/350V, 9d. .02-.1/500V 4/- .25 Hunts 1 1/6 .5 T.C.C. 1/9, etc., etc. **Close Tol. S/Micas**—10%, 5pF-500pF 8d. 600-5,000pF 1/- 1% 2pF-100pF 9d. 100pF-500pF 11d. 575pF-5,000pF 1/6. **Resistors**—Full Range 10 ohms-10 megohms 20% 1/4 and 1/2 W 3d., 1/2 W 5d. (Midget type modern rating) 1W 6d., 2W 9d. **Hi-Stab** 10% 1/4 W 5d., 1/2 W 7d. 5% 1/4 W 9d., 1% 1/2 W 1/6. **W/W Resistors** 25 ohms to 10K 5W 1/3, 10W 1/6, 15W 2/-. **Pre-set T/V Pots.** W/W 25 ohms-50 K 3/-. 50 K-2 Meg. (Carbon) 3/-.

JASON FM TUNER UNITS
Designer-approved kits of parts:
FMT1, 5 gns. 4 valves, 20/-
FMT2, £7. 5 valves, 37/6.
JTV MERCURY 10 gns.
JTV2 £13.19.6. 4 valves, 32/6.
NEW JASON FM HANDBOOK, 2/6. 48 hr. Alignment Service 7/6. P. & P. 2/6.

Speakers P.M.—3 ohms 2 1/2" Elac 17/6. Goodmans 18/6. 5" Rola 17/6. 6" Elac 18/6. 7" x 4" Goodmans 18/6. 8" Rola 20/-, 10" R. x A. 25/-, 9" x 6" Goodmans 25/-, E.M.I. Tweeter 29/6.



Send for detailed bargain lists, 3d. stamp.

We manufacture all types Radio Mains Transf. Chokes, Quality O/P Trans., etc. Enquiries invited for Specials, Prototypes for small production runs. Quotation by return.

RADIO COMPONENT SPECIALISTS

70 Brigstock Rd Thornton Heath Surrey Hours: 9 a.m.-6 p.m., 1 p.m. Wed. THO 2188. Terms C.W.O. or C.O.D. Post and Packing up to 1/6, 7d.; 1/6, 1/1; 3/6, 1/6; 5/6, 2/-; 10/6, 2/9.

Speaker Fret—Expanded bronze anodised metal 8" x 8" 2/3, 12" x 8" 3/-, 12" x 12" 4/6, 12" x 16" 6/-, 24" x 12" 9/-, 36" x 12" 13/6, etc. etc.

TYGAN FRET (contemp. pat.)
12" x 12" 2/-, 12" x 18" 3/-,
12" x 24" 4/-.

BARGAINS 4-SPEED PLAYER UNITS
Single Players carr. 2/6
Garrard 4 S.P. £6.19.6
Garrard TA Mk. 2 £7.19.6
Collaro "Junior" 75/-
B.S.R. (TU9) 79/6
E.M.I. Junior 89/6
Auto-Changers carr. 4/6
Garrard RC210 £10.10.0
Collaro "Conquest" £7.15.0
B.S.R. (UAB) £6.15.0
B.S.R. (UAB Stereo) £6.19.6
B.S.R. (UA14) £7.19.6

SINGLE SCREENED LEAD—Standard size, 8d. yd.; Ditto Lightweight for Pick-up, etc., 7d. yd.; ditto lightweight for PVC sheathed, 9d. yd.; Twin screened sheathed, 1/- yd.

VALVE HOLDERS—Paxolin: Int. Oct., EF50, VR92, 6d. each; Eng. and Amer. 4, 5 and 7 pin, etc., 1/- each; Moulded: Int. Oct. Mazda Octal, 7d. each; B12A (CRT), 1/3; B8G, 9d. each; Nylon or Moulded Ceramic: B7G, B9A skirted, 9d. each; B7G, B9A skirted, 1/- each; B7G with Can, 1/6 each; B9A with Can, 1/9 each; EF50, B7G, 1/- each; B9A ditto, 1/3 each.

ENAMELLED COPPER WIRE—1/6 reels: 14g-20g, 2/6; 22g-28g, 3/-; 30g-40g, 3/9. Other gauges quoted for.

PVC CONNECTING WIRE—10 colours (for chassis wiring, etc.)—Single or stranded conductor, per yd., 2d.

"POCKET 6" TRANSISTOR RADIO KIT—Med & L/W size

Osmer Ferrite Ae 10/-, Osc. Coil & 3 IF's 22/6. Driver & O/P Trans. 22/- Tuning Gang 10/6. 2 1/2" PM Speaker 17/6. Set 6 Transistors & Diode 45/- Printed Circuit 8/6. Vol. Control 8/- W/C Sw. 3/6. Cabinet & Dial 8/- Resistor Set 5/- Condenser Set 15/- Handbook, full details 1/6.
Complete Kit **REDUCED PRICE £8/10/0** Carr. 2/6

TRANSISTOR COMPONENTS

Midget I.F.'s—465 Kc/s 1/6" diam. 5/6
Osc. Coil—M/W. 1/6" diam. 5/3
Midget Driver Trans. 4.5:1 8/6
Midget O/Put Trans. 19.5:1 8/6
Elect. Condensers—Midget Type 1mfd-100mfd, ea. 1/9. 6V/12V wkg.
Vol Controls—Midget Type with edge Control Knob. 5K, 47K, 1 M/ohm, ea. 2/6.
Speakers P.M.—2 1/2" EMI 3 ohms 17/6. 7" x 4" Plessey 35 ohm 23/6.
Ear Plug Phones—Min. Continental type, 3ft lead, jack plug and socket. High Imp. 8/-, Low Imp. 7/6.

TRANSISTOR BARGAINS

Brand New—BVA 1st Grade
OC44 10/6 873 9/-
OC45 9/6 GET114 6/6
OC81 7/6 OC72 7/6
2/OC81 15/6 OC70 5/6
XA102 10/- OC71 6/-
XA101 9/6 OAO70 2/9
XB103 7/6 GEX34 2/9
XC101 8/6 OAO70 2/9
874 9/6 OAB1 2/9
Surface barrier type SB305 9/6 each All Post Free

SLEEVING—Various Colours 1mm, 2mm, 2d. yd.; 3mm, 4mm, 3d. yd., 6mm, 5d. yd.

CRT. HTR. ISOLATION TRANSFORMERS

New improved types, low capacity small size and tag terminated a.c. 200/250V. Secondaries nil, +25% +50% BOOST for 2V, 4V, 6.3V, 10.5V, 12V or 13V tubes. Each type 12/6 each. P. & P. 1/6.

TRIMMERS, Ceramic (Compression Type)—30pF, 70pF, 9d.; .0005 mfd Midget, 7/6. Transistor Type, J. Bros. 00. Midget Twin Gang 208pF+176pF, 9/-.

PHILIPS, Bee Hive Type (Conc. Air Spaced)—2-8pF, 1/-; 3-30pF, 1/-.

TUNING COND.—Twin Gang by J. B., etc. 365pF Midget, 8/6; .0005 mfd Midget, 7/6. Transistor Type, J. Bros. 00. Midget Twin Gang 208pF+176pF, 9/-.

SINGLE TUNING COND.—Reaction Type, Mica Dielectric, .0001 mfd, .0003 mfd, .0005 mfd, 3/6 each.

Wavechange SWITCHES, Midget Type—2 pole 2 way, 1 pole 6 way, 2/6 each; 1 pole 12 way, 2 pole 6 way, 3 pole 4 way, 4 pole 2 way, 4 pole 3 way, 3/6 each.

FUSE HOLDERS—Chassis Type: Single, 6d.; Double, 9d.; Panel Mounting Bulgin Type, 1/9.

FUSES—Cartridge Type, Standard 1 1/2". All standard values 6mA-10mA, 4d. each.

MAINS NEON TESTER—Vest Pocket Screwdriver with Neon Indicator. For Mains 200/250V and ignition Testing. New Reduced Price, 2/9.

KNOB—Modern Continental types: Brown or Ivory with Gold Ring, 1" dia, 9d. each; 1 1/2", 1/- each; Brown or Ivory with Gold Centre, 1" dia., 10d. each; 1 1/2", 1/3 each. LARGE SELECTION AVAILABLE.

METAL RECTIFIERS, STC Types—RM1, 4/9; RM2, 5/6; RM3, 7/6; RM4, 16/-; RM5, 21/-; RM4B, 17/6.

STC RECTIFIERS—E.H.T. Type Fly-back Voltages: K3/25, 2kV, 5/-; K3/40, 3.2kV, 6/9; K3/50, 4kV, 7/9; etc.

WESTINGHOUSE—Contact Cooled: FC116, 250V, 60mA, 11/9; FC101, 250V, 200mA, 21/-; FC31, 250V, 300mA, 28/6.

SIEMENS TYPES—Contact Cooled: 250V, 50mA, 7/6; 250V, 85mA, 10/-; 250V, 125mA, 15/-; 250V, 300mA, 26/6.

★ VALVES New Tested & Guaranteed

1R5 6/6	6X4 7/6	DK92 7/6	EL84 8/-
1S5 6/6	6X5GT 6/6	DK96 8/-	EL91 7/6
1T4 4/6	12AH8 10/6	DL92 6/9	EY51 7/6
3S4 6/9	12AT7 6/-	DL94 7/6	EZ40 6/6
3V4 7/6	12AU7 6/-	DL96 8/-	EZ80 6/6
5U4G 6/-	12AX7 7/6	EB91 4/6	EZ81 7/-
5Y3GT 7/6	12BH7 10/6	EBC41 9/6	PL81 13/6
5Z4G 7/6	12K7GT 8/6	EBF80 10/6	PL82 10/6
6AK6 6/6	12K8GT 13/6	ECC81 6/-	PY81 8/-
6AL5 4/6	12Q7GT 6/6	ECC82 6/-	PY82 7/-
6AM6 4/-	25A6G 10/6	ECC83 7/6	PCC84 9/6
6AT6 7/6	25L6GT 9/-	ECC84 7/6	PCF80 9/-
6BA6 8/6	35Z4GT 8/6	ECF82 7/6	PCF82 11/-
6BE6 7/6	35L6GT 9/6	ECH81 10/6	PCL82 7/6
6BR7 10/6	5763 10/6	ECH42 8/6	R19 12/6
6BW6 8/6	DAF91 6/6	ECL80 9/6	U76 8/6
6J7GT 8/6	DAF96 8/-	EF41 8/6	UBC41 10/-
6K7G 7/6	DF91 4/6	EF80 8/-	UCH42 10/6
6Q7G 7/6	DF96 8/-	EF86 9/6	UF41 10/-
6SL7GT 8/-	DH76 8/6	EF91 4/-	UL41 8/-
6SN7GT 8/6	DH77 7/6	EF92 5/6	UY41 8/-
6V6G 7/6	DK91 6/6	EL41 9/-	VW76 8/6

MATCHED PAIRS. EL84, 17/-; EL85, 25/-; 6V6G, 17/-; 6BW6, 18/-; KT33C, 19/6; 807 14/6 pair; KT66, 32/6.

SETS OF VALVES

DK96, DF96, DAF96, DL96 "REGENT"	29/6 per set
DK91, DF91, DAF91, DL92, or DL94	21/- per set
1R5, 1T4, 1S5, 3S4, or 3V4	21/- per set
6K8, 6K7, 6Q7, 6V6, 5Z4, "G" Types	27/6 per set
12K8, 12K7, 12Q7, 35L6, 35Z4, "GT" Types	35/- per set
ECH42, EF41, EBC41, EL41, EZ40	37/6 per set
UCH42, UF41, UBC41, UL41, UY41	35/- per set

P.P. OP. TRANSFORMERS. MR 3-15 ohms for EL84, 6V6, 6BW6, etc., 18/6; Op. Pen. 50mA, 5/6; 30mA, 4/6.

P. & P. 6d., over £1 post paid. C.O.D. 2/6

R. COOPER G8BX 32 SOUTH END CROYDON SURREY CROYDON 9186

VOLUME CONTROLS. All values, long spindle. L/S 2/9, s.p. 3/9, d.p. 4/3; ext. spkr. control 3/-.

P.M. SPEAKERS. 3 ohms 5" 14/6, 6 1/2" 17/6, 8" 21/-, 10" 25/-, 12" 30/-; Bakers 12" 15 ohm 15W, 90/-.

COAXIAL PLUGS 1/- each; **SOCKETS** 1/- each.

C.R.T. ISOLATION TRANSFORMERS with nil, 25% and 50% boost, low capacity a.c. mains 200/250V for 2V, 4V, 6.3V and 13V tubes. All 10/6 each. P. & P. 1/6.

VALVEHOLDERS. 4, 5, 7 pin English and U.S.A. B7G, 59A, 10, MO, B8G, 9d. each; B7G, B9A with screening can, 1/6; B12A, 1/3; Aladdin formers 1/2" with core, 8d. each.

JACK PLUGS. Miniature standard 3/-; **SOCKETS** 3/-.

CAPACITORS. Small mica, 5% 1pF to 100pF, 8d.; 120pF to 1,000pF, 9d.; 1,000V wkg., .01, .0015, .0025, .004, .005µF, 1/- each.

CRYSTAL DIODES. G.E.C., 1/6 each.

CERAMIC CAPACITORS. Close tol. 500V for V.H.F., 9d.

PAPER TUBULAR. .001-1 500V, 9d.; .25, 1/-; .5, 1/6; .01 1,000, 1/-.

PAPER BLOCKS. 4µF, 1,000 wkg., 3/6; 4µF 250V, 2/6.

RECTIFIERS. Contact cooled, 250V 50mA, 7/6; 85mA, 9/6.

REACTION CONDENSERS. .0001, .0003, .0005µF, 4/6 each.

HEATER TRANS. 200/240V, 6.3V, 1.5A, 7/6; 3A, 10/6.

RESISTORS. 1/2 and 1/4W, insulated, 4d. and 6d.; 1W, 8d.; 6W W.W., 1/-; 10W, 2/-.

ELECTROLYTICS. Wire ends. 25/25V, 1/6; 50/50V, 2/-; 12/50V, 9d.; 8/450V, 2/-; 16/450V, 2/9; 16/500V, 3/6; 32/450V, 4/-; 8+8/450V, 4/6; 8+16/450V, 4/6; can types; 16/450V, 3/6; 16+500V, 6/-; 32/500V, 6/6; 32/450V, 6/6; 20+20/450V, 4/6; 64+120/275V, 7/6.

WAVECHANGE SWITCHES. Midget: 1p 12W, 2p 6W, 3p 4W, 4p 3W, 4p 2V, long spindles, 4/6.

TOGGLE SWITCHES. QMB, s.p.s.t., 2/-; s.p.d.t., 3/3; d.p.s.t. 3/6; d.p.d.t., 4/-; rotary s.p., 3/-.

CHOKES. 65mA 10H, 5/6; 80mA 15H, 8/6; 100mA, 10H, 10/6; 150mA, 10H, 14/6.

12th EDITION

Illustrated Catalogue

9d. POST FREE

(refunded on first order)

U.K. and H.M. Forces anywhere

56 pages photographically illustrated on art paper. Over 2,000 new and guaranteed lines by the leading makers. Money back if not absolutely delighted. No junk or ex-Government goods.

More and more constructors looking out for a better service are becoming regular clients. When you want the best makes, the odd or difficult item with prompt attention consult our catalogue.

All orders dealt with by return

SOUTHERN RADIO & ELECTRICAL SUPPLIES

So-Rad Works

Redlynch Salisbury

The "Argonaut" (RR3)

The popular AM/FM Tuner Receiver based on one of the proved attested Jason designs 2/- (postage 4d.)

The "Eavesdropper" (RR4)

3-Transistor local station pocket receiver

1/6 (postage 2d.)

A Versatile 2-Valve Audio Pre-Amplifier (RR7)

—A Mullard design. Complete with circuit and main component layout, together with photographic illustrations 1/- (postage 2d.)

High-Gain Band-III Pre-Amplifier (RR8)

Improve poor I.T.V. reception with this simple but effective booster. 1/- (postage 2d.)

The Cooper-Smith "Prodigy" 6-Watt High Fidelity Amplifier (RR10)

Includes the latest modifications. Much additional material is also included, among this being a circuit for a microphone pre-amplifier, signal sources, and choosing a loudspeaker 2/6 (postage 4d.)

Obtainable from

DATA PUBLICATIONS LTD

57 MAIDA VALE . LONDON W9

FREE TO AMBITIOUS ENGINEERS

— THE LATEST EDITION OF ENGINEERING OPPORTUNITIES

Have you sent for your copy?

ENGINEERING OPPORTUNITIES is a highly informative 156-page guide to the best paid engineering posts. It tells you how you can quickly prepare at home for a recognised engineering qualification and outlines a wonderful range of modern Home Study Courses in all branches of Engineering. This unique book also gives full details of the Practical Radio & Electronics Courses, administered by our Specialist Electronics Training Division—the B.I.E.T. School of Electronics, explains the benefits of our Employment Dept. and shows you how to qualify for five years promotion in one year.

We definitely Guarantee "NO PASS — NO FEE"

Whatever your age or experience, you cannot afford to miss reading this famous book. If you are earning less than £20 a week, send for your copy of "ENGINEERING OPPORTUNITIES" today—FREE.

BRITISH INSTITUTE OF ENGINEERING TECHNOLOGY (Incorporating E.M.I. Institutes)
(Dept. SE/23), 29 Wright's Lane, London, W.8

THE B.I.E.T. IS THE LEADING ORGANISATION OF ITS KIND IN THE WORLD

WHICH IS YOUR PET SUBJECT?

Mechanical Eng.,
Electrical Eng.,
Civil Engineering,
Radio Engineering,
Automobile Eng.,
Aeronautical Eng.,
Production Eng.,
Building, Plastics,
Draughtsmanship,
Television, etc.

GET SOME LETTERS AFTER YOUR NAME!

A.M.I.Mech.E.
A.M.I.C.E.
A.M.I.Prod.E.
A.M.I.M.I.
L.I.O.B.
A.F.R.Ae.S.
B.Sc.
A.M.Brit.I.R.E.
City & Guilds
Gen. Cert. of Education
Etc., etc.

PRACTICAL EQUIPMENT

Basic Practical and Theoretic Courses for beginners in Radio, T.V. Electronics, Etc., A.M.Brit.I.R.E. City & Guilds, Radio Amateurs' Exam., R.T.E.B. Certificate, P.M.G. Certificate, Practical Radio, Radio & Television Servicing, Practical Electronics, Electronics Engineering, Automation.

INCLUDING TOOLS!

The specialist Electronics Division of B.I.E.T. (Incorporating E.M.I. Institutes) NOW offers you a real laboratory training at home with practical equipment. Ask for details.

B.I.E.T. SCHOOL OF ELECTRONICS

POST COUPON NOW!

- Please send me your FREE 156-page "ENGINEERING OPPORTUNITIES"
- (Write if you prefer not to cut page)
- NAME
- ADDRESS
-
-
- SUBJECT OR EXAM THAT INTERESTS ME



EDDY'S (NOTTM) LTD.

172 ALFRETON ROAD · NOTTINGHAM

New or Surplus Valves guaranteed and tested by return post

AC2/PEN	EF86	9/6	PZ30	9/6	6F33	6/6	7C5	7/6
DD	EF91	3/6	TDD4	7/6	6J5G	2/9	10F1	6/6
DAF96	EL41	7/3	VP23	6/6	6J5GT	3/9	12A6	5/3
DF91	EL91	4/6	VR150/		6J5M	4/3	12AT6	7/6
DF96	EY86	7/9	30	6/9	6J7G	5/-	12K7	5/3
DK91	EZ80	6/-	Z77	3/6	6K7G	1/11	12Q7	5/3
DL96	KT33C	6/6	1D5	7/6	6K8G	5/3	20D1	8/6
ECC81	MU14	7/-	1R5	5/6	6Q7G	5/9	20P1	9/6
ECC82	PCC84	7/6	1S5	4/9	6SG7M	4/9	20P3	12/6
ECC83	PCF80	7/6	1T4	3/11	6SN7GT	4/3	30F5	6/11
ECC85	PCL82	7/6	1L4	3/6	6AC7	4/3	35W4	6/9
ECL82	PEN36C	8/-	5U4G	4/9	6AL5	3/6	35Z4	5/3
EF36	PENA4	12/6	5Y3GT	5/9	6V6G	4/9	954	1/6
EF41	PL33	8/3	5Z4G	7/6	6V6GT	6/-	655	3/6
EF42	PY80	7/-	6B8G	2/11	6X5G	5/11	956	2/6
EF50	PY81	6/6	6C4	3/6	6X5GT	6/11		
EF80	PY82	6/9	6F15	9/6				

POCKET RADIO. 2-transistor with miniature speaker. Complete with all parts, wiring diagram and full instructions. 27/6. Batteries 1/-, P. & P. 2/-.

CAR RADIO. 7 transistors, Long and Medium, 2 watts output. R.F. stage and auto gain control. Size 7 $\frac{3}{8}$ " x 7 $\frac{1}{2}$ " x 2 $\frac{1}{2}$ ", 6 or 12V (state which), supplied with full instructions. 10 $\frac{1}{2}$ gns. Speaker extra, 17/11. P. & P. 5/6.

NIFE ACCUMULATORS. 1.25 V. Size 3" x 2 $\frac{3}{8}$ " x $\frac{7}{8}$ ". 7 amp. hrs. Weight 13oz. 1/11 each. P. & P. 2/- one only. Add 9d. per cell.

THROAT MIKES. 2/- each, post 10d. Could be used for electrifying musical instruments, etc.

ALL ABOVE ARE NEW AND GUARANTEED

Any parcel insured against damage in transit for only 6d. extra per order. All uninsured parcels at customer's risk. Post and Packing 6d. per valve extra. C.W.O. or C.O.D. only. C.O.D. charge 3/- extra. S.A.E. with enquiries.

INSTALLING HI-FI?

'RECORD HOUSING' cabinets are cheaper than you can make them yourself.

MULTIGRAM JUNIOR (illustrated)—price 18 gns. Holds: amp, pre-amp and tuner and a tape deck or turntable, plus 100 records. 36" long, 18 $\frac{1}{2}$ " deep, 14" high, plus 9" legs. Mounting boards measure 17" x 14" and 17" x 20". Mahogany finish.

A larger version—the **MULTIGRAM SENIOR** is 48" long, costs 23 gns.

In the background (see illustration) the matching **VIKING CORNER ENCLOSURE** for 8" Hi-Fi loudspeakers. Floor or wall mounted. Price 10 gns.



Use Record Housing's FREE Hi-Fi Housing Advisory Service. Send details of the equipment you wish to install. We will advise you on how best to house it—handsomely.

Write stating convenient shopping centres, to:—

RECORD HOUSING

Dept. RC. 961,
Brook Road, London, N.22

**OUR
NEW 5 STAGE SUPER SENSITIVE
TRANSISTOR PORTABLE
THE "BOBETTE"**

★ Simple to Build.
★ All first grade components.
A truly portable transistor radio giving full medium wave reception. Incorporates 5" High Flux Speaker, push pull output, first grade transistors, High-Q ferrite aerial, socket for car aerial, pre-tagged circuit board for easy construction. Attractive two-tone case.

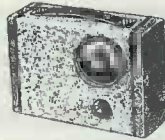

**Total Building Costs
£5. 2s. 6d.**

NO EXTRAS TO BUY
All parts sold separately.
Send 1/6 for itemised price list and full assembly instructions (free with order).

**EXPLORE THE WORLD
ON THIS I-VALVE
SHORT WAVE RADIO**

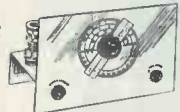

**Total Building Costs only
35/-**
P. & P. 1/6

★ Receives speech and music from all over the world.
★ Construction price includes valve and one coil covering 40-100 metres.
★ Can be extended to cover 10-100 metres.
★ Can be converted to 2 or 3 valve.
Send 2/- for wiring diagram and components price list.

Put your Favourite Programme on tape with the

R.C.S. TAPE TUNER

Will operate on all types of Recorder. Size 3 3/4" x 1 3/4" x 1". High impedance output, variable Med. wave tuning. Triple wound Super-Hi-Q coil. Easily constructed from full instruction data and Layout Diagrams.
(As described in March issue)



**Total building costs
30/-**
P. & P. 1/6

Send 2/- for wiring diagram and components price list.

R.C.S. PRODUCTS (Radio) LTD

11 Oliver Road · London · E17 (Mail Order Only)

**REPANCO
HIGH GAIN COILS**

Dual Range Crystal Set Coil Type DRX1	2/6
Dual Range Coil with Reaction, Type DRR2	4/-
Matched Pair Dual Range T.R.F. Coils Type DRM3, pair	8/-
Pair Dual Range Superhet Coils Type SH4, pair	8/-
Miniature Iron Dust Cored Coils Type "R":			
Range	Aerial	H.F.	Osc.
800-2,000m.	RA1	RHF1	RO1
190- 550m.	RA2	RHF2	RO2
70- 230m.	RA3	RHF3	RO3
15- 50m.	RA4	RHF4	RO4
Ferrite Rod Aerial Dual Range Type FR1	12/6
Miniature I.F. Transformers Type MSE (465 Kc/s), pair	12/6
Standard I.F. Transformers Type TCG (465 Kc/s), pair	13/6

**COILS AND TRANSFORMERS FOR
TRANSISTORISED CAR RADIO**

Medium Wave Aerial Coil Type XMA16	10/-
Medium Wave H.F. Coil Type XMF17	10/-
Long Wave Aerial Coil Type XLA18	6/9
Long Wave H.F. Coil Type XLF19	6/9
Oscillator Coil Type K015	5/-
Interstage Transformer Type TT11	10/-
Output Transformer (12V Radio), Type TT12	12/6
Output Transformer (6V Radio), Type TT13	12/6

Boxed with circuit and practical diagram of all-Transistor Car Radio.

Send S.A.E. for latest Repanco Components Catalogue.

**RADIO EXPERIMENTAL PRODUCTS
LTD**

33 Much Park Street - Goventry

Telephone 27114

Ask "ARTHURS" First

Note new address at

**125 Tottenham Court Road
London WC1**

Close to Warren Street Station

You will have the same service and obtain all your requirements in Radio Components, Electrical Goods, Accessories and Television as previously

Test Instruments in stock include
AVO · ADVANCE · COSSOR · TAYLOR
List on request

Est. 1919.

ARTHURS FIRST

Proprietors ARTHUR GRAY LTD

**GRAY HOUSE
125 TOTTENHAM COURT ROAD
LONDON WC1**

Telephone EUSton 5802/3/4

P.W. POCKET SUPERHET

**TRANSISTORISED PRINTED
BOARD**

A-Z CONSTRUCTIONAL BOOKLET 1/6
including "BLOWN-UP" DIAGRAM

SIMPLE MODIFICATIONS TO
ABOVE GIVING BOOSTED
PERFORMANCE FREE ON
REQUEST WITH S.A.E.

NEW CONTEMPORARY CASE

★ ★ ★

Ask your Dealer or write for Illustrated
Price List and Free Information

OSMOR RADIO PRODUCTS LTD

418 BRIGHTON ROAD SOUTH CROYDON
SURREY

Telephone CRO.5148/9

SMALL ADVERTISEMENTS

Private: 3d. per word, including address.
Minimum charge 2/6.
Use of Box Number, 2/- extra.

Trade: 9d. per word. Minimum charge 12/-.
Terms: Cash with order.

All copy must be received by the 6th of the month for insertion in the following month's issue. The Publishers cannot be held liable in any way for printing errors or omissions, nor can they accept responsibility for the *bona fides* of advertisers.

PRIVATE

STUDENTS preparing for the R.T.E.B. intermediate examination given expert private tuition in radio theory. Terms reasonable.—J. Armstrong, 185 North End Road, London, W.14.

FOR SALE. Airmec Televet, type 877. The complete television test instrument, with manual. £30 or nearest. Further details on request.—Clark, 106 Albert Avenue, Hull, East Yorks.

TO REPLACE missing loaned volumes, wish to purchase Vol. 21 *Chemistry Engineers* from Newnes "Electrical Engineers" series. Also Vol. 11 1957/58 *The Radio Constructor*.—Croft, Railways Laboratories, Box 703, Bulawayo, Southern Rhodesia.

FOR SALE.—Perdio Mini-six pocket transistor radio. Brand new. £9 10s. (list £12 1s. 6d.)—Box No. F.131.

FOR SALE. CR100/2. Good condition, N/L, manual, £15.—
Hunt, 18 Fir Tree Walk, Market Harborough, Leics.

FOR SALE. ECL82 amp inc. L.S. 47s.; record player cabinet 17s.; Collaro T.T. plus pickup 53s.; Oscilloscope; also various components. S.A.E.—5 Old Lane, Knebworth, Herts.

FOR SALE. To clear—Valves, at 7s. 6d. each: 5Y3GT, 5R4GT, XFG1, RG1-240-A, 6BW6, 83, T20, VT136, 955 with base. At 4s. 6d.: 6AT6, 6SA7, 6SK7, 6AG7, 6BA6, VR150/30, DL92, IS5, EL91, IS4, 6V6, 5Z4GT, 12AT7, 3M4, ECC82. At 2s. 6d.: 6AG5, 6K7, VR91, 6B8, CV51. New accumulators: Willard Radio-20-2, 2 volt 7s. 6d.; Varley Dry VPT, 2 volt 10s. Bell transformers, 200/250V a.c. in., 4-6-12V out. 7s. 6d. Mic. transformer, Woden MT101, 7s. 6d. Rotary transformers: 12V in. 480V 40mA out. 12s. 6d.; 12V in. 285V 60mA out. 17s. 6d. Labgear Tx coils p.p. DSL 21 and 14, 5s. each. Headset adaptors MC-385-A, high to low impedance 5s. 10 watt mod. choke 7s. 6d. Ditto, transformer, 7s. 6d. Linear L45 watt qual. audio amplifier, 200/250V a.c., £5. Emco-Unimat universal miniature machine tool, many extras, £25. Prices shown include postage and packing.—"East Keal", Romany Road, Oulton Broad, Suffolk.

FOR SALE. Mullard/Stern stereo 3/3 dual channel amplifier and stereo dual channel pre-amp. Both tested and modified by Sterns. For quick sale £12 o.n.o.—26 Towers Way, Leeds 6.

TRADE

LEARN RADIO AND ELECTRONICS the NEW Practical way. Very latest system of experimenting with and building radio apparatus—"as you learn".—FREE Brochure from: Dept. RC10 Radiostructor, Reading, Berks.

FREE FROM THE I.P.R.E. Syllabus of famous radio and t.v. courses. Membership conditions booklet, 1s. Sample copy *The Practical Radio Engineer*, 2s. post free.—Secretary, 20 Fairfield Road, London, N.8.

MORSE CODE TRAINING. Special courses for Beginners. Full details from (Dept. R.C.) Candler System Company, 52 Abingdon Road, London, W.8.

PANL, recognised for many years as the unique one-coat black crackle finish. Brush applied, no baking. Available by post in eighth-pint cans at 3s. 9d. from G. A. Miller, 255 Nether Street, London, N.3.

continued on page 159

Red Spot Transistors 2/3; White Spot 2/3; Yell./Gr. 3/3; Ediswan XA102 (Mixer Stage) 9/-; XA104 (I.F.s) 8/-; XA103 (I.F.s) 8/-; XB104 (A.F.) 6/-; Mullard OC71 6/6; OC72 8/-; OC44 11/-; OC45 10/-; Bargain sets 6 Transistors plus Diode—Ediswan 42/6, Mullard 47/6, Newmarket 42/6. P.W. Superhet complete Kit £7.15. (Ediswan or Newmarket transistors); £8.5. (Mullard transistors). Diodes 1/-, 2/-, 3/-; Sub. Min. Electrolytics 1, 2, 4, 8, 10, 16, 32µF 2/- each. Ardenite Trans. D239 8/6; D240 8/6; D131 10/-; D132 10/-. Balanced Inserts (as earpiece or speaker) 3/6; Silicon Rectifier 70 p.i.v. ½ A 3/3; Westalite Contact Rectifier 250V 60mA 7/6; Transformer 250-0-250V, 6V and 5V 15/-. Garrard Record Player Motor (45 r.p.m.) and Pick-up for Transistor Amplifier 70/-; Meter 200mA M.C. F.M. 2½" 12/6; 5A R.F. (2mA) 8/6; Hearing Aid Mike 31/6; Super Coax. 75 ohms 6d. yd; Valves 6X5 5/6, 6V6 5/6, 1L4 5/6; Speaker 18/6; Electrolytics: 8µF 500V 2/3; 8+½µF 3/3; 100+100 (375V) 3/9; V. Cond. 0.0005 T. Gang, Trimmers and Slow M. 9/6; Transistor Holders 1/-; Resistors 10% tol. 4d.; 5% tol. 9d. Tannoy Mike 5/-. Crystal Inserts (new) 7/6. Gorler Units, 1 watt Amplifier 92/6; I.F. Amplifier (460 kc/s pre-aligned) 92/6; 3 waveband Converter 90/3. Manual No. 167 describing and circuits 2/9 post free.

Terms—Cash with order. Post extra, excess refunded. Our Reflex Rx, best 2-transistor Receiver. Send 8d. stamps for notes.

MOORE'S EXPERIMENTAL SUPPLIES

8 & 10 GRANVILLE ST. SHEFFIELD 2

Telephone 27461

3-TRANSISTOR POCKET RADIO

WITH MINIATURE LOUDSPEAKER

ABSOLUTELY NO SOLDERING REQUIRED

UNIQUE DESIGN



39/6 Superb appearance. Simple instructions. Built in an evening. No drilling. No soldering. Complete in every detail. Full Medium wave coverage. Pocket size 4½" x 2⅞" x 1½"

Or the more powerful **SAVOY SUPER 3 55/6**

No Aerial required

ALL PARTS SOLD SEPARATELY
Battery 1/- extra, P. & P. 2/-

SAVOY BARGAINS

- High gain audio transistors, 4/6; P. & P. 3d.
- Ferrite rod, 4" x ⅝", 1/9; P. & P. 6d.
- Solid dielectric tuning condensers: 0.0003 mfd., 4/-; 0.0005 mfd., 4/3; P. & P. 6d.
- Miniature dynamic speakers. Resistance 30 or 70 ohms, 4/6; P. & P. 9d.
- 5ft phone cord with No. 9 jack plug, 2/-; P. & P. 6d.

SAVOY ELECTRONICS LTD

15 Maiden Lane, Strand, London, W.C.2
(Back of Adelphi Theatre)

H.A.C. THE ORIGINAL SUPPLIERS OF SHORT-WAVE KITS

One valve Super Sensitive All-dry Short-wave Receiver, Model "K". Complete kit including valve and chassis, 77/-. (Other S.W. kits from 25/-) Before ordering call and inspect a demonstration receiver, or send stamped envelope for full specification, catalogue and order form.

H.A.C. SHORT-WAVE PRODUCTS (DEPT. R)
44 OLD BOND STREET LONDON W1

No quantity too small **NYLON P.T.F.E.** List on application

ROD BAR SHEET TUBE STRIP WIRE

Brass Copper Bronze Aluminium Light Alloys

H. ROLLET & CO LTD

6 CHESHAM PLACE SW1 BELGRAVIA 4300
Also at Liverpool, Birmingham, Manchester, Leeds

LEARN RADIO & TV SERVICING

For your own business / hobby by a new exciting no maths system, using practical equipment recently introduced to this country

FREE BROCHURE FROM

RADIOSTRUCTOR

DEPT. G103 · READING · BERKS. 9.61

BLANK CHASSIS

in 18 s.w.g. aluminium, with 4 sides, 2" deep

6" x 4"	4/3	10" x 7"	7/-	12" x 8"	8/-
8" x 6"	5/9	12" x 6"	7/6	14" x 10"	11/6

Post and Packing 1/-

R/C "HILL" TRANSMITTER CASES, complete with chassis. Hammer-grey finish. 39/- P. & P. 3/6

PLASTIC KNOB ESCUTCHEONS, engraved Treble, Bass, Volume, Selector or Mains On/Off 10½d. each or 4/- set of five

also PLASTIC TUNING DIALS, engraved for Long and Medium wave. In red, green, blue, gold or black. 1/- each. P. & P. 6d

SHIREHALL ELECTRONICS LTD.,
Old School Works, Wrotham, Sevenoaks, Kent.

UNREPEATABLE T.V. TUBE OFFER

GENUINE REBUILT

12" Mullard Tube

Only £2.10.0

CARRIAGE 10/- Guaranteed 12 months
Other types available

S.T.S. LTD. 35 Pound Street
Carshalton Surrey
Telephone Wallington 9665

Transistors, Red, White, Yellow Spot types, 2/8.
Neon Test Screwdrivers, 3/6. Insulated Screwdrivers, 6s.
Screwdrivers with built-in Torch, 5/6. Ferrite Rods 8", 3/3. Litesold Soldering irons 10w mains, 21/-.
Condensers .001—.1 uF 9d. Spring Expanding Aerials, 3/-.
Bib cutters, 3/6. Repanco constructional envelopes, 1/6.
Crystal set coils, 2/6. T.R.F. Coils, 8/- pair. F.M. Coil sets, 29/6. Pointer knobs, Black, 9d., White, 1/-.
Sample range of other knobs, 6/- Refundable. L.R. Earpieces, 6/-.
Magnet Torches, 6/11. Unbreakable torch, 3/9. Fuse kits, 17/- box of 72.

Vidicon Camera tubes from £20

Terms—Cash with order. Postage 1/-. Over £3 free.

W. MARSHALL (Radio & TV)
THOMAS STREET SHEFFIELD

UNREPEATABLE OFFER



(Covers Medium Band)

THIS SUPERHET TRANSISTOR RECEIVER CAN BE BUILT FOR ONLY £6.15.6 plus 3/- p. & p. and 2/- battery.

Features:

1. Very easy to assemble.
2. Mullard's six latest transistors and Diode.
3. Printed Circuit.
4. 200 mW Push-pull output.
5. 2½" High flux speaker.
6. Fine leather hide cover.

Circuit diagram and instructions supplied free on order.

SURKITT ELECTRONICS LIMITED
16 Chalcot Square London NW1 Telephone Primrose 3962

TRANSISTORS

G.E.C. Only 42/6 per set, or 1-114, 5/9 each, 1-873, 7/9 each, 2-874, 8/9 each, 1 diode, 1/9 each.
Ediswan XC121 and XB113, 8/9 each. Post 7d. on each.

BRAND NEW VALVES 8/9 each

EL91, EL42, EZ90, EZ40, EF86, ECC81, EF81, EF91, 6V6, ECC33, HL41.
11/9 each—ECC84, EL34, EL37, EL38. Post 7d. on each.

T.V. TUBES 15/- each.

15" CRM153 and 12" CRM121B. Ex-rental service stock. P. & P. 5/-.
17" TV CHASSIS £10.10.0.

All channels guaranteed. Terms available. Carr. 25/-.

P.P. COMPONENTS LTD · 219 Ilford Lane · Ilford · Essex
Stamp for Free Catalogue

SMALL ADVERTISEMENTS

continued from page 157

JOIN THE INTERNATIONAL S.W. LEAGUE. Free Services to members including Q.S.L. Bureau, Amateur and Broadcast Translation, Technical and Identification Dept.—both Broadcast and Fixed Stations, DX Certificates, contests and activities for the SWL and transmitting members. Monthly magazine, "MONITOR", containing articles of general interest to Broadcast and Amateur SWLs, Transmitter Section and League affairs, etc. League supplies such as badges, headed notepaper and envelopes. QSL cards, etc., are available at reasonable cost. Send for League particulars. Membership including monthly magazine, etc., 21s. per annum.—Secretary ISWL, 12 Gladwell Road, London, N.8.

CATALOGUE No. 14. Government surplus and model radio control, over 500 illustrated items, 2s. 6d., (refunded on purchase of £2) post free.—Arthur Sallis Radio Control Ltd., 93 North Road, Brighton.

FIND TV SET TROUBLES IN MINUTES from that great book *The Principles of TV Receiver Servicing*, 10s. 6d., all book houses and radio wholesalers. If not in stock, from Secretary, I.P.R.E., 20 Fairfield Road, London, N.8.

SERVICE SHEETS (1930-1961) from 1s. Catalogue 6,000 models, 1s. S.A.E. enquiries.—Hamilton Radio, 13 Western Road, St. Leonards, Sussex.

"MEDIUM WAVE NEWS". Monthly during DX season.—Details from B. J. C. Brown, 196 Abbey Street, Derby.

THE INTERNATIONAL HAM HOP CLUB is a non-profit making organisation open to RADIO AMATEURS AND SHORT WAVE LISTENERS. OBJECT: To improve international relationships through an organised system of hospitality. MEMBERS offer overnight hospitality to visiting members, subscription 10s. per annum. ASSOCIATE MEMBERS invite radio amateurs to visit their stations. Associate membership 5s. per annum. FAMILY EXCHANGE holidays arranged, also FRIENDSHIP LINKS between radio clubs. The Club's official journal is free to both Full and Associate members.—Hon. Gen. Secretary: G. A. Parridge, G3CED, 17 Ethel Road, Broadstairs, Kent.

VHF UNIT—ready built. Front end f.m. unit. Coverage 85-100 Mc/s, i.f. 10.7 Mc/s. Single valve (ECC85). Price, including circuit and data but without valve, £2 12s. 3d., plus 2s. postage.

VHF TUNER UNIT—ready built without dial and valves. Price, including circuit and data, £6 16s., plus 3s. 6d. postage. Delivery ex-stock.—(Dept. E/1) Rotopons Limited, 54 Beddington Lane, Croydon, Surrey.

SPECIAL AMATEUR LICENCE MORSE COURSE

COMPLETELY NEW METHOD takes all the drudgery out of learning Morse. Passes secured in all cases even after previous failures.

By using **SPECIALLY** prepared recordings (3 speed L.P. player required) students learn automatically and without effort, perfect Morse in half the time required by any other method. Please S.A.E. For Booklet. Tape/Disc/Tape Service also available. **G3HSC, 45 GREEN LANE, PURLEY, SURREY**

SPARES, VALVES, TUBES, 1930-1960

Guaranteed perfect, set tested, ex-working equipment
 6K25 4/6 20P1 4/6 EF80 2/- PL33 4/6 PY81 4/6
 12AT7 3/- 20P3 7/6 EF91 2/- PL38 10/- PY82 4/6
 10C2 4/6 27SU 10/- EL33 4/6 PL81 4/6 PZ30 4/6
 10F1 3/- 185BT 12/6 EL38 4/6 PL82 4/6 U24 7/6
 10P13 4/6 B36 4/6 EY51 4/6 PL83 4/6 U281 7/6
 10P14 4/6 EB91 2/- KT36 4/6 PY31 4/6 PCC84 4/6
 20D1 3/- ECL80 4/6 N37 4/6 PY80 4/6 PCF80 4/6
 20F2 4/6 Pre-war 4-5-7-pin valves, 5/- each.

Postage & packing 6d. per valve. Also old American, side contact, etc. **SPEAKERS, 6", 5/-; Elliptical 7/6. Postage 1/6.**

NEW TRANSISTORS. Red spot, 2/6. OC45, OC72, OC76, 7/6; OC44, 8/6; OC35, OC201, 20/-.

CONSTRUCTOR'S PARCEL. 2 lb. assorted resist., cond., pots., etc., from Radio & TV, 7/6. Postage 2/6.

Send SAE with enquiries or for full list

ST. JOHN'S RADIO 3 Jews Row SW18
 Telephone VAN 8822

2 metre SUPERREGENERATIVE RECEIVER KIT 39/6.

—Write now for details and copy latest catalogue—stamp appreciated to cover postage.

Johnsons (Radio) St. Martin's Gt. Worc.

SURPLUS RADIO SUPPLIES

2 LAING'S CORNER MITCHAM SURREY

CV45 Voltage Stabilisers (equivalent to S130P) stabilises at 120V 5/-

Relay (single pole change over) 250 ohms. 4 mA. Can be adjusted to work down to 1½ mA. Size 2½" x 2½" x 1½" 5/-

Small Electric Motor size 7/8" x 5/8", reversible 5/-

Transistor Transformers. Interstage and output, per pair 10/-

1/- p. & p. per parcel

Send 1/6 for catalogue

Quality Components FOR CONSTRUCTORS

capacitors, resistors, coils, valves, diodes, controls, chassis, transformers, speakers, pick-ups, cartridges, stylis and all types of components in stock.

CONSTRUCTIONAL PUBLICATIONS

Mullard Circuits for Audio Amplifiers	8/6
Mullard Tape Pre-amp "C"	2/6
Quality Amplifiers, 7 designs	4/6
Jason F.M. Variable Tuners	2/6

Price lists available on request

J. T. FILMER

82 DARTFORD ROAD
 DARTFORD KENT
 Telephone Dartford 24057

RADIO AMATEURS ...

Get your Licence in

Half the Usual Time!

You must be a good Morse operator!

A "slap-dash" 12 w.p.m. neither satisfies the authorities, yourself, nor your operator friends. Morse operating is an exacting art unless your training is made simple and is based on sound fundamentals. For this reason the Candler System was invented to take the "grind" out of Code tuition, turning a tricky subject into a pleasurable pursuit.

★ Send 3d. stamp for the "Book of Facts"

CANDLER SYSTEM CO

(Dept. 55 RC) 25b Abingdon Road, London, W8
 Candler System Company, Denver, Colorado, U.S.A.

★ Crystal Lapel Microphone, ideal for portable tape recording, 17/6. P.P. 1/-.

★ Siemens High Speed Sealed Miniature Relay, 1700-1700 ohms, 15/- ea.

★ 2½in. 10 ohm Speaker, 17/6.

★ Pocket Iron, 220/250V A.C./D.C. 30 watts, complete with mains plug, case, etc. Handle unscrews to cover element enabling iron to be carried in pocket. Only 18/6. P.P. 1/-.

★ 1000 ohm Personal Phone with Leads and Jack Plug and Socket, suitable for most Commercial Transistor Radios, 15/6.

★ 9.065 Mc/s 3rd Overtone Crystal for all 27 Mc/s Model Control Transmitters, 12/6.

★ 7 section chromed Telescopic Aerials, 38in., with fixing bracket, 12/6. P.P. 1/6. 64in version, 17/6. P.P. 1/6.

★ 2½in. 80 ohm Speaker, excellent quality, 17/6. P.P. 9d.

★ 600 ohm Personal Ear Phone with jack and socket, 10/6. P.P. 9d.

★ 1 Watt Push-Pull Transformers for OC81 Transistors, 3 ohm, 21/- P.P. 1/-

ALL COMPONENTS IN STOCK for "WEYRAD" 6-Transistor Superhet. Booklet 1/3 post free.

Leaflet on request.

★ 1½in Square Poly. 2-gang Tuner with Trimmers, 17/6.

★ Sub-miniature Jack Plug and Socket, 3/6 complete.

★ Quartz Crystals Over 600 types in stock for all purposes—fully guaranteed.

Free List on Request

★ Sub-miniature 27 Mc/s 3rd Overtone Xtal for model control, 30/-.

★ Personal Earphones used with RANGER 2 and 3, British made, 12/6.

★ 2½in round 1½in deep, 3 ohm speaker, 15/- P.P. 1/-

★ Diodes: GD3, 2/-; OA70, 3/-; OA81, 3/-; OA91, 3/6; OA10, 8/-; OA85, 3/-; OA79, 3/-; GJ7M, 4/-; Z2A47F, 15/-.

★ DECCA AMPLIFIER ★ Portable Record Player Amplifier with tone and volume controls.

59/6 P.P. 2/-

● Fully Guaranteed ●

★ Jackson "OO" Tuner, 208+176, 9/6.

★ ½in square 365pF Tuner, U.S.A. Poly type, 8/6.

★ Crystal Mic. Inserts, 2in, 12/6; 1½in, 7/6; ½in, round or square 3/6. P. P. 6d.

★ Set of OSC. and 3 IFs. Size 7/8 x 7/8 x ½in, 21/-.

★ Mercury Batteries: 1.3V, 2200mA/H, 8 x 1in dia, 2/6; 1.3V, 5000 mA/H, 2 x ½in dia, 2/6; 1.3V, 500mA/H, 8 x ½in dia., 1/3; 1.3V, 14000mA/H, 2½ x 1½in dia, 5/-.

★ Low Impedance Mic. Inserts, approx. 2000 ohms. ½in dia. 15/-; 3/8 x ½in, 12/6; 3/8 x ½in, 10/- 1½ in diam., 15/-.

★ LARGEST RANGE OF STANDARD AND MINIATURE COMPONENTS IN THE COUNTRY.

★ 7 x 4in, 25 ohm Speaker, 22/6; 7 x 4in, 3 ohm Speaker, 20/-.

★ Miniature ½in diam x 7/8in edge volume controls with switch: 5k and 10k, 7/6 each; 5k, 10k, printed circuit, 7/6 each. 50k, 8/6.

★ Driver and Output Transformer (matched to 8/10 ohms), 12/6 pair.

★ 2½in 10 ohm Speaker, 17/6.

★ 5in 25 ohm Speaker, 25/-.

★ Submin. Condensers. All low voltage: 0.1, 0.25, 0.5, 1, 2, 4, 6, 8, 10, 16, 25, 30, 50, 100 mfd. All types, 2/- each.

★ Standard Miniature: 1, 2, 4, 8, 10, 25, 30, 50, 100, 200, 250, 500 mfd. All types, 1/6 each.

★ Large range of Transformers for all purposes. Let us quote for your circuit.

★ 3in speaker, 3 ohm, 15/-; 3in, 25 ohm, 22/6; 5in, 3 ohm, 15/-.

★ Ferrite Rod—1st Grade: 4 x 7/8in, 1/6; 5 x ½in, 1/6; 8 x 7/8in, 3/6; 8 x ½in, 3/6; 4 x 1½in slab, 2/-.

★ Standard Volume Controls ½in dia, ½in spindle: 5k, 10k, 25k, 50k 100k, 250k, 500k, 1 meg, 2 meg., 3/6, less switch; 4/6 with switch.

★ Miniature Light Weight, 4½ to 5V, 8mA Relay, 24/-.

★ Lightweight 4000 ohm Headphones, 12/6. P. P. 6d.

★ All Parts in stock for "Repanco" Mini-4 Superhet. Booklet, 1/3. Leaflet on request.

Please allow Postage and Packing on all orders.

★ MODEL CONTROL RECEIVERS ★

Lightweight Transistor Receivers for even the smallest model boat, car, train, aircraft, etc. A really fascinating hobby. Any valve type tone transmitter may be used with the "Supertone" range operating on 27 Mc/s radio control.

★ "SUPERTONE—RR4". Relayless Receiver, 4-transistor OC169/OC71/OC72/V15/20IP, giving 300mA current rise. No. relay, couples directly to actuator or servo, etc. Size 2½ x 2 x ½in. All parts 72/6. P.P. 1/6.

★ "SUPERTONE—IC". Single Channel OC169/OC71/OC72 transistors. Output to relay, 18mA rise. 2½ x 2 x 1in. All parts 59/6. P.P. 1/6.

★ "SUPERTONE—3C", 3 Channel Output to 3 Reed Unit, giving 3 Channels. OC169/OC71/OC72 transistors. Size as above. All Parts 59/6. P.P. 1/6.

SEND 6d. STAMP FOR DIAGRAMS AND DETAILS

ALL TRANSISTOR MEDIUM LONG AND SHORT WAVE PRE-BUILT UNITS IN STOCK. FULLY ILLUSTRATED BOOKLET SHOWING USES. 2/6

ALL TRANSISTOR FM TUNER PRE-BUILT UNITS. FULLY ILLUSTRATED BOOK SHOWING USES, 3/6

Opposite Edgware Road Tube Station
OPEN MON. to SAT. 9-6, THURS. 1 o'clock
Telephone: PADDINGTON 1008/9

SEE BACK PAGE

★ TRANSISTORS, STANDARD AND MINIATURE COMPONENTS

We stock the largest range of components in the country for the home constructor.



WE HAVE YOUR ITEM IN STOCK. Just ask and we will quote competitive prices.

POCKET TESTMETER

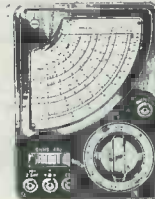

20,000 ohms per volt
Over 20 scales AC/DC resistor etc. A new pocket meter complete with leads, instructions and batteries.

£6.19.6

p.p. 1/6

FULLY GUARANTEED

CRYSTAL MICROPHONES



★ ACOS 39-1. Stick Microphone with screened cable and stand (list 5 gns.), 39/6. P.P. 1/6.

★ ACOS 40 Desk Microphone with screened cable and built-in stand (list 50/-), 19/6. P.P. 1/6.

★ ACOS 45 Hand Microphone with screened lead, very sensitive, 29/6. P.P. 1/6.

★ MC 43 Stick Microphone with muting switch and screened cable, 27/6. P.P. 1/6.
★ Brand New—Fully Guaranteed ★

★ RANGER 2 ★



Personal Pocket Radio

★ Two Transistor Two Diode version of "Ranger-3". See back page. The ideal pocket receiver.

All Parts 59/6 P.P. 1/6

★ PICTORIAL PLANS AND DETAILS FREE ON REQUEST

ADDON AMPLIFIER

250mW push-pull stage with 3-inch speaker. Converts any earphone radio to full loudspeaker.

All parts 59/6. P.P. 1/6

★ Diagrams Free ★

2 WATT POWER AMPLIFIER

★ Designed to boost up the output of Portable Transistor Radios when used in a Car. Works from 6 or 12 volt (state which) Car Battery—uses power transistor. All Parts 49/6. P.P. 2/-.

Type 38, TRANSMITTER RECEIVER

Complete with 5 valves. In new condition. These sets are sold without guarantee but are serviceable

7 to 9 Mc/s 22/6 P.P. 2/6
Headphones, 7/6 pair. Junction Box, 2/6.
Throat Mike, 4/6. Aerial Rod, 2/6.

★ VALVES ★
WE STOCK OVER 800 TYPES OF VALVES AND TUBES AT REALLY COMPETITIVE PRICES. FREE LIST ON REQUEST.

Henry's Radio Ltd
5 HARROW ROAD · LONDON W2

THE MODERN BOOK CO

The Radio Amateur's Handbook. 1961.
32s. 6d. Postage 2s.

20 Suggested Circuits. A Data Publication.
3s. 6d. Postage 4d.

Short Wave Receivers for the Beginner. A Data Publication. 6s. Postage 6d.

Romping through Mathematics. By R. W. Anderson. 5s. Postage 6d.

The Stereo Sound Book. A Focal Publication. 12s. 6d. Postage 9d.

Television Engineers' Pocket Book. By J. P. Hawker. 12s. 6d. Postage 6d.

A to Z in Audio. By G. A. Briggs. 15s. 6d. Postage 9d.

World Radio TV Handbook, 1961 ed.
16s. 6d. Postage 1s.

Model Radio Control. By E. L. Safford. 21s. Postage 1s.

TV Fault Finding. A Data Publication. 5s. Postage 6d.

Introduction to Wireless. By W. E. Pearce. 10s. 6d. Postage 9d.

Reference Manual of Transistor Circuits. By Mullard. 12s. 6d. Postage 1s.

A Beginner's Guide to Radio. By F. J. Camm. 7s. 6d. Postage 6d.

Practical TV Trouble-Shooting. A Gernsback Lib. Publication. 18s. 6d. Postage 9d.

We have the Finest Selection of British and American Radio Books in the Country

Complete catalogue 1s.

19-21 PRAED STREET (Dept RC) LONDON W2

Telephone PADdington 4185

THE RADIO CONSTRUCTOR

BOUND VOLUMES

Volume 14, August 60 to July 61 £1.5.0. postage 1/9
Attractively bound in blue cloth, with gold-blocked spine

Also available:-

Volume 12, August 58 to July 59 £1.5.0. postage 1/9

Volume 13, August 59 to July 60 £1.5.0. postage 1/9

Where all issues of a volume are returned for exchange 12s. 6d. postage 1/9

"Easibinders" for temporary or permanent binding 12s. 6d. postage 9d.

Indexes for volume 14 are now available, price 6d. postage 2d. A limited number are also available for volumes 4, 6, 11, 12 and 13 at the same price.

DATA PUBLICATIONS LTD 57 MAIDA VALE LONDON W9

RANGER - 3



Size 4 1/2" x 3" x 1 1/2"

No External Aerial or Earth
3-TRANSISTOR and 2-DIODES
 PERSONAL POCKET RADIO with
 5 stages giving clear reception on
 medium wave, amateur top band
 and shipping. Only first grade
 components used throughout.
 Amazing results.

ALL COMPONENTS

79/6 P.P. 1/6

Everything Supplied

● Easy to follow instructions
 with pictorial layouts

● Reception of Radio
 Luxembourg guaranteed
 (most areas).

Free Instrs. & Price List on request. Easy to build
 After Sales Service, Guaranteed Success

ALL TRANSISTOR TIME SAVER

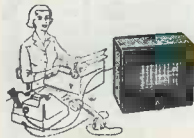

Office or Home Telephone
 PICK-UP AMPLIFIER

★ No more "Holding Up"
 wasting time waiting for
 your call to come through.
 When it does the amplifier
 can be switched off if
 required. No connections,
 just Sellotape the pick-up
 coil to back of phone as
 above.

BUILT, TESTED, READY
 TO USE

£5. 10. 0. P.P. 2/6

● 5" speaker; 3 months' battery life. Now with
 400mW output

● Portable 4-transistor Baby-Alarm as previously
 advertised. But now with 400mW output on 5"
 speaker. Can be used up to 200 yards, **£5.10.0.** P.P.
 2/6. Including battery and microphone. Battery life
 3 to 4 months used every day. Very sensitive.

6 - TRANSISTOR RADIO



Fidelity
"CORONET"

**6-TRANSISTOR MEDIUM &
 LONG WAVE POCKET RADIO**

- Size 2 1/2" x 4 1/2" x 1 1/4"
- Quality Push-Pull Speaker Output
- Guaranteed for 12 months
- Phone and Tape Sockets
- Carrying Case

ALL BRITISH DESIGN AND
 CONSTRUCTION



9 1/2 gns.

Reg. Post 2/6
 Incl. Battery

**3-TRANSISTOR AND
 DIODE PERSONAL
 POCKET RADIO**



SUPER - 3

A simple to build local station
 radio with personal earphone
 output. Built-in Ferrite Aerial
 and Battery lasting 9 months.

ALL PARTS

37/6 P.P. 1/6

● NO EXTRAS TO BUY
 Size 4 1/2" x 3" x 1 1/2"

● IDEAL for BEGINNERS

Quality output on
 personal earphone

PLEASE

Henry's Radio Ltd

PADDINGTON 1008/9

TURN
 PAGE

5 HARROW ROAD, LONDON W2

Open Monday to Sat. 9-6, Thu's. 10'clock

Send 6d. Stamp For New Illustrated Price Lists

CONTESSA

**6 TRANSISTOR MEDIUM AND
 LONG WAVE SUPERHET
 TERRIFIC SENSITIVITY**

SPECIFICATION

- 425mW Push-Pull Output
- 6 "Top-Grade" Ediswan Transistors
- New Type Printed Circuit with all
 Components marked
- Full Medium & Long Wave Tuning
- High "Q" Internal Ferrite Aerial
- Car Radio Adaption and AVC
- Slow Motion Fingertip Tuning with
 Station Names
- "Hi-Fi" Quality Speaker
- Attractive Rexine Covered Cabinet.
 RED/WHITE or BLUE/WHITE

COMBINED PORTABLE AND CAR RADIO

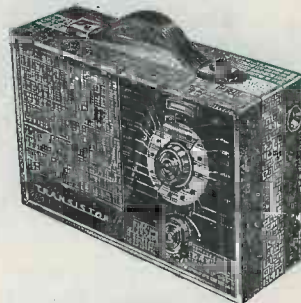

TOTAL COST OF ALL PARTS

£10. 19. 6 P.P. 3/6

LEAFLET ON REQUEST

JUST RIGHT FOR A DAY
 OUT-ANYWHERE!

AVO-METERS



AVO - MODEL 8
 Multi-Meter. (List price £24.10)

£17. 10. 0 Regd.

P.P. 5/-

Complete with Avo Test Leads
 and Batteries. Fully guaranteed
 new condition.

AVO - MODEL 7

(List price £19.10.0)

£12. 10. 0 Regd.

P.P. 5/-

Tested complete with Test Leads
 and Batteries.
 Fully Guaranteed.

FIRST GRADE TRANSISTORS

OC71	6/6	OC171	14/6	OC16	25/-
OC72	8/-	OC26	25/-	XB102	6/-
2-OC72	16/-	OC28	36/-	XB103	6/6
OC75	8/-	OC42	11/6	XC101	6/6
OC76	8/-	OC44	11/-	XC121	7/9
OC81	8/-	OC45	10/-	XA101	9/-
OC83	8/-	OC22	28/-	XA102	10/-
OC84	11/-	OC24	38/-	XC141	25/6
OC170	13/6	OC35	25/6	XA131	29/-

COMPLETE LIST FREE ON
 REQUEST

**6 MULLARD TRANSISTORS AND
 DIODE**

1-OC44 1-OC71 AND 1-OA81
 2-OC45 2-OC72 PER SET ONLY
 50/-

Other Matched Sets Available

PRACTICAL TRANSISTOR CIRCUITS

Contains easy-to-follow plans of 40
 all-transistor units, including light-
 operated switches, amplifiers, trans-
 mitters, receivers, test oscillators,
 signal tracers, hearing aids, radio
 control, etc. All parts
 available separately. **3/6**

POST FREE

**1/2 WATT
 4 TRANSISTOR
 AMPLIFIER**

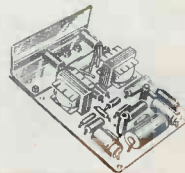

- 1 watt peak
 output.
- ±3dB 70 c/s to
 12 kc/s.

Built and Tested

69/6 P. & P. 1/6

● Output to 3 ohm
 speaker.

● 9 volt operated.

Kit of parts 62/6, P.P. 1/6

A printed circuit high gain amplifier size
 4" x 2 1/2" x 3" using Mullard OC71/OC81D
 and 2-OC81 Transistors. Ideal for Intercomm.,
 Record Player, Tuner Amplifier or any applica-
 tion requiring a quality and reliable amplifier.

● Full Details and uses on request

**"PW" 6 TRANSISTOR MEDIUM
 & LONG WAVE POCKET SUPERHET**

- 6 MATCHED
 MULLARD
 TRANSISTORS
 AND DIODE
- 150mW Push-
 Pull Output.
- Easy to follow
 Printed Circuit
 with all Com-
 ponents
 Marked
- Full Medium and Long Wave Tuning.
- High "Q" Internal Ferrite Aerial.
- Quality 2 1/2" Speaker.

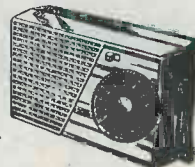

OUTSTANDING APPEARANCE
 AND PERFORMANCE

★ All Parts Sold Separately
 ★ No Technical Knowledge Required

● NO EXTRAS TO BUY ●

TOTAL COST ALL
 NECESSARY ITEMS **£8. 19. 6**
 No Extras to buy

DESCRIPTIVE LEAFLET
 FREE ON REQUEST.

WE CAN SUPPLY MOST OF
 THE COMPONENTS USED ON
 CIRCUITS PUBLISHED IN THIS
 MAGAZINE. QUOTATIONS
 BY RETURN.