

PUBLISHED IN CONJUNCTION WITH

THE

# RADIO CONSTRUCTOR

★ *Data Book Series*

★ *Radio Reprint Series*

★ *Panel Signs Transfers*

Send stamped addressed envelope for

## BROCHURE

giving details of ALL PUBLICATIONS

### DATA PUBLICATIONS LTD

57 MAIDA VALE LONDON W9

Telegrams Databux London

Telephone CUNningham 6141/2

Published in Great Britain by the Proprietors and Publishers  
Data Publications Ltd 57 Maida Vale London W9

Printed by A. Quick & Co. (Printers) Ltd 125 High Holborn London WC1 England also at Clacton-on-Sea  
Obtainable abroad through the following Collets Subscription Service Continental Publishers & Distributors Ltd  
William Dawson & Sons Ltd Australia and New Zealand Gordon & Gotch Ltd South Africa Central News Agency  
Holland "Radio Electronica"  
Registered for transmission by Magazine Post to Canada (including Newfoundland)

"JINGLEBELLS" — AMATEUR RADIO TELETYPE

VOLUME 12  
NUMBER 7  
FEBRUARY  
1959

# The RADIO Constructor



RADIO · TELEVISION · AUDIO · ELECTRONICS

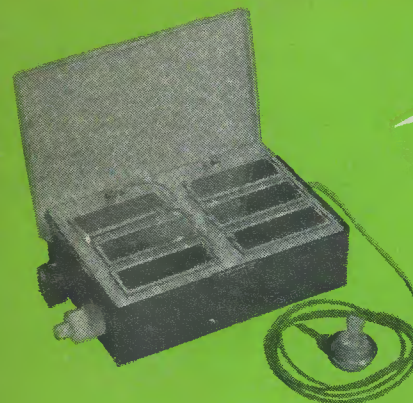

The SOLAR THREE  
Miniature Transistor  
Light-Operated  
Receiver

The JASON  
JSA2  
Twin-3-Watt  
Stereo  
Amplifier

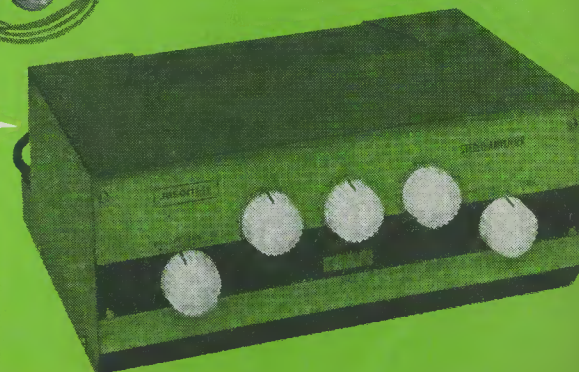

Included in this issue  
VERSATILE VALVE TESTER  
EASILY ASSEMBLED PRE-SELECTOR  
NEGATIVE FEEDBACK VALVE MILLIVOLTMETER  
"PROFESSIONAL" DIAL & DRIVE  
THE NEW "TRANSEVEN", Part 2

DATA  
Publications 1/9

## THE MODERN BOOK CO

**Television Engineers' Pocket Book.**  
By J. P. Hawker. 12s. 6d. Postage 8d.

**TV Fault Finding.** A Data Publication.  
5s. Postage 5d

**How to Get the Best Out of Your  
Tape Recorder.** By P. J. Guy.  
8s. 6d. Postage 6d.

**A Beginner's Guide to Radio.** By  
F. J. Camm. 7s. 6d. Postage 8d.

**Audio Design Handbook.** By H. A.  
Hartley. 23s. Postage 1s.

**A Beginner's Guide to Television.**  
By F. J. Camm. 7s. 6d. Postage 8d.

**Radio Valve Data.** Compiled by  
"W.W." 6th Ed. 5s. Postage 9d.

**Radio Control for Model Ships,  
Boats and Aircraft.** By F. C. Judd.  
Data Publication. 8s. 6d. Postage 7d.

**Foundations of Wireless.** By M. G.  
Scroggie. 15s. Postage 1s. 3d.

**Solution of Problems in Telecom-  
munications.** By C. S. Henson.  
25s. Postage 1s.

**Television Servicing Handbook.** By  
G. J. King. 30s. Postage 1s. 6d.

**Oscilloscope Techniques.** By A. Hass.  
23s. Postage 1s.

**An Electronic Organ for the Home  
Constructor.** By A. Douglas 15s.  
Postage 1s.

**Radio Engineer's Pocket Book.** By  
F. J. Camm. 6s. Postage 6d.

We have the Finest Selection of British and American Radio Books in the Country  
Complete catalogue 6d.

19-23 PRAED STREET (Dept RC) LONDON W2

Telephone PADdington 4185



### A Versatile 2-Valve Audio Pre-Amplifier

This 8-page booklet contains complete constructional details of a Mullard designed audio pre-amplifier. Complete with circuit and main component layout, together with photographic illustrations. The latest Mullard modification data is included.

Price 1/- Postage 2d.

Published by

**DATA PUBLICATIONS LTD** 57 Maida Vale · London W9

**EF86**  
Low hum, low noise  
voltage amplifying  
pentode.

**ECC83**  
High  $\mu$  double  
triode with separate  
cathodes.

**EZ81**  
Full wave indirectly  
heated rectifier with  
maximum output of  
150 mA.

**GZ34**  
Full wave indirectly  
heated rectifier with  
maximum output of  
250 mA at Va (r.m.s.)  
= 2 x 450V.

*Made for music*

**EL34**  
Output pentode with  
25W maximum anode  
dissipation.

**EL84**  
Output pentode with  
12W maximum anode  
dissipation.

**MULLARD LTD**  
Mullard House  
Torrington Place  
London W.C.1

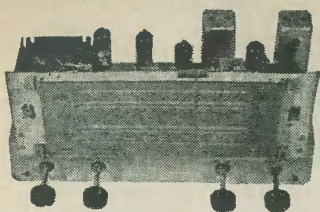

### 1959 RADIOGRAM CHASSIS

THREE WAVEBANDS S.W. 16 m.-50 m. M.W. 200 m.-550 m. L.W. 800 m.-2,000 m. 12 month Guarantee. A.C. 200/250V, 4-way switch. Short-Medium-Long-Gram. A.V.C. and negative feedback. 4.2 watts. Chassis 13 1/2" x 5 1/2" x 2 1/2". Glass dial 12 1/2" x 5 1/2" horizontal or vertical 10" x 4 1/2". 2 pilot lamps. Four knobs, walnut or ivory, aligned and calibrated. Chassis isolated from mains. Immediate delivery.

**BRAND NEW £9.10.0** Carr. 4/6  
TERMS: Deposit £5.5.0 and 5 monthly payments of £1  
MATCHED SPEAKERS: 8" 17/6. 10" 25/-. 12" 30/-

### ★ GARRARD 4-SPEED SINGLE RECORD PLAYER 4SP ★

£8 AUDIO PERFECTION POST FREE

De luxe Cabinet with amplifier and 6 1/2" speaker £6.15.0 or complete kit £14.10.0

### BUILD THIS REPRODUCER BARGAIN SPECIAL SINGLE PLAYER KIT

COLLARO 4-speed Gram-Pick-up Unit Handsome portable case 17 1/2" x 13 1/2" x 7" with room to play 12" records £42.12.6  
Ready built 3 watt amplifier with two valves and 7" elip. speaker, printed circuit £2.5.0  
or £9.15.0 complete kit post free

**I.F. TRANSFORMERS 7/6 pair**  
465 kc/s slug tuning miniature can 2 1/2" x 1" x 1". High Q and good band width. By Pye Radio. Data sheet supplied.  
Wearite M800 Midget I.F.S. 465 kc/s 12/6 pair  
Wearite 550 Standard I.F.S. 465 kc/s 12/6 pair

### New boxed VALVES 90-day Guarantee

1R5	8/6	6K8	8/6	EA50	1/6	EZ80	9/6
1S5	8/6	6L6	10/6	EABC8010	6	E1148	1/6
1T4	8/6	6Q7	10/6	EB91	6/6	HABC80	12/6
2X2	2/6	6SA7	10/6	EBC33	8/6	HVR2A	7/6
354	8/6	6SJ7M	10/6	EBC41	10/6	MU14	10/6
3V4	8/6	6SN7	8/6	EBF80	10/6	P61	6/6
5U4	8/6	6V6G	7/6	ECC84	12/6	PCC84	12/6
5Y3	8/6	6X4	7/6	ECP80	11/6	PCF80	11/6
5Z4	10/6	6X5	7/6	ECH42	10/6	PCF82	11/6
6AM6	8/6	757	10/6	ECL80	14/6	PCL82	11/6
6B8	5/6	12AH8	10/6	ECL82	12/6	PEN25	6/6
6BE6	7/6	12AT7	10/6	EF39	7/9	PL82	10/6
6BH6	10/6	12AU7	9/6	EF41	10/6	PY80	10/6
6BW6	10/6	12AX7	9/6	EF50	5/6	PY81	10/6
6D6	7/6	12BE6	9/6	EF50	8/6	PY82	10/6
6F6	7/6	12K7	8/6	Sylv.	SP61	5/6	
6HF6	3/6	12Q7	8/6	EF80	10/6	UBC41	10/6
6J5	6/6	35L6	9/6	EF92	5/6	UCH42	10/6
6J6	7/6	35Z4	9/6	EL32	5/6	UF41	10/6
6J7	8/6	80	10/6	EL84	10/6	UL41	10/6
6K6	6/6	807	6/6	EY51	12/6	UY41	10/6
6K7	5/6	954	1/6	EZ40	10/6	U22	10/6

### C.R.T. ISOLATION TRANSFORMERS

For Cathode Ray Tubes having heater cathode short circuit and for C.R. Tubes with falling emission. Type A. Low leakage windings. Optional 25% and 50% boost on secondary: 2V, or 4V, or 6.3V, or 10.3V, or 13.3V, with mains primaries, 12/6  
Our Latest Superior Product. Type A2. High quality low capacity 10-15pF. Optional boost 25%, 50%, 75%, 16/6 each  
Type B. Mains input. Low capacity. Multi output 2, 4, 6.3, 7.3, 10 and 13V. Boost 25% and 50%. This transformer is suitable for all TV tubes. 21/- each.

**RESISTORS.** Preferred values. 20% 10 ohms to 10 meg. 1/4W 4d., 1/2W 4d., 1W 6d., 1 1/2W 8d.  
**HIGH STABILITY.** 1/4W 1%, 2/-. All preferred values 100Ω-10MΩ. Ditto 5% 100Ω-5MΩ 9d. each

**WIRE-WOUND RESISTORS**  
5 watt } 1/3  
10 watt } 1/6  
15 watt } 2/-  
25 ohms-10,000 ohms

15,000 ohms-50,000 ohms, 5W, 1/9; 10W, 2/3.  
**WIRE-WOUND POTS** 3W Lab. Colvern, etc. Pre-set min. TV type. Standard size Pots, 2 1/2". Knurled slotted knob. Spindle, high grade. All values 25 ohms to 25k, 3/- each. 30k, 50k, 4/-; 5/6; 100k, 6/6  
Ditto Carbon Track 30k W/W EXT. SPEAKER to 2 Meg, 3/- CONTROL 10Ω, 3/-

### MAINS TRANSFORMERS

**STANDARD.** 250-0-250, 80mA, 6.3V tapped 4V 4A. Rectifier 6.3V 1A tapped 5V 2A and 4V 2A 22/6  
Ditto 350-0-350 22/6  
**MINIATURE.** 200V 20mA, 6.3V 1A 10/6  
**MIDGET.** 22V 45mA, 6.3V 2A 15/6  
**SMALL.** 220-0-220, 50mA, 6.3V 3A 17/6  
**STANDARD.** 250-0-250, 65mA, 6.3V 3.5A 17/6  
**HEATER TRANS.** 6.3V 1 1/2A 7/6  
Ditto, tapped sec. 2, 4, 6.3V 1 1/2A 8/6  
Ditto, sec. 6.3V 3A 10/6  
Mullard "510" 300-0-300, 120mA, 6.3V 4A c.t., 6.3V 2A tapped 5V 38/6

**O/P TRANSFORMERS.** Heavy duty 50mA, 4/6. Multi-ratio push-pull, 7/6. Miniature 3V4, etc., 4/6. Small pentode, 4/6. Hygrade push-pull 7 watts, 15/6. Heavy duty 10/20V 6k or 8k ct., 30/-

**L.F. CHOKES 15/10H 60/65mA, 5/-; 10H, 85mA, 10/6; 10H 150mA, 12/6; 5H, 250mA, 16/6.**

### CRYSTAL MIKE INSERT BY ACOS/6

Precision engineered. Size only 1/2" x 1/2"  
**ACOS 33-2 CRYSTAL DESK MIKE, 35/-**

**ALADDIN FORMERS and cores.** 1/2" 8d., 3/8" 10d. 0.3" FORMERS 5937/8 and cans TV1/2. 3/8" sq. x 2 1/2" and 3/8" sq. x 1 1/2", 2/- complete with cores.

**SLOW MOTION DRIVES.** Epicyclic ratio 6-1, 2/3. TYANA. Midget Soldering Iron. 200/250V or 230/250V, 16/9. SOLON MIDGET IRON, 25W, 24/-

**MAINS DROPPERS.** 3" x 1 1/2". Three adj. sliders. 0.3A, 750 ohms, 4/3; 0.2A 1,000 ohms, 4/3

**LINE CORD.** 0.3A 60 ohms per foot, 0.2A 100 ohms per foot, 2-way, 6d. per foot; 3-way, 7d. per foot

**MIKE TRANSF.** 50-1, 3/9; 100-1, 7d. per foot.  
**LOUDSPEAKERS.** P.M. 3 ohm 2 1/2" and 5" 17/6; 6" x 4" Rola, 18/-; 4" Hi-Fi Tweeter, 25/-; 8" Plessey, 19/6; 6 1/2" Goodmans, 18/6; 10" R.A., 30/-; 12" Plessey, 30/-; 10" x 6" R.A., 27/6; 12" Baker 15W 3 ohm or 15 ohm models, 105/-; Stentorian HF1012 10" 99/6.

**CRYSTAL DIODES.** G.E.C., 2/-; GEX34, 4/-  
**40 CIRCUITS FOR GERMANIUM DIODES, 3/-**

**TUNING AND REACTION CONDENSERS** 100pF, 300pF, 500pF, 3/6 each, solid dielectric.

**H.R. HEADPHONES** 4,000 ohms, brand new, 16/6 pr.  
**SWITCH CLEANER FLUID,** squirt spout, 4/3 tin.

**TWIN GANG CONDENSERS.** 365pF, miniature. 1 1/2" x 1 1/2" x 1 1/2", 10/-; 0.0005 standard with trimmers, 9/-; less trimmers, 8/-; Midget 7/6; 50pF single, 2/6.

**Aluminum Chassis.** 18 s.w.g. Plain, undrilled, with 4 sides, riveted corners and lattice fixing holes, with 2 1/2" sides. 7" x 4", 4/6; 9" x 7", 5/9; 11" x 7", 6/9; 13" x 9", 8/6; 14" x 11", 10/6; 15" x 14", 12/6; 18" x 16" x 3", 16/6.

### Volume Controls 80Ω Coaxial Cable

Midget size. Long spindles. Semi-air spaced Polythene insulated 1/4" dia. stranded core. Ideal Band III 9d. yd. Losses cut 50%.  
No Switch D.P. Switch 4/9  
3/- 4/9  
Linear or Log Tracks FRINGE QUALITY  
Air-spaced Coaxial 1/6 yd

**Coaxial Plugs** 1/- **Double Socket** 1/3  
**Sockets** 1/- **Outlet Boxes** 4/6

**Balanced Twin Feeder,** per yd 6d., 80Ω or 300Ω  
**Twin Screened Balanced Feeder,** 1/6 yd, 80 ohms

**Trimmers.** Ceramic 30, 50, 70pF, 9d.; 100pF, 150pF, 1/3; 250pF, 1/6; 600pF 750pF, 1/9. Phillips, 1/- each  
**BLACK CRACKLE PAINT.** Air drying, 3/- tin

**P.V.C. CONN. WIRE,** 8 colours, single or stranded, 2d. yd. Sleeving 1, 2mm, 2d., 2, 3mm, 3d., 6mm, 5d. yd.  
**NEON MAINS TESTER SCREWDRIVERS,** 5/3  
**SOLDER RADIOGRADE,** 3 yds 9d., 1lb 2/6

**THE HIGH GAIN BAND III TV PRE-AMP**  
Tunable Channels 8 to 11, Gain 17dB, Cascade Circuit. Complete kit with ECC84 valve, plans and instructions, 29/6 less power; or 49/6 with power pack. Plans only, 6d. Band I.B.B.C. version available for channels 1 to 5, same prices.

**Miniature Contact Cooled Rectifiers.** 250V 50mA, 7/6; 250V 85mA, 9/6. Selenium Rect. 300V 85mA, 7/6. Coils. Wearite "P" type, 3/- each. Osmor Midget "Q" type, adj. dust core, from 4/- each. All ranges. Teletron A.H.F. L. & Med. T.R.F. with reaction, 3/6. Ferrite Rod Aerials. M.W., 8/9; M. & L., 12/6. T.R.F. Coils A/HF, 7/- pair. H.F. Chokes, 2/6. Speaker Fret. Gold cloth, 17" x 25", 5/-; 25" x 35", 10/-; Expanded metal, silver, 15 1/2" x 9 1/2", 2/- each; Tygan, 4' 6" wide, 10/- ft; 2' 3" wide, 5/- ft. Samples

**SUPERHET COIL PACK 27/6**  
Miniature size high Q coils. Short, Med., Long, Gram. switching, with connection diagram. 465 kc/s i.f.

**Condensers.** New stock, 0.001μF 7kV T.C.C., 5/6; ditto 20kV, 9/6; 100pF to 500pF Micas, 6d.; Tubular 500V 0.001 to 0.001μF, 9d.; 0.05, 0.1, 1/-; 0.25, 1/6; 0.1/350V, 9d.; 0.5, 1/9; 0.01/2,000V, 1/9; 0.1/2,000V, 3/6. Ceramic Condensers. 500V 0.3pF to 0.01μF, 10d. Silver Mica. 10% 5pF to 500pF, 1/-; 600pF to 3,000pF, 1/3; close tolerance (plus or minus 1pF), 1.5pF to 47pF, 1/6; ditto 1% 50pF to 815pF, 1/9; 1,000pF to 5,000pF, 2/-

**NEW ELECTROLYTICS FAMOUS MAKES**

**TUBULAR TUBULAR CAN TYPES**

1/350V 2/- 64/350V 5/6 8/500V 3/-  
2/450V 2/3 100/25V 2/- 16/500V 4/-  
4/450V 2/3 250/25V 2/6 32/350V 4/-  
8/450V 2/3 500/12V 3/- 100/270V 5/6  
8/500V 2/9 8+8/450V 4/6 2,500/3V 4/-  
16/450V 3/6 8+8/500V 5/- 6,000/6V 5/-  
16/500V 4/- 8+16/450V 5/- 32+32/350V 4/6  
32/450V 5/6 8+16/500V 5/6 50+50/350V 7/-  
25/25V 1/9 16+16/450V 5/6 64+120/275V 7/6  
50/25V 2/- 32+32/350V 4/6 64+120/350V 11/6  
50/50V 2/- 32+32/500V 7/6 100+200/350V 12/6

**Full Wave Bridge Selenium Rectifiers.** 2, 6 or 12V 1 1/2A, 8/9; 2A, 11/3; 4A, 17/6 Free charger circuit

**Charger Transformers.** Tapped input 200/250V for charging at 2, 6 or 12V 1 1/2A, 15/6; 2A, 17/6; 4A, 22/6.

**12/6 PURETONE RECORDING TAPE**  
1,200ft on standard fitting, 7" metal reels. Spare reels 7" metal, 2/3; 5 1/2" plastic, 3/-; 7" plastic, 4/-

**SUPERIOR 1,200ft plastic tape, 21/-, 7" plastic reel.**  
**EMITAPE 7" Long Play 1,800ft, 45/-**  
**INSTANT bulk tape eraser, 200/250V a.c., 27/6.**

**BRAND NEW AND BOXED**  
Model UA8  
**OUR PRICE**  
**£6.19.6**  
**STEREO MODEL**  
UA12 £11.17.6

★ COLLARO ★  
**HIGH-FIDELITY AUTOCHANGER**  
Latest Model Studio "O" pick-up  
4 SPEEDS-10 RECORDS  
**BRAND NEW IN MAKER'S BOXES**  
**OUR PRICE £7.19.6** post free

★ GARRARD 4-SPEED RECORD CHANGERS RC121/D MK II MODELS ★  
With Plug-in Normal Head  
**AUDIO PERFECTION WIRED FOR STEREO**  
**OUR PRICE £10.15.0** each Post Free  
**Plug in STEREO HEAD £2 extra**

**AUTOCHANGER ACCESSORIES**  
Suitable player cabinets (uncut boards) 49/6  
Amplifier player cabinets with cut boards 63/-  
2 valve amplifier and 6 1/2" speaker for above 72/6  
3 valve amplifier and 6 1/2" speaker for above 95/-  
Wired and tested ready for use

**Wavechange Switches.** 2 p 2-way, 3 p 2-way, short spindle, 2/6; 5 p 4-way 2 wafer, long spindle, 6/6; 2 p 6-way, 4 p 2-way, 4 p 3-way, long spindle, 3/6; 3 p 4-way, 1 p 12-way, long spindle, 3/6; wafer change "MAKITS," 1 wafer, 8/6; 2 wafer, 12/6; 3 wafer, 16/-; 4 wafer, 19/6; 5 wafer, 23/-; 6 wafer, 26/6  
**Toggle Switches,** s.p. 2/-; d.p., 3/6, d.p.d.c., 4/-

**JASON FM TUNER COIL SET, 26/-, H.F.** coil, aerial coil, oscillator coil, two i.f. transformers 10.7 Mc/s, detector transformer and heater choke. Circuit and component book using four 6AM6, 2/-  
**Complete Jason FM Kit,** with valves and Jason superior calibrated dial, £6.15.0, post free.  
**Mullard 3-3.** Quality amplifier ready built, with power socket for tuner, £7.17.6.

**Valveholders.** Pax. int. oct., 4d. EF50, EA50, 6d. B12A, CRT 1/3. Eng. and Amer. 4, 5, 6 and 7 pin, 1/-  
**MOULDED Mazda** and int. oct., 6d., B7G, B8A, B8G, B9A, 9d. B7G with can, 1/6. B9A with can, 2/6. Ceramic, EF50, B7G, B9A int. oct., 1/- B7G with can, 1/9; B9A with can, 2/9.

**TV Fault Finding, 5/-** **Quality Amplifiers, 4/6**  
**Radio Valve Guide.** Books 1, 2 or 3 5/- each  
**TRANSISTORS.** Pye Goltpop Audio Y10/15A, 10/-  
R.F. 3 Mc/s, V6/R2, 18/-, Sub-miniature Electrolytics 5μF 12V, 8μF 6V, 16μF 12V, 25μF 6V, 3/- each

**Teletron Transistor Pocket Radios**  
Designers Specified Kits  
**COMPANION PRINTED CIRCUIT THREE**  
Local station receiver kit, 4 1/2" x 3" x 1 1/2", £4.19.6  
with 3 genuine Pye Goltpop transistors; plans 6d.

**Transidyne Superhet Six 6" x 4" x 1 1/2"**  
T.C.C. Printed Circuit, internal Ferrite aerial, Rola loudspeaker, push-pull output. All parts, cabinet and 6 genuine Pye Goltpop transistors.  
**£11.19.6** Plans, etc., 9d.  
No surplus reject transistors supplied

## 48-HOUR POSTAL SERVICE

Our written guarantee with every purchase

# RADIO COMPONENT SPECIALISTS

Buses 133 or 68 pass door. S.R. Stn. Selhurst

## 337 WHITEHORSE ROAD WEST CROYDON

Catalogue 6d.  
Telephone THO 1665

P. & P. 1/-, over £2 post free. C.O.D. 1/6 (Export welcome. Send remittance and extra postage)

# PREMIER RADIO COMPANY

B. H. MORRIS & CO (RADIO) LTD

(Dept. R.C.7) 207 EDGWARE ROAD LONDON W2  
Also 23 Tottenham Court Road London W1

Open till 6 p.m.  
Saturday

Telephone  
AMB 4033  
PAD 3274

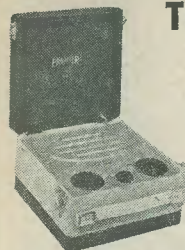

## THE "PETITE" PORTABLE

MAY BE BUILT FOR 7 GNS.  
plus 3/- post & pkg.

Batteries extra  
H.T. 10/- (Type B126) or equivalent.  
L.T. 1/6 (Type AD35) or equivalent.

- ★ Size only 8" x 8" x 4 1/2"
- ★ Weight including batteries 5 1/2 lb
- ★ 4 valves of the economy type
- ★ Medium and long wave superhet circuit
- ★ High Q frame aerial
- ★ High sensitivity on both wavebands
- ★ Pre-aligned i.f. transformers
- ★ 5" speaker of the latest type
- ★ Automatic on/off switch operated by lid
- ★ Designed in our own laboratory
- ★ Backed by an up-to-date Technical Information Dept.
- ★ Components available separately if desired
- ★ Simple to construct, using normal soldering methods
- ★ Instruction book 1/6

PLEASE ADDRESS ALL ENQUIRIES TO — 207 EDGWARE ROAD . LONDON . W2

## A complete range of PREMIER STEREO EQUIPMENT

including:

### The PREMIER DE-LUXE STEREO RECORD PLAYER AMPLIFIER



This is a 4-valve Stereo Amplifier with tone balance, speaker switch and volume control, size 12" long, 5 1/2" high, 3" wide, output of each section is 3 1/2 watts. £8 plus pkg. and post 4/6

**DE LUXE PORTABLE CABINET** suitable for housing the above Stereo Amplifier with detachable lid which will accommodate an 8" x 5" elliptical speaker, overall size of cabinet 18 1/2" x 13 1/2" x 9" deep. Price 75/- plus 5/- packing and postage  
Collaro 4-speed Changer £7.19.6, plus 5/- pkg. and post  
B.S.R. 5-speed Changer £7.19.6, plus 5/- pkg. and post  
Amplifier Cabinet £2.19.6, plus packing and post 5/-

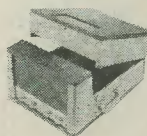

## DIOMATIC FREQUENCY CONTROL

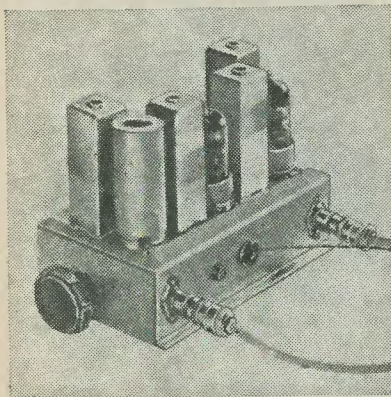

DIOMATIC FREQUENCY CONTROL is quite unique and offers very close control of the oscillator without the disadvantages associated with reactance valves. This enables you to receive three stations perfectly on tune at the turn of a switch. All the control circuit is **TOTALLY ENCLOSED** with the oscillator coil and nothing but D.C. is used to control the frequency.

We can undertake to align all tuners built and guarantee that built to our instructions and with our parts they will work as we claim, giving satisfaction to the builder and user. Send 2/- for detailed instructions and price list of this remarkably inexpensive unit to:

**C. & G. KITS Dept. F.M. 285 Lower Addiscombe Road Croydon Surrey**

## ★ SWITCHED TUNED FM-TUNER-VHF

With these star features:

- ★ Switch tuning
- ★ Diomatic frequency control
- ★ Hi-Fi cathode follower output stage
- ★ Hi-Fi pre-amplifier, giving 10 volts output
- ★ Very simple construction on chassis only 5" x 3 1/2"
- ★ Six-valve circuit, using double valves throughout
- ★ Single hole installation
- ★ Two high gain I.F. stages
- ★ Double interference limiting
- ★ Alignment service
- ★ All parts available separately

Parts complete with valves ... £7.19.6  
Alignment ... .. 10/6

This extremely successful and very popular switched tuner, described in May P.W., is well known throughout the field of amateur radio engineers and is giving excellent results in all parts of the country and abroad.

# EDISWAN

MAZDA

## TRANSISTORS

Experimenters and home constructors! To meet the increasing demand for economically priced quality transistors Ediswan Mazda are now making the following range available through your radio or electronics dealer.

Transistor Type	List Price	Description
XA 104	18/-	General purpose R.F. transistor, frequency changer and/or oscillator for long and medium wave bands. Minimum common base cut-off frequency 4 Mc/s. Maximum mean or peak collector to emitter voltage—12V. Minimum small signal current gain, 18.
XA 103	15/-	I.F. amplifier. Minimum common base cut-off frequency 2 Mc/s. Maximum mean or peak collector to emitter voltage—12V. Minimum small signal current gain, 15.
XB 102* and XB 104†	10/-	General purpose audio transistor. Maximum peak or mean collector to emitter voltage—16V. Range of small signal current gain, 18–47.

\*Maximum collector dissipation at 25°C—150mW  
" " " " 45°C—90mW

†Maximum collector dissipation at 25°C—120mW  
" " " " 45°C—60mW

## CONTACT YOUR DEALER OR HOME CONSTRUCTOR STORE FOR SUPPLIES

Full data from

SIEMENS EDISON SWAN LIMITED An A.E.I. Company

Technical Service Department 155 Charing Cross Road London WC2  
Telephone GERrard 8660 Telegrams Sieswan Westcent London

Technical  
training  
in radio  
television  
and  
electronics  
engineering  
with

**ICS**

The decision is YOURS. To be a success in your chosen career; to qualify for the highest paid job . . . to control a profitable business of your own. ICS home-study courses put your plans on a practical basis; teach you theory and practice; give you the knowledge and experience to take you, at your own pace, to the top.

Choose the **RIGHT** course,  
**RADIO AND TELEVISION  
ENGINEERING · RADIO AND  
TV SERVICING · RADIO SERVICE  
AND SALES · ELECTRONICS ·  
VHF/FM ENGINEERING**

ICS provides thorough coaching for professional examinations: AMBRIT.IRE, City and Guilds Telecommunications, Radio Servicing; Radio Amateurs PMG CERT. (MARINE).

**THERE ARE ICS COURSES TO  
MEET YOUR NEEDS AT EVERY  
STAGE OF YOUR CAREER.**

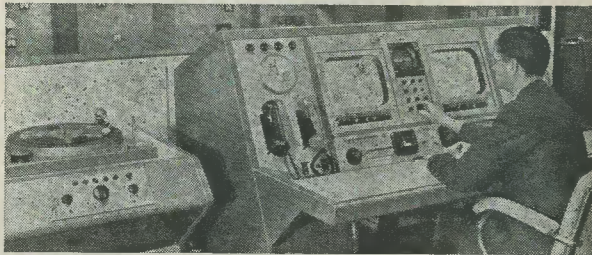

The first step towards success is to fill in and post this coupon today:

In return you will receive the FREE 60-page ICS Prospectus listing technical examinations and their appropriate ICS courses PLUS details of over 150 specialised subjects.

**AN EYE-OPENING SURVEY  
OF THE ICS WAY TO COM-  
PLETE TECHNICAL TRAINING**

### LEARN AS YOU BUILD

*Practical Radio Course*

Gain a sound up-to-professional-standards knowledge of Radio and Television as you build YOUR OWN 4 valve TRF and 5 valve superhet radio receivers, signal generator and high-quality multi-tester. At the end of the course you have three pieces of permanent and practical equipment and a fund of personal knowledge and skill . . . ICS Practical Radio courses open a new world to the keen radio amateur.

OTHER ICS COURSES INCLUDE:  
AGRICULTURE · HORTICULTURE  
ARCHITECTURE · WOODWORK-  
ING · SALESMANSHIP AND SALES  
MANAGEMENT · ART · PHOTO-  
GRAPHY · MECHANICAL,  
MOTOR, FIRE AND CHEMICAL  
ENGINEERING, ETC. A WHOLE  
WORLD OF SKILL AND KNOW-  
LEDGE FOR THE KEEN STUDENT.

#### INTERNATIONAL CORRESPONDENCE SCHOOLS

Dept. 248B International Buildings Kingsway London WC2

NAME ..... AGE .....

ADDRESS .....

OCCUPATION ..... 2.59

**AMAZING OFFER TO 'Radio Constructor' READERS!**

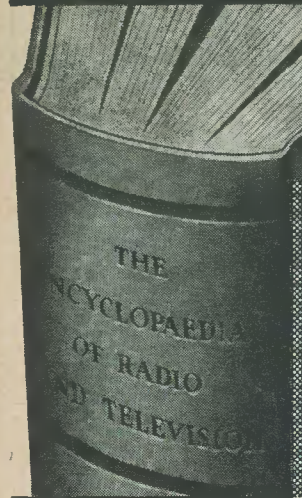

**YOURS on 7 DAYS'  
FREE APPROVAL!**

## ENCYCLOPAEDIA of RADIO and TELEVISION

**UP TO THE MINUTE!  
COMPREHENSIVE!  
AUTHORITATIVE!**

**736 PAGES**

Nearly **800**  
SPECIALLY PREPARED  
ILLUSTRATIONS

**Over 3,000 A-Z ENTRIES  
COVERING HUNDREDS OF  
SUBJECTS, including:**

Aerials; Amplification; Attenuation; Audio - Frequency Transmission; Automatic Gain Control; Broadcasting; Communication Systems; Colour Television; Detection; Direction-finding; Distortion; Electrical Machinery; Electrical Recording; Feedback; Feeders; Loudspeakers; Loading; Measuring Instruments; Modulation; Oscillators; Power Distribution; Power Supply; Public - address equipment; Pulse Code Modulation; Radar; Ratcheting; Reactance; Rectification; Relay Systems; Stereophonic Reproduction; Symbols, Abbreviations; Testing and Fault Tracing; Tilt and Bend; Units; Valves; Vision Frequency Transmission; VHF; Wave Propagation, etc.

### THE ESSENTIAL REFERENCE for AMATEUR or ENGINEER

Here's the complete A-Z guide, packed with clear explanations, latest information and valuable reference data, that meets the practical man's every need! Essential to amateur, radio engineer, apprentice or student. Over 3,000 easy-to-follow entries deal with every aspect of the theory and practice of television, radio, radar, etc. *New edition, brought up to date by an appendix covering recent developments.* The most remarkable value in any work of this type ever published! 736 pages. Over 300,000 words. Nearly 800 illus., drawings and circuit diagrams. De Luxe Edition, handsomely and strongly bound, yours (if kept) for only 30/- (cash price), or 11/6 down and 2 monthly payments of 10/- (31/6).



**ACT NOW!** Fill in form and post in 2d. stamped, unsealed envelope to Dept. H.J.26, People's Home Library, Odhams Press Ltd., Basted, Sevenoaks, Kent. Offer applies in U.K. only (not Eire), closes February 28.

**POST FORM TODAY! SEND NO MONEY NOW!**

To: Dept. H.J.26, People's Home Library, Odhams Press Ltd., Basted, Sevenoaks, Kent. Please send me, WITHOUT OBLIGATION TO PURCHASE, "Encyclopaedia of Radio and Television." I will EITHER return book in good condition, postage paid, within 8 days, OR send down payment of 11/6 eight days after delivery, then 2 monthly instalments of 10/- (31/6). ALTERNATIVELY, I will send cash price of 30/- eight days after delivery.

Signature..... Occupation.....  
(Persons under 21 will be sent a Guarantor Form). Age, if under 21.....  
Put tick where applicable: Cash  Terms  Householder  Lodgings   
Furnished Premises.  Unfurnished Premises.  Hotel  Live with Parents   
BLOCK LETTERS BELOW

NAME .....

Full Postal ADDRESS .....

H.J.26/Feb. 59 ..... in margin

# JSA.2 STEREOPHONIC

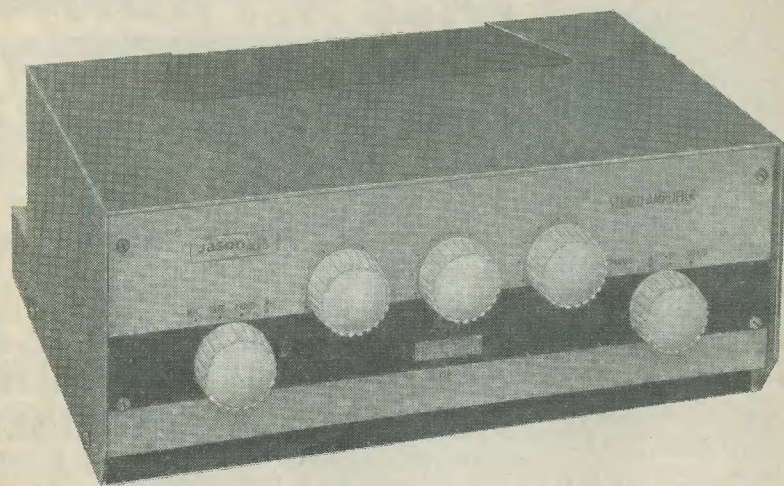

build it with an  
authentic

**Jason**kit

This is one of a series of Jason amplifier and tuner designs offered in kit form. Cases and front panels are uniformly styled for shelf mounting. In the JSA.2 each section will deliver 3 watts between 70 and 10,000 c/s at a distortion rate of less than 1%. 18 dB of feedback is applied in each half, and the stereo balance operates on both channels giving a total difference each way of 5 dB. Building with a Jasonkit ensures your amplifier being exact to the designer's tested and proven specification.

**THE JASON MOTOR & ELECTRONIC CO.,**

# AMPLIFIER

by G. G. Blundell

The Jasonkit for the JSA.2 is complete down to the last detail, including 5 valves. You save considerably by buying the kit complete as listed

	£ s. d.		£ s. d.
Chassis, base, cover, scale, screen plate	1 17 0	Nuts, screws, grommets, solder tags, spacers, p.v.c. wire, mains lead, etc.	6 6
1 mains transformer—MT248	2 2 0	<b>CONDENSERS</b>	
2 output transformers—OT3	1 4 0	1 32+32µF 350Vw with fixing clamp	7 6
1 mains selector plug and socket	3 0	1 50+50µF 275Vw with fixing plate	6 0
1 5-pin socket for spare power	6	2 25µF 25V working	4 0
1 2-pin socket for mains outlet	6	3 100µF 6V working	7 6
2 4-way audio input sockets with plugs and insulation plate	5 0	1 5µF 50V working	2 0
1 bulbholder	8	4 0.05µF 450V working	4 0
6 knobs	5 0	4 1,000pF 10%	2 8
1 set of tag strips	2 6	2 300pF 10%	1 4
2 B9 plugs	2 8	4 200pF	2 8
1 2-pole 4-way switch	4 0	<b>RESISTORS</b>	
1 2-pole 3-way switch	3 9	31 high stability 5% at 7½d. ea.	19 4½
1 2-pole 2-way switch	3 9	18 carbon ½W 20% at 4d. ea.	6 0
1 250Ω+250Ω plus switch	16 0	4 carbon 1W 10% at 9d. ea.	3 0
2 1MΩ+1MΩ potentiometer	1 8 0	<b>VALVES</b>	
1 300Ω preset potentiometer	2 0	2 EL84	1 12 0
2 low-loss B9 holders with can	2 0	2 ECF80	2 6 0
5 B9 holders	5 0	1 EZ81	11 10

TOTAL INCLUSIVE PRICE OF ALL PARTS BOUGHT TOGETHER **£13.19.0**

## JASONKITS FOR TEST EQUIPMENT

Full details of the following Jasonkits gladly sent on request:

VALVE VOLTMETER EM.10—4½" scale, valves and case	£18.10.0
CRYSTAL CALIBRATOR CC.10	£14.10.0 Ready built £18.19.0
OSCILLOSCOPE OG.10 with valves and tube	£22.10.0
AUDIO GENERATOR AG.10 10 c/s to 100 kc/s	£11.10.0
	Ready built £15.10.0
FM WOBBULATOR W.10	£9.0.0
STABILISED POWER PACK PP.10 with meter	£21.10.0
	Less meter £15.0.0

Further items for release shortly

**3-4(E) GT. CHAPEL STREET OXFORD STREET LONDON W1**

Between Tottenham Court & Oxford Circus Underground Stations

Telephone GERRard 0273/4

# MOTEK K9 Tape Deck



**STAR STRUCK WITH MOTEK**

The Motek deck has interstellar grace. Its Star features form a brilliant constellation which is bound to attract. Motek is five stars high. Stellations: Push Button Operation, Counter, Safety Erase Button, Pause Control, Three Speeds.

Details on request. Patents Pending.

KEEP YOUR TAPES ON MOTEK

List 21 GNS.

## MODERN TECHNIQUES

DHB/6358

Wedmore Street London N19 Telephone ARChway 3114

Officially recommended by Collaro

**TAPE RECORDER COILS**



Type	Price
Bias Osc. QT9	7/6
Bias Filter QT6	7/6
Treble Boost QT7	27/6
Bias osc. for push-pull circuit	7/6

Also recommended types for other makes

**COILS for the NEW MULLARD TAPE AMPLIFIER EXACTLY TO SPECIFICATION**

New SUB-MINIATURE HIGH Q COIL RANGE

For SUPERHET-TRF TRANSISTOR CIRCUITS

Type S.M. Ferrite Core 5/- retail

**OSMOR** (Dept.31) 418 Brighton Rd. South Croydon · Surrey Telephone Croydon 5148/9

THERE'S NO KIT LIKE

# Heathkit

BUILD-IT-YOURSELF KIT-SETS



SS-1 HI-FI SPEAKER.



S-88 HI-FI STEREO AMPLIFIER.



V-7A VALVE VOLTMETER.



UJR-1 JUNIOR TRANSISTOR RADIO

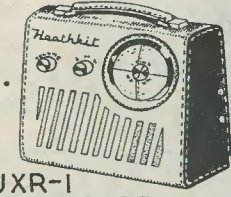

UXR-1 6 TRANSISTOR PORTABLE.

ARE YOU ON OUR MAILING LIST?

EASY TERMS AVAILABLE

LATEST RELEASES

5' OSCILLOSCOPE £34.15.0  
DX-40 TRANSMITTER £29.10.0

Please send without obligation full details of the above Heathkits as ticked below. (Please write in block capitals)

Name \_\_\_\_\_

Address \_\_\_\_\_

Model	Price Delivered		✓ here
V-7A	£ s. d. 15.14.0	The radio serviceman's best friend and a must for the experimenter. Now at a price to suit the pocket. Measures AC/DC volts, ohms and dB.	
S-88	25.5.6	Absolutely the latest in design. This model is a handsome 2-tone grey complete unit with elegant golden surround and relief. A real winner!	
UXR1	17.17.0 Incl. P.T.	In the top flight of portables. It has a handsome real leather case and with a few hours easy assembly you have a set in the 30-guinea class	
UJRI	2.19.6 Incl. P.T.	Youngsters are not excluded from our kit programme. This special single transistor set is an excellent introduction to radio and an instructive present	
SSI	10.9.0 Incl. P.T.	This twin speaker system is designed to meet the critical needs of the stereo enthusiast. Left in white wood for you to finish to own requirements	

Heathkits are the largest-selling electronic kits in the world

**DAYSTROM LTD** 401 SOUTHGATE ST · GLOUCESTER · ENGLAND  
A MEMBER OF THE DAYSTROM GROUP

## HOME RADIO OF MITCHAM

MIT  
3282

### BAKERS (Selhurst) LOUDSPEAKERS

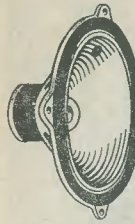

"THE CHOICE OF THE CONNOISSEUR"  
Rigid die-cast rust-proof chassis and massive high flux magnets. The first and foremost name in high quality moving coil loudspeakers.  
12" Stalwart with foam suspension £6.15.0 plus 3/6 post. 12" De Luxe with foam suspension £9.15.0 plus 3/6 post  
Details of full range and specifications sent on request

### JASON "MERCURY" Switched F.M. Tuner

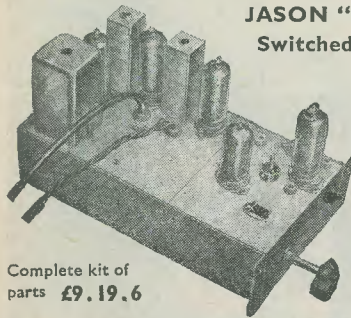

Complete kit of parts £9.19.6

VHF/FM at its simplest and best; the programme you want at the turn of a switch, always 'spot-on' tune with automatic frequency control. All parts standard and in stock. Full constructional data and price list 2/4 post paid.

### MULLARD TAPE PRE-AMPLIFIER TYPE "C"

All parts in stock for the Mullard tape pre-amplifier type "C," including the ready-wound WF 1388, 29/6 and the WF816, 22/-

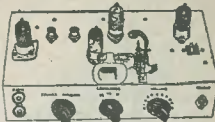

Send S.A.E. for fully detailed price list

### TELETRON "TRANSIDYNE"

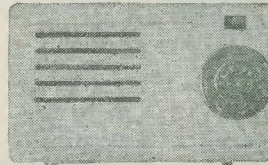

Build this wonderful little pocket transistor set for your holiday. Really easy to make because of fully punched printed circuit and all components carded and labelled. Excellent loudspeaker results on medium and long wave. Genuine 'Goltpo' transistors supplied in kit. Full constructional data 9d. Complete kit £12.19.6

Dept. C

187 LONDON RD MITCHAM SURREY  
Shop Hours: 9-6.30 p.m. (Weds. 1 p.m.)

## A SMALL DEPOSIT will bring you enough parts to make a complete TRANSISTOR POCKET RADIO

(Size  $5\frac{3}{4} \times 3\frac{1}{4} \times 1\frac{1}{4}$ ) using a printed circuit

★Send for FREE PRICE LIST (all parts sold separately) and/or 3/- for new simplified instruction booklet with suggested circuits and assembly details.

OUR CIRCUITS OFFER  
HIGH SENSITIVITY  
HIGH SELECTIVITY

using

R.F. Transistors 1GN. each  
L.F. Transistors 10/- each

all specially selected to give  
HIGH OVERALL GAIN with A.V.C.

MANY OTHER SUB-MINIATURE COMPONENTS AVAILABLE

SPECIALISED ELECTRONIC COMPONENTS LTD 8 Eccleston Square London SW1

MAIL ORDERS ONLY

### FULL MEDIUM & LONG WAVE COVERAGE

for as little as £9.19.6

- Miniature loudspeakers, only  $\frac{1}{8}$ " deep x  $2\frac{3}{8}$ " diam. 27/6
- Miniature oscillator and i.f. coils,  $\frac{1}{16}$ " high,  $\frac{3}{8}$ " diam. 8/-
- Jackson 00 twin gang tuning condenser with intersection screen 10/6
- Attractive high impact polystyrene cabinet with fittings for tuner, trimmers, speaker and circuit board 12/6

The

# Radio Constructor

incorporating THE RADIO AMATEUR

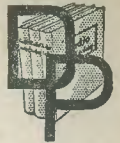

Vol. 12 No. 7

FEBRUARY 1959

ANNUAL SUBSCRIPTION 25/- (including postage)

## CONTENTS

- 494 Suggested Circuits: A Versatile Valve Tester  
by G. A. French
- 498 Can Anyone Help?
- 499 In Your Workshop
- 506 Understanding Television, Part 14  
by W. G. Morley
- 511 The Solar Three Miniature Transistor Light Operated Receiver, designed by G. A. French, Grad.I.E.E.
- 518 Technical Forum
- 520 The Jason JSA 2 Twin-3-Watt Stereo Amplifier  
by G. Blundell
- 528 Radio Miscellany, by Centre Tap
- 530 "Jinglebells"—Amateur Radio Teletype, Part 1  
by Jim Hepburn, VE7KX
- 534 The New Transeven, Part 2  
described by James S. Kent
- 537 A Negative Feedback Valve Millivoltmeter  
by G. K. Fairfield
- 540 An Easily Assembled Pre-Selector, by N. Fox
- 542 A "Professional" Dial and Drive, by K. J. Palmer

Editor

C. W. C. OVERLAND, G2ATV

Associate Editor

A. C. GEE, G2UK

Business Manager

J. H. BURROWS, A C A

Advertising Manager

F. A. BALDWIN, A M I P R E

Offices

57 MAIDA VALE LONDON W9

Telephone

CUNNINGHAM 6141  
(2 lines)

Telegrams

DATABUX, LONDON

## NOTICES

THE CONTENTS of this magazine are strictly copyright and may not be reproduced without obtaining prior permission from the Editor.

ARTICLES appearing in this magazine which describe kits are inserted only on condition that such kits, or special components thereof, are freely available at a trade discount to all retail advertisers.

OPINIONS expressed by contributors are not necessarily those of the Editor or proprietors.

THE EDITOR invites original contributions on construction of radio subjects. All material used will be paid for. Articles should preferably be typewritten, and photographs should be clear and sharp. Diagrams need not be large or perfectly drawn, as our draughtsmen will redraw in most cases, but all relevant information should be included.

ALL MSS must be accompanied by a stamped addressed envelope for reply or return. Each item must bear the sender's name and address.

TRADE NEWS. Manufacturers, publishers, etc., are invited to submit samples or information of new products for review in this section.

TECHNICAL QUERIES should be submitted in writing. We regret that we are unable to answer queries, other than those arising from articles appearing in this magazine; nor can we advise on modifications to the equipment described in these articles.

ALL CORRESPONDENCE should be addressed to THE RADIO CONSTRUCTOR 57 Maida Vale London W9  
REMITTANCES should be made payable to "DATA PUBLICATIONS LTD."



## Suggested

## Circuits

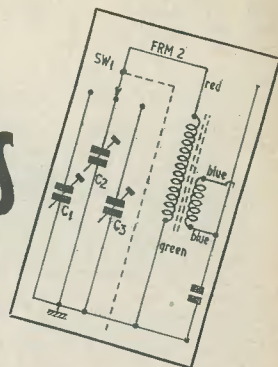

## No. 99 A Versatile Valve Tester

The circuits presented in this series have been designed by G. A. FRENCH, specially for the enthusiast who needs only the circuit and essential relevant data

VERY USEFUL ACCESSORY IN THE AMATEUR or professional radio workshop is an instrument capable of testing valve characteristics. Whilst it is generally appreciated that a valve tester does not examine all the points which contribute to the successful functioning of a valve in any particular circuit, it can still provide a useful measure of its general serviceableness. Also, it can often indicate shortcomings which are not obvious when the valve is fitted to the circuit in which it is to be used.

If it is to have any value, a valve tester must be capable of checking at least one valve characteristic. A test for emission only (as was provided some years ago in the cheaper units available commercially) is of little practical use. The most easily checked characteristic is mutual conductance, this term defining the change in anode current which occurs for unit change in grid voltage, anode voltage remaining constant.

## The Circuit

This month's circuit is that of a valve tester which has been especially designed for construction by the amateur. A considerable economy has been provided by the use of a.c./d.c. techniques and by dispensing with a mains transformer having a large number of heater voltage tappings. Instead of the trans-

former, dropper resistors are employed, these catering for valves whose heater currents fall into one of the two divisions normally encountered in modern receivers and televisions. Also, batteries are employed both for grid voltages and for powering 1.4 volt filaments. The use of batteries represents an advantage due to the fact that a large number of components are obviated. In service, the life of the batteries used in the tester should be of the order of several years at least. Another feature of the tester is that it is capable of being expanded at any future date so that the range of valves to be tested may be increased.

In the form illustrated in the circuit the tester is capable of measuring the emission and mutual conductance of any valve, other than a diode, whose anode current does not exceed 50mA, and whose heater or filament requirements are 0.1 or 0.3 amps in current or 6.3 or 1.4 volts in potential. This range covers almost all valves currently employed in radio and television receivers, with the exception of some line output valves.

## Circuit Operation

The functioning of the valve tester is based on the provision of switching circuits by means of which any desired potential may be applied to any electrode of the valve under test. The anode current for two grid voltages

is then measured, whereupon it becomes possible to check mutual conductance and, of course, emission. (Although not specifically intended in the design, it is possible also to check forward current in diodes by the simple process of checking the current which flows for an arbitrarily chosen positive anode voltage.) Information concerning valve potentials, emission, and mutual conductance is available from the valve manufacturer's literature. If desired, a set of cards can be made up for the valves most likely to be handled, these providing the necessary testing information in an easily assimilable form.

The circuit illustrates three valveholders, these being B9A, B7G and international octal. The pins of these valveholders connect to the appropriately numbered wires which travel to Electrode Selector Switches S<sub>1</sub> to S<sub>9</sub>. Electrode selector switch S<sub>10</sub> is connected to a fly-lead fitted with a crocodile clip, this catering for top-cap terminals. Valveholders other than those shown may be fitted to the tester, their pins connecting to the correspondingly numbered wires and switches.

The purpose of switches S<sub>1</sub> to S<sub>10</sub> is to connect the particular electrodes to which they correspond to the desired potential. In the diagram S<sub>1</sub>, 2 and 3 only are shown wired up. This is for purposes of clarity. S<sub>4</sub> to S<sub>10</sub> are connected up in exactly the same manner as are S<sub>1</sub> to S<sub>3</sub>.

The circuits selected by S<sub>1</sub> to S<sub>10</sub> are as follows: "H.T. Anode," "H.T. Screen-Grid," "Heater," "Grid," "Chassis" and "Free." It would be of value at this stage to examine the circuitry which corresponds with each of these settings.

If, via the corresponding switch, the anode of a valve connects to "H.T. anode," direct connection is made from the anode to meter M<sub>1</sub>. This meter is a 0-10mA instrument and is intended to measure the anode current of the valve under test. Should the anode current be higher than 10mA, switch S<sub>12</sub> has to be set to the 0-50mA position, whereupon it connects the shunt resistor R<sub>1</sub> across the meter. The meter terminal remote from the anode next connects to the arm of S<sub>11</sub>. This switch couples the anode, if current is less than 10mA, to the slider of potentiometer R<sub>4</sub>. If anode current is greater than 10mA, connection is made to the slider of R<sub>5</sub>. If desired S<sub>11</sub> and S<sub>12</sub> may be ganged together. The reason for having two instead of one variable resistor for controlling anode voltage is that these enable economies to be made in the power supply section. A single potentiometer connected across the h.t. supply and capable of handling anode currents up to 50mA would require to be a high wattage unit which, apart from drawing

a heavy standing current, would be expensive and difficult to obtain. The two potentiometers R<sub>4</sub> and R<sub>5</sub> are standard wire-wound types. It will be noted that R<sub>4</sub> is connected across the h.t. supply, whereupon it is capable of offering an anode potential at any level between zero and full h.t. voltage. R<sub>5</sub>, on the other hand, is connected in series with the h.t. supply, with the result that it is employed mainly for taking up changes in h.t. voltage given during the mutual conductance check. This method of connection for R<sub>5</sub> assumes, reasonably enough, that all valves under test whose anode currents are greater than 10mA are capable of operating with anode voltages around 200.

Meter M<sub>2</sub> measures the h.t. potential applied to the anode of the valve under test. The meter movement and series resistor employed here are left to the discretion of the constructor, who may wish to employ components already on hand. There is no necessity for the meter movement to be very sensitive, although its f.s.d. current should preferably not be greater than 10mA or so.

The next position on switches S<sub>1</sub> to S<sub>10</sub> causes the appropriate electrode of the valve under test to be connected to the "H.T. Screen Grid" circuit. In this instance the electrode is connected to the slider of R<sub>6</sub>, whereupon any positive potential from zero to full h.t. voltage, may be selected. Once again a voltmeter, M<sub>3</sub> with series resistor R<sub>3</sub>, measures the voltage applied to the valve. The remarks concerning the sensitivity of meter M<sub>2</sub> apply to this instrument also. It should be pointed out that the h.t. rectifier specified does not allow for more than a few milliamps drain in the M<sub>2</sub> and M<sub>3</sub> circuits. If insensitive meters are employed, it might be advisable to give a correspondingly higher rating to the h.t. rectifier.

The h.t. supply to both screen-grid and anode circuits of the tester are controlled by push-button S<sub>13</sub>. This button is depressed only when current and voltage measurements are being taken. The section of the tester which provides the h.t. voltage is given by rectifier W<sub>1</sub>, limiter resistor R<sub>10</sub> and reservoir condenser C<sub>1</sub>. The bleeder resistor R<sub>7</sub> ensures that the electrolytic condenser discharges when the equipment is switched off. As may be seen, this part of the tester is extremely simple and inexpensive.

## Heater Circuits

When an electrode selector switch is set to the "heater" position, the appropriate electrode of the valve under test is coupled to the arm of S<sub>15</sub>, the heater selector switch. S<sub>15</sub> then selects a suitable supply circuit. All supply circuits provide heater voltage with respect to chassis, whereupon it is necessary

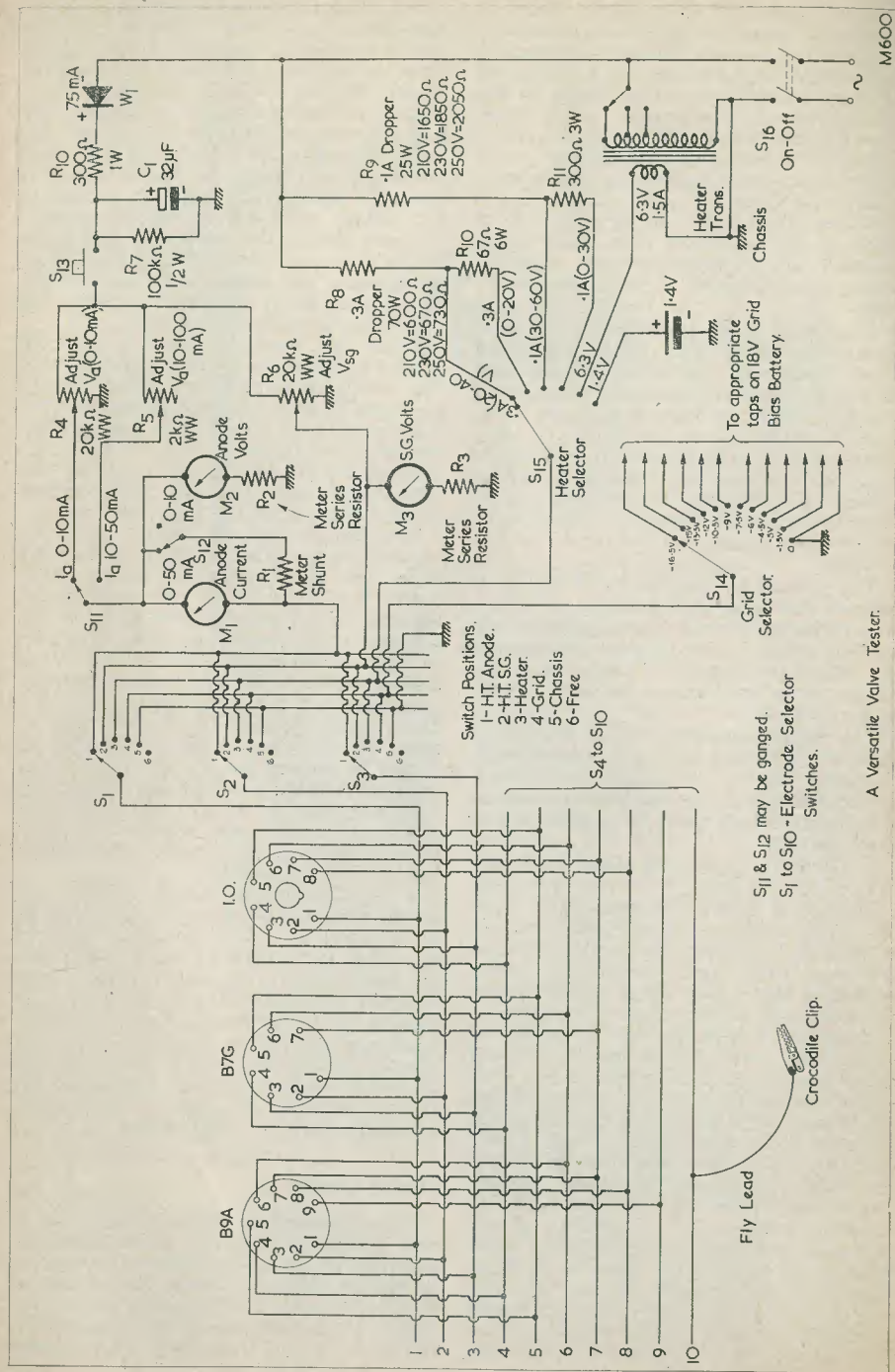

for the heater pin of the valve under test which does not connect to S<sub>15</sub> to be connected to chassis.

The first setting of S<sub>15</sub> is intended for 0.3 amp valve heaters whose voltages lie between 20 and 40. The heater dropper R<sub>8</sub> then ensures that the required current flows. The second position of S<sub>15</sub> is intended for 0.3 amp heaters whose voltage is less than 20, resistor R<sub>10</sub> being inserted to accommodate the lower heater voltage. The same principle is employed in the third and fourth switch positions, these catering for 0.1 amp heaters having voltages between 30 and 60, and voltages less than 30. It was considered necessary to provide two voltage settings for 0.3 and 0.1 amp heaters when design values were initially worked out, because any attempt to employ a single dropper value for all heaters in each current division would result in excessive disparities for heaters having low and high voltages. The values required in R<sub>8</sub> and R<sub>9</sub> are shown for differing mains voltages.

The next heater selector position is intended for 6.3 volt valves. In this case the circuitry is very simple, the requisite voltage being provided by the secondary of a conventional heater transformer.

The final heater selector position is for 1.4 volt valves. In this case the source of supply is a single 1.4 volt cell. Apart from the points mentioned above, the use of a cell in this position offers the advantage of a d.c. supply for the filament of the valve under test. Emission and mutual conductance readings taken from a battery valve whose filament is heated by a.c. are sometimes liable to be a little misleading. The cell employed here can be of any type, although it might be preferable to use a unit of the type intended for electric bell systems. The life of such a cell would be very long indeed.

Returning to the electrode selector switches S<sub>1</sub> to S<sub>10</sub>, the next position to be considered is the "grid" setting. This causes the appropriate electrode to be connected to S<sub>14</sub>, the grid selector switch. S<sub>14</sub> connects to a series of negative voltages lying between the limits zero and 16.5 volts, and increasing in steps of 1.5 volts. The voltage source here is provided by an 18-volt grid bias battery (or by two 9-volt batteries in series) the switch contacts connecting directly to the individual battery taps. Since there is no current drain on the grid bias batteries their life in the tester should be equivalent to their shelf life. A minor anomaly concerning the batteries employed in the tester is that the grid bias cells are quoted as having potentials of 1.5 volts whilst the single cell for filament valves is quoted as having a potential of 1.4 volts. The reason for this difference is that it is conventional to assume that a dry cell has a

potential of 1.5 volts off load, and a potential centring around 1.4 volts on load.

The next setting of switches S<sub>1</sub> to S<sub>10</sub> causes the appropriate electrode to be coupled to "chassis." The chassis connection is employed for electrodes such as suppressor grids and cathodes, and for heater or filament terminals which are not connected to the heater selector switch.

The final electrode selector switch setting is designated "free." This setting is mainly intended for "internal connection" pins, which must not be connected to any external circuit.

### Operation

A description of operation of the valve tester will be more readily understood if an example with an actual valve is described. Such a valve could be type 6V6.

Reference to a valve manual gives all the information required for testing the 6V6. It is first of all necessary to set up switches S<sub>1</sub> to S<sub>10</sub>. Pin 1 of a 6V6 is "not connected," whereupon we may leave S<sub>1</sub> in the "free" position. Pin 2 is a heater pin, and so we may set S<sub>2</sub> to "heater." Pin 3 is anode, and we correspondingly set S<sub>3</sub> to "H.T. anode." Pin 4 is screen-grid, whereupon S<sub>4</sub> is set to "H.T. screen-grid." Pin 5 is control grid, and S<sub>5</sub> is therefore set to the "grid" position. Pin 6 is, in practice, "no pin," whereupon S<sub>6</sub> is left in the "free" position. Pin 7 is the second heater pin, so S<sub>7</sub> may be set to "chassis." Pin 8 is cathode (and beam plates), so S<sub>8</sub> may also be set to "chassis." S<sub>9</sub> and S<sub>10</sub> are not required and they may be left in the "free" position.

The next switches to set up are S<sub>11</sub>, S<sub>12</sub>. These should be set to the 0-50mA position. S<sub>15</sub> should next be set to 6.3 volts. R<sub>5</sub> and R<sub>6</sub> should be at the minimum voltage ends of their tracks.

The valve manual\* gives operating characteristics for a 6V6 at 180 volts anode and screen-grid potential and -8.5 volts grid bias. S<sub>14</sub> should, therefore, next be set to -9 volts, this being the tap nearest to the grid voltage specified. The 6V6 may now be plugged in. After the valve has warmed up S<sub>13</sub> is depressed and R<sub>5</sub> and R<sub>6</sub> are adjusted to give readings of 180 volts in M<sub>2</sub> and M<sub>3</sub>. The anode current quoted in the manual for -8.5 volts grid voltage is 29mA at 180 volts. The valve tester offers 9 volts, whereupon the anode current of good valves should centre at a figure slightly lower than 29mA. S<sub>13</sub> should next be released and S<sub>14</sub> set to -7.5 volts. S<sub>13</sub> should then be depressed again and the new anode current checked. If necessary R<sub>5</sub>, and possibly R<sub>6</sub>, may be slightly readjusted to return to the previous

\* The figures quoted here are obtained from the *Brimar Radio Valve and Teletube Manual No. 7*.

anode and screen-grid voltages of 180. The difference between the two anode current readings then represents the change in anode current given by a change in grid potential of 1.5 volts, and the mutual conductance may be quickly ascertained from this difference. If the change in anode current had been 6mA the mutual conductance would have been  $6 \times 1/1.5$  or 4 mA/volt. The mutual conductance quoted in the manual for the test potentials just detailed is 3.7mA/volt, and so a 6V6 showing 4mA/volt may be considered as being in good condition.

Two points arise from the above description of operation. One of these concerns the push button S<sub>13</sub>. The purpose of S<sub>13</sub> is to ensure that h.t. is applied to the valve only when a reading is desired. S<sub>13</sub> should not be kept depressed when S<sub>14</sub> is being adjusted or the valve under test may momentarily receive zero bias between switch contacts. The presence of S<sub>13</sub> helps also to ensure that h.t. is not accidentally applied during setting up.

The second point arising from the description of operation concerns R<sub>4</sub>, R<sub>5</sub> and R<sub>6</sub>. Due to the fact that it is undesirable to operate certain multi-electrode valves with low anode and high screen-grid potentials, R<sub>6</sub> should not be set to a high potential whilst R<sub>4</sub>, or R<sub>5</sub>, are at the low voltage ends of their tracks.

#### Warning

*Before concluding, it must be reiterated that, in order to reduce expense, the valve tester design employs a.c./d.c. techniques, and that it consequently has a chassis which is connected to one side of the mains. As a result the normal safety rules applicable to equipment with live chassis must be observed. In the case of this particular unit it would be advisable to house the components in a wooden cabinet and to ensure that the panel on which valve holders and switches are mounted is made of insulating material. Care should also be taken to avoid shock when testing metallised or "metal" valves in the unit.*

## Can Anyone Help?

Requests for information are inserted in this section free of charge, subject to space being available

**BC.348R Receiver.**—R. Brown, 7 Marlborough Street, Dunkirk, Nottingham, wishes to convert this set to a double superhet, and would be glad if any reader can lend or sell him the circuit of the original.

**1155 Receiver.**—R. Webb, 4 Frith Close, Glenfield, near Leicester, needs full alignment details, and does not mind cost.

**Ekco PB-199 Receiver.**—P. Bithell of 61 Banbury Road, Stratford-on-Avon asks if anyone can help him obtain a service sheet for this set, which was made in 1938.

**Electronic Organ.**—H. D. Cowin, Maclay Hall, 17 Park Terrace, Glasgow C.3, makes a plea for information concerning the construction of a 3-octave polyphonic pedal board and ancillary generating and amplifying equipment to augment an existing reed organ. The equipment must be reasonably cheap, if possible using surplus valves such as the ARP.12, and it would be to advantage to include several stops, basically 8ft and 16ft flutes and 8ft and 16ft diapasons.

**R.1471 Receiver.**—D. M. Rogers, 31/33 Nelson Street, Southport, Lancs., asks for information and the circuit on this receiver. Can anyone help?

**Broadcast Receiver type BV.613, cat. ZA.24798.**—R. H. W. Sherwood, Ridgeway House, A.E.R.E., Harwell, Berks, would like to borrow a circuit diagram of and any information on this Army medium wave receiver which works from a 6V d.c. supply.

**Ekco A.28 Receiver.**—P. McKendry, 62 Regina Road, Finsbury Park, London, N.4, wants to borrow, or preferably buy, the circuit diagram with component values and modification data for this mains receiver.

**H.M.V. 1824 and Sobell 121T T.V. Receivers.**—W. R. Pritchard, 4 Handside Close, Welwyn Garden City, Herts, would like to purchase service sheets for these televisions.

**Type 4 or 5 Valve Tester.**—R. J. Cooke, 17 Princes Gardens, Peterborough, Northants, would like to borrow the instruction book, postage gladly refunded.

**BC.342 Receiver.**—R. W. Roberts, 1 Parc-y-dre, Ruthin, Denbighshire, N. Wales, would like to borrow or buy the full manual, and is also prepared to lend or swap any of the first four volumes of Newnes *Radio and Television Servicing* in exchange.

**PCR.3 Receiver.**—T. C. Keogh, 11 Marlborough Parade, Hillingdon, Middlesex, requires the manual—all expenses paid.

**Viewmaster T.V. Receiver.**—W. H. Jarvis, 14 Manor Road, Barnet, Herts, wishes to obtain the circuit diagram, etc., for this television, and is willing to pay costs, etc.

**Columbia C.505 Televisor.**—D. Millard, 48 Queens Park Road, Harbourne, Birmingham, wishes to buy, hire or borrow a service sheet, or to obtain the resistor values for the video stage.

## IN YOUR WORKSHOP



This month Smithy the Serviceman discusses an unfamiliar cause of instability with his assistant Dick

A VERY COMMON TRICK EMPLOYED BY writers of fiction who wish to emphasise the qualities of their main characters consists of introducing a second personality with markedly contrasting traits. Thus, the plodding, bumbling Dr. Watson throws into sharper relief the temperamental and brilliant Holmes. This technique seems to be especially prevalent in those stories which concern themselves with crime: Sexton Blake had (or is it still has?) his Tinker, Dr. Fell his terrified secretary, Nero Wolfe his Archie Goodwin, and so on. Some characters, of course, are sufficiently strong to stand out on their own in one way (like Lord Peter Wimsey, Maigret and Ellery Queen) or the other (like Hank Jansen).

Smithy the Serviceman, who had never heard of Hank Jansen, and his assistant Dick, who had read every Hank Jansen story published, could not, however, be described as having strongly contrasting characters. Instead of being 180 degrees out of phase with each other, as it were, they were both fairly closely matched. In most of their common interests one of the pair might lead and the other might lag, but the difference between them would be a matter of degree only.

Perhaps the most noticeable dissimilarity between the two lay in their attitude to their work and to the world in general. Once immersed in the entrails of a chassis, Smithy was lost to his immediate surroundings; and it was only after he had successfully run down to earth the cause of the particular fault he

was investigating that he came back to reality—whereupon, for a few moments, he would gaze a little absent-mindedly at the workshop around him. Dick, on the other hand, had a lively curiosity about anything and everything and, whilst his work took up much of his interest, the keenness of that interest was no greater than his keenness in any other of his activities.

One cold and foggy winter afternoon found the pair hard at work at their respective benches. Smithy had before him a receiver which suffered from instability at low signal levels, whilst Dick was working on an a.c./d.c./battery portable.

#### Instability

After a while Smithy gave a sudden grunt of satisfaction. He applied his soldering iron to a joint on the chassis and carefully checked the result on the picture given by the receiver. He next pulled the aerial plug from the receiver input socket and checked the receiver on all channels. Whatever the setting of its contrast control, it showed up a clean raster with nothing more detrimental than the self-generated noise from its tuner input stage.

Smithy straightened up and leaned back a little.

"Ah," he remarked, with considerable satisfaction.

Dick, at the other side of the Workshop, pricked up his ears at once.

"You sound as though you've cleared a really difficult one," he remarked over his shoulder.

Smithy started a little as he realised he was being overheard.

"Well, it was a bit of a stinker," he admitted eventually. "Although I must say I've met worse."

"What was the trouble?"

"The set went unstable on weak signal levels," replied the Serviceman. "The customer who uses it gets a good Band I picture but his Band III signal is very weak. When Band III came to this district he found that he could just pick up I.T.A. with his Band I aerial, with the result that he decided to save his lolly by refusing to put up a Band III job. The fact that he's got a ghostly picture and his poor old set is straining its guts to bring the detergent ads up above noise level doesn't seem to have affected his decision at all. I often wonder why people pay the full price of a t.v. set and then spoil it by trying to save on the aerial."

"You're veering," grinned Dick.

"Am I?" said Smithy a little absently. "Well, perhaps I am. Anyway, the set I've just fixed coped O.K. with the situation until a few days ago. Then, all of a sudden, it went on strike and refused to become stable on Band III, although it still worked normally on Band I."

"What was the snag?"

"Oh, the thing you so often find when you chase an awkward fault around the chassis. Just a dry joint."

Smithy turned back to his bench, apparently under the impression that he had fully answered Dick's question.

"Yes," Dick asked plaintively, "but a dry joint where?"

"Where?" said Smithy. "Why, on the a.g.c. line, of course."

Catching sight of Dick's expression, which was almost agonised with unsatisfied curiosity, the Serviceman reluctantly realised that that he would have to impart further information.

"I suppose," he grumbled, "I won't get any peace until I give you the full story, so I'd better get it over and done with. After I got the faulty chassis into the Workshop and on to the bench I started to put it through its paces. In cases of instability of this nature you can almost always be certain that one or more stages in the tuner or i.f. strip are on the verge of going unstable even when the strong signal is available. In the absence of a strong signal the a.g.c. line of the receiver becomes less negative, the guilty stage, or stages, provides greater amplification, and the instability appears."

"In this instance I first of all quickly checked the receiver on both Band I and Band III signals and on the channels in between. On the channels where there was no signal the receiver made no bones about

being unstable. The raster showed up white straight away, this indicating that a fair amount of i.f., the result of oscillation in the unstable section of the receiver, was hitting the video detector. Both Band I and Band III pictures showed up O.K., but this was merely because our very superior Workshop aerials pick up a good signal. I decided that the next thing to do was to reproduce the set-up existing at the customer's house in which Band III signal level was very weak."

"How did you do that?" broke in Dick eagerly. "Did you bung a bit of gash wire into the centre connector of the aerial socket and rely on the small amount of pick-up you got off that?"

"I did not," replied Smithy, with quiet dignity, "bung a bit of gash wire into the aerial socket of the receiver. Instead, I put attenuators in series with the Band III aerial until signal strength was sufficiently low for the instability to appear. I had two reasons for doing this, one being that, with a snag which repeated itself as reliably as this one did, it was a quick method of getting the set ready for trouble-shooting. Anyway, having connected the set up in the aforementioned manner, I next decided to have a closer look at the chassis."

"What was the second reason for not using the bit of gash wire?" interrupted Dick. He had just commenced to smoke a cigarette and Smithy realised, with subconscious surprise, that he could not remember his assistant lighting it.

"I shall have to tell you that later on," replied Smithy, dismissing from his mind the apparent puzzle of Dick's cigarette. "Now, having got the set unstable, the next thing was to decide where the faulty component causing the instability was situated. My first action was to give the chassis a perfunctory butcher's to see if there was any obvious fault which could be readily seen. As I have been dinning into your unreceptive ears ever since you've been in the Workshop, the policy of spending a minute or two looking for obvious faults pays off excellent dividends."

"But I always do do that," protested Dick. "Do you?" queried Smithy. "What about that sound receiver you had yesterday? You spent half-an-hour on it before you tumbled to the fact that someone at the customer's home had swapped over the i.f. and frequency-changer valves."

"Ah, yes," said Dick, "but that was an exception. Who'd think of looking for valves in the wrong holders?"

"I would, for one," replied Smithy, "and so would any other service engineer who'd grown cynical with the years, as I have. Anyway, let's get back to that instability."

#### A.G.C. Line

"Now, my quick look around for the

obvious," continued Smithy, "revealed nothing whatsoever, and so I had to search for something a little more hidden. I decided that I'd have a bash at seeing if I could isolate the trouble in either the i.f. strip or in the turret tuner. In this particular set a process like this was quite easy because the i.f. strip and tuner unit had a.g.c. lines which were fairly well separated from each other by a potential divider near the grid of the sync separator. So I first of all applied the trusty Workshop a.g.c. cheater<sup>1</sup> to the a.g.c. line going to the i.f. strip. With the cheater set to zero output volts the instability remained unchanged. As I put increased negative volts on the a.g.c. line the white raster on the screen merely got fainter and fainter, until it finally disappeared altogether at a negative voltage around 4 to 5. This was a very much greater a.g.c. bias than would occur under weak signal conditions and, so far as I could see, this check exonerated the i.f. strip altogether. Had the instability suddenly

decoupling condensers on the tuner a.g.c. line and, after removing the cheater, I at once checked these by shunting another across them. But I had no success. They were both entirely above suspicion."

"Hmm," remarked Dick, putting a second newly-lit cigarette to his lips, "it sounds as though you had an awkward one. At this stage, I'm afraid, I would have had terrible visions of digging my way into the tuner and seeing if there were any further a.g.c. decoupling components here which might have gone faulty."

"Once more," said the Serviceman, "exactly the same thought occurred to me. And I, also, had several unhappy moments pondering on it. However, a look at the circuit diagram of the set soon showed me that the only a.g.c. circuitry inside the tuner consisted of a leak to the cascode control grid and so I felt that there was not much risk of trouble here. I decided instead that there was something a little fishy on the a.g.c. line

Fig. 1. The "a.g.c. cheater" employed in the Workshop. The fly-leads connect to chassis and to the a.g.c. line under investigation, whereupon suitable voltages at a source impedance low enough to swamp out that existing in the receiver may be selected by R<sub>2</sub>. The rectifier in the cheater may be a germanium diode having a high turn-over voltage

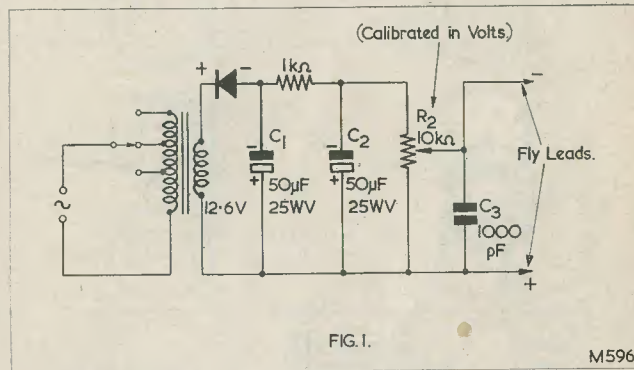

disappeared as I turned the cheater potentiometer from zero to a low negative potential I would have definitely suspected the i.f. strip as being unstable. Anyway, the next thing I did was to re-set the cheater potentiometer to zero volts and connect its fly lead to the a.g.c. input tag of the tuner. Whereupon, to my surprise, the instability cleared up at once!"

"That's queer," said Dick. "Do you think the low impedance to chassis provided by the cheater output was bypassing a faulty a.g.c. decoupling condenser?"

"You're a very good boy," said Smithy approvingly, "because that is exactly what I did, at first, think. There were only two

itself and so I applied the valve-voltmeter between the tuner a.g.c. line and chassis."

"It's a good thing," remarked Dick, "that we've got such posh gear in our Workshop. I bet that quite a few of the people who write in to us every now and again don't have valve-voltmeters!"

"Perhaps not," grinned Smithy, "but I'll deal with other ways of diagnosing this fault in a moment. To return to the valve-voltmeter, I wasn't at all surprised when I found this told me that the a.g.c. line to the tuner was positive to chassis. But I was surprised to find that it was as much as some 2½ volts positive. The a.g.c. lines on quite a few t.v. sets go a little positive under low signal conditions, but it is very rare to find them going any higher than, at worst, one volt. At any event I assumed, rightly enough as it

<sup>1</sup> See Fig. 1. This device was originally described in "In Your Workshop," *The Radio Constructor*, April 1957.

has turned out, that the high positive a.g.c. voltage was causing the tuner to go unstable. "The excessive 'plusness' of the a.g.c. line made me turn once more to the circuit diagrams. In common with quite a few t.v. receivers there was a high value bleeder from the top end of the a.g.c. load to the h.t. line, its purpose being to ensure that weak signals do not cause too much negative a.g.c. Such a circuit almost always requires a clamp diode, and I suddenly fell in to the fact that the diode must have gone faulty. But in this circuit there just wasn't any diode! It wasn't until I ran my gnarled finger along the tuner a.g.c. line in the circuit that I ran it to ground."

"Where was it?" "It was in one of the valves in the i.f. strip," chuckled Smithy, "the geyser who designed the set had very neatly pinned the a.g.c. line to, of all things, the suppressor grid of one of the i.f. amplifiers!" (Fig. 2).

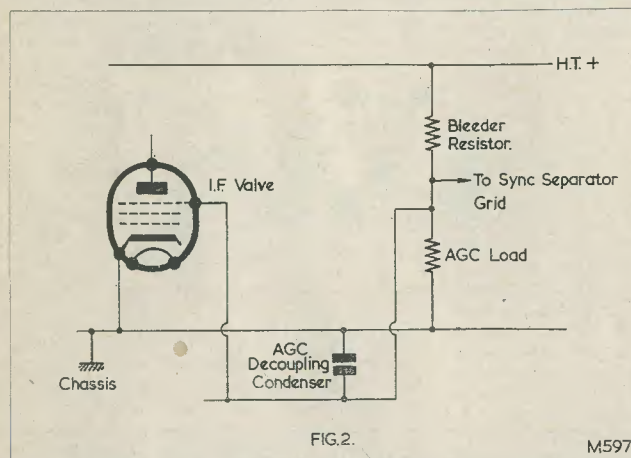

Fig. 2. It is common practice to couple the a.g.c. load resistor to the h.t. positive rail via a high value resistor. A clamp diode connected across the a.g.c. load then prevents the formation of a high positive voltage on the a.g.c. line. In this simplified circuit diagram the cathode and suppressor grid of an i.f. amplifier provide the clamp diode

"I don't get it," said Dick. "Well, it's simple enough," replied Smithy. "Provided that you don't mind a fairly high forward resistance, the suppressor grid and cathode of an i.f. valve make quite an effective diode. Such a diode is certainly good enough for an a.g.c. clamp. I need only add that, as soon as I saw this in the circuit, I immediately checked the connections in this part of the chassis. Whereupon, I found the proverbial cold joint on the suppressor grid valveholder tag."

#### Alternative Methods

"That's pretty interesting," remarked Dick. As if by magic a further freshly-lit cigarette

had appeared in his hand. "But there are still one or two points that are outstanding. For instance, how about detecting the snag without a valve-voltmeter?"

"That shouldn't be too hard," said Smithy, "although you would have to rely a little more on native intuition. If I hadn't had a valve-voltmeter I would have connected the output leads from the cheater the other way round so that its negative lead went to chassis, and would then have started taking the turret a.g.c. line slowly up from zero in the positive direction. If the instability had shown up when I had gone higher than 1 volt I would have expected, once more, a certain fishiness in the a.g.c. system."

"I see," commented Dick. "Now my next query goes back to something you mentioned earlier on. You said there were two reasons for not getting a low input signal at Band III by using an odd piece of wire as an aerial. One reason was that you wanted to have a

set of conditions similar to those in the customer's house, and one which would allow for easy trouble-shooting. What was the other reason?"

"Well, the other reason was that you occasionally get t.v. sets which go unstable if the aerial input circuit is not loaded by a proper aerial. I didn't want the risk of this occurring in the present instance as it might have given me misleading symptoms. I know that, theoretically, correct loading should presumably be given by connecting a quarter wavelength of wire to the centre connector of the aerial input socket, this resulting in something around 75 ohms aerial impedance when it is assumed that the chassis functions

as a counterpoise. In practice, though, the chassis doesn't always offer a good counterpoise and the impedance at the input socket may wander all over the place. Indeed, it is sometimes possible to promote instability by the use of a quarter wavelength of wire because the chassis, which may already have a few i.f. currents from decoupling points rumbling around its surface, is now forced to carry signal input currents as well. Instability of this nature is perhaps a little different from the case where instability results from an open aerial input circuit because it is more liable to occur on Channel I, where the signal input frequency is close to the intermediate frequency. Instability resulting from an open or incorrectly loaded aerial input circuit may occur at any channel on which the tuner feels like becoming temperamental."

that, if the set is to be used with a regular aerial, there's no point in doing this because the conditions of use automatically provide the cure. The second case of instability, wherein a single piece of wire is used as an aerial, can also be cured by the 300 to 400 ohm resistor. An alternative, and perhaps better, idea consists of connecting a yard or so of wire to the earthy side of the aerial input socket and let this act as the counterpoise. The counterpoise wire can usually be draped away somewhere out of harm's way. If the set is a portable with a single aerial rod similar instability troubles may occasionally arise, whereupon you might be able to effect a cure with the counterpoise wire, this being coiled up inside the cabinet. Taking care, of course, to ensure that the counterpoise is well insulated and is kept well away from live chassis parts."

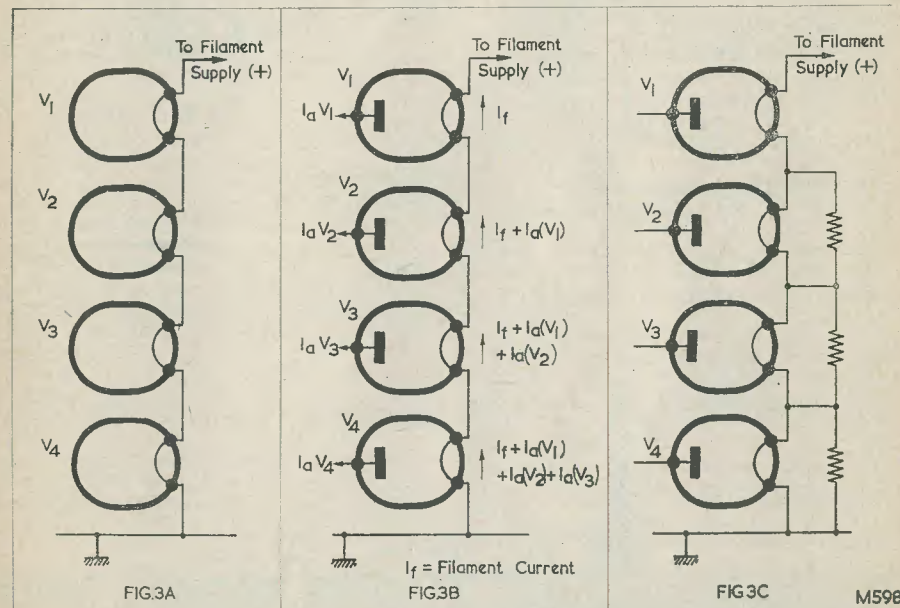

Fig. 3 (a) Filaments in a.c./d.c./battery receivers are normally connected in series. (b) As illustrated here, filaments lower down the chain have to carry the anode current of valves higher up. (c) The effect of the additional current may be counter-balanced by connecting resistors across each filament. In practice, designers usually manage to achieve sufficient protection with one or two strategically positioned resistors only

"Any cures?"

"For the case where instability occurs with the aerial circuit open," replied Smithy, "a useful cure consists of slapping a 300 to 400 ohm carbon resistor across the input to hold things down a bit. But you must remember

#### A.C./D.C./Battery Circuits

Smithy, obviously feeling that he had imparted all the instruction to his assistant that he was called upon to provide, turned back to his bench. But Dick was too swift for him.

"Smithy," he asked quickly, "I wonder if you can help me with this a.c./d.c./battery set I've got in for repair. It works perfectly well except for the fact that one of the valves seems to burn out every few months or so. I've checked over the chassis but I can't see anything out of the way."

"Well," said Smithy, frowning, "you couldn't have looked very far. Did you check the filament voltage of each bottle?"

more times do I have to tell you never to take anything for granted in the servicing game? Now, as you know, in an a.c./d.c./battery set all the filaments are connected in series like this." Smithy scribbled on a piece of paper. (Fig. 3 (a).) "If the current flowing through these filaments were only that given by the filament supply all would be well. But it ain't! This is because the valves pass not only filament current but anode current as

approach the negative end of the string. The filaments of the valves employed in a.c./d.c./battery sets are either 50 or 25mA types, and you need only a few extra milliamps, caused by anode currents higher up in the string, to give quite severe overloading lower down."

"I had never even realised that this trouble existed," commented Dick. "How do manufacturers overcome it?"

"By the simple process of shunting the filaments lower down the string with suitably valued resistors. Like this. (Fig. 3 (c).) These resistors carry the anode current of valves higher up and ensure that each filament passes its rated current. In practical receivers you may not find a single resistor across each filament as I've shown you, because the designers may have juggled things around such that, say, a single resistor across the bottom two filaments, or something of that order, gives sufficient protection. In your particular receiver I would suggest that you take a very close look at the resistor which is intended to protect the filament of the valve in question. It may have gone open or high.

"Incidentally, whilst on the subject of a.c./d.c./battery sets, I cannot offer too strong a warning to you to take care with them during servicing. Because of their very low filament currents, it's the easiest thing in the world to burn out all the valves by such things as accidentally applying a test prod to a wrong valveholder tag. It is, indeed, possible to burn out the valves even when all supplies are disconnected just by accidentally coupling a charged electrolytic across the filaments."

#### Cigarette Lighter

"O.K., Smithy," said Dick. "I'll take good care from now on."

Yet another lighted cigarette had appeared between his fingers. For the first time that morning, realisation of the mystery struggled

at last to the surface of Smithy's mind.

"Dash it all," he said, "I've just realised that you've been puffing away like a chimney for the last hour or so, and I've never yet seen you strike a match or use a cigarette lighter. How come?"

"Ah," said Dick. "I'm using my special Supervisor Baffling Cigarette Lighter.<sup>2</sup> This is designed especially for use in workshops and laboratories where, unlike you, the guv'nors are suspicious and old-fashioned."

"If," said Smithy, whose back was as impervious to "flannel" as a duck's to water, "you have got a red-hot bit of resistance wire secreted somewhere and burning up Workshop current, I shall withhold approval until I have carried out an inspection of said device. Proceed."

Dick looked a little pained.

"Well," he said, "it is a little like that, but the knobby thing about it is its disguise."

He indicated a chassis on which were mounted a transformer, a few valveholders with screening cans, some electrolytic condensers, and other small components. The chassis had the inconspicuous air that all such chassis have in Workshops.

"This chassis," said Dick, "is the disguise.

The transformer is an odd component having a 6.3 volt heater winding, and one of the valve cans is the lighter section. (Fig. 4.) An ingenious part of the design is that the element, when viewed from the top, looks just like the top spring of the valve can, thereby making the disguise even more impenetrable."

Smithy laughed out loud.

"Well, I've seen everything now," he chuckled. "But I must confess that your gadget has a certain Goon-like appeal. You can take an order from me for a second model right now!"

<sup>2</sup> This idea was contributed by reader T.A.N. of London.

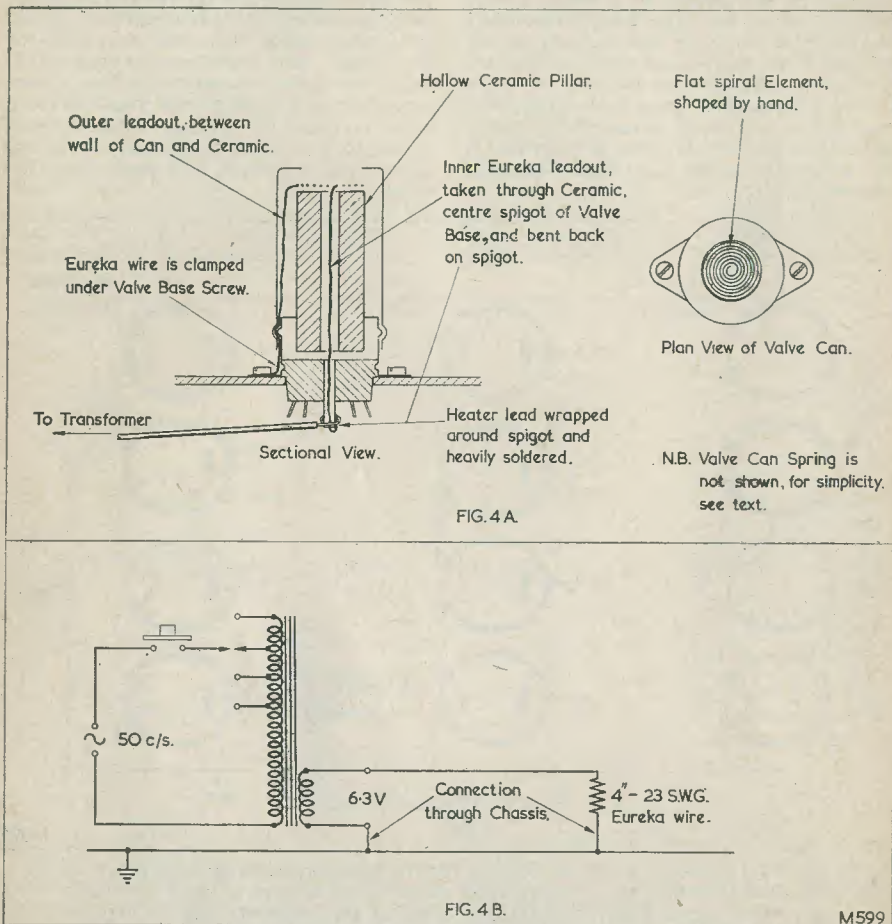

Fig. 4. Details of Dick's "disguised" cigarette lighter

"No," admitted Dick, "but I checked across the whole string of filaments and the total voltage seemed O.K. After all, the same current has to pass through all the filaments, so why should it be only one of the valves which keeps burning out?"

"Oh dear," sighed Smithy. "How many

well. Indeed, apart from the top valve, the filament of each valve in the string has to pass the anode currents of the valves above. (Fig. 3 (b).) You can, of course, add screen-grid current to anode current where applicable. The result is that the current passed by the filaments gets progressively higher as you

## HEATHKIT 6-TRANSISTOR PORTABLE In Leather Case

The Heathkit UXR-1 Kit, illustrated here, has the latest type gold-plated printed circuit, giving high performance and making for ease of assembly. A novel point is the use of a solid leather case. Battery life is between 300 and 500 hours, with normal usage. Good quality reproduction is obtained through a special high flux wide-angle speaker; and both Medium and Long waves are covered, ensuring reliable reception of the Light programme throughout the country. Available from Daystrom Ltd., Gloucester, the kit is priced at 17 guineas including P.T.

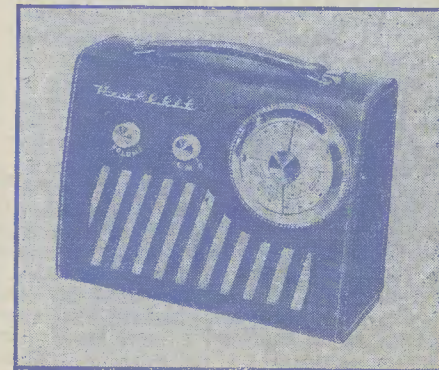

# UNDERSTANDING TELEVISION

PART 14

By W. G. MORLEY

The fourteenth in a series of articles which, starting from first principles, describes the basic theory and practice of television

IN OUR CONSIDERATION OF THE TELEVISION receiver we have, to date, devoted our attention to the basic form of the television signal, and to the cathode ray tube. We then turned to the tuner unit which, nowadays, almost inevitably constitutes the first few stages of the receiver. The output of the tuner unit feeds into the i.f. amplifier, or "strip," of the receiver, and it is this which we shall next consider.

## The I.F. Signal

In any television system the signal picked up by the aerial consists of two modulated carriers, one of these being the vision carrier and the other the sound carrier. In Britain, both these carriers are amplitude modulated and, in consequence, have sideband frequencies which extend away from the carrier by distances up to the highest modulating frequency being handled. In the British system the highest modulating video frequency is 3 Mc/s, and this can result in the formation of sideband frequencies at spacings of 3 Mc/s on either side of the vision carrier. In practice, however, most of the frequencies on one side of the vision carrier are suppressed, with the consequence that the sidebands given by the video signal can be considered as lying mainly between the vision carrier and a frequency 3 Mc/s below it.<sup>1</sup> The sound carrier also has sidebands, these

extending on either side of the sound carrier up to the highest sound frequency handled. As the sound modulating frequencies are relatively very much lower than the carrier frequencies, the resultant sidebands occupy very little space and there is no point in suppressing these on one side of the carrier, as is the practice with the vision signal. Fig. 78 (a) illustrates the situation which appears in British television channels and shows the frequency range occupied by the vision sidebands. It will be noted that the sound carrier is 3.5 Mc/s below the vision carrier.

Also shown in Fig. 78 (a) is the sound carrier for the channel above that under consideration. With several exceptions, channel spacing in Britain is 5 Mc/s, with the result that the sound carrier for the higher channel is 5 Mc/s above the sound carrier of the channel under consideration, and is 1.5 Mc/s above its vision carrier. The exceptions just mentioned to 5 Mc/s spacing between channels appear on Channels 1 and 2 (which are spaced by 6.75 Mc/s), and also, of course, on Channels 5 and 6 (which are in separate Bands), and on Channel 13 (which is the highest channel in Band 3).

In the television tuner, before the i.f. strip,

<sup>1</sup> For a more detailed description of the British transmission characteristic, see "Understanding Television"—part 4; April 1958 issue.

the purpose of the oscillator and mixer section is to convert the incoming signal to frequencies which may be conveniently handled by the i.f. amplifier. In modern British receivers the intermediate frequency universally employed for the converted vision carrier is 34.65 Mc/s with the result that, whatever channel is being received, the oscillator is always adjusted to run at a frequency 34.65 Mc/s above the vision carrier of the channel selected.

The result of converting the signals of Fig. 78 (a) is illustrated in Fig. 78 (b). We know that the vision carrier is converted to an intermediate frequency of 34.65 Mc/s, and this is shown in the diagram. The converted sound carrier, which was previously 3.5 Mc/s below the vision carrier, now appears at 38.15 Mc/s, 3.5 Mc/s above the converted vision carrier. The reason for this transposition may be readily understood if it is remembered that the sound carrier is spaced further away from the oscillator than is the vision carrier, thereby giving a higher difference frequency. Also illustrated in Fig. 78 (b) are the single sideband of the vision carrier, this now appearing above its carrier, and the sound carrier of the adjacent channel, which now appears below the converted vision carrier at a frequency of 33.15 Mc/s. In Fig. 78 (b) the sections of the converted signal which constitute the *vision i.f.* and the *sound i.f.* are indicated.

## The I.F. Amplifier

Since the i.f. amplifier of the receiver has to handle sound and vision intermediate frequencies, it is necessary for these to be separated at some point so that they may be handled individually. A simplified method of doing this is illustrated in the block schematic diagram of Fig. 79. In this diagram the output of the tuner unit is applied to two tuned amplifiers, one handling the vision signal and the other the sound signal. The vision i.f. amplifier is tuned so that it passes frequencies within the range 34.65 to 37.65 Mc/s, whilst the sound i.f. amplifier employs relatively sharply tuned circuits tuned to 38.15 Mc/s. The output of the vision i.f. amplifier is connected to the *video detector* and, thence, via the *video amplifier* to the modulating electrode<sup>2</sup> of the cathode ray tube. At the same time the output of the sound i.f. amplifier is connected to the *sound detector* and thence, via the *audio or sound amplifier* to the loudspeaker. Thus, both vision and sound i.f. amplifiers handle their respective signals and cause these to be applied, separately, to the cathode ray tube and to the loudspeaker.

A rather more practical form of television i.f. amplifier is dealt with in Fig. 80. In Fig. 80 (a) the output of the tuner unit is applied to a common i.f. amplifier, this being

<sup>2</sup> Either the grid or the cathode. See "Understanding Television"—part 5; May 1958 issue.

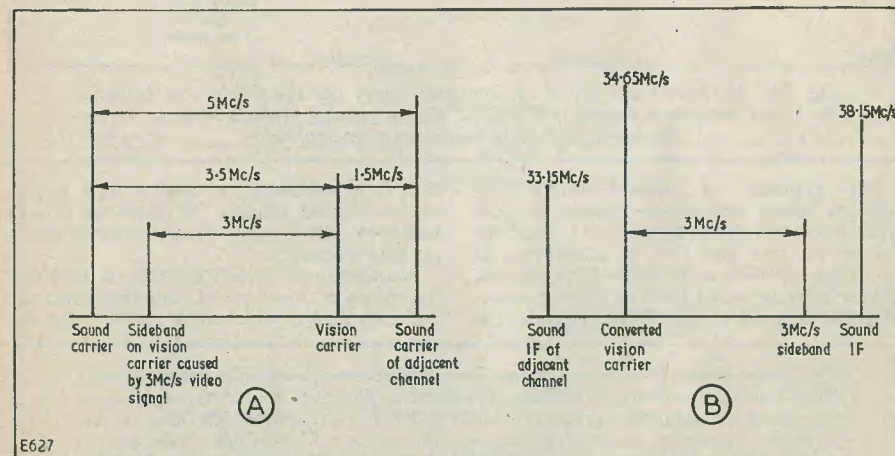

Fig. 78 (a) In a British television channel the vision information is largely contained in the range between the vision carrier and a frequency 3 Mc/s below it. The sound carrier is 3.5 Mc/s below the vision carrier. With a few exceptions, the sound carrier of the adjacent channel higher in frequency is 1.5 Mc/s above the vision carrier of the channel under consideration. (b) After conversion in the tuner unit the signal frequencies of (a) take up, in British receivers, the frequencies shown here

relatively flatly tuned and capable of amplifying signals within the range 38.15 to 34.65 Mc/s. Thus, both sound and vision i.f. signals receive amplification at this stage. The use of a common i.f. amplifier is customary in practical television receivers, and it usually employs a single valve.

After the common i.f. amplifier the signal is passed to the two separate i.f. amplifiers. The sound i.f. amplifier has relatively sharply tuned circuits, these being capable of amplifying the sound intermediate frequency and of preventing the vision intermediate frequency from reaching the sound detector at sufficient level to cause interference.

sort of response a simple tuned amplifier of this type could have and shows clearly the fact that the sound i.f. could reach the video detector at a sufficiently high level to cause interference unless some sort of special precaution was taken. This precaution consists, in practice, of fitting one or more rejector tuned circuits to the vision i.f. amplifier, these causing a sharp reduction in gain to occur at the frequencies to which they are tuned. Fig. 80 (b) illustrates a vision i.f. amplifier which has been fitted with *sound rejector* circuits tuned to 38.15 Mc/s and shows how the response is sharply modified at this frequency. In most vision i.f. ampli-

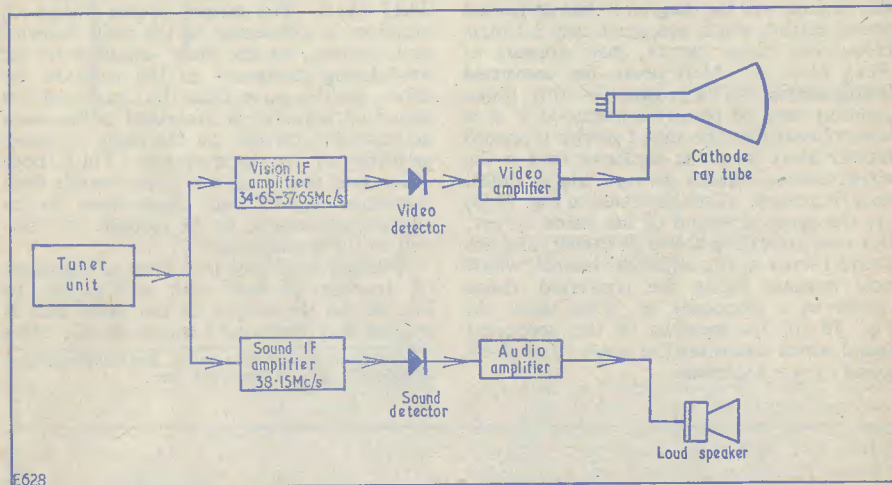

Fig. 79. The vision and sound i.f. amplifiers carry out the function of handling the vision and sound signals individually; and of passing them, separately, to the cathode ray tube or loudspeaker as applicable

The problem of mutual interference between sound and vision signals is more difficult to overcome in the vision i.f. amplifier due to the fact that this, in attempting to amplify a relatively wide band of frequencies, has to employ tuned circuits having somewhat flat responses. Fig. 80 (a) illustrates the

problem of mutual interference between sound and vision signals is more difficult to overcome in the vision i.f. amplifier due to the fact that this, in attempting to amplify a relatively wide band of frequencies, has to employ tuned circuits having somewhat flat responses. Fig. 80 (a) illustrates the

Another factor which is liable to influence the design of the vision i.f. amplifier concerns the interference which may result from the

Fig. 80 (a) Many television receivers have a common i.f. amplifier which handles both sound and vision intermediate frequencies. The relatively sharp response of the sound i.f. amplifier appears below the block representing this part of the receiver. Assuming no rejector circuits, the vision i.f. amplifier could have a response like that shown. (b) The addition of a sound rejector to the vision i.f. amplifier causes a sharp dip in response at 38.15 Mc/s. The slight rise in gain above 38.15 Mc/s illustrated in this diagram is not inevitable, although it occurs in many practical i.f. amplifiers. (c) A number of receivers have an adjacent channel rejector tuned to 33.15 Mc/s, causing thereby a reduction in response at this frequency. (d) The a.g.c. arrangement in a conventional receiver. It is customary to have more than one negative control voltage in the vision a.g.c. system, these applying different degrees of control to the various stages in the vision amplifier chain

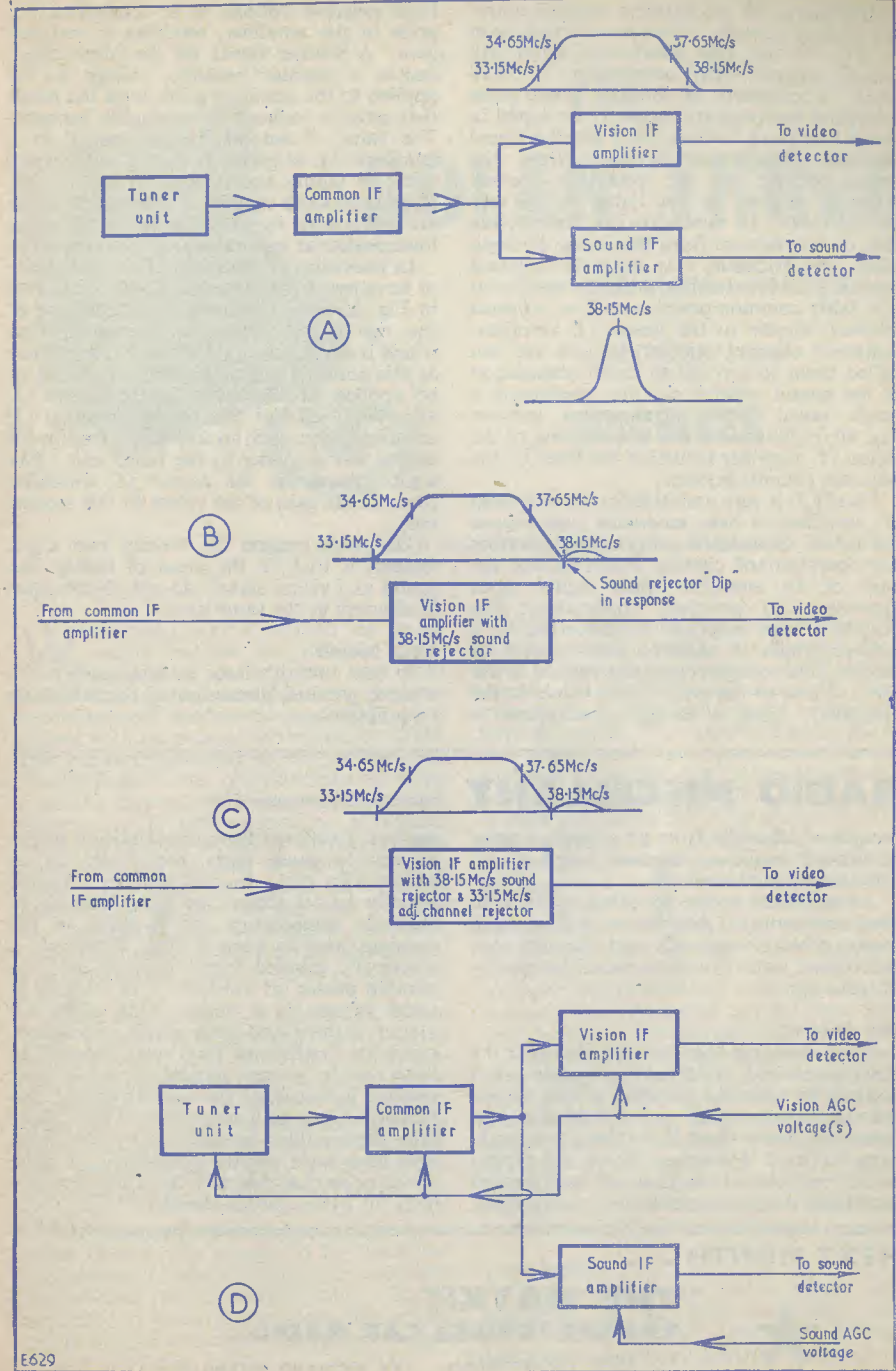



sound carrier of the adjacent channel above the desired channel. As we have already seen in Fig. 78 (b), this interfering signal will usually appear, after conversion, at 33.15 Mc/s. Fortunately, in Britain, where most television receivers are tuned to the signal in Band 1 or Band 3 which offers greatest signal strength, interference resulting from the sound carrier of the relatively weaker adjacent channel is not liable to be very considerable. In most districts, indeed, the risk of interference from this cause is negligible. Nevertheless, it is desirable to guard against such interference, with the result that it is fairly common practice to fit an *adjacent channel rejector* to the vision i.f. amplifier. Adjacent channel rejector circuits are not called upon to provide as much attenuation as are sound rejector circuits, whereupon a single tuned circuit arrangement suffices. Fig. 80 (c) illustrates how the response of the vision i.f. amplifier is further modified by the adjacent channel rejector.

Finally, it is very desirable for the television i.f. amplifier to have *automatic gain control* (or a.g.c.). Automatic gain control describes the operation of circuits which reduce the gain of an amplifier when signal input increases. In practical applications, the output of the amplifier is converted to a voltage which is negative with respect to chassis, this voltage being then applied in the form of bias to the grids of the valves in the amplifier. Thus, a strong signal causes a

large negative voltage to be applied to the grids in the amplifier, resulting in reduced gain. A weaker signal, on the other hand, causes a smaller negative voltage to be applied to the amplifier grids, with the result that gain is reduced by a smaller amount. The value of automatic gain control in a television i.f. amplifier is that it reduces the effect of fading and it helps to ensure that strong and weak signals on different channels are reproduced by the cathode ray tube and loudspeaker at approximately the same level.

In television i.f. amplifiers it is customary to have two a.g.c. systems. These are shown in Fig. 80 (d). The more comprehensive of the two a.g.c. systems is, normally, that which is employed in the vision i.f. amplifier, as this not only causes the controlling bias to be applied to the valves in the vision i.f. amplifier itself but also to the common i.f. amplifier (when such an amplifier is employed) and to the amplifier in the tuner unit. The a.g.c. system in the sound i.f. amplifier controls the gain of the valves in this section only.

The main reason for having two a.g.c. systems is that, in the event of fading, the sound and vision signals do not always alter in strength at the same time.

#### Next Month

In next month's issue we shall commence a more detailed discussion of the television i.f. amplifier.

## RADIO MISCELLANY

*continued from page 529*

records which suffer from wow, surface noise or limited frequency response aren't cheap, however small the price."

All of which seems to bring us back to where we came in. Maybe, as in the case of many other things, it's not cheaper l.p. records we want, but more expensive ones—at less cost.

#### Dry Subject

Some time ago this column discussed the advantages and drawbacks of garden-shed workshops when the question of rust caused through condensation was considered. An interesting letter from R.J. (Slough) recently came to hand. He writes: "I am just experiencing my first winter in a self-built garden workshop and, apparently like many other

readers, I suffered from condensation severe enough to cause parts, tools, etc., to be coated with rust. In cold weather I kept a paraffin heater (convector type) burning to maintain temperature for working in the evenings and to keep it dry. However, a chemically minded friend pointed out that paraffin passes off nearly 90% of its bulk in water vapour as it burns. This might not matter if there had been ample ventilation, but with "walls" on four sides exposed to bitter winds, greater ventilation would have resulted in loss of all the warmth gained. So I changed over to a small electric fire. Since then the troubles brought on by condensation have been greatly diminished. I write in the hope that this may be of interest, and help, to other garden-shedders."

#### NEXT MONTH . . .



### THE MAYKIT TRANSISTORISED CAR RADIO

for 12V Operation BY RICHARD MYERS

# The SOLAR THREE

Miniature Transistor

Light-Operated

## RECEIVER



Designed by D. J. FRENCH, Grad.I.E.E., of Henry's Radio Ltd

WITH THE CURRENT ADVENT OF TRANSISTORS suitable for use in home-constructor designs, the ease with which truly miniature receivers may be built by the amateur has become continually more evident with the passage of the last few years. The receiver described in this article—the "Solar Three"—can be considered as being a worthy successor to previous miniaturised designs on its performance as a receiver alone. However, it differs markedly from earlier designs in one important aspect. Whilst the Solar Three gives an excellent performance purely from the receiver point of view, it has the further especial distinction of possessing no battery supplies whatsoever. The circuit is powered entirely by light energy.

Due to the fact that it is light operated, the Solar Three can be truthfully described as having running costs which are nil. Whenever it is decided to use the receiver all that is necessary is either to place it in daylight, whereupon all power is obtained from the energy radiated by the sun, or, in the evening, near an electric light bulb. In both cases, operating power is obtained completely free of charge.

The light-sensitive section of the receiver which causes light energy to be translated into electrical energy employs six selenium barrier-layer photo-electric cells. These, connected in series, provide operating potentials of up to 2 volts according to the strength of light available.

When checked in the London area the receiver proved capable of providing, from local transmissions, a volume level well in excess of that which the hearing-aid insert connected to its output circuit could comfortably handle. This occurred when the set was placed near a window on a dull and completely overcast day. When the receiver was placed on the windowsill it was necessary to close the plastic lid of its case so that the light striking the photo-cells could be reduced to that which resulted in comfortable listening level. Even then, volume on one of the local stations had to be reduced by turning the receiver such that its ferrite frame was in a position close to that of minimum sensitivity. At night time a more than adequate output level was available when the receiver was positioned several feet away from a 100 watt electric light bulb.

Apart from its fascinating ability to operate from light rays, the Solar Three adequately meets the normal requirements of a pocket transistor receiver in the personal class. It is completely self-contained, it is housed in a neat plastic case measuring 4½ x 3 x 1½ in, and it has its own ferrite frame aerial. As was mentioned above, its audio output is fed to a miniature hearing aid insert.

#### The Circuit

The circuit of the Solar Three takes advantage of the very successful reflex arrangement employed in the Minor-One and Major-Two receivers described recently in

this magazine.\* The basic circuitry of the two receivers then described has been modified somewhat to fit it for its present application, the major change being the

\* The Minor-One and Major-Two, Personal Transistor Receivers, by D. J. French, *The Radio Constructor*, October, 1958.

addition of a third transistor to provide added a.f. gain.

The complete circuit of the Solar Three is illustrated in Fig. 1. Commencing at the input-end of the circuit, the receiver functions in the following manner. Variable condenser C<sub>1</sub> tunes winding L<sub>1</sub> of the ferrite frame

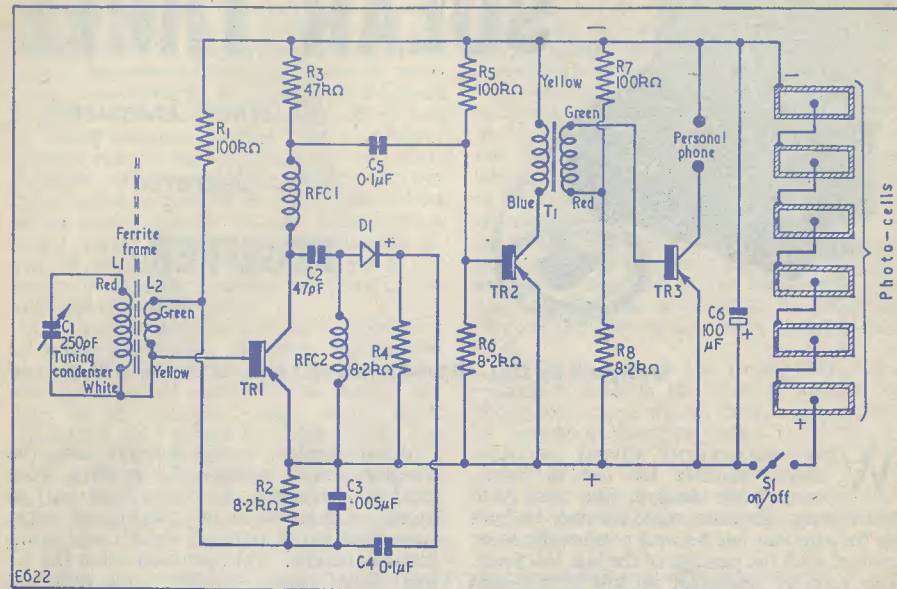

Fig. 1. The complete circuit of the Solar Three receiver

#### Components List

##### Resistors (all 1/4 watt)

- R<sub>1</sub> 100kΩ
- R<sub>2</sub> 8.2kΩ
- R<sub>3</sub> 4.7kΩ
- R<sub>4</sub> 8.2kΩ
- R<sub>5</sub> 100kΩ
- R<sub>6</sub> 8.2kΩ
- R<sub>7</sub> 100kΩ
- R<sub>8</sub> 8.2kΩ

##### Transistors

- TR<sub>1</sub> XA103, White Spot
- TR<sub>2</sub>, TR<sub>3</sub> XB104, Red Spot
- See text for alternatives

##### Photo-Cells

- 6 light cells 43mm x 17mm, Type B, with special solder (Henry's Radio Ltd.)

##### Inductors

- L<sub>1</sub>, L<sub>2</sub> Ferrite aerial, type M2 (Henry's Radio Ltd.)
- RFC<sub>1</sub> RFC<sub>2</sub> 1.55mH, High-Q (Henry's Radio Ltd.)
- T<sub>1</sub> Audio transformer 8 1/2:1, type D240 (Henry's Radio Ltd.)

##### Condensers

- C<sub>1</sub> 250pF variable miniature (Henry's Radio Ltd.)
- C<sub>2</sub> 47pF ceramic or silver-mica
- C<sub>3</sub> 0.005μF paper
- C<sub>4</sub>, C<sub>5</sub> 0.1μF 150V wkg paper
- C<sub>6</sub> 100μF 18V wkg electrolytic (Henry's Radio Ltd.)

##### Diode

- D<sub>1</sub> Germanium diode, OA70, GD3, GEX34, or similar

##### Sundries

- 1 Hearing aid insert, 400-1,000Ω impedance
- 3 Transistor holders (Henry's Radio Ltd.)
- 1 Chassis (component board), Solar Three type (Henry's Radio Ltd.)
- 1 Drilled case, Solar Three type (Henry's Radio Ltd.)
- 1 Photo-cell mounting plate (Henry's Radio Ltd.)
- 1 Push-button on-off switch

aerial, thereby selecting the signal required. A low impedance winding on the ferrite frame, L<sub>2</sub>, applies the selected signal to base and emitter of TR<sub>1</sub>, this transistor then functioning as an r.f. amplifier. The amplified r.f. signal at the collector of TR<sub>1</sub> becomes built up across RFC<sub>1</sub>, whereupon it is then applied, via C<sub>2</sub>, to the germanium diode D<sub>1</sub>. RFC<sub>2</sub> ensures that a d.c. return to the positive supply line is available at the "anode" terminal of the diode. The detected signal appears across R<sub>4</sub>, after which it is fed back, via C<sub>4</sub>, to the base of TR<sub>1</sub>.

TR<sub>1</sub> now carries out its secondary function of audio amplifier, whereupon it amplifies the detected a.f. signal applied to its base and emitter in conventional fashion. The collector connects, via RFC<sub>1</sub>, to the a.f. collector load, R<sub>3</sub>, after which it is passed via C<sub>5</sub> to TR<sub>2</sub> for amplification in normal manner. Due to the fact that transistor TR<sub>1</sub> carries out the dual functions of simultaneously amplifying r.f. and a.f. signals it can be described as operating in classic reflex fashion.

Before proceeding further, it would be interesting to devote a little more time to the functions carried out by some of the components in the TR<sub>1</sub> stage. This will not only assist in assessing the general operation of a very practicable transistor reflex circuit but it will also ensure that individual component functions are fully appreciated by the constructor. Typical of the double rôle played by components in reflex positions is that of condenser C<sub>3</sub>. At radio frequencies this condenser has a low impedance, with the result that the signal frequency voltage developed across coupling winding L<sub>2</sub> is effectively applied between base and emitter of TR<sub>1</sub>. At audio frequencies C<sub>3</sub> presents an impedance which is relatively high compared with the resistance of the diode load R<sub>4</sub>. In consequence it has very little bypassing effect on the a.f. fed to the base of TR<sub>1</sub> via condenser C<sub>4</sub>. Condenser C<sub>2</sub> and RFC<sub>2</sub> similarly function in two different manners. At r.f. C<sub>2</sub> has a low and RFC<sub>2</sub> a high impedance, whereupon r.f. at the collector of TR<sub>1</sub> is passed with little attenuation to diode D<sub>1</sub>. On the other hand C<sub>2</sub> has a high and RFC<sub>2</sub> a very low impedance to a.f., with the result that virtually none of the amplified a.f. appearing at the collector of TR<sub>1</sub> finds its way back into the detector circuit. Yet another component, RFC<sub>1</sub>, ensures that the two-way purpose of the circuit is fulfilled. At radio frequencies it has a high impedance thereby offering an adequate collector load for TR<sub>1</sub>. At audio frequencies it has a very low impedance, with the result that amplified a.f. may be built up across resistor R<sub>3</sub>.

Transistor TR<sub>2</sub> is a conventional a.f. amplifier which operates in an earthed emitter circuit. Its collector feeds into the

miniature coupling transformer T<sub>1</sub>, the secondary of which connects to the output transistor TR<sub>3</sub>. The collector of TR<sub>3</sub> feeds directly into the output headphone.

In all three stages, including the input reflex stage, bias for the transistors is obtained by a fixed potentiometer connected across the supply lines. The resistors concerned in providing bias are R<sub>1</sub>, R<sub>2</sub> for TR<sub>1</sub>; R<sub>5</sub>, R<sub>6</sub> for TR<sub>2</sub>; and R<sub>7</sub>, R<sub>8</sub> for TR<sub>3</sub>. The bias resistor values are the same at each stage.

Also shown in Fig. 1 are the six selenium photo-cells which provide the operating power for the receiver. These cells are connected in series, their output being fed, via switch S<sub>1</sub>, to the receiver circuits proper. A high-value electrolytic condenser, C<sub>6</sub>, ensures that the impedance of the power supply is kept to a negligibly low figure. The output given by the photo-cells varies according to the amount of light which falls on them, the maximum potential being of the order of 2 volts. Current consumption in the receiver is surprisingly low, it being approximately 1mA only at 2 volts.

The on-off switch shown in the diagram is not entirely necessary as there are, obviously, no batteries to conserve. However, it was decided to include the switch in order to avoid any deleterious effects which might be caused by the electrolytic condenser. The circuit does not include a volume control, because control of output may be obtained by the very simple process of shading the photo-cells or of turning the receiver so that the directional effect of the ferrite frame becomes apparent. Should it be decided to fit a volume control, however, such a component could consist of a 10kΩ potentiometer connected in place of R<sub>4</sub>, C<sub>4</sub> being connected to the slider.

#### The Transistors

The receiver may be constructed employing only those transistors which are specified in the parts list. However, the choice of transistor type is not excessively critical and the following information may be of assistance to readers who wish to employ alternatives.

TR<sub>1</sub> can be an XA103 type, as specified, or it can consist of any similar transistor having an alpha cut-off frequency greater than 2 Mc/s.

Transistors TR<sub>2</sub> and TR<sub>3</sub> may be XB104, as specified, or they may be Red Spot or any other low consumption audio type. Greater output will be made available if an XC101 is employed in the TR<sub>3</sub> position.

It is advisable to ensure that transistor lead-outs are not soldered directly into the circuit, as the compact layout of the receiver would necessitate soldering to shortened leads, with the consequent risk of overheating.

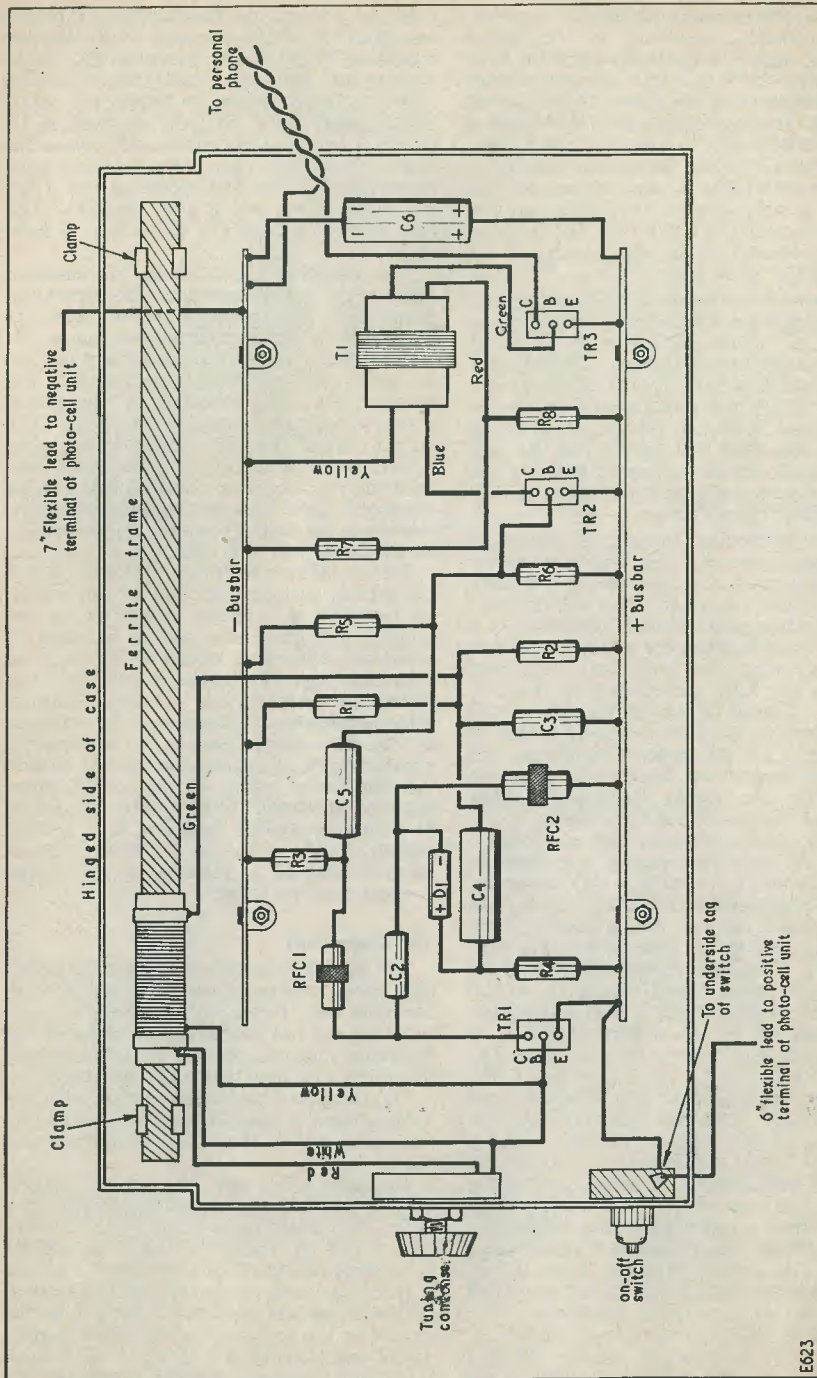
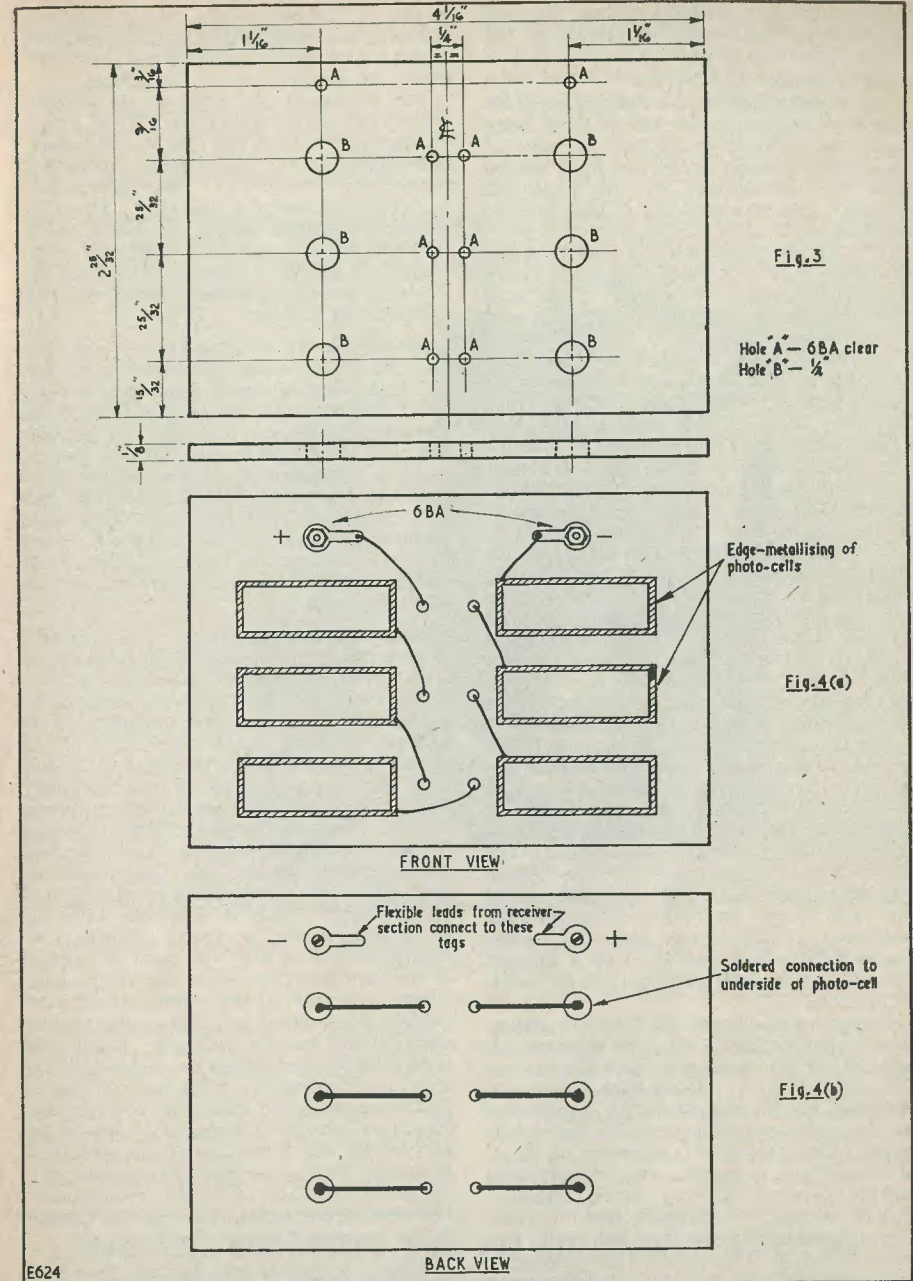

Fig. 2. Wiring layout of the receiver section. In order to simplify presentation this diagram illustrates the transistor holders without transistors plugged in

E623



E624

Fig. 3. Drilling dimensions for the plate on which the photo-cells are mounted. The material is Paxolin. Fig. 4. Front and back views of the photo-cell unit, illustrating the wiring to the cells. Although not shown here, all leads should be sleeved

Instead, transistor holders should be used throughout, these being mounted in the wiring.

#### Receiver Section Construction

The construction of the Solar Three falls into two basic parts, the first of these being concerned with the wiring and assembly of the receiver circuits proper, and the second with the manufacture of the photo-cell section. The receiver circuit will first be dealt with.

The complete layout of the receiver section is shown in Fig. 2. A ready-drilled component board (or "chassis"), made of insulating material is available for this part of the receiver, and this board will already have ferrite frame clamps and solder tags riveted to it. The ferrite frame is fitted to its clamps in the manner shown in the diagram. However, it is advisable to make this component one of the last to be wired into circuit, due to the brittleness of the ferrite material. Two busbars, made of heavy gauge tinned copper wire, travel along most of the length of the component board, these being connected (via the on-off switch in the case of the positive busbar) to the two terminals of the photo-cell unit. Most of the receiver components are then soldered directly to these busbars. Due to the short wiring lengths which result from the compact layout, solder joints to component lead-outs remote from the busbars are sufficiently rigid to obviate the necessity for additional anchoring.

The component board fits snugly into the bottom of the plastic case specified for the receiver, one end fitting under the on-off switch and the tuning condenser. Mounting holes for these last two components are already drilled in the case as supplied. The flexible lead to the personal earphone is taken through a small hole at the opposite end of the case to the on-off switch and tuning condenser. To avoid any strain on internal connections it is advisable to tie a knot in this wire, or similarly anchor it, on the inside of the hole.

Especial care should be taken to ensure that the coloured lead-out wires from the a.f. transformer are connected up in the manner shown in Fig. 2. Equal care should be observed, also, in making correct connections to the various lead-outs from the ferrite frame. The electrolytic condenser  $C_6$  must, of course, be connected into circuit with correct polarity. During wiring attention should be paid to ensuring that no component projects higher upward than  $\frac{1}{8}$  in below the edge of the case. This precaution is necessary in order to allow sufficient space for the photo-cell unit when it is later fitted.

#### The Photo-Cell Section

The next part of the receiver to be constructed is the photo-cell section. Due to the

nature of the photo-cells, and before any assembly is commenced, it is most important to note carefully the precautionary measures which are detailed later in this article.

The photo-cell unit employs six separate photo-cells which are affixed to a drilled Paxolin plate. Each cell has two terminals, one consisting of a completely metallised surface and the other of a clear surface with metallising around the edge only. The completely metallised surface is the positive terminal of the photo-cell and the edge-metallised surface is the negative terminal. The edge-metallised surface is that which is presented to the light.

Before use, the photo-cell mounting plate must be drilled out as shown in Fig. 3. The six large holes in this diagram accept wires which are soldered to the positive (completely metallised) surface of the cells. The six cells are glued to the plate with Perspex cement, and are connected up in the manner illustrated in Fig. 4. It will be noted that two 6BA nuts and bolts along one edge hold solder tags on both sides of the plate. These tags provide anchors for the flexible leads which connect the photo-cell unit to the receiver proper.

Before proceeding further it is necessary to give the following important information about the photo-cells. Because of their nature these may be irreparably damaged by excessive heat, by corrosive materials, or by careless handling. As a result it is of the utmost consequence to treat the cells with care, this being especially true when solder joints are made to the metallised terminals. Firstly, the iron employed for soldering connections *must not* be kept on the surface of the metallising for too long a period. Secondly, the low-melting-point, special alloy, solder which is available with the photo-cells *must* be used. Thirdly, no additional flux of *any* type must be applied to the metallising or to the connecting wire. Fourthly, if any of the photo-cells is accidentally short-circuited during soldering or wiring it will become damaged. Fifthly and finally, the wire employed for soldering to the cells *must* be fuse wire. This last stipulation, that concerning the fuse wire, is a requirement laid down by the manufacturers of the photo-cells, and it must be strictly observed. It cannot be too strongly emphasised that failure to meet any of the five requirements just detailed can result in irreparable damage to the associated photo-cells.

When the photo-cell section has been completed, the two anchoring lugs may be connected to the two flexible power leads shown in Fig. 2, taking especial care to ensure correct polarity. The photo-cell plate may then be fitted into the case above the receiver

section proper, whereupon the Solar Three is ready for operation.

#### Operation

In a simple circuit of this type no complicated lining-up procedure is needed and it is possible to check the receiver immediately after construction has been completed.

possible to tune in the desired local station with the aid of the tuning condenser. Final adjustments of volume may be carried out by rotating the receiver, so that the ferrite frame aerial is at varying angles to the oncoming signal, or by varying the light energy picked up by the photo-cells. If the receiver is

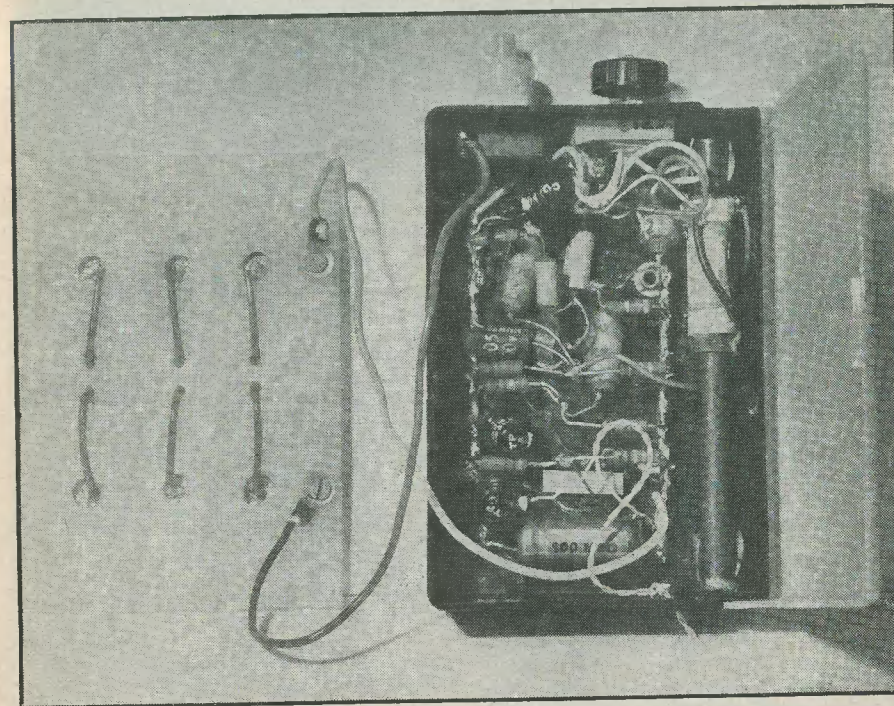

Showing arrangement of the Solar Three in cabinet, with the photocell panel removed for clarity

In order to test the receiver it is necessary for a source of light energy to be available. This may be provided by daylight or by electric light. In the case of the latter, adequate power should be available if the photo-cells are some two feet or so away from a 100 watt lamp.

After switching on the receiver it should be

operated in daylight it will very probably be found possible to achieve more than adequate output when the translucent lid of the case is closed, despite the fact that this significantly reduces the light energy reaching the cells. Experience with this fascinating receiver will soon make the owner familiar with its capabilities under differing light conditions.

## ENGLISH ELECTRIC VALVE COMPANY LIMITED

The company is holding a private exhibition at the Kensington Palace Hotel from 17th-21st March, both dates inclusive.

The display will consist of all that is modern in valve design technique in the world of radar, communication, transmitting,

broadcasting—both sound and vision—and instrumentation, together with new types of storage tubes.

English Electric will be delighted to welcome any readers who may wish to attend.

# Technical Forum

## Stereo Records

A TREMENDOUS AMOUNT OF INTEREST HAS been shown this year in the reproduction of stereophonic sound from gramophone records. This interest was further fired during the Radio Show by a large number of demonstrations by manufacturers of their reproducers. Aurally these demonstrations were very satisfactory but were marred, the writer recalls, by the very stuffy conditions of the small sound-proof rooms in which they were given.

to deal with the actual method by which the two sound channels are recorded in a single groove gramophone record of normal dimensions and appearance.

When searching for a dual channel system, the record companies had several requirements which the chosen system must fulfil, the most important of which are:

- (1) That it should be capable of being played with a single stylus pick-up. It is possible to visualise a scheme in which adjacent grooves in the disc are

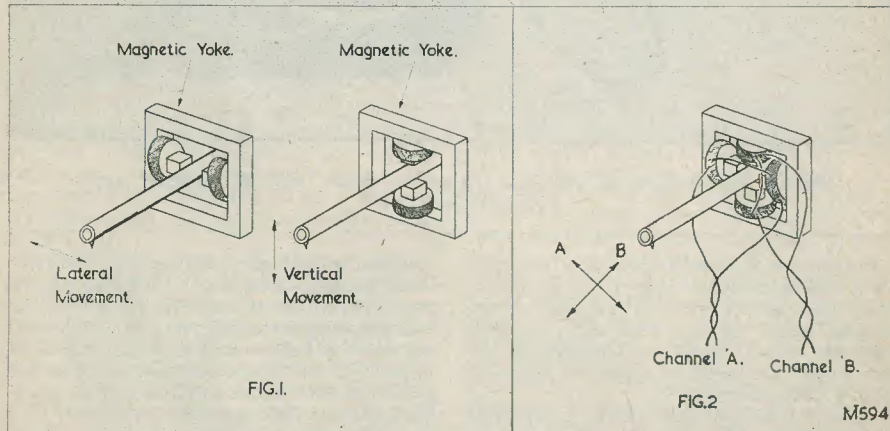

However, any discomfort was purely physical and did not prevent the imagination being aroused by this new method of obtaining an additional dimension in sound recording. From recent articles in these pages, readers will have become familiar with the relative simplicity of the amplifiers used in stereophonic systems, so in this article we propose

- used to carry the separate channels but some care would be required in lowering the pick-up, which could easily become mal-adjusted.
- (2) It should be capable of giving a fidelity of reproduction similar to that obtained with the L.P.s of today.
- (3) It should be compatible in that a stereo

record could be played on a non-stereo reproducer and provide good monaurial listening. This is largely an economic necessity to obviate the need to distribute each recording on the two forms of disc, which would lead to an increase in the cost of both, and at the same time create stocking difficulties in the shops.

## Two Methods

For a great many years now two systems of recording sound on discs in the form of physical deformation of its surface have been known. The two systems employ lateral modulation of the stylus as in the case of all modern records, or vertical modulation which is also referred to as the "hill and dale" arrangement. It is logical, therefore, that when the requirement arose for dual channel recording a scheme involving the use of both systems should be examined. However, as things have turned out, the solution was rather more complex than this; and to appreciate the reasons for this, it is worth examining the differences between the two techniques.

In the lateral method, the cutting stylus used when the master record is first made is caused to move from side to side in sympathy with the audio signal being recorded, the depth of the cut remaining unchanged. However, with the vertical system there is no lateral shift as the stylus moves only in the vertical plane, thus altering the depth of cut depending upon the modulating signal. Fig. 1 shows how the coils of an electromagnetic pick-up would be arranged to reproduce the two systems.

The original choice in favour of the lateral arrangement was made because of its greater freedom from distortion. The cause of distortion in the vertical system arises because when cutting the groove deeper in a master record more material has to be removed than when the stylus is raised by an equal amount. As the amount of energy expended by the cutting point is to a first approximation proportional to the amount of material removed, this gives rise to amplitude distortion which has a preponderance of second harmonic. The so-called 45/45 system of stereo recording was developed by the American Westrex Company, partly to overcome the disadvantage of vertical modulation, whilst at the same time offering other advantages. In the 45/45 system the two modulation axis, instead of being vertical and horizontal, are inclined at 45° to the vertical but they are still maintained at 90° to each other. The coil layout for an electromagnetic cutting head for the new system would be positioned as in Fig. 2. This arrangement makes the two channels identical

and provides a better degree of compatibility than is possible with the original scheme.

It may be argued that to divide the vertical components of the modulating signals equally between the two channels is simply dividing any distortion which may be present so that an equal amount appears on each channel. But in making such an assumption we would be accepting that any system employing vertical modulation is bound to be distorted. It is true that vertical recording was originally discarded in favour of the lateral method largely on the grounds of reduced distortion; but tests made more recently with modern cutting heads having a considerable amount of feedback have demonstrated that if any distortion should exist it is of negligible proportions.

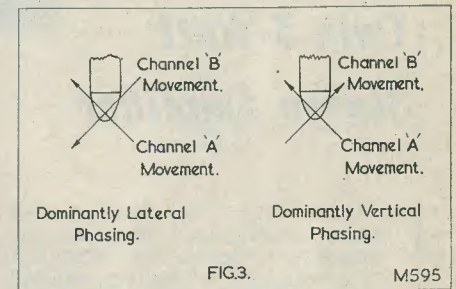

## Phasing

The relative phase of the two signals recorded on a stereo disc must be well defined because incorrect phasing can have a disturbing effect upon the low frequency performance of the reproducer. All recordings must therefore be made with an agreed phase relationship to avoid the listener having to reverse speaker leads from time to time as records are changed. Also, the agreed difference must be such that when a non-stereo record is played on a stereo equipment the correct phasing of the speaker is obtained. This is one of the important factors which govern the compatibility of the system. Let us consider for a moment the manner in which the needle of the pick-up moves in the combined groove of the stereo recording. It will be recalled that the two axis of movement are both at 45° to the surface of the record, so that there are two possible ways in which the movements may be phased. These are shown in Fig. 3 from which it will be seen that they can produce either a dominantly lateral movement or a dominantly vertical one. As the terms suggest, the first phasing method produces the most side-to-side shift on the needle whilst the second method provides a mainly vertical shift. The standard

*continued on page 527*

# The JASON JSA.2

## Twin 3-Watt Stereo Amplifier

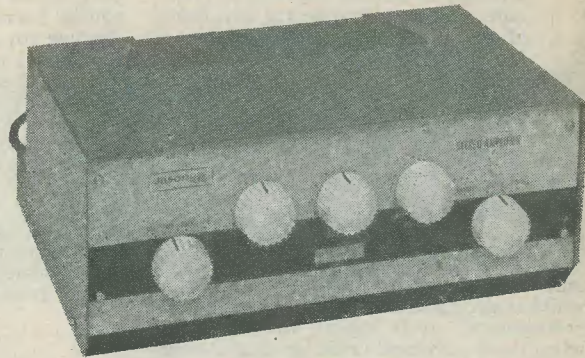

By G. BLUNDELL

THIS ARTICLE DESCRIBES A TWIN 3-WATT stereo amplifier which gives adequate volume for home listening. While it is true that better quality results from push-pull stages, it is difficult to design a push-pull stage which gives less than 10 watts. Therefore if it is desired to make a low output amplifier which at the same time costs less, it is necessary to use a single-ended stage using, for example, the EL84. The volume obtainable from this amplifier is surprisingly, indeed uncomfortably, loud in a small room. The frequency extends down to 20 c/s, while the amplifier is capable of producing 3 watts down to 60 c/s. At the top end, 3 watts at 10 kc/s is easily obtained, though the frequency response, of course, extends further.

Although the output transformer is not large, the low frequency response is achieved through the use of a special grade of annealed iron. The secondary winding is split into two halves, and these are connected in series for 15Ω and in parallel for 4Ω speech coils. This method makes the external connections more complicated when changing impedance, and the extra feedback resistor R<sub>23</sub> must also be added. It is certainly easier to simply select different tapings on the winding, leaving the feedback always connected to the 15Ω tap; but the feedback no longer operates directly on speaker but through the medium of the transformer, which is the very item we are trying to control with the feedback. The series and parallel method used here results in the same performance on both 15Ω and 4Ω speakers, while the transformer remains

completely balanced whichever impedance is being used. Due to the use of negative feedback, the distortion is less than 1%.

### The Output Section

Two stages are used, comprising the pentode section of an ECF80 and an EL84. The ECF80 is primarily an r.f. valve and Mullard Ltd. do not offer any guarantees about its audio performance. However, when used at these high levels there is no danger from hum, and if the triode is used before the pentode in the circuit there is no danger of instability. The writer hopes soon to see a re-based version of this valve, and it is understood that Brimar are working on this. The present valve has the anode of the triode and the grid of the pentode adjacent to each other, which prevents the pentode section being followed by the triode. In all fairness it should again be stated that the valve was designed for r.f. purposes. However, a re-based version would offer numerous possibilities such as pentode amplifier, triode phase splitter followed by push-pull output.

Feedback is applied from the output transformer secondary to the cathode of the ECF80 (18dB). The stability of this circuit is good, though not so good as can be achieved in push-pull stages. Components R<sub>21</sub> and C<sub>9</sub> across the output transformer primary, and C<sub>7</sub> in the feedback loop, contribute towards this stability. If the output is examined when feeding in a 1 kc/s square wave, only a very small "ring" should be observed.

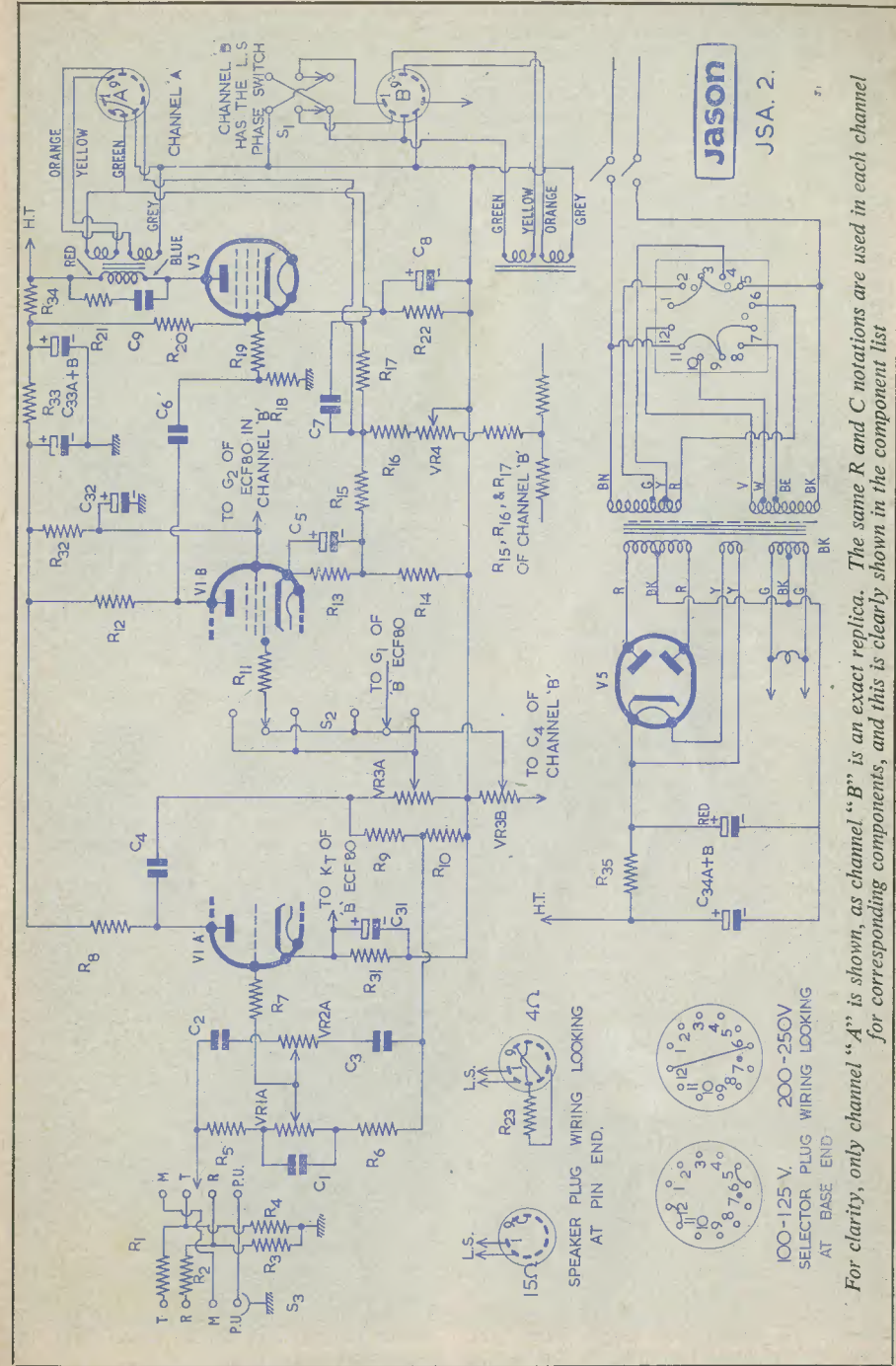

For clarity, only channel "A" is shown, as channel "B" is an exact replica. The same R and C notations are used in each channel for corresponding components, and this is clearly shown in the component list

The balance control operates on the feedback circuit to give a symmetrical change. The centre of the control is connected to chassis so that as the feedback in one amplifier is increased, the feedback in the other is decreased, giving a maximum difference of 5dB each way between the outputs.

The speaker phase switch reverses the speaker connections on channel "B" and simplifies the initial setting-up. The channel switch enables both amplifiers to be connected to either pre-amplifier at will, or each amplifier to be connected to its own pre-amplifier for stereo operation.

#### The Tone Control Stage

The triode section of the ECF80 contributes some gain but its main use is in the negative feedback tone control stages. A portion of the output is fed back from the junction of  $R_9$  and  $R_{10}$  to the grid circuit through two paths. The path  $C_3, VR_{2A}, C_2$  operates only at the high frequencies. The path through  $R_6$  operates to give overall negative feedback as well as selective negative feedback at the lower frequencies. The performance of this stage is quite good, and the centre positions of the linear controls will be found to give a flat response. 10dB lift and cut are achieved at 100 c/s and 10 kc/s respectively.

#### Constructional Notes

As can be seen from the point-to-point diagrams some use is made of tag panels, although many components are wired directly to their appropriate stages, such as  $R_{31}, C_{31}$ . The writer is in favour of this technique where the components are small. Neat wiring on tag panels inevitably makes the wiring longer. This can often increase hum pick-up, cause instability, or increase the cross-talk between channels in a stereo amplifier. In a compact amplifier such as this economy of space is essential, and careful thought must be given to the layout. For example, the mains transformer is on the opposite corner of the chassis to the input stages.  $C_{31}$  is mounted close to the input valves to avoid a loop which could pick up hum.

Note the presence of various grid stoppers,  $R_7, R_{11}, R_{19}$ , which must not be left out. All these valves have high amplification factors and will readily oscillate at high frequencies. The anode and grid circuits can form various kinds of oscillatory circuits such as tuned anode-tuned grid, or Colpitts. The grid and screen stoppers must be used to prevent this possibility.

First mount the tag panel with  $C_4$  and  $R_8$ , connect the appropriate length wires, and check the soldering carefully, as this part is

difficult to correct afterwards. Mount the valveholders, the potentiometers and the remainder of the components. Put in as many wires as possible before mounting the components on the tag panels. Mount the screened cable last of all as these wires tend to cover other components. Note the positioning of the anode wire of  $V_1$  which is taken through the chassis and back again. This is to prevent signal radiation from this wire being picked up in the input grid circuit of  $V_2$ . This can give rise to considerable cross-talk and is simply prevented by using the chassis as a shield.

#### Trouble Shooting

If there are no faulty components, and nothing is incorrectly wired, then clearly the amplifier will work immediately. Certainly most faults experienced will be due to wrong wiring and bad components. Check, therefore, very thoroughly. The voltage test table will show how the various stages are operating, although some variation may be expected due to valve and resistor tolerances.

Having checked the voltages, then in the absence of other equipment the amplifier may be checked aurally. Feed in a single-channel signal, radio or pick-up, into one channel. Move the switch into the stereo position and check the operation of the volume and tone controls. Inject the signal into the other channel and repeat the same checks.

If an audio generator and oscilloscope are available, more exact testing is possible. Feed a 1 kc/s sine wave into the radio input. Connect an audio power meter to the output (or an a.c. voltmeter across a 15Ω load). Increase the output until distortion shows on the oscilloscope trace. The power output should then read 3.5 to 4 watts (or the a.c. voltage between 7.25 and 7.7 volts), and the input signal voltage should be 150 millivolts. The sensitivity on the pick-up position should be 50 mV for the same output.

Check the power output at various frequencies to establish the power output curve, and at 1W output the frequency response may be checked and should be flat from 60 c/s to 10 kc/s. Feed in a 1 kc/s square wave to check the stability—no undue ringing should be observed.

The tone controls may then be checked with the aid of the 1 kc/s square wave. Various waveforms should be observed as shown in the accompanying diagram.

#### Setting Up the Stereo Amplifier

If the constructor cannot check the amplifier and pre-amplifier himself, Jason are prepared to give the usual tests, maximum power output, and square wave check for a nominal sum.

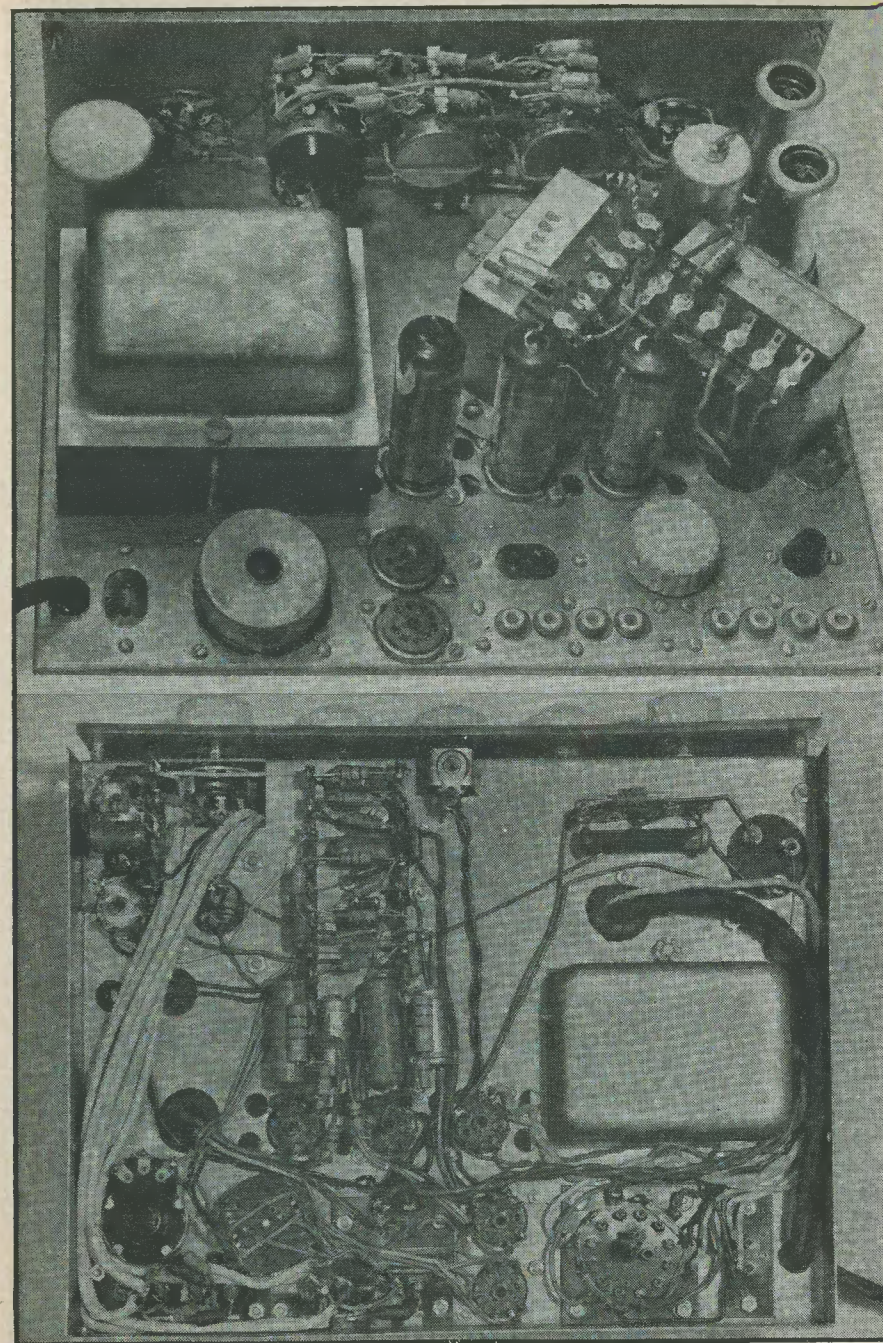

Above and below-chassis views of the Jason JSA.2

However, even though the units are satisfactory there still is the necessity of making the equipment function as desired, at home,

the room between 6 and 12 feet apart, with speakers pointing to the centre of the opposite side of the room. The best listening area

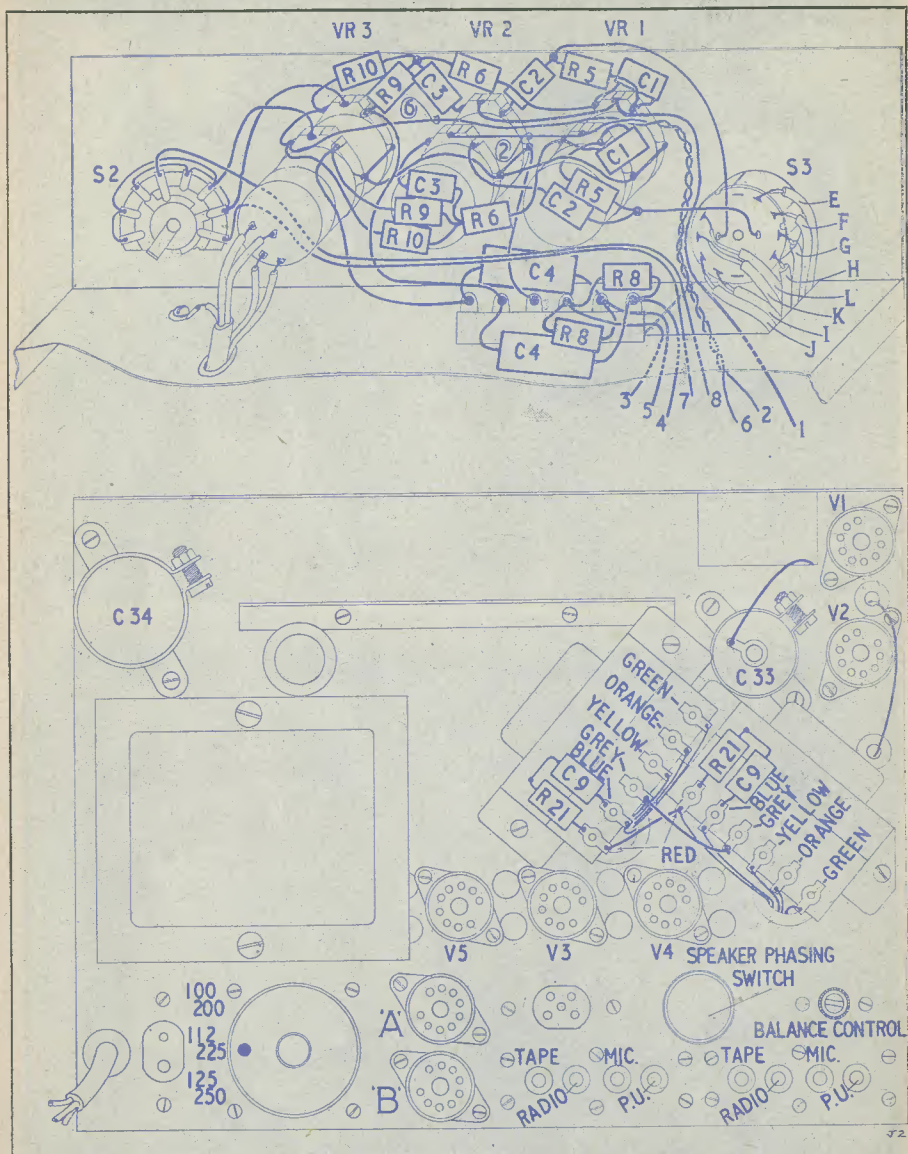

Above-chassis and panel controls point-to-point wiring

on stereo. This is not difficult providing the following tests are made carefully.

#### Speaker Positioning

Set the speakers in convenient corners of

should then be within a 30° angle of the speakers. The sound should not be reflected from the walls of the room, and in the writer's opinion the omni-directional kind

of tweeter is not very satisfactory. Better positions will be found later, when more listening experience is obtained, but this should enable reasonable results to be obtained.

functioning reasonably. Now, in the usual listening position, check that the sound appears to be coming from a small point exactly in the middle of the space between the speakers. Adjust the balance control to

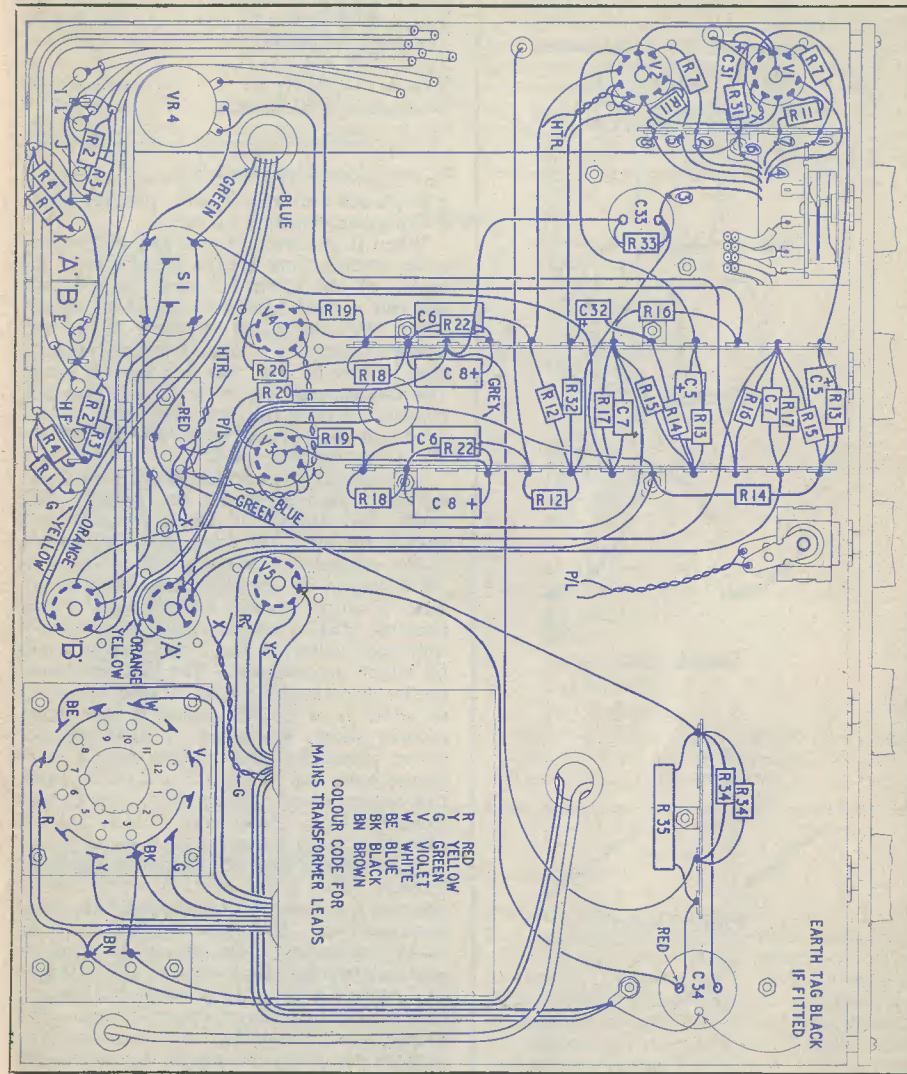

Point-to-point wiring below chassis

#### Speaker Phasing

Play a normal L.P. record with the stereophonic pick-up. Check by listening near each speaker that the levels are approximately the same and that each channel is

make the apparent source central. If this effect cannot be obtained, reverse the connections of one speaker only, and centring should then be possible. When the speakers are wrongly phased the sound appears to be



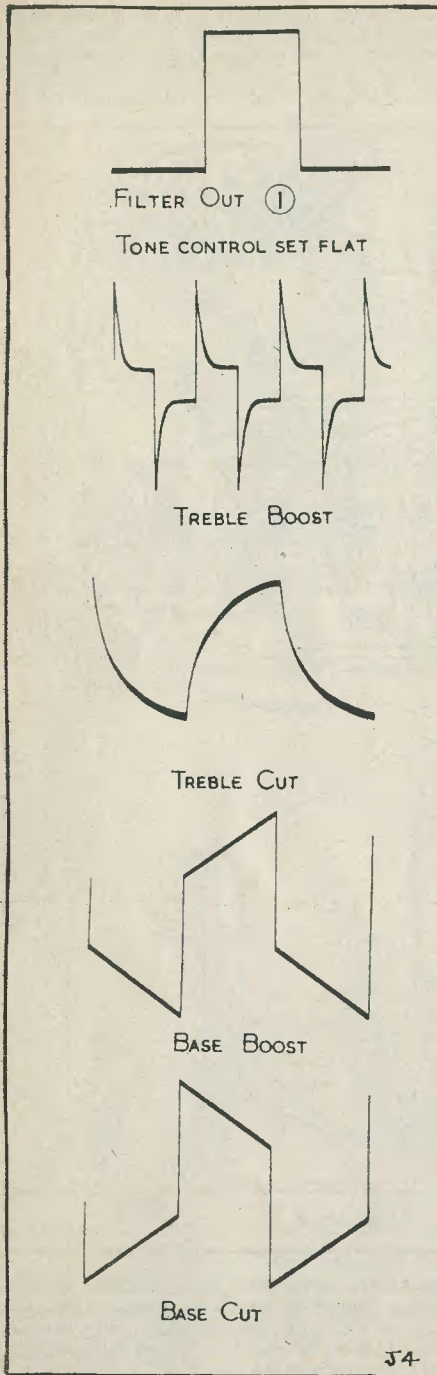

V <sub>k</sub> Rectifier	.. .. .	340
V C <sub>34A</sub>	.. .. .	330
V <sub>g2</sub> output valve C <sub>33B</sub>	.. .. .	260
V <sub>k</sub> output valve R <sub>22</sub> C <sub>8</sub>	.. .. .	8
V <sub>HT</sub> preamplifier C <sub>33A</sub>	.. .. .	205
V <sub>Anode</sub> ECF80 R <sub>12</sub> C <sub>6</sub>	.. .. .	90
V <sub>Cathode</sub> ECF80 R <sub>13</sub> C <sub>5</sub>	.. .. .	1
V <sub>g2</sub> ECF80 R <sub>32</sub> C <sub>32</sub>	.. .. .	44
V <sub>Anode</sub> ECF80 R <sub>8</sub> C <sub>4</sub>	.. .. .	50
V <sub>Cathode</sub> ECF80 R <sub>31</sub> C <sub>31</sub>	.. .. .	3

very nebulous. Try reversing the connections a few times until one is quite positive about which arrangement is correct.

When it is correct, the sound will appear to be coming from quite a small hole in the centre of the space between the speakers, and one should hardly be conscious of any sound from the actual speakers. If one can still hear the sound from the actual speakers, then it may be that they are too far apart. Try another position in the room. Gimmick records are good for these tests, such as that produced by *Gramophone Record Review Hi-Fi Test Record GRR1*.

Now on playing a stereophonic record, the full improvement should be realised. The sound will appear in depth, but also will gain in realism. The organ does not seem a likely subject for stereo, but in fact its reproduction is greatly aided by stereo. Also, it can be noticed by switching to each channel that a better band response is obtained; better, in fact, than can be heard on either one channel. The listener should not be discouraged if the first efforts are not as good as is hoped. Some of the stereo records which are being released are not above reproach; after all, the record companies have had to learn a great deal about this new medium. The sampler records now available from Decca and E.M.I. are extremely good and show what is possible.

A new effect may be noticed in the latest records. This is the effect of depth, which appears to be caused by the judicious use of reverberation. The fact that we normally listen "in stereo" helps us to discriminate what we want to hear against an undesired background noise. Many people will have a tape recording made in a normal room. The microphone cannot discriminate, and neither can the ear when the sound is played back through a single loudspeaker. Extraneous noises seem to be far more pronounced. Due to this effect it is necessary to make recordings in studios which are acoustically dead, and although the resultant sound is clear the effect is very flat. With the advent of stereo some of these background noises can be left in, without making the sound less clear, and the result is far more realistic. This is shown

very well in the E.M.I. swimming bath demonstration recording, or more usefully in the E.M.I. recording of the Beethoven Sixth Symphony conducted by Otto Klemperer. The effect of space and depth which is achieved in this record gives a pointer to the results we can expect in a year or so. Certainly the disc recording is not yet dead!

#### Stereo Sources

The disc is the only popular source of stereo available at the moment, and the Ronette turnover pick-up is a very good one to use. There are separate radio inputs, so

that this amplifier may be used with a stereo radio input. Separate tape inputs are also provided, but a stereo tape pre-amplifier would be required.

#### Compatibility of Records

It cannot be emphasised too strongly that many standard single channel pick-ups will cause damage to stereo records because the vertical stiffness of the pick-up movement is too great and permanent damage will be caused to the records. The opposite, however, is satisfactory, and a stereo pick-up can be used to play normal L.P. records.

#### Component List

R <sub>1</sub>	470kΩ H.S.	R <sub>34</sub>	5kΩ = 2 x 10kΩ in parallel C
R <sub>2</sub>	470kΩ H.S.	R <sub>35</sub>	120Ω 1W C
R <sub>3</sub>	150kΩ H.S.	C <sub>1</sub>	300pF
R <sub>4</sub>	150kΩ H.S.	C <sub>2</sub>	200pF ceramic
R <sub>5</sub>	270kΩ H.S.	C <sub>3</sub>	200pF
R <sub>6</sub>	270kΩ H.S.	C <sub>4</sub>	0.05μF 350VW
R <sub>7</sub>	1kΩ C	C <sub>5</sub>	100μF 6V
R <sub>8</sub>	47kΩ H.S.	C <sub>6</sub>	0.05μF 350VW
R <sub>9</sub>	270kΩ H.S.	C <sub>7</sub>	1,000pF 10%
R <sub>10</sub>	68kΩ H.S.	C <sub>8</sub>	25μF 25V
R <sub>11</sub>	1kΩ C	C <sub>9</sub>	0.001μF
R <sub>12</sub>	100kΩ H.S.	C <sub>31</sub>	100μF 6VW
R <sub>13</sub>	680Ω C	C <sub>32</sub>	5μF 50VW
R <sub>14</sub>	33Ω H.S.	C <sub>33</sub>	50 + 50μF 275VW
R <sub>15</sub>	100Ω H.S.	C <sub>34</sub>	32 + 32 350VW
R <sub>16</sub>	100Ω H.S.	VR <sub>1A&amp;B</sub>	1MΩ—1MΩ
R <sub>17</sub>	1kΩ H.S.	VR <sub>2A&amp;B</sub>	1MΩ—1MΩ
R <sub>18</sub>	470kΩ C	VR <sub>3A&amp;B</sub>	¼MΩ—¼MΩ
R <sub>19</sub>	1kΩ C	VR <sub>4</sub>	300Ω
R <sub>20</sub>	270Ω C	S <sub>1</sub>	2-pole 2-way
R <sub>21</sub>	4.7kΩ C	S <sub>2</sub>	2-pole 3-way
R <sub>22</sub>	220Ω 10% ¼W C	S <sub>3</sub>	2-pole 4-way
R <sub>23</sub>	1kΩ H.S.	Resistors R <sub>31</sub> —R <sub>35</sub> and Condensers C <sub>31</sub> —C <sub>34</sub> are common to both channels, but 2 off R <sub>1</sub> —R <sub>23</sub> , C <sub>1</sub> —C <sub>9</sub> are required.	
R <sub>31</sub>	680Ω C		
R <sub>32</sub>	270kΩ H.S.		
R <sub>33</sub>	10kΩ C		

## Technical Forum continued from page 519

now universally adopted is the first, in which in-phase signals fed to the two recording channels produce a dominantly lateral movement of the stylus; this is the phase which provides compatible operation permitting the playing of non-stereo recordings by means of a stereo pick-up. A further advantage of using greater lateral movement is that it permits of a larger dynamic range to be obtained; in other words, the difference between weak sound passages and the louder ones may be greater.

#### Summarising

The method finally adopted for the recording of two channels on a single groove of a gramophone record is the 45/45 system. By correctly choosing the phase of the two

channels, the system is largely compatible in that both stereo and non-stereo recordings may be played on a stereo equipment. The reverse is, however, only partly true. A stereo recording may be played on a standard monaural player and give very good results, but because the pick-up stylus has very little vertical compliance it will tend to plough out the vertical component on the recording. This may never be noticed whilst the record is played on the monaural amplifier, but it would most likely ruin the record for playing subsequently on a stereo reproducer. However, this minor disadvantage is small when compared with the advantages which this new form of disc recording technique makes available.

# radio miscellany

SOME TIME AGO, WHEN WRITING OF TIBET, I mentioned a book (not then published) by Robert Ford, who had operated from Chamdo under the amateur call-sign AC4RF. In 1957 it was published by Harrap & Co. Ltd. under the title "Captured in Tibet," and some twelve months later came out as a paper-back. During the period AC4RF was active, contacts with him were eagerly sought by amateurs all over the world if only for the sake of adding Zone 23 to their "worked" list. Those hoping to qualify for the American magazine-sponsored "Worked All Zones" certificate were, of course, the most eager. Zone 23 was, perhaps, the hardest of them all.

Many of those successful in working Bob Ford became worried after consulting their atlases as to whether Chamdo was situated in Tibet as claimed by Ford, or not. Their atlases definitely showed it as being in China. Hence quite a lot of argument ensued in amateur circles and AC4RF became one of the most talked about call-signs in the world.

The only other amateur station in Tibet was that of Reg Fox who, if I remember rightly, operated under the call AC4YN. Unfortunately, Fox was in poor health, and his appearances on the air became rare, so Bob Ford was something of an "exclusive." It was disconcerting, after many hours of patient searching, to have the fact that he was genuinely in Zone 23 open to doubt. As far as I can recall he rarely operated 'phone, which rather restricted short-wave listener interest.

The truth was, of course, that the area in which Chamdo was situated was between the years 1910-1918 annexed by and under the military occupation of China. In 1918 the Tibetans drove them out, but as they never bothered to publish maps, map-makers the world over copied those issued by the Chinese—and the Chinese never relinquished their claim despite its brevity! China, unlike Tibet, maintained diplomatic relations with other powers—hence the map-makers believed it to be correct and everybody else believed the map-makers!

While only brief passages of the book refer to amateur radio, his adventures make interesting reading. It is certainly worthy of special commendation if only because it is one of the few books in which all references to our hobby are correct in all details.

## Quickie

Many thanks to the kind readers who sent cards at Christmas—especially the Bedfast Amateurs. Our old friend (who missed out last year) again remembered me with his hardy annual of Ye Olde Worlde Snow-Covered Cottage upon which he draws a magnificent collection of t.v., rotary beam, long wire and ground-plane aerials. Another anonymous reader sent a similar card, adding that it was to soften my disappointment should the originator of this annual event again let me down. *His* Olde Worlde Cottage (standing next to a picturesque Olde Village Church) was signposted "Centre Tap Villa" and the aerials were added with silver metallic paint. This may have been an allusion to my recent references to printed circuits. It has me beaten—message and envelope printed in an obviously disguised hand, and postmarked "Heathfield," which further mystifies me as I cannot recall a 1958 correspondent from that part.

A third card in the same series was post-marked "Oxford." This delightful rural scene had cut-out aerials which jumped to attention as I opened the card. Instead of a picturesque church he gave Centre Tap Villa a jolly looking Olde Worlde Inn for a neighbour—and he added a line of footprints in the snow leading straight from my front door right into the four ale bar!

All very good fun which gave me a hearty laugh. I am now left wondering if I shall later be the recipient of a cardboard Easter egg with a printed circuit of a Geiger counter on the back.

## A New, New Look

Thinking of Geiger counters reminds me that following my recent remarks on protective clothing, I discover that *Lead News*

(publication of the Lead Development Association) includes some details of a new line in men's undies. A photograph of an apron is also reproduced. The material is a plastic product based on polyvinyl chloride and metallic lead powder. It is washable and has good draping qualities which make it aesthetically agreeable for curtaining material to give protection from scatter for users of X-ray apparatus, etc.

Another material for smaller area coverage (i.e. the protection of specific parts of the body against radiation effects) is made in the form of overlapping scales, as in a suit of Roman armour. The thickness of the lead scales is in the order of 0.25mm, but because of the overlap nearly 80% of the area is protected by two or more scales. As it can be bent, folded or shaped to body contours, it appears that with a little decorative colouring it would lend itself to natty suitings! Maybe life in those forward scatter zones we discussed won't be so dangerous after all when smart clothing in the form of zoot suits or teddy boy styles, made from lead scales, are available.

Has any enterprising reader bright ideas of setting up in the protective clothing dry cleaning business, with a small extra charge for radiation re-proofing?

nervous afflictions, not only bored me but began to irritate me. I turned more and more to the gramophone and soon found there is infinitely more lasting pleasure in good music well played than in the general run of t.v. programmes. I wish I had turned to serious music before, as I am anxious to widen the scope of my small collection of records but hardly know where to start. Having studied a full catalogue I am at a loss to know what titles and composers to choose from so many thousands. Titles alone mean nothing to me. I am also anxious to improve my speaker system and I shall be glad if you can also help me with any special recommendations."

I have written to him on the latter, suggesting a particular pair of matched speakers and a layout, but I am rather at a loss as to what to suggest in the way of records. A very high proportion of constructors, once they get interested in hi-fi, become music lovers. Personally I find few pleasures more satisfying than sitting in the comfort of my own drawing-room (preferably with lowered lights) and listening to my favourite composers on first-class equipment *without any distractions*. I gather from the experiences of others that the deep satisfaction found in good music is, for some reason, more easily

## Centre Tap talks about items of general interest

### Rising Brows

A nice letter comes from F.N. (Derby), who says that during 1958 this column proved to be his lucky star. He built the Jason f.m. unit largely because I praised it, and then added the Mullard 3-3 amplifier when I and several correspondents spoke highly of it. He was delighted with both the simplicity of construction, being comparatively a newcomer to our hobby, and the results. He then converted them into a radiogram. Almost simultaneously our quest for an ideal test-cum-pleasureable-listening record, triggered off by "Aberdonian," was getting really warm. As a consequence he bought several of the records recommended by correspondents, all of which have given him considerable pleasure. "Then," he goes on, "you wrote about the dreary pattern of the average t.v. programme. I, too, got fed up with the same old turns, same day, same time, week after week. Comedians who aren't funny and are unable to find new jokes more often than once in a twelvemonth, and crooners who make agonising sounds while jerking about as though they suffered from

acquired from your own radiogram than from the concert hall. Among our readers we have many music lovers. Will one of them, whose knowledge is deeper than my own, help F.N. in this quest? By the way, he asks that recommendations be classified "by type." By this I take it that he means classified as "melodic," "symphonic," "for acquired tastes only," etc.

### Further Last Word

As I half-suspected, G.A.N. (London Airport) was not allowed to have the final say about cheaper-than-standard long-play records. F.J. (Brixton, S.W.2) writes: "I admit I have only tried two of the discs of which he speaks so highly, but both have suffered from wow. My advice to readers is for them to keep their money in their pockets. I would add I am all in sympathy with any effort to reduce the excessive price of l.p. records. Two pounds odd is far too much. The manufacturing cost can surely be only two or three shillings—plus another sixpence or so for the colourful sleeves. But

*continued on page 510*



# JINGLEBELLS



## AMATEUR RADIOTELETYPE

Part I

By JIM HEPBURN, VE7KX

In the August 1957 issue of the R.S.G.B. *Bulletin*, there appeared a description of a versatile transmitter drive unit, which provided for Frequency Shift Keying. An editorial comment introducing this description included the remark: "Many of the advantages claimed for this system in commercial practice are, however, not of interest to amateurs, being concerned with high speed or teleprinter operation and diversity reception."

The following May there appeared in the correspondence columns of the *Bulletin* a letter from James T. Hepburn, VE7KX, taking the writer of the above comment to task for suggesting that teletype was not of interest to radio amateurs. He concluded his letter by pointing out that in Canada, the Advanced Amateur Radio Operators' Certificate (mandatory for phone operation below 27 Mc/s) includes questions on radio teletype.

Your Associate Editor, who has often wondered why teletype has not been encouraged by the R.S.G.B., wrote supporting VE7KX's letter. Following publication of this letter in the July *Bulletin*, he received several letters of encouragement from other British Radio Amateurs, and a letter from VE7KX thanking him for his support. Subsequent correspondence with the latter revealed that he had in fact submitted an article on teletype to the editor of the R.S.G.B. *Bulletin*, but had had it returned (quote) "as it is not the policy of this society to encourage the use of FSK."

Following a letter in the September 1958 *Bulletin* from GM3EFS, opposing amateur radio teletype, in which he suggested that the British Amateur Radio licence regulations prohibited teletype transmission, your Associate Editor wrote to the G.P.O. for clarification of the point. They replied that there was in fact no objection to its use provided such transmissions were confined to amateur bands in respect of which emission F<sub>1</sub> is authorised and that recognised international codes be used.

Having thus reassured ourselves on this point, we wrote to VE7KX for his articles, the first of which we have pleasure in publishing herewith. We feel that this is a subject of interest to many radio amateurs in this country and whilst the difficulty of obtaining equipment is very real, it may not be quite so great as at first appeared. But more of that subject later; here is the first of VE7KX's articles just as it came off his own teletypewriter.

THE USE OF PRINTING TELEGRAPH EQUIPMENT GOES BACK TO THE VERY BEGINNING OF ELECTRICAL TELEGRAPHY. SAMUEL MORSE'S ORIGINAL INVENTION EMPLOYED A MOVING PEN TO RECORD THE DOTS AND DASHES OF HIS CODE ON TO A MOVING STRIP OF PAPER TAPE. FOLLOWING MORSE INVENTORS FOR HALF A CENTURY STRUGGLED TO DEVELOP A MACHINE THAT WOULD RECORD TELEGRAPH SIGNALS IN WRITTEN OR LETTER FORM, BUT THEY WERE BEATEN BY THE MORSE CODE ITSELF. WHEN YOU CONSIDER THAT THE LETTER "J" IS THIRTEEN TIMES AS LONG AS THE LETTER "E" YOU WILL SEE THE MECHANICAL HEADACHES INVOLVED IN TRYING TO TRANSLATE THESE SIGNALS INTO ALPHABETICAL SIGNALS. IT WAS NOT UNTIL A FRENCHMAN NAMED BAUDOT CAME UP WITH A CODE IN WHICH THE LETTERS WERE ALL THE SAME LENGTH THAT TELEGRAPH PRINTERS BECAME PRACTICAL. MANY RADIO AMATEURS BELIEVE THAT A TELETYPE MACHINE WILL COPY C.W. SIGNALS; IT WILL NOT. IT USES THE BAUDOT CODE OR, AS IT IS NOW KNOWN, "INTERNATIONAL TELEGRAPH ALPHABET NO. 2."

A TELETYPE MACHINE CONSISTS OF A PRINTER AND A KEYBOARD BOTH DRIVEN BY A SINGLE CONSTANT SPEED MOTOR. MECHANICALLY IT IS A FEARSOME THING, CONSISTING OF SOME THREE THOUSAND PARTS, AND LIKE A CAMERA OR A WATCH IS BEST LEFT ALONE. ELECTRICALLY IT IS VERY SIMPLE, CONSISTING OF AN ELECTROMAGNET AND A S.P.S.T. SWITCH IN SERIES. THE MAGNET CONTROLS THE PRINTER AND THE SWITCH IS CONTROLLED BY THE KEYBOARD.

**SINGLE MACHINE OPERATION:** KNOWN AS "LOCAL LOOP." A CURRENT OF 30 MA D.C. FLOWING THROUGH THE MAGNET COIL AND KEYBOARD CONTACTS ALLOWS THE MACHINE TO OPERATE FROM ITS OWN KEYBOARD ON "LOCAL LOOP." A RESISTANCE OF 5 KΩ IS REQUIRED IN SERIES WITH THE LOCAL LOOP POWER SUPPLY OR ELSE THE MOVEMENT OF THE MAGNET ARMATURE WILL INDUCE SURGES IN THE LOCAL LOOP AND CAUSE DISTORTION.

**MULTI MACHINE OPERATION:** MACHINES ARE CONNECTED IN SERIES BY WIRE LINES. ONLY ONE POWER SUPPLY IS REQUIRED AND THE SAME MINIMUM CIRCUIT RESISTANCE IS REQUIRED.

**RTTY:** RADIOTELETYPE, AS FAR AS THE MACHINES ARE CONCERNED, IS THE SAME AS WIRE TELETYPE. RTTY, THEREFORE, IS A TECHNIQUE FOR CONVERTING WIRE OPERATION TO R.F. AND R.F. BACK TO WIRE. ALL TELETYPE OPERATES ON A MAKE-BREAK, ON-OFF, OR MARK-SPACE, WHICHEVER YOU CHOOSE TO CALL IT. A MOST OBVIOUS WAY, THEN, WOULD BE TO JUST KEY THE R.F. VIA THE KEYBOARD CONTACTS. AT THE RECEIVING END ALLOW THE OUTPUT OF THE RECEIVER TO ACTUATE A RELAY WHICH, IN TURN, WOULD KEY THE PRINTER "LOCAL LOOP." THIS SYSTEM IS BEING USED AT THE PRESENT TIME AND IS KNOWN AS "MAB" (MAKE AND BREAK) OPERATION. THIS SYSTEM HAS ONE BIG FAULT AND THAT IS THAT DURING THE BREAK, OFF, OR SPACE CONDITION THE SYSTEM IS WIDE OPEN TO NOISE AND INTERFERENCE WHICH MIGHT BE SEEN BY THE MACHINE AS A MARKING IMPULSE.

**AFSK:** AUDIO FREQUENCY SHIFT KEYING. HERE TWO AUDIO TONES ARE TRANSMITTED EITHER BY A.M. OR F.M. MODULATION OF THE R.F. CARRIER. ONE TONE REPRESENTS THE MARK CONDITION AND THE OTHER TONE THE SPACE CONDITION. AT THE RECEIVER THE TONES ARE SEPARATED BY FILTERS, RECTIFIED AND USED TO OPERATE A KEYS TUBE WHICH CONTROLS THE PRINTER MAGNET. IN AMATEUR OPERATION A TONE OF 2975 C/S IS USED FOR THE MARK SIGNAL AND A TONE OF 2125 C/S FOR THE SPACE SIGNAL; THIS IS SO THAT WE CAN ALL READ EACH OTHER! THIS SYSTEM IS VERY SUCCESSFUL FOR SHORT DISTANCES AND IS MAINLY USED ON TWO METRES, THOUGH IT IS ALSO LEGAL ON ELEVEN AND SIX METRES. (Bands depend on country—Ed.) PHASE DISTORTION AND FADING MAKE AFSK UNSUITABLE FOR LONG DISTANCE RTTY.

**FSK:** CARRIER SHIFT FREQUENCY KEYING PROVED TO BE THE ANSWER FOR DX RTTY AND IS THE MOST WIDELY USED METHOD TODAY. HERE AN R.F. CARRIER IS TRANSMITTED FOR THE MARK SIGNAL AND FOR THE SPACE SIGNAL WE "SHIFT" OR MOVE THE CARRIER TO ANOTHER FREQUENCY. A STANDARD SHIFT OF 850 C/S HAS BEEN ADOPTED AS MANY COMMERCIAL STATIONS USE THIS "SHIFT" AND WE CAN COPY THEM FOR MANY INTERESTING THINGS, AS WELL AS FOR ADJUSTMENTS, ETC. TO GENERATE THIS SHIFT IN OUR TRANSMITTER THE D.C. SIGNALS FROM THE "LOCAL LOOP" ARE FED INTO A REACTANCE MODULATOR ON OUR V.F.O. SAME AS FOR N.B.F.M. ASSUME THAT OUR TRANSMITTER IS ON 7140 KC/S TRANSMITTING A SPACE SIGNAL. IT WILL MOVE TO 7140.850 KC/S FOR THE MARK SIGNAL (WE HOPE!). TO RECEIVE THIS FSK WE SET THE B.F.O. ON THE RECEIVER TO OBTAIN A 2975 C/S AUDIO BEAT NOTE ON THE 7140 KC/S SIGNAL, AND WHEN THE SIGNAL SHIFTS TO 7140.850 KC/S THE AUDIO BEAT NOTE CHANGES TO 2125 C/S, PROVIDED WE HAVE SET OUR B.F.O. TO THE RIGHT SIDE OF THE RECEIVED SIGNAL! THESE TWO AUDIO NOTES FROM THE RECEIVER ARE FED INTO THE "CONVERTER," DESCRIBED IN THE AFSK SECTION ABOVE, THE SAME AS AN AFSK SIGNAL, TO KEY THE PRINTER MAGNET. THE FSK SIGNAL CAN ALSO BE CONVERTED AT THE RECEIVER I.F. FREQUENCY BY VERY SHARP FILTERS, BUT AMATEUR PRACTICE AT PRESENT IS TO USE THE AUDIO FREQUENCY "CONVERTER" SO THAT WE CAN COPY AFSK WITH THE SAME EQUIPMENT.

ON THE AIR, AMATEUR BAND RTTY WILL PUT THROUGH GOOD COPY WITH SIGNAL STRENGTHS THAT A REALLY GOOD C.W. OPERATOR CAN USE.

QRM DOES NOT BOTHER IT, BUT A FAST DX "FLUTTER" REALLY CHEWS IT UP! OUTSTANDING RTTY STATIONS SEEM TO PREFER VERTICAL GROUND PLANES FOR TRANSMITTING; AND GOOD RECEIVER A.V.C., PRODUCT DETECTION AND AUDIO CLIPPING ALL HELP AT THE RECEIVER END.

SUBSEQUENT ARTICLES WILL DESCRIBE THE BAUDOT CODE, THE TELETYPE MACHINE FUNCTIONING, A TYPICAL FSK KEYSER AND A SIMPLE THREE VALVE AFSK "CONVERTER."

**AN AFSK GENERATOR.** THE TRANSMISSION OF RADIOTELETYPE SIGNALS ON THE AMATEUR BANDS ON WHICH TONE MODULATION (A2) IS PERMITTED (ABOVE 50 MC/S IN CANADA) IS USUALLY ACCOMPLISHED BY MEANS OF TWO AUDIO TONES. THIS SYSTEM IS KNOWN AS AFSK (AUDIO FREQUENCY SHIFT KEYING).

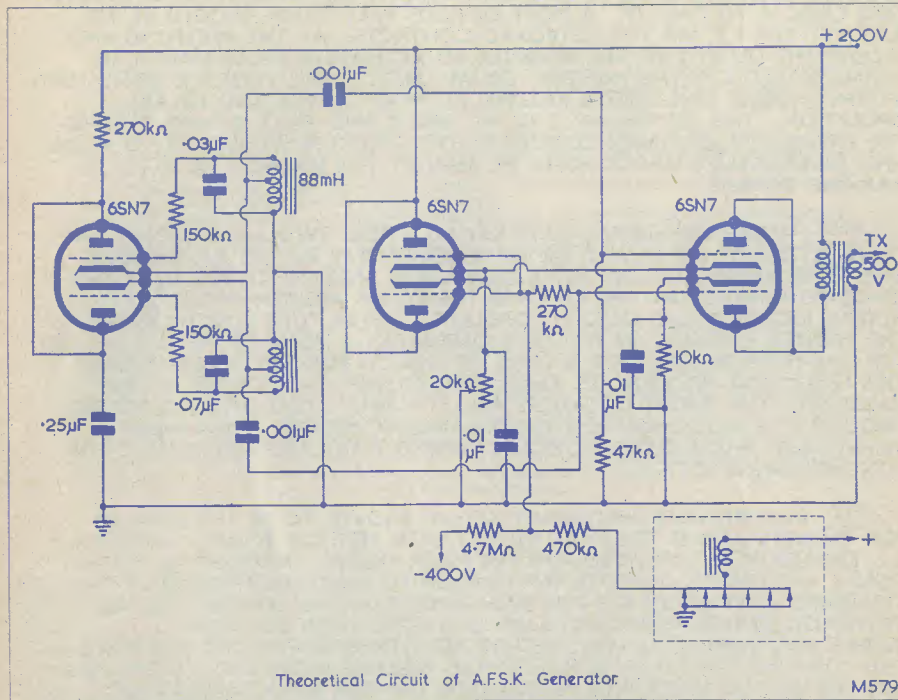

ESTABLISHED AMATEUR PRACTICE IS TO USE AN AUDIO FREQUENCY OF 2975 C/S FOR THE "RESTING" OR "SPACE" FUNCTION FREQUENCY AND 2125 C/S FOR THE "SIGNAL" OR "MARK" FUNCTION FREQUENCY. THESE FREQUENCIES ARE WITHIN THE AUDIO PASS-BAND OF AMATEUR RECEIVERS AND ARE OUT OF HARMONIC RELATIONSHIP WITH POWER LINE AND OTHER RANDOM TONE FREQUENCIES ENCOUNTERED. THE "SHIFT" OR DIFFERENCE IN FREQUENCY IS 850 C/S WHICH IS AN ACCEPTED STANDARD SHIFT FREQUENCY.

THIS AFSK TONE SIGNAL CAN BE GENERATED IN AN AUDIO OSCILLATOR AND THE FREQUENCY ALTERED BY A SHUNT CONDENSER KEYED BY A RELAY OR DIODE KEYSER OPERATED BY THE TELETYPE MACHINE KEYBOARD CONTACTS. HOWEVER, KEYING AN OSCILLATOR USUALLY MEANS COMPROMISING ON STABILITY AND SIGNAL WAVE-SHAPE, AND THE UNIT DESCRIBED HERE WAS DEVELOPED TO INCORPORATE THE ADVANTAGES OF AN M.O.P.A. HOOK-UP.

THE CIRCUIT, AS SHOWN BY THE ACCOMPANYING DIAGRAM, CONSISTS OF A PAIR OF ELECTRON-COUPLED AUDIO OSCILLATORS GENERATING THE SPACE AND MARK SIGNAL FREQUENCIES CONTINUOUSLY, FOLLOWED BY A PAIR OF DIFFERENTIALLY-KEYED CLASS A AMPLIFIERS WITH COMMON OUTPUT. THE OSCILLATORS USE TWO 88MH TOROIDS AS HIGH "Q" INDUCTANCES IN THE FREQUENCY DETERMINING TANK CIRCUIT. THESE TOROIDS ARE KNOWN LOCALLY AS "LOAD-POT TOROIDS" AND ARE USED IN TELEPHONE LINE WORK FOR CABLE LOADING. THEY HAVE TWO WINDINGS FOR CONNECTION IN EACH SIDE OF A TELEPHONE LINE AND IN THIS APPLICATION THE COILS ARE CONNECTED IN SERIES FORMING A CENTRE-TAP USED FOR THE CATHODE CONNECTION. ALTERNATIVELY THE CENTRE-TAPPED 500Ω WINDING OF A MIDGET SPEAKER TRANSFORMER CAN BE USED AS THE TUNED INDUCTANCE, BUT CONDENSER VALUES WILL HAVE TO BE CHANGED FROM THOSE SHOWN.

THE OUTPUTS OF THE TWO OSCILLATORS ARE COUPLED TO THE GRIDS OF THE DIFFERENTIALLY-KEYED AMPLIFIERS; A LOWER VALUE OF GRID RESISTOR IS USED IN THE GRID OF THE SPACE AMPLIFIER TO REDUCE THE AUDIO DRIVING VOLTAGE TO GIVE EQUAL OUTPUT ON EACH FREQUENCY. TO AVOID OVERDRIVING THE AMPLIFIERS, THE ANODE VOLTAGE OF THE OSCILLATORS IS REDUCED TO TWENTY VOLTS BY THE 270 KΩ SERIES RESISTOR.

ON THE SPACE POSITION OF THE TELETYPE MACHINE THE KEYBOARD CONTACTS ARE CLOSED TO EARTH AND THE BIAS DIVIDER NETWORK SUPPLIES 50 VOLTS OF NEGATIVE BIAS TO THE GRIDS OF THE KEYSER VALVE AND TO THE GRID OF THE MARK AMPLIFIER, CUTTING OFF THE MARK SIGNAL WHILE THE SPACE SIGNAL GOES THROUGH THE SPACE AMPLIFIER VALVE. ON THE TRANSMISSION OF A CHARACTER ON THE TELETYPE KEYBOARD, THE KEYBOARD CONTACTS OPEN AND A POSITIVE VOLTAGE OF 50 VOLTS APPEARS ACROSS THESE CONTACTS FROM THE PRINTER MAGNET COIL CIRCUIT. THIS POSITIVE SIGNAL CHANGES THE GRID BIAS VOLTAGE TO SLIGHTLY POSITIVE, PERMITTING THE MARK AMPLIFIER TO CONDUCT AND PASS THE MARK SIGNAL. AT THE SAME TIME THE KEYSER TUBE CONDUCTS AND RAISES THE CATHODE VOLTAGE OF THE SPACE AMPLIFIER SUFFICIENTLY TO CUT OFF THE SPACE SIGNAL BY THE VOLTAGE DROP ACROSS THEIR COMMON CATHODE RESISTOR; THIS 25 KΩ VARIABLE RESISTOR IS ADJUSTED TO THE NECESSARY CUT-OFF VOLTAGE.

THE OUTPUT OF THIS GENERATOR IS FED INTO THE AUDIO CHANNEL OF ANY CONVENTIONAL AMATEUR PHONE TRANSMITTER; OR ALTERNATIVELY, IT CAN BE USED TO TEST A CONVERTER UNIT ON LOCAL COPY. A CONVERTER UNIT IN AMATEUR RADIOTELETYPE TERMINOLOGY IS A GADGET USED TO CONVERT AN AFSK SIGNAL BACK INTO D.C. PULSES TO OPERATE THE PRINTER SELECTOR MAGNET OF THE TELETYPE MACHINE. A SIMPLE THREE-VALVE CONVERTER UNIT WILL BE THE SUBJECT OF A SUBSEQUENT ARTICLE.

## STAINLESS STEEL POLISHING

The increasing use of stainless steel in plants manufactured for the chemical, pharmaceutical, food, brewery and dairy industries, and for fittings in motor-cars, caravans, ships and aircraft, and for domestic hardware of all kinds, lends importance to a novel and patented process known as "electro-polishing."

The stainless steel article to be polished is immersed in an electrolyte and a current is passed through it, using the article as the anode. Instead of depositing metal on the article, as in electro-plating, the process is reversed and about 0.0005in is removed electro-chemically and evenly from the stainless steel. A highly polished and chemically clean surface remains.

Besides being cheaper and quicker than mechanical polishing, electro-polishing has other advantages. Any inclusions in the stainless steel, which are sometimes unavoidably introduced during manufacture, are removed electro-chemically, instead of being added to, as they tend to be by mechanical polishing. The electro-

polished article is therefore particularly resistant to corrosion, which makes it suitable for components where chemical purity and hygiene are paramount. Secondly, complex assemblies, which would be inaccessible for mechanical polishing, can be readily electro-polished. This in turn frees design, because there is no need to avoid shapes which previously would be difficult or impossible to polish by any other method.

A wide variety of articles of all shapes and sizes has been successfully treated by this process, varying from stainless steel tanks of 2,000 gallons capacity to small parts of cathode-ray tubes and wireless valves; and work has been carried out for Kodak, I.C.I., and many other firms. There seems to be almost unlimited scope for electro-polishing stainless steel components and assemblies, not only for the sake of the finished appearance, but also to improve resistance to corrosion.

The process is done by Electropol Processing Ltd., Trading Estate, Farnham, Surrey.

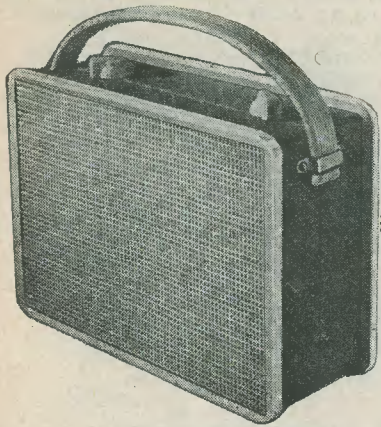

# The New TRANSEVEN

## A 7-TRANSISTOR RECEIVER FOR THE HOME CONSTRUCTOR

described by JAMES S. KENT

### PART 2

#### Stage 3

In order to prevent damage to the transistors by heat from the soldering iron, do not shorten the wire connections. These wires should be covered with 1 mm. p.v.c. sleeving before soldering into position. When soldering the transistors, use the wiring pliers as a heat shunt in order to avoid possible heat damage.

Fit the r.f. transistor TR<sub>1</sub>, soldering the collector (spot) to pin 2 of the OT1, the base (centre wire) to eyelet 4 and the emitter to eyelet 3.

Fit the first i.f. transistor TR<sub>2</sub>, connecting the emitter to tag 3 of the OT1, collector (spot) to tag 2 of TT2, and the base (centre wire) to eyelet 5.

With the second i.f. transistor TR<sub>3</sub>, connect the emitter to tag 3 of the TT2, the collector (spot) to tag 2 of TT3 and the base (centre wire) to eyelet 6.

Dealing next with the first audio transistor, TR<sub>4</sub>, connect the emitter to eyelet 7, the base (centre wire) to eyelet 8 and the collector (spot) to eyelet 9.

Taking the second audio transistor TR<sub>5</sub>, solder the emitter to eyelet 10, the base (centre wire) to eyelet 11 and the collector (spot) to eyelet 12.

With TR<sub>7</sub>, one half of the push-pull output stage, connect the collector (spot) to eyelet 19, the base (centre wire) to eyelet 14 and the emitter to eyelet 17.

Fit the other half of the output stage, TR<sub>6</sub>, soldering the collector (spot) to eyelet

20, the base (centre wire) to eyelet 18 and the emitter to eyelet 17.

The next step is to cut the blue and black leads off the solder tags on the ferrite slab aerial FS2 and join the solder tags, from which these leads have been removed, together; first at the LW coil tags and then at the MW coil tags. Cut 3in off the paxolin fixing brackets of the FS2 aerial from that end furthest from the slab.

Thread the yellow and red leads through the hole 28 and the green and orange leads through hole 22. (See stage one diagram for location of hole 22.) Turn the FS2 aerial so that the coils are in the position shown in the stage 3 diagram (see Fig. 3) and then screw to the angle brackets at J and L, using 6BA screws and nuts through the centre of the solder tags on the paxolin brackets of the FS2. Following this, seal the coils of the FS2 to the ferrite slab with wax. The above completes stage 3.

#### Stage 4 (Drawing No. 1)

In the point-to-point drawings for this stage (Fig. 3), the trimmer blocks have been shown "flat" for purposes of clarity.

Solder C<sub>4</sub> (800pF)—this value required for the Light programme on the Long wave band—from point 12 on the wavechange switch to the solder tag on the screw at G. Join the solder tags, nearest to the paxolin panel, of TC<sub>5</sub>, TC<sub>6</sub>, TC<sub>7</sub> and TC<sub>8</sub> together and connect to the solder tag on the screw at H. Join the top terminal tags of TC<sub>1</sub>, TC<sub>2</sub>, TC<sub>3</sub> and TC<sub>4</sub>

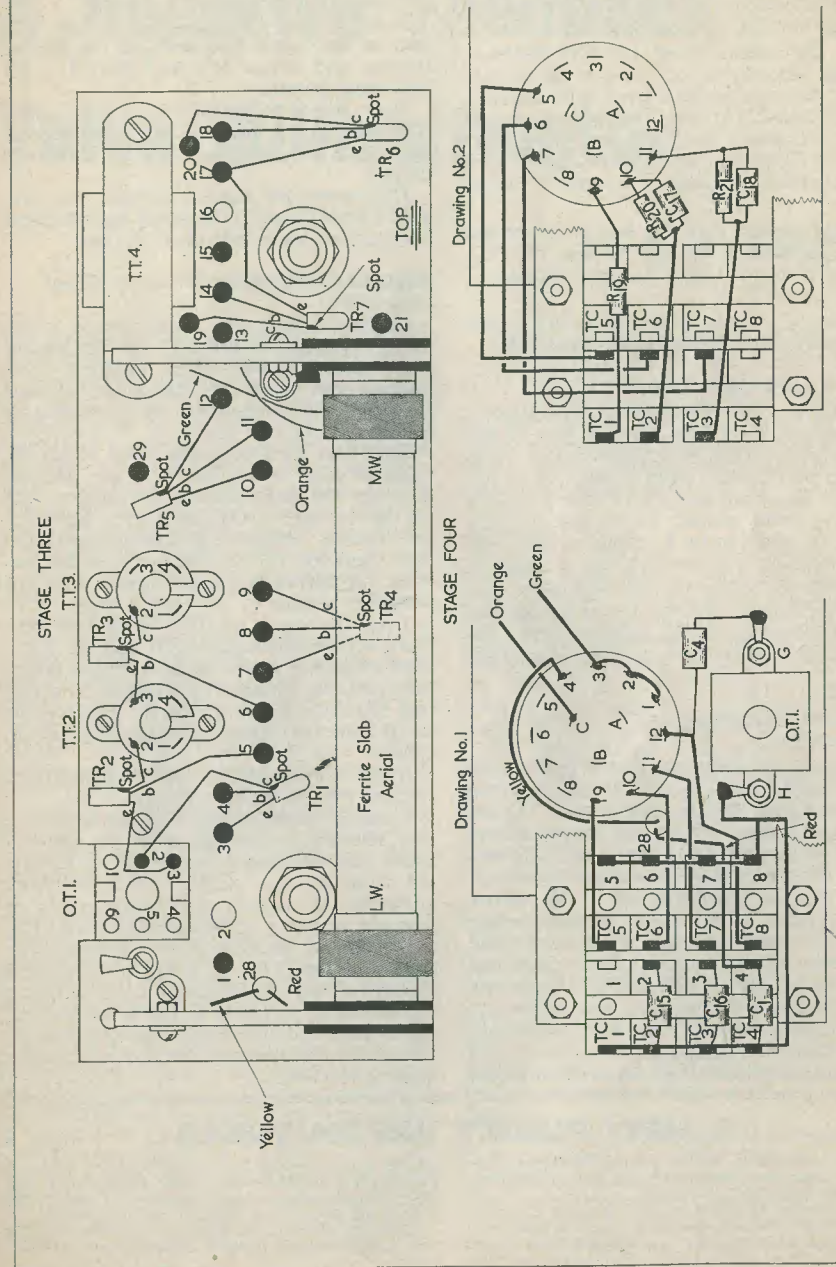

FIG. 3.  
Third and Fourth Stages of Construction.

together and connect to the solder tag on the screw at H.

Solder  $C_1$  (200pF)—for the Light programme on the LW band, from point 4 of  $TC_4$  to the top of  $TC_4$ . Connect the red lead from FS2, which we have previously brought through hole 28, to point 4 of  $TC_4$ .

Fix the yellow lead of FS2 (already through hole 28) to contact 4 on the switch. Solder the orange lead from FS2 (already through hole 22) to pole C on the wavechange switch. Connect the green lead from FS2 (via hole 22) to contact 3 of the switch. Now, join together contacts 1, 2 and 3 of the switch.

Solder contact 9 of the switch to the top of  $TC_5$ ; contact 10 to the top of  $TC_6$ ; contact 11 to the top of  $TC_7$  and contact 12 to the top of  $TC_8$ .

Solder  $C_{15}$  (see Table for value) across  $TC_2$  and  $C_{16}$  (again see Table) across  $TC_3$ .

#### Stage 4 (Drawing No. 2)

Solder  $R_{19}$  (value subject to experiment—see previous text) from contact 9 of switch to the top of  $TC_1$ ;  $R_{20}$  from contact 10 to the top of  $TC_2$ ;  $C_{17}$  from contact 10 to top of  $TC_2$ ;  $R_{21}$  from contact 11 to top of  $TC_3$  and  $C_{18}$  from contact 11 to top of  $TC_3$ . (Note: In addition to  $R_{19}$ , the values of all the foregoing components are subject to variations of value—see previous text.)

Lastly, connect the speaker and insert the battery plug into a  $7\frac{1}{2}$  volt battery. The completed receiver is now ready for alignment.

#### Alignment Instructions. (With Signal Generator)

Connect the signal generator lead to the emitter of  $TR_3$  (tag 3 of  $TT_2$ ) and feed in a 315 kc/s signal, adjusting the core of  $TT_3$  for maximum output. Move the generator lead to the emitter of  $TR_2$  (tag 3 of  $OT_1$ ) and adjust the core of  $TT_2$  for maximum output.

Connect the generator lead to the emitter of  $TR_1$  (eyelet 3) and adjust the bottom core of  $OT_1$  for maximum output. With the lead still connected to  $TR_1$ , give a final adjustment to the cores of  $TT_3$ ,  $TT_2$  and  $OT_1$  (bottom).

Switch to the LW position and adjust  $R_{17}$  (see circuit description), feed in a 200 kc/s signal from the generator and set  $TC_8$  to approximately 40pF, then adjust the top core

of  $OT_1$  for maximum output. Adjust  $TC_4$  also for maximum output.

Switch to the MW1 position, adjust  $R_{19}$  (see circuit description), feed in the signal frequency of the selected station, and adjust  $TC_5$  and  $TC_1$  for maximum output.

Switch to the MW2 position, adjust  $R_{20}$ , feed in the signal frequency of the desired station, and adjust  $TC_6$  and then  $TC_2$  for maximum output.

Next, switch to the MW3 position, adjust  $R_{21}$ , feed in the required signal frequency, and adjust  $TC_7$  and then  $TC_3$  for maximum output.

Disconnect the signal generator and give a final adjustment to the aerial and oscillator trimmers on each individual station.

#### Alignment Instructions (Without Signal Generator)

Connect a long wire aerial directly to the tuned windings of the FS2—to the orange lead when switched to a Medium wave position and to the red lead when switched to a Long wave position—and proceed as follows:

Switch to the LW position and adjust the value of  $R_{17}$ . Next, switch to the position covering the nearest local transmitter, and set the top core of  $OT_1$  level with the top of the former. Adjust the appropriate aerial and oscillator trimmers (see above instructions for identification of these), until the station is heard.

Tune the cores of  $TT_3$ ,  $TT_2$  and  $OT_1$  (bottom) for maximum aural output. Fit a 25pF capacitor in the aerial wire and repeat the core and trimmer adjustments as above but NOT the  $OT_1$  top core. Remove the aerial and repeat these adjustments as a final check.

By the same method, the remaining three stations may be tuned correctly.

It should be noted here that the receiver is very selective and consequently the required signal can very easily be missed by turning the trimmers too quickly. It is therefore advisable to tighten whichever oscillator trimmer is being adjusted ( $TC_5$ ,  $TC_6$ ,  $TC_7$  or  $TC_8$ ) and then turn the corresponding aerial trimmer ( $TC_1$ ,  $TC_2$ ,  $TC_3$  or  $TC_4$ ) right through its travel. Slacken off the oscillator trimmer approximately  $1/20$ th of a turn and again turn the aerial trimmer through its travel. Repeat this until the required station is being received.

## A NEW PLESSEY VHF/FM TUNER

A new addition to the wide range of radio components already manufactured by the Plessey Company Ltd. is the P.B.2 VHF/FM tuner.

This compact VHF/FM tuner is designed around a double triode valve, one section of which is used as an r.f. amplifier and the other as a self-oscillating mixer. The unit employs eddy-current tuning and is available

in two main versions, one having a tuning range of 87–101 Mc/s and the other having a range of 87/108 Mc/s. Consequently, tuners suitable for use in the U.K., Europe or North America can be supplied.

There are no oscillator drift problems with the unit and radiation is well within B.R.E.M.A. recommended limits.

# A Negative Feedback Valve Millivoltmeter

by G. K. Fairfield

IN DESIGNING AN INDICATING INSTRUMENT such as a valve-voltmeter for audio-frequency work, the main requirement will be that the output be independent of frequency over the range required. Secondly, stability of indication is essential—this must not vary whilst a series of readings are being taken. Absolute accuracy is of less importance as, for the main part, relative readings only are required and the results are plotted in decibel form. However, the methods used to obtain the first two requirements will usually mean that a high degree of absolute accuracy is realised.

The solution to these problems lies, of course, in the application of negative feedback to the amplifying circuit of the voltmeter. This has been incorporated in the circuit shown in Fig. 1. The first valve  $V_1$  provides the bulk of the loop gain and is directly coupled to a cathode-coupled pair of valves  $V_{2a}$ – $V_{2b}$ . This circuit has the ability to amplify without phase-inversion and is necessary to keep the phase relationships correct for the negative feedback taken from the output valve  $V_{3a}$ .

#### Negative Feedback Loop

Voltage feedback is used, the output being developed across a potential divider, formed by a crystal diode bridge circuit and a resistor  $R_5$  included in the cathode circuit of  $V_1$ . It is across this resistor that the fed-back potential is developed and, in order to extend the frequency range of the instrument, has been made to have an inductive component. This is achieved by winding approximately 12 turns of 38 s.w.g. Eureka resistance wire on a  $\frac{1}{4}$ in diameter former containing a dust core tuning slug. This core is adjusted during calibration to give the highest level frequency response, after the resistance value has been adjusted as described later in this article.

The bridge circuit which forms the upper arm of the potential divider consists of four GEX 45/1 germanium point-contact diodes, although almost any other four similar point-contact diodes will serve. The rectified output will appear across a 1mA moving-coil meter; this should have an internal resistance not greater than 1,000 $\Omega$ .

#### Anti-ripple Circuit

The second half of  $V_3$  is used as a hum reduction stage for the two earlier sections of the amplifier. No smoothing choke is used in the power supply and the ripple present at point X is applied to the grid of  $V_{3b}$  via  $C_1$ . The gain of this stage is adjusted by setting the value of  $R$  to give minimum ripple at point Y, the anode of  $V_{3b}$ , whence the h.t. supply for the earlier stages is taken.

Any ripple present in the amplifier will be rectified and show as a minimum reading on the meter when the input terminals are shorted. This should not be allowed to be greater than 2% of full scale deflection otherwise the readings at multiples of 50 c/s will be to some extent inaccurate.

#### Input Attenuator

The most sensitive range of the meter is 10mV r.m.s. for full scale deflection. Calibration may be made at 50 c/s using an accurate a.c. meter and a graduated wire-wound potentiometer of large diameter (see Fig. 2). With a known 10mV input to the meter the resistance value of  $R_5$  (number of turns) is carefully adjusted until full scale deflection is observed.

The attenuator can now be constructed. It is convenient to make this as a self-contained unit, the resistors and capacitors being grouped around the 6-way Yaxley switch used. Frequency correction is obtained by arranging a second potential

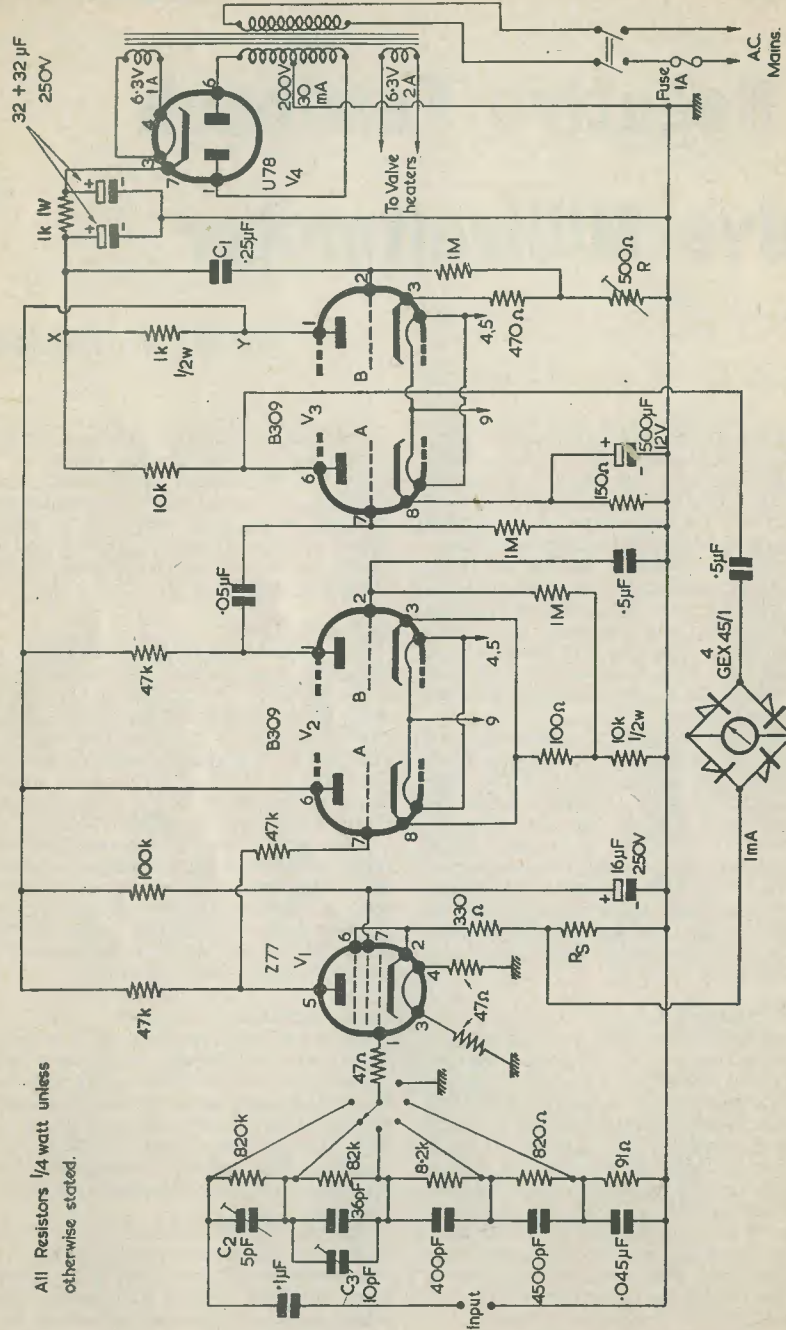

All Resistors 1/4 watt unless otherwise stated.

FIG. 1. Complete Circuit of Valve Millivoltmeter.

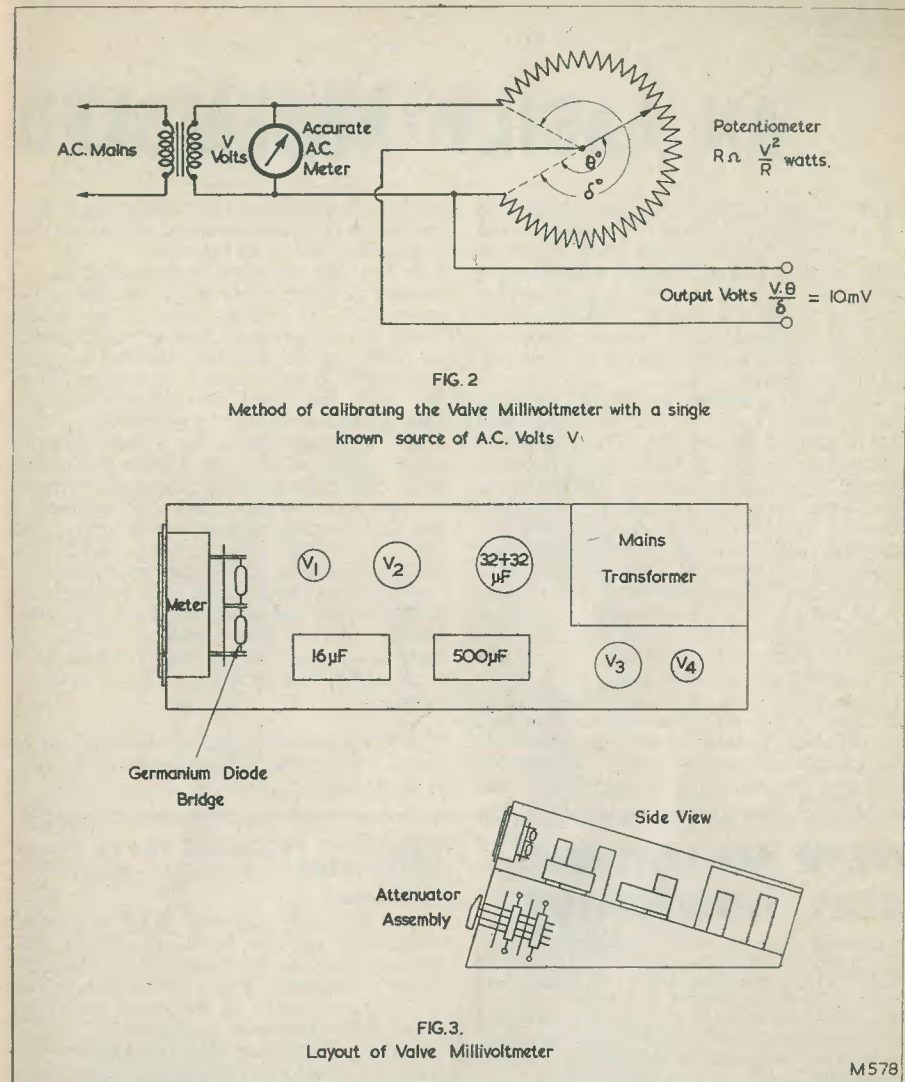

FIG. 2. Method of calibrating the Valve Millivoltmeter with a single known source of A.C. Volts  $V_1$ .

FIG. 3. Layout of Valve Millivoltmeter.

divider, this time a capacity one, in shunt with the purely resistive divider. With care the complete attenuator will then be independent of frequency up to a few megacycles. The resistors used should preferably be of  $\pm 5\%$  tolerance and carefully selected by measurement before insertion. However, it is often easier to adjust the resistance values of the completed attenuator *in situ* and this should be done, commencing with the largest value resistor to obtain, say, one-tenth of full-scale reading on the 100mV position for a known 10mV input. The 1V range can

next be tackled to give one-tenth full scale with 100mV input, and so on. It is sufficiently accurate to do this at 50 c/s as the linearity of the instrument will be good to at least 100 kc/s even without special adjustment of  $C_2$ ,  $C_3$  and  $R_s$ .

These latter adjustments should next be carried out using a calibrated signal generator, commencing as before, with  $R_s$  with the meter switched to the 10mV position, then  $C_2$  on the 100mV position, and finally  $C_3$  on the 1V range.

continued on page 540

# AN EASILY ASSEMBLED

THE PRE-SELECTOR DESCRIBED HERE WAS assembled in about two hours from components already to hand, chiefly in order to bring in some distant stations more easily and also to use up a few surplus components. It is a piece of apparatus which may interest some of the younger readers in particular, before they attempt to construct a full-size receiver.

The chassis measures 7in x 5in x 1½in deep, and was raised to 2in by means of hardwood blocks screwed at each end. This increase in height was made in order to give more clearance for the switch and potentiometer (the latter is actually used as a variable resistor, one end of the track being left unconnected). The coil, variable condenser (which in my case is one intended for a reaction control) and the mains transformer ("Cry Baby" type, Clyne Radio, or similar) are mounted on top of the chassis. The rectifier, electrolytic condenser and other components are mounted underneath.

To the back drop of the chassis is fixed an insulated socket strip for the aerial, also a coaxial socket to take the output lead. Inside the chassis are two 4-way tag strips; one supports the mains leads and earths the

electrolytic condenser unit, whilst the second carries the resistors associated with the anode and screen circuits of the valve.

In use, the pre-selector is coupled to the receiver and the aerial input is coupled to the room, loft, or outside aerial. The 4-pole 3-way switch, which is used as mains switch as well as pre-selector switch, is then positioned so that, although the valve heater is "on," the aerial is switched straight through to the receiver (position 2).

Any required station may now be tuned in on the main receiver, and then greatly increased in volume—with added selectivity—by switching the pre-selector to position 3 and adjusting the pre-selector tuning and gain controls. After some practice with this method, it will be found practicable to "search" for stations by operating simultaneously the pre-selector and main receiver tuning controls, thus enabling reception of stations so weak that the main receiver alone is unable to bring them above the background noise.

*NOTE: Output coaxial lead should not be connected to chassis of main receiver if latter is of the a.c./d.c. type.*

## NEW EDDYSTONE DIAL AND DRIVE

Stratton & Co. Ltd., Eddystone Works, Birmingham 31, have introduced a new geared slow-motion drive assembly which we have received for test and which we have no hesitation in recommending to all those readers interested in the construction of multi-band receivers, signal generators, audio oscillators and similar equipment.

The pointer has a horizontal travel of 7in over five scales intended for self-calibration. There is an additional scale which, in conjunction with a circular vernier scale marked in 100 divisions, enables the total travel to be divided by 500.

The movement is by cord drive to the pointer, and by pre-loaded gearing to the rotated component, a ratio of 110:1 being achieved. Fly-wheel loading ensures a smooth drive.

A diecast escutcheon, finished glossy black, Perspex window, knob, fixing screws and mounting template are provided.

The drive is suitable for mounting on metal or wood panels up to 7mm. (just over ¼in). The catalogue number is 898, and the retail price £2 18s. 0d.

## NEGATIVE FEEDBACK VALVE MILLIVOLTMETER—continued from page 539

### Performance

The frequency response of the completed instrument will be found to extend well outside the audio frequency range. With the writer's equipment this is linear from 20 c/s to 800 kc/s, rendering the meter useful for many radio frequency applications.

Stability is excellent and a long preliminary warm-up period is quite unnecessary. The accuracy, especially at the higher frequency end, is dependent on the care with which the attenuator is constructed, but on the most sensitive range this should be better than 3%.

### Layout

A suitable layout for the meter is shown in Fig. 3. The lead to the grid of V<sub>1</sub> from the attenuator should be kept as short as possible, and the heater leads twisted together and kept close to the underside of the chassis. The diode bridge circuit can best be mounted on a separate bakelite panel bolted to the rear of the meter.

# PRE-SELECTOR *by N. Fox*

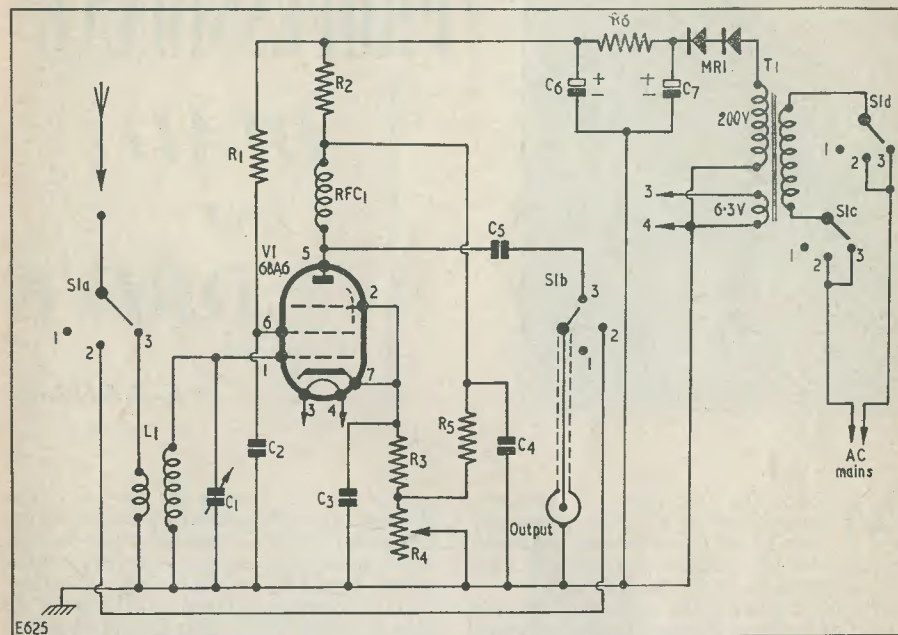

### Component List

#### Resistors

- R<sub>1</sub> 47kΩ ½W
- R<sub>2</sub> 1.2kΩ ½W
- R<sub>3</sub> 47Ω ½W
- R<sub>4</sub> 5kΩ w.w. pot.
- R<sub>5</sub> 470kΩ ½W
- R<sub>6</sub> 10kΩ 1W

#### Condensers

- C<sub>1</sub> 500pF variable
- C<sub>2</sub> 0.01μF 350V
- C<sub>3</sub> 0.01μF 150V
- C<sub>4</sub> 0.01μF 350V
- C<sub>5</sub> 100pF mica
- C<sub>6</sub>, C<sub>7</sub> 8+8μF 350V electrolytic

#### Miscellaneous

- S<sub>1a-c</sub> 4-pole 3-way rotary
- MR<sub>1</sub> Brimar DRM1B
- V<sub>1</sub> Brimar 6BA6
- L<sub>1</sub> Aerial coil of suitable range
- T<sub>1</sub> Mains transformer, "Cry Baby" (Clyne Radio) or similar
- B7G valveholder and screening can
- Input and output sockets and plugs
- RFC<sub>1</sub> R.F. choke of suitable range to match L<sub>1</sub>
- Three knobs, chassis 7in x 5in x 2in, panel 7in x 5in, two 4-way tag strips, screws, nuts, wire, etc.

## BOOK REVIEW

**THE RADIO AMATEUR'S HANDBOOK.** Published by the American Radio Relay League. Obtainable from the Modern Book Co., 19-23 Praed Street, London, W.2. Price in U.K., 32s. 6d.

The 1958-35th edition—of this radio amateur's "bible" enables its readers to get right up to date on the latest in amateur radio techniques. For the first time, a section on teletype (RTTY) is included. The single sideband (SSB) section has been increased and

the application of such recent developments as transistors to amateur radio equipment is featured.

There is something in this volume for everybody, from the rawest tyro just learning morse and wanting to build a simple short-wave receiver, through elementary theory to the construction of one's first transmitter, up to the most modern SSB transmitters, VHF gear and aeriels. This is a "must" for every radio amateur and a copy of the new edition will prove to be one of the most consulted books in one's shack.

A.C.G.



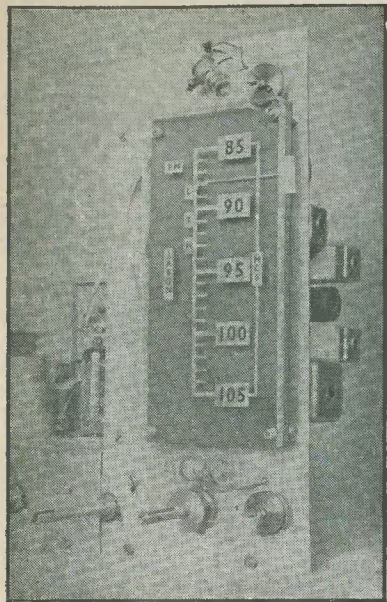

★  
**“PROFESSIONAL”**  
**DIAL**  
*and*  
**DRIVE**

by **K. J. PALMER**

**M**ANY IS THE TIME WHEN AN AMATEUR, on constructing a radio receiver, has been placed in an awkward situation by the lack of a suitable dial that will meet his requirements and individual taste.

I was faced with this problem when constructing an f.m. radiogram for domestic use. Apart from fulfilling the need of good radio reception, it had also to be of good appearance, fit in with the existing furniture, and therefore have a professional finish.

In this particular instance it had to have a vertical dial of dimensions to fit in with the overall proportions and design of the set.

There seems to be a lack of vertical f.m. dials on the market at present, and in any case I doubt if the overall dimensions would have been to my requirements.

There was only one answer, make one!

After a pitiful attempt at painting a scale, I found the answer in the following way:

**Materials Required**

One piece of 18 s.w.g. sheet aluminium; four 1in 4BA screws; two pieces of Perspex; suitable transfers; one piece of Formica (cherry red; colour optional); one small length of brass tubing  $\frac{3}{8}$ in bore; suitable pulleys, drum and cord, etc. for the drive.

The aluminium sheet is cut and drilled to suit the existing chassis of the set and is used as the front panel and support for the dial and drive.

After deciding the size and position of the dial, its outside dimensions are marked off on the aluminium. Four holes are then marked off on the aluminium  $\frac{1}{8}$ in in from the edge at each corner of the dial outline. These are then drilled 4BA clearance. At this point all holes required for the drive should be made. The details and design of the drive I have left to the individual constructor because of the varied requirements and the operative length of the scale. In this particular assembly a 5in scale length and a double reduction pulley system was used.

After the aluminium is drilled, the two pieces of Perspex are next cut and filed to shape. Place one piece of Perspex on the aluminium and mark through the four holes on to the Perspex. Put the two pieces of Perspex together, square the edges, and without moving them drill the four holes, this time 4BA tapping size. Separate the Perspex, and in one piece open out the four holes to 4BA clearance, and in the other tap out the holes 4BA.

It is well to mention at this point that care must be taken not to damage the surface of the Perspex, therefore the protective paper should be left on until the last operation has been completed. It is also advisable to use aluminium or lead vice clamps.

The Formica is next cut to the same size as the Perspex, and the four holes marked off and drilled 4BA clearance, ensuring that

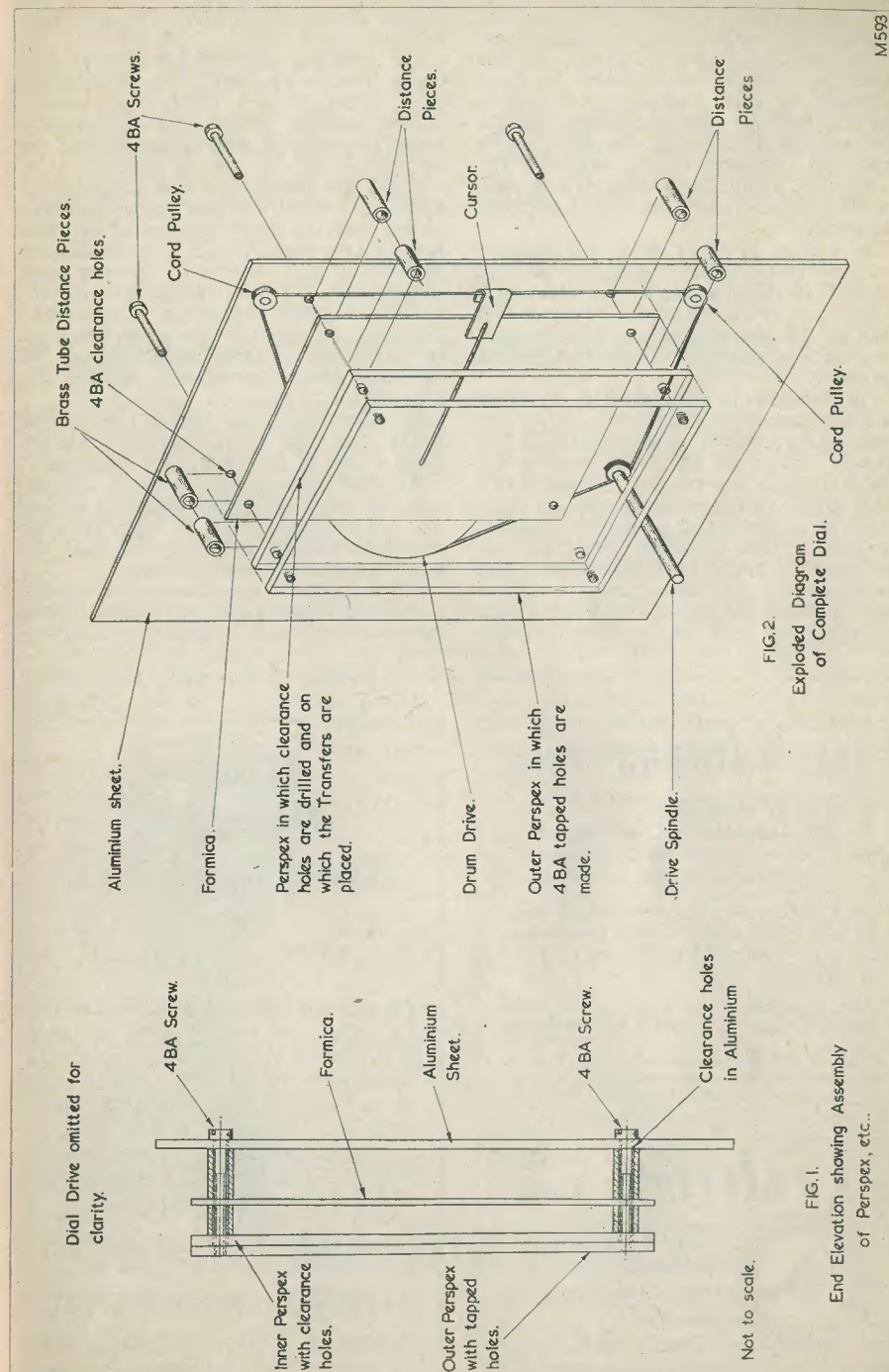

FIG. 2  
Exploded Diagram  
of Complete Dial.

FIG. 1.  
End Elevation showing Assembly  
of Perspex, etc.

M593

they are the same pitch as the holes previously drilled in the aluminium and Perspex.

Next cut the tubing into eight pieces; four pieces  $\frac{1}{2}$ in long, and four pieces  $\frac{1}{4}$ in long. Assemble the drive and scale as shown in Fig. 1. With a signal generator find the extreme ends of the scale, and mark with a pencil on the edge of the Perspex. The positions at 85 Mc/s and 105Mc/s were used for the scale described here. The dial is then dismantled.

On a piece of paper draw, full size, the scale and graduations, using the distance between the pencil marks as the total length of the scale. Place the piece of Perspex that has the 4BA clearance holes in it on top of the paper and align it to the scale drawn on the paper.

The transfers are next prepared. The type used are those that can be obtained in any model shop, and are normally used on model aircraft. These are used because they are simple to apply and require no varnish. To apply they are floated in a dish of warm water for a few seconds and then, sliding them off of their protective paper backing, are placed in position on the Perspex. The excess water is carefully blotted off. (Panel Signs transfers are suitable for this purpose. Sets PS3 (white) and PS4 (black) now include

station names, LW, MW, SW and FM.—Ed.)

On the scale described, a sheet of gold colour transfer was used for the graduations, black numerals and letters being superimposed on this. By using this method many variations of colour and design can be achieved.

When the transfers have been placed in position, the other piece of Perspex is placed on top and the whole is reassembled. (See Fig. 2.) Care must be taken to avoid trapping particles of dust between the Perspex when assembling. Do not attempt to glue the Perspex together, otherwise condensation will form between the two pieces when the set warms up. The infinitesimal air gap left between them when screwed together will prevent this.

The effect when assembled and illuminated is that the scale appears to be inside the Perspex, and is, of course, fully protected.

All that remains now is to fit the dial complete with the chassis into the cabinet that has an aperture cut in the front panel about  $\frac{1}{2}$ in shorter and narrower than the outside dimensions of the Perspex.

The final result is an inexpensive but professional dial that has been in continuous use for nine months and is still as good as new.

# There's MORE SCOPE

for the Technical man

## IN A R.A.F. SHORT SERVICE COMMISSION\*

In this age of missiles, electronics and nuclear weapons, the Royal Air Force offers almost unlimited scope for technical ability. As a R.A.F. Technical Officer you would be a key man in a key branch of the Service, doing work that is absorbing, responsible and, above all, varied.

In fact, if you have recently qualified, a R.A.F. Short Service Commission for 3, 4, 5 or 6 years in the Technical Branch gives greater opportunities for gaining all-round experience than almost any civilian appointment.

## Good prospects in the Service—and after

The main need is for electronic engineers and, to a lesser extent, for mechanical engineers. Promotion comes fast in this vital Branch. If you join at, say, 24 $\frac{1}{2}$  you could be earning £1,250 a year by 30 if married. There are also opportunities of applying for a Permanent

Commission; but, if you return to industry, special facilities are available to help you obtain a post in line with your age and added experience. On leaving the R.A.F., you receive a gratuity of £135, free of income tax, for each year served.

### THESE ARE THE QUALIFICATIONS

You do not necessarily have to be a university graduate; a sound scientific or engineering training is the essential. You must be medically fit and hold, at least, the Higher National Diploma or Certificate in electrical or mechanical engineering, plus G.C.E. at ordinary level in English Language—or equivalent qualifications. You can join as soon as you are

qualified, and up to the age of 37 (or 45 if you have previously held a Service Commission). This is a priority job in a foremost technical service. It offers you valuable experience for your career, excellent pay—and all the wider interest of life as a R.A.F. officer. Write now for full details to Air Ministry (E.C.A.211A), Adastral House, London, W.C.1.

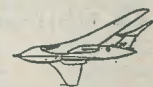

## THE ROYAL AIR FORCE

\*IF YOU ARE A GRADUATE with a Science or Engineering degree, and under 30, you can apply for a R.A.F. Permanent Commission straight away. Write for details of the fine career prospects and pay offered.

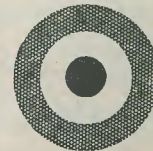

## Ask "ARTHURS" First

NOTE NEW ADDRESS AT  
125 Tottenham Court Road  
London WCI  
Close to Warren Street Station

You will have the same service and obtain all your requirements in Radio Components, Electrical Goods, Accessories and Television as previously.

Test Instruments in stock include Avo, Advant, Cossor and Taylor. List on request

VALVE MANUALS AVAILABLE  
Mullard 10/6 Brimar No. 7 6/-  
Osram Part 1, 2nd Edition 7/6  
Post and packing 9d. each extra

# Arthurs first

Est.  
1919

Proprietors ARTHUR GRAY LTD

Gray House  
125 Tottenham Court Road  
London WCI

Telephone EUSton 5802/3/4

## Radio Control Mechanisms

by  
RAYMOND F. STOCK

The first publication devoted entirely to the subject of radio control linkage mechanisms. Complementary to *Radio Control for Model Ships, Boats and Aircraft* and to other books on radio control.

64 PAGES PLASTIC ART BOARD COVER  
70 ILLUSTRATIONS

2nd Printing 4s. 6d. plus 4d. postage

DATA PUBLICATIONS LTD  
57 MAIDA VALE LONDON W9

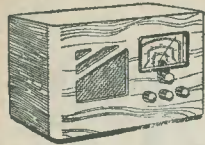

### HOME RADIO 79/6

AC/DC. Universal mains 5-valve octal superhet. 3 waveband receiver can be adapted to gram p.u. In attractive wooden cabinet 9½" x 18½" x 11½". Ins. carr. 7/6

### 17" TV CHASSIS, TUBE & SPEAKER £19.19.6

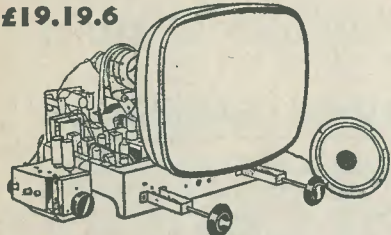

17" Rectangular Tube on mod fied chassis. Supplied as single channel chassis covering B.B.C. channels 1-5, or incorporating Turret Tuner which can be added as an extra at our special price to chassis purchasers of 50/-, giving choice of any 2 channels (B.B.C. and I.T.A.). Extra channels can be supplied at 7/6. Chassis size 12" x 14½" x 11" less valves. Similar chassis are used by well-known companies because of their stability and reliability. With tube and speaker £19.19.6. With all valves £25.19.6. Complete and working with Turret Tuner £28.9.6. 12 months guarantee on the tubes. 3 months guarantee on the valves and chassis. Ins. carr. (including tube) 25/-

### 14" TV CHASSIS, TUBE & SPEAKER

As above, with 14" Rectangular Tube. 12 months guarantee on tube, 3 months guarantee on chassis and valves. Chassis with tube and speaker (less valves) £15.19.6. With all valves £21.19.6. Complete and working with Turret Tuner £24.9.6. Ins. carr. (incl. tube) 25/-



### RECORD PLAYER CABINET 49/6\*

A practical cabinet, nicely designed, cloth covered two-tone (brown and coffee). Size 15" x 17" x 8" deep. Takes B.S.R. Monarch 4-speed autochanger and 6½" round or elliptical speaker. Carr. and Ins. 4/6

Many other types of beautifully designed cabinets in stock at similar prices to the above.

### B.S.R. MONARCH 4-SPEED AUTO-CHANGER £6.19.6

Incorporating auto and manual control complete with turnover crystal p.u. and sapphire stylus. P.P. & ins 5/6

### COLLARO 4-SPEED AUTOCHANGER £7.19.6

P.P. & ins. 5/6

**DUKE & CO.**

### SUPER CHASSIS 99/6

5-valve superhet chassis including 8" p.m. speaker and valves. Four control knobs (tone, volume, tuning, w/change switch.) Four w/bands with position for gram p.u. and extension speaker. A.C. Ins. carr. 5/6

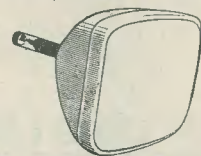
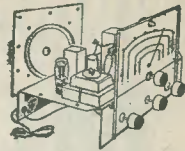

17" RECT. £7.10.0

Our 12 months guarantee (6 months full replacement, 6 months progressive) illustrates our whole-hearted confidence in the tubes we offer. We sell many hundreds a week throughout the country and have done so for the past seven years. Many of them go to the Trade, i.e. to Insurance Companies, Renters and Retailers who are thoroughly satisfied with our supplies. Remember, they also hold a 10 days money back guarantee.

9", 10", 14", 15" and 16" Round Tubes. Our special offer of these sizes £5. 12" TV tubes £6. Three months guarantee on round tubes. Ins. carr. 15/6

### REGETTERED IMPROVED VACUUM TV TUBES

12 months guarantee

14" RECT. £5.10.0

**EXPRESS DESPATCH SERVICE.** Please phone to confirm tube in stock. Send Telegraph Money Order Tube despatched passenger train same day.

### SOUND/VISION AND I.F. STRIP 10/6

Salvaged. Complete sound and vision strip. 8 valveholders. Less valves. I.F.'s 16-19.5 Mc/s. Size 8½" x 4½" x 4½". Drawings free with order. P.P. 2/6

### POWER PACK AND AMPLIFIER 19/6

Output stage 6V6 with o.p. trans 3 ohms. Choke. Smoothed h.t. 350V at 250mA, 6.3V at 5A, 22V at 3A, 6.3V at 4A and 4V centre tapped. Less valves. Ins. carr. 5/6

### B.S.R. FUL-FI CRYSTAL TURNOVER CARTRIDGES 19/6

Brand new. Including sapphire needles for L.P. and standard, giving fullest range and finest tone obtainable for any player. Can be fitted to all standard pick-up arms. P.P. 9d.

### PORTABLE AMPLIFIER MARK D.2 79/6

12 months guarantee. Printed circuit. Latest design. Dimensions 7" x 2½" x 5". A.C. only. Mains isolated 3-4 watts output. Incorporating the latest ECL82 triode pentode output valve giving higher undistorted output. Volume and tone controls, Knobs 2/6 extra. P.P. 3/6

### ★ STEREOPHONIC SOUND ★

Our extension speakers are ideal for this Extension Speakers 19/9 Polished wood cabinet of attractive appearance. Fitted with 8" p.m. speaker, W.B. or Goodmans. of the highest quality. Standard matching to any receiver (2-5 ohms). Switch and flex included. Ins. carr. 3/6. 4" x 7" ELLIPTICAL SPEAKERS 19/6 6½" ROUND SPEAKERS 12/6. Postage 2/9



## HOME RADIO OF MITCHAM

### SPECIAL OFFER OF SOLDERING IRONS

Brand new instrument soldering irons ideal for all radio work. Detachable bit, neon indicator lamp in handle, specially designed shape prevents accidental burns to bench. 220-240 volts only. Limited quantity at ONLY 18/6 each, plus 9d. post.



**HEADPHONES**—Last chance to obtain these brand new high grade high resistance headphones at a third of usual price. Ideal for crystal sets, short wave sets, monitoring tape recorders, test equipment, etc. In maker's boxes, NOT EX-GOVT. ONLY 15/- plus 1/- p.

### PULLIN SERIES 100 MULTI-RANGE TEST SET

Completely restyled with new diakon meter cover giving a wide angle and clear scales. Carrying handle and three-position stand incorporated. Printed circuit gives rugged accurate instrument with 21 ranges and sensitivity of 10,000 ohms per volt. Fully illustrated leaflet on request. **CASH PRICE £12.7.6.** Deposit £2.7.6. (delivery by return) and 12 monthly payments of 18/6.

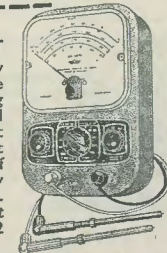

Dept. C 187 LONDON Road Mitcham Surrey Shop Hours 9-6.30 p.m. Weds. 9-1 p.m. MIT 3282



### DIRECT FROM MAKER TO USER!

HI-FI ENTHUSIASTS ALL OVER THE WORLD ARE BUILDING COOPER-SMITH AMPLIFIERS AND GETTING BETTER REPRODUCTION AT LOWER COST.

### WHY NOT YOU?

The "Prodigy" High Fidelity 6-watt combined Control Unit and Amplifier Complete Kit ... .. £13.7.6

The B.P.I. 10-watt High Fidelity Amplifier with separate Control Unit Control Unit Kit ... .. £8. 3.0 complete

Main Amplifier Kit ... .. £12.12.0 complete

Booklets containing full constructional details and price list of components of either of the above, 2/8 post free, or supplied free with each kit.

These amplifiers can also be supplied laboratory built and tested. Call for demonstration.

287/289 EDGWARE ROAD LONDON W2 Telephone PAD 5891/7595

For a really professional finish use ...

## PANEL-SIGNS TRANSFERS

### Set No. 1: Receivers and Amplifiers

Five sheets 8½" x 5½" containing one large scale, twelve control panels and white wording. 3s. 6d. postage 2d.

### Set No. 2: Test Equipment

Five sheets 8½" x 5½" containing two medium scales, twelve control panels and white wording. 3s. 6d. postage 2d.

### Set No. 4: Wording

As set No. 3, but in black. 3s. 6d. postage 2d.

### Set No. 3: Wording

Wording for Receivers, Amplifiers, Transmitters, Test Equipment and other Radio Apparatus, and Station Names. Five sheets, over 750 words and symbols. White. 3s. 6d. postage 2d.

Panel-Signs Transfers Fixing Varnish 1s. per bottle postage 6d.

Published by

## DATA PUBLICATIONS LTD

57 MAIDA VALE · LONDON W9

Telephone CUNningham 6141 (2 lines)

Telegrams Databux London

Send for FREE CATALOGUE TERMS AVAILABLE (DEPT. K.2.) Liverpool Street to Manor Park Station 10 minutes 621/3 ROMFORD ROAD MANOR PARK ROAD LONDON E12 Open all day Sat. Closed 1 p.m. Thur. Telephone ILF 6001/3

## QUICK EFFICIENT UP-TO-DATE COMPONENT SERVICE!

### Pocket Valve Radio

Anyone can build this beautiful precision Pocket Radio in 1 hour. No knowledge whatever needed, our simple, pictorial plans take you step by step! You can't go wrong. Remarkably sensitive—covers all medium waves incl. Luxembourg, Home, Light. Size only 2" x 3" x 5 1/2".

Not a toy! but a real valve radio! Uses self-contained battery and is a really personal-phone, pocket radio with detachable rod aerial. Ideal for bedroom, garden, etc. We can supply all the parts necessary, including case, screws, easy step-by-step plans for the Special Price of 37/6 (plus 2/6 post, etc.). **BUILD YOURS NOW!** (All parts sold separately.) Priced parts list, etc., 1/9. Big demand certain—send today! C.O.D. 2/- extra.

Can be Built for **37/6**



Can be Built for **47/6**

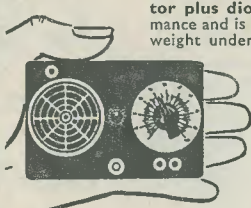

### TWO TRANSISTOR POCKET SET

Build the "Sky Pixie" Vest-pocket two-transistor plus diode radio which gives a superb performance and is highly sensitive. Size only 4 1/2" x 3 1/2" x 7/8" weight under 7oz!—yet it is a three-stage receiver covering all medium waves, working entirely off a tiny "pen-light" battery. Every part tested before despatch! Special step-by-step plans for absolute beginners. Total building cost including case, transistors, etc.—everything down to the last nut and bolt—**ONLY 47/6 with plans.** Postage, etc., 2/-, C.O.D. 2/- extra. (Parts sold separately. Priced parts list and plans 1/6.) **RUSH YOUR ORDER TODAY!**

### PRINTED CIRCUIT POCKET SET

Build this 3-transistor pocket radio... Printed Circuit Version! The "Companion" is comparable in sensitivity to a three-valve battery set; it is exceptionally small in size (4 1/2" x 3" x 1 1/2") and is a self-contained pocket radio that does not need aerial or earth. It has built-in speaker and covers medium and long waves. This unique little set can be built for only 97/6, everything included! (plus post and packing 2/6). All parts sold separately. Price list, etc., 6d.

"Money refunded if parts returned intact within seven days"

**CONCORD ELECTRONICS** (DEPT. RC4)

69 PRESTON STREET  
BRIGHTON 1

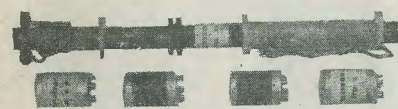

### TELETRON MINIATURE TRANSISTOR 42/-

Superhet coil kit (as illustrated) 470 kc/s I.F. Transformers and Oscillator coil in screening cans 3/8" x 3/8" dia. Dual wave Ferrite rod aerial 5 1/2" x 5/16" dia. Designed for the TRANSIDYNE miniature superhet receiver. Price 9d.

Descriptive folder with circuit and assembly instruction

**TELETRON TYPE FX.25 15/- each**  
Self-tuned, dual wave Ferrite rod aerial.



### TRANSISTOR I.F. TRANSFORMERS

High Q "potted" construction with Ferrite screw cores. Mounted in screening cans 1" x 3/8" dia., 6/6 each. Oscillator coil, 6/6. Transistor type Ferrite rod aerial for MW band, 10/-, Selective crystal diode coil type HAX, 3/- each.

Type HAX.L (for LW band), 3/6. Dual wave TRF coils, type A/HF, matched pair, 7/-, with adjustable iron dust cores.

**FERRITE ROD AERIALS** Wound on high permeability Ferroxcube rod. Medium wave, FRM 4" x 5/16", 8/9. Dual wave FRD, 8" x 5/16", 12/9.



Send 5d. in stamps for complete data and circuits. All types available from advertisers in this Magazine and local component stockists

**THE TELETRON COMPANY LIMITED**  
112b Station Road . Chingford . London E4 Telephone SIL 0836

## SMITH'S OF EDGWARE ROAD

ELECTRONIC COMPONENTS  
DISTRIBUTORS FOR OVER 25 YEARS

Four-sided Blank Chassis  
Made in our own works from commercial quality half-hard aluminium of 16 s.w.g. thickness, these chassis will carry components of considerable weight and normally require no corner strengthening.

We are now able to supply same day any size of chassis in 1/8" steps up to 17". Depths 1/2", 3/4", 1", 1 1/2", 1 3/4", 2", 2 1/4", 2 1/2", 2 3/4", 3", at the following rates:

48 sq. in.* 4/-	176 sq. in. 8/-	304 sq. in. 12/-
80 sq. in. 5/-	208 sq. in. 9/-	336 sq. in. 13/-
112 sq. in. 6/-	240 sq. in. 10/-	368 sq. in. 14/-
144 sq. in. 7/-	272 sq. in. 11/-	and pro rata
Post 1/3	Post 1/6	Post 1/9

(\*Length plus twice depth x width plus twice depth)

Stock Sizes  
6" x 4" x 2" 5/-, 7" x 5" x 2" 5/6, 10" x 4" x 2 1/2" 6/9,  
9" x 7" x 2" 7/-, 12" x 4" x 2 1/2" 7/3, 10" x 8" x 2 1/2" 8/6,  
12" x 5" x 3" 8/6, 12" x 7" x 2 1/2" 8/9, 13" x 8" x 2 1/2" 9/9,  
14" x 7" x 3" 10/6, 14" x 10" x 2 1/2" 11/6, 15" x 10" x 2 1/2" 11/9,  
17" x 10" x 3" 14/-  
1/4" flanges on two sides (inside or outside) 1/6 extra  
Soldered corners (new process) 2/- extra  
Panels any size up to 3ft x 4/6 sq. ft (sq. in x 3/4 d.)  
Bases to fit; price as panels plus 1/6. For larger sizes and "specials" send for quotation, giving full particulars of your requirements. Trade and quantity discounts.

287/289 EDGWARE ROAD LONDON W2  
Telephone PAD 5891/7595

## TV TUBE TROUBLE?

### DON'T HAVE IT REPLACED HAVE IT REBUILT!

For a fraction of the cost of a new tube your old Cathode Ray Tube can be rebuilt completely to manufacturer's specification and returned to you in 72 hours.

**Guaranteed for 7 months**  
FROM THE INVOICE DATE

We can also supply 12", 14", 17" and 21" rebuilt tubes from stock, fitted with completely new Gun Units. For full details and price lists (Trade Terms available) contact:

**VIDIO**  
REPLACEMENT CO  
Hales Street  
Deptford High Street  
London S.E.8  
Telephone TID 4506



## A television course for you to study at home

Entirely new! Practical!  
Bang up to date!

THE FAMOUS BENNETT COLLEGE  
OFFERS YOU THIS

An entirely new course of study based upon up-to-date techniques has now been prepared by The Bennett College.

The course is non-mathematical, and contains numerous clear diagrams, starting from the very beginning (even including the basic principles of sound radio receivers, if desired) and covering all the relevant knowledge that you need to know!

This is what you've been looking for! You can now gain thorough knowledge of this vast subject in your spare time at home. The course includes: production

of the signal, scanning and reproduction of picture from signal. Aerials, types and purpose. The cathode ray tube. Time-base oscillators, and output circuits. Synchronisation. Video frequency amplifiers. The TV tuner, turret, incremental, etc. Television test gear. Television faults.

For more details, fill in the coupon below. Your studies cost you very little, the book you need is included in the cost.

To THE BENNETT COLLEGE  
(DEPARTMENT B162TV) SHEFFIELD  
Please send me details of the new  
Television Servicing Course

NAME.....  
ADDRESS.....  
AGE.....

### Fluorescent Lighting

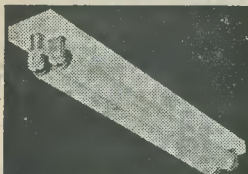

Complete lighting fittings. Built-in ballast and starters—stove enamelled white and ready to work. Ideal kitchen, workshop—anywhere.

**Twin 20** approximately 27" long complete with two 20W tubes, 49/6.

**Single 40** approximately 4ft long complete with one 40W tube, 39/6.

**Inductor 80** approximately 5ft long complete with one 80W tube, 59/6. Carriage and insurance up to 150 miles 5/6, up to 250 miles 7/6.

**21" Miniature** complete with 13W tube. Ideal for showcase or position where miniature fitting is required. Complete with latest 3/8" diameter tube, 49/6 each.

### Band III Converter

Suitable Wales, London, Midlands, North, Scotland, etc. All



the parts including 2 EF80 valves, coils, fine tuner, contrast control, condensers and resistors. (Metal case available as an extra.) Price only 19/6, plus 2/6 post and insurance. Data free with parts or available separately, 1/6. Please send two more kits, the one you sent last week is performing magnificently. We receive this sort of letter every day of the week, so if you have hesitated because you thought our kits too cheap you need hesitate no longer.

### Morganite Potentiometers

Single and 2-gang types available, standard size with good length spindle, all new and boxed. Single types 1/- each.

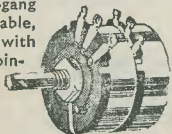

Values available: 5k, 10k, 25k, 50k, 100k, 250k, 1 meg, 2 meg. Gang type, 3/- each, values available: 5k+5k, 100k+100k, 1/2 meg+1/2 meg, 2 meg+2 meg.

All items advertised can be obtained from the following companies: if ordering by post address to nearest company.

Electronics (Eastbourne) Ltd. 66 Grove Road Eastbourne Sussex Telephone Eastbourne 6565 Half-day Wednesday	Electronics (Ruislip) Ltd. 42/46 Windmill Hill Ruislip Middlesex Telephone RUISlip 5780 Half-day Wednesday	Electronics (Croydon) Ltd. 266 London Road Croydon Telephone CROYdon 6558 Half-day Wednesday	Electronics (Finsbury Park) Ltd. 29 Stroud Green Road Finsbury Park N4 Telephone ARChway 1049 Half-day Thursday
--	--	--	---

### TWO OUTSTANDING METERS

**THE TAYLOR METER MODEL 100A**  
All the advantages of a valve voltmeter but none of its disadvantages. It is in fact the only meter in the world with a sensitivity of 100,000 ohms per volt and all these other features:

- D.C. current—2 microamps to 10 amps d.c. in 8 ranges
- D.C. volts—10 microvolts to 25kV in 8 ranges (25kV with external adaptor optional extra)
- A.C. volts—0-2.5kV a.c. in 6 ranges
- Ohms—0-200 MΩ in 4 ranges (self contained)
- 5 ranges of decibels
- 5 ranges of output
- 5" mirror scale movement
- Automatic cut out for meter protection
- Reverse polarity switch

Truly a fine instrument moderately priced at £31.10.0. Non-callers add 10/- carriage and insurance.

**THE TAYLOR METER MODEL 127A**  
A pocket size meter but with a big scale and a sensitivity of 20,000 ohms per volt d.c. Therefore an ideal unit for television servicing—robustly made and complete with leads and prods—20 ranges as follows:

- D.C. current—50 micro-amps to 1 amp
  - D.C. voltage—0-1,000 volts in 7 ranges (25kV with external probe optional extra)
  - A.C. Volts—0-2,500 in 6 ranges
  - Ohms—0-20Ω in 3 ranges (self-controlled)
- Self-contained, 3 1/2" movement. Price £10 or 18/- deposit and 21 fortnightly payments of 10/- non-callers add 5/- carriage and ins.

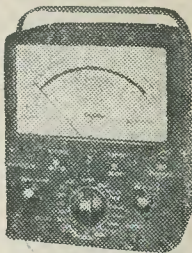

### A.C./D.C. Multimeter Kit

Ranges: D.C. volts 0-5, 0-50, 0-100, 0-500, 0-1,000. A.C. volts 0-5, 0-50, 0-100, 0-500, 0-1,000. D.C. milliamps 0-5, 0-100, 0-500. Ohms 0-50,000 with internal batteries; 0-500,000 with external batteries. Measures a.c./d.c. volts, d.c. current and ohms. All the essential parts including metal case, 2" moving coil meter, selected resistors, wire for shunts, range selector, switches, calibrated scale and full instructions. Price 19/6, plus 2/6 post and insurance.



### Last Chance for this Fine Bargain

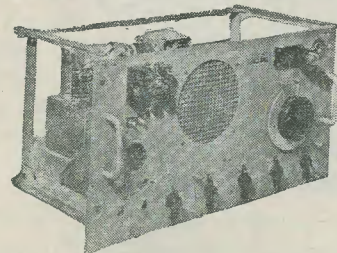

This is the R208 super short wave receiver covering 5-30 metres (10-60 Mc/s). Uses 6 valves. Has r.f. stage, 2 i.f. stages, b.f.o., etc. Muirhead instrument drive, two internal power packs, mains and battery vibrator pack. Complete with own p.m. speaker. Provision for phones and speaker muting. Complete in metal transit case; size approx. 24" x 18" x 12", weight 70lb. Suitable a.c. mains.

100-250 and 6 volt battery. In perfect condition, practically unused. Tested before despatch and guaranteed. Handbook free with each. Price £6.19.6, carriage and insurance 15/-. Or 10/- deposit, plus 15/- carriage, and 15 fortnightly payments of 10/-.



### Speaker Bargain

12" Hi-fidelity loudspeaker. High flux. Permanent magnet type with standard 3 ohms speech coil. Will handle up to 12 watts. Brand new by famous maker. Price 32/6, plus 3/6 post and insurance.

# ◆◆◆◆ REPANCO ◆◆◆◆

## HIGH GAIN COILS and QUALITY COMPONENTS for the constructor

### TRANSISTOR COMPONENTS

- |   |      |
|---|------|
| <b>FERRITE SLAB AERIAL TYPE FS2.</b> A new super-sensitive aerial, Long and Medium Wave, specially designed for transistor portable receivers. Complete with fixing brackets. Length 5 1/2" | 13/6 |
| <b>COMBINED OSCILLATOR AND 1st I.F. TRANSFORMER TYPE OT1</b> (315 kc/s), fully screened, 1 1/8" x 1 1/8" x 1 1/8" ... ..  | 11/6 |
| <b>2nd I.F. TRANSFORMER TYPE TT2</b> (315 kc/s), 1" x 3/8" dia. ... ..  | 5/-  |
| <b>3rd I.F. TRANSFORMER TYPE TT3</b> (315 kc/s), 1" x 5/8" dia. ... ..  | 5/-  |
| <b>PUSH-PULL INTER-STAGE TRANSFORMER TYPE TT4.</b> Ratio 1:1 ct. Stack 1 1/8" x 1 1/8" x 7/16"  | 8/6  |
| <b>PUSH-PULL OUTPUT TRANSFORMER TYPE TT5.</b> Ratio 15:1 ct. Stack 1 1/8" x 1 1/8" x 7/16"  | 8/-  |

### MINIATURE RANGE—For pocket receivers

- |  |      |
|--|------|
| <b>FERRITE SLAB AERIAL TYPE FS3.</b> Medium Wave only. With fixing grommets. Size 3" x 3/4" x 3/8"                 | 7/6  |
| <b>OSCILLATOR COIL TYPE XO8.</b> Medium Wave only. Overall size 1/2" dia. x 1". Enclosed in Ferrite pots ... ..    | 5/-  |
| <b>I.F. TRANSFORMER TYPE XT6.</b> Suitable for 1st and 2nd I.F. 455 kc/s. Size 1/2" sq. x 1 1/8"                   | 10/- |
| <b>I.F. TRANSFORMER TYPE XT7.</b> Designed for 3rd I.F.T. or detector I.F.T. 455 kc/s. Size as XT6 ... ..          | 10/- |
| <b>PUSH-PULL INTERSTAGE TRANSFORMER TYPE TT9.</b> Ratio 1:1 c.t. Radiometal Core. Size 3/8" x 3/8" x 1 1/8" ... .. | 12/6 |
| <b>PUSH-PULL OUTPUT TRANSFORMER TYPE TT10.</b> Ratio 8-1 ct. Matched to 3 ohm speaker. Size as TT9 ... ..          | 12/6 |

Practical and Theoretical circuits enclosed with each Repanco Transistor Component

### COILS AND TRANSFORMERS FOR ALL-TRANSISTOR CAR RADIO

- |   |   |
|---|---|
| Medium Wave Aerial Coil Type XMA16 ... 10/- | } Interstage Transformer Type TT1 ... 10/-              |
| Medium Wave H.F. Coil Type XMF17 ... 10/-   |   |
| Long Wave Aerial Coil Type XLA18 ... 6/9    | } Output Transformer (12 volt Radio) Type TT12 ... 12/6 |
| Long Wave H.F. Coil Type XLF19 ... 6/9      |   |
| Oscillator Coil Type XO15 ... 5/-           | } Output Transformer (6 volt Radio) Type TT13 ... 12/6  |

All this range boxed with circuit and practical diagram of all-Transistor Car Radio

### REPANCO EASY-TO-BUILD RECEIVERS

- Constructors' Envelopes of easy wiring plans, instructions and detailed price lists of components
- |   |                         |
|---|-------------------------|
| <b>THE HIWAYMAN</b> ... ..  | Envelope 1/6 (post 3d.) |
| <b>REPANCO ONE-VALVE</b> ... ..   | Envelope 9d. (post 3d.) |
| Beginner's Dual-range Radio Set for use with headphones   |                         |
| <b>REPANCO FM TUNER UNIT</b> ... ..   | Envelope 1/6 (post 3d.) |
| Using 4 EF91, 1 EB91, 1 EM80 Valves, Ratio Detector   |                         |
| <b>REPANCO "THREE DEE"</b> ... ..   | Envelope 9d. (post 3d.) |
| Dual-range Transistor Radio using 3 Transistors and Crystal Diode. Amazing loudspeaker reception from 7 1/2 volt battery supply   |                         |
| <b>REPANCO "MAJOR-7"</b> ... ..   | Envelope 1/6 (post 3d.) |
| Seven-transistor Portable tunable over Long and Medium Wave   |                         |
| <b>REPANCO "MINI-7"</b> ... ..  | Envelope 1/6 (post 3d.) |
| The amazing new transistor pocket portable radio with all the technical features of a standard receiver. Seven transistors, superhet circuit, fully tunable over medium wave. Size 5 1/8" x 3 3/8" x 1 1/8" |                         |

**JUST RELEASED!** A new comprehensive component catalogue for the radio enthusiast. With 56 pages and over 200 illustrations this offer should not be missed. Send 2/- postal order now. (Post free.)

## RADIO EXPERIMENTAL PRODUCTS LIMITED

33 MUCH PARK STREET COVENTRY

Telephone 62572

# CLYNE RADIO LTD.



All "R.E.P." & "T.S.I." Components  
Available ex-stock. Enquiries welcomed

ALL POST ORDERS AND CORRESPONDENCE TO  
162 HOLLOWAY ROAD - LONDON N7  
NOR 6295/6/7

18 TOTTENHAM COURT RD. LONDON W1  
MUS 5929/0095  
Callers welcome at both branches

## MULLARD TYPE "C" TAPE PRE-AMPLIFIER

(as described in last issue)

All necessary components, including valves, for this truly "Hi-Fi" pre-amplifier can be supplied at a special inclusive price of ONLY £12.9.6 plus 3/6 P. & P.  
All components available separately if required. Send stamp for price list.

## POWER PACK. All necessary components for power pack for above amplifier, 50/- inclusive, plus 1/6 P. & P.

### MULLARD 510 ULTRA-LINEAR PRINTED CIRCUIT HI-FI AMPLIFIER

This very famous amplifier is ideal and recommended for use in conjunction with the Type "C" Pre-Amp., enabling unequalled Hi-Fidelity recording and playback from any tape deck! All required components available at only £9.9.0 (including Ultra-Linear output stage) plus 3/6 P. & P., or assembled and tested £12.12.0.

## A SUPERB NEW TRANSISTOR PRINTED CIRCUIT POCKET PORTABLE (BY PERDIO)

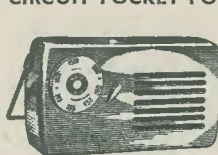

An attractive receiver employing 6 selected transistors and covering Medium and Long wavebands. Housed in smart cream plastic case, size 5 1/2 in x 3 1/2 in x 1 1/2 in, with gilt table stand and control knobs. All necessary components for construction of this beautiful

receiver are available at a special inclusive price of £9.19.6 plus 2/6 P. & P., including comprehensive, easy-to-follow instructions (available separately price 2/6 post free).

## CONSTRUCTORS BARGAINS!

**6V Vibrator Pack.** Ex-W.D. Output 140V 30mA. Fully smoothed. Size only 6 1/2" x 5" x 2 1/2". New condition. 12/6 plus 1/6 P. & P.  
**Instrument Bit Soldering Iron,** brand new, 16/6 plus 1/6 P. & P.  
**12V Vibrator Pack.** Mallory, brand new. Output 150V 40mA. Complete with synchronous vibrator. 12/6 plus 1/6 P. & P.

**Headset Special!** Excellent quality super lightweight low impedance magnetic headphones complete with button microphone attached and plastic ear moulds by world famous manufacturer. Absolutely brand new. 45/- pair, plus 1/6 P. & P.  
**CLR Low Impedance Headphones.** 5/6 pair, plus 1/- P. & P.

**DLR 5. Moving Coil low impedance Headphones.** 7/6 pair, plus 1/- P. & P.  
**12" Bakers Selhurst Loudspeakers.** 15 ohm, 15 watt, 30/14,000 c/s. Few only. Brand new. £4.10.0 plus 3/6 P. & P.  
**3-section Whip Aerials.** Ideal for fishing rods, etc. Each section 4ft. Only 7/6 set, plus 2/6 P. & P.

## RADIOSETTE

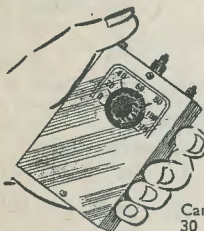

The ideal low cost transistor pocket radio for the beginner. The circuit utilises the new R.C.S. VARILoop-STICK transistor coil. A specially designed miniature .0004 tuning condenser permits the set to be in a case which fits the palm of your hand.

Can be built in 30 min es **30/-**

All components are sold separately, full construction data including plan of parts, 2/-

## ALL-WAVE RADIO

Ideal for the beginner or for those requiring a simple stand-by receiver

**35/-**

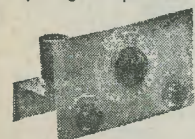

This 1 valve S.W. receiver can be built for 35/- from our list of components, which can be purchased separately. It includes valve and 1 coil covering 20-40 metres. Provision is made to increase to 2 or 3 valves if required, and all components are colour-coded so that the beginner can build this set quite easily. Send 2/- for specification, wiring diagram, layout and price list.

Postage: Under 10/-, 9d. Under 40/-, 1/6  
Over 40/-, post free

## R.C.S. PRODUCTS (RADIO) LTD

11 Oliver Road London E17 Mail Order only

# The Teletron TRANSIDYNE

Portable 6-Transistor Superhet Receiver with printed circuit

Circuit diagram with instructions available from most advertisers in this magazine, 1/- post free

## SAM MOZER LTD

288 Hedge Lane London N13

Telephone PALmers Green 1748

Sole Distributors to the Trade



Radio Component Specialists since 1946. Staffed by Engineers and Radio Amateur Constructors who enthusiastically try to give you a square deal and

**FULL VALUE FOR MONEY—**  
Try Us!  
SPEEDY MAIL ORDER SERVICE

## BAND III TV CONVERTER

180 Mc/s-205 Mc/s

Suitable London, Birmingham, Northern, Scottish, Welsh and I.O.W. ITA transmissions.

**Mk. 2 Model.** Latest cascode circuit using ECC84 and EF80 valves giving improved sensitivity (12 dB) over standard circuits, built-in power supply ac. 200-250V. Dimensions only 6 1/2" x 3", ht. 4". Simple and easy to fit—only external plug-in connections. Wired aligned and tested ready for use. State channel required. Guaranteed. Bargain offer—good results or full refund. **ONLY £3.19.6** Carr. and pkg. 2/6  
Band I/Band III changeover switch and B.B.C. aerial socket can now be fitted and wired to the above converter for 8/- extra.

**CONDENSERS.** Mica or s. mica. All pref. values. 2pF to 680pF, 6d. each. Ceramic types, 2.2pF to 5,000pF, 9d. each. Tubulars, 450V, Hunts and T.C.C., 0.001, 0.005, 0.01 and 0.1, 350V, 9d.; 0.02, 0.05, 0.1, 500V Hunts, T.C.C., 1/-; 0.25 Hunts, 1/6; 0.5 Hunts, 1/9; 0.001 6kV T.C.C., 5/6; 0.001 20kV T.C.C., 9/6, etc.  
**RESISTORS.** Pref. values 10 ohms 10 megohms, 20% tol., 1/6V, 3d.; 1/2W, 5d.; 1W, 6d.; 2W, 9d.; 10% h-stab., 1/2W, 5d.; 1/2W, 7d.; 5% tol., 1/2W, 9d.; 1% h-stab., 1/2W, 1/6  
**PRE-SET W/W POTS.** TV knurled slotted knob type. 25 ohms to 30,000 ohms, 3/-; 50,000 ohms, 4/-; 50,000 ohms to 2 Megohms (carbon), 3/-

## VOLUME CONTROLS

Log. or lin. ratios, 10,000 ohms-2 Megohms. Long spindles. 1 year guarantee. Midget Ediswan type, 1 1/2" dia. No sw. 3/-, d.p. sw. 4/9

**S.T.C. RECTIFIERS.** E.H.T. types, K3/25 2kV, 5/-; K3/40 3.2kV, 6/9; K3/45 3.6kV, 7/3; K3/50 4kV, 7/9; K3/100 8kV, 13/6, etc. Mains types: RM1 125V 60mA, 4/9; RM2 125V 100mA, 5/6; RM3 125V 120mA, 7/6; RM4 250V 250mA, 16/-; RM4B type 250V 275mA, 17/6, etc.  
**LOUDSPEAKERS.** P.M. 3 ohm, 2 1/2" Plessey, 17/6; 3 1/2" Goodmans, 18/6; 5" R. & A., 17/6; 6" Celes., 18/6; 7" x 4" Goodmans, 18/6; 8" Rola, 20/-; 10" R. & A., 25/-, etc.  
**SPEAKER FRET.** Expanded bronze anodised metal: 8" x 8", 2/3; 12" x 8", 3/-; 12" x 12", 4/6; 12" x 16", 6/-; 24" x 12", 9/-, etc. **TYGAN FRET** (Murphy pattern): 12" x 12", 2/-; 12" x 18", 3/-; 12" x 24", 4/-, etc.

## ANOTHER T.R.S.

### RECORD PLAYER WINNER

- LATEST 4-SPEED BSR Player unit (Model TU9)** and "Full-Fi" pick-up, £4.12.6, carriage 3/6
- 2-VALVE AMPLIFIER** wired complete with speaker, etc., on mounting board, £3.5.0, carr. 2/6
- CONTEMPORARY STYLED LIGHT-WEIGHT CASE** in maroon and grey, size 14 1/2" x 11 1/2" x 6", £1.7.6, carriage 2/6

SPECIAL OFFER

**ALL 3 UNITS ONLY £9, Carriage 4/6**

We can only show a small selection from our vast stocks in this advert. Write now for full Bargain Lists, 3d.



## RADIO COMPONENT SPECIALISTS

70 Brigstock Road Thornton Heath Surrey

Telephone THO 2188

Terms: C.W.O. or C.O.D. Post and packing up to 1/6 7d., 1lb 1/1, 3lb 1/6, 5lb 2/-, 10lb 2/9

## RECORD PLAYER BARGAINS

New Reduced Prices

**SINGLE PLAYERS.** 4-speed BSR (TU9), 92/6; 4-speed **COLLARO JUNIOR**, £4.10.0; 4-speed **GARRARD (4S.P.)**, £7.15.0, carr. and ins. 3/6  
**AUTOCHANGERS.** 4-speed BSR (UA8), £6.19.6; 4-speed **COLLARO**, £7.19.6; 4-speed **GARRARD (RC121/4D/MkII)**: plug-in head, stereo adapted, 10 gns., carr. and ins. 4/6. All above units are latest 4-speed models, fitted lightweight crystal pick-up and twin sapphire styli. Complete and ready to use.

## FINEST SELECTION AVAILABLE ALL BRAND NEW AND GUARANTEED 80 OHM COAX CABLE

NOW ONLY 8d. YARD!

Highest Quality Cable, low-loss Polythene Aeraxial, semi-air spaced, feeder losses cut 50%. Standard 1/2" dia. Stranded core. Famous make.

20 yds 12/6, carr. 1/6 40 yds 20/-, carr. 2/-  
Coax Plugs 1/-, Coax Sockets 1/-, Couplers 1/3,  
Outlet Boxes 4/6, B1-B3 Xover Unit 7/6

## C.R.T. HEATER-ISOLATION TRANS.

New improved types—mains prim. 200/250V tapped. All isolation transformers now supplied with alternative no boost, plus 25%, and plus 50% boost taps at no extra cost, all in one transformer. 2V 2A type, 12/6; 6.3V 0.6A type, 12/6; 10.5V 0.3A type, 12/6; 13V 0.3A type, 12/6. P. and p. 1/6. Other voltages in course of production. Small size and tag terminated for easy fitting. P. and p. 1/6

## EMITAPE RECORDING TAPE

ALL NEW AND BOXED

	Type 88 (Stand.)	Type 99 (Long Play)
3"	175ft ... 7/-	250ft ... 9/-
5"	600ft ... 19/-	850ft ... 24/-
5 1/2"	850ft ... 24/6	1,200ft ... 31/6
7"	1,200ft ... 30/-	1,800ft ... 45/-

Spare Reels (unboxed). 7" metal 1/6, 7" plastic (EM) 3/6

## RE-GUNNED TV TUBES—GENUINE OFFER

New heater, cathode and gun assembly can now be fitted to your old tube, revacuumed and reconditioned virtually as new. Fully guaranteed to highest standards—as used by our own Service Department. 12" £8; 14" £8.10.0; 17" £10. We regret only Mullard and Mazda types at present. Delivery approximately 7 days. Carriage and insurance 12/6

## MIDGET TRANSISTOR TYPE ELECTROLYTICS.

T.C.C. 2µF, 4µF, 8µF 6V, 3/6; 6µF, 10µF, 16µF 3V, 3/6; 32µF 1 1/2V, 3/6, etc.

## VALVES—NEW BOXED—ALL GUARANTEED

1R5, 1T4, 7/6; 1S5, 1S4, 7/6; 3S4, 3V4, 8/-; 5Z4, 9/6; 6AT6, 8/6; 6K7, 6/6; 6K8, 8/6; 6Q7, 8/6; 6SN7, 8/6; 6V6, 7/6; 6X4, 7/6; 6X5, 7/6; 7C5, 9/-; 7Y4, 8/6; DAF96, 9/-; DF96, 9/-; DK96, 9/-; DL96, 9/-; 35L6, 10/6; EABC80, 9/6; EB91, 6/6; EBC41, 10/6; EBC33, 8/6; ECC84, 12/6; ECH42, 10/6; ECH81, 10/6; ECL80, 12/6; EF41, 10/6; EF80, 10/6; EF86, 14/6; EF91, 8/6; EY51, 12/6; EZ40, 8/6; EZ80, 8/6; MU14, 9/6; PCC84, 10/6; PCF80, 10/6; PCF82, 10/6; PCL83, 12/6; PL81, 14/6; PL82, 10/-; PL83, 11/6; PY80, 9/6; PY81, 9/6; PY82, 8/6; U25, 15/6; UY41, 8/6

**SPECIAL—1R5, 1T4, 1S5, 1S4 or 3S4 or 3V4 per set 27/6**

Hours 9 a.m.—6 p.m., 1 p.m. Wed.

## Compare this! "5-VALVE PORTABLE RADIO"

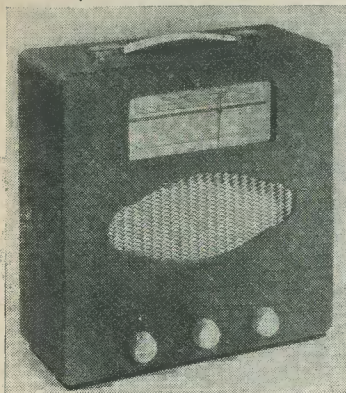

AC/DC portable radio—  
a well-known manufacturer's product, fully guaranteed and tested.

ONLY £7.12.6 pos 5/-

Portable polished wood cabinet ... .. 27/6 extra  
Super rexine portable cabinet ... .. 37/6 extra  
(As illustrated)

- ★ Built-in frame aerial
- ★ All Marconi valves
- ★ 7" x 4" elliptical speaker
- ★ Slow motion tuning
- ★ Two models available
- ★ Med., long, short and gram.
- ★ Med., short, short and gram.
- ★ Gramophone pick-up sockets
- ★ A complete and working unit
- ★ Ideal radiogram

Chassis size  
10" x  
10" x 4"

### RECORD PLAYERS

**Collaro Conquest.** The latest 4-speed autochanger with lightweight turnover crystal pick-up. Brand new and guaranteed  
£7.19.6 P.P. 4/6

**Collaro** 4-speed single player with latest turnover crystal pick-up. Brand new and guaranteed.  
£6.19.6 P.P. 3/6

**B.S.R. Monarch.** The latest version of this well-known 4-speed autochanger with turnover crystal pick-up  
£6.19.6 P.P. 4/-

**VIBRATOR PACKS.** Input 6V d.c. Output approx. 100V d.c. at 30mA, fully smoothed and r.f. filtered. Size 6½" x 5" x 2". Fitted with Mallory 629C vibrator. BRAND NEW. Boxed. 12/6

**PACKARD-BELL PRE-AMP.** Complete in screened case with 6SL7GT; 28D7 relay; leads, jack plug, etc. Handbook. Sealed in carton  
ONLY 12/6 P.P. 2/-

### RF UNITS

**TYPE 25** Switched. Tuning 30 to 40 Mc/s. includes 3 SP61s Carriage 2/6 10/-

**TYPE 26.** Variable tuning, 50 to 65 Mc/s. including 2 EF54s and EC52. Carr. 2/6 25/-  
(Circuits in stock for both types 9d.)

### SIX-TRANSISTOR POCKET-SUPERHET

- ★ Medium and Long wave
- ★ 6 selected transistors
- ★ Printed circuit
- ★ Internal ferrite aerial
- ★ 30 ohms speaker
- ★ Instruction booklet
- ★ Low consumption
- ★ Attractive plastic cabinet (red, blue and white colours)
- ★ 9V P.P.4 battery
- ★ Easy to build

All items supplied special inclusive price of

£9.19.6

P.P. 2/6

All components sold separately

Send for lists



SEND 3d. STAMP FOR NEW TRANSISTOR COMPONENTS LIST; QUARTZ CRYSTAL LIST; VALVE LIST; TRANSISTOR RECEIVER CIRCUITS, ETC.

**HENRY'S RADIO LTD** • 5 HARROW ROAD • LONDON W2

Opposite Edgware Road Tube Station

(DEPT. RCF)

Telephone PADDington 1008/9

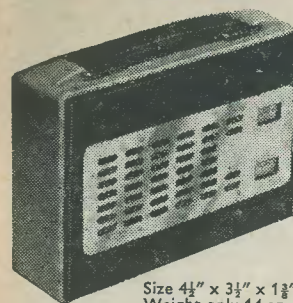

Size 4½" x 3½" x 1½"  
Weight only 14 oz.

## Special Offer! POCKET TRANSISTOR RADIO

- ★ 6-transistor Superhet
- ★ Medium and long wavebands
- ★ Push-pull output
- ★ Built-in ferrite aerial
- ★ Attractive moulded cabinet with gold trimmings
- ★ Printed circuit
- ★ Fully guaranteed

The product of a well-known British manufacturer: a receiver of the latest design using Mullard and Ediswan transistors.

List price 17 gns. OFFERED AT ONLY £10.10.0 incl. batteries  
NOT A DO-IT-YOURSELF—BUT A FULLY WORKING POCKET RADIO

This Portable 8-Transistor Superhet is tunable for both Medium and Long Waves and is comparable in performance to any equivalent commercial Transistor Set. Call and Hear Demonstration Model.

- ★ 8 EDISWAN Transistors
- ★ 250 Milliwatts output push-pull
- ★ All components identified
- ★ Medium and Long waves
- ★ Internal ferrite rod aerial
- ★ 7" x 4" elliptical speaker
- ★ Drilled chassis 8½" x 2½"
- ★ Point-to-point wiring and practical layout
- ★ Economical. Powered by 7½V battery
- ★ Highly sensitive
- ★ Attractive lightweight contemporary case. In various colours

Car Radio Conversion Components, 8/- extra  
A.V.C., 5/3 extra. 325mW version, 40/- extra

COMBINED  
PORTABLE/CAR  
RADIO  
Two sets for the price of one

We can supply all these items including cabinet for £11.10.0, P.P. 2/6. All parts sold separately.  
Circuit diagrams and shopping list free.

### "THE TRANSISTOR-8" Push-Pull Portable Superhet

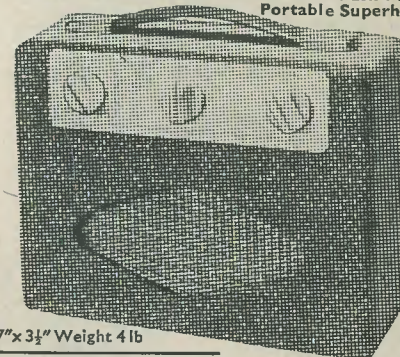

Size 9"x7"x3½" Weight 4 lb

### NEW!

## SOLAR-THREE

- ★ No BATTERIES!
- ★ No running costs! Uses light cells
- ★ Three transistors
- ★ Built-in Ferrite aerial
- ★ No aerial or earth

Send for free components list

A pocket transistor receiver working from daylight!  
(See this issue)

### NEW TYPE TRANSISTORS — PRICE REDUCTIONS JUNCTION TYPE P.N.P.

EDISWAN XA104 6 Mc/s osc./mixer, r.f. amplifier 18/-  
EDISWAN XA103 4 Mc/s i.f. and r.f. amplifier ... 15/-  
EDISWAN XB104 1 Mc/s audio output and driver 10/-  
(A pair in push-pull will give up to 250mW audio output)  
Continental OC44 12 Mc/s osc./mixer, r.f. amp. ... 30/-  
Continental OC45 6 Mc/s i.f. and r.f. amp. ... 25/-  
Continental OC72 325mW in push-pull ... 20/-  
Red Spot 800 kc/s audio amplifier ... 7/6  
White Spot 2 to 5 Mc/s r.f. and i.f. amp. ... 12/6  
Green/Yellow 600 kc/s audio amplifier ... 7/6  
Red/Yellow 1.5 to 8 Mc/s r.f. and i.f. amp. ... 15/-

NEWMARKET POWER TRANSISTORS IN STOCK

Large range of sub-miniature transistor components in stock.  
Send for new free list

### MAJOR-2 (Two-transistor pocket receiver)

- ★ 4-stage reflex circuit
- ★ Variable tuning over medium waves
- ★ Highly sensitive
- ★ No aerial or earth
- ★ Economical
- ★ Drilled and mounted chassis
- ★ Size 4½" x 3" x 1½"
- ★ Internal ferrite aerial
- ★ Weight less than 4 oz
- ★ Complete layout diagram

All items can be supplied, including EDISWAN transistors, battery, case and personal phone, etc., for 72/6, post free. All components sold separately. Circuit and shopping list FREE. Call and Hear Demonstration Model.

### MINOR-1

- ★ Variable tuning on medium waves
- ★ 3-stage reflex circuit
- ★ Highly sensitive
- ★ Internal ferrite aerial
- ★ Drilled chassis
- ★ Long-life battery
- ★ Complete constructional details
- ★ Size 3" x 2" x ¾"

Total cost, including transistor, personal miniature phone, case, battery and complete circuit and layout diagrams, 52/6 post free. All components sold separately. Circuit and shopping list FREE.

**HENRY'S RADIO LTD** • 5 HARROW ROAD • LONDON W2

At junction of Edgware Road and Harrow Road

(DEPT. RCF)

Telephone PADDington 1008/9

### The TRANSIDYNE RECEIVER

(Page 119 Sept.)  
Complete Kit £11.19.6  
or less transistors £8.15.6  
FREE—Special printed circuit  
solder with each kit  
Only genuine Teletron parts  
Full details and price list 1/- post  
free

Heavy duty 500pF reaction condensers 3/-. Small solid dielectric variables, 0.0001µF 3/-; 0.0003µF 3/9; 0.0005µF 4/-. Resistors from 3d. each. Assd. carbon (many 5%) 25 for 3/11, 50 for 7/6. Hi-Stabs 10% 1/2 watt 6d.; 10% 1 watt 9d.; 1% 1/2 watt 2/-. Many odd values available at lower prices. Send requirements for quotation. Ajax Crystal Set complete, 14/6; L.W. 15/-. Case and chassis 5/9. Teletron HAX coil 3/-. REP Dual Wave Xtal Coil 2/6. Headphones, lightweight, 14/- and 16/-. Nuts, bolts, washers, tags. Well assorted: 25 1/-, 72 2/9, 144 5/-. Miniature Neons 1/10.

### TRANSMITTING KEYS

Heavy duty with 27 in twin rubber cable, fitted robust jack plug. Ideal also for Morse practice. The plug alone is worth the price! Limited number at 1/6 each

### Sensitive Transistor Receiver

(Page 298 Nov.)  
All parts now available for this excellent receiver.  
Complete Kit (less speaker) £5.3.0  
or less speaker and transistors £3.10.0  
(S.A.E. for price list)  
7" x 4" Speakers 22/6  
(Others available)

TRANSISTOR ITEMS. Electrolytics 8µF 6V, 16µF 12.5V, 32µF 3V, 5µF 12.5V, 5µF 40V, 2.5µF 40V, 1.6µF 6V, 2.5µF 6V. All 3/- each; 100µF 6V 3/-; Paper 0.01, 0.001, 0.002, 0.005µF, all 8d. each. Transistor Holders 1/- each, 6 for 5/9, 11/- doz. Ardente T.1065 transformers (page 911—July), 12/-. Subminiature Speakers 12" round, 27/-; 2" x 3" elliptical, 33/-. Sub-miniature Output Transformers, single-ended or p/p, 12/6. Volume Controls, button type (totally enclosed), 47k and 1MΩ, 2/6; preset skeleton type 5k, 2/6; spindle type, 1/2M, 1M, 2M, 4/3 (page 705—'R.C.' May). Ardente Deaf Aid Earpieces E.R.100, with cord and plug. Limited number at 13/9. Ardente Catalogue 6d. Transistors: Yellow/Red 15/-; White Spot 14/-; Yellow/Green 9/6; Red Spot 9/-

Multicore Solder 4d. yd, 19 ft reel 2/6, 11b reel 14/9. Fine gauge for printed circuits, 40 ft reel 2/6. Switches, s/p from 2/3, d/p from 3/6. Ferrite Rods 8" x 1/2" diam., 2/-. Mains neon indicators with built-in resistor. Domed top, chrome bezel, 1" long 1/2" diam. Opal, red, amber, 3/10; green 4/7.

We recommend the 'LITESOLD' soldering iron for all work and especially printed circuits. Mains or battery, 21/6 complete (state mains voltage)

CONNECTING WIRE p.v.c. 50ft coil, 5 colours, 1/9. Sleeving, 15 ft, assd. colours and thicknesses, 8d. Tinned Copper Wire 24 s.w.g., 15ft 8d. Combined pack (3 above items) 2/9

### EASY PRESELECTOR

(Page 460)  
Complete Kit £3.10.6  
(including one coil)  
Ranges available: 750/2200 m., 180/500 m., 60/220 m., 15/50 m., 10/30 m.  
Please state range required  
(Extra coils 3/- each)

QUOTATIONS gladly given (S.A.E. please)

## R. FAGELSTON (MAIL ORDER)

Please add Postage to above prices

46 HARDWICKE ROAD · LONDON N13

### ★ VALVES

### NEW TESTED AND GUARANTEED

1R5	7/6	6X4	7/6	DK91	7/6	EP92	5/6
1S5	7/6	6X5G	6/6	DK92	9/-	EL41	10/-
1T4	6/-	12AH8	9/6	DK96	9/-	EL84	9/6
3S4	7/6	12AT7	7/6	DL92	7/6	EL91	7/6
3V4	8/-	12AU7	7/6	DL94	8/-	EY51	10/6
5U4G	6/-	12AX7	9/6	DL96	9/-	EZ35	8/-
5Z4G	9/-	12K8GT	13/6	EB91	5/6	EZ40	8/-
6AM6	6/9	12K7GT	8/6	EB41	8/-	EZ80	8/-
6AL5	5/6	12Q7GT	7/6	EBF80	9/6	EZ81	8/6
6AT6	7/6	25A6G	10/6	ECC81	7/6	KT33C	9/6
6BA6	8/6	25L6GT	7/6	ECC82	7/6	PCF82	11/-
6BE6	7/6	35Z4GT	8/6	ECC83	7/6	PL82	10/6
6BR7	10/6	35L6GT	9/6	ECC84	8/6	PY81	8/-
6BW6	8/6	53KU	11/6	EFC82	11/-	PCC84	9/-
6J5G	5/6	807	6/9	ECH81	10/6	PCF80	9/6
6J7GT	8/6	5763	10/6	ECH42	10/-	U76	8/6
6K7G	2/6	DAF91	7/6	ECL80	12/6	UCB41	10/-
6K8G	7/6	DAF96	9/-	EF36	7/6	UCH42	9/-
6Q7GT	8/6	DF91	7/6	EF39	5/6	UF41	10/-
6SL7GT	8/6	DG96	9/-	EF41	9/-	UL41	9/6
6SN7GT	8/6	DH76	8/6	EF80	8/-	UY41	8/-
6V6G	7/6	DH77	7/6	EF91	6/9	W76	8/6

Matched Pairs. EL84, 23/-; 6V6G, 17/-; 6BW6, 18/-; KT33C, 19/6; KT66, 27/6; 807 14/6 pair

1R5, 1S5, 1T4, 3S4, 3V4, DAF91, DP91, DK91, DK92, DL92, DL94, any four, 27/6 per set

P.P. Op. Transformers. MR 3-15 ohms for EL84, 6V6, 6BW6, etc., 18/6; Op. Pen. 50mA, 5/6; 30mA, 4/6

Volume Controls. All values, long spindle. L/S 3/-, s.p. 4/-, d.p. 4/9, ext. spkr. control 3/-

W.W. Pots. Pre-set 3/-; 3W long spindle 5/6, s.p. 6/6

P.M. Speakers. 3 ohm. 5" 16/6, 6" 17/6, 8" 21/-, 10" 25/-, 12" 30/-, Bakers 12" 15 ohm 15W, 9/0

Coaxial Cable. 75 ohm 1/2" stranded, 8d. yd; semi-air spaced, 9d. yd; screen cable single and twin, 9d. yd

Coaxial Plugs 1/- each; Sockets 1/- each  
P. and P. 9d. to £1; 1/6 to £2; over £2 post free. C.O.D. 2/6

### R. COOPER G8BX

32 SOUTH END CROYDON SURREY CROYDON 9186

C.R.T. Isolation Transformers with nil, 25% and 50% boost, low capacity a.c. mains 200/250V for 2V 4V. 6.3V and 13V tubes. All 10/6 each

Valveholders. 4, 5, 7 pin English and U.S.A. B7G, B9A, 1.0 Mc. B8G, 9d. each; B7G, B9A with screening can, 1/6; B12A, 1/3 Aladdin formers 1/4" with core, 8d. each

Scotch Boy Recording Tape, 1,200ft reels, 27/- Jack Plugs, miniature standard, 3/-; Sockets 3/- 2-Gang Condensers, 0.0005 small size, 7/6

I.F. Transformers, 465 kc/s, small size, 7/6 pair Capacitors, small mica, 5% 1pF to 100pF, 8d.; 120pF to 1,000pF, 9d.; 1,000V wkg. .01, .0015, .0025, .004, .005, 1/- each

Crystal Diodes, G.E.C., 1/6 each Headphones, lightweight, 4,000 ohm, 16/6 pair Ceramic Capacitors, close tol. 500V for V.H.F., 9d.

Paper Capacitors, tubular, .01, 1,000V, 1/-; 0.1 to 0.5 500V, 10d.

Paper Blocks, 4µF, 1,000 wkg., 3/6 Rectifiers, contact cooled, 250V 50mA, 7/6; 85mA, 9/6

Reaction Condensers, .0001, .0003, .0005, 4/6 each Heater Trans. 200/240V, 6.3V, 1.5A, 7/6

Resistors, 1/2 and 1/4W, insulated, 4d. and 6d.; 1W, 8d. 6W W.W., 1/-; 10W, 2/-

Electrolytics. Wire ends. 25/25V, 1/6; 50/50V, 2/-; 12/50V, 9d.; 8/450V, 2/-; 16/450V, 2/9; 16/500V, 3/6; 32/450V, 4/-; 8+8/450V, 4/6; 8+16/450V, 4/6; can types: 16/450V, 3/6; 16+16/500V, 6/-; 32/500V, 6/6; 32/450V, 6/6; 20+20/450V, 4/6; 64+120/275V, 7/6

Wavechange Switches, midget: 1p 12W, 2p 6W, 3p 4W, 4p 3W, 4p 2W, long spindles, 4/6

Toggle Switches. QMB, s.p.s.t., 2/-; s.p.d.t., 3/3; d.p.s.t., 3/6; d.p.d.t., 4/-

Chokes, 80mA, 15H, 8/6; 100mA 10H, 10/6; 150mA 10H, 14/6

Solder, Multicore, 4d. yd; Sleeving 2mm, 3d. yd

### SMALL ADVERTISEMENTS

Readers' small advertisements will be accepted at 3d. per word, including address, minimum charge 2/-. Trade advertisements will be accepted at 9d. per word, minimum charge 6/-. If a Box Number is required, an additional charge of 2/- will be made. Terms: Cash with order. All copy must be in hand by the 12th of the month for insertion in the following month's issue. The Publishers cannot be held liable in any way for printing errors or omissions, nor can they accept responsibility for the bona fides of advertisers.

### PRIVATE

FOR SALE. De-Luxe R1155A with power pack, speaker, switched output stage, gram input, phone terminals, tuning meter and eye, b.f.o., extension speaker switching and tone control. Offers. Deliver South London or Surrey.—Ewell 7115, evenings.

AMATEUR CLEARING DEN. Meters, valves, transformers, etc., all bargains. Stamp for list.—24 Cornwallis Avenue, S.E.9 (FOO 3994).

FOR SALE. Grayshaw Signal Generator type SG50, 100 kc/s—80 Mc/s, and TV Pattern Generator, 37.5 Mc/s—85 Mc/s, £7 the two.—J. Wakefield, 26 Lancaster Road, Basingstoke, Hants.

GENUINE OFFERS. G.E.C. metal cone loudspeaker, £5. Beautiful walnut octagonal cabinet, 10 gns. Brand new Axiette speaker, £6. Garrard RC110 autochanger, £4. Mullard FM Tuner with power pack by Homelab, £10.—9 Brenda Crescent, Thornton, Liverpool 23.

FOR SALE. TBY-8 American Navy portable transmitter/receiver 28/30 Mc/s. Perfect, spare valves, phones, mike, vibrator 4V, Manual of American surplus. Gift, £5.—Otter, 144 Victoria Road, Kirkby-in-Ashfield, Notts.

ASPEN 582 TAPE DECK. Built, with tape, hardly used, only £6 15s., o.n.o.—Folds, "Maidwin," Lye Hill, Breachwood Green, Hitchin, Herts.

LOOK! Multicoil packs, Long, Medium and Short Waves, 7s. each, post free. 465 kc/s intermediate frequency transformers, 4s. 6d. pair, post free. Hoover miniature trans, input 12 volts, output 310/365V at 30mA, 18s. each, post free. Send s.a.e. for more bargains to S. Young, 1 Berwick Road, London, E.17.

WANTED. Eddystone 706/W plug in coil.—S. McCrorie, 23 Newcastle Gardens, Whiteleigh, Plymouth, Devon.

SALE. Labgear Txing Coils, DSL/14; DSL/21, at 7s. 6d. each. Microphones, hand, No. 7 and No. 4A at 7s. 6d. each. Charging meters, 5—0.5 and 30—0.30 amp., at 5s. each. Eddystone Tx variable condenser, Type 831, 28—28pF, at 15s. Maxi-Q coils, chassis mtg., Range 1, white and yellow, at 2s. 6d. Morse key, Lionel Corp. "bug," at £1. Morse keys, on metal base, 3 1/2 in x 6 in. Neat job, 7s. 6d. G.E.C. xtal, 100 kc/s, 30s. Headset adaptors, high to low, at 5s. Pair R.F. meters, 0.3 amp. 2in sq., 10s. R.F. meter, 0—0.5 amp. 2in sq., at 5s. Ammeter d.c. 0—0.5 amp. 2in sq., at 10s. Volt meter, 2in sq., 0—20 at 5s. Battery testing volt meter, 12V/120V, 5s. Woden Mic transf. MT 101, at 15s. Labgear absorption wavemeter, 14 Mc/s, at 7s. 6d. Speaker in varnished wood cabinet, 12 x 12 x 6in., 15s. Rotary converter, 12V in; 285V, 60 mA out., 10s. Rotary converter, 12V in; 480V, 40mA out., 10s. 1/2 doz. assorted variable condensers, 7s. 6d. the lot.

SALE. Transformers, interstage audio, 10s. Postage and packing extra on all items.—East Keal, Romany Road, Oulton Broad, Lowestoft, Suffolk.

AUTOMATIC MORSE CODE SENDER for sale. Suitable for C.W. call sign sending, etc. Hand tape perforator and reel paper tape. 230V, a.c., variable speed, £5.—Box E.196.

continued on page 559

### NEW SURPLUS... BY RETURN

1A3	2/-	6L6M	10/6	803	20/-	EY51	12/6
1L4	5/-	6Q7G	7/6	830B	15/-	EY86	12/6
1R5	7/6	6Q7GT	9/6	866A	15/-	EZ40	8/6
1S5	7/-	6SA7M	7/6	959	5/-	EZ80	8/6
1T4	6/-	6SG7M	7/6	1616	5/-	EZ81	8/6
2A3	8/6	6SH7M	5/-	1629	4/-	GT1C	10/6
2X2	3/6	6S17M	7/6	EA50	1/6	GZ32	12/6
3A4	4/6	6SK7M	6/6	EABC8010	1/6	HK24G	25/-
3Q4	7/6	6SL7GT	7/6	EAC91	4/6	KT33C	9/6
3S4	8/6	6SN7GT	5/6	EAF42	10/6	PCC84	10/6
5763	10/6	6SQ7M	7/6	EB34	2/-	PCF80	13/6
5R4GY	12/6	6V6G	7/6	EB91	5/-	PCF82	10/6
5Y3G	8/6	6V6GT	8/6	EBC33	7/6	PCL82	13/6
5Y4G	6/6	6X4	6/6	EBC41	10/6	PL81	14/6
6AC7M	5/-	6X5GT	6/6	EBF80	9/6	PL82	9/6
6AG5	3/6	7B7	8/6	EBF89	10/-	PL83	10/6
6AK5	5/-	7C5	8/6	ECC82	9/6	PY80	8/-
6AL5	5/-	7C6	8/6	ECC83	10/-	PY81	8/6
6AM6	6/6	7S7	10/-	ECC84	11/-	PY82	9/6
6AQ5	8/6	7Y4	8/6	ECC85	10/6	PY83	9/6
6AT6	7/6	12A6M	6/6	ECC82	12/6	R19	12/6
6AU6	7/6	12AT6	8/6	ECC82	11/6	TT11	4/-
6B8G	4/6	12AT7	9/-	ECH42	10/-	UAF42	10/6
6BA6	8/6	12AU6	9/-	ECH81	10/-	UBC41	10/6
6BE6	7/6	12AU7	8/6	ECL80	12/6	UBF89	10/6
6BH6	7/6	12BE6	8/6	ECL82	12/6	UCC85	10/6
6B16	7/6	12CBM	7/6	EF36	4/-	UCH42	10/6
6BR7	11/6	12Q7GT	7/6	EF39	5/-	UCH81	10/6
6BW6	9/-	12K7GT	6/6	EF41	10/6	UF41	10/6
6C4	4/6	12SC7M	2/6	EF50	3/-	UF89	9/6
6C5M	5/6	12SJ7M	5/-	EF50(S)	4/6	UL41	9/6
6F6M	5/6	12SK7M	5/6	EF80	7/6	UY41	8/6
6J5GT	5/-	12SQ7M	8/6	EF85	10/-	UY85	8/6
6J5M	6/-	35L6GT	9/6	EF86	14/-	UABC80	
6J6	4/-	35Z4GT	7/6	EF89	9/6		
6J7G	7/6	35Z5GT	8/6	EF91	6/6	VU39	9/6
6K7G	3/6	42	7/6	EL32	4/-	VR150/30	
6K8G	6/6	50L6GT	9/6	EL41	9/6		7/6
6K8M	10/6	80	8/6	EL84	9/-	VS70	3/-
6H6M	3/6	446A	10/6	EM80	10/-	XP1.5	2/-
6L6G	9/-	801A	7/6			Z77	6/6

M.C. Meters. 2 1/2" rd. fl. (2" dial), 0—1mA, 21/-. Ditto but scaled 0—30V, 16/6. 0—500µA, 17/6. 2 1/2" rd. plug in electrostatic 0—1,500V, 16/6.

R107 Front End. For r.f. mix, osc. 3 bands 1.2—18 Mc/s (465 kc/s i.f.) with half-moon calibrated dial and slow motion drive, 40/- carr. paid, less valves.

Special Valve Offer! All prices per dozen. 1A3, XP1.5, 12SC7M, 18/-; 6H6M, 6AG5, 6K7G, EL32, 6B8G, TT11, 1626, VS70, 25/-; 6AC7M, 616, 6C4, EAC91, 1629, 801A, 2X2, 37/6; 6SN7, 12A6M, 1T4, 1625, 6F6M, 60/-; 6X5, 6K8G, 3Q4, EF91, 70/-.

Latest Model Acos Crystal Stick Microphones MIC39-1. Frequency response flat to 6 kc/s, and within 5dB to 12-kc/s. List price £5.5.0. Our price 67/6 or 55/- less stand. New, boxed. Post paid

Transistors. Yellow/green, aud., 250mW, 6/6; OC70, 12/6; OC71, 15/-; yellow/red, r.f. to 8 Mc/s, 13/6.

Midget Mains Transformers (same size as std. spkr. o/p). Input 230/250V, o/p 220V 20mA, 6.3V 0.6A. Ditto but 175V 25mA, both types 11/9 each, post paid.

Transmitter/Receivers. Army Type 17 Mk. 2. Complete with h.r. phones, hand mike and valves. 44-61 c/s. In good used condition, 29/6 each. Carr. paid. Few only. New ones 45/- each.

### SPECIAL OFFER

Performance Meters No. 2. Comprising 230V 50 c/s mains trans. 250-0.250V 30mA, 6.3V 1 1/2A, 5V 2A (60mA h.t. may safely be drawn), 20H choke, 5Z4, Y65 magic eye, 2 EF50, 1 EC52, 1 EA50, dozens of components, all in smart grey louvered case 10" x 9" x 9". Made by Parmeko. Brand new and boxed. Unrepeatable component value at only 32/6 each carr. paid (U.K. only).

Post 9d. Free over £2

S.A.E. Enquiries

## JOHN ANGLIN

385 CLEETHORPE ROAD GRIMSBY LINCS  
Telephone 56315



# EDDY'S (NOTM) LTD

Dept, RC 172 ALFRETON ROAD NOTTINGHAM

**THROAT MIKES** 1/- each, 11/- doz. Post 6d. Can be used for electrifying musical instruments.

**ACOS MIKE INSERTS** 4/11 each. High quality, can be used for tape recorders, baby alarms, musical instruments, etc. Post 8d.

**MORSE TAPPERS.** Plated contacts, adjustable gap. Heavy duty, good quality, 3/6 each, post 9d.

**TRANSISTORS.** Yellow/Green Spot 6/11; R.F. Yellow/Red Spot 13/11, post 4d

**RECORDING TAPE.** 1,200ft plastic reels, 7". 10/11, post 1/-.

**B.S.R. MONARCH 4-SPEED AUTOMATIC RECORD CHANGER.** Complete with high fidelity turnover head, type HGP37-1. Plays 10 records. For a.c. mains 200-250 volts. £6.19.6. Carriage 5/-. Brand new with full instructions

**GERMANIUM DIODES** 1/- each, 10/- doz. Post, etc., 4d.

**NEON MAINSTESTER/SCREWDRIVERS** 4/6 each, post 6d.

**JACK PLUGS,** standard type, 1/11, post 4d.

**GUITAR PICK-UP, "THE PLECTRO."** Super hi-fi, non-acoustical. Universal fitting 3" x 1 3/4" x 1/4". High output. Complete with lead and plug. Full and easy instructions. 39/11, post 1/-

**MIDGET BATTERY ELIMINATORS.** To convert most types battery portables to mains operation. 57/6 plus 2/6 post. Size 3 3/4" x 2 1/2" x 1 3/4". Smaller than h.t. battery alone. (Please state make and model number.)

## NEW AND SURPLUS GUARANTEED VALVES. ALL TESTED BEFORE DESPATCH

AZ1 12/6	ECC84 9/6	EF86 14/-	PL82 8/6	UY85 8/6	6A76 8/6	6X5GT 6/6	25L6GT 10/-
AZ31 10/-	ECC85 9/6	EF91 6/9	PL83 10/6	1C5GT 12/6	6B8G 2/11	6X4 7/-	25Z4G 9/6
B36 15/6	ECF80 12/6	EL41 9/6	PY80 8/-	1D5 10/-	6C4 5/11	7B7 8/-	35L6GT 9/6
CY31 12/11	ECH42 9/6	EY51 12/11	PY81 8/6	1H5GT 10/6	6B16 8/6	7C5 8/-	35W4 8/-
DAF96 8/6	ECH81 8/6	EY86 12/6	DD4 12/6	1R5 7/6	6F1 12/6	7C6 8/-	35Z3 13/11
DF96 8/6	ECL80 13/6	EZ80 8/6	U25 17/6	1S5 7/6	6F13 12/6	7H7 8/-	35Z4 7/6
DL96 8/6	EF40 14/-	EZ81 8/6	UBC41 9/6	1T4 5/6	6F15 12/6	7S7 9/6	35A5 10/6
DK96 8/6	EF41 9/-	GZ32 12/6	UCC85 9/6	3D6 4/9	6K7G 2/11	7Y4 8/-	807(B) 3/9
DM70 6/6	EF42 11/-	L63 6/-	UCH42 9/9	3Q5GT 9/6	6K8G 7/6	10F9 10/6	807(USA) 5/6
EBC41 9/6	EF50 3/-	L63 6/-	UCH42 9/9	3V4 9/-	6L6G 6/11	12AH7 7/6	954 1/6
ECC81 8/-	EF50(R) 4/11	PCC84 8/6	UF41 8/6	3U4G 6/6	6S7GT 5/9	12K7 7/6	955 3/11
ECC82 8/-	EF80 7/11	PCF80 9/11	UL41 9/6	6AG5 5/6	6V6G 5/11	12Q7 7/6	954 3/11
ECC83 9/-	EF85 7/11	PL81 16/-	UY41 8/-	6AG5 5/6	6V6GT 6/6	25A6G 12/6	956 2/11

Any parcel insured against damage in transit for only 6d extra per order. All uninsured parcels at customer's risk.

C.O.D. or C.W.O. only. S.A.E. with all enquiries. Postage and packing, 6d per valve extra. Over £3 FREE

Send 1/- for 56-page Illustrated Catalogue

Trade Enquiries Invited

## SMALL ADVERTISEMENTS

continued from page 557

### TRADE

**SERVICE SHEETS** sale/hire. Radio, television, electronics. Books list free.—Hamilton Radio, BCM/DATA4, London, W.C.1.

**THOUSANDS** of interesting items. List. Stamp please.—Rogers, 31/33 Nelson Street, Southampton, Lancs.

**MORSE CODE TRAINING.** Special course for Beginners. Full details from (Dept. R.C.), Candler System Company, 52 Abingdon Road, London, W.8.

**PANL,** recognised for many years as the unique one-coat black crackle finish. Brush applied, no baking. Available by post in 1/2 pint cans at 3s. 9d. from G. A. Miller, 255 Nether Street, London, N.3.

**THE INTERNATIONAL HAM HOPE CLUB** is a non-profit-making organisation open to RADIO AMATEURS and SHORT WAVE LISTENERS. OBJECT: To improve international relationships through an organised system of hospitality. MEMBERS offer overnight hospitality to visiting members, entrance fee 2s. 6d. ASSOCIATE MEMBERS invite radio amateurs to visit their stations. S.A.E. for FREE Associate membership. FAMILY EXCHANGE holidays arranged, also FRIENDSHIP LINKS between radio clubs. H.H.C.'s official journal, *Ham Hop News*, 5s. per annum. Hon. Gen. Secretary: G. A. Partridge, G3CED, 17 Ethel Road, Broadstairs, Kent.

**INCORPORATED Practical Radio Engineers** home study courses of radio and TV engineering are recognised by the trade as outstanding and authoritative. Moderate fees to a limited number of students only. Syllabus of Instructional Text is free. *The Practical Radio Engineer*, journal, sample copy 2s. 6,000 Alignment Peaks for Superhets, 5s. 9d. Membership and Entry Conditions booklet, 1s., all post free from the Secretary, I.P.R.E., 20 Fairfield Road, London, N.8.

**SERVICE SHEETS** for sale and hire. Radio/Television. S.A.E. enquiries.—J. Palmer, 32 Neasden Lane, London, N.W.10.

**JOIN THE INTERNATIONAL S.W. LEAGUE.** Free Services to members including Q.S.L. Bureau, Amateur and Broadcast, Translation, Technical and Identification Dept.—both Broadcast and Fixed Stations, DX Certificates, contests and activities for the SWL and transmitting members. Monthly magazine, "MONITOR" containing articles of general interest to Broadcast and Amateur SWL's, Transmitter Section and League affairs, etc. League supplies such as badges, headed notepaper and envelopes. QSL cards, etc., are available at reasonable cost. Send for League particulars. Membership, including monthly magazine, etc., 21s. per annum.—Secretary, ISWL, 86 Barringer Road, London, N.10.

**REMOTE CONTROL TRANSMITTERS,** type 3180, new, with telescopic aerial, working off 90V plus 1.5V battery, price 19s. 6d. per set without battery, c.w.o.—Batey & Co., Gaiety Works, Akeman Street, Tring, Herts. Tring 2183.

## REVACUUMED TV TUBES

All Guaranteed 6 months, carr. and ins. 12/6  
9-10", 3/16, CRM91, MW22/7-14, etc., £2.10.0. 12", CRM 121A-B, MW31/7-14-17-18, etc., £4.10.0. 14", 141K, MW36/24, CRM141/2, etc., £4.10.0. 15-16", 6901A, CRM153, etc., £5. 17", MW43/64, C17BM, CRM171, etc., £4.15.0.

**TRANSISTORS.** Red Spot, 7/-; White Spot, 12/6

**GUARANTEED VALVES—24-HOUR SERVICE**

6AM6 5/-	20P1 13/6	EF89 9/6	PY31 10/-
6BA6 6/6	B36 11/-	EF91 5/-	PY80 8/6
6BE6 6/6	EAF42 9/6	EL33 11/-	PY81 8/6
6C4 4/6	EB41 7/6	EL42 9/6	PY83 8/6
6C2 9/6	EB91 4/6	EL84 9/6	PZ30 12/-
6D2 5/6	EBC33 7/-	EY51 11/-	SP61 7/6
6F1 9/6	EBC41 9/-	EY86 15/-	U22 7/6
6F12 6/6	ECC81 7/6	EZ40 8/-	U24 12/6
6F13 9/6	ECC82 6/6	EZ41 10/-	U31 8/-
6F14 11/-	ECC83 8/6	EZ80 7/6	U801 16/-
6F15 11/-	ECC84 9/6	GZ32 10/-	UBA42 9/-
6L1 4/6	ECC85 9/6	KT33C 9/6	UBF1 9/6
6L18 9/6	ECH42 9/3	KT36 11/-	UCH41 8/6
6L19 9/6	ECL80 11/-	KT61 9/6	UCH42 9/6
6LD20 9/6	EF36 4/-	P61 2/6	UF42 9/-
6F28 11/-	EF39 5/-	PCF84 9/6	UF41 9/6
6X4 6/6	EF41 9/6	PCF80 9/6	UL41 8/6
10F1 9/6	EF42 12/-	PL33 11/-	UL44 9/6
10P13 11/-	EF50(A) 3/6	PL38 13/-	UL46 9/6
10P14 12/-	EF50(B) 4/9	PL81 14/6	UY8 12/6
20D1 9/6	EF80 6/-	PL82 9/6	UY41 8/-
20F2 9/6	EF85 7/-	PL83 11/-	Z66 15/-

For all details send 6d. for 12-PAGE LIST OF 800 SNIPS. Post 1/3 in £1. Min. 9d. No C.O.D. 10,000 SNIPS FOR CALLERS

**TECHNICAL TRADING CO**  
350/352 FRATTON ROAD PORTSMOUTH

**RADIO AMATEURS...**  
get your Licence in

**Half The Usual Time!**

You must be a good Morse operator! A "slap-dash" 12 w.p.m. neither satisfies the authorities, yourself, nor your operator friends. Morse operating is an exacting art unless your training is made simple and is based on sound fundamentals. For this reason, the Candler System was invented to take the "grind" out of Code tuition, turning a tricky subject into a pleasurable pursuit.

★ Send 3d. stamp for the "Book of Facts"  
**CANDLER SYSTEM CO**  
(Dept. 55 RC) 52b Abingdon Rd London W8  
Candler System Company Denver Colorado U.S.A.

## HIGH FIDELITY

Quality components of all types always in stock for the

**MULLARD 2-VALVE PRE-AMPLIFIER**  
**MULLARD 3-VALVE 3-WATT AMPLIFIER**  
**MULLARD TAPE PRE-AMPLIFIER TYPE C**

510 AMPLIFIER FM TUNER	circuits 3/6
912 PLUS AMPLIFIER	" 4/-
JUPITER STEREO UNIT	" 2/6
RADIO CONSTRUCTOR FM	" 2/-
MERCURY SWITCHED FM	" 2/-
DENCO FM TUNER	" 1/6

Price list available on request  
**J. T. FILMER** 82 DARTFORD ROAD DARTFORD KENT  
Telephone Dartford 4057

## RECORD PLAYER CABINETS

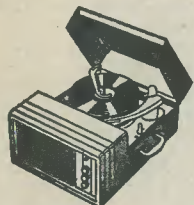

**79/6.** Stylish cabinet by famous manufacturer. Cloth covered in contrasting colours (red and grey). Grilled front control panel. Size 15" x 19" x 8 1/2" deep. Beautifully made. A cabinet of which you can be really proud. Takes 4-speed B.S.R. Monarch autochanger and a 6 1/2" round or elliptical speaker. Room for any amplifier of your own choice. P. & P. 4/6

**79/6.** A delightful looking cabinet in two-tone leatherette. Size 14 1/2" x 17 1/2" x 3 3/4". Will take B.S.R. Monarch 4-speed autochanger and 6 1/2" round speaker. P. & P. 4/6

**59/6.** A well-designed cabinet in brown leatherette. Strong clip fasteners, easy carrying handle. Takes B.S.R. Monarch 4-speed autochanger and space for a 4" x 6" elliptical speaker. Can be made up into an ideal record player. Size 16" x 14 1/2" x 8 1/2" deep. P. & P. 4/6

**49/6.** Famous manufacturer. In very smart red leatherette. Plated clip fasteners, carrying handle. Takes B.S.R. Monarch player and a 4" x 6" elliptical speaker. P. & P. 4/6

**8" P.M. SPEAKERS 5/9.** A bargain offer, but limited quantity of these modern type speakers. All tested and they have a light cone fault which is repaired, not affecting the quality. P. & P. on 1, 2/6; on 2, 3/6. Also **8" P.M. SPEAKERS 8/9.** An ideal gift if fitted in small cabinet. Complete with o.p. trans. fitted, 10/-, P. & P. 2/9

**EXTENSION SPEAKER, 19/9.** In attractive cabinet. Complete with 8" p.m. speaker, flex and switch. Standard matching to any receiver: 2-5 ohms. Size 11" x 13 1/2" x 6 1/2". A nice present and a real bargain. P. & P. 2/9

**FRAME OUTPUT TRANSFORMER, 3/9.** To match low-impedance coils. P. & P. 1/3

**I.F. TRANSFORMERS, 1/- pair.** 465 kc/s. Tested. Post 9d.

**S/V STRIP, 5/9.** Superhet. Takes 6 EF91, 1 6D2, 1 6F14 (valves extra). I.F.s 7.25-10.75 Mc/s. Please state channel required. P. & P. 2/6

**S/V STRIP PLESSEY, 25/6.** Superhet. Takes 6 6F1, 2 6D2 (valves extra). I.F.s 10.5-14 Mc/s. FREE drawing. P. & P. 2/6

**TURRET TUNER, £6.17.6.** 12-channel tuner. Suitable for above. Tunable to 9.5 Mc/s I.F. Post FREE TIMEBASE, 4/9. Contains scanning coil focus unit, line transformer, etc. Less valves. FREE drawing. P. & P. 3/6.

Stamp for Catalogue Regret U.K. only

(DEPT. R2) **219 ILFORD LANE • ILFORD • ESSEX** Telephone ILF 0295

P. P. C. O. M. P. O. N. E. N. T. S. L. T. D.

## SMALL ADVERTISEMENTS

Readers' small advertisements will be accepted at 3d. per word, including address, minimum charge 2/-, Trade advertisements will be accepted at 9d. per word, minimum charge 6/-, If a Box Number is required, an additional charge of 2/- will be made. Terms: Cash with order. All copy must be in hand by the 12th of the month for insertion in the following month's issue. The Publishers cannot be held liable in any way for printing errors or omissions, nor can they accept responsibility for the bona fides of advertisers.

**Forrest**

Transistor Transformers  
for Quality Equipment

**H. W. FORREST (TRANSFORMERS) LTD.**  
349 Haslucks Green Road Shirley Solihull  
Warwickshire Telephone SHirley 2483

**NYLON • P.T.F.E**

ROD BAR SHEET TUBE STRIP WIRE  
No quantity too small List on application

**BRASS COPPER BRONZE**

**ALUMINIUM LIGHT ALLOYS**

**H. ROLLET & CO LTD**

6 Chesham Place SW1 SLOane 3463  
Also at Liverpool Birmingham  
Manchester Leeds

Perforators, Reperforators, Teleprinters, Spare Parts,  
Terminals and V.F. Telegraph multi-channel units:  
Testing Equipment: Telephone Carriers and Re-  
peaters: Signalling Rectifiers 26B, 43A, RA87, etc.,  
Relays, Transformers, Filters: Repeating and Retardation  
Coils: Racks, Relay Bases. British, American and  
German Equipment.

Gaiety Works Akeman Street  
**BATEY & CO.** Tring Herts Tel TRING 2183

**BUILD YOUR OWN TAPE RECORDER**

Two-speed, twin track tape deck, kit of parts £8.5.0  
Amplifier kit £5.18.0; Power Pack kit £2.18.0. Both  
less valves. Send for full details of these excellent kits.  
Also available made up

**WISEMAN'S**

21A ANCASTER ROAD BECKENHAM KENT

Just Published . . .

Radio Reprint No. 10

**The Cooper-Smith**

**"PRODIGY"**



Of 20 pp, with Plastic laminated cover, the reprint deals fully with the construction of this 6-watt high fidelity amplifier, and includes the latest modifications. Much additional material is also included, among this being a circuit for a microphone pre-amplifier, signal sources, and choosing a loudspeaker.

2/6 postage 2d.

PUBLISHED BY

**DATA PUBLICATIONS LTD**

57 MAIDA VALE • LONDON W9

Telephone CUNningham 6141 (2 lines)

Telegrams Databux London

**H.A.C. THE ORIGINAL SUPPLIERS  
OF SHORT-WAVE KITS**

One valve Super Sensitive All-dry Short-wave Receiver Model "K." Complete kit including valve and chassis, 77/- (Other S.W. kits from 25/-) Before ordering call and inspect a demonstration receiver, or send stamped envelope for full specification, catalogue and order form.

**H.A.C. SHORT-WAVE PRODUCTS (DEPT. R)**  
11 OLD BOND STREET LONDON W1

**CHASSIS** 18 s.w.g. aluminium. Strengthened corners. All 2½" deep.

6" x 4" 4/- 10" x 7½" 6/6 12" x 8" 8/-  
7½" x 5½" 5/6 11½" x 7½" 7/6 14" x 9" 11/-

Prompt service. Add 1/- post and packing. Orders over £1 post free. Any published chassis available. Enquiries invited. Latest addition—Cooper-Smith Prodigy, 16/-.

**SWEETNAM & BRADLEY**  
BRISTOL ROAD • MALMESBURY • WILTS

**Res/Cap Bridge**

FOR

**35/- ONLY**

P. & P. 2/-

For checking all types of resistors and condensers

**BUILT IN 1 HOUR! DIRECT READING!!**

**READY CALIBRATED !!!**

Stamp for details of this and other instruments

**RADIO MAIL** Dept CF Raleigh Mews  
Raleigh Street Nottingham

**Bound Volumes**

Volume 11, August '57 to

July '58 inclusive,

attractively bound in

blue cloth, with

gold blocked spine,

PRICE £1.5.0. post 1/9



**SCOTTISH INSURANCE  
CORPORATION LIMITED**

**TELEVISION SETS  
RECEIVERS, TRANSMITTERS  
and other electronic equipment**

Television Sets, Receivers and Short Wave Transmitters are expensive to acquire and you no doubt highly prize your installation. Apart from the value of your Set, you might be held responsible should injury be caused by a fault in the Set, or injury or damage by your Aerial collapsing.

A "Scottish" special policy for Television Sets, Receivers and Short Wave Transmitters, provides the following cover:

- (a) Loss or damage to installation (including in the case of Television Sets the Cathode Ray Tube) by Fire, Explosion, Lightning, Theft or Accidental External Means at any private dwelling-house.
- (b) (i) Legal Liability for bodily injury to Third Parties or damage to their property arising out of the breakage or collapse of the Aerial Fittings or Mast, or through any defect in the Set. Indemnity of £10,000 any one incident.
- (ii) Damage to your property or that of your landlord arising out of the breakage or collapse of the Aerial Fittings or Mast, but not exceeding £500.

The cost of Cover (a) is 5/- a year for Sets worth £50 or less, and for Sets valued at more than £50 the cost is in proportion. Cover (b) and (ii) costs only 2/6 a year if taken with Cover (a), or 5/- if taken alone.

Why not BE PRUDENT AND INSURE your installation—it is well worth while AT THE VERY LOW COST INVOLVED. If you will complete and return this form to the Corporation's Office at the address below, a proposal will be submitted for completion.

NAME (Block Letters).....

(IF LADY, STATE MRS. OR MISS)

ADDRESS (Block Letters).....

/JB

**62-63 Cheapside London EC2**