

# RADIO CONSTRUCTOR

1'3

Vol. 2 No. 6  
JANUARY  
1949

*For Every Radio Enthusiast*



## Contents

MULTI PURPOSE 7-WAY  
TEST METER

From Surplus Gear.

Radio Miscellany.

Trade Review.

A USEFUL TWO-WAY INTER  
COMMUNICATOR.

Book Review.

TROUBLE SHOOTING.  
in superhet receivers.

Query Corner.

SHORT WAVE BATTERY  
SUPERHET.

INEXPENSIVE  
TELEVISION

Part 5 of the series.

"Surplus Gear Contest."

QRP Transmitter for 7 Mcs, etc.



AN AMALGAMATED SHORT WAVE PRESS PUBLICATION

# INSTRUMENT CO.

244, Harrow Rd., London, W.2.

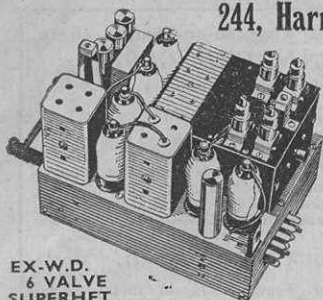

**EX-W.D.  
6 VALVE  
SUPERHET**

Complete less valves and crystal Can be adapted for 4 station push-button Receiver or Car Radio. Full of useful components.

**8/6**  
Plus 1/6  
postage

Above set can be supplied with valves. Post Free **32/6**

Data Book 1/6 on the above set.

**EX-RAF CLOCK UNIT.** This can be modified for use as clock or automatic timing device. Packed in Casket of strong bakelite or solid oak with sponge padding. Size of actual motor—diameter  $3\frac{1}{2}$ " x 1" deep. Casket 6" x 6" x 5" Post free, complete **12/6**

Write for list of bargains to Dept. R.C.

**INSTRUMENT CO., 244, Harrow Road, W.2.**

Telephone—CUNningham 0508

**WHEATSTONE BRIDGE**  
New. Fitted in beautiful teak case; using heavy stud type selector switches and precision galvanometer.

**£2. 15. 0** plus 2/6 packing & insurance

**MAINS TRANS.** Stand-up and Drop-through type. Primary 200-250v. Secondary 350-0-350 80mA. 5v 2amp., 4v 3 amp. Post paid **£1**

**NUTS, BOLTS, WASHERS** small sizes for model making. 7/6  
3 gross asstd.

**SCREENED FLEX.** Suitable for mikes 10/-

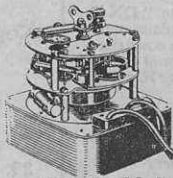

## Television

**DON'T DELAY  
ORDER THESE ITEMS NOW  
WHILST STILL AVAILABLE**

**R1355 RECEIVER** as recommended by this magazine for the construction of inexpensive television. Complete with RF unit type 25, 47/6 plus 5/- carriage.

**TYPE 6 INDICATOR** also specified £3/19/6, plus 15/- carriage in wooden case. 7/6 refund allowed on return of case.

**DROP-THROUGH TRANSFORMER** giving 350-0-350 and 6.3. Post free £1.

**E.H.T. TRANSFORMER** to give 2500 volts and 4 volts at 3 amps. 6.3 volts at 5 amps. Post free £2/10/0.

**E.H.T. RECTIFIER** (post free) 8/-

**CONDENSERS** 8mfd. 450 volts working. Each 1/9.

**DATA BOOK** giving full modification instructions and parts required for the Inexpensive Telescop. Post free 1/6

## HAVE YOU

had your FREE copy of our 32-page illustrated catalogue? It's about the same size as this magazine, with everything from A to Z, and good illustrations of all the important items.

No surplus gear is listed, all articles mentioned are the current products of the makers concerned, no need to bother what condition they are in, very much different to some of the surplus going about.

We sell a large amount of surplus as well, and issue special lists from time to time, copies of which are sent free to all customers on our regular mailing list. Are YOU on it? All orders are POST FREE, we're about the only firm that do this, no need to bother with postage, and every order is actually despatched on the same day that we receive it, a real RETURN OF POST SERVICE. Orders large or small are attended to promptly, so if you only want a few resistors, couple of condensers, or a coil, send us your order.

The following are just a few of the things described and illustrated in the catalogue.

Belling-Lee plugs, sockets, fuses, aerial kits, etc.; Denco: the complete range of their well-known products is available; Gardners transformers, chokes, etc., a very wide range stocked; Muirhead National HRO dials; Partridge transformers, chokes and the rest of their range here; Sifam instruments, including full details of their 3½in. moving coil, multi range test set, at a really amazingly low price: All Taylor instruments are here, and we do the H.P. terms for these: Wearite coils, switches, I.F. transformers, etc. Condensers, valves, and hundreds of other things.

Send a Post Card now, simply write "Catalogue Please," and your name and address, it's quite easy, and we'll have your copy in the post straight away. If you're wanting anything at the moment, just mention it, and we will send full information.

**TORBAY ELECTRIC**

43 Colley End Park Paignton S. Devon

## DENCO PRODUCTS

**MAXI-Q COILS.** A complete range of miniature iron-cored coils for straight or superhet receivers. Coverage: Range 1 0.175-0.525 Mcs; Range 2 0.515-1.545 Mcs; Range 3 1.67-5.3 Mcs; Range 4 5-15 Mcs; Range 5 10.5-31.5 Mcs when tuned by 300pF. Range 6 30-52 Mcs; Range 7 45-78 Mcs. when tuned by 50 pF. Made in following types: Blue (RF grid with coupling); Yellow (Mixer or Det. grid with coupling); Red (Superhet oscillator 465 Kcs. I.F.); White (Superhet oscillator 1.6 Mcs). Chassis type: Blue, Yellow, Red and White ranges 1-5 3/9, ranges 6 and 7 (no cores 3/3. Note—Ranges 6 and 7 are not made in white (red is suitable for various I.F.'s). Green (T.R.F. type with reaction and coupling) ranges 1-5 4/9, ranges 6 and 7 4/3. Plug in type (fit octal valve base): Blue, Yellow, Red and White ranges 1-5 4/-, ranges 6 and 7 in blue, yellow and red only 3/6. Green ranges 1-5 5/-, ranges 6 and 7 4/6.

**BULLETINS.** Technical Bulletin No. 1. Complete data on Maxi-Q coils with trimmer and padder values, circuits, etc., 3/2 post free. Technical Bulletin No. 2. Data and circuits on Coil Turrets CT6 & CT7. 3/2 post free. Technical Bulletin No. 3. Data and circuits on Coil Turret CT4. 3/2 post free.

**COIL TURRETS.** CT6 Five bands 10-2,000 metres for 465 Kcs. I.F. with illuminated dial calibrated in station names and wavelengths, slow motion drive, etc. £6/0/9. Without Dial and drive £4/5. CT7 as CT6 but with RF stage £8/13. CT4 6 band turret 10-2,000 metres £12/14/11. Without medium and long waves £9/6.

60 page illustrated Ham catalogue of over 1,000 lines, 9d. post free. Denco catalogue, 9d. post free.

## SOUTHERN RADIO AND ELECTRICAL SUPPLIES

85 FISHERTON ST., SALISBURY, WILTS.  
Telephone: Salisbury 2108



# EX-GOVERNMENT BARGAINS FROM VALLANCE'S

**BENDIX RADIO COMPASS UNITS.** Once again we are able to offer this excellent unit in first class condition. 15 valves. 4-6K7, 2-6B8, 2-2051, 6N7, 6SC7, 6L7, 6J5, 200—1750kcs. Makes a fine medium wave broadcast receiver. Price £4/17/6 Carriage Paid.

**RI155 RECEIVERS.** Excellent condition. Complete with valves. Waveband coverage 18.5—5.5 mcs. 7.5—3.0 mcs. 1500—600 kcs. 500—200 kcs. Line up RF amp. F/C, 2 IF stages, 2nd Det. AVC/BFO Magic eye. £11/15/0. Carriage Paid.

**BATTERY ELIMINATORS.** 120 volt 30m.a. Voltage stabilised with S130 stabiliser. Metal Rectification. Two heavy duty S.M. chokes. Output terminal panel with earth terminal and switch, mains lead and B.C. adaptor. Voltage adjustment panel. 200—230 volts A.C. only. Built in heavy metal case, green finish, with air vents and four rubber feet. A beautiful job. Brand New. (Ex. A.M.). Price £25/0. Carriage Paid.

**CRYSTALS.** By reputable American Manufacturers—R.C.A., Bliley, Valpey, etc., Pin spacing ½ inch. Two crystals will fit back to back in international Octal Valveholder. We can supply any frequency between 7,000 kcs. and 7,300 kcs. in steps of 25 kcs. Price 12/6. Intermediate frequencies can be supplied to within ¼kc. Price 15/-. All crystals are guaranteed to have an accuracy to within ±¼kc of the stated frequency.

**LIONEL AUTOMATIC BUG KEYS.** Made for the U.S. Army by the Lionel Corporation of New York. Built on heavy black crackle base with all other parts plated. Complete with Switch. Brand new. £2/11/6, post free.

**TUSB TRANSMITTER TUNING UNITS.** 19/6 Carriage Paid.

**WESTON BC-456B MODULATOR UNITS.** 12J5, transformer coupled to 1625 (807 with 12 volt heater). VR150 Stabiliser, modulation transformer, three relays. Complete but less power supply. 22/-, Carriage Paid.

**PAPER CONDENSERS.** 4mfd 500v.w. 4/6 each, post free.

**OIL FILLED CONDENSERS.** 2mfd 600v.w. with clips 2/6 each, post free.

**E.M.I. CATHODE RAY TUBES.** 3½ inch. green screen. Short Persistence. Electrostatic Deflection. 800 volts H.T. Complete with Base. 19/- post free.

**VALVES! VALVES! VALVES!** EF50, 7/6, 5R4GY 7/6, VR75/30, VR90/0B3, VR105/30, VR150/30, All 12/6. 884 18/9, 2050 15/-, PT15 32/6, RK34 20/-, K18C 25/-, TT11 20/-, OP80/600 (equiv T20) 21/-.

**1355 RECEIVERS.** As described in this Magazine (December, '48) for the Inexpensive Television Receiver. Good condition. Supplied less R.F. Unit. 37/6, Carriage Paid.

**LOUDSPEAKERS—PM.** All 3 ohm Voice Coil. Celestion 2½ inch, 28/-, Wharfedale 3 inch, 26/-, 5 inch, 26/-, 6 inch, 27/-, 8 inch, 29/6. All post free.

**BOLTS—ROUND HEAD BRASS.** ½ inch, 2BA 9d. doz., 4BA 6d. doz., 6BA 6d. doz. 1 inch, 2BA 11d. doz., 4BA 8d. doz., 6BA 8d. doz.

**NUTS—BRASS HEXAGONAL.** 2BA, 8d. doz., 4BA, 6d. doz., 6BA, 5d. doz.

**BRASS WASHERS.** 2, 4, and 6BA, 3d. doz. Switch. 5/3 post free. All values. Carbon. With Switch, 7/3 post free. All values.

**YAXLEY SWITCHES.** 1 pole 12-way, 2 pole 6-way, 3 pole 4-way, 4 pole 3-way. All types 4/6 each, post free.

**PRACTICE MORSE KEYS.** Built on polished wood base with working parts and terminals in brass. New and boxed. 3/6 post free.

**SUPPRESSORS FOR CARS AND CAR RADIOS.** Plug Suppressors. 1/3 each. Distributor Lead Suppressors. 1/6 each.

Condensers Suppressors for Dynamos, pumps, windshield wipers, etc., 5/6 each, plus 9d. extra postage and packing. (minimum).

**CARBON THROAT MIKES.** A lightweight, compact unit of American Manufacture. Complete with strap, cord and two pin plug. Brand new 1/11 post free.

**BAKELITE SHEET ½ inch THICK.** 12in. x 8in. 5/1, 10in. x 8in. 4/3, 10in. x 6in. 3/5, 8in. x 6in. 2/10, 6in. x 6in. 2/3, 6in. x 4in. 1/8. Post and packing 9d. extra (minimum).

**CARBON RESISTORS.** 1 watt Wire ended ± 20% 50, 100, 150, 200, 300, 350, 500, 600, 750, 820, 1,000, 1,500, 2,000, 2,200, 3,000, 3,500, 4,000, 5,000, 10,000, 15,000, 20,000, 25,000, 30,000, 40,000, 47,000, 51,000, 75,000, 100,000, 120,000, 150,000, 200,000, 330,000, 470,000, 750,000; 1 meg. 1.5 meg. 2.2 meg. 3.0 meg. 4.7 meg. 6.8 meg. 10 meg. All 1/- each. Post and packing 9d. extra (minimum).

**HEYBEARDS TRICKLE CHARGER TYPE T1.** Charges 2 volts at ¼ amp. to 6 volts at ¼ amp. from 200/250 volts A.C. Mains. Complete with instructions 25/- post free.

**ENAMELLED COPPER WIRE.** 1lb. REELS. 16 SWG, 18 SWG, 30 SWG 1/6, 22 SWG 1/9, 24 SWG 2/-, 26 SWG 2/2, 28 SWG 2/3, 30 SWG 2/4, 32 SWG 2/6, 34 SWG 2/9, 36 SWG 3/-, 38 SWG 3/4, 40 SWG 4/3. Postage 1/- extra (minimum).

**MT/M1 MIDGET MAINS TRANSFORMER.** This is a small upright type transformer, suitable for signals generator's, V.F.O.'s Midget Receivers and many other applications where size is the limiting factor.

**PRIMARY—200/230/250 volts with internally connected screen.**

**SECONDARIES—260-0-260 volts 50 m.a. 0-4.5 volts at 2 amps. 0-6.3 volts at 1.5 amps.**

**DIMENSIONS—3in. x 2in. x 3in. high with four mounting feet. New and improved design. Price 24/- post free.**

**PIFCO RADIOMETERS.** Measures A.C. and D.C. 0-6 volts and 0-240V DC current 0-30 m.a. Tests British 4 and 5 pin valves for filament continuity. A test instrument at a reasonable price. 26/- post free.

SPEEDY POSTAL SERVICE C.W.O. or C.O.D.

When sending C.W.O., please include sufficient extra for post and packing.

## VALLANCE & DAVISON LTD

144 BRIGGATE, LEEDS, 1

Tel.: 29428/9

Staff call signs: G2HHV, G3ABD, G3CML.



# Radio Constructor

Vol. 2, No. 6

Annual Subscription 16/-

January, 1949

(Waiting List)

Editors:

ARTHUR C. GEE, G2UK

W. NORMAN STEVENS, G3AKA

Technical Editor:

LIONEL E. HOWES, G3AYA

Advertisement & Business Manager:

C. W. C. OVERLAND, G2ATV

A RECENT letter from Len Philpott of Loughborough, whom readers will recognise as the maker of the "tailor made" metal Cabinet work which we have reviewed from time to time, contained a most interesting remark which set us thinking. He referred to "the ever changing fashion in ham gear."

It had never occurred to us that ham gear could have its "New Look" in much the same way that the XYL's clothes could! But apparently such is the case. Len tells us that fashions are "local"—not "national." The style is often started by some local "star" station who sets the pace in appearance for the rest of the gang. Where Len is concerned, the fashion usually involves metal cabinet work. Someone goes in for a pretty extensive rebuild, deciding perhaps on complete unit construction, with VFO, doublers, P.A. stage and modulator all in separate metal cabinets. As often as not Len is consulted on building cabinets to measure. And when the gang see the final set up they too decide to do a bit of rebuilding along the same lines. At the other end of the scale it may be simply a cabinet for a receiver. Someone suddenly decides to put his home built receiver into a cabinet instead of leaving it bare and unclothed on the bench. The result is a much smarter looking job and the rest of the boys follow suit.

The lack of housing accommodation is making the "separate shack" a rare luxury. As often as not an odd corner for the gear has to be found in the bedroom or living room. As a result the

small compact type of gear is increasing in popularity over the rack mounted or open type, and the efficiency of the tetrode type of valve with its low drive requirements, makes the construction of really compact gear quite simple. Where the gear has to be accommodated in the living room, the XYL or other female members of the household usually insist on neatness. Here again, the black or grey crackle cabinet comes into its own.

## fashions in gear

Judging from the gear being described in the American journals these days, a similar trend seems in vogue there. The "table-top" transmitter, often in a cabinet to match the receiver, is definitely in fashion. There are many more varieties of ready made cabinets available over there too, into which this type of compact gear can be built, but in this country anyway you can always get "first what you want at Philpotts."

So perhaps we can look forward to seeing more examples of this type of gear over here in the future.

A.C.G.

## NOTICES

THE EDITORS invite original contributions on construction of radio subjects. All material used will be paid for. Articles should be clearly written, preferably typewritten, and photographs should be clear and sharp. Diagrams need not be large or perfectly drawn, as our draughtsman will redraw in most cases, but relevant information should be included. All MSS must be accompanied by a stamped addressed envelope for reply or

return. Each item must bear the sender's name and address.

COMPONENT REVIEW. Manufacturers, publishers, etc., are invited to submit samples or information of new products for review in this section.

ALL CORRESPONDENCE should be addressed to *Radio Constructor*, 57, Maida Vale, Paddington, London, W.9. Telephone: CUN. 6579.

AUTHENTIC AND UP-TO-THE-MINUTE INFORMATION ON VHF, BROADCAST BAND AND AMATEUR ACTIVITIES IS GIVEN IN OUR MONTHLY PUBLICATION "SHORT WAVE NEWS."

TELEVISION FANS — READ "TELEVISION NEWS" MONTHLY



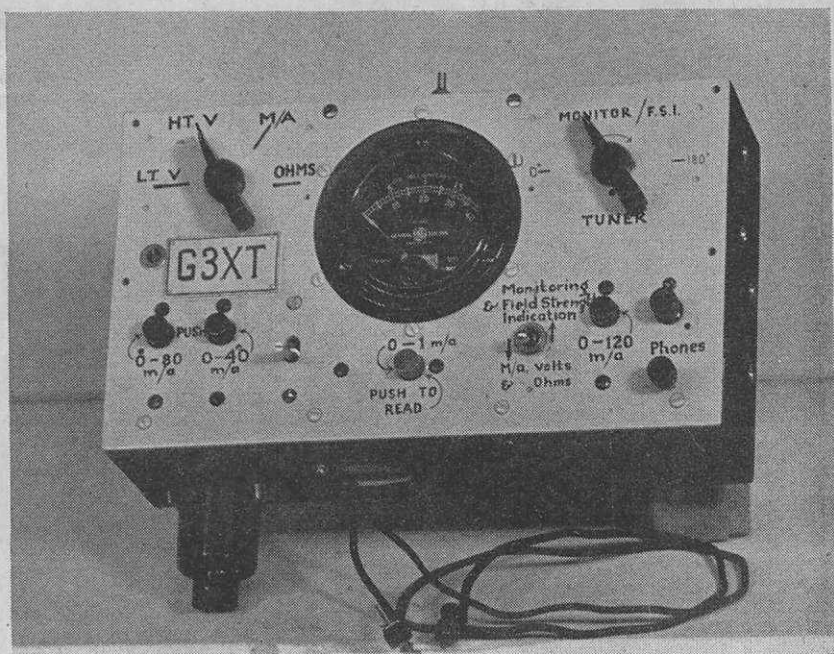

## Multi Purpose 7-way Test Meter from Surplus Gear

*Built and Described by*

W. OLIVER, G3XT

**T**HIS versatile instrument was made from an ex-Service surplus unit, the U.S. Army Signal Corps Control Box BC-1150-B, which cost 10/- at a local garage. Some of the unwanted components in the box were stripped out and sold to help towards the cost of the few additional parts (also mostly inexpensive surplus gear) which were needed to complete the conversion.

The finished meter has at least seven ranges (and could have more if desired). These include one LT voltage range, one HT voltage range, four current ranges, one or more resistance-measuring ranges, and in addition to these, a diode monitoring circuit for 'phone quality checking and approximate indication of field strength. All these sections are centred round the 0-1 mA FSD milliammeter which forms the heart of the instrument. By suitable choice of resistors for mA shunts and series voltage resistance, almost any ranges can be made available to suit your own individual requirements.

If you should have difficulty in obtaining the BC-1150-B Control Box, you may be able to get

a similar unit of different type which can be adapted to the ideas suggested in this article; and therefore the suggestions here are intended as a general outline which you can re-arrange to suit your own particular requirements.

Of the components in the original unit, the following are retained for the conversion:—

- 1 0-1 milliammeter (m.c. type) (scale calibrated 0-2 and 0-40).
- 1 rotary wafer switch (S<sub>6</sub>)
- 1 double-pole change-over switch (S<sup>1</sup>)
- 3 push-button (black) switches (S<sup>2</sup>, S<sup>3</sup>, S<sup>4</sup>)
- 1 push-button (red) switch (S<sup>5</sup>)
- 1 wire-wound meter shunt resistor (R<sup>2</sup>)
- 2 bakelite pointer-knobs

Metal case with front and rear panels

The remaining parts, including a pair of relays, four fixed capacitors, on-off switch, one red push-button switch, two plugs and the wiring, are stripped from the unit as they are not required. The necessary dismantling can be done very quickly and easily by unscrewing the rear panel of the case, which carries most of the unwanted

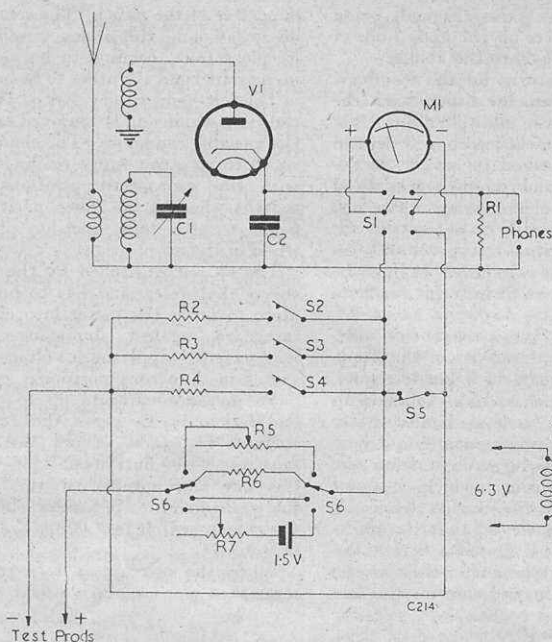

Circuit of the Multi-purpose Meter. Component Values:—C1 75—100 $\mu$ F; C2 0.001 $\mu$ F. For other values see text. Switches: S2, S3, S4 (black) push to MAKE contact. S5 (red) push BREAK contact.

parts, and disconnecting the wiring. Some of the tag-ended wires can be re-used very conveniently.

Additional components needed are as follows:—

- 2 ceramic acorn valveholders (5-contact type)
  - 1 ceramic midget variable capacitor (C<sup>1</sup>)
  - 1 fixed capacitor .001 $\mu$ F (C<sup>2</sup>)
  - 1 fixed resistor 4000,  $\Omega$  (R<sup>1</sup>)
  - 2 wirewound shunt resistors (see below) (R<sup>3</sup>, R<sup>4</sup>)
  - 2 variable resistors 0-10,000  $\Omega$  (R<sup>5</sup>, R<sup>7</sup>)
  - 1 fixed resistor (R<sup>6</sup>) (see below)
  - 1 1.5 volt dry cell
  - 1 miniature mains transformer 230v. input 6.3v. output (T)
  - 1 acorn diode (or triode strapped as diode) (V)
  - 1 burnt-out acorn valve (as glass coil-former)
  - 2 'phone terminals on insulating strip
  - 1 aerial terminal with feed-through insulator.
- Flex and test-prods.

Several of the above items call for some further explanation. For example, the two wirewound shunt resistors: the value of these will depend on the current ranges you wish to measure. In the original model the ranges are 0-1, 0-40, 0-80 and 0-120 mA. But any other ranges can be substituted by varying the resistors accordingly.

Similarly, the fixed series resistor (R<sup>6</sup>) for the HT voltage range can be chosen to cover any one desired range of high-tension voltage measurement. Methods of calculating and winding

the necessary resistors have already been described in previous articles by other contributors, so we need not go over all that ground again here!

In the original model a variable resistor (R<sup>5</sup>) is used for the LT voltage range. The advantage of this is that it enables several different ranges of LT voltage to be measured with a good deflection of the meter. The drawback is that the resistor must be pre-set to a known and reliable source of voltage before measuring an unknown voltage. If you feel this is a serious drawback, you can use a fixed resistor instead, compromising on a single convenient range.

The transformer I used was a G.E.C. "Gecolite"—an electrical "economy" lamp with built-in transformer, the whole thing plugging into an ordinary electric lampholder socket and designed to light a 6.3 v 0.3 amp. bulb from the mains. I adapted it by removing the coloured plastic shade, leaving the bakelite base which is a nice sliding fit in one of the large plug-holes in the case of the control box. Two small metal brackets secure it firmly in position. The leads from the transformer secondary are connected to a couple of longer wires going direct to the heater contacts on the acorn valveholder.

The other acorn valveholder serves as a coil-holder. The coil is wound on a burnt-out acorn valve serving as a glass former. 30 SWG wire is used, and the windings are secured in place



with cellulose self-adhesive tape, the ends being soldered to the pin-contacts on the glass bulb of the valve, which then plugs into the holder.

The correct number of turns for the windings, which are put on one over the other, with the cellulose tape acting as an additional insulator between the layers of enamelled wire, will depend on the waveband it is desired to cover. If the field-strength indicator and monitor is needed for more than one waveband, more than one burnt-out acorn will of course be necessary!

If preferred, a more orthodox type of coil can be used, with wavechange switching. It must be pretty compact, however, to fit into the available space.

Before attempting to reconstruct the unit, remove unwanted labels, etc., from the front panel, and give it two coats of a good enamel. I used cream plastic enamel, and also touched up the black bakelite parts, such as knobs, meter case, etc., with chocolate brown enamel.

The general layout will be evident from the illustrations, and the wiring, which is very simple, can be followed quite readily from the circuit diagram. Note, however, that the push-button switches have to be altered a little: the black one under the milliammeter has to be "swopped over" with the red one on the left

hand side of the panel. The remaining red one is discarded, and the phone terminals mounted in its place (one terminal to be insulated from the metal panel and the other to be in contact with it).

The left-hand rotary switch is left in position; the right-hand one is removed to make room for the variable capacitor. The change-over switch is wired to give test range readings (in conjunction with the appropriate positions on the rotary switch) when in the down position, and to give field strength indication or phone monitoring when in the up position.

The switch controlled by the red push-button shorts the meter, and has to be pushed deliberately to bring the meter into circuit. This is a safeguard against damaging the meter by inadvertently applying a voltage with the range-switch in the wrong position.

To measure currents up to one milliampere, one has only to press the red button. For currents in excess of one mA., however, you must press two buttons at once—the red one and the one appropriate to the range required. For resistance or continuity checking, you turn the rotary switch to "Ohms" and press the red button.

When the instrument is required for getting some idea of comparative field strengths from a

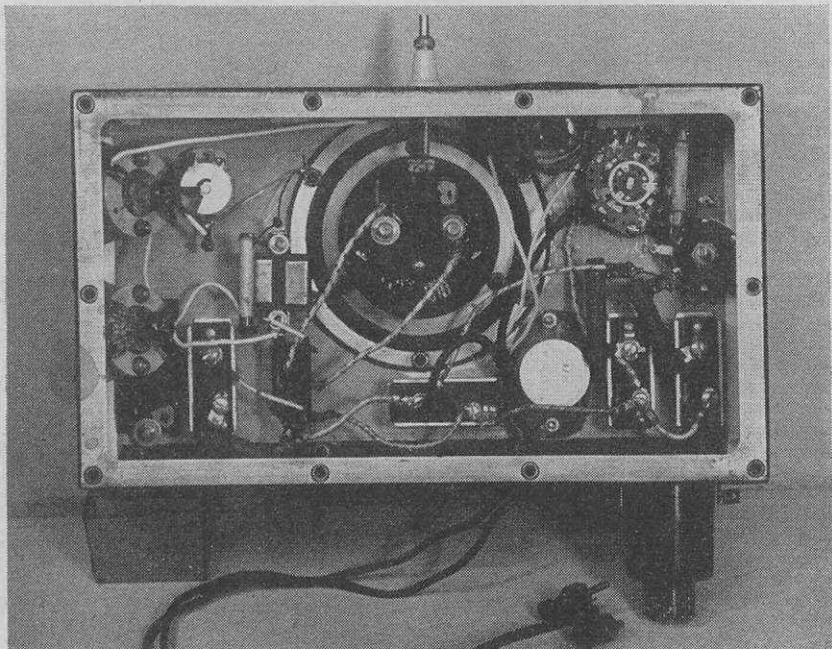

*The meter with back removed, showing the layout of the main components. No difficulty should be experienced in wiring.*

## MULLARD'S NEW VOLTAGE REFERENCE TUBE.

transmitter, you throw the change-over switch to the up position, which cuts out all the press-button paraphenalia, and the meter then reads directly 0-1mA. You plug an ordinary electric lampholder, on a flex, on to the Geolite transformer; connect a short aerial to the aerial terminal on top of the case; and connect a pair of 'phones to the 'phone terminals. After switching on and waiting a few seconds for the diode heater to warm up, the meter needle should show a current of a small fraction of a milliamp. On switching on and keying the transmitter, and tuning in the transmission with the variable capacitor on the meter unit, this reading should rise sharply, the amount of deflection depending on the strength of the incoming signal and the length of the pick-up aerial. Proceed cautiously, as full-scale deflection is easily obtained close to even a low-power transmitter.

If no results are obtained, the most likely fault is an unsuitable coil winding for the frequency in use. The correct number of turns can best be found by trial and error.

When the transmitter is modulated, speech should be heard at good strength in the 'phones, and the meter can thus be used as a monitor for checking quality. You can also form some idea of the depth of modulation.

The scale on the milliammeter as supplied in the BC-1150-B is graduated 0-2mA and 0-40mA. The 0-1 range can be read easily by halving the direct readings on the one scale, and the 0-40 can be read direct. Other ranges can be worked out readily enough.

For volts and ohms, however, it is not quite so easy, and in the latter case, especially, one should either add a scale calibrated directly in ohms, or else plot a graph to show the relationship between one of the mA scale readings and the corresponding value of ohms resistance.

Considering its low cost and ease of construction, this simple multi-purpose meter-monitor will be found an asset of real value to the average experimenter who wants to avoid the expense of more ambitious test equipment.

## THE EDITORS INVITE . . .

- Constructional articles suitable for publication in this journal. Prospective writers, particularly new writers, are invited to apply for our "Guide to the writing of Constructional Articles" which will be sent on request. This guide will prove of material assistance to those who aspire to journalism and will make article writing a real pleasure!

The rapid development of electronic devices during recent years has increased the need for a compact and stable source of voltage reference for direct use in electronic circuits. Such a need is fully met in the Voltage Reference Tube 85A1 recently introduced by Mullard Electronic Products Ltd. Working in a self-regulated, constant current circuit, this tube provides a voltage of extremely high stability such that it may, in the majority of applications, be used to replace a standard cell as a built-in source of voltage reference. It should thus prove of particular interest to designers of communications, scientific and industrial electronic instruments.

In construction, this new tube resembles a normal neon gas discharge tube. However, the high stability is achieved as a result of an entirely new manufacturing process. This process also ensures a high consistency in characteristics from tube to tube, so that tubes may be replaced without difficulty. Furthermore, a temperature co-efficient of less than  $-3.5\text{mV}/0\text{C}$  eliminates the necessity of temperature compensation in the vast majority of applications. The tube is of all-glass construction and is built up on a local type base which enables it to be firmly located into its socket. Long life, small size and reliable performance are other important features.

The ignition voltage of the tube is 125V. and the normal operating voltage is 85V. After an initial ageing period, the short-term stability (100 hours max.) is better than 0.1 per cent. whilst the stability over a period of 1,000 hours is better than 0.2 per cent. This high degree of stability is maintained even under intermittent switching conditions. The tube operates as a regulator over a current range of 1-8mA, but for optimum performance as a source of voltage reference, it is recommended to operate the tube at 4.5mA.

In addition to its use as a built-in source of reference voltage in electronic equipments, the tube may be used effectively as a reference against which to compare or fix the level of almost any physical quantity convertible into an c.m.f. It should thus prove of great value in position control systems, temperature control devices, etc., and for general use in laboratories. Another important use of the tube is to provide a standard potential for the mass-production calibration of electrical instruments.

As a regulating stabiliser, the tube is particularly recommended for those applications where abnormally high stability is required or special freedom from flicker is particularly demanded.

The maximum dimensions of the tube are as follows:—

Overall height 80mm; Seated height 65mm;  
Over diameter 32mm.

The list price is £1 15s. 0d.



# RADIO MISCELLANY

By *Gene Zap*

**F**OR a great number of years I have been trying to discover how much time the average person devotes to listening. By that I mean, to really LISTEN and not merely have "the wireless" on. I have always found myself forced to the conclusion that it is far less time than I could honestly bring myself to accept, and the lack of wide popularity of car radios, personal receivers and the like would seem to confirm this.

Yet there is always an outcry whenever any suggestion of curtailing broadcast hours is made, despite the promise of an improved general standard which would be made possible by the economies effected by reducing the number of hours. Actually the saving would be far greater than the first casual glance would indicate—the public are unmindful of the enormous technical, maintenance and administrative staff the BBC employ. Personally I am all for less hours if it means a real improvement, but then I must number myself with the doubters having failed to notice any improvement when they put our licences up from ten bob to a pound.

When they think of our American cousins getting theirs for nothing many listeners must wonder if our broadcasting would be better if we had a few rival sponsored programmes to enliven things. The BBC seems such a soul-less entity; a vast machine churning out uninspired programmes and we have never been allowed the chance to hear if anyone else could handle them better. I don't suppose we ever shall if our over-zealous bureaucrats and self-styled reformers with their ever expanding aims to control and nationalise everything, get their way.

## Official Stupidity.

The history of British broadcasting is simply a classic example of obtuse obstruction by high officials and lack of imagination by over-powerful Ministers—the very people we pay to plan our future. British broadcasting was born in February 1922 with the Marconi Co., Station at Writtle (2MT) near Chelmsford. It should be noted the first American station opened up its programmes in December, 1920.

As if determined to place every possible obstacle in the way of the Marconi Company, their permit to broadcast restricted the power to 10 watts, limited the time to a half-an-hour a week, required that part of the time be devoted to morse signalling and a pause after each seven minutes for a period of three minutes during which they had to switch over to reception on a Government wavelength in case they decided to change their minds about it and forbid the continuance of the programme.

The wheels of the bureaucratic machine grind

slow, so the three minute intervals were imposed for nine months and also applied to the 2LO transmitter which started about May of the same year. Here, in an unguarded moment, they generously gave permission for the use of 100 watts but to offset this they decided to prohibit the broadcasting of music! I forget how long it took to have this absurd restriction lifted, but it ran into months.

When the British Broadcasting Company (run by representatives of a number of radio manufacturers) was started in November, 1922, they so succeeded in popularising listening that the Government "nationalised" it immediately their Charter expired three years later.

Commercial broadcasting in England, indeed. Not a hope!

## Cut Prices.

I have been interestedly watching the domestic receiver market. There are so many points which fascinate me.

I am losing hope of seeing anything better than the eternal 4 plus 1. I still cannot believe that a large section of the public would be unwilling to pay the extra for an RF stage. Even the technically ignorant would be rapidly convinced with effective demonstration in the saleroom. The same old circuit with very ordinary cabinet design and controls isn't really good enough. We did even better way back in '39 and are supposed to have advanced since then.

The effects of purchase tax too, make the public shy, not surprisingly. Many of them have still got a better looking receiver at home which, pre-war, cost barely half the money.

The "easy-payment" inducement has become almost universal throughout the trade but it still doesn't stimulate business. It seems to be only a matter of time before we see the return of that former menace "the part exchange" where prospective customers toured around for a more "generous allowance"—in other words, a cut price!

## Knocked 'em in the Edgware Road.

During my long association with our hobby it has been interesting to watch how the centres of the retail trade for the constructor have waxed and waned in popularity. It is not that any particular district has ever attained an even near-monopoly but many of them have had turns in holding the dominant position.

Way back in '23, Lisle Street staked out its claim—not with ex-W.D. stuff, but with cut price components, and even today many old timers still tell of "Mother" Raymond's shop which largely helped in putting Lisle Street on the radio map.

(continued on next page.)

## TRADE REVIEW

# The "Karrigram"

The New V.S.E. High Fidelity  
Portable Record Reproducer

Designed exclusively for the flat dweller and other record enthusiasts who have neither the space nor the capital to purchase a full-sized instrument, the "Karrigram" is the answer to their demand for a truly portable record player which will give high fidelity reproduction, suitable for 200-240 volts A.C. mains operation.

Due to the horizontal speaker position in conjunction with a specially designed grill the sound distribution is omnidirectional and the case exhibits acoustical properties usually found only in much larger models. A 6½in. flat-type moving-coil speaker is used.

The curved shape of the case allows both 10in. or 12in. records to be played with the lid closed, thus eliminating "Surface scratch" from the pick-up. Both volume and tone controls are located on the side of the case, allowing adjustments to be made without opening.

A lightweight Garrard turntable unit is used and the high quality magnetic pick-up feeds a three valve amplifier employing a bass-boost circuit of 3.8 db per octave, the frequency response is flat from 40 to 15,000 c.p.s. The new Mullard all-glass B8A miniature series valves are used throughout.

The novel circuit design incorporates a capacitor as a wattless voltage dropper ensuring

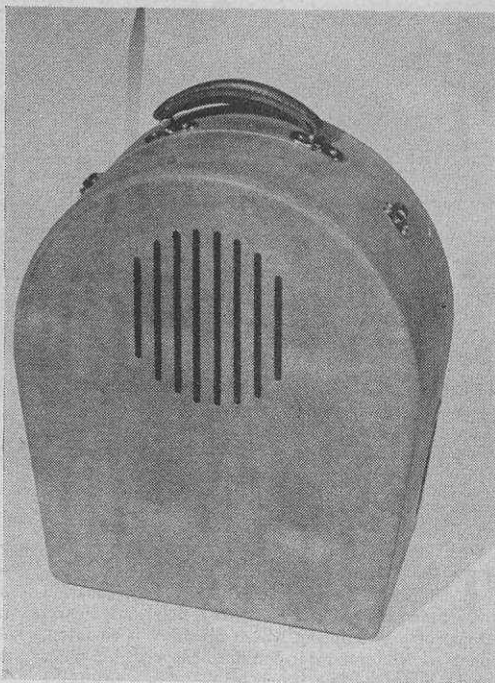

surge-free operation. The hum level, both from mains and pick-up input, is inaudible owing to special care in electrical design. A negative feed back of 14db ensures the maximum output of approximately 2½ watts with the minimum distortion obtainable from the valve combination used.

The whole instrument is readily portable, weighing only 16½lb., for a case size of approximately 14in. x 13½in. Adequate ventilation is provided and the layout is planned to facilitate servicing. The case is finished in lustrous rexine grey lizard skin, designed to blend with any interior. The price of the "Karrigram" is 18 gns. plus £8 1s. 8d. Purchase Tax.

Bishopsgate, Farringdon Street, Holborn, Tottenham Court Road, and later Fleet Street districts, have all at times been considered to have the distinction of being the Centre to which constructors gravitated and where both suburban and provincial visitors made their regular pilgrimages.

The Edgware Road district has for some time been a minor centre of its own and in recent years has been in the ascendancy where constructors from all parts flock on a Saturday. Anyone doubting the extent of interest in constructional radio should take a look round that way any Saturday afternoon, and the enthusiasts who foregather have come from miles around. The arrival of a branch of Premiers will

greatly strengthen the appeal and draw still larger crowds.

This area, easily accessible by all means of transport, with all classes of trade from the well-lined pocketbook to the Schoolboys hard saved coppers catered for, plus ALL the shops being open in the afternoon, has everything in its favour. A Saturday in Lisle Street is little different from a normal weekday. The neighbouring shops (Tottenham Court Road, Soho Street, etc.) are closed so if the visitor cannot get what he wants there he runs the risk of wasting the best part of the afternoon.

On form I guess I'll put my money on the Edgware Road taking the lead in the constructors Mecca Stakes.



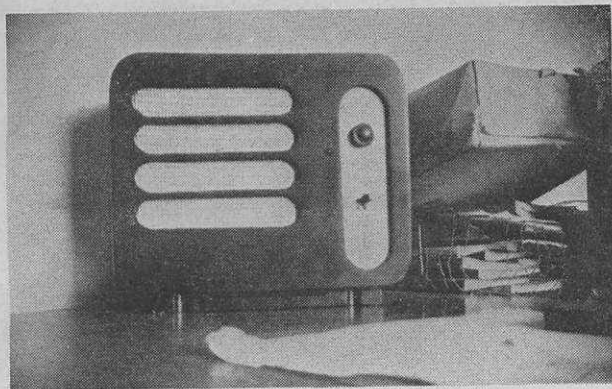

A  
Useful  
Inter-  
Communicator

*described by*  
V. RUMMERY, G3BEV

**T**HE writer, requiring an efficient inter-communication system for communication between two offices on the first and second floors of a building in which his office is situated, decided that an inter-communicator would be a great boon, saving time and energy; as running up and down a flight of stairs many times a day is no joke! I'm sure that those readers who require two-way communication between two or more points will be interested in this inter-communicator which is easily built and is designed around four easily obtainable tubes, namely the 6J7—6J5—6V6 and 6X5, all of the 6.3 volt octal based range which the writer prefers to use rather than the English based types.

#### Circuit.

The circuit is a simple three stage amplifier, resistance-capacity coupled which provides plenty of microphone sensitivity and adequate gain. A two stage amplifier was tried, but it was found that one had to talk rather close to the microphone to get the required output. Using an additional microphone amplifier, one can talk six feet from it and still get useful audio output the other end and for normal use the gain control requires to be set at only approximately quarter way up. The intercommunicator in use consists of a Master Unit and one extension or Sub-Unit, but any number of sub-units can be added if the necessary switch for selection of the various sub-units is added where marked X on the circuit diagram. The calling buzzer and its associated warning light were added as a refinement and are by no means necessary and need not be added.

First, we have a 6J7 microphone amplifier which is adequately de-coupled as is the next tube, a 6J5 to obviate any instability owing to the rather small chassis used. The 6J5 is used to

drive the 6V6 output stage, the whole being supplied with HT from a 6X5 rectifier. It will be noted that  $8\mu\text{F}$  capacitors are shown for decoupling; as a spare can-type  $8\text{-}8\mu\text{F}$  was on hand this was used, but two  $4\mu\text{F}$  will do equally well in this respect. The input transformer T1 should be of the screened type to obviate any external pick-up from the mains transformer, etc., and should be mounted where shown on the layout diagram. T1 should match the  $3\ \Omega$  speech coil to the grid of the 6J7—all of the well-known radio stores can supply a suitable microphone transformer.

The usual practice of using the speakers as moving coil microphones by use of switching is employed and no difficulty should be encountered here as this is not at all complicated. The switch connects the speech coil of the Master Unit speaker to either the input transformer T1 or the output transformer T2, and similarly the sub-unit speaker speech coil is connected either to the input transformer or output transformer. The TALK/LISTEN switch used is of the telephone key type with a spring bias, obtainable from any surplus store, and was used in preference to the ordinary tumbler switch as the action is much smoother and the spring bias makes the change from Talk to Listen much easier, as one only has to hold the switch down to Talk and release it to Listen. The other position (switch "up") is utilised for the calling circuit. In the sub-unit the switch is used the other way round, i.e., the switch is held down to CALL and released to LISTEN.

A battery of 3 volts is used to energise the calling buzzer and warning light (which is wired in parallel with the buzzer) and is so arranged that one battery (housed in the sub-unit cabinet) supplies both buzzers and warning lights in the Master and sub-units. The call switching is not

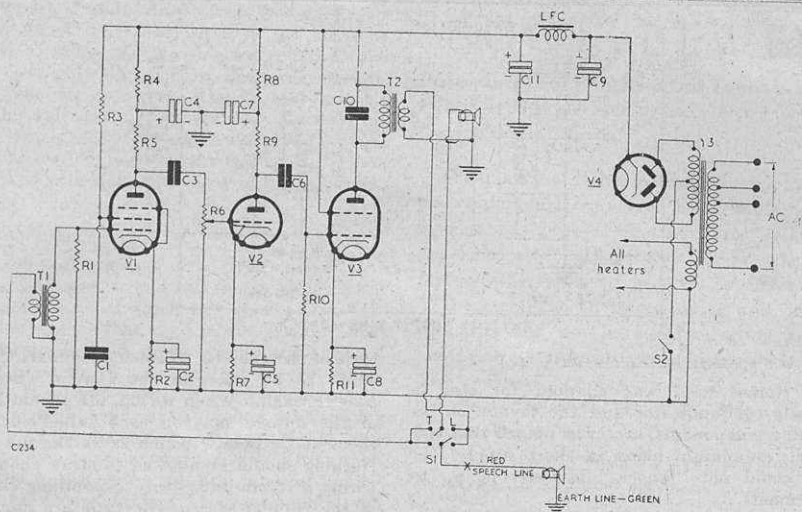

**Capacitors.**

- C1—1  $\mu$ F 350 v.w.
- C2, C5—25  $\mu$ F 25 v.w. electrolytic
- C3, C6, C8—.01  $\mu$ F 350 v.w.
- C4, C7—8  $\mu$ F 350 v.w.
- C9—8  $\mu$ F 350 v.w. electrolytic
- C10—.002  $\mu$ F 350 v.w.
- C11—16  $\mu$ F 350 v.w. electrolytic

- T1—Microphone transformer—screened
- T2—Output transformer—3  $\Omega$  secondary
- T3—Mains transformer, Primary 200—250 volts. Secondary 6.3 volt. 3 amp. 250-0-250 volts 60 mA.

**COMPONENT VALUES.**

**Resistors.**

- R1— $\frac{1}{2}$  meg  $\frac{1}{2}$  watt
- R2—2,000  $\Omega$  1 watt
- R3—1 meg  $\frac{1}{2}$  watt
- R4—20,000  $\Omega$   $\frac{1}{2}$  watt
- R5— $\frac{1}{4}$  meg  $\frac{1}{2}$  watt
- R6— $\frac{1}{2}$  meg volume control
- R7—1,000  $\Omega$  1 watt
- R8—15,000  $\Omega$   $\frac{1}{2}$  watt
- R9—150,000  $\Omega$   $\frac{1}{2}$  watt
- R10— $\frac{1}{2}$  meg  $\frac{1}{2}$  watt
- R11—250  $\Omega$  1 watt.

- LFC—50 mA 20 Henry choke
- S1—telephone key switch (See text)
- S2—single pole single throw switch.

complicated, in the STANDBY position it merely connects the calling circuit line to the buzzer in both Master and sub-units, and when the switch either end is in the CALL position it brings the battery into circuit to energise the distant buzzer. The return circuit is through the common earth wire (coded green on circuit).

The speakers used were a 3 $\frac{1}{2}$  in. for the Master Unit and a 5 in. for the sub-unit; as a spare 5 in. speaker was on hand this was used but a 3 $\frac{1}{2}$  in. can be used for both units of course, if so desired. A volume control was fitted in the input circuit of the 6J5 as with this amplifier one does not require all the gain available. The Mains transformer T3 shown need not have the various Primary voltage tappings as shown on the circuit, but most transformers are supplied with these taps to allow for the different mains voltages available. The Secondary consists of a 6.3 volt 3 amp. winding to supply all heaters and using a 6X5 rectifier only one winding is necessary, as the Cathode of this particular tube is brought out to a separate pin and not tied to the heater, this helps to keep the size of the transformer down to reasonable dimensions.

**Construction.**

The whole amplifier is built on a chassis measuring approximately 8 $\frac{1}{2}$  in. x 5 in. x 2 in. deep. The tubes are mounted in a line along the back of the chassis as shown in the layout diagram. The smoothing choke is mounted underneath the mains transformer as shown by the dotted lines. The Master-Unit speaker is mounted on a front panel 7 $\frac{1}{2}$  in. x 9 in. as shown and the TALK/LISTEN and CALL switch, volume control, stand-by HT switch and warning light are mounted one above the other at the extreme right end of the panel as viewed from the front. These controls were mounted horizontally as the cabinets used were made for inter-communicators and are provided with an opening 7 in. x 1 $\frac{1}{2}$  in., therefore the front panel controls had to be mounted within this area. It will be noted that one side of the input transformer T1 and the output transformer T2, are earthed; an earth tag under the transformer supporting bolts will serve as an earth point as no earth wires should be unreasonably long. Care should be taken when mounting the mains transformer to see that the windings do not interact with the speech

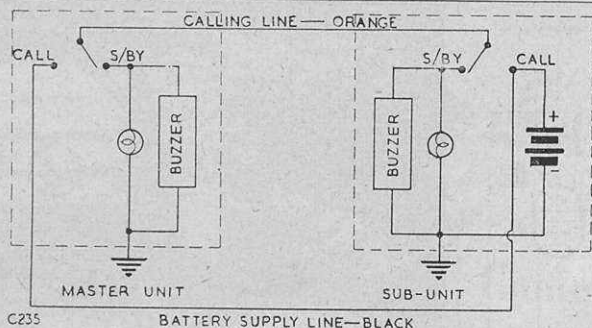

coil of the speaker in the Master-Unit.

The chassis used was adapted for use in this inter-communicator and the layout of the tubes and components, etc., was not all that was desired; aluminium being in short supply, the writer could not "knock" himself one up to requirements.

**Wiring.**

A few words about the wiring—this should follow the normal L.F. amplifier practice—i.e., all wiring of grid and anode circuits should be run in screened sleeving to keep hum and instability at bay, especially those to the Master-Unit speaker and 6J7 input circuits. All heater wiring should be wired in tightly twisted pairs. It will be found that with the layout given, and to which it is advised to adhere as closely as possible, no exceptionally long leads are required when wiring up if the components are mounted as shown. The components such as bias capacitors decoupling resistors and anode resistors, etc., can be wired directly into the circuit by their own wire ends. The only long leads are those to the speaker and volume control and de-coupling capacitors which are mounted above chassis.

The mains input lead should be kept away from the 6J7 input leads and brought out to opposite

ends of the chassis. Rubber grommets should be fitted to all holes in the chassis where wires pass through. When wiring, use should be made of the unused pins on each tube-holder, using them as tie points, which saves the use of tags. Nothing should be allowed to stray about in the wiring if it can be helped. Smoothing capacitors of the tubular electrolytic type are mounted in the wiring below chassis. A screened top cap should be used on the grid cap of the 6J7, or better still use a metal screening can around the whole tube. Component values do not appear to be critical but it is advised to stick to the values as given. The switch in the centre tap of the mains transformer secondary is provided to save current when standing-by, the only current drain being from the heaters which are kept warm ready for use.

There being no room in the Master-Unit to include the buzzer, this was mounted on a separate piece of plywood 4 in. square and screwed to the wall skirting of the room. Connections from the Master-Unit are via a multi-cable of six wires to a multi-tag strip mounted alongside the buzzer and from there only the four wires run to the sub-unit. If the calling circuit is dispensed with only two wires need be run to the sub-unit direct from the Master-Unit. The wiring to the sub-unit need

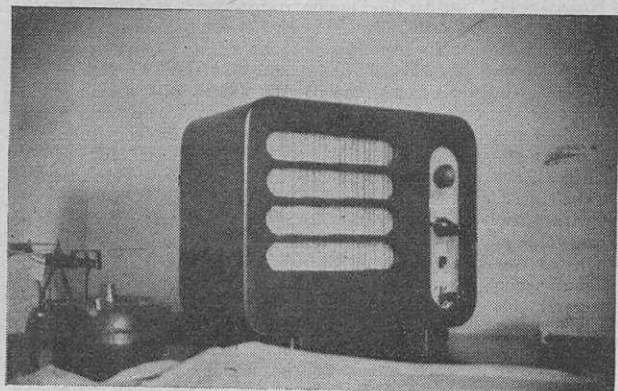

*The Master Unit. Panel controls, reading top to bottom, are Signal Lamp, Volume Control, Standby HT Switch, Talk Listen and Call Switch. The photo heading the article shows the Sub Unit.*



not be screened and ordinary twin bell wire may be used here. The four wires to the sub-unit are used as follows:—One common earth return for speakers and calling circuit, one for the speech circuit, one for conveying the battery current from the sub-unit to operate the Master-Unit calling circuit and the other wire used as the calling circuit line between the two units. These are marked with different colour codes on circuit.

#### Sub-Unit.

The sub-unit consists of a 5 in. speaker, the warning light, buzzer and call switch all mounted on to the front panel which measures  $7\frac{1}{2}$  in. x 9 in. (the same size as that used in the Master Unit) The battery is held down under a U shaped piece of brass which is bolted to a bracket which supports the front panel to the bottom of the cabinet. As I have stated before, the calling system may be dispensed with and would save the extra two wires between units. The circuit shows the wiring of the sub-unit, and no further comment is needed on this. The front panel layout is exactly the same as that of the Master Unit, except that there is no volume control or standby HT switch, so the controls of the sub-unit are spaced equally. The warning light is mounted at the top, and the call switch in the middle.

#### Cabinets.

For the benefit of those who will have to make their own cabinets, the size is as follows:— $10\frac{1}{2}$  in. long,  $8\frac{1}{2}$  in. high,  $5\frac{1}{2}$  in. deep. The top has four ventilating slots covered inside with speaker silk and the back also has ventilating slots similarly covered. The drawing shows the appearance of the front of the cabinet.

#### Operation.

When the units have been built and installed, the procedure is as follows:—The volume control on the Master Unit is set to give the required volume. To call the sub-unit the switch is pushed into the "up" or CALL position, this operates the buzzer and warning light in the sub-unit. Then, the switch is pushed down to its LISTEN position and when it is required to reply, the switch is held down while talking and released to LISTEN once again. When calling from the sub-unit, the operator merely holds his CALL switch down and this operates the buzzer and warning light in the Master Unit, the switch is then released to LISTEN. I must add that at the Master Unit, the HT standby switch must be switched to the ON position first before the amplifier will operate. When the conversation is finished, the HT standby switch should be switched to the OFF position once more to economise in current. The writer hopes that this article has made the building and operation of this Inter-communicator quite clear to those readers who wish to build a similar model.

## BOOK REVIEW

**Denco Technical Bulletin 3 Coil Turret C.T.4. 3/-.**  
Issued by Denco (Clacton) Ltd. 355/9 Old Road,  
Clacton-on-Sea, Essex.

The quality of Denco products is well known to our readers and one which has stimulated much interest has been their Coil Turret. This has developed through several stages, the C.T.4 representing the latest progress in this direction. It is a complete, all wave, tuning unit, intended primarily for use in communication receivers having an RF stage, mixer and separate oscillator. The range is 125 kcs. to 36 Mcs.—covered in six ranges, with an IF of 1.6 Mcs. The well-known Denco turret assembly arrangement is used with coils wound on low loss Polystyrene formers with iron dust cores.

D.T.B.3 deals very comprehensively with the design of this turret both from the theoretical and practical aspects. Constructors will greatly appreciate the section in the Bulletin devoted to recommended circuits, excellent circuit diagrams and block line diagrams giving the Constructor all the information required to build a first-class communication receiver around this turret.

This booklet is nicely produced and printed on art paper and should most certainly be obtained by all those interested in the construction of a high-grade communication receiver.

A.C.G.

---

**Clydesdale Supply Co:** List 5, which we mentioned in our last issue has now been supplemented by a 64 page catalogue. This, in effect, brings the total size of List 5 to 112 pages. The 48-page catalogue deals mainly with the larger components and units whilst the larger booklet concerns itself with the smaller components. Taking them together, a most comprehensive list of ex-Government equipment is presented. Readers may obtain copies by writing to the Company at 2, Bridge Street, Glasgow, C.5.

---

**Hamrad:** A periodic price list that we have not mentioned in these pages before is that issued by Hamrad Wholesale Limited of 348, Portobello Road, Ladbroke Grove, London, W.10. Containing a fine selection of gear, this list may be obtained on request from Hamrad.

# TROUBLE SHOOTING

---

## IN SUPERHET RECEIVERS

By F. W. FRERK

WHEN a new home-made superhet receiver is first put into operation many a home-constructor will be disappointed. There are a few peculiarities, which usually are not especially mentioned in the circuits published by coil-manufacturers or authors of books and articles, because the reader is supposed to know all about these minor features and operations. Yet, as a matter of fact, they are often the stumbling-block, which the constructor is unable to overcome.

### The Frequency Changer.

If the frequency changer refuses to oscillate, it is usually the oscillator coil which is not connected the right way round. The windings are not in phase and the oscillator does not work properly.

The coils are usually wound in the same direction and the universally accepted method of connection is, that the two *outside* wires, one from the primary and one from the secondary are connected to their respective anode and grid, while the *inside* ends are connected to +HT and to the padding capacitor.

A similar difficulty sometimes arises with the connections of the IF-transformers. It has to be borne in mind that the coil next to chassis is always the primary and has to be connected the outer wire to anode, the inner wire to +HT. The upper coil consequently is the secondary one and to be connected with the outer wire to the grid and the inner wire to the AVC or ground-line.

Much trouble and energy can be saved by spending sufficient time in planning the layout of a superhet. The placing of the components on the chassis is of the greatest importance. Parts, like capacitors and potentiometers, with shafts extending through the front panel, should be mounted first, after carefully moving them about on the chassis until a satisfactory arrangement, which offers the shortest possible connections has been found.

### Padders.

Rather too many of the would-be constructors get unexpected results from their completed sets. Some of them bring in stations at one end of the dial only, others tune correctly on certain frequencies but are far from their correct markings on other frequencies and sometimes all stations are crowded together in one small sector of the dial or the stations are spread apart and displaced.

The reason for all this? The set does not track. It is the padding capacitors that matter and it is usually the worst offender in home constructed superhets. Bad tracking occurs mostly because of wrong-size padding capacitors (rather than coils and coil-manufacturers), to a certain extent are to be blamed for it.

The manufacturers of a widely used set of superhet coils, changed the size of the padding capacitors for medium waves from  $750\mu\text{F}$  to  $500\mu\text{F}$  and nowadays to  $450\mu\text{F}$ . The radio dealer, who keeps a lot of different coils in stock, does hardly know which kind of coils he is selling and to be on the safe side, he usually adds a  $600\mu\text{F}$  capacitor, which is definitely wrong.

If the oscillator coil itself is too large, stations will tune in at much too high a figure on the dial, if too small at too low a figure.

If the padder is too large, stations will be crowded and displaced toward the higher frequencies and only those near the end of the dial may be tuned near their actual markings.

If the padder is too small the stations on the lower frequency end of the dial will be displaced and spread apart.

It is a safe plan, not to use one big variable padding capacitor of, say  $450\mu\text{F}$ , but to make it up of a fixed mica capacitor of  $400\mu\text{F}$  with a trimmer of  $50\mu\text{F}$  shunting it, because it is much easier to adjust the small trimmer, than a big padder.

There are two ways of fitting the padding capacitor either at the low potential end of the oscillator coil winding or at the high potential end. Usually it is fixed between the low potential end and ground. If it is connected, however, at the high potential end, it must be mounted clear of the chassis or grounded masses, to avoid an increase of circuit minimum capacity.

### Iron Cored Coils.

For iron-cored coils normally a fixed capacitor only is recommended and the necessary slight adjustment done with the iron core. Iron cored coils exhibit greater selectivity and are in any case of smaller physical dimensions.

Without going into the matter of the accurate alignment of a superhet set, ganging and tracking is often rendered more difficult by too long connections between two points, by unnecessary screening of grid and anode wires and by placing the different coils in the proximity of adjacent earthed objects. The inductance of the coils will be seriously affected, if the distance between

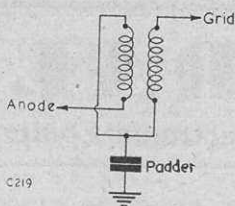

Fig. 1.

the windings and an earthed mass is less than the diameter of the coil. One point earthing for each stage is necessary, but sometimes the earthing of the coils has not been done in the proper way.

The earthy end of the oscillator anode winding should never be earthed directly, but should be connected to the unearthed side of the padding condenser, like the end of the grid winding, except the case of the long-wave coil—if there is one—which should be connected with its anode end direct to chassis. (Fig. 1).

**Wiring.**

All the wiring should be carried out with rigid tinned copper wire of about 18-gauge and all the earth returns from each stage should be taken to their own earthing tag, screwed to the chassis that holds the valve holder for that stage. Particular care should be taken to ensure that no part of the oscillator circuit will vibrate mechanically. Group boards seen in so many surplus receivers, are not always the ideal way to tag down resistors and capacitors. It is a safer practice to solder them direct to their respective valve pins.

**IF-Transformers.**

Though with a slight loss of gain a better selectivity may be achieved by using an IF-transformer in the last stage, that has centre-tapped primary and secondary coils. Using it on the secondary for the signal detector it reduces the damping on the tuned circuit by the signal diode. (Fig. 2). The AVC-diode then may be similarly tapped along the primary for the same purpose. IF-transformers of this kind are now on the market.

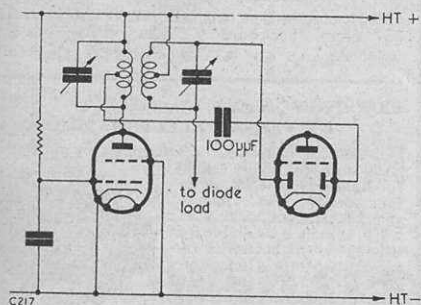

Fig. 2.

The centre-tap of the IFT secondary should be returned to cathode of the double-diode-triode and not to HT positive.

All IF-transformers must of course, be of the frequency for which the coils in use are designed.

The trimmers which may be soldered on the secondary tags of the aerial, RF and oscillator coils are usually adjusted by a small screw, which is in contact with one set of plates. This side of the trimmer should always connect to the earthy end of the coil, to avoid the frequency changing by the additional capacity of the trimming tool while being adjusted.

When the oscillator coil with its anode winding does not give the correct grid leak current or does not oscillate properly, especially in the short-wave band, increasing of the oscillator grid condenser from 100µF to 300—500µF or a slight increase of the voltage of the oscillator anode are suitable remedies. On the other hand the oscillator plate voltage should be as low as is consistent with adequate output.

It is a bad habit to use volume controls with a switch by which the set is switched on and off. The volume control circuit, mostly connected to the grid of the double diode triode, is much too vulnerable a part of the set as to be brought near both mains and RF-wiring.

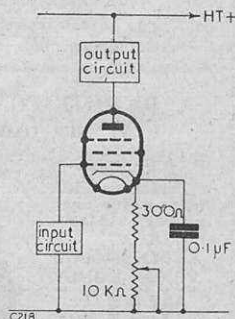

Fig. 3.

**RF Stage.**

A single RF-stage before the frequency changer is always useful, though often not necessary. It comes in handy, however, when a variable mu-valve (EF39) is used and a 10,000 Ω potentiometer provides for the adjustment of the RF-gain. A small resistor of about 300 Ω then gives minimum grid bias. The RF-gain control will often produce a regenerative effect and considerable gain, when turned full on. If there is, however, too much self-oscillation and instability, the small resistor between cathode and sliding arm of the potentiometer should be made larger (500 to 1,000 Ω). (Fig. 3).

Interaction between the oscillator and aerial section may be avoided by placing a screen between the two sections of coils and wafers of the wave-change switch. The leads from all decoupling capacitors to earth must be short and rigid. To cure instability in the RF or IF amplifiers grid stoppers of 100 to 200 Ω, soldered directly to the grid pin or the top-cap of the valve may be used fairly satisfactorily. A stopper of 5,000 to 250,000 Ω connected directly in the grid

(continued on page 483)



# CLYDESDALE

For Bargains in Ex-Services Electronic Equipment

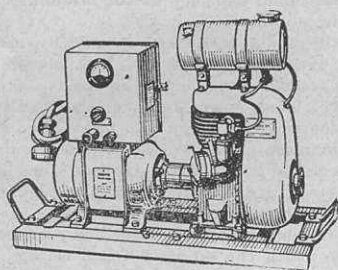

## PETROL ELECTRIC GENERATOR

288 watts, 14/32 volts, 9/15 amps.

JAP. 4 stroke, side valve, air cooled, governed, petrol engine 1 B.H.P. driving a shunt wound D.C. Generator, with control box, cut-out, fuse, ammeter and length of screened cable. Tested in operation before despatch.

CLYDESDALE'S  
PRICE ONLY

**£21**

CARRIAGE  
PAID

Large Selection of other types also available, all sizes. To light a caravan or a factory.

BRAND NEW.

### 12" RECORDING METAL DISCS

Single sided lacquer coated.

In sealed metal box, containing 16.

Priced at 35/- per box

CARRIAGE PAID

### REMOTE CONTRACTOR No. 4

(VENNER TIME SWITCHES LTD.)

A Relay Unit used for remote Switching of Transmitters. Comprising 24V relay and drive mechanism. ON/OFF switch and resistor, etc., in round metal case, with block plastic top, perspex window.

CLYDESDALE'S  
PRICE ONLY

**3/11** each.

POST PAID

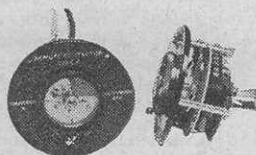

CIRCUITS AVAILABLE. R.1355 I.F. Amp. 1/3., R.F.24, 1/3., R.F.25, 1/3., R.F.26, 1/3., R.F.27, 1/3., C.R. Ind. 62, 1/3., C.R. Ind. 62A, 1/3., C.R. Ind. 6K, 1/3

Don't Miss This.

BRAND NEW. Ex. R.A.F.

### COMPLETE MORSE PRACTISE KIT

as illustrated.



Key Buzzer, and battery on baseboard, size 6½ x 6½ x ½ in. plus: Headphones and Service Signalling Manual.

ONLY

**15/11** Complete

POST PAID

BRAND NEW.

### 12 VOLT 72 a.h. ACCUMULATOR

Standard car type construction. Moulded case, height 8 x 14 x 7 ins. Wing nut terminals.

CLYDESDALE'S  
PRICE ONLY

**£6/15/0** each.

Packed in a wood case.  
CARRIAGE PAID



Ex. R.A.F.

### VERNIER SLOW MOTION DRIVE

A Muirhead Unit with an illuminated escutcheon graduated in degrees, 180-0. Ratio 38.1. Diameter 3 ins. A removable lamp holder plugs into the top of the drive unit and provides a marked logging point.

At **9/6** EACH.



### SILICON CRYSTAL DIODE

CV102, plug-in type, frequency 4250 kcs. resis. forward 269 ohms. backward 9 ohms, noise factor 14db.  
AT 5/- EACH. POST PAID.

BRAND NEW, in maker's carton.

### UNIVERSAL ELECTRIC MOTOR

For 200-250 volts. AC or DC mains by simply wiring, data supplied. Very useful for light bench work, develops better than 1/8 h.p. speed in excess of 2,500 r.p.m. a 1 in. spindle is available for driving when the fan is removed. Motor Generator, type 29. In. 24V. 16a. Out. 1,200V. 200ma. Size 11 x 5½ x 5½ ins.

CLYDESDALE'S  
PRICE ONLY

**25/-** each.

CARRIAGE  
PAID

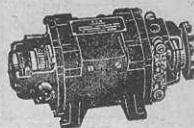

Further Supply Now Available.

Ex. R.A.F.

**BATTERY AMPLIFIER, A1134A**

Two stages, two valves, PM2HL, QP22B, with 3 trans. Mic. QPP input and output, suitable inter-com, pre-amp or modulator unit complete in metal case 7 x 5 x 4½ ins. with circuit, batteries required 120V.H.T. 9V.G.B. 2V.L.T.

Now at **11/6** each. POST PAID

The Electro-Magnetic Mic for A1134A, A1368 and A1219, with switch and short lead

At **5/6** each. POST PAID.

The Junction Panel 10D/1336 for A1134A contains matching sockets, terminal blocks, etc., mounted on board 6 x 4 ins.

At **4/6** each. POST PAID

Ex. R.A.F.

**BATTERY AMPLIFIER A1219**

A two valve, two stage, relay controlled pre-amplifier, similar to A1134A. Valves VR21 (PM2HL) VR35 (QP22B) complete in metal case 7 x 5 x 4½ ins. less batteries.

Priced at **12/6** each. POST PAID.

Ex. R.A.F.

**BATTERY AMPLIFIER A1368**

A two valve, two stage, intercom, pre-amp or modulator unit similar to A.1134A, valves VR21 (PM2HL) VR35 (QP22B) complete in metal case 7 x 5 x 4½ ins. less Batteries. With circuit.

PRICED AT **11/6** each. POST PAID

Johnson "Jumbo" valveholder for CV57, CV174, CV1293, etc. H.V. porcelain base, with retaining clamp. 3¼ x 2½ x 2½ ins.

PRICED AT **2/6** each or **25/-** per dozen. Post Paid

BRAND NEW.

**MIC. AND HEADPHONE ASSEMBLY**

in makers box.

Carbon Power Mic (Tannoy) in diecast hand piece with press switch. Moving Coil H'phones (40 ohm. Coil) sealed and moisture proof with rubber earpieces all wired to a 5 point moulded rubber plug. Ask for E.18.

CLYDESDALE'S  
PRICE ONLY

**15/6** per set.

POST PAID

E402. 5 way chassis socket type ZA2004 for above available at 1/6 each.



Ex. R.A.F.—

**IF/AF AMPLIFIER UNIT R1355**

5 stages of I.F. amplification, 8 valves, etc. A 1st class receiver by plugging-in R.F. units, 24, 25, 26 or 27 (not supplied) in metal case 18 x 9 x 8 ins. Used.

CLYDESDALE'S PRICE ONLY **30/-** each. CARRIAGE PAID

R.F. Unit 26 for 65—50 mcs.

R.F. Unit 27 for 85—65 mcs.

with variable tuning, suitable for alteration. Brand new

in maker's cartons **35/-** each. POST PAID, or used. 19/6 each.

R.F. Unit 24, for 26—30 mcs.

R.F. Unit 25, for 50—40 mcs.

Preset, switched tuning, suitable for alteration. Brand new in makers cartons at 19/6 each, post paid, or used, good condition 12/6 each.

Ex. R.A.F.—

**C.R. INDICATOR TYPE 62 or 62A**

Containing V.C.R.97 CRT. with mu-metal shield, Xtal unit, 19 valves, etc., in metal case 18 x 11½ x 8½ ins. Used, good condition.

CLYDESDALE'S PRICE ONLY **67/6** each. CARRIAGE PAID

For those T.V. experiments.

**CATHODE RAY INDICATORS**

BRAND NEW, Ex. R.N.—APW7336.

Used, good condition 6B. Each having a VCR 97, C.R.T. with mu-metal cover, 7 valves and various potentiometers, capacitors, etc. Complete unit in metal case 18 x 8½ x 7½ ins.

APW7336, at **70/-** each. CARRIAGE  
6B. at **59/6** each. PAID.

BRAND NEW. Ex. U.S. NAVY.

**3" C.R.T. INDICATOR**

Type 3BP1 cathode ray tube, with holder, in tilt-mtg. metal case, which is adjustable to any angle 0-45 degrees and can be locked in any position. Holder has 5ft. or 11 core metal braided cable wired to it. Case has telescopic light shield and glare-proof screen. Overall length 24ins, base 12ins. finish black crackle.

CLYDESDALE'S PRICE ONLY **45/-** POST PAID

CO-AXIAL CABLE.

Coil (12 yds.) first-class co-axial cable, approx. 80 ohms, 12 mm. at 7/6 per coil, post paid.

Any length top grade co-axial cable, 52 ohms 12 mm. at 6d. per yard. Minimum length 20 yds. 10/- post paid.

Now Available—ILLUSTRATED LIST No. 5, 112 Pages. If on our Mailing List your copy will be sent to you without application.

Send now for Illustrated Lists. Please print Name and Address

**CLYDESDALE SUPPLY CO LTD • 2 BRIDGE STREET GLASGOW - C.5**

\*Phone: SOUTH 2706/9

VISIT OUR BRANCHES IN ENGLAND, SCOTLAND AND NORTHERN IRELAND

# Query Corner

A "Radio Constructor" service for readers

## Crystal Filter.

"I am constructing a short wave superhet which is intended primarily for use on the Amateur bands. Would you advise the inclusion of a crystal filter in a receiver of this type?"

D. Lewis, Salfords.

Under normal conditions a half-an-hour spent in operating a superhet receiver on the short wave bands should prove sufficient to convince anyone of the desirability of having some means of increasing the selectivity. For example it is not an uncommon occurrence to find several stations operating in such close proximity to one another that beat frequency whistles are produced. In the majority of cases, these whistles may be reduced in strength, or entirely eliminated by increasing the selectivity of the receiver. Such an increase in selectivity considerably reduces the quality of reproduction but for general communication work this is of little importance providing the intelligibility of the signal is retained.

In the superhet type of receiver the overall selectivity depends mainly upon the selectivity of the intermediate frequency amplifier, and as this amplifier operates at a fixed frequency it is a relatively simple matter to use a crystal filter in order to sharpen its response. There are many different types of filter, the more complex ones employing three or four crystals in order that various degrees of selectivity may be obtained. However, the circuit diagram Fig. 1, shows an arrangement which for all normal purposes has proved highly successful. It makes use of a single crystal which is resonant at the intermediate frequency of the receiver with which it is to be employed.

The IF transformer which feeds the crystal may be of a standard pattern, but should preferably employ adjustable iron cores for tuning purposes. The fixed condenser across the secondary of the transformer should be

replaced by two condensers in series; each having a capacitance equal to twice that of the original component. By this means a centre tap on the secondary circuit is conveniently obtained. The action of this arrangement may be most easily understood by considering it as a four arm bridge, two arms consisting of the centre tapped IF transformer and the remaining two consisting of the crystal and the phasing capacitor. Now consider a voltage having a frequency remote from the intermediate frequency by, say 1 Kc, applied to the transformer. The reactance of the crystal at this frequency will be infinitely high, and the current in the crystal arm will be due to the capacitance of the crystal holder and associated wiring. This capacitance is represented by C.4 in the diagram. As the voltage at the ends of the IF transformer secondary will be in opposite phase, it will be possible, under these conditions, to adjust the phasing capacitor until it passes a current which is equal to the current through C.4. However, as these two currents are antiphase, they will cancel out and no signal will be passed to the IF amplifier valve.

When a voltage having a frequency equal to the intermediate frequency is applied to the transformer, the resistance of the crystal arm, now in resonance, will be very small, and hence the signal will suffer only slight attenuation. It will be realised from the foregoing, that this type of filter makes full use of the sharply resonant characteristics of the crystal. It will be remembered that a crystal has similar properties to a High "Q" series tuned circuit; that is, it presents a low resistance at its resonant frequency and an infinitely high impedance at all other frequencies.

It is convenient to control the phasing capacitor by means of a knob on the front panel of the receiver as it is found that under certain conditions, optimum results are obtained when

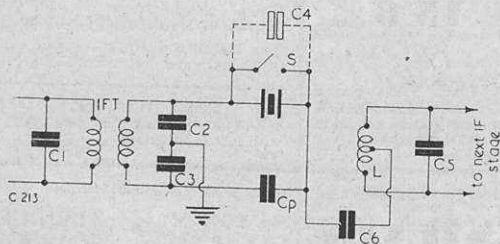

Fig. 1: A typical crystal filter circuit. The capacitance of C2 and that of C3 are equal to twice the capacitance of C1. The value of C6 is  $20\mu\text{F}$ .



the circuit is slightly out of balance. This is due to the fact that when in balance the response curve of the filter is that of the crystal itself, but by adjusting the phasing condenser to unbalance the circuit the response is made asymmetrical. This results in one side of the response curve being made steeper and the other side less steep. Thus when the interference is only on one side of the wanted signal the adjustment of the phasing condenser frequently results in a marked improvement in the signal to interference ratio.

From the circuit diagram it will be seen that the filter feeds into an additional tuned circuit which is adjusted by means of C-5 to resonate at the intermediate frequency. This tuned circuit may be taken from an extra IF transformer or the coil may be wound on a small former, the tapping point is in the centre of the winding. In order to obtain optimum results the crystal should be of the "X-cut" type. This type has a higher resonant impedance than that of the "Y-cut" type, and is therefore more suitable for use in filters which are fed by a transformer having a 1.1 ratio. As a crystal filter introduces a loss into the IF amplifier it is preferable to use two stages in this section of the receiver. In which case, it is convenient to connect the filter between the first and second IF amplifier.

The filter should be constructed in such a manner, that all leads are as short as possible. In order to achieve this, it may be necessary to operate the phasing condenser by means of an extension spindle. The additional coil and its associated trimming condenser should be mounted

## "Query Corner" Rules

- (1) A nominal fee of 1/- will be made for each query.
- (2) Queries on any subject relating to technical radio or electrical matters will be accepted, though it will not be possible to provide complete circuit diagrams for the more complex receivers, transmitters and the like.
- (3) Complete circuits of equipment may be submitted to us before construction is commenced. This will ensure that component values are correct and that the circuit is theoretically sound.
- (4) All queries will receive critical scrutiny and replies will be as comprehensive as possible.
- (5) Correspondence to be addressed to "Query Corner," Radio Constructor, 57, Maida Vale, Paddington, London, W.9.
- (6) A selection of those queries with the more general interest will be reproduced in these pages each month.

in a screening can. Finally it should be noted that the frequency to which the IF transformers are adjusted should correspond with the resonant frequency of the crystal.

If the points mentioned above are observed, and care is taken with the layout of the components in the IF stages, the advantages to be obtained from the use of a crystal filter will be fully appreciated.

## Mullard Cathode Ray Tubes with Standard Heaters for use in DC/AC Television Receivers.

Designers of DC/AC television receivers will be particularly interested in two new cathode ray tubes which have recently been announced by Mullard Electronic Products Limited. These tubes, a 9 inch type MW22/14C and a 12 inch type MW31/14C, have heaters rated at 6.3 volt, 0.3 amps, and may, therefore, be series run with the valves in the television receiver. Although the maximum first anode voltage has been reduced from 400 to 300, in practice this does not prevent direct interchangeability with older tubes as these are invariably operated at a first anode voltage below 300, this being usually obtained from the 300 volt line less the appropriate bias. The new tubes can thus be used as direct replacements in sets which have been using the Mullard

types MW22/7 or MW31/7 according to whether a 9 inch or 12 inch tube has been fitted.

In addition to the MW22/14C another tube, type MW22/14 is also in production. This is similar to the MW22/14C but has a coating of Aquadag applied externally to the flair of the tube, the purpose of which is to act as one electrode of a smoothing capacitor for the E.H.T. supply. This has the advantage that it eliminates the necessity of using a standard smoothing capacitor, thus reducing the cost of the equipment. It should be noted, however, that although the MW22/14 has identical operating conditions and characteristics to the MW22/14C, it is not directly interchangeable with this latter tube on account of the external conducting coating.

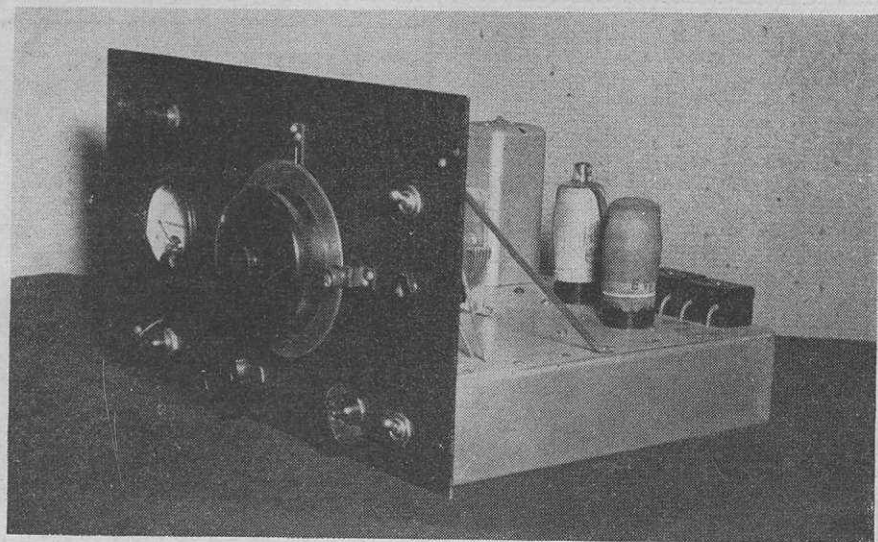

# A Short Wave Battery Superhet

*designed and constructed by*  
P. LUMB, ISWL/G46

**S**HORT-WAVE receivers described in the radio press seem to fall into two types: the straight receiver in its various forms from 0-v-0 to 2-v-2, and communication type superhets. Descriptions of simple superhets are in the minority. Amateur constructors usually start with a simple one-valver and then work their way up until the time comes to build a superhet. It is for such a constructor that this article is intended.

It was the author's intention when work was commenced to make the receiver as cheaply and as economical to run as possible, but at the same time to give an adequate performance. Various valve line-ups were tried, the final arrangement being, Mixer (Cossor 220TH), I.F. (Mazda VP23), detector, A.V.C. and L.F. (Mazda HL23DD) and B.F.O. (Mazda HL23). A B.F.O. was decided to be essential, as also was A.V.C., a reacting detector was therefore ruled out and a separate B.F.O. valve substituted for an output pentode. This resulted in battery economy whilst output was still sufficient for headphones.

## Mixer.

Taking each stage separately we start with the mixer which is quite conventional. The grid circuit is tuned by one half of a two-gang

capacitor taken from an old type 18 Walkie-Talkie, though any other will serve provided that a good slow-motion drive is fitted—the author used a Muirhead. The coils are standard 4-pin, which for 20 and 40 metre bands at least, need no modification. Though coils for 10 metres are also standard 4-pin, two home-made coils, both alike, could be wound. Other bands have not yet been tried, the author having very little interest in them. Standard coils will probably do though it may be necessary to remove a few turns from the oscillator coil. Tracking of the oscillator is achieved by the use of a  $50\mu\text{F}$  variable capacitor C3 across the main tuning capacitor C1. The only other remark needed concerning the mixer stage is that it is not controlled by the A.V.C. line. In such a receiver as this A.V.C. to the mixer would normally be deemed essential, but, as it is intended to add a two-valve R.F. amplifier, both valves of which are to be A.V.C. controlled, the mixer was left alone.

## I.F. Amplifier.

The I.F. stage is also quite conventional except that an "S" meter has been added. Very good meters, ideally suited to this use are available on the surplus market, the one used in this particular case being a 500 microamp 500  $\Omega$

LIST OF COMPONENTS

Resistors.

- R1 55,000 Ω
- R2 20,000 Ω
- R3 5,000 Ω
- R4 56,000 Ω
- R5 47 Ω
- R6 15,000 Ω
- R7 100,000 Ω
- R8 56,000 Ω
- R9 See text
- R10 55,000 Ω
- R11 1.2 Meg Ω
- R12 1.2 Meg Ω
- R13 500,000 Ω
- R14 1 Meg Ω
- R15 1 Meg Ω
- R16 160 Ω
- R17 40,000 Ω
- R18 22,000 Ω

Capacitors.

- C1 0.000127 μF (but see
- C2 0.000127 μF) text
- C3 50 μμF
- C4 0.02 μF
- C5 0.1 μF
- C6 100 μμF
- C7 0.1 μF
- C8 0.05 μF
- C9 0.05 μF
- C10 0.1 μF
- C11 100 μμF
- C12 0.01 μF
- C13 150 μμF
- C14 200 μμF
- C15 0.1 μF
- C16 25 μF 12 volt
- C17 0.002 μF
- C18 200 μμF
- C19 100 μμF
- C20 30 μμF trimmer

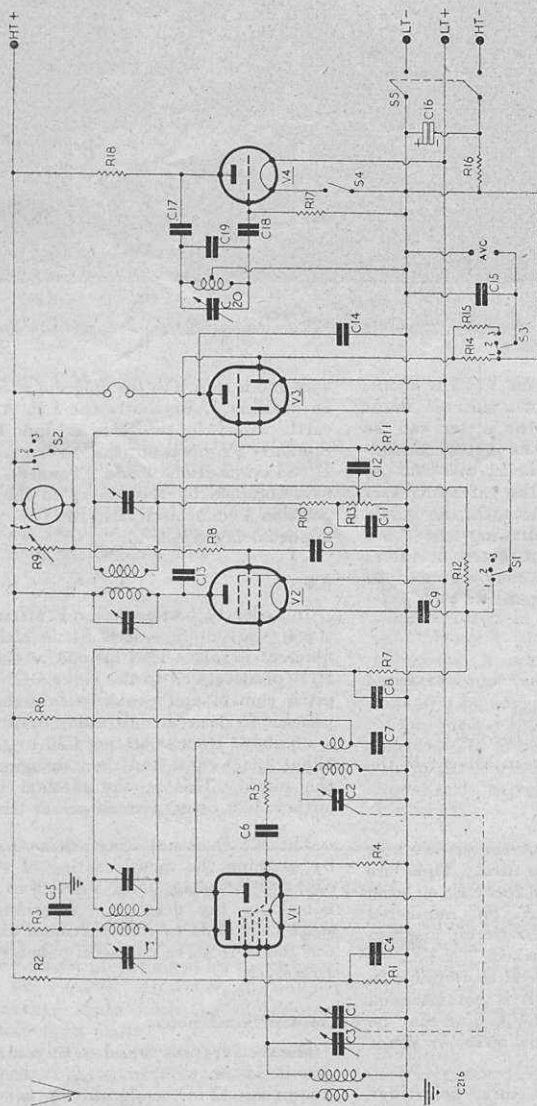

The lead connecting R14 to R16 should not be earthed as shown, but should be shown connected to the junction of R16/C16.

Other Components.

- Chassis, panel and metal for screen
- Slow-motion drive and coupler
- 3 pole 3 way switch
- S.P.S.T. toggle switch
- D.P.S.T. toggle switch
- Headphone jack
- Microammeter, see text
- 7-pin valveholder, ceramic
- Three Mazda octal valveholders
- Two 4-pin valveholders, ceramic
- Standard coils
- 465 Kcs. B.F.O. coil
- Pair 465 kes. IF transformers

Bracket and extension shaft for volume control

- Three terminal blocks
- Tags, tag strips, nuts, bolts, washers, etc.
- Cossor 220TH—V1
- Mazda VP23—V2
- Mazda HL23DD—V3
- Mazda HL23—V4
- or similar



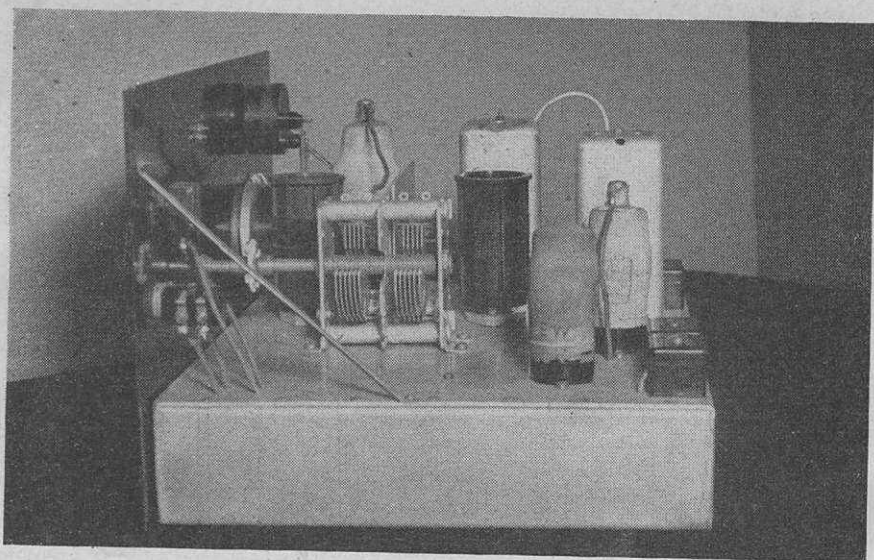

End view of the battery superhet. The position of the above-chassis components can be clearly seen.

model. The screen current to the VP23 is about 0.75 mA. so that by the use of a suitable shunt a 2,000  $\Omega$  variable resistor, the meter can be accurately brought to zero. The meter, incidentally, works in reverse, zero being 500  $\mu$ A. As the A.V.C. voltage applied to the valve increases due to an increase in signal strength, the screen current of the VP23 falls allowing the "S" meter to register. For different meters or valves the following simple formula may be used to determine the value of shunt needed:

$$R = \frac{I_m R_m}{I_s - I_m}$$

where R is the value of the shunt required  
 $I_m$  is the f.s.d. of the meter used

$R_m$  is the internal resistance of the meter

$I_s$  is the standing no-signal screen current of the valve used.

#### Detector, A.V.C. and L.F.

There is nothing fancy about the circuit here except that A.V.C. switching is used. There are three positions—off, A.V.C. to the I.F. on, and A.V.C. to both I.F. and R.F. on, numbered 1, 2 and 3 respectively. In the circuit diagram two terminals are shown marked "A.V.C."—these are to be connected to the R.F. amplifier in due course. Alternatively, if it is not intended to add any R.F. stages, the A.V.C. line may be fed to the mixer by either the series or shunt methods.

The A.V.C. switch used is a three pole three

way and is shown in the diagram as S1, S2 and S3. In position 1, S1 shorts the I.F. A.V.C. lead to earth whilst in positions 2 and 3 it is open. Similarly S2 shorts out the "S" meter on position 1. S3 on positions 1 and 2 connects the 1.5 volts bias obtained by R16 direct to the R.F. valves, position 3 connects R15 to the R.F. valves and so applies delayed A.V.C.

#### B.F.O.

In order to economise in L.T. current in this stage, the on-off switch S4 is included in the filament negative lead instead of the more usual H.T. positive feed to the valve. C20 is used as a pitch control and could be brought out of the panel if so desired. An alternative pitch control is available by first setting C20 to give a beat of about 1,000 c.p.s. and then swinging C3 to vary the pitch. This is the method used by the author, C20 being a small preset trimmer.

The B.F.O. is not screened in any way except by earthing the metal coating of the valve, no capacity coupling being needed to connect the B.F.O. to the detector. Screening the whole stage only adds to constructional difficulties and was found to serve no useful purpose in so simple a receiver.

#### Constructional notes.

The receiver was found to fit comfortably on a chassis 12 in. x 9½ in. x 2 in. deep, the panel measuring 13 in. x 7½ in. A small screen is

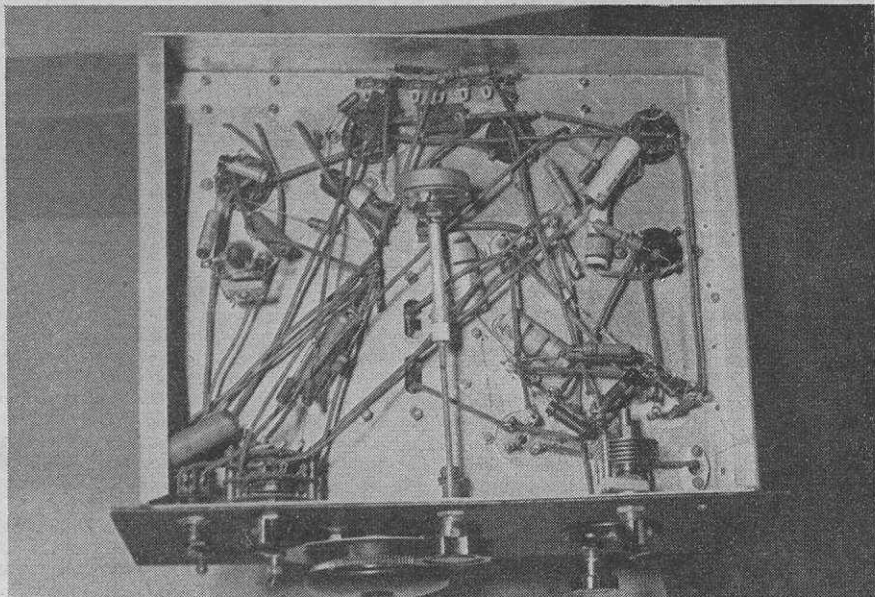

*Under-chassis view of the receiver. The extension rod in the centre is for R13. The capacitor on the extreme right is C3.*

fitted between the two coils. The layout can be seen from the accompanying photographs. Some long leads result but as these are all caused by the A.V.C. switching, none of the set's efficiency is lost. Wiring may be done in any order, all components being easily accessible.

Looking at the front view of the receiver, the knob above the "S" meter is the 2,000  $\Omega$  variable resistor R9, and below the meter is C3. The volume control is in the centre with the Muirhead drive controlling C1 and C2 above. The remaining pointer knob controls the A.V.C. circuits whilst on the right-hand side of the panel the top switch is the B.F.O. on-off switch S4, below which is the 'phone jack and the on-off switch S5 is in the bottom right-hand corner.

#### **Conclusion.**

Nothing fantastic is claimed for the performance of this receiver, though it will pull in DX stations. Its chief merits are that it is simple to construct, it is reasonably cheap and economical to run, and it is simple to handle. Only the I.F. transformers need aligning and suitable generators for this purpose are easy to construct—they have been featured in both the "Constructor" and the "News." In addition, one or two L.F. valves may be added when good speaker strength is obtained. As mentioned earlier R.F. valves may also be added.

Any further information required by intending constructors may be obtained by sending a stamped, addressed envelope to the author at 25, Pearl Street, Starbeck, Harrogate, W. Yorkshire.

## **"RADIO CONSTRUCTOR" SUBSCRIPTIONS**

We will probably be cursed for again bringing up the matter of the paper restrictions—it is difficult to say who is most pained by the subject, ourselves or our readers. However, the subject must be broached again since the subscription situation is now most acute.

With great reluctance we have to announce that we cannot accept further annual subscriptions until further notice. Those readers

who already hold subscriptions will be able to renew when the time comes. Others, desirous of taking out a subscription for the first time, must apply to be placed on the waiting list that has, had by necessity, to be started. Readers on the waiting list will be notified when a vacancy occurs.

We are sorry, chaps, but the matter is just as sore to us!

# Inexpensive Television

By G2ATV & G3AYA

## MISCELLANEOUS DATA

**L**OOKING back over this series of articles, we see that we have omitted to give details of the power supplies for the time base unit. Where a high voltage is used for the cathode ray tube, say from 2,000 volts upwards, it will be necessary to use an HT voltage—smoothed—of 400 to 500 for the time base, in order to give sufficient output to scan the tube face. This voltage is obtained if a transformer rated at 350-0-350 volts RMS at 80mA on the secondary winding is used, as the current consumption of the time base is small. Ordinary full-wave rectification using capacitance input is employed, with an  $8\mu\text{F}$  capacitor on each side of the smoothing choke. The latter should be rated at 10 to 20 Henries at 60mA. The LT winding for the time base is rated at 6.3v at 3A, and for the rectifier 5v at 2-3A. Should it not be possible to obtain quite as large a picture as would be desired, some increase in size will result if the tube is rotated through 90 degrees, and the connections from the time base amplifiers taken to the opposite deflector plates to those shown in the time base circuit, i.e., the "Y" plate connections taken to the "X" plates, and vice versa.

### Aerials.

We have now arrived at the point where some notes on testing, correction of common faults, and operation may be useful. First, the question of aerials. Both the authors are, at the moment, working their televisions on short, vertical indoor lengths of wire. This is, of course, by no means ideal, but our attitude is that if we can, as we do, get satisfactory results in this manner, then by using a decently designed aerial our readers should find it "a piece of cake." There may be, of course, some readers who are unable to erect an outdoor aerial—flat dwellers, for instance—and who decide to follow our example as a matter of necessity. In such a case, the best aerial to erect is a vertical quarter wave, 5ft. 3ins. long, and to couple this to the receiver by a length of co-axial feeder, the outside screening of which should be earthed. Where a loft or attic is available, something better can be achieved. There may be sufficient headroom to erect a vertical half-wave dipole, but if this is not possible, a half-wave dipole can be put up in the form of an inverted "V." The latter will not

give quite so high an input to the receiver, but has an advantage in that it is directional. By suitable positioning, the effects of electrical interference, as from car ignition, or "ghosts" due to the signal arriving from more than one direction owing to reflections, can be eliminated or minimised. Both types of aerial, which incidentally are available as commercial articles, can be reckoned as suitable up to a distance of some five miles from the transmitter.

Where an outdoor aerial can be erected, much better signal to noise ratios can be obtained. For the majority of viewers, satisfactory results will be achieved by using the standard dipole with reflector. To readers located on the fringe of the reception area, we suggest experiments with multi-element arrays, such as a dipole with reflector and director, this may result in steadier pictures, though some loss of quality can be expected owing to the reduced bandwidth of such aerials. Which brings us to another point. Whatever the type of aerial, it should have a reasonably large diameter in order to preserve a wide bandwidth, and can conveniently be made of 1 in. tubing. Also, if a dipole aerial is used, it will be necessary to modify the RF coil in the RF unit of the receiver, or to connect the lower half of the dipole, via its feeder, to the chassis of the receiver, and the top half to the aerial terminal.

### Receiver Alignment.

When purchased, the IF coils of the R1355 will be peaked, at 7.5 Mcs. This restricts the bandwidth of the receiver, and results in poor picture quality. The remedy is to stagger tune the IF's and to adjust the tuning of the RF unit until maximum quality is obtained. The IF's should be adjusted first, the cores being screwed in, or unscrewed, two or three turns each, starting with the last IF at the rear of the strip. The effect on quality should be noted whilst each core is adjusted—it should be borne in mind, of course, that staggering will reduce the sensitivity of the receiver, and the contrast or gain control will need to be increased as the staggering proceeds.

Next adjust the trimmers of the RF unit, starting with that of the local oscillator. We found best results came when these trimmers were tuned towards the sound channel, that is,



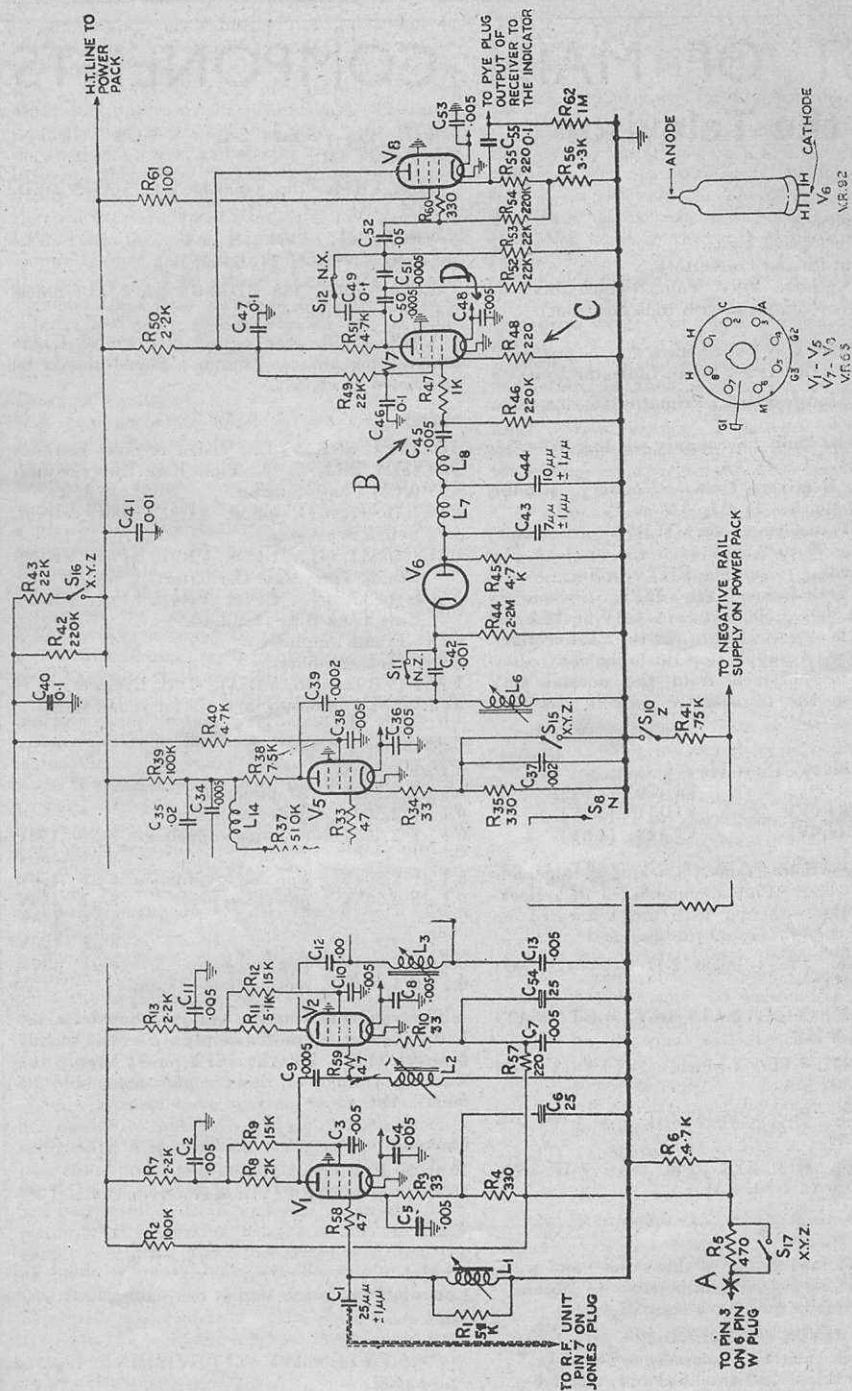

Fig. 9. Circuit of the R1355 vision receiver, the second and third IF stages not being shown. Points at which modifications are carried out are indicated by the lettering A-D. Point 'A'—contrast control fitted here. Point 'B'—C45 removed and bridged or short circuited. Point 'C'—Alteration of bias resistor. Point 'D'—Fitting of bias capacitor. (See December issue)

# LIST OF MAIN COMPONENTS for the Televisor

R1355 Receiver

or

R1426 Receiver

RF25 Unit (Vision Unit).

RF25 Unit (Sound Convertor).

VCR97 Cathode Ray Tube (which may be purchased complete with indicator unit).

or

5CP1 Cathode Ray Tube (which may be purchased with the ID6/APN4 Loran Indicator Unit).

**Mains Transformers.** Primaries to suit mains voltages.

**Time Base Unit.** Secondary winding 350-0-350 80mA. 5V 2A 6.3V 3A.

**Vision Receiver Unit.** Secondary winding 250-0-250 80mA. 5V 2 to 3A. 6.3V. 6A.

**EHT Transformer for VCR97.** Secondary winding 2,000 to 2,500V at 5mA. 4V 1.1A plus heater winding to suit the EHT rectifier.

**EHT Transformer for 5CP1.** Secondary winding 3,000—3,500V at 5mA. 6.3V at 0.6A (see text) plus heater winding to suit the EHT rectifier. The 6.3V 0.6A supply for this tube may alternatively be obtained from the normal 6.3V winding on the transformer used in the time base unit.

**EHT Rectifiers.** (Suitable types).

HVR2 (4.0V). VU120 (2.0V).

VU133 (4.0V). VU111 (4.0V).

VU134 (4.0V). VU113 (4.0V).

**Valve Base Connections.** Looking at underside of valve holder. Pins are numbered in a clockwise direction, starting with pin 1 located on the left of the keyway on the spigot.

**6V6, 6F6.** Pin 1-Shield 2-H 3-A 4-G2 5-G1 6-NC 7-H 8-C.

**6SN7.** Pin 1-GT2 2-AT2 3-CT2 4-GT1 5-AT1 6-CT1 7-H 8-H.

**6AC7, 6J7.** Pin 1-Shield 2-H 3-G3 4-G1 5-C 6-G2 7-H 8-A.

**6J5, 6C5.** Pin 1-Shield 2-H 3-A 4-NC 5-G 6-NC 7-H 8-C.

**5U4, 5Z4, 5R4, 5Y3.** Pin 1-NC 2-H 3-NC 4-A1 5-NC 6-A2 7-NC 8-H.

**6J7.** Pin 1-Shield 2-H 3-A 4-G2 5-G3 6-NC 7-H 8-C TC-G1.

**6H6, VR54.** Pin 1-Shield 2-H 3-AD2 4-CD2 5-AD1 6-NC 7-H 8-CD1.

**VR65-SP61.** Pin 1-H 2-C 3-A 4-G2 5-G3 6-Shield 7-NC 8-H TC-G1.

**EF50, VR91.** Pin 1-H 2-G2 3-A 4-G3 5-Shield 6-C 7-G1 8-Shield 9-H.

**VR92, EA50.** See circuit diagram of R1355 receiver for pin connections. Shield should be connected to chassis.

**Valves.**

5Z4 (5U4, 5R4, 5Y3). Vision receiver rectifier.

5Z4 (5U4, 5R4, 5Y3). Time Base Unit rectifier.

6J5 (6C5) Phase Splitter.

6AC7 (6SJ7, 6J7, EF50, VR91, SP61, VR65).

Synch Separator.

6AC7 (6SJ7, 6J7, EF50, VR91, SP61, VR65).

Frame Time Base Oscillator.

6AC7 (6SJ7, 6J7, EF50, VR91, SP61, VR65).

Line Time Base Oscillator.

6SN7 Frame amplifier.

6SN7 Line amplifier.

EA50 (VR92, 6H6, VR54). D.C. Restorer.

6V6 (6F6) Audio output stage for sound unit.

**Capacitors.**

0.1  $\mu$ F 2,500V

0.1  $\mu$ F 2,500V

0.1  $\mu$ F 2,500V

0.1  $\mu$ F 2,500V

Amplifier to

deflector plate

coupling capacitors. 8  $\mu$ F 450V

8  $\mu$ F 450V

0.1  $\mu$ F 2,500V

0.1  $\mu$ F 2,500V

For voltage doubler

power supply. 8  $\mu$ F 450V

8  $\mu$ F 450V

or

8  $\mu$ F 450V

0.1  $\mu$ F 3,000V

0.1  $\mu$ F 3,000V

For half-wave

rectifier power supply 8  $\mu$ F 450V

The values of working voltage quoted for the half wave rectifier power supply are for the VCR97 network only. For the 5CP1 power supply the working voltage of these capacitors should be 5000V. D.C.

**Chokes.**

10 to 20 H at 60mA (T.B. Unit).

10 to 20 H at 80mA (Vision Receiver Unit).

If you have missed any of this series—and we know that it is virtually impossible to obtain back copies—write now for a copy of—

**DATA BOOKLET 2.**

This booklet, entitled "Inexpensive Television" is a reprint of this series—modified and enlarged—

and contains all you want to know about this popular televisor. Copies are selling fast, so do not delay!

"INEXPENSIVE TELEVISION" is 1/8d. post paid.

towards maximum capacity. A point will be reached where what is known as "plastic" is obtained. This gives a somewhat "flat" picture from the point of view of contrast, but the outlines of objects are sharply outlined. Too much "plastic" gives a white line after a black outline, and vice versa, and should be avoided, but a little of this effect has a definite sharpening quality and is very useful. Care should be taken that the local oscillator trimmer is not tuned too far towards the sound channel, as this will result in interference getting into the time base causing the picture lines to vibrate (pull out), or give diagonal black lines on the picture due to sound interference reaching the grid of the cathode ray tube. The pick-up of unwanted signals at IF or RF may also show up as diagonal lines.

**Common Faults.**

A common fault which is not immediately apparent is loss of interlace. When this occurs, the lines making up the picture can be easily seen on a normal size picture, whereas with correct interlace this is not so. The presence or otherwise of this fault is easily checked by increasing brilliance, when the flyback lines will become visible. These lines should not be "paired." The fault may be due to a wrong setting of the frame frequency control to insufficient synch input to the frame time base, or to interference or feed-back from the line time base into the frame time base.

Vertical black bands appearing on the picture indicate ripple on the power supply to either the vision receiver or the tube network. The reason is insufficient or faulty filtering or decoupling. Even the heater wiring may be the cause of the trouble. Hum in the time base has the effect of causing a wavy edge or edges to the raster, and here again the remedy is obvious. Mains hum on the frame time base may also cause incorrect locking, in which the picture appears to be steady enough, but with the flyback lines superimposed.

We have made a few alterations to certain component values in the time base oscillators since the circuit appeared, resulting in improved linearity and performance. Referring to the circuit diagram, the altered values are now:

R6=47 k Ω    R15=22 k Ω    R22=20 k Ω  
R23=20 k Ω    R30=50 k Ω

Some readers have written saying that they are unable to purchase 0.25 μF capacitors of a sufficiently high working voltage for the time base amplifiers/deflector plates coupling. These are C11-12-15 and 16 in the circuit. These values are not at all critical, and can be from 0.1 μF upwards, at a working voltage to suit the EHT supply. Another point has arisen regarding the circuit we gave for a half-wave EHT supply. Fig. 3, October issue. In the drawing a smoothing capacitor was omitted. This should go from HT+ to HT- on the diagram, and should have a value of 0.1 μF or larger, and a working voltage to suit the supply.

**TELL YOUR OWN SURPLUS STORY**

**Opportunity for Constructors.**

It has been our policy for some time to ensure that we have an article each month dealing with the conversion of surplus gear. We know by now how wise a policy this has proved for those articles have been an overwhelming success and judging from the mailbag the only request is "More, please"!

Not only from readers have we been hearing. Several firms have approached us for permission to reprint several of these articles, and it was due to this, and the letters from readers, that prompted the issue of Data Booklet 2.

The interest, then, in such articles is immense. We can, however, only print such articles as we receive from readers. It is very obvious that many readers must have converted surplus units for various amateur purposes, but very few seem to take up the pen and put their ideas in writing.

It is in an attempt to unearth some of these hitherto unpublished ideas that we announce our Surplus Gear Contest. We invite articles concerned with the modification or conversion of surplus gear or units and for each article accepted we will pay the normal contribution rates. In addition to this we will pay £2 2s. for the best contribution and £1 1s. for the second best.

Details are as follows:—

- (1) The Contest is open to any contributor.
- (2) Any number of articles may be submitted by any one contestant.
- (3) The article(s) must concern the modification or conversion of surplus radio units and components.
- (4) The articles will be judged on their merits, taking into account ingenuity, practicability, and technical soundness.
- (5) Articles need not be typewritten, though this is preferable. This will NOT be taken into account when judging. Articles must be written (or typed) on one side only of paper and all accompanying drawings and sketches (which need only be rough) must be on separate sheets of paper.
- (6) All articles must be accompanied by a suitable SAE for return or acceptance.
- (7) The judges do not accept responsibility for MSS, which are submitted at owners risk.
- (8) The judges shall be the Editorial staff of "Radio Constructor" and their decisions shall be binding.
- (9) The closing date of the Contest is March 12th, 1949.
- (10) The winners will be announced in the April issue.

(continued on page 483).



# Q.R.P. Transmitter for 7 Mcs

By G. PENNINGTON, ISWL/G1185

**T**HE small transmitter to be described probably has its counterpart in hundreds of "shacks" throughout the world, for it is not far removed from the basic oscillator and modulator. However, despite this fact it is well worth the making, even if serious Q.R.P. work is not being undertaken, for there are very few amateurs who have never felt the need for a small "stand by" transmitter, when their main outfit was out of action for repair or for reconstruction.

## Circuit.

One glance at this is sufficient to reveal that it consists of two entirely separate valve circuits.

On examining the first of these—the pentode circuit—it will be seen that it forms a simple crystal-controlled oscillator, the anode circuit of which, contains a tuning arrangement, consisting of a coil (L), and a capacitor (C<sub>1</sub>). The crystal which governs the frequency of the oscillator, is contained in the grid circuit.

If the triode circuit is examined it will be revealed that it forms nothing more than a small low-frequency amplifier. The purpose of this is to amplify the minute output obtained from the microphone, until it is strong enough to modulate the oscillator.

Power from the tank coil, i.e., the coil in the anode circuit, is transferred to the aerial by means of a link coupling. It is essential that the latter should be well insulated from the tank coil.

## Components.

An output pentode is needed for the oscillator, and a low-frequency amplifying valve is needed

for the modulator. Types used originally were a KT2(Marconi) Pentode, and a 210LF(Cossor) Triode. No matter what kind of pentode is employed, the screen grid voltage should be experimented with, in order that the maximum efficiency be obtained.

The fixed capacitor (C<sub>2</sub>) should be of the flat mica type, and it is essential that it is not of the tubular type.

The microphone must be very efficient, and capable of giving a fairly high output without sacrificing quality.

A milliammeter of the moving coil type, and of a reliable make, should be chosen. It should give a maximum reading of 40mA., but one with a lower maximum reading can be used, providing that a suitable shunt is used in conjunction with it.

## Construction.

Originally a base-board and ebonite panel were used, but a metal chassis can be employed, if it is so desired. However, under such circumstances, it is very important to see that the variable capacitor (C<sub>1</sub>) is completely insulated from the chassis. The dimensions for both panel and base-board are given in the layout plan. It is worthwhile purchasing two metal brackets, in order to ensure that the panel cannot vibrate.

## Operation.

After making quite sure that no excess voltage is making its way to the filaments, the valves can be inserted, and the batteries switched on.

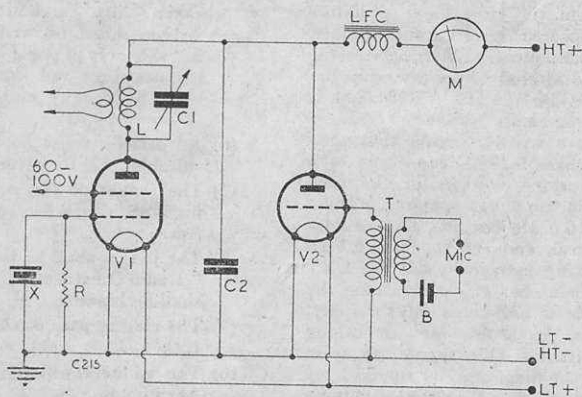

Theoretical circuit of the transmitter. Component values are C<sub>1</sub>, 50 $\mu$ F; C<sub>2</sub>, 0.001 $\mu$ F; R, 50,000.

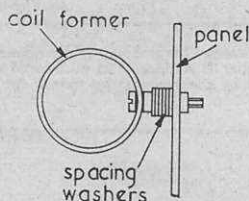

Method of fixing tank coil to the panel.

"Tuning up" the transmitter can then be commenced.

This is done by finding the position of the variable capacitor ( $C_1$ ), which causes the needle of the milliammeter to drop to a lower reading than it normally registers. At this point the circuit is said to be at resonance, and the transmitter is ready for use.

Although the transmitter is primarily intended for the 40 metre band, it can also be used on the lower frequencies, and on the 20 metre band, providing that the necessary crystals and coils are available.

The coil used, was wound on a three inch tube of paxolin, one and a half inches in diameter. It had twenty-two turns, which were kept in position by a thick coating of shellac. No. 18 S.W.G. wire was used, and it is advisable to use wire with some form of insulation. The coil was fixed to the panel by means of two thin bolts, an inch in length. A gap was maintained between the coil and the panel by means of spacing washers.

As it has already been mentioned, a link is used to couple the aerial to the tank coil. This link consists of two turns around the centre of the tank coil. They can be held in position by means of a very small amount of pitch.

**Ediswan:** A useful addition to ones valve data literature is the new leaflet issued by The Edison Swan Electric Company Ltd., which gives comprehensive details of Ediswan Special Purpose Valves. The valves dealt with include types for Industrial Applications, Communications, Rectification, Electro-Medical and so forth. Copies may be obtained from 155, Charing Cross Road, London, W.C.2.

(Continued from page 481)

- (11) The author who is judged to have submitted the best article will receive the normal payment plus a bonus of £2 2s. The second best will receive a bonus of £1 1s. Other articles submitted, and accepted, will be published and paid for at our normal rates.
- (12) Articles should be addressed to "Surplus Contest," c/o Radio Constructor, 57, Maida Vale, London, W.9.

(TROUBLE SHOOTING)

—continued from page 471)

lead of the output valve keeps HF-current from the grid.

The frequency changer preferably used nowadays is the Brimar type 6K8G or 6K8GT, of which the first one is the glass type while the second one is in a metal shell. This metal type has its pin No. 1 connected to the metal shell, which should therefore, be connected to the cathode, while pin No. 1 of the glass type is led to chassis. To support the almost complete isolation of signal frequency and oscillator frequency within this valve, it is a good plan to place the 0.1  $\mu$ F cathode decoupling capacitor (mica) from pin 8 across the valve holder between pin 4 and 5 to earth.

When wiring a superhet high-potential RF-wires must be kept well spaced from the chassis or grounded metal masses and should be connected as directly as possible between the points to be connected. So-called "neat" wiring, with wires thoroughly bent at right angles, is a thing of the past. When RF-wiring has to pass through the chassis, feed-through insulators should be used or the holes made specially wide and lined with rubber grommets. Valve holders should be mechanically strong. Paxolin holders often lack the mechanical strength and the ability to hold the valve tight.

The shorter the wavelength the home constructor wants to receive, the more important becomes the placing of components and the wiring, since every inch of wire may constitute a tuned circuit. Sometimes interaction takes place between the aerial lead to the wavechange switch and the anode lead of the first IF-valve. In this case, it would be better to screen the anode lead than the aerial lead, which often carries a voltage of higher frequencies than the IF. Even an aerial series capacitor which is badly situated may prove troublesome.

Finally the fact should always be borne in mind, that a basic rule for all wireless sets is, that they have to be provided with a copious amount of high tension. All modern valves can produce an undistorted reproduction only, if they are able to work on the straight part of their grid-volt-anode-current characteristic. If the HT is inadmissibly reduced the valve does not get the necessary anode voltage and is unable to produce strong signals without distortion. Often the whole trouble with a superhet is its lack of high tension, where it should be and of too much HT voltage, where it should not be, namely on the oscillator anode.

THAT GREMLIN AGAIN.

Words fail us when we think of that printer's error in the last issue where our illustrious journal was labelled "Radio Konstruktor." All we can think of is that the compositor was trying to bring a little *Kultur* into our lives! Or was it that he entered into the Xmas Spirit a little early?

# SMALL ADVERTISEMENTS

Readers' small advertisements will be accepted at 3d. per word, minimum charge 3/-. Trade advertisements will be accepted at 6d. per word, minimum charge 6/-. If a Box Number is required, an additional charge of 1/6 will be made. Terms: Cash with order. All copy must be in hand by the 10th of the month for insertion in the following month's issue.

## PRIVATE

**WANTED RADIO CONSTRUCTOR**—September, 1948, Buy or loan. Southwood, 70A, The Green, Southall, Middlesex.

**WANTED URGENTLY.** Circuit Diagram for R.A.F. Receiver No. 78.—Harrowell, 78, Hamilton Cres., Harrow.

**EX-R.A.F. T1154 transmitter.** Has been used on ham bands. Buyer to collect—£3 only. Marconiphone 10-inch mains energised speaker, complete with power pack, in strong cabinet. 200-250 v. AC. Excellent quality 30/- plus carriage. 1946 ARRL Handbook 7/6. Box 1043.

**AC ALL WAVE** Signal Generator for sale: Output attenuator, internal mod. or RF outputs, percentage modulation control, 360 degree dial, 200-250 v. AC operation. Demonstrated by arrangement. Price £5. Write or phone first. G2ATV, c/o SWN. (Cunningham 6579).

**"SHORT WAVE NEWS" CORRESPONDENT REQUIRES ACCOMMODATION IN BRISTOL.** Preferably with SWL or Ham. Please state terms, etc. to "Monitor," c/o Short Wave News, 57, Maida Vale, W.9.

**1117 WAVEMETER with Manual, £2/10.** Wavemeter D1 with crystals and manual, £4. Transformer 460-0-470v, 400 mA, 6.3v 3A, £1. 0-1mA moving coil meter, 5/— Roninson, Matmore, Brundall, Norfolk.

## TRADE

**COMPONENTS** for all circuits. Eddystone, Raymart, Wearite, JB, Allen, etc. Order from Smith, 98, West End Road, Morecambe. Send for lists. Quick service. Eddystone '640' £27/10. Westehta £7/15. 145 Mcs Guide 1/6. "P" Coils 3/-. Valves, Speakers, etc.

**TELEVISION MAGNIFYING LENSES** of famous make. To fit any and every make of receiver. JUST IN. OUR PRICE from £5/19/6:—Duke & Co., 219, Ilford Lane, Ilford, Essex.

**DUKE & CO. CLIENTS.** Stamps only please when sending for lists of valves from 3/6d. and receivers.—219, Ilford Lane, Ilford, Essex.

**QSL's and G.P.O. Approved Log Books.** Samples free.—Atkinson Bros., Printers, Elland.

**VALVES**—10,000 in stock. Most types available. Send for valve list, enclosing S.A.E.: Ransom, Bond Street, Brighton.

**G6MN** for the "best" QSL's and approved log books, send for samples: G6MN, Bridge Street, Worksop, Notts.

### TELEVISION NEWS :—

### EHT TRANSFORMERS 30/-

Input 230v — Output 2kv

### Set of metal-rectifiers for above 14/-

0.1μF	2.5kv	1/6
0.25μF	2.5kv	2/6
8.0μF	450v	3/6

Send for list of full details.

### GARLAND RADIO (Dept. R.C.)

4, Deptford Bridge, London, S.E.4

Phone: TIDeway 3965.

## Henry's Radio Component Specialists

We have the most comprehensive range of Radio Components of every nature.

Our reputation is your guarantee.

If unable to call, please send stamp for current price list.

(Dept. RC)

**5 HARROW ROAD, W.2** PADDINGTON 1008/9

(Opposite Edgware Road Tube)

No Shop keeps all you want—we keep more than most. That's why people say—

*"You'll probably get it at*  
**SMITH'S**  
*of Edgware Road"*

Pay us a visit and see for yourself

**H. L. SMITH & CO. LTD.**

287-9 EDGWARE ROAD, LONDON, W.2

Near Edgware Road Met. and Bakerloo

Phone PAD: 5891 :: Hours 9-6 (Thurs. 1 o/c.)

## BARNES RAD-ELEC CO.

12 Pipers Row, Wolverhampton

Xmas may be over but the ideal present is still a Communications 8 Valve R1116 Battery Set: Tesied: 2.v. 120 v. 15-2,500 M: Collected, £10 £11 delivered in special case: Send for leaflet 3d. S.130 New Year Lists, thousands of bargains 3d. S.130 Stabiliser Valves 5/6; Yaxleys Switches, 1 pole 6 way each of 2 banks 2/9; Robust Morse Keys 1/9.



# For Your Reading

## MAGAZINES.

### "Radio Constructor."

Published monthly and designed to cater for the home constructor, giving details of receivers, transmitters, test gear and other radio equipment. Price 1/3 monthly.

### "Television News."

Published monthly for the viewer. *Television News* gives details of forthcoming programmes, criticisms of past features, articles on stars and personalities of television and details of the latest developments both at home and overseas. Essential to the keen viewer. Price 1/- monthly.

### "Short Wave News."

The third of our magazines, catering for the "DX" fan. Up-to-date news of VHF, broadcast band and amateur activity are published in each issue in addition to constructional articles, exclusive news of the International Short Wave League, "visits" to ham shacks and other features of interest to the short wave enthusiast.

Price 1/3 monthly

*These magazines are distributed through local book-sellers. A limited number of annual subscriptions can be accepted, but please write first for confirmation. Sample copies will be sent on request.*

## OTHER PUBLICATIONS.

### "The Short Wave Listener's Annual."

The 1948 Edition of our famous Year Book has 112 pages crammed with data, much of it exclusive, of vital interest to the SW listener. Call Signs, Country Lists, Radio Zones, Call Areas, QSL Bureaux, BS Station Addresses, Codes, Station Lists, DX Maps, Propagation, Identification, Slogans, When to Listen, are only a few of the features that go to make this Annual a "must" for all those who take an interest in SW listening. Price 3/6

Few left only—Write first

### "These You Can Hear."

This booklet, well illustrated and printed on art paper throughout, was published to afford an opportunity to those who had just decided to take up the hobby of SW listening. Containing information of how to tune in stations, when to listen, and details of many internationally known stations this booklet is ideal for those just starting the hobby and of great interest to those who have already been bitten by the bug. Price 2/-

### Data Booklet No. 1.

The first in this series, this booklet deals with the now famous "Basic Superhet." It describes the construction of the basic receiver and various "add-on" units which may be added when the basic receiver has been built. Full coil and valve details are given. Price 1/-

AMALGAMATED SHORT WAVE PRESS LIMITED.  
57, Maida Vale, Paddington, London, W.9.  
Telephone: CUNningham 6579.

## PROOPS of Kingston-on-Thames offer GUARANTEED GOODS at amazing prices

All prices include carriage and Packing.

1½ Metre Receiver R.D.F.1. with full smoothing 3 x 8 x 8, valve line up:—1-5Z4, 1-VR137, 5-VR65 2-VR66, 3-VR91, 1-VR63, 1-VR54. Including 3 circuit diagrams with explanatory notes for the easiest conversion to television, sound or vision, also can be modified for 2 metres. All units guaranteed

OUR PRICE 57/6.

A.F. Amplifier Type A1271 in metal case 5in. x 5in. x 4½in. containing 1-VR56 (EF36) Input and output transformers, relay, volume control, 7 resistors and 5 capacitors, all useful components.

OUR PRICE 6/9.

Meters. 0-3.5 Amps RF thermocouple 2½in. panel mounting.

OUR PRICE 2/6 EACH

Crystals. Boxed, new, range 3,000 to 8,900 Kcs.

OUR PRICE 7/6 EACH

Please write for our extensive price list of Government surplus components and equipment.

PROOPS BROS., LTD., (Dept. D),  
39, Cambridge Rd., Kingston-on-Thames,  
Surrey.

Tel: KINGston 4614.

TELEVISION CONSTRUCTION FROM EX. GOVT. GEAR is becoming all the rage. THE RADIO CONSTRUCTOR Data Book No. 2 gives details of converting the R1356 Receiver and RF unit, 25, using the Type 6 Indicator for vision. We can supply these three units for only £5 5, the Data Book being supplied gratis. Call or send for these without delay. A recent large purchase of R1355 receivers enables us to make this reduction, but we anticipate the demand to be heavy. Please add 12/6 Carriage and 10/- deposit on packing case.

GEE INDICATOR UNIT 62A. Contains 12 valves EF50, 2 type EB34, 4 type SP61, 3 type EA50, and 6in. tube VCR 97, also shoals of potentiometers, capacitors, resistors, switches, etc. ONLY 99/6, or a few only BRAND NEW 20/- extra. Carriage, etc., as above.

AMERICAN INDICATOR APN4. Contains 3 valves 6SL7, 14 of 6SN7, 6 of 6H6, 1 of 6SJ7, 100 Kcs. Crystal, and 5in. short persistence CRT type 5CPI. Makes an ideal scope. ONLY 79/6. Carriage, etc., as above.

END OF YEAR STOCKTAKING SUNDRIES offered are: 90in. Telescopic aerials 4/11, Hand Microphones with Press Switch and lead 3/6, Moving Coil Microphone Inserts 2/-, Hand Torch with 2 type U2 cells 2/6, 2½in. 0-1 Milliamp FSD meters scaled 0-100, 15/-, 500 microamp meters 17/6. All above items are BRAND NEW. Please add postage. CWO please. SAE for lists.

Open until 1 p.m. Saturdays, we are 2 mins. from High Holborn, 5 mins. from Kings Cross.

U.E.I. CORP, The Radio Corner,

138, Grays Inn Road, London, W.C.1.

(Phone: TERminus 7937)