

Radio Constructor

Vol I No. 8

Annual Subscription 16/-

March 1948



Editors :

ARTHUR C. GEE, G2UK

W. NORMAN STEVENS, G3AKA

Advertisement & Business Manager :

C. W. C. OVERLAND, G2ATV

The Question of Transmitter Power

IT is good to see our national radio society—the Radio Society of Great Britain—reminding its members in a recent editorial in the "Bulletin" of the menace excessive transmitter output can be, when used for communicating over distances at which much lower power would give reliable communication. We have already drawn attention to this evil in an editorial in the "Short Wave News" as far back as September, 1946—an editorial which nearly lost us some of our best friends! We still stand by what we wrote then, and it is comforting to find the RSGB going even further and suggesting that amateurs should operate at inputs as low as possible—even below their licenced power—whenever reliable communication can be obtained at low power.

Readers of the QRP column in the "Short Wave News" will already know what can be done with really low power. Inputs as low as 3 watts have given reliable communication over distances covering most of the British Isles, and provided some higher power station does not come on a nearby frequency, communication can be maintained given suitable ionospheric conditions. In the congested state of our bands these days, there is a great temptation to push up one's power until one can crash through the QRM. This selfish attitude may be in keeping with current outlook, but it is not in keeping with the traditions of Amateur Radio. We feel that the appeal to use as low power as possible cannot be too frequently made. So we repeat it here. "Keep down your power to the minimum consistent with conditions."

To those who have their transmitter power limited by conditions beyond their control, we would like to offer some encouragement. From recent enquiries we have made it would seem that the great majority of British amateurs are using inputs ranging from 30 to 60 watts and are getting very satisfactory results both on phone and cw. Some of the best DX has been worked on 14 and 7 Mcs. with not more than 60 watts and plenty of pleasurable

phone contacts of the short-skip variety are made daily, with inputs of 30 watts. The only thing which spoils the reliability of these contacts is the activity of some of the high power stations. So once again, see how little you can get across with. We agree that if you want to work DX phone with the Antipodes, you'll need all of your 150 watts, but there is more in amateur radio than just working DX, and you certainly do not need 150 watts for the majority of contacts—and the most enjoyable contacts at that—which you will make.

EDITORIAL

Talking of power, reminds us that we hear many complaints on the air these days of transmitter output dropping to useless levels, through a fall in the mains voltage. Sunday morning, when the housewives get started on Sunday's dinner is a particularly bad time. It seems to be generally thought that this drop in power is due to a fall in transmitter H.T. voltage, but if you will take the trouble to measure it, you will find it does not drop as much as the plate current meter would suggest. The trouble is with the filament voltages. One transmitter which was particularly susceptible to mains voltage drop produced the following set of data. A fall in mains voltage from 250v. to 212v.—quite a common occurrence—produced a drop in H.T. of 100 volts only—from 720 to 620v. The input however fell from 100 watts to under 30! On checking the filament voltage it was found to have fallen from 6.3 volts to 4.25 volts. Valves of the 807 class are particularly susceptible to a low filament voltage and the great drop in output appeared to be due to this cause alone. The incorporation of a multitap selector switch on the mains input side of the filament transformer and an A.C. voltmeter permanently connected to the mains enabling the correct tapping on the transformer to be selected, immediately cured the trouble. Incidentally this switch enabled a voluntarily reduction in transmitter power to be most conveniently made, so that the policy advocated in the above paragraph really could be put into practice. A.C.G.

AUTHENTIC AND UP-TO-THE MINUTE INFORMATION ON V.H.F., BROADCAST BAND AND AMATEUR ACTIVITIES IS GIVEN IN OUR MONTHLY PUBLICATION "SHORT WAVE NEWS."

CHOKES

By Centre Tap

IN American radio literature R.F. and L.F. chokes are often referred to as "choke coils" and "filter inductors" respectively, names which aptly describe the purposes they serve, and this month it is proposed to briefly survey their construction and use.

An R.F. choke is essentially a coil offering an extremely high impedance to alternating or pulsating currents while it permits direct current to flow with little or no hindrance. It is thus used, and very effectively, to prevent A.C. from reaching stages where it is not wanted, and a well designed choke may have an impedance of several thousand ohms to a wide frequency range.

At its best an R.F. choke is little more than a compromise since it can only have its optimum efficiency at one particular frequency range, although the falling away is usually gradual enough to work satisfactorily throughout a given tuning band.

To reduce self-capacity (which in a perfect choke would be non-existent) it is wound in three or four banks or pies, but with UHF chokes the length of wire needed is so short that it can conveniently be wound single layer on a glass tube or other low-loss material. They are simple to make and frequently wound by experimenters, the length of wire used being equal to one quarter wavelength for which it is designed. One intended primarily for the 40 metre band would have 10 metres (roughly 11 yards) of say, 36 gauge silk covered or enamelled wire wound on a suitable small diameter cylinder.

For use on the broadcast bands it is usually better to buy one of reputable manufacture, unless one is keen on that sort of work, particularly as a well-designed choke should have a high impedance in each of several bands. Indeed some R.F. chokes offer a high impedance over quite a wide range of frequencies, in effect being equal to two chokes connected in series. This type are often "polarized" in the sense that they have to be connected a given way round with the correct end to the "hot" side of the circuit.

Similar practice is common in amateur use, particularly in S.W. converters and in all-wave sets, when a normal and a S.W. choke are used in series. In all such instances the latter should be connected to the anode of the valve.

Except when in series in the same circuit, R.F. chokes must be positioned well away from or in a different plane to each other and from coils, etc., otherwise they are liable to give rise to magnetic coupling between different parts of the circuit—the reverse of what it is intended to do.

L.F. Chokes

Low or audio-frequency chokes are basically high inductance coils wound on laminated iron cores. While they have a number of uses such as choke output filters etc., their chief use for filtering out hum in the power circuit of mains operated equipment.

Chokes designed for use on A.C. mains only have their laminations interleaved as in power transformers, but in those for use on D.C. the laminations are mounted the same way throughout. It is the latter in which we are most interested in receiver and transmitter design, and it is important for the beginner to note that the gap often visible at the ends of the limbs is intentional and should not be disturbed.

The direct current magnetises the core, reducing the inductance, and the air gap is left to counter the effects of saturation. It actually reduces the initial inductance but it maintains a higher value under heavy load. A choke with a very small, or no gap, has a high inductance at low values of current, but saturates easily when heavier currents are passed. Thus with low values of current their inductance is relatively high falling rapidly to a comparatively low inductance as the current increases. This type is known as the "swinging" choke and advantage is taken of this in several radio applications where the current varies considerably and it is necessary to keep the D.C. output as constant as possible. A well designed swinging choke would vary between 5 and 20 henries, and examples of its use are found in filter circuits particularly those fed by mercury-vapour rectifiers (reducing the surge on switching) and also in Class B audio amplifiers where the current may vary by as much as 1000%.

It should also be appreciated that the gap is of importance with chokes not intended for swinging—its misadjustment will lead to variation of the inductance. Manufacturers frequently fit paper, mica or fibre spacing inserts in the gap to prevent its disturbance. It is usually about 5 thousandths of an inch in a normal L.F. choke and in the home wound variety the

gap, if critical as it may be in sensitive receivers, can be found by experiment. To do this when used for smoothing, loosen the bolts, switch on and with the volume fully up while no signal is being received, adjust the size of the gap until hum is at a minimum. Suitable material can be inserted to ensure the gap remaining fixed before re-bolting the clamps. It is worth noting too when a smoothing choke is

mounted on the receiver chassis, orientation or slight change of position may be helpful in reducing hum. An unscreened choke inherently has a big "field."

Experiment can also be made in L.F. chokes used for output filters, decoupling, etc., in adjusting the gap if they are NOT of the type recommended by the set designer and any doubt is felt as to their suitability for the job on hand.

FROM THE MAILBAG

Use of Screened Wire

Your article in the November number on the 150 watt TX Modulator referred to method of using screened cable. I would like to submit a hint on the use of this cable for the benefit of other readers. The method explained ensures good electrical connection of screen to earth, obviates the risk of damaging the insulation and makes a very neat and clean job. (Sample enclosed).

Here is the procedure:

- (1) Cut off a length of cable about 1 inch longer than the distance between the two connecting points.
- (2) Unravel the screen covering at one end for about 1 inch.
- (3) Bring the screen strands together at one side and twist together tightly.
- (4) Cut around the insulation material to leave about $\frac{1}{8}$ inch of it exposed. Slide off the surplus insulation.
- (5) Repeat the above with the opposite end of the cable.
- (6) Tin the two ends of the cable and the two twisted ends of the screening. The length of cable is now ready for use.
- (7) When fitted in position, solder the two twisted ends of the screening to the nearest earth point.

The accompanying sketches will explain the procedure quite clearly. Hoping this little hint will be of assistance to readers.

J. C. DIXON (Preston, Lancs.)

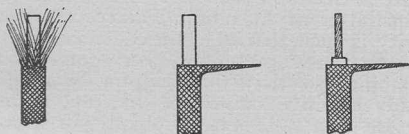

(a) Preparing the cable

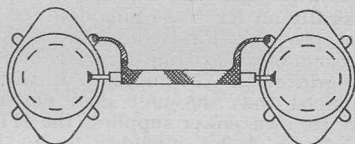

(b) The cable wired in position

Cutting Large Holes

How do YOU tackle the question of making a large hole in a chassis, such as that required for some types of mains transformer? The usual method advocated is to drill a series of small holes around the periphery, open these out into one another, and finish off with a file. Personally, I find this method involves breakage of too many drills, not to mention hard work, and do it this way. First, I drill a $\frac{3}{8}$ in. diam. hole in each corner except one, and with a small file open these to the outline. This enables a hacksaw blade, fixed in a padsaw handle, to be inserted, and the rest is plain sailing. One point to be watched is that the blade should not project more than 3 in., otherwise it tends to bend.

E. J. Clarke, ISWL/G10

(Brentford, Middx.)

NOTICES

THE EDITORS invite original contributions on construction of radio subjects. All material used will be paid for. Articles should be clearly written, preferably typewritten, and photographs should be clear and sharp. Diagrams need not be large or perfectly drawn, as our draughtsman will redraw in most cases, but relevant information should be included. All MSS must be accompanied by a stamped addressed envelope for reply or

return. Each item must bear the sender's name and address.

COMPONENT REVIEW. Manufacturers, publishers, etc., are invited to submit samples or information of new products for review in this section.

ALL CORRESPONDENCE should be addressed to "Radio Constructor," 57 Maida Vale, Paddington, London, W.9. Telephone CUN 6579.

A Television Sound Adaptor

By A. E. Rial

THE writer of this article is building a television receiver, using mainly war surplus components. As a perfectly good amplifier was available, it was thought that a considerable saving in cost would be obtained if for television sound reception this amplifier could be utilised, hence the adaptor about to be described.

At a location some 15 miles from the transmitter at Alexandra Palace, the sensitivity is such that all gain controls have to be set near minimum for comfortable listening, so that this adaptor should be quite effective anywhere in the normal service area, and most probably for a considerable distance beyond.

The Circuit

Reference to the theoretical diagram, Fig. 1, will show that the circuit employed is basically an RF stage plus detector, with output provision for feeding into the pick-up sockets of an existing receiver, or to the input grid of an AF amplifier. It will also be noticed that the unit does not incorporate its own power supplies, the HT and LT voltages being intended to be taken from the auxiliary apparatus, or from a separate power unit. 200-250 HT and 6.3v. LT.

The aerial is coupled inductively to the

RF tuned circuit L2/C1-CT1. The diagram indicates the connections for a single wire or marconi aerial; where a dipole is to be used the two feeders should be taken to both sides of the primary winding, the earthy end of L1 being taken to a separate terminal for the purpose, and not to chassis as shown. The chassis connections, by the way, are shown in an unusual manner on the diagram, and illustrate the system of taking all the earth connections of each stage to a common point on the chassis. One reason for this is to eliminate any wiring being common to two circuits, such as the grid and anode; even an inch of wire in common may be sufficient at these higher frequencies to cause instability. This method also helps to prevent unwanted coupling between stages.

V1 operates as a straightforward RF amplifier, with the gain being controlled by the variable screen potentiometer VR1. Tuned grid coupling to the following stage is employed, using a VHF choke in the anode of V1. The second EF50, V2, operates as a leaky grid detector in the usual manner. Regeneration is employed, the necessary RF being fed back from the cathode via a tap on L3. The more common reaction winding could be used, but as the

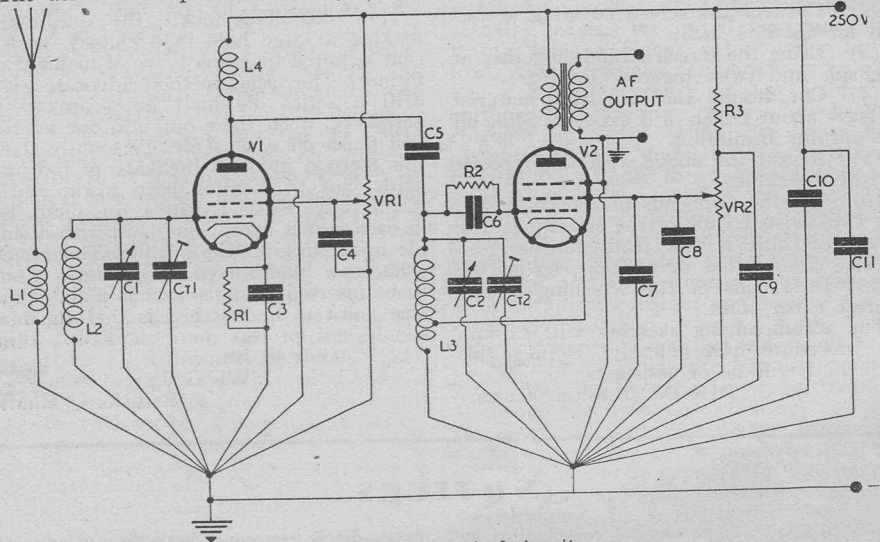
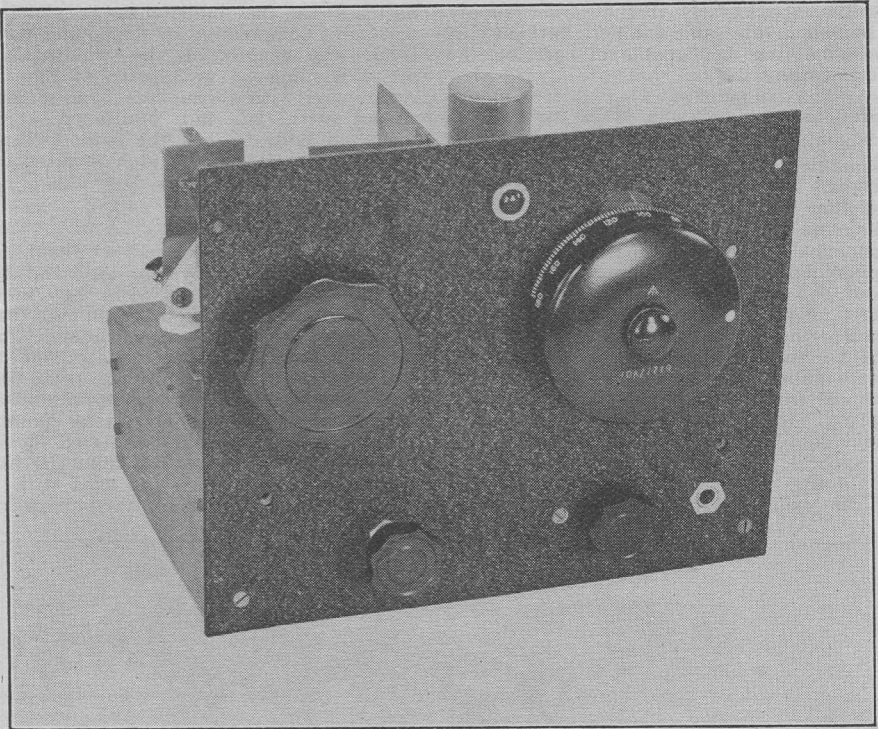

Fig. 1. Theoretical circuit

C1, C2 20 μF	C5, C6 100 μF , mica	C11 0.005 μF , mica
CT1, CT2 30 μF	C8 2.0 μF	R1 50 \sim
C3 50 μF , mica	C9 0.01 μF	R2 3 M \sim
C4, C7 500 μF , mica	C10 4.0 μF	R3 10000 \sim
VR1, VR2 50000 \sim	L1, L2, L3, L4 See text	



Front view of the adaptor. The controls are: (top left) RF tuning (C1); (top right) Detector tuning (C2); (lower left) RF valve screen control (VR1); (lower right) Detector screen control (VR2). The jack is for AF output

coils are air cored and have no formers, there would be a risk of mechanical weakness, e.g., any small movement leading to a difference between the relative positioning of the two windings would affect regeneration, and also to some extent the tuning. The amount of regeneration is controlled by a second variable screen potentiometer VR2. The output of the unit is taken from the anode of V2 via an audio transformer, which should be preferably physically small, as it will then have a smaller field and be less liable to hum pickup from any nearby source such as the heater wiring, or a nearby mains transformer if the power supply is incorporated in the same cabinet.

Component Parts

The constructor of any receiver or other apparatus for the higher frequencies is well advised to employ the highest quality components on which he can lay his hands. This is particularly the case in regard to R.F. and detector stages, and applies to the whole of this adaptor.

C1 and C2 should be of good mechanical construction, with either polystyrene, trolitul or ceramic end plates. The two

trimmers, CT1 and CT2, are shown in the photograph as being the mica postage stamp type. Whilst they are fairly satisfactory, better long term stability would result from the use of the concentric-vane or other air dielectric types, and these have in fact been substituted since the photograph was taken. C3, C4, C5, C6 and C7 should be either silver mica or silver ceramic. C11, across the H.T. supply, can be of paper, but mica would be more satisfactory. C8 and C10 are electrolytic capacitors, the former rated at 250 volts wkg and the latter at 500 volts wkg. The V.H.F. choke in the anode circuit V1 should be of good quality, but is easily made should one not be readily obtainable, by winding 30 turns of 28 swg enamelled wire, spaced one diameter, on a $\frac{1}{4}$ inch former of polystyrene rod.

Resistors can be half-watt throughout. While paxolin holders for EF50's were used for V.H.F. during the war, mycalex or ceramic holders are to be preferred, and are, surprisingly, easier to obtain than the paxolin type. The audio frequency transformer should be physically as small as

RADIO CONSTRUCTOR

possible, particularly if the power supply is housed in the same cabinet, but must at the same time be capable of carrying the anode current of V2.

Coils

The adaptor is for use on one band of frequencies only, so that no provision is necessary for coil switching or changing, and they can be permanently wired. The coils are very easily made, and are economical too, as by making them self-supporting no formers have to be worried about. L2 and L3 are each 6 turns 16 swg tinned copper wire, wound approx. 10 turns per inch. The finished outside diameter is $\frac{3}{8}$ in., and this is achieved by winding over a tubular former of $\frac{5}{8}$ in. diam. When removed from the former, the winding will "spring" to about the required diameter. The value of inductance required is not at all critical, and no anxiety need be felt should the finished coils not be exactly as the dimensions given above. An increase or

decrease in the inductance is simply a matter of compressing or expanding respectively the length of the winding. The aerial winding L1 is 2 turns of the same gauge-wire, with a systoflex covering, interwound with L2 and positioned at the "earthy" end. L3 has the cathode tap at roughly a half to one and half turns from the "earthy" end.

General Construction

The chassis is shown in the illustrations measures $8\frac{1}{2}$ in. long by 6 in. wide and $2\frac{1}{2}$ in. deep, and the panel is $8\frac{1}{2}$ in. by 7 in. As shown in the circuit diagram, the earth returns in each stage are brought to a common point. This necessitates the two variable capacitors C1 and C2 being insulated from the supporting brackets, and also from the panel. The latter point is taken care of by the insulated flexible couplers. It will be noticed from the panel view that a direct drive is used with the RF capacitor; this stage is comparatively

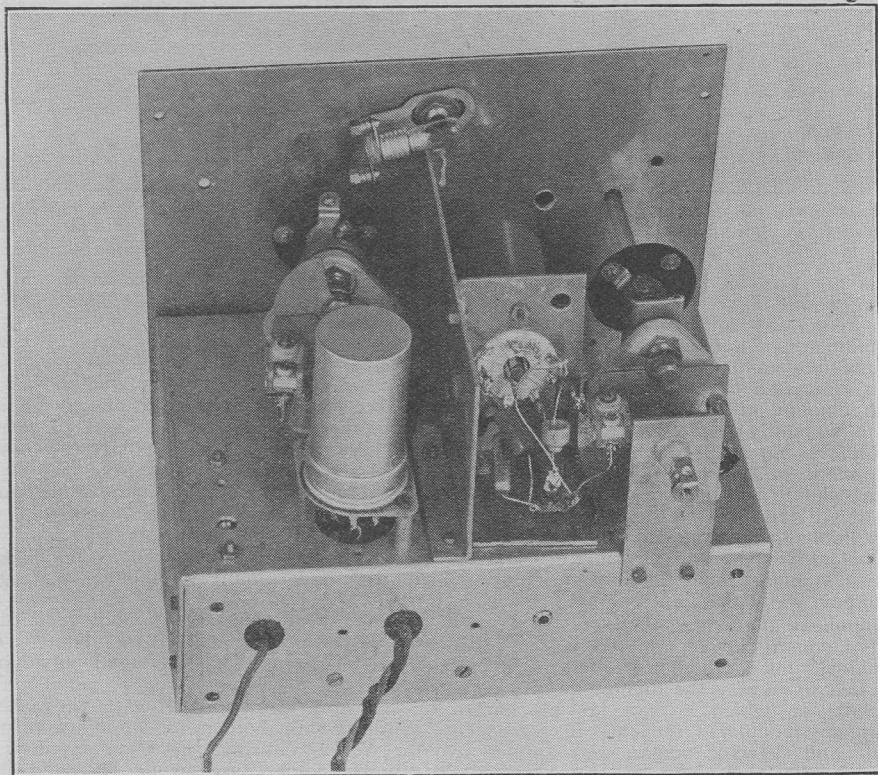

Rear view of the adaptor. V2 is the valve on the left, and V1 may be seen mounted horizontally behind the screen near the panel. The stand-off insulator on the bracket at the right hand corner is the aerial terminal

flatly tuned, and the large diam. knob takes care of any "reduction" needed.

The aerial input is mounted on a metal strip on the rear edge of the chassis and to ensure short wiring the coil is mounted immediately in front, followed by the tuning capacitor, hence the main reason for the insulated extension spindle. The RF valve is fixed horizontally alongside this assembly, in a "fore and aft" position. On the other side of the dividing screen, the detector valve is mounted on short stand-offs directly at the rear edge of the chassis. These stand-offs were used in order to remove a slight tendency to instability which was found when the EF50 was mounted at the chassis level. Immediately in front comes the detector coil, and in front of that again the tuning capacitor C2. Coil L3 as in the case of L2, has the grid end connected directly to the variable capacitor, and the other end supported by a stand-off insulator.

The small components mounted above the chassis consist of the bias resistor R1 and capacitor C3, the two trimmers CT1 and CT2, the screen bypass capacitor C4, coupling capacitor C5 and the grid capacitor C6 and leak R2.

Below chassis, the RF gain control and the regeneration control are placed sym-

metrically behind the front panel, the latter control being fitted with epicyclic reduction drive to make for more comfortable operation. The A.F. output transformer is tucked well away from other components in one corner of the chassis. If required, a jack for head-phones can be inserted in series with the primary winding of the transformer, and can be seen in the photo of the panel arrangement.

The output is taken through a screened lead and this passes through the chassis wall immediately by the output transformer, the power supply cables are brought in halfway along the chassis and are anchored to a mounting strip. From this, the remaining resistors and capacitors are supported by the wiring to their respective points.

Operation is extremely straightforward, and once the supply and output connections have been made it is simply a question of tuning in, and adjusting the gain controls for comfortable volume. Initially, some adjustment to the coils might be necessary, as explained earlier. If this is so, the squeezing or expanding should be made with the trimmers set at roughly half their maximum capacity, and the coils adjusted until the sound channel is received when the tuning capacitors are approximately at mid-scale.

Now Available:

DATA BOOKLET No. 1

(The Basic Superhet)

Describing the construction of a simple superhet receiver for use on AC mains, together with details of further stages which can be added to convert it into an efficient communications receiver.

- | | |
|----------------------|----------------------|
| ● The Basic Receiver | ● A Preselector Unit |
| ● Adding a BFO Stage | ● Valve Connections |
| ● Adding an RF Stage | ● Coil Data |

A valuable booklet for the newcomer to superhet construction

Obtainable through your local bookseller at 1/- or direct from the publishers at **1/2** post paid

AMALGAMATED SHORT WAVE PRESS LTD, 57 Maida Vale, London, W.9

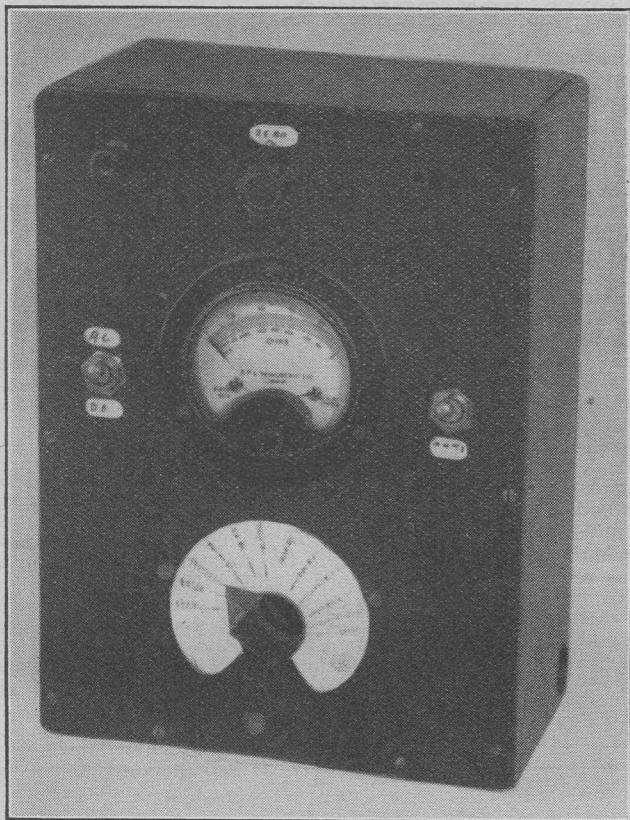

Simple Multi- Range Test Meter

By
H. J. Gibbins

THE multi-range tester is a most essential piece of radio apparatus, both for the amateur radio constructor and for those who wish to place their knowledge on a profitable basis. The test set to be described is simple to build and yet will cover most needs that arise in the constructional and trouble-shooting activities of the average enthusiast.

The fundamental movement chosen was of 0.1 mA. full scale deflection, since this meter can be made to cover a large range of voltage and current measurements by the addition of resistors in series and parallel. When choosing the meter, it is best to select one that has a scale five main divisions, each of which is sub-divided into ten divisions. This will give a scale which lends itself to easy reading with the following ranges:—

DC volts: 5, 50, 250, 500 and 1000 volts.

DC current: 1, 5, 50 and 500 mA.

AC: 100 and 100 volts.

As a 1 mA. instrument has a circuit resistance of 1000 ohms-per-volt, the resistors are simply calculated as 5000, 50000, 250000, 500000 ohms and 1 Megohm

for the DC voltage ranges given above. Precision resistors of 1% accuracy are obtainable but 5% is considered a sufficient tolerance for most radio test purposes and in any case there is not much point in using resistors of a greater accuracy than the movement itself.

The internal meter resistance will be added to the external resistance on each range, but the inaccuracy caused by this will be inconsiderable on all ranges except for, perhaps, the 5 volt range. Therefore it is advisable to take this into consideration by subtracting the meter resistance from the 5000 ohms external resistor. In actual practice this will usually be of around 100 ohms, so that the dropper will be about 4900 ohms.

The impedance of the rectifier, about 800 ohms must be taken into consideration when calculating the values of the resistors for the AC voltage ranges. Since this will have very little effect on the two ranges chosen, non-inductive resistors of 100,000 ohms and 1 Megohm will be found satisfactory. If lower ranges of AC voltage are contemplated (of the order of 5 or 10

volts) the rectifier impedance must be deducted from the resistor values. A disadvantage arises in that for any voltage of less than 10v. (AC), the calibration will be non-linear so that the scale readings obtained will only be accurate at the top end of the scale—there being a progressive error down the scale.

The shunts, or parallel resistors, for the DC current ranges will have to be wound to suit the instrument since their values will depend upon the internal resistance of the meter. The wire for these shunts may be of the 'eureka' type or alternatively wire from old filament rheostats, providing it is not too highly resistive, would serve the purpose. Manganese wire is yet another possibility. For the low resistances, heavy gauge (about 22 swg) is suitable while 34 swg wire will suffice for the lower current,

high resistance, shunts.

To determine the value of the individual current shunts, the following method is suggested. Connect the actual meter to a battery and variable resistor in series and then adjust the potentiometer until the meter reads full scale exactly (one mA.) If a 3-volt battery is used, the variable resistor should not be less than 3,000 ohms; a 50-volt battery, 50,000 ohms, etc.

After the meter has been set to full scale, commence to wind the shunts. The writer used paxolin strips and these suit the purpose ideally. Connect one end of the shunt (34 swg) to an end tag on the strip and then connect the tag, through a short length of thick copper wire to one of the meter terminals. To the other meter terminal do likewise with the other end of the shunt but also affix a razor blade. Now we

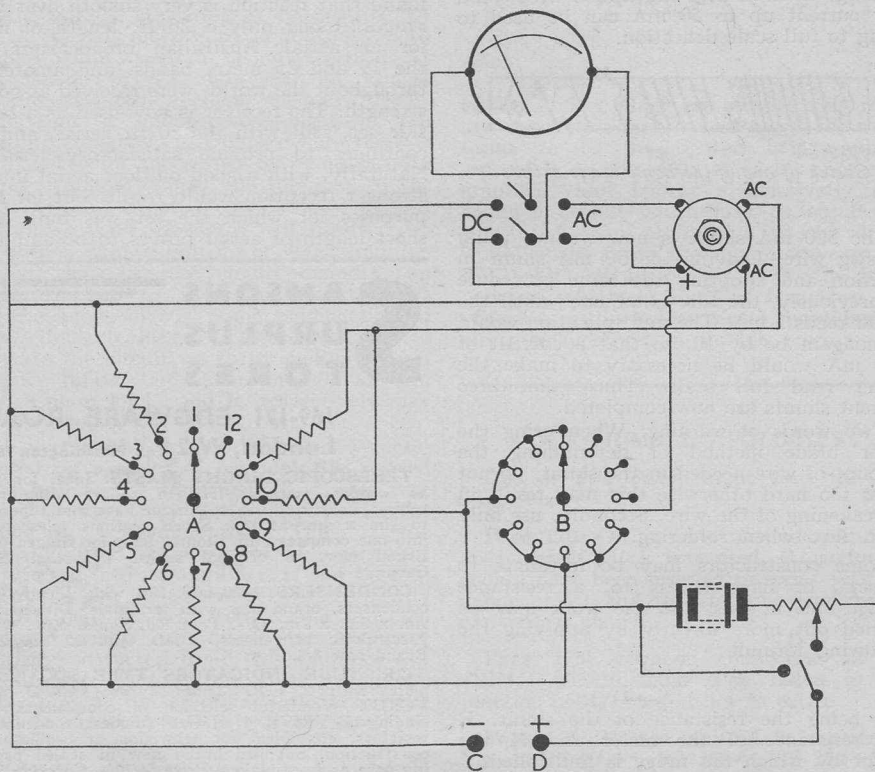

A and B constitute a two-bank 12-way rotary switch. Multi-range Switch positions are:

- | | | | | | | | | | | | |
|---|---|---|----------------------|-------------------|--------------------|---------------------|---------------------|----------------------|----------------------|-----------------------|----------|
| 1. High resistance range. 1 mA. range DC. | 2. Medium resistance range. 5 mA. range DC. | 3. Low resistance range. 50 mA. range DC. | 4. 500 mA. range DC. | 5. 5 v. DC range. | 6. 50 v. DC range. | 7. 250 v. DC range. | 8. 500 v. DC range. | 9. 1000 v. DC range. | 10. 100 v. AC range. | 11. 1000 v. AC range. | 12. Off. |
|---|---|---|----------------------|-------------------|--------------------|---------------------|---------------------|----------------------|----------------------|-----------------------|----------|

NB. Polarity of meter is important. Negative terminal is at left (DC side) and positive at right (AC side).

are all ready to adjust the shunt. By gently pressing the blade on to the shunt wiring it will make contact through the enamel or cotton covering. Part of the current will now pass through the wire and then through the blade. In other words a portion of the shunt is shorted out. It only remains to move the blade along until the meter reads 0.2 mA, four-fifths of the original current of the meter's deflection, so that at full scale the deflection would be 5 mA. With the shunt cut to the required length and soldered at both ends, the shunt is ready for use to bring the meter to its 5 mA range.

For the 50 mA shunt repeat the operation as for the 5 mA shunt, leaving that shunt still in position. Then set to full scale deflection. Using 34 swg wire, adjust the new shunt until the meter reads 0.5 mA. The reading, then, is thus multiplied by 10 and any current up to 50 mA can be used to bring to full scale deflection.



Sketch of one of the home-made shunts

The 500 mA shunt is now wound, using 22 swg wire. Leaving the 50 mA shunt in position and adopting the same procedure as previously, the wire is adjusted until the meter reads 5 mA. The multiplication would then again be by 10, so that a current of 500 mA would be necessary to make the meter read full scale. Thus, the three current shunts are now completed.

Two words of warning: When using the razor blade method of determining the amount of wire needed in the shunt, do not press too hard otherwise this may result in a weakening of the wire. Secondly, use only resin flux when soldering.

Some constructors may be fortunate to possess, or have access to, a resistance bridge and in this case the work may be carried out more directly by applying the following formula:

$$S = \frac{R}{(X-1)}$$

S being the resistance of the shunt, R the resistance of the meter and X the factor by which the range is multiplied.

There is also provision for measuring resistance, so that by using a 3-volt battery a 3000 ohms rheostat can be used. When calibrating the scale for the resistance range, short out the test leads and adjust rheostat until a full scale reading is obtained. Then connect resistors to the test leads and note the scale reading. The

correct ohmage can be worked out from the following formula:

$$X = \frac{I2}{(R \times I) - R}$$

where X is the unknown resistance, I is the full scale reading, I2 is the current reading with the unknown resistor in circuit and R is the internal resistance of the test set (consisting of meter, battery and rheostat).

$$R = \frac{I}{1000V}$$

where V is the voltage of the battery and I is the current in mA.

The resistance ranges in the described meter are divided by using the shunted current ranges, thus changing the value of R for the circuit.

(TWO VALVER—Cont. from p.220)

found that reaction is very smooth over the ranges. Using only a 20 ft. length of flex for an aerial, Australian broadcasters in the 19 and 25 metre bands, and amateurs throughout the world, were received at good strength. The receiver is now used as a bedside set, still with the 20 ft. aerial, and it continues to provide satisfactory results. Naturally, with a good outdoor aerial much stronger reception would result, but for the purposes for which the set was built the short length of aerial proves to be ample.

SAMSONS SURPLUS STORES

169-171 EDGWARE ROAD
London, W.2 Tel. PADDINGTON 7851

TELESCOPIC DINGHY MASTS. Ideal for use as wireless aeriels. 15ft. of square aluminium tubing measuring 2in. x 2in. at base and tapering to 1/2in. x 3/4in. at top. Seven sections telescoping into one compact 24in. Stoutly built for rugged use. Brand new, in original sealed wrapping. 25/- Carriage 1/6.

CONDENSERS. 2,500 mfd. 50v. wkg. Electrolytic condensers, brand new with terminals. Dimensions 9in. x 3in. x 2in. 15/- Post 10d. 32mfd. 500v. wkg. Electrolytic condensers. Dim. 4 1/2in. x 2in. 2in. Brand new 8/6. Post 8d.

C.R. TUBE INDICATORS TYPE I62C. Complete with 2 C.R. Tubes types VCR517 and VCR139. Wonderful selection of components including 3 VR65's, 1 6J5G, 4 diodes, condensers, resistors, etc. Ideal for television or oscilloscope construction. Supplied brand new in sealed packing case as from maker. Price 14/10/- Carriage 5/- No C.O.D.

NEW RANGE OF METERS—

ALL AT 12/6 EACH

0-50 ma. m.c. 2 1/2in.; 0-100 m.a. m.c. 2 1/2in.;
0-150 ma. m.c. 2in.; 0-250 ma. m.c. 2 1/2in.;
0-500 ma. m.c. 2 1/2in.;

All these meters are guaranteed brand new and boxed,—all by leading makers. One price, 12/6 each. Post 8d.

A Square Wave Generator

A simple circuit for square wave output

By D. Robertson

FURTHER to investigating a circuit (reported in *Electronic Engineering* P.286, Sept. 1946)—by K. A. Pullen, Junr., the following observations may be of interest to those requiring a simple circuit giving a square wave output. The circuit is claimed to operate up to 3 or 4 Mcs. running free, and a simple clipping stage will turn the output into a square wave. It comprises a grounded grid amplifier and cathode follower using a double triode such as the 6SN7.

The voltage appearing at the grid of V1 is a typical multi-vibrator output, both halves of the waveform being symmetrical. At the anode of V2, however, an almost square waveform appears, the only departure from a square wave being at the trailing corner of each pulse where there is a tendency for the corner to round off. By using a simple clipper the top part of the positive and negative pulses may be cut off and a good waveform will result.

With a supply voltage of 400v. and the values given in the circuit diagram, an output of up to 15v. peak-peak appears at the anode of V2. Some modification of the circuit values will be necessary to operate the circuit up to its maximum frequency limits, but values of 0.01 μ F and 100 K.ohms for C. and R. respectively may be used to try the circuit out.

A rectangular waveform may be represented by a series of harmonically related sine waves, the fundamental in this case being the frequency of the output since the waveform is symmetrical. Thus if the clipped output of the square wave generator is injected into an amplifier, it can be considered as if a large number of harmonically related sine waves were being injected simultaneously. Accordingly the frequency response characteristics of the amplifier will modify the shape of the waveform and an indication of the amplifier's characteristics may be observed instantly if the output is applied to a C.R.T.

The square wave may also be used in oscillograph technique as a "Z" or time axis when the wave is applied to the modulator grid of the C.R.T. causing the trace to "black out" during the negative pulses and be visible during positive pulses.

Two waveforms may be superimposed on a C.R.T. screen by mixing the outputs of

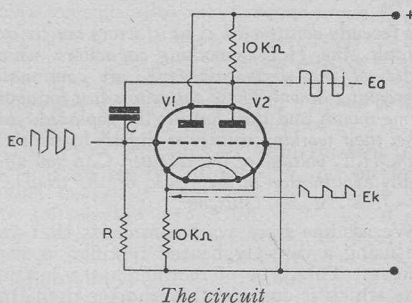

two amplifiers which are alternatively made non-conductive by a square wave, the waveforms to be investigated being applied separately to the grids of each appropriate amplifier, and appear alternatively in a common output which may be applied to the C.R.T. An alternative to the above would be to apply the square wave to the "Y" shift circuit of a C.R.O. the input being alternatively supplied from two amplifiers as in the previous case, providing an electronic method of double scanning.

OUR HUMBLE APOLOGIES

One or two errors crept into the last issue, viz:

Page 170: Owing to a misunderstanding, an incorrect block was used. Capacitor C8 should have been inserted in series with the anode of V1 and the coupling transformer and not as shown.

Page 175: Cathode connection of V2 (EF55) should have been taken to the junction of R7/C8 and not to earth.

Page 178: Values omitted in caption of Fig. 1: R1 1000 \sim , R2 500 \sim , R3 250 \sim

The Next Issue . . .

. . . will contain articles on a Versatile Test Instrument, A Button-base TRF3, Thermionic Valves, Modifications to the R1155 receiver, a new Aerial, etc.

Query Corner

A "Radio Constructor" service for readers



Electrolytic Capacitors

"A mains operated four valve superhet which I recently constructed is satisfactory but for one fault, the H.T. smoothing capacitors, which are of the electrolytic type, are continually breaking down. These capacitors last for about one month and then have to be replaced, and yet their working voltage is slightly higher than the H.T. voltage of the receiver. Can you offer any explanation of the cause of the trouble."
—J. W. Stacey, Glasgow.

We assume from your comments that you are using a directly heated rectifier in your receiver. This type of rectifier has a heating time which is considerably shorter than that of the indirectly heater valves in the receiver, and hence the H.T. voltage is applied to the valves before they are completely warmed up. This means that for about ten to twenty seconds there is practically no load on the power supply and the H.T. voltage during this period will be approximately equal to the peak value ($1.414 \times \text{R.M.S. value}$) of the rectifier anode voltage. This represents an appreciable overload voltage on the smoothing and reservoir capacitors. These capacitors

are not normally conservatively rated and the overload voltage results in excessive leakage current with consequent breakdown. Trouble of this nature is best remedied by insuring that the electrolytics are rated to withstand a voltage which is equal to the peak voltage on the rectifier anode. This voltage is, of course, the peak value of half the secondary voltage in the case of a full wave rectifier circuit. If attention is given to this point when next it becomes necessary to replace the capacitors it will be possible to operate the power supply under no load or light load conditions for an indefinite period of time without any trouble occurring.

Some set manufacturers use indirectly heated rectifiers in conjunction with electrolytics which are rated to withstand the normal working H.T. voltage. It is advisable, therefore, when testing receivers of this type to make sure that the power supply is delivering its normal load current; as the majority of the current is drawn by the output valve this means that it should be left in its socket when making tests which involve the operation of the receiver.

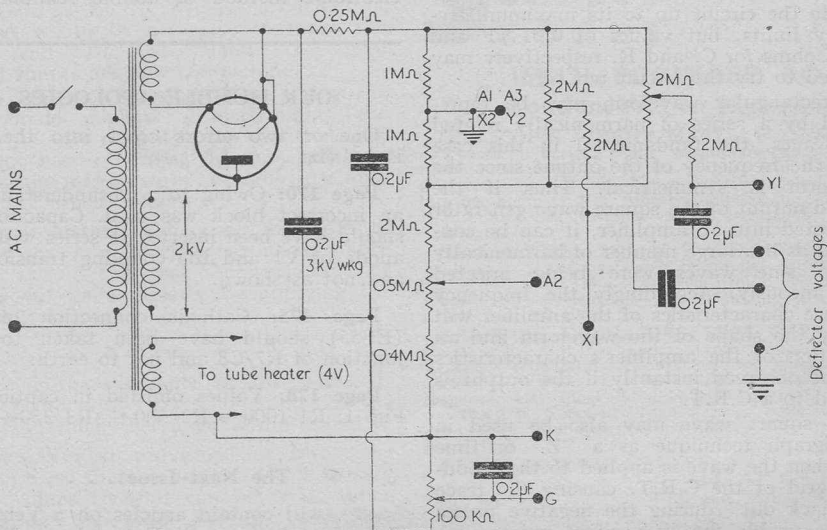

Fig. 1. Resistance network for CRT. The letters G, K, A, etc., denote the cathode ray tube electrode connections

Before leaving this subject there is one final point which is worthy of mention. It is not advisable to operate the wet type of electrolytics in any other but the vertical position as such capacitors are not normally completely filled with electrolyte. Because of this the area of anode or positive electrode, which is immersed in electrolyte may be decreased if capacitors are operated in a horizontal position, this naturally result in a reduction in value of the capacitance of the electrolytics.

Resistance Network for C.R.T.

"I recently purchased an Ex-Government cathode ray tube type VCR97 which I wish to use in an oscilloscope. Could you please let me know the normal operating voltage of the final anode, and perhaps you could suggest a suitable resistance network for use with this tube."

—J. K. Dean, Redditch.

The VCR-97 or the ECR60 or E4504B16 to give it its civilian type numbers has proved to be one of the most popular cathode ray tubes available at the present time. Its chief application is as an oscilloscope tube, but it has also been used with considerable success in home built television receivers. The normal operating voltage for the final anode of the VCR97 is 2000v., with a focussing anode voltage of between 250 and 450v. This latter voltage should be made adjustable for focussing. The grid base is approximately 0-80v. when the tube is operated under optimum conditions, minus 80v. being the voltage required to completely cut off the beam. Fig. 1 shows the method of obtaining the various electrode potentials from a potential divider which is connected across the 2000v. supply. It will be noted that the positive side of the supply is taken to earth to assist in preserving the stability of the trace, this procedure also rendering unnecessary the use of high voltage coupling capacitors in the deflector plate circuits. The two 2 M~ potentiometers are for the purpose of shifting the spot or trace to any desired position on the screen. This is achieved by varying the potential of one plate with respect to that of the opposite plate. This voltage should be capable of being adjusted either positively or negatively with respect to the other plate and consequently also to the first anode. It is important, if deflection defocussing is to be avoided, that the deflector plates should be approximately at the same potential as the final anode. This is achieved by feeding the signal to the deflector plates through a capacitor and returning the plate resistor to the final anode.

Owing to the very small amount of current which is drawn from the tube power

supply it is possible to use R-C smoothing, suitable valves for the components being shown in the circuit diagram. The rectifier is a Mullard HVR2, with a 2 volt heater.

Hum Bucking Coil

"I have a mains energised loud speaker from which the matching transformer has been removed. This has left four leads which have been disconnected, two go to the speech coil and two to a coil located at the speech coil end of the field energised winding. Can you tell me for what purpose this extra coil is intended, and also the manner in which it should be connected."—R. N. Priestley, Blackburn.

The extra winding, or hum bucking coil as it is generally called, is found on most mains energised loud speakers, and is for the purpose of cancelling out any mains hum which might be introduced into the speech coil. The hum bucking coil consists of approximately the same number of turns of wire as are on the speech coil, but in order to avoid losses a heavier gauge of wire is employed. The coil is connected in series with the speech coil but in such a manner that the two coils are wound in opposing directions. This latter point is important because, should the hum bucking coil be connected in the wrong sense hum will be increased.

It will be obvious from this explanation that any hum voltage induced into the speech coil by small variations in the energising field strength will be cancelled out by an equal voltage of opposite phase induced into the hum bucking coil.

"Query Corner" Rules

- (1) A nominal fee of 1/- will be made for each query.
- (2) Queries on any subject relating to technical radio or electrical matters will be accepted, though it will not be possible to provide complete circuit diagrams for the more complex receivers, transmitters and the like.
- (3) Complete circuits of equipment may be submitted to us before construction is commenced. This will ensure that component values are correct and that the circuit is theoretically sound.
- (4) All queries will receive critical scrutiny and replies will be as comprehensive as possible.
- (5) Correspondence to be addressed to "Query Corner," Radio Constructor, 57 Maida Vale, Paddington, London, W.9.
- (6) A selection of those queries with the more general interest will be reproduced in these pages each month.

CLYDESDALE

GM3BL
GM3ASM

FOR BARGAINS IN EX-SERVI

Brand New—DIPOLE AERIAL

Half-wave Dipole Aerial, with reflector, and crossarms, for approx. 6 metres, either vertical or horizontal mounting to existing wall bracket or mast. Robust construction Dipole 9ft. 3in., Crossarm 4ft. 11 $\frac{1}{2}$ in., Reflector 9ft. 7in. with 39ft. of co-axial cable and co-axial plug.

CLYDESDALE'S PRICE ONLY **21/-** each Carriage Paid

Or packed in a stout wood case (non-returnable) Carriage Paid **28/6** each

CO-AXIAL CABLE

Coil (12 yds.) first-class co-axial cable approx. 80 ohms, at special price **7/6** per coil, post free.

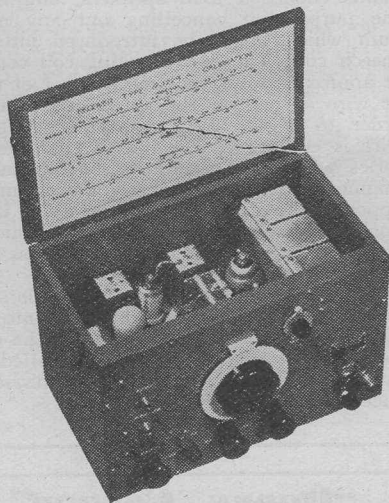

Brand New—R.1224A RECEIVER

Battery superhet with 5 valves, 2/VP23's, FC2A, HL2, 220PA. Three wavebands, 30-300 metres (9.0-1.0 Mcs.) R.F. Stage, Muirhead dials, 2 output choke capacity and 600 ohms line, in grey finish wood case 14 $\frac{1}{2}$ in. x 9 $\frac{1}{2}$ in. x 8 $\frac{1}{2}$ in., with circuit. Batteries required: HT 120 Volts, GB 9 Volts, LT 2 Volts.

CLYDESDALE'S PRICE ONLY **£5 15s.** each Carriage Paid

Circuit and data for R1224A at 1/3 post paid.

Brand New—STABILIZED H.T. ELIMINATOR

Type A.1. Input 200-250 Volts. Output stabilized 120 volts, 30 mA. Double smoothing V.S.110 Stabilizer, housed in ventilated metal case 11 $\frac{1}{2}$ in. x 7 $\frac{1}{2}$ in. x 6 $\frac{1}{2}$ in.

CLYDESDALE'S PRICE ONLY **£47/6** each Post Paid

Brand New—EX-U.S. NAVY SA-4A/APA-1 ANTENNA SWITCH

Motor driven aerial switch for 24V. with all necessary co-axial plugs, etc.

CLYDESDALE'S PRICE ONLY **14/-** Post Paid

Brand New—EX-U.S. NAVY AN/APA-1 AIRCRAFT RADAR EQUIPMENT

Comprising: Cathode Ray Indicator. Adjustable case with 3 BF1 CRT. Repeater Amplifier with 11 valves. 7/6SN7G's, 6H6, G6G, 2 x 2/879, 6 x 5GT plus other VHF gear. Control Unit and Instruction Book for 110/115V. 400/2400c/s.

CLYDESDALE'S PRICE ONLY **£4 17s. 6d.** Carriage Paid

Packed in wood box.

Brand New—

Set of plugs for AN/APA-1.

CLYDESDALE'S PRICE ONLY **7/6** Post free

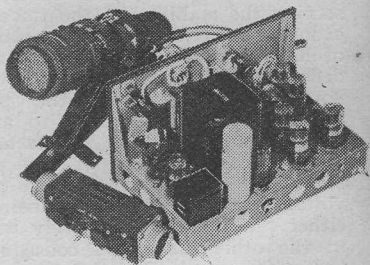

SEND NOW FOR NEW ILLUSTRATED LIST.

(Write Name and Address in BLOCK LETTERS please)

CLYDESDALE SUPPLY CO LTD

● The Radioman's Shop ●

ES ELECTRONIC EQUIPMENT

METERS

ALL BRAND NEW AND BOXED

Ammeter 5U/1635 Moving Coil 50-0-50 Amps. centre zero, black face 2in. Scale 2½in. square flange. **5/6** each Post Paid

Milliammeter 10A/8514 Moving Coil 0/150 mA., resistance 15 ohms. 2in. Scale, 2½in. square flange. **7/6** each Post Paid

Micro-ammeter 10A/8512 Moving Coil, 0/500 Micro-amperes. Resistance 75 ohms. 2½in. Scale, 3in. round flange. **27/6** each Post Paid

Micro-ammeter 10/12668 Moving Coil 0/100 resistance 175 ohms. 2½in. Scale **35/-** each Post Paid 3½in. round flange.

Electrostatic Kilo-Voltmeter 10AB/163 0/5 K.V. 3½in. flush mtg. **45/-** each Post Paid

Electrostatic Kilo-Voltmeter 10A/2060 0/2 K.V. 2½in. flush mtg. **27/6** each Post Paid

Voltmeter 5U/1636 Moving Coil 0/20V. 2in. Black Scale, 2½in. square flange. **5/6** each Post Paid

Voltmeter 10A/13379 Moving Coil 0/30C. Resistance 200 ohms per volt. 2in. Scale, 2½in. square flange. **5/6** each Post Paid

Voltmeter Moving Coil 0/40v. Resistance 8000 ohms. 2in. Scale, 2½in. square flange. **5/6** each Post Paid

HIGH VOLTAGE CONDENSERS

Transmitting Ceramic Hanged Pot Type

750 pf. 15 K.V.D.C. Wkg. 3½in. long, 1½in. dia. max.
 500 pf. 15 K.V.D.C. Wkg. 3½in. long, 1½in. dia. max.
 500 pf. 15 K.V.D.C. Wkg. 3½in. long, 1½in. dia. max.
 500 pf. 15 K.V.D.C. Wkg. 2½in. long, 1½in. dia. max.
 0.0015 mfd. 4 K.V.P.K. Mod. max. 3in. long, 3in. dia.

25 pf. 4 K.V.D.C. Wkg. 2½in. long, 1½in. dia. max.
 All at **3/11** each Post paid

36/- per dozen

EX-U.S.A.A.F. B.C.348 RECEIVER

Communication Receiver, covering 200-500 kcs. 1.5-18.0 Mcs. in 6 switched bands. 9 Valves, 3/6K7's, 6I7, 6B8, 6F7, 6C5, 4I, 991. Vernier tuning control, Crystal filter, noise limiter, A.V.C. M.V.C. and B.F.O. Controls with built in dynamotor operating from 28V. D.C. supply. Suitable for alteration, in metal case 18in. x 9in. x 9in. Tested in operation before despatch.

CLYDESDALE'S
 PRICE ONLY

£28 10s.

Carriage and
 packing paid

ELECTROLYTIC CONDENSERS

Aluminium Can Types

4 MFD. 350 V.D.C. W.K.G. single hole fixing
 At **3/6** each, 36/- per dozen

8 MFD. 750 V.D.C. W.K.G.
 At **8/6** each, 80/- per dozen

50 MFD. 12 V.D.C. W.K.G.
 At **1/6** each, 13/6 per dozen

200 MFD. 12 V.D.C. W.K.G.
 At **2/6** each, 20/- per dozen
 All post paid

METAL CASED

8 MFD. 750 V.D.C. at 140 degrees F. 600 V.D.C. at 160 degrees F. Size 4½in. x 4in. x 2in.
 At **6/-** each, 55/- per dozen

8 MFD. 500 V.D.C. at 140 degrees F. 400 V.D.C. at 160 degrees F. Size 4½in. x 3in. x 1½in.
 At **5/-** each, 45/- per dozen

8 MFD. 400 V.D.C. Wkg. 4½in. x 3in. x 1½in.
 At **4/6** each, 40/- per dozen

1 MFD. 2000 V.D.C. at 140 degrees F. 1500 V.D.C. at 160 degrees F. Size 4½in. x 2½in. x 1½in.
 At **3/-** each, 30/- per dozen

1 MFD. 750 V.D.C. at 140 degrees F. 600 V.D.C. at 160 degrees F. Size 2½in. x 2in. x 1in.
 At **1/6** each, 13/6 per dozen

1 MFD. 600 V.D.C. "Aerovox" Ceramic S.O. ins. Size 2in. x 1½in. x ¾in.
 At **1/6** each, 13/6 per dozen

0.5 mfd. 2000 V.D.C. Wkg. 4½in. x 2in. x 1in.
 At **2/6** each, 20/- per dozen

0.3 mfd. 1500 V.D.C. Wkg. 2in. x 2½in. x 2in.
 At **2/-** each, 17/6 per dozen

0.25 mfd. 2000 V.D.C. at 140 degrees F. 1500 V.D.C. at 160 degrees F. Size 2½in. x 2in. x 1½in.
 At **2/6** each, 20/- per dozen

0.1 mfd. 3000 V.D.C. Wkg. 2½in. x 2in. x 1½in.
 At **3/11** each, 36/- per dozen

All post paid

All tested before despatch

2 BRIDGE STREET, GLASGOW, C.5

'Phone: SOUTH 2706/9

VISIT OUR BRANCHES IN SCOTLAND, ENGLAND AND NORTHERN IRELAND

An Untuned RF Stage

For the DX One-Valver described in the February issue

By E. Munnery

THIS neat little unit was built primarily to precede the two valver described in the February issue, although it is admirably suited to be used in conjunction with any straight receiver of the 0-v-1, 0-v-0 variety. Naturally, being untuned, this unit will not provide a great deal of amplification—that was not the object sought. It will, however, greatly improve reaction and stability beyond all bounds of the imagination! Another advantage is that it will eliminate such bug-bears as “dead spots” and will take care of variations caused by a swaying aerial that are very noticeable on a straight that has no pre-detector stage.

Going back to the idea of a tuned RF stage, the writer agrees that it certainly does give added amplification, but the extra strength obtained is hardly worth the extra work and expense of fitting a variable capacitor. In any case, if a tuned RF stage is used it is better to incorporate it in the main receiver, so that the RF stage and detector variables can be ganged. Separate RF tuning can become too much like hard work! In any case, the unit as described has the great advantage that it is completely

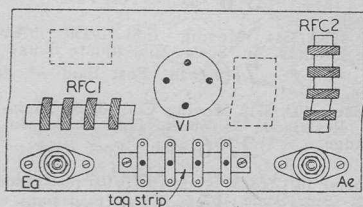

Fig. 2. Top view of the unit, showing component layout

portable and may be used to precede any receiver as required. With regard to actual amplification gained by tuning the RF stage, this is very slight on wavelengths below 100m.

Having outlined the objects and aims of the unit, let us proceed with a few constructional details. Despite that fact that the actual model was housed separately, there is nothing to prevent the prospective constructor fitting it into the cabinet of an existing receiver—by virtue of its size it will not take up undue space. Personally, the writer advocates a separate unit, for reasons prescribed above.

Regarding the two RF chokes, they must both be of the short wave type, covering, say, 10-100 metres, in order to be efficient over the ranges covered by the receiver itself. An alternative to RFC1 would be a resistor of around 20000 ohms but experiments have shown that a choke gives considerably better results.

Concerning the choice of valves, almost any RF pentode would be satisfactory, although in the model being described a rather antique SG215 is giving excellent results. The actual wiring is so very simple with no more than half-a-dozen components to wire up, so that little need be said on that subject. Layout, too, is a “natural.”

A few words on the method of connecting the unit to the main receiver may not come amiss and we will deal firstly with the battery leads. The three HT, and LT leads may be connected to the main receiver by means of a length of four-way cable. Probably the best method of connection is to

(Cont. at foot of next page)

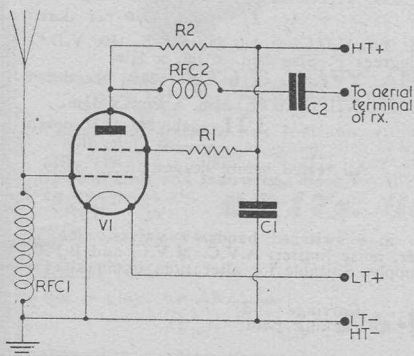

Fig. 1. Circuit of the RF stage

C1 0.1 μ F	R1 15000 \sim
C2 0.01 μ F	R2 5000 \sim

(Though this circuit is that submitted, we would have preferred to insert the RFC2 in series with the anode of VI and R2, taking the output direct from the anode—Ed.)

A Three Band 25-watt Transmitter

with built-in V.F.O.

By C. H. Henderson, G3CLD

THIS transmitter was designed to meet the requirements of the newly licensed amateur. It is capable of giving 25 watts input on 3.5 and 7 Mcs. using the final stage as an amplifier and 20 watts on 14 Mcs. using the final stage as a doubler. It would also make a very good drive unit for a higher power final amplifier. A feature of the transmitter is a built-in V.F.O. drive, thus bringing it into line with modern practice. The transmitter is built up on two chassis 12 by 8 by 3 inches deep and these are fixed one above the other in

(RF STAGE—from previous page)

fit a valve base to the actual receiver, appropriately wired-up to the HT and LT points, so that the cable from the RF stage may be simply plugged in when in use. The actual RF output should be connected via a length of screened wire, the screened casing being taken to earth, of course. This is joined straight on to the aerial terminal of the receiver.

If a separate chassis is decided upon, the dimensions necessary would be 3in. x 6in. x 2in.—this is ample size and could even be reduced if required. The size recommended, however, will be found to allow sufficient space to lay out the components comfortably. Since there is always the possibility of feed-back taking place, it is as well to place the two RF chokes so that their fields are at right angles to one another as can be seen from the layout sketch. The valve-holder should be of the low loss type. The aerial and earth are connected to the unit by means of $1\frac{1}{4}$ in. stand off insulators.

This little unit, which can be constructed in a very short space of time, will be a worth-while addition to the gear of those who rely on small battery-operated receivers. The writer has found his a valuable asset to his short wave listening.

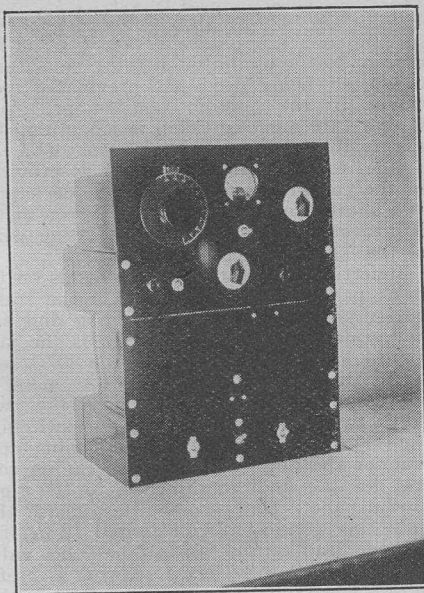

Fig. 1. Front view of the TX and power supply, assembled as one unit

the final assembly, to make a compact little transmitter as shown in Figures 1 and 2. The transmitter proper occupies the top chassis and the power packs the lower.

The Circuit

A rapid perusal of the circuit diagram will show that a Franklin circuit is used for the V.F.O. which is on 3.5 Mcs. Two EF50's are used in the Franklin oscillator circuit, followed by a 6K6 pentode operated as an untuned buffer. A 6V6 follows, which can be used as a tuned buffer or doubler. The final stage makes use of an 807. Two power supplies are provided. One supplies current for the 807 screen and all preceding valves; the other supplies the 807 plate current only. The ratings of these packs are 350 volts at 80 mA. for the first and 400 volts at 100 mA. for the second. A single heater supply suffices for all valves. Battery bias is used on the 807, whilst automatic bias is provided for the other valves. A switched and shunted meter enables both grid drive and anode currents of the 807 to be measured. R.F. output is via a link. Keying is by interrupting the Franklin H.T. supply, thus enabling "break in" operation to be used. Capacitance coupling is used between stages and parallel fed tuned stages are incorporated.

The two power supplies are quite conventional, type 5Y3 and 5Z3 valves being used as rectifiers. Electrolytic type smoothing capacitors are used, particular care being taken with the smoothing of the

current to the oscillator, a total capacitance of 34 μF being used. As previously mentioned in the "Radio Constructor," particular care must be taken in smoothing the supply to a Franklin oscillator if a T9 note is to be assured. A switch is provided in the centre tap of the 807 anode supply and another in the lead to the screen of the 807 to stop the transmitter radiating when in the "standby" position.

Referring to Figure 1, the controls on the front panels are as follows. On the transmitter panel, the Franklin tuning dial and its vernier is to the left. Below is the jack for the key and the switch in the 807 screen lead. An ex-Service type 0.5 mA. meter is located as shown. Beneath it is the two-pole, two-way toggle switch for switching the meter. Below this is the tuning control for the doubler stage. The tuning control for the final amplifier is to the right of the panel. The jack shown beneath this may be connected if desired into the cathode lead of the 807 so that this valve may be keyed if preferred. Keying is useful in this position if the unit is used to drive a higher powered R.F. amplifier.

On the power pack panel, a pilot lamp is located centrally, and below is the switch in the 807 anode H.T. supply. The other two toggle switches shown are in the primary of each transformer.

General Arrangement

Both transmitter and power packs are built upon standard chassis 12 by 8 by 3 inches deep. The panels are 12 by 9 inches and when complete, each unit is strapped together one above the other by stout pieces of half inch brass strip. The arrangement of these can be clearly seen from Figure 2. Two short lengths are run up at the back of the panels and two longer strips are arranged at the rear of the chassis as shown. This provides a perfectly rigid unit.

The location of the various components on each chassis can be seen from Figure 3. The screening box houses the Franklin oscillator coil, its padding capacitors, the tuning capacitor and the small feed-back capacitors C1 and C2. The 6K6 and 6V6 valves are located next to it and the 807 valve and its screening can and the final amplifier tuning capacitor and coil are located above the chassis on the right. On the power pack chassis, the two transformers and the rectifying valves are above the chassis, the smoothing capacitors and chokes being located beneath.

The under chassis arrangement of the transmitter section is shown in Figure 4. It will be seen that the chassis is divided into three compartments by two tinplate partitions. In the first of these are placed the resistors associated with the EF50's. The valve holders for these two valves can be seen, and the resistors are shown supported on a paxolin strip, an arrangement making for compactness and neatness.

In the second compartment are the resistors, etc., associated with the untuned buffer amplifier and the 6V6 doubler stage as well as tuning capacitor and coil for the doubler stage. The third compartment contains the components associated with the 807 final amplifier. In the centre of this compartment, a small choke, marked "A" in the circuit diagram, can be well seen. This is an antiparasitic choke in the grid lead of the 807 and is made by winding 10 turns of 16 SWG copper wire on a $\frac{1}{4}$ inch former—a piece of pencil will do fine—and pulling out the turns until they are just separated as shown.

The small variable capacitors C1 and C2 in the oscillator section require some comment. It is very desirable to have these feed-back capacitors adjustable, so that their capacity can be varied until the Franklin only just oscillates. These were therefore made up from oddments around the shack. Figure 5 shows diagrammatically how they are made up from three small porcelain stand-off insulators, some one inch brass bolts and nuts and a strip of brass across the top. The photo (Figure 6) makes the

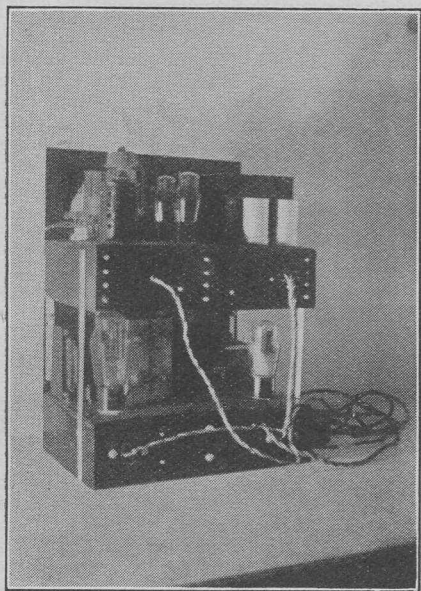
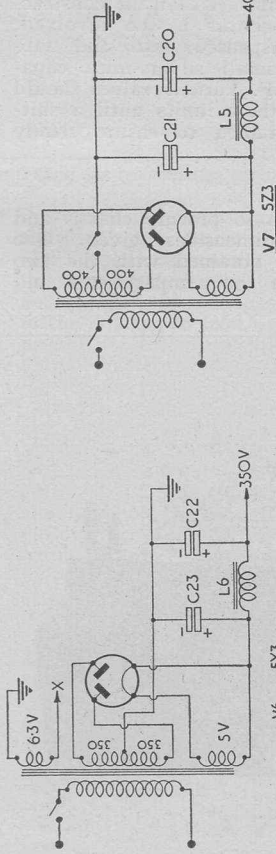
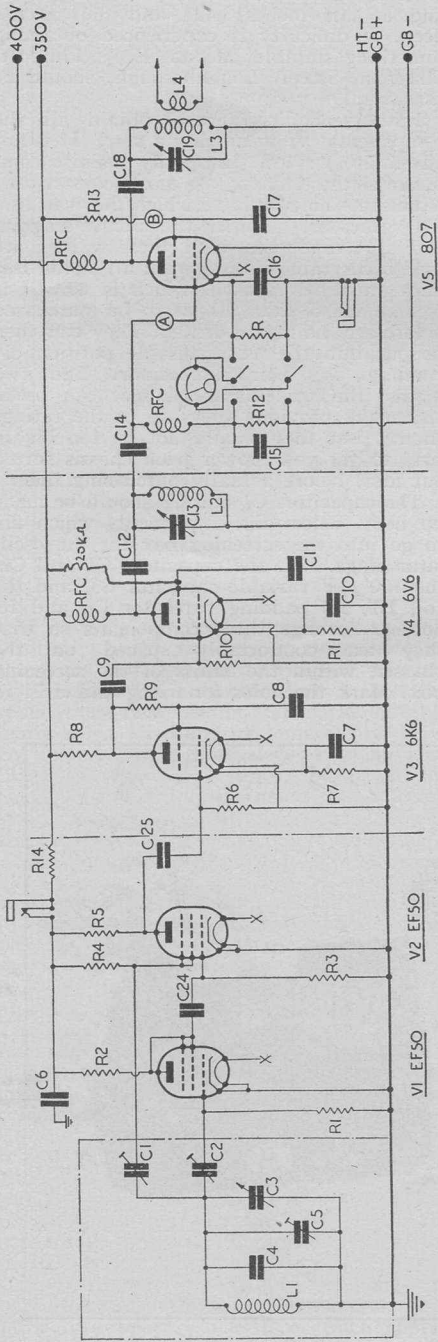

Fig. 2. Rear view of complete transmitter showing method of supporting the chassis one above the other

RADIO CONSTRUCTOR



- C1, C2 See text
 C3 100 $\mu\mu\text{F}$
 C4 450 $\mu\mu\text{F}$
 C5 50 $\mu\mu\text{F}$
 C6 0.1 μF
 C7, C8, C10, C11, C15, C16, C17 0.01 μF
 C9, C12, C14 100 $\mu\mu\text{F}$
 C13 60 $\mu\mu\text{F}$
 C18 0.002 μF
 C19 160 $\mu\mu\text{F}$
 C20, C21 4 μF , 500 V. wkg.
 C22 32 μF , 500 V. wkg.
 C23 2 μF , 750 V. wkg.
 C24, C25 100 $\mu\mu\text{F}$
 R1, 3, 6 100000~
 R4, 2, 9 30000~
 R5, 10 10000~
 R7, 11 250~
 R8, 13 5000~
 R12 25~
 R14 5000~
 L1, 2, 3, 4 See text
 L5 20 H, 100 mA. choke
 L6 30 H, 80 mA. choke

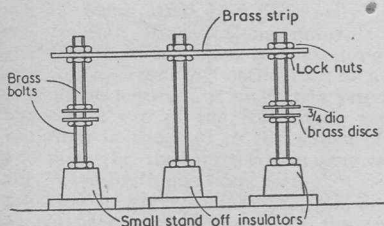

Fig. 5. Sketch showing the constructional details of the small variable capacitors C1 and C2

set up quite clear, and shows the general arrangement in respect to the other components in the screening box. The plates forming the capacitors are cut from sheet brass and are $\frac{3}{4}$ inch in diameter and are soldered to the heads of the brass bolts. Should some readers feel that the construction of these capacitors is too involved, they could be dispensed with and substituted by two small silver mica capacitors of 1 to 6 $\mu\mu\text{F}$. Various values should be tried between these limits until a suitable value is obtained to ensure steady oscillation.

Construction

The first step is to procure chassis and panels to the dimensions given. One chassis should be obtained with the two partitions to form the compartments and

a screening box about six inches long, four and a half inches wide and four inches deep. If difficulty is experienced obtaining something suitable, Messrs. E. J. Philpott, Chapman Street, Loughborough, should be consulted.

Having acquired these, obtain all the components before making a start. It is not advisable, we feel, to specify definite components these days, as most constructors have something on hand which they can use. All values are given in the circuit diagram and if components with these values are used, everything should work all right. But sizes must be watched, which is why it is recommended that all parts be purchased before any holes are drilled. They can then be put into the most suitable position depending on their dimensions. The two mains transformers for instance can be of any make provided they are of the ratings shown, but they should not be too big in size, so get your power pack chassis sorted out first, before actually purchasing them.

The capacitors C1 and C2 should be made up next. Select the components which are to go into the screening box for the oscillator stage, i.e., the capacitors C1 and C2, the 100 $\mu\mu\text{F}$ variable capacitor C3, and the coil L1, its padding capacitor C4 and its holder. Arrange these components so that they are comfortably spaced on the chassis, within the limits of the screening box. Mark the holes for fixing and drill to

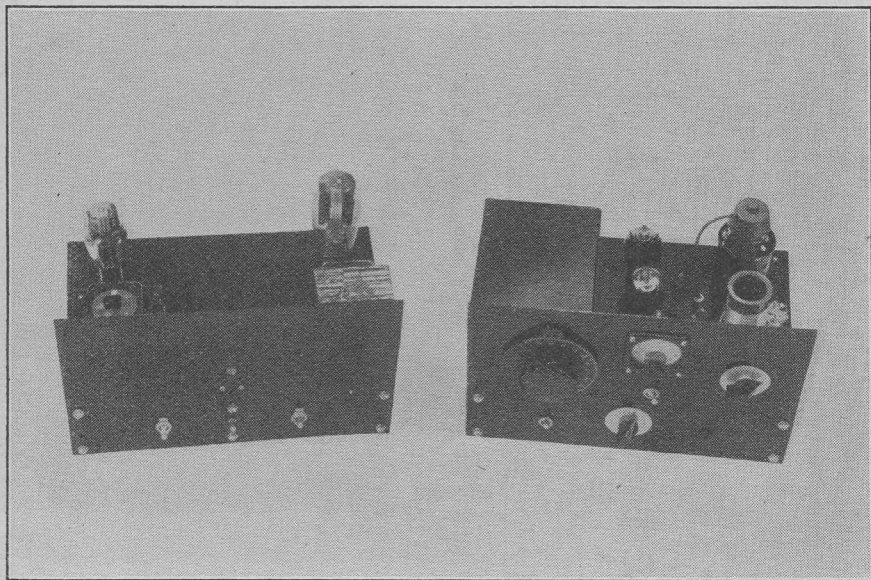

Fig. 3. The position of the various main components can be seen in this photograph

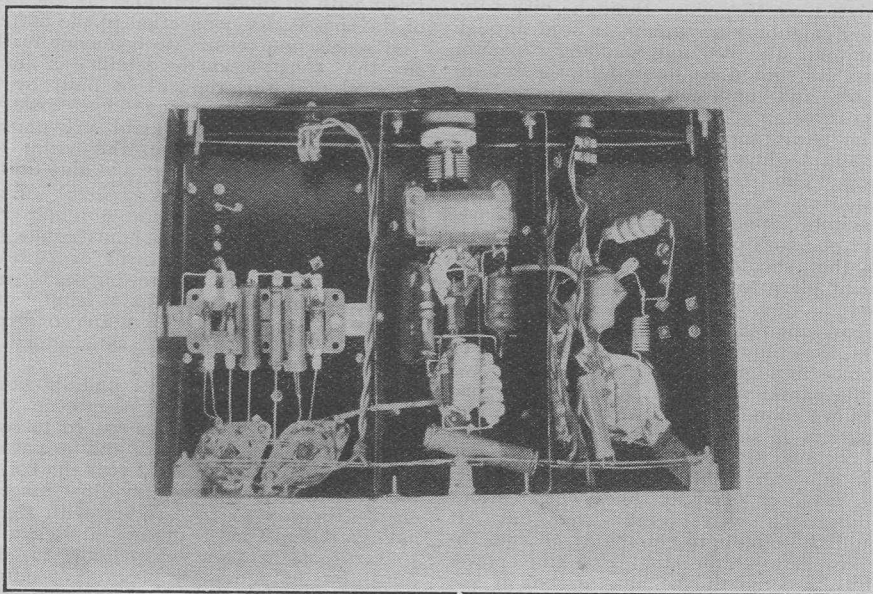

Fig. 4. Under chassis arrangement of the transmitter section

take suitable nuts and bolts. Mark suitable position for the tuning capacitor shaft on the panel drill and fix and mount temporarily. Place the screening box in position round these components and make suitable fixing holes. Drill and fix temporarily. Having got everything positioned satisfactorily, place the two EF50 valve bases on the chassis behind the screening box, locate symmetrically and mark positions. Cut out chassis to take these two valve holders.

The positions of the other valve holders, 807 screen and P.A. coil can be ascertained similarly. Mark and cut out suitable holes in chassis and mount up valve holders. The position of these components can be clearly seen from the illustrations. The P.A. coil is a four pin standard $1\frac{1}{2}$ inch diam. type and is mounted in a baseboard type holder. The panel is then marked out for the holes for meter, switches, tuning capacitors, etc.

Having got the chassis and panel drilled and the valve holders mounted, turn your attention to the underneath of the chassis. The exact position of the screens dividing it into three compartments, is not critical and the various components should be roughly positioned and temporarily fixed before finally marking the holes to fix the screens in position. Figure 4 makes the under chassis layout pretty clear. A tag strip is all that is needed in the first compartment and also a small standoff insulator to support a length of thick copper wire running along the back of the chassis,

through each compartment, carrying H.T. resistors, etc., requiring connection to the H.T. supply are connected directly to this, thus enabling a very neat arrangement to be had in each compartment. The switch in the 807 screen lead—which by the way is used for muting the TX when tuning the V.F.O. on to the desired frequency—is also located in this first compartment.

In the second compartment the doubler coil and its tuning capacitor are arranged as shown. A small $60\ \mu\text{F}$ variable must be used or difficulty will be experienced in getting it in. The coil former (Denco 4 pin) and its base are located as shown and the various resistors, R.F. chokes, etc., are wired in the most convenient positions. A small standoff insulator is fixed in this compartment also, as shown, to support the H.T. supply wire.

The third compartment contains the resistors, capacitors, chokes, etc., for the 807. The closed circuit jack for keying in the cathode of the 807, if required, is mounted in this compartment as shown and a standoff insulator is fixed in a similar position to that of the others in the first two compartments.

Wiring up the transmitter chassis is quite straight forward, its details being clearly indicated by the circuit diagram and the photos. All leads should be kept short and where they must be taken through the chassis, as for instance the lead to the anode cap of the 807, they must be adequately

insulated as they pass through, either by means of rubber grommets or feed-through insulators. The 450 $\mu\mu\text{F}$ padding capacitor across L1 should be located in the screening box and connected as close to the coil as possible.

The power supply needs little comment, its general layout can be seen from the photos. The transformers and valves are located on top, the smoothing chokes and capacitors being placed underneath. The exact positions of the latter are not important; they should be put in the most convenient place to give short leads and a tidy layout.

Observant readers will notice that details differ in the various photographs. For instance in Figure 1, two jacks are shown on the panel, whereas in Figure 6 only one is shown. Similarly a bank of smoothing capacitors is shown in Figure 2 on top of the chassis, whereas Figure 3 shows none. This is simply due to the photo having been taken at different times when various modifications were being tried out. It should be possible to get the 34 μF smoothing capacitors for the Franklin power supply underneath the chassis, but if the capacitors available are too big then they will have to go on top. Battery bias is used on the 807, so leads with wander plugs must be brought out through a hole insu-

lated with a rubber grommet at the back of the chassis, for connection to the battery.

It seems unnecessary to comment further on the constructional details as it is assumed that this rig will be built by the amateur already possessing some constructional experience, but should any unusual difficulties be encountered, the writer will be pleased to help readers via the Editor.

Coil Data

L1 in the V.F.O. unit must tune the eighty metres band. 12 turns of 20 SWG tinned, bare, copper wire on a $1\frac{1}{8}$ inch former, wound to take up a length of $\frac{3}{4}$ inch will be satisfactory. A Denco former and base will prove very satisfactory for this coil former.

L2, the buffer or doubler coil, is wound on a similar former with the same wire. For eighty metres, 30 turns spaced to cover $1\frac{1}{2}$ inches should be used and a parallel capacitor of 100 $\mu\mu\text{F}$ fixed across the coil on the former, to bring up the capacitance to enable the coil to tune eighty with the 60 $\mu\mu\text{F}$ variable. The 40 metre coil is similar, 15 turns of the same wire spaced to cover $\frac{3}{4}$ inch but no padding capacitor is required.

The P.A. coils are wound on standard $1\frac{1}{2}$ inch diameter 4 or 6 pin plug-in formers. Using the same wire, the 80 metre coil should be of 21 turns, on a former threaded

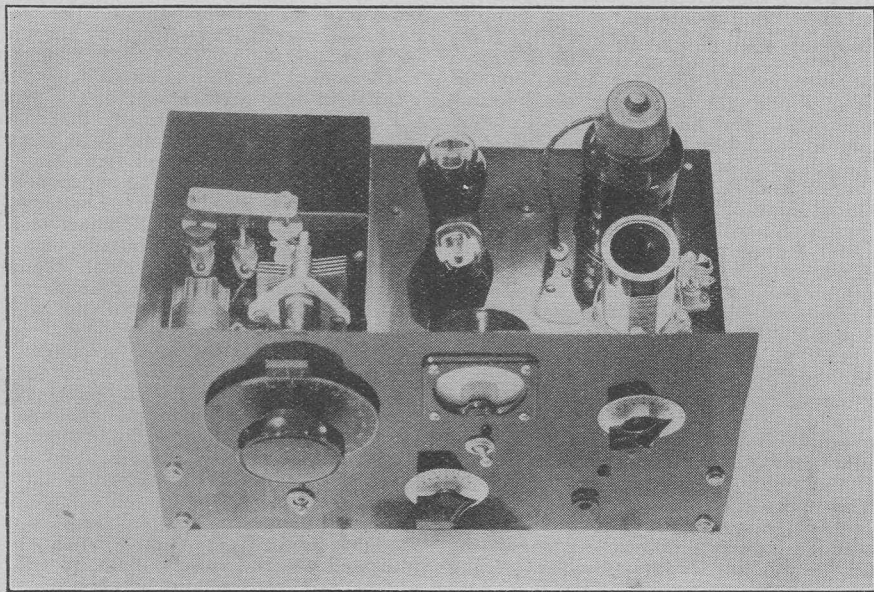

Fig. 6. View of transmitter unit showing the position of the various components in the screening box

17 turns to the inch. The 40 metre coil, 13 turns on a similar former and the 20 metre coil, $7\frac{1}{2}$ turns on an unthreaded former spaced to cover $1\frac{1}{2}$ inches.

Shunting the Meter

A few hints on how to shunt the meter may help those who have not so far tried their hand at this. With the numbers of ex-Service meters now available, readers will no doubt frequently wish to use what they have on hand and in this transmitter, where the one meter is required to read two different ranges, suitable shunts must be provided.

The meter used in this rig, is a 0 to 5 milliammeter. It can be shunted to read 0-10 mA., for the grid circuit and 0-250 mA. for the 807 anode circuit. The most simple way of making suitable shunts is to wire up the meter to be shunted in series with a multi-range test meter, a variable resistor or potentiometer of about 20000 ohms and a $1\frac{1}{2}$ volt battery as shown in the circuit of Figure 7. Shunts suitable for the ranges given can be made up from No. 28 SWG cotton covered copper wire. Referring to Figure 7, if A is the meter to be shunted and B is the test meter, first shunt A with a very short piece of wire only. On pressing the key switch, most of the current will go through the short piece of wire across A and very little through the meter. By increasing the length of the wire shorting out the meter, the amount of current passing through it will gradually increase until the meter is showing full scale reading for the required final reading—as shown on the test meter B. This is set first of all of course, by adjusting the variable resistor. Take care to break the circuit every time an adjustment to the shunt is made, otherwise the whole current will go through the meter which may be thereby damaged.

Tuning Up

First of all check filament voltages and the various H.T. voltages. The actual values of the latter will vary with circumstances, but check to see that H.T. is

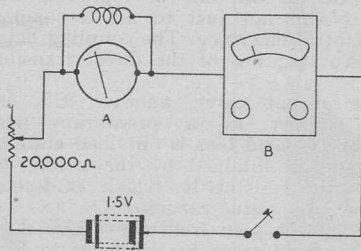

Fig. 7. Arrangement for determining values of shunts.

getting through to the anodes of the valves. Don't forget to connect up the 807 bias battery! Easy to do; easy to regret! Switch on the H.T. to the Franklin and allow to warm up. Tune the shack receiver to the 3.5 Mcs. band and then rotate the Franklin tuning control until the oscillations are heard in the receiver. If they cannot be found, check that the Franklin is oscillating by testing with a loop-lamp over the oscillator coil. If the capacitors are screwed well down to start with, the Franklin is certain to oscillate if the circuit has been wired up correctly. Once the oscillations have been found on the receiver and seem steady and clear, slacken off the two capacitors C1 and C2 equally, until the oscillations all but stop.

Next put the doubler coil in the doubler stage i.e. the 7 Mcs. one. Tune the doubler tuning capacitor until a loop-lamp placed over the coil indicated oscillation by glowing. If only a very faint glow is obtained, increase the capacity of C1 and C2 somewhat. The aim is to get adequate drive for the doubler stage with a minimum of capacity at C1 and C2. Having got the doubler stage working, switch on the H.T. to the 807 and tune for dip in the anode current. A loop-lamp over L3 should glow brightly. Couple up the aerial link coil L4—about 2 turns of stiff wire round the "cold" end of the P.A. coil, supported on two small standoff insulators will do well for this coil—and tune up the aerial. The anode current will then rise to give an input in keeping with the ratings indicated at the beginning of this article.

In Conclusion (Editorial Comment)

A few words to those who have not used a transmitter driven by a V.F.O. before. First of all do not work near the edges of the band unless you have a really accurately calibrated receiver or a good frequency meter in the shack—which by rights you should have if you are going to rely solely on the V.F.O. Secondly, do not swing from one end of the band to the other with the carrier on. If you'll listen on the bands, you'll hear people doing this and then you'll know why not to do it! The switch in the 807 screen will mute the transmitter, enabling you to tune the Franklin on the frequency you want without radiating a strong signal from the aerial. Thirdly, if you are working a "local" station, i.e. one which is not "DX" and which all "the boys" are after, get right on to his frequency. The pair of you will only occupy one channel then and you'll be making a little more interference-free room for some-

(Con. at foot of next page)

Two Valve Battery Portable

By H. Nunn

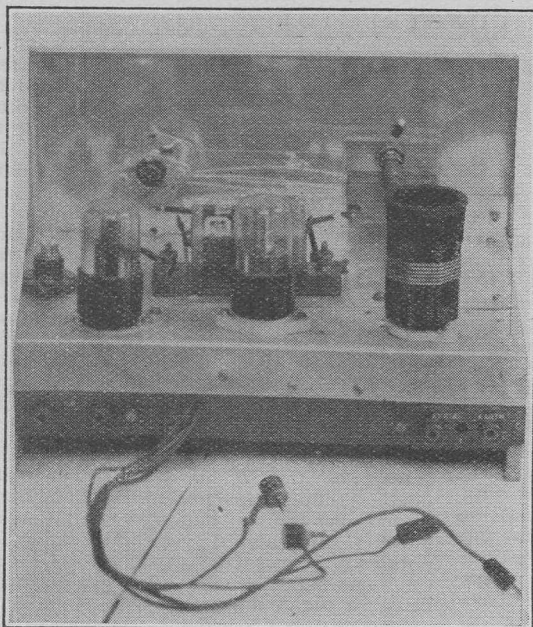

WANTING something light and portable, without having to use heavy batteries, and yet capable of pulling in a reasonable amount of short wave signals, the receiver about to be described was evolved. Since the receiver was to be mainly for outdoor reception during the summer months, weight was one of the main considerations when the set was in the "blueprint" stage. Therefore the use of HT batteries and accumulators was considered out of the question. Having previously built a small MW set, using merely two 9 volt grid bias batteries, the same idea

was tried for this short waver. The results have been very gratifying, and with good bandspreading and smooth regeneration this little receiver is highly recommended for those who want an efficient and truly lightweight receiver for field days or general out-of-doors listening.

The Circuit

The aerial is coupled to the coil L1 by a piece of bare wire twisted round the grid capacitor/coil lead. One or two turns was found to be sufficient coupling. The grid circuit is tuned by two capacitors—C1, as bandset and C2 as bandspread. The detector valve, a 1C5, is operated under the conventional leaky grid conditions. Reaction is also obtained by the usual method of feedback to the grid circuit, being controlled by the setting of C4. An RF choke is included in the anode circuit and it is advisable to use one of reputable manufacture and not just to use a component of doubtful efficiency. The coupling between the two stages is of the direct transformer type.

The output valve, another 1C5, has a grid stopper as a precaution against instability. Grid bias is obtained automatically and is obtained by the voltage drop across the resistor R, which is decoupled by the large value capacitor C.

As will be seen from the above description, and reference to the diagram Fig. 1, the receiver is of the utmost simplicity. There are no frills, no tricky circuits and

(25 WATT TX—Cont. from p.217)

one else. If you are after "DX" then you'll have to take your chance as to whether he is one of the queer fish who will not answer stations on his own frequency. Some stations are doing this nowadays with the result that everyone is piled up either side of them and the QRM is just as bad as ever! We feel that if you want to work a certain DX station then the proper place to call him is on his own frequency—not kilocycles away. One has to take one's chance with the others in most things in life, so why not with working DX as well? But there it is. Some stations will not work others on their own frequency so you will have to learn by experience just how far away from them to call.

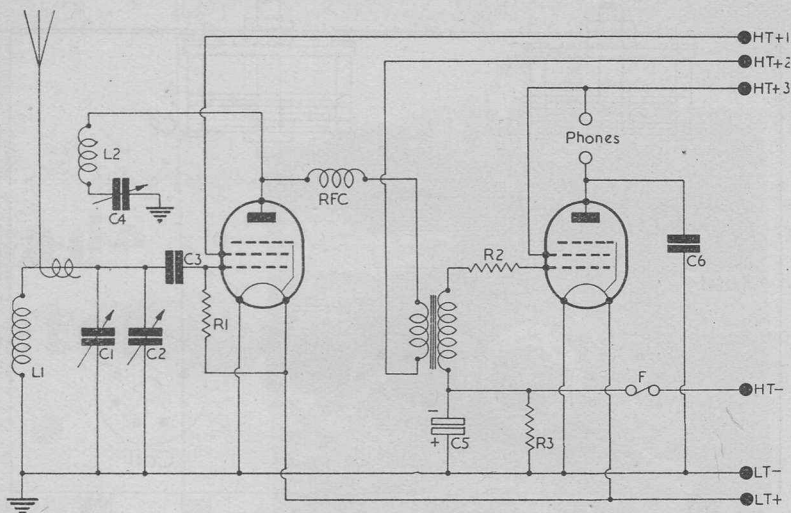

Fig. 1. Theoretical circuit

- | | | | |
|-------------------------|--------------------------------|-----------------|----------------------|
| C1 160 $\mu\mu\text{F}$ | C4 200 $\mu\mu\text{F}$ | R1 3 M \sim | Valves V1, V2, 1C5 |
| C2 20 $\mu\mu\text{F}$ | C5 10 μF 25 V. wkg. | R2 56000 \sim | L1, L2 Standard plug |
| C3 200 $\mu\mu\text{F}$ | C6 0.004 μF | R3 1000 \sim | in coils. |

the minimum of components are used. Considering these facts, the set performs exceedingly well under its limitations. Head-phones must, of course, be used.

Construction

Aluminium was chosen for the chassis and panel, partly because of its light weight and partly owing to the ease in working the metal. The panel measures 12in. x 7in. bent back 1in. at the ends and then bolted to the chassis. This helps to make the job rigid, the flexibility of aluminium being one

of its disadvantages. The chassis itself measures 10in. x 6in. x 3in.

In order to cut down costs to a minimum, the components used were those already to hand. A point here worth noting is that old components will serve admirably providing that they are of good quality. It is better to use an old component of good make rather than buy a new one of low efficiency.

The RFC should preferably be one with wire ends since it can then be connected directly to the valve holder and the transformer without any additional wiring.

Front view of the receiver. "Utility" drive is the band-spread tuning (C2); the other drive the bandset (C1). Control at left hand corner (Eddystone drive) is reaction (C4).

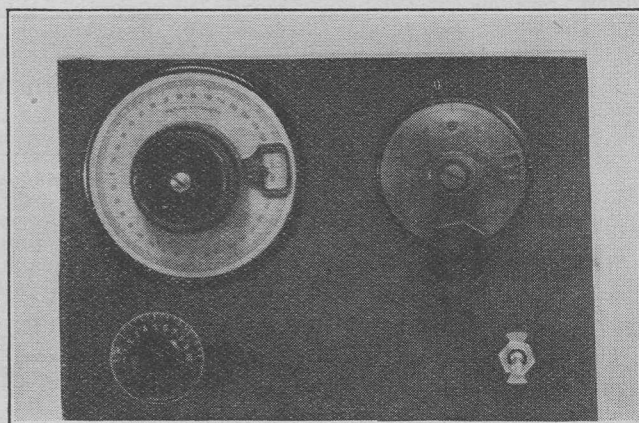

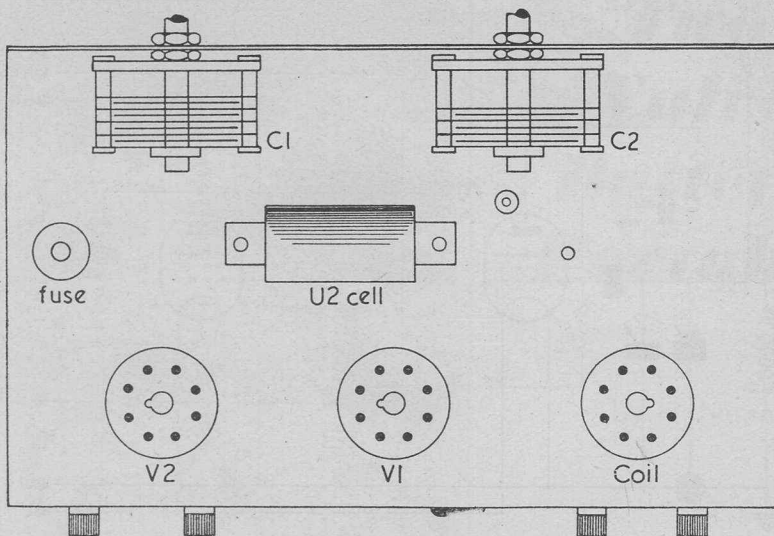

Fig. 2. Sketch showing above chassis layout

The first wiring to be carried out should be the filament leads, using cotton or rubber covered flex and twisted for neatness. The rest of the wiring should be made with fairly stout gauge wire in order to obtain rigidity and to minimise skin effects in the leads carrying RF. The sequence of wiring is not important, since there is so little involved, but it will be found convenient to leave the wiring of the automatic bias components until last. The aerial coupling lead consists of a length of wire joined at one end to

the aerial socket and then twisted round the insulated grid lead as mentioned previously.

Notes on Operation

The HT supply consists of two 9-volt grid bias batteries connected in series by wander plugs. The LT is supplied by a 1½v. "U2" cell. HT3 is 18v., HT2 is 16½v. whilst HT1 should be varied between 10½-15v. in order to obtain smooth reaction. When the correct voltage has been applied it will be

(Continued on p.204)

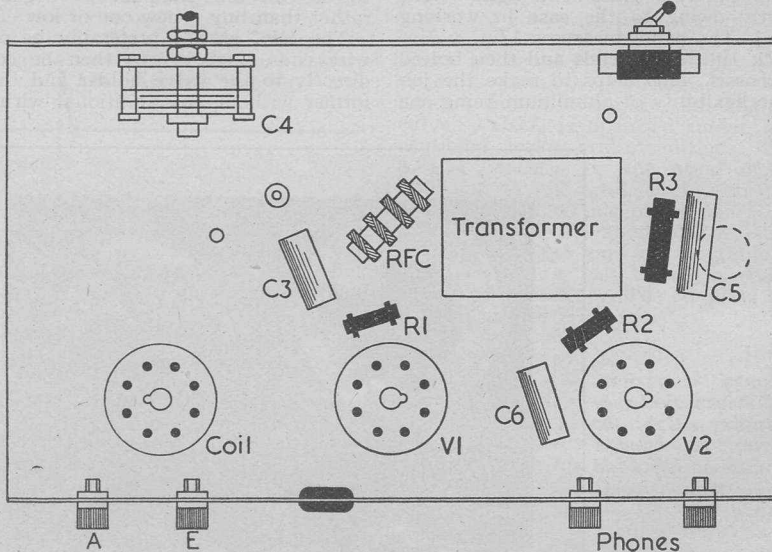
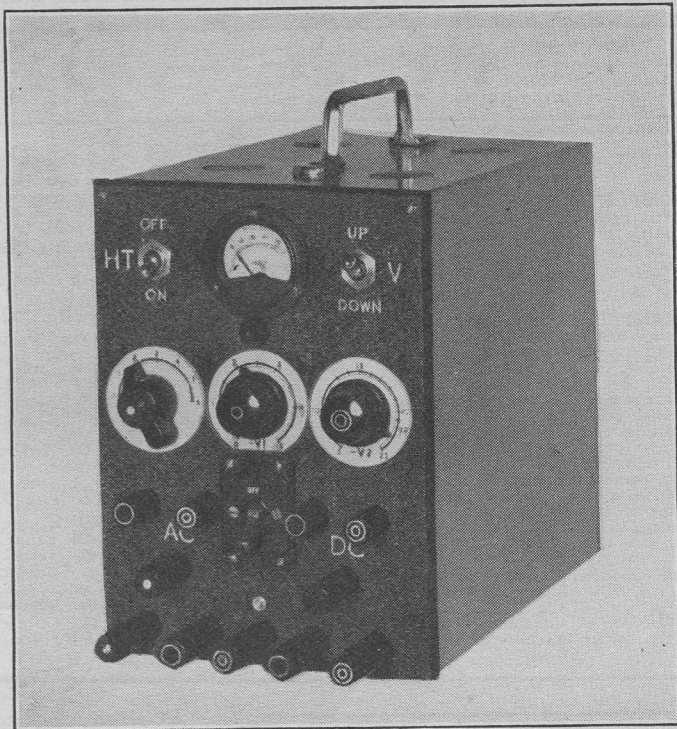

Fig. 3. Sketch showing disposition of components beneath chassis

Trade Notes

Universal Supply Unit



IT is a well-known fact that in every research, repair or service radio work, and in every constructors "den," a supply of various voltages and currents is vital to ensure efficiency in work. The Universal Supply Unit, marketed by Electronic Prototype Designers Ltd. of 123 Millway, London, N.W.7, admirably fills this need. The "USU" has been designed with a view to bringing it within reach of the average person's pocket. It is a small, portable, instrument, covering a space of only 6in. x 9in. and yet it can supply DC voltages up to 550, DC currents up to 200 mA. and adjustable AC insulated mains up to 3A. The unit is designed to operate from AC mains, 200-250v.

The controls allow the following to be achieved: A fine adjustment of the current is provided by a built-in variable resistor. A special terminal is provided for supplying a voltage 55v. higher than the one first adjusted. This will be found extremely useful in testing AC/DC receivers where the different voltages are required for anode and heater voltages. Heater voltages of 4 or 6.3v. are obtainable.

The three main controls are (left) AC current control, up to 3 A. with voltage adjustable from nil to 220v. by means of a multi-switch (centre and right). Continuous negative bias adjustment. The lower

series of terminals allow for heater voltages (4 and 6.3v.), and negative bias. The design of the transformer ensures the supply of heater voltages with the required accuracy demanded by the valve manufacturers from the lowest currents up to 10 A. The bias terminals provide voltage from nil to 23v. Both voltages are smoothed, though if a very sensitive circuit is under test a small capacitance-resistance filter may be necessary.

The terminals above the words "AC" provide insulated AC voltages, which can be used without any complications as a result of earthed points. Above the words "DC" is the equivalent in direct current voltages, with adequate adjustment. The small control above the centre dial control is for very fine adjustment of the current ranges. The meter is a DC current reading milliammeter.

A smoothing filter is provided in the instrument which reduced the AC ripple below 2% of the DC value.

Altogether, this is a most useful piece of gear for the radio experimenter and we were duly impressed at the versatility of the instrument when on test. It will supply almost any voltage or current one needs. The price of the complete instrument is £12. A descriptive leaflet is obtainable from the manufacturers.

SMALL ADVERTISEMENTS

Readers' small advertisements will be accepted at 3d. per word, minimum charge 3/-. Trade advertisements will be accepted at 6d. per word, minimum charge 6/-. If a Box Number is required, an additional charge of 1/6 will be made. **Terms:** Cash with order. All copy must be in hand by the 10th of the month for insertion in the following month's issue.

PRIVATE

COMPLETE DETAILS and constructional data for a high-class electric Hawaiian Guitar—7/6. G2HDU, 48 High Street, Oakham, Rutland.

WANTED URGENTLY permanent magnet loudspeaker 12in. or 18in. model. Must be in good condition. Also 1A7 and X66 valves. Gram motor with turntable, preferably with auto-stop and changer MCR1. Reasonable offers in cash for above or will exchange any of the following items: R1155 receiver, internal power-pack 230 v. AC mains. Excellent condition, and in working order. American AC/DC/battery portable radio, medium wave, excellent condition (makers Zenith Radio). 14 valve home-built communications receiver. Every component brand new and set only needs re-alignment and wiring of the tuning coils. 5 wave-bands, 2RF, Mixer, Osc., 2 IF's, noise limiter, S meter, Magic eye, etc. 12in. mains energised loudspeaker. Also the following valves: 829, 832, 715A, 211, PT15, 807, 1625, 1R5, 6AK5, 6AG5, 6J6, 717A, 956, 955, 954, 959, 957. Majority of all other popular valves and a few of the more remote types. Offers to ISWL/G15, 64 Cavendish Road, Kilburn, London, N.W.6. Write or call evenings).

TRADE

"These You Can Hear." A quality production, on art paper throughout, and lavishly illustrated, for the beginner to Broadcast Station listening. **Price 2/3 post-paid**, or 2/- from local booksellers.

Listener Reporting Pads. 50 printed report sheets for the compilation of really useful reception reports. With card cover and full instructions. **Price 2/6 post-paid.**

AMALGAMATED SHORT WAVE PRESS LTD
57 Maida Vale, Paddington, London, W9

G6MN for the "best" QSL's and approved log books, send for samples: G6MN, Bridge Street, Worksop, Notts.

ELAC L/SPEAKERS 3½in. w/trans. 16/-; 5in. w/trans. 17/6; 8in. less trans. 15/6. Power Pack for Canadian 58 Set (containing complete spare valves for set) 130/-. C.W.O. Stocks all types condensers, radio components. Enquiries invited. B. Martin, 17 Woodman Road, Brentwood, Essex.

COPPER WIRE. Enamelled, Tinned, Cotton, Silk-covered. All gauges. Screws, nuts, washers, soldering tags, eyelets. Ebonite and laminated Bakelite panels. Coil formers. Covered wires, earphones, etc. List S.A.E. Post Radio Supplies, 33 Bourne Gardens, London, E.4.

QSL's and G.P.O. approved log books, samples free, from Atkinson Bros., Printers, Elland.

"You'll probably get it at

Smith's of Edgware Road"

The Book on how to make it,
The Material to make it with,
The Components to put in it,
The Equipment to test it with,
The Cabinet to put it in.
(AND a fair deal!)

H. L. SMITH & CO. LTD.

287-9 EDGWARE ROAD, LONDON, W.2

Near Edgware Road Met. and Bakerloo
Phone PAD. 5891 :: Hours 9-6 (Thurs. 1 o/c.)

Henry's Radio Component Specialists

We have the most comprehensive range of Radio Components of every nature.

Our reputation is your guarantee.

If unable to call, please send stamp for current price list.

(Dept. RC)

5 HARROW ROAD, W.2 **PAD**ddington

(Opposite Edgware Road Tube)

1008/9

METAL WORK with a Difference!

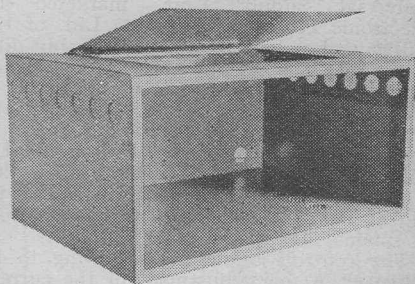

This is an example of gear which can be made to YOUR OWN dimensions and layout.

For full details and address of nearest agent, contact—

L. J. PHILPOTT (G4BI)

(E. J. PHILPOTT)

Chapman St., Loughborough Tel. 2864