

PRACTICAL
WIRELESS
SERVICE
MANUAL

F. J. C. AMM

PRACTICAL WIRELESS
SERVICE MANUAL

F. J. C. AMM

HEWES

By the Same Author

Practical Wireless Encyclopaedia
Radio Engineer's Vest-Pocket Book
Everyman's Wireless Book
The Superhet Manual
Radio Training Manual
Wireless Coils, Chokes and Transformers
Newnes Short-Wave Manual
Practical Wireless Circuits
Wireless Transmission
Newnes Television Manual

PRACTICAL WIRELESS SERVICE MANUAL

*A Complete Work on the Testing of all Types
of Wireless Receivers, and the Remedying of
Faults in Them*

EDITED BY

F. J. CAMM

(Fellow, Royal Society of Arts)

Editor of "Practical Wireless"

6th Edition

WITH 221 ILLUSTRATIONS

LONDON
GEORGE NEWNES LIMITED
TOWER HOUSE, SOUTHAMPTON STREET, STRAND, W.C.2

First Published 1938
Second Edition February 1940
Third Edition January 1941
Fourth Edition September 1941
Fifth Edition November 1942
Sixth Edition June 1944

PREFACE

I HAVE received in the course of the last few years many hundreds of requests, not only from the readers of my journals, but also from service engineers all over the country, for a book dealing entirely with the testing of wireless receivers of all types, the tracing of faults, methods of remedying those faults, the elimination of extraneous noises, the tracing of interference, and the hundred and one other matters concerned with ensuring that a receiver functions satisfactorily and economically. I have, therefore, produced this volume with the idea of serving alike the needs of the service-man engaged in the industry as well as the needs of the amateur.

Special chapters are devoted to methods of simple testing, suitable for amateurs who do not possess elaborate meters and testing equipment, whilst other chapters are designed to appeal to the professional man.

I have endeavoured to deal with every aspect embraced by the title of the book, and the information is drawn from a long experience of the troubles experienced with every type of receiver.

The servicing of radio receivers has become a recognised profession, and good salaries are paid to capable people who are able rapidly to diagnose the faults and to apply the necessary remedies. I hope that this volume will serve professionals and amateurs as a useful tool to be brought into regular use in the course of their work. I have presumed that readers will be aware of the elementary principles of receiver design, although the instructions are designed to enable faults to be located and cured without such knowledge.

F. J. CAMM.

CONTENTS

CHAPTER	PAGE
PREFACE	v
ABBREVIATIONS	ix
THEORETICAL SYMBOLS	x
I. CHOICE AND TYPES OF INSTRUMENTS	13
II. FAULT TRACING WITHOUT INSTRUMENTS	31
III. D.C. MULTI-RANGE MILLIAMMETER	40
IV. MEASURING RESISTANCE	46
V. MEASURING A.C. VOLTAGES	50
VI. MEASURING CAPACITY	55
VII. USING THE UNIVERSAL METER	61
VIII. A VALVE-VOLTMETER	68
IX. CALIBRATING AND USING THE VALVE-VOLT- METER	73
X. AN L.F. OSCILLATOR	78
XI. CALIBRATING AND USING THE L.F. OSCILLATOR	83
XII. A SIGNAL GENERATOR	89
XIII. TRACING FAULTS IN A SUPERHET	99
XIV. TRIMMING AND ALIGNING RECEIVERS	106
XV. TESTING VALVES	113
XVI. VALVE REPLACEMENT	118
XVII. REACTION FAULTS	123
XVIII. IMPROVING OLD SETS	129
XIX. UNIVERSAL (A.C.-D.C.) RECEIVER FAULTS	132
XX. CHECKING RECEIVER PERFORMANCE	135
XXI. DISTORTION—CAUSES AND CURE	140

PRACTICAL WIRELESS SERVICE MANUAL

CHAPTER	PAGE
XXII. TRACING SOURCES OF INTERFERENCE	146
XXIII. TEMPORARY REPAIRS AND SUBSTITUTION	156
XXIV. ADAPTING MILLIAMMETERS	159
XXV. RENOVATING CABINETS	162
XXVI. SERVICING WITH THE CATHODE-RAY TUBE	165
XXVII. TRACING AND ELIMINATING HUM	180
XXVIII. SIMPLE TESTS FOR COMPONENTS	191
XXIX. ADJUSTING AND TESTING COILS	204
XXX. SERVICING COMMERCIAL RECEIVERS	212
XXXI. SECOND-CHANNEL INTERFERENCE	236
XXXII. CHECKING PERFORMANCE	241
XXXIII. BACKGROUND NOISES	244
XXXIV. LOUDSPEAKER FAULTS AND REMEDIES	247
XXXV. EQUIPPING A SERVICE WORKSHOP	251
XXXVI. WIRELESS CALCULATIONS	264
XXXVII. COLOUR CODES	274
INDEX	285

ABBREVIATIONS

A.—Anode, or plate.	D.P.—Difference of potential.
A.A.—Artificial aerial.	D.P.D.T.—Double pole double throw.
A.C.—Alternating current.	D.P.S.T.—Double pole single throw.
AE.—Aerial.	D.S.C.—Double silk covered.
A.F.—Audio frequency.	D.X.—Long distance.
A.F.C.—Automatic frequency control.	E.—Earth.
A.G.C.—Automatic gain control.	E.M.F.—Electro-motive force.
A.M.—Amplitude modulation.	F.—Filament.
A.T.C.—Aerial tuning condenser.	F.M.—Frequency modulation.
A.T.I.—Aerial tuning inductance.	F.P.S.—Foot-Pound-Second.
A.V.C.—Automatic volume control.	G.—Grid.
A.V.E.—Automatic volume expansion.	G.B.—Grid battery or grid bias.
B.A.—British Association.	G.C.—Grid condenser.
B.C.L.—Broadcast listener.	G.L.—Grid leak.
B.E.M.F.—Back Electromotive Force.	H.F.—High frequency (same as radio frequency).
B.F.O.—Beat frequency oscillator.	H.F.C.—High-frequency choke.
B.O.T. Unit.—Board of Trade unit = 1,000 watt-hours, or 1 kilowatt hour.	H.P.—Horse power.
B.T.U.—British thermal unit.	H.R.—High resistance.
B.W.G.—Birmingham wire gauge.	H.T.—High tension.
C.C.C.—Closed circuit or secondary condenser or S.T.C.	I.C.—Intermittent current.
C.C.I.—Closed circuit inductance or secondary tuning inductance or S.T.I.	I.C.W.—Interrupted continuous waves.
C.G.S.—Centimetre - gramme - second system of units.	I.F.—Intermediate frequency.
cm.—centimetre.	I.P.—In primary (of transformer); start of primary.
C.P.—Candle power.	I.S.—In secondary (of transformer); start of secondary.
C.W.—Continuous waves.	kw.—Kilowatt = 1,000 watts.
D.A.V.C.—Delayed A.V.C.	L.F.—Low frequency.
db.—decibel.	L.F.C.—Low-frequency choke, or low-frequency coupling.
D.C.—Direct current.	L.R.—Low resistance.
D.C.C.—Double cotton covered.	L.S.—Loudspeaker.
D.E.—Dull emitter.	L.T.—Low tension.
Det.—Detector.	mA.—milliampere.
D.F.—Direction finding, or direction finder.	M.C.—Moving coil.
	mfd.—micro-farad.
	mhy.—microhenry.
	mm.—millimetre.
	mmfd.—micro-micro-farad.
	O.F.—Outside foil.
	O.L.—Output load.

THEORETICAL SYMBOLS

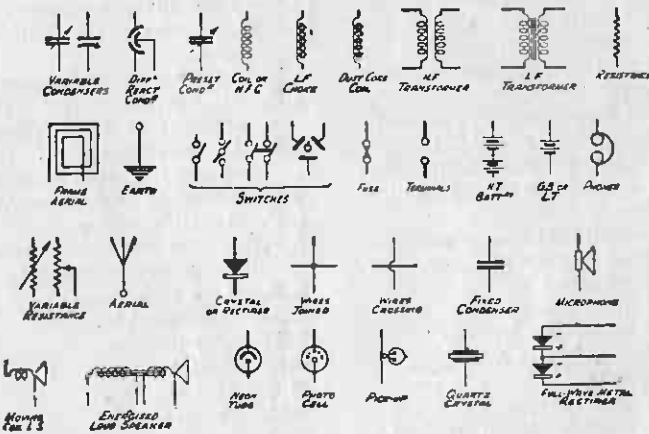
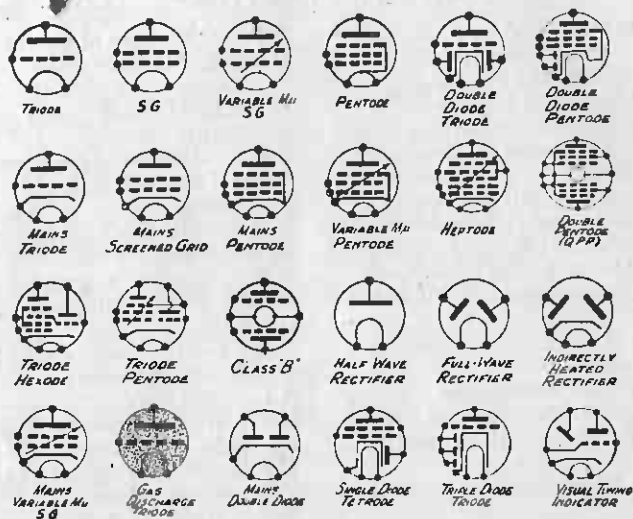

SYMBOLS

- O.P.**—Out primary (of transformer); end of primary. Also output.
O.S.—Out secondary (of transformer); end of secondary.
P.—Plate, or anode.
P.A.—Public address.
P.D.—Potential difference, same as D.P.
P.M.—Permanent magnet.
Pot.—Potentiometer.
P.V.—Power valve.
Q.A.V.C.— Quiet automatic volume control.
Q.M.B.—Quick make and break.
Q.P.-P.—Quiescent Push-pull.
R.F.—Radio frequency (same as high frequency).
R.M.S. Value.— Root - mean - square value.
Rx.—Receiver.
S.C.C.—Single cotton covered.
S.H.M.— Simple harmonic motion.
S.I.C.—Specific inductive capacity.
S.P.—Series parallel.
S.P.D.T.—Single - pole double throw.
S.P.S.T.—Single-pole single throw.
S.R.—Specific resistance.
S.S.C.—Single silk covered.
S.T.C.—Secondary tuning condenser.
S.T.I.—Secondary tuning inductance.
S.W.G.—Standard wire gauge.
S.W.L.—Short-wave listener.
T.R.F.—Tuned radio frequency.
T.S.F. (French abbreviation for Wireless — “Télégraphie sans Fils” (telegraphy without wires)).
T.T.—Tonic train.
Tx.—Transmitter.

SYMBOLS

Admittance	Y	Magnetic Flux Density ..	B
Amplification Factor ..	μ	Magnetic Field	H
Capacity	C	Power	P
Current	I	Period Time	T
Conductance	G	Permittivity	ϵ
Dielectric Constant ..	ϵ	Phase Angle	ϕ
Efficiency	η	Quantity	Q
Energy	W	Reluctance	S
E.M.F. (voltage)	E	Resistance	R
Electrostatic Flux Density	D	Resistivity	ρ
Frequency	f	Reactance	X
Impedance	Z	Self-inductance	L
Magnetic Flux	Φ		

UNITS

Ampere	A	Joule	J
Ampere-hour	Ah	Kilovolt-ampere	kVA
Board of Trade Unit. = 1,000 watt-hours or 1 kilowatt-hour ..	B.T. Unit	Ohm	Ω
Coulomb	C	Volt	V
Farad	F	Volt-ampere	VA
Henry	H	Watt	W
		Watt-hour	Wh

PREFIXES

Kilo	k	Micro	μ
Mega	M	Milli	m



FIG. 2.—The Thermionic or Valve Voltmeter has very wide uses. This is a Cambridge instrument of this type.

There are many firms now specialising in the production of test equipment, and the illustrations in this chapter show a representative collection of various types. For complete servicing there are various ranges of apparatus from the simple galvanometer to the cathode-ray apparatus by means of which the performance of any receiver may be demonstrated, not only for your benefit, but for the benefit

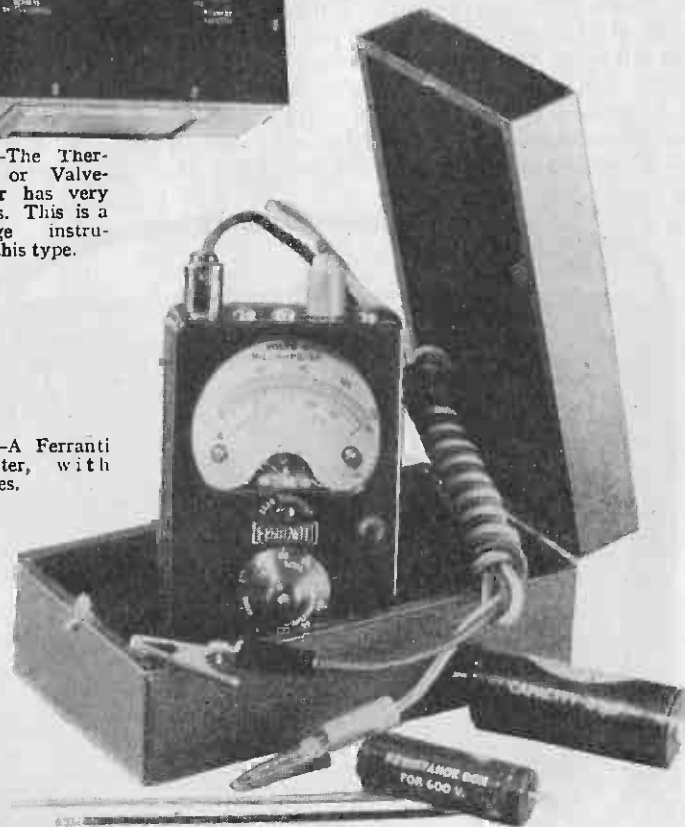

FIG. 3.—A Ferranti Multi-meter, with accessories.

of the customer. The galvanometer is merely an indication of current and as such may form the basis of various instruments. A milliammeter also gives a reading of current and forms the basis of various test instruments. By a simple application of the familiar Ohms Law this instrument may measure voltages, or resistance in ohms, and a single instrument may thus be built round it as described in later chapters. In addition to these simple pieces of apparatus there are bridges by means of which condensers, coils or resistances may be accurately balanced against known standards and their values accurately ascertained. Valves may be tested and in addition to the



Fig. 4.—Taylor Model 90 Multi-range Universal Meter (38 ranges).



Fig. 5.—This is a Valve Voltmeter for battery operation. The General Electric Company supply this model.

location of faults in the mechanical side it is possible by means of modern valve testers to ascertain the characteristics and compare these with the published figures and thus to judge whether replacement is necessary. A modern superhet receiver

depends for its efficiency upon the accurate lining-up of many tuned circuits—some receivers perhaps having as many as twenty such circuits and the slightest maladjustment in one of these may make all the difference in its performance. A modern signal generator enables every tuned stage to be properly adjusted, and all guess-work is avoided. It would be quite true to say that a superheterodyne receiver could not be properly adjusted without the use of an instrument of this type, and the work involved in endeavouring to make such adjustments would take many hours.

The charge which a service-man makes for his work must be calculated on an hourly basis, plus the cost of replacements, and thus it is essential, if a good trade is to be built up, that the work should be carried out expeditiously. The man-in-the-street does not fully understand the work involved and if you keep a receiver for a week or more he doubts your ability to carry out the work irrespective of any argument you may put forward. On the other hand, if you can deliver the set properly working in a day or two he immediately places your ability on a high plane and is not slow to talk about it to his friends and acquaintances. Cases have been recorded where a receiver has been serviced and after such work has given a better performance than when it was new—simply because the initial installation was carried out by an inexperienced man and the set was not working at its best when installed. It should therefore be the aim of every service-man



Fig. 6.—This is a typical set analyser, taken from the range of equipment supplied by the Weston Electrical Instrument Company.

to turn out the very best work and for this purpose he must have the proper equipment. Let us deal briefly with each type which he is likely to need for this purpose.

Meters.—Meters may be obtained to read current or voltage, and for those who do not wish to build up complete apparatus on the lines indicated in later chapters, a good multi-purpose meter should be the first item to be obtained. The Avometer is a good example of this type of instrument. A single open dial carries all the markings needed for

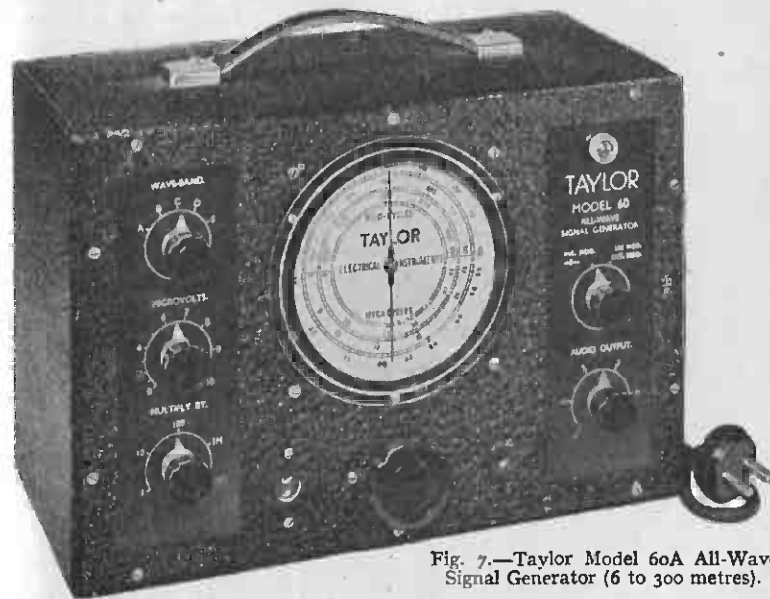

Fig. 7.—Taylor Model 60A All-Wave Signal Generator (6 to 300 metres).

this instrument and no calculations are necessary. Selector switches enable the single pair of testing leads to be connected to any part of a circuit and the current or voltage to be ascertained at a glance. Resistances or components in which the resistance value is of importance may also be tested with this instrument, and it may be used on any type of apparatus. Models are made for D.C. or A.C. use, or for use with Universal (A.C.-D.C.) apparatus. There are, of course, many similar instruments available, but this particular one is taken merely as an example. In some cases the meter movement is supplied as a separate piece of apparatus, and the additional equipment necessary to convert it into a device of the nature mentioned is supplied as separate units, so that they may be acquired from time to time and eventually all connected together.

Bridges.—Modern coils are wound to definite inductance values, and it is possible for turns to become short-circuited with a consequent modification in the inductance value. This may not affect the working of the receiver but may make it impossible to obtain an accurate tuning indication or introduce some other difficulty. The inductance of a coil, or of a choke or similar component may instantly be read by connecting it to an inductance

bridge. In its simplest form this will consist of a galvanometer and some fixed components. The coil to be tested is merely joined to a pair of terminals and a knob turned until the pointer shows the inductance value. In other instruments coils of known value have to be joined to another pair of terminals. In some cases a loudspeaker or pair of headphones are connected to the apparatus and the control is adjusted until a hum or buzz in the speaker ceases, when the value is read off. Similar types of apparatus are employed for measuring the capacity of condensers or



FIG. 8.—This Cossor Oscillograph is a useful example of the cathode-ray test apparatus.

the value of resistances, and with the aid of such apparatus unmarked or unknown components may easily be identified without waiting to communicate with the makers of the receiver.

Oscillographs.—Miniature cathode-ray tubes, housed in a neat cabinet are employed for adjusting delicate apparatus such as modern television receivers as well as for checking the performance of either receivers or amplifying apparatus. Contrary to common belief these are not difficult to operate and the makers supply very complete text-books with them. They enable one to calculate accurately the stage gain of a

CHOICE AND TYPES OF INSTRUMENTS

receiver and to see instantly whether any distortion is present. Peculiar faults not revealed by ordinary tests may easily be observed by the aid of this apparatus and leaky transformers, wrong values of by-pass

FIG. 9.—An all-wave oscillator. This is a Radiolab product that may be used for testing down to 10 metres. The batteries are in the small case

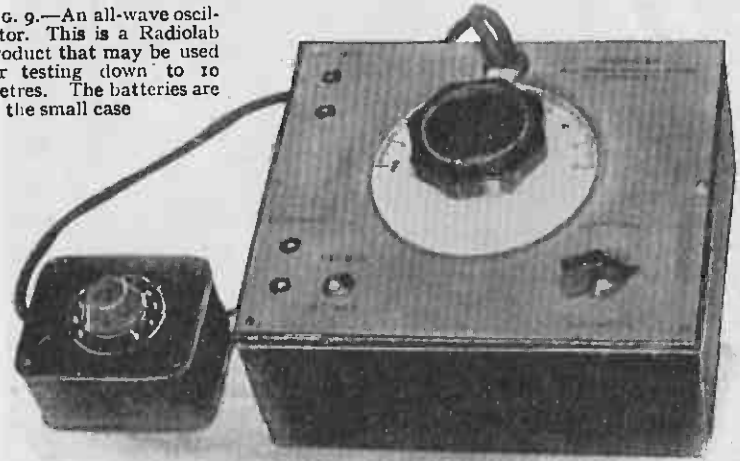

components and similar details are revealed in a moment. The frequency-changing stage in a superhet is the most important part of the



FIG. 10.—For trimming receivers this Ganging Oscillator by Cossor will prove very valuable.

apparatus and a slight fault existing here can result in a falling-off in the performance, perhaps only over a very short portion of the scale. The oscillograph will enable this to be ascertained and the necessary adjustments made to give an equal performance throughout the entire scale. Where a customer is interested, you can show him the

difference when a certain change is made in the circuit, and where a question of expense is involved this demonstration may be most convincing.

Signal Generators.—Testing has often to be carried out when no suitable programme is on the air, and a local signal is then essential. The serviceman who is not provided with a signal generator has to make use of a gramophone record or some other device and generally is not

FIG. 12.—To test for insulation, etc., this Wee-Megger, by Evershed and Vignoles, will prove very popular.

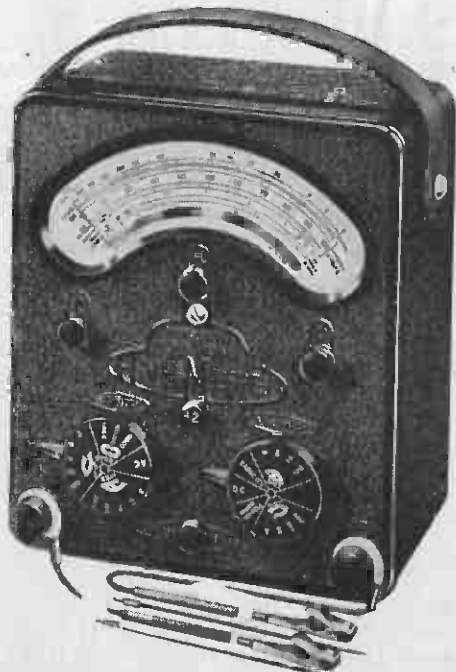
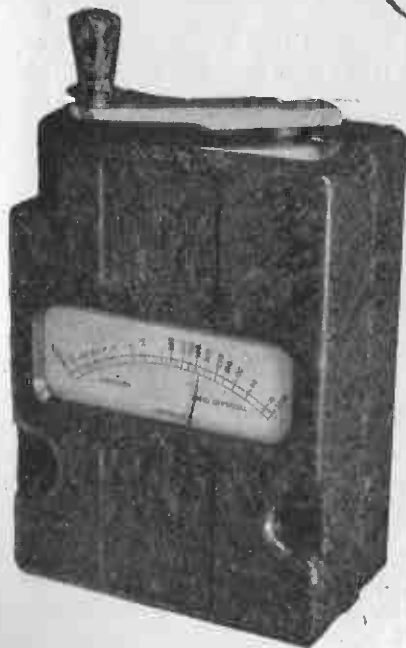

FIG. 11.—Above is one of the popular Avometers, designed for A.C. or D.C. use.

able to adjust the receiver on any wavelength. A generator may be used to provide a local signal on any wavelength from the highest now in use down to the shortest. The value of such a device needs no emphasis and this is probably one of the most valuable items of the complete service workshop.

Analysers.—Another type of instrument, which to a certain extent embodies certain of those already mentioned, is the circuit or set analyser. This enables many

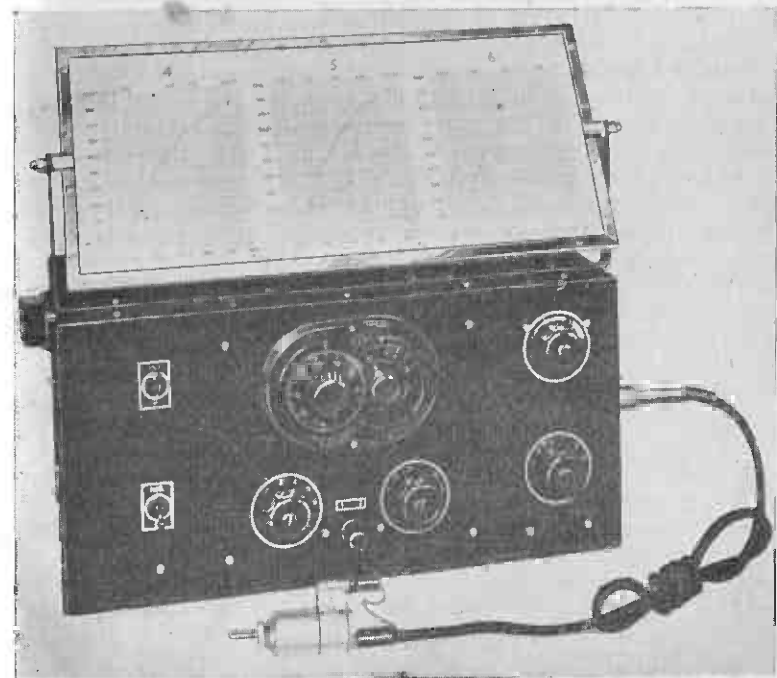

FIG. 12a.—Two further types of instrument. Above: The Pye "Life Test" instrument (mains operated) for locating intermittent faults, etc. Below: The Mullard Service Signal Generator (mains operated).

component tests to be made without removing the set from the cabinet. By the use of adaptors, plugs or prods it is possible to ascertain the working of any individual part of the receiver, valve stage or other arrangement. Some of these analysers are most ingenious pieces of apparatus and often enable a fault to be located more rapidly than by any other means.

Valve Testers.—These are made in various forms, but the principle is the same. The valve is plugged in, either in a holder arranged on the panel to accommodate the particular pin combination employed, or in a special separate adaptor, and it indicates the condition of the valve. In some cases a dial is calibrated "Good," "Bad," or "Medium" and thus you can show your customer instantly whether or not the valve is in need of replacement. Other analysers of this type indicate the resistance between elements, show anode current, filament or heater current, and all other essential details regarding the valve.

In addition to the specific instruments so far described there are numerous accessories. One or two firms, for instance, make a speciality of replacements for any type of receiver. Such items as condensers, for instance, are available in the form of replacement kits for any type of set, whilst special types of transformer may be obtained for use as substitutes or replacements.

Portable Apparatus.—The majority of the equipment so far described is of a type suitable for installation in a workshop and should be fitted as permanent gear, but there are in addition special portable instruments which may be taken out by the service-man so that a receiver may be tested in the customer's house. This will often save considerable time by revealing a small defect which may be rectified on the spot. Special portable aerials, for instance, by being connected to a set may reveal that the aerial is at fault and thus save the trouble of having the receiver collected or delivered for tests which would prove that everything was in order. Mains-testing equipment should, of course, form part of portable equipment as many cases of breakdown may be traced to faulty mains sockets, and obstinate cases of interference may also prove to be arriving via the mains. Various types of interference suppressor should therefore be found in the portable test equipment, and a suitable device will then soon be found for the particular trouble being investigated. Although hardly part of the apparatus of the average service-man, interference-tracing equipment is a definite service device, and by its aid the source of some local apparatus giving rise to interference may be traced. As explained later in this book, a small portable may be employed for this purpose if desired.

The illustrations in this chapter are merely representative and must not be taken as indicating the only suitable types of equipment. It would obviously be impossible in the small space available to illustrate every manufacturer's products and therefore items which may be regarded

as illustrating a particular type of instrument have been selected, but firms specialising in this type of equipment will be very pleased to render the service-man assistance in making a selection for his own particular requirements.

Multi-Purpose Instruments.—There is no doubt that a multi-purpose instrument, reading milliamperes, amperes, volts and ohms is desirable; but it is far better to purchase a high-grade milliammeter than a cheap and unbranded multi-range affair. If accuracy is the first essential—and it is when anything in the nature of research work is proposed—and when the outlay must be severely limited, a high-grade milliammeter cannot be bettered. It will be of the moving-coil type and will be accurate to within about 2 per cent. This instrument, although actually a milliammeter only, can be used with the addition of shunt and series resistances to read amperes, volts and ohms simply by buying or making suitable resistance units and connecting them as described later on in this volume.

Generally, it will be found best to obtain a meter with a full-scale deflection of 5 mA., and with a large-diameter scale which is easy to read.

If still greater accuracy is required, it will be necessary to pay £2 or so, and for this sum a degree of accuracy within approximately 1 per cent is to be expected.

D.C. or Universal.—The above details assume that the meter is required for measurements of D.C. only, since if it is necessary to measure A.C. as well a more expensive article must be obtained. This is because the two-purpose instrument must contain a rectifier which can be brought into circuit when dealing with A.C., and also a resistance device for compensating for the difference between A.C. and D.C. readings. In consequence, an average price for a first-grade instrument is something like £4. In general, however, universal current meters are made only in "multiple" types; that is, the meters are designed to include a switching system whereby various current and voltage readings can be taken. One of the best known of these multiple-range universal meters for measuring current, voltage and resistance is the Universal Avometer, illustrated on an earlier page, and there is another universal instrument by the same makers, known as the Universal Avominor. The latter is extremely good, and is sufficiently accurate for nearly every purpose, but has fewer ranges than the larger instrument.

There are two other reasonably-priced popular multi-range meters made by the same firm, these being for D.C. only, and known as the Avometer and Avominor; they are made to the same degrees of accuracy as the others mentioned above, and are priced at £8 8s. and £2 respectively. The smaller instrument is to be particularly

recommended to the amateur, whilst the larger is recognised as a standard part of the equipment of the radio test-engineer.

All of the Avo instruments are made to read current, voltage and resistance by the rotation of a switch, or by the use of alternative socket connectors.

Inexpensive Eight-Range Instrument.—Other combination instruments which are satisfactory for either experimenter or serviceman are the Pifco Rotameter and Radiometer, the various Ferranti models at prices from £5 15s., the Wearite (several types) and the Sifam. This short list is by no means comprehensive, and there are several other makers of high-grade meters. Of those mentioned, the Pifco Rotameter is of particular interest in view of the rather unusual and ingenious method incorporated for changing from one range to another. There are eight scales mounted on a rotor of octagonal section, and by turning this so that the appropriate scale is exposed the correct shunt or series resistance is automatically brought into circuit. The instrument incorporated is of the moving-coil type, whilst readings from 5 to 400 volts and from 10 to 250 mA. can be taken, in addition to which there is provision for inserting a valve and testing its filament for continuity. There is a cheaper model of the unit with moving-iron meter costing 29s. 6d.

Another Useful Universal Meter.—In the Ferranti range the A.C./D.C. Circuit Tester is worthy of special mention, since it can be used to cover fifteen ranges of voltage and current. It is guaranteed within 2 per cent at full-scale deflection, and is provided with test cords and crocodile clips as well as necessary shunts; additionally it is complete with neat protecting pocket case.

Choice of Meters.—In the Wearite range particular interest attaches to the Multimeter, which is suitable for either A.C. or D.C., has ten ranges and reads current, voltage and resistances from 100 to 2,500 ohms and 200 to 500,000 ohms. Like other meters designed for resistance measurement, it is fitted with a self-contained dry cell which has a very long life. Additionally, and this applies to all of the higher-priced instruments, it is fitted with a safety fuse which safeguards the meter against short-circuits which may occur due to applying the terminals to a high-voltage source without first setting the rotary switch to the correct position. It has a scale which is 2½ in. in diameter, and, which is therefore very easy to read.

The Sifam unit mentioned above is for D.C. only, and covers nine ranges with commendable accuracy. It is listed at £4 5s. and is fitted in a compact case with lid. The full scale milliampere readings are from 2.5 to 250, and there is in addition a range up to 1 amp. and four voltage ranges from 10 to 500. This instrument is not designed for resistance measurements, but can be used for this purpose in conjunction with an external battery.



Fig. 12b. (Above) The Pye "Trimeasy" Signal Generator. (Below) The Pye "Toolkit."

Single-Range Meters.—With regard to meters of the single-range type there is an extremely wide range of reliable instruments at a low price. In one make there are moving-coil milliammeters reading from 1 to 200 mA., and having resistance values from 100 to .5 ohms respectively. The prices range from 35s. for the 1 mA. meter to 30s. for those reading between 20 and 200 mA. For those who require a lower-priced instrument there is a number of moving-iron instruments which can be used for A.C. or D.C. at will, and which are guaranteed accurate to within plus or minus 5 per cent. The price of any of these meters is 12s. 6d. Incidentally, there are several voltmeters and ammeters in the same range and at the same price. For those who require a still cheaper job there are some miniature panel-mounting instruments—for volts, amperes or milliamperes—at only 7s. 6d. These are not as accurate as the others, of course, but are nevertheless reasonably good when it is required only to make normal tests.

Other instruments of similar types are made by Ward and Golstone and Sifam, amongst others, whilst Ferranti are also makers of a very wide range of single-purpose meters of all kinds. These are generally of the more expensive pattern, and they are made to fine limits of accuracy.

A Few Hints.—It is obviously impossible to give even brief details of all the meters which are on the market, so we will give a few simple rules which should be observed in choosing a suitable meter. The first is that the instrument should be of well-known make—that is a valuable safeguard and ensures a degree of accuracy compatible with the price charged. Buy a moving-coil meter if you can afford it, and if D.C. only is to be measured. If price is an important consideration, and you have to measure both D.C. and A.C., a moving-iron meter must be obtained. In buying a milliammeter get one with a low resistance, but when buying a voltmeter see that it has a high resistance—1,000 ohms per volt is the ideal, but 250 ohms per volt is fairly satisfactory for ordinary test purposes. It is better to buy a really good single-purpose meter than a mediocre multi-range instrument.

Resistance of Meters.—There are many different types of meter upon the market, but I will first explain why the cheap double-reading meter may prove misleading unless used only for particular purposes. On some of these meters it will be found that one voltage range (generally from 0 to 12) is marked in black figures, whilst the high range (generally from 0 to 120) is marked in red figures, and upon the face of the instrument will appear the letter "R," followed by a figure, on one side of the dial in black, and on the other in red. These figures indicate the resistance of the meter on both ranges, and a typical cheap meter will probably be found to have values of 200 ohms on the low-voltage range and 2,000 ohms on the high-voltage range, and to many amateurs these figures may appear to be unimportant.

However, from the familiar Ohms Law we know that current is relative to voltage and resistance, and, therefore, if we have a meter reading 120 volts with a resistance of 2,000 ohms, we can see that the current passing through that resistance (the meter) will be 120 divided by 2,000, or 60 mA. How many small battery receivers have an H.T. consumption approaching that value? Yet, this means that if the meter is joined across the H.T. battery sockets in order to test the voltage of it, a current of 60 mA. will be drawn, and so in a very short



Fig. 12c. A Mullard Master Valve Tester (mains operated). Primarily designed for the testing of all types of valves; it has, however, numerous other applications.

time you will be taking as much from the battery as your receiver would take in many hours of listening. Apart from this, however, you will not get a true idea of the state of the battery for the following reason. Suppose that the battery has been in use for some long time and is therefore in rather a poor state. Your receiver may consume, say, 10 or 15 mA., and the battery may be in such a state that it can just maintain this load for another week or so without the voltage dropping unduly. It is presumed, of course, that the reader is aware that current and voltage are related, and that as the current drain rises the voltage supplied will fall off, and vice versa. Well then, when the

meter is applied across such a battery, owing to the much higher current which is taken to drive the meter needle across the dial the voltage which is indicated will be much less than the actual voltage of the battery. It may be argued that this will result in the user throwing away a battery which in any case is nearly exhausted and is thus likely to give rise to trouble, but the main point is that the user is deprived of some hours of good listening due to the sudden load which has been imposed on the battery.

The Grid Battery.—In the case of the grid bias battery it must be remembered that no current is normally taken, and, therefore, if the cheap meter is used at frequent intervals an unnecessary drain is imposed and the life proportionately shortened. In the actual receiver circuit even more misleading results will be obtained, as in many cases the current taken by the meter will be added to that already taken in that part of the circuit, and thus will give either a lower voltage reading than is required, or will fail to give a reading at all. The latter trouble will occur if the voltage to the detector stage is measured, as in this stage the normal current is only of the order of 1 mA. or so, and therefore the addition of a further drain of 30 mA. will show its effect in the voltage dropped across the resistance in the anode circuit, in addition to which the detector valve may have a resistance of such a low value that it will also modify the current taken and so add to the trouble.

Suppose that it is required to know the anode current taken by the output valve. This may be about 9 or 10 mA. for a good power valve, and normally included in the anode circuit will be a loudspeaker transformer primary having a D.C. resistance of perhaps 1,000 ohms, across which a drop of 10 volts would occur. If now a further resistance of 2,000 ohms is included in series (as it would be to read the anode current), a further drop of 20 volts would occur, and this will naturally result in a wrong reading being shown.

The type of meter just referred to will only be suitable for instantaneous readings of voltage as delivered by the L.T. and H.T. batteries, and must therefore be placed in circuit and removed as quickly as possible, and beyond this they have no further application. On the other hand, if the service-man obtains one of the better class of meters, having a resistance of 1,000 ohms per volt, this may be used to test the batteries or to take actual readings whilst the receiver is working, and will give a true indication of the state of affairs. A better scheme, of course, is to obtain only a very low-reading milliammeter and to use this in conjunction with various resistances in order to take readings of voltage, current, and other things, and this will give the purchaser not only much better service, but will provide him with a device which will give many hours of interesting study in the way of showing how various components function, the effect of different methods of coupling and so on. Practically all the large service testing devices have as their

basis a meter such as this, and the money required for such an item is well repaid.

Later chapters explain the purpose and use, as well as (in some cases) the making, of other instruments, such as oscillators, resistance bridges, multi-purpose instruments, etc.

STANDARD UNITS

Ampere.—Unit of current. A pressure of 1-volt will pass a current of 1-ampere through a resistance of 1-ohm (see Ohms Law). It represents a flow of 1 coulomb per second.

Ampere-hour.—Unit of quantity of electricity, equal to 3,600 coulombs. One unit is represented by a current of one ampere flowing for one hour.

Board of Trade Unit (B.O.T.).—The Board of Trade Unit is 1,000 watt hours, and is equal to 3,415 British Thermal units.

Coulomb.—Unit of quantity of electricity. It is equal to one-tenth of an absolute electromagnetic unit.

Dyne.—C.G.S. unit of force. The force which when acting on a mass of 1 gramme imparts to it an acceleration of 1 centimetre per second per second.

Erg.—C.G.S. unit of work. Equal to 1 dyne-centimetre.

Farad.—Unit of capacity. A condenser has a capacity of 1 farad when a charge of 1 coulomb raises the potential 1 volt. In wireless the practical unit is the microfarad (·000001 farad); sub-division is the micro-micro-farad = ·000,000,000,001 farad.

Henry.—Unit of inductance. It is the unit of mutual inductance or self-inductance in the electromagnetic system. The henry is equal to 10^9 C.G.S. electromagnetic units. It represents the inductance of a circuit in which an induced electromotive force of 1 international volt is created when the current in it varies at the rate of 1 international ampere per second.

International Ampere.—The practical unit of electric current representing the unvarying current which when passed through a neutral solution of nitrate of silver deposits silver at the rate of 0·001118 of a gramme per second.

International Coulomb.—Practical unit of electric quantity, representing the quantity of electricity transferred in 1 second by a current equal to the international ampere.

International Farad.—The practical unit of capacity representing the capacity of a condenser which is charged to a potential of 1 international volt by imparting to it a quantity of 1 international coulomb.

International Ohm.—Practical unit of resistance, representing the resistance offered to an unvarying current of electricity by a column of

PRACTICAL WIRELESS SERVICE MANUAL

CHAPTER I

CHOICE AND TYPES OF INSTRUMENTS

ALTHOUGH a qualified service-man may carry out all his work with the aid of a single instrument, this involves considerable calculation for various types of test and consequently leaves room for errors to creep in which may nullify the results of his tests. A properly equipped service workshop, on the other hand, will contain a fair number of instruments, each of which is designed for a specific task and thus servicing a modern receiver is not only simplified, but it is a simple matter instantly to test any component, and replacements are thus made only where essential. In addition to time-saving, the acquisition of a complete set of test equipment will result in money-saving, and the work will be more efficiently carried out—and a customer's satisfaction will mean more work. A good service-man should build up a business in which goodwill plays a most considerable factor, and recommendations from one customer to another will soon enable the initial cost of equipment to be covered and thus greater profits will accrue.



FIG. 1.—The Taylor Model 81A, 74-range (Universal Meter).

and this helps to prevent the oscillators from wandering from their pre-selected frequency.

Screening Box.—The three-compartment screening box is not a standard component, and must be made in accordance with the dimensions shown in Fig. 55. The provision of a screening box exactly as shown is an essential in order to prevent interaction between the two radio-frequency oscillators, which would otherwise prevent extremely low frequencies from being produced, owing to the tendency for the two oscillators to pull into step when tuned to nearly the same frequency.

There are two other points to be watched when constructing the

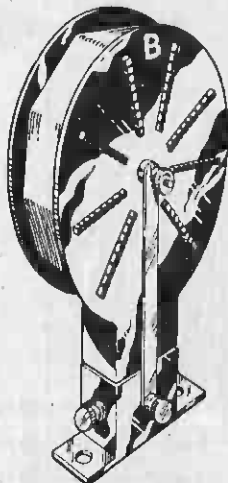

FIG. 54.—The type B coil and holder.

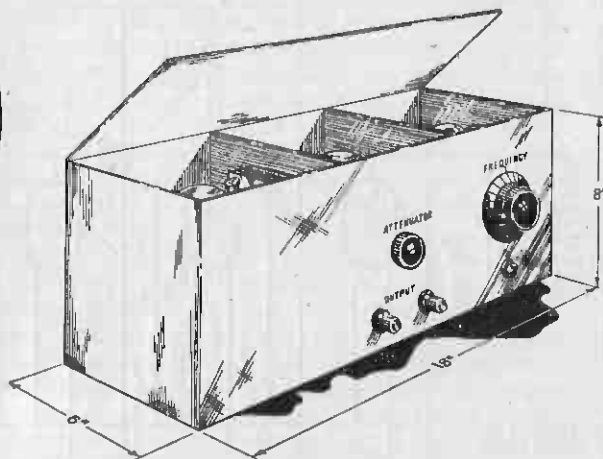

FIG. 55.—The complete L.F. oscillator and screening box.

apparatus, viz.: the necessity for insulating the components which are brought out through the screening box. Suitable insulating bushes should be procured for the spindles of the .0001 mfd. variable condenser, the output volume control, and the output terminal which is connected to the slider of the volume control. Actually, in the original model both output terminals have insulating bushes, but this is purely for the sake of uniformity of appearance. It will be seen that none of the aforementioned points is at earth potential, and, in the case of the .0001 mfd. variable condenser, failure to insulate the spindle will short-circuit the H.T. battery.

Checking Connections.—Reference to the drawings, and particularly to the wiring diagram in Fig. 56, should enable the constructional work to be completed, and then the connections should be

carefully checked over with the aid of the resistance meter, previously described, to ensure that everything is in order before connecting the batteries. Emphasis is laid on this point because the oscillator valves are self-biased by their grid-leaks, and failure of these valves to commence oscillating when switched on may cause damage to their filaments. It is also worth while to make certain that the insulating bushes previously mentioned are really efficient—and this can be done by placing the filament switch in the "on" position and joining the terminals of the resistance meter, firstly, between the H.T. positive lead and the screening box, and then between the junction of the 2-mfd. output condenser and the 25,000 ohm. volume control and the screening

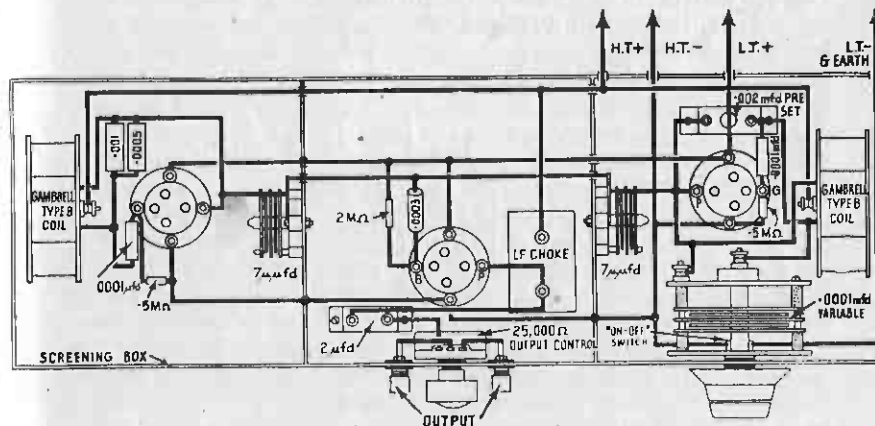

FIG. 56.—The wiring diagram of the L.F. oscillator.

box. In the first instance there should be no deflection at all, and in the second the meter should read 25,000 ohms if the bushes are satisfactory. Before the second test is made the volume control should be rotated to the maximum position, or fully in a clockwise direction.

List of Parts Required for the Low-Frequency Oscillator.

- 2—Inductances, Range B
- 1—.0001 mfd. Variable Condenser, with slow-motion drive
- 1—.002 mfd. (maximum) Pre-set Condenser
- 2—7 mmfd. Air-dielectric Pre-set Condensers

CHAPTER X
AN L.F. OSCILLATOR

PARTICULARS are given here of an instrument which will fulfil the needs of both the service-man and the listener when investigating problems connected with L.F. amplifiers; the apparatus is quite simple if the principles governing its working are understood.

All my readers have, no doubt, heard the weird whistles and groans which can be produced by an oscillating detector valve when tuned to a carrier-wave, and will remember that as a carrier-wave is tuned in the pitch of the note varies from a high-pitched squeak to a deep bass note, vanishing at "silent point" and then rises again, finally to vanish as a high-pitch squeak again. This heterodyne note as it is called would therefore appear to cover all the audio frequencies, and should be ideal for loudspeaker testing as we can pick out whatever note we like from the whole musical scale, and reproduce it through our loudspeaker for as long as we like while we make adjustments.

Using a Fixed "Carrier Wave."—What we must do is to provide our own fixed "carrier wave" and mix it with a "carrier wave" whose frequency can be varied to produce the heterodyne note we require in a way which will not interfere with our neighbours. Those readers who have constructed superheterodyne receivers will know that when we mix in the grid circuit of a detector valve the output from two valves oscillating at radio frequencies we produce a third frequency, i.e., the intermediate frequency which is equal to the difference between two separate frequencies. For instance, a 200-Kc. carrier-wave mixed with a 310-Kc. carrier-wave and then rectified will produce a frequency of 110 Kcs., which is known as the intermediate frequency, or I.F.

Now suppose we make our two "carrier-waves" oscillate on frequencies comparatively close together, say for instance 300 Kcs. and 301 Kcs., we shall produce a frequency of 1 Kc. or 1000 cycles which will, after rectification, be audible in a pair of headphones or a loudspeaker. Suppose now we wish to alter the pitch of this note, and increase its frequency to 2,000 cycles, we must merely re-tune one of our "carrier waves" so that the difference between the two is 2,000 cycles.

Hartley Oscillators.—In the instrument described in this chapter the two "carrier-waves" are produced by two Hartley oscillators, one with its frequency fixed at approximately 300 Kcs., and the other variable between 300 Kcs. and 310 Kcs., thus giving us an audible

AN L.F. OSCILLATOR

range of frequencies between 0 and 10,000 cycles which will cover the band of audio-frequencies usually considered adequate for good reproduction.

Reference to the circuit diagram (Fig. 53) will show that the Hartley oscillators are constructed from centre-tapped plug-in coils tuned in one case by fixed condensers of .001 mfd. and .0005 mfd. connected in parallel, and in the other by a pre-set condenser of .002 mfd. maximum capacity with a variable condenser of .0001 mfd. in parallel. The output from the anodes of the two oscillators is taken via air-spaced trimming condensers of 7 mmfd. maximum capacity to the grid circuit of a detector

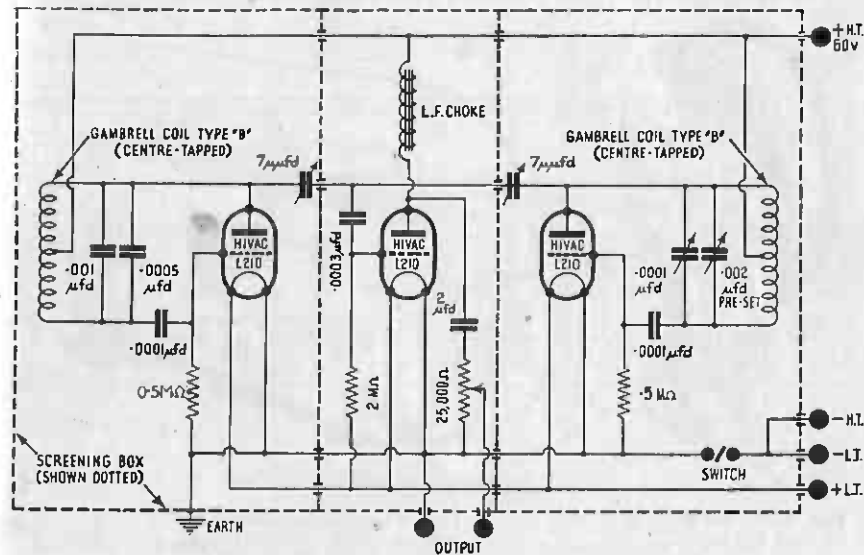

FIG. 53.—Theoretical diagram of the L.F. oscillator.

valve in whose anode circuit the audio-frequency note appears. This audio-frequency component is developed across an L.F. choke and fed through a 2 mfd. by-pass condenser to a 25,000 ohm. potentiometer which acts as a volume control, and enables us to adjust the audio-frequency output to the voltage required.

The values of the components have been so selected that the range of 0 to 10,000 cycles is covered by rotation of the .0001 mfd. variable condenser, and any deviation from the specified coils will result in failure to obtain the full range of the instrument. A further reason for the choice of these coils is that their construction renders them reasonably free from inductance variation owing to temperature rise and fall,

and failure of the valve to commence oscillating immediately it is switched on has always been traced to a faulty component or a wrong connection.

Checking the Variable Frequency Oscillator.—The next step is to check our variable frequency oscillator in a similar way, and to do this the valve should be removed from the fixed oscillator and inserted in the valve-holder in the right-hand compartment. Set the vanes of the .0001 mfd. variable condenser to minimum and screw up the .002 mfd. pre-set condenser to maximum. We should now hear the carrier-wave from this oscillator in the receiver at a slightly higher setting than the first oscillator gave, but if unable to locate it, satisfy yourself that the valve is oscillating by the "wetted finger" method. Having satisfactorily proved that both our radio-frequency oscillators are working, we can put all three valves into their sockets and try to mix their outputs to produce the L.F. component we require. Set the 7 mmfd. trimmer condensers to minimum capacity, connect a pair of headphones to the output terminals, turn the volume control to maximum, switch on and slowly unscrew the .002 mfd. pre-set condenser. Now, if all is in order, we should hear quite a strong whistle in the

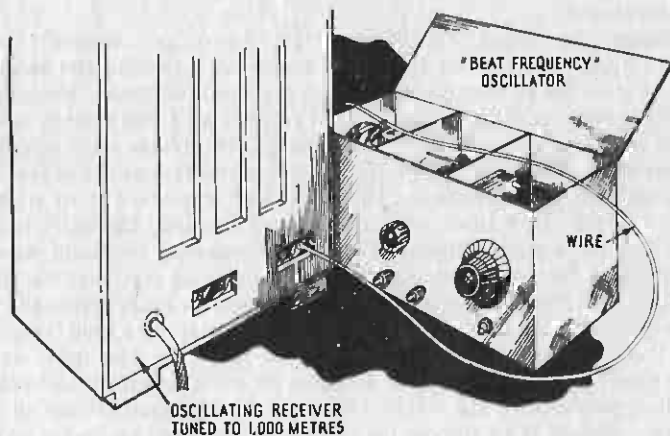

FIG. 57.—Connect a length of wire to the aerial terminal of an oscillating receiver, and lay it across the open top of the oscillator.

phones, commencing with an extremely high-pitched tone and coming down the scale till a silent point is reached. What we want to do is to set the pre-set condenser at the silent point and then replace the lid on our screening box. When this has been achieved we shall find that rotating the dial of the .0001 mfd. variable condenser (which has been in its minimum position until now) causes the note to reappear and rise gradually in pitch over the whole scale.

The components incorporated in the beat-frequency oscillator have been so selected that the rotation of the variable condenser produces an audible note which rises from 0 to approximately 12,000 cycles per second, and, if we find during our checking operations that the wavelength of our fixed oscillator is not reasonably close to 1,000 metres we may expect to find that the range of audible frequencies is restricted, owing to our parallel condenser being low in capacity value. That is why it is advisable to check the wavelength of the oscillators rather than rely entirely on the "wetted finger" method of checking for oscillation.

Setting the Trimmers.—The next step is to set the 7 mmfd. trimmer condensers for maximum audio-frequency output. In this connection it has been ascertained that the maximum output will be delivered when the radio-frequency output from the oscillators is mixed at the detector grid in the ratio of 10 to 1. In order to achieve this



FIG. 58.—The piano keyboard, showing corresponding frequencies.

result the valve-voltmeter should be connected across the output terminals of the beat-frequency oscillator in parallel with our headphones and, with the .0001 mfd. variable condenser set so that an easily audible note is produced, the trimmer condensers should be adjusted until the valve-voltmeter gives the highest reading. A word of warning is necessary here, however, and is briefly this. Although it may be possible to boost up the audio-frequency note by setting the trimmers to maximum capacity, we shall find that our lower frequencies will have vanished owing to the oscillators having affected each other and pulled into step. The procedure recommended is as follows: Leave the trimmer condenser in the right-hand compartment set at minimum and rotate the trimmer in the left-hand compartment until maximum output, as indicated on the valve-voltmeter, is obtained. Then turn the .0001 mfd. condenser to minimum, set the .002 mfd. pre-set condenser to silent point and ascertain, by swinging the variable condenser, that the lower audio-frequencies are still audible. Then increase the capacity of the right-hand trimmer a little and repeat the routine.

Continue increasing the capacity until the output is greatest, and the low-frequencies are still present. Careful adjustment of my own instrument has enabled me to get nearly 3 volts of audio-frequency output while still producing notes as low as 20 cycles per second.

Calibrating the Dial.—Having made the best possible adjustment to our instrument, we can proceed to calibrate the dial of the variable condenser in frequencies. Very few people have access to a calibrated L.F. oscillator or series of tuning forks, but all my readers will undoubtedly be able to find a piano which has recently been tuned, against which to compare their oscillator. Fig. 58 shows which notes on the piano correspond to various frequencies, and if the output from

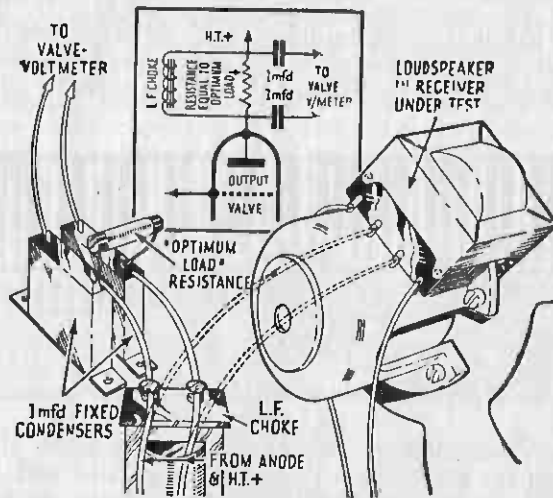

FIG. 58.—Disconnect the speaker from the set and substitute a resistance equal to the optimum load of the output valve in parallel with an L.F. choke.

the beat-frequency oscillator is connected to the pick-up terminals of a receiver, an appropriate note struck on the piano and the variable condenser rotated until a similar note is heard in the loudspeaker. The dial setting can be noted down to correspond with the frequency selected. By repeating this process with various notes on the piano, a graph may be drawn showing frequencies against dial settings. As will be seen, the notes on the piano do not reach such high frequencies as our oscillator will produce, but by listening carefully it is possible to tell when the oscillator is producing a note an octave above the note struck on the piano, and if it is remembered that this will correspond to a frequency twice that of the note struck, a calibration of the whole scale will be possible. Readers who are not musical may think it

advisable to enlist the services of a musician (a violinist for preference) to assist them in plotting these higher frequencies.

While rotating the variable condenser two things may be noticed: (1) The appearance at several points on the scale of subsidiary "chirps," and (2) the valve-voltmeter will give different readings for different frequencies. In the case of (1), the "chirps" are caused by harmonics beating with the fundamental to produce further audible frequencies, but as they are relatively weak, they may be disregarded rather than that elaborate filter circuits to eliminate them shall be included. Case (2) explains the necessity for an output volume control, because when it is desired to take the response curve of the L.F. portion of a receiver or amplifier it is necessary to make the voltage input equal at all frequencies in order that variations in the output at the speaker terminals may be measured.

The L.F. Response Curve.—To take the L.F. response curve of a receiver or amplifier, connect the output of the beat-frequency oscillator to the input or pick-up terminals of the receiver under test, and connect the valve-voltmeter across these terminals as well, now rotate the variable condenser and select the lowest voltage obtained as a basis for comparison. Quite a low voltage, say, .5 volt, will be quite suitable if the amplifier has a high gain. Now disconnect the speaker from the set and substitute an output choke with a resistance equal to the optimum load of the output valve, as shown in the manufacturer's valve data charts, in parallel (see Fig. 59). Set the beat-frequency oscillator at 50 cycles, adjust its output with the valve-voltmeter to the pre-determined level, and then transfer the valve-voltmeter to the output

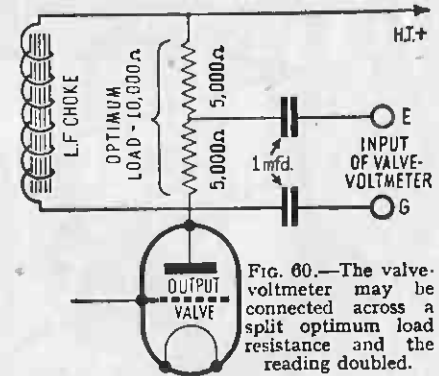

end of the amplifier by connecting it across the load resistance which we have just inserted. Measure the output volts at this frequency and repeat the procedure at a number of points in the range of audible frequencies. Then plot a graph showing the variation of these voltages with different frequencies and the response curve of the amplifier will be available. We can, of course, if we want to be more technical, reduce these voltage ratios to decibels, and plot the result on logarithmic graph paper. This has the effect of telling us more exactly what our amplifier will sound like to the ear, because quite large differences in output voltage may be inaudible to the ear which is itself logarithmic in its response to sound intensity variations.

- 1—.001 mfd. Fixed Condenser
- 1—.0005 mfd. " "
- 2—.0001 mfd. " "
- 1—.0003 mfd. " "
- 2—2 mfd. " "
- 1—5 megohm Fixed Resistances
- 1—2 megohm " "
- 1—25,000 ohms Output Control
- 1—L.F. Choke, 40 Henries
- 1—Toggle "On-off" Switch
- 1—Three-compartment Screening Box
- 3—4-pin Baseboard Mounting Valve Holders,
Wire, Baseboards, Systoflex, etc.
- 3—Valves, Type L210

CHAPTER XI

CALIBRATING AND USING THE L.F. OSCILLATOR

THE first thing to make sure of is that both the radio-frequency oscillators are working. As will be seen from the values of the components chosen, the approximate wavelength of the fixed oscillator should be somewhere near 1,000 metres. Should any reader have incorporated centre-tapped coils other than those specified, he can, provided the inductance of the coils is known, calculate the wavelength of his fixed oscillator by employing the formula—Wavelength in metres = $1885 \sqrt{LC}$, where L is the inductance in circuit expressed in microhenries, and C is the capacity in circuit expressed in microfarads. In the case of the inductance coils, which have an inductance of 200 microhenries, the formula will read—Wavelength = $1885 \sqrt{200 \times .0015}$, or 1,030 metres.

Tuning the Fixed Oscillator.—Most broadcast receivers will tune to 1,000 metres, but it will be necessary to make the receiver oscillate if we are to hear anything from our local oscillator. Presuming a suitable receiver is available, tune it roughly to 1,000 metres, which will be approximately the lowest wavelength receivable with a normal receiver switched to "Long-Waves," increase reaction until the receiver oscillates, and then disconnect the aerial lead, replacing it by a short length of wire. Now insert an appropriate valve into the valve-holder in the left-hand compartment of the beat-frequency oscillator, switch on and, with the cover removed from the screening box, and the short length of wire from the aerial socket of the receiver lying across the top of the oscillator, tune the broadcast receiver until quite a loud "carrier-wave" is heard (Fig. 57). If this can be heard we can quite easily prove that our fixed oscillator is working by switching it off and noting the disappearance of the heterodyne note in the loudspeaker of our receiver. Should it be impossible to tune in the fixed oscillator on the receiver, do not jump to the conclusion that the fixed oscillator is not working, but carefully check over all the connections, and connect the 10 mA. range of the multi-range meter in the H.T. positive lead to the oscillator. Switch on again and a reading of 2 or 3 mA. should be obtained which, if the valve is oscillating, will rise to 4 or 5 mA. when the grid connection is touched with a wet finger. This test is infallible for checking oscillation because there will be no change of anode current unless oscillation is taking place. No difficulty has been experienced in obtaining oscillation with this type of Hartley circuit,

.0005 mfd. variable condenser. As neither set of vanes of this condenser is at earth potential, it is necessary to insulate them from the panel and, for this purpose, the condenser is mounted on a "universal" bracket screwed to the baseboard, and provided with an insulated extension spindle which passes through the panel, and engages with the vernier dial which is mounted externally.

In order to modulate the oscillator, terminals are provided on the panel which are to be connected to corresponding terminals on the beat-frequency L.F. oscillator, and the voltages available from the latter source are injected into the grid of the H.F. oscillator. Grid circuit modulation is not always suitable, but in this case we are not dealing with a power oscillator, and the output from the beat-frequency L.F. oscillator would not be large enough to modulate the H.F. oscillator if anode modulation were used. A switch mounted just above the modulator terminals serves to short-circuit them when not in use and the .001 mfd. condenser acts as an effective by-pass for the high-frequency component when the modulator is in circuit.

Turning now to the anode circuit of the valve, it will be seen that this is connected via an H.F. choke to H.T. positive, and the plug-in coil is parallel-fed through a .0003 mfd. pre-set condenser. The reason for this is that when a Hartley circuit is set up with a direct drive the grid of the valve is sometimes overrun and "squegging" commences. By varying the feed by means of the pre-set condenser we can control the oscillation of the valve and arrive at a setting which will give smooth oscillation over the whole wave-band.

Output.—The output from the oscillator is taken from the anode end of the plug-in coil, and fed to a 5,000 ohm potentiometer through a .0001 mfd. condenser. This form of feed is open to criticism, as the condenser does not allow a constant load on the oscillator at all settings of the potentiometer, and will be found to exercise some control over the wavelength emitted by the oscillator. This is not serious, however, and, provided the potentiometer is set at a fixed point while making a wavelength calibration, no trouble should be experienced. From the slider of the potentiometer a screened lead is run through the side of the screening box, and care should be taken to make a good connection between the screening braid on this lead and the case. It is suggested that a 4 BA clearance hole is drilled close to the hole through which the screened lead passes and a soldering tag secured by a bolt and nut fixed in place. The screened lead should then be bound with some thin tinned copper wire and soldered to the tag. At the other end of the screened lead two crocodile clips should be attached, one to the central wire itself and one to a wire soldered to the screening braid. The length of screened lead outside the box should be sufficient to enable connection to be made to components inside a receiver, but not so long that undue losses are introduced. About 2 feet should be ample.

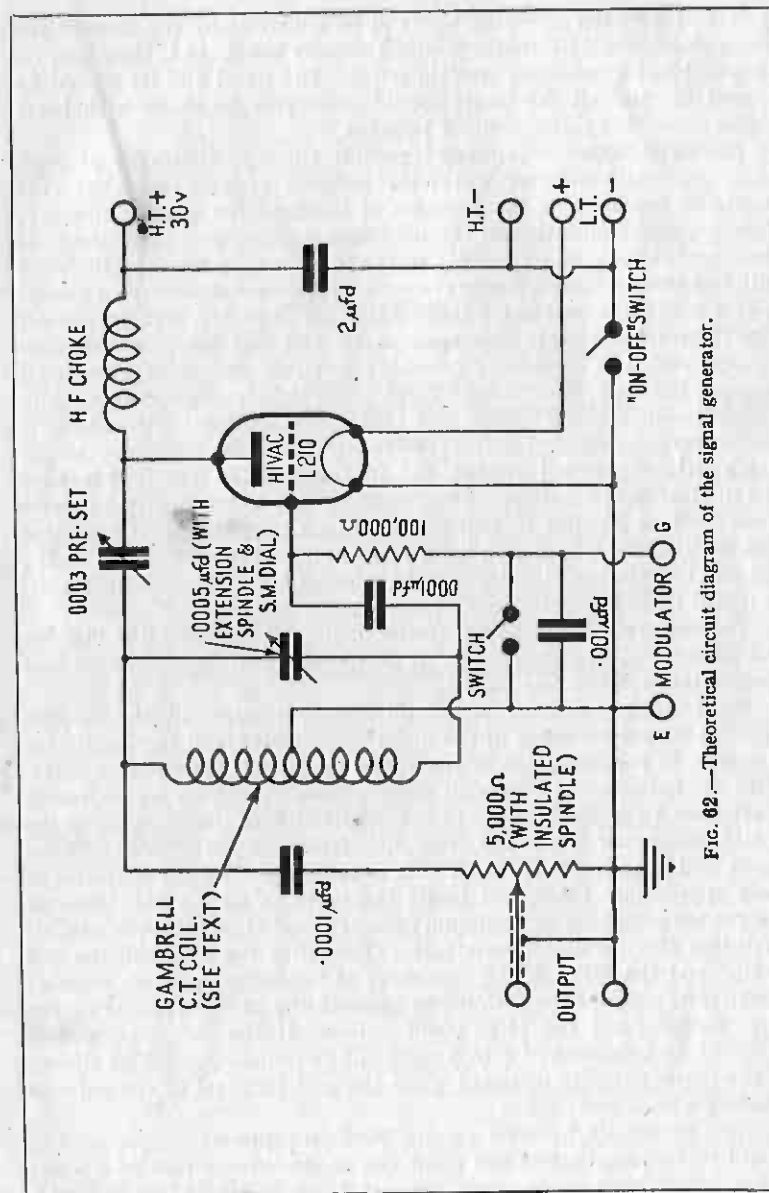

Fig. 62.—Theoretical circuit diagram of the signal generator.

The size of the screening box will be governed by the sizes of the accumulator and H.T. battery which readers select, and, therefore, no hard-and-fast dimensions are laid down. The panel and lid should be a good fit, and all the joints should preferably be made with brass angles or welded throughout, if possible.

Choice of Coils.—One point regarding the coils is worthy of mention. No doubt readers will have suitable plug-in coils, but care should be exercised in the selection of these, as the whole frequency, stability, and calibration of the oscillator is dependent upon the coils used, and it may be impossible to cover the whole wavelength range with but three coils of other make. Nevertheless, before buying special coils it may be as well to try those which are available, and the nearest sizes in ordinary plug-in coils are Nos. 50, 150, and 500. Readers may wonder why it is considered necessary to cover the whole wave-band between 150 metres and 3,500 metres, when broadcast receivers usually tune between 200-550 metres and 1,000-2,000 metres. The reason is that superheterodyne receivers have intermediate frequency stages which often require adjustment, and are tuned to 465 Kcs. (645 metres) or 110 Kcs. (2,727 metres). Also, when testing very sensitive receivers it may not be possible to reduce the output from the signal generator sufficiently when working on its fundamental, and the second harmonic, equal to half the wavelength, may be selected and used for adjustment, as it will be much weaker.

The construction of the apparatus should not be difficult if Figs. 62 and 63 are studied closely. Fig. 61 illustrates clearly the screened lead passing through the side of the box.

Final Adjustments.—First of all check through all the circuits with the resistance meter of the multi-range tester, and pay particular attention to the insulation of the anode circuit of the oscillator valve. With no batteries or valves in circuit there should be no deflection apart from an initial "kick" of the needle, due to the charging of the 2 mfd. condenser when the resistance terminals are joined between anode and negative L.T. If all is in order connect up the batteries to their appropriate leads, and insert the valve in its socket. Unscrew the pre-set condenser to minimum capacity, and close the switch short-circuiting the modulator terminals. Then, with the B coil in the coil holder, and the $\cdot 0005$ tuning condenser at minimum capacity, connect the 10 mA. range of the D.C. meter between the 30-volt tapping on the H.T. battery and the H.T. positive lead. If the oscillator is now switched on a current of 3 to 5 mA. will be indicated, and no change in the current should be noted when the grid terminal of the valve is touched with a wet finger.

Now commence to screw up the $\cdot 0003$ mfd. pre-set condenser, and it will be noticed that at one point the anode current falls to a lower value, which rises again when the wet finger is applied to the grid.

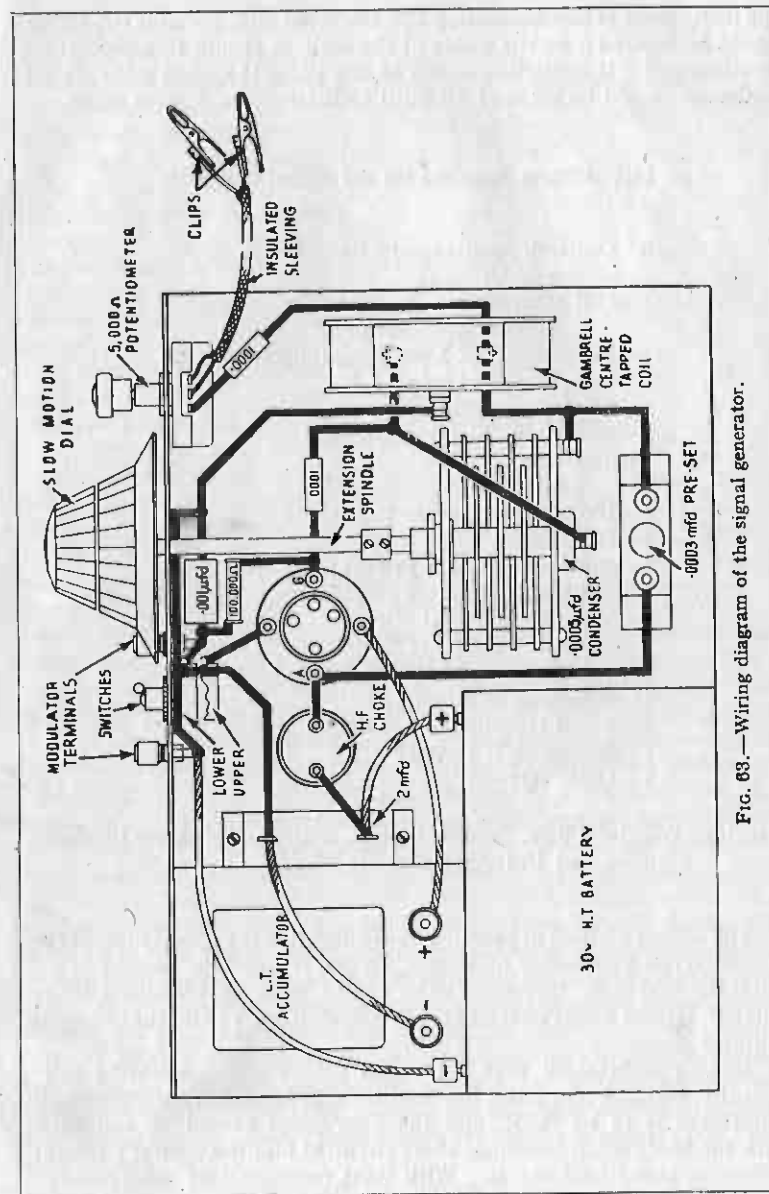

Fig. 63.—Wiring diagram of the signal generator.

The instrument is now oscillating and the .0005 mfd. variable condenser should be rotated over the whole of the scale to ensure that oscillation is maintained. If oscillation ceases at any point the .0003 mfd. pre-set condenser should be screwed up until oscillation commences again.

List of Parts Required for the Signal Generator

- 3—Centre-tapped plug-in Coils (Sizes B, E1, and G)
- 1—Coil-holder (with provision for centre-tap terminal connection)
- 1—Potentiometer, 5,000 ohms (ungraded) with insulated spindle
- 1—4-pin Valve-holder
- 2—0001 mfd. Fixed Condensers
- 1—001 mfd. " "
- 1— 2 mfd. " "
- 1—100,000 ohm $\frac{1}{2}$ -watt Resistance
- 1—H.F. Choke
- 1—0003 mfd. (max.) Pre-set Condenser
- 1—0005 mfd. Variable Condenser
- 1—Micro-vernier Dial
- 2—" On-off " Switches
- 2—Terminals (one with insulating bush)
- 1—Screening Box (see Text)
- 1—2-volt Unspillable Accumulator
- 1—30-volt H.T. Battery
- 1—L210 Valve

Sleeving, Wander Plugs, Screened Lead, 2 Crocodile Clips, Insulated Spindle, and Universal Bracket.

The easiest method of carrying out calibration is to press into service a heterodyne wavemeter of known accuracy, but this method is not suitable. We shall, therefore, have to fall back on broadcast transmitting stations whose wavelengths we know, in order to do the necessary calibration.

Having ascertained that our signal generator is oscillating satisfactorily, we must now select the conditions under which our wavelength calibration is to be made, and the instrument should be calibrated with the modulation terminals short-circuited and the output potentiometer set about half-way in. With most receivers this will provide a

useful signal, and if the potentiometer is always set to the position we select we shall be able to rely on the accuracy of our calibration.

Using a Broadcast Signal.—Now connect the output leads from the signal generator to the aerial and earth terminals of your broadcast receiver via a .0002 mfd. condenser, as shown in Fig. 65, leaving the normal aerial and earth connections in place. Then tune the broadcast receiver accurately to a station whose wavelength is known, say, London National (261.1 metres), then switch on the signal generator and with Coil B in the socket, and the lid of the screening box firmly closed,

slowly rotate the dial of the tuning condenser from minimum to maximum. Now, if the signal generator is oscillating satisfactorily, we shall hear at one point on the scale a beat note in the loudspeaker of our receiver very similar to that which is produced if we make our set oscillate and then tune in to a station. This beat note always commences as a high-pitched whistle, which falls in pitch to a silent point and then rises again and vanishes as the tuning controls are rotated. The beat note produced by our signal generator will behave in a precisely similar way, and all we have to do is to set the signal generator at the silent point midway between the two audible notes and jot down the dial reading. Now re-tune the broadcast receiver to another station and repeat the process until a reasonable number of points have been logged down corresponding to wavelengths between 200 and 450 metres. The E1 coil should then be inserted in the coil socket, and the process repeated with stations whose wavelengths lie between 400 and 550 metres, also tuning the receiver to 900 metres which is usually easily identifiable as the wavelength used by commercial aircraft stations, and taking a reading of the dial setting for this wavelength. Finally, insert the G coil and take readings against broadcasting stations whose wavelengths are known between 1,000 and 2,000 metres.

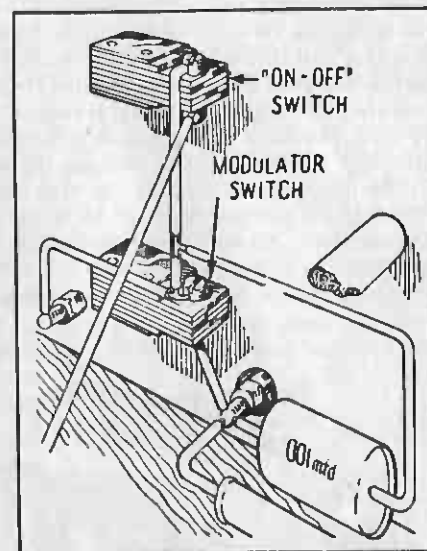

FIG. 64.—Details of the wiring connections to the switches of the H.F. oscillator.

Calibrating Graphs.—This will give us a nucleus for drawing calibration graphs on each of the three coils, but it will be noticed that there is a gap in the graphs between 550 metres and 900 metres, and that no readings have been obtained above 2,000 metres. However, these are quite easy to fill in if it is remembered that our signal generator not only produces a fundamental frequency, but also a number of harmonics, the loudest of these being the second harmonic corresponding to a frequency twice that of the frequency to which the generator is tuned. If readers are not used to thinking in frequencies, the second harmonic will be found at a point equal to half the wavelength of the setting of the generator.

This makes it easy to fill in the gaps in our calibration chart, for if, for instance, we tune our broadcast receiver to London Regional (342.1 metres) and rotate the dial of our signal generator from minimum

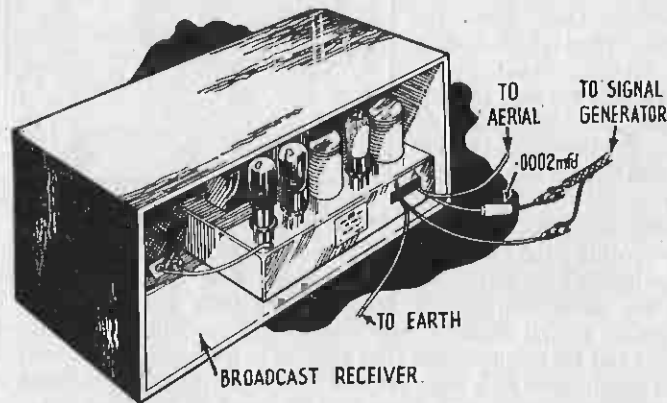

FIG. 65.—Connecting the signal generator to the receiver with a .002 mfd. condenser in the aerial lead.

to maximum we shall hear a beat note when it is tuned to 342.1 metres, and if we continue to rotate the dial, a second beat note of slightly smaller strength, when it is tuned to twice this wavelength or 684.2 metres. Thus, by selecting known stations between 300 and 450 metres and putting down the dial settings obtained on the signal generator when its second harmonic beats with these stations we can fill in the gap between 700 and 900 metres, thereby making known the settings for 645 metres which is equivalent to 465 Kcs. intermediate frequency.

Turning now to the wavelengths above 2,000 metres, we can take readings in precisely the same way. For instance, tune the broadcast receiver to Droitwich (1,500 metres) and rotate the dial of the signal generator with the G coil in circuit until the beat note produced by its

second harmonic is heard. The dial setting will then correspond to 3,000 metres. Similarly Radio-Paris, on 1,648 metres, will give us the setting for 3,296 metres, and so when we have plotted our graph we shall be able to locate 2,727 metres, which is equivalent to 110 Kcs. intermediate frequency.

Beat Note Audibility.—So far so good, but there is one point on which we have yet to touch. If our broadcast receiver cannot be made to oscillate, we shall not hear a beat note from our signal generator unless the receiver is tuned to a station, so we must find some means of superimposing an audible note on the output of our signal generator if we are to use it for adjustment purposes. This is the purpose of the modulation terminals, and we shall find that if we connect the output

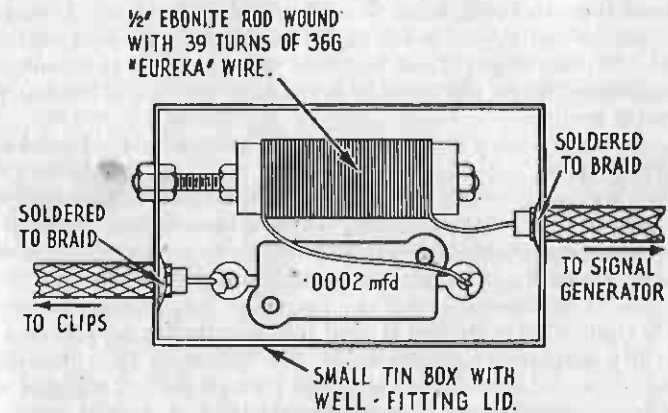

FIG. 66.—The components for a "dummy aerial" mounted in a small tin box.

terminals of the beat frequency oscillator to the modulation terminals of the signal generator and open the modulation switch we shall hear the audible note produced by the L.F. oscillator in the loudspeaker of a broadcast receiver which is connected and tuned in to the signal generator. We shall be able to vary the pitch of the note produced by varying the setting of the dial on the L.F. oscillator and also vary the strength of the note by adjustment of the output potentiometer on this instrument. A word of warning may be necessary here, viz., the output from the L.F. oscillator should never be increased to a point where the beat note produced by the signal generator and a broadcasting station when listened to on a receiver, sounds harsh. If insufficient volume is produced in the loudspeaker of the set, always increase the output from the signal generator, not the L.F. oscillator, otherwise the signal generator may be over-modulated.

However, if we suspect that our amplifier has a pronounced resonance at 5,000 cycles the figures obtained will soon prove our suspicions, and we can safely assume that, if our amplifier shows a reasonably flat response, then our loudspeaker is providing the resonance.

When testing amplifiers with a high gain our output voltages may lie outside the range of our valve-voltmeter, even with the smallest input we can measure. This, however, is not important, because we can quite easily split our load resistance into two halves, and double the voltage readings obtained on our valve-voltmeter across one-half of the resistance. Fig. 60 will show how to do this.

Apart from the uses of the instrument as a speaker-rattle locator, etc., it provides a source of low-frequency voltage for modulation purposes, and in Chapter XII a radio-frequency oscillator will be described, which can be made into a modulated signal-generator by attaching it to the beat-frequency oscillator.

CHAPTER XII

A SIGNAL GENERATOR

THE instrument about to be described produces, in conjunction with the beat-frequency oscillator already dealt with, a steady signal over the whole range of approximately 150 metres to 3,500 metres, which can be modulated to produce an audible note in headphones or loud-speaker of any frequency within the range of the beat-frequency oscillator. Not only can it be used to check alignment of circuits, but an idea of the selectivity and sensitivity of any receiver can be gained, and comparisons made between individual receivers. This will, of course, be invaluable to a service-man, for he can compare the performance of a receiver which he knows is up to standard with one which he suspects is failing, and carry out adjustments to render the poorer receiver equal in performance to the standard model. Furthermore, he can settle, once and for all, the relative merits of any two receivers by taking readings of their performance and comparing them.

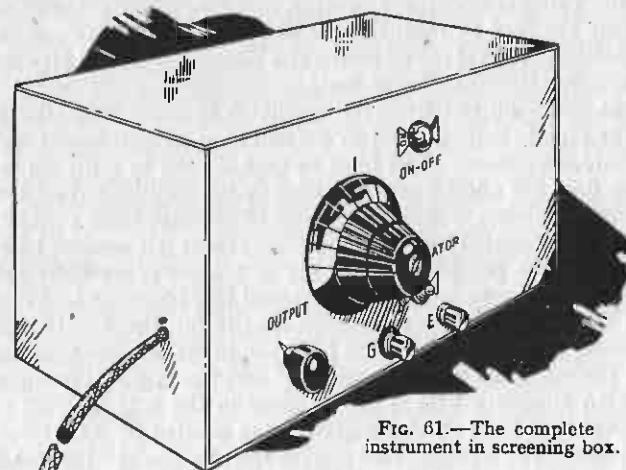

FIG. 61.—The complete instrument in screening box.

The Hartley Circuit.—On examining the circuit used, shown in Fig. 62, readers will see at once that it is the familiar Hartley oscillator using centre-tapped coils of the plug-in variety to cover the wave-range required, and tuned by a

of 'phones, in the anode circuit of each of the L.F. valves and the detector, and by transferring the aerial lead from the first valve to each consequent H.F. valve, and then to the grid circuit of the detector. Up to a point, the same idea holds good with a superhet, but it is obviously impossible to eliminate H.F. stages, because there probably are none. The I.F. valves correspond to the H.F. valves in a "straight" arrangement, but they are not tuned to the signal frequency, but to another frequency outside the range of broadcast wavelengths. For this reason it would be useless to transfer the aerial lead-in to the grid terminal of one of the I.F. valves.

Converting to a "Straight" Circuit.—The simplest procedure in a case like this is to transfer the lead which normally goes from the grid terminal of the aerial tuning circuit to the grid of the first detector or frequency-changer to the grid of the I.F. valve, and to break the connection from the latter to the I.F. transformer. This is shown in Fig. 67, where the original connections are indicated by broken lines and the new ones by heavy lines. When this has been done it is evident that the I.F. valve is used as an ordinary H.F. amplifier, its input circuit being tuned to the frequency of the signals to be received.

This is not sufficient to provide reception though, because the anode circuit of the I.F. valve is still tuned to the intermediate frequency, and so nothing—or very little—in the way of signals would be passed on to the detector. The next step, therefore, is to modify the anode circuit arrangement so that it will respond to the frequency of the received signals. One method would be to replace the primary winding of the L.F. transformer with an H.F. choke; but a simpler idea is merely to transfer the grid-condenser connection from the secondary winding of the transformer to the anode terminal of the primary winding; this also is indicated in Fig. 67.

After making the simple alterations described—they may be made very roughly, and without disturbing the rest of the set—the receiver becomes a simple "straight" three-valver, comprising an H.F. amplifier, choke coupled to a leaky-grid detector, and L.F. amplifier. As such, it should be capable of providing good reception from at least half a dozen stations, assuming that the original fault was in the frequency changer, as had been assumed. Super-selectivity should not be expected, nor should long range, because there are only two tuning circuits (the original band-pass tuner) and reaction is not employed. Nevertheless, should it be found that a new component or valve is required, and this cannot be obtained immediately, the receiver can be used as a reasonably efficient three-valver for an indefinite period.

A Precaution with Mains Sets.—In making the above suggestions, it has been assumed that the receiver was a four-valve battery-operated instrument of the simplest type, embodying a pentagrid frequency-changer, followed by a single I.F. amplifier, a leaky-grid detector, and

a pentode output valve. The general idea holds good, however, for most other types of set, but in the case of a mains receiver it is better, after changing the connection from the band-pass filter, to connect the grid of the first valve direct to the lower end of the tuning circuit, so that it receives its usual bias voltage. If this were not done the valve would pass more than its normal H.T. current, and if the valve were removed from its holder the H.T. and L.T. voltages applied to the other valves might become too high. The method of "earthing" the grid is shown in Fig. 68, where it will be seen that the grid must be connected to the A.V.C. line (where provided), to the variable bias supply, or directly to the earth line.

When there are two I.F. valves the anode circuits of both must be modified, whilst a .0002 mfd. grid condenser and a 2-megohm leak should be included in the grid circuit of the second, as shown in Fig. 69. The object of these components is to prevent the grid from being biased positively by the H.T. voltage, and to ensure that the bias voltage remains as before.

If the set still refuses to function after making these minor alterations to the wiring, it can be treated in a similar manner to a "straight" arrangement by taking the lead from the grid terminal of the band-pass tuner to the grid of the second I.F. valve, and then to the grid condenser of the detector. Even with the latter connection the set should operate, although signals will naturally be rather weak; nevertheless, it is possible in this way to check the I.F. valves and their corresponding circuits.

Checking Diode Second Detector.—The position is not quite so straightforward when a double-diode-triode or similar valve is used as second detector, but even then the main principles may be applied, as shown in Fig. 70. In this case one end of each winding of the I.F. transformer which feeds into the diode is disconnected and replaced by a double-wound coil and a .0005 mfd. variable condenser. The coil may be of any type having primary and secondary windings,

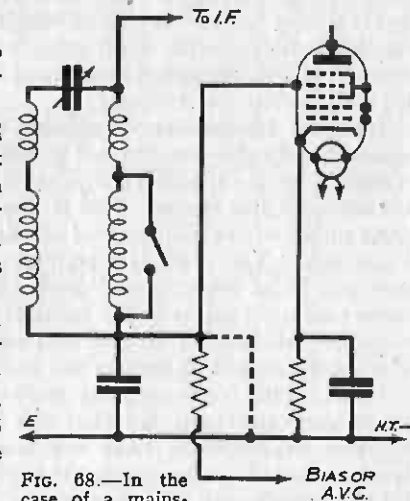

FIG. 68.—In the case of a mains-operated set the detector grid of the frequency-changer should be connected so as to receive the normal bias, as shown, when using the modified connections shown in Fig. 67.

tuning condenser has to be operated at the same time as the original gang condenser, of course—but no difficulty should be found in obtaining some sort of reception.

Gang-condenser Connections.—The tuning circuit is the part which probably causes more difficulty than any other; this is to be expected in view of the fact that it is this which differs most from the corresponding part of the older types of receiving set. Sometimes it is found, for instance, that nothing but the local stations can be heard, the signals from these being much weaker than they should be, and the dial reading being entirely different from what would be anticipated. Such a fault generally points to the fact that the gang condenser has been wrongly connected, the oscillator portion being joined to one of the signal-frequency coils instead of to the oscillator coil. This mistake can easily be made because there is no standard position for the oscillator section (which has quite a different capacity and a different "law" from the others), and it is sometimes placed at the end nearest to the operating spindle, and sometimes at the other end. Very often the condenser is marked in some way, but this is not universal.

The Oscillator.—Should there be any doubt concerning which is the oscillator section it is easy to check up by removing the screening cover and examining the vanes. In most cases the moving vanes are of different shape, whilst the fixed vanes are cut away more in the centre where the spindle passes them. When the condenser is of the three-gang type it is easy to find one section which is different from the other two, but this is not possible when using a two-gang component. Fig. 71, however, shows the general shapes of the vanes in both sections, and this should clear the difficulty.

Incorrect Intermediate Frequency.—Another trouble which is experienced by those who do not follow any published design, or who do not employ the specified components, is similar to that just described, but normally less severe. This is due to using a condenser designed for an intermediate frequency of one figure with coils designed to work at a different I.F. This is a trap which is very easily fallen into by those who build from "junk" parts picked up at a cheap store! Yet another similar trouble is due to using I.F. transformers of the wrong frequency calibration; in this case the dial readings will be approximately correct, but all signals will be very weak—if received at all.

When tuning is not perfectly sharp—as it should be with a superhet—it is generally indicated that the trimmers on the intermediate-frequency transformers have not been correctly adjusted, although attention should also be directed to the trimmers on the gang condenser. But the latter rarely cause flat tuning; they are more likely to reduce signal strength, because the tuning nearly always "follows" the tuning of the oscillator condenser.

Interference.—When long-wave interference is in evidence, however,

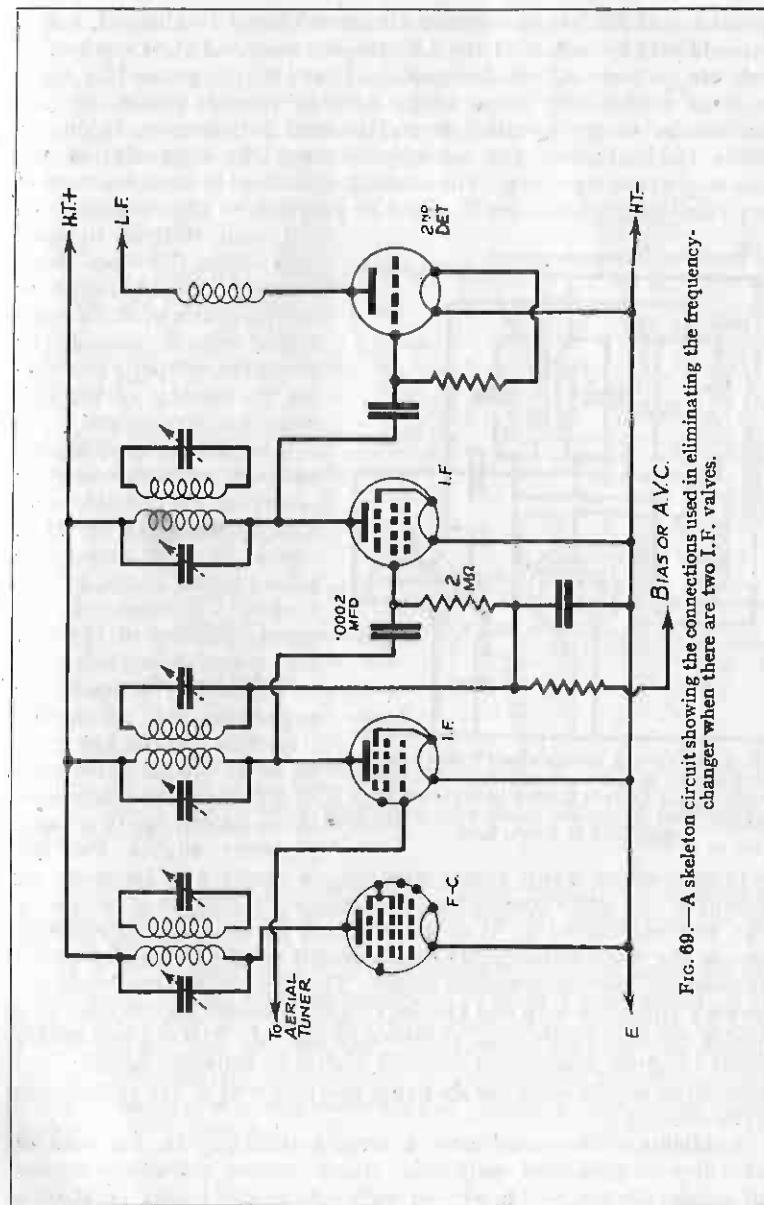

FIG. 69.—A skeleton circuit showing the connections used in eliminating the frequency-changer when there are two I.F. valves.

the setting of the gang-condenser trimmers should be checked, whilst it should also be seen that the I.F. transformers and their connecting leads are properly screened, especially if any of the connecting wires are more than a few inches long. Another possible reason for this interference, or for so-called second channel interference, is due to signals leaking across the capacity between the electrodes of the frequency-changing valve. The amount of leakage is nearly always of very small proportions, but it might be sufficient to allow signals from

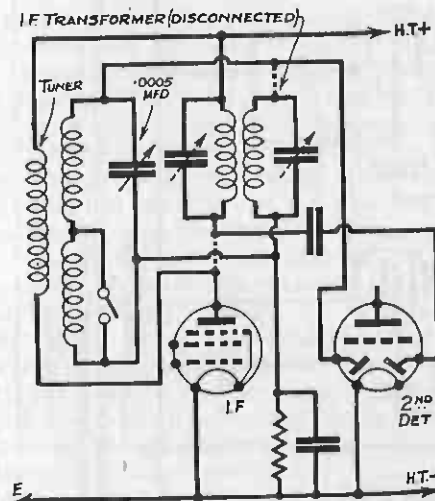

FIG. 70.—When a double-diode-triode type of valve is used as second detector the I.F. transformer which feeds it should be replaced by a double-wound tuner and .0005 mfd. variable condenser as shown here.

or otherwise cut down signal strength. A choke can be made by winding about 200 turns of 36-gauge enamelled wire on a bobbin of $\frac{3}{4}$ in. internal diameter. It is not essential to split up the winding, because the small self-capacity which results from pile-winding is not sufficient to have any serious effect. The bobbin can be made by screwing two cardboard end cheeks 1 in. in diameter to the ends of a wooden rod about 1 in. long, as shown in Fig. 74. The rod and cheeks should be given a couple of coats of shellac or cellulose varnish, and connections can be made by soldering short lengths of flex to the ends of the winding.

Instability.—The same cure is often satisfactory in the case of instability or persistent oscillation, which renders reproduction poor and causes the set to "howl" at each side of the tuning point of a

the local stations to pass. And when this does occur whistles will be heard at various parts of the tuning scale, which cannot be eliminated properly by altering the settings of the I.F. transformer trimmers.

One simple modification which is often successful in removing the trouble consists of inserting an H.F. choke of low inductance between the anode of the frequency changer and the anode terminal of the first I.F. transformer, as shown in Fig. 73. A small, inexpensive and unshielded "reaction" choke can often be used, but the inductance of a better-class component is so high that it will probably silence the set,

signal. Another reason for this instability is too close a coupling between the primary and secondary windings of the I.F. transformers. When the positions of the windings are variable it is an easy matter to effect a remedy by moving them farther apart. When they are fixed, a similar result can be obtained by connecting a fixed resistance of between 200 and 1,000 ohms between the ends of the primary winding

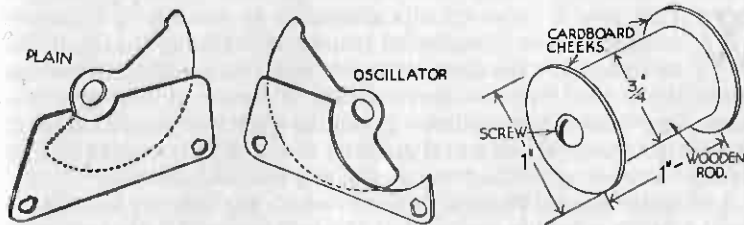

FIGS. 71 and 72.—The general shape of the vanes in a plain and oscillator section of a superhet-type gang condenser.

FIG. 74.—Details of the spool for the special choke indicated in Fig. 73.

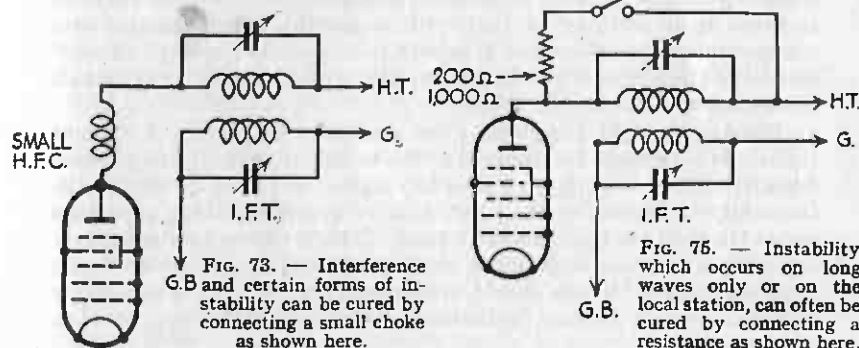

FIG. 73.— Interference G.B and certain forms of instability can be cured by connecting a small choke as shown here.

FIG. 75.— Instability which occurs on long waves only or on the local station, can often be cured by connecting a resistance as shown here.

of one or both of the transformers. In most cases it will be sufficient to join a 500-ohm resistance in parallel with the primary of the first I.F., as shown in Fig. 75.

It is very often found that the instability is experienced on long waves only, or when receiving one or two powerful transmissions. When this is the case it is a good plan to connect an on-off switch in series with the resistance, as in Fig. 75, because the resistance does actually reduce the sensitivity of the receiver to a certain extent, and thus impairs the reception of weaker signals. Leads to the switch should be short and screened.

Using a "Dummy" Aerial.—The simple .0002 mfd. coupling condenser used for calibration purposes will usually be found a satisfactory means of connecting the output from the signal generator to a receiver under test, but some readers may wish to construct a more complete "dummy aerial." As will be seen on reference to Fig. 66, it consists of a small brass or tin box, into which the output lead from the signal generator is led at one end, and the shielding braid connected to the box to earth it. Inside the box are mounted a .0002 mfd. fixed condenser, and a small inductance wound with 36 gauge "Eureka" wire. These are connected in series, and brought out to a further short length of screened lead, the screening of which is again secured to the box. The short length of lead is terminated by crocodile clips in the manner shown. This little accessory serves to reproduce more or less accurately the conditions to be expected when a broadcast receiver is connected to an outside aerial, and if the signal generator is used to calibrate a receiver for wavelength it will be found that the readings obtained will be maintained when the receiver is actually used on a normal aerial and earth system.

Some readers may be interested to know exactly what the sensitivity of their receivers is in actual terms of microvolts, etc., fed into the aerial circuit. I must make it clear that this equipment will not do this. Measurements of this description require very costly and complicated apparatus, quite beyond the capabilities of most amateurs to construct, but these instruments will provide a means of tracking all the trouble which an amateur or serviceman is confronted with, and if used intelligently are capable of giving eminently satisfactory results within the sphere of their capabilities. It should be understood that although each of the instruments which have been described will operate separately, and, indeed, have been designed with that end in view, yet their major usefulness will be achieved if they are used in conjunction with one another.

CHAPTER XIII

TRACING FAULTS IN A SUPERHET

IN principle, the location of faults in a superheterodyne receiver is the same as with a "straight" receiver, but there are many additional actual tests which should be applied. When a multi-range meter is available it is, of course, a fairly simple matter to check the various components; but before doing this it often saves time to trace the fault to the particular portion of the circuit in which it exists. For example, if it is first ascertained that it lies in the intermediate-frequency amplifier, comparatively few components have to be tested to find the defective one; but if it is simply known that the fault is in a part of the circuit previous to the L.F. amplifier, a good deal of time might be wasted in testing every individual component in that part of the set.

Process of Elimination.—It is fairly common knowledge that a "straight" receiver, employing both high and low frequency stages, can be tested stage by stage by connecting the loud-speaker, or a pair

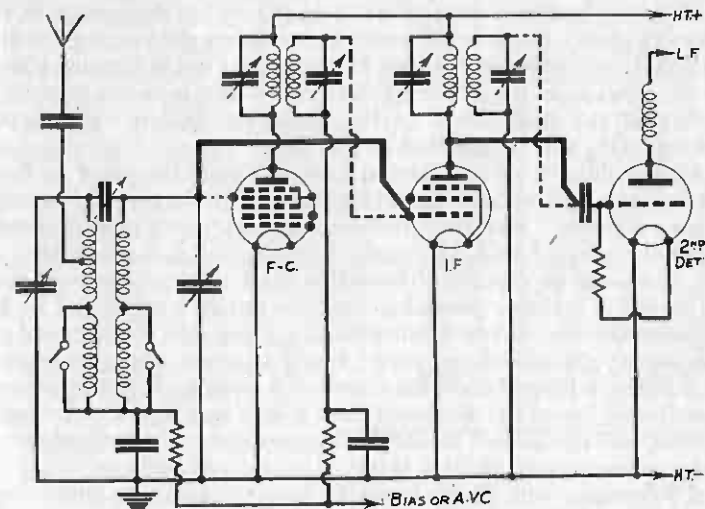

FIG. 07.—This skeleton circuit shows how the frequency-changer of a typical superheterodyne can be cut out of circuit, so converting the set into a "straight" arrangement. Broken lines indicate original connections, and heavy lines the new connections.

matched, due to excessive capacities across one or more of the other tuned circuits, and these should be examined, as explained later.

When ganging, try to arrange matters so that the capacity of the trimming condensers is at a low value, so as to avoid restricting the tuning range of the receiver. If the trimmers are set at a high value, then, when the tuning condenser is near its minimum position, the capacity across each coil will be large and the receiver will not tune to a low wavelength. Similarly, the increase of wave range at the upper end of the scale will be small, since the capacity of the trimmers will then be only a very small percentage of the capacity of the condenser.

Having ganged the receiver at the lower end of the medium wave-band, a weak station at the upper end of the tuning scale should be tuned in, and the trimmers varied to see if any improvement can be obtained. If the coils and condensers are in good order, there should be no necessity to alter the values of the trimmers.

Now return to the lower end of the wave-band and finally, and accurately, gang the receiver on a very weak station of as low a wavelength as possible. Ganging should now hold good over the whole of both wave-bands.

Using a Meter.—The use of a meter greatly simplifies ganging, since it is now possible to see what is happening, and to obtain far greater accuracy than by ear.

The meter should be inserted in the detector anode circuit, and, in order that the meter shall not cause instability, it should be inserted in a position as far from the actual anode of the valve as possible. Between the decoupling resistance and the H.T. supply is a good place, but where the valve is of the indirectly heated type, the meter may be inserted in series with the cathode lead.

Where a diode is used as a detector, and A.V.C. is employed, the meter should be inserted in the anode circuit of one of the controlled valves.

With a receiver using a leaky-grid detector, a station is tuned in and the trimmers adjusted for minimum reading on the milliammeter. Gang on a fairly powerful station, as otherwise the effect of trimming will not be noticeable, but take care that there is no overloading of the detector, as this will result in "double hump" tuning and fictitious results will be obtained. If the detector works on the anode bend principle, maximum signal strength is indicated by a maximum reading of the milliammeter.

Never be satisfied until you can obtain a definite decrease in signal strength on either side of the optimum point. This should be indicated by the reading of the milliammeter increasing greatly immediately the station being received is slightly off-tune, that is, directly the tuning condenser is rotated slightly.

When using a meter in the anode circuit of a valve controlled by an A.V.C. system, accurate ganging is obtained when the deflection is at a minimum.

Where a milliammeter is not available, a voltmeter may be connected across a voltage dropping resistance in the anode circuit, and the receiver ganged by adjusting the trimmers for minimum voltage drop across the resistance.

Uneven Ganging.—It may happen that a receiver gangs perfectly well at the bottom end of the scale, but not at the top. This is bound to occur to a slight extent in all sets, but may be overcome if the condenser is fitted with a concentric trimmer which can be operated from the front of the panel. If the ganging becomes more and more out of step as the condenser is advanced, then the fault is definitely in the coils. On the other hand, the condenser is at fault if the ganging is uneven, that is, the set is properly ganged at the bottom of the scale, is out of gang at the middle, and then falls into gang again at the top. A condenser may be corrected by bending one of the segments, but this is not a job which the average constructor can carry out, and the condenser should either be returned to the manufacturers or the work entrusted to a skilled service-engineer.

If the ganging is out only at one particular point, it is in all probability due to the resonance effect of the reaction choke, or an H.F. choke used for parallel feeding in one of the anode circuits. This effect is not so important, however, as it will only upset ganging at one definite point, and can usually be remedied by substituting a different choke.

A change in the position of the reaction condenser alters the stray capacity across the detector circuit, and it is not possible, therefore, to gang a receiver so that the matching is accurate for all positions of the reaction condenser. It will be appreciated that ganging must be most critical when trying to receive a foreign station, and that in such a case use will have to be made of the reaction control. As explained above, it is important, therefore, to gang a receiver with the reaction condenser advanced so that the receiver is just short of oscillation.

Affect of Trimming on the Wave-range.—It will be appreciated that, by altering the trimmers, a station can be received at several points on the tuning scale. For example, it would be possible accurately to gang a receiver so that London Regional, instead of being received at a dial reading of 342 metres, was received either at 330 or 350 metres, depending on the setting of the trimmers. But, in the former case, it would not be possible to receive stations which would normally come in at the 200-210 metres mark, and, in the latter case, the top end of the wave-range would be curtailed. Therefore, having trimmed a receiver correctly, all trimmers should be screwed out and the receiver re-ganged with the minimum capacity across each circuit. Any slight

divergence in the position of stations as determined by the tuning dial can generally be put right by altering the position of the dial.

Ganging on the Long Wave-band.—A receiver which is correctly ganged on the medium waves should also be correctly ganged when the receiver is switched over to long waves. With modern coils, arrangements are made so that the stray capacity due to the aerial is constant on both wave-bands. Most of the individual stray capacities are bound to be the same whatever wave-band the set is switched for, but, on the other hand, some, notably switches, self-capacity of the long wave windings of the coil, leads, etc., may greatly differ. Assuming that the coils are correctly matched for the long wave-band as well as the medium wave-band, the most usual cause of mis-ganging on the long waves is due to the self-capacity of the switches. It is important, therefore, always to use switches of as low a self-capacity as possible.

Reducing Stray Capacities.—Stray capacities include the grid to filament capacity of valves, the anode capacity of valves, the capacity of the valve-holders, the capacity of screened H.F. leads, the capacity of chokes and condensers, reaction coils, etc.

Every effort should be made to keep these stray capacities as low as possible, in order to increase the wave-range of the receiver. When using screened wire in H.F. leads, always use sleeving of large diameter with as thin a connecting wire as possible, so that there is a good space between the metal braiding and the wire.

Iron-cored H.F. chokes have a much higher capacity than air-cored, while A.V.C. or grid bias decoupling condensers must be made as large as possible to avoid their having too great an effect on the tuning of the circuit in which they are used.

Similarly, the wiring can introduce quite a large capacity, and it is advisable to keep all wires carrying high frequency currents as short as possible. Another mistake which is commonly made, especially in mains receivers, is to use a screened wire for connection to the grid of the detector valve. This should always be avoided as the capacity of such a lead is bound to affect ganging.

Ganging Superheterodyne Receivers.—Ganging a superhet is slightly different, but is no harder than ganging a simple straight receiver with only two tuned circuits, provided the following procedure is carefully followed.

First, adjust the trimmers of the I.F. transformers to about their midway position, and unscrew the trimmer controlling the condenser tuning the oscillator coil. The remaining trimmers should be set to their midway positions. Now tune in a weak station at the bottom end of the medium wave-band and adjust the trimmers of the I.F. transformers, beginning with the anode trimmer of the first I.F. coil and working backwards to the grid trimmer of the last I.F. coil, for

maximum signal strength. Now adjust the trimmers of the aerial coil, or band pass coils, if the latter are used, and endeavour to tune in a station at the top end of the scale, and adjust the trimmer of the oscillator tuning condenser for maximum volume, at the same time gently "rocking" the ganged condenser. Now adjust the I.F. trimmers for maximum volume and return again to the bottom end of the scale. The I.F. trimmers are again adjusted for maximum signal strength, and a return made to the top of the scale, where the I.F. trimmers are again adjusted. This procedure is carried out until a position is found for the I.F. trimmers which is constant for both ends of the scale. The trimmer of the aerial circuit, or band-pass circuit, is then adjusted for maximum signal strength. It will be appreciated that it is possible to set the trimmers of the I.F. coils so that all the I.F. circuits are accurately in tune, but at a frequency of 100 or 120 Kcs. instead of the 110 Kcs. required. If the stations are received at their correct wavelength as determined by the dial, then it is safe to assume that the intermediate frequency is correct. Otherwise, the intermediate frequency is not operating at its correct wavelength, and the whole procedure must be repeated.

Having ganged correctly for the medium wave-band, attention should now be turned to the long waves. A separate padding condenser in the oscillator circuit is included for this purpose. Tune in a station and adjust this condenser, which is usually of the pre-set type and mounted on the baseboard, for maximum signal strength, gradually rotating the main tuning condenser until the station is received at its correct wavelength. The receiver is now correctly ganged for both wave-ranges.

In carrying out the operation of ganging a receiver it is essential to tune in a station which is not subject to fading. The performance of the operations in daylight will ensure that no fading is occurring, and it is better to use a station transmitting speech, since music varies so in volume.

A good plan is roughly to gang the receiver during the evening, and then to carry out the final ganging in daylight. If it is not possible to find a weak station at first, especially in the case of a superhet where there is no manual pre-detector control, the local station may be used for ganging by cutting down the signal strength by using a very short indoor aerial. Gang up roughly on this and then connect up your outdoor aerial. You should now be able to find a weak foreign station on which to carry out ganging. With a straight receiver using variable- μ valves, the signal strength of the local station can, of course, be cut down by increasing the bias, but even then it is better to turn the volume full on and endeavour to find a weak foreign station.

The use of a meter greatly facilitates ganging a superheterodyne receiver. A milliammeter is inserted in the anode circuit of the I.F. valve,

CHAPTER XIV

TRIMMING AND ALIGNING RECEIVERS

WHEN two or more circuits are tuned by the use of a ganged condenser, it is necessary to trim each section of the condenser to counteract the effect of the different stray capacities across each section caused by the added capacity of the aerial, wiring, valve-holders, etc. This is accomplished by adding a small adjustable amount of capacity to each of the tuned circuits, and is usually carried out by means of a trimmer for each section of the ganged condenser.

A properly ganged receiver is one in which the ganging holds good over the whole of both wave-bands. The first essential is that the coils shall be accurately matched, that is, the inductance of each must not vary by more than 0.5 per cent. The second requirement is that the matching of the various sections of the ganged condenser shall be accurate at all settings. Actually, of course, this is not possible as a commercial proposition, and it is sufficient for the capacity of each section of the condenser to be exactly the same at about six points on the tuning dial.

Ganging Straight Receivers.—The procedure of ganging a straight receiver is to arrange the trimmer of the tuned circuit with the greatest capacity due to wiring, etc., at a low value, and then to adjust the trimming condensers of the other tuned circuits until the capacities across the coils are the same in all cases. This is shown by the receiver being more selective and tuning sharply. The tuner is now correctly adjusted and the circuits should, if coils and condensers are accurately matched, remain in tune with each other over the whole of both wave-bands.

Before dealing with actual ganging, it will, perhaps, be as well to consider the causes of the added capacity and how to reduce it to a minimum. An aerial, for instance, has a large capacity to earth, which must be compensated for by the action of a trimmer on the section of the condenser which tunes the aerial circuit. This capacity is greatly reduced, however, by the use of an H.F. transformer in the aerial circuit, but it is always as well to re-trim the circuit when the receiver is used with a different aerial.

The position of the reaction condenser affects the tuning of the detector circuit. The capacity across this circuit varies with the by-pass capacity in the anode circuit of the detector valve, but this effect can be obviated by the use of a differential reaction condenser. When using an ordinary reaction condenser, however, it is best to gang with the

detector circuit just on the point of oscillation, since the receiver will then be accurately ganged when the transferred capacity in the grid circuit of the detector valve corresponds to the most selective condition of the tuned circuits.

A screen grid-valve or an H.F. pentode acting as a detector transfers but little capacity to its grid circuit, but, nevertheless, it is still advisable to gang the receiver with the detector just short of oscillating point, as the set is then in its most selective position.

Modern ganged condensers are fitted with trimmers which are controlled either by a screw or star wheel situated at the side or on top of the condenser cover. The latter is more convenient, since it is very accessible. To gang a straight receiver, first set the trimmers to about their midway position and then tune in a weak station of as low a wavelength as possible. Always gang on a weak station, since the ear is very much more sensitive to small changes in volume when the total volume is small than it is when the total volume is large. Now adjust the trimmer of the detector tuned circuit for maximum volume by moving it slightly in or out. At the same time "rock" the main tuning condenser, and gradually bring the dial reading to the correct setting for the station being received. The detector trimmer should be gradually rotated to keep step with the movement of the main tuning condenser, and, when the correct setting of the latter is obtained, a final adjustment should be given to the trimmer to bring the station up to maximum volume.

Band-pass Tuners.—When a band-pass circuit precedes the H.F. valve, attention should next be turned to the circuit of the band-pass tuner, which feeds the grid of the H.F. valve, i.e., the second band-pass circuit. Adjust the trimmer of the condenser section which tunes this circuit for maximum volume, and then carry on with the aerial circuit. Always commence at the detector stage and work backwards, no matter how many tuned circuits are incorporated in your receiver.

If one of the trimming condensers has to be screwed right in, the other trimmers should be unscrewed a little and the whole procedure of ganging recommenced. Similarly, if one of the trimmers has to be set at its minimum value, then the other trimmers should be increased a little and the receiver re-ganged. If this is not done, it is impossible to tune the receiver correctly. If one of the trimmers has to be fully out it indicates that the stray capacities associated with that particular circuit are too great and the capacities of the other sections of the condenser must be increased. If one of the trimmers has to be screwed right down tight, then the stray capacities across that circuit are lower than those associated with the other circuits, and the latter must be lowered by unscrewing the trimmers a little. If it is impossible to gang the receiver without one of the trimmers being either all-in or all-out, then the fault is, assuming the coils and condensers to be correctly

without some means of checking, may appear very obscure. For example, low insulation between the heater and the cathode of an indirectly heated valve is a frequent source of hum, and is more likely to occur in valves of the "universal" type, although by no means unknown in A.C. valves. Grid-to-cathode shorts or partial shorts are also not infrequent and, in general, the risk of poor insulation between electrodes is more likely to occur in the more complex types of valves, such as frequency-changers, and the various types of multi-function valves such as double-diode-triodes.

The second essential test is on the emission of the valve, and will show whether a valve which will pass the first test is serviceable or whether, by reason of age or mishandling, it has lost its emission and requires to be replaced. There are several ways in which such tests can be conducted, and numerous types of suitable equipment are dealt with in earlier chapters. This explains methods to be adopted when such apparatus is not available. For the tests on insulation between electrodes quite simple apparatus will suffice. The simplest is to connect a suitable voltage and a neon lamp in series between each pair of electrodes in turn. A high tension battery or the output of a mains unit, a neon tube of the type used in tuning indicators with a suitable series resistance, and a pair of test prods are all that are really essential (see Fig. 76), and will suffice when only very occasional tests are required. But for those who are likely to be doing a fairly large amount of testing, or who take a pride in the appearance of their equipment, it may be worth while constructing a more impressive apparatus consisting of a panel with a line of valve-holders of different

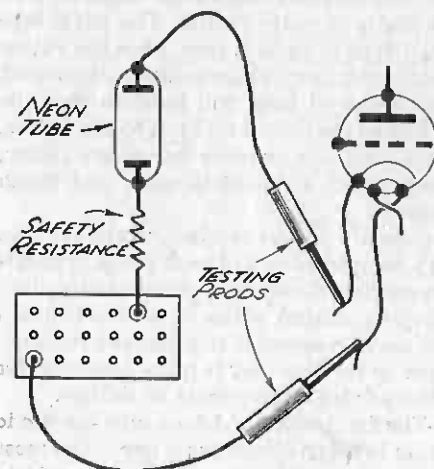

FIG. 76.—A general method for testing inter-electrode insulation.

types—4 and 5-pin, 7-pin, 9-pin, and side contact—with the neon lamp fitted behind a neat escutcheon, and a switching device to permit the various pairs of electrodes to be selected for testing.

A Suggested Tester.—It will be found that two rotary switches connected in accordance with the diagram shown in Fig. 77 will achieve this object, and if ten-way switches which are standard products, are used, any combination of two electrodes in any standard type of valve can be tested. It is advisable to number the switch positions from 1 to 10 consecutively, and to connect

them to the sockets of the valve-holders bearing the same numbers according to the standard B.V.A. convention, reserving No. 10 for the top cap. A list of the standard connections for various types of valves should also be obtained, and mounted on a card for ready reference.

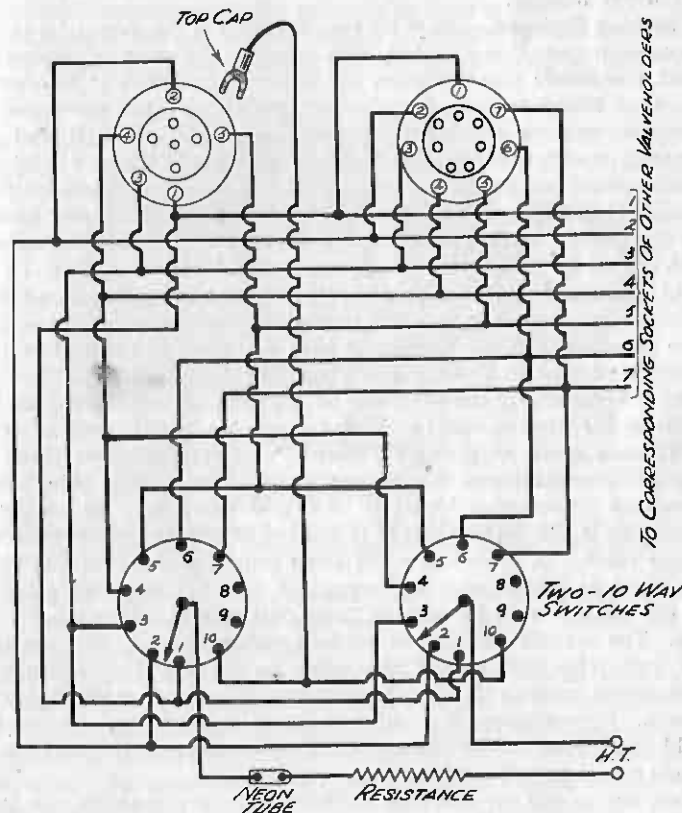

FIG. 77.—A layout for a tester of inter-electrode insulation.

As an alternative to using two switches, an arrangement of numbered sockets may be used, and for this purpose a single 9-pin valve-holder of the chassis-mounting type is particularly handy, each socket being connected permanently to the socket bearing the same number in every other holder, and the test connections being made by means of two plugs attached to short flexible leads. In this test low insulation is, of course, indicated by full illumination of the neon tube, and it will be necessary first to adjust the value of the safety resistance to a value

suitable for the test voltage used. Valves should be tested when hot, i.e., after the heater or filament has been in circuit for some time, as poor insulation is often the result of expansion, and is only revealed after the valve has warmed up. When testing between grid and cathode, with grid positive, a low resistance will be indicated due to grid current flowing.

Checking Emission.—Next for consideration is the means for taking the emission test. The simplest, and possibly the most convenient, is to test the anode current when the valve is operated at its correct filament or heater voltage, and the voltages at the other electrodes are maintained at some standard values such as anode volts 100, and grid volts zero, or such other values as are indicated in the maker's catalogue or characteristic curves. Care should be taken that if the test conditions are such that the anode current is likely to be substantially greater than the normal anode current under working conditions, the valve is not in circuit for longer than is necessary to take the readings. In the case of output valves it is generally advisable to select testing conditions in which the anode voltage is less than the normal rated anode voltage of the valve, or in which a negative bias is applied to the grid to limit the anode current to a safe value, otherwise there is risk that even in testing the emission of the valve will be impaired. But whatever the test conditions are, they should be values for which adequate data as to the approximate anode current for a normal valve is available. Even so, it should be remembered that valve-makers allow a fairly wide margin of working "tolerances," that is to say, a valve may be passed as satisfactory if the anode current is somewhat less or greater than the average value. If, therefore, a variation from the expected test value to as much as 50 per cent is observed, it does not necessarily signify that the valve is unfit for service, more particularly if it is a fairly old valve. The normal emission of modern valves is on a very generous scale, and quite good results may often be obtained in practice with valves which appear to be considerably sub-normal with respect to emission. Nevertheless, if a valve is found to be of low emission it should be deemed a possible suspect if other tests on the receiver as a whole reveal no other faults.

Test equipment for checking emission can vary between the most simple, and the very elaborate. A panel with a range of valve-holders and a selection of split-circuit adaptors is adequate for occasional testing, or for still less frequent use a row of different valve-holders of the baseboard type with short leads and wander plugs connected to each terminal can be used in conjunction with a row of sockets connected to sources of high tension, low tension, and grid bias. There are, of course, many ingenious adaptors of the universal type which permit every type of valve to be tested in this way, or the ingenious reader may like to spend an hour or two devising switching arrangements

which will simplify operation, and minimise the number of loose leads and connections.

If tests on inter-electrode insulation and emission indicate that the valve is in reasonably good condition, no further tests on the valve, as a valve, are necessary. It is, of course, quite an easy matter to check the mutual conductance of the valve by noting the anode current under two different conditions of grid voltage (the difference should be small, say $1\frac{1}{2}$ volts), and then dividing the change of anode current by the

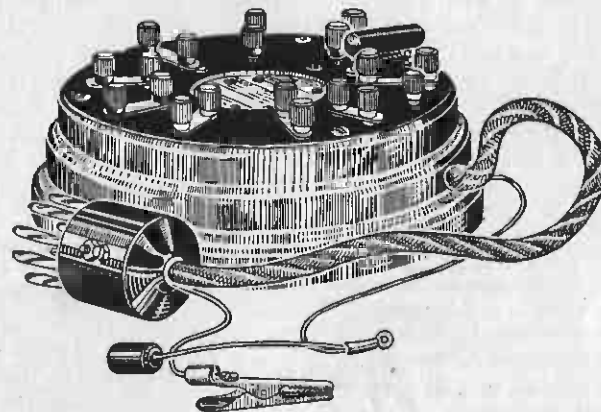

FIG. 78.—An interesting commercial all-valve test panel. This is a most useful accessory for the keen experimenter and service engineer.

difference in grid voltage, but the value of such a determination, being the "static" characteristic and not the "slope" under working conditions, is very problematic.

But when the valves have proved to be good or reasonably good, it is advisable to make further tests of the valves in position in the set, checking voltages to each electrode and currents in each circuit. Since the valves are above suspicion, any abnormalities must be due to circuit defects, and the nature of the irregularities usually furnishes some clue to the actual trouble.

which is, of course, controlled by A.V.C., and the foregoing adjustments are made until a minimum reading is obtained on the meter.

The operation of ganging a receiver may perhaps appear a little formidable from the foregoing, but it is in practice quite simple and interesting if the work is carried out systematically. To start off with a receiver on which it is just possible to receive the local station, and then to "hot it up" by ganging, so that upwards of fifty stations may be received, is work which is well worth doing, and amply repays all the time and trouble spent on it.

Once the ganging and aligning has been accurately and carefully carried out, leave well alone. It is practically an impossibility for the settings to alter, and therefore only harm can result from further adjustment.

A good plan is to run a couple of drops of sealing wax over the trimming screws to prevent them from turning due to vibration. If adjustment is required at a later date—because a new valve is fitted, for example—the wax can easily be chipped away with the blade of the screwdriver.

CHAPTER XV

TESTING VALVES

THE standard of performance and consistency reached by modern valves is very high, and the troubles which occur are mainly the result of using old valves which are past their prime, although, of course, there are instances in which the valves are definitely faulty.

This suggests that the first stage in testing out a receiver for the elimination of faults should be to examine each valve separately, and that amateurs should be acquainted with the methods of conducting such tests. There is a quite mistaken notion that valve testing always involves the use of a large quantity of expensive equipment. While it is true that certain types of test can only be performed with the use of a considerable amount of very accurate gear, it is possible to carry out all the essential tests required by the amateur with quite simple equipment such as may be rigged up at home for a very modest expenditure of time and money.

Two Distinct Types.—It should be remembered that there are two distinct types of tests on valves. The first are on the valves outside the set, and are intended to indicate their condition and efficiency. The other tests are those conducted on the valves under the operating conditions obtaining in the receiver, and are, therefore, of more consequence in affording a check on the working conditions which may or may not be affected by circuit faults or valve faults. The advantage gained by carrying out the initial type of tests is that, once the valves have been proved to be in good order, any abnormalities discovered during the course of the second series of tests will indicate that the trouble, whatever it may be, is due to the circuit and not to the valves. Moreover, if the first tests reveal that one or more valves are faulty, replacement will, in most cases, effect a complete cure, and much valuable time will have been saved.

In examining valves independently of the receiver, there are two alternatives. One is to conduct a complete series of tests which approximate to those adopted by valve-makers during and after manufacture, and the other is the application of a simpler series of tests calculated to determine whether the valves are in reasonable serviceable condition.

The simpler testing technique to be described is quite adequate for the amateur and, indeed, for the service departments of dealers.

Inter-electrode Insulation.—The first test is a check on inter-electrode insulation. Sub-normal insulation between electrodes is one of the most common defects found in valves, and a source of many troubles which,

H.P.T., Tungram P.P.222, Hivac T.220, Osram P.T.2 and P.T.2-K., Mazda Pen. 220, and Mullard P.M.22A. Each of these valves has a maximum undistorted output in the neighbourhood of 500 milliwatts, and the combined anode and screening-grid current does not exceed about 10 mA. at 120 volts H.T. In other words, although they provide a greater output than a small triode, they are equally economical of current.

In using a valve of this type it is necessary to replace the existing 4-pin valve-holder by one of the 5-pin type; the connections are as before, with the exception that an additional lead must be taken from the screening grid socket (centre) to a tapping on the H.T. battery (see

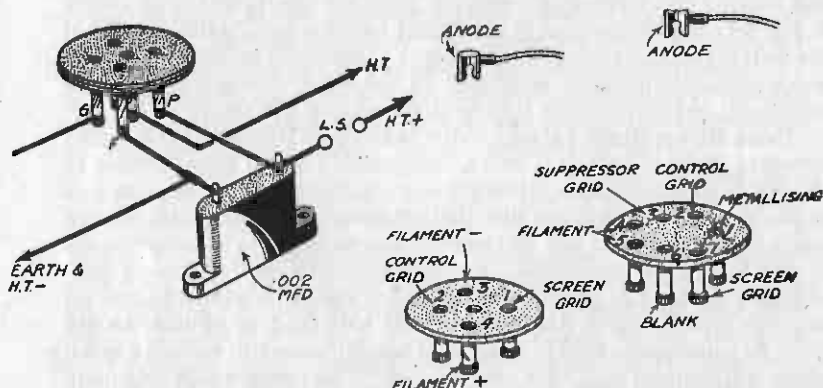

FIG. 80.—When replacing a small power valve by a pentode, a 5-pin holder must be used, a lead being taken from the centre socket to H.T. + as shown, and a fixed condenser joined between the anode socket and earth.

Fig. 80). There is another point to remember, which is that the optimum load of the pentode will be much higher than that of the triode which it replaces. This means that for the best results different tapplings on the speaker transformer must be used. If the speaker is not of the "universal" type it might be worth while to have the transformer changed by the makers, but if this expense is objected to it will be better to use a high-amplification triode, as mentioned above.

Tone Correction.—A pentode has a tendency to give emphasis to the higher musical frequencies, and it is generally recommended that a tone-correction device be used. But despite this, many listeners prefer the tone provided by the pentode, so that in practice the extra fitting is not always required. Details of the condenser and resistance required are given on the makers' instruction sheet, but it will very often be found quite sufficient to connect a fixed condenser between

the anode of the valve and earth, as shown in Fig. 80. The value of the condenser can be varied to suit individual requirements, but .002 mfd. frequently provides adequate correction.

The H.F. Stage.—When replacing a high-frequency valve of the S.G. or variable- μ type it is worth while to use a variable- μ pentode in its place. This type of valve can be used either with or without the variable- μ control, and the latter can be added later on if desired. Modern variable- μ H.F. pentodes can be obtained with 4-pin or 7-pin bases, but it might sometimes be found easier to obtain a 7-pin valve when a replacement becomes necessary. This will involve the replacement of the existing valve-holder, and the connections must be changed

as indicated in Fig. 81. Where chassis-mounting valve-holders are used it will be necessary slightly to enlarge the hole in the chassis, and this can be done with a rasp or coarse file. Representative variable- μ H.F. pentodes are: Cosorr 210 V.P.T., Hivac V.P.215, Osram V.P.21, Mazda V.P.215, and Mullard V.P.2.

Loss of Stability.—It is possible that the change may at first cause the set to become unstable—this is because of the higher efficiency of the new valve—but a few slight modifications should clear this

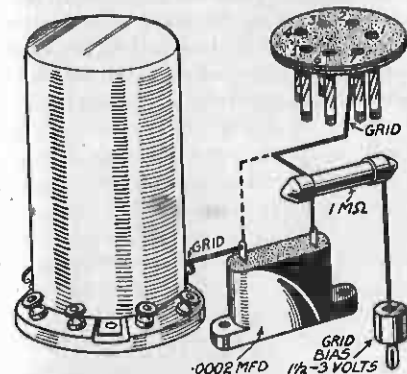

FIG. 82.—Fixed bias can be applied to an H.F. pentode by using the simple connections shown here.

difficulty and make the set more sensitive than it ever was before. When the set originally had a variable- μ control, stability should be secured by working with a lower setting of the potentiometer and by varying the screening-grid potential. Where such a control was not provided, it might be added, or a fixed bias may be applied, as shown in Fig. 82, by inserting a .0002 mfd. fixed condenser in the lead between the tuning coil and the grid, and taking a lead from the grid through a 1 megohm grid leak to the 1½ or 3-volt tapping on the G.B. battery. Even when using this fixed bias the new valve will nearly always give better results in the way of increased range and greater selectivity than the old one.

The Detector.—With regard to the detector valve, it will rarely be desirable to change to a type different from that previously employed, unless it is considered worth while to modify the circuit to take an H.F. pentode. The modification is comparatively simple, and has been dealt with at length in these pages before.

When it is not proposed to make any circuit modifications the best

CHAPTER XVI

VALVE REPLACEMENT

IT is in some respects unfortunate that present-day valves continue to function for such a great length of time before burning out. The reason is that in many instances listeners "make-do" with reception which is not nearly as good as it should be, due to the valves being well past their prime. A difficulty arises because it is not always an easy matter to tell whether or not the valves are "up to standard." This can be done quite easily, of course, by means of a tester of the type which enables the mutual conductance to be checked, or even by taking anode-current readings at various bias voltages and comparing these with the figures given by the makers for new valves.

Lost Efficiency.—

The main point to bear in mind, however, is that valves do frequently become less efficient after they have been in use for some time; often there is no sign of a falling-off in performance for a few years, but in other instances the emission begins to get less after

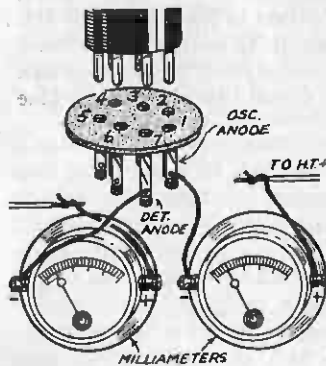
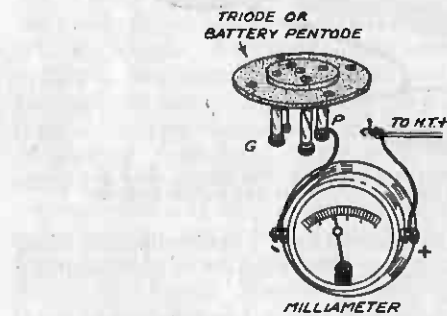
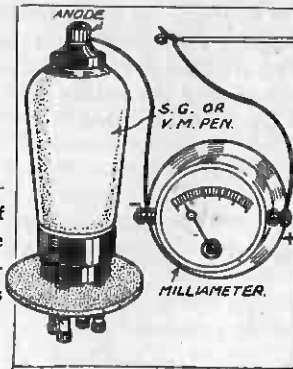

FIG. 79.—
Methods of
checking anode
current of dif-
ferent types
of valve.



a year or so. It is wise to try the effect of replacing the valves by new ones or by others which are known to be in perfectly good condition.

A preliminary test of the "integrity" of the circuit should be made before inserting the new valves.

Anode Current Tests.—If, for any reason, this procedure is inconvenient, the next best thing when a valve tester is not available is to measure the anode current of each valve in turn at intervals of a few months and compare the readings. A drop in current will immediately indicate that the particular valve is becoming less efficient, provided, of course, that the H.T. voltage is the same as when the previous test was made. The method of testing is perfectly simple and is as shown in Fig. 79; a milliammeter is connected between the anode terminal of the valve and the lead to high-tension positive. The position of the anode connection varies according to the type of valve and holder employed, but connections for the simpler types are shown in Fig. 79.

Using Higher Grade Valves.—After it has been decided that it would be worth while to replace a valve, the question of the type of valve to be used in its place arises. It might be considered an obvious procedure to use a new valve exactly like that which has become faulty, but in many cases this would not be the ideal method, and in a few instances it would even be impossible. Valves have been improved very considerably during the past few years, and it would be foolish to buy an obsolete type of valve simply because it happened to be like the old one. As an example of this, suppose it were intended to replace a small power valve in an S.G., det., P. receiver. The power valve originally used would probably be of a type which provides a low amplification, and, consequently, only a modest volume for a given input. That being the case, it would definitely be worth while replacing it by either a pentode of the high-efficiency, low anode-current type, or by a high-amplification triode, such as the Cossor 220 P.A., Osram L.P.2, and Mullard P.M.2A, to mention a few. These valves give a greater degree of amplification than ordinary small triodes, and are intended for use when only a single L.F. stage is used and when it is not desired to employ a pentode; their consumption of L.T. and H.T. current is no more than that of ordinary triodes.

Substituting Pentodes for Triodes.—In using valves of this type for replacement purposes, no alterations need normally be made, unless to the G.B. voltage. The valves are provided with 4-pin bases of standard type. Rather more care must be exercised when replacing a triode by a pentode, however, for the connections must slightly be modified, and if a valve of incorrect type is chosen, the high-tension current may be a good deal greater than the supply unit can satisfactorily supply. The following are a few of the pentodes which can normally be used to replace small power valves without any difficulty arising: Cossor 220

be wasted, are fed back to the grid circuit so that the currents already there are strengthened.

Advantages of Reaction.—The benefits of reaction are not merely confined to increasing volume, for its effect is the same as reducing the resistance, and thus damping, of the circuit. However good modern tuning coils and their associated condensers may be, a certain amount of loss is bound to exist. Since reaction helps to reduce the resistance of the circuit, it follows that the efficiency of the circuit is improved by its use, and therefore it is made more selective and efficient.

Reaction may be obtained from a detector valve or an H.F. valve, and, in some extreme cases, even a separate valve may be employed; a moving coil or a fixed coil may be used, and, in the latter case, the degree of reaction obtained may be altered by means of a variable condenser or a variable resistance, and the coil may be in series or in parallel with the anode circuit of the valve.

For the purpose of dealing with reaction faults, we will consider the most popular method in use to-day, i.e., the choke-fed system, with fixed coil and variable condenser in parallel with the anode circuit.

A typical reaction circuit is shown in Fig. 84, with indications showing why reaction may be faulty. In this particular circuit, the H.F. currents appearing at the anode of the valve are prevented from getting into the low frequency circuits by means of the H.F. choke, H.F.C.1, and they are by-passed to earth via the reaction coil, L2, and condenser, C.2, the latter controlling the degree of reaction obtained. A small fixed condenser, C.4, is also connected in parallel with the anode circuit, the purpose of this being to by-pass any H.F. currents not wanted for reaction purposes, and to prevent "Miller effect" when reaction is at zero.

The following are the faults most commonly met with in reaction circuits:—

1. Reaction not sufficient.
2. Reaction too fierce.
3. Reaction only effective on one wave-band.
4. Reaction only effective over one part of a wave-band.
5. Reaction flattens tuning and reduces volume.
6. Hand-capacity effects.

There are, of course, many other reaction difficulties, but they are supplementary to, and will be dealt with, under one of the above headings.

Insufficient Reaction.—Every set should, if working properly, be capable of being made to oscillate at all settings of the tuning condenser by means of increasing reaction. If this is not so, there are a variety of reasons and remedies. There may be a loose or dry joint in one of the connections, the grid leak and/or condenser may be of the wrong value, or the valve may not make good contact in its valve-holder.

We will presume that all connections have been examined and that, except for reaction, the set is working efficiently. Probably the greatest cause of inadequate reaction, presuming the valve is good, the coils efficient, and the right value of reaction condenser is being used, is low H.T. on the anode of the valve, or a wrong value of by-pass condenser (C.4, in Fig. 84). A common cause of inadequate high tension is too high a value for the decoupling resistance, R.2, in the anode circuit. If, say, 60 volts are recommended, the constructor should not try a drastic increase, even if this does seem to improve reaction, as this is more than likely not the real cause of failure, the large increase in high tension merely enabling reaction to be obtained while hiding the true fault. A small increase of about 10 volts can only be of benefit, but more should not be tried. If the high tension applied to the valve is too low, the anode resistance, R.2, is either too high or else the decoupling condenser, C.5, is leaky. The voltage, both sides of the resistance, should be measured with a high-resistance moving coil

voltmeter (a cheap moving iron instrument is of no use for reasons that have been pointed out in these pages more than once). If there is a very great difference (say, 120 volts at the battery end, and only 20 volts on the anode side), the resistance is obviously dropping too many volts, and may be conveniently reduced in value. On the other hand, if this resistance is being used as a coupling resistance to the next stage of the receiver, care should be taken not to reduce its value too much, as this will cause the amplification of the stage to be lowered. In such a case, the resistance should never be lowered in value to less than twice the impedance of the valve.

If this slight increase in H.T. has no beneficial result, the by-pass condenser, C.4, should be reduced in value. The next step should be to increase the capacity of the reaction condenser, C.2, by fixing a small condenser of, say, .0001 mfd. capacity across its terminals.

An inefficient or shorted H.F. choke will cause insufficient reaction, as this will allow the H.F. currents required for reaction to get into the L.F. stages. Such a state of affairs would generally be easily traceable, as it would be accompanied by distortion due to the presence of the H.F. currents in the L.F. stages,

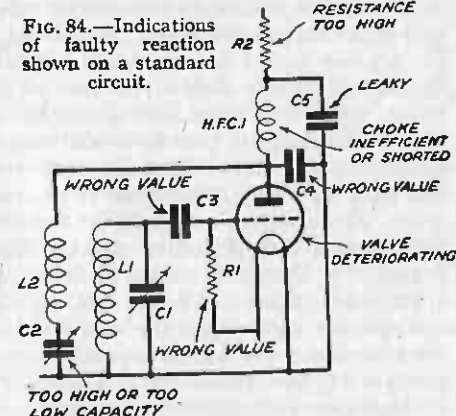

FIG. 84.—Indications of faulty reaction shown on a standard circuit.

If reaction works properly when a new H.T. battery and a fully charged accumulator are in use, then nothing can be gained, as it is obvious that the receiver has been correctly designed, and that the reaction fault is due to either a run-down H.T. battery or accumulator.

Reaction too Fierce.—This state of affairs is just as bad as insufficient reaction. Probably worse, because a very slight increase in reaction causes the set to become unstable and to burst into oscillation. Because reaction is too fierce, it must not be assumed that the H.T. on the anode is of too high a value. Reducing the H.T. severely is just as bad as increasing the value of grid bias applied to an H.F. valve to prevent instability. Both are but half-measures, and will greatly affect the sensitivity. If a few volts reduction does not smooth out reaction, a fixed resistance of about 250 to 500 ohms should be connected between the anode of the valve and the reaction coil. The value of this resistance depends a good deal on the value of the by-pass condenser and a series of different values for both these components should be tried. Wrong values of grid leak and/or condenser will also cause excessive reaction, and these may conveniently be lowered.

A great deal of fierce reaction may also be caused by instability in the high-frequency stage of the receiver. If the latter uses a variable-mu valve, the volume should be reduced so as almost to cut out the signals. This H.F. stage will then be biased to such a degree as to prevent any instability in it and reaction should be tried. If it is now quite smooth, the fault obviously does not lie in the reaction circuit, but in the H.F. stage, which should be tested for instability.

Reaction Only Effective on One Wave-band.—This fault may be remedied in the same manner as described for insufficient reaction, but it may also be due to a faulty coil, especially where a common reaction coil is made do for both medium and long waves. At any rate, some improvement may be obtained by treating as outlined above, but perhaps at the expense of rather fierce reaction on the band which was normally working satisfactorily.

With highly efficient coils, especially the modern ones using iron cores, parasitic oscillation is likely to be generated in the detector valves. This is shown by the set going into oscillation on the long waves with the usual slight "pop," but without giving the usual squeal on the received carrier, and before the full amplification from reaction has been obtained. This is due to the detector valve going into oscillation at a frequency determined by the combined constants of the reaction circuit and that portion of the grid circuit between the grid, and the earth-line of the receiver.

Parasitic oscillation is easily cured by including a stopping resistance in the reaction circuit, as explained earlier. By making this resistance high enough, the long-wave band may be made to work with satisfactory reaction, but it may then be found that at the lower end of the

medium-wave band reaction has become unsatisfactory. From our experience we have found that the values which give the best results are 250 ohms for the resistance, a by-pass condenser of .0002 mfd. capacity, and a reaction condenser of .0002 mfd. capacity. These will give satisfactory operation over the whole of both wave-bands, provided of course, the rest of the circuit is in order.

Reaction Only Effective Over One Part of a Wave-band.—This is another fault which may be due to a variety of reasons, and the constructor will have to carry out all the tests already described if he wants to put matters right. Probably a slight increase in high tension, and an alteration of the value of the by-pass condenser will be found to be most beneficial, but it must always be remembered that, even in the best of sets, there is bound to be a slight difference in the degree of reaction obtained at the bottom and top of a wave-band.

Reaction Flattens Tuning and Reduces Volume.—This fault is obvious—either the reaction coil is connected the wrong way round or else the reaction condenser (if a differential condenser is being used) has been wrongly connected. It is thus a very simple matter to put things right.

Hand-capacity Effects.—A set that "squeals" every time a hand is brought near the reaction condenser can never work at its best. It usually happens that, even if the set does not actually oscillate as the hand approaches, the volume is reduced considerably when the hand is taken away from the reaction control after the latter has been used to bring up the volume of a foreign station.

This fault only appears when the reaction condenser is connected between the coil and the anode of the detector valve itself. Some coils have the "earth" side of the reaction coil permanently joined to a common earth terminal on the coil base. In such cases, the reaction condenser can only be connected between the coil and anode, and the only remedy is to fix an aluminium or copper shield behind the panel, but in front of the reaction coil. When this shield is joined to the earth-line of the receiver, it prevents the capacity of the hand and body from affecting the reaction condenser. An improvement may also be made by making sure that the fixed vanes of the condenser, and not the moving ones, are connected to the anode.

If the coil has both ends of the reaction winding free, the reaction condenser should be connected between the "earth" end of the reaction coil and the earth-line of the receiver. Here again, make sure that the moving vanes of the reaction condenser are connected to earth, and the fixed vanes to the coil.

Other faults which appear in reaction circuits are "back-lash," where the set goes into oscillation at one setting of the reaction condenser, and comes out of oscillation at another; growling, where an increase in reaction causes the set to "growl" and not oscillate properly;

type of valve is nearly always one of the super-detector class, which is represented by the Cossor 210 Det., Hivac D.210, and Mullard P.M.2 D.X. These valves have a comparatively low amplification factor, but they are very stable and provide a very smooth reaction control. They are very suitable for use with transformer or parallel-fed transformer coupling, especially when the coupling component has a step-up ratio of 1.5 or more. When greater amplification is required of the valve—for example, when a low-ratio transformer or resistance-capacity coupling is used—somewhat better results can be obtained by using a replacement valve of the H. or H.L. class; these have an amplification factor of about 25, compared with one of about 15 for the super detectors.

Care with Mains Sets.—The same general rules as those outlined above apply also to mains sets, but greater care must be taken with those because the power-supply unit is invariably designed to give an output which is just right for the valves originally used. Additionally, valves of different type will gradually call for different bias resistances, and so on.

CHAPTER XVII

REACTION FAULTS

PRACTICALLY every "straight" receiver employs variable reaction. Before dealing with reaction faults, it may be as well to consider what reaction is, how it is obtained, and why it is used.

A simple reaction circuit, devoid of all but the bare essentials, is shown in Fig. 83. When signals are received by a radio set, they are first of all amplified and selected by the high-frequency stage and then passed on to the grid of the detector valve via the tuned circuit, L.1 C.1, in Fig. 83, where they are rectified (or detected) and passed on as amplified signals to the L.F. stages of the receiver. These rectified currents appear at the anode of the detector valve, but despite the detecting properties of the valve, and its associated grid leak R.1 and condenser C.2, high frequency potentials are also superimposed on the grid, and appear at the anode to be passed on to the L.F. stages with the amplified rectified signals. Now these high-frequency currents are of no use to us in the L.F. stages. In fact, they can do a great deal of harm, but if we include a reaction coil, L.2, in the anode circuit, we can arrange for at least the greater percentage of these H.F. currents to return to earth through the coil. If this coil is brought close to the tuning coil, L.1, the H.F. currents flowing through it will induce further H.F. currents into coil L.1, so that the original H.F. currents appearing at the grid of the detector valve will be greatly strengthened. The closer the two coils are brought together, the greater the induced currents in coil L.1, and thus the greater the signals will be increased.

If brought too close together, however, the valve will oscillate of its own accord, independent of the incoming signals. In current practice, the reaction coil is fixed in relation to its closeness to the tuning coil L.1, and the degree of feed-back of the H.F. currents for reaction purposes is controlled by a variable condenser in series with coil L.2, but, whatever method is used, one thing is common to all, that is, the H.F. currents appearing at the anode of the valve, and which would otherwise

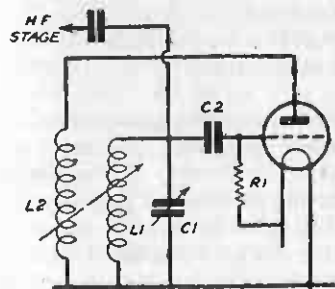

FIG. 83.—Theoretical diagram of a standard reaction circuit.

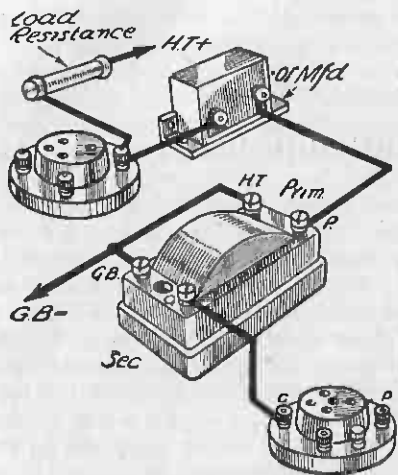

FIG. 86.—This method of connecting an L.F. transformer (parallel-fed) gives improved bass response.

of an extra tuning control. The easier method of improving selectivity by fitting a more selective coil between the H.F. valve, and the detector, may therefore be adopted. An H.F. transformer having a step-up ratio of approximately 3 to 1 can be relied upon to provide reasonably good selectivity if a well-designed reaction circuit is fitted. The cap terminal of the H.F. valve should be joined to one terminal of the primary winding of the coil, and the other primary terminal to H.T. +, the secondary winding being connected to the tuning condenser in the usual manner.

The L.F. Amplifier.—After the H.F. amplifier has been satisfactorily modified attention should be paid to the L.F. stage or stages. The L.F. amplifier has more effect on quality of reproduction than the H.F. stages and therefore, if quality is inferior particular attention should be paid to the couplings and valves used in the former. If

Improving Selectivity.—The selectivity of most old type receivers is inadequate for present-day requirements, but this may be improved without making drastic alterations to the circuit arrangement.

The most effective method is to fit an extra tuned stage between the aerial terminal, and the existing first tuned stage. This extra stage should consist of a coil similar to the ones in the receiver, and a .0005 mfd. tuning condenser. Unless the existing gang condenser is replaced by a new one having an extra section, the addition of the extra stage introduces the disadvantage

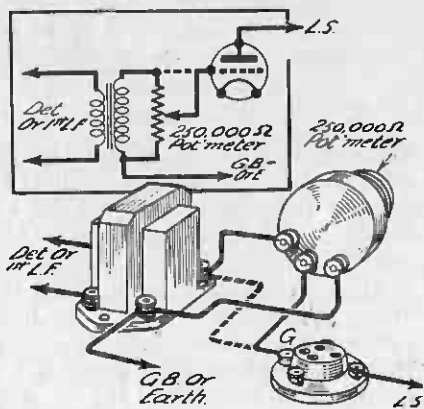

FIG. 87.—A simple and useful L.F. volume control.

lack of bass is experienced the L.F. transformer should be parallel-fed as shown in Fig. 86. With this type of coupling no direct current is passed through the primary winding of the transformer and therefore the primary inductance is higher than it would be if the primary winding were connected between the valve anode and H.T. +. Apart from improved bass response this method of connection also obviates the possibility of a primary burn-out.

L.F. Volume Control.—If two L.F. stages are used the addition of an L.F. volume control is very desirable in order to prevent overloading of the last two valves. The control should have a resistance of between 250,000 ohms and 1 megohm and should be wired as shown in Fig. 87. This control is particularly useful if a pentode valve is used in the output stage, as this type of valve is easily overloaded. It can also be used as a volume control when the receiver is being used in conjunction with a pick-up for gramophone record reproduction.

When locating the control, in a new design, it is always advisable to select a spot as close to the grid of the associated valve as possible to reduce the risk of an interference or interaction being introduced by a long grid lead:

As the control is directly across the grid circuit, it is essential to select a component of a reliable make otherwise severe crackling noises might be set up in the output stage by a defective resistance element or a faulty contact between the moving arm and the element.

To obtain the most even control, it is advisable to use a component having a graded resistance, as this allows smooth and progressive variation of the signal strength.

If metal panels or chassis are used, care must be taken to see that the spindle of the control is in itself insulated from the moving arm, or that the fixing arrangements of the components are such that contact is not made between the arm and the chassis or panel.

and oscillation with the reaction condenser at zero. All are, however, closely associated with one or more of the faults dealt with above, and a cure can generally be effected by reducing H.T. slightly or by increasing the value of the by-pass condenser.

Another reaction fault sometimes met with is "crackling," as reaction is advanced. This can only be due to a dirty reaction condenser, or else to one or more of the plates being slightly bent and allowing H.T. to momentarily short across them as they are rotated.

SUMMARY

<i>Fault</i>	<i>Remedy</i>
Reaction insufficient . .	Increase H.T. on anode slightly. Decrease value of by-pass condenser. Increase value of reaction condenser. Test H.F. choke and decoupling condenser. Alter values of grid leak and condenser. Replace valve.
Reaction too fierce . .	Decrease H.T. on anode slightly. Increase value of by-pass condenser. Add small fixed stopping resistance in reaction circuit. Decrease value of grid condenser. Connect grid leak to negative instead of positive side of filament.
Reaction only effective on one wave-band	Treat as for insufficient reaction. Carry out cure for parasitic oscillation, i.e. add stopping resistance in reaction circuit.
Reaction only effective over one part of a wave-band	Increase H.T. Try different values of by-pass condenser.
Reaction flattens tuning and reduces volume	Reverse connections to reaction coil, or, if a differential reaction condenser is in use, reverse connections to the two sets of fixed plates.
Hand-capacity effects	Connect condenser between "earth" side of coil and earth-line of the receiver. If condenser must be connected between coil and anode, use larger knob and shield the condenser.
Crackling	Clean reaction condenser. Test for shorts between fixed and moving vanes.

IMPROVING OLD SETS

IF the set is of the commonly used three-valve type, having one H.F. amplifying stage and one L.F. stage, it may have an ordinary S.G. valve as high-frequency amplifier, with volume controlled by means of the reaction condenser. This type of receiver is often prone to H.F. instability, and in cases where the aerial is situated near a transmitting station overloading of the detector valve may occur. An improvement may be effected by fitting a variable- μ pentode valve in the first stage. The degree of amplification obtainable from this type of valve can be reduced practically to zero by applying a bias voltage to its control grid, and this voltage can be varied according to the volume required by means of a variable potentiometer.

The easiest method of adding this type of control to an old receiver is as follows: Disconnect the lead at present joining the grid terminal of the S.G. valve-holder and connect it to one terminal of a .0005 or

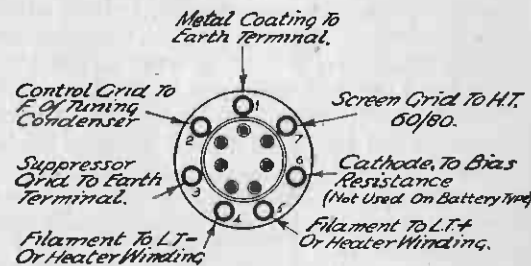

FIG. 85.—Standard connections for a 7-pin H.F. pentode.

.001 mfd. fixed condenser, and then connect the other terminal of this extra condenser to the grid terminal of the valve. The centre terminal (connected internally to the moving arm) of the variable potentiometer should then be connected via a fixed resistance of approximately 500,000 ohms to the grid of the S.G. valve-holder, the two end terminals of the potentiometer being joined to H.T.- and G.B.-9 respectively. When this modification is made it is also advisable to substitute a three-point on-off switch for the two-point type; one terminal of this should be connected to earth and H.T. —, the second terminal to G.B. —, and the third terminal to L.T. —. Some of the modern H.F. pentodes have seven pins, and if one of this type is fitted the method of connection shown in Fig. 85 should be adopted.

CHAPTER XIX

UNIVERSAL (A.C.-D.C.) RECEIVER FAULTS

OWING to the gradual changing over of D.C. supplies to A.C., the demand for receivers that will work equally well when supplied from either A.C. or D.C. mains has increased. There is no doubt that they have met with a great measure of success, and have overcome the difficulties which were experienced with this type of valve when it was first introduced.

A.C./D.C. Valves.—A transformer cannot be used on a D.C. supply to step the mains voltage down to the value required by the valve heaters, and the current passed through the heater circuit must be taken direct from the mains through a dropping resistance or lamp. In the interests of economy this current must be kept low, and therefore valve-heater resistance is made reasonably high—the actual value differs with different makes of valve, but 60 ohms is about the average. The average A.C. type of valve, on the other hand, has a resistance of only

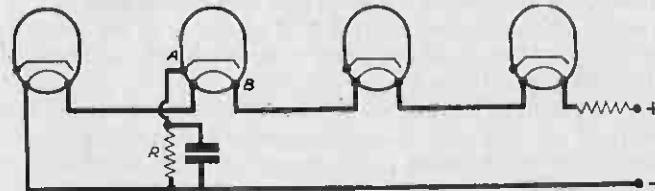

FIG. 88.—Heaters wired in series showing points at which breakdown can occur.

4 ohms, and therefore the A.C. valve should be more robust than the A.C./D.C. type. In practice, however, there is little to choose between the two types in this respect nowadays—an A.C./D.C. valve can be relied upon to give a useful life of about eighteen months.

Insulation Breakdown.—A more common trouble than a heater burn-out is a breakdown of the insulation between the heater and the cathode. This sometimes happens in A.C. valves, but is more commonly experienced with the A.C./D.C. type, owing to the greater potential difference which exists between cathode and heater in the latter. Referring to Fig. 88, and assuming that the valves are of the 16-volt type, there will be a potential difference of 32 volts between the positive end of the heater of the centre valve and the negative line. Again, assuming that the bias voltage obtained by means of the resistance R is

2 volts, there will be a potential difference of 30 volts between points A and B—the cathode and the heater. In some cases the potential difference between these two points can be much higher, and, therefore, it will be readily realised that a breakdown can occur at this point unless the insulation between cathode and heater is effective. It is in this respect that modern A.C./D.C. valves are greatly superior to the earlier models.

Consumption.—The consumption of an A.C./D.C. receiver is higher than that of an A.C. receiver having a similar undistorted wattage output at the speaker. This is due to the higher heater circuit consumption of the A.C./D.C. set. The average three-valve A.C. set has a heater circuit consumption of 12 to 16 watts, whereas in a three-valve A.C./D.C. type using .2 amp. valves, with a supply voltage of 240 volts, the consumption is 48 watts. The H.T. consumption of the two receivers will be somewhat similar—approximately 30 watts for a table model—and, therefore, the total consumption of the A.C./D.C. receiver will be more

than one and a half times that of the A.C. set. This does not materially affect the lighting bill, however, as the difference is less than the consumption of one lamp of normal wattage.

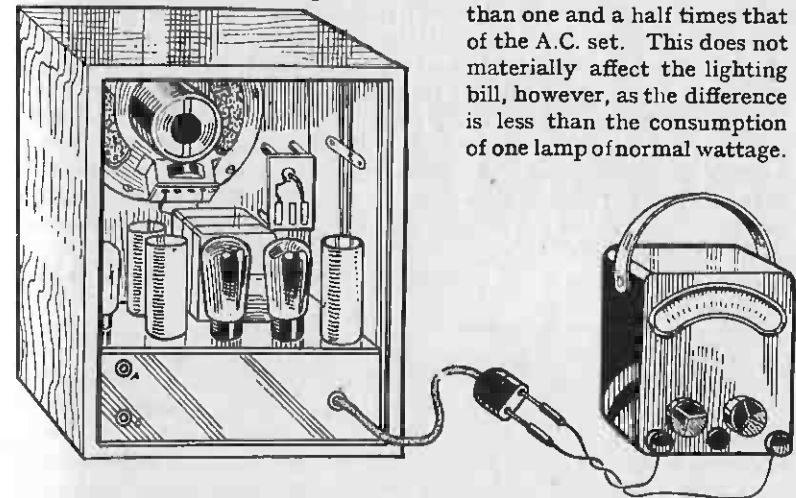

FIG. 89.—Showing method of checking heater circuit continuity of A.C./D.C. set.

Dropping Resistance.—When constructing an A.C./D.C. set, a reliable component should be used for limiting the current passed through the heater circuit. Some manufacturers use a special lamp known as a barretter, whereas others use an ordinary resistor. Most home constructors will probably use a resistance, and, therefore, great care should be taken to choose the correct type. It should have the correct resistance value and must also be capable of carrying the required current without becoming overheated. For example, if the valves used are of the .2 amp. type, the current must be limited to this value and

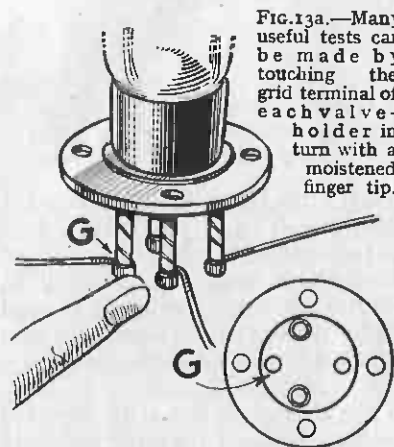

FIG. 13a.—Many useful tests can be made by touching the grid terminal of each valve-holder in turn with a moistened finger tip.

Start with the Last Valve.—Should none of these tests give any indication of where the fault lies, and if there are no sounds from the speaker when the H.T. wander plugs are pushed into the battery sockets, it will be fairly safe to assume that the trouble lies with the last valve or with the loud-speaker itself. It is, of course, assumed that it is known that the H.T. and L.T. batteries are in fair condition—if they were not it is unlikely that the set would become "dead" suddenly.

In order to test the valve properly meters are required, but a good indication can be obtained by replacing it with one of the other valves in the set. Should it be found that the speaker then makes even a slight clicking noise when switching the set on and off, the valve can be suspected. Try the effect of substituting a new valve in the output stage so that a final check can be made. Assuming that there is still no response, the speaker will come under suspicion, and can be tested by connecting one lead to the positive terminal of the accumulator and touching the other lead against the negative terminal. If the speaker is in order there will be a fairly loud click, both as the contact is made and broken; absence of sound suggests that the speaker is defective. A further test might be made, however, by replacing the accumulator with a 9-volt G.B. battery.

Systematic Grid Tests.—Despite the absence of signals, it will be often found that a click is heard in the speaker when the set is switched on, or when the positive H.T. wander plug is inserted. It will then be evident that the fault is somewhere in the set prior to the anode circuit of the last valve. Moisten the finger-tip and touch the grid terminal of the output valve (see Fig. 13a). A noise should be heard in the speaker when this is done, but if not, the transformer or grid condenser and leak connected to the grid (according to whether transformer or R.C. coupling is used) is probably at fault. Repeat this test by touching the grid terminals of preceding valves one at a time until a point is reached at which no sound whatever can be heard in the speaker. As soon as this valve is reached it will be known that the fault lies in the circuit of that valve; the valve or one of the components connected to it must be defective. The grid-circuit components can be eliminated from the test by removing the wire joined to the grid terminal and repeating the test. If it is found that a sound

can then be heard the grid-circuit components are known to be the cause of trouble.

The tests described should make it possible to locate the faulty part of the set, so that assistance can be asked, or so that the suspected components can be tested separately or replaced one at a time. The necessary tests will be explained in a later chapter.

Crackling Noises.—Instead of the set being completely "dead," we might now consider the procedure when trouble is experienced due to crackling noises. Actually, most of the tests described can be applied in the first place, but others are necessary. The first should be to disconnect the aerial and earth leads and see whether the trouble ceases; if it does the cause must have been interference from outside the set, when more thorough tests must be instituted. But should it

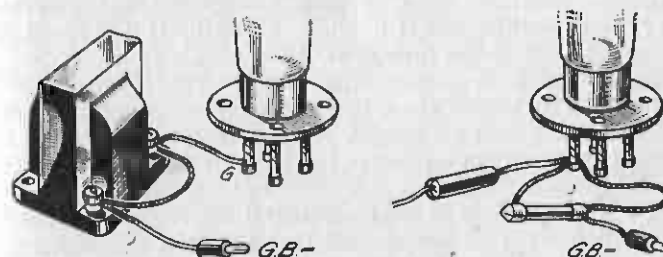

FIG. 13b.—Progressive tests can be made by short-circuiting the grid circuits of different valves. Methods are shown for transformer and R.C. couplings.

be found that the disconnection has no marked effect the set should again be examined for bad or loose connections. See that the valves are fitting tightly in their holders; gently press each from side to side to see if the valves are loose, or if the holders are damaged. Tighten up the terminals on all components, and clean any that appear dirty. Make sure that the H.T. wander plugs are clean and fitting tightly, and look for partial short-circuits between any two wires, between a wire and a screen, or between the metallised coating of a valve and a lead running close to it.

The next test should be to connect the grid terminal of the holder for the output valve to its G.B. lead, as shown in Fig. 13b. That the fault was in the output valve or the speaker would be indicated by the fact that the crackling continued, whilst silence would mean that the cause of the trouble was in a preceding stage. Repeat this test on other valve holders, working "backward" towards the first valve until the location of the fault is determined. That done, it remains to test individual components and valves, as before. When this method of procedure does not produce any definite result, a fairly good test can

be applied to the speaker by connecting it to a battery, as mentioned above, but this time leaving both leads permanently connected for a few seconds; crackling would at once point to the speaker as being at fault.

Poor Signal Strength.—Weak signals call for altogether different tests, although some assistance might be gained by trying some of those already described. In this case, however, instruments become practically essential, and it might be impossible to gain any real indication of the fault without taking measurements of voltages at the various valve-holder filament and anode terminals. At the same time it might be helpful to try replacing any resistances in the anode circuits—coupling and decoupling resistances—with others of similar or not widely differing values, since one of these might have developed a partial open circuit, so reducing the H.T. voltage. Also observe the effect of short-circuiting the H.F. choke, especially if it is found that the reaction condenser has little or no effect.

Tracing a Fault.—As an example of what can be done without the use of any instrument, the author had occasion to test a set which had been built to one of his designs. The constructor complained that all he could get was slight oscillation and weak signals with the reaction condenser advanced. The first conclusion to be drawn, therefore, was that the L.F. stages were at least working, if not efficiently. The fact that oscillation was obtained showed that the detector valve was in order, so it was assumed that the fault was somewhere in the H.F. stage. Since the coils and valves were new, it was thought that they could not be the cause of the trouble, although it was possible. On transferring the aerial to the anode of the H.F. valve, no improvement was obtained, so it was concluded that the aerial coil, and H.F. valve, were in order. The only components between the H.F. and detector valves were an H.F. choke, and a small fixed condenser. The aerial was next tried on the actual grid of the detector valve, and good signal strength was obtained. Working backwards from the grid of the detector valve to the anode of the H.F. valve via the feed condenser and the H.F. choke, it was found that signals could be obtained on either side of the condenser, and on the *H.T. side* of the choke, but not on the actual anode of the valve. Now the purpose of an H.F. choke being to stop H.F. currents from getting into the H.T. system and to block them so that they will be by-passed by the feed condenser to the grid of the following valve, it followed that the feed condenser had been connected on to the H.T. and not the anode side of the H.F. choke. The choke in question was of the screened type with a pigtail connection for the anode, and a common terminal at the base for the feed condenser, and, on examination of the wiring, it was found to be as suspected, viz., that the terminal common to the pigtail had been connected to H.T. so that the H.F. currents wanted for feeding the

grid coil of the detector circuit were blocked by means of the H.F. choke. This accounted for the weak reaction and signals. On connecting the choke in the correct manner, signal strength, reaction, etc., were all that could be desired and the set worked perfectly. Fig. 14 shows the set as it was wrongly connected and Fig. 15 the correct connections.

Checking Connections.—First, therefore, when testing a set without the aid of any instruments, see that all connections are correct and tight, that battery voltages are correct, that wander plugs and spade terminals make good connections, that valves make good contact

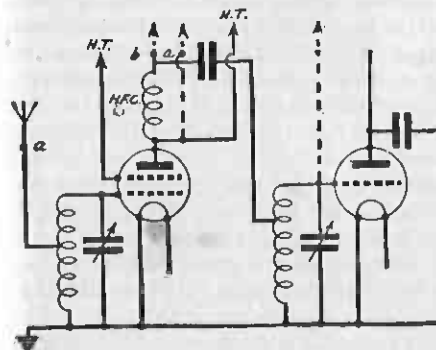
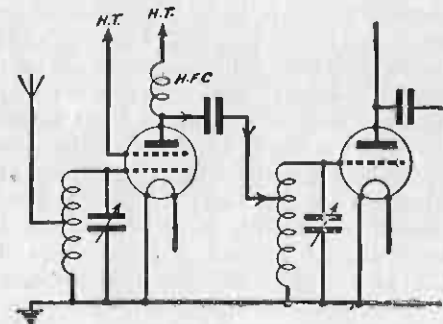

FIG. 14 (left).—Showing how H.F. choke connected the wrong way round stopped signals from reaching the detector valve. When the aerial was connected to points marked *a* signals were not obtained, but signals were received when the aerial was connected to points marked *b*.

FIG. 15 (right).—Showing how the choke should have been connected. The H.F. choke blocks the H.F. currents and a condenser by-passes them to the detector valve in the direction of the arrows.



in their holders (clean the valve pins with emery cloth or a fine file and open them a little with a pen-knife), and that aerial and earth are connected. If the fuse blows when the set is switched on, look carefully for short circuits between terminals, see that the metal ends of resistances do not touch the chassis, that the H.T. is connected to the anode circuits, and not the filaments.

After giving the set a thorough examination in this way, remove the H.T. wander plug. A click heard in the loudspeaker would indicate

that the output valve at least was working. Advancing the reaction control suddenly should cause the set to oscillate, indicating that the detector anode and the L.F. stages were at least in working order. Now touch the grid terminal of the detector valve holder. If the set howls, you may assume that the detector valve is in order. Similarly, by touching the anode and grid terminals of the H.F. valve in turn, a "pop" heard in the loudspeaker would indicate that these circuits were also working. Also, when touching the aerial terminal, a "pop" should be heard if the set is working. When testing in this manner, better results will be obtained if the finger is moistened.

The H.F. Stage.—If the H.F. stage seems to be at fault, connect the aerial to the anode cap of the screen-grid valve. If signals can now be heard, the fault lies either in the S.G. valve itself, the aerial coil and/or its associated condenser, or in one of the other components in the H.F. stage. If no signals are heard, then the fault must be after the H.F. stage, and the aerial should be transferred to the detector grid terminals as described above.

To test for emission needs instruments, but one can always find out to a certain extent whether the valve is functioning properly in this respect by inserting a pair of 'phones in between the H.T. feed to the suspected valve and the anode terminal of the valve. There should be a sharp click in the 'phones on connecting them if the valve is in order (Fig. 18).

The blowing of fuses obviously indicates a short circuit or excessive current, due to a leaky condenser, etc. To test for a short circuit remove all valves and, with the H.T. and L.T. batteries connected and the switch in the "on" position, connect a flash-lamp across the filament terminals of each valve-holder in turn. A short circuit of this nature is guarded against in most modern circuits by the fuse. See that you use one of the correct current rating.

Perhaps a better way of testing for H.T. shorts, and one which it is always wise to carry out before inserting the valves in a newly constructed receiver, is to remove the H.T. battery, and leave the accumulator connected. With one pole of the flash-lamp connected to L.T. plus of the accumulator, touch each anode terminal in turn. If the bulb is illuminated in any case, then that particular H.T. circuit is faulty and should be examined.

The voltages across the filament sockets of the valve-holders can also be tested by connecting a flash-lamp across them. If no illumination at all is obtained, then the on/off switch may be faulty, or the accumulator discharged. If illumination is obtained at one or more of the valve-holders, it is a simple matter to check the remainder of the L.T. wiring.

Testing Components.—If after careful thought and systematic examination of a set as described above, results are still poor or

unobtainable, the next step must be to test the components. Having isolated the fault to some extent, the number of components which require to be tested should not be many.

Under the heading of "coils," we will consider not only tuning coils, but also H.F. chokes, transformers, and any component which utilises a coil of wire, for the purpose of our very elementary tests without instruments cannot do more than establish whether or not there is continuity throughout the winding. For such a test, the usual pair of headphones and a dry battery provides a ready means, but unless one is rather careful, misleading results may be obtained. For example, when testing the windings of an L.F. transformer, a break in the wiring would not stop a click being heard in the 'phones when they were connected up as shown in Fig. 19, simply because the two windings on either side of the break act as a sort of condenser and charge up, thus producing the click. If, however, the click is quite substantial, and occurs not only when the 'phones are connected, but also when they are disconnected, then it is safe to assume that the winding is not broken. The total absence of a click would indicate that the winding had either broken away from one of its terminals, or else that the break was very near one end of the winding.

With Flash-Lamp and Battery.—A better plan is to revert to the flash-lamp and battery. Due to the resistance of the wire, it will be necessary to increase the applied voltage and for this purpose a grid-bias battery can be used, stepping the voltage up gradually until the lamp is illuminated. The bulb may not light at all, owing to the high resistance of the winding, which causes a large voltage drop across it. Look for a small spark as the circuit is made and broken. When the resistance is comparatively low, such as in

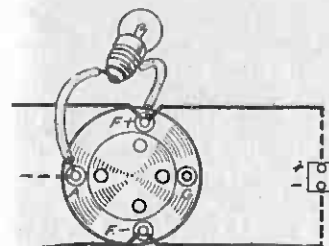

FIG. 16.—Testing for H.T. shorts.

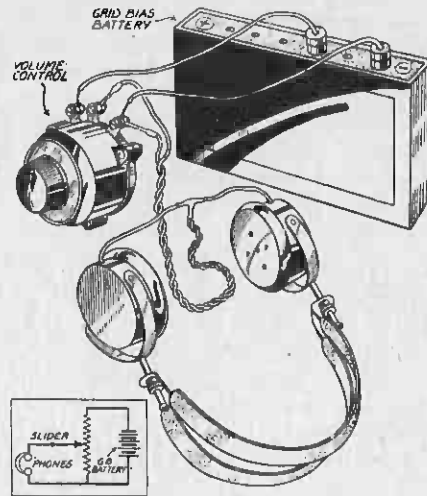

FIG. 17.—Testing a volume control for continuity, good contact, and noise.

PRACTICAL WIRELESS SERVICE MANUAL

tuning coils or I.F. transformers, the flash-lamp bulb and battery also offers a highly effective and reliable means of checking continuity.

H.F. chokes can be further tested after checking continuity by connecting them in the aerial lead to the set. If signals are cut down considerably in strength, then the choke is in order. This test can be amplified by connecting the choke across the tuning condenser in a receiver. The circuit should be retuned to the station being received and the volume compared. A good H.F. choke will not cause much loss in strength.

Other high-resistance components such as volume controls and fixed resistances can also be tested by the 'phones and battery method. With volume controls, the 'phones and battery should be connected first across the two outer terminals, and then between the centre and

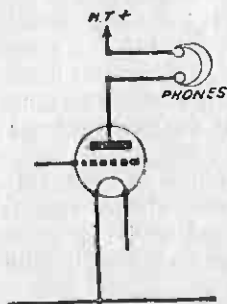

FIG. 18 (above). — Connect 'phones, as shown, in each anode circuit to test valves.

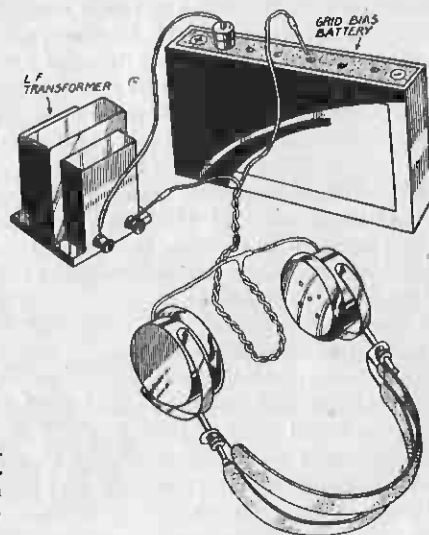

FIG. 19 (right). — Testing an L.F. transformer or other high resistance winding.

each outer terminal in turn. Then connect up as shown in Fig. 17, and gradually rotate the sliding contact, at the same time tapping the free tag of the 'phones on to the centre terminal. Then with the 'phones joined to the centre and one outer terminal, gradually rotate the control. A slight scraping noise should be heard in the 'phones, but if crackles are present, then the slider is not making good contact with the resistance proper. Carefully take out the slider and bend it a little. Smear the element with vaseline and try out again, until no crackles are heard as it is rotated. It may be that, due to continual use, it is not possible to get the slider to make good contact at all positions of its travel. In such a case it is possible, at least where the control is

FAULT TRACING WITHOUT INSTRUMENTS

used to vary the bias applied to an H.F. valve, to connect a 2 mfd. condenser across the sliding contact and the top end \pm that is, the terminal of the control connected to the voltage dropping resistances (not the end connected to earth) of the control to stop the crackles.

Testing Condensers.—The most common component in a receiver is a condenser. Variable condensers may be tested for shorts and noises by using the 'phones and battery, disconnecting associated coils. Gradually rotate the condenser vanes, and, when a short occurs, a loud noise will be heard in the 'phones. The remedy is either to bend the offending vane, or to adjust the position of the moving vanes in respect to the fixed vanes by means of the usual bolt fixed at the back of the condenser. If the faulty condenser happens to be part of a ganged unit,

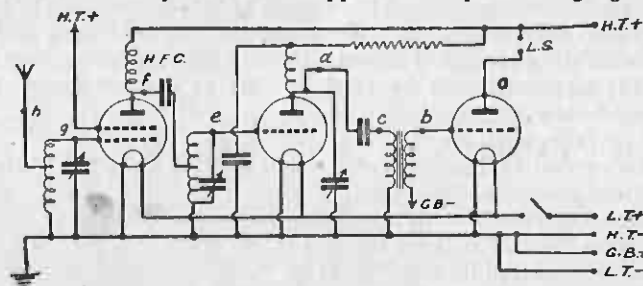

FIG. 20.—A simple three-valve battery circuit in its essentials. Touching the lettered points (beginning at *a*) in the order shown should result in "plops" being heard in the speaker if the circuit is in order.

however, bending the vanes will affect ganging, and if the fault does not disappear after thoroughly cleaning with a pipe-cleaner, the condenser should be returned to the makers.

Fixed condensers are easily tested by simply connecting them across an H.T. battery for a moment or two, and leaving them for three or four minutes. Then short the terminals by means of a pen-knife or a piece of stout copper wire. If the condenser is good and will hold its charge, a spark, depending on the capacity of the condenser, should be obtained. Quite a large spark, for example, can be obtained from a 2 mfd. condenser which has been charged with a voltage of as low as 50. Small condensers of about .0003 mfd. may be tested by 'phones and battery. A loud click should be obtained, but on touching the condenser with the free end of the 'phones once more, no click should be heard. Before carrying out such a test, however, the condenser terminals must always be shorted to remove any charge. Small fixed condensers may further be tested by connecting them across the terminals of a charged 2 mfd. condenser and leaving for a few minutes. Having disconnected the small condenser, a spark should be obtained on shorting the terminals of the larger condenser, indicating that the small condenser was not leaky as the larger one had not lost its charge.

pure mercury at the temperature of melting ice having a mass of 14.4521 grammes, a constant cross-section, and a length of 106.3 centimetres.

International volt.—Practical unit of electromotive force, representing that E.M.F. which when steadily applied to a conductor having a resistance of 1 international ohm creates in it a current of 1 international ampere.

International watt.—The energy used in 1 second by an international ampere when flowing at a pressure of 1 international volt.

Joule.—Unit of energy. One joule equals 10^7 ergs. It represents the work expended per second on a circuit in which there is a current of 1 international ampere, and between the ends of which there is a difference of potential of 1 international volt.

Kilovolt-Ampere.—1,000-volt amperes.

Kilowatt.—1,000-watts or 1.34 horse-power.

Kilowatt-hour.—1,000-watt hours.

Light, Speed of.—Light waves travel at 186,000 miles per second. This is the speed also of wireless waves.

Line.—The practical method of measuring a magnetic field is in lines or kilolines. The line is identical with 1 electromagnetic unit of magnetic flux; kiloline equals 1,000 lines.

Mho.—Unit of Conductance ("ohm" reversed). It is the reciprocal of the ohm. Thus, a body having a resistance of 4 ohms would have a conductance of .25 mhos.

Ohm.—Unit of Resistance. The resistance which will permit the flow of 1 ampere when a pressure of 1 volt is applied.

Sound, Speed of.—Sound waves travel at 1,142 feet per second.

Unit Electrostatic Charge.—The charge which in a vacuum at a distance of 1 centimetre from an equal charge will produce a force of repulsion of 1 dyne.

Unit Electrostatic Flux.—The electrostatic flux existent in a unit electrostatic tube of force.

Unit Magnetic Flux.—The magnetic flux existent in a unit magnetic tube of force. Unit is the Maxwell.

Unit Magnetic Pole.—That pole which located in a vacuum at a distance of 1 centimetre from a like pole produces a mechanical force of repulsion of 1 dyne. The total number of lines of force which passes through a unit magnetic pole equals π .

Volt.—Unit of potential. It is the pressure required to pass a current of 1 ampere through a resistance of 1 ohm.

Volt-Ampere.—The product of the root mean square volts, and root mean square amperes.

Watt.—Practical unit of power equivalent to a rate of working of 1 joule per second or 10,000,000 ergs per second. Volts times amps equals watts.

FAULT TRACING WITHOUT INSTRUMENTS

EVEN when a meter is available it is often better to make a number of preliminary tests without using it—even the experienced service-engineer does not take measurements until he has formed some kind of idea regarding the fault which exists. Moreover, all of the preliminary tests depend more upon common sense and a general knowledge of how the receiver operates than upon advanced technical knowledge. Even the beginner can find out a considerable amount by making simple and logical tests.

When the Set is "Dead."—In the first place, let it be assumed that a battery set which had previously behaved normally suddenly refuses to "work." This must be due to a broken circuit at some point in the receiver: a valve filament might have burned out; a wire might have come adrift; one of the aerial, earth, or speaker leads might have broken or slipped away from its terminal; or a component might have developed a sudden fault. It is obvious that a start must be made by carefully examining the connections, preferably by gently "prodding" each wire with a pencil while the set is switched on. If that does not yield any result, the effect of switching the set on and off should be observed. There should be a click in the speaker when this is done; if not, the battery connections should be suspected, whilst the effect of removing and replacing the H.T. wander plugs should be tried. The accumulator terminals and connections should also receive attention, and any dirt or corrosion should be scraped away. See that the speaker leads are properly connected to the receiver and to the speaker, and try the effect of short-circuiting the terminals of the on-off switch with a short piece of wire, as shown in Fig. 13. If the latter causes signals to return it will be evident that the switch is faulty, and should be repaired by bending the spring contacts, or else replaced.

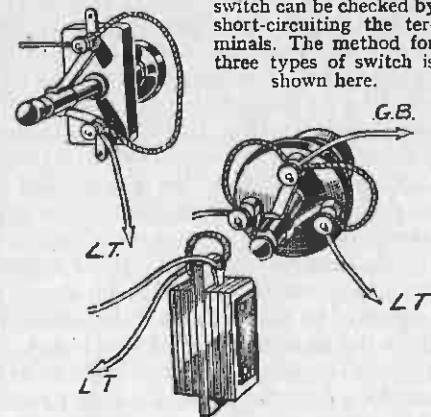

FIG. 13. — The on-off switch can be checked by short-circuiting the terminals. The method for three types of switch is shown here.

ordinary triode of the L. or H.L. type and is connected in the same way as a leaky-grid detector. Reaction coupling is practically "fixed," but slight variations can be made by means of the .002-mfd. pre-set condenser during use.

Using the Oscillator.—In order to use the oscillator it is necessary only to plug in the valve and a standard four-pin coil (details for construction will be given later), and to connect a 2-volt accumulator and a 60-volt H.T. Incidentally, it is sometimes possible to use the same batteries as are used to feed the receiver, but the separate ones are to be preferred. After connecting it is necessary only to place the oscillator a few feet away from the aerial lead-in wire, and then to operate the

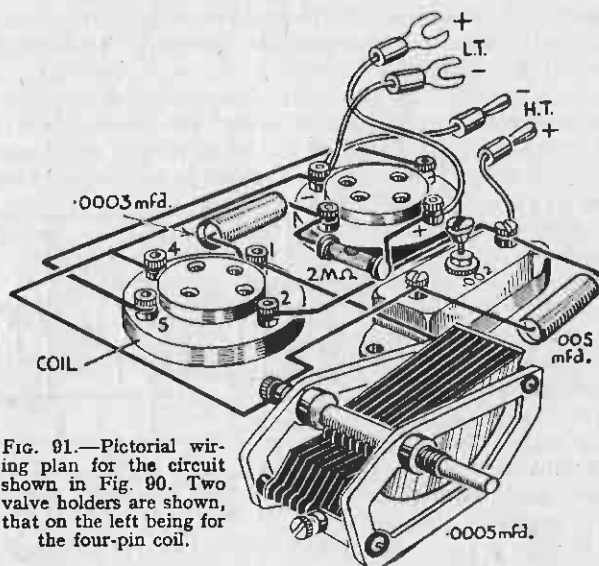

FIG. 91.—Pictorial wiring plan for the circuit shown in Fig. 90. Two valve holders are shown, that on the left being for the four-pin coil.

oscillator tuning condenser until a high-pitched whistle is heard in the speaker. This is obtained only when the set and oscillator are tuned to the same frequency, and consequently the four-pin coil must be of such a size that it is appropriate to the wavelength to which the set is tuned.

When the oscillator and receiver have been adjusted in this manner the effect of making the various alterations to the set can be noted by comparing the strengths of the note emitted by the speaker in various circumstances. In the same manner, experiments in selectivity can be carried out by noting the "spread" of the received note over the receiver tuning scale. Incidentally, this "spread" can be varied very

considerably by altering the position of the oscillator in respect of the aerial lead-in, or of the set, so it must remain in the same relative position throughout the tests. It will generally be found best, however, to move the oscillator so far away that the whistle is very sharply tuned. When first using the oscillator, adjust the pre-set condenser until the note is perfectly clear.

Oscillator Coils.—With regard to the coils, as mentioned above it is possible to use standard ready-made components, but those who wish to make their own can use commercial four-pin formers, allowing approximately 75, 110 and 220 turns for the grid winding (between pins 1 and 4), and 40, 50 and 80 turns for reaction (between pins 2 and 5) for medium waves, 465 Kcs. I.F., and long waves, respectively. The windings should be about $\frac{1}{8}$ in. apart and should consist of 30-gauge enamelled wire for the two smaller coils, and of 38-gauge enamelled for the largest. In each case the windings are arranged side by side, and both windings are wound in the same direction; the diameter of the former is $1\frac{3}{8}$ in. Details are given in Fig. 92. If it is wished to use the oscillator for short waves, suitable coils can be made, using approximately 9 and 6 turns for 30 metres; other ranges in proportion.

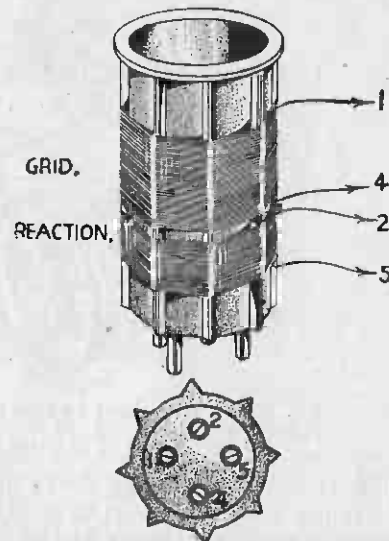

FIG. 92.—Details of an easily-made type of four-pin coil. Winding data is given in the text.

Ganging I.F.'s.—It will be appreciated that the oscillator can usefully be employed for ganging and trimming, by adjusting the trimmers until the received whistle is at its loudest. In the case of a superhet the intermediate-frequency transformers can be adjusted in a similar manner, although some form of "artificial" coupling might be necessary due to the components being fully screened. One method is to wind a single turn of wire round the oscillator coil, and then to wind the other end of this wire round an unscreened lead to the primary winding of the first I.F. transformer. When this is done the oscillator must be placed near to the set so that the coupling lead is short. For 110 and 150 Kcs. the long-wave coil should be used, whilst for 465 Kcs. the middle coil will be suitable. In the case of the lowest frequency

mentioned it will also be necessary to connect a .0005-mfd. fixed condenser in parallel with that used for tuning the oscillator in order to tune to the corresponding wavelength of about 2,700 metres.

Visual Output Checks.—In many cases it is not sufficient to judge the output of the set by ear, especially when more than a few seconds must elapse between making the necessary adjustments. The reason is that it is impossible to "remember" sounds, and therefore even large variations are not easily recognised. A better method is to use some form of output meter, the simplest of which is an A.C. voltmeter (such are

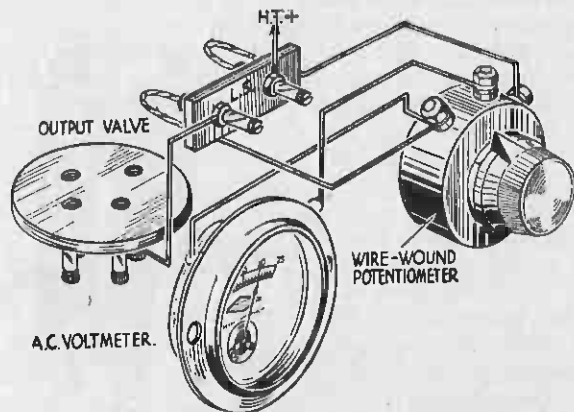

FIG. 93.—A simple and accurate method of comparing outputs in various circumstances, by connecting an A.C. voltmeter and potentiometer in place of the loudspeaker.

quite cheap) connected as shown in Fig. 93. The purpose of the 5,000-ohm potentiometer is to provide a reasonable load in the anode circuit of the output valve, and to vary the proportion of the output applied to the voltmeter so that a convenient portion of the scale can be used. It must be remembered that the meter does not read actual output volts, or output watts, but merely enables comparisons to be made. In practice the potentiometer should first be set so that it is short-circuited, the reading being zero. The potentiometer can then be adjusted until about a one-quarter-scale reading is obtained. After making a note of the exact reading the potentiometer should not be altered during the course of the experiments.

Any adjustments which result in an increased reading will be known to have resulted in a greater output being obtained and hence in increased efficiency, whilst the opposite is also true.

This system of measurement is not ideal because the optimum load of the output valve will probably not be provided, unless especial care is taken in this direction. To a large extent this objection can be overcome

by using a sensitive milliammeter (reading up to not more than 2 mA.) in conjunction with a .005-mfd. condenser and variable resistance, as shown in Fig. 94. The resistance is first set to its maximum value, and then adjusted until a convenient reading is obtained on the meter scale. After that the procedure is the same as described above.

Another Method.—Another method, which has the advantages of being inexpensive and rather fascinating, is where a miniature neon lamp is used in place of the voltmeter shown in Fig. 93. In this case, increased output is indicated by increased brilliance of the neon, although

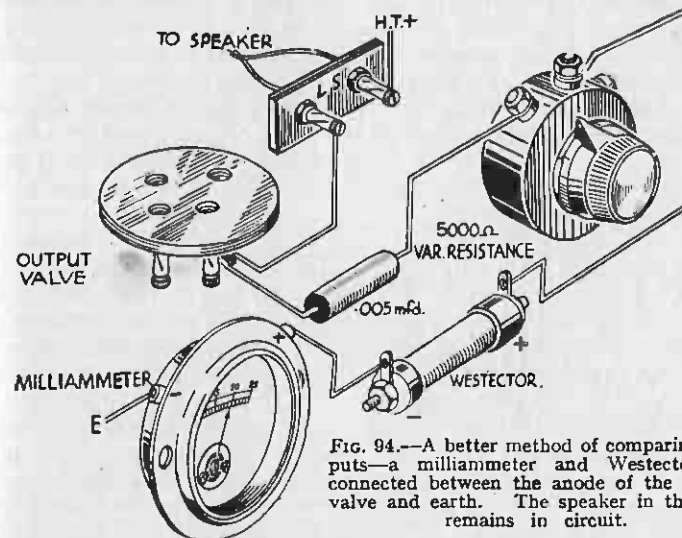

FIG. 94.—A better method of comparing outputs—a milliammeter and Westector are connected between the anode of the output valve and earth. The speaker in this case remains in circuit.

most accurate results can be obtained by setting the potentiometer until the light is just extinguished. Any adjustment which causes it to glow again will be known to have resulted in greater output. After this adjustment has been made the light can be extinguished again and further adjustment tried.

therefore, if the mains voltage is 240 volts the total resistance in the heater circuit must be 1,200 ohms. Assuming that five .2 amp. valves are used their total resistance will be 500 ohms, and therefore, the dropping resistance must have a value of 1,200 ohms less 500 ohms, *i.e.*, 700 ohms.

Pick-up and A.E. Connections.—As the H.T. —line of the A.C./D.C. set is in direct connection with one of the mains leads, it is necessary to connect a condenser between H.T. — and the earth socket, otherwise there is the possibility of the mains being short-circuited when the earth lead is joined to the set. It is also advisable to adopt the same precaution with the aerial, as the aerial socket is generally connected direct to H.T. — through the aerial coil, and, therefore, if the aerial is not well insulated a short-circuit can occur as in the case of the earth lead. When a pick-up is used, it is advisable to connect the leads to the grid circuit of the first valve of the amplifier via fixed condensers, otherwise a shock can be obtained when the pick-up is handled.

The most common trouble with A.C./D.C. receivers is a burnt-out valve or dropping resistance. If no signals are obtainable, and the receiver seems quite dead, the first test should be that shown in Fig. 89. The multi-metre should be set for measuring ohms, and its two leads should be connected across the mains plug. If a valve or the dropping resistance is burnt out no reading will be obtained; in most sets a reading of between 500 and 1,000 ohms is obtained across these two points, but the value varies slightly with the valve types used, of course. H.T. and H.F. tests should be conducted in the same manner as in A.C. main sets.

CHECKING RECEIVER PERFORMANCE

IT might be thought that it would be a perfectly easy matter to decide how good or how bad a receiver is simply by connecting it to aerial and earth and listening to it. This would be a sufficiently good method of testing when only rough comparisons are to be drawn, but it is useless as a means of checking the results of experiments. The alteration might be so small that it is not audible in average conditions, in which case the time spent in experimenting would probably be wasted.

It is not suggested that the service-man and experimenter should provide themselves with expensive calibrated valve-voltmeters, cathode-ray oscillographs and the like, but he should have a small amount of simple apparatus, most of which can be made at home quite cheaply.

Obtaining a "Test" Signal.—One of the first requirements is a device for generating a steady signal; this is because the signals sent out by a broadcasting station—with the exception of the tuning note—are quite useless for fairly accurate test purposes. The more usual apparatus and tests applied are dealt with in a previous chapter. As an

example of what is meant it can be explained that if an attempt were made to measure the output of a receiver, no matter how good the measuring instrument happened to be, it would be impossible to gain even a rough idea when, say, a band was playing. The reason is that the intensity of sound at the transmitting station is constantly varying between extremely wide limits, and corresponding variations must occur in the sound reproduced by the speaker, or in the output from the last valve.

A simple and reliable miniature transmitter—for that is what an oscillator comprises—can be made by using a single valve in the circuit shown in Fig. 90, and using the connections indicated in the wiring plan in Fig. 91. It may be seen that a four-pin plug-in coil is used in a standard regenerative circuit with series reaction. The valve is an

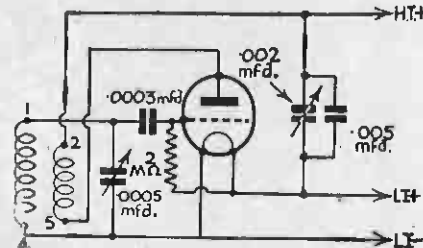

FIG. 90.—Circuit of a simple and effective local oscillator suitable for test purposes and for accurate trimming of a receiver.

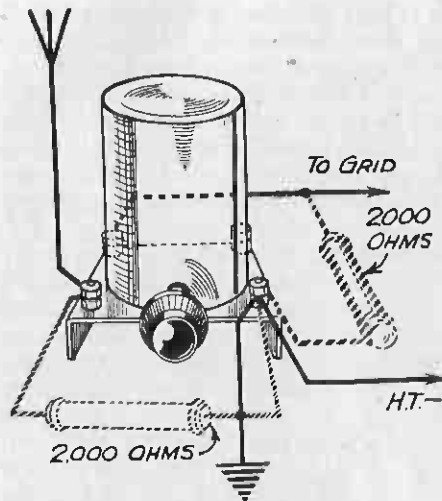

FIG. 96.—Too-sharp tuning can be modified by connecting a fixed resistance in one of the positions indicated here.

the screening grid. The optimum voltage can be found only by trial, because sometimes it is considerably higher than that usually suggested by the makers, and frequently it is lower. Suffice it to say, however, that oscillation can often be prevented by making the adjustment referred to: This is easily done in the case of a battery set with separate tapping, but there is a little more difficulty where a mains set is concerned, or where the supply is by means of a potentiometer consisting of a pair of fixed resistances, wired as shown in Fig. 97.

Screening-Grid Voltage.—

In the latter case, the applied voltage can be reduced by using a resistance of higher value in the position marked A, whilst it can be increased by using a lower resistance. The simplest and most accurate method of checking is to replace the two resistances by a potentiometer, wired as in Fig. 98. The resistance rating of the potentiometer should be approximately equal to the combined value of the two resistances in series. For example, if the resistances have values of 10,000 and 15,000 ohms, a 25,000-ohm potentiometer would be suitable.

Self-oscillation of the first valve can also be due to the fact that the decoupling condenser between the screening grid and earth (or cathode in some mains sets) is defective or of incorrect capacity. A 0.1-mfd. condenser is generally most satisfactory, but it should be a good-quality

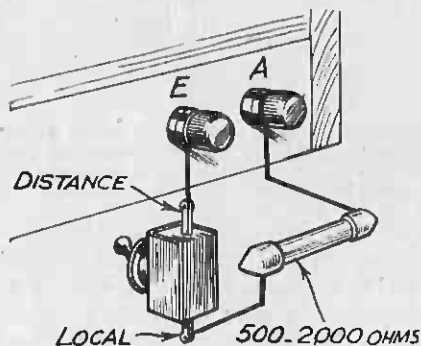

FIG. 96a.—Showing the simplest system of local-distance switching.

non-inductive type. Condensers of higher value may possibly be less effective due to the very small inductance (even so-called non-inductive condensers have a slight amount of inductance) being greater than that of the lower-capacity component.

H.F. Coupling Too Tight.—Oscillation can also be due to the use of

an unsatisfactory H.F. choke, or to the coupling between the windings of an H.F. transformer being too tight. The method of checking and correcting the choke is obvious, but there is not much which can be done with regard to the coil, unless the user feels competent to remove a few turns from the primary winding—assuming that the secondary is tuned. Another method which sometimes yields satisfactory results is

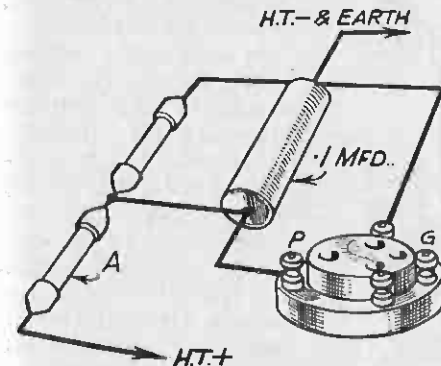

FIG. 97.—When a fixed potentiometer is used to apply the screening-grid potential, the applied voltage can be increased or reduced by using a lower or higher value for the resistance marked A.

to shunt a fixed resistance across the primary winding, as shown in Fig. 99. The resistance reduces efficiency to a certain extent, but if it cures the oscillation trouble its use is justified. The value of resistance required must be found by trial, but the highest which has the desired effect should eventually be used. In passing, it is worth mentioning that this idea is very often applicable to superhets, especially those in which the I.F. transformers (which correspond with the H.F. transformer just mentioned) have separate windings which can be moved in relation to one another. In more than one instance it has been found possible to remove all traces of distortion and instability simply by moving the windings slightly farther away from each other. The alteration, besides giving greater stability also sharpens tuning, although it is inclined to cause a slight loss in sensitivity.

The Detector Stage.—In most cases the detector valve is responsible for very little of the distortion which might take place in the set, but there are a few points which should be observed. For example, if the valve is preceded by more than one H.F. or I.F. stage there is a danger of its being overloaded unless power-grid connections are used—the main considerations are that the anode voltage should be not less than 100, and that the grid leak and condenser should have values of approximately .25 megohm and .0001-mfd. If the valve is being overloaded it is always worth while to try the effect of increasing the anode voltage,

or of using a valve of the L.F. type. If this does not overcome the trouble it might be necessary to replace the triode with a double diode or with a "Westector," but this is necessary in very few cases indeed, and certainly only when there is a tremendous amount of amplification prior to the detector.

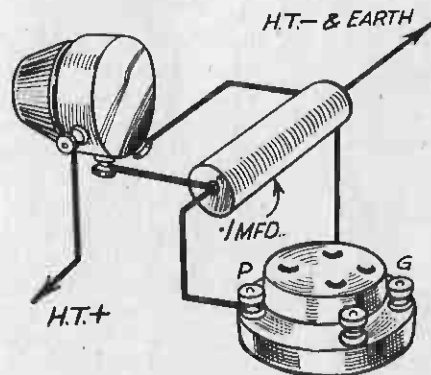

FIG. 98.—Easy S.G. voltage adjustment by means of a variable potentiometer. This can be mounted inside the set and left alone after once properly set.

normal manner; instead, signal strength increases for a time as the reaction setting is advanced, and then diminishes again. The trouble might be due to bad design of the set or to the detector grid coil being unsuitable, but it can often be set right by including a fixed resistance of about 250 ohms between the reaction winding and the reaction condenser.

L.F. Overloading.—

The coupling component used between the detector and low-frequency stage can be the cause of various kinds of distortion. If the set is of comparatively old type, however, and employs a cheap type of transformer, or even an R.C.C. unit, the user will find that a new transformer of good, modern type will be fully

occasionally happens that parasitic oscillation occurs in the detector stage, and that this can be prevented only by disconnecting one of the reaction leads. This peculiar form of oscillation, by the way, can be recognised by the fact that operation of the reaction condenser is erratic, or that the set does not appear to go into oscillation in the

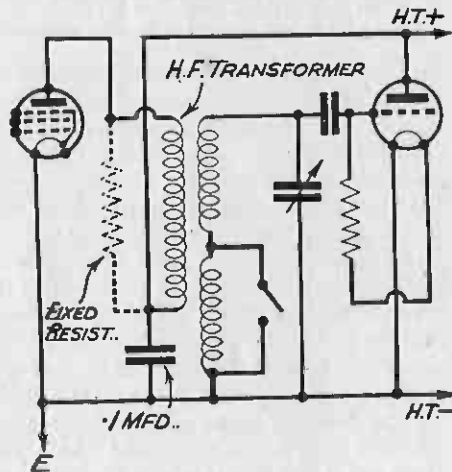

FIG. 99.—H.F. instability can often be overcome by connecting a resistance in parallel with the primary of the H.F. transformer, or by using a looser coupling between the windings.

L.F. TRANSFORMER

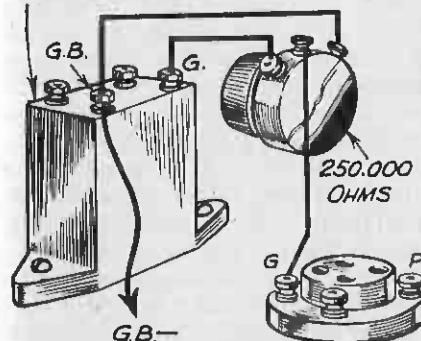

FIG. 100.—Overloading of the L.F. stage can be avoided by fitting a volume-control potentiometer, as shown here.

justified. If it is not found necessary to apply a very high anode voltage to the detector valve, a resistance-fed transformer is to be preferred, for this will provide greater amplification and better quality than an ordinary cheap transformer. On the other hand, a really high-grade transformer is hard to beat.

If it is thought that the L.F. valve is being overloaded a check can be made by reducing the input to it—either by including a volume-control potentiometer in its grid circuit, as shown in Fig. 100, or even by using the local-distance switching arrangement mentioned above. If overloading is definitely taking place the most satisfactory method is

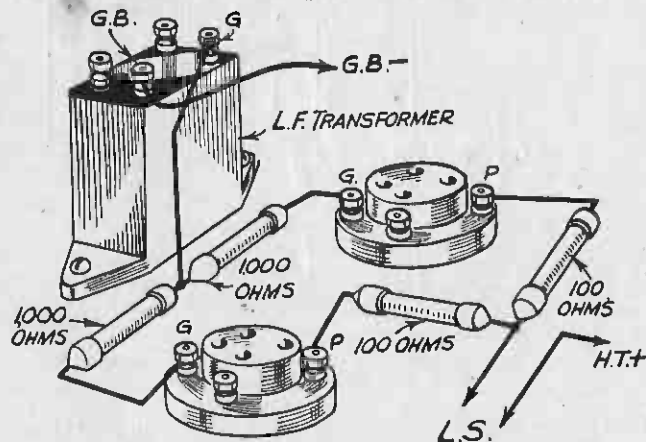

FIG. 101.—Showing how two L.F. valves may be wired in parallel. Note the grid and anode "stopper" resistances.

to replace the valve by one of "larger" type. Thus, a small power valve could be replaced by a super-power valve. Another method, which is not strongly recommended, is to connect another similar valve in parallel with it, as shown in Fig. 101. None of these methods should be used, however, until experiments have been made in connection with increasing the anode and grid-bias voltages to the existing valve; these simple alterations will often provide a complete cure.

CHAPTER XXI

DISTORTION—CAUSES AND CURE

WHEN reproduction is not as good as it should be, and if distortion is suspected, it is usual to lay all the blame on the low-frequency portion of the set. In many cases this is quite wrong, for there are many other sections of the receiver which may be responsible for the trouble. Let us follow through a typical H.F.-Det.-L.F. circuit with a view to considering the possible sources of distortion.

The Aerial Tuning Circuit.—It is quite safe to assume that the signals which reach the aerial from any of the B.B.C. transmitters are as free from distortion as is possible, although the same cannot be said of two of three of the Continental stations. For this reason it is best to make any tests which may be necessary on the nearest B.B.C. transmitter, although weaker signals from other British stations may also be used for purposes of certain comparisons. The signal striking the aerial might possibly be "mutilated" immediately due to the aerial-tuning circuit being of inefficient design, but this is unlikely. Nevertheless, if reproduction is low pitched the input

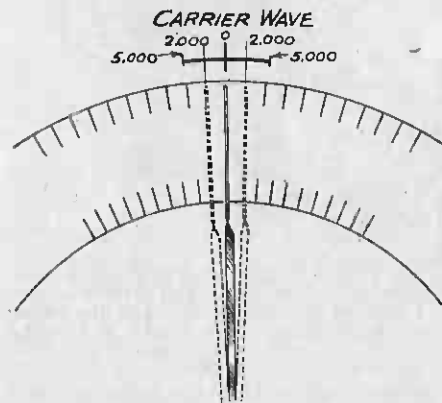

FIG. 95.—In a sharply-tuned circuit the higher frequencies may be lost as indicated here, where broken lines indicate the amount of movement of the tuning pointer before signals rapidly become weaker.

tuning circuit might come under suspicion. The reason is that if, for some reason, the circuit tunes very sharply the higher musical frequencies may be "lost". This is best understood by considering the musical or audible frequencies as extending on each side of the exact tuning point of the carrier wave, as suggested diagrammatically in Fig. 95.

High-Note Cut-off.—When the tuning is exceptionally sharp it might happen that the input circuit will not pass on frequencies above, say, 2,000 cycles; the result is bound to be boomy reproduction. Should the aerial circuit be suspected of causing trouble in the manner which has

been suggested it would be well to note the effect of connecting a fixed resistance of about 2,000 ohms either between the aerial and earth terminals, or between the ends of the aerial coil, as shown in Fig. 96. The resistance will certainly cause a reduction in selectivity, but if better quality is obtained it will be known that the coil is unsuitable when good reproduction is required. An improvement would in most cases be obtained by fitting a band-pass filter in place of the single-circuit coil. This provides a more uniform response as indicated in Fig. 95a.

Local-Distance Switching.—The latter test does not indisputably prove that the original coil was in some way unsuitable, because the main effect of the resistance might simply have been to cause a reduction in efficiency of the input circuit, and thus a lower input to the grid of the first valve. Thus, if the valve were previously being overloaded it might operate well within its capacity with the resistance in circuit. This could be proved most easily by noting whether or not the resistance had any effect on the quality of reproduction when listening to weaker signals. In either case, the fitting of a "local-distance" switch to put the resistance in or out of circuit at will would be justified. The simplest arrangement is that shown in Fig. 96a, where an ordinary on-off switch is wired in series with a fixed resistance between the aerial and earth terminals. When the switch contacts are closed the set is most suitable for reception of powerful signals, and when they are open distant reception can be obtained without any loss of efficiency. The most satisfactory value of resistance is best found by trial, but it is often found that one of 500 ohms is just right.

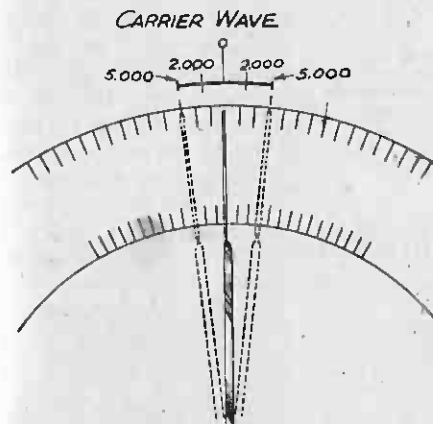

FIG. 95a.—When a band-pass tuning circuit is used, the full range of audio-frequencies can be "covered," since signals vanish suddenly at the two extremes of the tuning band.

Self-Oscillation.—Another common source of distortion is in the circuit of the H.F. valve itself. Probably the valve tends to oscillate in certain conditions; and distortion is an inevitable result of oscillation at either high or low frequency. Quite often the only alteration required to produce a remedy is in respect of the H.T. voltage applied to

be disconnected and the frame wired in its place, the other end being earth connected, as shown in Fig. 102. It does not matter very much whether the tuning condenser is left in circuit or not, because the interference is very rarely confined to any particular wavelength, but is completely untuned.

When the frame aerial has been connected it should be found that the interference is most pronounced with the edge of the frame pointing in one particular direction (really there are two opposite directions because the frame responds equally to signals from the front and rear edges).

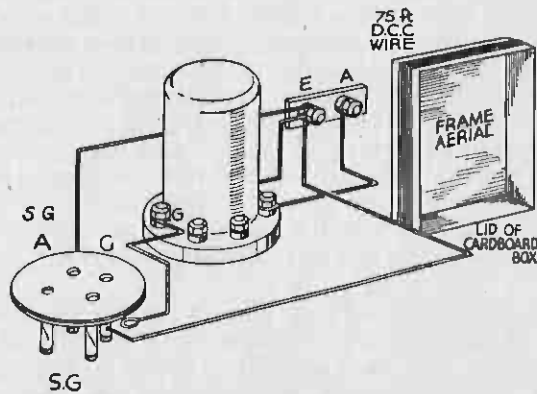

Fig. 103.—Connections for an improved frame aerial used in conjunction with a screen-grid set.

The frame aerial should thus be rotated until the strength of the interference attains a maximum, after which the volume control, where fitted, should be turned down until the crackles are only just audible in a pair of 'phones connected to the speaker terminals. The next step is to move the set and frame first in one, and then in the other direction of the frame, carefully observing whether the interference increases or diminishes. It is almost sure to become more pronounced when the outfit is moved in one direction, and the frame should therefore be moved as far as possible in that direction, the frame occasionally being rotated slightly so as to keep the interference as loud as possible. It will be evident that every time the sound increases the frame has been moved nearer to the source of trouble.

When the Interference is External.—If the interference is due to some piece of apparatus inside the house it should eventually be located by progressing along the lines described. On the other hand, if it is established that the source is outside the house it will generally be necessary to call in the assistance of the Post Office Engineering Department. To do this, it is necessary to obtain an appropriate form from the

local Post Office, fill in the details asked for, and send it to the address given on it. In most cases an experienced engineer will call in a few days (without charge) and continue the search. (See Figs. 102 and 103.)

The commonest sources of interference are electric signs of the flashing type, electric motors of all kinds, ordinary motor cars, refrigerators, etc. Included under electric motors, of course, are a hundred-and-one pieces of apparatus of ordinary domestic use in which the motor is included, such as vacuum cleaners, coffee grinders, fans, hair-dryers and so on. From all of these items the interference can be introduced into the receiver by conduction through the electric supply mains or by radiation from the apparatus. In the latter case, of course, it may be fed to the receiver through the aerial or earth leads, or even picked up by the inter-circuit wiring or some inductive component.

Battery or Mains Receivers.—In the case of a receiver operated from ordinary batteries, there is no possibility of the interference arriving via the mains, and thus any interference will come from the aerial or earth leads or from induction between supply wires inside the walls of the house. If the interfering apparatus is very close, there may even be direct pick-up by the circuit

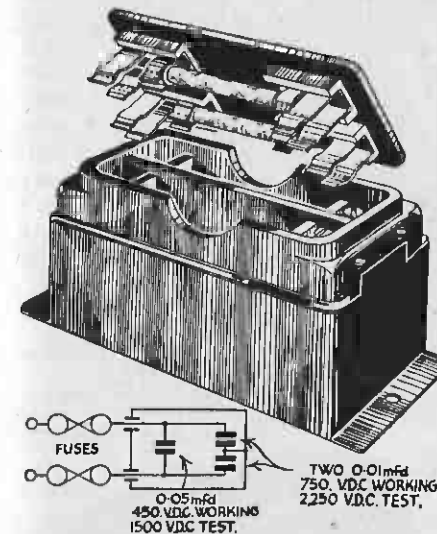

Fig. 104.—The Belling-Lee type 1171 interference suppressor and circuit.

wiring. The users of the apparatus should take the necessary steps to avoid interference, and there are several schemes for preventing motors and similar electrical equipment from radiating interference. When an electrical circuit is broken or interrupted a small spark will be seen and if some inductive load is included in the circuit there will be a considerable radiation of energy when the spark occurs. A non-inductive shunt across the contacts which are broken will prevent (in most cases completely) the formation of a spark and thus the radiation of the interference, and the shunt may take the form of a specially-wound coil or a simple condenser. In an electric motor, for instance, the brushes will make-and-break at the commutator, and if an electric motor is inspected whilst it is working the sparks will

be seen at the junction of brushes and commutator. Thus, in view of the above remarks, a condenser may be joined across these two points to prevent the interference, but it is found that better elimination is obtained when a condenser is joined to each brush and the junction of the two condensers is joined to earth or to the casing of the motor.

Whilst ordinary condensers may be employed, it is necessary to guard against an overload of the condenser, and where the mains voltages are connected to the motor, good insulation is required to avoid the risk of anyone receiving a serious shock on touching the condenser. (See Figs. 104 to 109.)

Commercial Units.—A number of firms make up a unit consisting of the two necessary condensers inside a case, with a terminal for connection to earth and amongst these firms may be mentioned Messrs. T.C.C., Belling-Lee, Bulgin, Dubilier, etc.

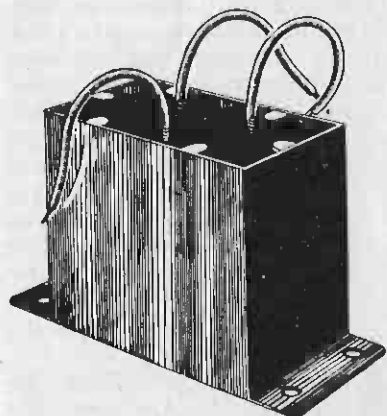

FIG. 105.—A Dubilier anti-interference unit which is obtainable in different types.

Some examples are seen in Figs. 104 to 109. Where it is not possible to obtain access to the actual motor (such as in a modern domestic vacuum cleaner) the interference-removing device may be included in the mains leads to the apparatus, and in such a case a smaller component would be employed, such as the Belling-Lee Flex Lead Suppressor, shown in Fig. 110, or the T.M.C. device shown in Fig. 111.

In some cases it may even be found that the inclusion of this type of suppressor in the mains leads to a mains receiver will remove the interference, without connecting it to the interfering apparatus, and thus, where more than one piece of apparatus gives rise to the interference a single suppressing device may be used continuously. If the

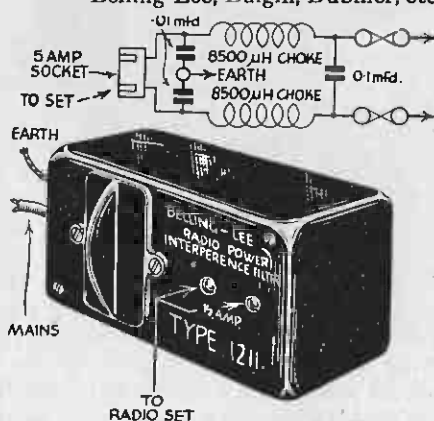

FIG. 106.—This device is employed on the input circuit to a radio receiver, and is a Belling-Lee product.

trouble is only slightly reduced in intensity when aerial and earth are removed it will indicate in most cases that it is being induced, and a removal of the receiver to another part of the room should result in a further modification of the interference. In such a case it will be necessary totally to screen the receiver in order to prevent pick-up by the wiring.

If, however, no alteration in intensity results when aerial and earth are removed it may be taken that the source of the interference is the

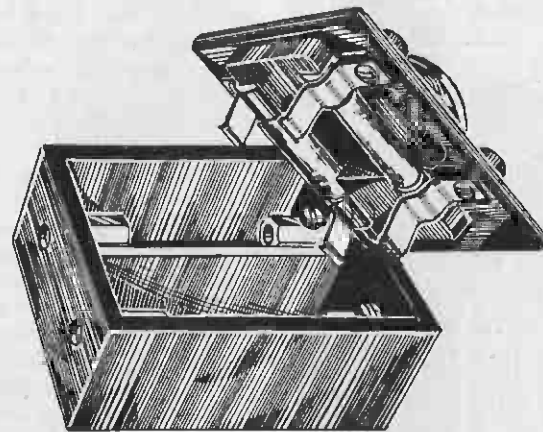

FIG. 107.—A twin mains fuseholder from Bulgin.

mains supply leads and the remedies already mentioned, or to be mentioned later should be adopted.

If the interference comes from some outside source, where it is not possible to fit the interference eliminating apparatus, or where no control over the apparatus may be obtained by the listener, some form of anti-interference aerial system must be employed, and the Goltone Rejectostat (Fig. 112) aerial employed. In these forms of aerial a special screened lead-in wire is employed and it is intended that the aerial proper—that is, the horizontal portion—should be erected where possible clear of the area of interference. Then, to make up for the long lead from the aerial to the receiver, a special impedance-matching transformer is connected between the aerial and the lead-in wire, whilst a similar transformer is then joined between the receiver and the other end of the lead-in wire. Without such transformers, the loss due to the long lead and to the capacity existing between the lead and the outside metallic (earthed) casing would be so great that only the nearest and most powerful stations would be heard.

So far we have only considered the interference which arises from electrical apparatus situated either in the actual house or at least within the near vicinity. There are, however, several other sources of crackles or clicks which can mar the received programme, and the commonest of these is a poor fitting connector. This may be of any form, and does not necessarily refer to a plug or socket. It was stated in the opening paragraphs of an earlier Chapter that when a current

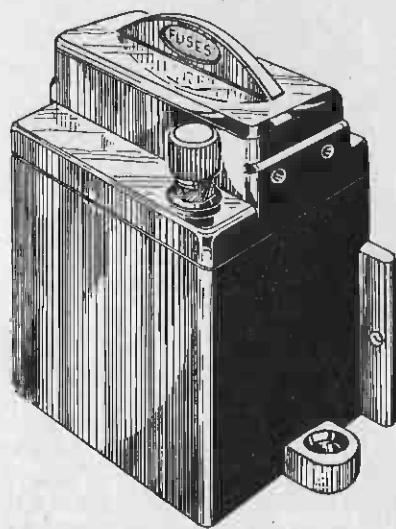
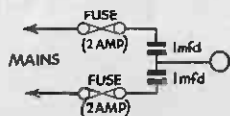

FIG. 108.—A simple but efficient suppressor made by T.C.C.

slightly so that the overall diameter is slightly greater than the internal diameter of the sockets. When the pins are pushed into the socket they are closed together, but owing to the natural springiness of the metal the sides make good contact with the sides of the socket and thus no trouble should be experienced.

Worn Contacts.—It is often found, however, that after some period of use the natural springiness of the metal is lost and one of the pins makes a poor contact in the socket, or only touches at one point. Vibration, due either to passing traffic in the street, or to the weight of a person walking across the floor, will cause the plug to shake in the socket and the contact is then made and broken erratically, with the

was interrupted a spark took place and that this gave rise to a radiation and thereby caused a noise in the receiver. This type of radiation is untuned—that is to say, owing to the absence of a resonance circuit, there is no exact frequency upon which the noise will be heard. Owing to this, it matters not what wavelength the receiver is tuned to, the noise will be heard as a background. In the average home there are many sources of supply in which continuity of contact has to be relied upon for the function of some appliance or apparatus, and it is here that an intermittent current or supply can give rise to the noises already mentioned. For instance, the ordinary mains plug and socket consists of two brass sockets into which two brass pins are forced. To ensure a firm contact the usual procedure is to slot the pins and open them

result that arcing takes place and the crackles and other noises are heard through the wireless receiver. The remedy is obviously to make quite certain that the contact is firm and reliable, and in this connection the novel Clix plug which is shown (Fig. 113) may be recommended. Instead of a slotted brass pin a unit the insulated plug head carries two cotter pins, and the wire leads are passed through the looped heads of these and when the two parts of the head are fitted together the wires are rigidly held whilst the cotter makes perfect permanent contact in the usual type of socket.

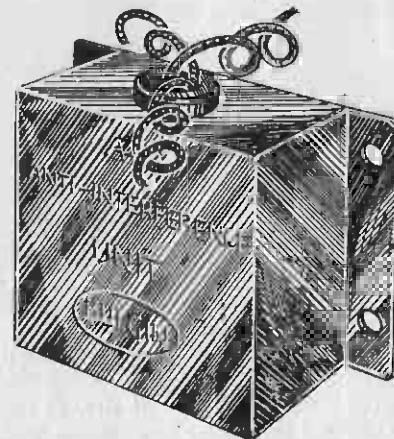

FIG. 100.—A combined condenser anti-interference unit from the Bulgian range.

An ordinary electric lamp can also give rise to crackles and interference in a similar manner. The base of an ordinary electric lamp is provided with two soldered connections, the solder being usually left in a "rounded" condition, so that it may bear against the small spring pins in the lamp-holder.

It may be found in certain cases (especially with cheap or foreign lamps) that the solder is insufficient to enable the contact to be firmly made when the lamp is in its final position in the holder and this can give rise to crackles as already mentioned. The remedy is to run some more solder on the contacts, and also to inspect the spring plungers in the holder and make quite certain that they return to their "full out" position after being depressed. (Any test at this point should, of course, only be made when the supply is switched off at the mains.)

Car Interference.—When listening on the short-waves interference may easily be experienced from passing cars. The ignition system gives

rise to quite a powerful radiation, and when a car radio is being employed the trouble is, of course, increased. Special interference suppressors may, however, now be obtained for the sparking plugs (which

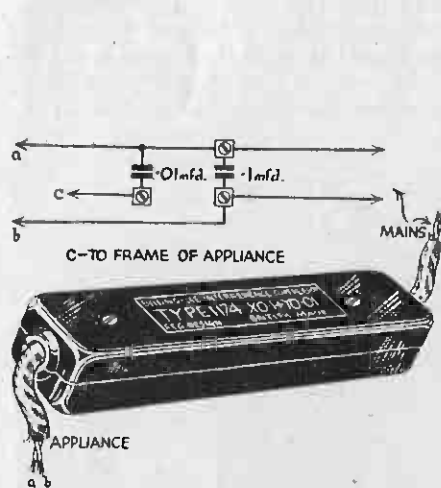

FIG. 110.—A flex lead suppressor (together with the circuit which is employed) from the Belling-Lee range.

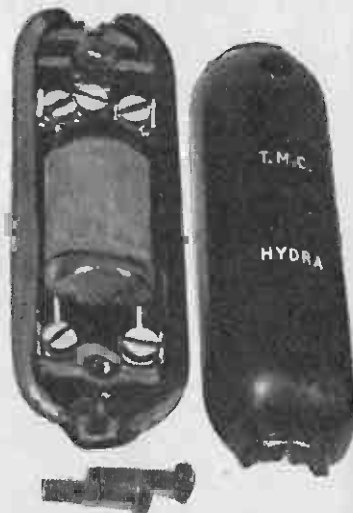

FIG. 111.—This is a flex lead suppressor made by T.M.C.

provide spark from the interrupted current already referred to) and for the magneto (Fig. 114), and these may be obtained from Messrs. Belling-Lee or Dubilier.

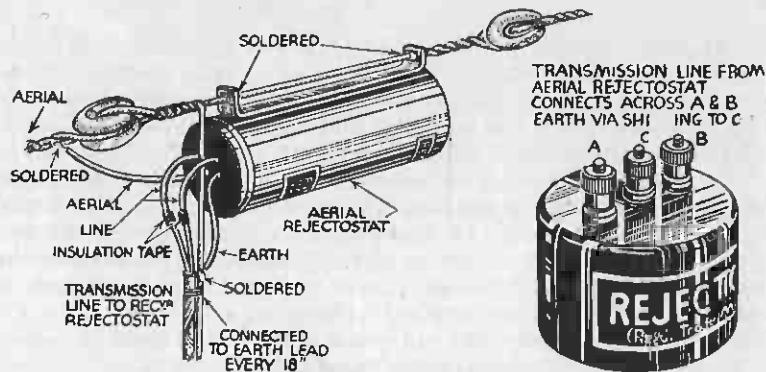

FIG. 112.—The aerial Rejectostat used for avoiding losses in a screened aerial system.

This is the remaining part of the Rejectostat equipment, and is used to feed the receiver.

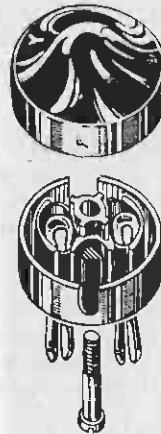

FIG. 113.—The Clix patented plug which avoids all troubles arising from crackles due to poor contact.

ordinarily receiver, the cheaper type of choke rated at .6 amps. and costing 3s. 6d. will be found quite suitable.

Legislation is probable, making it an offence to manufacture or use apparatus capable of giving rise to interference with broadcast reception.

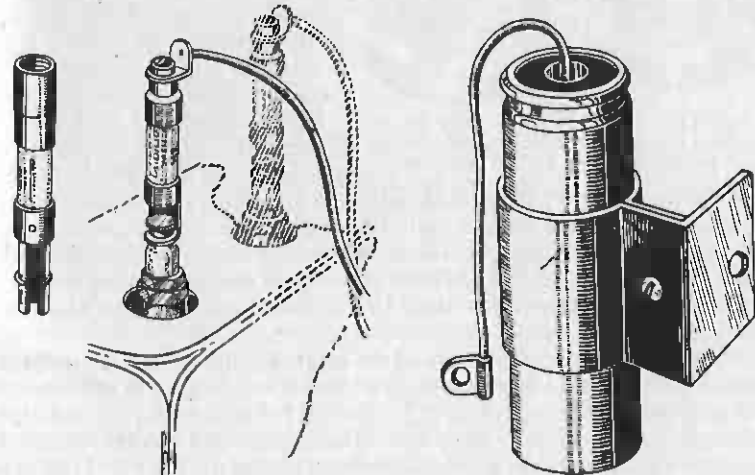

FIG. 114.—The method of preventing interference from motor-car plugs.

FIG. 115.—For reducing interference from windscreen wipers and similar apparatus this Dubilier unit is ideal.

CHAPTER XXII

TRACING SOURCES OF INTERFERENCE

A GOOD deal has been written concerning the remedies to apply in order to overcome electrical interference, but the first difficulty encountered is almost invariably that of finding the cause and source of the trouble. It would be useless to fit choke-condenser filters in the mains leads if the so-called man-made static is caused by a flashing sign outside the house, just as it would be a waste of time to fit an interference-free aerial system if the crackles were being conveyed to the receiver through the mains-supply leads. The first step should thus be to decide the reason for the impaired reception, and although

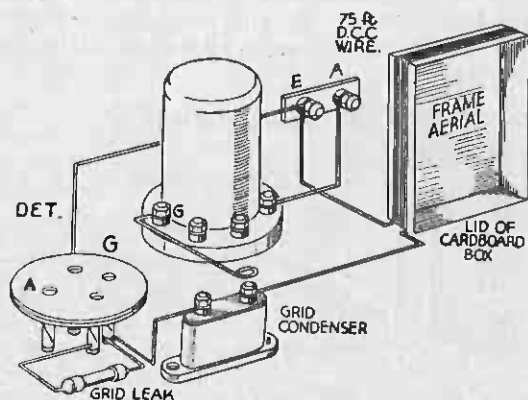

FIG. 102.—Showing the connections for an improvised frame aerial used with a det.-L.F. receiver.

the Post Office engineers are always very helpful in this respect when their services are requested, the service-man should endeavour to carry out a little "detective" work on his own before asking for outside assistance.

The very first test to apply is to disconnect the aerial and the earth; if the suspected interference then disappears it is obvious that the cause is external to the set.

Pick-up or Wire-conveyed.—In the first place, it is evident that if the set is battery operated the interference must be picked up by the aerial or by the connecting leads used with it. For this reason it is a

good plan where a mains-operated set is used to arrange with an assistant to compare the results obtained with his set with those provided by the mains receiver in the location in which the trouble is observed. This will generally give an immediate clue to the type of interference—mains-borne, or direct pick-up. When the interference is fed into the receiver by means of the mains leads it is evident that a choke-condenser filter is required. A certain amount of experiment may be required in order to determine the most suitable values of condensers and chokes, but the procedure will be comparatively straightforward.

If it is definitely determined that the trouble is due to pick-up, the next step should be to remove the aerial lead-in at the point where it enters the house and note whether this makes any difference. If it does, a screened down-lead might prove effective and should certainly be tried. Should this make very little difference, however, the effect of altering the position of the leads to the speaker (where it is external to the set) should be tried, whilst it should be observed whether an alteration in position of the batteries and their leads makes any difference. These points are raised because it is frequently found that some of the leads run near to a wall through which an electric conduit is taken, and if the wires are parallel to this they make ideal "interference aeri-als."

Bad Contacts.—If none of these changes has any pronounced effect it will often be indicated that the interference is due to a bad or intermittent contact to some piece of electrical apparatus in the house. A small motor, a vacuum cleaner, an electric-light switch, or an electric bulb which is loose in its holder might be at the root of the trouble. If any of these is suspected it will probably be a fairly easy matter to confirm the suspicion by switching off the particular item. In this respect it should be mentioned that a switch having contacts which are worn, and across which sparking or arcing takes place, can be the cause of a mysterious form of trouble which is intermittent in character. In the same manner a loose electric lamp bulb can produce interference due to slight arcing between the bulb "pips" and the spring-loaded contacts in the holder. Other cases have been observed where the trouble was due to a bad contact between one of the wire coils in an electric fire and the terminal post to which it is attached.

Direction Finding.—Should it be found impossible to locate the source of trouble by trial-and-error methods it is often possible to arrange a direct system of location by the use of a frame aerial in conjunction with a battery set. A portable receiver is most convenient for the purpose, but where this is not available a simple frame aerial consisting of about 75 ft. of 26-gauge cotton-covered or enamelled wire wound round the lid of a cardboard box and connected to a battery set (preferably one having a "straight" circuit), may be used almost equally well. In the latter case the grid lead from the aerial coil should

CHAPTER XXIII

TEMPORARY REPAIRS AND SUBSTITUTION

MANY service-men are under the impression that when a component or valve breaks down or develops a fault, a similar item must be obtained as a replacement. In general this statement is perfectly true, but with a little careful thought it is often possible to utilise another component or valve until the correct parts are available.

It is, of course, unwise to make such substitutions and exchanges when the theoretical knowledge which you possess is insufficient to enable a full understanding of such change to be obtained, but the following notes will give some idea of the possibilities.

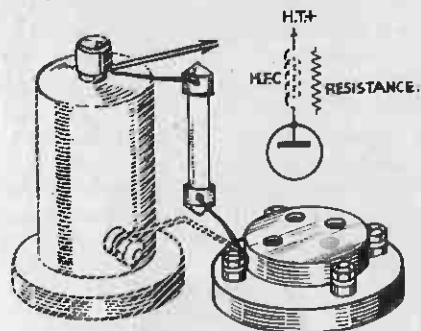

FIG. 116.—An H.F. choke may be replaced by a resistance in most circuits without marring the performance.

will prevent signals and in this position we find chokes and transformers—components which are generally found to fail when an excess current is passed. Under normal conditions, therefore, a breakdown will indicate that an excessive current has been passed and before carrying out any replacement an examination should be made to ascertain the cause of the breakdown.

When this has been located and the fault remedied a new component will be indicated and it may so happen that a similar item is not readily obtainable. In the case of an H.F. choke a resistance may be included in many cases with very little loss of efficiency, and the only general trouble will be found in a reduced voltage on the valve (Fig. 116). In many cases this may be remedied in a very few moments by connecting the H.T. lead from that valve to a higher tapping on the H.T. battery

Breakdowns.—Let us deal first with breakdowns which might occur and prevent a receiver from working. In general the only components which are likely to suddenly break down and prevent reception are those across which a difference in potential exists, or in other words, those which are carrying a current. In the average receiver these will consist of the coils, chokes and transformers. A breakdown of a component in an anode circuit

or connecting it to the maximum H.T. positive lead. For normal reaction circuits the value of the substitute resistance will not be found critical and for many types of H.F. coupling also the resistance will be found to function as well as the choke except, perhaps, on the lower wavelength ranges.

Transformers and Resistances.—In the case of a transformer breakdown it may be safely taken for granted that only the primary will be found faulty, as there is no current of any magnitude flowing through

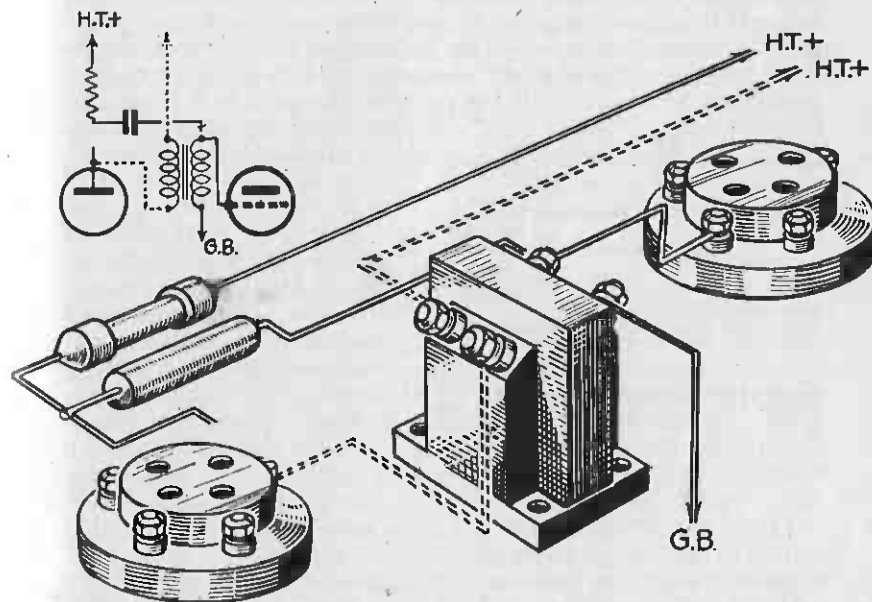

FIG. 117.—An L.F. transformer primary winding may break down. It may be replaced by a resistance and condenser coupling as shown.

the secondary. Temporarily, the secondary could be used in the anode circuit, but such a course is not recommended in view of the fact that it is not designed for the passage of a steady D.C. Therefore, in order to enable reception to be carried out a resistance may be placed in the anode lead, with a coupling condenser between the anode and the grid of the following valve, the secondary remaining in its original position but now serving as a grid leak in the form of a choke. It may even be found that results are improved by this scheme. If desired, subsequent modification would consist only of a resistance in place of the transformer secondary, thus substituting R.C. coupling for transformer coupling (Fig. 117).

Q.P.P. or Class B valves, this regulation is extremely good and very little difference in voltage exists over very wide limits of current. On cheap and old pattern instruments, however, the difference may be very great. Let us suppose you have such a unit joined to a receiver

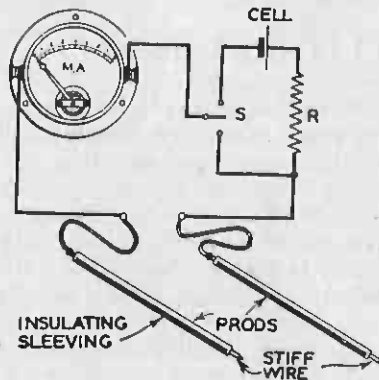

FIG. 120.—How a milliammeter may be used for test purposes over a wide range.

age applied to the detector valve, and as this is generally only a matter of a few milliamperes, the effect of connecting a low resistance across it will be to give a very serious error indeed (Fig. 119). How then can

we find the actual voltage delivered by a small main unit, or applied to a detector valve, or take similar readings if we cannot afford to purchase a good high-resistance voltmeter? If we obtain a good milliammeter we can, by ascertaining the current which is flowing, obtain a fair idea of the output. A good milliammeter maybe obtained much more cheaply than a good voltmeter, and by obtaining a meter having a full scale deflection of, say, 2 mA. it will be possible to utilise shunt resistances (as has already been explained in these pages), to obtain higher

readings. A meter of this description could, for instance, be joined in the negative H.T. lead, with a suitable shunt to enable it to read somewhere about the total current which is used, when, from the above reasoning we may obtain a very fair idea of the voltage output. If, for instance, it is found that the total current is only 10 mA., and the unit

is rated at 150 volts with 25 mA., it would be worth while to add a further resistance across the output terminals of the mains unit in order to bring up the total current drain to 25 mA. and thus give you a fair assurance of obtaining the correct 150 volts. Similarly, by including the milliammeter in the anode circuit of the detector valve, and noting the current passing, it is possible from a study of the valve-maker's characteristics to ascertain within close limits the H.T. applied to the valve. In the output stage, the combination of grid bias applied, and anode current passing, will also enable you to ascertain the voltage. Correct grid bias, with a low anode current, will indicate low H.T. voltage and vice versa.

The Detector Stage.—It is very often desired to measure the voltage

applied to the detector valve, and as this is generally only a matter of a few milliamperes, the effect of connecting a low resistance across it will be to give a very serious error indeed (Fig. 119). How then can

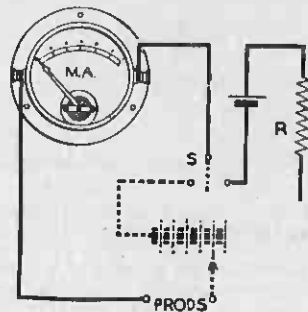

FIG. 121.—This diagram shows how the meter may be used with a high voltage for testing components, etc.

is rated at 150 volts with 25 mA., it would be worth while to add a further resistance across the output terminals of the mains unit in order to bring up the total current drain to 25 mA. and thus give you a fair assurance of obtaining the correct 150 volts. Similarly, by including the milliammeter in the anode circuit of the detector valve, and noting the current passing, it is possible from a study of the valve-maker's characteristics to ascertain within close limits the H.T. applied to the valve. In the output stage, the combination of grid bias applied, and anode current passing, will also enable you to ascertain the voltage. Correct grid bias, with a low anode current, will indicate low H.T. voltage and vice versa.

Checking Circuits.—The same simple instrument may also be employed for the purpose of checking the efficiency of tuning circuits or of adjusting ganged circuits, simply by including it in the anode circuit and adjusting for the maximum deflection. That is to say, if a tuned circuit is being tested against another known one, the local station would be tuned in and the total current reading in the anode circuit of the detector valve noted. The new coil would be then included, and tuned to the local, and the current reading compared with that obtained with the previous circuit. Similarly, for adjusting ganged circuits, each section could be connected in turn and the appropriate readings noted.

By remembering the relationship between the three different sources previously mentioned, it is also possible to ascertain values which in the ordinary way would perhaps be unreadable. For instance, if the meter be employed with a voltage in series and the circuit under examination be isolated and connected so that the resistance may be ascertained, upon re-connecting the circuit and including the meter in series in order to ascertain the normal current flowing, the voltage applied could easily be worked out.

There are many other uses to which the milliammeter can be put, and it should thus be the first item which the wireless listener obtains. (See Figs. 120 and 121.)

Where a resistance has failed, it may generally be found that only another resistance may be used in its place, although in the case of a decoupling resistance it may generally be found that an H.F. choke will answer the same purpose, but will permit the application of a higher voltage to the valve. This point should therefore be borne in mind when making this substitution.

Condensers and Valves.—A condenser of one value may generally be replaced by a component of another value for temporary listening purposes, although if the condenser forms part of the main tuning circuits it is possible for ganged tuning schemes to be put out of alignment. A temporary expedient in such a case may be to alter the necessary trimmers for the time being, or until a correct value of component may be obtained. If the faulty condenser is of a low value,

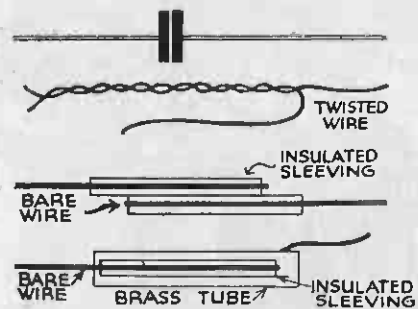

FIG. 118.—As a substitute for a broken condenser, one of the schemes shown above may be employed.

a temporary condenser may be readily constructed by twisting together a length of wire, the capacity varying according to the thickness of the wire, the insulation thickness and the length of the wire. Two alternative schemes are also shown in Fig. 118. It may even be found that by adopting one of these schemes in place of a condenser already in use a much more critical value is found with consequent improved performance.

In the case of valves there is not the same latitude, although it is possible to make preparations for circuit modifications at a future date. For instance, take the case of a straight three receiver of the Detector and two L.F. arrangement in which a valve breaks down. In obtaining a new valve one of the S.G. type could be obtained and used in the present detector stage. If the L.F. valve was the faulty valve a change round should be made to enable the S.G. valve to be used in the detector valve-holder. The necessary extra items could then be obtained at odd times and the circuit eventually converted to an S.G. detector Power arrangement with increased range and volume.

Old type coils should certainly be replaced by modern components and no attempt should be made to obtain out-of-date coils because they were originally used. The majority of manufacturers to-day supply a diagram with the coil showing the connections and wiring details and it is not a difficult matter to incorporate this in an existing circuit. The improvement will be well worth the expenditure involved and it may even be said that such a course should be adopted with all receivers in which the coil is two years old or more.

ADAPTING MILLIAMMETERS

ALTHOUGH the famous Ohms Law has been repeatedly described and is now known by every radio experimenter, and probably nearly every listener, it is not realised by many how the knowledge of this formula will very often save not only a lot of worry and doubt, but even expense. The relationship between volts, resistance and current enables certain factors to be ascertained with very little difficulty and I have shown in earlier Chapters how the value of a resistance may be ascertained by joining it across a voltage supply and by similar methods

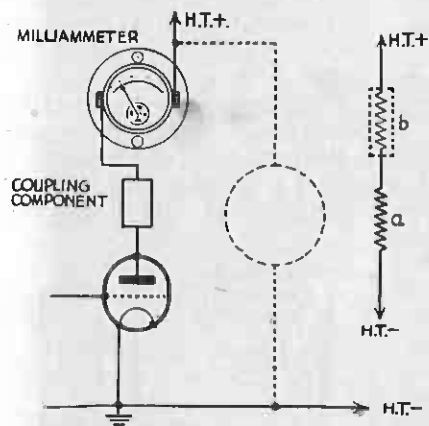

FIG. 119.—A meter connected as shown by the dotted lines would generally give a false reading. The circuit may, however, be considered as shown on the right, and a milliammeter may be used to ascertain the voltage; "a" is the valve resistance.

have described how to test other small components. There, is, however, another very important application of this small formula which will be of great assistance to users of small mains units especially, and also to those who are desirous of finding out how certain parts of a receiver are functioning.

The Effect of Load.—The majority of mains units are rated to deliver a certain voltage at a certain current. That is to say, a unit might be stated to deliver 150 volts at 25 mA. This particular unit need not, however, be restricted to this current if for any reason a larger

drain is required. Owing to the relationship between current and voltage, however, if any larger current drain is imposed the voltage output will be lower than 150 volts. Similarly, if the unit is employed with a small receiver in which the total anode current requirements are only of the order of say 10 mA., the voltage will be in excess of 150. The actual difference between the voltage at different currents depends upon what is known as the regulation of the unit and in some modern types of instrument, especially those designed for use with

RENOVATING CABINETS

THE majority of marks that make a cabinet look shabby are scratches, chips and finger marks, and such cabinets can easily be rejuvenated by the following method, which should be followed in the case of French polished and sprayed cabinets.

The materials required are:—a small bottle of French polish, a "water" stain in powder form to match the colour of the cabinet, and a fine paint brush.

For Scratched Surfaces.—To touch up scratches or chips, proceed as follows:—Place a little polish in a saucer and add just enough of the powder stain to colour the mixture, mix well and gradually add more powder until the approximate colour required is obtained. It is as well to be a little on the light side as the colour can always be darkened when adding a second coat.

Thoroughly clean the scratch with a cloth dipped in methylated spirits and carefully "paint" the scratch with the mixture of stain and polish, taking very great care not to get any on the polished surface of the cabinet, or the surface will be spoilt. Should the mixture get on to the cabinet, wipe it away as quickly as ever possible.

When the first coat has dried thoroughly, a second may be applied, and if the scratch has been coloured to match the rest of the cabinet by the first application of the mixture, the second "coat" should be of polish only. Otherwise, continue the treatment as outlined above with another coating of the mixture. When tackled in this way, the scratch will soon be filled, and will scarcely be discernible.

Using Plastic Wood.—Some scratches, or chips, are too deep to be removed by this method and plastic wood should be used. This is obtainable from most ironmongers and, since it will not take a stain, the coloured variety should be used, and a little pressed firmly into the scratch with the blade of a pen-knife. Here again, take care not to allow any of the plastic wood to creep on to the rest of the cabinet, as it contains a powerful solvent which will quickly attack the polish and give it a matt surface. Smooth off the surface of the wood as soon as it is applied, and leave to dry for at least an hour. Plastic wood contracts as it dries, so the surface when applied should be just slightly above the level of the cabinet. When hard, it should be carefully levelled down with a very fine sandpaper. The mixture of stain and polish may then be applied as before, and any irregularities in the surface of the plastic wood will be levelled up by this application. This method is so effective that the position of a scratch may be practically hidden.

RENOVATING CABINETS

When a cabinet is merely dull, the application of a little "oilet" or "liquid glass", coupled with plenty of "elbow grease", should be tried. It is surprising what a few minutes of such treatment will do, but if no improvement is obtained, any of the many commercial car polishes (cellulose type) are extremely good, not only for removing finger marks and generally cleaning up the cabinet, but also in giving an extremely high polish and removing fine scratches from most of the finishes used in cabinet manufacture. Such treatment is of no avail when the cabinet has been hand French polished.

Perhaps the worst kind of cabinet to tackle is one on which the actual polish surface has worn off, due to continual use and polishing.

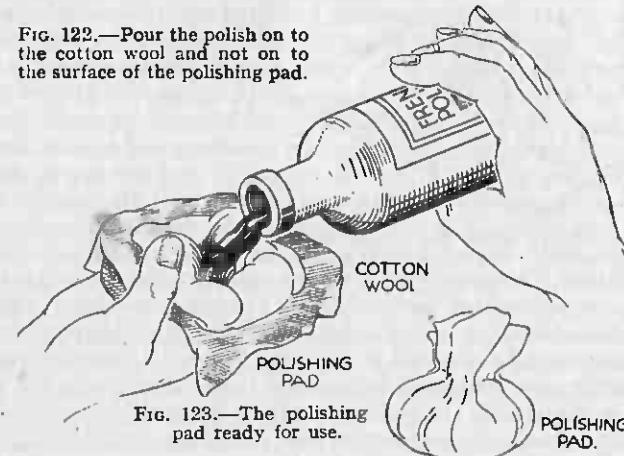

FIG. 122.—Pour the polish on to the cotton wool and not on to the surface of the polishing pad.

FIG. 123.—The polishing pad ready for use.

Too many people make a habit of regularly polishing their cabinet with polish, with the result that they do more harm than good and gradually remove the surface. Rub it over occasionally by all means, but use only a soft, clean duster, with no polish.

In such a case, the only way to make a good job of the cabinet is to "strip" it, that is to remove all that remains of the existing polished surface by well rubbing the cabinet with fine sandpaper. Always sandpaper the way of the grain, never across the grain, and make a perfectly smooth and uniform surface before attempting any repolishing. After sandpapering, clean the cabinet with a duster and then with a rag moistened with methylated spirit to remove all grease.

This time, however, the polish cannot be applied with a brush, or a very uneven surface, showing all brush marks, would result. The following method should be followed, and although it may seem a little tedious, it will render results equal to a new cabinet, and is well worth the time and patience.

Polishing Hints.—Place a small amount of cotton wool in the centre

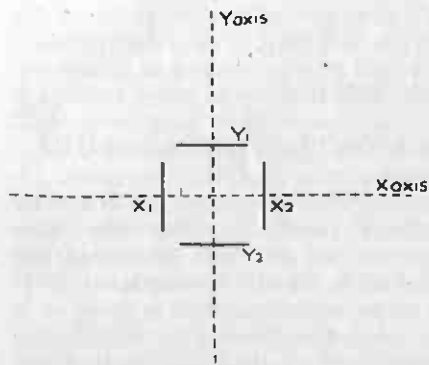

FIG. 125.—Plan view of the deflector plate arrangement to give horizontal, vertical, or resultant deflection.

spot (definitely visible as a spot). Fast voltage variations, however, will, owing to the persistence of vision, cause the movement of the light spot to show up as a line trace.

X Deflection as a Function of Time.—In radio we are particularly interested in voltage wave forms. This is another way of saying that we are particularly interested in the exact manner in which the voltage varies with respect to time. If we wish a "picture" of a voltage wave-form to be visible on the screen it will be of no use applying the voltage either to the X plates alone, or to the Y plates alone, or to both together for that matter. Suppose we did apply an alternating voltage to the X plates. The light spot will certainly move in strict accordance with the voltage variations, but as it will run backwards and forwards along a straight line the trace of this line will be the only visible result (see Fig. 126).

What is required is that the X deflection shall cause movement of the light spot across the screen independently of any variation of the voltage under test; preferably the movement of the spot with reference to the X axis should be at uniform speed, in which case the position of the spot with reference to the X axis will be a function of time. Then if

horizontal and vertical, dependent upon the vector resultant of the two deflecting forces.

If constant deflection voltages are applied the light spot will take up a position dependent upon the deflection resultant but will thereafter remain steady so long as the plate potentials keep constant. If there is any variation of voltage at the deflecting plates the light spot will move in sympathy and a very slow variation of voltage will be shown by a slowly moving

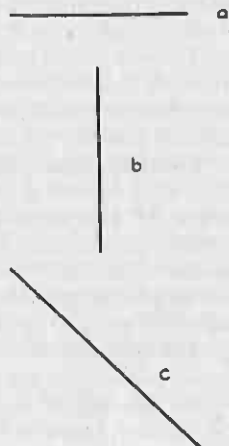

FIG. 126.—Showing the effect of applying periodic deflecting voltages, without time base:—
(a) Trace obtained when the voltage is applied to the X plates only.
(b) Trace obtained when the voltage is applied to the Y plates only.
(c) Trace obtained when the voltage is applied to both X and Y plates simultaneously.

the voltage under test is applied to the Y plates the position of the spot with reference to the Y axis will be a function of this voltage. In brief, horizontal movement represents time, vertical movement represents voltage variation, and the excursion of the spot over the

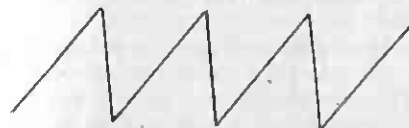

FIG. 127.—Saw-tooth waveform of voltage for X deflection as a function of time.

screen will actually "graph" the waveform of the voltage. As to how many cycles will show up will depend upon the ratio of the voltage frequency to the X sweep frequency, but we will return to this point presently.

In radio service-testing we are not normally concerned with transient waveforms and, therefore, do not want the X deflection to give just a single sweep across the screen. What is desirable is that a horizontal traverse shall occur at a uniform speed (usually from left to right), that the spot shall then fly back rapidly to the starting point and immediately start another left to right traverse at the same speed as before, and so on.

Remembering that X deflection depends upon the voltage applied to the X plates we can now see what kind of deflecting voltage is required. For the left-to-right traverse a voltage increasing in a linear manner will be necessary, and for the rapid right-to-left fly back a sudden drop of this voltage to the starting value will be required. In other words, we want an X deflecting voltage of saw-tooth waveform, as shown graphically in Fig. 127, and a "time base" circuit to produce such a voltage will be an essential part of the oscillograph.

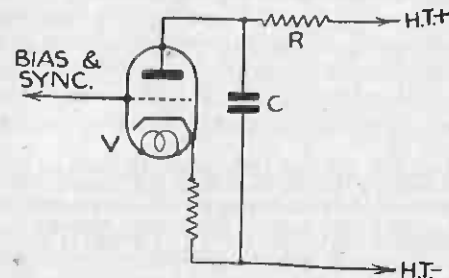
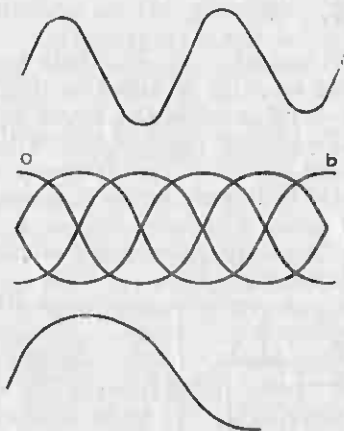

FIG. 128.—Simple circuit illustrating the principle of the time base.

Time Base Systems.—Quite a lot can be written about time base systems, but we will content ourselves here with the basic principle. Fig. 128 is a greatly simplified sketch of a time base circuit and will serve to illustrate the principle. A condenser, C, is connected in series with a resistance, R, across an H.T./D.C. source. Upon first switching on, the condenser will charge up and the voltage across it will rise at a rate governed by the values of both C and R. If it were not for the presence, across C, of the gas-filled triode V, the condenser would charge up to the voltage of the D.C. supply and further action

would cease. As matters stand, however, the condenser will charge up to the break-down voltage of V (the voltage at which the gas ionizes). The valve becomes conductive and the condenser will discharge through it, the condenser voltage dropping very rapidly to the extinguishing voltage of V. Then C will charge up again until the triode once more permits discharge, and so on.

There is a natural tendency with the simple arrangement of Fig. 128 for the condenser voltage, during the charging period, to rise exponentially, but it is very desirable that the voltage rise shall be linear.



FIGS. 129, 130, and 131.—Screen traces of an alternating voltage waveform for different ratios of A.C. frequency to the time base "sweep" frequency. The traces are appropriate to ratios of 2/1, 5/4 and 1/1 respectively.

particular test that is being made. With the simple arrangement of Fig. 128, variation of C or R will give speed control. As the light spot keeps repeating its left-to-right traverse we can speak of the "sweep frequency." Obviously, the speed of the traverse, and the sweep frequency are closely related.

It is to be understood that the fly back (right-to-left) sweep of the spot should be so fast as to render the return stroke invisible (or only faintly discernible). It is to be mentioned, however, that certain oscillographs have arrangements for modulating out the beam during the fly back sweeps.

A Waveform "Picture."—Any person handling CRO testing gear for the first time will be well advised to make some tests on an A.C. voltage derived from the mains (suitably stepped down). Such tests

If the striking voltage of the triode is kept well below the H.T. voltage the voltage rise will then be approximately linear, but another way of tackling the problem is to charge the condenser through a valve, generally a diode or a pentode, worked at saturation point. With suitable operating conditions the condenser voltage variation can be made to be a close approximation to the saw-tooth waveform, and can be utilised to give us the particular X deflection discussed above.

Flexibility of control is an important requirement with a CRO and it is very desirable that the speed of the left-to-right traverse shall be adjustable, according to needs of any

form useful preliminary practice in handling the apparatus and getting to know the scope of the controls of the oscillograph.

Suppose the time base voltage is in operation on the X plates at a frequency of 25 sweeps per second and that the A.C. test voltage is supplied to the Y plates at a frequency of 50 cycles per second. During each visible traverse of the spot it will be moved from left to right by the X deflection and will also be moved up and down by the voltage on the Y plates, the vertical deflection being in strict accordance with the Y voltage. The net result will be that the line trace made by the spot will mark out the waveform of the voltage on the Y plates and with the frequency values specified above two cycles will show up on the screen (see Fig. 129). If the time base is speeded up to 50 sweeps per second 1 cycle only will appear (see Fig. 131).

In both these cases the ratio of the "work" frequency (as we will now call the frequency of the voltage under test) to the sweep frequency is a whole number. The ratio of work to sweep frequency is 2/1 for Fig. 131, and 1/1 for Fig. 129. It is interesting to consider what will happen for work/sweep frequency ratios which are not whole numbers. If, starting with the conditions appropriate to Fig. 131 the time base is slowly speeded up it will be found that before the simple, single cycle "picture" of Fig. 131 appears the trace on the screen will pass through a succession of interlace patterns. An interlace pattern will appear whenever conditions are such that the light spot finishes the end of one sweep at a different point in the A.C. cycle to that at which it started the sweep. Then, naturally it will trace out, during the next sweep, a curve which appears on the screen in out-of-phase relationship to the first curve.

An example is shown in Fig. 130. Such an interlace pattern is not as crazy as it might appear at first sight. As a matter of fact the ratio of work to sweep frequency can be accurately determined by inspection of the pattern. The rule for determining the work/sweep frequency is simple. The ratio of work to sweep frequency is equal to the ratio of the number of peak amplitude points to the number of curves. In Fig. 130 there are 5 peak amplitude points (A and B together count as one) and 4 curves. Hence, the ratio of work to sweep frequency is 5/4.

Frequency Calibration.—From the foregoing it is easy to see that if the work frequency is known, the sweep frequency can be very readily ascertained. Conversely, if the sweep frequency is known the work frequency can be determined. With the CRO, therefore, it becomes a simple matter to determine the frequency of any L.F. voltage applied to the Y plates.

In normal radio fault tracing, or ganging work, the need to do this is not likely to arise, but since most service workshops contain audio-oscillators (even if they are only rough and ready "howlers") it is

worth noting that the CRO provides a delightfully simple means of calibrating an audio-oscillator in terms of cycles per second.

If the audio-oscillator's output is made to operate on the Y plates, and the ratio of work to sweep frequency determined, as described above, then, provided that the sweep frequency is known, it is a matter of simple calculation to determine the frequency of the Y voltage. The fact that the sweep frequency must be known, and known accurately, presents no difficulty, because this can be ascertained beforehand with the aid of the A.C. mains.

Locking the "Picture."—Any irregularities, or drift, in the operation of the time base are most undesirable in frequency calibration work, or when a waveform is being closely examined, and it is therefore important to have provision for synchronising.

In the case of a gas-filled triode the voltage at which the discharge occurs is very dependent upon the grid potential, and by applying an alternating voltage to the grid it becomes possible to synchronise the time base, and this A.C. voltage. It is customary, with servicing oscillographs to have switching, or terminal connections, enabling the time base to be synchronised either with the mains voltage or with any particular test voltage that is operating on the Y plates.

When the time base and the voltage on the Y plates are synchronised it is possible to lock the screen trace so that it does not wander, and thus a steady "picture" is obtained.

In frequency calibration work the time base should, of course, be kept synchronised with the A.C. mains throughout the tests since the mains frequency is the frequency standard upon which the calibration is based.

Obtaining H.F. Response Curves.—For radio service testing it is absolutely essential to have, in addition to the oscillograph itself, an accurately calibrated oscillator providing not only the normal amplitude modulated H.F. output but also, when required, an H.F. output that is "wobbled" by the time base of the oscillograph. The expressive word "wobulation" has been created to describe a variation of the oscillator frequency over a band of frequency values and in the manner described below.

For an H.F. response curve to be shown on the screen of the CRO we want, first, the frequency of the testing oscillator to vary in a linear manner during each sweep of the light spot. With the light spot at the commencement of a sweep the oscillator frequency must be so many Kcs. (according to the band-width covered) below the frequency corresponding to the tuning setting of the oscillator. Then, as the light spot moves across the screen, the oscillator frequency must come up to the tuning setting value, rise above it and, at the end of the sweep, be as many Kcs. above the tuning setting value as it was below at the commencement of the sweep. The next sweep must give a repetition of the foregoing, and so on.

Wobble.—Since the X deflecting voltage, from the time base, controls the horizontal traverse of the light spot, it should be obvious that, in some way, the X deflecting voltage must be made to bring about the required frequency variation (wobbling) of the oscillator. There are various ways in which this can be brought about. One commonly used method takes advantage of the fact that the input capacity of a triode is dependent upon the working amplification factor of the valve, this effect occurring as a result of the anode to grid feed back through the inter-electrode capacity. It is a simple matter to arrange that the input capacity of a triode shall form part of the capacity of the oscillator's tuned circuit. For "wobble" of the oscillator output the input capacity of the triode must vary with the sweep of the oscillograph. The input capacity changes with the effective amplification of the valve and this amplification depends upon grid bias, so it should be obvious that some connection between *Voltage* and *tuning* can be secured. Very careful design is, of course, necessary to secure the particular kind of frequency that is required, but as far as we are concerned at the moment it will be sufficient for us to appreciate that the "wobbling" of the oscillator H.F. output can be brought about by feeding the grid of the triode (or other type of valve connected as a triode) from the time base circuit.

Constant Amplitude.—The ordinary amplitude modulation of the oscillator is cut out of action while the oscillator is being "wobbled" and with a good outfit the output of the oscillator will be constant in amplitude but varying in frequency in the manner described.

It is important to understand that the X deflection of the oscillograph must now be looked upon not so much as being a function of time as a function of frequency. The X axis of the screen must, in other words, be regarded as a frequency base.

For obtaining the "picture" of an H.F. response curve it will be necessary that a direct voltage act on the Y plates and that this voltage shall vary with the amplitude of oscillations in the circuits under test. As regards receiver testing the receiver itself contains the necessary item for the production of the direct voltage. We refer to the receiver's detector. In radio service testing, therefore, the Y deflection is operated by the rectified output of the detector. The trace on the screen will be a graph of the detector output volts against frequency, over the range of H.F. values covered by the "wobulation."

The horizontal and vertical scales are to be regarded as linear scales, by the way—not logarithmic.

Fig. 132 shows a possible result that would be obtained from one or more H.F. circuits, plus the detector, in the case where the receiver has no band-pass couplings. Sometimes the curve will be inverted, as in Fig. 133. As to which way the curve will extend, up or down, on the screen will depend, first, upon the type of detector and the point from

which the Y voltage is taken, e.g., a Y input taken from a grid detector anode will give inversion with respect to the trace obtained if the Y input is taken from a diode anode. The question of inversion will also depend upon the use, or otherwise, of any stages of R.C.C. amplification between the receiver's detector and the Y plates, and upon the number of stages, if an amplifier is in use. The matter is not one of any very great concern to the service engineer because whatever the vertical sense of the "picture" on the screen it is of equal utility.

The service engineer is not so much concerned with absolute measurements as he is with comparative measurements. It is true that where such values as valve voltages and currents, component resistances, etc., are concerned, straight measurements form an ordinary testing procedure, but where such factors as receiver sensitivity, selectivity and quality of reproduction are concerned, the service engineer works in an atmosphere of comparisons.

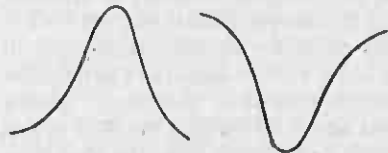

Figs. 132 and 133.—H.F. response curve inversion.

CRO apparatus enables the service engineer to see, instantly and exactly, what happens as a result of many possible component changes

or adjustments, and removes a great deal of the uncertainty that inevitably overhangs the work of anybody who has to service receivers without the aid of the cathode-ray. The very considerable removal of uncertainty is the outstanding feature of cathode-ray testing technique, and labels the CRO as essentially a time saver. To appreciate this time saving element of cathode-ray testing, one has only to consider that very common example of a service engineer trying to improve the selectivity of a receiver. Whatever adjustment or component repair that he may make, it is necessary for him to check up to find the extent of the improvement, if any. How will he do this? Suppose we say, by a reception test. This may seem a very proper way to make a check, but it is going to take time, even if it is only a matter of minutes. Minutes are precious in service work, and it may well happen that a succession of such reception checks are required, in which case the time involved will mount up considerably. With CRO apparatus, however, an H.F. response curve check will give all the information that is wanted, and the occurrence of any change in selectivity will be instantly apparent, and without the least uncertainty.

CRO apparatus for service testing consists essentially of two instruments, the oscillograph and the oscillator, the latter being of the special type previously referred to. The oscillograph will contain a time base and one, or perhaps two, R.C.C. amplifiers, the latter being designed for linear amplification over a wide range of frequencies. For normal

service test requirements one amplifier will usually be found to be sufficient, this being used to amplify the Y deflecting voltage in the cases where insufficient deflection would be obtained without amplification.

As regards the controls on the oscillograph, that are to be considered as most usual these are:

Sweep frequency control (generally coarse and fine adjustments are provided).

Amplifier gain control.

Synchronising control.

Focusing control.

Sweep amplitude control.

Shift control (It is very convenient to have means of shifting the screen "picture" up or down, particularly when H.F. response curves are being obtained).

It is to be understood, of course, that the time base can be switched in or out, as required.

Most receiver servicing tests are carried out with the time base in action, the Y deflection being controlled by signals picked up at various alternative points in the receiver. It is to be mentioned that one side of both the X and Y deflecting systems are normally "tied down" in potential, and that the deflecting voltages are applied between the "free" X plate and E, or the "free" Y plate and E. Thus, with the time base switched on for X deflection, the Y deflecting voltage can be picked up from the receiver with the aid of one test prod. The amount of information that can be gathered by a run round with this one test prod is usually a source of surprise to people not previously familiar with cathode-ray testing technique.

The CRO as Output Meter.—When straightforward peak signal trimming adjustments are being made the oscillator can be used on amplitude modulation, and the CRO employed as an output meter.

Assuming that receiver, oscillator and CRO are all earthed, all that will be necessary will be to take the Y lead to the anode of the output valve. With push-pull, or Class "B" output, the Y lead can be taken to either of the two anodes. It will usually be desirable to have the CRO'S amplifier in use between receiver and Y, and the gain should be adjusted to give maximum sensitivity of indication (consistent with the trace not running off the screen vertically).

If the time base is switched on, the trace will be that of an A.C. waveform (due to the audio frequency modulation of the oscillator), the Y deflection being controlled by the potential variations at the output valve anode. Trimming adjustments will have the effect of causing the screen "picture" to expand or contract vertically, and a peak adjustment is indicated by maximum vertical distance between positive and negative peaks. Alternatively, the time base could be switched out, in which case the Y deflection will produce a simple

vertical straight line trace, and trimming may be adjusted to give the maximum length of line.

Ganging.—As an aid towards the re-ganging of receivers in general, and of modern type, the CRO and associated oscillator, must be regarded as virtually a necessity if speed, with certainty, is to characterise the work.

In the simple case of a receiver having no pretensions to band-pass characteristics, and where all trimmer settings will be of the peak type, the CRO may usefully be employed as an output meter, as described above. Perhaps in connection with such a simple case, one could say that simpler gear than CRO apparatus would be quite satisfactory, but it must be remembered that the CRO provides the means of checking up on H.F. response curves. This is a valuable attribute, even where a "straight three" receiver is concerned.

It is with the receiver containing band-pass couplings that the CRO really shines as a trouble remover, and a time saver.

In such a case a considerable amount of the adjusting will be done with reference to H.F. response curves. The procedure is easy to follow, and such precautions are as necessary are not at all complicated. We will deal with the latter first.

The A.V.C. should be kept cut out while all the trimming is being done. (Disconnect A.V.C. feed lines from A.V.C. detector and earth them to chassis). It is important to realise that the action of A.V.C. can lead to false response curves appearing on the screen. The reason for this is that although the trace on the screen represents a graph of detector output volts against frequency, the conditions under which any particular response curve is produced are artificial, and differ in one important respect from the conditions of actual radio reception. In actual radio reception carrier and sideband frequencies are present simultaneously, but with a "wobbled" H.F. input the frequencies covered by the base of the response curve are passed through by the oscillator in succession, and at a certain rate. Referring to Fig. 134 the oscillator will attain the frequency F1 before it reaches the frequency F2. If the rise of H.F. amplitude exceeds the A.V.C. delay voltage the A.V.C. diode will commence to rectify. The A.V.C. feed line to the controlled valves has, however, a certain time constant, and in view of the consequent "sluggishness" of the A.V.C. bias variation, it should be easy to appreciate that although the H.F. response of the receiver under reception conditions might correspond to a symmetrical curve such as that of Fig. 131, yet, under "wobulation" conditions, the trace shown on the screen could be rendered lop-sided by the effect of A.V.C.

The idea of keeping the test signal well down in amplitude, so that the delay voltage keeps the A.V.C. out of action, may suggest itself to the reader, as an alternative to cutting out the A.V.C. by circuit modification, but while this is satisfactory enough for quick check test

purposes it is not to be advised when actual ganging work is being done. When making trimmer adjustments with an H.F. response curve as guide it is desirable to have a reasonably big "picture" on the screen, and this makes a very low amplitude of input unsuitable. At the same time care must be taken that valve overloading is not permitted as this, again, would give distortion of the trace. Using the CRO amplifier in front of the Y plate with the gain well up will make it easier to get a good size of trace, without overloading of the receiver valves.

Another precaution concerns the frequency at which the time base is run while H.F. response curves are being taken. This should not be too high and, as a general rule, 25 sweeps per second can be considered as satisfactory.

The procedure for ganging follows the usual practice as regards the sequence of the adjustments. With a superhet, for instance, the I.F. trimming should be done first.

When adjusting band-pass I.F. stages for satisfactory response the Y amplifier lead should be taken from the detector. If this is a diode

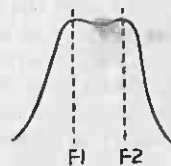
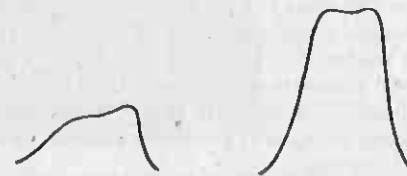

FIG. 134.—Illustrating the effect of A.V.C. on the tube.



FIGS. 135 and 136.—On the left is seen the effect of heavy damping on an I.F. circuit, and on the right how it appears when the damping is removed.

the high potential end of the diode load resistance will be the proper test point.

Where grid detectors are concerned one most frequently finds a resistance anode load in modern receivers, but should the case be met where L.F. transformer coupling is used between the detector and the succeeding valve the anode circuit should be temporarily modified to have a resistance load while an H.F. response curve is being taken; otherwise the reactance component of the primary impedance will tend to produce a false shape of curve. Use the detector anode as a test point.

If a receiver contains three I.F. transformers the I.F. test signal ("wobbled") should be applied to the grid of the first I.F. valve, and the combined response curve of Nos. 2 and 3 transformers got right first. Then the test oscillator input can be shifted back to the frequency changer grid, and No. 1 transformer adjusted to give satisfactory response of the I.F. section of the receiver, as a whole. During I.F.

aligning work the receiver's oscillator should, of course, be kept out of action.

When band-pass circuit adjustments are tackled with the aid of an output meter indication only, it is particularly easy to land up with a pseudo band-pass response that is, in reality, a double peaked curve obtained by mis-tuning. There is little risk of doing this with a CRO response curve indication if a careful eye is kept on the changes of response curve shape with each trimmer adjustment. The CRO user scores heavily over his less fortunate technical brethren in the respect that the former is able to see *instantly* what effect any particular band-pass trimmer adjustment is having.

After the I.F. stages of a superhet have been correctly aligned the oscillator trimming and padding can be attended to, using the CRO as output meter. Then the signal frequency circuits should be aligned, and if there are any band-pass couplings involved, the adjustments should be done against a receiver over-all H.F. response curve, using a "wobbled" test signal. In any case, a final check should be made of the over-all H.F. response curve.

The fact that H.F. response traces can be obtained makes the CRO an extremely useful device as an aid to the location of faults. As many of our readers will be able to testify, the locating of a fault frequently takes far more time than the actual rectifying of the fault, once it has been found. Particularly is this liable to be the case when the fault is associated with an H.F. circuit and affects the selectivity or sensitivity of the receiver.

Considering the H.F. section of a receiver it will be appreciated that no fault can develop affecting selectivity, or sensitivity, without in some way "making its mark" on the H.F. response curve.

Figs. 135 and 136 illustrate a case in point. A superhet gave weak reception. Results were so poor on all wavebands that it became a matter of immediate interest to find out what the I.F. stages had to say for themselves. A response curve check on the I.F. section of the receiver gave the result of Fig. 135. This curve showed definitely that there was trouble in the I.F. section; moreover, its shape and size suggested the presence of excessive H.F. damping. Fig. 136 shows the effect of clearing the fault (a resistance leak through an I.F. trimmer).

Time in locating intermittent H.F. faults can very often be saved by obtaining an H.F. response curve and watching to see exactly what happens to it when the fault occurs. To quote an example: A superhet developed an intermittent signal fluctuation on one waveband. A "wobbled" test signal was applied, and a watch kept upon the over-all H.F. response curve. It was observed that when the signal fluctuation occurred it was associated with a sideways jump of the response curve. A sideways movement of an H.F. response curve indicates one of two possible happenings, either a change of applied signal tuning, or a

change of receiver oscillator frequency. In the case under consideration, the first possibility could be ruled out so it became obvious that the fault, whatever it might be, was causing the receiver oscillator frequency to shift. This information made the tracing of the fault a comparatively simple matter, and a certain padding condenser was very soon on the scrap heap.

In the case of a dead receiver, with no signal coming through, the common procedure of stage jumping can often be superseded by the

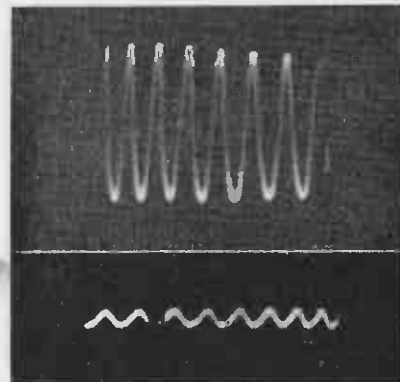

FIG. 137 (top).—"Looking" at the signal at the anode of the output valve, and in FIG. 138 (bottom) at the grid of the output valve.

process of searching for the "lost" signal with the Y amplifier test lead of the CRO, with the time base switched on.

Within limitations it is even possible to probe around the H.F. section of a receiver, and to detect the presence of H.F. oscillations. The actual appearance of the screen "picture" produced by modulated high frequency will depend upon the time base frequency, and the type of oscillograph. With the usual servicing type of oscillograph, and a comparatively low time base frequency, the H.F. trace will appear as a blur of light shaped within an outline corresponding to the audio modulation of the H.F. We have used the word limitations in connection with this method of H.F. circuit testing. Obviously, the amplification provided by the Y amplifier will be the deciding factor as to how small an amplitude of H.F. will be the minimum that will show any signs on the CRO screen.

Figs. 137 to 140 reproduce the tracking of a modulated test signal, starting from the anode of the output valve of a superhet, and working

forward for a certain distance through the receiver. Fig. 137 was obtained from the anode of the output valve, and Fig. 138 from the grid of this valve. For Fig. 139 the Y amplifier lead was taken to the grid of the double diode triode which preceded the output valve. The amplitudes of the traces of Figs. 137 and 138 should not be compared with those of Figs. 139 and 140. The gain of the Y amplifier was kept well down for the traces of Figs. 137 and 138 but was brought up for the remainder of the tests.

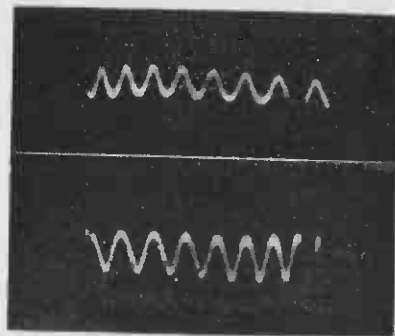

FIG. 139 (top).—The signal at the grid of a double-diode-triode. FIG. 140 (bottom).—The signal at the detector diode anode. The decrease of amplitude of Fig. 140, with respect to Fig. 139, is due to loss in the resistance-capacity network between diode and grid.

Performance over a Waveband.—If an over-all H.F. response curve of a receiver is taken on a "wobbled" test signal at one end of a waveband, and the receiver tuning control is turned, the curve on the screen will shift along towards the edge of the screen (and disappear if the receiver tuning is altered too much). By a corresponding change of test oscillator tuning the "picture" can be pulled back in position. It should be obvious that by appropriate changes of both receiver and test oscillator tuning the H.F. sensitivity and selectivity of the receiver can be studied at every point over the whole waveband. The test oscillator output amplitude should be constant.

Receiver Comparisons.—By arranging a convenient form of change-over switching for the test oscillator output, and the Y amplifier input leads, the relative performances of two receivers can be very readily determined. The use of over-all H.F. response curve indications will give

all the information that is required as regards comparisons between the H.F. sensitivity and selectivity of the two receivers.

To allow for overall sensitivity, the CRO could be used as an output meter. If it becomes necessary to compare L.F. gains only, then an audio test voltage could be applied to the appropriate points of the two receivers.

It is hoped that readers who have not yet used CRO apparatus will have gathered some idea from the foregoing of the versatility of the CRO



FIG. 141.



FIG. 142.



FIG. 143.

The CRO as a faults "tell-tale" when used as an output meter.

FIG. 141.—A signal trace taken from No. 1 anode of a Class B output valve. All well. FIG. 142.—What happens at No. 1 anode with a high resistance in No. 2 anode circuit. FIG. 143.—The effect at No. 1 anode of a break in No. 2 anode circuit. These curves represent potential variations, not current.

from the servicing point of view, even when it is associated with no more than a "wobbulator oscillator."

There are many test applications that must suggest themselves to the reader who understands the principles of the CRO. Obvious possibilities associated with the waveform obtained on an output meter

test will come to mind. Figs. 141, 142 and 143 are given just to emphasise the fact that even when the CRO is acting as an output meter it is still a fault "tell-tale." The reader will no doubt consider the idea of a study of output waveform giving a clue as to the type of any distortion that may be caused by a fault, although it is to be remembered that the ear of an experienced man will take some beating when it comes to a matter of drawing a quick distinction between one form of distortion and another.

of a square of linen or fine rag, as in Fig. 122, and pour sufficient of the staining polish (which should be made up as described on page 163) on to the wool so as to damp it right through. Screw the rag round the wool so as to make a tight pad, as in Fig. 123, with a smooth polishing surface. Slight pressure of the fingers on the sides of the pad should cause some of the polish to ooze through the linen.

Apply the polish in circular motions as indicated in Fig. 124, with a gentle but firm pressure, taking care to cover every portion of the surface with a layer of polish. If more polish is required, never pour it on to the rag, but undo the pad and add polish to the cotton wool. If the pad sticks to the surface being polished, apply a spot of linseed oil

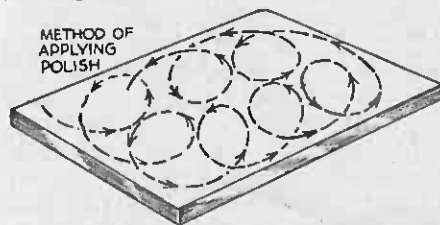

FIG. 124.—Always apply the polish with circular movements, and do not stop in the middle of a piece of work.

to the actual polishing surface of the pad. On no account add more than one spot unless the surface is extremely large. This will prevent the pad sticking as the polish hardens. When the first application has dried thoroughly, rub it over very lightly with extra-fine sandpaper, working the way of the grain as before, and then apply another layer of polish, but using, this time, a slightly drier pad, and working in very small circles. Work up and down the surface in these small circles and, at the end of each line, draw the pad very lightly across the newly-polished surface in the direction of the grain.

If it is found that the surface is patchy when dry, i.e., polished in some places, but with dull patches here and there, the surface must be lightly sandpapered once more and the above procedure repeated again, until, finally, a highly polished surface is obtained. Practice, of course, makes a great deal of difference to the ease with which a cabinet may be completely re-polished.

Finally, there are one or two hints that may save time and patience, viz., never attempt polishing except in a dry atmosphere; always see that the pad is clean and smooth and, above all, never go over a polished surface until it has become quite hard. It is not the amount of polish, nor the pressure, that produces a good surface, simply the continued rubbing. Speed does not matter, but rather an even steady circular movement with even pressure.

Cabinet Scratch Remover.—A useful scratch remover has been produced by Messrs. Holiday & Hemmerdinger. This is in the form of a tube with a small felt "wick" at the end, and this is used as a brush with which the liquid contained in the tube may be applied, and at the other end of the tube is a stain for application when the colouring of the cabinet has been removed. The price is 2s., and on test the apparatus works most effectively on cabinets of all types.

SERVICING WITH THE CATHODE-RAY TUBE

FOR service-bench testing the cathode-ray oscillograph is rapidly coming into its own. Many service establishments have cathode-ray apparatus, but there are still many which have yet to take up cathode-ray testing technique. It can be prophesied, however, that in the natural course of the evolution which is going on it will only be a matter of time before the cathode-ray oscillograph becomes as commonplace as any other of the testing instruments which are now regarded as essential for speedy and efficient servicing.

Of all the indicating instruments that human ingenuity has devised the cathode-ray oscillograph is probably the most versatile, although many of its applications necessitate the use of apparatus additional to the oscillograph itself. In some cases elaborate set-ups are required.

There must be many of our readers who are interested in the radio servicing possibilities of the oscillograph when used, at the most, with an oscillator of suitable type, and this Chapter has been written for their especial benefit.

Electron Beam Deflection.—Various types of C.R. tubes are employed in servicing oscillographs; some are of the gas-focused type, others of the high-vacuum, electron lens-focused type. There are differences of screen sizes, differences in the visual and photographic properties of the screen traces, etc., but a feature that they have in common is the provision of two sets of deflector plates (in the simplest case, two pairs of plates) mutually at right angles and so arranged that the beam of electrons shot from the gun (anode) on to the fluorescent screen passes through both sets of plates. The electric field produced by the application of a potential difference to one set of plates deflects the electron beam in a direction perpendicular to the surfaces of these plates and to an extent proportional to the value of the applied voltage. Certain oscillographs also contain coils external to the tube assembly but capable of causing deflection of the beam by the magnetic field set up by currents in the coils.

It is normally arranged that the deflecting force of one set of plates tends to move the light spot horizontally across the screen and these particular plates are invariably referred to as the X plates. The other set of plates tend to move the light spot vertically, and are called the Y plates (see Fig. 125).

If deflecting voltages are applied to both sets of plates simultaneously the light spot will be moved in a direction somewhere between

mains in respect of modulation hum, it may be necessary to include a high-frequency choke in each mains lead to the set, each choke being by-passed to earth by a condenser of, say, .01 mfd. should this be found necessary. It is very important that the insulation of these

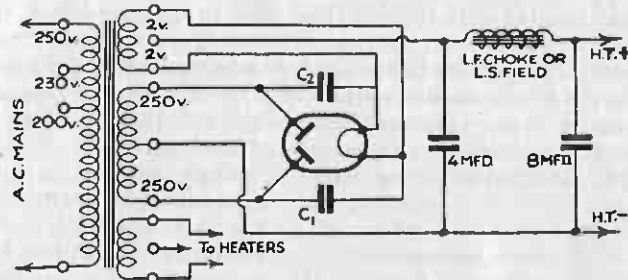

FIG. 146.—Two "buffer" condensers may be joined to the anodes of a full-wave rectifying valve to remove modulation hum.

chokes and condensers be of a high order to withstand the mains voltage and, of course, the H.F. chokes must be capable of carrying the full load current of the receiver.

Inside the Set.—Next for consideration are those causes of hum which are to be found in the receiver itself—in most cases definite faults in individual components or in portions of the wiring. In nearly every case the trouble will be found either in the mains circuits, that is to say, the power pack or battery eliminator, or in the low-frequency section of the receiver, and these two portions of the set should be tested in sequence, working backwards from the mains transformer.

Sometimes hum assumes serious proportions simply because the power unit, designed as a full-wave rectifier, is operating actually only as half-wave rectifier, with the result that the normal smoothing, adequate for full-wave rectification, is now insufficient. Various faults could result in one half of the rectifier section becoming inoperative—for example, a disconnection in one half of the H.T. secondary winding, or a bad or broken connection at one of the rectifier anodes, either in the valve or on the holder or in its wiring (see Fig. 147). Another cause of

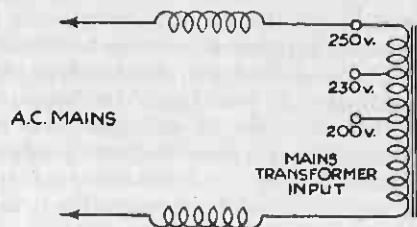

FIG. 148a.—H.F. chokes (of correct design) may be advantageously included in each main lead.

excessive hum is an incorrect centre-tap on the H.T. secondary of the mains transformer. Any of these faults can be discovered by measuring the voltage between H.T. negative and each of the rectifier anodes with an A.C. voltmeter. The two readings should, of course, be practically

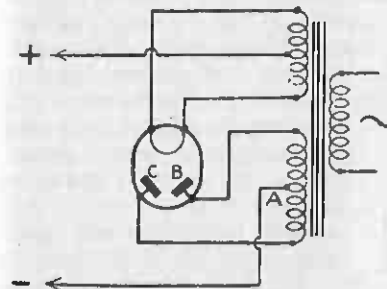

FIG. 147.—Any disconnection or poor contact between A and B or A and C will produce hum as the mains unit will be working as a half-wave rectifier. Test voltages between A and B and A and C with an A.C. voltmeter. Readings should be the same.

identical. It should also be noted that abnormal hum may be due to the absence of an earth connection to the core of the transformer or to the smoothing choke, or to this connection making poor contact.

The next section of the receiver which may be the seat of hum is the high-tension smoothing circuit. A complete or even partial short circuit in the smoothing choke may be the trouble and can usually be traced by measuring the D.C. resistance of

the choke. This will immediately reveal a dead short (indicated by practically zero resistance) but unless the original resistance is known it is not always easy to discover whether a partial short exists, and substitution by a choke known to be intact is the best test.

Condenser Tests.—Faults in the smoothing condensers can usually be discovered best by substitution, and for this purpose any 4 mfd. condenser of suitable voltage rating may be connected first in parallel

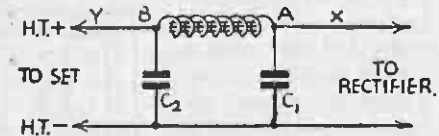

FIG. 148.—Short or partial short between A and B will result in hum. Also a disconnection or short circuit in C₁ or C₂. In the latter case current at X will be greater than at Y.

with each smoothing condenser in turn. A marked decrease in the amount of hum suggests an open circuit or low capacity in the condenser under test. If this test, applied in turn to each smoothing condenser, does not reveal the fault, it is possible that there is a leakage in one of the condensers, and each should be removed in turn and substituted by a known good condenser (see Fig. 148). A leaky condenser can also be detected by measuring the total rectified current in the lead between the rectifier cathode and the first smoothing condenser, and comparing it with the total H.T. current in the lead between the final smoothing choke and the receiver.

An individual test on a condenser can be applied easily by

connecting an H.T. source momentarily to its terminals. After removing the H.T. source, the terminals of the condenser may be shorted by the blade of the screwdriver, when a substantial spark should occur, indicating that there is no leak in the condenser. A quantitative test on the

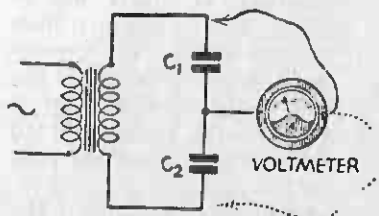

Fig. 149.—A rough test for the capacity of C_2 when C_1 is known. Measure volts across C_1 (V_1) and across C_2 (V_2). Then $C_2 = \frac{V_1}{V_2} \times C_1$.

capacity of a condenser is not so easy to arrange without special apparatus, but if an A.C. ammeter or milliammeter is available the following rough tests may be applied: a 4 mfd. condenser will pass approximately .25 amps. at 200 volts 50 cycles. Tests with other voltages, frequencies and capacities can be made, working on the formula that the current through a condenser is equal to

6.3 multiplied by the frequency, and then by the capacity in Farads and multiplied by the voltage. Another test is to connect the condenser under examination in series with another of known capacity, and the whole across an A.C. supply of known voltage, measuring then the voltage across each condenser, as indicated in Fig. 149. The capacity of the unknown condenser can be estimated roughly from the proportion of the total voltage appearing across it, or by the ratio of one value to the other.

If the smoothing circuit appears to be in order so far as the quality of the components is concerned, it may be worth while to ascertain whether a sufficiently low hum level can be obtained by increasing the capacity of the smoothing condensers. In many old sets condensers of only 2 mfd. or 4 mfd. were used, but to-day 4 mfd. and 8 mfd. are common values. Increased capacity up to a total of 16 mfd. for each condenser may result in improvement in respect of hum, but it is of no practical value to use greater capacities.

Other Possible Sources.—Here the trouble is most likely to be due to a disconnection in a grid bias by-pass condenser, or a grid decoupling condenser, although there are other parts which should be given attention. The best method is to test stage by stage from the output end

of the receiver, by silencing all the previous stages. Commence operations by connecting grid of the output valve to chassis via a condenser of from .01 to 1.0 mfd. capacity. This will ensure that no signal from any other part of the circuit will reach the valve. If the hum persists it probably arises from a breakdown in the bias by-pass condenser, or, of course, it may be due to insufficiently smoothed supply to the field of an energised moving-coil speaker. If, however, the hum ceases when the output valve grid is shorted to chassis in this way, the source of the hum must be sought further back in the set, by disconnecting the grid short-circuiting condenser and re-connecting it between the grid of the previous valve and chassis. If the hum continues, a faulty bias by-pass

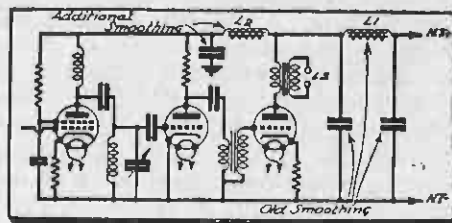

Fig. 150.—Additional smoothing may be provided for the H.F. and detector stages as shown here.

of the receiver, by silencing all the previous stages. Commence operations by connecting grid of the output valve to chassis via a condenser of from .01 to 1.0 mfd. capacity. This will ensure that no signal from any other part of the circuit will reach the valve. If the hum persists it probably arises from a breakdown in the bias by-pass condenser, or, of course, it may be due to insufficiently smoothed supply to the field of an energised moving-coil speaker. If, however, the hum ceases when the output valve grid is shorted to chassis in this way, the source of the hum must be sought further back in the set, by disconnecting the grid short-circuiting condenser and re-connecting it between the grid of the previous valve and chassis. If the hum continues, a faulty bias by-pass

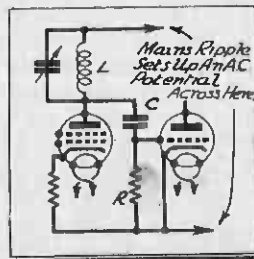

Fig. 151.—The coupling condenser is in series with the choke and leak across H.T.

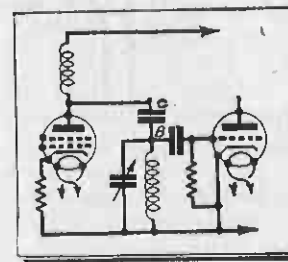

Fig. 152.—Where a tuned-grid coupling is employed this also is across H.T. as shown here.

or decoupling condenser should be looked for, or a faulty anode decoupling condenser, or even a defective grid leak. Gradually, by working back in this way, the trouble will be isolated to one stage, and all likely spots in that region can be examined. In the detector stage, for example, an open circuit in a grid leak, direct pick-up from the heater circuit by grid leaks or diode detector wiring, can be suspected. If the hum is more noticeable on gramophone reproduction the layout of the pick-up leads should be examined to see whether there is undue risk of picking up from mains leads, and screened pick-up leads provided with the screening properly earthed.

In this connection all screened leads should be carefully examined at an early stage of the proceedings as a broken or poor earth connection to the screening is a prolific cause of hum. Other likely causes are a high resistance earth, a high resistance joint anywhere in the wiring, and bad earthing connections to condenser cases.

Another point which should be looked to is the condition of all indirectly-heated valves. Poor insulation between the heater and

cathode may appear after a valve has been in service for a long period and will inevitably result in excessive hum.

Hum and the S.G. Stage.—It is true to say that mains hum can be so reduced that it is definitely impossible to tell when the set is on and

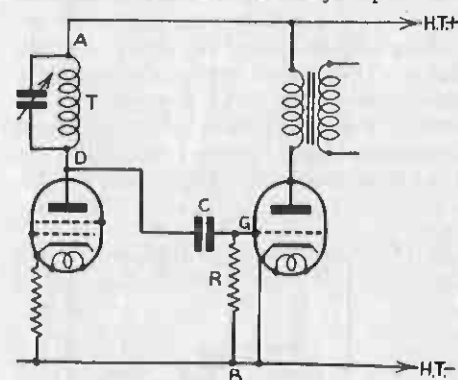

FIG. 153.—A standard tuned-anode circuit.

when it is switched off; such a state of perfection is difficult and costly to obtain, but a little attention will render a receiver silent to the extent that the ear must be placed against the loudspeaker to detect any trace of hum. The elimination of hum is not, as has already been explained, solely concerned with smoothing in the power pack; there are other

causes, and there are means whereby the efficiency of the mains smoothing apparatus can be raised to a high state of efficiency at a cost well below that which would be necessary if smoothing were accomplished by the sheer size of chokes and condensers.

The main smoothing choke must, necessarily, possess a moderate inductance, as it will have to carry considerable current, and a choke

having a high inductance and current-carrying capacity would be too large for the average set. It is usual, therefore, to have a choke in the high-tension lead that is common to all valves and then to use another choke of high-inductance in the lead that carries the high-tension current to all the valves other than the power valve, and in this manner a most efficient smoothing unit can be obtained. This arrangement is shown at Fig. 150.

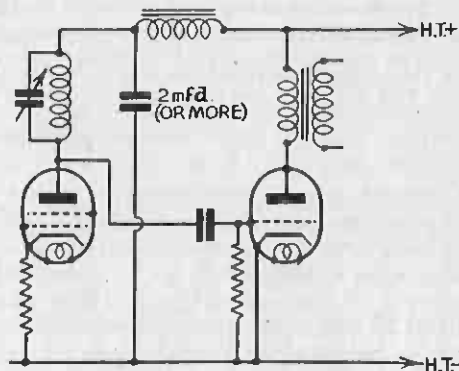

FIG. 154.—How the smoothing may be increased by including an L.F. choke.

One must not overlook the fact that smoothing is more important in the earlier stages, due to the fact that the following stages amplify it, and for this reason the screen-grid stage, or stages, should be most carefully designed to prevent even the least trace of hum creeping in.

Returning to the subject of mains hum in the screen-grid stage, let us turn our attention to tuned anode coupling which is often a serious cause of this trouble. A glance at Fig. 151 will show that the detector grid is connected to a point midway between a grid leak and condenser which are in turn connected between cathode and the high-tension supply, where there is sure to be a trace of mains ripple. If the condenser

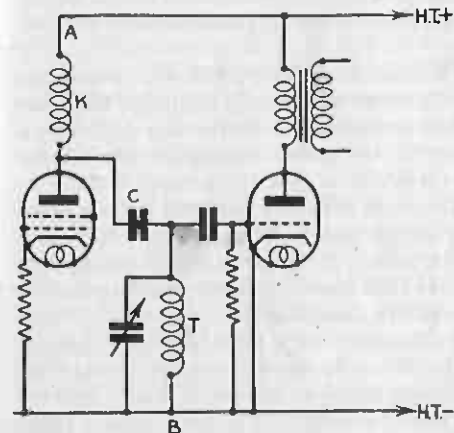

FIG. 155.—The tuned-grid circuit which overcomes the difficulties mentioned above.

were large, say, 1 mfd., the grid would have imposed upon it all the ripple in the high tension supply, since the A.C. voltage present (in the form of a ripple), would all be across the grid leak (the impedance of such a large condenser being small). In Fig. 151, however, the grid condenser is small, so the grid will be subjected to a somewhat lower voltage, but still be quite large enough to cause trouble. If reference is made to Fig. 152 it will be seen that the detector valve is connected across the tuned-grid coil, which is in series with the coupling capacitor "C." The impedance of the tuned grid coil at the mains frequency will only be a minute fraction of that of "C," consequently only a negligible portion of the A.C. ripple will be across the grid and cathode of the valve and no mains hum will be passed on to the detector from this source. The foregoing remarks clearly show that a bad hum might in certain circumstances be cured by changing the method of H.F. coupling, a procedure that is far from being as well known as it deserves to be.

An Unusual Defect.—Before going on to the question of modulation hum there is a small defect possible in the valve that may cause a form of mains hum that cannot be cured in any way save by replacement. This trouble is defective insulation between the cathode and the heater wire which it surrounds bringing cathode and heater into direct metallic connection, and this makes the valve behave as though it were not indirectly heated.

Modulation hum is not so common as it used to be owing to the modern mains transformer having a shield between primary and secondary, interposed for the sole purpose of stopping H.F. currents from flowing into the mains, which is the usual cause of this parasitic hum. As already explained, this type of interference only appears when a carrier wave is present, since it takes the form of a modulation of the low frequency on the carrier in just the same way that a low note would be imposed upon the carrier wave at the broadcasting station. It should be remembered that 50 cycles, the usual electric mains periodicity, is an audible frequency and is just over two octaves below middle C on the piano. If a loudspeaker were connected to the mains direct, through a suitable resistance, it would hum in just the same manner as if a receiver were used.

Another cause of modulation hum is A.C. ripple in the screen-grid lead which can again be cured by extra smoothing, although there are exceptions. A case was recently investigated where the A.C. ripple entered the S.G. valve by way of the screen condenser from stray currents flowing in the chassis, a truly curious happening.

Faint Hum Unavoidable.—The most carefully designed set will often give a faint trace of hum, after it has been attacked at all points, but even this can be cleaned up by a moving-coil having a hum-bucking coil, a device that feeds a little A.C. into the speech coil in opposite phase to the hum, so that the latter is exactly cancelled out.

Hum and the Tuned-Anode Coupling.—The tuned-anode coupling, or some modification of it, is still in use in many commercial and constructor-built receivers; furthermore many of the popular kit receivers use tuned-anode couplings, and there must be tens of thousands of these still in use. The advantages or disadvantages of tuned-anode couplings from a point of view of stage gain and selectivity is another story, and it is the intention in this chapter to discuss it from the aspect of introducing mains hum. The use of the tuned-anode coupling is probably the very last circuit detail that the constructor would blame for mains hum.

If the smoothing arrangements in the power pack are perfect, or very nearly so, all well and good, but if, as is usually the case, they are short of this ideal to a greater or lesser extent, the tuned-anode coupling will produce a surprising hum level compared to that obtainable with any other coupling. Fig. 153 shows a skeleton diagram of a tuned-anode H.F. stage followed by the conventional detector. Now any unsmoothed ripple will be in the form of a voltage ripple across the points A-B. The impedance of the tuned-anode coil T will be negligible to mains frequency, so the unsmoothed ripple in the H.T. voltage is in effect across the points D-B. The ripple voltage is therefore across D-B, and a proportion of it across the grid cathode of the detector valve G-B, in proportion to the resistance of the grid leak R and the impedance of

condenser C. This considerable proportion of the mains ripple being fed into the detector valve will be duly amplified by it and the succeeding L.F. stage or stages. The detector valve transformer coupled to the power valve might easily give an amplification of 200 or more times; thus it will be seen how necessary it is to keep hum out of the detector grid.

Tuned-Grid is Safe.—Except by gross carelessness mains hum is not, of course, introduced into the grid of the H.F. valve, as the grid circuit has no connection whatsoever with positive H.T. Where hum is present in a set using a tuned-anode coupling, it is a simple matter to note the amount of the prevailing hum caused by ripple getting through the tuned-anode coil by merely shorting the detector grid to cathode (or in the case of a battery set with eliminator to L.T.+). If this simple test shows that considerable hum is emanating from this source, two courses are open. One is to increase the smoothing in the ordinary way by inserting a choke and condenser as shown at Fig. 154, the reason for so positioning the choke being that the small anode current taken by the screen-grid valve permits a choke of fine gauge wire to be used, with consequently greater inductance for a given size or cost. The other cure is to change the coupling to tuned-grid. The reason why this modification eradicates the hum is particularly interesting, and an explanation is thought worth while. Fig. 155 shows the skeleton circuit of a tuned-grid stage followed by the conventional detector. As in Fig. 153 mains hum would appear as an A.C. ripple voltage across A-B, and in consequence will be across the choke K, the condenser C, and the tuned grid coil T, the three being considered in series. Now at mains ripple frequency the impedance of T is negligible compared with the impedance of C and K consequently for practical purposes all ripple voltage will be across C and K, the grid cathode circuit of the detector valve being tapped across the coil T, which, as mentioned above, has a negligible mains hum voltage developed across it, thus no appreciable hum is introduced into the detector grid, with a very considerable decrease in the overall mains hum of the receiver.

Hum in the Radiogram.—The average home-built radiogram has a disappointingly high hum level, whether built as a complete radiogram in the first place, or whether built by uniting a pick-up and gramophone motor with an existing chassis.

It should not be overlooked that where mains hum is exactly the same on gramophone and radio, it will appear that the mains hum is worse on the gramophone, due to the soft passages met with on gramophone records, which, dropping down to a volume level approaching that of the hum, naturally tend to accentuate the presence of the latter. Where the smoothing arrangements are such that the hum level, while being the same on radio and gramophone, is objectionable, the usual steps must be taken to increase the efficiency of the smoothing arrangement,

TRACING AND ELIMINATING HUM

OF all the possible defects in receiver performance, none is more annoying than hum, and although hum emanates from one source, the possible immediate causes are so numerous that tracking the seat of the trouble in any particular set is far from a simple task, particularly as it is likely that several factors will be found to be contributing to render the hum-level higher than is desirable or necessary.

Hum, of course, is always derived in the first place from the electricity mains—even in a battery-operated receiver—but the immediate causes are many and varied and can be briefly classified under four main heads: first, faulty receiver design and layout; second, maladjustment of circuits or components; third, faulty components or internal wiring; and fourth, external causes. It is obvious that if the design and layout of any set and its attendant wiring is such that undesirable coupling between signal circuits and the mains is avoided, and, in the case of a mains set or receiver using a battery eliminator, if adequate smoothing and decoupling circuits have been provided and are in good order, the final hum level should be very low. Any tests, therefore, for discovering the seat of excessive hum must be directed to checking all the above points in logical sequence.

Looking for Clues.—In the descriptions of the various tests to be applied, common errors in design and layout will be noted and, of course, the tests are calculated to reveal such errors as well as actual electrical and mechanical defects. However, when examining a receiver with the object of organising a hum hunt, it is as well first to make a preliminary observation of the smoothing circuit and of the general layout of the components and wiring in order to gauge the general standard of the receiver, and possibly to discover a clue as to likely trouble spots.

The next point is to examine the adjustment of any device included for reducing hum, such as a potentiometer across the filament winding of the mains transformer, the slider of which determines the centre-tap from which the cathode line of the set is taken.

If these obvious tests fail to effect a cure, it is next necessary to discover whether the trouble is due to defects within the receiver itself or to external causes, and the possibility of the latter should be eliminated first. The route of the aerial and earth leads should be traced back to discover whether either of these wires passes close to or runs parallel with electric light wiring—a very fruitful cause of hum. It should be

mentioned here that hum from this cause can occur in battery sets as well as mains sets, and if the receiver under examination is battery-driven, coupling between aerial and/or earth leads and the electric light circuits should be at once suspected. This type of trouble is most likely to occur if the aerial and earth leads are long or their route is straggly; if the aerial itself is of the indoor type, fixed to the picture rail, under floor-boards or in the loft; or if a considerable amount of temporary wiring or flexible leads for lamps and domestic appliances is employed. Another point which should be watched is the flexible wire connecting the receiver or battery eliminator to the mains. This should be kept as far away as possible from the aerial and earth wires.

A Tunable Effect.—A very large proportion of the hum due to

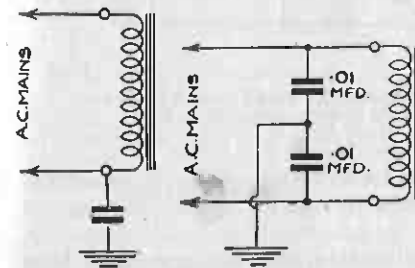

FIG. 144.—A condenser between earth and one side of the primary will prove very useful as a hum remover.

FIG. 145.—Two condensers connected across the primary winding, and the centre tap joined to earth.

external agencies in mains-operated sets if of the type known as "modulation hum" or "tunable hum," the latter name referring to the fact that its intensity is only serious when the set is tuned to certain definite wavelengths. It is due to the presence, in the mains supply, of certain radio frequencies which become modulated by the 50-cycle mains frequency. If the set is tuned to the radio frequencies present in the mains supply, only quite

a small amount of coupling between the mains and the radio-frequency circuits of the receiver is needed to result in amplification and rectification of the hum-modulated, mains-borne radio-frequency signals and the reproduction of a very considerable amount of hum in the loudspeaker. If tunable hum is discovered, one or another of the following schemes should effect a cure. A fixed condenser of from .0003 to .01 mfd. capacity may be connected either across the mains input to the receiver or from one side of the mains input to earth (see Figs. 144 and 145). By reversing the mains plug the correct side can be ascertained. The condensers employed should be of high quality, with mica insulation, and preferably of 1,000 volts test rating in order to avoid the slightest risk of a short circuit across the mains.

When the hum is tunable, that is to say, only occurs while tuned to a station, usually a powerful "local," it can be cured by connecting a .01 mfd. fixed condenser on each side of the rectifying valve filament, and the secondary "outers" (see Fig. 146).

In the case of D.C. mains, which are often very much worse than A.C.

manufacturer, damage often occurs in transit. This is particularly so in the case of inductance components, such as coils, transformers, and chokes, as the very fine wire used in these is easily damaged. As a general rule it is necessary only to test these components for continuity, as in nine cases out of ten the defect which occurs is a broken wire in one of the windings.

Transformers and Coils.—An easy method of testing transformer continuity is shown in Fig. 156. As indicated, the milliammeter should be connected in series with the transformer winding and a small battery. A cheap meter is suitable for this test, but readers who do not already possess a meter are advised to obtain a moving-coil instrument. These meters are more expensive than the moving-iron type, but are more reliable for general test work, and are therefore a good investment. The majority of L.F. transformers have a primary winding (P. to H.T.) resistance of approximately 500 ohms and a secondary winding (G to GB) resistance of approximately 1,500 ohms. If a milliammeter having a full-scale deflection of 10 mA. is used, a $4\frac{1}{2}$ -volt grid-bias battery will therefore be suitable for testing purposes. A definite kick of the meter needle when the battery plug is inserted will indicate that the winding is not broken. If it is desired to measure the actual resistance of the winding, Ohm's Law must be applied. For example, if a battery of $4\frac{1}{2}$ volts is used, and the meter registers 9 mA., it will indicate that the resistance of the winding is 500 ohms. Likewise a reading of 3 mA. with the same battery in use will indicate a winding resistance of 1,500 ohms. When making the preliminary test it will be advisable to use a lower voltage, say $1\frac{1}{2}$ volts, in order to avoid damage to the meter should the transformer winding resistance be very low. If an abnormally high current reading is obtained it will indicate that there are shorted turns in the transformer winding—this, by the way, is not an uncommon defect. Low-frequency chokes can be checked in the same way as transformers, but in the case of output chokes the resistance is sometimes as low as 200 ohms, and therefore care must be taken to use a low voltage for testing purposes.

Breaks in coil and high-frequency choke windings are often experienced, due in most cases to the wire attached to the terminal tags being twisted too tightly. As the resistance of coil windings is very low, however—between approximately 1 and 25 ohms in the case of medium- and long-wave windings—the method adopted for transformer testing cannot be used, as a sufficiently low voltage cannot be obtained. To test coil continuity it is therefore necessary to connect a resistance in series with the milliammeter, as shown for the condenser test in Fig. 157. If a 10 mA. meter and a $4\frac{1}{2}$ -volt battery are used, a one-watt resistance having a value of 1,000 ohms will be suitable. The resistance of the coil is negligible as compared with that of the extra resistance, and therefore a reading of approximately $4\frac{1}{2}$ mA. should be obtained. The exact

resistance of the winding cannot be measured by this simple means, of course, but the measurement of the D.C. resistance of a coil is not very important as the inductance is not entirely governed by the resistance. High-frequency chokes may be checked for continuity in exactly the same manner as coils, and as in the case of the coil winding the actual resistance cannot be measured accurately by a milliammeter. As mentioned before, however, the usual defect in coils and chokes is a broken winding and therefore a continuity test will suffice.

Condenser Tests.—Variable condensers work on the principle of one set of vanes moving in or out of a set of fixed vanes, with the air (or

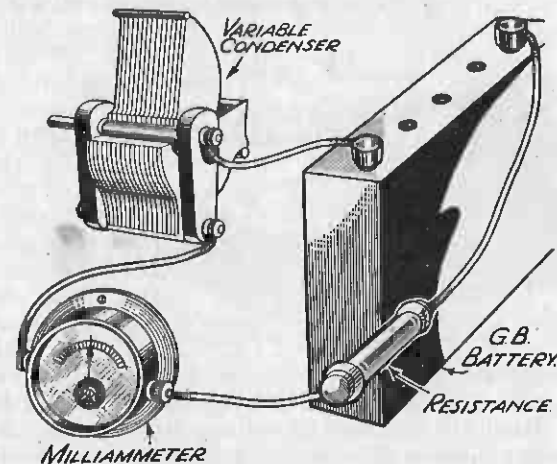

FIG. 157.—Testing a condenser for short circuits.

solid insulating material) in between the vanes acting as a dielectric. It is therefore essential that the vanes do not come in contact with each other. Owing to the close proximity of the fixed and moving vanes in the modern midget condensers it often happens that they touch each other at certain points during rotation. It is therefore advisable to test these components before assembling them. This can be done as shown in Fig. 157, using a milliammeter, a 1,000 ohms resistance, and a $4\frac{1}{2}$ -volt battery. If the condenser is in order a reading will not be registered, but if there is a short between the fixed and moving plates at any point a reading of $4\frac{1}{2}$ mA. will be obtained.

It is sometimes found, however, that fixed condensers are defective. These components are given an insulation test by the manufacturers, and are then given a working voltage rating of approximately half the test voltage. It is very important that the condenser should not be connected in a circuit where the voltage across its terminals exceeds the

working voltage specified by the manufacturers, and it is desirable in the interests of safety to choose a component having a slightly higher rating than the actual circuit voltage. Condensers having a capacity over .1 mfd. can be tested for leakage by the method shown in Fig. 158. A voltage approximately equal to the working voltage of the condenser should be connected momentarily across the condenser terminals. A leakage period of approximately three minutes should then be allowed before the screwdriver test is made. It will be noted that the screwdriver is rested on one terminal of the condenser, the end being then brought close to the other condenser terminal. If the component is in order a spark will occur, but if a spark does not take place a defective

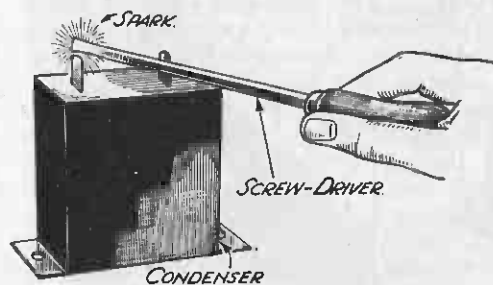

Fig. 158.—A method of testing high-capacity condensers.

condenser will be indicated. When conducting this test care should be taken to keep the hand clear of the metal portion of the screwdriver, otherwise an uncomfortable shock may be experienced, and it is also emphasised that if an electrolytic condenser is under test, the test voltage leads must be connected the right way round otherwise the component may be damaged. It is also possible to test condensers by means of a neon lamp and a source of voltage, the condenser being connected in series with the neon lamp and the D.C. supply leads. If the neon glows continuously it will indicate that the condenser is useless, but if the discharge flashes occur at intervals of one minute or more the component may be considered satisfactory.

To test low-capacity condensers of .001 mfd. or less it is advisable to use a pair of 'phones and a G.B. battery. The 'phones should be connected in series with the battery and the condenser to be tested. If a slight click is heard in the 'phones when the battery plug is inserted it will indicate that there is no break inside the condenser, but a very loud click will indicate a short circuit. If a slight click is also heard in the 'phones when the 'phone leads are connected across the condenser after the latter has been disconnected from the battery for two or three minutes, it will indicate that the condenser is capable of holding its charge. The simple tests outlined above will not enable the service-man to decide the exact capacity of a condenser, of course. A capacity bridge is necessary for this purpose, but as the instrument is rather expensive it is not always considered worth while for the average service-man. We would insist, however, that such an instrument be purchased.

Testing Resistances.—It is not often that a faulty resistance is found in a kit of parts, but it is as well to give these components a test before commencing constructional work. A milliammeter should be used for this purpose in conjunction with a battery, as shown in Fig. 159. Assuming that the value of the resistance is not even roughly known, a low voltage should be used for the preliminary test. By applying Ohm's Law the exact value of the component to be tested may be decided. For example, if a voltage of $1\frac{1}{2}$ volts is used and a reading of 10 mA. is obtained it will indicate that the resistance has a value of 150 ohms. Similarly, if a 6 mA. reading is obtained with a 60-volt battery in use, the resistance value will be 10,000 ohms.

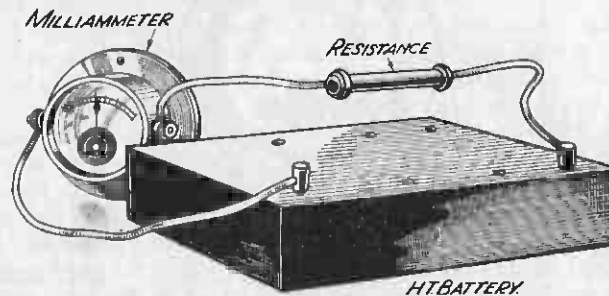

Fig. 159.—Checking the value of a fixed resistance.

Valve Tests.—It is very seldom that a new valve becomes defective before reaching the constructor, but as it is very important that valves be in perfect order, a means of testing them is very desirable. The simple method of checking filament continuity by means of a flashlamp bulb and battery, as often used by radio dealers, is quite inadequate, as a valve may register filament continuity and yet be useless.

The valve depends for its action on the fact that a heated wire shoots off electrons into space. In the case of the battery valve this wire constitutes the filament (the cathode in the case of the indirectly-heated valve).

This filament is heated by means of the L.T. accumulator, and free electrons are shot off into the valve vacuum. The filament is surrounded by a metal plate, known as the anode, to which a high positive voltage is applied. This plate attracts the electrons from the filament, thereby completing the plate-filament circuit, and allowing current to flow through the valve from H.T.+ to H.T.—. It is apparent, therefore, that the valve can only operate when the filament is capable of emitting electrons. After a valve has been in use a lengthy period the number of electrons shot off from the filament gradually falls, and then the valve is said to be losing its emission. In order to test the condition of a valve it is therefore necessary to measure the current passing through the

plate-filament circuit when a certain voltage is being applied to the plate and filament. This may be effected by means of a milliammeter, and service-men are advised to build the cheap tester shown in Fig. 160. The valve to be tested should be inserted in the holder, and the requisite L.T., G.B., and H.T. voltages connected across the respective terminals on the tester. The reading on the milliammeter should then be compared with the figures given on the valve manufacturer's leaflet.

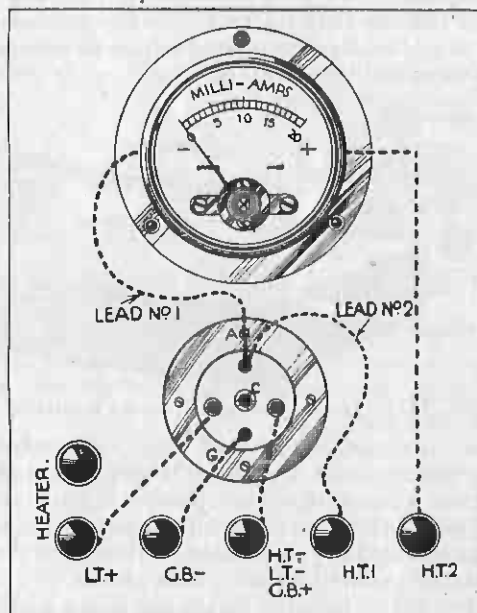

FIG. 160.—Wiring diagram of a simple valve tester.

When testing triodes, terminal H.T.1 should be left disconnected, this being only brought into use when testing S.G. or H.F. pentode valves. Lead marked No. 1 should then be transferred to the cap terminal, and H.T.1 terminal connected to the 60 or 80-volt socket of the H.T. battery. When testing five-pin directly-heated pentodes, the centre socket of the holder (marked C) should be connected to H.T.2 terminal. If an indirectly-heated valve is to be tested, the lead shown connected to H.T.—, G.B.—, and L.T.— should be transferred to the unused heater terminal, and a lead should be connected between the centre pin of the valve-holder and the H.T.— terminal. A large 4-volt accumulator (or the 4 volt 1 amp. winding of a mains transformer), connected across the heater terminals may then be used for L.T. supply.

After the components have been tested in accordance with the instructions given the assembly work may be completed and the receiver prepared for its preliminary test. In the first place, the H.T., L.T., and G.B. batteries should be given a rough voltage test, but it is emphasised that the actual voltage under working conditions can only be ascertained whilst the batteries are supplying the normal current requirements of the set. Nevertheless, it is advisable to give the batteries the suggested preliminary check as this provides a rough indication of the condition of the cells. If the H.T. battery registers less than 75 per cent of its rated maximum voltage, it should not be used, as apart from the fact that it will be inefficient as a voltage supplier, its internal resistance may be so high that it will cause instability in the receiver. This type of instability generally takes the form of a motor-boating noise. The L.T. cell should register two volts, and if the voltage is lower than this when the cell is not supplying current the necessity for a re-charge is indicated. It is emphasised, however, that the condition of a cell is better ascertained by means of a hydrometer than by a voltmeter. When the accumulator is fully charged the specific gravity as registered by the hydrometer should be approximately 1,210, and should not be allowed to drop below 1,170. The voltage should remain practically steady at 2 volts between these gravity limits.

Voltage Tests.—If the batteries are found to be in order, the battery leads from the receiver may be connected up and the voltage at the valve holder pins checked before the valves have been inserted. This will give the true voltage at these points unless there is a high resistance in the circuit between the valve-holder pin and the battery. In simple receivers where no decoupling resistances are used, a true voltage indication will therefore be obtained by this method, but in modern multi-valve sets decoupling resistances are generally connected in the anode circuits and therefore the readings obtained will be slightly erroneous, even if a reliable meter is used. This is an opportune moment to point out that it is very desirable to use a meter having a high "ohms per volt" constant—preferably 500 ohms per volt, or higher—as the error occurring when testing voltages in circuits possessing a high resistance is much lower when the resistance of the meter is high.

If a reading is not obtained when the voltmeter leads are prodded across the valve-holder filament pins, the receiver filament wires, the on-off switch, and the L.T. leads to the accumulator should be suspected. It is pointed out that lack of voltage may be due to a short circuit as well as to a break in the leads or at the switch. If the leads are in order a check for a short-circuit should therefore be made. This is often due to the L.T.— terminal of the on-off switch making contact with a metal or metallised chassis, or to twisted L.T. leads being frayed. The H.T. voltage should be measured by prodding the + and — leads of the meter across the anode pin of the valve-holder and H.T.— respectively; it

should be noted that the anode of the British type S.G. or H.F. pentode valve is connected to the top cap terminal, the normal anode pin of the valve being joined to the screening grid. If a reading is not obtained at the anode pin, the circuit between the pin and the H.T. + lead should be checked. If the wiring between these two points is in order, the components (H.F. choke, H.F. coil primary winding, L.F. transformer primary, or anode resistance) should be tested for a break; it is also pointed out that as in the case of the L.T. circuit, lack of voltage may be due to a short across the circuit. This generally occurs in a condenser, and therefore if a break cannot be located, the decoupling and by-pass condensers connected across the circuit should be tested.

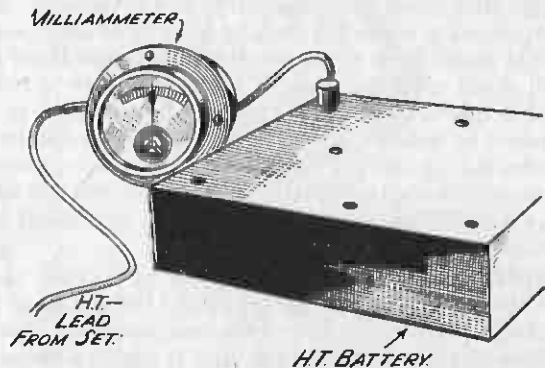

FIG. 161.—Checking total current consumption.

Current Tests.—After approximately correct voltage readings have been obtained at the valve-holder anode and screen pins, the valves may be inserted and the current consumption checked. The total consumption may be measured by connecting the milliammeter between the H.T. — socket of the battery and the H.T. — lead from the receiver, as shown in Fig. 161. When connected in this position the meter will register the total valve consumption plus the current taken by screen potentiometers connected between H.T.+ and H.T.—, and the current lost due to leakage across these two points. The individual valve consumption may roughly be checked by removing each valve in turn, commencing with the output valve; it should be noted that this test will only prove accurate if the batteries are in good condition. The current drop occurring as each valve is removed in turn will indicate the current consumption of the removed valve, of course. The reading registered after all the valves have been removed will indicate the current taken by the potentiometers, plus leakage. The actual current that should be taken by these potentiometers may be calculated by applying Ohm's Law—current equals voltage divided by resistance. If

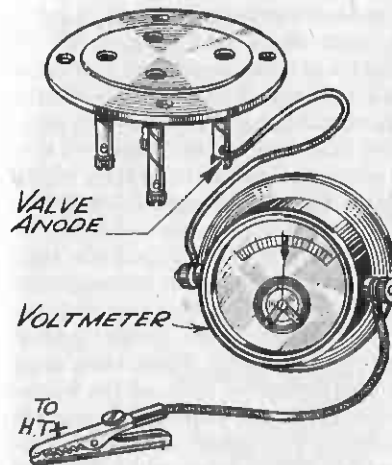

FIG. 162.—Showing a method of checking anode voltage.

the current registered by the meter exceeds that which should be taken by the potentiometers, a leakage across the H.T. battery will be indicated and therefore the aforementioned condenser tests must be conducted and the wiring also carefully re-checked. It is also possible to test the current consumption of the valves by connecting a milliammeter between the valve anode and the anode lead, as shown in Figs. 162 and 163. This, by the way, is the more accurate method of the two, but is the more difficult to conduct.

Class B and Q.P.P. Stages.—

When a pentode or a triode valve is used in the output stage, the current consumption should remain constant, irrespective of the volume of the received station. When a Q.P.P. or a Class B output stage is used, however, the current consumption varies with the volume, and therefore the quiescent consumption of the valves should be measured when no signals are being received. The consumption is of course much higher when a strong signal is being received and, therefore, the actual consumption may be decided approximately by taking the mean of the maximum peak current and the quiescent current.

Summary.—Low voltage readings may be due to run-down H.T. battery or to a high resistance in the anode or screen circuits. High voltage readings, on the other hand, will be due to the anode resistances having a

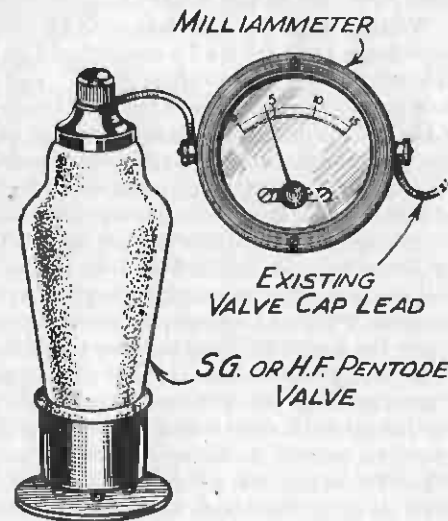

FIG. 163.—Checking the current consumption of an S.G. valve.

value below that specified. High current consumption will indicate that the bias voltage is too low, that there is a leakage across the H.T. circuit, or that excessive voltage is being applied to the valve anodes or screens. Low current consumption indicates the use of a run-down H.T. battery or to the application of excessive G.B. voltage.

It is emphasised that the foregoing instructions apply only to sets supplied from H.T. batteries. If an eliminator is used the tests which will be suggested for mains receivers in the next paragraph should be made.

Mains Sets.—In preceding pages it was pointed out that the tests described were not, in all cases, applicable to mains-operated receivers. It was suggested that voltage tests could be made before inserting the valves in their respective sockets, and that the anode current passed could be measured by removing each valve in turn. These tests must not be applied to mains sets, as removal of one or more of the valves while the mains unit is on may cause damage to condensers connected across the output circuit of the rectifier, or to the rectifier itself. This rule also applies to receivers employing battery type valves supplied from an eliminator. In receivers of this type it is therefore advisable to fit a fuse in the input circuit so that components will be safeguarded if there happens to be a short circuit across the receiver wiring. This fuse should have a current rating slightly higher than the normal current consumption of the set, so that the current surge which occurs when switching on can safely be handled.

Voltage Tests on A.C. Sets.—As in the case of the battery type of set voltage tests should be conducted first. If the receiver is supplied from an A.C. source of supply an A.C. and a D.C. meter should be used in order to make a thorough check of the voltages. Most modern valves of the A.C. type require a heater voltage of 4 volts; this may be measured by prodding an A.C. voltmeter across the heater terminals of the valve-holders. It is very desirable to keep the heater voltage within 5 per cent of the specified value if good results are to be obtained. Should the voltage not fall within the 4-volt limit the mains transformer should be inspected. It will have been noticed that transformers have voltage and current ratings marked on their terminal strips—for example, 4 volts at 5 amps. It is necessary to connect the correct load across the heater winding in order to obtain the correct output voltage. In the case quoted above, five 4-volt 1 amp. valves may be fed from the 5-amp. winding. If only one or two valves were used, the load would be too low and, in most cases, the voltage applied to the heater circuit would be excessive. In such cases a dissipating resistance should be connected across the winding (calculated by applying Ohm's Law) in order fully to load the winding. Another cause of incorrect heater voltage is the use of the wrong input socket on the mains transformer. If the voltage of the mains does not exactly coincide with any of the

markings on the transformer, a socket having the next higher voltage marking should be used: for example, if the supply is 235 volts and the transformer is marked 200, 220, and 240, the 240-volt socket should be used. The use of the 220 socket in this case would cause excessive voltage to be applied to the heater circuit. Lack of voltage across the valve heater pins may be due to a break in the leads between the heater winding of the transformer and the valve pins, a break in the heater winding, or a break in the primary winding of the transformer; it is assumed, of course, that the input fuse is in order.

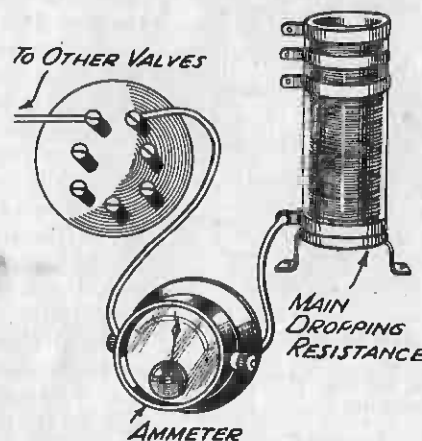

FIG. 104.—Measuring the heater current in A.C./D.C. receiver.

The A.C. meter may then be used to measure the voltage across the H.T. secondary winding of the transformer, in order to ascertain whether the correct voltage is being applied to the rectifier. Lack of voltage at this point may be due to a break in the leads from the transformer, or to a break in the primary or the secondary winding of the transformer. A dead short circuit across the winding would also cause lack of voltage, but this fault does not often occur. Low voltage at this point may be due to shorted turns in the transformer secondary, and high voltage may be due to shorted turns in the primary winding. After ascertaining that the A.C. voltages are in order, the D.C. meter may be used to test the voltages on the anodes and the screens of the valves. It is essential for the meter to have a high internal resistance if accurate readings are to be obtained, especially in the case of valve screens. If the receiver chassis cannot conveniently be removed, the voltages may be measured from the top of the chassis by slightly lifting the valves so that the meter prod may be touched on the requisite pin. When this is done care must be taken not to lift the valve too far so as to break contact in the

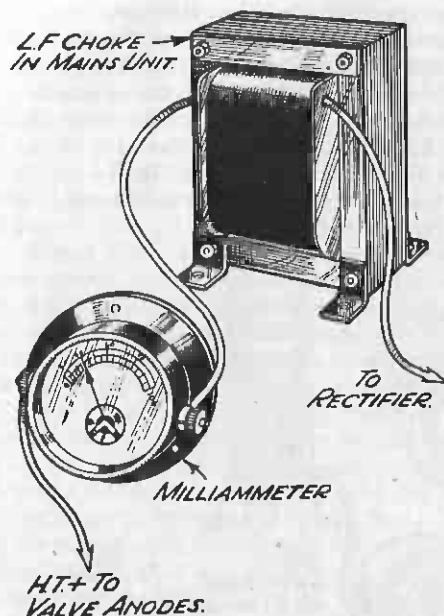

FIG. 165.—Measuring the total H.T. current consumption.

be due to low anode or screen resistances, excessive smoothed voltage, or high bias resistance. Lack of voltage will indicate a break in the anode or screen circuit due to a defective component (e.g., transformer primary, resistance, or choke) or wire.

Current Tests.—If the voltages are in order, it is generally found that the current consumed by the valves is also of the correct value, as voltage and current is to a great extent interdependent in mains receivers. The total current consumption may best be measured by connecting a milliammeter in the output circuit of the rectifier, and the

holder sockets, and it must also carefully be ascertained that the meter positive prod does not touch the chassis. After the positive prod has been placed in contact with the point at which a voltage measurement is required, the negative prod should be connected to the metal chassis. This will give the anode voltage plus the bias voltage if contact is being made to the anode pin of the valve, or the screen voltage if the positive prod of the meter is in contact with the valve screen pin. Low voltage at these points may be due to high anode or screen circuit resistances, to low smoothed voltage being supplied from the rectifier, or to the use of a low value bias resistance. High voltage, on the other hand, may

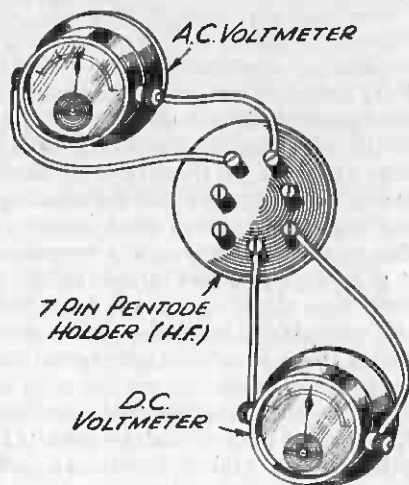

FIG. 166.—Showing method of testing voltage of H.F. pentode.

individual consumption of the valves may be checked by breaking the anode lead and connecting a milliammeter to the free ends; the mains supply must, of course, be switched off before the break is made. High current consumption will indicate that the applied voltage is excessive; that the bias resistances have a low value; or to a short or partial short across the circuit; partial shorts are generally due to leakage in condensers. Low consumption may be due to the use of high

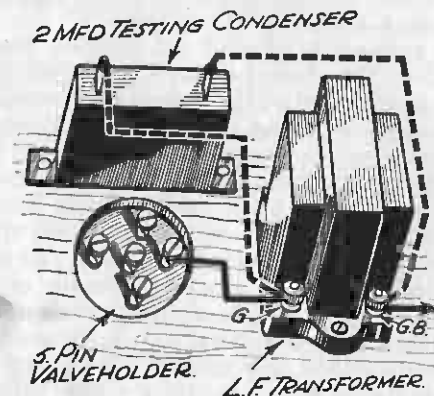

FIG. 167.—Localising hum by grid short-circuit method.

bias resistances, or low input voltage. In receivers of the A.C./D.C. type the heater current should also be measured. This may be done in the manner shown in Fig. 164, where an ammeter is shown connected between the negative end of the main dropping resistance and the heater pin of the first valve in the series sequence. It is emphasised at this point that valve heaters are connected in series in A.C./D.C. and D.C. receivers, and therefore the removal of a valve or the use of a valve with a broken heater circuit will produce a break in the whole heater circuit. (See also Figs. 165 and 166).

a subject which has already received so much attention in these columns that it would be redundant to include it here. On the other hand, when a noticeable increase in hum is apparent when switching to gramophone, very simple steps can be taken to overcome the trouble. In the first place, it is impossible to over-emphasise the necessity of earthing the pick-up arm, and for screening the pick-up leads and properly earthing such screening. Most pick-ups are provided with an earth terminal, but unfortunately in several makes this earth terminal is not in proper metallic connection with the whole arm. This state of affairs arises in those designs where the tone-arm is in two pieces, earthing of one piece relying entirely on contact through some swivel or rocker which, while mechanically sound, is electrically indifferent. The remedy is, of course, to earth the odd pieces together, so that the earth terminal provided is in metallic contact with the whole structure. There are usually quite a few screws in various parts of a pick-up terminal, and it is not difficult to link them together with flexible wire. Many metal pick-up arms are finished in black or brown "lacquer," the conductivity of which is questionable, and care should be taken to see that earthing is accomplished to pure metal, the lacquer or other synthetic finish having been carefully scraped away for the purpose.

Screening.—For screening pick-up leads almost any screen wire is suitable, provided that it is reasonably dense, but it is necessary to take more care in earthing the screening than would be imagined necessary. In the absence of a metal band going right round the screen tubing, it is suggested that if an inch of the screening be unplaited and twisted together, and the earthing wire affixed by soldering, a decent contact to each strand of the screen will be ensured.

The very position of the gramophone motor and pick-up causes the leads to these two components to be more or less parallel, and for this reason it is desirable, and is, in fact, general commercial practice to screen the mains leading to the gramophone motor for about two feet of their length, starting, of course, close up to the motor. The electric motor frame will certainly have an earthing terminal on it, which should be duly earthed, and if the motor board is metal this should also be earthed. It is not good enough to rely on the fact that the motor frame is bolted to the motor board, as, in time, oil may find its way under the bolts when they become slackened by vibration, resulting in absence of electrical continuity.

It is not satisfactory to take a single wire connected in turn at the points above mentioned, and finishing at the earth terminal. The most efficient and convenient arrangement being one wire earthing the motor and motor board, and a separate wire earthing the tone-arm and pick-up leads. Reversal of the pick-up leads should be tried, as in certain types of pick-up, one particular way round will tend to induce less hum.

CHAPTER XXVIII

SIMPLE TESTS FOR COMPONENTS

THIS chapter is intended particularly for home constructors, who will not possess extensive testing equipment, and must therefore rely upon simple apparatus to locate faults. During recent years receivers have gradually become more complicated, in order to cope with the necessity for increased selectivity. There has also been a tendency to use one or more dual-purpose valves in the majority of receivers. It is not surprising, therefore, that partial breakdowns often occur in modern sets, even though the standard of reliability of most components has steadily been improving. Fortunately, however, it is possible to trace the majority of faults by means of a combined meter of the volts-milliamperes type, as the measurement of the voltage

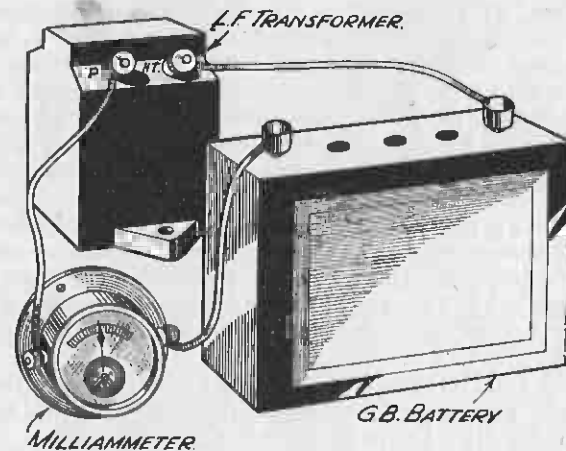

FIG. 156.—Showing method of testing transformer continuity.

and current at various vital points in the receiver will enable the owner to localise the defective component. The home-constructor has a definite advantage over the commercial set owner when a breakdown occurs, of course, as he knows the receiver circuit arrangement and the purpose of each component.

When building a receiver it is advisable roughly to test the components before assembly, for although these are carefully tested by the

is appreciably greater than the others, however, the exact figures may be ignored. When a pair of similar coils are employed in the same receiver the D.C. resistance of the windings of both should be the same; if not, it will be a fair indication that the coils are not matched, or that one of them is faulty.

In addition to testing the tuned windings of the coil, the reaction winding should also be tested for continuity by placing the ohm-meter across its terminals. The resistance of this winding will probably be found to be equal to about half of the long-wave tuned winding, but

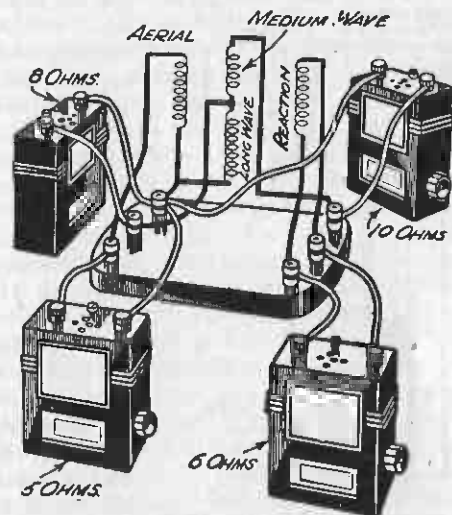

FIG. 169.—A combined theoretical and practical diagram showing the points between which a dual-range tuner with loose-coupled aerial winding should be tested with an ohm-meter, and the (very approximate) reading to be expected.

provided that there is continuity the resistance value need not generally be considered. Fig. 169 shows the various points, to which the meter should be connected, and gives a rough indication of the readings which one might expect to obtain.

A Simpler Test.—When an ohm-meter is not available it is possible to make a suitable instrument by means of a milliammeter and various shunt and series resistances, as described earlier in this book.

Quite a simple and fairly reliable test can, however, be made simply by using a 100-mA. fuse bulb and a grid-bias battery. First of all, the positive and 1½-volt negative battery tapings should be used, and the two "test" leads connected to the two ends of the coil, as explained before. When the switch is in the medium-wave position it

should be found that the bulb glows, but the light should not be so bright as when the two "test" leads are joined together, if it is, the windings, or connections from them, must be short-circuited. If the wavechange switch is turned to the long-wave position the light should either go out completely or become dim. If the light does go right out, increase the voltage of the G.B. battery in 1½-volt steps until the light returns. If the bulb glows when the switch is in the medium-wave

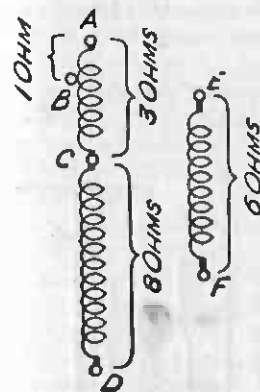

FIG. 170.—The diagram illustrates the method described in the text for tracing the connections of a typical coil.

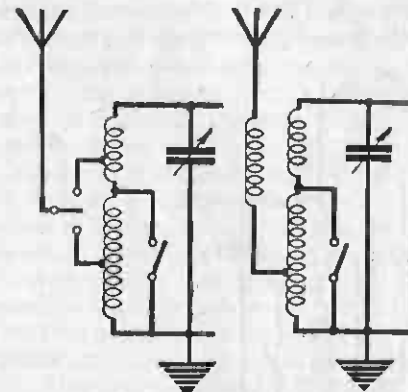

FIG. 171.—Two common types of aerial coil.

position, and cannot be made to do so on long-waves, it is a clear indication that the long-wave winding is either disconnected from the terminal or broken at some point. The leads to the terminals can be traced, and if these are in order, examination should be made at those parts of the winding where the wire passes from one slot to the next. If the wire has been broken or fractured at one of these places it will probably be necessary to remove a portion of the winding until the ends of the break can be scraped clean and soldered together again.

Should it be found that the resistance is just the same regardless of the position of the wave-change switch, it will generally be found that the switch itself is at fault. Should the resistance remain low (equal to that of the medium-wave section only), the switch contacts are probably failing to "open." On the other hand, if the resistance remains high, the contacts are not "closing" properly, perhaps due to one of the contacts being strained or because it is dirty. The method of effecting a remedy naturally depends upon the type of switch employed, but once the fault has been traced, the cure will generally be fairly obvious.

Tracing Coil Connections.—It sometimes happens that the tester has a coil for which the connections are not known. When this is the

case it is generally a fairly simple matter to trace out the terminals by applying the tests described above in the "reverse direction," as it were, that is, measurements must be taken between various terminals. For example, if it were found that a resistance of, say, 3 ohms occurred between two particular terminals, whilst the resistance between the other pair being 11 ohms, it would be evident that the first two terminals were those joined to the ends of the medium-wave winding, and that the second two terminals tested were joined to the ends of the long-wave winding. In other words, the tuning condenser would have to be

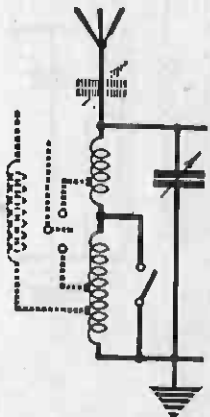

FIG. 172.—The simplest modification of the coils shown in Fig. 171.

connected between the terminals from which the 11-ohm reading was obtained, the wavechange switch being wired between those terminals between which a resistance of 8 ohms was measured.

This will perhaps be understood more clearly by making reference to Fig. 170, which shows the circuit of a typical coil with the terminals lettered from A to F, and with the resistance readings just mentioned indicated. After locating the tuned windings, the next step would be to find the tapping marked B; this could be done by connecting one side of the meter to terminal A, and moving the other lead about until a resistance of about 1 ohm was obtained. The reaction winding could be located by finding—by means of the meter—two terminals which were connected together, but which were not in connection with the tuned winding. In some cases, however, the lower end of the reaction coil (Terminal F), would be joined to terminal C, when a reading would be obtained between terminal E and every other terminal on the coil.

The reaction terminals would easily be located, however, due to the fact that the terminal showing the least resistance from terminal E would be joined to the other end of the reaction winding.

The tests just described could be carried out fairly satisfactorily by means of a fuse bulb and battery, as explained before, but the process would be somewhat more laborious and slow.

It is assumed when the service-man purchases a coil of reputable make that there will be no difficulties in the operation of the receiver which will be directly attributable to the coil itself. Unfortunately, this is not true, and even the best coil which is made might give rise to troubles, but they are not due to faults in the coil *per se*, but are linked up with the method of using the coils. It is as well, therefore, to consider just what faults in a receiver can be traced to the coils, and thus to eliminate some of the difficulties which might be encountered by the set constructor. Firstly is the question of selectivity. The modern coil is designed to offer a certain degree of selectivity, and this may be obtained by including a primary winding, or by tapping down on the coil and thus remove the heady damping effect. Many service-men might purchase such a coil, and thus using it in a simple detector circuit with a very large aerial, might find that the selectivity is not sufficiently high for these particular set of conditions, and thus would blame the coil. Obviously, in such a case it will be found that the shortening of the aerial will not weaken signals in any respect, but that as the length is reduced, so the selectivity increases, until a point is reached where any further reduction in length is generally round about 40 ft. to 60 ft. and a modern coil will be found to offer adequate selectivity when used in these conditions.

Modifying a Coil.—Where the coil is of the transformer or auto-transformer type, that is, as shown in Fig. 171, it might be found that, owing to the fact that the local conditions are bad, or that the aerial is unfortunately rather short, signal strength is poor, and many distant stations can only just be heard. In such cases, an improvement can be effected without tampering with the actual coil, by joining the aerial to the "top" or high-potential end of the secondary winding. If the aerial is joined direct to this joint, the waveband covered by the coil will be slightly higher than with the primary in use, and thus low tuning stations such as Fécamp, may not be received. If, therefore, it is found desirable to use this method of connection, and the results are satisfactory except so far as the reception of the lower stations is concerned, it might be worth while to remove a few turns from that end of the coil. In the majority of air-core coils, this part of the winding is generally wound in ordinary solenoid fashion, whilst the long-wave section (which is joined to earth, is pile wound, either as a duo-lateral winding, or in slots on the former. On iron-core coils the high-potential end of the winding is generally of Litz wire, whilst the long-wave section is of

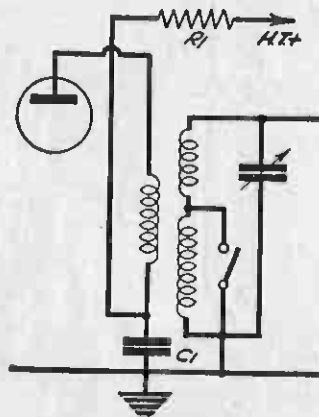

FIG. 173.—The usual coupling for an H.F. stage—the H.F. transformer it will be seen is almost identical with the aerial coil.

finer wire. There should thus be no difficulty in finding the correct end, although Fig. 170 should remove any difficulties.

The H.F. Coil.—The coils used for coupling the H.F. to the detector valve (or for coupling together two H.F. stages), are very often similar to the aerial coil, and where the transformer type of winding is employed it may again be found that the selectivity is so high that serious loss of signal strength results. A simple modification in such cases is to cut out the transformer effect, and to employ a parallel-fed grid coil, which is made clear in Figs. 173 and 174. In Fig. 173 is shown the principal associated components, and in Fig. 174 the modifications have been made,

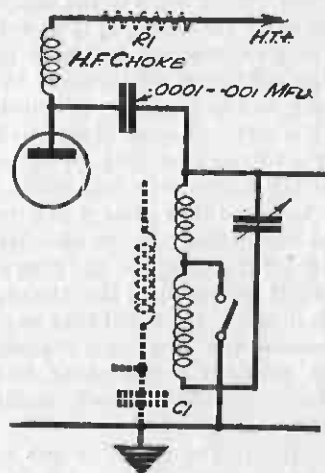

FIG. 174.—A modification of Fig. 64. It may be advisable to retain the resistance R_1 , and the condenser C_1 to act as decoupling components.

and the old part of the circuit is shown in broken lines. Both the modification mentioned in the aerial circuit, and the H.F. transformer modification will give greatly increased signal strength, but naturally the selectivity will be very much poorer. It is therefore necessary for the constructor to decide which arrangement is most suitable for his needs, and in this respect a few nights' tests will soon enable him to decide.

Switching Defects.—A good commercial coil should not give trouble arising out of the switching, but in view of the fact that certain materials do corrode, and that many coils are included in receivers which contain an accumulator, there is the possibility of acid corrosion as well as the normal oxidation. A good switch mechanism is self-cleaning, that is to

say, the contacts rub against each other as they come into contact, and this tends to wipe off any oxide and give a clean contact. Where it is found that long-wave reception is ideal, but that on switching to the medium waves results are poor, perhaps accompanied by scratching noises, or intermittent signals, suspect the switch mechanism. Carefully examine the contacts, and make sure they are clean. If an accumulator is kept near the coils, you may find a green deposit on the metal, and this should be wiped off with a rag dipped in strong soda water and the metal thoroughly cleaned. Operate the switch and watch the movement of the contacts. If it is found that there is a very minute wiping action, it may be possible to increase the effect by slightly bending the longer part of the switch arm. The actual method of attacking this will depend upon the switch, and care should be taken not to damage the actual contacts (which in some cases are silver), nor to break off the thin wires which may be soldered to the contacts.

CHAPTER XXIX

ADJUSTING AND TESTING COILS

THIS information is taken from our companion handbook, *Wireless Coils, Chokes, and Transformers*.

Modern coils are so efficient and generally free from faults that a chapter under the above heading might scarcely seem to be justified. But the queries received by me from a large number of readers indicate that, as a rule, coils are by no means well understood, and that the average novice in home construction is at a loss to know how to carry out proper tests when the coils come under suspicion. Let it be pointed out right away that a large number of the minor difficulties which do present themselves in connection with tuners and coil assemblies are due to unsympathetic treatment of them. As an example of this it should be explained that, of a large number of readers' coils which have been examined in my laboratories at various times, most of these have been damaged by attempting to over-tighten the terminals, with a result that these have been turned round bodily and the thin leads to them from the windings have thereby been broken.

Do not Over-tighten Terminals.—It is unnecessary to make the terminals more than finger-tight, but this warning has not always been observed. I am strongly in favour of soldering connections wherever possible, and if coil connections (and those to most other components for that matter), were made by soldering the leads to small soldering tags fitted under the terminal nuts many difficulties would at once vanish. Perhaps makers are in some measure responsible, due to the fact that many of them do not supply the necessary tags with their components, but it need hardly be mentioned that neat and useful soldering tags can be bought for a few coppers per hundred.

A very common reason for coil terminals being loosened is that thin connecting wire, or even stranded flex, is used for making connections; this is very liable to lock the nut on the thread of the terminal shank, so that when an attempt is made to screw the nut right down the whole terminal must work loose.

Short-circuited Terminals.—Even if the lead from the winding to the terminal does not break, there is another difficulty that might present itself in the case of coils the terminals of which are mounted on a pressed metal baseplate fitted with insulating washers or bushes. When the terminal is loosened washers come apart and allow the terminal to slip out of position, and thus make contact with the metal base. As the earth terminal is generally connected to the base, one of the windings

will be short-circuited. If it is the tuning winding that is affected, there will be an absence of signals on either one or both wavebands, but if the reaction coil is shorted it is possible that the H.T. supply might be short-circuited, with serious results. A few instances have been noted where the valve-filaments have been burnt out due to this. The reason is illustrated in Fig. 168, where it will be seen that the on-off switch is in the combined H.T. — L.T. — lead, this lead being joined to the earth terminal. When H.T.+ is inadvertently connected to earth due

to the coil short the voltage applied to the filaments is equal to that of the H.T. tapping used to feed the detector and of the accumulator in series.

It will be clear from what has been said that, if a coil terminal is loose, it is very important that a careful examination should be made and the looseness corrected. If the lead to the terminal from the winding appears to be badly twisted the wire should be scraped clean and re-soldered.

Measuring the Resistance of the Windings.—Really accurate and scientific tests of tuning coils cannot be made by using the limited amount of apparatus usually possessed by the average service-man,

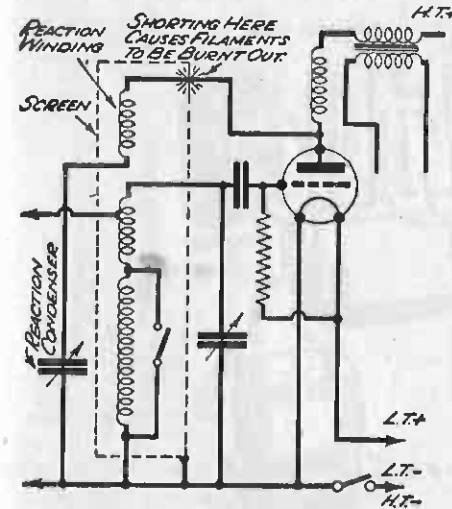

FIG. 168.—This circuit shows how the valve filaments might be burnt out due to one terminal of the reaction winding shorting to the coil screen or baseplates.

but it is generally sufficient to take readings of the D.C. resistance of the various windings, when any break, faulty operation of the wave-change switch, or bad terminal connection can be traced. An ohmmeter is required for taking these measurements, and an instrument such as the "Pifco" Rotameter, "Avo-Minor" or "Avometer" is useful. If the terminals of the meter are connected between the grid and earth terminals of the coil, readings of approximately 2 ohms and 10 ohms should be obtained when the wave-change switch is in the medium and long-wave positions respectively. These readings will not necessarily be obtained, and the figures will vary to a certain extent, according to the particular make of coil being tested, but the ratio between the two readings should be about 5 : 1. So long as one reading

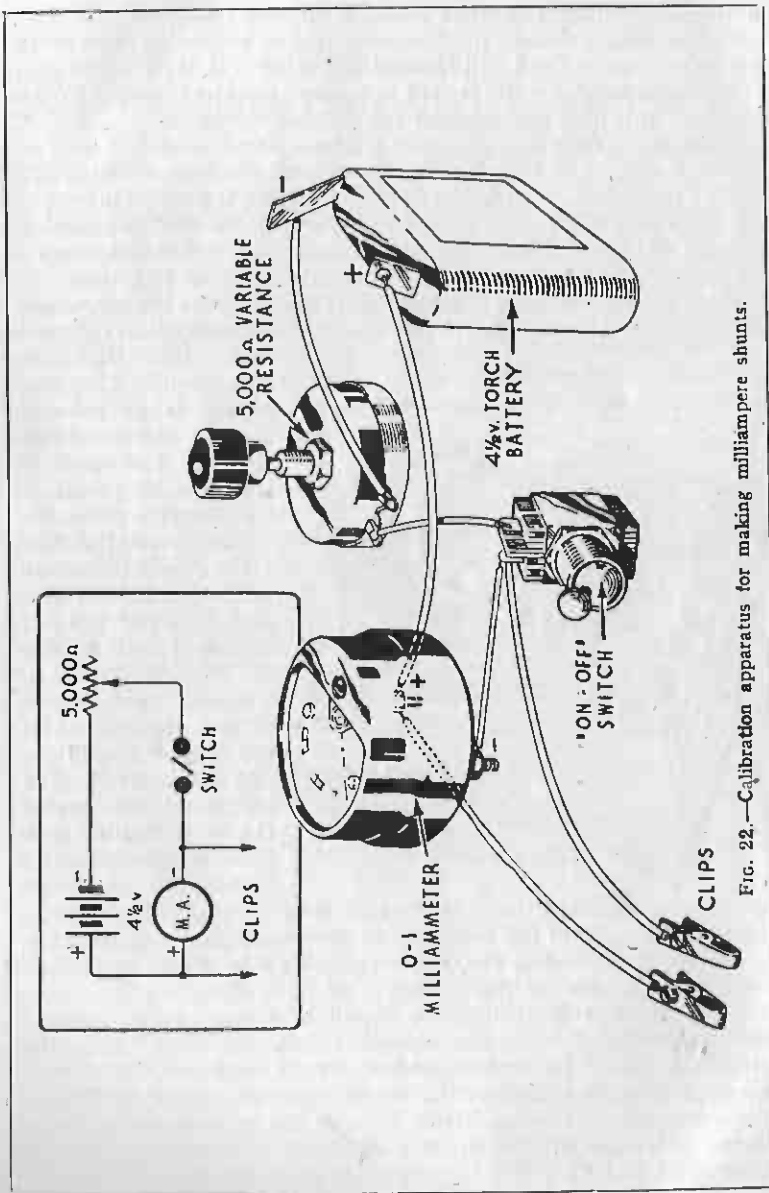

Fig. 22.—Calibration apparatus for making milliammeter shunts.

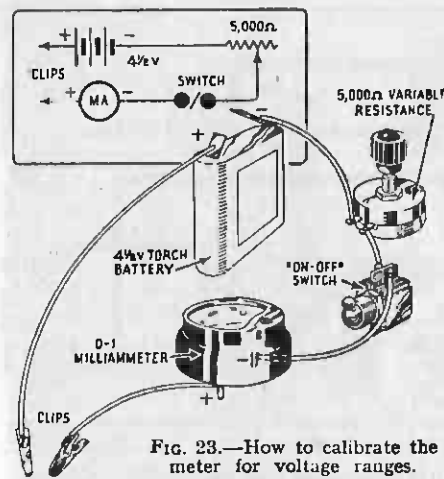

Fig. 23.—How to calibrate the meter for voltage ranges.

deflection of 0.1 mA. A little experiment is required to determine the correct value, so run through your stock of resistances to find one which will give the desired result. As an alternative, you may find it possible to remove the outer enamel of the resistance with a pen-knife at one end, and carefully scrape the resistance coating itself until the desired deflection is obtained. This will be the series resistance for the 10-volt range which is used to calibrate the remaining two voltage ranges.

Final Ranges.—To obtain the next range, connect the 10,000 ohms resistance you have obtained in series with the milliammeter and across a source of voltage, say 9 volts, from a high-tension battery. If the battery is in a good condition, and it should be for calibration purposes, the meter will read .9 mA. Disconnect the 10,000 ohms resistance and substitute the 100,000 ohms resistance. The reading of milliammeter should now fall to .09 mA., or one-tenth of the previous reading, whatever that may have been. If it does not, find a 100,000 ohms resistance, which will give the necessary fall in current.

For the final 500-volt range, leave the 100,000 ohms resistance connected, but increase the voltage applied until a reading of, say, 9 mA. is again obtained, i.e., 90 volts. Now substitute the 500,000 ohms resistance and, if this is suitable, the meter will indicate 0.18 mA., or one-fifth of the previous reading. Select a resistance which will give this result, and this will be the correct series resistance for the 500-volt range.

We now have all the necessary shunts and series resistances to extend the meter ranges to 10 mA., 100 mA., 10 volts, 100 volts, and 500 volts. In addition, of course, our meter by itself will indicate 1 mA., and .1 volt for full-scale deflection.

Assembling and Wiring.—All that remains is to fit the meter, switch, and associated resistances on to the panel and wire them up as shown in Fig. 24. This should need no detailed explanation, especially if reference is made to the theoretical circuit in Fig. 25, and no difficulty should be experienced in using the meter if it is remembered to set the switch always to 1 mA. before taking voltage readings, and to be careful to select the correct ranges when making measurements.

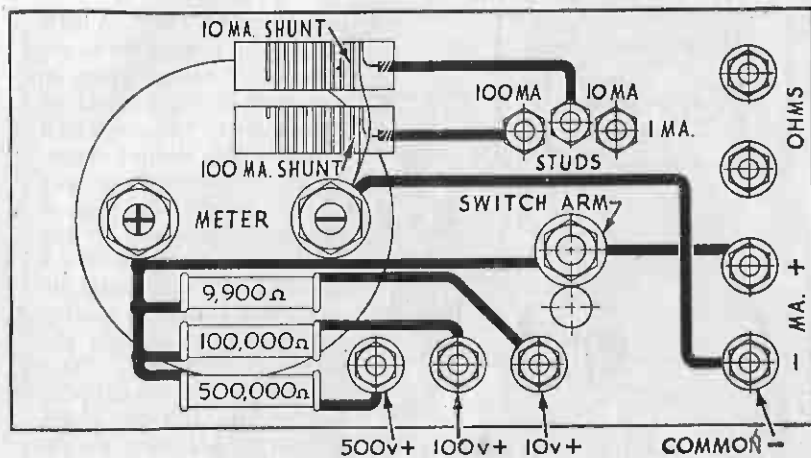

FIG. 24.—Back of panel wiring diagram.

With regard to the scale, you may be able to inscribe an actual calibration for each range, but we have found no difficulty in reading direct from the existing meter scale by multiplying the figures indicated by the pointer by the full-scale reading of the range in use. For instance, when on the 10-volt range a reading of .6 mA. equals 6 volts (i.e., $.6 \times 10$), when on the 500-volt range a reading of .4 mA. equals 200 volts (i.e., $.4 \times 500$), and when on the 100 mA. range a reading of .5 mA. equals 50 mA. (i.e., $.5 \times 100$).

It should be emphasised that if the manufacture of the resistances has been carefully carried out, the joints well soldered when wiring up, and the contacts of the switch are of low resistance, the accuracy of the complete instrument will be of the same order as the meter itself, and the better the meter the higher the all-round accuracy obtainable.

In a subsequent chapter it will be explained how this instrument

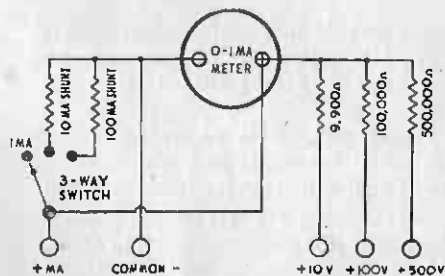

FIG. 25.—Theoretical circuit diagram of the unit.

the necessary terminals and means of access for adjusting the variable resistance are shown. If this addition is not required, however, the meter may be assembled as a complete unit, and will be found a useful adjunct to any amateur's or service-man's equipment.

In addition to the above conversion to an ohmmeter, a unit has been designed to attach to the instrument described herein, to enable direct readings of alternating voltage to be made. This will be also described later.

In its present state the meter will prove invaluable when carrying out quite a number of tests connected with components and receivers, and, before proceeding with the construction of the additional units mentioned in the following chapters, it is advisable to carry out a series of experimental tests and thus become familiar with the operation and application of the meter.

The warning given concerning the setting of the shunt selector switch cannot be too strongly emphasised, in fact, it would be advisable to take the slight extra trouble involved and fit a fuse in series with the lead from the common negative terminal. Suitable fuses, are now obtainable, but on no account should use be made of an ordinary pocket lamp bulb which might serve such purposes in other circuits.

From time to time the switch action should be examined to see that the rotating arm is still making perfect contact with the studs, the surfaces of which should be kept clean and free from oxidation.

When carrying out current tests, especially in the case of H.F. circuits, care should be taken to see that the connecting leads are not too long and that they do not cross over or come near the L.F. portion of the receiver. If this suggestion is not observed, it is highly probable that instability will be produced in the receiver which, in turn, will have the effect of producing erroneous readings. If such effects are created when short leads are used, then it would be advisable to connect across the input terminals, a fixed condenser of, say, 0.1 mfd.

CHAPTER III

D.C. MULTI-RANGE MILLIAMMETER

THE unit described in this chapter is intended as a nucleus, around which it will be possible through the medium of subsequent chapters to form a complete laboratory equipment of test apparatus. Moreover, the construction is not outside the capability of the average mechanic, or service-engineer, as access to precision instruments for calibration purposes is not required. In short, the necessary series resistances and shunts can be chosen, or made at home with the aid of the instrument with which they are to be used, and the simple calibrating apparatus shown. I would add, moreover, that this calibrating apparatus will be used as part of the instrument later to extend further its usefulness.

The parts required are :—

- One Moving-Coil Milliammeter—full-scale reading 0—1 mA. (internal resistance approx. 100 ohms).
- One Three-way switch, with low resistance contacts.
- One Ebonite Panel, 7 in. by 5 in. by $\frac{1}{4}$ in.
- One Box with hinged lid (see Fig. 21).
- Seven Terminals.
- One Resistance (fixed), 10,000 ohms (1 watt).
- One Resistance (fixed), 100,000 ohms (1 watt).
- One Resistance (fixed), 500,000 ohms (1 watt).

All the above resistances to be of the composition type, and to be selected as described in the text.

- Two yards 30 gauge "Eureka" D.S.C. wire.
- Two yards 20 gauge "Eureka" D.S.C. wire.
- Two small wooden spools or lengths of $\frac{1}{4}$ -in. ebonite rod.
- One Resistance (variable), 5,000 ohms (wire-wound).
- One "On-off" Switch.
- One $4\frac{1}{2}$ -volt Flash-lamp Battery.

Calibrating Apparatus.—The first step is to set up the calibrating apparatus, and make the shunt resistances for extending the milliamp scale to 10 mA. and 100 mA. First, connect up the meter, dry battery, switch, and 5,000 ohms variable resistance, as shown in Fig. 22, taking care that the resistance is set so that all the element is in circuit. The meter will then be found to give, with the switch in the "on" position, a deflection somewhat less than full scale. Decrease the variable resistance until 1 mA. is accurately indicated on the scale, then bare the ends of the 2 yards of 30 gauge D.S.C. "Eureka" wire and attach these two bared ends across the clips. The reading of the

D.C. MULTI-RANGE MILLIAMMETER

milliammeter will then drop to a value just above 0.1 mA. The "Eureka" wire must then gradually be shortened, testing across the clips every inch or so, until 0.1 mA. is indicated accurately. It is the wisest plan to check that the meter still reads 1 mA., when the wire is removed from the clips; if it does not, readjust the variable resistance.

When the correct length of wire has been found, double it back on itself and wind it on one of the small wooden spools or ebonite rods, securing the ends with a binding of thread. The whole shunt may then be given a coat of shellac or immersed in hot paraffin wax, and allowed to drain and dry. If the internal resistance of the meter is exactly 100 ohms, the value of the shunt just described will be 11.1 ohms.

A little extra care must be taken when calibrating the 100 mA. range, and the switch must be opened every time the resistance wire is removed

from the clips for adjustment. The procedure is as follows: connect the resistance we have just made to the clips, then decrease the variable resistance until the meter indicates 1 mA., open the switch and remove this resistance and replace it with 2 yards of No. 20 S.W.G. "Eureka" wire, switch on and the reading of the meter should be just about 0.1 mA. Now switch off and shorten the wire, testing inch by inch, taking care to switch off every time

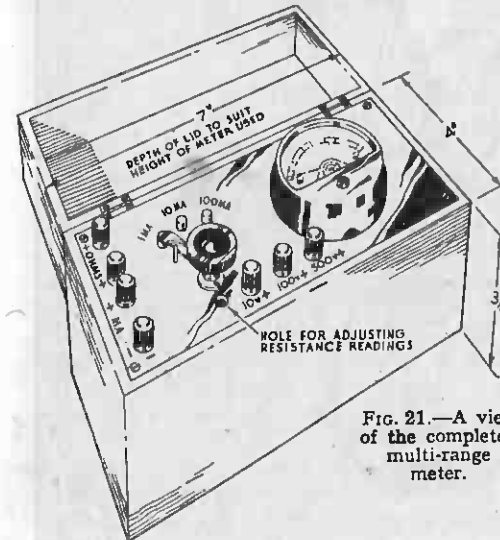

FIG. 21.—A view of the completed multi-range meter.

the wire is removed for adjustment, until 0.1 mA. is accurately indicated. Finish off the resistance as previously, and you will have the two shunts extending the milliampere ranges to 10 mA. for the first shunt and 100 mA. for the second.

Now rearrange the calibration circuit as shown in Fig. 23, and short-circuit the clips, set the variable resistance "all-in," close the switch, and reduce the variable resistance until the meter reads 1 mA. Now open the clips and insert the 10,000 ohms composition resistance; the reading should now be .1 mA. If it is not, you will probably be able to find amongst your stock a resistance of a nominal value of 10,000 ohms, which is sufficiently low to make the meter give an accurate

existence or otherwise of the local oscillations. A comparison should be made between the anode current value with the connections unaltered and the anode current value with the grid coil short-circuited, or with a large capacity condenser connected between oscillator grid and earth. A more indirect, but quite useful way of finding out if the receiver oscillator is out of action is to use the output from an external test oscillator. Unmodulated oscillations should be injected into the signal grid circuit of the frequency changer, or first detector, and the test oscillator and receiver should be tuned for signals as a combined outfit. If signals can be brought in in this way there will be no doubt that the receiver oscillator has a fault. Incidentally this external oscillator test would disclose the fact if the receiver oscillator happened to be generating but to be hopelessly out as regards frequency ranges. It is very unlikely that the receiver would have been completely "dead" under this condition but, in any event, with the external oscillator in use it would be possible to pick up the beats between the two sets of oscillations if some searching were carried out with the test oscillator.

If the receiver oscillator does prove to be out of action, coils should be tested for continuity and short circuits; the possibility of an open-circuited or short-circuited condenser should also be allowed for. This does not cover all possibilities, but faults of more tricky character, will be considered at a later stage.

After this digression in connection with the oscillator of a superhet we will return to the general case under consideration and assume that the position has been reached that a particular stage of the receiver has been located as faulty, but that the fault itself has not yet been tracked down. The valve itself must come under suspicion first and no further move made until it is definite that there is no valve trouble.

Testing the Valves.—Parts connected in any way to the positive H.T. lines of the receiver are more likely to develop defects than those in grid circuits, or low potential tuning circuits, for the reason that the former parts are subjected to greater stresses. A short-circuit across H.T. can be ruled out now because a fault of this nature would necessarily have forced attention upon itself at the commencement of the proceedings. It must be remembered that we have made the rule to get "life" in the output stage as one of the first moves, and any fault leading to absence of H.T. (or L.T. for that matter) would come up for investigation at once. It is right time now to make a voltage test between anode and chassis as an open circuit in any transformer winding, choke winding, or resistance connected in series with the anode circuit will then be shown up. If the valve is of the indirectly heated type a voltage test should also be made between anode and cathode to check up on the possibility of a break between cathode and chassis. If the valve is of the screen-grid or pentode type, the screen to chassis voltage should be checked as well.

If the fault still does not show up, a grid circuit break should be considered as a possibility, and tested for.

If the fault is still elusive the most likely possibilities are: a short-circuit across the anode load, a short-circuit across the grid circuit, or, if one is in use, an open-circuited grid condenser. As regards the anode load matter, think of the case of the primary circuit of an I.F. transformer with a trimmer condenser across the winding. If there happened to be a short-circuit through the latter it would have the effect of preventing any amplified I.F. oscillations being developed in the anode circuit and there would be no input available for the next valve. When the anode load is of high resistance type, as with resistance-capacity coupling, a short-circuit across the load should have been noticed with the anode voltage test.

When a short-circuit across a winding of comparatively low D.C. resistance is the fault, the occasion calls for a test with an ohmmeter that will give low resistance indications. If the ohmmeter available is of the type that does not give readable indications for low resistances the position may be a little difficult.

An open-circuited grid condenser can easily be checked up by using another condenser on a shunt test.

It is to be hoped that by now the fault will have been found, but should the case still be obstinate it may pay to consider the possibility of an open circuit, or very high resistance contact, between a valve-holder terminal, or socket, and the valve pin. A milliammeter test in the anode circuit should prove useful, as a fault of the above type will generally show up if the milliamps are measured. It is to be pointed out, however, that any fault affecting anode current is a fault that must incidentally affect the actual anode voltage. As to whether this would be noticed at the time an anode voltage test is being made depends not only upon the extent of the voltage discrepancy (which may in some cases only be very slight) but also upon the alertness of the tester.

"Diary" of a No Signal Case.—Receiver: A mains superhet of typical modern design. Report: No signals.

Receiver switched on and dial lights up. No signals obtainable on either of the two wavebands provided. Sound of mush heard in speaker. Output stage is alive, then, and probably I.F. stages working.

Jump aerial lead forward to signal grid of frequency changer. No result.

Decide to check I.F. stages. Apply modulated test oscillations at I.F. frequency to signal grid circuit. These signals come through well. Case beginning to look like a dead oscillator one. Switch out modulation of testing oscillator and adjust for signal frequencies. Connect aerial to normal receiver terminal, and search for signals, using tuning controls of both testing oscillator and receiver. Signals come rolling in. Sure that receiver oscillator is dead now.

Try new frequency changer valve. Nothing doing. Wonder if there is any H.T. on oscillator anode? Try with voltmeter. There isn't. On the track now.

Take chassis out of cabinet. Notice that directly connected to oscillator anode socket is a 50,000 ohm resistance and a .002 mfd. condenser. Resistance obviously in H.T. feed line, so switch on receiver and test for volts at each end of resistance. Get voltage reading at end of resistance remote from valveholder. Surely fault is an open resistance. Switch off receiver and make ohmmeter test of resistance. Get a jolt, for resistance is in order. (Ought to have taken closer notice of the voltage reading just now.) Try ohmmeter test from oscillator anode to chassis. Low reading obtained. Notice that condenser connects from oscillator anode to the oscillator coil assembly. Evidently it is a reaction feed condenser. Think it must be shorting through. Disconnect one end of condenser and test. Got the trouble now—condenser is shorting through.

Replace condenser with similar type. Try receiver. Everything seems O.K., but don't like making any changes in an oscillator circuit without checking the trimming.

Hardly seems necessary here but decide to make sure. Connect up ganging gear and find that the oscillator trimming condenser can do with a slight alteration. Make the necessary adjustment.

Weak Reception.—When the trouble is that the receiver as a whole is below its normal standard of sensitivity there are two checks which should be made at the outset: (1) on the valves, (2) on the valve operating voltages.

Once the valves have been proved to be satisfactory, and each to be working at its proper voltages, it will be advisable to ascertain whether there is any lack of amplification on the L.F. side of the receiver, and a test with a gramophone pick-up or an L.F. oscillator should be made. When it is definitely known as to whether the trouble is on the L.F. side, or on the H.F. side (or on both), the best scheme is to consider possible types of fault, and to carry out a series of elimination tests.

Dealing with L.F. trouble first: the speaker should be regarded with suspicion at the start and a test with a substitution speaker should be made. If the speaker does prove to be faulty some of the possible faults are:

Shorting speech-coil turns.

High resistance in speech-coil circuit.

Weak magnet (in permanent magnet type).

With a mains-energised type of speaker there may be shorting turns in the field winding. If the field winding is used for smoothing this fault would, however, probably draw attention to itself at an earlier stage of the proceedings.

With a moving armature type of speaker there may be shorting

turns or a weak magnet. The output transformer, if one is in use, should be tested for shorting primary or secondary turns, and for high resistance in the secondary. If there is choke-capacity feed to the speaker the choke should be tested for shorting turns, and the condenser for low capacity.

Where field, transformer and choke windings are concerned one should always be on the look-out for shunt condensers which may be shorting through, or have low leakage resistance, and may quite possibly cause suspicion to be wrongly directed to the windings. In the case illustrated in Fig. 175, for example, a short-circuit through C will throw the D.C. resistance of R across the primary of the output transformer. If R or C are not disconnected before making an ohmmeter test of the primary resistance the reading obtained will be somewhat lower than the actual primary resistance value.

Having cleared the speaker and any speaker coupling system it is advisable to work back, circuit by circuit, towards the detector. It is to be anticipated that the coupling between two L.F. valves or between the detector and an L.F. valve, will be one of the following types: resistance-capacity, choke-capacity, transformer, shunt-fed transformer, or shunt-fed choke, and faults in such systems are not usually difficult to trace. Test for shorting turns, resistances of too low values, shunt leakage resistances, and also check up on coupling condensers.

The H.F. Stage.—The high-frequency side of the receiver is not such an easy proposition if the fault happens to reside there. Remembering that the valves and their operating voltages have already been covered, it is necessary to view all tuned circuits with suspicion.

The possibility of the group of tuned circuits contained on the H.F. side of the receiver being out of alignment (i.e., faulty ganging) must be considered and the adjustments of the various trimming condensers should be checked for correctness. Incidentally, the results obtained on the tests involved in a ganging check may very possibly reveal the location of the fault even though it may not be a fault of ganging adjustment. If it is found that the adjusting of any trimming condenser fails to have any effect on the output of the receiver, or if no definite optimum adjustment can be found, then the circuit concerned should receive very thorough examination.

Any H.F. tuned circuit forming part of the amplifying chain in the receiver contributes something to the over-all amplification, provided that the circuit is in the resonant condition. As far as the tuned circuit itself is concerned its quota of amplification arises in the sense that the voltage built up by the oscillations in the circuit exceeds the value of the E.M.F. that is exciting these oscillations. This "circuit amplification" is greater the lower the effective H.F. resistance of the circuit. Thus, if the amplification of any particular circuit is below normal it may either be that the circuit is mistuned or that there is excessive

H.F. resistance. All this may seem to be very elementary but the point is that a number of fault possibilities become apparent if consideration is given to the above.

Taking the first reason for lack of amplification (circuit mistuned), some of the faults to look out for are :

Disconnected tuning or trimming condenser.

Wrong adjustment of the condenser.

Incorrect capacity of any fixed condenser involved.

In connection with the latter is it to be noted that although the simplest form of tuned circuit is as shown in Fig. 176, a large number of

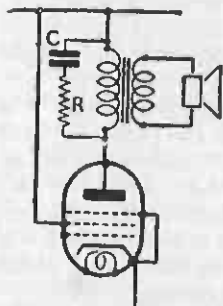
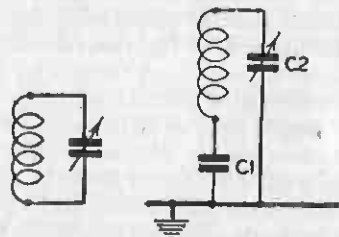

FIG. 175.—A tone control circuit which can create difficulty when trying to locate a fault.



FIGS. 176 and 177.—A normal tuned circuit and a modification in common use which is referred to in this chapter.

cases will be found in radio receivers where the circuit is of the character shown in Fig. 177, the circuit containing a fixed condenser in addition to the variable condenser. From the diagram it is easy to appreciate that C1 is part and parcel of the tuned circuit, but anybody not especially alert might be liable temporarily to overlook the fact when exploring round an unfamiliar chassis. Any defect in C1 will naturally effect the behaviour of the tuned circuit and, should the latter prove to be faulty, C1 should receive as much attention as any other part of the circuit.

H.F. Resistance.—Dealing with the second reason for lack of amplification (excessive H.F. resistance) some of the commonest faults are :

High resistance joint.

Shorting coil turns.

Leakage resistance through trimming condenser.

Shunt leakage resistance of any kind.

There is rather a "snag" where shorting coil turns are concerned. Shorting turns will give a reduced D.C. resistance to a coil and the fault will probably be located by a careful ohmmeter test; but the actual effect of the fault in the radio sense is to increase the effective H.F.

resistance of the circuit. Of course, another effect of shorting turns is to give mistuning, but as to whether this aspect will lead to the location of the fault will depend upon the particular testing methods that are being employed.

As usual, any grid coupling condensers must come up for investigation, and also any condenser that forms the coupling unit of a capacity-coupled band-pass system. One item that is rather more important than is sometimes appreciated is the anode by-pass condenser that is used in many receivers employing a triode or pentode detector. Where diode detector circuits are in use any H.F. by-pass condensers across the diode loads should not be ignored. By-pass condensers joined across bias resistances connected between cathodes and chassis are not to be exempted from suspicion, until proved to be in order, as an open circuit will lower the amplification of the stage concerned. This is a case where shunt testing with another condenser may save time.

There are degrees of weak reception, and the cases of receivers that give exceedingly weak reception (say, faint traces of local stations only) are to be regarded as very possibly containing faults of the kind that were dealt with on a previous page dealing with "dead" receivers. Some receivers will give a trace of signals with faults which in other receivers would lead to complete absence of reception.

Broken Grid Connection.—The following is given as an actual example of a case involving very weak reception. It will serve also to illustrate a rule of importance, namely, to be on the look out for any special features or peculiarities of the fault symptoms with the object of taking advantage of any short cuts that may be indicated. The case was that of an all-wave superhet of modern design with which only faint sounds of local broadcasts could be heard. It was observed that the volume control had no effect upon these signals. From the fault-tracing point of view the matter of immediate importance was the failure of the volume control action, and no attempt was made to carry out general faulty stage localising tests. All that mattered at the moment was that there was some fault either in the volume control or at some point not far after it.

The receiver contained a double diode triode, functioning as second detector, A.V.C. detector and L.F. amplifier. The element of the volume control formed part of the signal diode load, and the grid of the valve was fed from the volume control through a resistance and a condenser. An ohmmeter test was made of the volume control and this was found to be in order. The next test was a continuity test from the grid to the condenser mentioned above and the fault was at once discovered. The lead from grid to condenser was a screened lead, and the wire had broken inside the sleeving. The volume control feature of the symptoms gave the clue, however. It should perhaps be mentioned that the weak trace

of signals that could be heard while the fault existed were to be heard by virtue of stray coupling.

Instability.—This will manifest itself in the form of whistling, howling, or motor-boating. In the case of the superhet receiver, however, there are a number of whistle possibilities not associated with instability, but these will be dealt with separately in a later chapter.

It is well to keep very much in mind, when endeavouring to locate the cause of receiver instability, that there are certain components and certain features of assembly design deliberately introduced for the purpose of preventing instability; consequently when instability does occur these items should be gone over very thoroughly.

There are various ways in which instability can occur, but there is one fact common to all cases, and that is there must be one circuit which is producing an A.C. E.M.F. in another

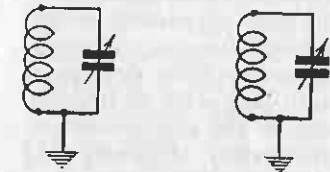

FIG. 178.—Two H.F. circuits which may need decoupling.

circuit. Thus, unwanted couplings of some kind or other must be ferreted out and "killed" if the instability is to be cured. Now, two circuits will couple together if an alternating magnetic field, or an alternating electric field, of one links with the other; also if there is some impedance which is so connected that it is common to the two circuits.

Decoupling Methods.—Decoupling resistances and condensers are provided to cut out the couplings that would be set up between circuits by the impedance of a common H.T. supply, etc. Screening cans, screening partitions, and screened sleeving are introduced to cut out inductive couplings; also certain leads may be well spaced, and some kept to a minimum of length with a view to reducing unwanted couplings to a negligible value. Also, certain by-pass condensers will play an important part in preventing instability.

An open-circuited decoupling or by-pass condenser is easy to trace, as a test with another condenser in shunt will remove the effect of the fault. As a matter of fact, whenever instability is experienced it is a good plan, as a first move, to work round the chassis, shunt-testing all "likely" condensers. The contacts between screening cans, screening partitions, and the chassis should be checked; also the contacts between

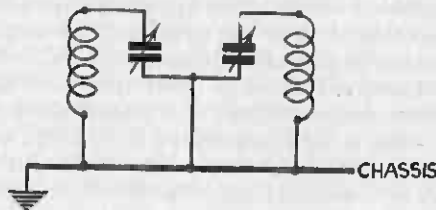

FIG. 179.—How the two circuits are connected in the receiver.

screened sleeving and chassis. Decoupling resistances should not be overlooked, and H.F. filter coils and condensers should be tested.

Elusive Faults.—Should the fault prove to be elusive the following paragraphs may contain the key to the solution:

The fact that two H.F. circuits may be shown in the receiver's theoretical diagram as completely separate does not necessarily mean that in the receiver itself they have no common part. If each of the two circuits has one side earthed it may well be that there is a wire in the chassis assembly which is a common earthing wire for the two circuits. The designer will have seen to it that, under normal conditions, this

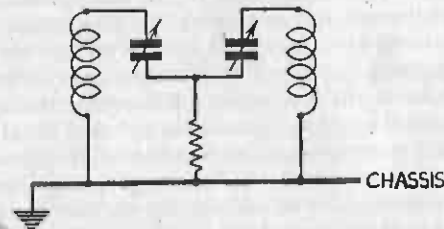

FIG. 180.—Showing how a common earth can couple the two circuits through the resistance set up in the defective connection.

wire has insufficient resistance to form an appreciable coupling between the two circuits. Suppose, however, that bad contact develops at either end of the wire, then there is quite a possibility that one effect of the resistance introduced will be to couple up the two circuits sufficiently to cause trouble. If Fig. 178 represents the two circuits then Fig. 179 may represent the arrangement as it holds in the receiver itself. Should the common "earth" of the two condensers develop an appreciable resistance the arrangement is then as shown in Fig. 180, in which obvious coupling exists between the two circuits. If all "earthing" bonds are regarded as potential danger points, and given close attention, any such fault should not cause any bad delay in fault clearance work.

Any radical displacement of the wiring of H.F. circuits is apt, in some cases, to cause instability. This point, however, will probably need consideration only if there have been any component changes made in the receiver. A broken connection between the coating of a metallised valve and the valve pin is one of those often overlooked faults which will sometimes be responsible for instability.

Testing Fixed Condensers.—A fixed condenser may be faulty in one of the following respects:—internal short-circuit, internal open circuit, excessive D.C. leakage (i.e., resistance between terminals "down"), incorrect capacity value, power factor too high.

To take the last item first, the question of testing for power factor

does not usually worry the average service engineer who has limited testing gear. He usually relies on substitution checking to help him if he has any suspicions regarding a condenser on this score. An internal short-circuit is easy enough to locate as a simple ohmmeter test will reveal the fault.

Excessive D.C. leakage at low voltages will also show up on an ohmmeter test, but care should be taken that shunt circuits do not give rise to false indications if test is made while the condenser is still in place and connected up in the receiver. There is always the possibility that a condenser which proves to be in order on a low voltage test may develop excessive D.C. leakage at a higher voltage, and a test with a milliammeter connected in series with the condenser under working conditions may show trouble. With such a test as this, however, all due precautions should be taken to guard against meter damage.

For routine testing of condensers (as separate items) for excessive D.C. leakage a source of D.C. (batteries or an A.C. H.T. eliminator) is most useful on the service bench. A milliammeter should be joined in series with the condenser and the D.C. source together with a series resistance of sufficient value to restrict the current to the value of the maximum meter reading, should the condenser choose to short. Alternatively, a voltmeter could be used, in series, as a current indicator. In this case the voltmeter range should embrace the voltage of the testing supply. In the case of electrolytic condensers it must be remembered that these have polarity and that any test voltage, including even that of a simple ohmmeter test, should be applied in the correct sense.

Capacity Values.—An internal open circuit can easily be detected if the condenser is of large capacity, but it is not such an easy proposition if the condenser is of small value, unless a capacity tester is available. In the latter event, of course, it is simply a matter of testing for capacity value.

Assuming that a capacity tester is not available, an ohmmeter test of high capacity condensers will show whether or not there is an internal disconnection. If the condenser is in order, the pulse of charging current taken from the ohmmeter's voltage source will give a noticeable "kick" of the needle when the test leads are applied to the condenser. If the needle kicks over and then falls back it is a sign that the condenser has taken a charging pulse and therefore cannot be internally disconnected. The difficulty with the testing of small capacity condensers by this method is that the charging pulse is too small to give any noticeable indication on the normal type of ohmmeter. Fortunately, a shunt capacity test with the suspected condenser connected in the receiver will overcome any difficulties that may arise in this way.

Checking for incorrect capacity value is an awkward proposition as far as accurate tests are concerned unless a capacity tester is available. Assuming the absence of a capacity tester, the matter is not so serious

as it may perhaps seem, because actually it is only with fixed condensers used for high-frequency adjustment, tracking, etc., that critical values are necessary. In those cases, of course, a good capacity tester should be used.

Ganging Troubles.—Modern receivers with H.F. amplification invariably have ganged tuning, and poor performance can be due to the high-frequency circuits being out of alignment. This trouble may be found to have been caused by misguided efforts on the part of an inexperienced person who has been experimenting with the adjustments; sometimes a component fault will be responsible for the receiver being "out of gang"; sometimes it will be found that a trimmer condenser adjustment has shifted, under the effects of vibration. Finally, a component replacement made in a high-frequency circuit will very often put the receiver out of alignment, necessitating reganging.

To put the cart before the horse, the procedure for reganging will be considered first and faults that may make reganging necessary will be dealt with afterwards. For ganging work in any other than the simplest of cases a calibrated modulated H.F. oscillator is virtually a necessity, and the oscillator should have a variable output amplitude control.

This instrument makes it possible to apply to the receiver circuits modulated H.F. inputs of selected frequencies and of suitable amplitudes. Obviously it will be necessary to have some means of observing the effects of ganging adjustments, but the idea of judging the optimum settings by listening to the sound of the signals in the speaker is to be deprecated as most unsatisfactory. A much used and good method is to use an output meter (A.C. voltmeter) connected across the speaker.

Eliminating A.V.C.—Before we go into details of ganging procedure there are a number of general points which are worth noting. If A.V.C. is incorporated in the receiver it must be remembered that an A.V.C. action tends to counteract the effects of H.F. carrier amplitude changes, as far as the receiver output is concerned. To say the least of it, such an effect is most undesirable when ganging adjustments are being made. There are three alternative ways of overcoming this difficulty. The most obvious is to cut out the A.V.C. by temporary circuit modifications. Another solution of the problem is to use, instead of the output meter, a D.C. milliammeter, or a D.C. voltmeter, and to take the anode current, or the anode voltage, of one of the controlled valves as the indication for ganging. Undoubtedly, however, the best way is to use the output meter and to keep the testing signal down to a sufficiently low amplitude that the A.V.C. detector is not operated.

If the receiver ganging is badly out to begin with, care should be taken as the circuits are brought closer and closer into alignment that the increasing oscillation amplitude does not start up the A.V.C. action. A useful rule is to keep cutting down the oscillator's amplitude whenever the receiver circuit improvements permit.

In the majority of cases only one setting of any particular trimming condenser will give a peak indication on the output meter and this setting will be the correct one for ganging purposes, but there are exceptions. In the case of a superhet oscillator circuit, there may be two trimmer settings which give output meter peaks and one of these settings is definitely the wrong one to use. The other exception is one that can sometimes prove to be rather troublesome if elaborate test gear is not available, and this case arises with tightly coupled circuits designed for band-pass response. Here the tuning adjustment of each circuit, for any given frequency, is affected by the coupling influence of the other circuit; moreover the correct adjustments of the two circuits are those which will give the actual band-pass response characteristic for which the circuits and coupling were designed. Adjusting for a single maximum peak on the output meter will not be correct in such a case. With the average straight receiver, it will not normally be found that the presence of any coupled tuned circuits will introduce any difficulties, but with certain types of superhet receivers which employ band-pass I.F. transformers the latter may present rather a problem. A cathode-ray oscillograph, with "sweep" control on the testing oscillator frequency, provides, of course, the perfect solution of the problem, because with such apparatus the actual frequency response curve of any individual coupling, or of the receiver as a whole, can be made visible on the oscillograph screen. Thus, the complete effects of any trimmer adjustment can be watched. To have an oscillograph available is not, however, the good fortune of everybody, so we must consider how to get along without it although it must be admitted that in certain cases the lack of an oscillograph represents a considerable disadvantage.

It is to be noted that correct ganging is more than a matter of getting circuits into alignment, for perfect alignment could be secured and the receiver could still be incorrectly adjusted. The most obvious case of this would be that of lining up I.F. circuits on a ganging signal adjusted to a frequency which is not the actual I.F. specified for the receiver. Where signal frequency circuits are concerned, one could possibly line up the circuits with too much capacity in every trimmer and the effect of this would be that the receiver would not then tune down to the lowest wavelength which it was designed to cover on the particular waveband concerned. It is advisable to aim at keeping each trimmer at as low a capacity as possible with the important reservation that the final setting must be an optimum one.

For adjustment of trimmers in signal-frequency circuits a test signal frequency corresponding to a wavelength near the lower end of the wavelength band should be used. A manufacturers' service manual usually gives instructions as to the frequencies which should be used for reganging work on the receiver concerned, but if such information is not available, choose some frequency which tunes in near the minimum

end of the tuning dial of the receiver. On the normal medium and long wavebands frequencies of 1,400 kc/sec. (214 metres) and 300 kc/sec. (1,000 metres), respectively, are generally satisfactory.

Reganging the Straight Receiver.—An output meter should be connected across the speaker (a large capacity condenser should be used in series to keep D.C. out of the meter), and the testing oscillator's leads connected to the A and E terminals of the receiver. The oscillator lead to the A terminal should be taken either via a dummy aerial unit or via a .0002 mfd. condenser, if the former is not available.

Reganging the Superhet.—The work of reganging a superhet, assuming that it requires readjusting right through, must be divided into several distinct parts:

- (1) Lining up the I.F. stages to the correct I.F. value and, possibly, for a good shape of response curve.
- (2) Oscillator trimming.
- (3) Signal frequency circuits' trimming.
- (4) (With certain exceptions) Oscillator tracking.

If band-pass complications are not anticipated the procedure described below should be satisfactory in all normal cases:

Connect up an output meter to the speaker, and cut out the receiver oscillator temporarily by joining a large-capacity condenser from oscillator grid to chassis. Connect the testing oscillator output leads to the signal grid of the frequency changer, or first detector, and to E, respectively. The lead to the grid should be taken via a condenser (a 0.1 mfd. should do). Tune the testing oscillator to the correct intermediate frequency value and keep down the test signal amplitude to the lowest possible value, consistent with a satisfactory output-meter indication.

Adjust the I.F. trimmers in turn for peak response, starting at the last I.F. secondary and working back to the first primary. Next, run the testing oscillator frequency through resonance and back, and and watch the output-meter needle for any signs of bad asymmetry of response. This step should be taken as a precaution against getting "caught" should the I.F. transformers prove to be tighter coupled than was anticipated.

If it is known that the I.F. amplifier is designed for a pronounced band-pass characteristic, there are two ways in which the adjustments can be tackled, assuming that oscillograph gear is not available:

- (1) Trim for peak response and then readjust by trial and error to get as symmetrical and as steep-sided a response curve as it is possible to judge by watching the output meter while running the test-oscillator frequency to and fro through resonance. Care should be taken, however, that in the enthusiasm of getting a symmetrical variation of the output-meter needle, that the I.F. amplifier is not dropped in sensitivity too much. As a matter of fact, it will pay whenever a slight readjustment of a trimmer does not appear to be very helpful to let the trimmer "stay

put" as it was. (2) Impose fairly heavy damping on each I.F. circuit in turn while its companion is being trimmed for peak response. A shunt resistance of from 10,000 to 50,000 ohms should be tried, connecting it across a primary while the corresponding secondary is being tuned, and *vice versa*.

Oscillator Trimming.—If it so happens that the receiver has a variable-coupling control on one or more of the I.F. transformers, then the latter should be tuned for peak response with the coupling kept at minimum.

As a reminder—always be ready to reduce the signal amplitude whenever circumstances permit.

When the I.F. circuits have been adjusted the oscillator trimming must be tackled. Connect up the testing-oscillator leads to the A and E terminals, as described for the ganging of a straight receiver, and take away the shunt condenser which was temporarily connected to the oscillator circuit.

Check the pointer setting of the receiver.

The medium waveband should be dealt with first, and it is to be assumed that the rest of the adjustments described below apply to the one waveband. Apply a test signal as you would for a straight receiver, and turn the main tuning control of the receiver to the dial reading corresponding to this. Start with the oscillator trimmer of the receiver at minimum capacity and increase the capacity until an output-meter peak is obtained. By commencing at the lowest capacity and stopping at the first peak setting, the risk, which arises in some cases, of tuning to the second channel oscillator frequency will be avoided.

The oscillator circuit must now be left severely alone while the signal-frequency circuits are lined up in the normal manner.

This brings the position up to the matter of oscillator tracking. By the process already gone through the difference between the signal and the receiver oscillator frequencies has been made equal to the intermediate frequency. It is necessary that this relationship shall hold reasonably closely all over the waveband. When the ganged condenser has identical sections the "tracking" of the oscillator is secured with the aid of extra series capacity in the oscillator circuit. In some receivers, and on certain wavebands, the series-tracking condenser will be a fixed condenser. In such a case, if there is no component defect and the right value of the I.F. has been used, the tracking will come right when the oscillator trimming has been done. Assuming, however, that the tracking condenser is variable, it should be adjusted on a test signal near the top end of the waveband. The tracking condenser should be adjusted for a peak response on the output meter, and since it is most important not to disturb the settings of the trimmers while this job is being done, it is advisable to rock the main tuning control of the receiver slightly and obtain the best combination of

tracking condenser and tuning-control settings. The adjusting of the tracking condenser is liable to affect the optimum setting of the oscillator trimming condenser, and a return should therefore be made to the lower end of the waveband and the oscillator trimmer readjusted, if necessary.

Many receivers contain ganged condensers in which the oscillator tuning section differs from the others in the respect that it has specially shaped plates designed to give the correct oscillator tracking without it being necessary to use an additional series tracking condenser. "Shaped

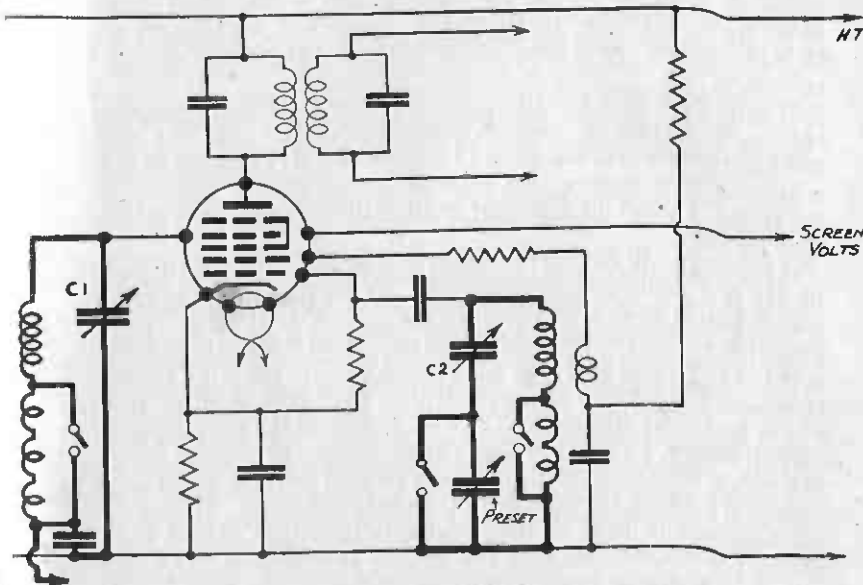

FIG. 181.—This skeleton diagram shows a superhet frequency-changer stage, with C1 and C2, the two-gang tuning condenser.

plate tracking," however, normally only holds good over one waveband (usually the medium), and extra tracking condensers are brought in for other wavebands. In a case of this nature the oscillator adjustment on the medium waveband is merely that of trimming, but other wavebands will involve both trimming and tracking adjustments.

Dealing with the general matter of reganging a superhet, it is to be understood that once the receiver has been adjusted right through on one waveband, the I.F. stages are finished with. The other wavebands, however, must be dealt with individually, as far as signal frequency and oscillator circuit adjustments are concerned.

Faults Which Affect Ganging.—There are two possible ways in which faults affecting ganging may show up. In one case it may be

found impossible to get an optimum adjustment on a trimmer. In the other case it may be found that while the receiver will gang up perfectly on one test frequency it gets out of gang at other frequencies. This type of trouble can occur with straight receivers just as much as with superhets.

When searching for faults affecting ganging, all coils and condensers associated with the high-frequency circuits must be regarded as potential trouble points. It is to be assumed, however, that any such drastic types of fault as breaks or short-circuits would most probably have drawn attention to themselves before one would have got so far as to bother about ganging. A disconnected trimmer is a possible exception.

If any particular circuit refuses to give satisfactory response to trimmer adjustments, common sense will suggest that the trimmer itself and its connections should be inspected. If these are in order it is reasonable to assume that there is excessive shunt capacity across the circuit. A bad displacement or alteration of wiring may be responsible for this.

If ganging will not hold constant over a waveband the trouble may be due to a faulty ganged condenser. If the plates have been abnormally bent, if there is end play on the spindle, or if a set of "fixed" plates has shifted position (sometimes the "fixed" plates are adjustable) it is not to be expected that the various circuits tuned by the ganged condenser will keep in line, even if they have been lined up properly at one particular frequency. Close inspection of the ganged condenser may, therefore, be worth while. Certain ganged condensers have split end vanes, the segments of which can be bent to bring about capacity matching between the sections of the whole condenser. If, due to mishandling, one or more of these segments have been shifted from the proper position, trouble with the ganging is inevitable. The occasion calls for the job of bending the offending segments back into place. In a bad case it will be necessary to go through a series of ganging-check processes, working the condenser round from minimum to maximum and segment by segment and to make trial-and-error adjustments of the end vane segments until the matching is secured.

Tracking Adjustments.—In the case of the superhet oscillator circuit, bad tracking may be experienced and there are a number of possible types of fault which could be responsible for this. A defect in the oscillator section of the ganged condenser is, of course, a possibility, and so is that of a defective oscillator coil. Where fixed tracking condensers are used it will need no more than a capacity change of one of these to throw the tracking out. Incidentally, it will sometimes be found that a combination of a fixed and variable condenser is used for tracking. If, when carrying out tracking adjustments, it is found that the variable condenser will not give a peak setting, then the fixed

condenser associated with it should be suspected before anything else. (Fig. 181.)

It should be noted that the tracking will be wrong if the oscillator has, by some mischance, been tuned to the wrong beat, and the advice given earlier in this article to work from minimum capacity of the oscillator trimmer towards the first peak setting is important, although it must be admitted that in some cases it would not be found possible to tune to the second peak. However, it is as well to be careful on this point.

If coils have become unmatched there may be a little difficulty in locating the faulty one, although probably the clue will be obtained from the behaviour of the trimmer in the circuit which contains the faulty coil. Any suspected coil should be closely inspected for such faults as displaced turns, loose turns, or turn-insulation defects. With certain kinds of iron-core coils it is possible for trouble to be produced by a core displacement.

If any particularly obstinate case is met with when endeavouring to find the cause of ganging defects, the possibility of valve trouble may be well worth investigating. Due to the effects of inter-electrode capacity the valves do have an influence on ganging adjustments and it is even possible that incorrect valve-operating voltages may indirectly have some effect on the ganging. Again, the anode by-pass condenser associated with triode detectors has a bearing on the actual tuning of the grid circuit and should not be overlooked in a troublesome case.

Dial Readings.—Check the pointer setting of the receiver. This is an important matter as the ganging work can be rendered unnecessarily tricky if the pointer is not set properly relative to the rotor of the ganged condenser. Adjust the oscillator frequency to the chosen test value and turn the receiver tuning control to the dial reading appropriate to this frequency; also adjust the oscillator's attenuator control to give a suitable initial reading on the output meter.

The next move is to make the actual trimming adjustments. If the receiver employs reaction it is advisable to do the trimming with the reaction control advanced to a setting that the user would normally employ when searching for distant stations. The first trimmer to be adjusted should be that associated with the detector input circuit, and the other trimmers should be adjusted in turn, working back towards the aerial. Each trimmer should be adjusted to give a definite peak reading on the output meter. If, as progress is made, the meter reading starts to get high on the meter scale, cut down the oscillator output accordingly. Should the receiver jump into oscillation, reduce the reaction setting.

If it is found that one trimmer has to be adjusted to minimum or maximum without reaching a "peak setting" try adjusting the trimmer while the main tuning control of the receiver is varied slightly each way.

If an optimum setting of the trimmer can be found with the main tuning control slightly altered, leave the latter at the new setting, and attend to the trimmer adjustments all over again. The point here is that the initial setting of the ganged condenser may have been slightly out, particularly if the dial is not very accurate, or if the pointer setting is not critical.

When every trimmer has been given a definite optimum adjustment the ganging should be in order for the waveband concerned. To make sure that all is well, however, the following checks should be made: verify that the receiver has not been lined up with a little too much capacity in all the trimmers, by setting the receiver tuning to the lowest wavelength of the band and resonating the test oscillator to the receiver. The oscillator should be at a frequency corresponding to this wavelength. Check up on the matching of coils and ganged condenser sections by testing the trimmer settings at a wavelength, say, about half-way up the waveband, but be careful that the trimmer adjustments are left at the optimum setting found at the higher test frequency.

A Possible Problem with the Superhet.—If the other wavebands of the receiver involve separate trimmers each of these wavebands should be dealt with in the manner described. With most M.W./L.W. straight receivers, however, ganging on the M.W. band will be all that is necessary.

It will be noted in the foregoing that single peak indications on the output meter have been adjusted for, and it will be unusual if the adjustments are not satisfactory with a straight receiver of average type.

There are certain peculiarities in the case of ganging a superhet receiver. The I.F. stages must be attended to before any other sections of the receiver, and if the I.F. value is not known, the best thing to do is to apply an I.F. test signal from the testing oscillator and to tune the oscillator to give maximum response through the I.F. stages. Ignoring the possibility of the receiver adjustments having been tampered with, it is fairly reasonable to hope that all the I.F. circuits will not be so badly out of adjustment that the test oscillator frequency giving the maximum response will not at least be somewhere near the correct value.

Once the question of I.F. value is settled, the ganging of a superhet, although more involved than in the case of a straight receiver, is not to be regarded as complex. The only difficulty (and only in certain cases) may be that already touched upon, namely, that of getting the right shape of response curve.

Distortion.—There are two different types of distortion. One is frequency distortion, which is produced by the receiver giving disproportionate amplification to different frequencies, i.e., "cuts" high notes, exaggerates high notes, shows frequency resonances, etc. It must be understood that frequency distortion is to be expected of every receiver of average type, and that it is to be regarded as a fault

only when the distortion is greater than normal. Incidentally, if frequency distortion is greater than normal a non-technical owner of a receiver does not usually say that the receiver is distorting. "The tone has become poor" is the complaint usually made.

The other kind of distortion is amplitude distortion. With this type of distortion the modulation waveform of the signal is so badly treated by the receiver that alien frequencies are introduced and the sound emitted by the speaker thus contains components not present in the original. Very little amplitude distortion can be tolerated without the reproduction being considered definitely most unpleasant. Amplitude distortion will occur as a result of valve overloading; speakers, too, can become overloaded if too great an input is applied and will produce amplitude distortion. With some receivers overloading will occur if a local station is tuned in and the receiver worked at the fullest volume of output. It would not always be fair to the designer, however, to regard such a case as that as a fault.

The minimising of frequency distortion is very much wrapped up in the design of the receiver. The high-frequency response, the proper matching of valve and anode load impedances, the correct choice of a large proportion of the fixed condenser values, and, of course, the design of the speaker, are all matters that have a bearing on audio-frequency response. Certain receivers will be found to contain tone correcting devices. The most familiar example is that of the compensating condenser, or condenser-resistance combination, shunted across the primary of the output transformer when a pentode output valve is in use in the output stage. Naturally, tone correction arrangements should be viewed with the eye of suspicion if frequency distortion is bad.

To deal generally with the procedure in tracing causes of distortion—if there is no particular clue immediately apparent—it will be advisable to check up on the valves and the valve operating voltages, as a first move. It is important to check up on the operating conditions of the valves as in some cases quite a small departure from normal will introduce distortion. The process of valve and valve voltage checking will amount to a check up on quite a large number of fault possibilities. With push-pull, Class B or Q.P.P. output stages, a special watch should be kept for any signs of inequality in the two halves of the system. A milliammeter test in each output anode circuit in turn should be made if there is any doubt on the matter.

If the valves are in order and have been proved to be working under correct voltage conditions, and if the trouble is that of amplitude distortion it is high time to consider the speaker as the possible seat of the trouble. There may be a damaged cone (or cone suspension). With a moving-coil speaker there may be filings or other particles in the gap, speech-coil former off centre, or loose speech-coil turns. Such faults as

shorting turns in speaker or output transformer windings are to be mentioned, although these would probably call for investigation more on the score of weak reception. A similar remark applies to the possibility of a weak magnet with a P.M. speaker.

If a receiver incorporating A.V.C. shows evidence of excessive valve overloading although the valves are in order, there is every possibility that something has gone wrong with the A.V.C. system. All resistances, condensers, and connections associated with the A.V.C. network should be checked over.

The cause of excessive frequency distortion is not always easy to find. As regards a detector or L.F. stage it will be advisable to check all resistance and capacity values and the resistances of any transformer windings should also be closely checked.

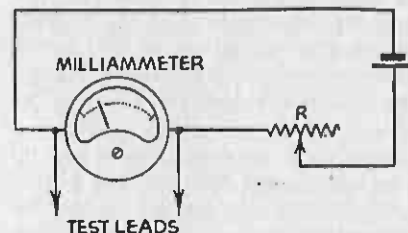

FIG. 182.—Method of using a milliammeter for low-resistance testing.

There is a great difference between a low-resistance coil in normal condition and the same coil with a number of the turns shorting, yet the difference would not be appreciable on an ohmmeter test if the instrument were not designed for low-resistance measurements.

If any reader is experiencing difficulty where low-resistance tests are concerned, but possesses a low-resistance milliammeter, he can very easily make a device which will give comparative indications on low resistances.

In Fig. 182 a milliammeter is shown connected up to a D.C. voltage source through a variable resistance. The latter should be adjusted until the meter is giving full scale reading.

Suppose the milliammeter happens to be a 0-30 mA. instrument with a resistance of 5 ohms. If a 5-ohm shunt were placed across the meter the reading would fall back. As to the exact position where the needle will settle, this will be partly dependent upon the value of R and the voltage regulation of the supply, but it will be somewhere above the 15 mA. scale reading. A 4-ohm shunt would give a lower reading; a 3-ohm shunt lower still, and so on.

Thus we have got an arrangement whereby different low resistances will give certain and different meter readings. Furthermore, with decreasing values of shunt resistance readable indications can be obtained down to a minimum value that may be regarded as surprising by those who have not used such a device before.

To use the arrangement as a testing device two extra leads should be taken from the milliammeter terminals and used as the test leads. For making comparative tests the device can be used as it stands; for actual resistance measurements calibration would, of course, be necessary. The lower the resistance of the meter the lower will be the minimum value of resistance that will give readable indication on the meter. The usual care to guard against meter damage should be exercised during the rigging up of the arrangement and the initial adjustments.

Poor Selectivity.—The overall selectivity of a receiver is something upon which each of the H.F. tuned circuits has a bearing. Thus, when the selectivity of a receiver is below normal it is necessary to take an interest in any factor that affects the selectivity of each individual H.F. tuned circuit. The superhet receiver has certain selectivity peculiarities of its own, but these will be dealt with later.

If selectivity is below normal a ganging check may be useful in some cases, not only because the actual trouble may be directly associated with ganging adjustments but also because the effect of some particular test readjustment may give a clue as to the particular circuit which contains the fault.

It is a fundamental fact that the selectivity of any given tuned H.F. circuit is lower the greater the effective H.F. resistance of the circuit. Very frequently the search for the cause of low selectivity will develop into a hunt for a fault that is putting up the H.F. resistance of a circuit. It is important to note that the H.F. resistance of a circuit can be increased either by an increase of resistance in series with the circuit, or by a reduction of resistance in shunt with the circuit. Thus it is necessary to take into account not only the series circuit itself but also all components which are connected, either actually or effectively across the circuit.

The possibility of a valve being to blame must be allowed for and this, again, is one of the occasions when valve substitution may solve the problem.

If the valves are O.K. and it has come to a case of trying to track down the cause of excessive damping in some particular H.F. circuit the actual procedure will be greatly dependent upon the actual arrangements of the circuit and the accessibility of the various parts. If the circuit has M.W./L.W. switching (shorting out the L.W. winding on the medium range) and the selectivity is below normal only on the medium-wave range the switch contacts should be closely examined. Any excess resistance in the contact must inevitably have a bad effect upon the medium-wave performance.

Superhet Peculiarities.—With normal reception the I.F. amplifier of a superhet receiver is fed by the frequency-changing stage with a signal, the carrier frequency of which is the difference between the

wanted signal carrier and the local oscillation fundamental frequencies. The I.F. stages, although selective, give no discrimination at all between an input signal properly produced as described above, and any other signal at intermediate frequency which may be produced by signal combinations other than that of the wanted carrier and the oscillator fundamental. For example, if the difference between an unwanted carrier and the local oscillation frequency comes within the range of the I.F. amplifier the latter will, unless prevented, amplify the resulting I.F. signal just as readily as the one produced by the wanted signal.

Thus, with the superhet principle of operation, there is the danger that undesirable frequency combinations may produce I.F. signals, and it is to be noted that the I.F. amplifier itself offers no protection, apart from its normal selectivity. It will be obvious, therefore, that the selectivity of the signal-frequency circuits (i.e., those in front of the frequency changer) is a matter of very considerable importance, in view of the fact that it governs to a great extent the number and amplitude of unwanted signal frequencies reaching the frequency changer.

If the I.F. amplifier does happen to be carrying more than one I.F. signal, then the beats between these will be taken by the second detector and L.F. section of the receiver to produce a whistle in the speaker.

Second-channel Interference.—The interference case already mentioned, namely, that of an unwanted signal combining with the local oscillation fundamental frequency to produce an I.F. signal, is the well-known "second-channel" case. When the receiver is tuned to a wanted station the frequency of the latter is, in all normal cases, below the local oscillation frequency by the amount of the I.F. value. Second-channel trouble, if present, will be caused by an unwanted station above the frequency of the local oscillations by the amount of the I.F. value.

There are a number of other whistle possibilities. If the oscillator has any pronounced harmonics an unwanted signal and an oscillator harmonic may combine to give an unwanted I.F. signal. Combinations of incoming signal frequencies may give unwanted I.F. signals (without the oscillator coming into account). Harmonics in the frequency changer open up further possibilities.

We must now proceed to tackle the case of the superhet that is producing whistles. It must be noted that the progress of superhet design during the past few years has included whistle reduction among the improvements made, and that where a superhet of early design is concerned, the case may be one where it is not so much a matter of a fault as that of the "vintage" of the receiver.

Eliminating Whistles.—First and foremost a ganging check is most important. As far as second-channel interference is concerned, some receivers incorporate special suppression-coupling systems, so, in these cases, the suppression system should be very carefully gone over if second-channel trouble is experienced. This is really a case where it is

important to have the receiver service manual in order that the exact signal frequency-coupling arrangements can be closely studied.

Valves and valve-operating voltages must (yet again) not be ignored, particularly as excessive harmonic generation is a fruitful source of whistle trouble. In view of what has been stated about the signal-frequency circuits, it will be realised that any faults which lower the selectivity of the signal-frequency side of the receiver will tend to cause trouble, so every care should be taken to make absolutely certain that the signal-frequency circuits are in order.

Apart from the causes of whistle generation already mentioned, there are two others. First, there is the "common or garden" case of H.F. instability, and this should be handled in the manner described earlier. The remaining case is one that can be quite troublesome. The importance of keeping high frequency out of the L.F. section of any receiver, owing to the possibility of feed-back to the earlier stages, has already been emphasised. In the case of the superhet receiver it is not so much a feed-back of the fundamental intermediate frequency which will cause trouble as a feed-back of the harmonics of the I.F. Any H.F. filtering arrangements associated with the second detector are, therefore, items to suspect if there is trouble on the above score; also screening generally.

Mains Hum.—In view of the fact that a mains receiver contains components (the smoothing components) specially concerned with the minimising of hum, it is obvious that, when hum is experienced, these are the very first items to check.

An open-circuited smoothing condenser is a simple fault that can cause hum. Shorting turns in a smoothing choke (or field winding, if this is used for smoothing) is another possibility. Both these faults can be easily checked by test. If the smoothing system is in order, valves should be the next to receive attention; in particular, an insulation failure between heater and cathode of an indirectly-heated valve may be the fault.

Other possibilities are a breakdown of one half of a centre-tapped filament potentiometer, or wrong adjustment if the latter is variable. Mains-transformer insulation defects can be responsible for hum, but it is to be expected that such a type of fault will come up for investigation upon some other score than hum (possibly smoke).

There are many possibilities involving inductive coupling between the mains transformer and an L.F. transformer, or even grid wiring, which need hardly be anticipated with commercially-built receivers, but the point may be worth considering if any non-standard replacements have been made in the receiver. There is one cause of hum which is particularly exasperating, and that is the case where excessive hum only comes on when a signal is tuned in. This case is called modulation hum, and is dealt with in Chapter XXVII on Hum Troubles.

CHAPTER XXX

SERVICING COMMERCIAL RECEIVERS

THE types of defect that can cause trouble in radio receivers are quite small in number compared to the number of possible faults. If the word "fault" is used in the sense as normally understood by technical people this statement is not as paradoxical as it may seem at first sight. A high-resistance soldered joint (dry joint) is a well-known defect but a dry joint at one end of a bias resistance must be regarded as a very different fault to a dry joint at one side of an I.F. trimming condenser. So very great is the number of fault possibilities that it is a useless proposition to attempt to draw up a comprehensive list of faults with their symptoms, quite apart from the fact that combinations of faults can occur simultaneously, with correspondingly complex results.

A defect which, in itself, is simple enough may not always be very easy to track down, particularly if the fault symptoms do not give definite indication as to the type of defect, and its probable position. For any measure of success in fault tracing, it is absolutely necessary to work systematically, and one of the secrets of rapid fault tracing is that of dividing the work into distinct sections, each with a definite purpose. An example of a typical plan of campaign is:—

1. Ascertain the general fault symptoms and decide, as far as possible, what sections of the receiver are faulty.
2. If the fault symptoms are of multiple character, pick on one particular symptom feature as the first item requiring clearance.
3. Localise the particular circuit containing the fault concerned.
4. Trace the fault itself.
5. Clear the fault.

If there are still other faults remaining, start over again at 1, and so on. There are exceptions to every rule, and it is not always possible to adopt the actual plan outlined above, but every effort should be made to get on to some such scheme whenever circumstances permit.

Tackling the Dead Receiver.—We assume the case of the receiver that gives no radio reception on any waveband. Adopting a very broad classification of the fault possibilities these can be regarded as being in three groups:—

1. Battery supply faults, or mains supply faults ;
2. Valve faults;
3. Faults in other components, or wiring.

The first move should always be to check up on possibility No. 1. Meter tests are not always necessary at this stage for it may be obvious

immediately upon switching on the receiver that voltage supplies are not lacking. No doubt should be permitted upon the matter, however.

The next move should be to check the output stage, including the speaker, for "life," and attention should not be withdrawn from the output stage until it is known that it is capable of responding to an L.F. input. The trouble with the receiver may prove to be in the output stage, or may be detected while the output stage is being tested, but if such is not the case the next job is that of locating the faulty stage.

There are various ways in which this can be done, the best method being determined by circumstances. Sometimes whole sections of the receiver can be checked by quite simple tests involving no testing gear. For example, if a straight receiver is provided with reaction in the detector circuit, and it is found that operating the reaction control produces the familiar sounds in the speaker caused by the receiver jumping into oscillation, then it is fairly reasonable to assume that the detector valve itself, and all sections of the receiver following the detector, are in order. Again, bringing the aerial lead forward, circuit by circuit, towards the grid circuit of the detector as is explained in another part of this book, may enable trouble on the H.F. side of the receiver to be located. By applying modulated oscillations, at I.F. frequency, direct to the I.F. stages the latter can be checked over for response without any dependence having to be placed on the actions of the receiver oscillator and signal frequency stages. If the I.F. and receiver oscillator stages are known to be in order, the signal frequency stages can be checked by employing the output of the testing oscillator, at signal frequencies.

The possibility of the receiver oscillator being out of action must never be overlooked where the case of a dead superhet is concerned, but it is advisable to make quite certain of the I.F. stages before going to any trouble in checking up on the receiver oscillator section. If it appears probable that the receiver oscillator is out of action a valve test should be made, or a substitution valve tried, and if there is no valve fault a test should be made for H.T. on the oscillator anode. If this proves to be present there are now the alternatives either of making a close search for fault in the oscillator circuit, or of making absolutely certain first that the oscillator really is out of action. If the exact arrangements of the oscillator stage are familiar and coil ends, etc., are readily accessible it may pay to test round for a fault immediately the suspicion arises that the oscillator is out of action. If, however, there is any uncertainty as to the oscillator arrangements, or if the oscillator coils and condensers, etc., are very inaccessible, then it may be advisable to prove definitely that the oscillator is not generating before exploring the "works."

Anode Current Value.—The fact that the mean oscillator anode current when the valve is oscillating differs from the current value when the valve is not oscillating indicates one possibility of testing for the

by means of an oscillator and an output meter, but when the set was tried out on ordinary broadcasting transmissions with a good aerial whistles occurred all round the dial and reception of the local stations was almost impossible due to very severe distortion. The latter of course provided a very important clue to the cause of the whistles. It was not due to misalignment of the tuned circuits, but to overloading of the first detector. A very short aerial (just a yard of wire attached to the aerial terminal of the receiver) gave perfect reception of the local stations and the set was free of all whistles except the two normal second-channels to be expected at 323 metres and 450 metres, but of

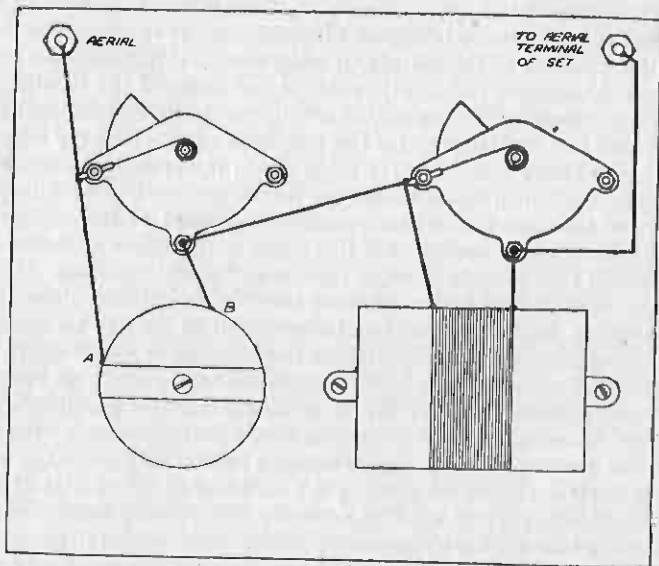

Fig. 183.—A twin wavetrapped for removing second-channel interference on medium waves. A, Beginning of winding; B, End of winding.

course strength of foreign stations was greatly reduced. While a "local-distance" switch would, at first sight, appear to answer the purpose in a satisfactory manner, it was soon apparent that, although this would render undistorted reception of the local stations possible, it could not do anything towards removing the whistles. What was wanted was something that would reduce the strength of the locals without affecting other stations.

Many readers will remember the days of the wavetrapped, and if they suffer from second-channel interference with their modern superhet, they should not hesitate to visit their "junk box" and fetch out a wavetrapped. Insert it between the aerial and the receiver, tune the set to the

local station, and then adjust the wavetrapped for minimum signal strength. It certainly affected a complete and lasting cure in the case of the superhet referred to above, and had but little effect on transmissions of near wavelength to the locals. For instance, Radio Normandy is received at very good strength free of London National, while Hamburg is still a very good station just clear of London Regional.

A Twin Wavetrapped.—If there are two local stations, as there were in the case referred to above, a twin wavetrapped should be used. This was made up of two coils of about 50 turns of wire each wound on 2½ in. diameter formers, and each tuned by a .0005 mfd. bakelite dielectric condenser.

The condenser is connected right across the winding in each case, so that it tunes the whole coil. One end of the first coil is connected to the aerial and one end of the second coil to the aerial terminal of the set, the free ends of the two coils being joined together. The whole assembly is mounted on a small baseboard with the axis of the coils at right angles to prevent interference and breakthrough. The sketch (Fig. 183) makes the whole assembly very clear.

Tune in one of the local stations, and adjust one wavetrapped condenser for minimum response. Now tune in the other local station and repeat the procedure with the second condenser. This will result in the strength of the local stations being reduced and will therefore remove the second-channel whistles caused by them.

So far we have only considered an intermediate frequency of 110Kc,

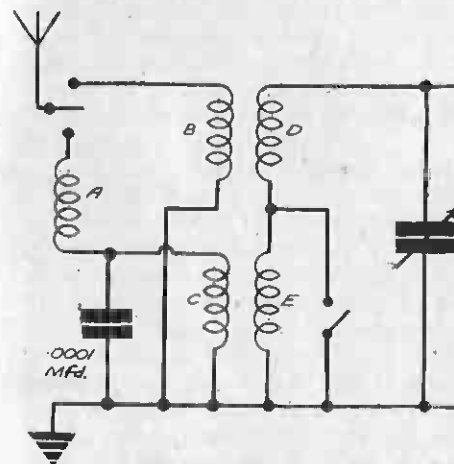

Fig. 184.—Circuit diagram of a 465Kc long-wave filter applied to an H.F. transformer; A, I.F. filter coil; B, Medium-wave coupling coil; C, Long-wave coupling coil; D, Medium-wave tuning coil; E, Long-wave tuning coil.

and its effect in producing whistles. It is apparent that if we can arrange the intermediate frequency so that these second-channels normally produced fall outside the normal broadcast wavelengths, then we can produce a set which will be free of whistles. This gave rise to the development of an I.F. of 465Kc, and this frequency is now being widely used, as it renders the medium wave band free of second-channel interference, and enables the H.F. circuits to be much simpler. In fact it is common practice with a 465Kc intermediate

CHAPTER XXXI

SECOND-CHANNEL INTERFERENCE

THIS Chapter describes various ways and means of counteracting this form of interference in superhet receivers.

The most popular receiver to-day is undoubtedly the superhet because of its great selectivity and range. Nevertheless, it suffers from a rather serious snag—that of whistles appearing at various settings of the dial. These are caused by the actual process of frequency changing.

A powerful station (usually the local) can produce even a small voltage at the grid of the frequency changer when the set is tuned to a station widely differing in wavelength from that of the local; and if this difference in wavelength happens to be equal to, a product of, or even an harmonic of the intermediate frequency, then a beat note is obtained, and a whistle is audible.

When the intermediate frequency is, as it usually is, 110Kc, it is apparent that when the oscillator is tuned to 1101Kc, stations of wavelengths corresponding to 1000Kc and 1220Kc will both produce the required intermediate frequency of 110Kc. Interference will result and, if the unwanted transmission happens to be very powerful, then the interference will be serious and a loud whistle will be heard.

The obvious remedy for this trouble is to introduce sufficient selectivity in the H.F. circuits to prevent the unwanted signals occurring at the grid of the frequency changer valve when the set is tuned to the desired transmission. Unfortunately, if the unwanted signal is the local station, second-channel interference is almost inevitable, as it is not a practical proposition to introduce sufficient H.F. selectivity.

In London the frequency of the two local stations (London National and London Regional) is 1149Kc and 877Kc respectively, so that with intermediate frequency of 110Kc, second-channel interference will occur at 929Kc and 677Kc, the oscillator being tuned to 1039Kc and 777Kc respectively. This interference corresponds to wavelengths of 323 metres and 450 metres approximately, and if these are the only whistles that occur, they are not of very great importance.

Selective Tuned Circuits.—A complete remedy lies in the provision of several highly selective tuned circuits prior to the first detector valve, but this is an expensive proposition and not worth while, and it also removes the advantage of a superhet in giving a high degree of selectivity in a simple and cheap manner through the action of the I.F. circuits.

Experience has shown that two H.F. tuned circuits (either of the band-pass type or two single circuits coupled by an H.F. valve) are sufficient to remove all whistles other than those caused by the local station. Even two local stations should produce only two whistles, corresponding to received transmissions lower than the frequency of the local stations by twice the intermediate frequency.

It sometimes happens, however, that whistles are produced all round the dial. If these do *not* disappear when the local stations are closed down, then they must be due to H.F. or I.F. instability and are outside the scope of this chapter. If, however, no whistles are apparent when the local stations are not working, then it is safe to assume that they are caused by second-channel interference. It is important before tackling a problem of this nature to make sure that it is second-channel interference, and not instability which is the cause of the trouble.

Correct Ganging Necessary.—Having seen that second-channel interference can be removed by the provision of extra highly selective circuits, it follows that the first thing to do is carefully to check the ganging of the tuned circuits and get this as accurate as possible, and also to see that the I.F. transformers are adjusted to the correct frequency. It is very possible that this check will provide more accurate ganging and that greater freedom from whistles will result.

Many readers will no doubt have had the experience of continual retrimming of the H.F. circuits and adjustment of the I.F. transformers without any appreciable reduction of the number of whistles. If they are situated near a powerful local transmitter they are almost bound to have come across this effect, which is caused, not by misalignment of the tuned circuits, but by overloading of the first detector by the local station (or stations). With a good aerial, a local transmission can easily impress anything up to 20 volts R.M.S on the grid of the first detector and part of this voltage must of necessity always be present whatever the setting of the tuning condensers. When this is added to the voltage of the received station it is apparent that overloading will easily occur and cause whistles.

Reducing the input to the receiver, either by using a shorter and less efficient aerial system, or by inserting a small condenser in series with the existing aerial and the receiver, will effect a cure, but it will of course reduce the strength of all stations in the same proportion, so that more post-detector amplification will in all probability be necessary. Where A.V.C. is fitted, the set will, because the input is reduced, have to work under more sensitive conditions. The controlled valves will amplify more with the result that valve hiss and atmospheric will be increased and reception badly marred.

Avoiding Overloading.—A case in point was a superhet, with an H.F. stage preceding the first detector, in use in London. The I.F. transformers and the H.T. tuned circuits had been accurately adjusted

human voice. For example, the range of the human voice is from about 60 to 1,000 cycles per second, and that of the cornet is from about 150 to 1,200 cycles per second.

It can be seen from the above particulars that by measuring the input to the set in microvolts of a "standard signal" required to produce an output of 50 milliwatts, the sensitivity of any type of receiver can be specified. Moreover, the test indicates the overall efficiency of the H.F., detector and L.F. stages in a "straight" set, or of the frequency-changer, I.F. stages, second detector and L.F. amplifier of a superhet. As the sensitivity of a receiver varies according to the wavelength to which it is tuned, tests must be made at various condenser settings on the various wavelengths covered by the set. The results can then be shown as a smooth curve on graph paper.

Selectivity Curves.—When we come to consider selectivity, the same general rule holds good. In this case, however, two signal generators are used in series; one of these produces an "interference" signal of the form mentioned above, and the other the "required" signal which is not modulated. The only reason for not modulating the latter is that it would then be impossible to measure the output which is representative of the extent of interference. The output is measured first when the two signals are at the same frequency or wavelength, after which the tuning of the "interference" signal is altered above and below the frequency of the "wanted" signal, and the output obtained at various settings of the signal generator is measured. A graph can then be drawn from the results obtained; this is the reverse of the usual "peaked" curves with which most readers are already familiar.

Automatic Volume Control.—The recommendations also cover the measurement of the A.V.C. action of a set, again using the "standard signal." When making the tests the signal input is first set to 1 volt, and the receiver volume control adjusted so that the set delivers one-quarter of its nominal power output, which is normally one-quarter of the rated maximum undistorted output of the last valve. After that the input is progressively reduced in convenient steps, and the output measured at each step. Theoretically, of course, the output should remain constant but in practice it tails off to zero as zero input is reached. Nevertheless, when using a highly-developed modern set, there is only a slight change in output over the first half of the range of input reduction. Results of these measurements can be expressed on a graph, where the vertical ordinate is marked as audio-frequency output, and the horizontal ordinate in radio-frequency input. Alternatively, the result can be given as a fraction representative of the "slope" of the curve at any particular point. In this respect, the expression is comparable with that used to indicate the "slope" of the anode-current-grid-volts curve of a valve (this expression is known as the slope or mutual conductance).

Response and Acoustic Output.—The "Acoustic Tests" include the preparation of a graph to show the change in "loudness" of the output according to the variation in frequency of the signal modulation. This graph takes into consideration the performance of the valves, inter-valve couplings and of the loudspeaker, and is similar in appearance to the curves sometimes given by manufacturers in connection with pickups, microphones and speakers.

Other tests, which are too numerous and involved to be dealt with adequately here, are for distortion, acoustic sensitivity and hum. Some of these are inter-dependent, as well as being calculated by taking into consideration some of the results obtained from the tests described above. They call for a large amount of delicate apparatus, which would be too expensive for other than manufacturers, whilst a considerable amount of mathematics is involved in producing the final figures.

Sufficient has been written to give an outline of the future possibilities with regard to the accurate expression of the precise performance of receivers of all types.

frequency to use only one tuned H.F. circuit, thus dispensing with a coil and a condenser, and making the initial cost of the receiver considerably cheaper.

When we come to long waves, however, the matter is somewhat different. It is possible, particularly near to a local station, for a small amount of medium-wave signal to creep through the self capacity of the coil when it is actually tuned to some long-wave station. Since the oscillation frequency when receiving long waves falls within the medium waveband when using an I.F. of 465Kc, it is clear that any creep through of this nature will give rise to whistles.

Aerial Circuit Filter.—This is minimised by including a filter in the aerial circuit, this filter being switched in only when receiving long waves. This filter only permits signals up to about 350Kc to pass through and hence no creep through of medium wave signals occurs. A coil of about 300 turns layer-wound on a former of 1 in. diameter is sufficient. The size of the coil will vary with different sizes of aerial and different localities, but the actual value required can best be found by trial, it being easy to make a small coil, and then take off a few turns until the correct value is found. The ideal to aim at is a coil of just sufficient size to give good signal strength in daytime without excessive second-channel whistles at night. Fig. 184 shows a suggested method of connecting the filter. Note that the .0001 mfd. condenser is essential. A small mica fixed condenser is the type to use, or a .0002 mfd. pre-set may be inserted, as this will enable accurate control to be obtained.

CHECKING PERFORMANCE

THE Radio Manufacturers' Association has taken an important step by publishing for the benefit of its members two booklets. Both are called "Specification for Testing and Expressing Overall Performance of Radio Receivers"; Part I is devoted to "Electrical Tests", and Part II to "Acoustic Tests". These publications are not intended as instruction to members, but as suggestions, with the object of bringing the tests down to a uniform basis. No doubt the suggestions will be generally adopted, in which case the science of radio receivers will have been taken a step further.

It is not intended to repeat the large amount of information, the various formulae and the graphical expressions of results which are given, but simply to explain in simple language some of the tests which are described. In many cases, the details given are of a highly technical nature, and could not be adequately dealt with in this chapter, but their meaning is interesting and instructive.

Overall Sensitivity.—The R.M.A. suggest that tests for sensitivity of the receiver as a whole should be made when the set is delivering an output of 50 mW—which is the lowest loudspeaker output for entertainment value in the average room of a house. This output is referred to as the "standard" output, and the primary object of the sensitivity test is to measure the signal input, in microvolts (millionths of a volt) required to produce such an output. In theory this is simple enough, but there are many practical difficulties in the way of making the appropriate measurements.

The first is that the output is dependent, not only upon the voltage of the signal input, or of the carrier wave, but also upon the amount of modulation—sound impulses—imposed upon that carrier wave. Thus, it is recommended that the steady signal, which must be provided by a signal generator of accurate design, should be modulated to the extent of 80 per cent. This means, roughly, that the oscillations representing the sound "mixed" with the carrier wave should be of about one-third the strength of the carrier. It is very important that the signal be constant, and this means that it must consist of a single note; an ordinary signal consisting of speech or music would not do, because of its constantly and rapidly-varying intensity. It is also important that the measurement be taken at a standard frequency—a note of uniform pitch. Thus, it is suggested that a 400-cycle note should be employed for modulation. Such a frequency is representative of the average of the notes given by most musical instruments and of the

CHAPTER XXXIII

BACKGROUND NOISES

OWNERS of short-wave sets are often disappointed to find background noises so pronounced that clear reception is practically impossible. The fact must be faced that interference is definitely more troublesome on the short waves, but this does not mean that it is necessary to tolerate incessant "hisses" and "crackles." In most instances it will be found that these unwanted noises have their source in the set, and that they can be prevented.

The fact which must be remembered is that a set operating on short waves is far more sensitive to bad connections and improper contact than is a broadcast receiver. This can often be proved when using an all-wave receiver, for it is noticed that although there is a "background" of silence when the wave-change switch is turned to the medium or long-wave position, this is far from the case when the set is adjusted for short-wave tuning. Some of the trouble is often due to outside sources—such as atmospherics and electrical interference—over which the listener may have little or no control, but on the other hand a pronounced improvement might be possible by carefully checking the wiring and components.

Greater Resistance to Higher Frequencies.—As an example of what is meant, a soldered connection might provide an apparently perfect contact at the lower frequencies (medium and long-waves), whilst it offers a fluctuating resistance of several hundreds of ohms to currents of very high frequency. The very same idea applies to looped connections, for it requires only a small deposit of oxide on the surface of the wire or on the face of a terminal nut to turn a good contact into a distinctly bad one.

When various "hissing" noises are heard it is thus a good plan first of all to disconnect the aerial and earth leads and then to listen carefully while the various controls are operated. Should it be observed that the noises continue it will be evident that the fault is within the receiver. If the noises do cease, and if they cannot be re-started by any adjustment of the receiver, it will be known that interference is being picked up by the aerial-earth system, and that "external" measures will have to be taken. That aspect is not to be considered here, for it has formed the subject of previous chapters, and is in itself somewhat complex. It is, however, worth while before turning attention to the set to make quite sure that the aerial and earth leads are not broken or fractured and that they are properly connected to the set.

BACKGROUND NOISES

Loose Connections.—When it has been decided that the set is at fault the first step is to try tapping it in various places with the hand; if the noise is affected by this treatment a loose connection will at once be indicated. The particular connection at fault can then be found by the simple process of examining all joints in turn. All terminals must

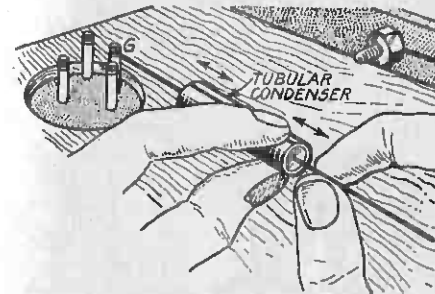

FIG. 185.—See that the wire-end connectors of fixed condensers are not loose and making bad contact by testing to see if there is any possible end movement.

also be checked for tightness, and it must be ascertained that the valves are properly and tightly fitted into their holders. This check might appear to be too simple to warrant full investigation, but it is usual eventually to find that the trouble was due to some very light matter which had been overlooked. Just as with a normal broadcast receiver, terminals, looped wire ends and valve-pins must be seen to be clean, and should be lightly rubbed with fine emery or glass-paper if any doubt exists.

With regard to terminal connections, it is not unusual to overlook the fact that terminals attached to components may themselves not be perfectly tight. Consequently, they should be checked, if necessary removing the components from the set in order to tighten the terminals as well as to examine the leads to them, where these are exposed. It is also wise to scrutinise the windings of coils and chokes when the accumulator is housed in the same cabinet as the set, because it has often been found that acid fumes from the accumulator have attacked and "eaten" the cotton insulated covering. If such windings do appear to have suffered it is best, where possible, to rewind the component; sometimes, however, it will be necessary to fit a new one.

Wire-ended Components.—Another point which is often

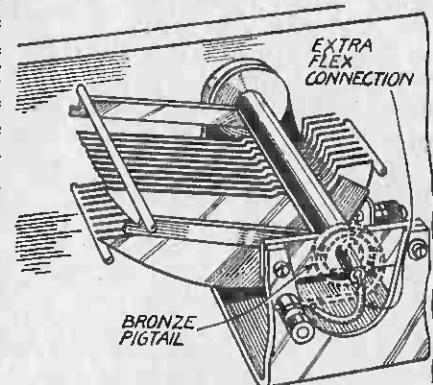

FIG. 186.—In some of the older types of variable condenser connection to the rotor is made by means of a copper spiral. Noise can often be stopped by replacing this with a short length of flex, as shown.

and although this can give rise to distorted reproduction a more serious effect is that the resultant sagging of the speech coil may cause the coil former to foul the sides of the air gap. Again, this may be periodic, occurring only at certain volumes. With some cones it is possible to dry them out, but in most cases a new cone is called for. Re-centring is a difficult task, but may be simplified by slipping strips of card or ivory at three or four points round the speech coil whilst the spider or centring bolt is locked into position. Special small wallets consisting of a number of strips of varying thickness are supplied by Messrs. Holliday and Hemmerdinger and will facilitate this operation.

A broken web on the spider will be obvious and the only satisfactory cure here is to replace it—preferably by a similar spider obtained from the makers of the speaker.

Energised Speakers.—The field winding of an energised model is wound to a definite resistance, and if over-run the covering of the wire may char and eventually give rise to a short-circuit. If this occurs on two or more adjacent turns it will not make a great deal of difference except perhaps to result in a slight rise in temperature. Where, however, the short-circuits effectively cut out many turns the resistance of the field will be reduced and excessive H.T. will be applied to the valves. The increased current resulting from this will cause an

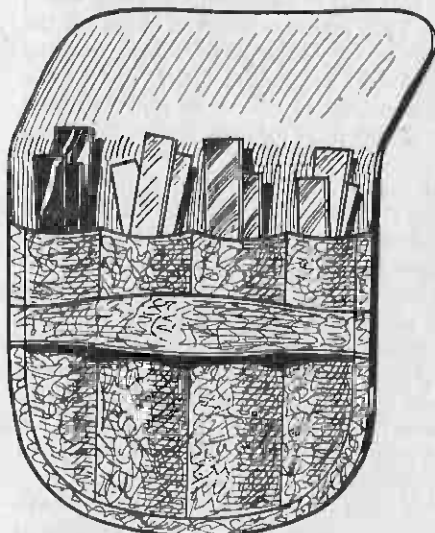

FIG. 188.—A service accessory for loud-speaker repairs.

increase in the temperature of the field and more charring will probably take place. A new field winding is the most satisfactory solution where it is definitely traced to over-heating, but where movement or some other cause has resulted in a slight wearing of the insulation the field winding may merely be impregnated with good shellac or if the coil is unwound a small piece of insulation tape may be wrapped round the defective part. Fairly elaborate apparatus is necessary in order to identify short-circuited turns in a field winding and the use of an ohm-meter which is really accurate will in most cases enable the service-man to ascertain whether or not these exist.

Mis-Matching.—The speaker is generally provided with a matching

transformer mounted on the speaker chassis and this should be suitable for the valve in use in the output stage. Where distortion is present and all normal tests fail to reveal the trouble, the fact should not be overlooked that the output valve may have been replaced by one having a different impedance and thus the speaker is not matched. A good output transformer, with multi-ratio tappings or terminals is a useful accessory for the service-man and will enable him quickly to ascertain

whether the output transformer is at fault. The speech coil leads should be disconnected from the existing transformer and the universal matching transformer then joined to the speech coil and connected in the output circuit.

Where a speaker and receiver combination produces a tone which is too deep, and it is found that this is due to the thickness of the cone, it may be found that modifications in the circuit do not enable the pitch to be raised satisfactorily. A simple remedy in this case is to remove the bolts holding the speaker to the baffle and to replace them, inserting large distance pieces between baffle and speaker. This will leave an airspace between the speaker and the baffle and will serve to raise the tone appreciably in most cases.

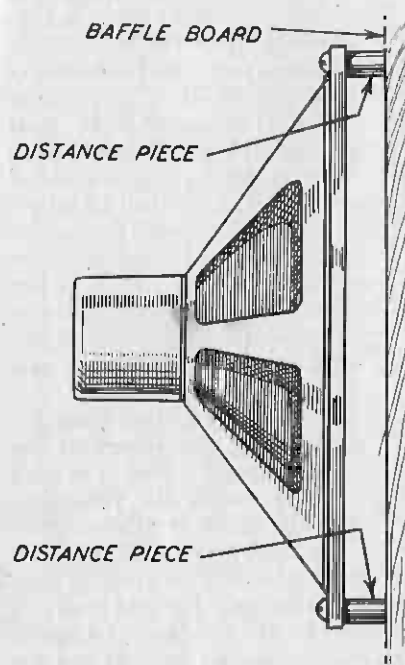

FIG. 189.—Reducing bass response by spacing the speaker from the baffle.

A "Buzz" Test.—Finally, when a speaker is to be tested, one of the simplest methods is to "buzz" it at a low frequency. The standard mains 50-cycle supply is ideal for this purpose and will reveal many faults in a speaker which may not be discernible by ordinary means. To enable the speaker to be used on a mains supply without risk of damage an old mains transformer may be employed. The primary is usually tapped to suit mains from 200 to 250 volts and there will probably be 10 or 15 volts available at one of the tappings when joined to your particular mains. The speaker may be connected to this spare winding or spare terminals as shown in Fig. 198. An excessive voltage should not be employed.

overlooked concerns the wire ends of components such as tubular fixed condensers and fixed resistances. It is by no means rare to find that the wire ends of a condenser have been loosened due to careless soldering or due to their having been pulled loose when fitting the component. As a test the condenser and each lead in turn should be held, a careful note being made of any end movement of the lead. Where this fault is suspected it is quickest to fit a new component—which will probably cost only a few pence.

If it had been noticed that the "fizzing" noises were accompanied by a form of oscillation, special attention should be paid to condensers used for decoupling the anode circuit of the detector or the screening grid of an H.F. valve. If a condenser is used as a by-pass between the detector anode and earth, this also should receive attention.

The Tuning Condenser.—

When the background noises are in evidence only while the tuning condenser is being operated it will almost certainly be found that the friction contact between the rotor and the corresponding terminal is bad. Often the correct method of procedure will be obvious, but if there is no form of tension or pressure adjustment it will generally be found that a cure can be effected by the simple process of applying a trace of graphite grease or graphited oil to the bearing. The oil sold by garages and known as "colloidal-graphite-treated lubricant" is ideal for the purpose, and a spoonful is sufficient to treat fifty condensers.

Where a slow-motion drive is used with the tuning condenser this might be the cause of the noises, since a form of electrolytic action sometimes takes place where there is a friction drive. Any trouble in this respect can be overcome by applying the graphited lubricant mentioned above to all bearings and points of friction contact. In some of the older types of tuning condenser a spiral of wire or flat copper strip is used for making contact between the moving vanes and a terminal. This can cause "noises" if the turns of the spiral touch as the spindle is rotated. The best cure is to replace the spiral by a short length of fairly stiff insulated flex, making sure that the ends are well soldered.

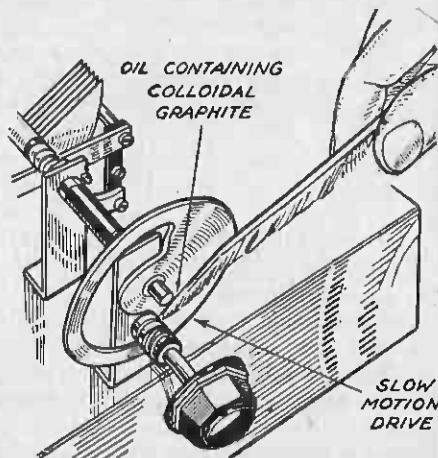

FIG. 187.—Using a feather for applying a little lubricant to the condenser bearing.

LOUDSPEAKER FAULTS AND REMEDIES

WHEN a receiver is being serviced it is often found that all the existing tests fail to reveal anything wrong with the circuit or components. In such a case the speaker will be at fault, and many service-men now adopt the procedure of testing the speaker first—considering this as the weakest link in the chain. There are many obscure faults which may exist in this part of the equipment and which may fail to answer normal tests. Such items as shorted turns on the speech coil or field, for instance, may be very difficult to locate. Dealing with the usual faults in a more or less sequential order, one of the commonest troubles is that which gives rise to what may only be called a "paper and comb" form of reproduction. This may be due to several things, the most usual being a torn cone. This will not be readily seen if the speaker is mounted with its dust-bag intact, and the speaker will therefore have to be dismantled. This should, of course, be the first step in testing the speaker. A tear or rupture in the fabric of the cone should be easily seen unless it occurs round the edge of one of the types of cone which has corrugations round the edge. A careful examination will in this case have to be made and the surrounding frame, with felt ring must be removed. The simplest cure for this trouble is to repair the fracture and in some cases this may be done merely by carefully coating the torn edges with a good adhesive. A patch may be used in some cases but will interfere with reproduction. In some cases, of course, this may be tolerated and only with a quality receiver will it be necessary, unless the fracture is very large, to replace the cone.

Speech Coil and Leads.—In some cases the speech-coil turns may have become loose and can give rise to a similar effect and the remedy is again to re-attach them with a good adhesive. On most speakers two flexible leads are anchored to the cone and taken down to the speech coil, and these should be kept clear of the cone. If, due to mishandling, they have been pushed near to the cone they may vibrate and come into contact with the cone at certain frequencies or at a certain volume and thus give a periodic "comb and paper" effect. Short-circuited turns on the speech coil will upset the matching and give rise to the type of distortion which is experienced with an unmatched output stage, and only by removal of the cone will it be possible to identify this type of fault unless the resistance of the coil is known beforehand and a good ohmmeter is available to read the resistance.

Distorted Cones.—When a speaker has been kept in a damp atmosphere there is a possibility of the cone becoming flabby and distorted

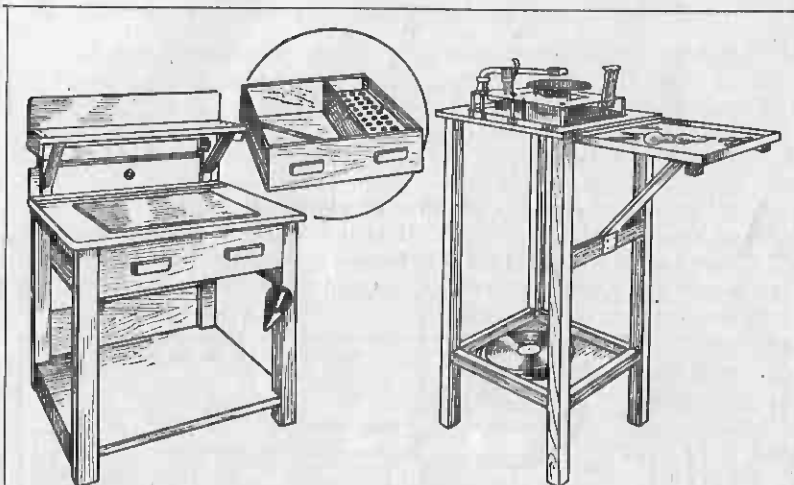

FIG. 192.—Above may be seen two ideal workbenches such as are found in the E.M.I. service range. That on the left is felt-covered to avoid scratching cabinets, and on the right is a gramophone unit for L.F. circuit testing.

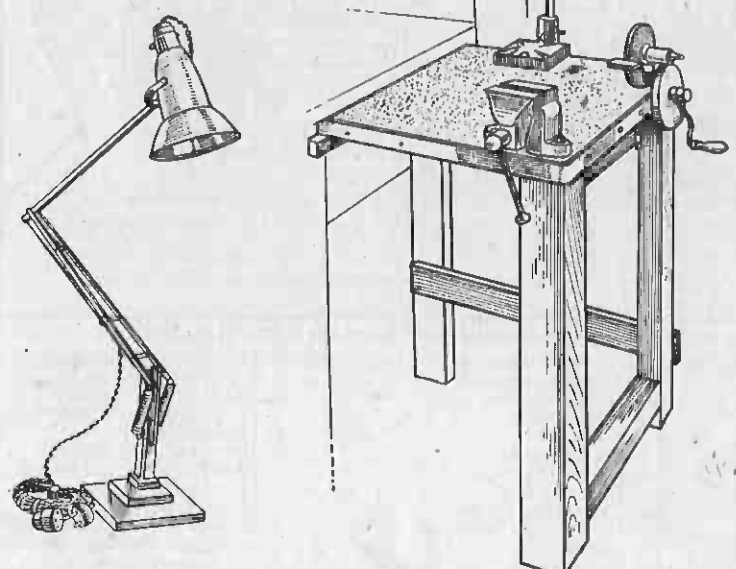

FIG. 193.—Two further valuable service accessories. An adjustable table lamp and an extension bench to carry additional tools.

EQUIPPING A SERVICE WORKSHOP

In this pictorial chart it will be noticed that the various "furnishings" are numbered and indexed, so if we take them in numerical order we will have cleared up most of the points.

Item 1.—The bench, a most important fitting in any workshop. The construction of a bench of this description is very simple, as will be appreciated from the drawing.

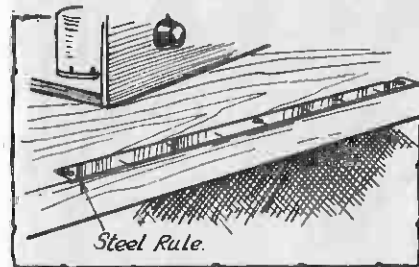

FIG. 194.—A steel rule screwed to the bench is handy for measuring wire, etc.

Whilst it is not necessary to have a very hefty affair for radio work it is as well not to go to the other extreme and have a flimsy one that bends at each saw-cut. The supports should not be less than $2\frac{1}{2}$ in. square and ordinary floor-boarding will be found very suitable for the top. It will be noticed that the bench takes up the whole length of the

wall in front of the window. Although this position is claimed at the expense of a short aerial lead-in, it will be justified by better lighting on the job in the vice.

Item 2.—A cupboard, housed under the bench, will be found very useful for storing the enormous amount of oddments which only a wireless fan can hoard. If this cupboard is judiciously sub-divided a remarkable degree of orderliness may be maintained.

Item 3.—The tool-drawer a "close-up" of which is shown in Fig. 195 is supported on wooden runners which are screwed to the underside of the bench. The sliding tray, shown here, will be found very handy for smaller tools, such as gauges, callipers, small screwdrivers, etc., which otherwise have a nasty habit of hiding themselves under the larger tools in the drawer.

Item 4.—A sheet of zinc covering one end of the bench will be found useful for the soldering department.

Item 5.—The vice. Although this need not be of cumbersome dimensions, for radio work, it is as well to have something fairly sturdy, as some of our jobs (such as metal chassis

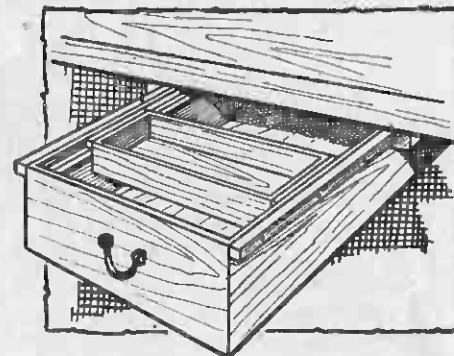

FIG. 195.—The more delicate tools should be kept together in the sliding tray of the tool drawer.

EQUIPPING A SERVICE WORKSHOP

construction) may call for a solid foundation. Just a word about the mounting of the vice. Place it fairly near a bench support for rigidity but not directly over one as some awkwardly shaped job, which we may have to tackle, may require space directly underneath the vice.

Item 6.—A rack for files, screw-drivers and chisels. The latter especially should be kept in this manner, as the cutting edges will soon become sadly out of condition if the chisels are kept in the tool drawer.

Item 7.—The bench stool.

Item 8.—The scrap-box, if regularly and judiciously employed, will maintain the tidiness of the workshop.

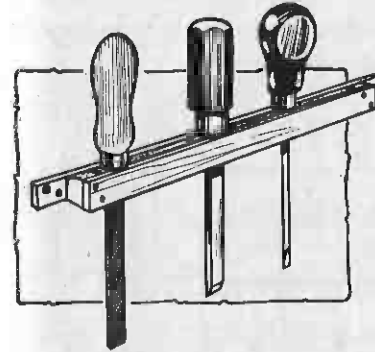

FIG. 199.—A handy rack for files, screw-drivers and chisels.

The Electrical Side.—These items—1 to 8—give us the main essentials for our constructional department. Now let us step into the electrical and testing laboratory. It is here that the fruits of our constructional labours come up for judgment, so let's be fair and give them a good trial.

Item 9.—The testing bench. As may be readily seen from our

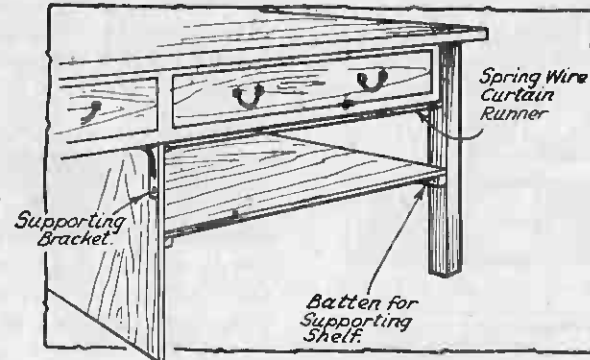

FIG. 200.—The "power-station" or battery compartment.

chart this is really a common or garden kitchen table. A couple of drawers will come in handy for storing our logbooks, slide rules, pencils, pens, and all the "clerical" records of our "works."

Item 10.—The generating station, otherwise known as the battery cupboard, is shown in detail in Fig. 200. The shelf should, for preference,

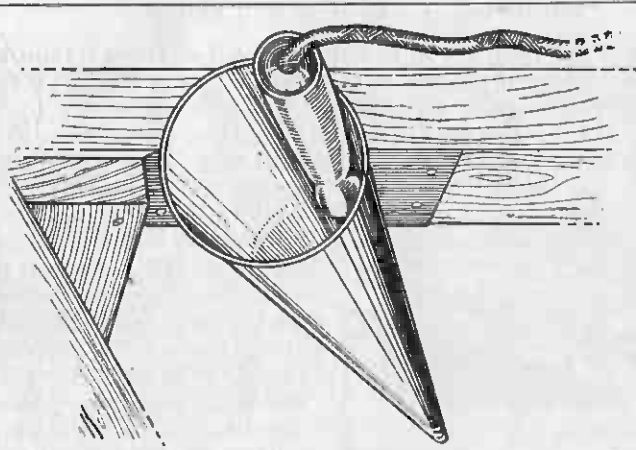

FIG. 198.
A steel container into which the soldering iron may be placed to avoid damaging the bench.

FIG. 196.
Tools in the right place will simplify service work. Here are some hints for creating a tidy workshop. On the left may be seen how to store small tools in holes drilled in the end of the bench. Below is a suggestion for aerial and earth strips to avoid untidy leads.

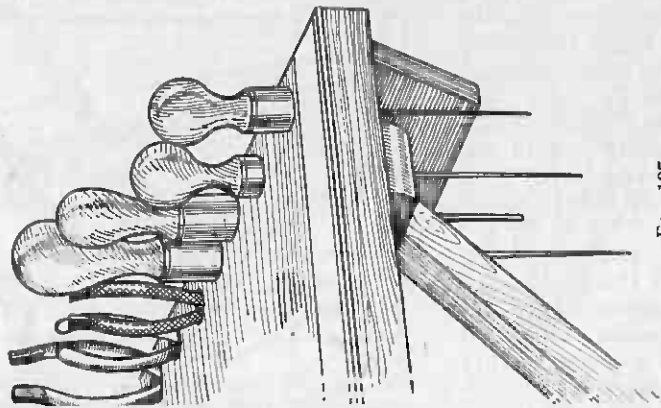
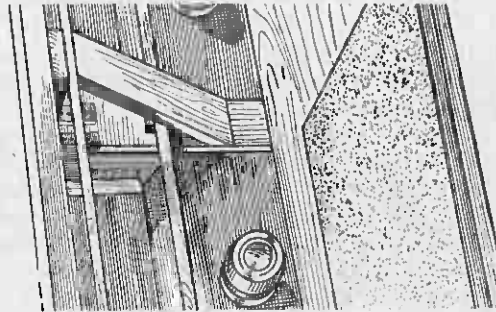

FIG. 197.
A simple form of tool rack for the bench end.

be covered with a sheet of rubber (an old rubber mat will do nicely), so that any acid spill, will do no damage.

Item 11.—The bookshelves, for our works of reference, can easily be put up, and this will complete all the constructional additions to our testing bench.

Item 12.—The power distribution department, or to be more homely,

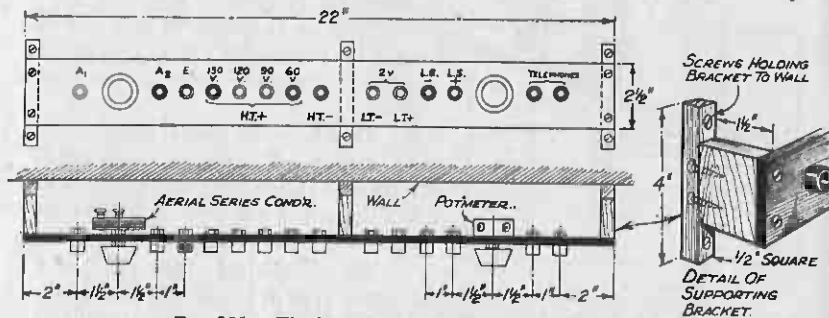

FIG. 201.—The lay-out of the universal terminal strip.

the universal terminal strip. This is simply an ebonite strip mounted on wooden brackets and fitted with sockets. Fig. 201 shows the constructional details and layout. Two refinements will be noted; namely, the aerial series condenser and the potentiometer. The wiring up of the former is shown in Fig. 202, and by this arrangement we can either test a set directly from the aerial (by connecting to A) or through the aerial series condenser by plugging in to A2. The object of the potentiometer will be fairly obvious from Fig. 203. It is wired between the loudspeaker and the telephone terminals, in series and enables 'phones to be used in

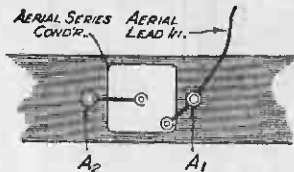

Fig. 202. Connections for aerial series condenser.

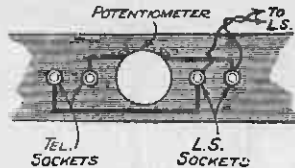

Fig. 203. Connections for potentiometers.

comfort, irrespective of the output of the set. A multi-flex battery cord connects the terminal strip to the power supply and thus a choice of voltages is available for use. The L.T. side may, of course, be elaborated with further plugs and a switch, so that a choice of 2, 4 or 6 volts is available. As most sets incorporate the grid-bias battery, it is not worth while, in view of the additional amount of wiring, etc., to include grid-bias tappings on the terminal strip. Fig. 204 shows a connecting lead suitable for use between the terminal strip and the set under test. If

each of these leads is of a different colour it will obviate the risk of making incorrect connections.

Item 13.—As will be readily seen, this is a shelf and as such justifies itself. Its purpose, however, is twofold, as it also forms the support for the aerial lead-in.

Item 14.—The aerial lead-in tube.

Item 15.—The aerial lead-in is carried under the shelf (as suggested above) direct to the A plug on the terminal strip.

Item 16.—Insulated hooks support the aerial under the shelf.

Now we come to the lighting arrangements of our workshop.

Item 17.—This is a stout wire running parallel to and directly over the bench, and carries the bench light.

Item 18.—A sliding clip of this description enables the light to be moved to any position over the bench. This clip,

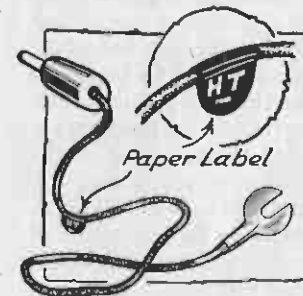

FIG. 204.—A flexible connection for use between the terminal strip and the set.

as will be seen by a glance at Fig. 205, is made from an ordinary spring paper-clip, gripping a piece of wood.

Item 19.—A three-way adaptor. There are innumerable ways of tapping a lighting point, but the three-way adaptor of good quality will be found very useful for our purpose. An alternative suggestion is to fit a two-way adaptor (which, perhaps, will be more readily obtainable) for supplying the two lights. The wall-plug flex is then taken direct from the ceiling rose, either above or below the ceiling. This wiring should be encased in a lead covering if carried below the ceiling; it may be supported by staples driven into the rafters above the plaster. When the position of the first rafter has been found the subsequent staples may be carefully driven in at distances equal to the pitch of the rafters.

Item 20.—This consists of a batten type lamp-holder and a switch mounted on a wooden base. This complete unit, when wired up, serves as a useful point of supply for the electric soldering-iron.

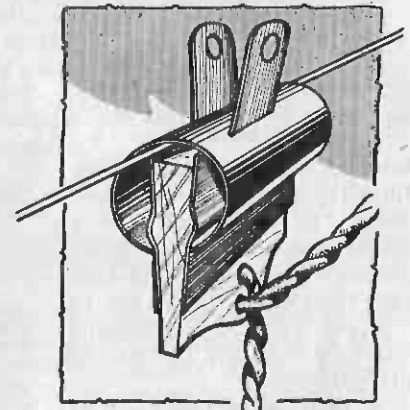

FIG. 205.—The sliding clip for supporting the bench light.

Item 21.—A lamp-holder incorporating a switch in its construction will be found most suitable for the bench light.

Item 22.—This table-lamp (shown also in Fig. 206) is very handy on our testing bench, for the flexible tubular standard enables the light to be directed in any required direction.

Item 23.—An electric soldering-iron will be found a great time, labour, and temper saver.

Item 24.—The loudspeaker (preferably of the moving-coil type) should be mounted on a baffle-board as large and as thick as possible. For space economy reasons the loudspeaker may be mounted in the corner of the room as shown and supported by brackets to the picture-rail. It is as well to remember to have a space of nine inches to one foot from the top of the board to the ceiling.

Item 25.—A pair of headphones will be found almost indispensable for short-wave work.

Item 26.—A set under test. This brings us to the end of our list and more or less completes the job.

These twenty-six items are, of course, just the "bare bones" of our workshop. Maps, charts, lists of



FIG. 206.—A useful lamp for the testing bench.

stations, calendars, pipe-racks, will all gradually find a place allotted to them and give a homely and individual atmosphere. Why not turn out that spare room now, for when you've a proper room for practising your hobby—it will be twice as interesting.

A Distribution Board.—It is an excellent plan to have a bench equipped with a suitable terminal board and meters, which acts as a main distribution panel between the batteries and the receiver; where mains equipment is used it might be possible to arrange the panel between a standard supply unit and the set, but there are more difficulties in this respect

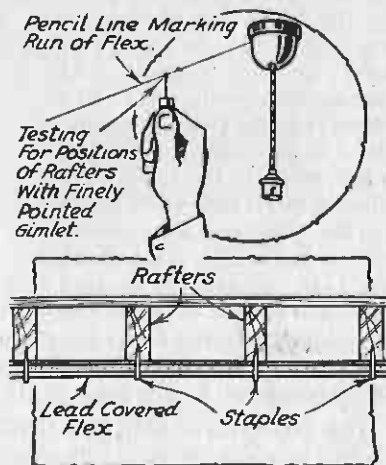

FIG. 207.—These pictures show how to support the lead covered flex.

The bench itself can be quite a simple affair consisting of an old table about 3 ft. high, the top of which is covered with green baize or even light-coloured oilcloth. As to the distribution panel, this may be as simple or complex as desired, but details will be given of an arrangement which is fairly inexpensive, although combining all of the most important features. First requirements are that rapid and accurate measurements can at any time be taken of the H.T. voltage applied to a particular set tapping of the current taken at any point of the L.T. voltage

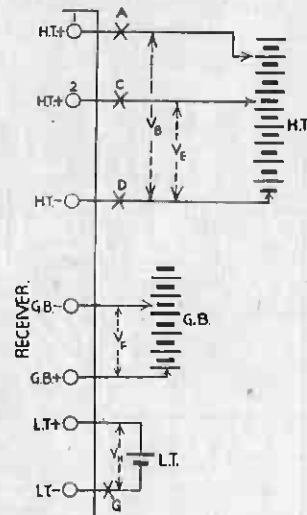

FIG. 208.—This diagram shows the point at which voltage and current readings have normally to be taken.

and current, and of the G.B. voltage. Fig. 208 shows the points at which measurements frequently need to be taken, the points at which current readings are required being indicated by crosses, and those between which voltage measurements are needed being marked by arrows and a letter V. This is the simplest arrangement of battery leads, and yet no less than eight meters would be required if simultaneous readings were to be taken at every important point. It would obviously be an expensive matter to buy eight reliable and accurate meters, besides which they would occupy a considerable amount of space.

Use of Plug and Jacks.—An alternative and better scheme, if it could be adopted, would be to use a single multi-range meter and to make provision for quickly applying it to any one of the eight points. Actually, there is little difficulty in this if the meter is fitted with a plug, and if jacks of suitable type are included in the wiring. The meter might be

one of the many good types now available for about £2 and four single-circuit and four closed-circuit jacks are required. Single-circuit jacks, are used for the voltage readings, the others being for taking current measurements. The reason for using the latter is that the circuit must be broken when the meter is connected and re-made when the meter plug is removed.

Jack Connections.—The idea will be more easily understood by referring to Fig. 209, where the jacks are shown in pictorial form. It can be seen that there are three connections to the closed-circuit jacks used for current readings, and that when the plug is not inserted points marked 1 and 2 are short-circuited due to the spring contacts. The

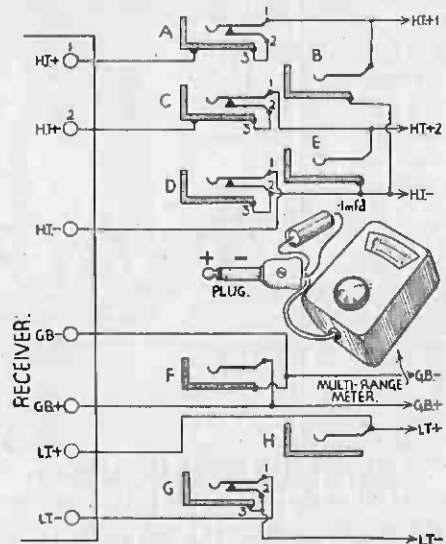

FIG. 209.—This illustration shows the connections to the jacks at the same points as indicated in Fig. 208.

other jacks have only two terminals, these being joined one to each point between which the voltage is to be measured; thus, the jacks have no effect when the meter is not connected.

Suppose now that it is wished to measure the voltage being applied to the terminal marked H.T. +1, all that is necessary is to set the meter to read up to, say, 150 volts and to insert the plug into the jack marked B. Similarly the voltage to H.T. +2 is found by inserting the plug into jack E. The current passing to H.T. +1 lead is found by adjusting the to read meter in milliamperes and placing the plug into jack A. In the same manner the G.B. voltage can be found by using jack F, the

L.T. voltage by using jack H, the L.T. current by using jack G, and so on.

In connection with the wiring of the jacks, it should be noticed that the leads are the opposite way round to jacks D and G to those to jacks A and C. This is because these are in the negative leads, and it is important that the correct polarity of the meter be employed. With the

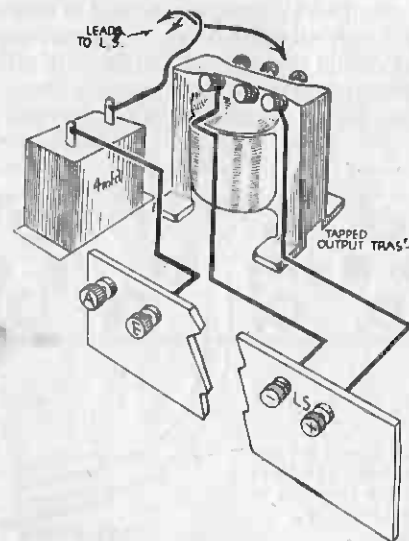

FIG. 210.—This shows how the refinement of a choke-capacity output filter can be added to the distribution panel.

wiring shown, the tip of the plug should be connected to the positive terminal of the meter, and the main arm to the negative lead.

Panel Layout.—The method of arranging the jacks is not important, but a panel such as that shown in Fig. 201 is very convenient. This is made from a strip of ebonite, and is provided with six terminals—for aerial and earth, loudspeaker and low-tension leads, and with Clix sockets for the grid-bias and high-tension connections. The jacks are arranged between the terminals and sockets, those for current readings being above the centre line, and those for voltages being below, as indicated. This ebonite strip can be attached to the back of the bench, and should preferably be covered in at the back so that stray wires cannot fall on the terminals and connections and so cause short-circuits.

Another refinement consists of a .0003-mfd. bakelite-dielectric

condenser mounted between the aerial and earth terminals, and connected in series with the aerial lead-in; this can be used for varying the degree of selectivity when the set under test is not provided with a series-aerial condenser. If a D.C. mains unit is employed for H.T. supply, another refinement might consist of a 1-mfd. fixed condenser wired between the earth terminal on the panel and the earth lead.

An Output Filter.—The idea of using the loudspeaker terminals on the panel is that a standard loudspeaker, placed in what has been found to be the best position in the room, can be permanently connected to them. The speaker should preferably be fitted with a tapped matching transformer, but an alternative is to mount a choke-capacity output filter on the panel, connected as shown in Fig. 210. It will be seen that the

can be modified in various ways to suit individual requirements and it would be a perfectly simple matter to include additional jacks for extra H.T. and G.B. leads. Those who have an output meter of some kind could also arrange to plug this into a jack connected to the loudspeaker terminals. In the case of mains operation some of the leads might carry A.C., in which case it must be remembered that an A.C./D.C. meter would be necessary in order to take all measurements. Generally speaking, however, the system is more suitable for battery-set users, and unless the reader has a fair knowledge of electricity he is not advised to attempt to modify it for use with mains sets. This does not apply when an eliminator is used in conjunction with battery sets, since the layout, as described, is perfectly satisfactory in such a case, the mains unit simply being considered as being identical in principle with the H.T. battery shown.

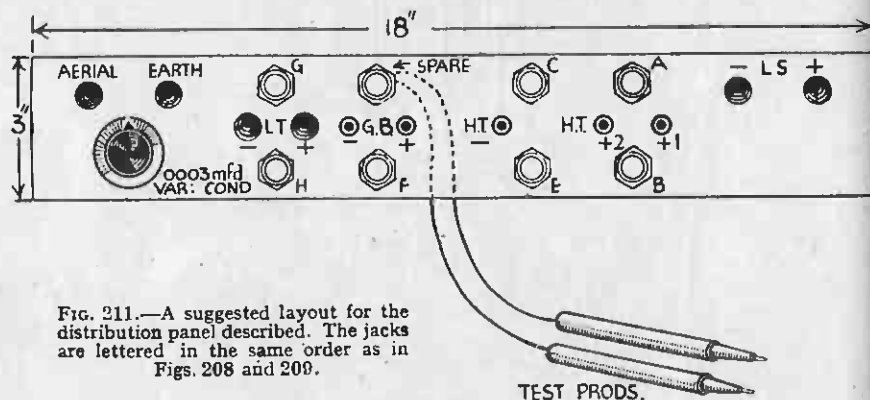

FIG. 211.—A suggested layout for the distribution panel described. The jacks are lettered in the same order as in Figs. 208 and 209.

two ends of a tapped output transformer are connected to the two speaker terminals on the panel, the speaker itself being connected to any one of the other terminals by means of a flexible lead with spade terminal, and also to one terminal of a 4-mfd. condenser, the other terminal of which is joined to the earth terminal on the panel.

Reverting to the meter and its plug, it is best to connect a .1-mfd. non-inductive condenser in parallel with the meter to act as a by-pass when current readings are being taken. If this were not done instability might be introduced due to the comparatively high resistance of the meter. The meter can then be mounted on a suitable bracket above the test panel or arranged to hang from a hook on the wall. In any case it will be found convenient to arrange yet another open-circuit jack on the panel and to attach a couple of leads with test prods to this. Then any measurements which have to be taken inside the set, or when testing components, can be taken simply by inserting the meter plug into the "spare" jack and using the test prods in the normal manner.

Modifications.—The general arrangement which has been described

Switch Faults.—Although really coming within the heading of bad contact, the on-off switch has not been mentioned. If this is of the old push-pull type it is quite feasible to expect that the contact strips are making bad contact with the metal-ended plunger; the test is to

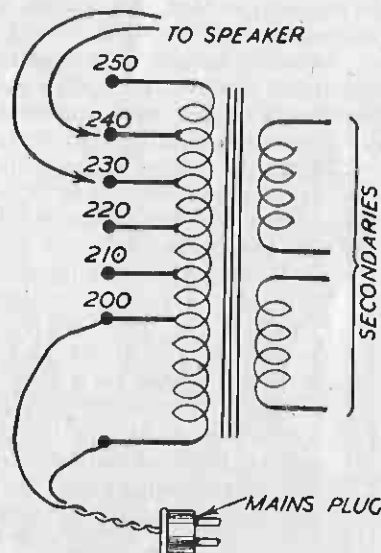

Fig. 100.—A "buzz" test for speakers, using a mains transformer.

short-circuit the switch with a short length of wire. If it proves to be faulty it should be replaced by another of the more reliable quick-make-break type. The wavechange switch may also be the cause of trouble when a two-range coil is in use, but in most cases the noises would then be heard on one waveband only. The method of effecting a cure depends entirely on the form and construction of the switch, but if it is not built into the coil it is wise to replace it—again with one of the quick-make-break pattern.

When all other tests fail to reveal the source of the background noises it is well to remember the possibility (only slight, it is admitted), of there being a faulty contact inside the cap of the detector valve. This can be checked only by replacing the valve. Fixed resistances, especially the grid leak, can sometimes be tracked down as responsible for the trouble. The reason is generally that the contact between the composition element and the terminals or connecting leads is not sound. Replacement provides the simplest check, although the grid leak can often be tested by simply disconnecting one end; if the noise then ceases the component should be replaced.

EQUIPPING A SERVICE WORKSHOP

A GLANCE at Fig. 191 will give an idea of the layout suitable for a small service workshop. It is impossible, of course, to give a hard and fast layout (as the rooms will vary in almost every case), but as we must start somewhere, we will assume that the room has four walls, a door and a window.

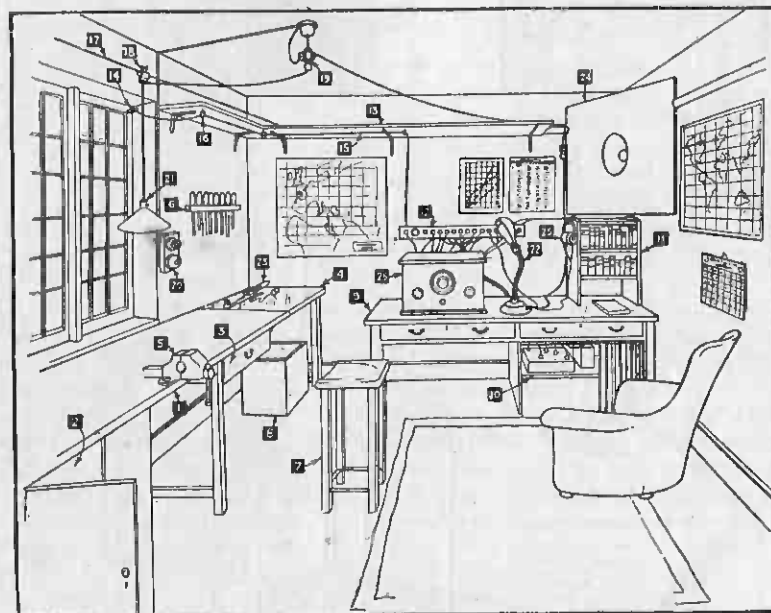

Fig. 191.—This Pictorial Chart shows the layout of the workshop.

- | | |
|-----------------------------------|---|
| Item No. 1.—The work bench. | Item No. 14.—Lead-in tube. |
| " " 2.—A useful cupboard. | " " 15.—Aerial lead-in. |
| " " 3.—The tool drawer. | " " 16.—Insulated hook. |
| " " 4.—Sheet of zinc. | " " 17.—Stout galvanised wire. |
| " " 5.—The vice. | " " 18.—Sliding Clip. |
| " " 6.—The tool rack. | " " 19.—Three-way adaptor. |
| " " 7.—The bench stool. | " " 20.—Wall-plug and switch. |
| " " 8.—The scrap box. | " " 21.—Light plug and switch. |
| " " 9.—The testing bench. | " " 22.—Adjustable lamp. |
| " " 10.—The battery compartment. | " " 23.—Electric soldering iron. |
| " " 11.—Bookshelf. | " " 24.—Loud speaker mounted on baffle-board. |
| " " 12.—Universal terminal strip. | " " 25.—Headphones. |
| " " 13.—Shelf. | " " 26.—A set under test. |

that the power in watts which is dissipated (or lost) is $1/100 \times 1/100 \times 25,000$, or $\frac{25,000}{10,000}$ which is obviously 2.5 watts. Having made this calculation we know that the resistance used in this circuit must be rated at not less than 2.5 watts, and we should generally use a 3-watt component to provide a sufficient factor of safety; a resistance of lower wattage rating would be liable to burn out in use, due to the resistance being overloaded.

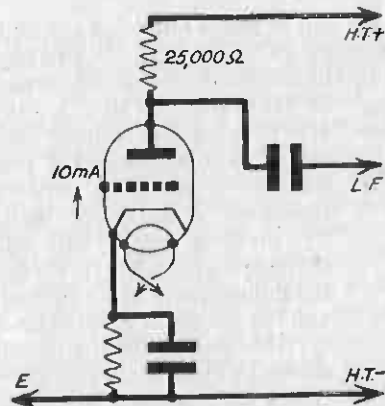

FIG. 214.—In order to determine the wattage rating of an anode resistance, it is necessary to know its resistance rating, and the current passing through it.

It might not be clear to some readers how the expression I^2R was found from the original Ohm's Law equations to be the same as ER —voltage multiplied by resistance—or, in other words, how I^2 was found to be the same as the voltage drop. But we saw that the voltage drop (E) is equal to I multiplied by R , and if also we multiply this by I we get the expression I^2R .

arithmetic which is not difficult to follow. Suppose it is required to find the highest wavelength that can be reached when a coil of 2,200 microhenrys (a typical long-wave coil) is used in parallel with a .0005-mfd. tuning condenser. The wavelength is found by using the equation: $\text{wavelength} = 1,884 \sqrt{L \times C}$ where L is the inductance of the coil in microhenrys, and C is the capacity of the condenser in microfarads, the wavelength being in metres. We have first of all to multiply together the inductance and capacity, and then to find the square root of the result, and finally to multiply this by 1,884. Taking the first step we get $2,200 \times .0005$, or $\frac{2,200 \times 5}{10,000}$ which works out to 1.1; when

the square root of 1.1, which is 1.05 approximately, is multiplied by 1,884 we get as the result, 1,978.2, this being the wavelength in metres.

If the required wavelength and coil inductance were known, the correct capacity could be found by reversing the calculation and in the same manner the correct inductance could be determined from a knowledge of the wavelength and capacity. These calculations are slightly more involved, however, and since it is rarely necessary to use them, we will not consider them further.

Screening Grid Potentiometers.—In the opening paragraph mention was made of finding the values of resistance required in forming a fixed potentiometer, and this is a problem which often crops up in connection with an S.G. valve of which the screening grid is supplied from a potentiometer as shown in Fig. 215. If the screening grid did not pass any current, the two resistances would have values proportional to the maximum supply voltage and the voltage required. In other words, if the H.T. supply delivered a voltage of 200 and 80 volts was required for the screening grid the upper resistance, marked R_1 could have a value of 60,000 ohms, and the lower one, marked R_2 , a value of 40,000 ohms. Alternatively, values of 30,000 and 20,000 ohms could be used.

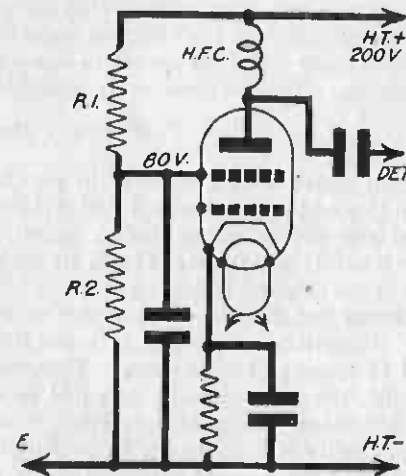

FIG. 215.—Several interesting points arise when calculating the values of resistances required for a fixed screening-grid potentiometer.

It will be seen from this that the first step is to decide upon the approximate total resistance; with a mains set a maximum value of 50,000 ohms is generally suitable, and with a battery set, 100,000 ohms can be used successfully.

In the above assumption of no current we simply made the lower resistance of such a value that its proportion to the total was the same as the proportion between the required voltage and the total H.T. voltage—2 to 5, but let us see what would happen if the screening grid passed 1 mA. The voltage drop occasioned by the upper resistance would be $1/1,000$ multiplied by, say, 30,000, or 30, and thus the voltage actually applied to the screening grid would be 80 less 30, or only 50 volts. Consequently, either the resistance marked R_1 must be reduced

in value, or that marked R2 must be increased. This apparent peculiarity is due to the fact that the cathode-screening-grid circuit is in parallel with the lower resistance, thus reducing its effective value. It is possible to evolve an equation from which the exact values of resistance could be determined, but it is generally better for the non-mathematical serviceman to use trial-and-error calculations and working on the lines indicated above, until suitable values are found.

Series and Parallel Resistances.—In dealing with resistance calculations above we did not consider the effect of connecting resistances in series and in parallel. If resistances are placed in series the effective value is, as might be supposed, equal to the sum of the resistances. Thus, if resistances of 500, 1,000 and 20,000 ohms were joined in series the total value would be 21,500 ohms. When they are joined in parallel the result is entirely different, and the effective resistance of the combination is, mathematically speaking, equal to the reciprocal of the sum of the reciprocals. This expression is simplified if written:

Total $R = \frac{1}{1/R_1 + 1/R_2 + 1/R_3}$, etc. This means that if the three

resistances mentioned above were connected in parallel the effective value could be found by adding together: $1/500$, $1/1,000$ and $1/20,000$, which equals $61/20,000$, and reversing this to $20,000/61$, which gives the result as approximately 330 ohms. It will be noticed that this is less than the value of the smallest resistance.

Condensers in Series and Parallel.—When two or more condensers are used together the effective capacity is found by reversing the methods described in respect of resistances. Thus, when condensers are joined in parallel, the total capacity is equal to the sum of the capacities of the individual components. When condensers are in series the resulting capacity is equal to the reciprocal of the sum of the reciprocals. If, for example, a .0005-mfd. condenser is connected in

series with one of .0003 mfd. the resultant capacity is $\frac{1}{1/.0005 + 1/.0003}$,

which is $\frac{1/8}{.0015}$ or $\frac{.0015}{8}$, which is .0002 mfd. approximately.

USEFUL FORMULAE

Frequency Formula

Formula for frequency is: $f = \frac{10^6}{2\pi\sqrt{LC}}$ where L = inductance in microhenrys and C = capacity in microfarads.

Wavelength of Tuned Circuit

Formula for the wavelength of a tuned oscillatory circuit is: $1884.96\sqrt{LC}$, where L = inductance in microhenrys and C = capacity in microfarads.

Inductance

The formula for inductance in microhenrys is: $L = \frac{9.86/D^2N^2K}{1000}$

where L = inductance, D = diameter of coil in centimetres, l = length of coil in centimetres, N = number of turns per centimetre, and K = a constant. See table.

This Table shows the Value of K, which must be Calculated from D

$\frac{D}{l}$	K	$\frac{D}{l}$	K
4.00	.3654	1.25	.6381
3.75	.3743	1.00	.6884
3.5	.3944	.90	.7110
3.25	.4111	.80	.7351
3.00	.4292	.70	.7609
2.75	.4545	.60	.7885
2.5	.4719	.50	.8181
2.25	.4972	.40	.8499
2.0	.5255	.30	.8838
1.75	.5579	.20	.9201
1.5	.5950	.10	.9588

Inductive Reactance

Calculated from the formula $2\pi fL$, where f = frequency and L = the inductance.

Capacity of a Fixed Condenser

$$C = \frac{.0885 AKN}{1,000,000 d}$$

Where K = Specific Inductive Capacity of dielectric.

N = Number of dielectrics.

A = Area of overlap of plates in square centimetres.

d = Thickness of dielectric in centimetres.

Another Formula:

$$C = \frac{AKN}{4,500,000 d}$$

Where A = Area of one plate in square inches.

K = S.I.C. of dielectric.

N = Number of plates minus one.

d = Thickness of dielectric in inches.

Capacity of Variable Condensers

$$C = \frac{.0885NS}{1,000,000 d}$$

Where N = Number of moving vanes.

S = Area of both sides of one moving vane in square centimetres.

d = Air gap between moving vanes and fixed vanes in centimetres.

H.F. Transformer Ratio. $(n) n^2 = \frac{R}{R_0}$

R being the dynamic resistance of the tuned circuit and R_0 the A.C. resistance of the valve.

Stability in Screen-Grid Stages.

One Stage.

Stable if $\frac{\omega g C_0}{\sigma_1(\sigma_2 + \sigma v)}$ is less than 2.

C_0 = residual anode-grid capacity in farads.

= $.001 \times 10^{-12}$ for Cossor S.G. Valves (all types).

= $.0045 \times 10^{-12}$ for Cossor MS/Pen A.

σ_1, σ_2 = conductance of grid and anode* circuits respectively.

= $1/R$ where R = dynamic resistance in ohms.

σv = anode filament conductance of valve.

= $1/R_0$.

Two Stages.

Assuming identical tuned circuits throughout, and ignoring damping effects of valves on tuned circuits.

Stable if $\frac{\omega C_0 g}{\sigma^2}$ is less than 1.14 (Tuned Anode).

or if $\frac{\omega C_0 g}{\sigma^2}$ is less than $1.14n^2$ (Tuned Transformer).

where σ = conductance of tuned circuit (secondary) and n = transformer ratio.

* In the case of transformer coupling, or its equivalent, replace σ_2 by $n^2\sigma$, where n = transformer ratio, σ = conductance ($= \frac{1}{R}$) of tuned secondary.

OHMS LAW

For D.C.

$$I = \frac{E}{R}$$

Watts dissipated
= $I^2 R = E I$.

For A.C.

$$I = \frac{E}{Z} \text{ where } Z = \text{impedance of circuit.}$$

Watts dissipated
= $I^2 R$
= $E I \cos \phi$

where ϕ = phase angle between E and I .

Capacity of Condensers in Parallel.

$$C = C_1 + C_2$$

Capacity of Condensers in Series.

$$C = \frac{1}{\frac{1}{C_1} + \frac{1}{C_2}} = \frac{C_1 C_2}{C_1 + C_2}$$

Resistances in Parallel.

$$R = \frac{1}{\frac{1}{R_1} + \frac{1}{R_2}} = \frac{R_1 R_2}{R_1 + R_2}$$

Resistances in Series. $R = R_1 + R_2$

Resistance, Capacity and Inductance in Series.

Resulting Impedance.

$$Z = \sqrt{R^2 + \left(\omega L - \frac{1}{\omega C}\right)^2} = \sqrt{R^2 + X^2}$$

Reactance of Coil. $2\pi f L$.

$\pi, 3.14$; f , frequency; L , inductance in henrys.

Reactance of Condenser. $\frac{1}{2\pi f C}$.

C , capacity in farads.

Net Reactance. $X = X_L - X_C$

At Resonance. $f = \frac{1}{2\pi \sqrt{LC}}$, or $\omega^2 = \frac{1}{LC}$

Wavelength. $\lambda = 1884 \sqrt{LC}$.

λ , in metres; L , in microhenrys; C , in microfarads;

$\lambda \times f = 300,000,000$.

Resistance of a Tuned Circuit at Resonance (Dynamic Resistance).

$$R = \frac{L}{C \times r}$$

r being the equivalent series resistance.

Magnification of Tuned Circuit. $m = \frac{\omega L}{r}$

Current in Series Circuit at Resonance. $I_{\text{res.}} = \frac{E}{r}$

where r is equiv. series resistance of circuit at wavelength concerned (high-frequency resistance).

Inductance of Single Layer Coil.

$$L = \pi^2 n^2 D^2 / k \times 10^{-2}$$

L , in microhenrys; π , 3.14; D , diameter in cms.; n = number of turns to the cm.; l , length in cms.; k , a factor depending upon the length/diameter ratio.

When $\frac{D}{l} =$	0.1	0.5	1.0	2.0	3.0	4.0
$k =$	0.96	0.82	0.69	0.526	0.429	0.365

Resonant Frequency of Tuned Circuit.

$$= \frac{1}{2\pi \sqrt{LC}} \text{ or } \omega^2 = \frac{1}{LC}$$

Wavelength of Tuned Circuit at Resonance.

$$\lambda = 1884 \sqrt{LC}$$

λ , in meters; L , in microhenrys; C , in microfarads;
 $\lambda \times f = 300,000,000$.

Resistance of a Tuned Circuit at Resonance (Dynamic Resistance).

$$R = \frac{L}{C \times r}$$

r being the equivalent series resistance.

Selectivity of Tuned Circuit.

Voltage across tuned circuit = $\frac{100}{\sqrt{1 + 4m^2 \left(\frac{\delta f}{f}\right)^2}}$ per cent. of voltage at resonance.

Where f = Frequency of resonance in cycles.
 δf = Amount of detuning in cycles.
 m = Magnification of tuned circuit.

Optimum Coupling between Two Coils.

(For maximum signal).

$$M = \frac{\sqrt{r_1 r_2}}{2\pi f}$$

r_1, r_2 are the H.F. resistances of the two circuits

f = Frequency of resonance.

M = Mutual inductance between coils.

Coefficient of Coupling.

$$k = \frac{M}{\sqrt{L_1 L_2}}$$

Where M = Mutual inductance.

$L_1 = L_2$ Inductance of two coupled circuits.

WIRELESS CALCULATIONS

THERE are many who do not seem able to make the few simple calculations necessary to determine, say, the correct value for a decoupling or bias resistance, the wavelength range which can be covered when using a certain coil and variable condenser, or the sizes of resistances required to form a fixed potentiometer. It is often thought that the arithmetic involved is of a difficult nature, or that the equations are for mathematicians only, whereas the calculations are often a good deal simpler than those required to draw up a cricket analysis or in working out the sums that are regularly done at school by boys of twelve; the only real difference is that a little knowledge of wireless practice is required in addition to that of arithmetic.

Ohm's Law.—Of all the calculations that must be made time after time that in connection with resistance values is the commonest, as well as being the easiest. All calculations involving resistance, current and voltage are based on Ohm's Law, which states that the current flowing in a circuit is always equal to the voltage causing the flow divided by the resistance which tends to oppose it. Thus, if a voltage of 100 were applied to the simple circuit shown in Fig. 212, the current passing through it would be 100 divided by 20,000, which is 1/200th of an ampere. It is generally more convenient to work in terms of milliamperes, which are one-thousandths of an ampere, so that

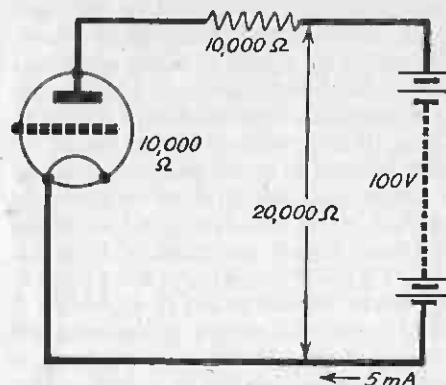

FIG. 212. A simple circuit which shows the relationship between current voltage and resistance.

the figure becomes 5 mA. The simple circuit shown is typical of all valve anode circuits, and the fixed resistance might be a coupling resistance or it might represent the resistance of a transformer or other component.

The formula for Ohm's Law which we have just used is written in mathematical terms, thus: $I = \frac{E}{R}$

where I is the currents in amperes, E is the voltage,

and R is the resistance in ohms. This simple and useful formula can be re-written in at least two other ways in order to make it more convenient when the voltage or resistance is required, the other

two factors being known. For example, we could write: $R = \frac{E}{I}$ or $E = I \times R$.

Bias Resistance Value.—Let us see how it works out when we want to find the value of the bias resistance shown in Fig. 213. In this case it is known that the current passed by the resistance (the anode current of the valve) is 10 mA., and that the required voltage drop across the resistance—the bias voltage—is 20. The required resistance is obviously found by dividing 20 by 10 and multiplying by 1,000 (to change the milliamperes into amperes), and the answer is 2,000 ohms.

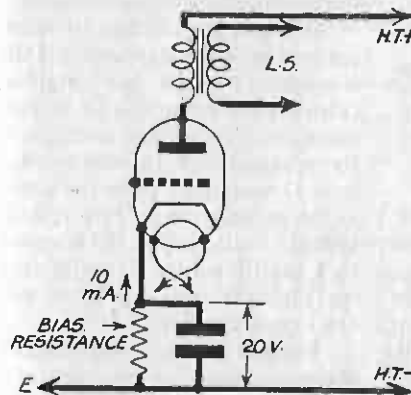

FIG. 213.—The method of determining the correct value of a bias resistance can be understood by reference to this circuit.

Now suppose in the circuit shown in Fig. 212 that we know that 5 mA. is required to flow through the valve and that the resistance of the valve is, say, 5,000 ohms, while the anode resistance has a value of 10,000 ohms; we want to know the voltage necessary to ensure the correct current. All that we need to do is to multiply the current in amperes by the resistance in ohms, and we get $5/1,000 \times 15,000$, which is 75 volts.

Once we have seen these applications of Ohm's Law it is not difficult to apply it to all resistance, voltage and current calculations, when two of the values are known and the third is required.

Resistance Wattage Rating.—There is another application of Ohm's Law which must be used when it is required to find the correct wattage rating for a resistance. Power, in watts, is actually the product of the voltage and the current, in amps., but we often know the current passing and the resistance value of, say, a coupling resistance, without knowing the exact voltage dropped across the resistance. But it is not difficult to see from the above equations that wattage can be determined from the formula: $W = I^2 R$. In words, this formula reads: the wattage is equal to the current in amps. multiplied by itself and by the resistance in ohms. Thus, in Fig. 214 we have a resistance value of 25,000 ohms and a current of 10 mA. or 1/100 amp. We see, therefore,

Valve Base Connections for Continental Valves

See Fig. 216

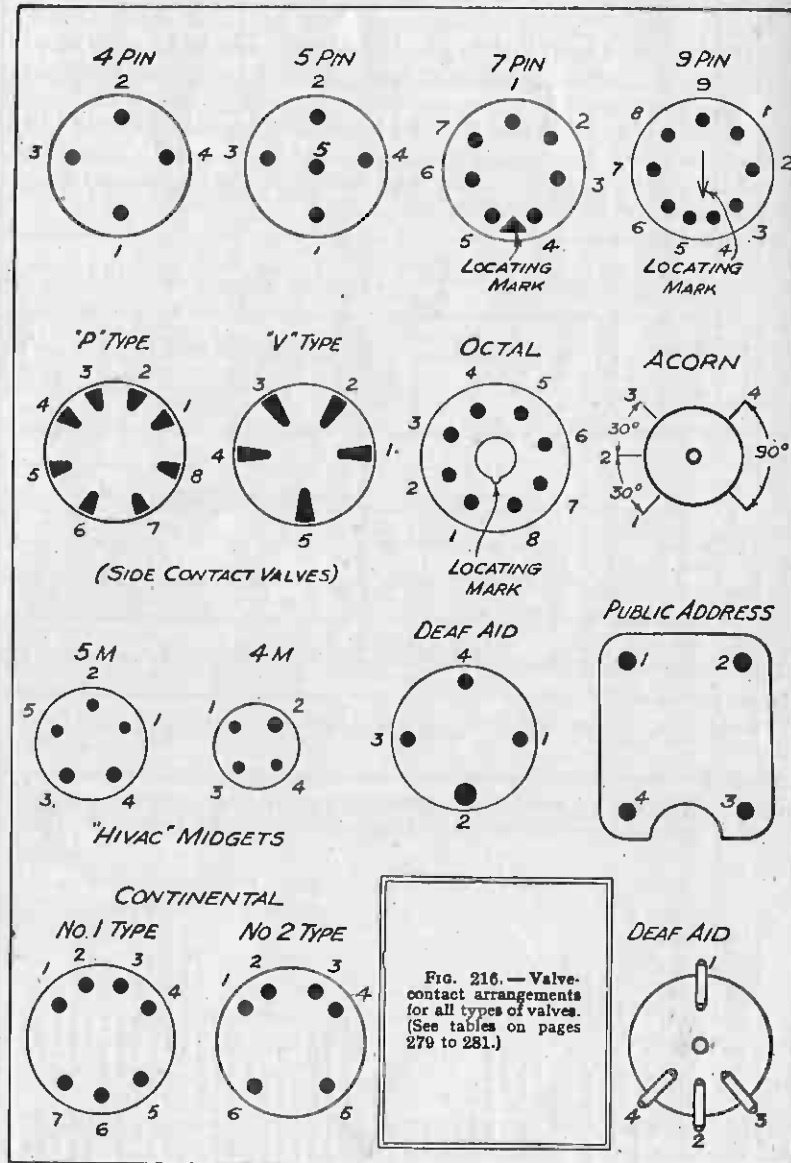

Type.	Base	Pin Connections.							Top Cap
		1	2	3	4	5	6	7	
H.F. Pentode ..	1	G2	H	H	C	A	G3	—	G1
H.F. Pentode ..	2	G2	H	H	C	A	M	G3	G1
Triode ..	2	—	H	H	C	A	M	G1	—
Double-diode ..	2	G2	H	H	C	D1	—	—	D2
Frequency Changer ..	2	G2	H	H	C	A	A0	G0	G1
Output Pentode ..	1	G2	H	H	C	A	G1G3	—	—
Output Pentode ..	2	G2	H	H	C	A	G3	G1	—
Rectifier ..	1	C1	H	H	C2	A2	A1	—	—
Rectifier ..	2	C1	H	H	C2	A2	—	A1	—

Valve Base Connections for Hivac Midget Valves

Type.	Base	Pin Connections.					Top Cap
		1	2	3	4	5	
Triode ..	1	A	G	F	F	—	—
Tetrode (S.G.) ..	1	G2	G1	F	F	—	A
Output Pentode ..	2	A	G1	F	F	G2	—

Mullard Universal Side-Contact Valves

Valve Type.	Base	Contact Connections.								Top Cap
		1	2	3	4	5	6	7	8	
Triode ..	P	M	H	H	C	—	—	—	A	G
H.F. Pentode ..	P	M	H	H	C	G3	—	G2	A	G1
Output Pentode ..	P	—	H	H	C,	—	—	G2	A	G1
Octode ..	P	M	H	H	C,	G2	G1	G3,	A	G4
Double-diode ..	V	D2	H	H	C,M	D1	—	—	—	—
Double-diode (alternative) ..	V	M	H	H	C	D1	—	—	—	D2
Rectifier, Half-wave ..	P	—	H	H	C	—	—	—	A	—
Rectifier, Voltage Doubling ..	P	C1	H	H	C2	A1	—	—	—	—
Visual Tuning Indicator (TV4) ..	P	—	H	H	C	—	G	Target	A	—

FIG. 216.— Valve contact arrangements for all types of valves. (See tables on pages 279 to 281.)

Abbreviations used in Table on page 277

- I.H.—Indirectly heated. D.H.—Directly heated.
 M.—Metallising. F.—Filament.
 H.—Heater. C, C1, etc.—Cathodes.
 A, A1, etc.—Anodes (A0—Oscillator anode).
 G or G1—Control grid (G0—Oscillator control grid).
 G2—Screening grid. G3—Suppressor grid.
 D, D1, etc.—Diodes (anodes). Targ.—Target.

Valve Base Connections for American (Octal) Valves

Valve Type.	Base	Pin Connections.								Top Cap	
		1	2	3	4	5	6	7	8		
Triode ..	I.H.	Oct.	M	H	A	—	G	—	H	C	—
Triode ..	I.H.	Oct.	M	H	A	—	A	—	H	C	G
H.F. Pentode ..	I.H.	Oct.	M	H	A	G2	G3	—	H	C	G1
Output Pentode	I.H.	Oct.	M	H	A	G2	G1	—	H	C	—
Heptode ..	I.H.	Oct.	M	H	A	G3, G5 (G1)	G0 (G2)	A0	H	C	G4
Double-diode	I.H.	Oct.	M	H	D2	C2	D1	—	H	C1	—
Double-diode-triode	I.H.	Oct.	M	H	A	D1	D2	—	H	C	G
Double Triode	I.H.	Oct.	—	H	A1	G1	G2	A2	H	C	—
.. sep. cath.	I.H.	Oct.	—	H	A1	C1	G2	A2	H	C2	G1
Rectifier, Full-wave	I.H.	Oct.	M	H	—	A	A	—	H, C	—	—
Rectifier, Full-wave	I.H.	Oct.	—	H	H	A2	C2	A1	—	H, C1	—
Rectifier, Full-wave	I.H.	Oct.	M	H	A	—	A	—	H	C	—
Rectifier, Full-wave, Gaseous ..	Oct.	M	—	A	—	A	—	—	—	C	—

Valve Base Connections for Acorn and Deaf-Aid Valves

Type.	Base	Pin Connections.					Top.	Bottom
		1	2	3	4	5		
ACORN								
Triode ..	1	H	C	H	G	A	—	—
H.F. Pentode ..	1	H	C	H	S	SG	A	G
DEAF AID								
Triode (D.H.) ..	2	A	G	F	F	—	—	—
Triode (I.H.) ..	2	A	C	H	H	—	G	—
Triode (Mullard)	3	A	G	F	F	—	—	—
PUBLIC ADDRESS								
Triode ..	4	A	F	G	F	—	—	—

VALVE-LEG SPACING DIAGRAMS

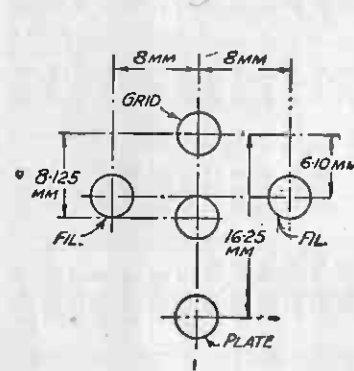

FIG. 217.—Valve-leg spacing for 4- and 5-pin valves. The diameter of the valve pins is 3.2 mm.

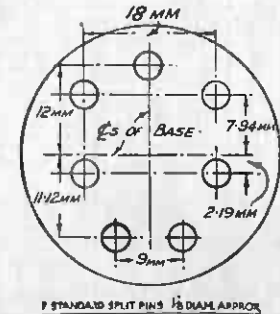

FIG. 218.—Valve-leg spacing for 7-pin valves.

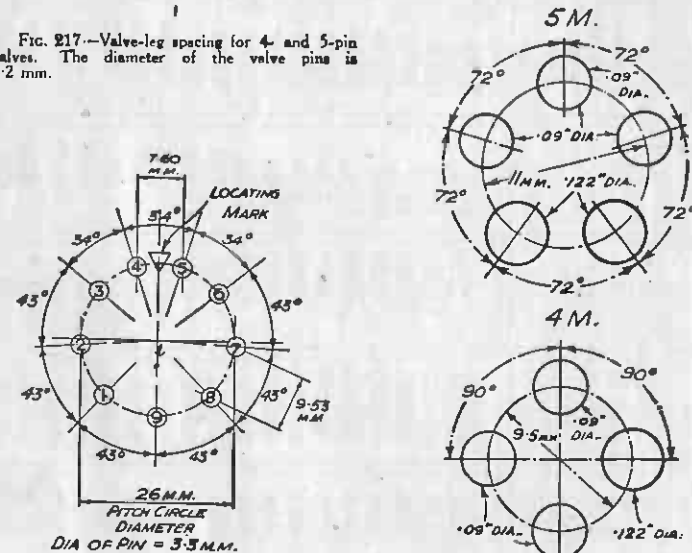

FIG. 219.—Valve-leg spacing for 9-pin valves.

FIGS. 220. and 221.—The two diagrams above show the valve-leg spacing of the Hivac midjet valves (see table on page 270).

Copper Wire Data

Standard Wire Gauge.	Diameter in Inches.	Resistance in Ohms per Yard.	Resistance in Ohms per Pound.	Pounds per Ohm.	Weight in Pounds per 1,000 Yds.	Yards per Pound.	Turns per Inch.				
							Enamel Covered.	Single Silk Covered.	Double Silk Covered.	Single Cotton Covered.	Double Cotton Covered.
10	.128	.001868	.0120	83.3	148.8	6.67		7.64	7.55	7.35	7.04
11	.116	.002275	.0200	50.0	122.2	8.16		8.41	8.30	8.06	7.69
12	.104	.002831	.0280	35.7	98.22	10.23		9.35	9.22	8.93	8.48
13	.092	.003617	.0550	18.1	76.86	13.00		10.5	10.4	10.0	9.43
14	.080	.004784	.0820	12.2	58.12	17.16		12.1	11.8	11.4	10.6
15	.072	.005904	.1400	7.14	47.08	21.23		13.3	13.1	12.5	11.6
16	.064	.007478	.2021	4.95	37.20	26.86	15.0	14.9	14.6	14.1	13.2
17	.056	.009762	.3423	2.38	28.48	35.00	17.1	16.9	16.5	15.9	14.7
18	.048	.01328	.6351	1.56	20.92	47.66	19.8	20.0	19.4	18.5	17.2
19	.040	.01913	1.315	.757	14.53	68.66	23.7	23.8	23.0	21.7	20.0
20	.036	.02362	2.012	.497	11.77	85.00	26.1	26.3	25.3	23.8	21.7
21	.032	.02890	3.221	.309	9.299	107.6	29.4	29.4	28.2	26.3	23.8
22	.028	.03905	5.498	.181	7.120	140.6	33.3	33.3	31.8	29.4	26.3
23	.024	.05313	10.14	.098	5.231	191.6	38.8	38.5	36.4	33.3	29.4
24	.022	.06234	14.38	.069	4.395	228.3	42.1	42.1	40.0	35.7	31.3
25	.020	.07653	21.08	.0471	3.632	275.3	46.0	46.0	43.5	38.5	33.3
26	.018	.09448	32.21	.0309	2.942	340.0	50.6	50.6	47.6	41.7	35.7
27	.0164	.11138	46.55	.0215	2.442	410.0	55.9	55.1	51.6	44.6	37.9

Copper Wire Data

Standard Wire Gauge.	Diameter in Inches.	Resistance in Ohms per Yard.	Resistance in Ohms per Pound.	Pounds per Ohm.	Weight in Pounds per 1,000 Yds.	Yards per Pound.	Turns per Inch.				
							Enamel Covered.	Single Silk Covered.	Double Silk Covered.	Single Cotton Covered.	Double Cotton Covered.
28	.0148	.1398	70.12	.0141	1.989	503.0	61.4	60.4	56.2	48.1	40.2
29	.0136	.1655	98.65	.0101	1.680	596.6	66.2	65.2	60.2	51.0	42.4
30	.0124	.1991	142.75	.0069	1.396	716.6	73.3	72.0	67.1	54.4	44.7
31	.0116	.2275	185.80	.0054	1.222	820.0	77.8	76.3	70.9	56.8	46.3
32	.0108	.2625	248.20	.0040	1.059	943.3	83.0	81.3	75.2	63.3	50.5
33	.0100	.3061	337.50	.0029	.9081	1100	88.9	87.00	80.0	66.7	52.6
34	.0092	.3617	471.00	.0023	.7686	1300	98.0	93.4	85.5	70.4	54.9
35	.0084	.4338	676.50	.0014	.6408	1556	106	101	91.8	80.6	61.0
36	.0076	.5300	1009	.00098	.5254	1903	116	110	102	86.2	64.1
37	.0068	.6620	1574	.00064	.4199	2380	128	120	110	92.6	67.6
38	.0060	.8503	2598	.000385	.3269	3056	143	133	121	100	71.4
39	.0052	1.132	4645	.000217	.2456	4066	168	149	134	109	75.8
40	.0048	1.328	6360	.000156	.2092	4766	180	159	142	114	78.1
41	.0044	1.581	9020	.000112	.1758	5700	194	169	150		
42	.0040	1.913	13150	.000076	.1453	6866	211	191	167		
53	.0036	2.362	20120	.000050	.1177	7500	230	206	179		
44	.0032	2.989	32210	.000030	.0929	10766	253	225	192		
45	.0028	3.904	54980	.000015	.0712	14066	282	247	208		

ABBREVIATIONS

S.W.G.—Standard wire gauge; B.W.G.—Birmingham wire gauge; D.C.C.—double-cotton covered; S.C.C.—single-cotton covered; D.S.C.—double-silk covered; S.S.C.—single-silk covered.

CHAPTER XXXVII COLOUR CODES

MANUFACTURERS of complete receivers often adopt a code for the wiring of the receiver so that their service engineers may more easily locate certain leads when testing the receiver. By adopting a colour code for standardisation it becomes a simple matter for a service-man or experimenter instantly to identify components or other details in any make of receiver, and such items as mains transformers, resistors, condensers, fuses, and battery leads are now also identified in this manner.

Resistance Codes.—For fixed resistors the code consists of three colours, and although these are sometimes given in the form of

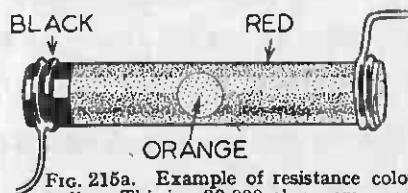

FIG. 215a. Example of resistance colour coding. This is a 20,000 ohm. component.

three bands or dots on the component, the standard way which is most generally adopted is to colour the entire body of the component for the first colour, one of the tips for the second colour, and to display the third in the form of a dot or band on the centre of the body. This is the order in which the colours are read, and the colours in each case stand for the figures from 0 to 9. The complete reference table is as follows:

Colour	Figure	No. of Noughts
Black	0	None
Brown	1	0
Red	2	00
Orange	3	000
Yellow	4	0000
Green	5	00000
Blue	6	000000
Violet	7	
Grey	8	
White	9	

An example will make the scheme quite clear. Suppose we have a resistance with a red body, a black tip, and an orange spot or band. Then the value will be 2 (red body), followed by one nought (indicated by the black tip), followed by three noughts, or, in other words, 20,000 ohms. If it is found that a resistance does not bear a dot or band

COLOUR CODES

on the body it indicates that the dot is of the same colour as the body.

Condenser Codes.—In the case of fixed condensers the code is exactly similar, but the basis, instead of the ohm, is the micro-microfarad. Thus, a .001 mfd. condenser (which is the same as a 1,000 mmfd.) would be indicated by a brown dot followed by a black dot followed by a red dot. In addition to small fixed condensers, however, a code is drawn up for multiple condenser blocks, provided with cable or flexible leads for connection. The following is the recommended code:

The highest capacity positive voltage	Red
The second highest	do.	Yellow
The third highest	do.	Green
The fourth highest	do.	Blue
The fifth highest	do.	Violet
Principal negative connection	Black
Second	do.	Brown
Third	do.	Grey
Centre connection for voltage doubler condensers		White

Where a condenser has two terminal wires only, they are red and black (for positive and negative respectively), irrespective of the capacity and voltage rating of the condenser. Where two capacities are equal, the higher voltage shall be given the higher colour in the table. In addition to the colours it is also necessary to mark condensers in which two or more complete units are embodied, and for this purpose the following marks are adopted:

Common positive junctions shall be marked	+
" negative	" " " "	-
Series connections shall be marked	±

Unconnected Sections:

Thus 8 + 8	denotes 2 sections with a common positive.
8 - 8	" 2 " " " " " " negative.
8 ± 8	" a series voltage doubler connection.
8 & 8	" 2 isolated sections.

Fuses.—Fuses for use in battery or mains receivers are also coded to indicate the value, the colour usually being shown by a strip of coloured paper inside the glass tubular container. The code is as follows

60 mA.	Black	1 amp.	Dark Blue
100 mA.	Grey	1½ amp.	Light Blue
150 mA.	Red	2 amp.	Purple
250 mA.	Brown	3 amp.	White
500 mA.	Yellow	5 amp.	Black & White
750 mA.	Green			

Electron beam deflection, 165
Emission testing, 116
Energised speakers, 248

F

Fault tracing, 31
Filter, aerial, 240
Formulae, 268
Frequency calibration, 169
— formulae, 268
— wave-length conversation table, 284
Frequencies, musical, 85
Fuses, blowing, 36
— colour codes, 275

G

Gang condenser connections, 102
Ganging, faults in, 227
— intermediate frequency transformers, 137
— on long wave band, 110
— receivers, 106
— superhet, 225
— troubles, 223
— uneven, 109
— using meter for, 108
— with cathode ray tube, 174
Generator, signal, 20, 89
Graphs, using for calibrating, 96
Grid bias voltage, measuring, 66
— connections, broken, 219
— tests, 32

H

Hand capacity, 127
Hartley, oscillators, 78
— circuit, 89
High frequency response curves, 170
— note cut off, 140
H.F. circuit, checking, 65
— coil modifying, 210
— coupling, too tight, 143
— stage, replacing valves in, 121
— resistance, 218
— stage, faults in, 217
— stage, testing, 36
— transformer, formulae, 270
Hum, in radiogram, 189
— S.G. stage, 186
— tracing, 180

I

Impedance matching, 273
Inductance, formula, 269
Inductive reactance, 269
Instability, 104, 220

Instruments, choosing, 13
— general purpose, 15
— types of, 13
Insulation, breakdown, 132
Inter-electrode insulation, 113
Interference, 102
— caused by cars, 153
— external, 148
— mains, 155
— second channel, 234, 236
— tracing sources of, 140
Intermediate frequency, incorrect, 102
— transformers, ganging, 137

L

Life test instruments, 21
Local distance switching, 141
Long wave band, ganging on, 110
Loud speaker cones, faults in, 247
— faults, 247
Loud speakers, energised, faults in, 248
Low frequency amplifier, improving, 150
— oscillator, 78
— calibrating, 83
— overloading, 144
— response curve, making, 87

M

Magnification of tuned circuits, 271
Mains hum, eliminating, 235
— interference, 155
— transformers, colour code of, 270
Meter, conversions, 278
— universal, using, 61
Milliammeter, D.C. multi-range, 40
Milliammeters, adapting, 159
Motor car interference, 153
Multi-meter, 14
— purpose instruments, 23
Musical frequencies, 85

N

Noises, crackling, 33

O

Ohm's law, 264, 271
Oscillation, 141
Oscillator coil, 137
— testing, 102
— trimming, 226
— using, 136
Oscillators, Hartley, 78
Oscillographs, 18
Output valve, current taken by, 64
Overloading, avoiding, 237
— L.F., 144

P

Pentodes, substituting for triodes, 119
Piano keyboard and frequencies, 85
Pick-up connections of universal receiver, 134
Plastic wood, repairing cabinets, 162
Point to point testing, 49
Polishing cabinets, 163
Portable apparatus, 22
Potentiometers, screening grid, 267
Prefixes, 11

Q

Q.P.P. stage, 199

R

Radiogram, hum in, 189
Reactance, inductive, 269
— net, 271
— of coils, 271
— condensers, 271
— table of, 60
— values, 59
Reaction, effective on one wave band only, 128
— faults, 123
— faults and remedies, 128
— insufficient, 124
— partially effective, 127
— too fierce, 128
Receiver comparison, 178
— performance, checking, 135, 241
Receivers, old, improving, 129
Reception, weak, 215
Re-ganging, straight receiver, 225
Repairs, 186
Resistance, breakdown, 157
— colour codes, 274
— measuring, 46
— of coil windings, measuring, 205
— wattage rating, 255
Resistances in parallel, 271
— series and parallel, 268
— testing, 195
Response curve, making, 87
— curves, high frequency, 170
— tests, 245

S

Screened grid stage, hum caused in, 186
Screening grid, potentiometers, 267
— voltage, 142
Screening leads, 190
Second channel interference, 234, 236
Selectivity, curves, 242
— improving, 130
— poor, 233
Self oscillation, 141
Sensitivity, checking, 241

Service equipment manufacturers, 82
Set analysers, 16
Short circuit, testing for, 36
Signal generator, 89
— generators, 20
— strength, weak, 34
Signals, lack of, 31
— lack of, 215
Smoothing condensers, 62
Speech coil, testing, 247
Straight receiver, ganging, 225
Stray capacities, reducing, 110
Substitution, 158
Superhet, converting to straight circuit, 100
— peculiarities, 233
— reganging, 226
— tracing faults in, 99
Superhets, ganging, 106, 110
Switching defects, 210
— local distance, 141
Symbols, 10, 11

T

Test signal, obtaining, 135
Time based system, 167
Tone correction, 120
Tracking adjustments, 228
Transformer, breakdown, 167
— intermediate frequencies ganging, 137
— ratio, H.F., 270
Transformers, simple tests for, 192
— testing, 37
Theoretical symbols, 10
Trimming, effect on wave range, 109
— oscillator, 226
— receivers, 106
Tuned anode coupling, hum caused by, 188
— circuits, wave length of, 269
Tuning condenser, noises caused by, 240
— flat, 127

U

Units, electrical, 11, 29
Universal instruments, 23
— meter, using, 61
— receiver, aerial-earth connections of, 134
— receiver faults, 132
— receiver, pick up connections of, 134

V

Valve base connections, 277
— detector, replacing, 121
— H.F., replacing, 121
— leg spacing diagrams, 281

PRACTICAL WIRELESS SERVICE MANUAL

Valve pins, connections for, 278
— replacement, 118
— tester, 13
— testers, 22
— voltmeter, 14, 68
— voltmeter, calibrating, 73
— using, 76
Valves, breakdown of, 158
— loss of efficiency, 118
— testing, 113, 165, 214
Variable condenser, capacity of, formula for, 270
Voltage dropping resistance, 133
— grid bias, measuring, 66
— screening grid, 142
— tests, 197
— tests, on A.C. sets 200

Voltages, A.C., measuring, 50
Volume control, adding, 131
— controls, testing, 38

W

Wattage consumption of receiver, 133
Watts dissipated, 271
Wave length range finding, 266
— formula for, 271
— frequency conversion table, 284
— of tuned circuits, 269
— of tuned circuit, 272
Wave trap, 239
Wire data, 282
Whistling noises, eliminating, 234
Workshop, Equipping, 251

RADIO CAREERS

AN IMPORTANT GUIDE



This modern guide indicates clearly how all engaged in the Wireless industry can equip themselves for safe and highly-paid posts, not only during hostilities, but in the face of the keener competition which will come with a return to peace-time conditions.

"ENGINEERING OPPORTUNITIES" contains 112 pages of highly useful information. It gives full details of our very comprehensive series of modern WIRELESS COURSES, including **General Wireless Engineering, Talking Picture Engineering, Television and Radio Servicing**, etc.

RADIO SERVICING AND TELEVISION

Our two courses in modern Radio Servicing and Television are particularly popular. The Servicing Course deals with every phase of work covered by the modern **Radio Serviceman**, both from the technical and purely practical aspects, whilst Radio Engineers who are thinking ahead are giving close consideration to the study of **Television**. There is no doubt about it that with Peace will come an enormous boom in Television, and the man who is equipped with the most up-to-date knowledge of Television practice and principles will find himself in a position to skim the cream of this new market.

"ENGINEERING OPPORTUNITIES" also explains the most efficient way of preparing candidates for such recognised Examinations as **A.M.I.E.E., A.M.Brit.I.R.E., City and Guilds**, etc.

We definitely Guarantee—"NO PASS—NO FEE"

The Wireless industry is alive with possibilities. In your own interests you should write for your copy of "ENGINEERING OPPORTUNITIES" to-day. It will be sent **FREE** and the book is bound to indicate many opportunities which otherwise you might miss.

BRITISH INSTITUTE OF ENGINEERING TECHNOLOGY
160, Shakespeare House 17/19 STRATFORD PLACE, LONDON, W.1

Why not get the very best out of your Short-wave listening ?

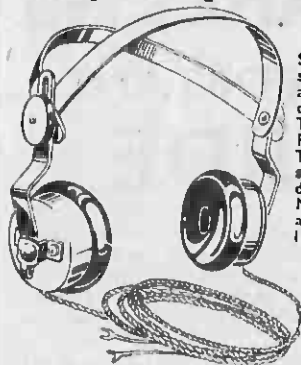

Short waves on the loudspeaker are all very well, but somehow or other, it seems that the most interesting and most sought-for transmissions are the most distant—and the faintest.

This is where ERICSSON SUPERSENSITIVE TELEPHONES come to the aid of the short-wave "fan". They annihilate distance . . . securing at pleasurable strength the faintest transmissions, rendering them a delight to listen to through their purity of tone. Marvellously sensitive, light and comfortable in wear—a big point during long spells of listening. Very robust in spite of their fine sensitivity.

At most good radio dealers. If you have any difficulty, write direct to:

ERICSSON TELEPHONES, LTD.
56 Kingsway, London, W.C.2 Tel. HOLborn 6936.

25/-

Ericsson

SUPER
SENSITIVE
TELEPHONES

AUSTERITY RADIO LIMITED

(Formerly F. H. WILSON)

Radio testing gear of every description made to your own specification

Comprehensive stocks of:
Condensers Transformers Resistors
Coils Valve-holders dropping Resistances, etc. etc.

SEND US YOUR REQUIREMENTS - WE CAN SUPPLY

307, HIGH HOLBORN,
LONDON W.C.1 Phone: HOLborn 4631

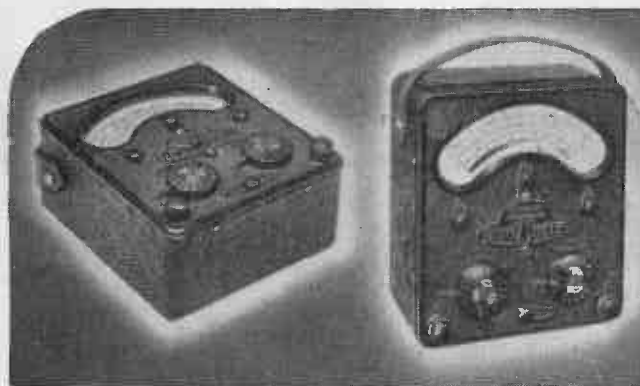

50-range Model 7
Universal AvoMeter

40-range Model 40
Universal AvoMeter



Regd. Trade Mark

PRECISION TESTING INSTRUMENTS

"Avo" Instruments, by their simplicity, extreme versatility and high accuracy, make possible that economy of time which is the essential feature of profitable servicing and maintenance.

Extensively used by radio manufacturers, service engineers and throughout industry, they set a recognised standard of accuracy and fine workmanship by which other instruments are judged.

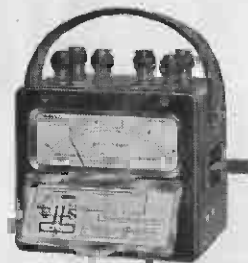

The "AVO"
Milliohmometer

At the time of going to press with this book, orders can only be accepted which bear a Government Contract Number and Priority Rating.

Sole Proprietors and Manufacturers:—

THE AUTOMATIC COIL WINDER & ELECTRICAL EQUIPMENT CO. LTD.
Winder House, Douglas Street, London, S.W.1

Phone: VIctoria 3404-7

**74 RANGE
UNIVERSAL TAYLORMETER**



We also manufacture—
Model 65A
 Signal Generator 100 Kc to
 46 Mc. in six ranges A.C.
 Mains operated
 Price £14 14s. 0d complete
Model 45A/S
 Mutual Conductance Valve
 Tester. Covers all popular
 British, American and Conti-
 nental Valves. A.C. Mains
 operated.
 Price £15 15s. 0d
Model 47A/S
 Mutual Conductance Valve
 Tester combined with Multi-
 range Universal meter A.C.
 Mains operated
 Price £18 18s. 0d

This series of Multirange Universal Instruments is unique in combining extreme sensitivity with a very wide range of measurements

Model 83C has self-contained ranges as follows —
 D.C. Volt ranges from 0.01 Volt to 5,000 Volts
 A.C. Volt ranges from 0.1 Volt to 5,000 Volts
 A.C. & D.C. Current from 0.50 μ A to 10 Amperes
 Resistance from 0.1 Ohms to 50 Megohms with internal batteries.

With external batteries the resistance range can be extended to 1,000 Megohms and by the use of an adaptor, six ranges of Capacity and Inductance measurements are also available. All A.C. & D.C. Voltage measurements are at 20,000 Ohms per Volt

Model 83A. 4,000 Ohms per Volt A.C. & D.C.
 Price £15 15s. 0d.
 Model 83C. 20,000 Ohms per Volt A.C. & D.C.
 Price £19 19s. 0d.

Taylor
 electrical instruments Ltd.

Send your enquiries to—
TAYLOR ELECTRICAL INSTRUMENTS LTD.,
 419-424 Montrose Avenue, Slough, Bucks.
 Telephone: Slough 21381 (4 lines) 'Grams: "Taylins, Slough"

WHEREVER

A CONDENSER IS REQUIRED

THERE IS A

DUBILIER

TO MEET THE CASE

— and meet it well

DUBILIER CONDENSER CO. (1925) LTD



BULGIN

(Registered Trade-Mark)

RADIO PRODUCTS

The Choice of Critics

For over 20 years the name BULGIN has been synonymous with all that is best in the Radio and Electrical Component world, whether for the government, set manufacturer, technician or enthusiast. Over 2,000 manufactures of outstanding merit.

We ask the kind indulgence of the public in delivery until peaceful conditions return.

A. F. BULGIN & COMPANY, LTD.
BY-PASS ROAD, BARKING, ESSEX
RIPPLEWAY 3474 (4 lines)

LONDON CENTRAL RADIO STORES

*Extensive stocks
of radio, television and
electrical components*

*Manufacturers'
surplus stocks bought
for cash*

*Suppliers to Government
Departments, Universities
and keen amateurs*

23 LISLE STREET, W.C.2

PHONE

GERRARD

2969



Speakers & Components

THE CHOICE OF EVERY GOOD RADIO ENGINEER

TRANSFORMERS

Service Universal Output
Transformer

Miniature Service Universal
Output Transformer

Service Intervalve Trans-
former

DETAILS AND PRICES
GLADLY SENT ON
APPLICATION

Only Orders bearing
Govt. Priority Nos.
can be accepted

STENTORIAN
SPEAKERS

FACTORY
SPEAKERS

TRANSFORMERS

VALVEHOLDERS

SWITCHES

CHOKES

WHITELEY ELECTRICAL RADIO CO. LTD. MANSFIELD, NOTTS

WHY YOU SHOULD USE ONLY

ERSIN MULTICORE

THE SOLDER WIRE WITH
3 CORES OF
NON-CORROSIVE ERSIN FLUX

- Avoids Dry Joints
- Increases Electrical Efficiency of Joints
- Speedily makes Sound Joints on Dirty or Oxidized Surfaces
- Always Correct Proportions of Flux and Solder
- No Additional Flux Required
- Low Melting Point (190° C. for 60/40 alloy)
- Approved by Air Ministry and G.P.O.
- All-British and acknowledged by the Leading Manufacturers to be the finest Cored Solder in the world.

FREE

Two informative publications on soldering have been issued by Multicore Solders Ltd. Executives are invited to send for copies and a free sample of Multicore Solder.

MULTICORE SOLDERS Ltd.
Commonwealth House
New Oxford St., W.C.1
Tel. : CHANcery 5171/2



PRACTICAL WIRELESS SERVICE MANUAL

Wavelength-Frequency Conversion Table
Metres to Kilocycles

Metres.	Kilocycles.	Metres.	Kilocycles.
5	60,000	370	810.8
6	50,000	380	789.5
7	42,857	390	769.2
8	37,500	400	750
9	33,333	410	731.7
10	30,000	420	714.3
25	12,000	430	697.7
50	6,000	440	681.8
100	3,000	450	666.7
150	2,000	460	652.2
200	1,500	470	638.3
205	1,463	480	625
210	1,429	490	612.2
215	1,395	500	600
220	1,364	510	588.2
225	1,333	520	576.9
230	1,304	530	566
235	1,277	540	555.6
240	1,250	550	545.4
245	1,225	560	535.7
250	1,200	570	526.3
255	1,177	580	517.2
260	1,154	590	508.5
265	1,132	600	500
270	1,111	650	461.5
275	1,091	700	428.6
280	1,071	750	400
290	1,034	800	375
295	1,017	850	352.9
300	1,000	900	333.3
310	967.7	950	315.9
320	937.5	1,000	300
330	909.1	1,250	240
340	882.4	1,500	200
350	857.1	1,750	171.4
360	833.3	2,000	150

Note.—To convert kilocycle to wavelength in metres, divide 300,000 by the number of kilocycles.

To convert wavelength in metres to kilocycles, divide 300,000 by the number of metres. 1 megacycle = 1,000,000 cycles or = 1,000 kilocycles. Thus, 30,000 kilocycles = 30 megacycles.

INDEX

A

Abbreviations, 9
Acoustic output tests, 243
A.C./D.C. receiver faults, 132
— valves, use of, 132
A.C. sets, voltage tests on, 200
— voltage, measuring, 50
Aerial circuit filter, 240
— connections of universal receiver, 134
— dummy, using, 98
Aligning receivers, 108
Amplifier, low frequency, improving, 130
Analysers, 16
Anode current tests, 119
— value, 213
Anti-interference units, 150
Automatic volume control, 242
— eliminating, 223
A.V.C., checking, 67

B

Background noises, 244
Bias calculations, 273
Band pass tuners, peak separation of, 271
— trimming, 107
Battery leads and plugs, colour code of, 276
Beat note audibility, 97
Breakdowns, causes of, 156
Bridges, 18
Broadcast signal, testing of, 95

C

Cabinet scratch remover, 164
Cabinets, polishing, 163
— renovating, 162
Calibrating apparatus, 40
Calibration, frequency, 169
Capacity of fixed condenser, formula for, 269
— variable condensers, formula for, 270
— measuring, 55
— values, 222
Capacities, stray, reducing, 110
Car interference, 153
Cathode ray tube, servicing with, 165
Chokes, testing, 37
Circuits, checking, 161
Class B stage, current consumption of, 199

Code, colour, 274
Coil, connections, tracing, 207
— H.F., modifying, 210
— modifying, 209
— reactance of, 271
— windings, measuring resistance of, 205
Coils, adjusting, 204
— oscillator, 137
— simple tests for, 192
— testing, 37, 204
Colour code, 274
Commercial receivers, servicing, 212
Components, simple tests for, 191
— testing, 36
Condenser, capacity of fixed, 269
— colour codes, 274
— reactance of, 271
— tests, 183, 193
— values, 51
Condensers, breakdown of, 158
— in parallel, 271
— series, 271
— and parallel, 268
— smoothing, 62
— testing, 39
— testing fixed, 221
Connections, testing, 35
Copper wire data, 282
Coupling, co-efficient of, 273
Crackling noises, 33
Current consumption of receiver, 133
— tests, 198, 202
— anode, 119
— value, anode, 213

D

"Dead" receiver, servicing, 212
Decoupling methods, 220
Detector diode, testing, 101
— stage, distortion in, 143
— stage, measuring voltage of, 160
— valve, replacing, 121
Dial readings, checking, 229
Diode, testing, 101
Direction finding, 147
Distortion, 140, 230
— in detector stage, 143
Dummy aerial, using, 98

E

Earth connections of universal receiver, 134
Electrical symbols, 11
— units, 11

PRACTICAL WIRELESS SERVICE MANUAL

circuit and, from them, plot a graph on squared paper. With a meter resistance of 100 ohms the list will appear as follows:

500 ohms—0.9 mA.	1,000 ohms—0.818 mA.
2,000 ohms—0.692 mA.	3,000 ohms—0.6 mA.
5,000 ohms—0.473 mA.	8,000 ohms—0.360 mA.
10,000 ohms—0.31 mA.	15,000 ohms—0.231 mA.
20,000 ohms—0.183 mA.	30,000 ohms—0.131 mA.
	50,000 ohms—0.0825 mA.

and a graph drawn from these figures is shown in Fig. 28

The insertion of these figures is not so difficult as it sounds, and if reasonable care is taken when removing the scale from the instrument, no damage will be sustained. The whole meter movement must be withdrawn from the case before the scale can be removed, and the scale

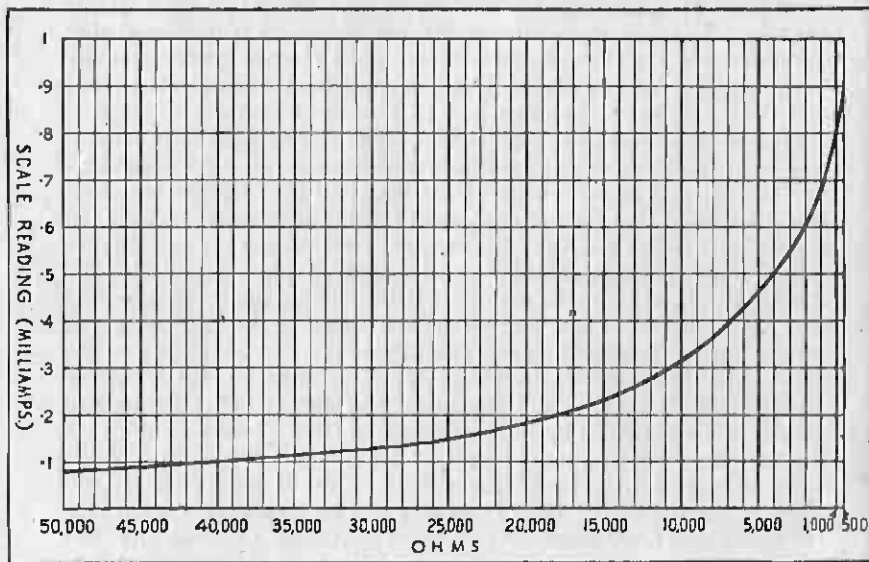

FIG. 28.—A graph drawn to enable dual readings to be made

should be pinned down (with the heads of the drawing-pins bearing on the edges of the scale) to some flat surface, such as a drawing-board, while the figures are inserted. A convenient place is directly underneath the milliampere calibration, and if this is black, a distinctive coloured ink, such as red, should be used. It will be found that most reputable instruments have a scale on which it is possible to write with drawing ink, but a slight roughening of the surface may prove advantageous. A light dusting with french chalk will be found to help in getting the

MEASURING RESISTANCE

ink to run on smoothly. Fig. 29 will show exactly how the scale looks when the resistance calibration has been included.

Point-to-Point Testing.—The sphere of usefulness of the completed ohmmeter does not end with the measurement of resistance, though this is its primary function. It can, of course, be used as a point-to-point tester, and any bad joints in the wiring of a receiver will be shown by the failure of the meter to read zero ohms. Another application is to use the meter to indicate short circuits in condensers or between the electrodes of valves. A fault of this nature will cause the meter to give a full-scale deflection when the resistance terminals are connected across the suspected component. A quick method of checking for an internal disconnection inside a smoothing condenser is to connect the resistance terminals to the suspected condenser and watch the needle of the meter closely while the connection is being made (Fig. 30). Provided the condenser has a capacity of 1 mfd. or greater the meter will kick, and then return to zero, showing that the internal battery has charged up the condenser. If the condenser is

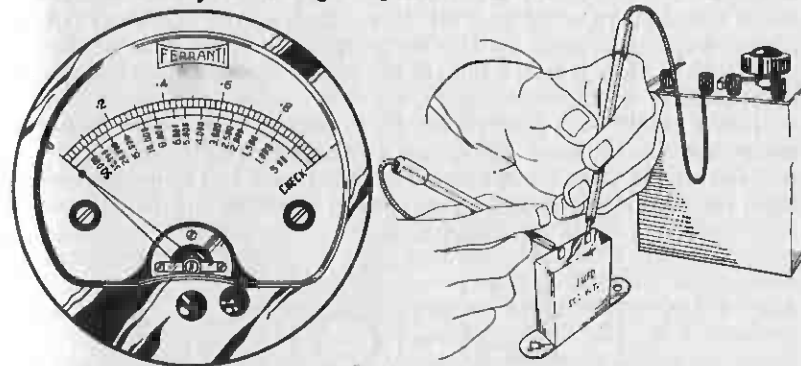

FIG. 29.—Showing the resistance calibrated readings added to the scale of a milliammeter.

FIG. 30.—The ohmmeter in use testing a fixed condenser.

perfect, no further kick should be apparent until the connections to the condenser are reversed, when there should be a further kick owing to this reversed polarity. Care should be taken when testing electrolytic condensers by this method, as these condensers are polarised, and must be connected in the correct way. The positive pole must always be connected to the positive terminal of the meter (see Fig. 27), and should not be reversed. When attempting to test high-voltage electrolytic condensers by this method do not be led into thinking that the condenser is faulty if the meter reads zero ohms because these condensers sometimes require a somewhat higher polarising voltage than the 4.5 volts which are available from our meter.

CHAPTER IV

MEASURING RESISTANCE

MOST service-men have experienced at one time or another the annoyance entailed by the lack of a suitable means of determining the value of a resistor which is colour-coded only, when no copy of the standard colour code is to hand or the spot has been rubbed off the body of the resistor. Furthermore, a great many receivers incorporate wire-wound potential dividers which cannot be marked with their ohmic value, and although reference to the circuit diagram or service instructions will usually give the correct value of the resistance element, very few listeners have any means of determining whether the sections of the potential divider are intact or even completely open-circuited.

The multi-range D.C. meter described in the previous chapter can, by the addition of the components which have already been procured

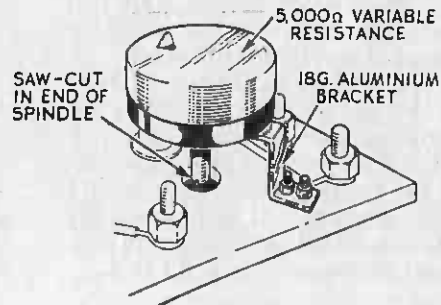

FIG. 26.—Fixing the 5,000 ohms variable resistance in position.

and used to calibrate the extended ranges, be easily modified for use as a direct reading ohmmeter, having a range of 500 to 50,000 ohms. This range would seem to be quite suitable for diagnosis purposes, as very few wire-wound resistances lie outside it, and great accuracy is not required when resistances of the magnitude of megohms are to be checked. Actually, it is possible to distinguish between 100,000 ohms and 1 megohm by this instrument, but the scale becomes so cramped for these high resistances that an accurate calibration is impossible.

The first step is the inclusion of the 5,000 ohms variable resistance,

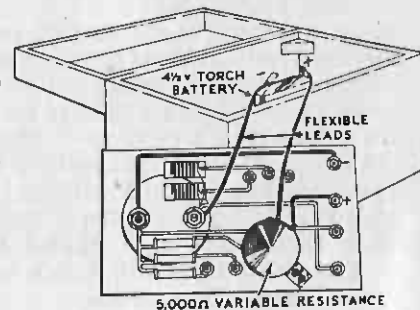

FIG. 27.—The extra connections to convert an ohmmeter.

and the 4½-volt torch battery inside the instrument case. The resistance is supported on a bracket made from 18 gauge aluminium, bent to shape and drilled as shown in Fig. 26, and fixed under the panel in such a way that the spindle of the resistance comes immediately under the hole which we have already provided through the panel to enable the zero of the resistance range to be set. No dimensions have been indicated on the sketch of this bracket as the actual size will depend on the make of resistance used. Before mounting the resistance, a saw-cut should be made with a fine hack-saw blade across the end of the spindle so that it is possible to insert a small screwdriver through the hole in the panel to adjust it. The battery can easily be accommodated in the bottom of the instrument box, and connections made to it by means of flexible leads sufficiently long to permit the replacement of the panel after the battery has been slipped into the clip or strap which retains it.

Additional Connections.—The extra connections needed inside the case are clearly shown in Fig. 27, and it will be remembered that the terminals for the resistance meter have already been mounted. No difficulty should be experienced in completing this part of the work, and the actual calibrating can now be proceeded with.

Rotate the resistance until the whole of the element is in circuit, and then short-circuit the terminals which have just been connected up. This should be done with a short length of heavy gauge wire, and it will be found that the meter shows a reading somewhat less than full scale. Now, with a fine screwdriver, engage the saw-cut in the resistance spindle and rotate it carefully until exactly 1 mA. is indicated by the meter. It will now be seen that if we remove the short-circuiting wire from the terminals, and connect a resistance across them, the reading of the meter will be decreased by an amount depending on the value of the resistance we have inserted. Say, for instance, the battery gives exactly 4.5 volts, and the meter has an internal resistance of exactly 100 ohms, then by the application of Ohm's Law we know that the variable resistance must be set at 4,500 minus 100 ohms or 4,400 ohms to pass 1 mA. round the circuit. Now, if we include 10,000 ohms in the circuit our total resistance will be 10,000 plus 4,400 plus 100 ohms, or 14,500 ohms. Again applying Ohm's Law, we find that 4.5 volts across this resistance will drive 4.5 divided by 14,500 or 0.31 mA. round the circuit, and this will be the reading indicated by the meter.

It can safely be assumed that a flash-lamp battery will maintain its potential of 4.5 volts for some months when it is only required to give 1 mA. intermittently, and provided the calibration is carried out carefully, and the battery is replaced when the variable resistance has to be rotated an undue amount to make the meter indicate 1 mA., the resistance readings can be relied on for a high degree of accuracy.

Meter Readings.—The next step is to draw up a list of meter readings which will be obtained with various values of resistance in

the condenser will be 90 degrees out of phase with the current passed by the combined resistance of the meter and the rectifier, so it is necessary to use the formula: $X = \sqrt{Z^2 - R^2}$, where X equals the reactance required, Z equals the impedance of the total circuit and R equals the resistance. Inserting the values we have obtained we find that $X = \sqrt{(9,010)^2 - (870)^2}$, or 8,969 ohms. We have now to find a condenser which will have a reactance of this value at a frequency of 50 cycles, and this is obtained from the formula

$$C = \frac{1,000,000}{2 \times 3.14 \times 50 \times 8,969} \text{ or } 0.355 \text{ mfd.,}$$

but we are unable to obtain a condenser of this capacity, so we must, therefore, connect several condensers in parallel to build up the value we require. On referring to Fig. 32 you will see that the condensers

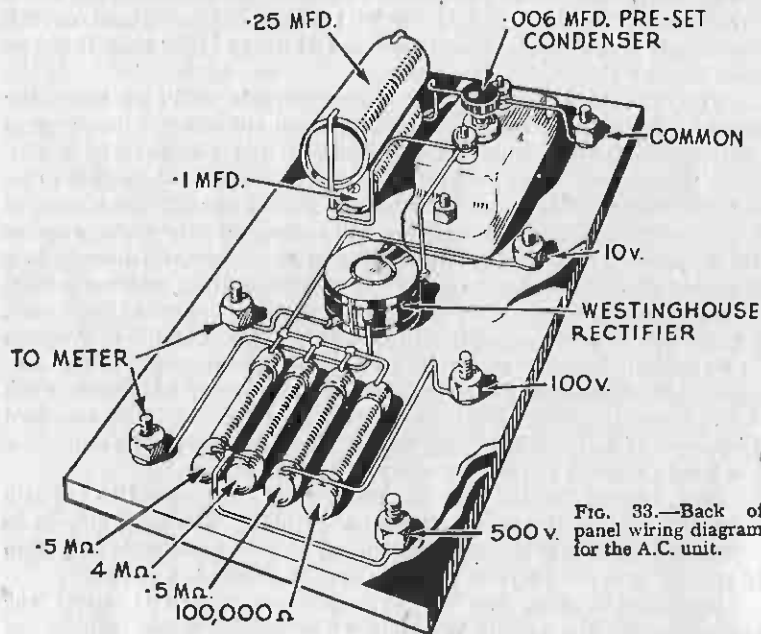

FIG. 33.—Back of panel wiring diagram for the A.C. unit.

used are one of 0.25 mfd., one of 0.1 mfd., and a pre-set condenser with a maximum capacity of 0.006 mfd., this latter being included to enable a final adjustment to be made if it is possible to compare our meter with a meter of known accuracy. Should this not be possible, it will be found that this condenser should be screwed right home and then slacked off about one-quarter of a turn.

We can now turn our attention to the resistances which are used

to extend the range of the meter to read 100 volts and 500 volts maximum. Remembering that we already have an impedance of 9,010 ohms in circuit, and that a current round the circuit greater than that required to give full-scale deflection, on D.C. by 1.11 times will be required, we can start our calculations from a basis of 100,000 ohms, which would be the correct resistance if D.C. were to be passed through the circuit. Dividing 100,000 by 1.11, we get 90,090 ohms, and subtracting 9,010 ohms from this figure we are left with 81,080 ohms, which is the resistance we require. This, again, is a non-standard value, so two resistances are used in parallel, one of 100,000 ohms and one of 0.5 megohm.

These do not give precisely the value required, but are sufficiently near for our purpose.

The resistances required for the 500-volt range are calculated in a similar manner and are found to be 0.5 megohms and 4 megohms, connected in parallel.

Wiring Connections.—

The actual construction and wiring of the unit is clearly shown in Fig. 33, and should present no difficulty, the only point to be stressed being that the connections to the rectifier unit should be made in accordance with the instructions contained in

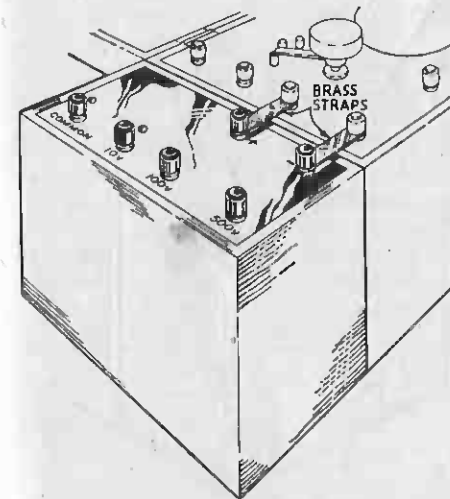

FIG. 34 (left).—The complete A.C. unit in its cabinet connected to the meter.

the maker's leaflet which will accompany the rectifier, as the latest type differs slightly from the type actually used by myself in mechanical construction, though the electrical characteristics are similar. The rectifier, fixed condensers, and resistances are supported by the wiring, which should be of at least 18-gauge tinned copper wire to give the necessary rigidity.

The appearance of the A.C. section when connected to the multi-range meter is shown in Fig. 34.

The use of a condenser in the circuit ensures that the rectifier cannot be damaged if D.C. is accidentally applied to the terminals of the A.C. section, and also allows the complete meter to be used as an output meter without extra safety devices.

When using the meter for the latter purpose it should be noted that

CHAPTER V

MEASURING A.C. VOLTAGES

THE universal meter now covers all the most useful ranges of D.C. measurement met with in radio receiving testing, but there are many occasions when it is wished to ascertain the A.C. voltages existing in all-mains receivers in order to check such things as mains transformer windings, filament voltages, and the voltage of supply mains. Our meter will not, at present, give any deflection when connected to an A.C. supply, and some means of turning the A.C. into D.C. and then measuring it will be required.

Metal Rectifier Unit.—The most convenient method of doing this is by the well-known metal rectifier unit, and the Westinghouse Brake and Signal Co., of 82 York Road, King's Cross, London, N.1, market a special rectifier suitable for meter work. This little rectifier is supplied in various styles, but the one most suitable for our purpose is the M.B.S.1.

Now it would seem a simple matter to connect this rectifier to our meter and connect series resistances to the A.C. side to extend the range as we did when constructing the D.C. meter, but unfortunately, there are several peculiarities about metal rectifiers and moving-coil

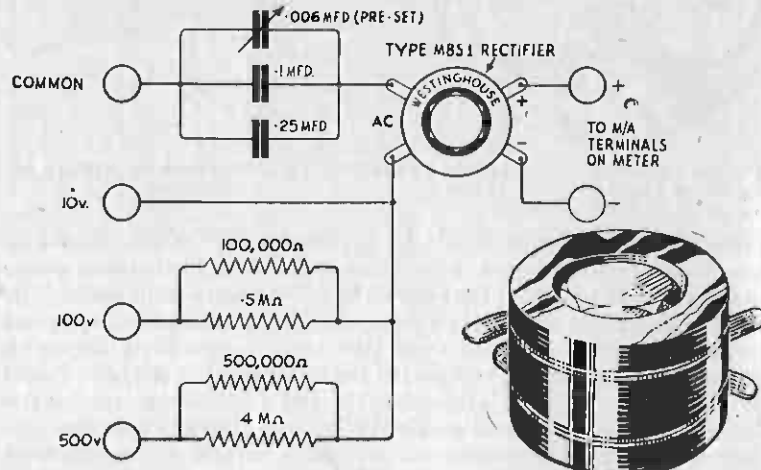

FIG. 32.—The theoretical circuit diagram of the A.C. unit.

FIG. 31.—The Westinghouse rectifier. Type M.B.S.1.

meters when we wish to read rectified voltages which prevent so easy a procedure.

To explain briefly, the metal rectifier, when connected to a moving-coil meter, presents a resistance to an external circuit which varies with the amount of current passed through the rectifier. It is not necessary, however, to measure this variation for each individual rectifier and meter, as the manufacturers publish curves showing the variation likely to be experienced with meters of various internal resistances, and these curves can be relied on to an accuracy greater than that which we require. The general appearance of the rectifier is illustrated in Fig. 31.

The second difficulty met with is the fact that a moving-coil meter, instead of reading "R.M.S." values of A.C. voltage (which are what we require), is sufficiently sensitive to read average values which are lower than "R.M.S." values by 1.11 times. This will, of course, necessitate series resistances of a value 1.11 times lower than those we used for our D.C. meter.

The difficulties mentioned are not insuperable, and fortunately the use of a condenser for a series resistance on the lower voltage range will correct the non-linear characteristic of our rectifier and meter. Most readers will be aware that when a condenser is connected in an A.C. circuit a current will flow round that circuit, the amount of current being dependent upon the frequency of the supply, the voltage across the condenser, and its capacity. Thus, a condenser will behave in a precisely similar manner to a resistance, except that, whereas a non-inductive resistance will not vary its value with changes of frequency, a condenser of given capacity will pass more current at 100 cycles than at 50 cycles. To use a condenser as a "series resistance" for our A.C. meter, therefore, means that the meter will only read accurately when A.C. at one frequency is applied across its terminals. The standard frequency of A.C. mains in this country is 50 cycles, and so our meter has been designed to read correctly at this frequency.

Now, having decided that our meter shall be designed to indicate correctly A.C. voltages of 50 cycles periodity, the next step is to calculate the value of condenser necessary to give a full-scale deflection of our meter when 10-volts A.C. are applied across the circuit.

Condenser Values.—As we have now to pass 1.11 times the current round the circuit to produce the deflection we require, the impedance of the total circuit will be equivalent to $\frac{10,000}{1.11}$ or 9,010 ohms.

This value will be made up of the resistance of the meter and rectifier and the reactance of the condenser in series. The resistance of the meter and rectifier is obtained from the maker's curves, and is found to be approximately 870 ohms for the rectifier we have chosen, and a meter with an internal resistance of 100 ohms. The voltage passed by

There is no easy method of extending the current ranges of our A.C. instrument and the construction of suitable transformers for this purpose is rather beyond the capabilities of the reader. However, the occasions on which A.C. current measurements need to be taken for receiver diagnosis are fortunately rare, and the omission of extended current ranges need not be considered a very great drawback or one which unduly restricts the scope of our meter.

Measurement of Capacity.—There is, however, one very useful type of measurement which can be made with our A.C. unit, and

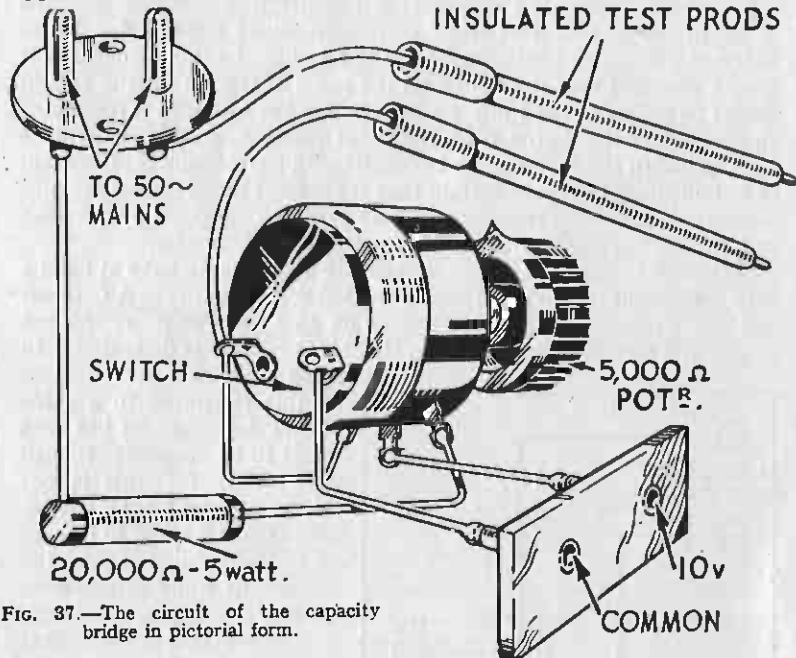

FIG. 37.—The circuit of the capacity bridge in pictorial form.

that is the measurement of capacity. For this purpose it is necessary that a source of A.C. is available and A.C. mains will usually be accessible to those readers who have constructed the rectifier unit. In this connection it is assumed that the mains to be used are 200-250 volts, 50 cycles, but any other voltage or periodicity can equally well be accommodated, by suitable modifications to the meter. Electrolytic condensers cannot be measured with this type of instrument, as it operates on A.C.

It will be seen from the circuit diagram (shown diagrammatically in Fig. 36, and pictorially in Fig. 37) of the additions to be made to the unit, that the A.C. mains are fed to a voltage divider formed by 20,000 ohm fixed resistor, and a wire-wound potentiometer of 5,000 ohms,

across which the 10-volt range of the A.C. unit is connected and the condenser under test. The switch is included in the leads to the meter to serve the double purpose of disconnecting the capacity measuring circuit and thus prevent damage to the meter when adjusting for full-scale deflection before taking capacity measurements. From the foregoing it will be clear that although the illustrations to this part show the capacity unit as a separate piece of apparatus, the inclusion of the extra components can conveniently be made in the same box as the A.C. unit described in Chapter V. If made up as a separate unit, providing the switch is in the "off" position after capacity measurements have been taken, there is no necessity to disconnect the unit in order to use the remainder of the apparatus.

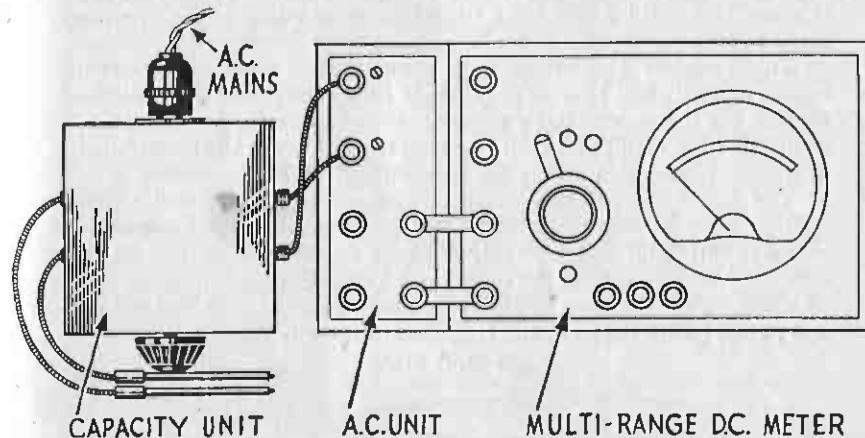

FIG. 38.—The unit connected to the universal meter.

The inclusion of insulated test prods is another very necessary precaution because unless these are connected together or bridged across a condenser, fairly high A.C. voltages are present and there is a possibility of an unpleasant shock being sustained if bare test prods are carelessly handled. The type of test prod in which the connecting plunger is spring-controlled will be found to be the most suitable as there are no exposed metal parts unless readings are being taken.

A condenser, it has been explained, will permit a flow of alternating current and the amount of current passed will depend on the capacity of the condenser, the voltage applied to it and the periodicity of the supply. This is the principle governing the capacity measurements which we propose to make.

Mounting the Components.—No difficulty should be experienced in mounting the components in the box and the wiring is quite straightforward and may be followed easily from the drawings,

with special reference to Fig. 38. Make sure that the 5,000 ohm potentiometer and switch are constructed in such a manner that the switch is "off" when the knob is rotated fully in an anti-clockwise direction and that all joints in the wiring are sound. The potentiometer shown in the illustrations is the Bulgin, Type No. V.S.44, and which will be found to be eminently suitable.

Now connect the units together as shown in Fig. 39, short-circuit the test prods by extending their points, locking and clamping them together in a crocodile clip and rotate the 5,000 ohm potentiometer until the switch is "off". Plug into the A.C. mains and rotate the potentiometer until the switch "makes". The meter should now show a small deflection and further rotation of the potentiometer will increase this until a full-scale deflection is obtained. We are now ready to commence calibration.

Those readers who have a large assortment of fixed condensers of known capacity will be able to calibrate their meter directly by disconnecting the mains, removing the short-circuit from the test prods, re-connecting the mains and then touching the test prods to the terminals of the condensers and noting the deflection given by the meter.

The larger the capacity of the condenser the higher will be the reading given by the meter and with the circuit as shown capacities between .001 mfd. and 1.0 mfd. will give readable deflections of the meter. A chart showing the deflections for various capacities can then be prepared on the lines of the one illustrated in Fig. 40 and cut out and pasted inside the lid of the D.C. meter for ready reference.

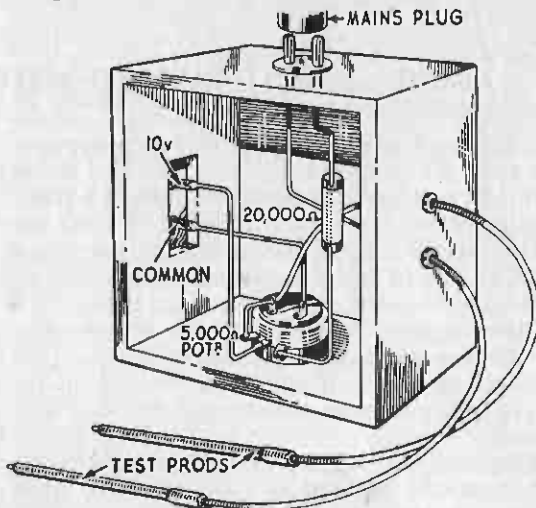

FIG. 39.—The completed unit ready for calibration.

Calibration Chart.—This procedure, however, will not assist the reader who has not ready access to suitable condensers, but a calibration chart may be prepared by the following method.

The formula for calculating the reactance of a condenser is $\text{Reactance} = \frac{10^9}{2\pi f C}$ where $\pi = 3.14, f = \text{fre-$

quency of the supply and $C =$ the capacity of the condenser in micro-farads. If we select, for example, a condenser of 0.1 mfd. capacity we find, on inserting the values in the above formula, that

$$\text{Reactance} = \frac{10^9}{2 \times 3.14 \times 50 \times 0.1} \text{ or } 32,000 \text{ ohms. At first we}$$

should be led to assume that we had merely to add this value to the 25,000 ohms already across our mains supply, which we will assume is 250 volts and apply Ohm's Law to give us the current flowing round the circuit. We should, however, be wrong, because we had forgotten that the current flowing through a condenser is 90° out of phase with the voltage passing through a resistance connected in series with it and therefore we must use a further formula to enable us to add the reactance to the resistance. This formula we have already used

when constructing the 10-volt range of our A.C. meter and, you will remember, is $\text{Impedance} = \sqrt{(\text{Reactance})^2 + (\text{Resistance})^2}$. Rewriting this with our values inserted we find that $\text{Impedance} = \sqrt{(32,000)^2 + (25,000)^2}$ or 41,000 ohms approximately. Now we can apply Ohm's Law and find that the current flowing round the circuit = $\frac{\text{Mains Voltage} \times 1,000}{41,000}$ or 6.1 mA.

We know that we have set our meter to read 1 mA. with 10 mA. flowing round the external circuit, so that our meter will read 0.61 mA. and this is actually the reading obtained when a condenser of 0.1 mfd. capacity is connected to our test prods.

Reactance Values.—The calculation of reactances and the transference of the values obtained to the scale of the meter is rather a laborious process, so for the guidance of constructors the following list has been compiled of the more usual capacities showing the meter reading obtained and though these values may vary slightly with different mains voltages they may

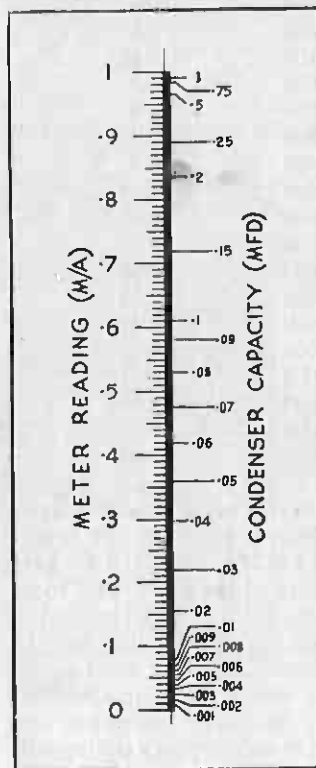
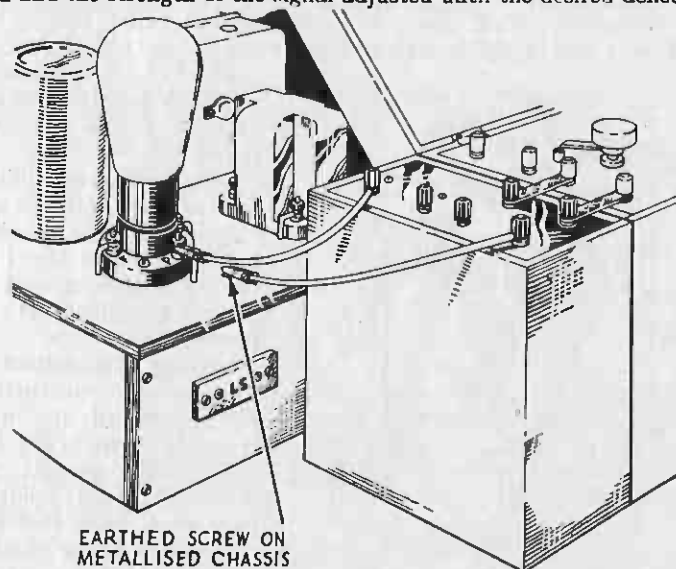

FIG. 40.—The calibration chart showing meter readings and condenser capacities.

the correct range to use will be dependent on the output of the receiver and the strength of the signal being received. It will be advisable to connect the 500-volt range to the speaker terminals if these are brought out for the purpose of an extension speaker connection, and if an insufficient deflection is then given by the meter, the 100-volt range may be tried. Should the extension speaker terminals be arranged for a low impedance speaker, the 10-volt range should be used and the strength of the signal adjusted until the desired deflection



EARTHED SCREW ON METALLISED CHASSIS

FIG. 35.—Using the complete apparatus as an output meter.

is obtained. Obviously a steady reading of the meter will only be obtained when a signal such as the B.B.C. tuning note, is being received as the reading of the meter will fluctuate rapidly if music or speech is being reproduced. Also the actual voltage developed at the loud-speaker terminals will not be indicated unless a 50-cycle note is being received, but the meter can be used with every success to indicate the efficiency of the receiver when ganging adjustments are being made, if the B.B.C. tuning note or a steady heterodyne note produced by two interfering stations is used for adjustment purposes. In a subsequent chapter a suitable oscillator for producing locally a steady signal of this type will be described.

Should no extension speaker terminals be available, connection should be made by means of crocodile clips to the anode of the output valve and an earthed portion of the receiver (Fig. 35).

CHAPTER VI

MEASURING CAPACITY

THE previous chapter gave all the necessary information to enable readers to construct a rectifier unit for use with the Universal D.C. Test Meter and also outlined some of the uses to which the completed instrument might be put. In this connection it should be noted that the switch on the panel of the D.C. meter should *always* be placed in the 1 mA. position before the A.C. unit is connected and used. If the switch is in any other position, no damage will be done either to the meter or to the rectifier but erroneous readings will be obtained. Also, make certain that the correct range is used for A.C. measurements, as the rectifier unit may easily be damaged by overload and, in this respect, is not so robust as the meter movement.

Where A.C. mains of known voltage are available we have at hand a very convenient method of checking the 500 volt range of the A.C. meter and the 4 megohm parallel resistance on this range may be reduced

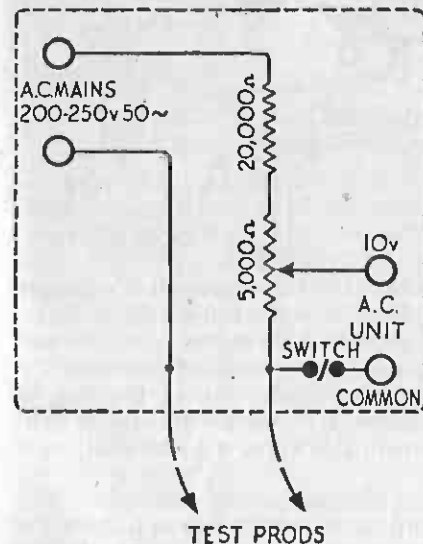

FIG. 36.—The theoretical circuit of the capacity bridge.

In some instances a reduction of this resistance to a value of 3 or 2.5 megohms has been found to be necessary, though the reason for this is not readily apparent. Of course, care must be taken to disconnect the mains from the instrument while adjustments are made.

The voltages are indicated on the 0 to 1 mA. scale in precisely the same way as when the meter is used for D.C. measurements, i.e., on the 10-volt range all readings should be multiplied by 10, on the 100-volt range by 100, and on the 500-volt range by 500. For example, using the 500-volt A.C. range a reading of 0.2 mA. will equal 0.2×500 , or 100 volts.

Commencing from the entry of the mains, the first component which may require to be checked is the mains transformer. If any doubt exists as to whether this component has been wired correctly or that the various leads have been identified correctly, the easiest method of checking the wiring is to connect the leads marked A and B, which are easily identifiable because they are much heavier in gauge than the other leads, to a 4 volt A.C. supply obtained from the filament sockets of a valve-holder in an A.C. receiver (Fig. 42). This will energise the other windings of the transformer and the voltages developed across other pairs of leads from the transformer can be measured, using the A.C. adaptor. Although these voltages may be slightly higher than normal owing to the transformer being unloaded, they will serve to indicate the leads which are connected to the various windings internally.

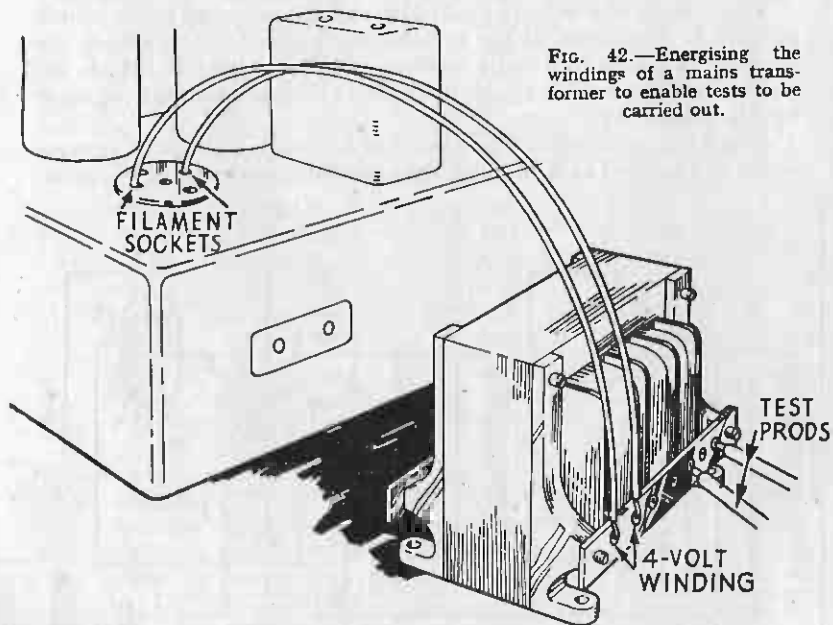

FIG. 42.—Energising the windings of a mains transformer to enable tests to be carried out.

Smoothing Condensers.—The next components to come under suspicion might be the smoothing condensers C and D if the hum in the receiver were excessive, and though the capacities used for smoothing are usually higher than can be indicated on the scale of our capacity meter, a very useful indication of the capacity available can be obtained by utilising the method outlined in the second article of this series whereby the resistance terminals are connected to the condenser,

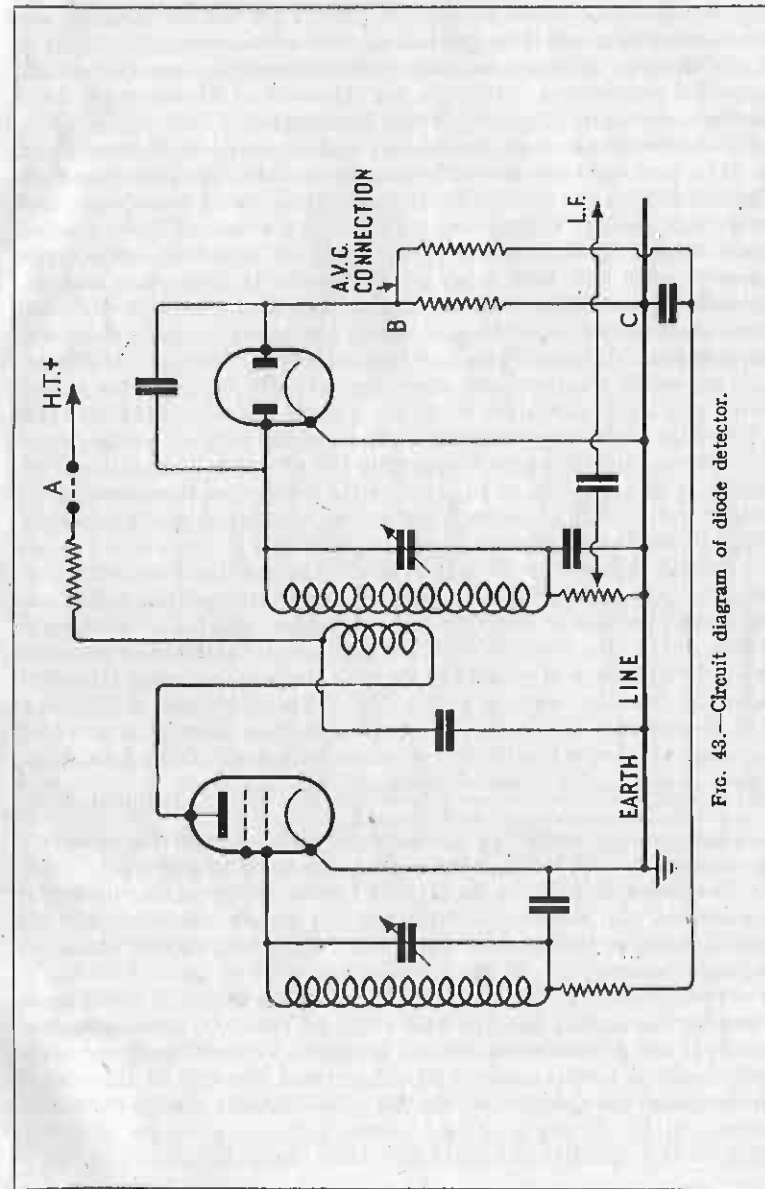

FIG. 43.—Circuit diagram of diode detector.

and the "kick" given by the meter on connection noted. The resistance meter will also indicate the presence of a short-circuit in a condenser by giving a full-scale deflection when connected to the suspected component, although the precautions to be taken when testing electrolytic condensers must be observed.

The smoothing choke has usually a comparatively low resistance to D.C., and although the resistance meter will indicate a complete disconnection it is rather difficult to ascertain whether a short-circuit between individual turns exists. However, if the hum in the receiver is excessive, and the smoothing condensers are perfect, it can safely be assumed that the inductance of the choke is inadequate and improved results will be obtained if this component is replaced. Care must of course be taken to ensure that the choke is firmly fixed and the clamping bolts holding the core lamination are adequately tightened.

Connecting the resistance meter between the anode of the output valve and the filament circuit of the rectifier valve will indicate that a circuit exists in the smoothing choke, and the primary of the output transformer, and the current flowing in this circuit will usually be sufficiently large to enable us to measure the voltage at the anode of the output valve with adequate accuracy by connecting the appropriate range of the D.C. voltmeter across points E and F.

Current Taken by Output Valve.—The next measurement to be made will usually be the current taken by the output valve, and the correct position to insert the 100 mA. range of the D.C. milliammeter will be at G in the diagram. Should the current indicated be excessive it will be necessary to adjust the value of the bias resistance (H) which is in the common negative return lead. To adjust this resistance it will be necessary to measure the current flowing through it and then calculate the correct value of resistance by using Ohm's Law which states that $\text{Resistance} = \frac{\text{Voltage}}{\text{Current}}$, where the voltage required is the grid-bias voltage needed by the valve in question, and the current is the current flowing through the circuit, expressed in amperes.

The decoupling resistance (J) and the secondary of the intervalve transformer can be checked by using the resistance meter, and the anode circuit of the detector valve will be the next circuit which will require checking.

If we attempt to measure the voltage at the anode of the detector valve by connecting the 100 volt range of the D.C. voltmeter across points K and L we shall obtain an erroneous value because our meter will absorb a certain amount of current and will add to the voltage drop across the components in the anode circuit. A more correct value will be obtained by first measuring the resistance in circuit between H.T. positive and point K. Then break the circuit at point M

and measure the current flowing. Applying Ohm's Law again we find that the voltage at the anode of the detector valve equals the maximum H.T. voltage minus the current in circuit expressed in amperes multiplied by resistance in circuit.

Checking the H.F. Circuit.—The H.F. circuit of the receiver can be checked by similar methods, and the only other point at which erroneous readings are likely to be obtained is the screening-grid connection of this valve. At this point the voltage is obtained from a potentiometer across the H.T. supply and connecting our D.C. voltmeter across points N and O will increase the current flowing through the potentiometer and lower the voltage at N. The correct voltage can only be ascertained by measuring the resistances forming the potentiometer, adding them together and then finding the current flowing through the circuit by dividing the voltage across the potentiometer by the value of the resistance so obtained. Now we must measure the current taken by the screening grid of the valve by connecting our milliammeter between the junction of our potentiometer resistance and the actual S.G. connection to the valve and add this to the current flowing through the potentiometer between the valve and H.T. positive is multiplied by the total current flowing through it, the volts dropped by the resistance will be obtained, and subtracting this voltage from the voltage across the potentiometer, the actual voltage at point N will be available.

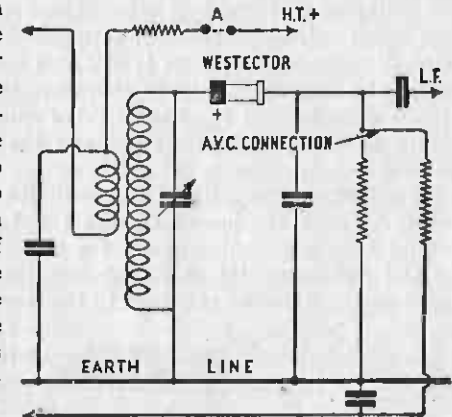

FIG. 44.—Circuit of a detector stage using a "Westector."

The foregoing procedure may sound rather more complicated than it actually is, so perhaps a concrete example may be useful as an illustration. Suppose that the resistances forming our potentiometer have values of 20,000 ohms and 30,000 ohms, the latter resistance being connected to H.T. positive, our measured screen consumption is 0.5 mA, and our H.T. supply is 250 volts. The current flowing through the potentiometer when the screening grid is disconnected will be $\frac{250}{50,000} = 0.005$ amps or 5 mA. Add 0.5 mA to this figure which gives

us 5.5 mA passing through our 30,000 ohm branch. The volts dropped in this branch will now be equal to $30,000 \times .0055$, or 165 volts. Subtracting this from 250 (our total voltage) we find that the actual potential at our screen-grid connection is 85 volts.

Measurement of Grid-Bias Voltage.—The final use of the universal meter dealt with now is one which many readers find difficulty in measuring. It is the measurement of voltage of the grid bias supplied by a Diode Detector or "Westector" when used in an A.V.C. system. Reference to Fig. 43 will show that this is merely a skeletonised diagram of a diode detector supplying A.V.C. to a variable-mu H.F. valve, while Fig. 44 shows an appropriate circuit utilising a Westector. Inserting our milliammeter at point A in the circuit will enable us to read the current taken by the H.F. valve, and on tuning in a strong signal we shall note, if our A.V.C. system is working properly, that this current decreases and we can use our meter as a tuning indicator. However, if we attempt to find out how much extra bias has been introduced by the signal, by connecting our voltmeter across points B and C, i.e., across the diode load resistance, the current flowing in this circuit will be found insufficient to give a deflection of the needle. We must therefore resort to other means to find this bias voltage and the easiest method is by comparison.

Tune in a strong signal and with the milliammeter connected at point A, note the lowest current reading that can be obtained by careful tuning, now disconnect the aerial from the receiver, switch off and disconnect the A.V.C. connection from the diode load resistance at B. Connect this lead to the 3-volt negative socket of a grid

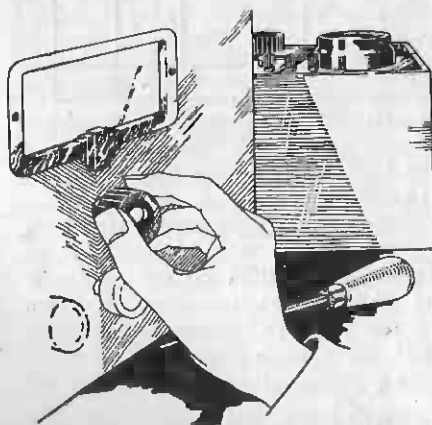

FIG. 45.—The receiver must be slowly tuned through the signal when checking A.V.C.

been supplied by the diode. By measuring the voltage in this way it will be possible to estimate the efficacy of the A.V.C. system to deal with incoming signals of varying strengths and useful data can be compiled on the comparative strength of transmissions received by noting the amount of grid-bias voltage produced by the diode on different stations.

Checking A.V.C.—Perhaps, while on the subject of A.V.C., it may not be out of place to indicate an easy way of checking the efficiency of any receiver in this respect. Connect our universal meter as an output meter to the speaker terminals of a set incorporating A.V.C., in the manner outlined earlier. Then tune in a powerful signal (your local station when radiating its tuning note will do—a steady-signal being necessary), and watch the output meter. Now, although we know that as we tune across the powerful signal the voltage applied to the input of the receiver will vary considerably and continuously, yet if the A.V.C. system is functioning properly the reading of our meter should rise quickly as we approach the station and then remain almost steady until we have passed through the exact tuning point of the station to which we are listening and then quickly fall away again. If the reading of our output meter rises to a peak with a sharply defined maximum we may be practically certain that our A.V.C. system is not doing all that it should. It must be emphasised however that the receiver must be *slowly* tuned through the signal (Fig. 45) or the flat-topped response due to the A.V.C. will be missed.

It will be obvious to readers that the chief drawback to the universal meter so far described is its inability to measure voltages without extracting a maximum of 1 mA of current from any circuit to which it may be connected in order to energise its own movement. There is only one type of meter which will read voltages, either A.C. or D.C., without extracting current for itself and that is the valve-voltmeter.

be relied on for the purpose of reference and will be found sufficiently accurate for all normal uses :

CAPACITY (mfd.)	Reactance at 50 cycles.	Reactance 25,00 ohms summed at 90°.	Meter Reading.
1.00	3,200 ohms	25,200 ohms	.99 mA.
.75	4,300 "	25,360 "	.985 "
.50	6,500 "	25,800 "	.965 "
.25	13,000 "	28,200 "	.89 "
.20	16,500 "	29,900 "	.835 "
.15	22,000 "	34,800 "	.718 "
.10	32,000 "	41,000 "	.61 "
.09	35,000 "	43,000 "	.58 "
.08	40,000 "	47,180 "	.53 "
.07	45,000 "	51,400 "	.485 "
.06	54,000 "	59,500 "	.42 "
.05	65,000 "	69,600 "	.36 "
.04	80,000 "	83,700 "	.30 "
.03	110,000 "	112,800 "	.22 "
.02	160,000 "	161,800 "	.155 "
.01	320,000 "	320,700 "	.078 "
.009	354,000 "	354,100 "	.07 "
.008	398,000 "	398,000 "	.063 "
.007	455,000 "	455,000 "	.055 "
.006	531,000 "	531,000 "	.047 "
.005	637,000 "	637,000 "	.039 "
.004	797,000 "	797,000 "	.031 "
.003	1,061,000 "	1,061,000 "	.0236 "
.002	1,580,000 "	1,580,000 "	.0157 "
.001	3,200,000 "	3,200,000 "	.008 "

The range of capacities covered by our unit is necessarily restricted and some readers may wish to extend this range to suit their own needs. The methods by which the range described has been prepared are perfectly suitable for calculating different ranges and the main point to be noted is this. If measurement of larger capacities is to be made the current through the circuit must be increased and if a smaller capacity range is required the current must be reduced. This is most easily done by variation in the value of the fixed resistor and potentiometer. The present range covers the most useful values of condensers and will prove a valuable adjunct to the listeners or serviceman's equipment.

CHAPTER VII

USING THE UNIVERSAL METER

THE reader having now completed the constructional work, and having calibrated the universal test meter will, no doubt, soon begin to find many uses for it. At this juncture it may not be out of place to outline some of the different measurements which can be made, and mention the means which the reader can take to ensure that the indications given by the meter are accurate indications of the currents and voltages which he requires to measure.

It will no doubt occur to the reader that the universal meter cannot be used to take some of the measurements which are necessary for accurate diagnosis in a radio receiver, but these chapters include descriptions of all necessary apparatus to form a complete testing equipment for the laboratory.

Fig. 41 gives the simplified circuit of a 3-valve A.C. mains receiver which will be used as a basis for the explanations which are to follow.

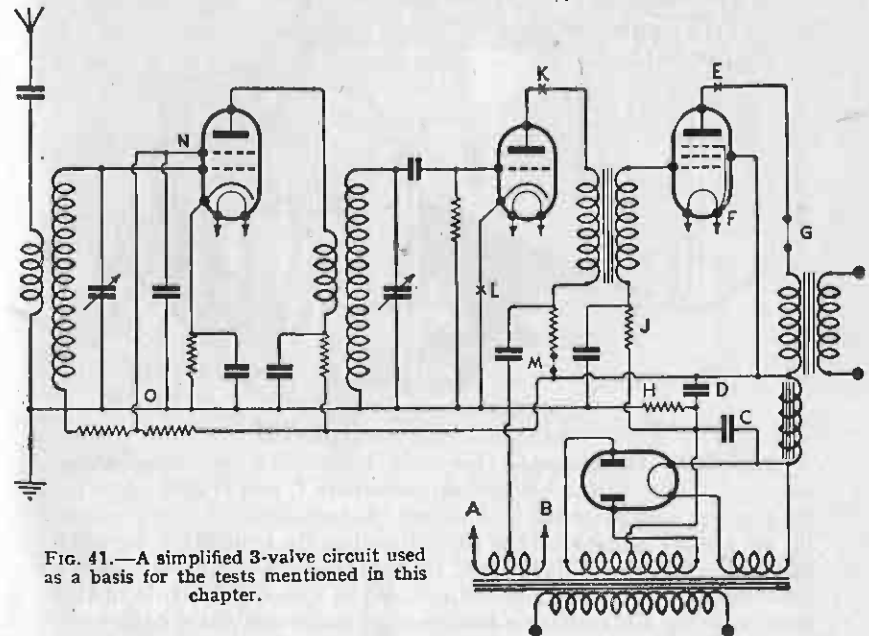

FIG. 41.—A simplified 3-valve circuit used as a basis for the tests mentioned in this chapter.

select a negative tapping which will reduce the anode current to approximately the value we require and then make our final adjustment by rotating the 25 ohm potentiometer across the filament circuit of the valve which gives us a final control over a range of 1 volt positive to 1 volt negative. Fortunately a P2 valve with 50 volts on its anode and 9 volts negative on its grid is almost biased to "cut-off" and the filament potential divider will be found to give ample adjustment.

Coming next to the anode circuit of the valve we see that a variable resistance of 20,000 ohms is connected in series with the milliammeter

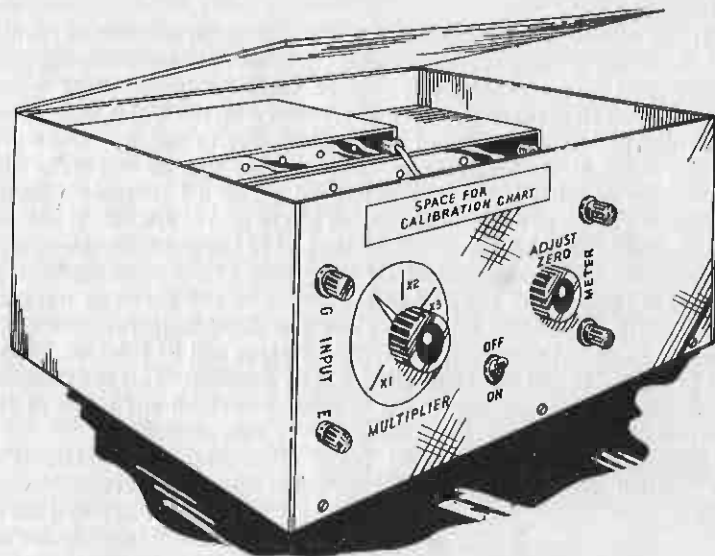

Fig. 47.—The completed instrument in its screened box showing the space left for the calibration chart.

to 50 volts positive H.T. This resistance provides a means of limiting the current taken by the valve when grid-bias is removed or neutralised by an applied voltage. If we look at the characteristic curves of a P2 valve we shall find that with no volts on the grid and 50 volts positive on the anode, the anode current will rise to approximately 12 mA. This would obviously be greater than we could read on the 0 to 1 mA scale of our universal meter and furthermore would be a fairly heavy load on the small capacity H.T. battery we intend to use. If, however, we include a resistance in the anode circuit of the valve we can cut down the anode current which will flow for low values of grid-bias without affecting the grid circuit or the maximum range of

our meter in any way. Also, by making this resistance variable we have an easy method of arranging that our milliammeter shall read exactly 1 mA. when the maximum voltage we wish to measure is applied to the grid circuit of the P2. As will be seen from Fig. 48 the 20,000 ohm resistance is mounted on a bracket on the baseboard as it is unnecessary to adjust this continually and provided it is set at the commencement of calibration or measurement, all further adjustment is carried out by the external controls.

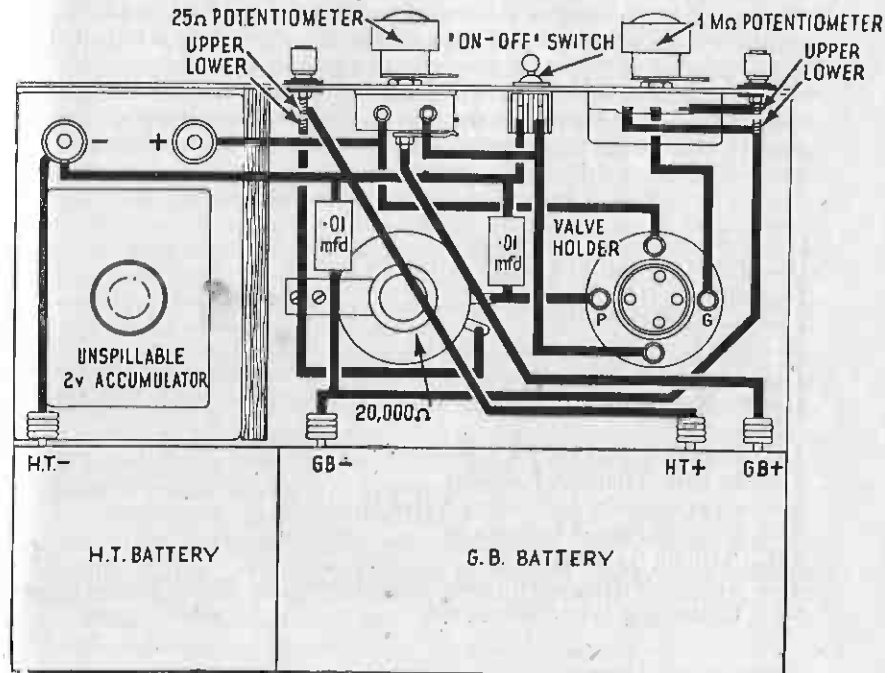

Fig. 48.—The full wiring plan for the valve-voltmeter.

Constructional Details.—The foregoing explanation deals with all the major technical details of the meter and we can proceed with the constructional details.

The whole apparatus is mounted on a metal panel and wooden baseboard which should be inserted, as shown in Fig. 47, into a metal screening box in order that the readings obtained on the meter are unaffected by stray H.F. fields. The size of the screening-box is governed by the size of the H.T. battery and unspillable accumulator which the reader wishes to incorporate, and hard and fast dimensions are therefore not given. At this juncture it may as well be

CHAPTER VIII

A VALVE-VOLTMETER

MANY readers regard the valve-voltmeter as a highly complicated piece of apparatus, so difficult to calibrate and operate that it would be quite out of the question to construct one, far less use it. This chapter touches lightly on the theory governing the operation of the type of valve-voltmeter which is to be constructed, in order that this impression may be dispelled and a very useful instrument added to the equipment of every keen reader.

The grid of a valve used as an anode-bend detector is biased negatively until no current flows in its anode circuit. Now, if a voltage be applied to the grid circuit in opposition to the grid-bias voltage, i.e., positive to grid and negative to filament circuit, a certain percentage of the negative bias will be cancelled out and current will commence to flow in the anode circuit. The magnitude of this current will be governed by the reversed voltage applied and if we connect an appropriate D.C. milliamperage range of our universal meter in the anode circuit of the valve we shall be able to measure this voltage by calibrating the milliammeter in terms of the applied voltage.

Alternating Voltage.—When an alternating voltage is applied to the grid of an anode bend detector valve the negative half-cycles are suppressed because the valve is so heavily biased that no further change in anode current can take place with an increase of negative volts, but the positive half-cycles reduce the negative bias in precisely the same way as a steady positive direct voltage and the anode current of the valve will rise in sympathy.

It will thus be seen that it is quite easy to connect up a suitable valve in such a way that the application of positive voltages to its grid will produce visible indications of current through a meter connected in its anode circuit. When a given alternating voltage is applied to the grid, exactly identical indications will be obtained on the anode milliammeter, no matter whether the frequency of the applied voltage is 50 cycles from the mains or an extremely high frequency generated by a wireless transmitter. Of course, there are limitations to the frequency accuracy of a valve-voltmeter but as the limitations are set by the grid filament capacity of the valve used, the shortness of the wiring to it and similar factors, an ordinary receiving valve will operate quite satisfactorily in this respect over a range of frequencies from 50 to 1,500,000 cycles per second, a range more than sufficient to meet the needs of the majority of my readers.

The valve chosen for this valve-voltmeter is the Marconi or Osram P2, because with an anode voltage of 50 volts and 9 volts on the grid the characteristics will allow us to measure 5 volts D.C. or A.C., without running into positive grid current. It may seem unnecessary to provide a "grid-base" of 9 volts in order to measure a change of only 5 volts but my readers will remember that a R.M.S. voltage of 5 volts A.C. has peaks which are 1.404 times the magnitude of the R.M.S. volts which we are to measure, and the voltage will actually rise to 7 volts peak. Therefore, by allowing a grid base of 9 volts we effectively prevent the flow of grid current within the range of our instrument.

If we wished to measure, say, 50 volts directly, we should require a valve which needed at least 70 volts grid-bias to stop anode current flowing and a correspondingly higher anode voltage. This would obviously be impracticable with any battery-driven valve and so we must incorporate some form of potential divider to multiply the initial voltage range of our instrument. Reference to Fig. 46 will show that the voltage we wish to measure is applied across a 1 megohm potentiometer, the slider of which is connected to the grid of the valve. It will be seen that if the slider is turned to the end of the potentiometer which is connected to input terminal G, the whole of the external voltage applied is received by the grid of the P2 valve and therefore our calibration will be direct, but if we set the slider half-way down the resistance element only half the applied voltage will be received by the grid of the valve and our calibration will be doubled. This is extremely convenient and it has been found possible to extend the range of the instrument to read 50 volts quite easily by this means.

Setting the Zero.—The next point of interest in the circuit is the method adopted for setting the "zero" of the valve-voltmeter.

It will be appreciated that as we increase the grid-bias on our P2 valve its anode current will fall, and as it will be very difficult to read on the milliammeter in its anode circuit the exact point when the current falls to zero it will be more convenient to select an arbitrary point on the scale, say, the first small division, or .01 mA and set the meter to read this value before we commence to take readings. For this purpose we must use a grid-bias battery and

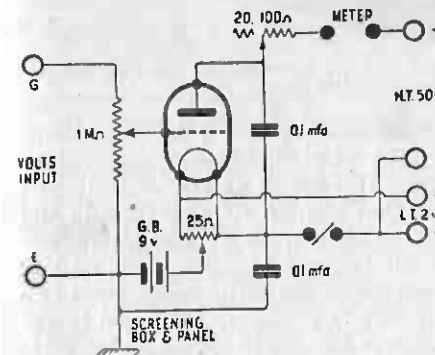

FIG. 46.—The theoretical circuit of the valve-voltmeter.

baseboard set until the whole of the resistance element is in circuit. Now switch on the valve-voltmeter, and it will be noticed that the pointer of the universal meter gives a little "kick" and then returns to a very low reading on the scale. It might be thought that the 25 ohm zero-adjusting potentiometer on the front panel should now be set so that zero was actually indicated on the milliammeter, but this is not the case owing to difficulty in ascertaining the exact setting at which the milliammeter reads zero. A much more satisfactory method, and the one adopted in this case, is to adjust the 25-ohm potentiometer until the pointer of the milliammeter reads .02 mA. This point will now become the zero point for the voltage scale of the valve-voltmeter, and the meter should always be checked before making measurements to ensure that, under the foregoing conditions, a true zero is indicated.

The valve-voltmeter should now be switched off, the multi-range meter disconnected, and its 10-volt D.C. range connected across the

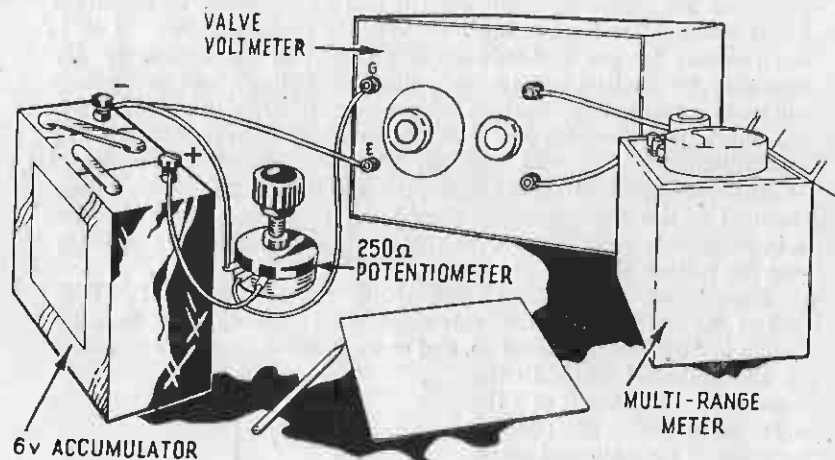

FIG. 50.—Adjusting the zero reading.

leads from our calibrating voltage supply marked G and E, and the 250-ohm potentiometer varied until *exactly* 5 volts (or half-scale deflection) is registered. Then re-connect the universal meter to the "meter" terminals of the valve-voltmeter and the calibration leads G and E to their appropriate input terminals as shown in Fig. 50. Switch on the valve-voltmeter, and it will be found that the pointer of the universal meter will now give a reading somewhat higher than the zero reading which we previously selected. By rotating the 20,000 ohm resistance on the baseboard until the universal meter reads exactly 1 mA, the scale will be set to read 5 volts between .02 mA and

1 mA. It may be advisable now to disconnect the calibration voltage by removing one of the leads from the accumulator, or dry batteries, and to note that the pointer of the milliammeter falls immediately to our previously selected zero position. If it does not do so, a slight readjustment of the zero-adjusting potentiometer will be necessary. The internal 20,000 ohm resistance will not need re-setting unless the characteristics of the P2 valve change considerably, and with the limited periods of use which we are likely to give the instrument, the life of the valve should be almost indefinite. It has also been found that the replacement of the valve has very little effect on the calibration of the instrument, provided the instrument is re-set for zero and maximum readings whenever it is necessary to make this replacement.

Checking the Deflections.—All that remains now is to make a note of the deflections given by the milliammeter for various voltages

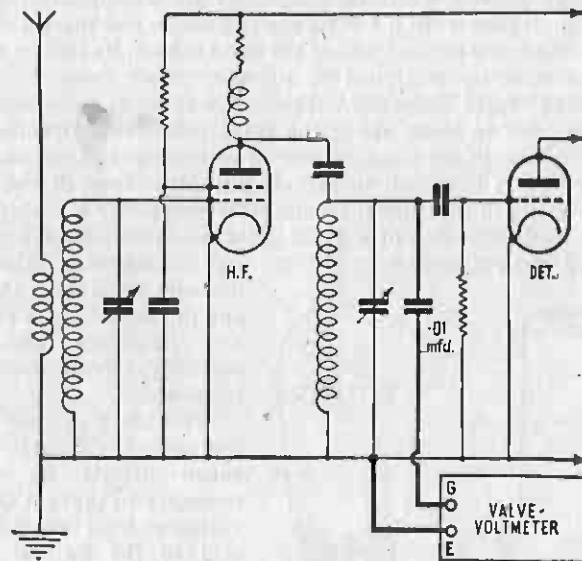

FIG. 51.—Method of measuring the voltage developed across a tuned circuit.

between 0 and 5 volts applied to the input terminals, and to obtain these readings the required voltage is selected by adjustment of the 250-ohm potentiometer with the 10-volt range of the universal meter connected across leads G and E and then noting the deflection given by the milliammeter when this voltage is applied to the valve-voltmeter. Some readers may care to plot a graph of these readings, and so be able to measure intermediate values directly, but the valve-voltmeter

calibration is nearly linear, and a chart is prepared in the same way as the capacity chart described earlier.

Having prepared the graph or chart it only remains to calibrate the multiplier potentiometer. This is quite a simple matter, and should present no difficulty. First apply 5 volts to the input terminals of the valve-voltmeter so that a full-scale deflection is given by the milliammeter, then rotate the multiplier knob in a clockwise direction until the milliammeter indicates 2.5 volts in accordance with our calibration chart. Mark the position of the multiplier pointer and call it X2, then if the pointer is left in this position all the readings obtained on the valve-voltmeter will be multiplied by two, and we have extended our range to 10 volts maximum. Again rotate the multiplier knob until 0.83 volts is indicated and mark this point X6. This extends the range to 30 volts maximum, and all readings obtained with the multiplier knob in this position must be multiplied by 6. Finally, carefully rotate the multiplier until 0.5 volts are indicated, and mark this point X10. We shall now have extended the scale to 50 volts maximum, and all readings must be multiplied by 10.

Using the Valve Voltmeter.—The calibration is now complete, and we can start to make use of the valve-voltmeter. It will find its major application in the measurement of voltages in circuits where the current flowing is too small to actuate any other type of voltmeter; for instance, it will measure the voltage developed by a steady signal across the load resistance of a diode detector—a very useful guide to A.V.C. efficiency. Also it will measure accurately the voltage developed by a signal of any frequency across the secondary circuit of an output transformer.

To measure the radio-frequency voltages across tuned circuits it will be necessary to prevent the H.T. voltages from reaching the grid of the P2 valve, and mica condensers of .01 mfd. capacity should always be connected in series with the input terminals before making measurements in any circuit where D.C. currents are also flowing. When measuring A.C. voltages existing across, say, the anode

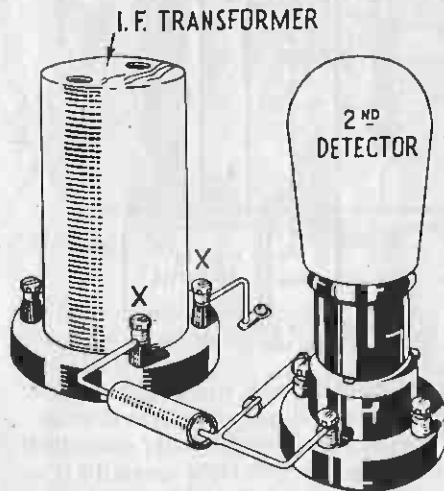

FIG. 52.—The meter is connected to the points XX, across the secondary of the I.F. transformer nearest the second detector.

resistance of an L.F. amplifier, the capacity of the condensers should be increased to as large a value as possible, though care should be taken to see that the insulation of the condensers chosen is high. Fig. 51 will show the connections to the valve-voltmeter when measuring the H.F. voltage developed across a tuned circuit, in this case the tuned-grid coil of an H.F. amplifier, and it will be noticed that the "G" terminal is connected to the high potential end of circuit and the "E" terminal to earth. This procedure should always be followed wherever possible, because it is advisable to keep the metal case of the valve-voltmeter at earth potential to eliminate stray pick-up effects. The valve-voltmeter connected as shown in Fig. 51, will actually measure the H.F. voltage presented to the grid of the detector valve if the set is tuned to a powerful local station, and by experimenting with the voltages applied to the H.F. valve and, incidentally, by making any modifications to the aerial coupling coils, etc., it is possible to see the result of such experiments as a gain or loss in voltage. The I.F. and frequency-changer circuit of a superheterodyne could also be experimented with using the meter connected across the secondary of the I.F. transformer nearest to the second detector (Fig. 52) and, if the magnification is not too great, it is possible to measure the amplification of a valve, and its coupling components, by first adjusting the voltage across its grid circuit by an H.F. volume control to 0.5 volts, then transferring the valve-voltmeter to the coil in the anode circuit of the same valve and again measuring the voltage. If the reading given is, say, 45 volts, then the stage gain

is $\frac{45}{.5}$ or 90.

mentioned that the valve-voltmeter will work quite satisfactorily without the complete screening box provided that extremely high accuracy is not required, but in all cases the metal panel should be retained. This introduces slight complications because three of the terminals to be mounted on this panel are not at earth potential, and it will therefore be necessary to insulate their stems by suitable insulating bushes. Also the 1 megohm and 25 ohm potentiometers should be of the type whose spindles are not connected to the rotating contact. Alternatively, the spindles could also be insulated by suitable bushes, but this system is not quite so satisfactory, as the screening is impaired by bringing "live" spindles through the panel.

The remainder of the constructional work and wiring is straightforward, and if the explanatory drawings are followed carefully, no difficulty should be experienced in constructing the valve-voltmeter.

List of Parts Required for Valve-Voltmeter

- 1 — Screening Box (see text).
- 1 — Panel (metal) and baseboard to fit above.
- 1 — 60-volt H.T. Battery.
- 1 — 9-volt G.B. Battery.
- 1 — 2-volt unspillable Accumulator.
- 1 — 1 megohm Potentiometer (ungraded and with insulated spindle).
- 1 — 20,000 ohm. Wire-wound Variable Resistance (with insulated spindle).
- 1 — Mounting Bracket for last above.
- 1 — 25 ohm. Filament Rheostat.
- 1 — 4-pin baseboard-mounting Valve Holder.
- 2 — 0.01 mfd. Fixed Condensers.
- 1 — "On-off" Switch.
- 4 — Terminals (three with insulating bushes for metal panel).
Connecting Wire, Screws, etc.

CHAPTER IX

CALIBRATING AND USING THE VALVE-VOLTMETER

IT will be observed a space is provided on the front panel of the instrument for a calibration scale to be gummed on, and that a circular white paper scale is to be gummed to the panel under the knob of the 1 megohm multiplier potentiometer. Alternatively, if the surface of the panel is matt finished aluminium, it is quite possible to omit these paper scales and draw the calibration points on the metal itself in Indian ink, afterwards covering the markings with a coat of colourless cellulose lacquer.

Before we commence calibration it will be necessary to procure a 6-volt accumulator, and a 250 ohm variable potentiometer. If it is inconvenient to get a 6-volt accumulator, four large-capacity dry cells may be used to supply the calibration voltage, as their voltage will remain reasonably constant with a current drain of 24 mA, over the short period which we shall use to make measurements. The accumulator or dry cells and the 250 ohm potentiometer should be connected up as shown in Fig. 49, but the actual connection to one terminal of the voltage supply should only be made when calibration is in progress in order to limit the current drain imposed and thus maintain the voltage as stable as possible.

Connections and Adjustments.—Now connect the H.T., L.T., and G.B., batteries to the valve-voltmeter, making sure that the switch is "off" before doing so, and connect the milliamper terminals of the universal meter to the "meter" terminals of the valve-voltmeter. The positive terminal of the universal meter should be connected to the "meter" terminal of the valve-voltmeter, which is connected internally to the H.T. positive plug, and the switch should be set at 1 mA. The multiplier potentiometer is then rotated in a fully anti-clockwise direction, i.e., to ratio 1, and the 20,000 ohm variable anode resistance mounted on the

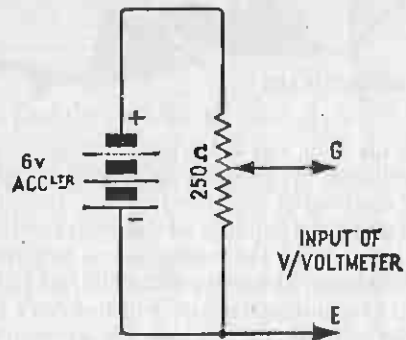

FIG. 49.—Theoretical circuit of the calibration apparatus.