

Practical

AUGUST 1987 £1-10

ISSN 0141-0857

# Wireless

The Radio Magazine

Capacitors  
Passive Filters  
Microwave MESFETs



Dayton Hamfest Report  
The AR88D Valved  
Comms Receiver

# Reg Ward & Co. Ltd.

1 Western Parade, West Street, Axminster, Devon, EX13 5NY.

Telephone: Axminster (0297) 34918

## Yaesu

FT1	HF Transceiver	P.O.A. (—)
FT980	HF Transceiver	1750.00 (—)
SP980	Speaker	110.00 (2.50)
FT767		1550.00 (—)
FEX767(2)	2m Module (767)	169.00 (2.50)
FEX767(7)	70cm Module (767)	215.00 (2.50)
FEX767(6)	6m Module (767)	169.00 (2.50)
SP102	Speaker	75.00 (2.00)
SI 1290	MkII New Super 290	429.00 (—)
FT990	2m M/Mode Port/Transceiver	379.00 (—)
MMB11	With Mutek front end fitted	409.00 (—)
NC11	Mobile Bracket	37.50 (1.50)
NC11	Charger	10.50 (1.50)
CSC1	Carrying Case	6.50 (1.50)
YHA15	2m Helical	7.50 (1.50)
YHA44D	70cm 1/2wave	12.50 (1.50)
YMA9	Speaker Mike	22.00 (1.50)
MMB15	Mobile Bracket	14.55 (1.50)
FT23	2m Mini HH	223.50 (2.50)
FT73	70cm Mini HH	243.50 (2.50)
FN89	Spare Battery Pack (23/73)	25.00 (1.50)
FN810	Spare Battery Pack (23/73)	30.00 (1.50)
FN811	Spare Battery Pack (23/73)	46.00 (1.50)
NC.18C	Charger (23/73)	12.35 (1.50)
NC.28	Charger (23/73)	15.40 (1.50)
NC.29	Base Charger (23/73)	53.00 (2.50)
PA6	Car Adap/Charger (23/73)	16.00 (1.50)
MMH12A2B	Speaker Mic	27.00 (1.50)
FT727	2m/70cm HH	425.00 (3.00)
FN83	Spare Battery Pack	41.00 (1.50)
FN84	Spare Battery Pack	46.00 (1.50)
FN85	Empty Coil Case	10.00 (1.50)
FT209R	NEW 2m H/Hand/CW/FNB3	P.O.A. (—)
FT709R	70cm H/Hand	P.O.A. (—)
FT270RH	2m 45W FM	299.00 (—)
FT21RH	2m FM 45W	299.00 (—)
FRG9600M	60-950MHz Scanning RX	509.00 (—)
MMB10	Mobile Bracket	10.00 (1.50)
NC9C	Charger	11.50 (1.50)
PA3	Car Adaptor/Charger	21.85 (1.50)
FN82	Spare Battery Pack	27.00 (1.50)
YM24A	Speaker Mike	27.00 (1.50)
FT226F	2m Base Station	999.00 (—)
4304726	70cm Module for above	349.00 (3.00)
FRG8800	HF Receiver	639.00 (—)
FRV8800	Converter 118-175 for above	100.00 (2.00)
FRT7700RX	A.T.U.	59.00 (2.00)
MH18B	Hand 500 8pin mic	21.00 (1.50)
MD18B	Desk 500 8pin mic	79.00 (1.50)
MFA13B	Boom mobile mic	25.00 (1.50)
YH77	Lightweight phones	19.99 (1.50)
YH55	Padded phones	19.99 (1.50)
YH1	L/weight Mobile H/set-Boom mic	19.99 (1.50)
SB1	PTT Switch Box 208/708	22.00 (1.50)
SB2	PTT Switch Box 290/790	22.00 (1.50)
SB10	PTT Switch Box 270/2700	22.00 (1.50)
FF501DX	Low Pass Filter	38.50 (1.50)

## Icom Products

IC761	New Super HF Transceiver	P.O.A. (—)
IC751A	HF Transceiver	1465.00 (—)
IC735	New HF Transceiver	949.00 (—)
AT100	100W ATU (75/745)	365.00 (3.00)
AT150	150W ATU (735)	315.00 (3.50)
PS55	Ext PSU (735)	185.00 (3.00)
IC505	50MHz multi-mode portable	459.00 (—)
IC290D	2m 25W M/Mode	542.00 (—)
IC28E	25W FM	399.00 (3.00)
IC28H	2m 45W FM	399.00 (3.00)
IC Micro	2E New Mini HH	239.00 (3.00)
IC2E	2m The Original HH	225.00 (3.00)
IC275E	New 2m 25 Base Stn	299.00 (3.00)
IC4E	70cm HH	1029.00 (—)
IC4E	70cm HH	285.00 (3.00)
IC48E	70cm 25W FM Mobile	299.00 (3.00)
IC48E	70cm 10W M/Mode	449.00 (3.00)
IC320	2m/70 Dual Band FM Mobile	617.00 (—)
IC275E	23cm HH	556.00 (—)
IC12E	Gen Cov RX	428.00 (3.00)
ICR71	VHF/UHF Scanner	825.00 (—)
IC7000	25-1300MHz Discone	957.00 (—)
SP3	Ext Speaker	82.00 (2.50)
CK70	DC Cable (R70/R71)	61.00 (2.00)
EX257	FM Board (R70/R71)	7.00 (1.50)
GC5	World Clock	43.00 (2.00)

### SPECIAL OFFERS

YAESU FT209R(3)	WAS £299	NOW £219
YAESU FT209R(4)	WAS £305	NOW £229
YAESU FT209R(4)	WAS £325	NOW £199
YAESU FT757GX	WAS £399	NOW £299
YAESU FP757GX	WAS £1199	NOW £899
KENWOOD TH21 2m HH	WAS £225	NOW £189
KENWOOD TH41 70cm HH	WAS £268	NOW £218
KDK FM740	WAS £399	NOW £299

## Kenwood

TS940S	9 Band TX General Cov RX	1995.00 (—)
AT940	Auto/ATU	258.23 (2.50)
SP940	Ext Speaker	92.32 (2.50)
TS930S	9 Band TX General Cov RX	1750.00 (—)
AT930	Auto/ATU	192.75 (2.50)
SP930	Ext Speaker	90.94 (2.50)
TS440	NEW 9 Band TX General Cov RX	1195.00 (—)
AT440	Auto/ATU	152.73 (2.50)
PS50	H/Duty PSU	234.63 (2.50)
SP430S	160-10m Transceiver 9 Bands	1095.00 (—)
AT130	All Band ATU/Power Meter	220.05 (2.50)
SP230	External Speaker Unit	70.12 (—)
TS530SP	160m-10m Transceiver	895.00 (—)
TS430S	160m-10m Transceiver	995.00 (—)
PS430	Matching Power Supply	183.26 (3.50)
SP430	Mobile Mounting Bracket	43.00 (2.50)
MB430	FM Board for TS430	16.66 (2.50)
SM220	Station Monitor	50.68 (2.50)
BS5	Band Scope Unit (520/530)	362.37 (3.50)
BS8	Band Scope Unit (830/940)	72.05 (2.00)
TS322	10/160 2K Linear	81.22 (2.00)
TM251A	2M 25W Mobile FM	1495.00 (7.00)
TM401A	70cm 12W Mobile FM	392.82 (3.00)
TH21	2M Mini HH	189.00 (2.50)
TH41	70cm Mini HH	218.00 (2.50)
TH205	2M HH	218.01 (3.00)
TH215	2M HH Keyboard	258.00 (3.00)
TR751	2M 25W M/M Mobile	649.00 (—)
TS711	2M 25W Base Stn	991.29 (—)
TS811	70cm 25W Base Stn	1085.00 (—)
R2000	Gen Coverage HF/RX	637.26 (—)
VC10	118-174MHz Converter (R2000)	170.76 (2.00)
R5000	NEW General Coverage HF/RX	895.00 (—)
VC10	118-174MHz Converter (R5000)	175.32 (2.00)

## Linear Amps

TOKYO HI POWER		
HL 160V	2m, 10W in, 160W out	244.52 (2.50)
HL 82V	2m, 10W in, 85W out	144.50 (2.50)
HL 110V	2m, 10W in, 110W out	249.00 (2.50)
HL 35V	2m, 3W in, 30W out	76.00 (2.50)
HL 30	2m, 3W in, 30W out	54.00 (2.50)
HL 30V	70cms, 3W in, 30W out	122.50 (2.50)

MICROWAVE MODULES		
MML144/30-LS	inc preamp (1/3 w i/p)	98.90 (2.50)
MML144/50-S	inc preamp, switchable	106.95 (2.50)
MML144/100-S	inc preamp (10w i/p)	149.95 (3.00)
MML144/100-HS	inc preamp (25w i/p)	159.95 (3.00)
MML144/100-LS	inc preamp (1/3w i/p)	169.95 (3.00)
MML144/200S	inc preamp (3/10/25 i/p)	369.94 (3.00)
MML432/30L	inc preamp (1/3w i/p)	169.95 (2.50)
MML432/50	inc preamp (10w i/p)	149.50 (2.50)
MML432/100	linear (10w i/p)	334.65 (3.00)

B.N.O.S.		
LPM 144-1-100	2m, 1W in, 100W out, preamp	235.00 (3.00)
LPM 144-3-100	2m, 3W in, 100W out, preamp	235.00 (3.00)
LPM 144-10-100	2m, 10W in, 100W out, preamp	205.00 (3.00)
LPM 144-25-180	2m, 25W in, 180W out, preamp	305.00 (3.00)
LPM 144-3-180	2m, 3W in, 180W out, preamp	355.00 (3.00)
LPM 144-10-180	2m, 10W in, 180W out, preamp	355.00 (3.00)
LP 144-3-50	2m, 3W in, 50W out, preamp	245.00 (3.00)
LP 144-10-50	2m, 10W in, 50W out, preamp	145.00 (3.00)
LPM 432-1-50	70cm, 1W in, 50W out, preamp	255.00 (3.00)
LPM 432-3-50	70cm, 3W in, 50W out, preamp	255.00 (3.00)
LPM 432-10-50	70cm, 10W in, 50W out, preamp	215.00 (3.00)
LPM 432-10-100	70cm, 10W in, 100W out, preamp	395.00 (3.00)
LPM 432-3-100	70cm, 3W in, 100W out, preamp	395.00 (3.00)

## SWR/PWR Meters

HANSEN		
FS50VP	50-150MHz 20/200 Interval PEP/SWR	106.70 (2.50)
FS300V	50-150MHz 20/200 PWR/SWR	53.50 (2.50)
FS300H	1.8-60MHz 20/200/10W	53.50 (2.50)
FS210	1.8-150MHz 20/200 Auto SWR	63.50 (2.50)
W720	140-430MHz 20/200W	52.75 (2.50)

WELZ		
SP10X	1.8-150MHz PWR/SWR	39.95 (2.50)
SP122	1.8-60MHz PWR/SWR/PEP	79.95 (2.50)
SP220	1.8-200MHz PWR/SWR/PEP	67.95 (2.50)
SP225	1.8-200MHz PWR/SWR/PEP	119.95 (2.50)
SP420	140-525MHz PWR/SWR/PEP	74.95 (2.50)
SP425	140-525MHz PWR/SWR/PEP	119.95 (2.50)
SP825	1.8-200-430-800-1240MHz	179.00 (2.50)

TOYO		
T430	144/432 120 W	52.50 (2.50)
T435	144/432 200 W	58.00 (2.50)

## Scanning Receivers

SX200	VHF/UHF Scanner	325.00 (3.00)
SX400	VHF/UHF Continuous Coverage	645.00 (3.00)
AOR2002	VHF/UHF Continuous Coverage	487.30 (3.00)
HX2000	HH Scanner	269.00 (3.00)

## Datong Products

PC1	Gen. Cov. Con.	137.40 (2.00)
VLF	Very low frequency conv.	34.90 (2.00)
FL2	Multi-mode audio filter	89.70 (2.00)
FL3	Audio filter for receivers	129.00 (2.00)
ASP/B	r.f. speech clipper for Trio	82.80 (2.00)
ASP/A	r.f. speech clipper for Yaesu	82.80 (2.00)
ASP	As above with 8 pin conn	89.70 (2.00)
D75	Manual r.f. speech clipper	59.95 (2.00)
D70	Morse Tutor	56.35 (2.00)
MK	Keyboard Morse sender	137.40 (2.00)
RFA	RF switched pre-amp	36.00 (2.00)
AD270-MPU	Active dipole with mains p.s.u.	51.75 (2.00)
AD370-MPU	Active dipole with mains p.s.u.	69.00 (2.00)
MPU	Mains power unit	6.90 (2.00)
DC144/28	2m converter	39.67 (2.00)
PTS1	Tone squelch unit	46.00 (2.00)
ANF	Automatic notch filter	67.85 (2.00)
SRB2	Auto Woodpecker blanker	86.25 (2.00)

## CW/RTTY Equipment

Tono 550	Reader	329.00 (3.00)
ICS/AEA		
PK64	Complete Packet/Amor terminal	239.00 (3.00)
PK232	Packet/RTTY Terminal	269.00 (3.00)

BENCHER		
BY1	Squeeze Key, Chrome base	67.42 (2.50)
BY2	Squeeze Key, Black base	76.37 (2.50)

## Vibroplex

lambic Standard		66.33 (3.00)
lambic Deluxe		78.09 (3.00)
Vibrokeyer Standard		78.09 (3.00)
Vibrokeyer Deluxe		78.09 (3.00)
The Original Standard		73.54 (3.00)
The Original Deluxe		82.74 (3.00)

HI-MOUND MORSE KEYS		
HK703	Up down keyer	38.35 (2.00)
HK704	Up down keyer	26.35 (2.00)
HK706	Up down keyer	21.80 (2.00)
HK707	Up down keyer	20.15 (2.00)
HK710	Up down keyer	99.25 (2.50)
HK802	Up down solid brass	109.00 (2.50)
HK803	Up down solid brass	104.50 (2.50)
HK808	Up down keyer	66.95 (2.00)
MK703	Twin paddle keyer metal base	34.50 (2.00)
MK705	Twin paddle keyer marble base	32.78 (2.00)
MK706	Twin paddle keyer	30.48 (2.00)
STARMASTER	Keyer Unit CMOS Memory	54.70 (3.00)
STARMASTER	Keyer Unit CMOS Memory	95.00 (3.00)
KENPRO		
KP100	Squeeze CMOS 230/13.8v	109.25 (3.00)
KP200	Memory 4096 Multi Channel	234.55 (3.00)

## Power Supplies

DRAE			
4 amp	43.40 (2.50)	6 amp	75.00 (3.00)
6 amp	65.00 (3.00)	12 amp	125.00 (3.50)
12 amp	86.50 (3.50)	25 amp	185.00 (4.50)
24 amp	125.00 (4.50)	40 amp	385.00 (4.50)

## Aerial Rotators

KR250	Light Duty	78.00 (3.00)
AR200XL	Light Weight	59.95 (3.00)
AR40	5 core Medium Duty	125.00 (2.50)
KR400	Med/H Duty	139.00 (3.00)
KR500	6 core Elevation	149.00 (3.00)
KR400RC	6 core Medium Duty	169.00 (3.00)
KR600RC	8 core Heavy Duty	219.00 (3.00)
T2X	8 core Very Heavy Duty	499.00 (—)
KR5400	Elevation/Azimuth	279.00 (3.00)
KR5600	Elevation/Azimuth	369.00 (3.50)
KR200SDX	45 Degrees, Medium/Heavy Duty	113.85 (2.50)
KR1000SDX	45 Degrees, Heavy Duty	123.57 (2.50)
SWT1	2m ATU	40.26 (2.00)

## Switches

SMCS 2U	2N 50239	18.95 (2.00)
SMCS 2N	2 way 'n' Skts	23.50 (2.00)
Welz	2 way SO239	29.95 (2.00)
Welz	2 way 'n' Skts	49.00 (2.00)
Drae	3 way SO239	15.40 (2.00)
Drae	3 way 'n' Skts	19.90 (2.00)
Kenpro KP21N2	way Switch	27.00 (2.00)

## Miscellaneous

DRAE	Wavemeter	27.50 (2.00)
T30	30W Dummy load	8.50 (2.00)
T100	100W Dummy load	38.00 (2.00)
T200	200W Dummy load	56.00 (2.00)
CT20A	20W Dummy Load PL259	15.95 (2.00)
CT20N	20W Dummy Load N. Plugs	22.95 (2.00)
CT530	100W Dummy Load (500WHmin)	58.99 (2.50)
DRAE	2m Pre-set A.T.U.	14.50 (2.00)

TOKYO HI-POWER		
HC200	10-80 HF Tuner	115.00 (2.50)
HC400	10-160 HF Tuner	199.00 (3.50)

CAP CO.		
AERIAL TUNERS		
SPC300D	1kW PEP	225.00 (6.00)
SPC3000D	3kW PEP	

# Practical Wireless

The Radio Magazine

AUGUST 1987 (ON SALE 9 JULY)

VOL. 63 NO. 8 ISSUE 965

## NEXT MONTH

PW "Blenheim"  
VHF to HF Receive  
Converter

A Smarter Repeater

Packet Radio—the  
Siskin TNC220  
reviewed

PLUS

"Valved Comms  
Receivers"  
The Hallicrafters  
S-27D

and

All the usual  
features

Don't miss  
it—place  
your order with  
your  
newsagent now!

**On sale August 13**

Contents subject to last-minute revision

- 20 Scaling Antennas for Other Frequencies—2**  
*F. C. Judd G2BCX*
- 22 The Selection and Use of Capacitors**  
*E. A. Rule*
- 26 Passive Bandpass Audio Filters**  
*S. Niewiadomski*
- 30 Computing Corner**  
*Paul Newman G4INP*
- 32 Packet Radio—4**  
*Roger J. Cook G3LDI*
- 34 Valved Communications Receivers**  
*The AR-88D by Chas E. Miller*
- 40 E. V. Appleton from Personal Acquaintance**  
*Dr L. W. Brown G0FFD*
- 42 Practically Yours**  
*Glen Ross G8MWR*
- 46 The Microwave MESFET—1**  
*Brian Dance*
- 50 Dayton Hamvention Report**  
*V. J. Copley-May G3AAG*
- 52 Multiple Choice**  
*Practice Questions for the RAE*

We are sorry that Part 5 of *Test Methods and Equipment* has had to be held over this month, due to pressure on editorial space.

### Regular Features

71 Advert Index	54 On the Air	43 Subscriptions
44 Book Service	68 PCB Service	24,29,38 Swap Spot
14 Comment	15 PW Services	14 Write On
16 News Desk	39 Short Wave Magazine	

#### Editorial and Advertisement Offices:

Practical Wireless  
Enefco House  
The Quay  
Poole, Dorset BH15 1PP

☎ Poole (0202) 678558 (Out-of-hours service by answering machine)  
Prestel 202671191

**Editor** Geoff Arnold T.Eng FSERT G3GSR  
**Assistant Editor** Dick Ganderton C.Eng. MIERE G8VFN  
**Art Editor** Steve Hunt  
**Technical Features Editor** Elaine Richards G4LFM  
**Technical Projects Sub-Editor** Richard Ayley G6AKG  
**Technical Artist** Rob Mackie  
**Advertisement Manager** Roger Hall G4TNT  
☎ 01-731 6222  
**Administration Manager** Kathy Etheridge  
**Clerical Assistant** Claire Horton  
**Accounts** Annette Martin

THIS MONTH

# the new dual band transceiver from KENWOOD, the **TW4100E**.



I am sure that you will remember the enthusiastic reviews that were written about the KENWOOD TW4000A dual band FM mobile transceiver. Its amazing sensitivity, audio quality and ergonomic perfection still endear the transceiver to many radio amateurs.

The TW4100E is a NEW dual band FM transceiver from KENWOOD. However, working on two metres and seventy centimetres, having excellent sensitivity, audio quality and ergonomic perfection is where its similarity with the TW4000A ends. Using the latest in technology, the designers of the TW4100E have achieved increased performance and, at the same time, made operation even simpler. By working through a predetermined sequence the front panel controls enable the operator to set the transceiver according to the band plan and his own preferences. Options available are shift (+, - or duplex), frequency stepping (5, 10, 12.5, 20, 25 or 50 KHz) and repeater shift (600 KHz, 1.6, 5, and 7.6 MHz). Once programmed the above parameters very much aid successful and safe operating.

With the KENWOOD TW4100E, not only do you have the normal simplex and repeater modes but crossband duplex as well. Priority channel monitoring takes on a new meaning if the full audio can be heard whilst you are transmitting instead of the usual

"bleep" and loss of signal. If you work another amateur who has the necessary equipment to simultaneously transmit on one band and listen on the other, and many stations do have this facility, then a telephone style conversation is possible. Anyone who has not experienced this type of operating will soon come to prefer the natural conversation style of QSO that is possible.

**With the KENWOOD TW4100E duplex is easy!**

Driving and operating at the same time has always been a problem. With the high level of traffic on today's roads it is essential that the operator can easily control his transceiver. KENWOOD engineers have simplified the rig's operation by providing ten memories, each of which will hold information on frequency, simplex or repeater operation and whether or not the tone burst is on or off. By pushing a single button all this information is transferred to the VFO. Of course it is still held in memory for future use. You therefore have ten independent VFOs. KENWOOD's attention to detail is shown by the following additional facility. If having transferred a repeater frequency to the VFO, you move onto an adjacent simplex channel, you can, by the push of two buttons, cancel the tone burst and reset the shift from repeater to simplex. Of course, two more presses of the same buttons restore the facilities.

**With the KENWOOD TW4100E you have mobile operating safety!**

Linear amplifiers are not needed with the KENWOOD TW4100E! Power output from the transceiver is 45 watts on two metres and 35 watts on seventy centimetres which is more than enough to cope with difficult terrain. The rig has an efficient heat sink which ensures reliable operation under the most demanding of circumstances.

**With the KENWOOD TW4100E you have reliable and effective communication!**

The TW4100E has another facility that is not mentioned in its handbook. Not mentioned because unless you are a RAYNET member on an approved operation or engaged on a real emergency, to use the equipment in such a way is outside the compass of the licence as we presently know it.

The facility is that the TW4100E will act as a private crossband repeater. This means that you can park your car in a decent location and wander off into an RF black spot. Armed with a small low power handheld, you can talk back to the TW4100E which is constantly checking the two pre-set crossband frequencies. Your transmission is received and simultaneously transmitted by the TW4100E on the other band. When a station replies, the message is again simultaneously retransmitted to you. Of course you need to have another amateur in your car to oversee the operation and it must be a recognised RAYNET use. The KENWOOD TW4100E also has automatic time-out after three minutes.

The TW4100E can have DCL (digital channel link) and DCS (digital code squelch) facilities when the optional MU1 board is fitted. With DCS you could so arrange that unless the correct five figure access code data burst is received, the TW4100E ignores the transmission and doesn't retransmit it.

**With the KENWOOD TW4100E, extended facilities!**

The TW4100E is a remarkable transceiver, a complete package for the VHF and UHF operator. See one soon at your local LOWE ELECTRONICS shop.

**TW4100E ..... £766.37 inc VAT carriage £7.00**

## LOWE ELECTRONICS OPEN DAY,

Saturday, 15th August 1987  
from 10.00am until 5.00pm

On the 15th of August, Lowe Electronics are holding an OPEN DAY at their head office in Matlock.

This is your opportunity to see not only the latest in equipment from KENWOOD but also visit the workshop facilities that have made LOWE ELECTRONICS the leading amateur radio company in Europe.

To make the event even more special, other well-known names in amateur radio are joining us for the day: MICROWAVE MODULES, J BEAM AERIALS, JOHN BIRKETT from Lincoln, STRUMECH, and M & B from Leeds.

Personalities in Matlock on the 15th for you to meet will be Geoff Arnold, editor of PRACTICAL WIRELESS (also representing the new SHORT WAVE MAGAZINE), Andrew Steele, English programme director from the short wave station HCJB, and Simon Spanswick and Michael Murray from EDXC (European DX council for short wave listeners).

The RSGB in the shape of Martin and Jenny Shardlow (Martin is our regional representative) will be in the entrance hall, extending a warm welcome and answering any queries you may have on the society.

Special . . . just for the OPEN DAY, the first one hundred customers to open a LOWE CARD account and make a purchase, or purchase on their existing LOWE CARD account will qualify for a FREE weekend break for two. The weekend break to be taken from a choice of over 100 hotels throughout the British Isles. (Note, purchases must be above £15.00 to qualify).

The following is also SPECIAL, but only for the Open Day. We have received from Kenwood's head office in Tokyo notification of some items of radio equipment that we thought were no longer available, classic pieces that when current sold like hot cakes, TM201A, TM401A, TR9130, TR9500, TW4000A. These items will be available at special prices. Please note the following carefully! The shipment is not scheduled to arrive until a day or so before the OPEN DAY, we don't know the final prices, we will not be keeping a waiting list for the equipment because until it arrives we don't know exactly what we are getting. You have to come along to Matlock on the 15th, or if that is impossible, then ring after 10.00 on the day itself - ACCESS, BARCLAYCARD or LOWE CARD will suffice.

Talk-in on the day is in the capable hands of our local club, the TOR AMATEUR RADIO ASSOCIATION and a two metre station will be found on S22 from around 9.30 using the call sign G8LW. There will also be an HF station on the air, its call sign being G4LOW. Even if you can't make it to Matlock, look out for both these stations as a special QSL card will be issued on the day.

The Club are also organising a BRING and BUY section in the parking area behind the offices. This will be your opportunity to rent table space for an hour or so and get rid of your surplus radio bits and pieces (note, this is not a car boot sale). Further details from David, G8GIY on 0629 2817.

Finally, for the children there will be FREE rides behind a scaled-down steam traction engine.

It promises to be a great day, we look forward to seeing you on Saturday, 15th August.

## LOWE ELECTRONICS LTD.

Chesterfield Road, Matlock, Derbyshire DE4 5LE  
Telephone 0629 2817, 2430, 4057, 4995.

send £1 for complete mail order catalogue.

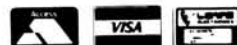

**45 watts** on 2 metres, the TM221E.  
**35 watts** on 70 centimetres, the TM421E.



The new **KENWOOD TM221E** and **TM421E** two metre and seventy centimetre **FM** mobile transceivers have been specifically designed to condense maximum performance and operating convenience into a compact package. Output power is 45 watts on two metres (TM221E) and 35 watts on 70 centimetres (TM421E). Receiver sensitivity matches the output power of the set and measures an amazing 0.141uV for 12dB SINAD (across 144-146). The figures are those given by Chris Lorek in his recent TM221E review published in the July edition of **HAM RADIO TODAY**.

**Much discussion** has taken place recently regarding 12.5 and 25 kHz spaced frequency channels on the two metre band. With the new mobiles channel spacing is not a problem. **KENWOOD** with their usual attention to detail have made the frequency step user selectable. The steps available are 5, 10, 12.5, 15, 20 and 25 kHz. Once programmed either microphone up/down button or the transceiver front panel knob can be used to step the transceiver across the band. Of course should it be necessary the selected step can easily be changed.

**A new orange backlit liquid crystal display** gives the transceiver an amazingly clear frequency readout that can be read in the brightest of sunlight.

**The transceiver has all essential operating aids.** There are 14 memory channels, each of which holds frequency, whether simplex or repeater operation is required and whether or not the tone burst is on or off. Scanning can either be memory with the ability to lock out unwanted channels or band with the scan limits set by the operator. The usual priority channel facility is also included to make sure that no call is missed. As well as showing the operating frequency the display also indicates which of the facilities are being used.

**Occasionally** a piece of equipment comes along which catches the imagination; the RC10 remote controller/handset for the TM221E and TM421E does just that. Designed to operate with either transceivers or link both together, the RC10 looks more like a cellular radio car phone than a piece of amateur radio equipment.

**In fact** the RC10 not only looks like a car phone, but as a speaker and microphone are built-in, operates as would a telephone handset. Easily mounted in any car, dashboard or transmission tunnel, the RC10 controls all transceiver front panel functions with the exception of on/off and high/low power selection. The functions controlled by the RC10 are volume, squelch on/off, frequency readout, keypad frequency entry, memory selection and frequency or memory scanning. Full duplex operation is possible when both transceivers are fitted.

**From a security point of view** it may even be possible to mount the transceivers out of sight and only have the controller on view. Since most thieves now know that a cellular phone is not a saleable item, owning an RC10 may be a wise investment!

**Although** I have not seen the RC10, I am of the opinion that it will do much more than I have already described. I suspect that it will be possible for the RC10, when used in conjunction with both 2 metre and 70 centimetre transceivers, to operate as a personal repeater. Parked at the top of a multi-storey car park and left unattended, I would not be surprised if you could not talk-in to the installation from another small handheld on 70 centimetres (say a TH41E) and have your transmission re-broadcast at a higher power from the good location on 2 metres. Any reply would be re-transmitted to you on 70 centimetres. Useful and ideal for staying in contact when wandering around town. Helpful also for RAYNET use.

**TM221E** ..... £334.60 inc VAT carriage £7.00  
**TM421E** ..... £378.00 inc VAT carriage £7.00

## airband receivers

**R537S** ... a tunable airband receiver covering 118 to 136 MHz plus the facility for two crystal controlled channels (crystals not included).  
**R537S** ... £69.51 inc VAT, carriage £2.00. Crystals £4.60 each.

**R528** ... an airband receiver scanning four out of six crystal controlled channels (crystals not included). The R528 also has a manual channel selection switch.

**R528** ... £125.36 inc VAT, carriage £2.00. Crystals £4.60 each.

**R532** ... not needing crystals, the R532 is a synthesized receiver covering the airbands from 110 to 136 MHz and having 100 programmable memory channels (ten banks of ten). Operating on 12 volts DC, the R532 can be used either mobile or at home with the optional mains power supply. Add a nicad battery pack and carrying case and the R532 is also ideal for portable use.

**R532** ... £224.05 inc VAT, carriage £7.00.

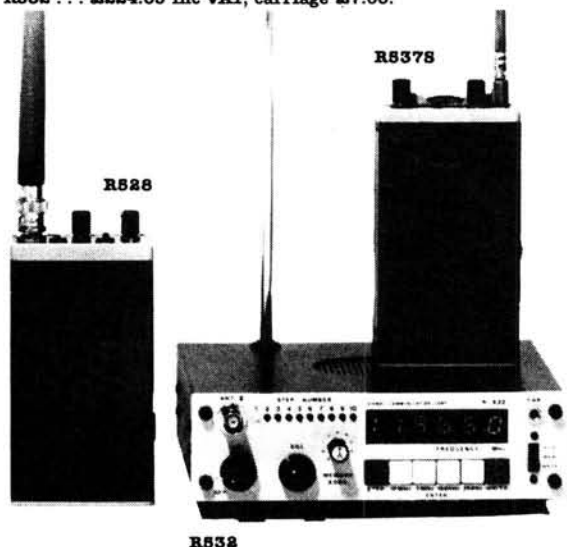

## DAIWA meters

**CN410M** ... Frequency range 3.5 to 150 MHz, forward power switchable 15/150 Watts, reflected 5/50 Watts, SO239 connectors.

**CN460M** ... Frequency range 140 to 450 MHz, forward power switchable 15/150 Watts, reflected 5/50 Watts, SO239 connectors.

**NS448 with remote head** ... Frequency range 900 to 1300 MHz, forward power switchable 5/20 Watts, reflected 1.6/6.6 Watts, N type connectors.

**NS660P** ... switchable meter reading (average, normal PEP and hold PEP) and provision for optional remote head (U66V), frequency range 1.8 to 150 MHz, forward power switchable 15/150/1500 Watts, SO239 connectors.

**U66V** ... remote head, frequency range 140/525 MHz, max 300 Watts, N type connectors.

**BC20** ... extension cable for U66V, approx 20 metres long.

**CN410M** ... £61.78 inc VAT, carriage £1.50.



**CN460M**  
 ... £65.40  
 inc VAT,  
 carr £1.50.

**NS660P** ... £115.00  
 inc VAT, carriage £2.50.

**NS448** ... £86.60  
 inc VAT,  
 carriage £2.50.

## LOWE ELECTRONICS LTD.

Chesterfield Road, Matlock, Derbyshire DE4 5LE  
 Telephone 0629 2817, 2430, 4057, 4995.



send £1 for complete mail order catalogue.

# 2 NEW MOBILE MASTERPIECES

## IC-900 Super Multiband FM System.

This new addition to ICOM's Ham radio equipment is a multiband FM transceiver system that allows the mobile operator to customize a communications system for his favourite bands. Up to 5 optional band-units can be installed with the IC-900 for instant access to a wide range of frequencies from the 28MHz HF band to the 1240MHz UHF band. Only a small remote controller is necessary for control of all these bands. A flexible optical fibre is used between the Remote Controller and the Interface Unit. The IC-900 has independent, full duplex capability on all bands, providing simultaneous receive and transmit operation.

The function display on the Remote Controller shows two separate operating frequencies simultaneously. The IC-900 system transceiver is equipped with 10 fully programmable memory channels in each Band Unit. The system can therefore store up to 50 different memory channels.

This revolutionary new concept in Multiband operation is available from your ICOM dealer. Also feel free to contact ICOM (UK) LTD for assistance or information. The IC-900 Multi-band system consists of a Remote Controller, Interface Unit A, Interface Unit B and a series of specially designed Band Units.

UX19	28—30MHz	10 watts
*UX59	50—54MHz	10 watts
*(No mobile operation allowed in UK)		
UX29	144—146MHz	25 watts
UX29H	144—146MHz	45 watts
UX49	430—440MHz	25 watts
UX129	1240-1300MHz	10 watts



## IC-1200, 23cms FM Mobile.

To complete the range of VHF/UHF FM Mobiles this new model is now available for the 23cm Ham band, it is based on similar features to the already existing IC-28E 2m and IC-48E 70 cms mobile units. This Mini-mobile transceiver will fit easily anywhere in your vehicle or shack. Power output is 10 watts or 1 watt low. The IC-1200 is so new we do not even have a picture of it, however, the large front panel LCD readout is designed for wide angle viewing and front panel controls are straightforward to make mobile operation safe and easy. The IC-1200 is a superb example of ICOM's dedication to exploring new communication equipment.

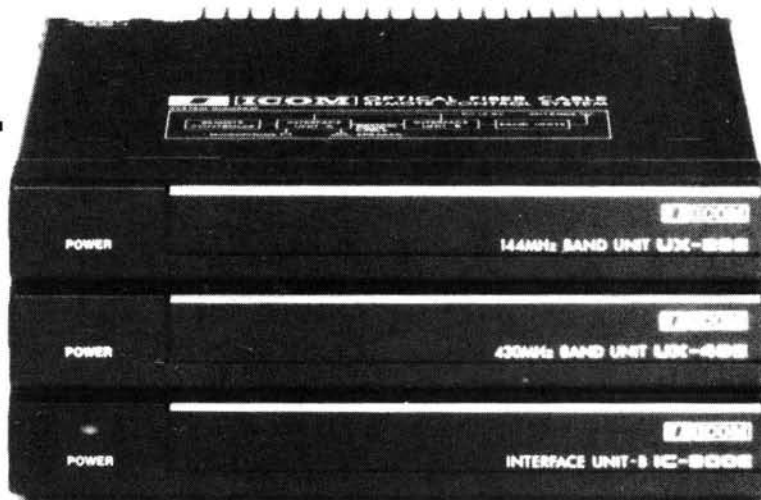

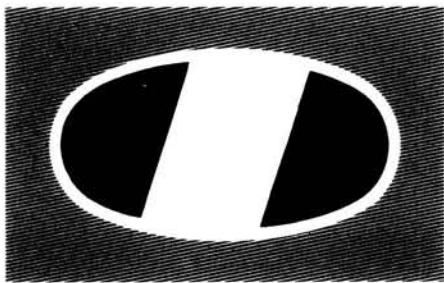

# ICOM

# Communications

## THE HOTTEST ITEMS THIS SUMMER



### VHF/UHF FM Handportables

If you want a handheld with exceptional features quality built to last and a wide variety of interchangeable accessories, take a look at the ICOM range of FM transceivers. All ICOM handportables come with a nicad battery pack, AC wall charger, flexible antenna and wrist strap.

### Micro 2E/4E

These new micro-sized 2 metre and 70 centimetre handportables give the performance and reliability you've come to expect from ICOM. Measuring only 148 x 50 x 30 the Micro fits in your pocket as easily as a cassette tape. The Micro 2E/4E features an up/down tuning system for quick frequency adjustments, 10 programmable memories, a top panel LCD readout, up to 2.5 watts of output (optional).

### IC-2E 2 metre Thumbwheel Handportable

This popular handheld from ICOM is still available. For those amateurs who require a straightforward and effective FM transceiver the IC-2E takes some beating. Frequency selection is by means of thumbwheel switches (with 5Khz up switch) simplex or duplex facility. Power output is 1.5 watts or low 150 milliwatts (2.5 watts possible with BP5A battery pack).

### IC-02E/04E 2 metre and 70cm Keypad Handportable

These direct entry CPU controlled handhelds utilise a 16 button keypad allowing easy access to frequencies, memories and scan functions. Ten memories store frequency and offset, these handhelds have an LCD readout and power output is 2.5 watts or low 0.5 watt. 5 watts is possible with the IC-BP7 battery pack or external 13.8v DC.

### IC-12E 23cm Handportable

Similar in design and style to the 02E/04E this 1296Mhz handheld utilises ICOM's experience in GHz technology, gained by the excellent IC-1271E base station. Power output is 1 watt from the standard BP3 nicad pack, external 13.8v DC powering is available to the top panel jack. With the growing number of repeaters on 23cm. The IC-12E makes it an ideal band for rag chew contacts.

ALSO AVAILABLE FOR ICOM HANDPORTABLES ARE A LARGE RANGE OF OPTIONAL EXTRAS INCLUDING A VARIETY OF RECHARGEABLE NICAD POWER PACKS, DRY CELL BATTERY PACKS, DESK CHARGERS, HEADSET AND BOOM MIC, LEATHERETTE CASES AND MOBILE MOUNTING BRACKETS.



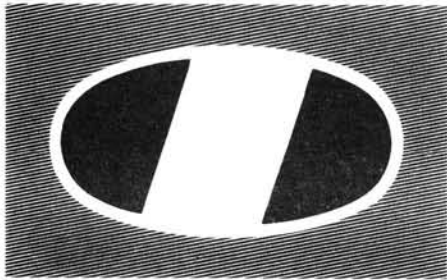

# ICOM



## IC-751A.



### IC-751A

#### Features:

- All mode.
- 100kHz-30MHz General Coverage Receiver.
- 100 watts.
- 12v Operation.
- 105dB Dynamic Range.
- 32 Memories.
- Electronic Keyer.
- Full Break In (40wpm).
- 500 Hz CW Filter.
- HM36 Microphone.





# TOP HF

## IC-761, HF TRANSCEIVER with General coverage receiver.



The new ICOM IC-761 H.F. Transceiver has many features making it probably the best top of the line Amateur transceiver available today. This all mode transceiver features an internal aerial tuning unit and A.C. power supply. The A.T.U. boasts a 3 second band selection and tune up with a VSWR matching of less than 1.3:1. For the serious operator the 100kHz-30MHz general coverage receiver and 105dB dynamic range make it ideal for DX chasing. Frequency selection is by the main VFO or via the front panel direct access keypad. And for when reception is difficult, pass band tuning, I.F. shift, notch filter, noise blanker, pre-amp and attenuator should enable you to copy even those weak DX stations whether amateur or broadcast. The C.W. operator will appreciate the electronic keyer, 500Hz filter and full break in (40wpm) other filter options are available. The IC-CR64 high stability crystal is standard as is the CI-V communications interface for computer control. Twin VFO's and split mode for cross band contacts the IC-761 features program scanning, memory scan and mode select scan and the 32 memories can store frequency and mode. The transceivers operating system is held permanently in ROM and is not dependant upon the lithium battery. The cell is used for memory back up only. A new style meter gives P.O., A.L.C., IC, VC, COMP and SWR readings. This new equipment is fully compatible with existing ICOM accessories such as the IC-2KL 500 watt linear amplifier. Here we believe the IC-761 will set a new trend that others will surely follow. For more information please contact your nearest ICOM dealer

Telephone us free-of-charge on:  
**HELPLINE 0800-521145.**  
 — Mon-Fri 09.00-13.00 and 14.00-17.30 —  
*This is strictly a helpline for obtaining information about or ordering ICOM equipment. We regret this service cannot be used by dealers or for repair enquiries and parts orders. Thank you.*

You can get what you want just by picking up the telephone. Our mail order department offers you free same day despatch whenever possible, instant credit, interest free H.P. Barclaycard and Access facility, 24 hour answerphone service.

## IC-735.



- IC-735
- Small Compact Size.
  - 100kHz-30MHz General Coverage Receiver.
  - 100 watts.
  - 105dB Dynamic Range.
  - FM Standard.
  - 12v Operation.
  - Large LCD Readout.
  - 12 Memories.
  - CI-V Communications Interface.
  - HM12 Microphone.

**Datapost**



**ICOM (UK) LIMITED**  
 Dept PW, Sea Street,  
 Herne Bay, Kent CT6 8LD.  
 Tel: 0227 363859.



# South Midlands

**SCHOOL CLOSE, CHANDLERS FORD IND. EST., EASTLEIGH**

From the 1st July Amateur Electronics and South Midlands Communications have amalgamated. With the combined talents, expertise and stocks of both companies, the range of equipment and services will be unsurpassed in Europe.

★ **OPEN DAY – FOR AMATEURS** ★  
10 am – 5 pm SUNDAY

10% OFF ALL NEW EQUIPMENT PURCHASED (EXCEPT MASTS) – CASH ONLY  
CAR BOOT SALE – APPROX. 100 FREE SPACES – NO TABLES

FREE RADIO SPEC. CHECK – 1.8 – 430MHz only

**WIN AN FT290R – and NUMEROUS OTHER PRIZES**

LICENSED BAR & REFRESHMENTS AVAILABLE ON SITE

Numerous local attractions – why not make it a family day out?

TALK IN ON S22

NEW

**BEST VALUE ON 2M ONLY £299**

## FT211RH

45W OUTPUT

- ★ 45/10W Switchable RF Output
- ★ Easy 'one touch' push button operation
- ★ Reversible sloped front panel
- ★ Large green easy to read LCD
- ★ Ten memories (independent Tx & Rx)
- ★ Switchable 12.5/25kHz steps
- ★ Priority channel monitoring
- ★ C/w Hand mic and mobile mounting bracket



**OPTIONAL ACCESSORIES**

SP55	External Speaker .....	£19.55
YH1	Headset (C/W Mic) .....	£19.00
SB10	PTT Switch Unit .....	£21.00
MH 10F8	Speaker/Mic .....	£22.00
MH 14A8	Speaker/Mic (C/W Tone Burst) .....	£23.00
MF 1A3B	Boom Mic (Via SB10) .....	£25.00

NEW IMPROVED



## NOW EVEN BETTER!

- ★ All Mode SSB (USB + LSB) CW, AM & FM
- ★ All Band Tx (General Coverage Rx)
- ★ 100% Duty Cycle (100w CW, FM 25w AM)
- ★ Pushbutton mode selection
- ★ Switchable VFO steps (all modes)
- ★ New Notch Filter
- ★ Dual VFO's and 10 Memories (Freq. & Mode)
- ★ Computer Compatability (with optional interface)

**OPTIONAL ACCESSORIES**

FP757HD	Heavy Duty P.S.U. ....	£239	FAS-1-4R	Remote Antenna SW .....	£80
FP757GX	Light Duty P.S.U. ....	£69	FC757AT	Automatic ATU .....	£349
				FL7000 500W Solid State Linear Amplifier	£1,600

## FT757GXII

**£969 inc. VAT**

**LEEDS**  
SMC (Northern)  
Nowell Lane  
Industrial Estate  
Leeds LS9 6JE  
Leeds (0532) 350606  
9.5-30 Mon-Sat

**CHESTERFIELD**  
SMC (Midlands)  
102 High Street  
New Whittington,  
Chesterfield  
Chest. (0246) 453340  
9.30-5.30 Tues-Sat

**BUCKLEY**  
SMC (TMP)  
Unit 27, Pinfold Lane  
Buckley, Chwyd  
Buckley (0244) 549563  
10-5 Tues, Weds, Fri  
10-4 Sat

**JERSEY**  
SMC (Jersey)  
1 Belmont Gardens  
St. Helier, Jersey  
Jersey (0534) 77067  
9-5 pm Mon-Sat  
Closed Wed

**N. IRELAND**  
SMC N. Ireland  
10 Ward Avenue  
Bangor  
County Down  
0247 271875

**BIRMINGHAM**  
SMC (Birmingham)  
504 Alum Rock Road  
Alum Rock  
Birmingham B8 3HX  
B'Ham (021237)  
1497/6313  
9.30-5.00 Tues-Sat

**AXMINSTER**  
Reg Ward & Co Ltd  
1 Western Parade  
West Street,  
Axminster  
Devon EX13 5NY  
Axminster (0297) 34918  
9.5-30 Tues-Sat



Southampton Showroom open 9.00-5.00 Monday to Friday, 9.00-1.00 Saturday. Service Dept open Mon-Fri 9.00-5.00.

AGENTS: JOHN DOYLE, TRANSWORLD COMMS, NEATH (0639) 52374 DAY (0639) 2942 EVE  
BOOTH HOLDINGS, SALTFOED, BRISTOL 02217 2402

DAVID STENNING, G4JA, LOUTH 0507 604967  
JACK McVICAR, SCOTCOMMS, EDINBURGH 031 657 2430

# CU B's on 4 & 6

FT767GX



FT726R



FT690R2/A



★ Specifications for VHF/UHF options. All mode LSB, USB, CW, AM and FM. 10W RF output all modes (AM 2.5W carrier)\* 4 Micro-processors, Dual VFO's and 10 memories. Push button selection of mode, freq., mem. channel etc. Large Fluorescent 'Easy to Read' display. Computer & Packet radio compatibility.

★ Specifications for VHF/UHF options. All modes LSB, USB, CW & FM. 10W RF output & <0.25µV for 12dB sinad\* Synthesised dual VFO's & 11 memories. Switchable freq. steps and programmable RPT shift. Full duplex operation (with optional module). Packet radio compatibility.

All mode FM, CW, LSB & USB. Fully synthesised, dual VFO's & 10 memories. 2.5W RF output & <0.25µV for 12dB sinad. Large clear LCD and separate S/P/O meter. Optional FL6020 10W linear amplifier c/w Hand mic, Battery Case, Antenna & strap.

### ANTENNAS & ACCESSORIES

FTV107R(6) FTV107R c/w 6m module £149.00

648	4 element optimised 50MHz	£74.75
UR43	Solid centre coax 5mm	per metre £0.31
UR76	Stranded centre coax 5mm	per metre £0.32
UR67	Low Loss 10.2mm	per metre £0.79
H100	in 25, 50, 100, 200m lengths	per metre £0.79
IC505	50MHz 3/10W O/P Transceiver	£459.00

50/3	3 element yagi 50MHz	£39.95	£2.65 p&p
50/5	5 element yagi 50MHz	£59.90	£2.65 p&p
DB4	4 element yagi 50/70MHz	£115.00	£4.00 p&p
4Y6M	4 element yagi 50MHz	£48.88	£2.85 p&p
4Y4M	4 element yagi 70MHz	£36.63	£2.85 p&p
PH2-4M	Phasing Harness 2 way 70MHz	£19.90	£1.85 p&p

FT690R2/A	50 MHz Multimode (as above)	£429.00
FL6020	10W linear for FT690R2/A	£109.00
50/726	6M Module for FT726R	£249.00
50TV	6M Module for FTV series	£ 99.00
50/767	6M Module for FT767GX	£169.00

## DTI APPROVED – FOR CLASS B FROM 1st JUNE '87 A SELECTION FROM OUR CATALOGUE

### ANTENNA ROTATORS

KR250	Bell type twist switch control	£78.00
AR40	Bell type turn push control	£125.00
KR400RC	Bell type 360 deg. round meter	£169.00
AR50	Bell type 5 position pre-select	£149.00
CD45	Bell type meter readout	£219.00
KR600RC	Bell type 360 deg. round meter	£219.00
HDR300	Bell type digital readout	£699.00
KR800SDX	Bell type 450 deg. variable speed	£325.00
KR1000SDX	Bell type 450 deg. variable speed	£368.00
KR2000RC	Bell type heavy duty round meter	£445.00
KR2000	Bell type meter control +/- 90 deg.	£445.00
KR400	Bell type meter control +/- 180 deg.	£139.00
KR500	Elevation meter calib. +/- 90 deg.	£149.95
KR500B	Heavy duty version of KR500	£259.95
KR5400	Azimuth/elevation dual control	£279.00
KR5400A	Azimuth/elevation computer control	£339.00
KR5600	Azimuth/elevation heavy duty	£369.00
KR5600A	Azimuth/elevation HD comp. control	£389.00
KR010	Intell. rface KR5400A/KR5600A	£275.00

### ROTATOR HARDWARE

50425	Ubolt clamps AR22/AR40 std.	£10.18
50463	Ubolt clamps CD45 etc. heavy duty	£16.68
KS050	Rotary bearing 1 3/8" mast	£19.95
KS065	Rotary bearing 2" mast	£29.95
KC038	Rotary bearing for KR400/KR600	£16.95

### ROTATOR CONTROL CABLE

RC5W	5way for KR400RC etc.	per mtr. £0.48
RC6W	6way for KR250/400/500 etc.	per mtr. £0.66
RC8W	8way for CD45/KR2000RC etc.	per mtr. £0.72

Carriage on rotator cable £1.90 up to 20 metres, over 20 metres £2.65.

Prices subject to fluctuation.

### FREE FINANCE . . .

On many regular priced items SMC offers Free finance (on invoice balances over £120) 20% down and the balance over 6 months or 50% down and the balance over a year. You pay no more than the cash price! Details of eligible items available on request.

### VHF/UHF MOBILE ANTENNAS

#### HAND PORTABLE ANTENNAS

6P2T/PL	6 section telescopic with PL259	£5.33
6P2T/BNC	6 section telescopic with BNC	£7.94
T144H	Tele. 2 metre 1/2 Wave with BNC	£13.50
2H/PL	Helical for 2 metres with PL259	£5.33
2H/BNC	Helical for 2 metres with BNC	£7.94
HS430	70cm 1/2 Wave with BNC	£9.75
HS430S	70cm 5/8 Wave with BNC	£9.75

#### MOBILE WHIPS

370F	70MHz 3/8 Wave 5.3ft.	£18.54
20W	144MHz 1/4 Wave 1.6ft.	£3.15
2VF	144MHz 1/2 Wave foldover 3.5ft.	£16.13
78F	144MHz 7/8 Wave foldover 5.7ft./	£21.15
78B	144MHz 7/8 Wave ball adjust 5.6ft.	£18.64
78SF	144MHz 7/8 Wave short whip 4.7ft.	£21.15
88F	144MHz 8/8 Wave 6.5ft.	£24.10
258	432MHz 2x5/8 Wave foldover 3.1ft.	£29.37
268E	432MHz 2 section colinear 6db	£32.80
358	432MHz 3x5/8 foldover 4.7ft.	£33.73
70N2DX	144/432MHz 6/8 + 3x5/8 Wave	£37.75

#### MOBILE BASE MOUNTS

SMCGCA	Gutter clip c/w 4M cable + PL259	£14.25
SMCSOCA	Cable ass. S0239 4M cable PL259	£6.90
SMCSOCAL	Cable ass. S0239 6M cable PL259	£7.20
SMCTMCAS	Trunk mount c/w 6M cable PL259	£12.25
HDTMCA	Heavy duty truck mount c/w 5M cable	£16.85
SOMM	Mag Base c/w 4M cable PL259	£12.75
SMCSOWM	Adj. angle wing mount base	£6.00
SMCGCD	Gutter clip adjust angle for SOCA	£6.45
BSD	Bumper strap stainless band	£11.50

Carriage extra on all the above.

### VHF/UHF FIXED ANTENNAS

#### JAYBEAM 2 Metre

HO/2M	Halo head only	£7.13
HM/2M	Halo with 2ft. mast	£8.34
UGP/2M	Ground plain folded radiator	£15.41
C5/2M MK2	Vertical Colinear 4.8dbd	£89.70
LR1/2M	Vertical Colinear 4.3dbd	£35.71
LR2/2M	Vertical omnidirectional	£28.18
LW5/2M	5 Element Yagi 7.8dbd	£17.31
LW8/2M	8 Element Yagi 9.5dbd	£21.85
LW10/2M	10 Element Yagi 10.5dbd	£28.23
LW16/2M	16 Element Yagi 13.4dbd	£42.44
PBM10/2M	10 Element Parabeam 11.7dbd	£55.20
PBM14/2M	14 Element Parabeam 13.7dbd	£58.08
Q4/2M	4 Element Quad 9.4dbd	£35.31
Q6/2M	6 Element Quad 10.9dbd	£46.28
O5/2M	5 over 5 slot fed Yagi 10.0dbd	£30.82
D8/2M	8 over 8 slot fed Yagi 11.1dbd	£42.38
5XY/2M	5 Element crossed Yagi 7.8dbd	£33.41
8XY/2M	8 Element crossed Yagi 9.5dbd	£43.01
10XY/2M	10 Element crossed Yagi 10.8dbd	£53.94
PMH2/C	2 Way harness circ. polansation	£12.82
PMH2/2M	2 Way harness for 2 Metres	£14.15
PMH4/2M	4 Way harness for 2 Metres	£35.25

#### SMC VHF/UHF ANTENNAS

GDXA	Discone 100-440MHz low VSWR	£46.35
GDX1	Discone 80-480MHz low VSWR	£55.75
GDX2	Discone 50-480MHz low VSWR	£69.65
VHFL	Discone 65-520MHz receive only	£22.50
GP23	2 Metre colinear 3x5/8 7.8db	£64.25
GP144W	2 Metre colinear 2x5/8 6.4db	£42.00
GPV5S	2 Metre colinear 2x5/8 6.4db 100W	£45.50
GP2M	2 Metre ground plain 100 Watt	£23.65
GP432X	70Cms colinear 3x5/8 6.8db	£47.50
GP714	70Cms colinear 14 step co-ax 10dbi	£88.20
358FG	70Cms colinear 3x5/8 base antenna	£57.75

### GUARANTEE

Importer warranty on Yaesu Musen products. Aply staffed and equipped Service Department. Daily contact with the Yaesu Musen factory. Tens of thousands of spares and test equipment. Twenty-five years of professional experience.

● 2 years warranty on regular prices Yaesu products.

### FREE S.M.C. SERVICE INTERLINK DELIVERY . . .

Free Interlink delivery on major equipment. Small items, Plugs, Sockets, etc. by post £1.75. Antennas, Cables, Wire & larger items. Roadline up to £5.00. Interlink delivery available, upon request, for items other than radios, from £7.30 depending on weight. Same day despatch whenever possible.

# AKD

TEL.  
0438 351710

Unit 5  
Parsons Green Estate  
Boulton Road  
Stevenage  
Herts SG1 4QG



MAIL ORDER DEPT.  
Stock Items Normally  
Despatched within 48 hours,  
21 days latest.

## TV INTERFERENCE PROBLEMS??!

Are you having trouble receiving a watchable picture on your TV? If so, the cause may be aerialborne interference. For many years AKD has manufactured a low cost range of in-line interference suppression filters that are easily inserted into the aerial system to help reduce the effects of interference from local taxi radio, CB, amateur radio, airport radar, etc. Each filter is terminated in standard aerial co-ax plug and socket and requires no external power. Fitting could not be more simple. No technical knowledge is needed. There are 11 standard stocked filters in our range, but individual filters can be tuned to reject interference at specific frequencies if required. If you are not sure which filter type to order or have any questions regarding interference phone our helpline on 0438 351710 and ask for John who will be pleased to assist you in making the best choice of filter.

### THE FILTER RANGE IS AS FOLLOWS:

#### FILTER TYPE RBF1

A range of filters designed to eliminate Radar Blip, especially noticeable on video recorders. Stocked on channel 36 and 846MHz (RAF Boulmer interference) can be tuned at our factory from 420MHz to 890MHz. **£6.75 each**

#### FILTER TYPE TNF2

A range of Tuned Notch filters stocked on generally useful frequencies used by Amateur Radio operators, CB users, Private Taxi companies. Can also be factory tuned to reject any spot frequency up to 300MHz. **£7.75 each**

**TORROID RINGS** £2.50 per pair

#### FILTER TYPE HPF1

Used in weaker reception areas for general interference problems. Use with UHF TV, Video & Pre-Amps **£6.75 each**

#### FILTER TYPE HPFS

Used in strong signal area for severe interference on UHF only **£7.00 each**

#### FILTER TYPE BB1

A general purpose filter that can be used on its own or together with other filters in our range for severe interference problems. Ideal at the input of VCR and Pre-Amps. **£6.75 each**

OUR FILTERS ARE SUCCESSFULLY USED BY LEADING TV RENTAL COMPANIES AND CARRY OUR USUAL 14-DAY MONEY-BACK GUARANTEE

#### HFC1

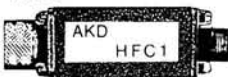

#### CONVERTER

For the FRG 9600/965 our new HF Converter, connects to the aerial socket, and powered direct from the 8 Volt o/p of the FRG 9600. Tune from 100, 1MHz to 160MHz, gives tuning range of 100Khz to 60Mhz, uses double balanced mixer, with low pass filter on input.

**£49.00**

#### WA1



#### WAVEMETER

**£24.95**

Our Waveabsorption meter for 2 Mtre transmitters meets licensing requirements range 120Mhz to 450Mhz, very sensitive, can also be used as field strength meter within its range. Requires PP3 type battery (not supplied).

\* Can be supplied with BNC termination for other scanners \*

## Unfilter 'CLAMP-ON' RADIO-FREQUENCY CHOKE

PHONE OR SAE FOR PRODUCT SPECIFICATION & APPLICATION NOTES

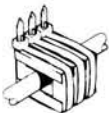

Allows leads to be toroidially protected without the need to cut or remove plugs or connectors. Ideally suited for moulded plugs, leads, ribbon, and large diameter cables. Can easily be fitted and stacked in multiples to increase rejection. 'UNIFILTER' works by suppressing the interference currents that flow along the outside of cables without affecting the signals or power flowing inside. This means that you don't need to worry about upsetting normal operation or invalidating guarantees. Suitable for both reducing the emission of, or rejecting the effect of, 'common mode' interference as experienced on computer, hi-fi & speaker leads, as well as the normal mains & aerial cables.



UF 4 KIT (SUITABLE FOR SMALLER INSTALLATIONS) **£9.89**

UF 8 KIT (FOR MULTI INSTALLATIONS) **£19.55**

ALL PRODUCTS ARE AVAILABLE FROM US DIRECT MAIL ORDER OR WHY NOT MAKE USE OF OUR ACCESS & VISA FACILITIES TO ENSURE MINIMUM DELAY

ALL OUR PRODUCTS CARRY THE USUAL AKD 2 YEAR GUARANTEE. PRICES QUOTED ARE CORRECT AT TIME OF GOING TO PRESS AND INCLUDE VAT, POSTAGE & PACKING

TRADE ENQUIRIES WELCOME

Props: RT & VEL Wagstaffe. Technical Adviser: John Armstrong

## SPECTRUM COMMUNICATIONS

MANUFACTURERS OF RADIO EQUIPMENT AND KITS

### 4 and 6m EQUIPMENT

**RECEIVE CONVERTERS** 4 or 6m antenna input, 10 or 2m i.f., variable gain 0-26dB, n.f. less than 3.5dB. Buffered local oscillator output, types RC4-10, RC4-2, RC6-10 and RC6-2. PCB kit **£17.25**, PCB built and tested **£24.50**, boxed kit **£29.25**, boxed, built and tested **£41.00**.

**TRANSMIT CONVERTERS** 4 or 6m 500mW output, 10m drive 25mW to 500mW. Local oscillator input matches receive converters. Types TC4-10 and TC6-10. PCB kit **£16.50**, PCB built and tested **£25.75**, boxed kit **£28.50**, boxed built and tested **£41.00**.

**TRANSMIT CONVERTERS** 4 or 6m variable power 80mW to 2.5W, 2m or 10m drive 10mW to 100mW. Local oscillator input matches receive converters. Types TC4-10H, TC4-2H, TC6-10H, TC6-2H. PCB kit **£27.50**, PCB built and tested **£37.75**, boxed kit **£39.50**, boxed built and tested **£53.00**.

**TRANSCIVE CONVERTERS** Single board version of receive converter and 500mW transmit converter, 10m drive 25mW to 500mW. Types TRC4-10 and TRC6-10. PCB kit **£39.00**, PCB built and tested **£54.00**, boxed kit **£54.00**, boxed, built and tested **£83.25**.

**TRANSCIVE CONVERTERS** Separate receive converter and 2.5W transmit converter in a single boxed unit, 2m or 10m drive 10mW to 100mW only, requires r.f. sensing switch and attenuator for use with 2.5W 2m rigs. Types TRX4-10H, TRX4-2H, TRX6-10H and TRX6-2H. Boxed kit **£60.00**, boxed and built **£99.50**.

### CB to 10m

**CB TO 10 FM CONVERSION BOARDS - THE FIRST COMMERCIALY AVAILABLE**, suits all UK FM CB rigs to give 29.31 to 29.70MHz. Size only 63x40x13mm. Built and aligned board SC29 **£15**. Or send your rig and we'll fit it. **£28** inc. return P&P for mobiles. **£31** inc. for base rigs.

**MULTIMODE CB CONVERSIONS**, send your 120 channel rig and we'll convert it to give 28.01 to 29.70MHz in straight sequences without gaps. Colt 1200DX, Cobra 148, Hy Gain 5, Multimode 2, Major M360, Tristar 747 & 777, Super Star 360, Concorde, etc., **£62** inc. return P&P. Jumbo or Colt Excalibur 1200, **£65**. 80 Channel rigs such as Stalker 9 or Major M588 are modified to give 28.31 to 29.70MHz in straight sequence without gaps. **£45.00** inc. return P&P. 200 Channel in 4 bands of 50 are converted to give 28.00 to 30.00MHz or 28.00 to 29.70MHz as required. Super Hy Gain 5, Lafayette 1800, Super Star 2000. **£45.50** inc. return P&P. Nato 2000 **£52.50**, Super Star 2000-5x40CH **£70**. Colt 1600, 4x40CH, **£65.50**.

VAT & P&P INC PRICES  
Delivery within 14 days subject to availability. 24 hr answering.

UNIT B6, MARABOUT INDUSTRIAL ESTATE, DORCHESTER, DORSET. TEL: 0305 62250

# RST

MAIL ORDER CO.  
Langrex Supplies Ltd.,  
Climax House,  
159 Fallsbrook Road,  
Streatham, SW16 6ED.

SPECIAL EXPRESS MAIL ORDER SERVICE

AZ31	2.75	EM81	2.50	PL519	6.00	6AK5	5.99	6K06	8.00
CL33	4.00	EM87	2.50	PL802	6.00	BAL5	1.50	6L6G	5.00
DY86/7	1.50	EN91	6.50	PY33	2.50	GAM6	6.02	6L6GC	5.75
DY802	1.50	EY51	2.75	PY81	1.50	GAN5	4.75	6L7	2.50
E88CC	10.33	EY86	1.75	PY82	1.50	GANBA	3.50	6L06	7.50
E180F	12.05	EY88	1.75	PY83	1.25	GAC5	3.25	6D7	3.75
E810F	35.48	EY88	1.75	PY83	1.25	GAR5	25.00	6RH8/6KN8	
EABCB0	1.25	EY500A	3.00	PY88	2.00	GAS6	8.66		
EB91	1.50	EZ80	1.50	PY900A	4.00	GAS7G	8.75	6SA7	3.00
EBF80	1.50	EZ81	1.50	PY900	1.50	GAT6	1.25	6SC7	2.75
EBF89	1.50	GY501	3.00	PY801	1.50	GAU5GT	5.00	6S17	3.25
EC91	8.00	GZ32	4.00	QV02-6	38.00	GAU5	2.50	6SK7	3.50
ECC33	4.50	GZ33	4.75	QV03-10	26.25	GAW8A	3.75	6SL7GT	3.00
ECC35	4.50	GZ34	4.00	QV03-20A	48.38	6B7	3.25	6SN7GT	3.00
ECC81	1.75	GZ37	4.75	QV06-40A	46.00	6B8	3.25	6SS7	2.75
ECC82	1.75	KT61	5.00	QV03-12	6.00	6BA6	1.50	6SG7M	2.50
ECC83	1.75	KT66	15.00	R18	3.00	6BA7	5.00	6UBA	2.25
ECC85	1.75	KT77 GOLD	12.00	R19	9.24	6BE6	1.50	6V6GT	4.25
ECC88	3.50	KT88 LION	20.00	R18	3.00	6BH6	2.50	6XA	3.00
ECC91	8.93	N78	15.00	R19	9.24	6BJ6	2.25	6X5GT	1.75
ECF80	1.50	OA2	3.25	SP41	6.00	6BN6	2.00	12AX7	1.75
ECH35	3.00	OB2	4.35	SP61	4.00	6BQ7A	3.50	12BE6	2.50
ECH42	3.50	OC3	2.50	U19	13.75	6BR7	6.00	12BE6	2.50
ECH81	3.00	OD3	2.50	U25	2.50	6BR8A	3.50	12BY7A	3.00
ECL80	1.50	PC86	2.50	U26	2.50	6BS7	6.00	12E1	20.00
ECL82	1.50	PC88	2.50	U37	12.00	6BW6	6.00	12HG7	4.50
ECL83	3.00	PC92	1.75	UABC80	1.25	6BW7	1.50	30F1/12	1.38
ECL86	1.75	PC97	1.75	UBF89	1.50	6BZ6	2.75	30F4	2.50
EF37A	5.00	PC900	1.75	UCH42	2.50	6C4	1.25	30F19	2.50
EF39	2.75	PCF80	2.00	UCH81	2.50	6C6	3.50	30PL13	1.80
EF41	3.50	PCF82	1.50	UCL82	1.75	6CB6A	2.50	30PL14	1.80
EF42	4.50	PCF86	2.50	UCL83	2.75	6CD6GA	5.00	57Z8	55.00
EF50	2.50	PCF801	2.50	UJF89	2.00	6CL6	3.75	805	45.00
EF54	5.00	PCF802	2.50	UL41	5.00	6CH6	13.00	807	3.75
EF55	3.50	PCF805	1.70	UL84	1.75	6CW4	8.00	811A	18.33
EF80	1.75	PCF808	1.70	UY41	4.00	6D6	3.50	812A	47.50
EF86	3.50	PCH200	3.00	UY85	2.25	6D05	7.50	813	65.00
EF91	2.95	PCL82	2.00	VR105/30	2.50	6D06B	4.75	866A	35.00
EF92	6.37	PCL83	3.00	VR150/30	2.50	6EAB	3.00	872A	20.00
EF183	2.00	PCL84	2.00	Z158	25.00	6E4	1.85	931A	18.50
EF184	2.00	PCL85	2.50	Z803U	25.00	6F6	3.00	2050	7.50
EH90	1.75	PCL86	2.50	2D21	3.25	6GK6	2.75	5763	4.50
EL32	2.50	PCL805	2.50	3B28	50.00	6H6	3.00	5814A	4.00
EL33	4.00	PD500	6.00	4CX250B	58.00	6H56	3.77	5842	12.00
EL34	4.00	PL200	2.50	5R4GY	5.50	6J5	4.50	6080	14.00
EL36	2.50	PL36	2.50	5U4G	3.00	6J6	8.93	6146A	12.00
ELL80	25.00	PL81	1.75	5V4G	2.50	6J7	4.75	6146B	12.00
EL81	5.25	PL82	1.50	5Y3GT	2.50	6JB6A	6.50	6550	10.00
EL84	2.25	PL83	2.50	5Z3	4.00	6JE6C	7.50	6883B	12.50
EL86	2.75	PL84	2.00	5Z4GT	2.50	6JS6C	7.50	6873	7.50
EL91	7.39	PL504	2.50	6R0L2	1.75	6K6GT	2.75	7025	4.50
EL95	2.00	PL506	5.50	6AB7	3.00	6K7	3.05	7027A	8.00
EL360	18.50	PL509	6.00	6AH6	5.00	6K8	3.00	7360	10.00
								7586	15.00
								7587	23.00

Open daily to callers: Mon-Fri 9 a.m.-5p.m.  
Valves, Tubes and Transistors - Closed Saturday.  
Terms C.W.O. only, allow 7 days for delivery. Tel. 01-677 2424/7.  
Prices excluding VAT add 15% Quotations for any types not listed S.A.E. **946708**  
Post and packing **£1.00** per order

THE LONDON AMATEUR EMPORIUM  
FOR EVERYTHING RADIO

191 FRANCIS ROAD  
LEYTON · E10 6NQ · LONDON  
TELEX 8953609 LEXTON G

PHONE  
01-558 0854  
01-556 1415

**dressler**  
FOR ICOM

OPEN MON -  
SAT 9AM - 5.30PM  
INTEREST FREE  
HP FACILITIES AVAILABLE  
ON MANY ITEMS  
PROMPT MAIL ORDER



**dressler**  
FOR YAESU

IC28E/IC48E

VERY LATEST MINI-MOBILE  
25/45 watts. RX 138-174MHz  
£££ unbelievable value.

ICOM R7000 25MHZ-2000MHZ  
SPECIAL OFFER!!



FREE  
ARA 500  
ACTIVE ANTENNA  
WORTH £139.00  
£969

**LATEST REMOTE  
CONTROLLED ICOM**

28MHz - 50 - 144 - 432 - 1200

All in one unit. Full duplex.  
600 CH memory, etc.



ICOM MICRO 2  
HANDHELD

ICOM IC-02E

ALSO  
AVAILABLE  
IC275E

ALL SONY PRODUCTS  
UK SUPPLIED



£239 inc. NiCad  
Charger & Case



£275



£854  
SPECIAL OFFER

SONY AIR 7

PORTABLE-AM-FM

144-174MHz  
108-136MHz  
150KHz-2194KHz

£249



**BUY A  
R71 FOR £825  
& RECEIVE AN ARA 30  
FREE  
WORTH £129**

WIDE RANGE OF YAESU/ICOM,  
TRIO/KENWOOD, H.F., V.H.F., U.H.F.  
SCANNING RECEIVERS AND  
TRANSCIVERS IN STOCK ICOM ICA2 ALL  
CHANNELS TX/RX 5 WATTS, 108-135 AND  
175 MHz £450 - COMMERCIAL  
PROFESSIONAL, MARINE, CELLULAR  
AND AMATEUR RADIO SALES AND  
SERVICE.

SONY ICF 200ID

76-108 MHz  
116-136 AIRBAND  
153-29,995kHz  
FM - AM - SSB 32 MEMORIES  
INC PSU, CARRY STRAP  
& EARPHONE

£325



SONY ICF 7600D  
76-108MHz

76-108MHz  
153-29,995MHz  
Complete with case,  
mains power supply,  
earphone and  
frequency list.

£169

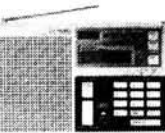

FRG 8800 £575



NEW

FT767 YAESU



FULL HF GENERAL  
COVERAGE TRANSCIVER

£1395

FRG 9600 £475



**ACTIVE ANTENNAS**

dressler - ara 30 -  
active antenna

200 kHz . . . 40 MHz

Professional electronic circuitry with very wide  
dynamic range. Meets professional demands  
both in electronics and mechanical ruggedness.  
120 cm long glass fibre rod. Circuit is built into  
waterproof 2.5 mm thick aluminium tube. Ideal  
for commercial and swl-receiving systems. £129.  
See Review in August 1985 Issue p.35

**DRESSLER  
ARA 500  
ACTIVE ANTENNA**

50MHz to 1300MHz

Gain 17dB Typical

**TECHNICAL SPECIFICATIONS  
FOR ARA 500**

Gain 17dB Typical (14-17dB)  
Frequency Range 50-1300MHz  
Noise Figure 1dB at 50-180MHz  
1.5dB below 300MHz  
2.0dB below 350MHz  
2.7dB below 400MHz  
3.0dB below 500MHz  
3.8dB below 650MHz

£139.00

Operation is possible up to 1300MHz  
with gain of 10dB

Noise 4-6dB  
Intercept Point 3rd Order: +18dbm at Input  
Post £3.00 or Securicor £7.00 extra

Both antennas come complete with 7 metres of cable, interface, power supply and brackets.

**LINEARS**

**SPECIAL OFFER  
4 ONLY D200S £925**

D200 2 MTR 500W SSB

£858

D200S 2 MTR 750W SSB SEE PANEL ABOVE

D70 70 CMS 550W SSB

£1030

CARRIAGE FREE - SECURICOR

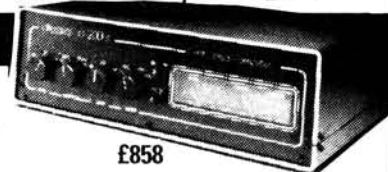

**PRE-AMPS - NEW MODELS**

MODEL	FREQ.	NOISE	GAIN	POWER	PRICE
EVV1296C	1.25-1.3GHz	0.9-1.2	16-18dB	100W	£162
EVV700SMD	430-440MHz	0.5-0.9	15-18dB	500W PEP	£124
EVV2000SMD	144-146	0.6-0.9	16-18dB	1KW PEP	£124
EVV200VOX	144-146	0.6-0.9	16-18dB	450W PEP	£112
EV2GAAS	144-146	0.6-0.9	15-18dB	100W PEP	£75
VV INTERFACE FOR ABOVE PRE-AMPS					£31

**RECEIVE PRE-AMPS**

MODEL	FREQUENCY	NOISE	GAIN	PRICE
EWPA 560	50-600-1GHz		16.5dB-1dB	£79
EWPA 560(N)	50-600-1GHz		16.5dB-1dB	£89
IP3 order	+ 18dBm			
ERPA 1296	1.25-1.30	0.8	17-18dB	£120
ERPA 435	430-440	0.5	15-18dB	£70
ERPA 144	144-146	0.7	16-18dB	£66
ASA 12	0-1GHz		Masthead Antenna Switch	£59

**IDEAL FOR VHF SCANNERS, CARAVANS,  
AND BOATS. SUPERB TV RECEPTION.**



"The Oldest Name In Amateur Radio"

# STAR MASTERKEY



Star Masterkey ..... £54.70  
 CMOS Memory Keyer ..... £95.00

## THE ORIGINAL



Deluxe ..... £82.74  
 Std ..... £70.54

## THE IAMBIC



Deluxe ..... £78.09  
 Std ..... £63.98

Send an S.A.E. for further details and special prices when you buy a S.M.K. and one of the Vibroplex range.

Post and Packing on the above £3.00

# DEWSBURY ELECTRONICS

176 LOWER HIGH STREET,  
 STOURBRIDGE, WEST MIDLANDS  
 Telephone: (0384) 390063/371228  
 Telex: 336712 SHEL TN G

# PRACTICAL WIRELESS KITS

Kit Name	Date	Price	Category	Component	Price
Downton Freq. to Voltage Converter	June 87	19.70	COMMENTS	DIODES	2N3904 14
Side Tone Oscillator	June 87	9.60		BAT85 26	2N3906 14
Itchen LCD Bridge	April 87	26.90	1N914 04	2N4126 35	
Woodstock Short Wave Converter	March 87	26.50	1N916 16	LINEAR IC's	
Masthead Preamp For 144MHz	Feb 87	38.30	1N4001 08	LM567 22	
Westbury Basic Wobblulator	Jan 87	16.50	1N4002 06	555 CMOS 64	
High Z Musket Voltmeter	Dec 86	24.50	1N4005 08	741C 20	
Taw VLF Converter	Nov 86	14.20	1N4148 03	CA358 44	
Active Antenna	Nov 86	17.80	0A90 09	CA3140E 42	
Automatic Nicad Charger	Oct 86	18.20	0A91 10	CA3240E 106	
Simple 50MHz Converter	Sept 86	21.50	W005 22	ICM7555 64	
Arun Parametric Filter	May 86	49.30	TRANSISTORS	LF351 46	
Meon 2 50MHz Transverter (144MHz IF)	April 86	43.30	LM358 44	LM566 128	
Rtly Morse Modem (No Case)	Jan 86	31.85	BC107 14	MC1458 40	
Two Tone Oscillator	Dec 85	21.30	BC108 14	MC1496 150	
Meon 50MHz Transverter (28MHz IF)	Oct 85	43.30	BC109 14	S042P 230	
Capacitance Meter	Oct 85	21.30	BC109C 18	S81L 655	
Fet Dip Oscillator	Oct 85	19.90	BC148 11	SL1621 610	
Add On BFO			BC178 21	SL1640 510	
(Inc. C804 + Optional Comps.)	Aug 85	12.95	BC212L 16	SL6440 480	
Triambic Keyer	Feb 85	18.45	BC213 11	T8A810 98	
Morse Sending Trainer	July 84	12.00	BC214L 16	T071 46	
Auto Notch Filter	June 84	25.90	BC478 28	T074 115	
Morse Practice Oscillator	Jan 82	9.20	BC547 11	T084 100	
			BC548 11	XR2206 480	
			BC549 11	YC549 246	
			BC559 11	REGULATORS	
			BF180 36	7805 42	
			BF199 19	7812 42	
			BF200 36	7815 42	
			BF204 36	7815 42	
			BF241 31	7824 42	
			BF244 36	78L05 29	
			BF244B 40	78L09 55	
			BF245A 48	78L12 29	
			BF256 43	78L15 29	
			BF256L 48	CMOS	
			BF961 77	4001B 16	
			BF981 84	4011B 16	
			BFY90 88	4015B 39	
			BSX20 34	4017B 35	
			J304 70	4021B 38	
			J309 74	4023B 16	
			J310 74	4046B 49	
			TIP41 44	4047B 49	
			TIP41A 48	4050B 45	
			TIP42A 50	4070B 20	
			VN10KM 89	4075B 16	
			VN10LM 76	4077B 29	
			2N2926 18	4093B 22	
			2N3055 59	4541B 142	
			2N3704 14	40105B 145	
			2N3706 14	74HC04 26	
			2N3819 40	74HC32 26	
			2N3866 130	74HC390 88	
25w High Quality with Long Life Element 1.7 metre lead (240v)		£4.45			

PRICES DO NOT INCLUDE VAT, WHICH SHOULD BE ADDED TO THE TOTAL ORDER VALUE AND P&P CHARGES. P&P = 70p UNLESS SPECIFIED. ARTICLE REPRINTS 50p (IF REQUIRED). ALL KITS ARE COMPLETE (LESS BATTERIES), UNLESS SPECIFIED INCLUDING PCB, CASE, ALL COMPONENTS, CONNECTORS AND HARDWARE. ALL COMPONENTS ARE NEW AND TO FULL SPECIFICATION. CHEQUE, P.O., OR ACCESS TO:

CPL ELECTRONICS, 8 Southdean Close, Hemlington, Middlesbrough, TS8 9HE  
 TEL: 0642 591157  
 Other kits are available plus a wide range of components etc.  
 ACCESS, MAIL OR TELEPHONE ORDERS WELCOMED. FREE PRICE LIST ON REQUEST.

# THE HAMGEAR PMX PRESELECTOR



Introducing our new HF band preselector and antenna tuning unit combined, covering 1.7 to 34 MHz completely. The ATU section allows endless experiments with various lengths and types of antenna and offers correct matching of these antennas to your receiver.

The pre-amp section has a gain of 20 DBS which can be controlled down to zero gain, then on down to minus 15 DBS, allowing a boost just where the RX might need it or an attenuation where the band dictates.

The PMX can also be supplied with a built-in calibrator, having outputs at 1 MHz, 100 KHZ and 10 KHZ, with harmonics of these throughout the HF spectrum.

Casework is all metal with brushed aluminium engraved panel.

Prices are:  
 Unpowered PMX ..... £69.00  
 Mains powered PMX ..... £78.00  
 Mains powered PMX with calibrator ..... £97.00

All prices include U.K. postage.  
 Send for 4-page information on this PMX series.  
**HAMGEAR ELECTRONICS**  
 125 Wroxham Road, Norwich NR7 8AD.  
 Tel: Norwich (0603) 405611.

**Where a good deal more costs a good deal less . . .**

**ICOM** IC 735 £865



Call or telephone 01-992 5765 for latest prices and information plus full range of H.F. equipment and accessories.

IC 761



£POA



**NEW from AMERITRON  
AL 84 H.F. Linear Amp  
Economy with high performance at low prices  
JUST £599!**

FT757 £849 **YAESU**



Telephone 01-992 5765 for latest information on the YAESU value for money high performance equipment. Full range of accessories available.

FT 767



£1399



Four exciting hand holds from ICOM for you to come and try . . . or call 01-992 5765 and we'll send you the proof. Full Icom PMR Range in stock.

**AMERITRON RC S4**



Remote Coax Switch

Freq: up to 150 MHz  
Power: 240 V  
no control cable reqd.  
4 antenna positions on switch

**AMERITRON ATR 15**



ANTENNA TUNER

1500 W 'T' network  
A.T.U. 1.8-30 MHz in 10 dedicated bands  
**WATCH THIS SPACE - COMING SOON - EXCITING NEW PRODUCTS FROM THE USA!**



Voted the world's number one range of hand helds by the experts, available now from stock - or ask for literature. Telephone 01-992 5765



**YAESU FRG 8800 - Continuous Coverage Receiver**



Twin VFO's plus keyboard/computer interface control - all mode SSB, CW, AM & FM. Memories, scanning, filters. Includes 2-dimensional LCD, graphical SIMPO. **£575**

**ICOM R71 General Coverage Receiver**

Keypad entry, 32 memories SSB, AM, RTTY, CW & FM (optional) 0.1-30 MHz. Twin VFO's Scanning, Selectable AGC, noise blanker, pass band tuning and deep notch filter! Super value!!



**ONLY £739**

**FRG 9600**



**£525**

THIS EXCELLENT RECEIVER FROM YAESU WILL NOW COVER 0-30 MHz H.F. & FROM 60 MHz-950 MHz AT NO EXTRA COST - CALL NOW FOR DETAILS!

**- WHERE A GOOD DEAL MORE COSTS A GOOD DEAL LESS!!!**

**OUR BIG BUYING POWER GUARANTEES YOU A FIRST CLASS DEAL ALL ROUND. SEND 90p FOR OUR BUMPER LITERATURE PACK**



**ICOM 7000 £859**

Prices subject to currency fluctuations. E. & O.E.

**Amcomm**  
**-of-London**



**AR 2002 £459**

**373 Uxbridge Road, London W3 9RN. Tel: 01-992 5765/6. Telex: 24263 Fax: 01-861 2591**



## RAYNET or Playnet?

A few years ago I decided to become a member of RAYNET. The idea of an Emergency Radio Service to provide cover to "User Services" appealed to me. I

duly joined and received a copy of the RAYNET Manual, which stated that we would be trained so that in the event of a disaster or emergency we could be called upon to assist with radio cover for the user services.

I fully expected regular exercises with these services, mock disasters, etc. Up until now, the only exercises with user services have been at marathons, fun-runs and road races assisting the St. John's Ambulance Brigade. The main task has been to accompany an

ambulanceman; if some poor soul needs greater medical treatment than he can give, we call Control. Our other duty is to pass on numbers of runners passing us. Other "Exercises" include security duties at a motor show and walks.

I fully support the RAYNET organisation, but feel that I cannot be a member of RAYNET when 99 per cent of exercises are for organisations requiring a message handling service. If the day comes when a full-scale call-out is initiated, I personally would feel inadequately trained to

assist any of the "Users", as my only experience has been at the above-mentioned events, where we are not under any form of pressure.

Are other groups actively involved with the user services in full scale exercises, or is RAYNET becoming a message handling service at events for organisations who are prepared to donate a few pounds to the funds of a "highly trained" group of amateurs? Comments would be welcomed.

**M. J. L. Taylor G8XTU  
Doncaster**

## RSGB

Further to the Editorial in the May 1987 issue of *PW*, I too have wondered whether this new departure in the RSGB journal is a clever subterfuge to make us think that they are at last becoming democratic.

In the course of my work I travel the country extensively, and speak to many amateurs either at the factories and labs which I

visit, or in various clubs to which I am invited.

Invariably, whenever our national society is mentioned, one meets the whole gamut of human emotions, ranging from an amused indifference to absolute contempt. The present set-up, comprising a Council which is largely self-perpetuating within the "old-boy network"; several part-time committees; a large

number of volunteer workers and an overworked (and probably underpaid) staff, cannot fail to be ponderous and inefficient.

However, the things most people comment on, apart from delays or failure to reply to correspondence, especially if it concerns something "awkward", is the confounded conceit and cavalier attitude to the membership. It is time that

the present "old gang" was got rid of in some way. They really do not know the meaning of "ham spirit", not to mention the "good faith" which we were told some forty-odd years ago was so important.

Is there any chance of your organisation acquiring *Radio Communication* and making it interesting to read?  
**Andrew Mitchell  
Chessington, Surrey**

## PW COMMENT

### The Good News . . .

THE ANNOUNCEMENT OF THE RELEASE of extended amateur bands at 50MHz and 70MHz to both "A" and "B" Licensees in the UK was probably one of the best leaked secrets for some time, and it was sensible that, in the end, only about a week's notice was given. The official announcement of May 22 is reproduced in full in our News pages. Anyone who saw it in the *London Gazette* might have been panicked into thinking that Class B licence-holders had simultaneously lost all bands above 250MHz, but in fact a simple printing error had replaced a comma by a full stop in that particular edition.

The negotiators of the RSGB and the DTI are to be congratulated for bringing the lengthy lobbying and talking, and the experimental period of use of 50MHz by Class A licensees, to such a satisfactory conclusion. We hope that the submission in support of an amateur 50MHz allocation which *Practical Wireless* put to the Merriman Committee also had some effect.

From observations locally during the first week of June, there was a very low level of activity generally on 50MHz, despite the beacons showing that some nice DX was to be had. In particular, Class B licensees are not yet much in evidence, even though quite a few have equipped themselves for the band in anticipation. Still, sales of *PW* "Meon" 50MHz transverter p.c.b.s have taken a marked upward swing, so perhaps things will perk up in a few weeks!

Incidentally, whilst on the subject of the RSGB, I was pleased to see published in the June issue of *RadCom*, the very balanced report by Ian White G3SEK on the 10MHz s.s.b. debate. Also printed there were two letters critical of RSGB operations and practices. This is indeed a welcome change of policy, and can do nothing but good for the reputation of the RSGB among radio amateurs, whether members or not. Let's

hope that this is a start of a whole new trend!

Less good news, for radio amateurs anyway, is the announcement that the London ITV channel is to go ahead with 24 hour-a-day broadcasting, with the probability of this being extended to the rest of the country in time. Previously, it was at least possible to escape from the problems of TVI resulting from the many inadequately designed TV receivers in use in the UK today, by waiting until the small hours of the morning when the programmes had ended.

Even if you accept that there is a significant demand for all-night TV broadcasting, and I personally doubt it, the question remains, where is all the extra programme material to come from? From the evidence of one's eyes in viewing today's output, and regardless of individual preferences and interests, the creative resources are already being stretched pretty thin.

One more cloud on the horizon, I'm afraid, which is that we've reluctantly had to put the cover price of *Practical Wireless* up by 10p to £1.20 commencing with our next issue, dated September 1987. It's 18 months since our last cover price rise, and during that time we've absorbed no fewer than four increases in paper prices and one in printing costs. Even at £1.20 an issue, *PW* is the UK's least expensive (and, we think, the best) radio hobbyist magazine, but there is a way that you can cushion the shock.

How? Well, we shall hold the present rates — that's £13 to UK addresses and £15 by surface mail overseas — for all subscription applications received at our offices in Poole by Monday, August 31. For our overseas readers, this deadline is extended to Monday, November 30, to allow for normal transit delays.

Complete the form on page 43 and return it promptly to take advantage of this offer. Readers in the UK can save a few more pennies by using our new Freepost address.

**Geoff Arnold**



## Abbreviations

In *PW*, June 1987, G4VCT has aired his pet dislikes about 'phone; may I do likewise for c.w.? To be impartial, I will censure young and old alike.

How is it that some newly licensed c.w. operators have got it into their heads that "ES" means "IS", and come out with such things as "NAME ES BILL". I wonder how this word for "AND", (I deliberately refrain from calling it an abbreviation), came into use. As far as I know, "ES" does not mean "AND" in any European language.

Turning now to the older, experienced operator, one thing I absolutely abhor is the supposedly slick word (usually American) that is actually longer in terms of dots and dashes than the word it replaces. For example, "YEP" for "YES". I think there should be a special name for this sort of thing—perhaps it should be called an Irish abbreviation.

As I'm Irish it's alright for me to say things like that!

**M. A. Sandys G3BGJ**  
Bournemouth

I was interested in Roy G4VCT's comments on the Q-code. I think it is still important to use on 'phone under poor signal conditions. One starts with "QSY up ten", "My QTH town is Dereham", "My QRA is AM25C". If it's a YL, it's nice to wish her "88"! It's all part of amateur radio handed down to us.

If Roy wants to use old-fashioned English it's up to him, but don't expect us all to come down to that level.

**John Tye G4BYV**  
Dereham, Norfolk

## Morse

Having just read the "Morse Testing" letter in the May issue of *PW*, I really must make the comment that I took my Morse Test in 1985 (at wet and windy Woburn), and not only was I told that I had passed, I was given the necessary paperwork to send off for my "A" licence.

There is no experience that I know of like the nerves before and the elation (if you pass!) after taking the test.

**Brian Smith GODAH**  
Boxworth, Cambridge

Send your letter to the Editorial Offices in Poole, the address is on our Contents page. Writer of the Star Letter each month will receive a voucher worth £10, to spend on items from our PCB or Book Services, or on *PW* back numbers, binders, reprints or computer program cassettes. And there's a £5 voucher for every other letter published.

Letters must be original, and not duplicated to other magazines. We reserve the right to edit or shorten any letter. Brief letters may be filed via our Prestel Mailbox number 202671191. The views expressed in letters are not necessarily those of *Practical Wireless*.



# OUR SERVICES

## QUERIES

We will always try to help readers having difficulties with a *Practical Wireless* project, but please observe the following simple rules:

1. We cannot give advice on modifications to our designs, nor on commercial radio, TV or electronic equipment.
2. We cannot deal with technical queries over the telephone.
3. All letters asking for advice must be accompanied by a stamped, self-addressed envelope (or envelope plus International Reply Coupons for overseas readers).
4. Write to the Editor, "Practical Wireless", Enefco House, The Quay, Poole, Dorset BH15 1PP, giving a clear description of your problem.
5. Only one project per letter, please.

## COMPONENTS, KITS AND PCBs

Components for our projects are usually available from advertisers. For more difficult items, a source will be suggested in the article. Kits for our more recent projects are available from CPL Electronics, and from FJP Kits (see advertisements). The printed circuit boards are available from our PCB SERVICE (see page 1 of this issue).

*Practical Wireless*, August 1987

## CONSTRUCTION RATING

Each constructional project is given a rating, to guide readers as to its complexity:

### Beginner

A project that can be tackled by a beginner who is able to identify components and handle a soldering iron fairly competently.

### Intermediate

A fair degree of experience in building electronic or radio projects is assumed, but only basic test equipment is needed to complete any tests and adjustments.

### Advanced

A project likely to appeal to an experienced constructor, and often requiring access to workshop facilities and test equipment for construction, testing and alignment. Definitely not recommended for a beginner to tackle on his own.

## BACK NUMBERS AND BINDERS

Limited stocks of most issues of *PW* for the past 18 years (plus a few from earlier years) are available at £1.25 each, including post and packing to addresses at home and overseas (by surface mail).

Binders, each taking one volume of *PW*, are available price £5.50 to UK addresses, £5.75 overseas, including post and packing. Please state the year and volume number for which the binder is required. Prices include VAT where appropriate.

## CLUB NEWS

If you want news of radio club activities, please send a stamped, self-addressed envelope to **Club News**, "Practical Wireless", Enefco House, The Quay, Poole, Dorset BH15 1PP, stating the county or counties you're interested in.

## ORDERING

Orders for p.c.b.s, back numbers and binders, *PW* computer program cassettes and items from our Book Service, should be sent to **Post Sales Department**, "Practical Wireless", Enefco House, The Quay, Poole, Dorset BH15 1PP, with details of your credit card or a cheque or postal order payable to Practical Wireless. Cheques with overseas orders must be drawn on a London Clearing Bank.

Credit card orders (Access, Mastercard, Eurocard or Visa) are also welcome by telephone to Poole (0202) 678558. An answering machine will accept your order out of office hours.

## SUBSCRIPTIONS

Subscriptions are available at £13 per annum to UK addresses and £15 overseas, from "Practical Wireless" Subscription Department, Competition House, Farndon Road, Market Harborough, Leicestershire LE16 9NR. Tel: (0858) 34567. Airmail rates for overseas subscriptions can be quoted on request.

## Licence Changes

The following announcement appeared in the UK Gazettes dated 22May 1987.

### NOTICE OF VARIATION WIRELESS TELEGRAPHY ACT 1949

The Secretary of State gives notice, pursuant to Section 1(4) of the Wireless Telegraphy Act 1949 to those licensed under either an Amateur Radio Licence (A) ("Licence A"), or an Amateur Radio Licence (B) ("Licence B"), which have been issued and remain in force, of the following variations to both the above named licences:

1. In Clause 2 of Licence B, the following words shall be substituted for sub-clause (b):

"The Station shall be used only with those frequency bands which appear between the frequencies 50.00MHz and 250,000MHz in the first column of the Schedule subject to those limitations named in the second column of the Schedule and shall be used only with a power not exceeding that specified in the fourth column of the Schedule and shall use only those types of transmission named in the fifth column of the Schedule."

2. From 1st June 1987 the Schedule to both Licence A and Licence B shall be varied to delete all entries in respect of the frequency band 50.00MHz to 50.50MHz and frequency band 70.025MHz to 70.500MHz in the first column of the Schedule, and replace them respectively with entries in respect of frequency band 50.00 to 52.00 and 70.00MHz and 70.50MHz in the first column. This means that both Class A licensees and Class B licensees may transmit within these frequency bands in accordance with the amended Schedule entries shown to the right.

Frequency bands in MHz	The Amateur Service	The Amateur Satellite Service	Maximum Power		Permitted Types of Transmission
			Carrier	PEP	
50.00-51.00	Primary. Subject to not causing interference to other administrations. Antennas limited to 20 metres above ground level with horizontal polarisation only. No mobile operation in the band.	No allocation	14 dBW erp	20 dBW erp	Morse Telegraphy RTTY Data Facsimile SSTV

Frequency bands in MHz	The Amateur Service	The Amateur Satellite Service	Maximum Power		Permitted Types of Transmission
			Carrier	PEP	
51.00-52.00	Secondary. Subject to not causing interference to other administrations. Antennas limited to 20 metres above ground level with horizontal polarisation only. No mobile operation in the band.	No allocation	14 dBW erp	20 dBW erp	Morse Telegraphy RTTY Data Facsimile SSTV

Frequency bands in MHz	The Amateur Service	The Amateur Satellite Service	Maximum Power		Permitted Types of Transmission
			Carrier	PEP	
70.00-70.50	Secondary. Subject to not causing interference to other services.	No allocation	16 dBW	22 dBW	Morse Telegraphy RTTY Data Facsimile SSTV

Clause 2 shall have effect accordingly.

*M V Coolican,*  
on behalf of the  
Secretary of State  
for Trade and Industry

Dated 12th May 1987.

## What the Changes Mean

In the 50MHz band, portable operation and operation from an alternative address or location is now permitted, but you're still not allowed to go mobile. Remember that the power limits on this band are quoted as **effective radiated power** (e.r.p.), rather than transmitter power output. This means you have to allow for the combined effect of the loss in the antenna feeder, and the gain (if any) of the antenna. The potential for interference to European TV services operating in this band is still to be borne in mind.

For those still not used to thinking about power in dBW: 14dBW = 25W, 16dBW = 40W,  
20dBW = 100W, 22dBW = 150W.

Prefixes you might encounter on 50MHz, apart from G

of course, are CT, EA, EI, LA, OX, TF and ZB2, plus W/K and VE when conditions are right. Other countries in Region 1 have expressed an interest in using the band, too. On 70MHz the choice is limited to EI, ZB2 and possibly 5B4.

Harmonics of both these bands fall in places where they can cause a lot of trouble, and efficient filters on the output of your rig are essential if you are to avoid upsetting commercial and military users (2nd and 3rd harmonics of 70MHz) or your neighbours (the 2nd harmonic of 50 MHz falls in f.m. broadcast band II). A simple yet effective design for a trapped filter giving around 58dB rejection of 100MHz with only 0.5dB in-band insertion loss was described in the *PW* "Meon" transverter articles (Oct. 1985 and Apr. 1986 issues).

## Galashiels Open Day

The Galashiels and District ARS are holding an Open Day on August 30. It will be held in the Focus Centre, Livingstone Place, Galashiels, with the doors opening at 11am.

There will be trade stands, bring and buy as well as all the usual activities. They also hope to have Morse testing there, too. For more details, contact  
**John G. Campbell**  
GMOAMB,  
21 Hareshaw Bank,  
Tweedbank, Galashiels.

## CB on the Move

The DTI have announced the launch date for the new CB service as September 1. The service, on 26/27MHz, will be available from then, and is based on a recommendation by the Conference of European Posts and Telecommunications Administration (CEPT). It will be available to all CB licence holders under the terms of the existing licence.

The existing 27MHz service will continue to be available in parallel for some time to come. Nearer to September, following the

conclusion of a licence review, new CB information sheets will be sent to licence holders giving full details of the revised licence and new service.

## Can You Help?

A reader has a Telefunken TS205 radio receiver lying on the shelf—all for the want of the circuit diagram. Does anyone know of the whereabouts of one? If so, then contact:  
**Mr W. S. Simith,**  
7 Failford Place,  
Kilmarnock,  
Ayrshire,  
Scotland KA3 1UJ.

Paul Thompson G6MEN uses a Yaesu FT-708R on board a BMW twin. The system works well, if listeners can bear wind noise and engine noise. The problem is receive audio. He uses a small oblong speaker in the left-hand side of his helmet.

He can think of two solutions to the problem, (i) buy a quieter motorcycle, (ii) buy a police-specification helmet and ear/mic insert. Both are a little expensive! Can anyone help? If so write to:  
**Paul Thompson G6MEN,**  
PO Box 32,  
Shrewsbury SY1 1ZZ.

## No April Fool!

No-one was more surprised than Peter Pennington when he attended the AGM of the South East Kent (YMCA) ARC on April 1 and found himself the centre of attraction.

The club chairman, Richard Pascoe, opened the meeting with a tribute to one of the club's longest serving

members—Peter.

Many years ago he started an RAE class at the Dover club, complete with lesson sheets for those who missed some of the classes. These sheets have been requested by people all over the country, and he got others to help him teach. Over 200 students have now passed the RAE—a tribute indeed.



## Outlawed 'Phones

The DTI have announced new legislation to make the import, manufacture, sale or possession of certain unapproved cordless telephones illegal.

After May 21, any cordless telephone that does not conform with MPT 1311 and is designed for use on frequencies below 853MHz must not be

sold. Unlawful equipment can be seized and an offender can face fines of up to £2000.

Approved telephones will carry a green disc that states that they are suitable for connection to the public telephone network.

By outlawing certain cordless 'phones, the DTI aims to remove a considerable source of interference to a wide range of legitimate radio users.

## RAE Courses

**Stevenage:** The RAE classes run by the Stevenage & District ARS will be starting at 7.30pm on October 6. Further details can be obtained from Prestel **MBX 219994795** or telephone **Stevenage 724991**.

**Tonypandy:** The Rhondda College of Further Education have their RAE enrolment from September 7. The course runs at the college on one evening per week (probably Mondays) for 30 weeks. More details on **Tonypandy 432187**.

**New Addington:** A 20-week course leading to the City & Guilds 765 exam starts on September 30. The course is being held at Addington High School, Fairchildes Avenue, New Addington and the classes are from 7.30 to 9.30pm. Enrolment is on September 30 from 9am to 12.30pm. George Portsmouth is the course tutor. More details on **0689 41461**.

**Liverpool:** The RAE course is being held at the Mabel Fletcher Centre of Sandown College and starts in the week commencing September 14. Enrolment is on September 8. The course is held on 2 evenings per week from 6.30 to 9pm. More details from the course tutor **Mabel Fletcher Centre on 051-733 7211 ext 37**.

**Halesowen:** A 30-week RAE course is being run at Halesowen College, West Midlands on Thursday

evenings from 7 to 9pm. They commence on September 24.

Enrolment takes place at the College on September 8 and 9. Further details from the course tutor **Colin Prior G60TT on 021-550 1451**.

**Bristol:** Brunel Technical College is running three courses for the radio amateur. Monday evenings is theory, Tuesday evenings is Morse and Wednesday evenings is practical. Enrolment is September 8 and 9. Other dates are available to suit individuals. Further details from the course tutor **Phil Brouder G3ZJH on 0272 41241 ext 2164**, this is the Department of Aerospace and Radiocommunications Engineering.

**Arnold & Carlton College of FE:** Enrolment can be by post or at the college on Monday, September 7 from 10am to 8pm and on Tuesday and Thursday, September 8 and 10 between 2pm and 8pm. This college has six different classes you could join: The RAE class both full and short course; a Construction class; a Morse Practice class; an Introduction to the RAE class; an After the RAE class and a class to cater for Foreign Languages for the Amateur. For further details contact:

**R. G. Wilson G4NZU, Arnold & Carlton C of FE, Digby Avenue, Mapperley, Nottingham NG3 6DR.**

## Special Event Stations

**GB6HF:** The Houghton-le-Spring ARC will run the special event station on 3.5 and 144MHz from October 2–October 11 to celebrate Houghton Feast. It marks the dedication of the Church to St Michael.

**GBOUWC:** Between August 28 and 31, this station will operate from St. Donat's Castle in South Wales. This is the home of the Atlantic College, the first of the United World Colleges, which celebrates its 25th anniversary this year. The main mode will be s.s.b. on the h.f. bands between 3.5 and 28MHz. More details from: **Dr. John Devonshire**

### GB6HF

HOUGHTON-LE-SPRING  
ST. MICHAEL AND ALL-ANGELS



**GW4LFF, St. Donat's College, Llantwit Major, S. Glamorgan CF6 9WF.**

**GB1ERS (GB7ERS?):** This station will be on the air during the last week in July. This will be for the 84th East Reading Wellington Scout Troop Summer Camp at

Thorness Bay, IOW. They will be operating on 144 and 430MHz s.s.b. and f.m.

**GB2GJR:** This station will be run from the Crewe Heritage Complex for the 21st Anniversary British Rail ARS and celebrating 150 years of railways with Crewe Heritage. They will be using

all bands up to 430MHz from July 4 to August 16. See **G. Sims G4GNQ, 85 Surrey Street, Glossop** for more details.

**GB1CXI:** The Treble One Squadron was formed on 1 August 1917, from a nucleus flight of No. 14 Squadron, at Deir-ei-Belah in south-west Palestine. This station is celebrating their formation on August 1 and 2. They will be using 144MHz from the Squadron's current location RAF Leuchars. All contacts will receive a QSL card, as will all s.w.l. contacts. **Dave Bloomfield GM1RFM, QTHR**, can tell you more.

## Rally Dates

**July 12:** The Worcester & District ARC are holding their Droitwich "Strawberry" Rally at the High School, Droitwich. Gates open at 11am and there is both free parking and entrance. All the usual trade stands will be there, plus family entertainment and free transport to the local strawberry field (weather permitting). Morse tests by prior arrangement with the RSGB and talk-in on S22. For more details, contact **Steve Colledge GOAOC, QTHR**.

**\*July 12:** The Sussex Mobile Rally will be held at Brighton Racecourse. Large area for free car parking, admission £1, disabled and children under 14 free. Refreshments, including hot meals are available in the Bars and the Cafeteria. For the family a free minibus service runs regularly to and from the seafront throughout the day, and a number of other diversions are available on the Rally site. For disabled visitors, ramps, lifts and wide gangways ensure easy access for wheelchairs. More from **Mark Spillett G4UAW on 0903 782594**.

**July 19:** The Anglian Mobile Rally will be held at the Highwoods Sports Centre, Severalls Lane, Colchester. This is close to the A12-A120 interchange at Ardleigh. Doors open 10am. Talk-in will be S22. For more details, contact **E. Jacobs G6HQI, 26 Pondfield Road, Colchester**, or telephone **0206 860403**.

**\*July 19:** The Cornish RAC are holding their rally at the Cornwall College, Pool, Redruth. Contact **D.W. Howard, Rame Common Farm, Carrnie, Helston, Cornwall** for more details.

**\*July 26:** The Scarborough ARS are holding their rally in The Spa, Scarborough. Licensed bar and cafeteria is available. Doors open 11am. More details from **I.G. Hunter G4UQP on 0723 376847**.

**August 2:** The Rolls Royce ARC are holding their rally at the Rolls Royce S&SC, Barnoldswick. Doors open at 11am and talk-in will be available as well as trade

stands, refreshments and other attractions. Contact **L. Logan G4ILG, 19 Fenton Avenue, Barnoldswick** for more details.

**\*August 2:** The RSGB rally will be held at Woburn Abbey, Woburn. More about the rally from **Robin Hewes G3TDR on 0784 56513**.

**\* August 9:** Hamfest '87, organised by Flight Refuelling ARS, will again be held at FR Sports & Social Club, Merley, Wimborne, Dorset. The gates will be open from 10am to 5pm and there will be the usual entertainment for all the family. Free parking is available to visitors and the entrance fee is 30p (children free).

**August 9:** The Essex Area of the 934 Club UK have their 3rd mobile rally at Brentwood Halfway House, at the junction of the A127 and A128. Gates open between 10am and 6pm. There will be both 934MHz and amateur stations in operation. Admission is free. For more information, contact **Frank Glendinning, 5 Danescroft Close, Leigh on Sea, Essex**.

**\*August 15:** The famous Lowe's Open Day returns this year, by popular request. Obviously to be held at Lowe Electronics HQ at Chesterfield Road, Matlock, Derbys. More about the activities from **Lowe Electronics on 0629 2430**.

**August 15:** The Wight Wireless Rally will be held at the Wireless Museum, Arreton Manor, near Newport. The rally opens at 11am and closes at 5pm. Talk-in on S22 and GB3IW. All the usual trade stands will be there. Details from **Douglas Byrne G3KPO on 0983 67665**.

**\*August 16:** The West Manchester RC are holding the Red Rose Rally at the Bolton Exhibition Centre, Silverwell Street, Bolton. All the usual refinements. Doors open at 11am. Admission 50p. **Dave G1100** can tell you more on **0204 24104**.

**August 23:** The Newbury & District ARS are holding a radio car boot sale at The Acland Hall and Recreation Ground, Cold Ash, Newbury. Gates open from 10am to

5pm. Pitches are £5 or £4 if pre-booked, inside tables are £10 (limited supply).

**Mike Fereday G3VOW** can tell you more on **0635 43048**.

**August 30:** The annual rally of the British Amateur Radio Teleprinter Group (BARTG) have their rally at Sandown Park Racecourse. It is THE rally for the RTTY enthusiast, but also has plenty to interest all radio amateurs. There will be a car boot sale, plenty of free car parking and catering facilities. Doors open between 10.30am and 5pm.

**August 30:** The Galashiels & District ARS are holding an open day at the Focus Centre, Livingstone Place, Galashiels. There will be trade stands, bring & buy as well as all the usual activities. They also hope to have Morse testing. More from **John G. Campbell GMOAMB. Tel: 0896 55569**.

**August 31:** The Doncaster & District RAYNET Group are holding their rally at the Bircotes Sports Centre, Bircotes, Doncaster (Grid Ref: SK630922). Doors open at 11am (10.30 for the disabled). Admission is 50p.

**September 6:** The South Bristol ARC are holding their rally at the Hareclive Youth and Hartcliffe Community Centres, Hareclive Road, Hartcliffe, Bristol. Doors open between 10am and 5pm. There will be radio dealers, bring and buy as well as general traders. Admission is 50p. For more information, contact **Len Baker on Bristol 834282**.

**September 6.** The West Kent AR Rally is being held in the Angel Centre, Tonbridge, Kent. Doors open between 10.30am and 4pm. There will be talk-in on S22, SU8 and 29.5MHz f.m. using the callsign GBOWKS. There is free parking, a bring and buy, club stands, many trade stands and a stamp fair. More from **Nigel Peacock G4KIU on 0892 515678**.

**September 13:** Dunstable Downs Radio Club are holding The National Amateur Radio Car Boot Sale at the Shuttleworth Collection, Old Warden Aerodrome. Open from 10am to 5pm. Admission

50p. **Phill Norris G6EES on 0582 607623** can tell you more.

**\*September 13:** The Scottish National Amateur Radio Convention will be held at the Magnum Leisure Centre, Irvine, Ayr. The leisure complex includes restaurant, cafe and licensed bar facilities, as well as water slides, etc., for the juniors ops. The PW Tennamast Scotland Trophy for the highest placed Scottish station in the PW QRP Contest will be presented. **Bob Low GMOECU, QTHR**, can tell you more.

**September 13:** The South Midlands Communications Open Day will be held at the SMC HQ at School Close, Chandlers Ford Ind. Est., Eastleigh, Hants. More details from **South Midlands Communications on 0703 255111**.

**\*September 13:** The Telford Rally will be held at Telford Racquet & Fitness Centre, Telford. Talk-in will be via GB4TRG on S22 and SU8. Doors open 11am (10.30am for the disabled). There will be lectures by MAXPAC on packet radio, G3RZP/G4FNC on linear amplifiers and G3SEK on extra long Yagi antennas. Full catering and bar facilities are available. Morse tests will be available (pre-book with RSGB). There will be a huge flea-market, plus over 100 trade stands. More from **Martyn Vincent G3UKV on 0952 55416**.

**\* September 13:** The Lincoln Short Wave Club also call their rally Hamfest '87, and this will be held at the Lincolnshire Showground and Exhibition Centre—6km north of the city on the A15. In addition to the usual stands of interest to the radio amateur they hope to have helicopter rides, model car racing, the police, the fire brigade and lots more. There is ample parking, caravans by arrangement, refreshments and a licensed bar with real ale! More details can be obtained from **Pam Rose G4STO on Gainsborough 788356**.

**\* Practical Wireless and Short Wave Magazine in attendance.**

## Microwave Newsletter

The Microwave Newsletter is a monthly amateur radio publication for the microwave enthusiast published by the RSGB.

The format takes a little getting used to, it is an A4 gatefold, folded to A5 size! Still, once you master the art of finding the consecutive pages there is no problem.

It is full of information from the sources of parabolic dishes to constructional projects, which I'm sure are vital for the microwave amateur.

A year's subscription is available to RSGB members for £6 and to non-members £7.06. If you would like to receive copies of the newsletter, send your money to the RSGB, marking your envelope Microwave Newsletter.

**RSGB,  
Lambda House,  
Cranborne Road,  
Potters Bar,  
Herts EN6 3JE.**

## Microwave Dinner

When we last mentioned the Microwave Bands Assembly and Dinner there was a mix-up about the day and date. The truth of the matter is that it is on Saturday July 18. Tickets and more details available from:

**Fredrick T. Smith,  
5 Pinfold Crescent,  
Penn,  
Wolverhampton WV4 4ET.**

## Battery Growth

Duracell UK have made further improvements in the design of the MP401 mercury battery. The nominal capacity of the 1.4V battery has been increased from 1100mAh to 1200mAh, which is a real bonus to those with equipment using it.

The stable discharge voltage makes it ideal for powering electronic circuitry. It also has a long storage life in excess of 2½ years.

## Surface Mount Crystals

IQD has announced a new range of surface mount crystals.

Several different styles are available, all in standard frequencies including conventionally sealed metal can crystals with glass epoxy base: 4.9mm high (3.579545–17.73447MHz) and 8.6mm high (up to 75MHz); AT-cut miniature ceramic resonators 2.03mm high (8–20MHz); crystals in a miniature ceramic package 2.03mm high (10kHz–2MHz); d.i.p. crystal packages 5mm high

(4–20MHz); crystals in a ceramic "tile" package only 3.7mm high (3.579545–8.388MHz); Gull wing crystals with third wire (4–100MHz).

Some models are available to MIL specifications.

IQD also offer a comprehensive range of standard crystals with over a million units held in stock ready for immediate delivery. For more details contact:

**IQD,  
North Street,  
Crewkerne, Somerset,  
TA18 7AR.  
Tel: 0460 74433.**

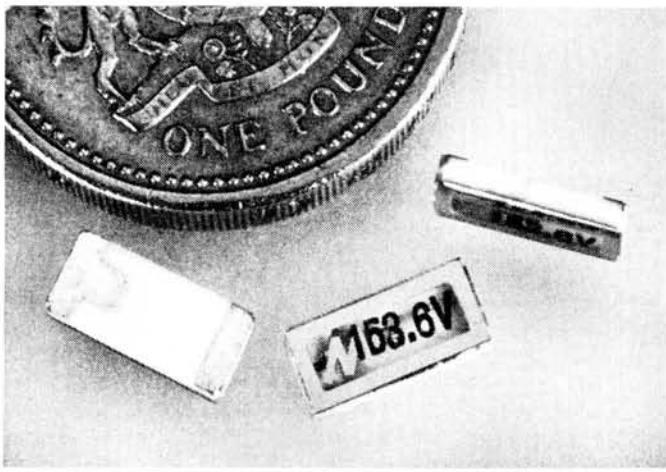

## PW QRP Contest

If you are one of the Scottish stations that has just entered the PW QRP 144MHz Contest, then you may like to see the trophy that is being presented to the highest placed Scottish station.

It is the PW Tennamast Trophy, and will be presented at Scotam in the Magnum Sports Centre in Irvine on September 13.

Many thanks to Tennamast for the trophy, GM1SQZ for the engraving and GM4XHB for the photograph.

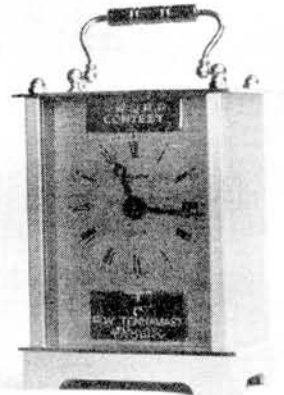

## Ex "G" Radio Club

This radio club was founded in 1959 by Reg Cherrill W3HQO and others of a similar background and the same common interest. That is a love and respect for Great Britain and citizens thereof.

Membership is open to radio amateurs who were born in the UK and are currently domiciled abroad, current citizenship is not important. Associate membership is open to radio amateurs who were not born in the UK but whose spouse was. This also applies to those whose parents were born in the UK.

If you would like more details of the Ex "G" Radio Club, then write to: **Frank Fletcher, 52 St. Ives Park, Ringwood, Hampshire BH24 2JX, England.**

## AR Auction & Barbeque

On Tuesday September 8, the Rugby Amateur Transmitting Society is holding an auction of radio goodies. As well as the barbeque there will be other refreshments available.

Admission is only 20p and the car parking is free. Doors open at 7.30pm. The venue is the Cricket Pavilion, "B" Building Entrance, BTI Radio Station, A5 Trunk Road, Hillmorton, Rugby.

For further information please contact: **Kevin Marriott G8TWH, 41 Foxon's Barn Road, Brownsover, Rugby, CV21 1LA. Tel: 0788 77986.**

## Did You Know?

A press release from Mullard dropped on my desk the other day, all about a new range of implosion diodes. *What diodes, I thought—never heard of them!*

Turning to the next page brought the answer, and I quote: "Implosion diodes (i.d.s) offer a similar mix of characteristics to glass bead diodes, but are manufactured using a unique vacuum implosion process, which glass passivates and hermetically seals the diode crystal in one production step. The pressure of the glass envelope clamps the crystal between two molybdenum studs.

"An i.d. has a lower voltage drop than a glass bead diode because the pressure contacts have lower resistance than the alloy welded joints used in glass bead diode manufacture. The finished product is mechanically and electrically rugged and suitable for use in hostile environments." So now you know!

## Club Changes

The **Guildford & District Radio Society** have a new secretary, he is Mike Blewett G4VRN. The club meets in the clubhouse of the Guildford & District Model Engineering Society, Stoke Park, Guildford on the 2nd and 4th Fridays. Meetings start at 8pm. If you would like more details about the club then write to Mike at: **32 Milton Crescent, Godalming, Surrey GU7 2NT.**

# Theory

Some fairly simple conversions based on the 144MHz Slim Jim were dealt with in Part 1 but at the same time, F. C. Judd G2BCX pointed out that whilst it is not difficult to change dimensions according to the frequency ratio, it does not follow that the performance of a re-dimensioned antenna will be equal to that of the original. The only way of verifying this is by measurement, which is easier said than done, in Part 2 he shows how this can be done.

# Scaling Antennas for Other Frequencies-2

Even the most simple beam antenna can present problems when re-dimensioned for use on a frequency band other than the one it was originally designed for.

Constructional changes will be necessary in any case and it is almost certain that the performance obtained with the original will not be repeated. For example, the ZL5-10, featured in *PW*, March 1986 (page 22) is a five element ZL Special for the 28MHz band (Fig. 2.1). Although the design was based on the original 144MHz version, the dimensions were NOT directly scaled up from this. In order to maintain expected performance parameters, i.e., matching, radiation pattern, beamwidth and gain, all the element lengths and spacing had to be adjusted mainly because of the diameter of the element material used and therefore a different velocity factor to be taken into account. Other items also had to be re-dimensioned; for example, the crossed-over phasing lines between the two driven elements, just visible above the double boom as in Fig. 2.2. These are made from 6mm diameter aluminium tube and not from thick wire or 300Ω ribbon feeder which could be used for a 144MHz version.

In short, this antenna was virtually designed for the 28MHz band and to provide a performance that would not have been obtained by simply scaling up the dimensions of the 144MHz version by a factor of 5.

However, providing the change to a

lower frequency is not too great, for instance 145 to 70MHz (ratio approx. 2), then reasonable success should be possible although further empirical adjustment may be necessary to achieve a performance equal to the original.

## Changing Dimensions for a Higher Frequency Band

The author has received many letters concerned with changing the dimensions for antennas such as the 12-element ZL Special and the '2BCX 16-element 144MHz beam for operation on 430MHz. Both antennas are featured in the *PW* publication *Out of Thin Air*. The frequency ratio is  $145/430 = 0.3$ , which does not lend itself too well because, apart from the fairly large upward change in frequency, there is a substantial reduction in all dimensions. Again we meet the combined problem of element material diameter and velocity factor which can alter the phase relationship of currents flowing in the driven as well as the parasitic elements. The result is radiation pattern distortion, loss in power gain and reduced bandwidth which may make it difficult to obtain an acceptably low v.s.w.r. across the band.

Whilst some readers have attempted construction of one or the other of these antennas for 430MHz they have not been certain of performance, even

though operation has indicated that it might be satisfactory simply because the antenna appears to have good directivity and therefore must have some gain.

This is not proof of a specified performance, the parameters of which can only be verified by measurement in a suitable environment with accurately calibrated measuring equipment. Such equipment was detailed in the *PW* publication *Wires and Waves*, page 34, or see references at the end of the article. Incidentally, all the foregoing comments could well apply to antennas other than those designed by the author, especially when the change in frequency is large, one way or the other.

## References

- Aerial Performance Measurement, Antennas Part 10. *PW*. Nov. 83; Part 11, Dec. 83.
- Power Gain from TX Aerials, *PW*, Aug. 80.
- Aerial Design in Practical Yagi Design. *PW*, Feb. 84 or *Wires and Waves*, *PW* publication.
- Using Scale Models, *Out of Thin Air*, *PW* publication.

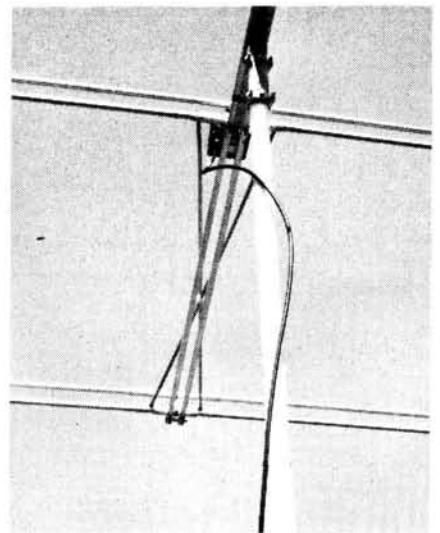
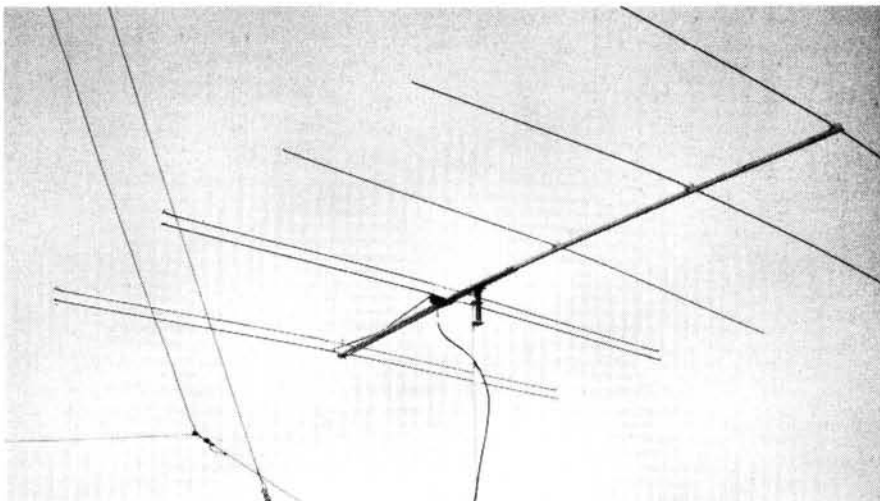

Fig. 2.2: The redesigned cross-over phasing line for the ZL5-10 (see text)

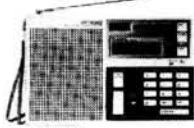
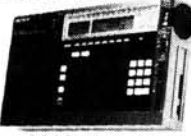







Fig. 2.1: The ZL5-10, a five element ZL Special for the 28MHz band based on the original 144MHz ZL series of antennas

# YOUR ONE STOP LISTENER SERVICE!

**HUGE STOCKS — BEST PRICES — GOOD BACKUP — FREE SECURICOR\***

\*AVAILABLE ON MOST MAIN ITEMS

WE STOCK MOST PRODUCTS  
ADVERTISED IN THIS MAGAZINE

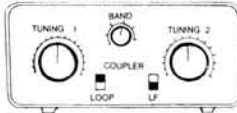
<p><b>SONY ICF7600D PORTABLE COMMUNICATIONS!</b></p> <p>Not a toy, but a serious communications receiver. 150kHz-30MHz AM/SSB plus FM 76-108MHz. Digital readout, memories, clock and provision for external antenna. Listen to the DX at work! Mains or battery.</p>  <p><b>£169 FREE SECURICOR</b></p>	<p><b>SONY ICF2001D RECEIVER SUPER PORTABLE + BASE HF + AIR BAND COVERAGE</b></p> <p>Described as "the best portable on the market" by a reviewer, it covers 150kHz-30MHz plus FM air band. Memories scanning, etc., at a bargain price. External aerial socket and a host of other features. 230V AC or battery.</p>  <p><b>£329 FREE SECURICOR</b></p>	<p><b>NEW SONY PRO-80 RECEIVER AM/FM/SSB 115kHz-223MHz</b></p> <p>A major innovation in monitor receivers. Just think a complete short-wave and vhf monitoring system in your pocket! Memories, scanning etc. Order today.</p>  <p><b>£329.00 CARRIAGE FREE</b></p>
<p><b>TR10 R5000 JUST ARRIVED! TOP SPECIFICATION RECEIVER</b></p> <p>The newest and best receiver so far from Trio. A high specification covering 100kHz-30MHz AM/FM/SSB/CW. Comprehensive facilities include memories and scanning, etc. Send today for full specification. PX welcome!</p>  <p><b>£895 FREE SECURICOR</b></p>	<p><b>R537S AIR-BAND MONITOR 118-136MHz</b></p> <p>This well known receiver is ideal for air-band monitoring. Pocket size and battery powered with whip antenna. Highly sensitive and used by many professionals.</p>  <p><b>£69.00 CARRIAGE £2.00</b></p>	<p><b>ICOM R7000 VHF/UHF MONITOR COMPLETE COVERAGE TO 2GHz</b></p> <p>The best VHF/UHF monitor on the market! 26-2000MHz and highly sensitive. It's not cheap but it really is a superb monitor for the serious user. Every possible facility you will ever need!</p>  <p><b>£939 FREE SECURICOR</b></p>
<p><b>TRIO R2000 HF RECEIVER POPULAR BASE MONITOR</b></p> <p>Well respected, it covers 150kHz-30MHz AM/SSB/CW plus memories, scanning, digital readout and optional VHF module 118-174MHz. Like all Trio equipment it has a super specification.</p>  <p><b>£637 FREE SECURICOR</b></p>	<p><b>YAESU FRG8800 HF RECEIVER IDEAL BASE STATION</b></p> <p>The highly regarded Rx from Yaesu. 150kHz-30MHz AM/SSB/CW plus VHF module option. High resolution LCD display plus memories and scanning. Very popular and super performance.</p>  <p><b>£619 FREE SECURICOR</b></p>	<p><b>AOR 2002 SCANNER VHF/UHF MONITOR</b></p> <p>From AOR the famous VHF/UHF monitor that covers 26-1300MHz AM/FM. Highly compact. 230V or 12V DC with LCD, memories and scanning. Ideal for the serious user. A wide range of facilities and 230V AC or 12V DC.</p>  <p><b>£487 FREE SECURICOR</b></p>
<p><b>GLOBAL AT1000 AERIAL TUNER</b></p> <p>The AT1000 is a receiver aerial tuner designed to give you maximum performance from your receiver. Covering the frequency range 150kHz to 30MHz it matches all the modern receivers produced in recent years. Ideal for matching long wire, dipoles or balanced feeder.</p>  <p><b>£69.00 POST FREE</b></p>	<p><b>Here's a few accessories that will make for better listening:</b></p> <ul style="list-style-type: none"> <li>Global lightweight mono headphones <b>£5.95</b></li> <li>G5RV 5-band dipole 80-10m (100ft long) <b>£16.95</b></li> <li>Dipole kits; 2 x insulators + centre piece <b>£5.95</b></li> <li>Sony AN-1 active whip antennae 150kHz-30MHz internal/external <b>£49.00</b></li> <li>AD270 active indoor dipole + psu (9ft long) <b>£51.75</b></li> <li>AD370 active outdoor dipole + psu (9ft long) <b>£69.00</b></li> <li>CWR-880 RTTY/CW reader with LCD display <b>£269.00</b></li> </ul>	

## THE UK'S BEST FREQUENCY GUIDES

**COMPLETE VHF/UHF FREQUENCY GUIDE 26-2250MHz**

**£4.95 + 80p p&p**

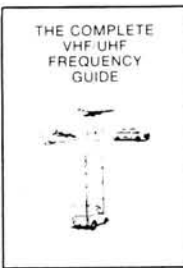

This guide has sold over 4,000 copies since its publication last August and is still selling well. Mainly because it is recognised as being of tremendous value and unique in radio literature. If you are one of the many who are curious to know who transmits where, in the wide VHF/UHF spectrum, then this is a guide that you should not be without. This book gives comprehensive details of all the main users of this part of the radio spectrum. The frequency range is subdivided into sections under appropriate headings for the type of services using the particular sub-divisions. All kinds of service are covered including land, sea, air and space. Full details are included of duplex splits for bases and mobiles plus some useful editorial. If you are at all interested in this part of the radio spectrum, you will find this a most valuable and absorbing book.

**UK LISTENERS CONFIDENTIAL FREQUENCY LIST 1.6-30MHz**

**£5.95 + 80p p&p**



**NEW FOURTH EDITION**

**1978 EDITION** This famous listing is now in its fourth edition. Completely updated for 1987 and a lot thicker. Yet the price is the same as the 1986 edition! Many additional frequencies have been added and of course some have been deleted where the service is known to no longer exist. Packed full of information on all that happens between 1.6 and 30MHz, you will find this fascinating reading. Covering all aspects of the shortwave service, here is just a selection of the listings included: AVIATION, BROADCAST, MARINE, EMBASSY, MILITARY, RTTY, FAX, PRESS, and much more. Not only frequencies and stations, but in many cases times of transmissions as well. This is not an American import, but a UK printed manual specially for UK listeners. If you are one of the few people that haven't purchased one of these yet, then you really don't know what you have been missing. If on the other hand you have our previous editions, we know that you will want to get the latest edition. Available end of March. Order your copy today.

**VHF/UHF AIRBAND FREQUENCY GUIDE + FREE UPDATE SERVICE**

**£5.95 + 80p p&p**



Just published, this is the UK's foremost list of military and civil radio frequencies. Nearly three times as large as the 1986 edition and bang up-to-date. Every conceivable airfield is listed from the smallest grass field to the largest of our international airports. We have now included full airways listings plus helipads and off-shore rigs. In addition, there are listings of company frequencies, VOLMETs and miscellaneous air-to-air frequencies. Don't confuse this with other guides you may have seen. This one is REALLY comprehensive and packed with information. For the newcomer there is some interesting editorial plus photographs, and a very useful telephony designation list. Full colour semi-stiff covered in large format style makes this one of the best presented guides yet. Undoubtedly the best manual there is available to the enthusiast today. There is also a free up-date service to purchasers so you won't need to worry about the information becoming out of date. That's real service!

Better Short Wave Reception	<b>£6.00 + £1.00 p&amp;p</b>	Air Traffic Control by David Adair	<b>£6.99 + £1.00 p&amp;p</b>
Oceanic HF Airband Frequency Guide	<b>£2.95 + £0.60 p&amp;p</b>	Air Traffic Control by Ian Allan	<b>£3.50 + £0.70 p&amp;p</b>
World Radio HF Teletype Frequency List	<b>£3.95 + £0.60 p&amp;p</b>	Air Band Radio Handbook	<b>£4.99 + £1.00 p&amp;p</b>
World Radio & TV Handbook (1987)	<b>£17.95 + £1.75 p&amp;p</b>	Scanners: A VHF/UHF Listeners Guide	<b>£7.95 + £1.00 p&amp;p</b>



**RETAIL & MAIL ORDER:- 18-20, Main Road, Hockley, Essex SS5 4QS.**  
Tel: (0702) 206835, 204965

**RETAIL ONLY:- 12, North Street, Hornchurch, Essex RM11 1QX.**  
Tel: (04024) 44765

Visa and Access by telephone. 24hr. Answerphone.

# The Selection and Use of Capacitors

According to the author's dictionary, a capacitor is a device consisting of two or more conducting plates separated by a dielectric and used for receiving and storing an electric charge. "Oh, if only it were that simple!", says E. A. Rule.

In practice, capacitors come in many different types and each type is designed for a specific application. Failure to use the correct type can lead to either poor results or complete failure of the finished project. By far the most common type found in *Practical Wireless* projects is the electrolytic, and this article looks at their features.

## Electrolytics

The most common of these are the aluminium electrolytic capacitors, these use aluminium for the conducting plates and this may be plain foil or etched foil. The plain foil type tend to have a lower impedance at radio frequencies but etched foil is the most common as it enables a higher capacity to be obtained for a given volume (i.e.

smaller capacitors for a given number of microfarads). We are not going into the various merits of the different designs here as this information can be found in many text books, but we shall be considering how to use and select an electrolytic capacitor for a particular application. Before we can do this it is important that we understand the various parameters and specifications.

The first of these are the **working voltage** and the **surge voltage**. The working voltage is the voltage that the capacitor has been designed to be used at, in other words it is the ideal operating voltage. Capacitors may be used at lower voltages than that specified, but must **NEVER** be used at higher voltages. The surge voltage is the absolute maximum voltage that can be applied for a **short** period of time and this voltage is normally 10 to 15 per cent higher than the working voltage. The capacitance range of electrolytic capacitors ranges from about 0.5 $\mu$ F to hundreds of thousands of microfarads and in general as the capacitance value becomes higher, the available working voltage becomes lower. The main reason for this is that the sheer size of high capacitance, high voltage capacitors becomes a problem both with regards to manufacturing and costs.

The next important specification is the **ripple current** rating. This rating becomes very important when selecting electrolytics for power supply circuits or where a.c. currents are present. In a power supply circuit the main reservoir capacitor charges up to the

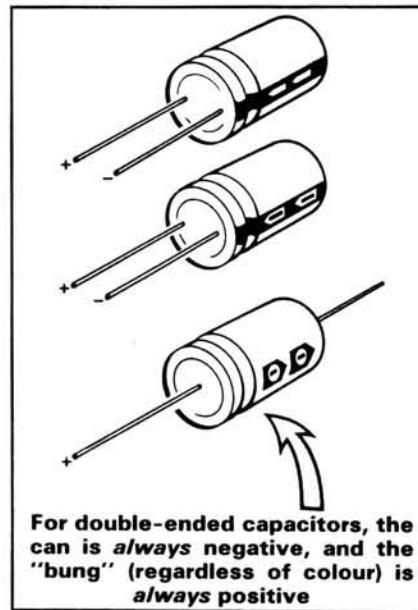

peak of the rectified voltage and then discharges into the load. The capacitor "smooths" out these peaks and the load "sees" a fairly steady d.c. supply. However, the fact remains that the charging current consists of a series of halfwave pulses and this is the ripple current. The rating of ripple current given for an electrolytic is the maximum current that can be handled without undue heating of the capacitor and **MUST NOT** be exceeded. With a bridge rectifier the ripple current is approximately equal to the d.c. load current whereas in a fullwave and halfwave rectifier circuit it would be 1.4 and 2.8 times the load current respectively. Taking a 5 amp load current as an example, with a bridge rectifier we can use a capacitor with a 5 amp ripple current rating, but the fullwave circuit would require one rated at  $5 \times 1.4 = 7A$  and the halfwave rectifier circuit would require one rated at  $5 \times 2.8 = 14$  (this is one reason why the bridge rectifier circuit is so popular as it enables small capacitors to be specified).

The ripple current rating is normally specified for a frequency of 100Hz. At other frequencies a correction factor is introduced and Figs. 1 and 2 show typical curves for ripple current against temperature and frequency.

Another important factor is the equivalent series resistance (e.s.r.) value. Because of internal losses the actual impedance of the capacitor may not be that which one could normally calculate according to text book formula and Fig. 3 shows a typical imped-

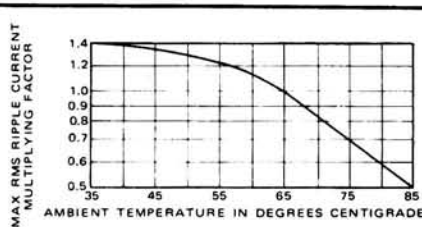

**Fig. 1: Ripple current correction factor for temperatures above 65°C, based on a frequency of 100Hz. For other frequencies the correction factor shown in Fig. 2 must also be applied. Note, the ambient temperature is the normal internal case temperature of the equipment, not room temperature**

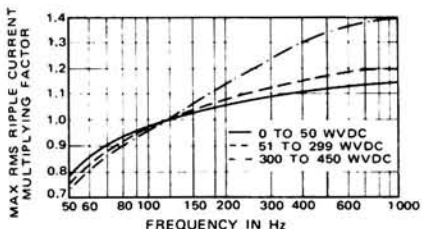

**Fig. 2: Ripple current correction factor against frequency. Note that the working voltage rating for the capacitor may affect the correction factor. Each type of capacitor will have different factors, that shown is fairly typical**

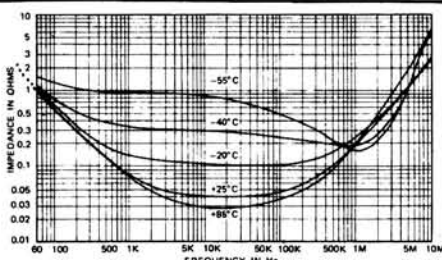

**Fig. 3: Impedance of a capacitor against frequency, note also that the operating temperature can affect the impedance. The curve shown is for a typical capacitor of 2200 $\mu$ F, 20V working**



ance curve for an electrolytic capacitor. Note that the actual impedance increases at both very low and very high frequencies. These curves are available from manufacturers and should be consulted if it is proposed to use a capacitor in a circuit where frequencies other than 100Hz are possible; for example, when a capacitor is used as the output coupling capacitor for an audio amplifier.

Which brings us to another very important aspect in using electrolytics. All electrolytics are polarised, that is, they **MUST** be connected into circuit with the positive and negative supply connected to the correct terminals. When a.c. and d.c. voltages are applied at the same time it is **ever important** that the **SUM** of the positive peak of the a.c. and the d.c. voltages does **NOT** exceed the working voltage of the capacitor. Second, the negative going peak of the a.c. must not send the overall voltage below zero, Fig. 4 should make this point clear. The maximum reverse voltage that an electrolytic can stand before being damaged is less than 2 volts.

All capacitors have a leakage current and this is a function of the design of the capacitor, its capacitance and the applied voltage. This leakage current is specified by the manufacturer and although not so important when a capacitor is used for a power supply or for decoupling, it can be very important when a capacitor is used for coupling between stages or in a timing circuit. For example, taking the circuit shown in Fig. 5, this is a typical volume control circuit used in many audio amplifiers and radios. The applied voltage is 100V and the capacitor is 10 $\mu$ F. Now a typical leakage current may be 3 $\mu$ A. This leakage current flows through the volume control and will produce a voltage across it of 30mV.

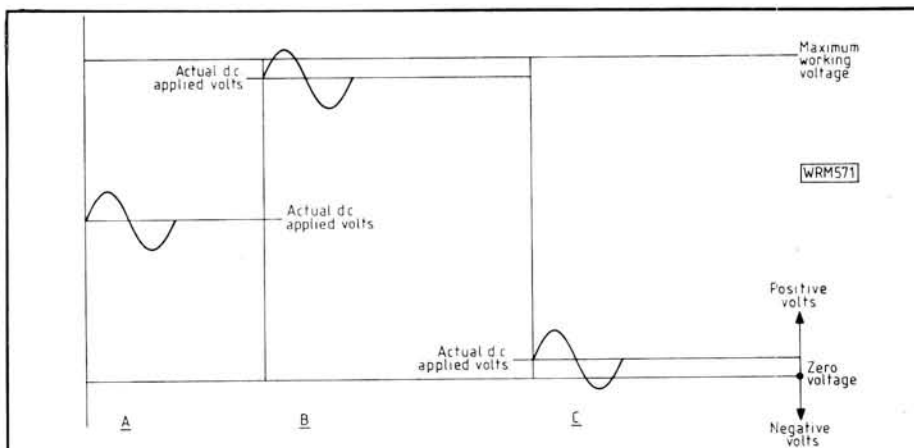

**Fig. 4:** Shows how an a.c. signal superimposed upon the working d.c. voltage may take the capacitor outside its ratings at both maximum and zero levels as the a.c. signal swings about its datum level which is equal to the applied d.c. (A) is safe. (B) voltage swings too high. (C) voltage swings below zero and therefore is putting a voltage of reverse polarity on the capacitor

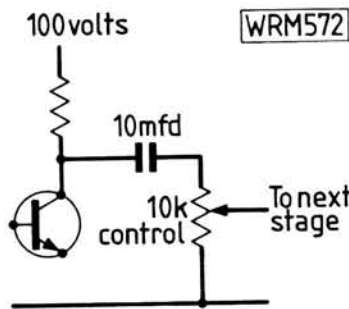
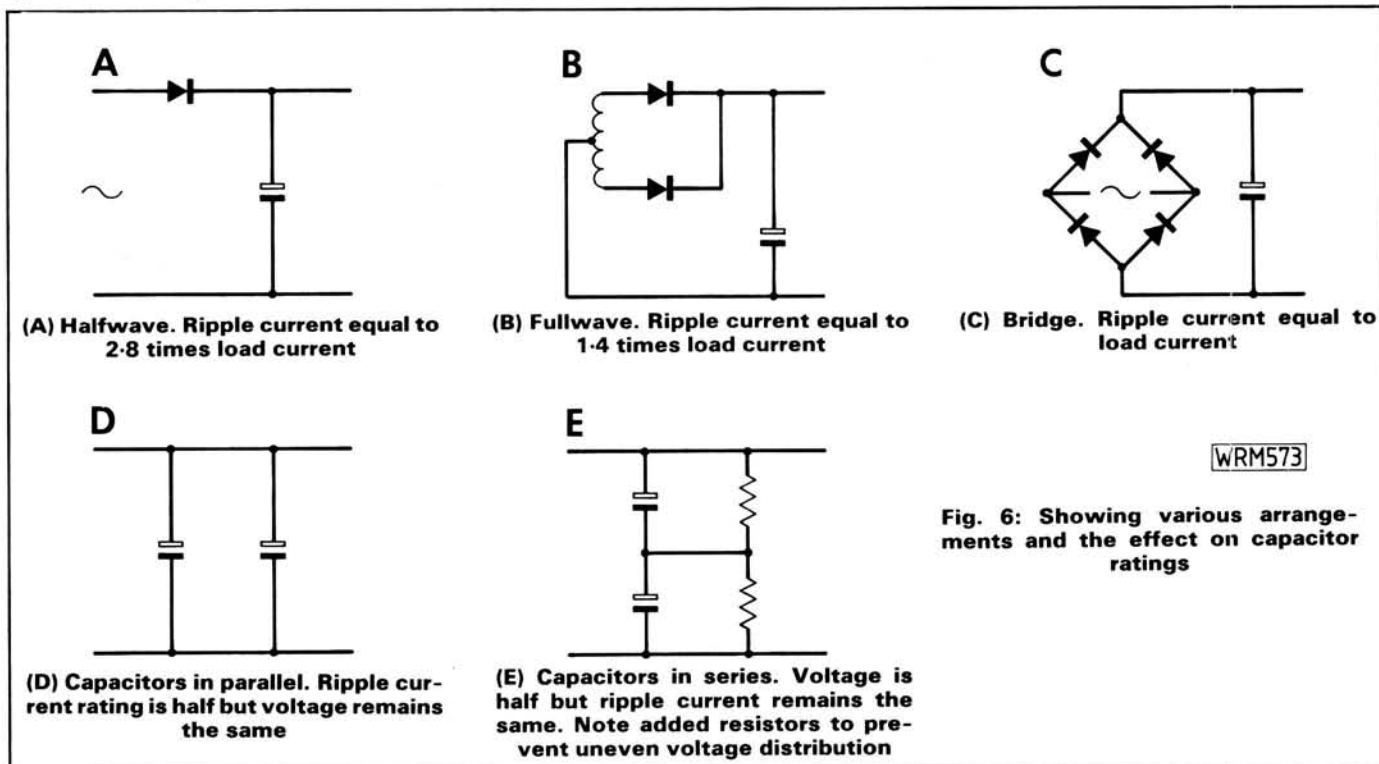

**Fig. 5:** Showing how a leakage current through the capacitor could put a d.c. voltage across the volume control, causing noisy operation. A leakage current of only 3 $\mu$ A will produce a voltage across the control of 30mV

This means that as the control is varied it will put a varying d.c. voltage onto the next stage, this may in some cases upset the biasing of that stage but is more likely to cause the control to sound very noisy in operation, this effect would largely depend on the amount of amplification which followed the control and is one reason why controls tend to be high signal level circuits.

Coming now to the general application of electrolytics, we would expect

to find the larger metal can types in power supplies and/or power circuits. A rough "rule of thumb" is to use a 1000 $\mu$ F for every amp of load current. For example, the ubiquitous 13.8 volt 5 amp power supply would need a 4700 $\mu$ F capacitor (nearest standard value) and if used with a bridge rectifier this would need to have a ripple current rating of 5A. Its working voltage will depend on the maximum off-load voltage and typically could be around 25V. Where very high load



**Fig. 6:** Showing various arrangements and the effect on capacitor ratings

(and ripple) currents are involved it is sometimes better to use two or more capacitors to spread the load. If two 3300 $\mu$ F capacitors were used in parallel for a 6A supply, each would only have to handle a 3A ripple current and this would reduce the heating caused by the current by a factor of two, giving a larger safety margin. Likewise, with two capacitors in series to obtain the correct working voltage. When in parallel, the working voltage is the same as the supply but the ripple current rating is reduced. When used in series the ripple current rating remains the same but the working voltage rating is reduced. However, it is important that resistors are connected across capacitors in series to prevent uneven distribution of the voltage. The various arrangements possible and the effect on the capacitor's rating is shown in Fig. 6.

We would also expect to find the larger types used in the output stages of audio amplifiers. The ripple current rating is also important in these but a correction factor must be applied for the different frequencies in use. The correction factors for the range 50Hz to 1kHz, are shown in Fig. 2. Taking a typical power amplifier of 50W into a 4 $\Omega$  load we get a load current of:

$$I = \frac{W}{R}$$

Therefore:

$$I = \frac{50}{4} = 3.5A$$

From the correction factors we can see that at 50Hz it is 0.8 but at 1kHz it becomes 1.2, therefore the correct ripple rating would be 1.2  $\times$  3.5 = 4.2A. At higher frequencies the correction may need to be higher but it depends very much on the design of the capacitor and the manufacturer's data should be consulted.

Another factor which will have an effect in the example given is the e.s.r. value. Referring back to Fig. 3, we can see that at 1kHz the impedance is around 0.05 $\Omega$  and can be ignored, but at 20Hz it would be around 2 $\Omega$  which is equal to half the load impedance and considerable power losses could be

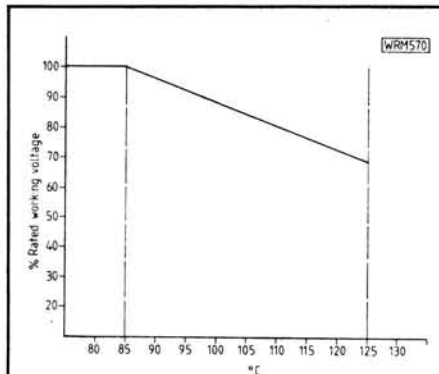

**Fig. 7: Temperature derating curve for metal cased Tantalum capacitors. For certain types (resin coated for example) 85°C is still the maximum safe operating temperature**

introduced depending on the phase angle of the load. From this it can be seen that for audio output stages the capacitor should be one designed for a low e.s.r.

In small signal circuits the ripple current rating can often be ignored and even the e.s.r. may not be important if the circuit impedances are relatively high. However, in very high quality audio amplifier circuits these losses have to be considered as they can introduce distortions of various kinds to the signals.

## Danger

Never operate electrolytic capacitors outside their ratings, it is **VERY** dangerous. Over voltage operation or high ripple currents can generate heat which in turn produces gases which build up to high pressure inside the can. The author has seen what can happen in such cases, the first when a 14 s.w.g. steel front panel was buckled under the force of an exploding capacitor. The second was a neat hole in the top of a cabinet where the top of a metal can type has blown off with considerable force and gone through the cabinet like a bullet! If you find a capacitor which is hot to the touch, switch off and **keep away** until it has cooled down, at the

very least you could get electrolyte blown into your eyes if you are close to an exploding electrolytic capacitor. Without doubt, modern electrolytic capacitors are very reliable when used correctly, regrettably, they do come in for a lot of misuse and the author has seen many examples of this, particularly in power supplies for the CB market. One such example had a 3A ripple rated 25 volt capacitor used in a 7A power supply which also had 30V across the capacitor when off load!

## Tantalums

Another type of electrolytic capacitor in common use is the tantalum. In general these are not unlike the aluminium type and similar precautions have to be observed, but the tantalum capacitor has special properties which make it a very useful component. The range of capacitance and voltages is limited when compared with aluminium types but they have the advantages of much lower leakage currents and closer tolerance. The aluminium types have tolerances of anything from -20% up to +80%, whereas the tantalum types are around  $\pm 20\%$  with  $\pm 10\%$  being available. This makes them more useful in timing circuits, etc., because this closer tolerance is also coupled with a lower leakage current. The leakage is generally less than 1 $\mu$ A when used correctly. The correct polarity is very important with tantalums as they can only stand 1V or 10% of the rated voltage (which ever is the less) reverse voltage.

Tantalums can be operated at a higher temperature than the aluminium types and the graph in Fig. 7 shows a derating curve when used above 85°C. The maximum operating temperature is 125°C compared with 85°C for aluminium. However, it is important to check against the manufacturer's data as some types of tantalum are only usable up to 85°C due to the type of case used, for example, resin coated types are alright up to 85°C whereas metal case types can go up to 125°C. **PW**

## SWAP SPOT

Have Icom AT500 auto a.t.u., little used, v.g.c., boxed. Would exchange for Altron mast plus manual a.t.u. e.g. FC107, FC102 or similar manual a.t.u. Plus cash. Ian. Tel: Stalham 82075 (daytime). C902

Have Super 8mm cine camera. Would exchange for 430MHz transceiver or good all-band RX. Also have Pye F460 base station requires tuning from 456 to 432MHz. P. G. Robins, 290 Priory Road, St. Denys, Southampton SO2 1LS. C917

Have lots of electronic gear. Would exchange for PW Tape 1 for ZX81 or any ZX81 add-on. J. Brown, 45 Marlborough Avenue, Falmouth, Cornwall TR11. C925

Have computer, Acorn Atom fully expanded plus toolkit ROM, serial and parallel interfaces, many extras. Also

Got a camera, want a receiver? Got a v.h.f. rig, want some h.f. gear to go with your new G-zero? In fact, have you got anything to trade radio-wise?

If so, why not advertise it FREE here. Send details, including what equipment you're looking for, to "SWAP SPOT", *Practical Wireless*, Enefco House, The Quay, Poole, Dorset BH15 1PP, for inclusion in the first available issues of the magazine.

**A FEW SIMPLE RULES:** Your ad. should follow the format of those appearing below, it must be typed or written in block letters; it must be not more than 40 words long including name and address/telephone number. Swaps only—no items for sale—and one of the items **MUST** be radio related. Adverts for **ILLEGAL** CB equipment will not be accepted.

The appropriate licence must be held by anyone installing or operating a radio transmitter.

quantities of 5.25in discs both SS/SD and DS/DD. Would exchange for anything aeronautical, e.g. radio navigation equipment, any instruments, radio navigation or other charts, manuals, w.h.y? Godfrey G4GLM, 63 The Drive, Edgeware, Middlesex HA8 8PS. C929

Have 10GHz cavity wavemeter, micrometer type by BTH Ltd. Would exchange for small computer. G4FFO. Tel: Cambridge 860150. C956

# R. WITHERS COMMUNICATIONS LTD

Manufacturers, importers and suppliers of world famous communications products  
 584 HAGLEY ROAD WEST OLDBURY, WARLEY, BIRMINGHAM B68 0BS  
 021-421 8201/2/3. VODAFONE 0836 504587. PRESTEL MBX 214218216 FAX 0214212468  
 Amateur Radio. Business Radio. Radio Telephones. Sales. Service Accessories and antenna systems.



YAESU



THE TECHNICALLY ORIENTATED  
 RADIO COMMUNICATIONS  
 SPECIALISTS.

## ...RWC NEWS FLASH!!

**PRICES DOWN** ●—● Due to better exchange rates ●—● we can now offer many brands at reduced prices ●● for a change, prices are coming down —●—● this rarely happens ● time to take advantage? ●●● Compare our prices —●● some amazing reductions on Hand Helds ——— reductions on scanners ●—● popular models at the moment are —●

FRG9600 Mk 1/2/3 ●—● FT209R ●—● FT23R ●—● FT73R ●—● FT727R ●—● FT767 ●—● FT757 Mk1 ●—●  
 All at lower prices than the competition —●●● call now ●●●—

### ★ HANDHELD TRANSCEIVERS ★ WE OFFER MORE TO CHOOSE FROM . . .

★ = Extended RX available, TX for Export Only		
★ KENPRO KT220EE 2MTR 5W LCD H/H	£199.00	P/P £10.00
KENPRO KT400EE 70CM 2W H/H	£199.00	P/P £10.00
★ CTE 1600 2MTR 3W (SAME AS IC2E)	£165.00	P/P £10.00
★ ICOM MICRO 2E 2MTR 2.5W EXT RX	£229.00	P/P £10.00
★ ICOM IC28E 25W MOBILE EXTD. RX	£349.00	P/P £10.00
★ YAESU FT209R 2MTR FNB3 NICAD	£199.00	P/P £10.00
YAESU FT290R MK1 2MTR M/MODE	£319.00	P/P £10.00
YAESU FT290R MK1 C/W NICADS	£339.00	P/P £10.00
YAESU FT290R MK2 2MTR M/MODE	£399.00	P/P £10.00
YAESU FT690R MK2 6MTR M/MODE	£369.00	P/P £10.00
YAESU FT690R MK2 C/W NICADS	£389.00	P/P £10.00
★ FT23R 2MTR HANDHELD FNB10 inc charger	£239.00	P/P £10.00
★ FT73R 70CM HANDHELD FNB10 inc charger	£249.00	P/P £10.00
FT727R DUAL BAND HANDHELD	£385.00	P/P £10.00

### ★ BASE STATIONS ★

YAESU FT26R WITH 2M	£799.00	P/P FREE
YAESU FT757GX MK 1	£749.00	P/P FREE
YAESU FT757GX MK 2	£899.00	P/P FREE
ICOM IC275E 2M BASE STATION (Probably the best 2m Base Station available)	£899.00	P/P FREE
FT767 Super multi band base station	£1390.00	P/P £10.00

### FULL RANGE OF MATCHING ACCESSORIES IN STOCK

### ★ SCANNING RECEIVERS ★

WE OFFER THE LARGEST RANGE AND OPTIONS

YEASU FRG9600 MK1 60-905 MHZ	£459.00	P/P £10.00
YEASU FRG9600 MK2 60-950 MHZ	£499.00	P/P £10.00
YEASU FRG9600 MK3 100 KHZ-950 MHZ	£599.00	P/P £10.00

### ★ YAESU FRG9600 MK3 PACKAGE: ★

MK3 Receiver, ICOM AH7000 Super Discone Antenna, PA4C AC Adapter, 1/2 size G5RV. Complete H/F-UHF Broadcast/Amateur/PMR Receiving Station **£699.00 inc. carriage**. Options: PAL Video Unit @ **£27.50**, BBC CONTROLLER PROG. **£49.50 inc. post**. Existing owners please note we offer extended coverage, improved sensitivity, HF mod, sae or phone for more details.

### ★ ICOM ICR7000E ★

25-1300MHZ SPECIAL PRICE **£862.50 carr. £10.00**. ICR7000E with AH7000 antenna at **£942.50, carr. £10.00**.

**THE WORLD'S BEST KNOWN SCANNERS, DIRECT FROM THE DISTRIBUTORS**

Bearcat Scanners are value for money and the most popular.

### ★ BEARCAT ★

UBC100XL LB/AIR BAND VHF/UHF Handheld	£219.00	POST FREE
UBC175XL as above, desk-top FREE DISCONE	£209.00	POST FREE
FDK AIR BAND SYNTHESIZED H/H 118-136 MHZ	£139.00	POST £3.00
FDK VHF-FM SYNTH. H/HELD 139-174 MHZ	£145.00	POST £3.00
REGENCY HX850 AM-FM VHF-UHF H/H SCANNER	£235.00	POST £3.00
REGENCY MX7000 AM-FM VHF-UHF D.TOP SCANNER	£399.00	POST £5.00

(Coverage the same as the AOR2002)

WE STOCK ALL CURRENTLY AVAILABLE MAKES OF SCANNING RECEIVERS

### ★ SPECIAL MOBILE ANTENNA OFFER ★

SUN KG309SE2 5/8 Ant c/w Moulded SO239 Lead and guttermount assy. £20.00 inc post

### ★ 6 METERS ★

SPECIAL OFFER for PYE A200 Linear Amplifiers. We have various models available. Tested working with 3 month guarantee. For 4m, 6m and 2m. .5W to 10W input, 10-60W output. All modes, mod kits available for 6m conversion.

Prices range from	£39.00	P/P £3.50
6M DIPOLE KIT	£9.50	P/P £3.00

**Important.** Please confirm your order before sending payment as we do not wish you to be disappointed if the model you require is sold out or the price has gone up! Special offers are subject to availability, we DO NOT advertise products or models that are NOT normal stock items. The above offers will be sold on a first come first served basis. Please DO NOT DELAY, as with previous offers we always get hundreds of enquiries when the offers are SOLD OUT! Instant Credit available Subject to Status.

Mail Order welcome, you may order by Access, Visa, Diners Club, Amex or CWO for immediate despatch. Please call for further details or brochures. Prices variable and are subject to change without prior notice.

ALL PRICES CORRECT AT TIME OF GOING TO PRESS.

E&OE.

Tel: 021 421 8201 (24hr answerphone)

Telex: 337676 G TELEX-G



# Passive Bandpass Audio Filters

This article, by S. Niewiadomski, describes some recent work carried out on the subject of passive bandpass audio filters using preferred value components

The performance of a basic passive bandpass design is investigated using computer simulation and practical tests. By adding extra lowpass sections, the performance of the basic filter is improved and again simulation and experimental results are presented for these enhanced filters.

Some general notes on the uses of audio filters are also included, as well as some reasons why active filters have become dominant over passive designs.

## Uses of Audio Filters

Audio filters have many uses in electronics in general and radio communication in particular. For example, a simple filter is usually incorporated just after the detector stage in a superhet receiver to prevent unwanted high frequencies from passing into the audio stages. In a direct conversion receiver, the selectivity depends almost wholly on the audio filter response and so a better filter is usually used than in a superhet. By only allowing the intended frequencies into the audio amplifier, much of the background hiss can be eliminated from the audio output of a receiver. This can improve intelligibility and reduce listener fatigue.

Transmitters usually have a filter between the microphone input and the

modulator to limit the bandwidth of the modulating frequencies, and hence the final output spectrum.

A more recent application of audio filters is to bandlimit the input to analogue-to-digital converters and filter unwanted frequencies from the output of digital to analogue converters.

## Active or Passive Filters?

Active audio filters using op-amps have become popular in recent years despite the complexity required to achieve a performance comparable to a passive design incorporating inductors. Some of the advantages of active filters which are often quoted are:

(a) Low cost; particularly when compared to expensive inductors required in passive designs.

(b) Good isolation; being independent of the impedances of the preceding and succeeding circuits.

(c) Easily cascaded; complex filter shapes can be built up from simple cascaded sections.

(d) Adjustable gain; gain or loss can be provided by the filter.

(e) Small size and weight; again the absence of inductors is a major contributor here.

(f) Ease of design.

Apart from providing gain, a passive

filter can satisfy all the above criteria as long as suitable cheap, miniature inductors can be found.

Of course, active filters also have drawbacks. The active elements require power, produce noise and have limited ability to handle large signals. Op-amp designs also have a limited upper operating frequency unless expensive, high frequency devices are used. These drawbacks are usually ignored when the alternative is to use inductors in a passive design.

Probably the main reasons for the decline of passive filters are the misunderstandings which surround the use of inductors. These misunderstandings can be explained by:

(a) The lack of published designs using preferred value inductors and capacitors.

(b) Ignorance of the fact that ready-wound standard value inductors are available easily and cheaply.

(c) The belief that highly accurate inductance and capacitance values must be used to obtain acceptable results.

(d) The misconception that only high-*Q* inductors are suitable for filter applications.

(e) A general "phobia" of winding inductors particularly ones with several hundred turns of wire.

One source of ready wound inductors which have been found to be suitable for audio filters are stacks of telephone line loading coils made available to amateurs by the Chesapeake and Potomac Telephone Company. These have been popularised mainly by the efforts of W3NQN with articles published in *QST* and *Radio Communication*<sup>(1)</sup> magazines. However, these inductors are physically quite large and are not well suited to assembly on p.c.b.s in compact modern equipment.

This article shows with the aid of simulation results and practical tests that passive audio filters with excellent performances can easily be constructed at low cost. Rather than starting from scratch by explaining the basics of design of a passive filter (which actually is not difficult) a bandpass design published in the 1983 *Radio Amateur's Handbook* (reproduced here by kind permission of the ARRL) is used as the starting point. This design is based on the telephone line loading coils.

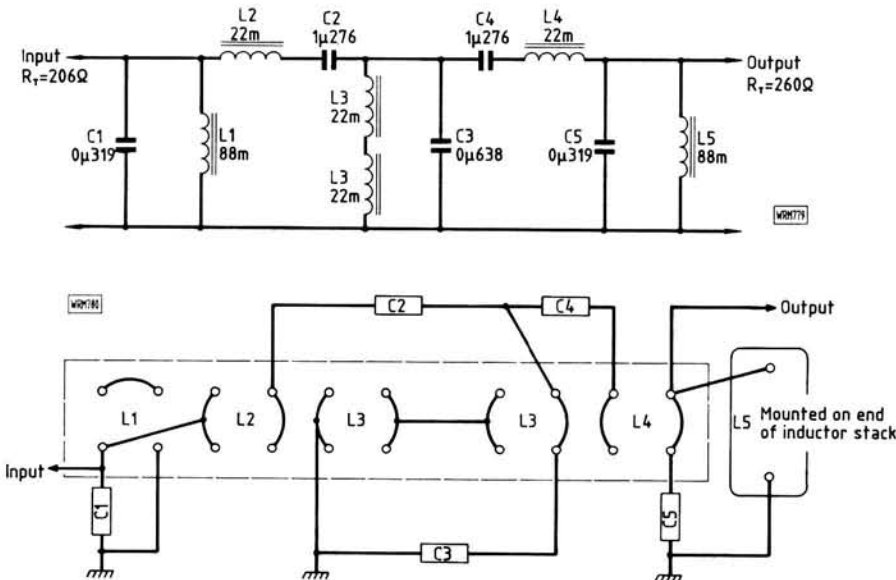

Fig. 1: The ARRL design

For those who want to look deeper into the design of passive filters, the book *Simplified Modern Filter Design*<sup>(3)</sup> is well recommended. Some other useful references are given at the end of this article.

## The ARRL Bandpass Design

The circuit of the ARRL design is shown in Fig. 1. The inductor values correspond to those that can be obtained from the telephone line loading coils used. It is recommended in the text published with the circuit that the capacitances are obtained by measuring nearest preferred value capacitors and selecting the appropriate values. Also shown in Fig. 1 is the method of interconnecting the coils to produce the desired circuit.

A filter of this type is derived from a lowpass design which is transformed into the bandpass configuration shown. The lowpass design can be obtained from tables of standard driving and termination impedances and upper and lower cut-off frequencies. In this case the impedances are both 206Ω and the frequencies are approximately 320Hz and 2.9kHz. The non-standard impedances occur because the inductor values and cut-off frequencies were fixed at the design stage which leads to the impedances being the values they are.

The performance of this filter is plotted in Fig. 2. Differences between the calculated and measured responses occur because the resistance of the coils (due to their non-infinite *Q*) causes insertion losses particularly at low frequencies.

## Modifying the ARRL Filter

Now we can consider what can be done to the design to make it easier to construct. If the basic configuration of

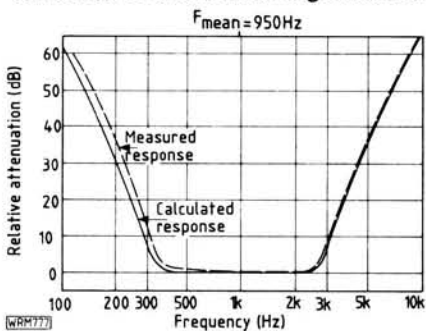

Fig. 2: Measured and calculated response of Fig. 1

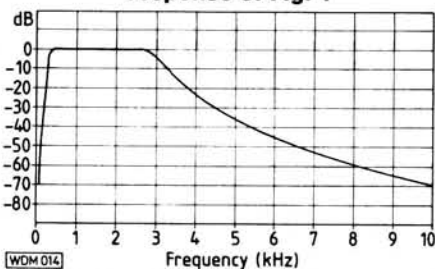

Fig. 3: Simulation results for rounded values

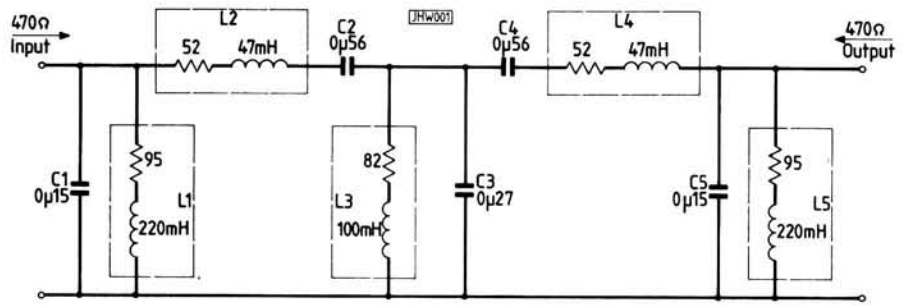

Fig. 4: 470Ω bandpass design with rounded values

the filter is not to be changed, there are three variables which can be juggled and setting any two of them fixes the third. These variables are the cut-off frequencies, the termination impedances and the component values. Usually, the frequencies and impedances are set to desirable values and so the components are calculated to give those values. Remember that with the ARRL filter, the inductances were fixed so that to arrive at the correct frequencies the impedances have to be 206Ω.

The impedances can be altered by changing the component values without altering the frequency response. If the capacitors and inductors have values of *C* and *L* respectively with a termination impedance of *R* then the values required (*C*<sub>1</sub> and *L*<sub>1</sub>) to give an impedance of *R*<sub>1</sub> are given by:

$$C_1 = \frac{C \times R}{R_1}$$

and

$$L_1 = \frac{L \times R_1}{R}$$

If we choose the new impedance to be higher than the old one, then the capacitors will be reduced in value and the inductors will be increased. A convenient value to use is 470Ω, giving a worthwhile reduction in the largest capacitor which at 1.276μF is rather large. The value of *C*<sub>1</sub> for 470Ω is therefore given by:

$$C_1 = 0.319 \times \frac{206}{470} = 0.14\mu\text{F}$$

and for *L*<sub>1</sub>:

$$L_1 = 88 \times \frac{470}{206} = 200.8\text{mH}$$

A complete list of the component values is given in column 2 of Table 1. Column 3 of Table 1 shows these components rounded to the nearest preferred values.

Using a network analysis program on an Apple II micro-computer the circuit with the values of column 3 of Table 1 was simulated. The results are plotted on the graph of Fig. 3. It can be seen that the results differ very little from those plotted on Fig. 2. It just happens that most of the rounded component values are very close to their theoretical values. Inductors *L*<sub>1</sub> and *L*<sub>5</sub> are the worst in this respect, being approximately 10 per cent higher

than their ideal value. Other simulations have shown however, that all the components in a filter can deviate from their ideal values by as much as 20 per cent without seriously affecting the filter's performance.

## Practical Components

There should be no problem in obtaining the capacitors for use in this filter, Siemens polyester type<sup>(A)</sup> have been found to be ideal. Preferred value inductors are available from Toko stockists<sup>(B)(C)</sup> who sell the 10RB and 10RBH range in E12 values from 1mH to 1500mH. These inductors are only 14mm and 10.5mm in diameter and have a lead spacing of 0.2in. They are ideal for mounting on p.c.b.s or Veroboard.

The *Q* quoted for these inductors in the Cirkit catalogue is typically 100, measured at 50kHz. The *Q* of an inductor is given by the formula:

$$Q = \frac{2\pi fL}{R}$$

where *f* is frequency in Hz  
*L* is inductance in H  
*R* is resistance in Ω

For the 100mH component, the resistance is quoted as 82Ω and so at 1kHz (a more realistic frequency for an audio filter) the *Q* is:

$$Q = \frac{2 \times \pi \times 10^3 \times 100 \times 10^{-3}}{82} = 7.7$$

Of course, at 100Hz, the *Q* is as low as 0.77!

Many theorists would dismiss these inductors as having a *Q* so low at audio frequencies as to be unsuitable for use in audio filters. The effect of these low *Q* values on the filter performance is now investigated.

## Suppliers:

- (A) Electrovalue Ltd., 0784 33603.
- (B) Cirkit Distribution Ltd., 0992 444111.
- (C) Bonex Ltd., 01-992 7748.

## Simulation and Practical Tests

To simulate the effect of the finite *Q* of the inductors, the circuit of Fig. 1 has been re-drawn with a resistor in series with each inductor equal in value to its d.c. resistance. This more realistic circuit is shown in Fig. 4. Simulation results from this circuit are

shown in Fig. 5 as a series of dots.

This circuit was built on Veroboard with Toko inductors and Siemens polyester capacitors. No detailed constructional details are given here, but the author has built these types of filter on Veroboard and p.c.b.s without problems. Probably the most important factor is to lay the components out to separate the input and output terminals from each other.

Using a Hewlett Packard 3585A spectrum analyser and a Bryans 2500 XY pen plotter, the response was measured. The spectrum analyser was set to generate an output sweeping from 20Hz to 10kHz simultaneously monitoring the output voltage from the filter. To match the 50Ω output impedance of the analyser to the 470Ω input impedance of the filter, a 430Ω resistor was connected in series with the drive voltage. This provides a drive impedance close enough to 470Ω to give results indistinguishable from those which would be obtained from the exact figure. A 100μF capacitor was also connected in series with the input to prevent any d.c. current flowing through the inductors, which can upset their performance due to core saturation.

A 470Ω resistor was connected across the filter output to provide the correct termination impedance and the output voltage was monitored using a high impedance probe. The analyser calculates the ratio of output to input voltage, in dB, and displays the results on its screen. To provide a permanent record of the results, the analyser can drive the pen plotter. The experimental results are plotted on the same scale as the simulation results to make comparison easy. The solid line on Fig. 5 is the actual response obtained for the practical circuit.

Note that the frequency axis of Fig. 5 is calibrated linearly, rather than in the more usual logarithmic way. The peak at the extreme left of the plot is a characteristic of the spectrum analyser and not the filter.

The results are plotted with the 0dB level set at the 1.5kHz overall attenua-

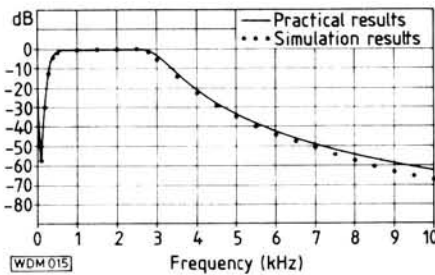

▲ Fig. 5: Practical and simulation results of Fig. 4

Fig. 7: Additional lowpass elliptic filter (5th order)

tion. At 1.5kHz, the actual insertion loss of the filter is 1.5dB.

A comparison of the simulation and practical results indicates good agreement at most frequencies. At 10kHz, the practical results give an attenuation of approximately 62dB relative to the passband response, compared to 67dB expected from the simulation. This compares to approximately 67dB obtained for the ARRL design at 10kHz, taken from Fig. 2. At 100Hz, the attenuation is approximately 57dB and though it is not clear from Fig. 5, the attenuation is greater at lower frequencies. This gives useful attenuation of 50Hz and 100Hz mains hum in an audio path.

It can be seen that the filter constructed using miniature Toko inductors has a performance comparable to the ARRL design using bulky telephone line loading coils. The most significant difference between the results from the ideal inductors (Fig. 3) and the real inductors with non-infinite *Q* (Fig. 5) is the non-zero insertion loss at all frequencies. This can easily be compensated for by increasing the gain of the audio path.

Encouraged by these results, the aim now is to improve the performance of the filter to see what can be achieved. It is thought that the low frequency response is adequate for eliminating

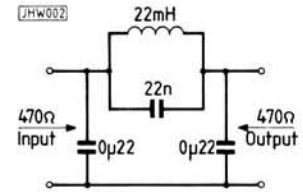
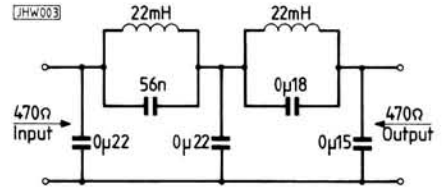

Fig. 6: Additional lowpass elliptic filter (3rd order)



mains hum and the low frequency components of speech. However, the performance at high frequencies could usefully be modified to improve the roll-off rate. Rather than start again with a completely new filter, it was decided to design extra lowpass sections to add to the present filter. By designing the new sections to have input impedances of 470Ω, they can simply be cascaded to the present filter output without mis-match.

## Improving the Filter Performance

The lowpass filters which can be cascaded to the bandpass design are shown in Figs. 6 and 7. Again, the inductor and capacitor values have been rounded and they represent thoroughly practical designs which can be used as they stand if required. Both designs are elliptic lowpass filters which offer the fastest roll-off of any filter type. The drawback of this type of filter is that they exhibit ripple in the passband and rather than having continuously increasing attenuation in the stopband, the response shows minima of attenuation which are specified at the design stage. An excellent treatment of this type of filter is given in Reference 2.

The specifications for these two filters is given below:

	Fig. 6	Fig. 7
Input Impedance	470Ω	470Ω
Output Impedance	470Ω	470Ω
Maximum Passband Ripple	1dB	1dB
Cut-Off Frequency	3kHz	3kHz
Minimum Stopband Attenuation	35dB	35dB
Frequency of High Attenuation	6.1kHz	3.4kHz

When the designs of Fig. 6 and 7 are cascaded with the bandpass filter, the circuits of Figs. 8 and 9 result. Using the same test set-up as previously, the

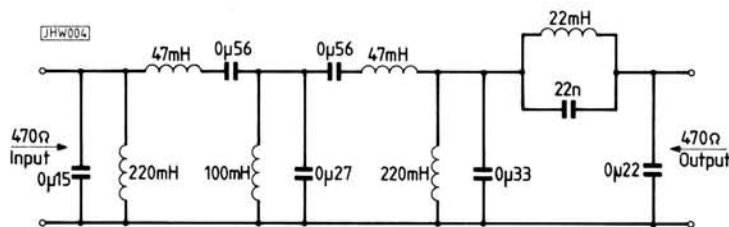

Fig. 8: 470Ω bandpass filter with added 3rd order lowpass section

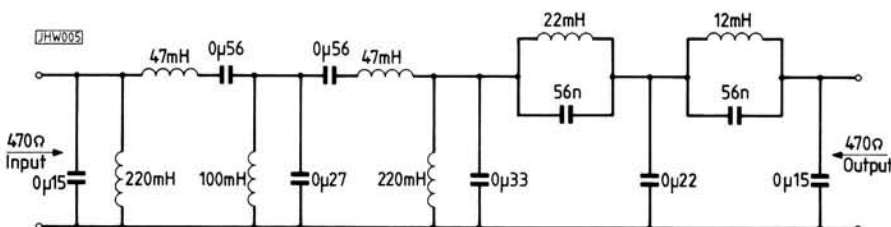

Fig. 9: 470Ω bandpass filter with added 5th order lowpass section

Component	Termination Impedance		
	206Ω	470Ω	470Ω (Rounded Values)
C1	0.319	0.140	0.15μF
C2	1.276	0.559	0.56μF
C3	0.638	0.280	0.27μF
C4	1.276	0.559	0.56μF
C5	0.319	0.140	0.15μF
L1	88	200.8	220mH
L2	22	50.2	47mH
L3	44	100.4	100mH
L4	22	50.2	47mH
L5	88	200.8	220mH

**Table 1: A complete list of component values**

responses of these two filters were obtained. They are shown in Figs. 10 and 11 respectively. Again the simulation and practical results are shown for comparison and the 0dB level is set at the 1.5kHz overall attenuation. The actual insertion losses at 1.5kHz are 2.6 and 2.7dB respectively. The 1dB of passband ripple contributed by the lowpass sections are almost insignificant and would be unnoticeable for speech purposes.

The improvement in performances can be seen clearly. The very high attenuations at high frequencies are not evident in practice, possibly due to the measurement set-up noise levels and leakage around the filters. However, the improvements are obtained at very low cost, both in monetary terms and extra bulk. In fact, the response shown in Fig. 11 is approaching the ideal bandpass shape.

## Methods of Driving and Terminating the Filters

Whether these filters are incorporated into existing equipment or included in new designs, the correct input and output impedances must be pro-

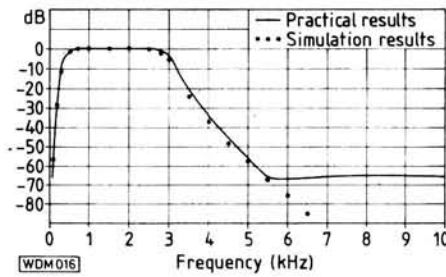

**Fig. 10: Practical and simulation results of Fig. 8**

vided. Some methods commonly used to interface to passive and audio filters is shown in Fig. 12. A common emitter amplifier which can use almost any commonly available transistor is shown in Fig. 12 (a). The collector resistor provides the correct drive impedance for the filter. The other resistors around the transistor are chosen to set the d.c. voltage at the collector at a value which allows an a.c. swing compatible with the signal level being handled. Termination for the filter is provided by the gate resistor of the f.e.t. stage, the input impedance of the f.e.t. source follower being very high.

A circuit using op-amps is shown in Fig. 12 (b). The output impedance of an op-amp is very low and so the matching impedance to the filter is provided by R1. Resistor R2 terminates the filter and should be equal in value to the output impedance of the filter. By choosing the appropriate value of R3, any reasonable gain can be obtained from the circuit. Of course, combinations of transistors and op-amps can be used in the same circuit. Note that in general, the f.e.t. equivalent of the common emitter amplifier, the common source amplifier, does not have an output impedance equal to the drain resistor.

## Conclusions

It has been shown that passive audio filters can be constructed using miniature preferred value inductors and capacitors. A considerable saving in

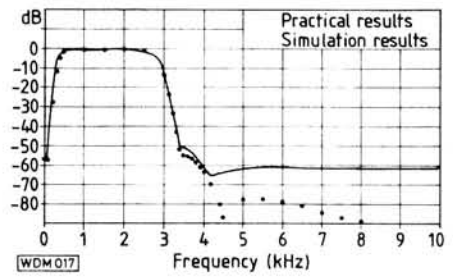

**Fig. 11: Practical and simulation results of Fig. 9**

cost and size will be obtained, particularly by using miniature inductors rather than pot-cores or telephone line loading coils. Despite their comparatively low *Q*, Toko inductors are well suited for use in these filters.

In total, three designs of bandpass filter have been presented, having gradually improving performances. The final design has a response approaching that of an "ideal" bandpass filter.

It is hoped that this article has dispelled some of the myths which surround passive audio filters. They are easy to design, cheap and easy to use and can give results far superior to active designs. It may well be that passive filters will make a come-back into amateur designs.

## References

- (1) *Simplified elliptic lowpass filter construction using surplus 88mH inductors* by E. E. Wetherhold W3NQN. *RadComm* April 1983.
- (2) *An introduction to elliptic filters for the radio amateur* by J. Wilkinson G4HGT. *RadComm* Feb 1983.
- (3) *Simplified Modern Filter Design* by Philip R. Geffe. *Illiffe*.

## Other Useful References

- Handbook of filter synthesis* by A. I. Zverev. Wiley.
- Filter design and evaluation* by G. E. Hansell. Van Nostrand Reinhold Company. **PW**

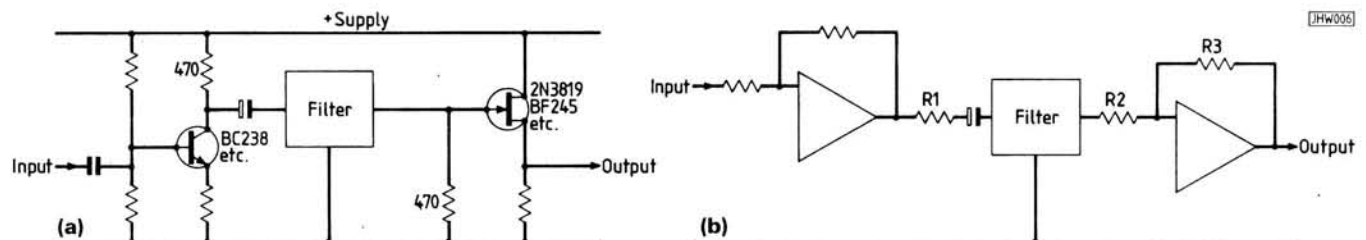

**Fig. 12: Methods of driving and terminating passive filters**

# SWAP SPOT

Have Sony 4-track TC366/4 reel-to-reel tape recorder. Would exchange for FRG-7 or similar short wave receiver. K. J. Faulkner, 35 Hilrose Avenue, Urmston, Manchester M31 1PB. Tel: 061-748 9604. **C931**

Have Trio R1000 fitted f.m. 144MHz transceiver 143/9 at 0/25W 144 to 28MHz transverter, Microwave Modules, FT0790 and 30W linear, MM4001 RTTY transceiver and keyboard, SMC 10EM (CBM272) 28MHz, etc. etc. etc. Tel: 01273 810000. **C966**

mag mount, IC-2E heavy duty NiCad and case. Would exchange for TS130S or similar. G4YUG. Tel: 0473 830147. **C944**

Have Citronics SM-506-1 stereo mixer, ex-disco unit, tape, aux, mic and disc inputs, slave and monitor outputs. Must be of use to someone! Needs four knobs. Would exchange for R107 RX. A. Hawkins, 166c Kestrels View, Runcorn, Cheshire. **C966**

## Feature

# Computing Corner

As mentioned in the June issue, conversion of the well-known GM4IHJ satellite prediction software to Amstrad CPC6128 format is complete and has already been received well by a few users. I hope to be present at the AMSAT Colloquium in Guildford on July 18-19 and to demonstrate these programs then. I look forward to meeting some of you there perhaps.

Through the auspices of both GM4IHJ and SARUG, Pat G3IOR took a tape of GM4IHJ programs to LZ1DP and LZ6DV when he visited during May. I hope these programs enable even more efficient satellite operation in LZ.

I know that a number of users are converting published programs from BASICS like ZX81 and Spectrum into Amstrad Locomotive Basic so this will be of interest to you especially. It concerns the absence of the trig-functions ASN (arcsine) and ACS (arccosine).

These functions are not present in Loco Basic (and others) and so they must be synthesised using ATN (arctangent), which is present. The only amateur-radio source of this conversion is GM4ANBs book *Amateur Radio Software* (page 5), which is available from PWs Book Service.

The given conversions are for ASN and ACS as follows:

$ASN(X) = ATN(X/SQR(1-X*X))$

$ACS(X) = PI/2 - ATN(X/SQR(1-X*X))$

If the value of X is in itself an expression then evaluate that into an intermediate variable and substitute that for X in the required expression above. (Thanks to GM4IHJ).

A number of users have made the expected transition from Sinclair Spectrum to Amstrad CPC computers although interestingly they retain the Spectrum for some applications. The CPC6128 seems to be favourite amongst these users.

The CPC6128 is a very good machine capable of anything required of it. Don't assume from this that everything is already available—far from it! What we really need is a growing selection of programs to draw on. In this connection, I was very glad to hear from Jim Luck G0BTG who will gladly make available a small selection of CPC6128 programs and small utilities on request. You MUST send a formatted disc (DATA format) plus return postage and packing<sup>(1)</sup>. The Morsetutor is particularly nice.

A small number of translations from the original French of some Amstrad

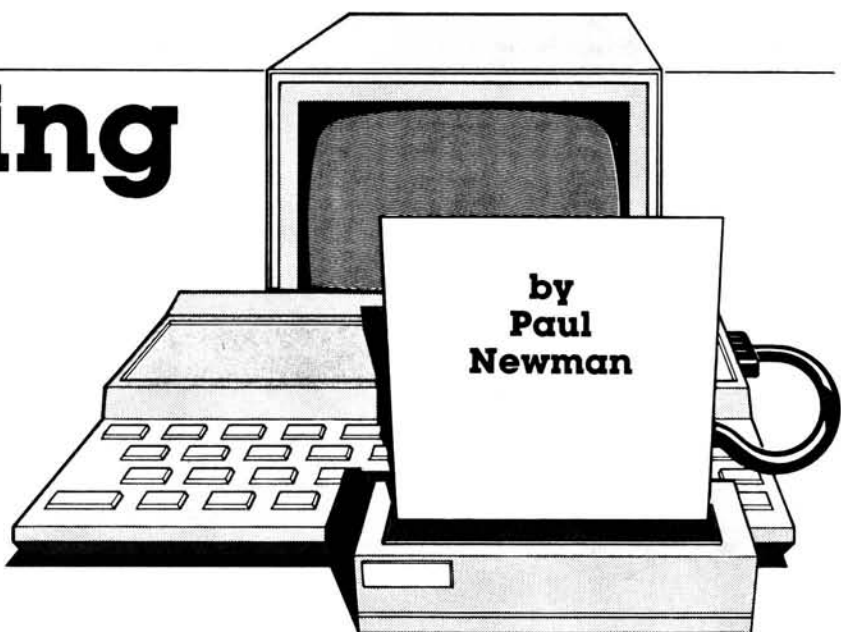

projects have been obtained (courtesy Wardhill Translations<sup>(ii)</sup>) and these describe a simple CPC664/6128 RTTY system, a Mailbox and a controller for the Tono 777 terminal unit which would, one imagines, be readily adaptable to almost any similar unit. Further information can be obtained from me<sup>(iii)</sup>.

An interesting idea for the Amstrad (which I'm developing for publication at a later date) is that of a simple timer system enabling you to use the computer to gather late-night or otherwise unattended UoSAT passes on your cassette recorder. The CPC664 and 6128 have cassette motor-control facilities which use the usual "remote" jack on a computer cassette recorder. The motor-on/motor-off command is callable directly from BASIC without resort to machine-code so it could be used to switch your cassette on and off as desired.

Type CALL &BC6E on your 664/6128. You will hear the motor-relay click after a short pause. Type CALL &BC71 to switch the motor off. Thus, using the remote jack only plugged into the cassette and the cassette audio input taken from your receiver, you have the basis of a timed-delay recording system. Building a comprehensive timer system will be left for another time, but many of you will be able to do this yourselves using the LocoBasic command AFTER—the explanation in the manual should suffice. The main part of my project will be to make this operate entirely automatically from the relevant prediction software.

Information on using the CPC cassette is a little sparse but I'm hoping to receive some soon. If it's helpful to our interests I'll pass it along of course.

## ASTRID UoSAT Receiver System

Many of you will remember my mentioning the ASTRID satellite receiver system some time ago and I thought that they had stonned work on this

excellent system. I was therefore delighted to hear from Steve Webb G3TPW, the Director of SRW Communications Ltd, that ASTRID is alive and well under the care of her new company<sup>(iv)</sup>.

ASTRID is a purpose-built receiver system for the UoSAT satellites OSCAR-9 and 11 and is ideal for use with the G4IDE/G4INP satellite decoders as well as the G4HLX "spix" program. Spectrum users who want full telemetry date-frame results can get this from the two ASTRID programs supplied for this purpose by G4INP<sup>(v)</sup>.

## G1FTU SSTV for the Spectrum

The latest G1FTU interfaceless Spectrum program is now available in the form of G1FTU SSTV<sup>(vi)</sup>. This SSTV program has intelligent noise and false-sync rejection and has virtually eliminated vertical picture tearing during bursts of QRM.

All received pictures are within Spectrum screen format thus eliminating picture-scrolling during reception. The user has full control of brightness and contrast during live reception. Transmission of frame-stores or SCREEN\$ can be made in 8, 16 or 32 second black and white and 24, 48 and 96 second colour. Both line and frame-sequential colour modes can be used. Grey-scale and colour-bar memories are automatic and there are 9 text memories plus a personalised CQ memory. All memories are viewable on screen at once. Provision has been made for interfacing your own printer to the program in order to get full-screen dumps on a "proper" printer.

The package is supplied in a variety of formats, all including sample pictures and screens which you can re-transmit. Tape, Microdrive and Opus disc formats are available. My only minor criticism is that using the pictures-tape is a little hit and miss. A brief "directory" of this tape would be extra-helpful. ▶ 41





# Packet Radio

Here is Part 4 of this series. Roger Cooke G3LDI thinks that if you have been following the three previous parts you should be a "dyed in the wool" packet operator!

This mode is certainly catching on at an enormous rate and I would like to take this opportunity of thanking those that have either spoken to me over the air, telephoned or written to me with encouraging and enthusiastic remarks.

The last major facet of packet radio is operation via JO-12, the Japanese store and forward packet satellite. Mode JD, as it is known, is proving to be a problem on JO-12 with the system still not fully functional, after several attempts at installing the necessary software. However, it is hoped that it will be workable soon and a description of the system will be of help to any potentially active station.

The idea is "non-real time" QSOs, where a message can be up-loaded for somebody on the other side of the world during hours socially acceptable to the sender, with the knowledge that the recipient too can use socially acceptable hours to retrieve it. Thus JO-12 has become known as the flying mailbox even before it is fully operational. It will also carry informative bulletins which will be of great interest.

The satellite will be usually in the listening mode and will start transmitting "on demand". In other words, when an acceptable AX.25 frame including UI is received on one of its uplink channels of 145.85, .87, .89 and .91MHz, it will transmit a mode JD p.s.k. signal on its downlink frequency of 435.910MHz. This will continue as long as AX.25 frames are received at less than three minute intervals. It will return to listening mode if no AX.25 is heard for more than three minutes.

The "on demand" operation happens during the period when the satellite is on. This occurs every other two hours. While in the on period there is a five second burst of p.s.k. every minute to indicate availability. The other two hour period is when the satellite is off and nothing is heard. A weekly schedule will be organised after enough power usage data has been analysed. If there is no mode JA, more than four days should be available for JD.

The first version of the BBS system should be available soon, but please understand that in your enthusiasm, should you receive a busy signal, the software is undergoing tests and it may be some time before the BBS is ready and available for full use. However, the envisaged commands on the first version of the program are as follows:

- F list latest 10 message header with message number
- F\* list all the message headers
- R(n) read a message numbered (n)
- W send a message. You will be asked the receiver and subject. Send (cr). (cr) or (cr) control Z to end message
- K(n) kill message numbered (n). A message being read by other stations cannot be killed. FO-12 is a multi-user system and only the originator of the message can kill it
- H help

Your TNC should be set as follows:

- Protocol It has to be version 2. The TNC-1 will not work unless fitted with WA8DED proms
- Command TNC-1 V2
- TNC-2 AX25L2V2 on
- T1 timer 6 seconds or longer
- Command TNC-1 F6
- TNC-2 FRack 6
- Max frames 2 or 3 is suggested
- Command TNC-1 02 or 03
- TNC-2 MAX2 or MAX3

**Notes:** The callsign to be used for the connect command is 8J1JAS. The number of messages is limited to 50. If more than 50 messages are posted, older messages will be overwritten. The maximum available memory as message storage is 192KB.

There will be no command to log-out. Simply disconnect using the TNC disconnect command. No personal mail will be supported by the first version. Your message can be read by anyone and you can read any other

message. While the BB is in operation the digital repeater is disabled. Digipeater packets will not be accepted by FO-12. Increasing numbers of users will slow the response and require longer T1 time. The maximum acceptable length of the data portion of a packet (PACLEN) is 199. It should, of course, be set shorter than this. FO-12 transmits at PACLEN 128 and MAX-frames 1.

This information comes from JAM-SAT and is only preliminary and can be changed. However, it gives a very good idea how the satellite will hopefully behave once the software is working properly.

In order to operate packet on FO-12 you will need a TNC and an external p.s.k. MODEM to replace the standard on-board MODEM. There are two currently available, one produced by TAPR and the other by Dr. James Miller G3RUH. This will no doubt form the basis of most of the FO-12 operation this side of the "pond".

The basic requirements for JAS1/FO-12 mailbox operation are shown in Fig. 1. As in any similar satellite set-up the essentials are:

- 1: 145MHz band transceiver for the uplink of 145.85, .87, .89 and .91MHz
- 2: 430MHz band transceiver for the downlink of 435.910MHz
- 3: TNC
- 4: p.s.k. MODEM
- 5: terminal v.d.u.

The p.s.k. MODEM has to replace the on-board standard Bell 202 MODEM built into most TNCs. Usually this is capable of being by-passed, albeit with a few minor mods and details of how to connect to the TNC are included in the book that comes with the board. Details are also available for the PK232.

Construction is quite easy and straightforward, components easily available and either on-board or external power supplies can be used. The specifications are as follows:

- 1: MODEM: Downlink: Input 50mV to 5V r.m.s. RX audio. PSK demodulator to t.t.l. digital, 1200baud. Uplink: 1200baud Manchester encoding modulator to mic level (about 30mV pk-pk) TX audio. RX carrier LOCK LED indication. Selectable loop bandwidth. Morse code regenerator.

- 2: Connects to AX.25 TNC MODEM disconnect jack. Suitable for TNC-1 or TNC-2 or any other providing the internal MODEM can be bypassed.

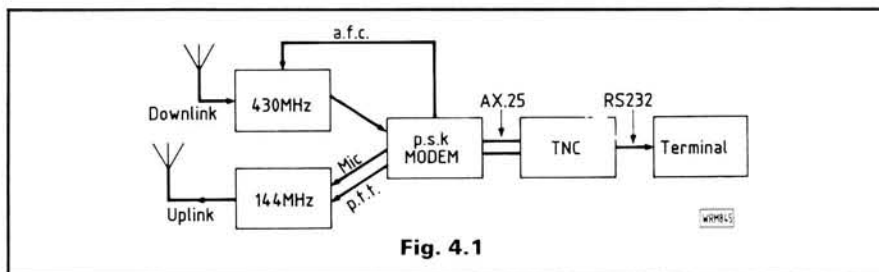

Fig. 4.1

TNC digital connections needed:  
TXdata, RXdata(in), RXdata(out),  
TXclock, Gnd.

3: Digital a.f.c:

Tracks changing Doppler shift via the up/down signal lines of your RX rig. Designed for all known Icom, Trio and Yaesu standards, adjustable for 10–100Hz/step. Positive pulses, negative pulses and Icom bi-level. Tracking on/off switch. Manual tuning indication by i.e.d.s and centre-zero meter.

4: Set-up:

Three pre-set pots for p.l.l. frequency, local 6V supply and up/down tuning again.

5: Power:

AC power supply on-board or 12V a.c. or 12V d.c. at 40mA.

6: PCB 160 × 100mm single Eurocard, double-sided, plated through, legended with instruction. Circuit uses standard c.m.o.s. and l.s.t.t.l. Boards available from AMSAT-UK price £16.50(a).

(a) AMSAT-UK, 94 Herongate Road, Wanstead Park, London E12 5EQ

The first transatlantic QSO via mode JD took place on Feb 28 between Tom Clark W3IWI and James Miller G3RUH. Other EU calls heard at the same time were DB2OS and ON6UG. Some interesting terrestrial tests have also been carried out using p.s.k. with a claimed 10 to 15dB improvement over the conventional f.m. mode. Tests are being carried out locally in Norwich between Paul G4VLS and Paul G4ZBA on a local link and hopefully there will be two more of us soon hopefully with FO-12 capabilities.

Packet is a mode which can be “left” to enable other chores to be done while monitoring a frequency (or frequencies in the case of a BBS/Gateway). A circuit which gives an audible indication of a connect is shown in Fig. 2. This can be added without too much trouble and can prove quite useful. Switch S1 disables the device.

Another accessory I have found quite useful is the audio filter. With some practice, it is possible to close the bandwidth sufficiently to produce good copy and cut out the QRM. There are several models to buy or with reference to the ARRL handbook one can be constructed. However, if possible, obtain the selectivity at i.f. as this would be the better approach.

A very helpful hint appeared in the Feb '87 edition of *Gateway* regarding QRM from the TNC200. The modifications come from Herb Salls WB1DSW:

The TNC develops its source for -5V d.c. by converting some of the

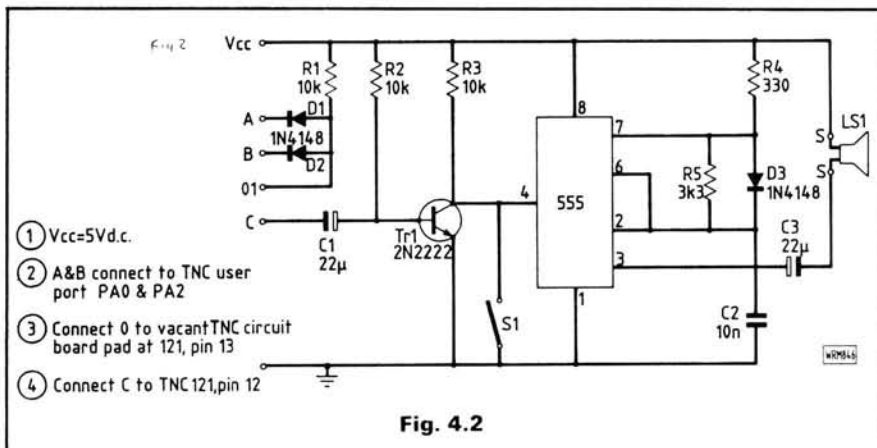

Fig. 4.2

+12V using what is called a “charge pump”. While this is an effective means of getting -5V (ugh!), it also is the cause of the irritating noise interfering with h.f.

To solve the problem, remove R1 (47Ω) and replace it with a 10mH choke. Lift the positive ends of the rectifier diodes (CR2 and CR5) and connect a choke (10mH) in series with each diode, taking care not to short out onto the cabinet. Connect two 10nF disc ceramic capacitors, one between U2, pin 3 and ground, and the other between U2, pin 11 and ground. These mods quieten the TNC considerably on h.f. and it will copy weaker signals, because it does not now introduce its own bit errors due to the noise.

Noise is a major problem nowadays with computer based systems. It really is a pity that manufacturers do not pay more attention to these problems. Not only is it in the home-based hobby products, one only has to drive through a large town or city to find out that radiated computer hash is a by-product of a modern hi-tech age. Pity the

powers that be did not introduce the same stringent rules as they have in the USA instead of just “monitoring the situation”.

I was monitoring the 144MHz band during lift conditions the other evening and I had to smile at a transmission from a G6 to a G8. The packet read something like, “Some of the so-called A-class licensees are coming back to v.h.f. after having tried h.f. packet and getting fed up with the retries.” That packet went out about 10 times! I quoted that instance merely to illustrate that the anomalies of propagation can affect v.h.f. as well as h.f. No doubt the lift was causing collisions, forcing the re-try count up and making copy difficult. Propagation can be just as punitive on h.f., especially over a difficult path, such as to the Pacific or the West Coast of the States over the North Pole. The polar flutter takes its toll and causes havoc with digital modes, RTTY and AMTOR being affected in much the same way. However, under normal conditions, on any mode, results are determined by the path. If the path is good, be it h.f. or v.h.f. then copy will be good.

Some news of the locals just to finish with. Country scores increase almost daily with some friendly (?) competition locally as to who is going to make DXCC first. Paul G4VLS is at 33 countries and uses a minibeam at about 9m. Ted G4RCI has a similar antenna and has over 40 worked. Paul G4ZBA uses a tribander at 13.5m and has worked over 50 countries, while Mick G4RMN has a Yagi at 27m. I have the antenna shown in the photograph, with a home-brew 3-element Yagi for 14MHz at 30.5m and the Elan for 21/28MHz at 33.5m and I have worked 59 countries now. Most surprising is Reg G8QR who uses a TA31 at 4.5m and he is only tailing me by four countries!

That’s just about it. I hope you have enjoyed reading the series as much as I have enjoyed writing them. Comments can be dropped into my BBS on 14.099 or 21.107MHz during the week and 3.595 on Sundays. Happy packeting!

PW



My home-brew 3-element Yagi for 14MHz and the Elan for 21/28MHz

# Valved Communications Receivers

*This month, Chas E. Miller looks at perhaps the most legendary of communications receivers, the AR88D.*

The makers of the AR88, the RCA Victor division of the Radio Corporation of America, Camden, New Jersey, describe it simply, and with becoming modesty as "a general-purpose communications receiver". The legions of users of this fine set would probably be more forthcoming about what has become one of the all-time greats of the valve radio world. These splendid receivers were proven in battle during WWII, and were eagerly snapped up by amateurs and s.w.l.s when they were released onto the surplus markets at the ending of hostilities.

Forty years ago the going price of an AR88 would be £40 to £60, at a time when £10 per week was a very good wage indeed, and above what most struggling radio enthusiasts could dream of attaining. Translate that to the wages common today and you will have a good idea of what the cost of an AR88 was in "real terms". I well remember talking to one surplus dealer who showed me some large, massively reinforced aluminium packing cases that had been designed to be dropped by parachute. He had bought about 300 of these at a few pounds apiece. To his great surprise (he said), on opening the crates he found that each one contained an AR88. You might care to compute the profit on that transaction, which to one cursed with a suspicious mind may not appear to be entirely fortuitous!

Personally, I have bought two AR88s, the first being one of the worst-maintained I had ever seen, and the second being undoubtedly the best. Restored to good order the first gave me a great deal of pleasure until economic circumstances forced its sale. I sincerely hope that the second will not suffer the same fate! I have heard of AR88s changing hands for anything between £25 and £125; even at the higher figure they must be a bargain. For the lower price one can expect no more than a "rough set" that will need a lot of attention to get it up to good working order, but it will still be a good investment. The following notes will enable the AR88 owner to carry out most of the electrical repairs without undue difficulty.

## General Description

The AR88D is a 15-valve superheterodyne covering 535kHz to 32MHz in six bands. It has two stages of r.f. amplification preceding the frequency-changer stage which employs separate mixer and local oscillator valves. There follow three i.f. amplifiers and detector and noise limiter stages. Audio frequency signals are amplified and passed to a single-ended output stage capable of delivering 2.5W undistorted, into loads of 2.5 and 600Ω. The power supply unit is built into the receiver and utilises a full-wave rectifier and voltage regulator. The mains transformer is tapped to accept inputs from 100V-117V, 117V-135V, 135V-165V, 190V-230V and 230V-260V. Power consumption is 100W. A socket at the rear of the receiver permits the use of a vibrator power supply unit with direct d.c. feed to the heaters, or batteries may be employed. The size of the set overall is 489mm wide by 279mm high and 489mm deep. The weight is around 50kg (1cwt). The sensitivity for 0.5W output is well under 1μV over most of the frequency coverage. The tuning is equipped with mechanical bandspread, and an antenna trimmer. The rest of the controls are: mode (off: transmit: receive mod: receive c.w.); band change; r.f. gain; selectivity;

a.g.c./noise limiter switch (manual gain alone: manual gain with n.l.: a.g.c. alone); noise limiter setting; tone.

## The Circuit

The antenna input may be from long-wire or dipole antenna via sockets at the rear of the receiver. Separate r.f. transformers for each band couple the signals to the control grid of the 1st r.f. amplifier (V1, 6SG7). The cathode of this valve is earthed, negative grid bias being employed. The level is established by the manual r.f. gain control, which also acts on the 2nd r.f. amplifier and the 1st and 2nd i.f. amplifiers, with a fixed minimum setting. The r.f. gain control is also connected into the a.g.c. system, as we shall see a little later.

Amplified signals appearing at the anode of V1 are passed on to the 2nd r.f. amplifier (V2, 6SG7) via r.f. transformers which have separate primary windings for the two lower frequency bands and a shared primary for the four higher bands. A similar arrangement is employed to couple V2 to the mixer valve (V3, 6SA7). Conventional cathode bias is used for this valve. Its oscillator grid is coupled to the anode of the local oscillator valve (V3, 6J5) via a small capacitor. Oscillator V3 works in a tuned-anode manner, with separate coils for each band wound in

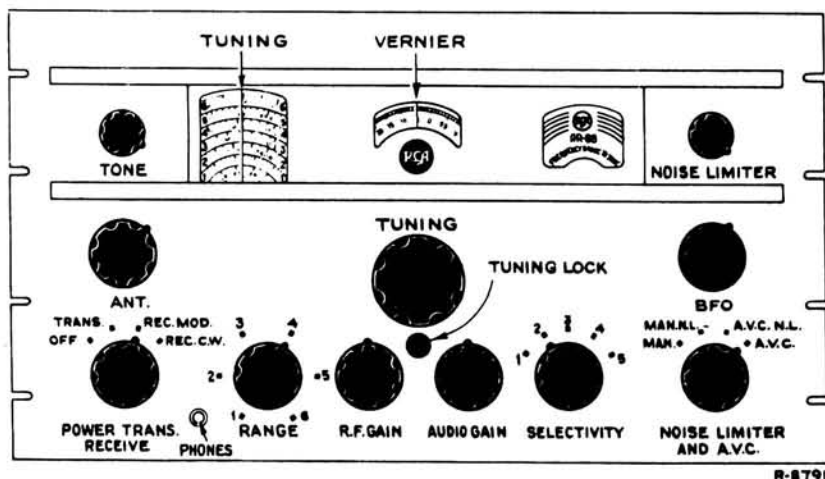

The AR88D front panel control layout

auto-transformer style. Local oscillator frequency is in all cases 455kHz higher than signal frequency.

Intermediate frequency signals appearing at the anode of the mixer valve are coupled to the 1st i.f. amplifier (V5, 6SG7) by a transformer of complex design which incorporates the optional crystal filter and variable-selectivity switching. Between V5 and the 2nd i.f. amplifier (V6, 6SG7) and V6 and the 3rd i.f. amplifier (V7, 6SG7) are transformers of a band-pass design plus the variable-selectivity facility. No a.g.c. is applied to V7, and it is operated with fixed cathode bias. It thus becomes, effectively, an a.g.c. amplifier, with beneficial results to the a.g.c. system as a whole. The b.f.o. (V12, 6J5) is coupled to V7 via a very small capacitance (twisted wire). Loose coupling of this nature helps to prevent the b.f.o. from becoming locked to the i.f., a situation which would result in no audible note being produced for c.w. work. Readers of this series will recall that problem was dealt with in the R1155 receiver by operating the b.f.o. at approximately half the intermediate frequency and using its harmonic to produce an audible note. Returning to the AR88, the level of output from the b.f.o. has been arranged to be just below that needed to initiate a.g.c. action, and thus switching it into circuit does not affect the gain of the receiver.

The detector is part of a double-diode valve (V8, 6H6) of which the other section operates as the a.g.c. delay diode. This part of the circuit is closely associated with the noise limiter (V9, 6H6) and it is recommended that the simplified diagram (Fig. 1) be studied in conjunction with the following description of how the system works.

The first section of V8 is a conventional diode detector for which the noise limiter control (R48, 66kΩ) and R49, 33kΩ in series act as load resistor. Audio frequency signals developed

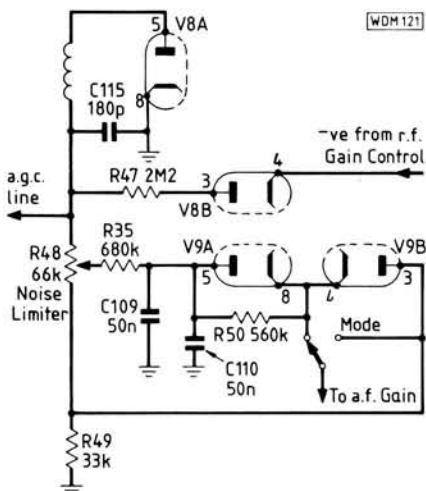

**Fig. 1: Simplified circuit diagram of the detector, a.g.c. delay diode and noise limiter circuitry**

*Practical Wireless, August 1987*

across R48, R49 are tapped off at their junction and fed to the anode of the second section of V9 and also to the section of the mode switch which operates as noise limiter in/out control. When the limiter is not required the a.f. signals are passed directly to the volume control and V9 plays no part in the operation of the receiver. When the limiter is switched in, a.f. signals can pass to the volume control only via V9B, and thus the amount of voltage on the cathode of this section will affect the passage of those signals; if it is raised sufficiently the diode will not conduct and the set will be muted. Looking at the R48, R49 combination it will be seen that of the d.c. voltage appearing across them due to the presence of a signal at the detector diode, only one third will be available at their junction and thus at the anode of V9B. When the noise limiter control is at minimum the voltage at the anode and cathode of V9A will be virtually the same as that at the anode of V9B and thus the latter valve will operate normally. When the control is advanced, however, the increase in voltage at the cathode of V9B will bring it to the threshold of cut-off. In this condition a sudden rise in voltage such as would be brought about by a burst of ignition interference will take it past the threshold and prevent any signal from passing through it. Since the duration of an ignition pulse voltage is brief compared to that of the a.f. signal the latter is not affected to any great degree. The absence of the characteristic crackling and popping of ignition and other impulsive interferences improves the intelligibility of the a.f. signals markedly. Once the level at which the limiter begins to operate has been set it will remain substantially constant until and unless the setting of the control is altered.

Now let us turn to the a.g.c. circuitry. In true American manner the voltage appearing at the signal diode load is used as a source of a.g.c. voltage and it will be seen to be filtered off by R47 and taken to the anode of V8B. The cathode of this valve goes to the manual r.f. gain control via R42 and consequently receives a negative bias dependent upon the setting of the control. This has the effect of delaying the a.g.c. action until the voltage at V8B anode exceeds that of its cathode. When manual gain control is used V8B is shorted out by a switch (S22) and the voltage from R46 is applied to the grids of the controlled valves via the a.g.c. line. Resistor R55, in series with the bottom end of the r.f. gain control establishes a fixed minimum bias voltage for the controlled valves.

Audio frequency signals appearing across R51, the gain control, are fed to the grid of V10 (6SJ7) which is a straight r.f. pentode operating as a voltage amplifier. High values of resistance are used to feed the screen grid and anode of this valve and it receives negative bias via R36, R37. The cath-

ode resistor R39 serves mainly to introduce negative feedback derived from the output transformer via R54. Incorporated in the coupling circuit between V10 and the output valve (V11, 6K6) is a simple top-cut tone control consisting of the capacitor C117 and the variable resistor R52. Note that the main coupling is by two capacitors (C118, C122) in parallel. Negative bias is again employed for V11.

The power supply section consists of a mains transformer suitable for inputs of between 100V and 250V, 50/60Hz, a full-wave rectifier (V14, 5Y3GT) and choke-capacitance smoothing for the h.t. line. In addition there is a voltage regulator (V13, VR150) to provide a stable 150V supply for the local oscillator. All valve heaters (save that of V14) are connected in parallel and fed from a single winding on the mains transformer. Interposed between the power supply section and the receiver proper is a plug and socket device which permits the operation of the receiver on batteries if necessary. When the plug is withdrawn another may be inserted to feed in the heater and h.t. supplies from an external source, the internal supplies being automatically disconnected (although the smoothing arrangements remain in circuit).

## Servicing the AR88

Despite the apparent complexity of the circuit and that of the under-chassis wiring when looked at for the first time, the AR88 is reasonably easy to service, provided that a logical approach is made. In the case of complete silence or weak signals it will be fairly straightforward to localise faults into either the r.f./mixer, i.f. detector/output or power supply sections by the usual signal extraction or injection techniques employing a signal tracer or generator respectively. If this is followed by voltage checks on the suspected stage(s) the root of the trouble should not be long in coming to light. As with all vintage radio sets, the probability of some of the coupling and decoupling capacitors having become "leaky" must be considered. Because of the somewhat unusual bias arrangements in this receiver extra care is called for in testing these components, as will be explained.

From practical experience the author has found that many persons otherwise fairly familiar with radio sets have difficulty in dealing with the negative smoothing/bias circuitry that was used in many domestic as well as communications sets. The arrangement of the smoothing capacitors in particular seems to cause head-scratching. What has to be borne in mind is that in such circuits there is always a resistance of some kind between the centre-tap of the mains transformer h.t. winding and earth. This may take the form of one or more resistors, or of the actual smoothing choke or loud-

**Fig. 2: Complete circuit diagram.**  
 Note that the valves are drawn up-  
 side-down compared to the usual  
 convention

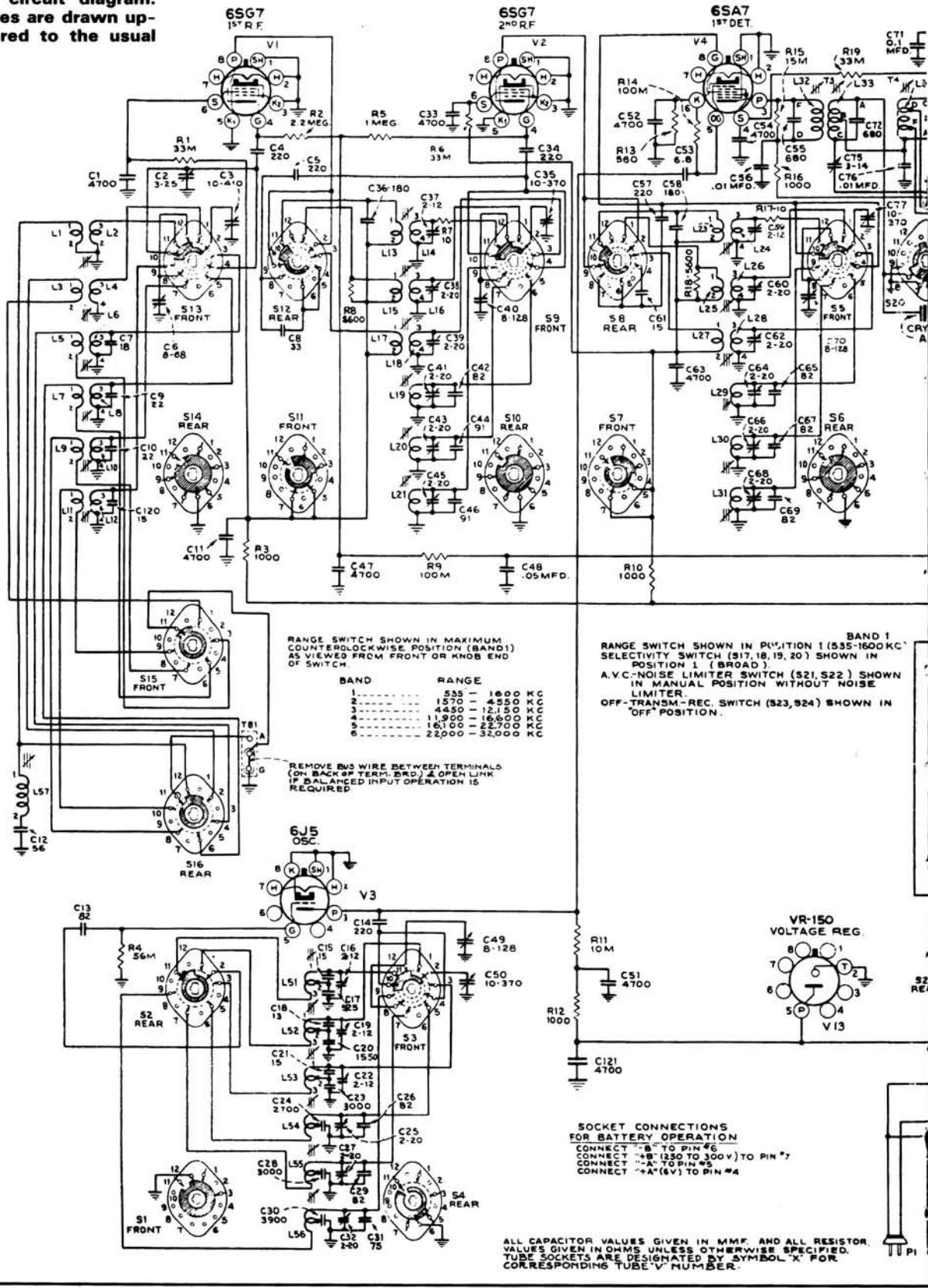

speaker field. Whatever it is, its junction with the h.t. centre-tap will be at a certain voltage negative with respect to chassis. In most case the negative terminal of the h.t. reservoir capacitor will be taken to that junction and **not to chassis**. It is essential that this arrangement be followed when capacitors are replaced, or the result will be a powerful mains hum in the loudspeaker and low h.t. because the reservoir just won't be working properly. In some

cases the capacitors, if in a multiple block or can, may have a separate negative lead for the reservoir, whilst in others there may well be a separate capacitor together in this position, with its case insulated from the chassis. Occasionally the negative of the reservoir may be earthed, with a large value electrolytic connected between the h.t. centre-tap and chassis. This is not a very popular arrangement however and those just described are far more

likely to be found in elderly sets. With a source of negative voltage available it is common practice for potential dividers to be fitted to give suitable bias voltages for different parts of a receiver. In the case of the AR88 the divider is made up of R43, R44 and R45. Note the way in which the smoothing capacitor negatives are connected. Because negative bias is applied to the grid of the output valve this may mask the effects of a leaky

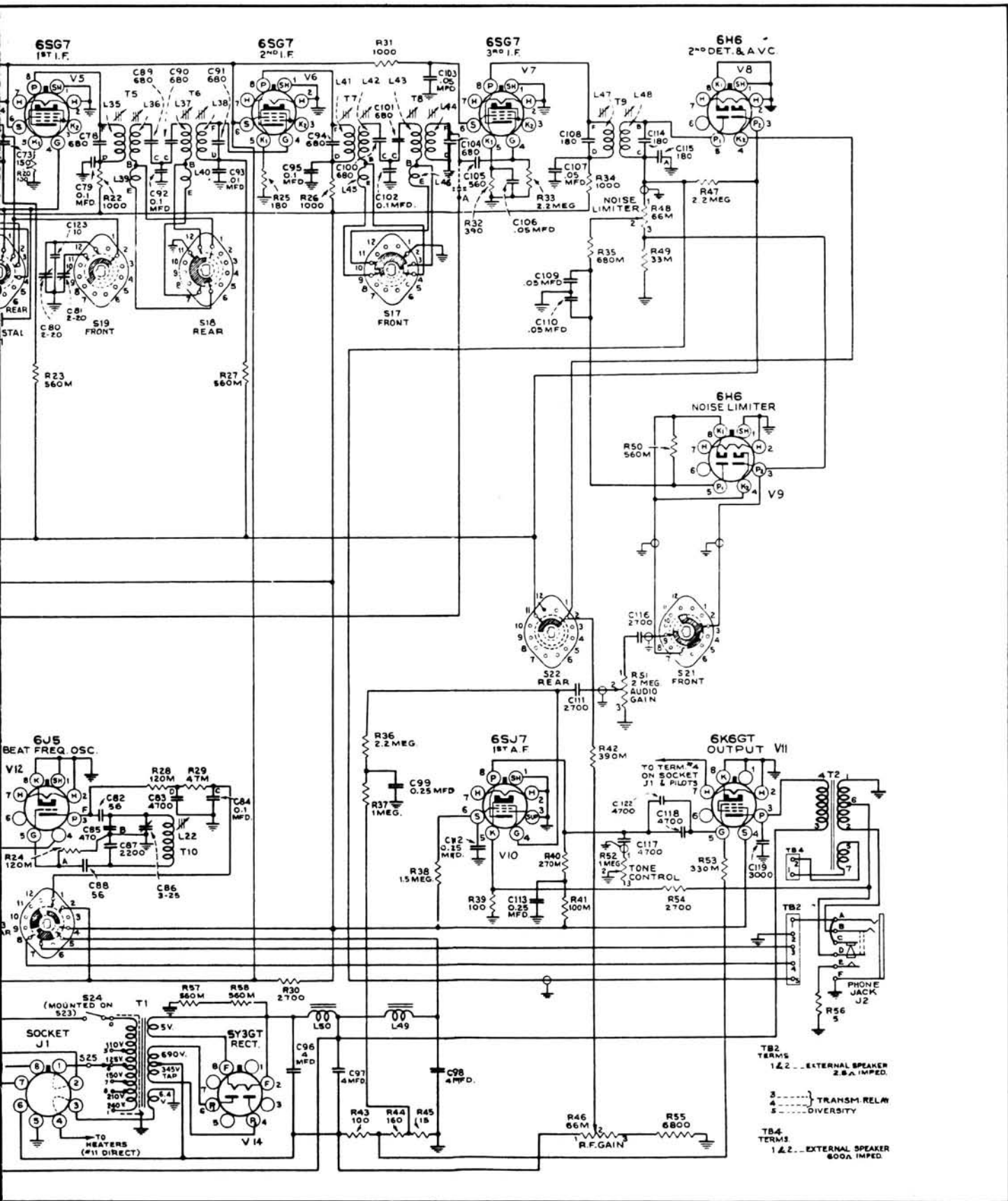

coupling capacitor if the grid voltage is checked—it may well show a negative reading on the meter, but this may not really be sufficient. This is where the standard check of shorting the anode of the previous valve to chassis whilst measuring the h.t. voltage comes into play. If a leaky coupler is reducing the bias by feeding through positive volts, the h.t. will inevitably be affected by the output valve drawing heavy current. The shorting test will most cer-

*Practical Wireless, August 1987*

tainly show up such a fault. On the other hand, decoupling capacitors on the negative line must be without leaks as well, because with rather high values of resistor being used for decoupling any slight short to chassis can have serious consequences. At the same time the values of the resistors must be spot-on to give the correct bias for each valve. In the AR88 this means that the capacitors on the a.g.c. line, which also carries the negative bias for the con-

trolled valves, must be in good order. All this may sound somewhat daunting, but thanks to modern high resistance test meters the task of checking bias voltages has become a lot simpler than in the days of the 1000 ohms per volt type which represented the best available for many years! If in doubt, and you haven't a capacitance bridge which will apply voltage checks to capacitors, replace those suspected to obviate further trouble.

ANTENNA COIL INDUCTANCE  
ADJUSTMENTS FOR  
FREQUENCY BANDS

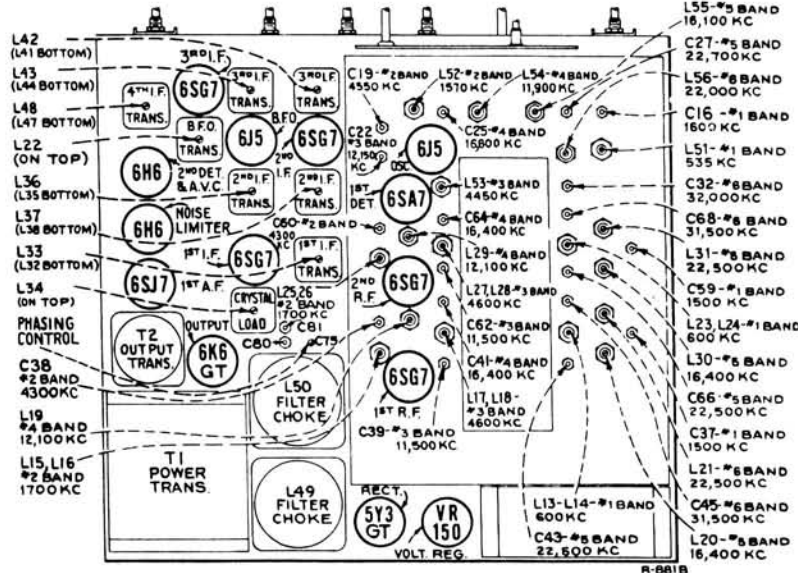
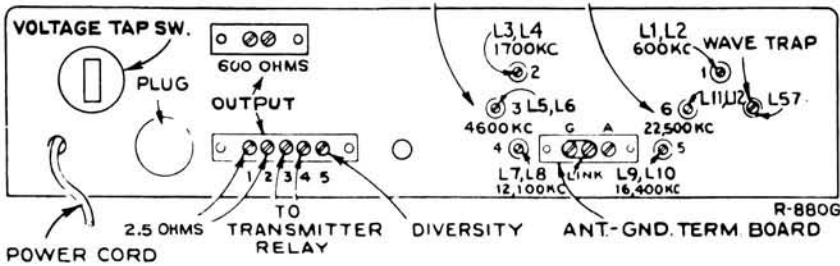

Fig. 3: Layout and alignment points on the rear and top panels of the chassis

The order in which alignment is carried out, and frequencies used, are shown in the table, and the locations of the trimmers are shown in Fig. 3. An accurate signal generator is a must, and something to watch out for when it is connected to the set is that no d.c. path shall exist across the leads. This is to prevent a bias voltage from inadvertently being shorted to chassis when the signal is applied to the grid of a valve. RCA recommend that a 0.1µF capacitor be inserted in series with the "hot" generator lead. Note too, that the makers specify that a wobulator and oscilloscope should be used for i.f. alignment, and give no specific instructions for the use of an ordinary a.m. generator. In cases of dire necessity one could peak up the trimmers with an output meter and a 455kHz input, but if there is no good reason to suspect misalignment leave well alone is the motto until the proper test gear becomes available!

Another little true tale to end with: the author received a letter from a *Practical Wireless* reader in Malaysia who had witnessed Allied troops dumping surplus AR88 receivers in a river. (Makes one feel sick, doesn't it!) After a suitable interval, when it became safe to do so, certain persons rescued the sunken sets and found that once drained of water they functioned perfectly. The ultimate "soak" test? **PW**

RF ALIGNMENT PROCEDURE

Step	Range	Set Dial	Generator Frequency	Set Antenna Trimmer	Trim for max. output
1	1	i.f. end	535kHz	—	L51
2	1	h.f. end	1.6MHz	—	C16
3	Repeat 1 and 2 until extreme end frequencies are as indicated				
4	1	1.5MHz	1.5MHz	Max. output	C37,C59
5	1	600kHz	600kHz	Untouched	L2,L14,L24
6	Repeat 4 and 5 until circuits remain in alignment over the band				
7	2	i.f. end	1.57MHz	—	L52
8	2	h.f. end	4.55MHz	—	C19
9	Repeat 7 and 8 until extreme end frequencies are as indicated				
10	2	4.3MHz	4.3MHz	Max. output	C38,C60
11	2	1.7MHz	1.7MHz	Untouched	L4,L16,L26
12	Repeat 10 and 11 until circuits remain in alignment over the band				
13	3	i.f. end	4.45MHz	—	L53
14	3	h.f. end	12.15MHz	—	C22
15	Repeat 13 and 14 until extreme end frequencies are as indicated				
16	3	11.5MHz	11.5MHz	Max. output	C39,C62
17	3	4.6MHz	4.6MHz	Untouched	L6,L18,L28
18	Repeat 16 and 17 until circuits remain in alignment over the band				

Step	Range	Set Dial	Generator Frequency	Set Antenna Trimmer	Trim for max. output
19	4	i.f. end	11.9MHz	—	L54
20	4	h.f. end	16.6MHz	—	C25
21	Repeat 19 and 20 until extreme end frequencies are as indicated				
22	4	16.4MHz	16.4MHz	Max. output	C41,C64
23	4	12.1MHz	12.1MHz	Untouched	L8,L19,L29
24	Repeat 22 and 23 until circuits remain in alignment over the band				
25	5	i.f. end	16.1MHz	—	L55
26	5	h.f. end	22.7MHz	—	C27
27	Repeat 25 and 26 until extreme end frequencies are as indicated				
28	5	22.5MHz	22.5MHz	Max. output	C43,C66
29	5	16.4MHz	16.4MHz	Untouched	L10,L20,L30
30	Repeat 28 and 29 until circuits remain in alignment over the band				
31	6	i.f. end	22.0MHz	—	L56
32	6	h.f. end	32.0MHz	—	C32
33	Repeat 31 and 32 until extreme end frequencies are as indicated				
34	6	31.5MHz	31.5MHz	Max. output	C45,C68
35	6	22.5MHz	22.5MHz	Untouched	L12,L21,L31
36	Repeat 34 and 35 until circuits remain in alignment over the band				

NOTES:

1. Dummy antenna 200pF on Range 1; 200Ω elsewhere.
2. Set tone and gain controls fully clockwise.
3. Set power switch to position 3.
4. Set NL/AVC switch fully clockwise.
5. Generator modulation 30% at 400Hz.
6. Connect output meter across speaker voice coil.
7. Before aligning Range 1, apply a modulated 455kHz signal to the antenna input and tune the i.f. wave-trap trimmer L57 for minimum output.

SWAP SPOT

Have Hugh Cocks u.h.f. to v.h.f. Band I/III TV upconverter, Band I/III pre-amplifier, B2 notch filter v.g.c. Would exchange for any Spectrum computer, parts of CB equipment. Dave. Tel: 051-336 5614. **C967**

Have FT-75 plus d.c. and a.c. p.s.u. and v.f.o. (not working on 21MHz only). Would exchange for radio equipment, w.h.y? or small linear amp, 3.5-28MHz. Dale. 2/1 1 Dunphail Road, Glasgow G34 0BX. **C968**

Have hi-fi speaker stands and a.m. car radio. Would exchange with cash adjustment for single channel 430MHz f.m.

receiver or transceiver working on RB14, converted p.m.r. base or mobile set, ideal (not pocketfones). G4OHB. Tel: 021-449 3530. **C970**

Have Zenith 2 camera outfit. Would exchange for a 144MHz multimode. T. Williams, 51 Alemein Drive, Winsford, Cheshire CW7 1DG. **D002**

Have Colour Genie computer, RTTY transceiver, c.w. receive, split screen, type ahead, hand books, tapes, recorder, b/w portable. Would exchange for commercial power supply 13.8V 20A. D. W. Noel Thomas G3ZLN. Tel: 49139. **D009**



# CRICKLEWOOD ELECTRONICS LTD

## It's no secret!

**FREE!**  
catalogue

**SUMMER EDITION**  
HUNDREDS OF LOWER PRICES,  
HUNDREDS OF NEW DEVICES.

that there is a real difference at Cricklewood Electronics. That's why you should never be without the FREE CRICKLEWOOD ELECTRONICS COMPONENTS CATALOGUE, for sheer variety, competitive prices and service from the U.K.'s number one 100% component shop. No gimmicks, no gadgets or computers, just components, millions of them, all easily available by mail order, calling or credit card telephone orders. Just pick up the phone for a pen to get your FREE copy now (no SAE required). You have nothing to lose.

**CRICKLEWOOD ELECTRONICS LTD.**  
40 Cricklewood Broadway NW2 3ET  
01-450 0995 & 01-452 0161  
ALL MAJOR CREDIT CARDS ACCEPTED  
Telex 914877 Phone or write today

# WINCHESTER COMMUNICATIONS

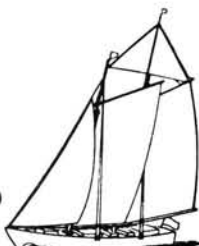

**ICOM** AUTHORISED AGENT

## PMR - AMATEUR - MARINE

WINCHESTER COMMUNICATIONS is pleased to announce that, with immediate effect, we have been appointed agents for ICOM Amateur, P.M.R. and Marine Radio Equipment and CAPCO antenna products. We aim to provide the best service to Radio Amateurs in Southern England.

### ICOM IC-28E - ON THE ROAD FOR LESS

**ARE YOU SENSITIVE?**  
ICOM IC-28E is - look . . .



- \* Better than .18uV for 12dB SINAD
- \* Auto dimmer on LCD backlight
- \* 21 Memory channels
- \* 12.5/25 KHz resolution
- \* Optional IC-HM17 Speaker/Mic and SP10 Speaker
- \* Optional HS15 Flexible Mic and PTT switchbox.
- \* £359.00 inc. (P&P £3.75)
- \* IC28H available - 45W output - £399.00 (P&P £3.75)

Ex stock CAPCO SPC 300D ATU 1KW P.E.P. £225.00 inc.  
SPC 3000D ATU 3KW P.E.P. £325.00 inc.  
P&P on ATUs £7.50

**Trinder House, Free St., Bishops Waltham, Hants SO3 1EE**  
**Tel: 04893 3404**  
TLX: 265871 MONREF  
72:MAG 30407

### VALVES

\*High Quality      Prices correct as at 7/4/1987  
\*\*Very High Quality      but may fluctuate. 15% VAT incl

A1065	1.40	EF89	0.80	EF86	1.25	EY51	0.90	PFL200	1.10	UBF89	0.70
A233	7.00	EC52	0.65	EF89	1.60	EY81	0.75	PFL200*	2.80	UCC84	0.85
A2900	12.75	EC91	4.40	EF91	1.60	EY86-87	0.60	PL36	1.10	UCC85	0.70
AR8	1.15	EC92	1.85	EF92	2.15	EY88	0.65	PL81	0.85	UCC82	2.50
ARP3	1.15	EC81	0.95	EF95	0.95	EZ80	0.70	PL82	0.70	UD81	0.75
ARP35	0.70	EC82	0.95	EF96	0.60	EZ81	0.70	PL83	0.60	UD82	1.60
ATP4	0.90	EC83	0.75	EF83	0.75	GM4	0.90	PL84	0.90	UF41	1.35
B12H	6.90	EC84	0.80	EF84	0.75	GV50	1.30	PL84A	1.25	UF80	1.60
CY31	1.40	EC85	0.75	EF812	0.75	GZ32	1.40	PL508	2.00	UF80	1.60
DAF70	1.75	EC88	0.80	EF1200	0.85	GZ33	4.20	PL509	5.65	UF85	1.20
DAF96	0.75	EC189	0.95	EF90	0.85	GZ34	1.40	PL519	5.85	UL84	0.95
DE122	32.80	EC304	0.65	EL32	0.85	GZ34*	3.80	PL82SE	3.45	UM60*	1.60
DF32	0.65	ECF80	0.95	EL34	2.10	GZ37	3.95	PY80	0.70	UM84	0.70
DF96	0.70	ECF82	0.95	EL34*	4.55	K166*	15.50	PY81-800	0.85	UY82	0.70
DFH6	0.75	ECF802	1.80	EL82	0.70	K177*	14.00	PY82	0.75	UY85	0.85
DL32	1.10	ECM42	1.20	EL84	0.95	K188	11.00	PY88	0.60	VR100-30	1.45
DY86-87	0.65	ECH81	0.70	EL86	0.95	K188**	25.00	PY500A	2.10	VR150-30	1.80
DY802	0.70	ECH84	0.80	EL90	1.75	ML4	3.20	QDV03-10	5.95	X61M	1.70
EQCC	2.80	ECL80	0.65	EL91	6.50	ML6	3.20	QDV03-10*	7.50	X66	1.80
E180CC	11.50	ECL82	0.75	EL96	1.25	MY120-01	29.50	QDV03-20A	27.50	Z749	0.75
E1148	0.58	ECL85	0.75	EL504	2.70	N48	5.90	QDV06-40A	28.50	Z759	19.00
EAT6	1.60	ECL86	0.90	EL509	5.85	OA2	0.70	QDV06-40A*	49.50	Z8000	3.45
EB34	0.70	EF9	3.50	EL519	7.70	DB2	0.80	QDV03-12	5.75	Z801U	3.75
EB91	0.60	EF22	2.90	EL821	8.45	PCL82	1.95	QY01	1.80	Z803U	18.50
EB333	1.85	EF37A	2.15	EL822	9.95	PCL84	0.85	TT21	37.50	Z9007	2.45
EB30	0.90	EF80	0.85	EL180SE	4.50	PCL86	0.80	TT22	37.50	IA3	2.75
EB391	0.90	EF83	3.90	EM80	0.80	PCL86-85	0.95	UABC80	0.75	IL4	0.65
EB80	0.95	EF85	0.60	EM87	2.50	PS500-510	4.30	UBF80	0.70	IR5	0.80

VALVES AND TRANSISTORS Telephone enquiries for valves, transistors, etc. Retail 749 3934, trade and export 743 0899  
POSTAGE: £1-£3 55p, £3-£5 85p, £5-£10 85p, £10-£15 £1.05, £15-£20 £1.60 Minimum order £1.00. Delivery by return

**COLOMOR (ELECTRONICS LTD.)** 170 Goldhawk Rd, London W12  
Tel: 01-743 0899 or 01-749 3934. Open Monday to Friday 9 a.m.-5.30 p.m.

# SALE PRICE T.E.T. ANTENNAS

— WHERE A  
GOOD DEAL MORE  
COSTS A GOOD  
DEAL LESS!!!

## NOT TO BE REPEATED!!

First come,  
first served!

<b>MV3BH</b>	3 BAND TRAP VERTICAL NO RADIALS	<b>£29.00</b>	<b>HB210S</b>	10 ELEMENT 2 METRE YAGI BEAM	<b>£19.50</b>
<b>MV4BH</b>	4 BAND TRAP VERTICAL NO RADIALS	<b>£39.00</b>	<b>HB15M3SP</b>	3 ELEMENT MINI YAGI BEAM 21MHZ	<b>£49.00</b>
<b>MV3BHR</b>	3 BAND TRAP VERTICAL WITH RADIALS	<b>£39.00</b>	<b>HB20F2SP</b>	2 ELEMENT MONOBANDER YAGI BEAM 14MHZ	<b>£89.00</b>
<b>MV4BHR</b>	4 BAND TRAP VERTICAL WITH RADIALS	<b>£59.00</b>	<b>HB20F4SP</b>	4 ELEMENT MONOBANDER YAGI BEAM 14MHZ	<b>£99.00</b>
<b>TE214</b>	2 METRE 14 ELEMENT YAGI	<b>£29.00</b>	<b>SQ10</b>	2 ELEMENT SWISS QUAD 28MHZ	<b>£39.00</b>
<b>HB15F2T</b>	2 ELEMENT YAGI BEAM 21MHZ	<b>£49.00</b>	<b>HB20M3SP</b>	3 ELEMENT MONOBANDER YAGI BEAM 14 MHZ	<b>£95.00</b>
<b>HB15M2SP</b>	2 ELEMENT MINI BEAM YAGI 21MHZ	<b>£49.00</b>	<b>QYU10</b>	10 ELEMENT 70CMS QUAGI BEAM	<b>£15.99</b>
<b>HB15F3T</b>	3 ELEMENT YAGI BEAM 21MHZ	<b>£59.00</b>	<b>SQ007</b>	2 ELEMENT 70 CMS SWISS QUAD	<b>£19.99</b>
<b>HB20F3SP</b>	3 ELEMENT MONOBANDER YAGI 14MHZ	<b>£79.00</b>	<b>SQ22</b>	2 ELEMENT 2 METRE SWISS QUAD	<b>£19.99</b>
<b>HB32SP</b>	3 ELEMENT YAGI BEAM 21 AND 28MHZ	<b>£79.00</b>	<b>SQY06S</b>	6 ELEMENT 2 METRE QUAGI BEAM	<b>£23.99</b>
<b>SQY08S</b>	8 ELEMENT 2 METRE QUAGI BEAM	<b>£21.50</b>	<b>SQ15</b>	2 ELEMENT SWISS QUAD	<b>£29.99</b>
<b>MLA4</b>	4 BAND MINI LOOP 3.5 7 21 AND 28MHZ	<b>£39.00</b>	<b>SQ61</b>	2 ELEMENT SWISS QUAD 50MHZ	<b>£39.00</b>
<b>AX210N</b>	10 ELEMENT CROSSED YAGI BEAM	<b>£35.00</b>	<b>SSL218</b>	9 ELEMENT OVER 9 2 METRE BEAM	<b>£28.95</b>
<b>HB102FT</b>	2 ELEMENT YAGI BEAM 28MHZ	<b>£49.00</b>	<b>SSL720</b>	9 ELEMENT OVER 9 70 CMS BEAM	<b>£28.95</b>

\* CARRIAGE EXTRA      All orders on first come first served until stock exhausted.  
ALL ABOVE AT £6.50 via Securicor.      PLEASE TELEPHONE BEFORE ORDERING TO ENSURE STOCK AVAILABLE.

MANY OTHER ITEMS ON SALE THIS MONTH, PLEASE TELEPHONE YOUR REQUIREMENTS.

Shop opening hours  
9.30-5.00pm  
— Closed Mondays

# Amcomm of London



373 Uxbridge Road, London W3 9RN. Tel: 01-992 5765/6. Telex: 24263 Fax: 01-861 2591

# E. V. Appleton from Personal Acquaintance

Let us for a moment go back fifty years to the time when, with his wife and daughters, E. V. Appleton lived in the upper two floors of a large house, 30 Chesterford Gardens near Hampstead Heath and a short walk from the Tube station from where he was in easy reach of King's College in the Strand. The ground floor of that house contained the library and two laboratories while the basement housed a third laboratory, the darkroom and our workshop-cum-kitchen.

It was all supported by the Halley Stewart Trust and known as the Halley Stewart Laboratory. He enjoyed a game of table tennis and he would, on returning from College in the evening, often involve one or other of the better players in a keen game on the ping pong table which was one of the chief features of the basement laboratory. The ground floor laboratories each contained a wireless receiver consisting of large metal lined boxes with carefully screened compartments containing the various stages of that new-fangled thing the superhet.

There were three tuning dials to be kept in step as the frequency of the pulse transmitter on the roof of King's College Annexe was progressively varied, while the receiver output was fed to a gas-filled self-focusing Cossor c.r.t. with a bread boarded time-base and a directly heated cathode operating at  $-2\text{kV}$ , and therefore stood on a large block of paraffin wax under the table—for safety!

E. V. Appleton at the time was particularly interested in the circularly polarised ordinary and extra-ordinary waves, the split echo occurring near the critical frequency of F2 region, while we in the other laboratory were engaged in the first ever measurement and publications<sup>(1)(2)</sup> regarding ionospheric absorption and quantitative evidence of the existence of a D region. E. V. Appleton would sometimes burn some of the midnight oil with us before retiring upstairs, then re-appear around 6am or earlier, clean shaven, spruce and breakfasted, with pipe in mouth and a few comments, albeit friendly, regarding our stubble and black coffee.

He had a dedicated approach to

*Dr. L. W. Brown GOFFD  
takes a look at the life of  
Prof. E. V. Appleton.*

everything he undertook. In his research, administration of the Physics Dept and lectures to honours students on Modern Electrical Theory he was ever approachable, helpful, friendly and chatty, and admired and respected by all his students. Above all he had "presence" be it in the college lecture theatre, in private discussion or in a Royal Society meeting. The author's first experience of that "presence" was as a prospective undergraduate sitting the other side of the desk from the Dean of the Science Faculty at King's College, London. The reader can readily imagine this young man's buoyant response when two or three years later E. V. Appleton then asked him "How would you like to do wireless with me?"

E. V. Appleton was a gifted individual, an energetic leader and always completely self-assured. He was no quiet back room boy, rather was he outspoken and a commanding personality. His place in history owes as much or more to that personality as to what he did and accomplished.

At King's and of incidental historical interest, he followed past eminence: Clark Maxwell who had first predicted the existence and the nature of electric waves and Charles Wheatstone of Wheatstone Bridge fame had each in his time occupied the chair which E. V. Appleton now held, while E. V. Appleton's immediate predecessor O. W. Richardson, Nobel prizewinner and Yarrow Research Professor of the Royal Society, was still actively engaged on research in the college in his own special field, namely thermionic emission of electrons from hot cathodes.

From King's College E. V. Appleton also supervised and conducted much of the work of the Radio Research Station at Slough, today known as the Rutherford-Appleton Laboratory. But while his pioneer work and leadership in ionospheric matters and radio wave



propagation are now widely understood and acknowledged, it is not so well known that he was also interested in the study of atmospheric electricity and the mapping and theory of thunderstorms. He was earlier also closely involved in the theory and operation of thermionic vacuum tubes, i.e. wireless valves. He developed the theory of valve oscillators and also wrote a book on valves, one of a series of Methuen Monographs on Physics with which he was directly concerned.

Following the experiments of Marconi and the suggestions of Kenelly and Heaviside that wireless waves may be reflected back to ground from some altitude above earth, E. V. Appleton, at the age of 32, devised and carried out experiments to test the suggestion<sup>(3)</sup>. Those early experiments used the frequency-change method in which the frequency of a c.w. transmitter is varied by a small amount. The sky wave being later on arrival at the receiver will therefore lag the ground wave in phase or frequency and the difference is a measure of the path length of the sky wave from which the existence and apparent height of the reflecting region can be determined.

The use of pulse techniques in radio echo sounding was developed by the Americans Breit and Tuve<sup>(4)</sup> the year following E. V. Appleton's first experiments but whereas they did not fully exploit this powerful tool, E. V. Appleton immediately adopted the method and used it in what he called  $P^1/f$  measurements, i.e. apparent ionospheric height versus frequency of transmission, the classic method of ionospheric investigation now used all over the world. Today, his apparatus is called an ionosonde, and the results an ionogram. In this way he investigated E, F1 and F2 regions and their variation with solar radiation, aurora and sunspots activity in experiments at Slough, Tromsø and Hampstead.

*Practical Wireless, August 1987*

In parallel he developed the complex magneto-ionic theory of electromagnetic fields and wave propagation in an ionised medium in the presence of a magnetic field. He had over the years the assistance of a number of research students, Barnett, Green, Builder, Taylor, Pulley and others, each of whom made their contribution. Like most pioneers, he also had a number of contemporaries, Eccles, Eckersley (T. L.), Chapman, Hartree and others who each made a contribution but were in fact drawn along by the trail blazer.

He left King's College and Hampstead in the summer of 1936, and that was a puzzle to some because it appeared to end a brilliant era and bequeath the subject through default to lesser individuals. He had created the subject of upper atmospheric physics, then appeared to leave it to others to pursue. Since they were not his equal, he appeared to leave a partial vacuum. He became a Fellow of St John's College, Cambridge, a functionary and

dignitary first at the DSIR then as Principal of Edinburgh University, seemingly strange for so gifted a scientist. One wonders, for we shall never know, did he miss his way that day when at only 44 years of age he left London and Hampstead or was it deliberate, was he calling it a day?

He later became KCB and a Nobel prizewinner. The author saw him two or three times in the later years, on an anti-aircraft gun site, in his Edinburgh days and at an IEE dinner. E. V. Appleton, affectionately "the Prof", a Yorkshireman, was a man of great character, a friendly person it was a privilege and a pleasure to know in those, now far off, intensive professional and ionospheric days.

### Personal Note

Dr. Brown was Professor Appleton's last research student while still at King's College. He also left King's College in that summer of 1936, as did Dr. F. W. G. White, the latter to

become Professor of Physics at Canterbury University College, Christchurch, New Zealand. For this reason that early work on absorption and the nature of D region abruptly ended.

### References

(1) *Some Measurements of the Reflexion Coefficient of the Upper Atmosphere For Wireless Waves*, by F. W. G. White and L. W. Brown. Proc Royal Society, 1936.

(2) *Studies of the Absorption of Wireless Waves in the Ionosphere*, by L. W. Brown. University of London PhD Thesis 1936.

(3) *Local Reflexions of Wireless Waves from Upper Atmosphere*, by E. V. Appleton and M. A. F. Barnett. Nature 1925.

(4) *A Radio Method for Estimating the Height of the Conducting Layer*, by G. Breit and M. A. Tuve. Nature 1925.

PW

30 ▶

## QL News

As always I have made every effort to bring you news of applications covering as many micros as possible but despite this activity in the QL area seems to be limited. I find it rather surprising, since in USA, where QLs are available in kit-form at give-away prices (£120), they are being snapped up by thousands. Many are already in use on Packet Radio and there is a rumour of a complete SSTV system. Don't enquire yet—since I have nothing further on this.

I was, through the SARUG newsletter, able to pass on a little QL software which may be of wider interest see reference (vii). It is as follows:

- (a) a terminal program for use with the Minor Miracles WS2000 modem although suited to others, no doubt.
- (b) a simple Morse decoder (F LeMay).
- (c) a terminal program for the GLB AX25 board or ASCII comms via a modem (courtesy G6TJT).
- (d) ATV captions generator (NOT SSTV!!!) (courtesy G6TJT).
- (e) Morsetutor—(courtesy G6TJT).

## The Spectrum 128K Plus-2

Users of this micro will be unable to use interfaceless programs due to the lack of an EAR socket through which to feed the audio. Neill G4HLX has come up with an excellent modification to add this feature simply and effectively which he published through SARUG recently; part two of this

*Practical Wireless, August 1987*

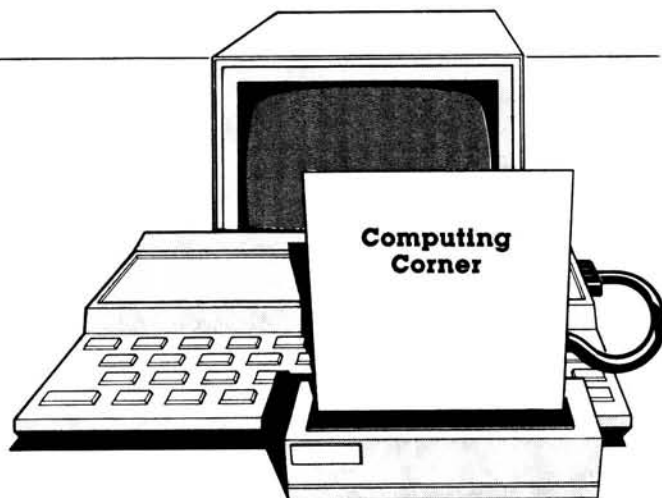

describes fully screening the micro for a.f and r.f.i. and will be published in issue 27.

I also believe that a plug-in module is available which adds an EAR socket although I've been unable to locate precise details yet. I'm told that it plugs into the edge-connector and if this is so then it might interfere with other peripherals. Perhaps someone can tell me differently.

### Odds and Ends

Quite a lot of interest has been generated by the mention last time of the Spectrum-West antenna control system. I know that several enquiries are in hand, so please do let me know the result of these.

Users of an early version of GM4IHJ's "EQXER" program should contact G4INP for a small bugfix—unnecessary if you obtained the copy after mid-April 1987.

### References

(i) Jim Luck G0BTG, 11 Deanswood View, Leeds LS17 5JX. Include a stamped addressed envelope for use as a return label. Pack disk securely please.

(ii) Wardhill Translations, Kirkjuvagr, Galaha, Orphir, Orkney KW17 2RB.

(iii) Paul Newman G4INP, 3 Red House Lane, Leiston, Suffolk IP16 4JZ. Sae required.

(iv) SRW Communications Ltd, Astrid House, The Green, Swinton, Malton, N. Yorks YO17 0SN.

(v) ASTRID/UO1 and ASTRID/UO2 address as (iii).

(vi) Pearson Computing, 42 Chesterfield Road, Barlborough, Chesterfield, Derbys S43 4TT.

(vii) via G4INP, enclose formatted QL cartridge and return postage. Please pack cartridges securely, only 1 required.

# Practically Yours

by Glen Ross G8MWR

## Lightning Strike?

One thing that most amateurs have worried about at some time or another is protecting the station from lightning. Some wonder whether it is a big enough risk even to need to bother about at all or whether it should be left to luck. The whole subject is beset with superstition and old wives' tales, you know the sort of thing. Never stand by an open window because lightning follows a draught; lightning can't go around corners; it always follows the shortest path and it never strikes twice in the same place.

The weirdest advice I have received is not to play the piano in a thunderstorm because lightning is attracted to sound. If that is true then it is the only thing that likes my piano playing!

## What Causes It?

Lightning is just a gigantic spark between an electrically charged cloud and the earth or another cloud. The storms are of two types, convectional or frontal. In the convectional type, heated surface air rises into the colder air above it. In the frontal type, a mass of cold air coming in on the front rides over the warmer air below. In both cases a very unstable condition is set up, causing condensation and the formation of a thunder cloud. A very large charge is set up in which the underside of the cloud usually assumes a negative potential and the upper surface goes positive with respect to earth.

## The Mechanism

The flash that you see is in fact not a single stroke but a complicated occurrence. First, when the charge in the clouds builds up to a suitable level, a pilot or leader stroke travels towards the earth at a speed of around 160km per second. This leader stroke only carries a current of a few amps but is quickly followed by more strokes of rapidly increasing intensity. When the leaders reach the ground the current increases enormously and the main stroke then flows from the ground up to the cloud and may often have a current in excess of 200 000A. This main stroke is then followed by a dart stroke which finally drains the available energy. What we see as a single stroke may in fact consist of up to forty individual events.

## The Risks

The chances of your mast getting struck obviously depend on the fre-

quency of lightning storms in your area and these figures are not easy to obtain. On a world-wide basis it is estimated that there are around 50 000 storms a year and a total of about nine million strikes per day.

From figures that are available it would seem that the average over the UK is around fifteen storms a year in any given locality. It can be assumed that there are likely to be two strikes per thunderstorm in every 2.5 square kilometres of ground although figures of up to 45 strokes have been recorded. The higher an object is the more likely it is to get hit and in theory a 15m tower in an area having fifteen storms per year is likely to get hit once every eight years. For a 30m tower the chances are about one strike every five years. In actual fact the chances are likely to be less because the mast itself can provide a degree of protection.

## Induction Effects

We usually worry about the actual effects of a direct hit but we can also get serious trouble from strikes at considerable distances from us. Operators using h.f. will know that even a storm at a distance of 160km or more can cause considerable noise problems. The electrical field surrounding a storm can produce some really startling figures. For example, a plastics coated metal clothes-line running about 2m above ground was found to have an induced charge of nearly 15kV per metre when there was a lightning strike 5km away. This sort of thing could easily blow the front end of your receiver if you do not have suitable protection installed.

## Suitable Protection

For the purposes of this section we will consider towers and metal masts to be the same thing. A well-grounded mast will give a "zone of protection" around it and tests have shown that this zone is about three times the height of the structure, so an 18m mast would give protection in a 27m radius or more around it. These figures assume that the mast is higher than other objects within the zone.

A tower embedded in a concrete block is not a grounded structure and effective earthing must be provided. The best time to do this is before you pour in the concrete. The grounding electrodes should be buried below the permanent moisture level and may consist of a metal plate at least one

metre square or two or three earth rods. If rods are used they should be at least 12mm in diameter and about 2.5m long. An inexpensive alternative is to use two or three old car wheels which you can rescue from a scrap yard.

## Connecting

The connections to the earthing metal should be made using heavy gauge wire and for safety more than one wire should be provided. All the underground connections should be well waterproofed so as to avoid corrosion and breakage. If you are using old wheels these can be connected on to an old piece of conduit and the conduit installed in such a way as to come up through the concrete filling. Connections should then be made to the metal structure in more than one place and these connections should be waterproofed.

If your tower is already installed then a suitable earthing system is to use two lengths of 12.5mm pipe about 2-2.5m long installed near the base of the tower but at least 2m from each other. These should then be securely bonded to the mast.

## The Feeders

To give added protection, the feeders should be run down inside the tower structure as far as possible. If you are using coaxial cable then you should fit the arrestors which are available commercially at low cost. For open wire feeders it is easy enough to make up a small spark gap arrangement, the space between the feeder element and the earthed element being set at about 6mm. For long wire antennas a very simple system is to use an old car spark plug with the antenna connected to the terminal and the metal body of the plug taken to earth. A Jubilee clip will help to make a good connection.

## Final Thoughts

If you really want to see what a nearby storm can produce, disconnect your long wire from the receiver and connect a neon lamp from the long wire to ground, the display is both interesting and frightening. There is no way that you can be sure that lightning will not strike, but if you keep this information in mind and act on it you will have reduced the possibility of problems to insignificant levels.

*Practical Wireless, August 1987*

**Yes! PW's cover price is going up next month to £1.20 but . . .**

**DON'T PANIC**

Subscription orders received before 31 August 1987 will be honoured at the present price (see below). For overseas readers that deadline is extended to 30 November 1987.

**MORE SAVINGS!**

Our UK readers can save a few pennies more by using our new FREEPOST address (no stamp required) . . .

**PW PUBLISHING LTD. FREEPOST, SUBSCRIPTIONS DEPT., ENEFCO HOUSE, THE QUAY, POOLE, DORSET BH15 1PP.**

**TAKE ADVANTAGE OF THIS GREAT SUBSCRIPTION OFFER**

Wherever you live, a Postal Subscription will ensure that you receive your copies of PRACTICAL WIRELESS and/or SHORT WAVE MAGAZINE regularly, through your own letterbox, before it gets onto your newsagent's shelf. Order a Joint Subscription and you will qualify for the Special Discount.

Fill in the Order Form below and post it to: PW Publishing Ltd., FREEPOST, Subscriptions Dept., Enefco House, The Quay, Poole, Dorset BH15 1PP (no stamp required). Credit Card Orders taken on (0202) 678558.

Please indicate the type of subscription required:



£13.00 (UK)

£15.00 (Overseas)

(Prices correct at May 1987)

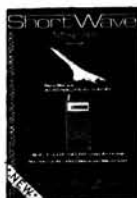

£17.00 (UK)

£17.00 (Overseas)



£27.00

£27.00

Special Joint Subscription

To: PW Publishing Ltd., FREEPOST, Subscriptions Dept., Enefco House, The Quay, Poole, Dorset BH15 1PP (no stamp required).

Name .....

Address .....

I enclose cheque/PO (Payable to PW Publishing Ltd) £ .....

Charge to my Access/Visa Card the amount of £ .....

Card No.

Valid from \_\_\_\_\_ to \_\_\_\_\_

Signature .....

# BOOK SERVICE

The books listed have been selected as being of special interest to our readers. They are supplied from our editorial address direct to your door. Some titles are American in origin. A number of new titles have been added to the service. Watch out for further additions in the months to come.

## RADIO

### AN INTRODUCTION TO RADIO DXING (BP91)

**R. A. Penfold**  
How to find a particular station, country or type of broadcast and to receive it as clearly as possible. 172 pages £1.95

### A TV-DXERS HANDBOOK (BP176)

**R. Bunney**  
Information on transmission standards, propagation, receivers including multi-standard, colour, satellites, antennas, photography, station identification, interference, etc. Revised and updated 1986. 87 pages £5.95

### BEGINNER'S GUIDE TO RADIO (9th Edition)

**Gordon J. King**  
Radio signals, transmitters, receivers, antennas, components, valves and semiconductors, CB and amateur radio are all dealt with here. 266 pages 0/s

### BETTER SHORTWAVE RECEPTION (USA)

**W. S. Orr W6SAI & S. D. Cowan W2LX**  
Receivers, antennas, propagation, DX listening techniques for the short waves and v.h.f. 158 pages £7.32

### COMMUNICATION (BP89)

**(Elements of Electronics—Book 5)**  
**F. A. Wilson**  
Fundamentals of line, microwave, submarine, satellite, digital multiplex, radio and telegraphy systems are covered, without the more complicated theory or mathematics. 256 pages £2.95

### FOUNDATIONS OF WIRELESS AND ELECTRONICS (10th Edition)

**M. G. Scroggie and S. W. Amos**  
Covering d.c. and a.c. circuits, L, C, tuned circuits and selectivity, valves, semiconductors, transmission lines, antennas, radiation, oscillation, modulation, detection, amplification, superhet receivers, c.r.t.s, waveform generators and switches, computers and power supplies. 551 pages £8.95

### GUIDE TO BROADCASTING STATIONS (19th Edition (1987/88))

**Philip Darrington**  
Frequency and station data, receivers, antennas, Latin American DXing, reporting, computers in radio, etc. 240 pages £6.95

### INTERNATIONAL RADIO STATIONS GUIDE (BP155)

Revised and updated in 1985, this book shows the site, country, frequency/wavelength and power of stations in Europe, the Near East and N. Africa, North and Latin America and the Caribbean, plus short-wave stations worldwide. 128 pages £2.95

### QUESTIONS & ANSWERS RADIO

**Eugene Trundle**  
Basics of electrical theory, radio and semiconductors, receivers, amateur and CB radio, and test equipment. 110 pages £2.95

### RECEIVING STATION LOGBOOK (RSGB)

Standard logbook for the s.w.l. in horizontal A4 format. 32 lines per page. 50 pages £2.35

### THE COMPLETE VHF/UHF FREQUENCY GUIDE

This book gives details of frequencies from 26—2250MHz with no gaps and who uses what. There are chapters on equipment requirements as well as antennas, etc. 60 pages £4.95

### VHF/UHF AIRBAND FREQUENCY GUIDE

A complete guide to the airband frequencies including how to receive the signals, the frequencies and services, VOLMET and much more about the interesting subject of airband radio. 74 pages. £5.95

### WORLD RADIO TV HANDBOOK (1987)

Country-by-country listings of long, medium and short wave broadcasters and TV stations. Receiver test reports. English language broadcasts. The s.w.l.'s "bible". 576 pages £17.95

## DATA & REFERENCE

### DIGITAL IC EQUIVALENTS AND PIN CONNECTIONS (BP140)

**A. Michaels**  
Equivalents and pin connections of a popular selection of European, American and Japanese digital i.c.s. 256 pages £5.95

### INTERNATIONAL DIODE EQUIVALENTS GUIDE (BP108)

**A. Michaels**  
Possible substitutes for a large selection of many different types of semiconductor diodes. 144 pages £2.25

### INTERNATIONAL TRANSISTOR EQUIVALENTS GUIDE (BP85)

**A. Michaels**  
Possible substitutes for a popular selection of European, American and Japanese transistors. 320 pages £3.50

### LINEAR IC EQUIVALENTS AND PIN CONNECTIONS (BP141)

**A. Michaels**  
Equivalents and pin connections of a popular selection of European, American and Japanese linear i.c.s. 320 pages £5.95

### NEWTONS COMPUTER ENGINEER'S POCKET BOOK

This is an invaluable compendium of facts, figures, circuits and data and is indispensable to the designer, student, service engineer and all those interested in computer and microprocessor systems. 203 pages £8.95

### NEWTONS ELECTRONICS POCKET BOOK 5th Edition

Having been in print now for over 20 years, this book is continually being updated. Despite the increasing emphasis on microcomputers in this edition, the aims of the book are unchanged, namely the presentation of all aspects of electronics in a readable and largely non-mathematical form for both the enthusiast and the professional engineer. 315 pages £8.95

### RSGB RADIO DATA REFERENCE BOOK

**G. R. Jessop G6JP**  
The 5th Edition of an essential book for the radio amateur's or experimenter's workbench. 244 pages Hardback £8.56

### SEMICONDUCTOR DATA BOOK

**A. M. Ball**  
Characteristics of about 10 000 transistors, f.e.t.s, u.j.t.s, diodes, rectifiers, triacs and s.c.r.s. 175 pages 0/s

## PROJECT CONSTRUCTION

### HOW TO DESIGN AND MAKE YOUR OWN P.C.B.s (BP121)

**R. A. Penfold**  
Designing or copying printed circuit board designs from magazines, including photographic methods. 80 pages £1.95

### INTRODUCING QRP

**Collected Articles from PW 1983-1985**  
An introduction to low-power transmission, including constructional details of designs by Rev. George Dobbs G3RJV for transmitters and transceivers from Top Band to 14MHz, and test equipment by Tony Smith G4FAI. 64 pages £1.50

### PRACTICAL POWER SUPPLIES

**Collected Articles from PW 1978-1985**  
Characteristics of batteries, transformers, rectifiers, fuses and heatsinks, plus designs for a variety of mains-driven power supplies, including the PW "Marchwood" giving a fully stabilised and protected 12V 30A d.c. 48 pages £1.25

## AMATEUR RADIO

### A GUIDE TO AMATEUR RADIO (RSGB)

Amateur Radio—the hobby, the equipment, workshop practice, the licence, the RAE (including sample questions). 154 pages £3.62

### AMATEUR RADIO CALL BOOK (RSGB)

**Spring 1987 Edition**  
This useful work now incorporates a 48-page reference section of useful information for amateur radio enthusiasts. 310 pages £4.73

### AMATEUR RADIO LOGBOOK (RSGB)

Standard logbook for the transmitting amateur in horizontal A4 format. 25 lines per page. 96 pages 0/s

### AMATEUR RADIO OPERATING MANUAL (RSGB)

A mine of information on just about every aspect of amateur operating, including international callsign series holders, prefix lists, DXCC countries list, etc. 204 pages £6.16

### HOW TO PASS THE RADIO AMATEURS' EXAMINATION (RSGB)

**G. L. Benbow G3HB**  
The background to multiple choice exams and how to study for them with nine sample RAE papers for practice, plus maths revision. 91 pages £3.15

### INTRODUCING MORSE

**Collected Articles from PW 1982-1985**  
Ways of learning the Morse Code, followed by constructional details of a variety of keys including Iambic, Triambic, and an Electronic Bug with a 528-bit memory. 48 pages £1.25

### INTRODUCING RTTY

**Collected Articles from PW 1980-1983**  
Basics of RTTY, ways of generating and decoding it. A simple and inexpensive way of trying out RTTY using a Sinclair 16K ZX81. 33 pages £1.00

### MOBILE LOGBOOK (RSGB)

Pocket-sized for the mobile operator. £1.00

### PASSPORT TO AMATEUR RADIO Reprinted from PW 1981-1982

The famous series by GW3JGA, used by thousands of successful RAE candidates as an aid to their studies. Plus other useful articles for students of amateur radio. 96 pages £1.50

### QUESTIONS & ANSWERS AMATEUR RADIO

**F. C. Judd G2BCX**  
What is amateur radio? The Radio Amateurs' Exam and Licence. The technology, equipment, antennas, operating procedure and codes used by amateurs. 122 pages £2.95

### RADIO AMATEURS EXAMINATION MANUAL (RSGB)

**G. L. Benbow G3HB**  
A standard aid to studying for the Radio Amateurs Examination, covering the whole of the 1986-88 syllabus. 155 pages £3.62

### RADIO AMATEUR'S GUIDE RADIO WAVE PROPAGATION (HF Bands)

**F. C. Judd G2BCX**  
The how and why of the mechanism and variations of propagation in the h.f. bands. 144 pages £8.95

### RADIO AMATEUR'S MAP OF NORTH AMERICA (USA)

Shows radio amateurs prefix boundaries, continental boundaries and zone boundaries. £2.25

### RADIO AMATEURS PREFIX MAP OF THE WORLD

Showing prefixes and countries, plus listings by order of country and of prefix. 1014 x 711mm £1.60

### RADIO AMATEUR'S WORLD ATLAS (USA)

17 pages of maps, including the world-polar projection. Also includes the table of allocation of intranational callsign series. £2.75

### SWM GREAT CIRCLE MAP OF THE WORLD

Showing Great Circle bearings and distances, callsign prefixes, time zones and DX Zones. 1018 x 634mm £4.00

### TELEPRINTER HANDBOOK (RSGB) 2nd Edition

This covers the theory and practice of radio teleprinter equipment, both European and American. In addition it covers description and maintenance data on most of the popular machines. 14 chapters. £6.10

### THE COMPLETE DX'ER (USA)

**Bob Locher W9KNI**  
Equipment and operating techniques for the DX chaser, from beginner to advanced. 187 pages £8.21

## THE RADIO AMATEURS DX GUIDE (USA)

15th Edition

The guide contains information not easily obtained elsewhere and is intended as an aid and quick reference for all radio amateurs interested in DX. 38 pages. £2.75

## THE SATELLITE EXPERIMENTER'S HANDBOOK (USA)

A guide to understanding and using amateur radio, weather and TV broadcast satellites. 207 pages. £9.25

## UNDERSTANDING AMATEUR RADIO (ARRL)

Understanding and building transmitters, receivers, antennas, power supplies and accessories. 222 pages. £4.20

## VHF HANDBOOK FOR RADIO AMATEURS (USA)

H. S. Brier W9EGQ & W. I. Orr W6SAI  
VHF/UHF propagation, including moonbounce and satellites, equipment and antennas. 335 pages. £13.37

## VHF/UHF MANUAL (RSGB)

G. R. Jessop G6JP  
Theory and practice of amateur radio reception and transmission between 30MHz and 24GHz. 520 pages. Hardback £9.86

## ANTENNAS (AERIALS)

### AERIAL PROJECTS (BP105)

R. A. Penfold

Practical designs including active, loop and ferrite aerials plus accessory units. 96 pages. £1.95

### ALL ABOUT CUBICAL QUAD ANTENNAS (USA)

W. I. Orr W6SAI & S. D. Cowan W2LX

Theory, design, construction, adjustment and operation of quads. Quads vs. Yagis. Gain figures. 109 pages. £7.63

### BEAM ANTENNA HANDBOOK (USA)

W. I. Orr W6SAI & S. D. Cowan W2LX

Design, construction, adjustment and installation of h.f. beam antennas. 198 pages. £8.00

### HF ANTENNAS

FOR ALL LOCATIONS (RSGB)

L. A. Moxon G6XN

Taking a new look at how h.f. antennas work, and putting theory into practice. 260 pages. £6.17

### OUT OF THIN AIR

Collected Antenna Articles from PW 1977-1980  
Including such favourites as the ZL Special and '2BCX 16-element beams for 2m, and the famous "Slim Jim", designed by Fred Judd G2BCX. Also features systems for Top Band, medium wave/long wave loop designs and a v.h.f. direction finding loop. Plus items on propagation, accessories and antenna design. 80 pages. Order Code OOTA £1.80

### SIMPLE AMATEUR BAND AERIALS (BP125)

E. M. Noll

How to build 25 simple and inexpensive aerials, from a simple dipole through beam and triangle designs to a mini-rhombic. Dimensions for specific spot frequencies, including the WARC bands. 80 pages. £1.95

### THE ARRL ANTENNA BOOK

14th Edition (USA)

A station is only as effective as its antenna system. This book covers propagation, practical constructional details of almost every type of antenna, test equipment and formulas and programs for beam heading calculations. 327 pages. £9.10

### THE ARRL ANTENNA COMPENDIUM Volume 1 (USA)

This book makes fascinating reading of hitherto unpublished material. Among topics discussed are quads and loops, log periodic arrays, beam and multi-band antennas, verticals and reduced size antennas. 175 pages. £9.25

## TWO-METRE ANTENNA HANDBOOK

F. C. Judd wrote this book for radio amateurs new to the 144-146MHz band. The range of antennas described will cater for most situations, particularly those where space is a problem.

## WIRES & WAVES

Collected Antenna Articles from PW 1980-1984

Antenna and propagation theory, including NBS Yagi design data. Practical designs for antennas from medium waves to microwaves, plus accessories such as a t.u.s., s.w.r. and power meters, and a noise bridge. Dealing with TVI. 160 pages. £3.00

### 25 SIMPLE INDOOR AND WINDOW AERIALS (BP136)

E. M. Noll

Designs for people who live in flats or have no gardens, etc., giving surprisingly good results considering their limited dimensions. 64 pages. £1.75

### 25 SIMPLE SHORT WAVE BROADCAST BAND AERIALS (BP132)

E. M. Noll

Designs for 25 different aerials, from a simple dipole through helical designs to a multi-band umbrella. 80 pages. £1.95

### 25 SIMPLE TROPICAL AND MW BAND AERIALS (BP145)

E. M. Noll

Simple and inexpensive aerials for the broadcast bands from medium wave to 49m. 64 pages. £1.75

## FAULT-FINDING

### ARE THE VOLTAGES CORRECT?

Reprinted from PW 1982-1983

How to use a multimeter to fault-find on electronic and radio equipment, from simple resistive dividers through circuits using diodes, transistors, i.c.s and valves. 44 pages. £1.50

### PRACTICAL HANDBOOK OF VALVE RADIO REPAIR

Chas E Miller

The definitive work on repairing and restoring valved broadcast receivers dating from the 1930s to the 60s. Appendices giving intermediate frequencies, valve characteristic data and base connections. 230 pages. Hardback £15.95

### QUESTIONS & ANSWERS RADIO REPAIR

Les Lawry-Johns

How to fault-find and repair valved and transistorised receivers, car radios and unit audio equipment. Suggested lists of tools and spare parts. 106 pages. £2.95

### SERVICING RADIO, HI-FI AND TV EQUIPMENT

Gordon J King

A very practical book looking at semiconductor characteristics, d.c. and signal tests, fault-finding techniques for audio, video, r.f. and oscillator stages and their application to transistor radios and hi-fi. 205 pages. 0/5

### TELEVISION INTERFERENCE MANUAL (RSGB)

B. Priestley

TV channels and systems, spurious-radiation TVI, strong-signal TVI, audio breakthrough, transmitter design. 78 pages. £2.02

### TEST EQUIPMENT FOR THE RADIO AMATEUR (RSGB)

H. L. Gibson G2BUP

Techniques and equipment for tests and measurements on devices, systems and antennas. 142 pages. Hardback £5.76

## COMPUTING

### AMATEUR RADIO SOFTWARE (RSGB)

John Morris GM4ANB

Using a computer for c.w., RTTY, data, plus calculations for antennas, distance, bearing, locators, satellites, sun, moon and circuit design. 328 pages. Hardback £7.29

### AN INTRODUCTION TO COMPUTER COMMUNICATIONS (BP177)

R. A. Penfold

Details of various types of modem and their applications, plus how to interconnect computers, modems, and the telephone system. Also networking systems and RTTY. 96 pages. £2.95

### AN INTRODUCTION TO COMPUTER PERIPHERALS (BP170)

J. W. Penfold

Covers monitors, printers, disk drives, cassette recorders, modems, etc., explaining what they are, how to use them and the various types of standards. 80 pages. £2.50

### MICROPROCESSING SYSTEMS AND CIRCUITS (BP77)

(Elements of Electronics—Book 4)

F. A. Wilson

A comprehensive guide to the elements of microprocessing systems, which are becoming ever more involved in radio systems and equipment. 256 pages. £2.95

### NEWNES COMPUTER ENGINEER'S POCKET BOOK

This is an invaluable compendium of facts, figures, circuits and data and is indispensable to the designer, student, service engineer and all those interested in computer and microprocessor systems. 203 pages. £8.95

## AUDIO FREQUENCIES

### AUDIO (BP111)

(Elements of Electronics—Book 6)

F. A. Wilson

This book studies sound and hearing, and the operation of microphones, loudspeakers, amplifiers, oscillators, and both disc and magnetic recording. 320 pages. £3.50

## THEORY & CALCULATIONS

### BEGINNER'S GUIDE TO ELECTRONICS

Owen Bishop

For youngsters thinking of a career in electronics; theory and applications in computers, radio, TV, recording, medical and industrial electronics. 240 pages. £4.95

### RADIO FREQUENCY INTERFERENCE (USA)

What causes r.f.i.? Are all r.f.i. problems difficult, expensive and time-consuming to cure? These questions and many more are answered in this book. 9 chapters. £4.30

### THE SIMPLE ELECTRONIC CIRCUIT AND COMPONENTS Book 1 BP62

The aim of this book is to provide an inexpensive but comprehensive introduction to modern electronics. 209 pages. £3.50

## HOW TO ORDER

O/P = Out of Print  
O/S = Out of Stock



International  
Radio Stations  
Guide

EDITORIAL DEPT.

An Introduction  
to Computer  
Communications

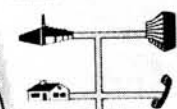

NEWNES  
RADIO and  
ELECTRONICS  
ENGINEER'S  
POCKET BOOK

Audio

Digital IC  
Equivalents  
and Pin  
Connections

ADRIAN MICHAELS



Add 75p per order postage (overseas readers add £1.50 for surface mail postage) and send a postal order, cheque or international money order with your order (quoting book titles and quantities) to **PW Publishing Limited, Enefco House, The Quay, Poole, Dorset BH15 1PP**. Payment by Access, Mastercard, Eurocard or Visa also accepted on telephone orders to Poole (0202) 678558. Books normally despatched by return of post but please allow 28 days for delivery.

# The Microwave MESFET

## Part 1

*MESFETS are the simplest form of amplifier device available for higher frequencies, says Brian Dance as he unravels some of the mystery surrounding these devices.*

In spite of the enormous success of the silicon planar transistor, this device has very definite limitations when it is used at higher and higher frequencies. Such conventional transistors are known as bipolar types, since the current flows in both *p*-type and in *n*-type semiconductor material as it passes through the device. The limitations on the performance of such devices as the frequency rises through values of a few GHz is so serious that it soon became clear another type of device was needed for use in such frequency regions.

The fabrication of the first gallium arsenide m.e.s.f.e.t. (metal semiconductor field effect transistor) in 1964 proved to be the most significant breakthrough. The initial development of m.e.s.f.e.t. devices was slow, but then intensive research on these devices was undertaken to satisfy the need for light-weight, low-power, high-reliability devices able to replace travelling wave tubes at frequencies of up to some tens of GHz where bipolar transistors are useless.

The research resulted in a rapid improvement of the performance of commercial m.e.s.f.e.t. devices and types are now available which can be used at frequencies of up to about 60GHz. Initially the main applications were in the military and satellite fields where costs are not so restrictive as in many other fields. Unfortunately microwave m.e.s.f.e.t. devices are considerably more expensive than bipolar transistors and therefore the latter are still used for the less demanding applications at frequencies of up to about 5GHz. The simplest form of amplifier device available for higher frequencies, m.e.s.f.e.t.s are also used at frequencies of about 1GHz upwards where the highest possible performance is required.

It seems almost certain the m.e.s.f.e.t. devices will be widely employed in ground stations for the low-noise reception of television signals in DBS systems. This will create a far larger market for m.e.s.f.e.t. devices and should result in a very substantial lowering of prices. Small signal m.e.s.f.e.t. devices are available which can provide both higher gain and lower noise amplification than bipolar types at increasingly higher frequencies. Other m.e.s.f.e.t. devices can provide

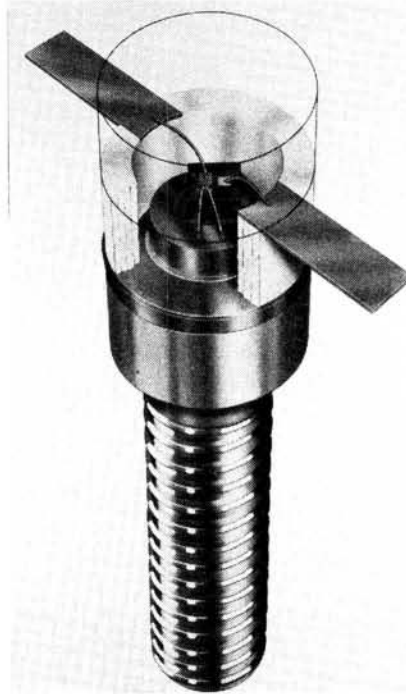

**Plessey gallium arsenide m.e.s.f.e.t. device**

moderate power output levels at somewhat lower frequencies.

### Internal Structure

The internal structure of a m.e.s.f.e.t. device is shown in Fig. 1.1. The current flows only through the thin *n*-type layer and therefore m.e.s.f.e.t.s are unipolar devices. The main advantage of selecting a unipolar device is that the charge storage in the base region of a conventional bipolar transistor is eliminated. It is this charge storage which mainly limits the high frequency performance of bipolar devices.

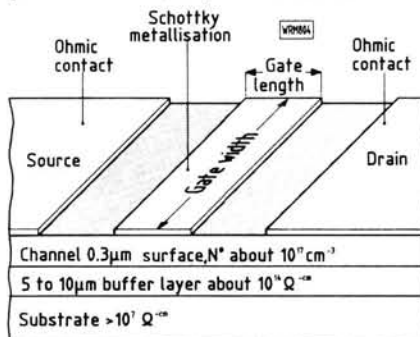

**Fig. 1.1: Internal structure of a m.e.s.f.e.t. device**

The construction of individual m.e.s.f.e.t. devices varies considerably from one type to another, but the thin *n*-type channel of Fig. 1.1 has a typical thickness of 0.3 micron and contains  $10^{17}$  impurity atoms per  $\text{cm}^3$ . It is deposited on a high resistivity buffer layer (which may have a thickness of about 10 micron). The buffer layer is formed on a substrate of much lower resistivity.

The gate is a metal electrode, not a semiconductor material. A Schottky metal to semiconductor junction is formed by the gate, so the acronym m.e.s.f.e.t. may also be interpreted as metal Schottky field effect transistor.

The gate potential controls the width of the channel in the thin *n*-type layer, and this potential can therefore be employed to control the number of charge carriers flowing in the channel; this determines the current flowing between the source and drain.

As m.e.s.f.e.t.s are depletion devices, the gate potential is made more negative, the channel becomes narrower until eventually the gate is sufficiently negative to close the channel completely with the result that the drain-to-source current is cut-off.

The high frequency performance and hence the maximum practical operating frequency of a m.e.s.f.e.t. is dependent mainly on the channel length. The smaller the channel length, the lower the stray capacitance and the higher the maximum frequency of operation. The channel length is determined mainly by the length of the gate electrode shown in Fig. 1.1. Unfortunately it is very difficult to manufacture m.e.s.f.e.t. devices with very short gate lengths by conventional photolithography, especially if price considerations dictate that a high yield of successful devices must be obtained. Electron beam lithography is now often used, but the use of such new techniques inevitably raises costs, so it is used only for devices to be operated at the higher frequencies.

In general, gate lengths of about 1 micron have been widely used for devices designed to operate at frequencies of the order of 4GHz, such as those in satellite receiver ground stations. A gate length of 0.5 micron is more suitable for m.e.s.f.e.t. devices intended for operation at 10–15GHz,

*Practical Wireless, August 1987*



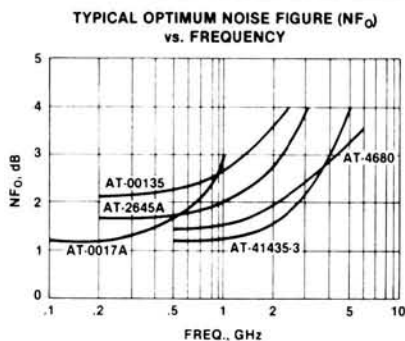

Fig. 1.2

whereas gate lengths around 0.2 micron or less are appropriate for frequencies of over 20GHz. Unfortunately the fabrication of devices with such gate lengths is quite difficult.

Apart from the increase in the maximum operating frequency, the reduction of the gate length of a device tends to produce an improved signal-to-noise ratio at any given frequency. The gate length is therefore one of the most important parameters of a m.e.s.f.e.t. device.

Designed for the production of appreciable power at microwave frequencies, m.e.s.f.e.t.s have the same basic internal construction as that used in low power devices, with a similar gate length. However, the gate width is greater in power devices and it is important to minimise the thermal resistance from the device junctions to the case to prevent an excessive temperature rise. The maximum output power obtainable from the latest commercial devices at any given frequency has steadily increased year by year during the past decade and the noise figures of these power devices have also been steadily reduced. However, as the frequency of operation increases, it becomes far more difficult to obtain even a moderate amount of output power.

## Materials

The best m.e.s.f.e.t. devices are fabricated in gallium arsenide, although m.e.s.f.e.t. devices can be produced more economically in silicon. Gallium arsenide is not only a much more expensive material than silicon, but it is far more difficult to work with. A silicon surface can be easily oxidised to form a passivating layer of silicon dioxide which prevents the ingress of contaminants, whereas gallium arsenide cannot be passivated in this way. Gallium arsenide is very brittle, so that much thicker wafers of this expensive material must be used than in the case of silicon processing. In addition, the proportion of gallium arsenide m.e.s.f.e.t. devices produced which perform satisfactorily is much lower than in the case of silicon based products.

One of the main attractions of gallium arsenide is the high electron

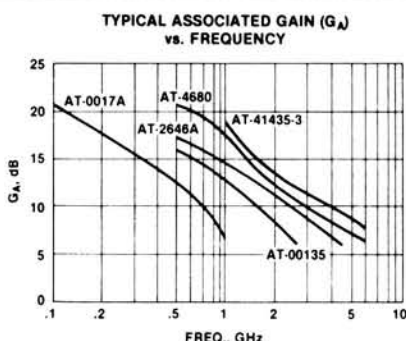

Fig. 1.3

mobility of about  $8000\text{cmV}^{-1}\text{s}^{-1}$  which is over five times that of silicon ( $1500\text{cmV}^{-1}\text{s}^{-1}$ ). This high electron mobility is the main reason why gallium arsenide m.e.s.f.e.t. devices offer a better high frequency performance than comparable silicon devices. The electrons carry the current in the *n*-type channel of Fig. 1.1. It may be noted that hole mobility in gallium arsenide is lower than that in silicon; gallium arsenide m.e.s.f.e.t.s for high frequencies are therefore always *n*-channel devices, since the performance of *p*-channel devices would be limited by the hole mobility in the *p*-type channel. Gallium arsenide is not normally used to fabricate bipolar transistors, since the minority carrier lifetime in this material is about 250 000 times less than in silicon and very few of the minority carriers in the base region would reach the collector. However, minority carriers play no part in m.e.s.f.e.t. operation and have no effect on gallium arsenide m.e.s.f.e.t. performance.

Gallium arsenide is currently employed in all m.e.s.f.e.t. devices which must provide an optimum performance. However, a silicon-on-sapphire technique has been developed by General Electric of New York for fabricating m.e.s.f.e.t.s which can provide a moderate output power of under 1W at a frequency of up to 3GHz. These silicon-sapphire m.e.s.f.e.t.s can be produced more economically than gallium arsenide devices, it may also be possible to integrate them into monolithic silicon circuits.

## Bipolar Comparison

In order to compare the performance of typical bipolar silicon high

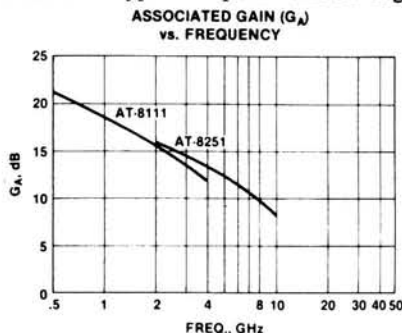

Fig. 1.4

frequency transistors with that of gallium arsenide m.e.s.f.e.t. devices, we will consider the typical noise figures and gain values which can be provided by these two types of device. However, it must be made clear that each product is designed for a certain frequency range, while some types are designed for low-cost applications where a sacrifice in performance must be accepted. Thus these considerations must be borne in mind and not just the device performance alone.

The variation of the noise factor for typical devices from the Avantek range of bipolar transistors with frequency is shown in Fig. 1.2. The AT-0017A (which is suitable for operation only at relatively low frequencies) and the AT-00135 are from this manufacturer's general purpose range of silicon bipolar devices, whereas the other devices are from the low noise range. It can be seen that the typical noise figure rises rapidly with increasing frequency until the devices are of little use for low noise reception.

The typical associated gain of these Avantek devices falls with increasing frequency as is shown in Fig. 1.3. Again the performance of the bipolar devices falls rapidly with increasing frequency. The optimum noise figure for two m.e.s.f.e.t. devices from the same manufacturer is shown in Fig. 1.4. The AT-8111 is a small signal ultra-low-noise gallium arsenide device designed for operation in the 2-6GHz region. The AT-8251 is an ultra-low-noise medium-power gallium arsenide m.e.s.f.e.t. intended for use in the 2-12GHz range. It can be seen that the noise figure of both of these devices is very low throughout the frequency range for which they are designed to operate. The decrease of the associated gain of these devices with increasing frequency is shown in Fig. 1.5.

## Noise Figure

It must be made clear that the noise figure of a device depends on the bias and other circuit conditions employed. The values quoted are those obtained under optimal conditions. Even at 30GHz noise figures are now approaching 2dB, while at 18GHz they are about 1.4dB and at 4GHz about 0.25dB in the best m.e.s.f.e.t. circuits.

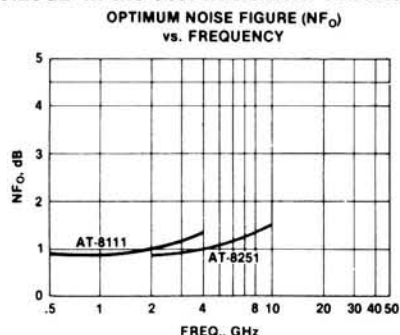

Fig. 1.5

Devices are available with short gate lengths which have  $f_T$  (transition frequency where the gain is unity) of about 100GHz. Such devices can be used as oscillators at frequencies of up to some 80GHz.

Plessey Semiconductors has introduced a dual-gate gallium arsenide m.e.s.f.e.t. device, the P35-1310, in which the second gate can be employed for automatic gain control. The variation of the gain with the second gate voltage at 12GHz is shown in Fig. 1.6. The noise figure and the associated gain of this device are plotted against the drain-to-source current,  $I_{DS}$  in Fig. 1.7.

Gallium arsenide m.e.s.f.e.t. devices used at ambient temperatures can provide a noise performance equivalent to a noise temperature of about 70K in the 4GHz region. The noise level can be reduced to about 55K by cooling the m.e.s.f.e.t. device with a thermo-electric cooling device, but this involves the consumption of power—a vital point in amplifiers used in a satellite. Parametric amplifiers can offer noise temperatures of somewhat under 50K even when not cooled, whereas cooled parametric amplifiers can offer noise temperatures of 30K for thermoelectric cooling or under 15K for cooling by liquid gases. Still lower noise temperatures can be obtained by using a maser, but this involves liquid helium cooling in complex equipment and a reduced bandwidth.

## Handling and Circuit Precautions

Gallium arsenide m.e.s.f.e.t. devices require careful electrical handling. Unlike m.e.s.f.e.t. devices, there is no insulating dielectric between the gate and the channel. A small potential across the Schottky gate structure can cause large currents to flow between the metal gate electrode and the semiconductor material below it. As the gate has very small dimensions, this will almost certainly result in the fus-

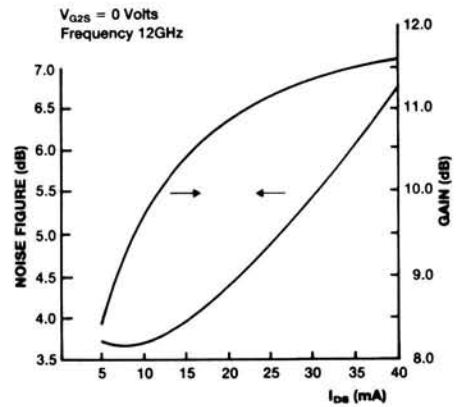
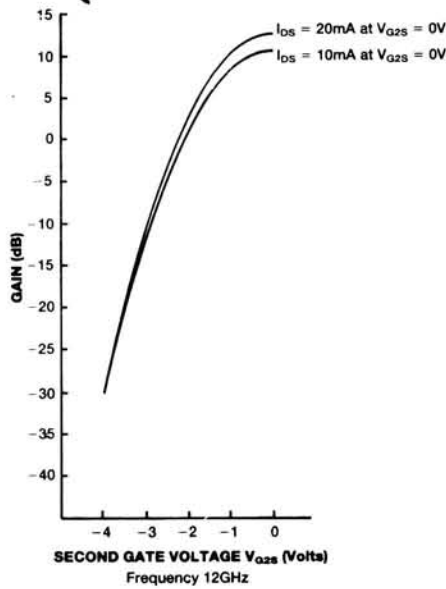

▲ Fig. 1.7: Noise figure and associated gain against drain-to-source current

◀ Fig. 1.6: The variation of the gain with the second gate voltage at 12GHz

ing of the gate electrode and the destruction of a relatively expensive device. This is not surprising, since it can be shown that even a small current can produce a current density in the region of the gate electrode of the order of a million amps per  $\text{cm}^2$ .

The gate electrode must never be allowed to become positive with respect to the channel. Care must be taken to ensure that the bias voltage is applied to the gate before the power is applied to the circuit generally. In general it is desirable to use separate positive and negative power supply lines to bias the drain and gate electrodes separately.

In addition, gallium arsenide m.e.s.f.e.t. devices can be easily destroyed by the electrostatic charge accumulated on the gate electrode of the device. It is wise to be safe and to ground anything before it is allowed to touch the device. The leads of devices not currently in use should be shorted together.

Care should be taken to ensure that any soldering iron used to solder m.e.s.f.e.t. devices into a circuit is

properly grounded and the soldering time should be minimised. Before attempting to solder the device into a circuit, the points to which it is to be connected should be grounded.

## Power MESFETS

The output power which a single gallium arsenide m.e.s.f.e.t. can provide is limited to about 1W for each 1mm of the gate width for optimally designed devices and circuits over the 4–15GHz frequency range. In practice this means that using current technology one can obtain about 10W output from a device at frequencies of several gigahertz and about 4W at 10GHz. The output can be increased somewhat by using a number of m.e.s.f.e.t. devices in parallel; thus some 40W of output power can be obtained at several gigahertz.

If one requires higher power levels of some hundreds of watts, one will normally use travelling wave tubes rather than m.e.s.f.e.t.s. Apart from the greater power level required by the travelling wave tube to heat the cathode, etc., the reliability of travelling wave tube is considerably worse than that of m.e.s.f.e.t. devices and these factors can be of great importance in satellite borne equipment. Even in low power m.e.s.f.e.t. devices, one can expect the mean time between failures to increase by a factor of about 2 for each  $10^\circ\text{C}$  fall in the channel temperature.

Although output power levels from gallium arsenide m.e.s.f.e.t. devices can reach about 1W at 20GHz the available output power falls rather rapidly with increasing frequency. When one leaves the microwave region and passes into the millimetre wavelength frequency region at about 30GHz, m.e.s.f.e.t. devices are unsuitable for the generation of appreciable power and travelling wave tubes are normally employed.

Each year the maximum power level available at any frequency using m.e.s.f.e.t. devices rises and the picture may alter considerably in the next few years.

*Practical Wireless, August 1987*

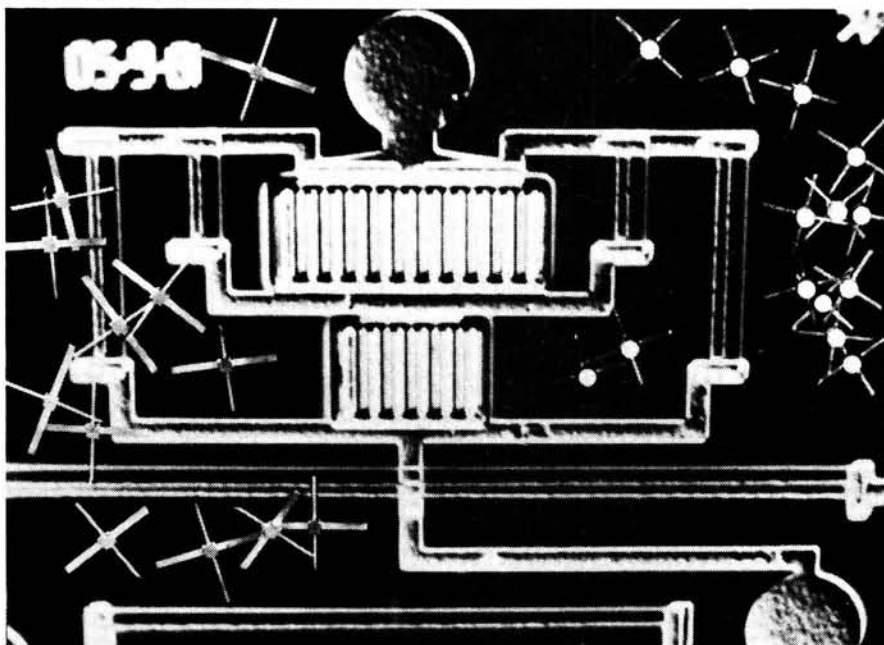

Silicon monolithic microwave i.c.s from Wave Devices (Avantek)

## AUDIO FILTERS MODELS FL2, FL3, FL2/A

Model FL3 represents the ultimate in audio filters for SSB and CW.

Connected in series with the loudspeaker, it gives variable extra selectivity better than a whole bank of expensive crystal filters. In addition it contains an automatic notch filter which can remove a "tuner-upper" all by itself. Model FL2 is exactly the same but without the auto-notch. Any existing or new FL2 can be up-graded to an FL3 by adding Model FL2/A conversion kit, which is a stand-alone auto-notch unit. Datong filters frequently allow continued copy when otherwise a QSO would have to be abandoned.

Prices: FL2 £89.70, FL3 £129.37, FL2/A £39.67

## ACTIVE RECEIVING ANTENNAS

Datong active antennas are ideal for modern broadband communications receiver — especially where space is limited.

- highly sensitive (comparable to full-size dipoles).
- Broad-band coverage (below 200 kHz to over 30 MHz).
- needs no tuning, matching or other adjustments.
- two versions AD270 for indoor mounting or AD370 (illustrated) for outdoor use
- very compact, only 3 metres overall length. ● professional performance standards.

Prices: Model AD270 (indoor use only) **£51.75** Both prices include mains power unit.  
Model AD370 (for outdoor use) **£69.00**

## MORSE TUTOR

The uniquely effective method of improving and maintaining Morse Code proficiency. Effectiveness proven by thousands of users world-wide.

- Practise anywhere, anytime at your convenience.
- Generates a random stream of perfect Morse in five character groups.
- D70's unique "DELAY" control allows you to learn each character with its correct high speed sound. Start with a long delay between each character and as you improve reduce the delay. The speed within each character always remains as set on the independent "SPEED" control.
- Features: long life battery operation, compact size, built-in loudspeaker plus personal earpiece.

Price: **£56.35**

Our full catalogue plus further details of any product are available free on request. All prices include VAT and postage and packing. Goods normally despatched within 3 days subject to availability.

Barclaycard, Access Orders — Tel: (0532) 744822



**DATONG  
ELECTRONICS  
LIMITED**

write to dept. P.W.  
Clayton Wood Close  
West Park  
LEEDS LS16 6QE  
Tel: (0532) 744822 (2 lines)

## SPECTRUM TRANSCEIVE

The TX-3 RTTY/CW/ASCII TRANSCEIVE program is now available for the Spectrum. It has all the facilities of the BBC and CBM64 versions and will operate with an interface or T.U.

Forget what you thought you knew about Spectrum direct decode systems. This one will transceive 300 baud RTTY or ASCII at 170Hz shift with only a simple interface. Its performance and facilities outclass other software by a large margin yet it is very easy to use. Some of the features are:

Split-screen type-ahead operation, receive screen unwrap, 24 large memories, clock, review store, call sign capture, RTTY auto CR/LF, CW software filtering and much, much more.

The program comes with an adapter board which plugs into the Spectrum expansion port and accepts the interface or T.U. It will work with any 48/128k Spectrum, including the +2. Tape + adapter £35. Users of the CW QSO program can upgrade for £25. BBC and CBM64 program £20 tape, £22 disc.

TIF1 INTERFACE has computer noise reduction, RX filters, TX outputs for MIC, PTT and KEY. Perfect for our TX-3 and RX-4 programs. Kit £15 (assembled PCB + cables & connectors), ready-made boxed with all connections £25 (state rig).

## SPECTRUM RX-4 RECEIVE

We now have a version of this amazing program using the adapter board mentioned above. This enables even better reception of RTTY/CW/SSTV and AMTOR with any 48/128k Spectrum, including the +2. Uses TIF1 (see above) for all modes or a T.U. for RTTY and CW. Tape + adapter £40. Existing RX-4 users can upgrade for £21. RX-4 is also available for BBC, CBM64 and VIC20 £25 tape, £27 disc (not VIC20). The BBC RX-4 is now completely compatible with the Master Series. Master users may exchange their programs free of charge.

We also have superb BBC, CBM64, Spectrum, VIC20, Electron programs for Morse Tutor £6, Locator £7, Logbook £8 and RAE Maths £9 as well as a great UK/Europe and World Map and Locator for BBC/Electron £10. Any BBC or CBM64 program also on disc at £2 extra.

Prices include VAT and 1st Class p&p Inland, airmail overseas, normally by return. Eire, C.I., BFPO deduct 13%.



**technical software (P.W.)**

Fron, Upper Llandwrog, Caernarfon LL54 7RF. Tel. 0286 881886



Books for radio amateurs

**FDK**

**ELLIOTT ELECTRONICS**

for the Radio Enthusiast

MICROWAVE MODULES

INSTANT HP AVAILABLE

QSY OLD MAN TO

AERIAL ACCESSORIES AND MASTS

**JAYBEAM AMATEUR ANTENNAS**

APPOINTED DISTRIBUTOR

RIGS, ANTENNAS, SWR BRIDGES, POWER SUPPLIES, TEST GEAR, COMPONENTS, MORSE KEYS, COAXIAL CABLES, ROTATORS, MICS, PLUGS AND SOCKETS, SWITCHES

Call us on (0533) 553293  
OR COME AND LOOK AROUND AT  
26/28 Braunstone Gate, Leicester

THE 'HAM SHACK'

**GO!**

## CALLING ALL LISTENERS . . . CALLING ALL LISTENERS

JULY ISSUE OUT NOW

**Short Wave Magazine**

### AUDIO FILTER

Build our simple add-on filter to improve your s.w. receiver.

### AERONAUTICAL RADIO — 3

Godfrey Manning finishes his series with a look at instrument landing systems and general navigation aids.

All the regular features:—  
Seen & Heard, Bandscan, Grassroots, etc.

**PLACE A REGULAR ORDER WITH YOUR NEWSAGENT**

## what is a KENWOOD RC10?

TO FIND OUT TURN TO PAGE 3 AND READ ABOUT THE TM221E & TM421E!



# Dayton 1987

*At least 30 000 hams from all corners of the globe assembled at this year's Dayton Hamvention. This was the 36th such event and it continues to be the Mecca for all those having an interest in amateur radio. Vic Copley-May G3AAG was at the show and here is his report.*

# REPORT

The *Mobil Travel Guide* describes Dayton, Ohio as being in the Great Lakes District of the USA. By English standards this description might raise a few eyebrows as Dayton is more than 240km from the nearest of the Great Lakes!

What does it take to put on a show of this magnitude? The Dayton Amateur Radio Association publish a programme for the event which runs to some 78 pages. Jim Simpson WB8QZZ must, once again, be congratulated. This was his second year as General Chairman—the first time that this has happened, I understand—and to run the convention Jim needed no less than 34 assistants chairing 30 separate committees. The club itself has 29 committees who appear to leave no stone unturned.

Some cynics describe the city of Dayton as the anti-cultural centre of the United States. Be that as it may, the hospitality is "wall-to-wall". Vast halls and lecture theatres housed the exhibitors and various Forums covering every aspect of amateur radio. The Flea Market is undoubtedly the largest in the world.

It was nice to see that a Forum for home construction was sponsored by the Rev. George Dobbs G3RJV, ably assisted by Colin G3VTT and Peter G3PDL—the only one of the 36 Forums sponsored by "aliens".

To cover the Hamvention as a news gatherer it was quite impossible for me

to pay other than a brief visit to many of the Forums. Every possible interest was covered from the needs of the DX hound to the avid contester, the s.w.l. and the chess by radio devotee.

Once again I travelled to Dayton as the guest of Prof. John W. Day W4XJ who is an Honour Roll DXer along with several other DXers from Knoxville, Tennessee. We booked in on the Friday afternoon and I purchased ticket number 20 282 for \$10—a good investment as it turned out! The following morning it was drawn as one of the prize-winning numbers and I won a \$54 Mosley  $\frac{3}{4}$ λ 144MHz antenna. John K4RIG told me of the time when he had just bought a \$400 TH7DXX Tri-band beam and five minutes later his ticket drew—guess what?—yes, a TH7DXX!

The draw is made every two hours for the prizes which were donated by 134 of the exhibitors. You could have won anything from the new Icom IC-761 h.f. transceiver with an IC-2KL linear to a subscription to a DX news sheet.

Guest speaker at the banquet was Hank Feinberg K2SSQ, better known for having received 18 international film awards for his documentaries. Hank designed and built ET's communicator for the film from parts picked up at a previous Hamvention. Lady teacher Carole Perry WB2MGP received the Amateur of the Year award while Hank WORLI—said to be the

father of amateur packet radio—received the Technical Excellence Award.

## The US Scene

Dayton is the one place where you can pick up most of the facts about what is going on in our hobby as well as many of the rumours. Some of the facts were put at a Forum by Wayne Green W2NSD/1. Wayne is editor and owner of the popular 73 magazine and is obviously concerned by the decline in amateur radio in the USA. He quoted from an FCC report that some ten years ago 75 per cent of newly licensed amateurs were teenagers while today only ten per cent are in their teens. His concern is that old-timers are not doing enough to promote amateur radio in schools and colleges around the nation. A criticism that could equally be levelled in the UK, but I think that he might have overlooked just how much the advent of computer technology has siphoned off many with a technical bent. We need to promote the integration of amateur radio with the home computer craze if we are to attract these wizards into our fold.

## A Place to Meet

A cap or name badge is worn to identify yourself to all and sundry, although the more eccentric wear other forms of identity. In this way I was able to pick out many familiar callsigns, many of whom I had only met over the air. No difficulty in picking out the HB9s—they appeared in force bearing an enormous Swiss flag and wearing lederhosen—some 120 in all. Maybe it was just ignorance or perhaps colour-blindness but their delegation was mistaken by a few as Red Cross representatives!

An early encounter was with Ian VK3MO of big antenna fame. Unkind compatriots rumour that he uses 20kW to his 4+4+4 stacked monobanders. If you have ever talked to him about propagation you soon realise that he doesn't need high power to put in that big signal. He is currently planning a 5+5+5 monobander, so he is sure to continue to be the first and last when the band opens and closes.

Bill K1GQ, who has written many antenna design articles, graciously allowed me much of his time to discuss the computer evaluation of a new antenna.

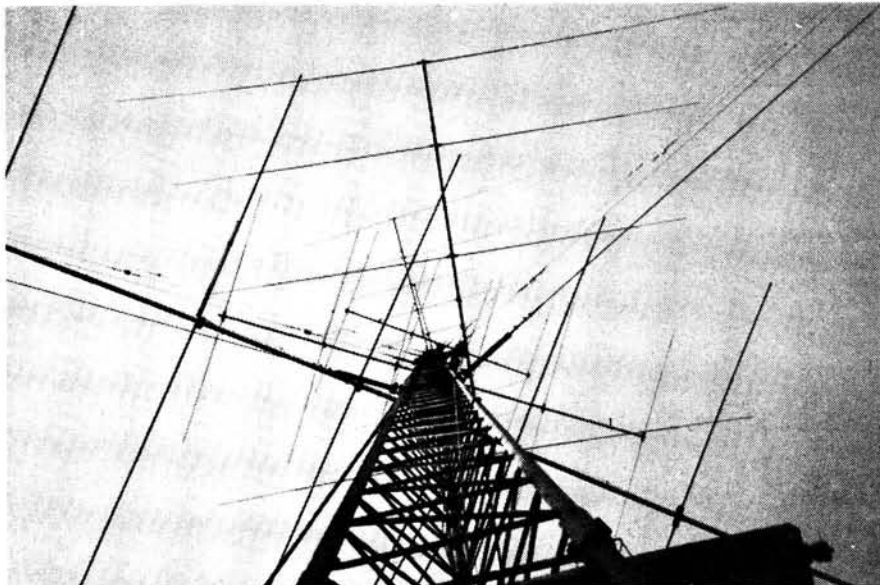

One of N4ARs eleven towers

There were many other enjoyable and valuable encounters both at the show and in the hospitality suites, and just in case you felt lonely a biplane flew around the convention advertising "FAROUT ARC WELCOMES YOU. 147.135".

## How was Business?

The traders reported record sales. As of March 21 around 166 000 Novice and Technician Class amateurs in the US had their licences "enhanced". This allows them over 90 times more spectrum space and partial use of the 29MHz band. Compared with last year I was told that the sales of "low band" equipment has increased substantially. No doubt this licence enhancement had much to do with the heavy sales. I am sure that the new licence conditions will have helped sales on the G QRP stand which always seemed to be busy.

Amateurs never seem at a loss to find an excuse to spend money on their equipment. In spite of a last quarter rise in US inflation of 5.3 per cent and a drop in non-agricultural workers' wages of 0.1 per cent, spending was heavy.

## ARRL

The ARRL was tucked into one of the halls and seemed to be doing brisk business. It is interesting to note that whilst there are some 430 000 licensed amateurs in the States only about 140 000 are members of the ARRL—less than a third. The RSGB does better with nearly half of the UK licensed amateurs as members but neither society should be happy until a majority are members of the representative body.

## What's New

The pride of the show was undoubtedly Ten-Tec's new transceiver. Previewed at last year's Hamvention Ten-



The open air traders

Tec call it the Paragon and I was given a "guided tour" by Communications Sales Manager, Joe Redwine N4AVF. This is an all-band (including the new WARC bands) rig with a very impressive specification. Sensitivity 0.25µV for 10dB S/N ratio; 16-pole crystal ladder filtering for 2.4kHz bandwidth with a 1.6:1 shape factor at 6/60dB as standard, 1.8kHz, 500 or 250Hz optional and all front panel selectable; claimed noise floor is -129dBm at 2.4kHz bandwidth; intercept point +5dBm; notch filter better than 50dB; dynamic range quoted as 95dB at 200Hz, and an 8-pole active audio bandpass filter.

The price was being quoted at \$1995 and I got so excited about it that I took time out to visit the Ten-Tec plant at Sevierville where I was shown around by the Vice President—Marketing, Sidney WOLYM.

The yardstick by which c.w. contestants measure receiver performance has long been the Drake R4C fitted with Sherwood filters. Bill Maxan N4AR, who is well respected in the contesting

world, told me "If they've got their figures right it could be better than the R4C which is the best ham receiver I know".

Many of the one hundred or so employees are dedicated amateurs and I found it difficult to understand how they finance their enormous research and development programme. They make all their own aluminium presswork for their range as well as tool-making for outside companies. The p.c.b.s are all glass fibre for reliability and some 40 per cent of their total production goes to government departments.

Production should start in July or August, and it is interesting to note that you will be able to repair it yourself, with help from them, without voiding the warranty.

Icom had their IC-761 h.f. transceiver, already announced in the UK, on show at \$2499—phew! Their IC-1200 mobile rig for the 1.2GHz band at \$699 looked interesting, but the IC-900 multi-band mobile was probably the most interesting addition. The controller fits onto the dash panel and is a mere 74 × 51 × 25mm and the interface unit stacked with up to six separate band units fits into the boot. Fibre optics are used for remote mounting and it can operate cross-band. With 45W r.f. out on 144MHz it is expensive.

Kenwood had their new concept for amateur radio—the IP-100 Illustrophone. This is a digital graphic communicator and is already being sold in Japan. Used in conjunction with an f.m. transceiver it allows you to draw on a pad and your drawing will be reproduced on a similar Illustrophone at another station—and you do not need a computer.

With the US Novices and Technicians being allowed to use RTTY and packet, sales of equipment for these modes were bound to increase. At Dayton Advanced Electronic Applications Inc. showed the latest version of their PK-232 which now has a Weather



Lovely car number plates

FAX option. GBL Electronics Inc. introduced a packet controller designed for portable and solar-powered stations at \$179.95. Kantronics had their KPC-4m all-mode communicator. This has both h.f. and v.h.f. radio ports with simultaneous h.f. and v.h.f. packet connects and digipeating. It costs \$319.

This has been just a brief outline of some of the more interesting items that caught my eye as space is limited.

## Prices

I cannot understand why UK prices are so much higher than those in the USA. The difference cannot be accounted for by VAT, import duty or shipping costs and many US states now have a six per cent sales tax to be added



Good communications is essential

to any quoted prices. Nobody pays the manufacturers' recommended retail price and many manufacturers quote an "amateur net price" which is usually 10 per cent less than the recommended price. Dealers may offer a discount and haggling is standard procedure. Perhaps our UK importers can explain why in some instances we pay double the US price.

In conclusion you will notice that I have not mentioned the vast Flea Market. This year I decided to give it a miss and doubtless missed innumerable bargains. The Flea Market at Dayton is reputed to be the largest in the world and, as I have not been to Japan, I will have to take their word for it.

So, with shouts of "See you next year, buddy," we left for home. **PW**

# multiple choice... multiple choice... QUESTIONS multiple choice... multiple choice...

If you are an aspiring RAE candidate or just feel like testing your knowledge of amateur radio these multiple choice style questions will fill your needs. The questions are typical of those appearing in both the RAE papers, but they are not taken from these papers. Answers next month.

Paper 2 Section 2. Electrical Theory—effective resistance in parallel circuits

## Question 8-1

What is the resistance between points P and Q?

- a. 9Ω
- b. 10Ω
- c. 11Ω
- d. 12Ω

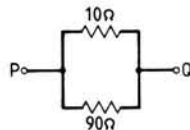

Paper 1 Section 1. Licensing Conditions—operators Clause 1 (1) (c)

## Question 8-3

If the Licensee is present and supervising, who else can operate the station?

- (i) another licensed amateur
- (ii) the holder of an Amateur Radio Certificate
- (iii) (during disaster relief operations only) the representative of a user service

- a. (i) only
- b. (ii) only
- c. (i) and (ii)
- d. all of them

Paper 2 Section 2. Electrical Theory—phase difference

## Question 8-4

In an a.c. circuit containing only capacitance, the current

- a. is in phase with the voltage
- b. lags the voltage by 90 degrees
- c. leads the voltage by 90 degrees
- d. is independent of the voltage

Paper 2 Section 7. Measurement

## Question 8-2

The diagram above shows a power unit supplying a receiver.

Where should an ammeter be placed to measure the current drawn by the receiver?

- a. position A
- b. position B
- c. position C
- d. position D

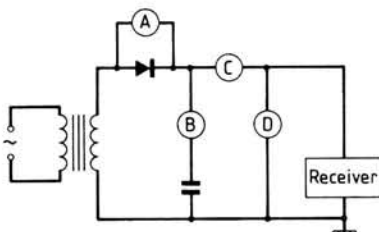

Paper 2 Section 6. Propagation and Aerials—coupling

## Question 8-5

The purpose of an antenna tuning unit (a.t.u.) is to

- a. match the antenna to the transmitter
- b. measure the output impedance of the transmitter
- c. adjust the s.w.r. bridge to the antenna
- d. reduce the output of the transmitter to the legal limit

Paper 2 Section 6. Propagation and Aerials—velocity ratio

## Question 8-6

The speed of a radio wave through a coaxial cable is related to the cable's

- a. resistance
- b. velocity ratio
- c. internal diameter
- d. wattage

SITUATED AT SOUTHERN END OF M23 — EASY ACCESS TO M25 AND SOUTH LONDON

HF RECEIVERS	£	(c&p)
Icom ICR71	825.00	(—)
Kenwood R2000	637.00	(—)
Kenwood VC10 V.H.F. Converter	170.76	(2.00)
Kenwood R5000	895.00	(—)
Yaesu FRG8800	639.00	(—)
Yaesu FRV8800 V.H.F. Converter	100.00	(2.00)

HF TRANSCEIVERS	£	(c&p)
Kenwood TS940S	1995.00	(—)
Kenwood TS930S	1750.00	(—)
Kenwood TS440S	1195.00	(—)
Kenwood TS430S	995.00	(—)
Kenwood TS830S	1095.00	(—)
Kenwood TS530SP	895.00	(—)
Yaesu FT980	1750.00	(—)
Yaesu FT757GX	969.00	(—)
Yaesu FT767GX	1550.00	(—)
Icom IC735	949.00	(—)

V.H.F. SCANNING RECEIVERS	£	(c&p)
Icom ICR7000	957.00	(—)
Yaesu FRG9600	525.00	(—)
A.O.R. AR2002	487.30	(—)
Signal R532 "Airband"	224.00	(—)
Sony Air 7	249.00	(—)

V.H.F. SCANNER ACCESSORIES	£	(c&p)
A.K.D. HFC1 HF Converter	49.00	(1.00)
Revcone Discone Antenna 30-500MHz	31.50	(2.00)
Icom AH7000 Antenna 25-1300MHz	82.00	(3.00)

ANTENNA TUNER UNITS	£	(c&p)
Yaesu FRT7700 Short wave listening	59.00	(2.00)
Yaesu FC757AT	349.00	(—)
Kenwood AT230	220.00	(2.50)
Kenwood AT250 auto	385.00	(—)

2.M. TRANSCEIVERS	£	(c&p)
Kenwood TH21E Handheld	189.00	(—)
Kenwood TR751E 25w multimode	649.00	(—)
Kenwood TS711E base station	991.00	(—)
Kenwood TH205E Handheld	218.00	(—)
Kenwood TH215E Handheld	258.00	(—)
Yaesu FT290II Portable multimode	429.00	(—)
Yaesu FT203R + FNB3 Handheld	255.00	(—)
Yaesu FT209RH + FNB3 Handheld	309.00	(—)
Yaesu FT270RH 45w F.M. mobile	469.00	(—)
Yaesu FT726R base station (70cm optional)	999.00	(—)
Yaesu FT23R Handheld	249.00	(—)
Icom IC2E Handheld	225.00	(—)
Icom IC02E Handheld	229.00	(—)
Icom IC28E 25w mobile	359.00	(—)
Icom IC271E base station	835.00	(—)
Icom IC3200E 2m/70cm F.M. mobile	556.00	(—)
Icom Micro II Handheld	239.00	(—)

70cm TRANSCEIVERS	£	(c&p)
Kenwood TH41E Handheld	218.00	(—)
Kenwood TR3600E Handheld	353.00	(—)
Kenwood TS811E base station	1095.00	(—)
Yaesu FT703R + FNB3 Handheld	289.00	(—)
Yaesu FT709R + FNB3 Handheld	319.00	(—)
Yaesu 70cm module for FT726R	349.00	(—)
Yaesu FT73R Handheld	269.00	(—)
Icom IC4E Handheld	285.00	(—)
Icom IC04E Handheld	299.00	(—)
Icom IC471E base station	927.00	(—)

KENWOOD ACCESSORIES	£	(c&p)
MC 50 Desk Microphone	48.59	(2.00)
MC 60A Desk Microphone with Pre-amp	93.02	(2.00)
MC 55 Mobile Microphone with Control Box	55.53	(1.00)
MC 35S Hand Microphone 4 pin	22.91	(1.00)
MC 40S Up/down Hand Microphone 6 pin	19.07	(1.00)
MC 42S Up/down Hand Microphone 8 pin	22.22	(1.00)
SMC 30 Speaker Microphone TH21	29.85	(1.00)
LF 30A Low Pass Filter 1KW	34.02	(2.00)
SP 40 Mobile Speaker	22.22	(1.00)
HS 7 Miniature Headphones	16.66	(1.00)
HS 6 Ultra Light Deluxe Headphones	25.68	(1.00)
HS 5 Deluxe Headphones	39.57	(1.00)
HMC 1 Headset with Vox TH21 etc.	34.71	(1.00)
VS 1 Voice Synthesizer Module	34.02	(1.00)
AD 1 Screwed Phono to BNC Adaptor TH21E/41E	3.85	(0.50)
IF 232C RS232 interface TS711/811E/940/440/R5000	72.89	(1.00)

ANTENNA BITS	£	(c&p)
HI-Q Balun 1:1 5kW P.E.P.	12.50	(1.00)
Bricomm Balun 4:1 1kW	11.20	(1.00)
Bricomm 7.1MHz Epoxy Traps (pair)	9.95	(1.50)
Self Amalgamating Tape 10M x 25mm	4.25	(0.75)
T-piece polyprop Dipole centre	1.60	(0.25)
Small ceramic egg insulators	0.65	(0.20)
Large ceramic egg insulators	0.85	(0.20)

CABLES ETC.	£	(c&p)
URM67 low loss coax 50 ohm	0.75	(0.25)
UR76 50 ohm coax dia. 5mm	0.30	(0.10)
UR70 70 ohm coax	0.35	(0.10)
UR95 50 ohm coax dia. 2.3mm	0.40	(0.10)
4mm Polyester Guy Rope (400kg)	0.20	(0.10)
50mtrs. 16 swg hard drawn copper wire	6.95	(1.50)



GOODS NORMALLY DESPATCHED WITHIN 24 HRS - PRICES CORRECT AT TIME OF GOING TO PRESS - E&OE - MAIL ORDER AND RETAIL

BREDHURST ELECTRONICS LTD HIGH ST, HANDCROSS, W. SX. RH17 6BW (0444) 400786

## BILLINGTON VALVES

### VALVES, TRANSISTORS AND COMPONENT BARGAINS.

New valves and transistors. Huge range stocked. Rarity our speciality.

Competitive prices. SAE for catalogue. Phone for quotation.

Wholesale and export enquiries welcome.

**WE WILL BUY VALVES.** Certain types only are required e.g. PX4, PX25, PP3/250, PP5/400, DA30, DA60, DA100, M22-200, but complete shop clearance, etc., considered.

**USED GOVT SURPLUS TEST EQUIP.** Repaired Avo 8 multimeters £75 delivered. Tektronix 465 dual trace scope 100MHz as new condition, works perfectly, with probes + lid £750 delivered.

**COMPONENTS.** Please add VAT @ 15% to all prices. NEW Gould electrolytic capacitor 10,000uF @ 50V, 18.7A discharge, special quality for computer use, etc. 4in tall, usually £8-£12. Our price £4 delivered.

China "egg insulators. White ceramic, old style 75p delivered.

**PRIMARY BATTERIES.** Unused and perfect, but several years old. 4.5V primary battery by Crompton-Parkinson. High current for radio control etc. Measures 6" x 3" x 2". Makers price £7 plus. Our Price £1.25 + 50p post.

**NEW VARIAC.** In case with 13A mains socket for output. Mains in 0-270V @ 3A out, 47-400MHz. Bargain @ £40 delivered.

**BLACK WAYRAD TRANSFORMER (NEW).** 1/2 duty cycle rated (5 mins on, 10 mins off). Weighs 20lbs. Primary = 0-10-20 and 0-105-110-200-230. Output = 1185-0-1185 @ 360mA d.c. £25 delivered.

**CONSTANT VOLTAGE TRANSFORMERS.** All famous brands. 5kVA, weighs 700lbs approx. Will control input mains fluctuations -40V or +20V. Output is 230V ±0.1%. Price £200 delivered.

**2.5A ISOLATING TRANSFORMER.** Potted Parmeco, black, oil filled. In = 0-10-210-230 twice. Out = 0-180-220 @ 2.5A. £20 delivered.

**AUTO TRANSFORMERS.** (Brown laminated). In = 0-115-200-210-220-230-240-250. Out = 115V @ 13.05A or 200-250V @ 7.5A. £25 delivered.

Many other new transformers in stock. Listing should be finished during July.

1000 resistors £3.50 delivered.

**INCREDIBLE BARGAIN PACKS**

2.5kg of mixed transistors, relays, capacitors, resistors, potentiometers, transformers, switches (weight includes wrappings).

£5 delivered (+VAT). Or 10kg = £10 delivered (+VAT).

**TO ORDER.** Please add VAT @ 15% to all orders. Postage is specified on each item. We accept Barclaycard. Usually same day despatch. Govt + export orders welcome.

BILLINGTON VALVES, 39 Highlands Road, Horsham, West Sussex RH13 5LS

Tel: 0403 864086. FAX 0403 210108. Telex: 87271 PRODSS G.

If visiting in person, please phone first to check that office is attended.

## South Midlands Communications



### HF ANTENNAS

South Midlands Communications has the largest stocks and range in Europe - your one stop source for antennas, rotators, cable etc.

**NEW Jaybeam Minimax.** At last a professionally manufactured minibeam built to Rolls Royce standards.

MINIMAX 10.15-20M, gain (pk) 6dbd F/B 12db typical LE 16.1ft. Boom 9.8ft. wt 15kgs

	£327.75	£4.50	p&p
GO2E	2 Ele. Ant. 10-15-20M	299.00	5.90
12AVQ	Vertical 10-15-20M	78.95	3.75
14AVQ	Vertical 10-15-20-40M	106.00	3.75
105BA	5 Ele. Yagi 10 metres	220.00	3.95
153BA	3 Ele. Yagi 15 metres	135.00	3.95
203BA	3 Ele. Yagi 20 metres	259.00	4.90
205BA	5 Ele. Yagi 20 metres	499.00	9.40
DB10-15A	3 Ele. Yagi 10-15M	209.00	4.80
TH3JNR	3 Ele. Yagi 10-15-20M	299.00	4.50
TH2MK3	2 Ele. Yagi 10-15-20M	279.00	4.50
EX14	5 Ele. 10-15-20M 'Explorer'	499.00	7.50
TH5MK2	5 Ele. 10-15-20M 'Thunderbird'	649.00	7.70
TH7DX	7 Ele. 10-15-20M 'Thunderbird'	755.00	9.75
VR3 MK3	Vertical 10-15-20M	70.15	2.90
TB3 MK3	3 Ele. Yagi 10-15-20M	299.00	5.90
TB2 MK3	2 Ele. Yagi 10-15-20M	202.40	4.90
TB1 MK3	Rotary Dipole 10-15-20M	101.20	3.35
TB3/SSKIT	Converts TB3 MK2 to TB3 MK3	59.80	2.50
HQ1	Mini 'Quad' 6-10-15-20M	199.00	4.00
G4MH	Mini Beam 10-15-20M	98.00	4.50
TD-HP	Trapped Dipole 10-20-40-80M 1000W PEP	49.00	2.65
G5RV	H.F. Dipole	16.68	2.65
HF3VNB	Vert. 12-17-30M 1000 PEP	73.15	3.00

### MOBILE ANTENNAS

	£	p&p
TRIBANDER 86	Antenna Two Sections 10-15-20M Slide Switch	36.34 2.20
GWBASESTND	Base Standard	8.45 1.00
LF3COILS	Loading Coil 30M/40M/80M/160M	8.45 1.00
LFWHIP	Telescopic Whip	5.87 1.00
FLEXIWHIP	Antenna Mast + Telescopic Whip (10M Basic)	27.54 2.20
FFCOILS	Loading Coil 15M/20M/40M/80M/160M	8.45 1.00
FLEXI 10	Mobile 80-40-30-20-17-12-10-2 Coils	61.53 2.35
PL SERIES	PL259 Mount 20M/40M/80M/160M	From 18.34 2.35

SCHOOL CLOSE, CHANDLERS FORD IND. ESTATE  
EASTLEIGH SO5 3BY. Tel: 0703 255111



# On The Air

## On The HF Bands

Reports to Paul Essery G3KFE  
Practical Wireless, Enefco House, The Quay, Poole, Dorset BH15 1PP

Liddery, dear readers, becomes daily more prevalent on our bands. In past years, one could reasonably expect the DX hounds and contest types to be a mite better operators than most, if only because bad operating lost new ones or contest points, or even both. Amateur radio for years now has been plagued with people who come on the bands "cold"—never active as s.w.l.s but only buying a commercial rig once the ticket has been obtained. To say they don't know "A" from a bull's foot is fair, but most people sympathise and the learning can be pretty short. No, our complaint is more fundamental—liddery among those who ought to know better.

*CQ Magazine* has a Hall of Fame—perhaps we should create a Hall of Infamy, containing a Clot of the Month, culminating in a Clown of the Year. Let us make a first nomination—you dear readers can do the rest. Ours is firstly for the optimist, calling CQ DX Twenty at about 35 w.p.m. with the usual thirty CQs to one call sign—at the top end of the PHONE segment! The second nomination goes to the DX operator who takes in callers by continent and the last two letters of their call, and then goes back to another continent! That particular operation was okayed for DXCC credit, but after careful listening we would take long odds that something like 30 per cent of the QSOs in his log weren't with the station named!

What we need is a bit of good old-fashioned mockery of these buffoons—other DX Columns please join in and help.

### Events

The Andaman/Nicobar expedition by the VU gang netted a total of 30 500 contacts of which Miss Bharathi VU2RBI herself made 14 450 QSOs in 182 countries. However, it rather looks as though the second trip has sunk, as the support offered has been minimal. One can't help thinking that maybe they should wait a couple of years before setting up another one, when the bands are a little livelier. Overall, though, a good show.

The *CQ Magazine* DX Hall of Fame has elected G3FKM—and we couldn't think of a worthier person than John. Apart from writing the *RadComm* DX piece for more years than enough—certainly before yours truly started with *Short Wave Magazine*—John has always stood for and symbolised the very best things in amateur radio and DX operations. Our congratulations, John.

We have hearings and reports of a station signing YAODX and claiming to be "glad to get back on the air"; but despite the signal apparently coming at the right time, direction and strength, the column is unimpressed, and doesn't intend to waste a QSL on Box 1, Kabul. On the other hand, if someone could show us such a card...

After all the hoo-ha, it is understood that the DL7FT Mount Athos QSLs have been accepted by the DXCC desk for credit after a careful examination—in which case it follows that someone was trying to foul up Frank's expedition but didn't succeed. Also accepted for DXCC are the various

Operation Raleigh stopovers, and those T50DX cards for Somali.

### Top Band

Our copy of VE3INQs *Top Band Annual News Digest* came to hand recently, and from it we have news of W1BB. Stew has had several visits to hospital and is now in a nursing home. The breathing problem has led to a tracheotomy and pneumonia. The house at 36 Pleasant Street from which Stew sent out Top Band Bulletins to so many for so many years has been sold, as has most of the amateur radio gear; some remains, as W1BB still hopes to get back to use it in due course. Sadly, the long lay-off has changed the "countries score on Top Band" position somewhat; when W1BB had to give up he was well ahead of the pack with his 157 countries worked; now the top score is W8LRL at just over 200. But at least we know W1BB is still with us, and we can send our good wishes on behalf of every Top Band DXer in Europe.

Rolf Rasp PY1RO has a 70m tower to play with, and has now used it with a linear-loaded version of Bi-Square elements; alas, the winds took it down before it has been properly evaluated. Now Rolf has, in effect, a three-element electrically steered version of the quad on Top Band, with which PY1ZAE about 50km away gives him a front-to-back ratio of 10dB and front-to-side 15dB. Clearly, the next move is to hoist the thing up to the top of the tower which will get the bottom up to 15m; and by now doubtless PY1RO will be in serious business. It's a long time since we remember s.w.l. Rolf Rasp operating in the old Magazine Club Contest on Top Band, but even then he was internationally known.

G3BDQ (Hastings) offers three sessions on the band; April 21 saw him booking in UA3ZOY, UB5MTN, RA3QDF, RF6FIK, UA4AQZ, UA3RMX, RQ2GIG, and UA4COL: on the 26th 4X4NJ, AA1K, and UT5UGE and on May 16 IO2X, I5ESR, and UB5FDZ. John notes also that his old friend G3BRD of Seaham, a few kilometres west of John, has designed a new Top Band antenna which is going great guns on the DX front.

G2HKU (Sheppey) requires an article in this magazine covering a spray for his lawn which would keep the grass nicely at the one-inch level, and so result in much more amateur radio activity... a delightful idea! Ted stuck to his key this time and worked F8IH/EA, RA3DFP, EI7H and IK2GXX.

### The 3.5MHz Band

It seems to the author that one needs a special sort of mind to enjoy DXing on this band on s.s.b., but the c.w. end is rather better. Anywhere on the band, the possession of a good receiver, and the skill to drive it well are paramount, followed in short order by a decent antenna system.

G3NOF's old mast is now down and at the time of his letter the new 18m one had not been erected, so Don is having a lean time for the moment. However, on 3.5 and 7MHz, Don has replaced the inverted-V trap dipole with a semi-vertical made from

half a trap dipole, and with this he made s.s.b. QSOs between 2300–0000Z to PA6IARU, TP2CE, TR8JLD, TU4CG, VO2WL, ZS1MH, 3A/DF6FK and 4U1TU.

QRP c.w. on 3.5MHz netted G2HKU DL4KCA, UB5HAP and GM3PFQ, using three watts input.

Nice to hear again from G4KKI (Swinton) who has been having a shack sort-out and rebuild. The 3.5MHz band is now covered by a DSB 80 built out of the junk-box on a p.c.b. made about four years ago; the original has acquired an r.i.t. and c.w. sidetone, both from articles in the G-QRP Club *SPRAT*. The "weak link" in the system is the antenna; there is no front garden, and the backyard is 4.5 x 6m, the house being a terraced one in the middle of the town. Over the roof is draped a trap-loaded dipole for 3.5 and 7MHz, and inside the loft there is a dipole bent round, halo-fashion, for 14MHz. This set-up doesn't sound very promising, but on 3.5 it gave c.w. QSOs with GD3FXN, G0AHW, G3MBN, G3YIA, G3YLL, G3UAA, G4WUY, GM3MXN, G4SBU, G3NSA, G4ZXN, G4HMD and G8KI over a period of a couple of weeks.

G4XDJ (Billingham) offers on 3.5MHz his two-way QRP contact with G3UZU/A, who was parked-up somewhere in the Liverpool area.

G0HGA (Stevenage) got shot of that old B Licence in short order, and is now active on c.w. with an HW9—though a couple of weeks later we heard that the p.a. transistors had gone into self-destruct mode while looking into a near perfect s.w.r., thanks to a tiny miscue in the building. However, HA8KUX, HB9CYY, ON4DB, SM5FSB, OK1KAY, G10BMR, OK1LNH, OK1CGI, HB9IK, DL9YA, UB5JWB, SP2WV, RR2RM, SP1DPA, RQ3GIG, GM3TMK, RB5SA, YU7AKB, Y37ZB, plus many DL/PA/ON/F/GW/GM and northerly Gs. Already, we notice, Angela has become aware of wind and weather, and what they do to antennas suspended from trees—but, on the other hand, getting and keeping antennas up trees is a part of the fun!

### The 7MHz Band

Much DX is worked, little is talked about! However, G3BDQ managed some 154 stations in three hours in the CQ-M contest, plus JA4VUQ and TR8CA on c.w. John's activity this time has in any case been rather low, there being more "priority" things to be done.

The semi-vertical antenna at G3NOF had, to the time of writing, yielded just one DX QSO, with VK3RE on s.s.b.

G4VFG (Ivybridge) says he often works Ws on 7MHz c.w., but nothing much of note recently.

The Big Rig on 7MHz c.w. netted KM3T, K5MA, UZ9MWF, UD6DKW and HZ1HZ.

G3BSN notes that the problem of r.f. interference generated by the "one-arm bandits" installed in local pubs is quite a nuisance in any built-up area; G4HNO was able to prove the point rather neatly—when monitoring 28.5MHz, someone on the staff pulled out the plug of the bandit, and lo! the interference ceased.

*Practical Wireless, August 1987*



G3NOF has received his Golden Jubilee DXCC Award and says it is quite colourful; but Don is already up to 181 countries worked in 1987!

**GWOHWT** writes to note that he saw our reference to **SU1ER** in the May issue, and is booked for a shack visit soon; the bad news, though, is that his application for an Egyptian licence was turned down; this is the same reply as he and **G4ABI** got in the Sudan last year.

## New Bands

Of course these bands are occupied mainly by other things than mere amateur radio—indeed, were they to be marked on a map the spot should be inscribed “Here be Dragons”; but the c.w. lovers can at least practise their art in relative peace, save for the odd **TWIT** who uses ‘phone.

**G4VFG** looked on 18MHz one day and heard **9V1TL** and **9M2FS** who worked a few each on c.w., and finally each other—but Peter’s **QRP** bleeps didn’t crack the noise level. On 10MHz, amid all the din, **G4VFG** hooked **F8VN**, **DJ5XO**, **UZ3AYR**, **IK1EVQ**, **RB5BE**, **W2FJ**, **LA9PEA**, **UQ3PM**, **LZ2MK**, **KY9L**, **KO1H**, **QE3HCS** and **UO5WT**.

**G3BSN** (Clapham) offers hearings of **EA**, **I**, **UA**, **UK**, **SM**, **LZ**, and **DL**, plus a **QSO** with **KQ9A/I3** in Vicenza. Phillip also notes that **G0GQT** has worked **VKs**, on both c.w. and s.s.b. Both have, of course, booked in a shoal of **EU** small-fry. All 10MHz.

**RB5BE** was the only c.w. contact on any new band for **G2HKU**, who raised him on 10MHz.

We had thought that with the wider availability of these bands, activity and reports would be on the increase, but this doesn’t seem to follow.

Nonetheless more reports wouldn’t by any means come amiss!

## The 28MHz Band

The propagation forecast, alas, doesn’t go far enough ahead to be much use by the time this reaches you; but suffice it to say that the bands are really hopping; the forecast shows nothing worse than “High Normal” between May 29 and June 9, with the 54-day indications giving similar labels to June 10–15 . . . and all down to new-cycle spots. Get out the Sundance routines—Think Spots!!

Of course for real openings on 28MHz we need to see a sunspot count of above 50, but there are still things happening, and this is the time of year.

Don at **G3NOF** says there have been several openings to Europe, plus some to the Middle East, and once as far as **VU**. **G3NOF** worked s.s.b. with **OD5AS**, **VU2LAM**, **4X4JU**, **4X7T**, **4Z4AB** and **7Q7LW**.

**G3BSN**, as already noted, finds 28MHz operation almost impossible, thanks to **QRM** radiated from computers and the one-arm bandits. Hence Phillip’s list shows **EA3DER**, **EA5FQS**, **EA3AFH/M** 70km south of Barcelona, **IY4M** beacon,

**IK4CBO**, **T77M** in San Marino, and **YU3CCD**, while **Heard** includes **IY4M** beacon, **EA3JA** beacon, **SM3JLA** on c.w., **HA5AAP**, **OH5NW** and shoals of near Europeans.

**G4VFG** now has a station in the car so that he can check the band at lunchtime at the work **QTH**, high up near Plymouth airport. In the car is fitted a **Belcom LS102**, plus a **CP163** linear power-switched between 25, 50 and 100 watts and the antenna is a home-brew loaded whip arrangement. With this, s.s.b. yielded **EA3CYQ**, **EI4DW**, **GM4WJA**, **EA4BYJ**, **4Z4ZW**, **ZS3PQ**, **EA6ZR**, **EA7GFA**, **EA5GBS**, **HA0MM**, **OE3PW**. **FD1HAA/P**, **SM4RIK**, **5T5NU**, plus c.w. to **FD1DJG** and a half-QSO with **VE1BNN** who couldn’t copy the complete call.

## The 21MHz Band

**SWL G. Hitchins** has a problem of an evening with a noise every 10–15kHz up the band; which sounds very much like **TV** line-timebase harmonics. George heard **LU4BX**, **OD5SM**, **TA2G**, **Z24JS**, **3D6CV** and **4X9B**.

Naturally, with things “almost getting there” on 28MHz, 21MHz has been quite exciting. **G4VFG** has put up a 5/8 wave vertical on the band, up the side of an oak tree in the garden; this is used with an earth stake and four quarter-wave radials, the vertical part being only about 300mm from the tree. This has made it out to **PY5OC**, **A4XRS**, **PY5TT**, **PU1JMY** (c.w.), **5T5EV**, **J28EM**, **VP8BKK**, **TU2GC** and **HK3LBF**.

**G3NOF**’s analysis of the band shows the short path morning opening to Asia, **JA** and **Indonesia** was good, with **Africans** in the afternoon, **South America** between tea and dinner, and some strong **Ws** around 2200Z. Don made s.s.b. contact with **AP2P**, **DV7PI**, **HL2INX**, **J28EM**, **JA1RGD**, **JA4IKD**, **JE3GUP**, **JF2WXS**, **J16KVR**, **JL1MWI**, **JR1RCQ**, **JR6EA**, **JY5CO**, **K1BAZ/DV1**, **OE5SYM/5N3**, **P29AR**, **TJ1CH**, **TR8CA**, **TR8JLD**, **TR8RLA**, **TU2AZ**, **TZ6VV**, **UA0AFA**, **UI8LBP**, **UI9BWF**, **UW9CE**, **VP8BKK**, **VU2LAM**, **VU2TTC**, many **YB/YCs**, **ZD8MAC**, **ZD8SW**, **ZS1IF**, **ZS6BFU**, **ZS6KCC**, **Z21BP**, **Z24JW**, **4S7RR/A**, **5H3BH**, **5T5CJ**, **5T5NU**, **9L1TS** and **9V1WP**.

**G4XDJ** found **4X500** on this band for a new prefix, plus **I1QQI**, **UZ9CXE**, **OH1NOA**, **4X4HT**, **LA1KK**, and **UW6AL**, while 21MHz s.s.b. amused **G3BDQ** by way of **YC5NCK**, **YB0KM**, **DL2BK/SV9**, **J28EM** and **9V1WO**.

## Now 14MHz

The author is largely confined to this band by the limitations “up aloft” and his own dislike of having several skywires up at once on engineering grounds.

**SWL Hitchins** notes **CN5SE**, **PP8ZBO**, **TU2JU**, **XE1MN**, **YV5CSX** and **5T5EV**.

Most evenings the band has been open to somewhere or other, and those with interesting calls were having a ball; we

heard **H25SA** in Cyprus, celebrating 25 years of Cyprus **ARS**, comment that he had over 1000 **QSOs** in the log since starting operating that day; he went **QRT** in the end, leaving a disconsolate **Yank** enquiring what country he’d missed.

**G4VFG** has a look occasionally just in case something’s interesting; thus s.s.b. accounted for **ZB21B**, **ZD8CW** (for whom the correct **QSL** information would be appreciated), **TA3C**, **JX9CAA** and **SO9NEA** who was **LA3NEA** on a visit there.

**G2HKU** used c.w. to raise **VK7NC**, **UM8NAC**, **W7FU**, **VK4XA**, **VK2QL**, **5AOA** (**QSL** via **SP6BZ**, no call signs on envelope), **N6VV**, **K5MM**, **W5ADZ**, **WA6VOV** and **K9BG**.

**G4KKI** has an indoor antenna and a **PW** Teme transceiver on the band, modified at the front-end and the driver/p.a. circuitry. Three watts out, into the indoor bent dipole already described, yielded c.w. contacts with **W4FNS**, **OX3KD** for a new one, **SP8AMK**, **OH3TM**, **UA9JH** for a new continent, **UQ1GWE**, **OH8BGM**, **UB0YW**, **UB5PCO**, and **KI4R**, with **Gotaways KH6**, **PY**, **YV**, **SV**, **OU5** and **JY5DP**.

Long path contacts with the **Antipodes** and **JA** have been “on” between 0600–1100, says **G3NOF**; short path was also good around noon to **JA** and **Asia**. Some s.s.b. contacts were made with **A61AB**, **AH8CS**, **DU1KT**, **EA9KQ**, **FF6REF/P/EMB** (Embier Is.), **FM5CL**, **FM5WE**, **FO5IW**, **G3TTC/VS6**, **HB9VP/KH6**, **HV3SJ**, **J73RM**, **J88AQ**, **JA7HMZ**, **JH8IGC**, **KH6IJ**, **KX6DS**, **KL7JID**, **OD5SM**, **OH0/DL7ANR**, **P43DO**, **OX3KM**, **S79CW**, **SMODWH/BT0** (Mt. Everest), **T30BY**, **T77T**, **TF1PS**, **TP2CE** (Council of Europe), **TV6MED**, **TX26FC**, **UA0ZDD** (Zone 19), **V85WS**, **VKs**, **VP9BP/KH6**, **W7PSO/KH6**, **YB5NOF**, **ZK1DD**, **ZK2EKY**, **ZL1BBD**, **3A7E**, **3A7JO**, **4U1VIC**, **4X39ID**, **6W6JX**, **8P6OV**, **8R1PK** and **9Q5NW**.

**G4XDJ** made his mark with **HB9DGC**, **LA4B**, **OH2TO**, **YU2TS**, **LY7L**, **WA3EBG**, **PT8CW**, **TA1W**, **VE1DJ**, **SJ9WL**, **TV6RE**, **JW6WDA**, **EV9AX** and **OX3XM**.

Finally, **CN32FIC** (**QSL** Box 299 Rabat), **4S7GX**, **JA2GBO**, **LY7L**, **ZD8CW** who is **Roger G3ZDW**, **RS7WP**, **KH6IJ**, **UM8MK**, **EM7BR**, and **VU2NTA** were all c.w. contacts in the log of **G3BDQ** on 14MHz.

## Oddments

The **W1WY** Contest Calendar is always invaluable; this month it shows the **AGCW-DL QRP** Contest over July 18–19, 1500Z–1500Z. Only the **QRPers** will be interested in this one, but of course they will be hoping you will listen for them; the exchange is **RST** plus power input. Over the same weekend, one would expect the c.w. leg of the **SEANET DX** Contest, but no word this year, either to **W1WY** or the author.

**Deadlines for the next three issues are: July 27; August 28; September 28.**

## VHF Up

Two major items to report this time, the first being the release of the 50MHz and 70MHz bands to Class B licensees on June 1 and the second, the first major Sporadic-E opening of the year on 144MHz on May 28. These topics will be fully reported in the appropriate paragraphs, later.

*Practical Wireless, August 1987*

## Awards News

Congratulations to **Dave Robinson G4FRE** from Felixstowe (SFK) who has joined the 70MHz VHF Century Club. His certificate was issued on May 21 and, although this award has been available for

decades, Dave is only the 14th member. 97 of the confirmed **QSOs** were on tropo mode from **AL07a**, two via meteor scatter and one by Auroral mode.

The station at **G4FRE** comprises an **Icom IC-202**, a 144/70MHz transverter by **Microwave Modules** and a home built

*Reports to Norman Fitch G3FPK  
40 Eskdale Gardens, Purley, Surrey CR2 1EZ.*

4CX250B amplifier. The antennas are either a 5-ele Yagi by MET or a modified 3-ele Yagi by Halbar with a coaxial balun added, 6m a.g.l. Dave's best tropo DX is GM4LIP/P (WP30f) on Islay at 637km; best m.s. DX is 859km to GB4ZAP/P (YT48f) in Orkney. The Ar QSO was with GM4ZUK (GRN).

For details of the VHFCC and QTH Locator Squares Century Club (QTHCC) write to the Awards Department at *Practical Wireless*, Enefco House, The Quay, Poole, Dorset, BH15 1PP, enclosing an s.a.e. or an i.r.c. as appropriate.

## Beacon News

The Canadian beacon VE1SIX on 50.088MHz is reported to be operational again as from May 16. It runs 50W to a 4-ele Yagi pointed towards Europe.

Paul Turner G4IJE (ESX) has built a beacon TX to be operated from Malta. It was due to be taken there by GW3LDH and the frequency (QRG) is stated as 50.085MHz. Paul confirms the output power as 10W and believes that a 4-ele Yagi by Jaybeam will be used. The locator is JM75FV and the antenna will be pointed towards the UK. The Gibraltar 50MHz beacon ZB2VHF was still off the air at the end of May having been silent since last December.

Nearer home, the Cornish beacons GB3CTC have been off the air since May 17. Activity from this region is never very great as there are not all that many operators looking for DX. Consequently, without any beacons, it is difficult to know if conditions are up or down in that direction.

## DXpedition News

Nigel Wilson G4VVZ has written on behalf of the Derbyshire Hills Contest Group about their proposed trip to the Irish Republic in August. They will be based in VN square and intend to operate -/P from UN and UO as well. The dates are August 2-14, taking in the Perseids meteor shower.

The callsign will be EI2VPX on the European v.h.f. net found on 14MHz and on u.h.f. Operation is planned on 70, 144, 432 and 1296MHz and other callsigns, to be advised later, will be used thereon. The Group is seeking permission to be allowed to operate on 50MHz. Some activity on higher microwave bands may be possible depending upon conditions.

From VN square, the operating frequencies would be 70.22, 144.144, 144.22, 432.22 and 1296.22MHz. The QRGs from UN and UO would be 70.18, 144.084 for c.w. m.s., 144.18 for tropo and 144.484MHz for s.s.b. m.s.

The group will include G4FRE, G4VVZ, G4XUM, G4YUZ and G8ROU. Readers wanting to arrange m.s. skeds should contact David Hardy G8ROU, Thorntree House, Wensley, Matlock, Derbys., DE4 2LL. His telephone number is Matlock (0629) 732620 and they are keen to conduct some m.s. tests on 432MHz at the peak of the Perseids.

## Contests and Tables

The results of the Derby and District ARS v.h.f. contest on March 15 have arrived. The full legal power section was won by G4CRA/P (ESX) with 10 998 points, runner up being Ela Martyr G6HKM (ESX) who accumulated 7956 pts. The low power, 25W maximum, section was won by G4RLF/P (WLT) with 16 640 pts

and runner up was GW6TGX/P (GWT) with 14 168 pts. There were nine entries for the QRO section and 16 for the QRP part. Only one entry was received for the s.w.l. section, but it was disqualified. Anyone requiring a copy of the full results should send an s.a.e. to David Palmer G1DHQ at 119 Green Lane, Derby, DE1 1RZ.

The Third Annual CQ World-wide v.h.f. WPX Contest is over 48 hours from 0000UTC on July 18. Details were given in the July issue. The next two legs of the 10GHz Cumulatives are on July 12 and August 9, 0900-2100UTC.

August 8 sees the 144MHz low power event from 1500 to 2300 and the following day, 0900-1500 there is the 432MHz version. On August 23 there is the 1296/2320MHz contest from 0900 to 1500.

Concerning the claimed scores in the Annual Table, several readers have asked how some participants have so many counties worked. As explained in previous months, the counties are the 78 in G, GD, GI, GJ, GM, GW and GU plus the 26 in the Irish Republic making a possible maximum of 104. You can include your own county, country and square in your totals.

## Repeater Note

On May 25 a new microwave repeater became operational from Berkshire. It is GB3RU located 10km west of Reading and is on channel RM9, the output QRG being 1297.225MHz. When not operating in repeater mode it stays on as a beacon. Reception reports to Chris Young G4CCC, who is QTHR.

## The "New" Bands

A notice in the London, Edinburgh and Belfast Gazettes on May 22 announced modifications of the licence conditions affecting the 70MHz and 50MHz amateur bands. Both have now been available to Class B licensees since June 1.

First 70MHz, in which the amateur service still has secondary status. This means we must not cause interference to other services entitled to use the band on a primary basis. The band has been slightly extended and is now 70.000 to 70.500MHz. There are no restrictions on mobile, portable and alternative address operation but remember that the maximum carrier power delivered to the antenna on c.w. is 16dBW (50W approx) and on s.s.b. 22dBW (130W approx) p.e.p.

Now 50MHz, and here we have gained considerably in that it is now the same "width" as 144MHz, the upper limit now being 52MHz. Furthermore the amateur service now has primary status between 50 and 51MHz and secondary status from 51 to 52MHz.

The restrictions on portable and alternative address operation have been abolished but mobile operation remains out. The maximum antenna height remains 20m a.g.l. and the power levels are unchanged. On c.w. the maximum e.r.p. (effective radiated power with respect to a dipole antenna) is 14dBW (25W) and on s.s.b. mode 20dBW (100W) is the maximum p.e.p.

To take an example. Assume you are using a Yagi beam with a claimed gain of 4.5dB over a dipole and are using 18m of UR67 coaxial cable between the TX and the antenna. The antenna system gain would be 4.5 minus 0.8dB feeder loss or 3.7dB. On c.w. mode therefore, your TX

QTH Locator Squares Table

Station	Band (MHz)			Total
	1296	430	144	
G3IMV	7	116	397	520
G8GXP	30	140	307	477
GJ4ICD	59	117	241	417
G4KUX	—	79	335	414
G4NQC	63	99	250	412
G3UVR	63	113	217	393
G3XDY	78	131	180	389
GW4LXO	45	100	240	385
G3JXN	80	126	172	378
YD2IS	—	37	341	378
GW4TTU	37	87	238	362
G4R6K	35	93	233	361
G6DER	70	104	177	351
G8TFI	79	141	126	346
G4DCV	25	71	248	344
DL8FBD	—	69	274	343
G4IJE	—	—	338	338
G4XEN	—	98	232	330
G4DEZ	44	38	246	328
G3BW	15	38	269	322
G3CQJ	44	102	175	321
G1EZF	32	86	200	318
G4MCU	25	82	201	308
G8XVJ	—	86	213	299
G4DHF	—	—	290	290
G4TIF	—	106	178	284
G4FRE	63	136	84	283
G8PNN	58	94	128	280
G6MGL	50	89	135	274
G6XVV	17	62	188	267
G6HKM	15	98	153	266
G6YLO	32	104	128	264
G4MUT	24	87	140	251
G6HKS	—	65	186	251
G1KDF	22	85	139	246
G4SWX	—	—	239	239
G4NBS	56	95	86	237
G4SSO	—	55	164	219
G3FPK	—	—	219	219
G6DZH	—	82	136	218
I4YNO	—	—	214	214
G4MJC	—	28	182	210
GM4CXP	—	30	179	209
GW8UCQ	—	81	128	209
G4SFY	—	—	208	208
G4MEJ	—	—	204	204
G6ECM	—	—	200	200
G4IGO	—	—	198	198
G8LFB	—	—	197	197
G4HGT	—	52	142	194
G4YCD	—	36	155	191
G1EGC	—	44	144	188
GOCHE	—	—	181	181
G1LSB	—	105	75	180
GM0BPY	—	54	123	177
G4YUZ	—	—	177	177
GW3C8Y	18	46	107	171
G4XEK	—	—	167	167
G8MKD	—	49	117	166
G8ZDS	—	41	123	164
GJ6TMM	—	31	128	159
G1GEY	—	30	124	154
G4DOL	—	—	154	154
E15FK	—	19	131	150
GW8VHI	—	48	102	150
G4CQM	—	52	94	146
G6AJE	3	52	90	145
G6XLL	—	36	109	145
G4FVK	14	43	71	128
G4RSN	2	34	92	128
G8RWG	—	13	105	118
G6XRK	—	1	117	118
ON1CAK	—	—	117	117
G0FOT	—	54	49	103
G4T6K	—	—	101	101
G6MXL	7	34	57	98
G8XTJ	—	—	98	98
G1DOX	20	27	49	96
G6CSY	16	39	34	89
GM8BDX	13	31	41	85
G4JZF/P	—	80	—	80
G1DWQ	—	—	72	72
G0FBG/PA	—	17	54	71
GW6VZW	—	—	70	70
G0HDZ	—	—	55	55
GU4HUY	—	—	54	54
G1CRH	—	—	50	50
GM0GDL	—	7	38	45
G1HGD	—	7	38	45
G1N6V	—	—	41	41
G2D8V	1	4	27	32
G1VTR	—	23	6	29

Starting date January 1 1975.  
No satellite or repeater QSOs.

PROFESSIONALS AND DISCERNING  
RADIO AMATEURS ALWAYS CHOOSE



THE TOWER  
PEOPLE

**COMPACT LATTICE TOWERS—SLIMLINE TUBULAR MASTS**

Telescopic—Tiltover, Fixed—Mobile from 3M to 60M.  
Over 50 Models, suitable for a wide range  
of civil and military applications such as:

- Radio Communications
- Amateur Radio
- CCTV and Surveillance
- Meteorological Monitoring
- Aero & Marine Nav Aids
- Flood Lighting etc.

Purpose designed using 4.5m and 3m section modules  
for low retracted heights and cost effective shipping.  
Engineered to B.S.I. standards and hot dip galvanised to  
BS729 for protection. Wind loads are based on BS CP3  
CHAP V PT 2 1972 for wind speeds up to 100mph/160kph.

RELIABILITY—QUALITY—KNOW HOW.

SEND S.A.E. FOR FULL DETAILS.

WE DESIGN—WE MAKE—WE SELL—DIRECT. No Middle Man.  
At manufacturers prices—you get best value.

ALSO SPACE SAVER 3ele 4 BAND AQ6-20 BEAM  
169.00 + 7.00 CARR.

**ALLWELD  
ENGINEERING**

Factory 6, 232 Selsdon Road,  
South Croydon, Surrey, CR2 6PL  
Tel: 01-680 2995 (24 hr) 01-681 6734

Stock items normally sent within 7 days:

HP TERMS AVAILABLE

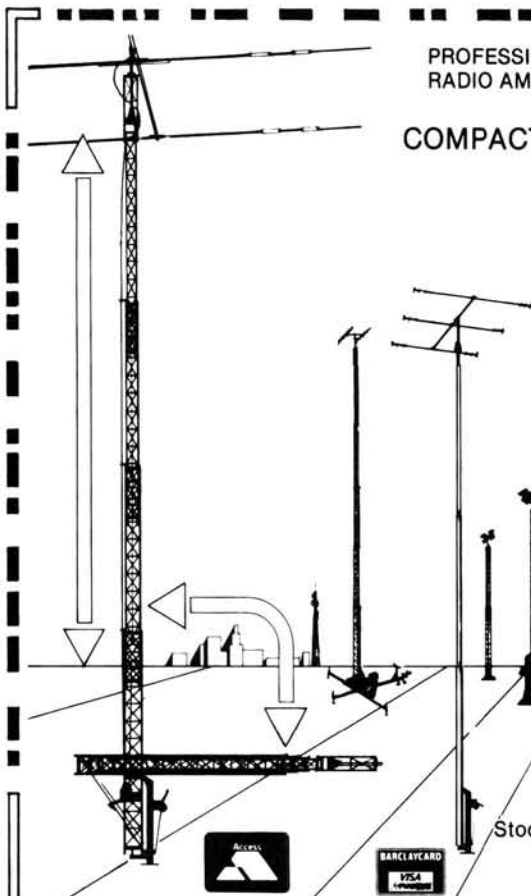

**AMATEUR ELECTRONICS UK**

G6XBH  
G1RAS  
G8UUS

**R.A.S. (Nottingham)**  
Radio Amateur Supplies  
Tel: 0602 280267

**Visit your Local Emporium**  
Large selection of New/Used Equipment on Show

**AGENTS FOR:**  
F.D.K.  
AZDEN  
ICOM  
YAESU  
ALINCO  
KEMPRO

**ACCESSORIES:**  
Welz Range  
Microwave Modules  
Adonis Mics  
Mutek Pre-Amps  
Barenco Mast Supports  
DRAE Products  
BNOS Linear & P.S.U.'s

AGENTS FOR CELLNET AND VODAFONE RADIOS  
AERIALS, Tonna, Halbar, New Diamond Range of Mobile Whips, Jaybeam  
BRING YOUR S/H EQUIPMENT IN FOR SALE  
JUST GIVE US A RING  
Monday: CLOSED Tuesday-Saturday: 10.00am to 5.00pm

**3 Farnon Green, Wollaton Park, Nottingham NG8 1OU**  
Off Ring Rd., between A52 (Derby Road) & A609 (Ilkeston Road)

**TRIPODS** heavy duty Army unit with motorised head unit to give 360° rotation motor 6/24V DC reversible length closed approx 36" fixed length legs adjustable to 45" est load 50Kg with approx 60 mts cable & drum, weight inc cable approx 17 Kg new cond. £85 **VARIACS** panel mt 240v O/P 0/270v at 2 amps. £18.50 **SPK UNITS** Army AFV type 3 ohm size 5 1/2" dia 3 1/2" deep in metal case. £8.50 **ARMY AE KITS**. 30ft 10 section mast or Ae 1" with guys, stakes, base insul carrying bag etc new cond. £36 **BLOWERS** for 115v 50c med size snail type outlet 2 1/2 x 2" new. £16.50 240/115 Trs if req £2.50 **X.BAND W.M.** ex AM direct cal 9.17 to 9.47 Gz as var atten 0/100Db with meter to give relative pwr will adapt to other freq in case. £32.50 **H.F. PRE SELECTOR** Army unit tunable 2/29 Mc/s in 4 bands direct cal fitted 10.1 s.m. drive as two high Q tuned coils per band 75 ohm I/P & O/P on 19" panel well made unit £26.50 **SCOPES** Solartron ex MOD type CD1400 gen purpose dual beam Y amp DC to 15 Megs at 100 Mill/V Cm or 10 Mill/V at 750Kc T.B. 0.5 Us Sec/Cm to 200 Mill/S Cm, TB expan to X5, int cal, 5" flat face CRT with 4Kv P31 trace, size 13x7x17" tested with book. £95 **PHOTO FLASH CAPS**. 215 Uf at 2.5Kv Pk £14.50 Flash tubes with reflc reqs ext trig. £6.50 **MARCONI EXT MOD.** enables AM, Pulse, Video mod to be applied to RF signals up to 500 Mc/s in 50 ohm RF circs mains operated with book, £28 **VIDEO TAPE** Sony type V-60H 1/2" on 5" spools new 4 for £11.50 **AUTO TRANS** 200/250v to 115v at 560 watt. £18 also 230/115v at 150w £7.50 both enc. types. **MONOC SIGHT** 5x27.5 var focus £9. For callers. Tape unit with amp 12v 30 watt PA with speaker. £35 Computer Term with K/Brd. Printer, Power unit in carry case. £15 Aircraft HUD (head up displays) with CRT, Lens etc. £15 & £35.

Above prices include carr/Post & VAT. Goods ex-equipment unless stated new.  
2x18p stamps for List 40 allow 14 days for delivery.

**A.H. SUPPLIES**  
122 Handsworth Rd, Sheffield S9 4AE.  
Phone: 444278 (0742).

**HAVING DIFFICULTY GETTING YOUR COPY OF PRACTICAL WIRELESS?**

Then place a regular order with your newsagent **NOW!**



Dear Newsagent, please reserve/deliver my monthly copy of PRACTICAL WIRELESS

Name \_\_\_\_\_

Address \_\_\_\_\_

Signed \_\_\_\_\_

Distributed by Comag

output power must not exceed 14-3.7=10.3dBW (10W approx).

The DTI has stated it will review the present power levels before the end of this year. It cannot be emphasised too much that the licensed power levels are not to be exceeded otherwise we run the risk of the band being withdrawn. This is because, since the 50MHz band is not generally available in ITU Region 1, the DTI must ensure that TV and other services using the band in neighbouring countries are afforded an agreed protection ratio.

## Auroral Records

In the June issue, I mentioned the G4VBG/UA3IFI QSO on 144MHz via Ar mode on 7 Feb 1986 as being the probable best DX from the British Isles. Now **Nick Peckett G4KUX** (DHM) has told me of a contact some years ago on this mode between GM4ILS (IO87IP) and RA3YCR (KO73CG) which works out at 2389 ± 5km. I gather this has been confirmed but the GM has also worked a Moscow station which could exceed that QRB by about 100km. That QSO may not have been confirmed.

## The 50MHz Band

From the Irish Republic many readers have worked Dick Madigan EI9Q (Waterford) recently. Dick told me he applied for a 50MHz permit two-and-a-half years ago. In desperation he wrote to the Irish authorities pointing out he was approaching his 80th birthday so they had better get a move on. That did the trick, the permit arriving on his birthday on April 15.

Dick had worked about 50 different Gs in the first six weeks, but no GMs. He has worked CT1WW and EA1MO. 9H1CG (HV) has also been worked although I was not aware that Maltese amateurs had then got permission to operate although they have been using cross-band mode.

Regular users will know about the Sunday morning m.s. activity periods from 0600UTC. **Ken Ellis G5KW** (KNT) tells me that m.s. enthusiasts are extending this activity at 0800, 0900 and 1000UTC.

**Bob Nixon G1KDF** (LNH) reports hearing EA1MO at S3 on May 19. He has been working cross-band 144/50MHz to GM4YPZ (GRN) on April 25; GM4CXP (BDS) on the 26th; GM3TSL (GRN) on the 30th. He reports EI9Q, EI6AS (Dublin) and EI2W (Dublin) as regulars. On May 23 there was a lot of 50/28MHz cross-band activity from G to DL, EI and OZ.

**John Stace G3CCH** has written to point out he is in Humberstone and not Northumberland. He has been QRV since Jan 1 and has worked 158 different sta-

### Annual c.w. ladder

Station	Band (MHz)				
	70	144	430	μWave	Points
G4ZEC	—	390	—	—	390
G4ZNU	—	151	3	—	154
G4XEN	—	145	8	—	153
G4OUT	—	107	—	—	107
G4ZVS	—	102	—	—	102
G0DJA	—	57	—	—	57
G0HGA	—	53	—	—	53
G4VOZ	24	—	21	—	45
G4YIR	—	41	—	—	41
G4AGQ	11	12	14	1	38
G2DHV	5	23	2	—	30
GM4CXP	—	21	—	—	21
E15FK	—	10	6	—	16
GW4HBK	4	—	—	—	4

Number of different stations worked since January 1.

### Annual v.h.f./u.h.f. table January to December 1987

Station	70MHz		144MHz		430MHz		1296MHz		Total Points
	Counties	Countries	Counties	Countries	Counties	Countries	Counties	Countries	
G1KDF	—	—	91	11	62	7	18	4	193
G4NBS	41	5	54	10	44	11	15	6	165
G6XVV	—	—	70	13	50	8	12	2	155
G6HKM	—	—	63	14	45	9	19	4	154
G1SWH	—	—	87	9	48	7	—	—	151
G1LSB	—	—	55	11	46	12	—	—	124
G4DEZ	—	—	34	10	42	11	13	5	115
G4WJR	—	—	78	10	—	—	—	—	88
G4MUT	26	1	38	9	11	2	3	1	87
G6AJE	—	—	39	9	30	6	—	—	84
G1EHJ	—	—	39	7	25	6	—	—	77
G3FPK	—	—	62	14	—	—	—	—	76
GW6VZW	—	—	58	10	—	—	—	—	68
GW4FRX	—	—	58	10	—	—	—	—	68
G4AGQ	13	1	28	8	13	4	1	1	67
G4VOZ	30	3	—	—	29	5	—	—	67
G4ZTR	12	2	22	5	21	4	2	1	66
G8XTJ	—	—	54	11	—	—	—	—	65
G6MGL	—	—	25	6	25	2	1	3	62
G4TKG	—	—	50	12	—	—	—	—	62
G6MXL	—	—	31	7	12	4	3	1	58
G4YIR	—	—	46	12	—	—	—	—	58
G0H0Z	—	—	45	11	—	—	—	—	56
G1CRH	—	—	47	9	—	—	—	—	56
ON1CAK	—	—	37	13	—	—	—	—	50
G1VTR	—	—	16	2	22	5	—	—	45
G1GEY	—	—	35	8	—	—	—	—	43
G0HGA	—	—	32	5	—	—	—	—	37
G2DHV	7	1	20	4	3	1	—	—	36
GW4HBK	32	4	—	—	—	—	—	—	36
GM4CXP	—	—	26	4	3	2	—	—	35
G4SEU	25	3	—	—	4	2	—	—	34
G4WND	25	4	—	—	—	—	—	—	29
G6XRK	—	—	8	6	—	—	—	—	14

Three bands only count for points. Non-scoring figures in italics.

tions in nine countries up to May 15. He uses a 5-ele Yagi by Tonna. His best tropo DX is EI9Q on April 9.

John reminds me of the daily net on 3.718MHz for the 50MHz enthusiasts. He monitors 53.75MHz, the f.m. TV sound channel E2, for Es propagation. On April 20 he worked CT1WW (WB) and EA1MO (XB) by Es. He says that the band does not seem very popular with SSTV or packet radio users but maybe that will soon change.

**Martyn Jones G4TIF** (WKS) uses a Trio TS-700G driving a MuTek 10W transmitter with a 2-ele Yagi by MET. The latter was erected on April 18 just in time for the Es opening on the 20th in which he worked CT1WW and EA1MO. He has made 50/28MHz cross-band QSOs with EA3ADW (BB) and EA2JG (YD) on May 8 and 18 respectively.

Writing on May 20, **John Jennings G4VOZ** (LEC) reported his first cross-band 50/28MHz QSO of 1987 with SM6PU (JO62MP) on that day.

There was a major Es event on May 28. G5KW told me that the first G/9H QSO was between G3CCH and 9H1CG (HV 13b) and that the Maltese do indeed have permission to operate on 50MHz. This makes sense since the Malta TV station is on E10, our old Band 3.

**Paul Turner G4IJE** (ESX) worked about 20 stations cross-band during this event. At 2320, after the affair had finished, he copied the Greenland beacon OX3VHF (GP60QQ) on 50.045MHz at RST529 for a time. The propagation mode sounded similar to the transatlantic Es we get in the summer.

## The 70MHz Band

G4VOZ is the only reader reporting on 70MHz this time. John mentions the large group of Midlands stations now using f.m. with vertical antennas. He has suggested they try horizontal polarisation to see what can be achieved in the way of DX.

On April 21 he worked G3ADZ in Rugby,

back on the band for the first time in 15 years. G4GZS was also contacted and he uses a Spectrum transverter on f.m. and s.s.b. May 6 brought GW4ALG (GWT) on c.w. G4HGT (YSW) contacted on the 10th now has a 6-ele Yagi aloft. G3XEV/M in Dudley was worked on f.m. on the 13th, one of a group using 70.26MHz.

On May 17 John worked G4XMT in Sedgley who was using a Europa transverter; G4ZUR in Atherstone using a Spectrum with 0.5W of s.s.b. and G3YJX in Wadebridge on c.w. but only RST439. Another new one was Paul Lewis G4APL just down the road from G3FPK at Caterham (SRY) on the 18th.

## The 144MHz Band

The first Sporadic-E opening of 1987 involving British Isles stations occurred on May 28, after the published deadline so this report has been compiled from my many QSOs with those who took part.

The event seems to have started around 1620 lasting about 90 minutes. The lower v.h.f. bands had been chaotic earlier in the day suggesting widespread E-layer ionisation. The following countries were definitely worked; I, IT9, LA, OK, SP, UA3, UC, UP, YU and 9H.

G4KUX worked YT4AM (IE) at 1659 and SP3MFI (JL) at 1712. Also heard/ worked in the northeast were SP9HRP and SP7IY in KK, I4 and YU3 regions. **Jan Alblas G4XNL** (SXE) thinks he was hearing Finnish broadcast stations on Band II and at 1621 worked LA3QR (DU), then nothing till SP9AMK (JK) at 1645.

**Dave Gregory G8JDX** (DVN) telephoned to report QSOs with SP9 area. At G3FPK the event was happened upon at about 1710, a great cacophony raging around the s.s.b. calling frequency. The only stations identified under all this were UP1BWR (MO) and UC2AAB (NN). Many people were calling "CQ Es" on c.w. but I did not hear anyone working anything at that time.

I telephoned John Nelson GW4FRX and

*Practical Wireless, August 1987*

he immediately worked RA3LE (QO21h) on s.s.b. the QRB being 2298km. The event was somewhat disappointing since there did not seem very much activity from the DX end.

All reporters agree that fading was severe. One second signals were enormous but very shortly afterwards they had all but disappeared into the noise. This probably explains why many stations were heard calling the DX while the DX was actually transmitting and in QSO with someone else.

**Alan McMillan G4SSO** (LDN) called "CQ Es" several times away from 144.300MHz and each time a G3 followed him and immediately started his call. I heard this and thought it very poor operating manners. Surely we will have more success if we spread out over 200-300kHz in these hectic events?

Now the other news starting with the mail from overseas. **Reg Woolley GW8VHI** is now in West Germany where he has the call DA4RG. This is a CEPT call so he can use it almost anywhere without prior permission, simply by adding the appropriate prefix in front; e.g. F/DA4RG or LX/DA4RG. On May 17 he operated as PE/DA4RG from CL34f using high power and four 13-ele DL6WU Yagis, working GW4s SMW and UWR, both in YL and G3KPV (ZL). For mobile work Reg uses an Icom IC-202 and 50W amplifier to a halo antenna.

**John McGowan EI2FN** (IO63XD) from County Wicklow has written for the first time. He uses a Yaesu FT-290R and 100W amplifier with a 7-ele "ZL" type antenna. From the end of July into early August he will be in Co. Leitrim.

He submitted log extracts for May listing 67 G and GW stations worked on the 6th, 17th, 24th and 25th from what must be an excellent coastal site. Some of the longer DX included G0FRX (HBS), G1AVE and G4YIR (ESX), G0EJG (YSS), G4RKY (KNT) and G1OJJ and G1DPL (DVN) on the 6th. On the 17th G1RER (LDN), on the 24th G6LFP (OFE) and G3KPV (BRK).

Welcome now to a new Belgian reader **Johan Van De Velde ON1CAK** from Leidekerke in Brabant province. His station consists of a Kenwood TS-711E, Tono 2H150G amplifier and two 9-ele Vagarda antennas at 34m a.s.l. fed through 25m of RG-213 cable.

Johan enters our tables and is a keen WAB (Worked All Britain) fan with book no. 7001. Since getting his licence on 24 Dec 1985 he has worked 25 countries on the band and 117 squares, all G and GW counties, four GM regions, GJ, GU and Co. Down in GI.

**Dolf Butselaar PE1AAP** from Amersfoort has written to say that a Dutch contest group will be taking part in the CQ WPX event on July 18/19 from JO22RC with the special callsign PA6VHF instead of their usual PI4AMF. QSLs go via the Bureau or to PO Box 910, NL-3800 AX Amersfoort, Netherlands.

Next the news from the UK, starting with **Angela Sitton G0HGA** (HFD) who is still as keen as ever with her c.w. activity. She mentions the matter of procedures on c.w. and suggests these might be included in the Morse test somehow. I would agree that operating procedures ought to be included in the RAE syllabus. This would cover both c.w. and 'phone operation so that newcomers would have a basic idea about conducting a QSO. At present it is akin to learning the technicalities of driving a car but never being taught the rules of the road.

Angela operated in the good tropo lift on May 24 and her 10W of s.s.b. and low 4-ele Yagi produced five QSOs with Dutch stations, but no c.w. contacts for the ladder, not for the want of trying.

**Philip Everitt G1CRH** (CBE) noted only a couple of lifts up to May 18. These were on the 5th and 8th and resulted in four more counties for the table. By the way, you may only count the Scottish regions once, Philip. On the 5th he worked GMOBQM/P (DGL) and G1GEY (TWR) and on the 8th GC1GDV/P (JN29).

In the contest on May 3, **Mark Page G1EGC** (BKS) worked DK9TF/P (EL), DL8SCD/P (EJ), DK0EL/P (EK) and F6EKG/P (CH). None of the Germans were in the Dubus version of the contest and would only accept the Universal locators. On May 8 at 2216 he worked I1KTC (EF44g) who was calling CQ several times. That was on 144.307MHz and he later went on 144.230MHz with I2FAK (EF77g).

G1KDF (LNH) found conditions to northern Scotland good on May 4 and Bob worked GM1NJK (HLD). Another fine catch was G4NRE (FMH) back on the band after a long break. On the 8th in the evening FC1BBD (BJ) was contacted and HB9AEN/P and LX1JA were heard weakly.

After the Irish news broadcast on May 17 Bob worked EI8FV/P (Offaly) and in Kildare EI7BJB and EI8EQ/P. By the way this news bulletin is from 1045 local time on 144.275MHz. G15VC has been operating in the Republic as EI3VTF/P and Bob has worked him in counties Meath on May 14, Monaghan (16th), Cavan (23rd) and Longford and Roscommon on the 26th. Hence Bob's 1987 British Isles county tally of 91 worked.

**Gerry Schoof G1SWH** has also been working many Irish counties from the Manchester area including EI4AQB (VN) in Galway, EI2FN/P (Leitrim), EI9FE (Tipperary), EI4AEB (Louth), EI4CA (Cavan) and EI9GJ/P (Wexford) all on April 20. He found EI4EY (Limerick) on the 26th and on May 4 EI3VTF/P when in Meath.

On May 9, in the DIG contest, **Pat Billingham G4AGQ** (SRY) came on s.s.b. for a change and worked DB8KJ (DK) although none of the beacons was stronger than usual. Welcome to **David Sewell G4FVK** who enters the Squares table with 71 worked. He also operates on 430 and 1296MHz.

**Colin Ford G4ZVS** (WMD) is now up to 102 different stations worked on c.w. up to May 19 and, in the lift between May 3 and 8, he found EI2FN (Wicklow), EI8Z (Dublin), G3WKF (CNL) and G3WYB (DVN). On the 9th he contacted FD1JLQ/P in Calais.

**Ron Wilson G4NZU** (NOT) thought it about time he took part in the c.w. ladder and enters it with 151 on 144MHz to put him in second place. Just for fun a club has been formed called the "Z Club" open to anyone with a Z in their callsign. Send a 241 x 165mm s.a.e. to Bob at 9 Greythorn Drive, West Bridgford, Nottingham, NG2 7GG for details. He is looking for c.w. contacts into Cornwall.

**Ian Cornes G4OUT** (SFD) received a brass Morse key kit from his wife Janice G4THY and has been busy using it. Up to May 5 he had 107 points for the 1987 ladder. A brief note from **John Wimble G4TGK** (KNT) mentions three new 1987 countries; LX2GB/P on April 29, DL20M on May 2 and HB9AEN/P on May 8.

**J. Singleton G4WJR** (LNH) likes the new-look v.h.f. coverage and enters the

annual table for the first time. His equipment consists of a Yaesu FT-480R and Microwave Modules amplifier capable of 100W, the antenna being a 17-ele Yagi from Tonna. His main interest is in the WAB programme and he is looking for amateur radio programs for Atari computers.

**June Charles G4YIR** (ESX) called EI2FN for 50 minutes on May 6 before making contact. EI is a rarity from Colchester it seems. Another new 1987 country was LX2GB on April 28.

**Ela Martyr G6HKM** (ESX) now only needs West Glamorgan to complete her 1987 Welsh collection. A CQ call to the West Country on May 7 brought replies from G6LFN (CNL) and G0AEA (IOS). The next day she worked GJ4ZFM/M and GJ6OZB on f.m. mode. The HB9HB beacon was audible but the nearest she managed to Switzerland was FC1BBW (DI20g). During the excellent lift on May 24, Ela was one of the lucky ones to work OY9JD (WW) who was only running 30W but who was very strong down the East Coast.

**Ron Reynolds' G6WEM** letter was written on May 11 and covered April activity from Prittlewell (ESX). He does not care for contests so stayed off on May 2 and wishes that the organisers would restrict contest activity to certain parts of the bands, leaving other areas free for those who do not want to participate.

On May 5 Ron worked G6UMN on Walney Island (CBA). Next day signals from the northeast were good and he heard people calling vainly for LA and OZ contacts. That figures as it would have been the monthly Scandinavian Activity Night. On the 8th, HB9SAX/P was S9 for about ten minutes in the evening and he heard I2FAK at RS32.

**Derrick Dance GM4CXP** (BDS) added one new square, AS, thanks to GM4DMA/A on one of the North Sea platforms. Apart from that, up to May 15 little of note worked in spite of a reasonable amount of time monitoring.

**John Nelson GW4FRX** is now regularly on from Powys. He has a genuine 400W at the antennas which are bayed 17-ele Tonna Yagis at 21m. His a.s.l. is 127m giving a good take-off in the main DX directions. *SWM* readers will recall John's definitive series of articles on high power amplifiers and power supplies. His 144MHz amplifier uses a pair of 4CX350FJ valves with a high-tech control logic and power supply. Best DX to date is RA3LE as mentioned earlier.

**Clive O'Hennessey GW4VVX** (GWT) has a new "tower" for his 17-ele Yagi. He reckons it cost about £1000 per foot but then it does have two bedrooms built in! He reports that last year's trip to XS square was a radio disaster but that he and Steve Jones GW6TGX will be going there again this August.

They have rented a cottage from August 8 to 22 and hope to have reliable equipment for 144 and 430MHz. They have the call GB2XS and another special event call GBOLCS for the Lairg Crofters' Show for the 15/16th. GB2XS will be in XS80g and GBOLCS in XS78d, the respective WAB areas being NC70 and NC50. The working QRG will be 144.222MHz but as it is primarily a family holiday they will not be booking any skeds.

**Paul Baker GW6VZW** (GWT) operated in the May 2/3 contest working Fs in AJ, AK, BJ and ZH, ONs in BK and CK and PAs in BL and CL. On the 8th he found DB8KJ for a new 1987 country and heard G4WVI

(NLD) calling CQ from ZP square.

A late note from **Godfrey Hands GOFBG/PA** (JO21NX) reveals no change in his squares totals due to lack of activity, coupled with generally poor conditions and a broken rotator since last Christmas, now replaced. He runs 10W on the band.

From **G3FPK** the only rarity was **G8BPNP** (SLD) on May 24 who peaked to about S3-4 around 2210. Ian is in **ZU44f** and runs 100W to a 14-ele Yagi. Ducting was very selective that evening. For example when **GM0FRT** (YR80j) was pounding in at S9 on the Surrey hills, stations apparently equally well sited and equipped north of the Thames were getting much poorer reports.

## The 430MHz Band

**G1EGC** found three new squares on May 8, **HB9SAX/P** (DG), **DK3BU** (DN) and **PA3DWD** (CN). **G1KDF** found conditions in the May 2 contest poor. On the 5th Bob worked **GM0GDL** (CTR); **E14BVB** (Waterford) on the 8th and **GM6YQS** (DGL) on the 21st.

**Paul Brockett G1LSB** (LCN) lists the following worked on May 2; **DK0VD/A** and **DK0VS/P** in DJ, **PA0GUS/P** (CN), **DL2KBB** and **DLOKK/P** in DK, **PEOMAR** (CL), **PI4ALK** (CM), **DK3FB/P** (DL), **DLOJT/P** (DM), **DF1DU/P** (EK) and **G16ATZ** (XO).

On the 5th Paul worked **E15FK** (VL08e) and on the 8th **F6FLE** (AK), **GJ4ICD** (YJ) and **HB9SAX/P**. Otherwise he found conditions rather flat over this reporting period. **G1SWH** is up to 48 counties in the table, May new ones for Gerry being **GM0GDL** and **G0CNZ** (TWR) on the 5th.

**Phillip Stanley G3BSN** (LDN) sent in his regular neat and detailed report. In addition to "the regulars" he listed in the July issue he offers **G6DER** (YSS), **G4CYA** (YSS), **G6WZA/P** (SOM) and **G8GXP** (YSS). **G1JGS** (IOW) should have been listed as -/P by the way.

Overseas stations heard/worked between mid-April and mid-May were **PE1EWR** and **FC1JHP** (BL), **PA3CAK** (CL), **PA0JOP** (CN), **DK3JB** and **DL9AAK** in DL and **PE1CNN** (DN). Home stations heard/worked were **G3KAU** and **G6DBX** in SXW, **G4ZFO** (IOW), **G4XEN** (NHM), **G6YVN** (YSS), **G8JHL** (MCH), **G4UVM** and **G6BKX** in SFD, **G4BYV** (NOR), **G3LQR** (SFK), **G1LGG** (WMD), **G6VSN/P** (KNT) and **G8LPY** (SXE).

The c.w. mode is rather rare on 430MHz and Phillip lists **G4PDL** (LDN), **G4AGQ** (SRY), **G3ENO** (YSS), **G4ERG** (HBS) and **G1OIG** (BKS). He records marathon QSOs with Sue Frost **G4WGY** (LDN) one lasting four hours. **ON4APZ** (BL) was the only DX heard on c.w.

**G4AGQ** found it hard going in the May 2 contest, his first contact being **G8TFI/P** (Sheppey) using an 8 x 21-ele array. Pat wonders if this is the problem; too narrow beam widths making the band sound rath-

er empty. On the 9th he had a c.w. QSO with **ON4APZ/P** who was using 10W to a corner reflector. Pat uses 10W to a 19-ele Yagi.

**John Tye G4BYV** (NOR) mentions a long-running series of skeeds with **G8BAV** in Derby at 0700 every work day. It started with 10W of a.m. later with 50W of s.s.b. using a variety of antennas. The best was a 13-ele Yagi to a design by **K2RIW**, still in use. Over 3500 QSOs were made.

**G6HKM** only heard a handful of stations in the May 2/3 contest. New counties were Dyfed, **GW8ELR**, and North Yorkshire. **Colin Redwood G6MXL** (DOR) lists all-time new ones as **G4THB/P** (YSN) in the may contest, and **GW8ELR** and **GJ4ICD** on the 8th.

## The Microwave Bands

**Dave Ackrill GODJA** (WMD) operated from Worcestershire Beacon in the Malvern Hills for the second leg of the 10GHz Cumulatives on May 10 making four contacts. Best DX was **G3UYM/P** on Shenlow Hill at 58km; next was **G3ZME/P** on Brown Clee at 45km, then **G3OXL/P** on Walton Hill at 38km. The other was only one kilometre to the next hilltop to **G4GMV/P**. An attempt by Dave and **G8SWZ** to work **G8MWR/P** on 24GHz over a 205km path failed as Glen could not get to the exact location he had planned for.

In an activity night on July 14 the MEB Club is hoping to have 10 and 24GHz stations on the air to demonstrate simple wide-band systems to others.

**G1KDF** worked 17 stations in the May 2/3 contest the only real DX being **G4ZAP/P** (KNT). On May 6 an attempt with **G4RKV** (KNT) failed after successful QSOs on 144 and 430MHz. The foregoing on 1296MHz.

**G3BSN** uses an Icom IC-1271E at 10W output to four 23-ele Tonna Yagis 18m a.g.l. fed with Andrews HJ-550 Helix cable. A 150W amplifier using two 2C39BA valves is under construction but Phillip hopes to use Siemens YD-1270 valves later which should give 300W if adequately cooled, for 1296MHz.

He made an f.m. QSO with **G8IFT** in Birmingham recently on 1297.500MHz and signals were still readable as low as 40mW power over a 150km path. Phillip lists "regulars" as **G6JHR**, **G8VR** and **G8XIR** all in Kent, **G8CHW** (HFD) and **G8IFT** (WMD) on 1296MHz. Overseas he offers **PA0FRE** and **PE1GHG** in CL, **PE1EWR** (BL) and **PA0RDY** (CM).

Stations heard/worked were **G3IMV** and **G8BCL** (BKS), **G6DER** and **G8GXP** (YSS), **G3XBY** (WKS), **G8JHL** (MCH), **G4BYV** (NOR), **G4CBW** (SFD), **G8XVJ** (LNH), **G1OCA** (MSY), **G4OIG** (KNT), **G3OSS**, **G2AIW** and **G4GLN** (LDN), **G3PMX** and **G6HKM** (ESX), **G4YPC** (SRY), **G8DKK** (BFD) and **G1HOW** (BKS). Phillip mentions the possibility of operation from the Isle of Wight in the summer, after talking with **G1JGS**.

**G4BYV** operated in the May contest on 3.4GHz and worked **PE0MAR/P** (CL), **PA0GUS/P** (CN), **PA0RDY** (CM) and **G4FRE/P** (AL). He reports Keith Hewitt **G6DER** now QRV on the band. John says that **PE1GHG** (CL) has his beacon **PI7GHG** on 2320.853MHz now beaming towards Austria. However, it has been heard on the east coast so reports would be welcome.

**G6HKM** and husband Roy **G3PMX** now have their 23-ele **F9FT** Yagi rotatable so took it in turns to operate in the contest. Their DX included **PA0PLY** (CM), **G8GXP** (ZN) and **PE0MAR/P**. On May 6 Ela worked **G8JHL**, then **G3KFD** (WMD) and on the 8th **G4XOL** (MSY). Later that day she worked **PA0ANS** (DN) and **G4MXI** (AN) for new squares and on the 24th, **DB1BX** (DM) was another new one, all on 1296MHz.

Very rare, are c.w. QSOs on 1296MHz, but **G4AGQ** raised **G4YPC** all of 20km away on May 3. **G6MXL** reports **G6XZA** (SXW) and **G4ZTR** (ESX) on May 8 as all-time new ones on 1296MHz. Colin also worked **G4JCC** (HPH) the same day.

On May 10, **Paul Thompson G6MEN** (SPE) with **G1SPU** and **G0HCU** back-packed their 10GHz gear for 2½ hours to reach Cader Berwyn 826m a.s.l. near Llanrhaeadr, for the Cumulatives. Most successful path was to **G3NKL/P** on Longridge Fell at 120km. They think they should be able to work over 150km to Cumbria or NW Yorkshire in the summer.

**Dave Bullock G6UWO** (NOT) has written to say that he and John Wood **G6JQL** are keen home-brewers who have been building 1296MHz equipment for the last 18 months. There is a net on the band every Monday night 2000-2130, regular callers being **G6ISB**, **G4KXL**, **G1HSD** and **G6PHJ**.

Dave's station is a Yaesu FT-290 with LMW local oscillator and transmit converter, with RX being a home made interdigital converter with single bipolar r.f. pre-amp. Two home-made 25-ele quad loop Yagis are used, one for receive, the other for transmit. Using only one watt he has worked **G6DER**, **G4LU**, **G8IFT**, **G4NBS**, **G8XVJ**, **G4KXL**, **G4TXG**, **G8JHL**, **PE1ALA** and **DG8EAJ**. Also, in a very screened direction, **G1KDF**, **G4XOL** and **G3ZTR**. A 2C39 p.a., power supply and GaAsf.e.t. pre-amp are on the stocks.

## Sign Off

No space for any "waffle" this time. Please ensure you get all your correspondence to me by the deadlines in the box. I would like to publish the 2320MHz All-time Table again so please send me your latest counties, countries and squares totals if you use the band.

**Deadlines for the next three issues are: July 29; September 2; September 30.**

Reports to Mike Richards  
200 Christchurch Road, Ringwood, Hants BH24 3AS

## RTTY

Welcome to the new RTTY column. As regular readers will no doubt be aware Ron Ham has decided to concentrate on his first love, propagation. I am taking over this popular column and hope I can continue as well as Ron has done in the past. I'm sure you would all like to join me in thanking Ron for all his good work.

I will start by giving you a short history of my own interest in radio. I have been a

s.w.l. since I was about 10, after being introduced to this fine hobby by my father. I was first licensed in the early 1970s as **G8HHA**. This callsign was such a mouthful on phone that I was forced to concentrate on the data modes! Initial interest was Morse which then spread to encompass the whole range with the exception of SSTV. This obsessive interest in radio and electronics has also led me to a career in

the communications industry for which I am grateful. Well that's it in a nutshell, I only hope I can follow Ron's high standard.

Now to some changes. The RTTY and AMTOR charts are now combined and include packet radio operation. By combining all three modes of reception into one chart we can increase the amount of other information reported. The chart is compiled by combining my own log with logs

**WE WOULD LIKE YOU TO VIEW ALL OUR PRODUCTS!!!**



**ONLY AVAILABLE  
IN OUR NEW CATALOGUE  
PRICED 75p**

Send for a copy of our brand new glossy covered illustrated CATALOGUE for Summer '87. We've got some surprises for you, with the introduction of new Multi-standard Televisions/Monitors, a new range of Aerial Rotators and many, many more items. We've retained all of the well established and popular products, but have taken this opportunity to introduce lots of exciting new items for you the enthusiast. Our extensive listings cover domestic, fringe and DXing installations within Bands 1 to 5 inclusive. **AERIAL TECHNIQUES** provide a complete and comprehensive consultancy service for ALL reception queries and problems. **WOULD YOU LIKE TO RECEIVE AN EXTRA ITV CHANNEL AT LITTLE EXTRA COST? IF SO, SEND FOR OUR CATALOGUE AND INCLUDE AN SAE TOGETHER WITH DETAILS OF PRESENT ITV REGION RECEIVED.** For a speedy dispatch, ACCESS and VISA Mail and Telephone orders may be placed for any of the products listed in our NEW illustrated Catalogue. We are active TV/FM DXing specialists — your guarantee of honest and knowledgeable advice.

**AERIAL TECHNIQUES IS UNIQUE —**

**OUR NEW HIGH QUALITY CATALOGUE COSTS ONLY 75p**



**AERIAL TECHNIQUES (PW)**  
11, Kent Road, Parkstone,  
Poole, Dorset, BH12 2EH. Tel: 0202 738232.



## ANTENNA TUNER

For outside or **INDOOR** antennas, end-fed LONG WIRES or dipoles, **BOOST DX** and reduce interference 100kHz-30MHz in 6 overlapping ranges, **IDEAL** for FRG7700 etc or 10W tx, **BANDPASS** design (not just usual "T" high pass) with pre-wound high Q coils, also adapts to WAVEMETER, Field strength meter etc, **only £29.90**, get **MORE DX**.

**RARE DX UNDER QRM? DIG IT OUT** with a **Tunable Audio Notch filter**, between receiver and extension speaker, **BOOST** your DX/QRM ratio, 40dB notch, **£21.20**, hear **WEAK DX**.

Each fun-to-build kit (ready-made to order) includes **ALL parts, CASE, pcbs** are fibre-glass, **CONNECTORS**, instructions, by-return postage, (Europe same, Giro 21.923.4000) and **FREE "Kit News"**.

## CAMBRIDGE KITS

**45 (PV) Old School Lane, Milton, Cambridge.**

**DD DORSET**  
*satellite*  
**DISH T.V.**

## SATELLITE TV

Systems, components, everything you need to join the exciting world of satellite television.

DIY-24 channel remote control receivers, plus 1.2m dish, LNB, polarswitcher etc. £485 ex. VAT! Technical back-up included.

Vast range of dishes, LNBS, plugs, books — you name it we have it.

Send now for our comprehensive component catalogue (S.A.E. required A4 size).

**4 Station Road, Parkstone, Poole, Dorset**  
**Telephone: 0202 749495**

## S.E.M. UNIT P, UNION MILLS, ISLE OF MAN Tel: MAROWN (0624) 851277

**S.E.M. QRM ELIMINATOR.** Just had a 'phone call to say "It's b..... marvellous." A neighbour had installed an ex-arcade game machine for his kids and this station couldn't operate because of the QRM until he used our **ELIMINATOR** — can do the same for you! Any sort of interference, it can be next to your receiver (your computer?) or several miles away, any freq. 1.5-30MHz. Connects in your aerial lead and removes the interference before it gets to your receiver, and you can transmit through it. **£85 Ex-stock.**

If you don't believe its true, try one for 10 days, if it doesn't solve your problem, we'll refund, less £5 to cover costs. We have many delighted owners now, who can't speak too highly of performance. With comments such as "I can operate for the first time for years" or "you have got a winner".

**NEW S.E.M. Dummy load.** 100W with dummy load/through switch. So you leave it plugged in line. **£22.00** Ex-stock.

**NEW S.E.M. TRANZMATCH Mk III.** Now has a switch to select DIRECT to aerial, BALANCED or UNBALANCED or DUMMY LOAD. The matching unit retains its tremendous versatility capable of matching virtually any aerial to 50 ohms at up to 1kW, balanced or unbalanced. The link coupled output isolates the aerial from the rig, which can cure TVI both ways. Their robust construction is proved by the ones in daily use for 15 years. 1.8-30MHz £110. Ezitune built in £39.50 (see below). Built in dummy load £8.90 Ex-stock.

**S.E.M. 2 metre Transmatch,** match your V.H.F. aerial, 1KW max. **£32.00** Ex-stock.

**S.E.M. EZITUNE.** Do you use an antenna matcher? You need our Ezitune to tune it to your frequency without transmitting. Listen to the S9+ noise on your receiver and adjust your aerial tuner for a dip in the noise and you are matched up to 50 ohms (1:1 SWR). Protect your radio and stop tuning QRM. **£45** boxed, or p.c.b. + fixing bits and instructions to fit in any A.T.U. **£39.50.** Ex-stock.

### VERY WIDE BAND PRE-AMPLIFIERS

They cover from 3-500MHz with a noise figure of 1.5dB and an unprecedented +30dB 3rd order IP at the INPUT. Gain is 9dB. We make three types. Straight pre-amp, this has a signal loss if you switch it off, **£32.00.** One which switches to "straight through" when switched OFF, can be used for transmitting through (100W) if supplied with 12V on receive and 0 on TX, costs **£37.00.** An R.F. switched unit is **£45.00.** All Ex-stock. We are continuing to make our highly acclaimed dedicated 2 Metre pre-amps with adjustable 0-20dB gain and 1dB N.F. Receive only **£21.90.** R.F. switched **£34.00** and with 240V P.S.U. **£39.00.** Ex-stock.



### CONVERTERS for LF, MF, HF, VHF, UHF.

Our new H.F. CONVERTER opens new horizons for receivers, use with the new all mode V.H.F., U.H.F. receivers FRG9600 and ICR7000, extends their coverage down to 100kHz, giving you LF, MF, HF, VHF and UHF. You tune your RX from 100MHz up, e.g. 103.500 is 3.5MHz. It has two aerial sockets, one for H.F. into the converter and one for V/UHF switches straight through into your RX when you switch the converter OFF, i.e. No plugs to change. All this for **£45.00.** Ex-stock.

**R.F. NOISE BRIDGE.** If you are experimenting with aeriels you need one of these units. Tells you the resonant frequency and impedance of your aeriels and also invaluable for measuring 1/4, 1/2, etc., wavelength of feeders, etc. **£45.00.** Ex-stock.

**WAVEMETER.** A pretty little absorption wavemeter, to satisfy the licence conditions. 1.5-30MHz with a meter indication. **£39.50.** Ex-stock.

**IAMBIC KEYS.** We use the world famous CURTIS chip which eliminates the little idiosyncrasies common in other keys. Opto-isolators from the chip ensure that R.F. can't get in, a common problem with multi-chip keys. Compatible with any TX. **£45.00.** An excellent twin paddle key often mistaken for ones costing several times more at **£19.50.** Ex-stock.

**2 METRE LINEAR POWER AMP/PRE-AMP.** People are constantly telling us that comparing different makes our Pre-amp is best. (See Pre-amps for spec.) Three models, Sentinel 40 14x power gain e.g. 3W IN-40W OUT. Ideal for FT290 **£85.00.** Sentinel 60, 10W IN-60W OUT **£95.00.** Sentinel 100 10W IN-100W OUT **£135.00.** All Ex-stock.

**AUDIO MULTIFILTER.** Has fully adjustable BAND PASS, HIGH PASS, LOW PASS and 2 NOTCH filters. From 2.5kHz to 20Hz. Making the most versatile filter available. **£75.00.** Ex-stock.

**T.V.I.** Our Braid Breaker/High Pass Filter cures T.V.I. by plugging into the TV aerial socket. **£7.50.** Ex-stock.

**S.E.M. SWITCH.** 3 way ant. switch + 4th position to earth. 1kW. S0239S D.C.-150MHz. **£23.00.** Ex-stock.

### 12 MONTHS COMPLETE GUARANTEE INCLUDING ALL TRANSISTORS.

Prices include VAT and delivery, C.W.O. or phone your CREDITCARD No. Ring or write for further data. Orders or information requests can be put on our Ansaphone at cheap rate times.

received from readers and shows all prefixes heard. Obviously the more logs I receive the more representative the charts and my comments will be.

This month's logs have shown that the poor conditions during the latter part of April have been steadily improving to peak around the middle of May with several good openings on 14 and 21MHz. RTTY activity levels were given a welcome boost on May 9 and 10 due to the 21st Alessandro Volta RTTY contest.

**Terry Stanley GOGTO** reports the following new calls on packet: 9H4B (Malta), 9M2OK (West Malaysia), 9V1WN (Singapore), A4XKC (Oman) and SO5GZE (Poland). Terry now has a total of 54 prefixes worked/heard on packet, well done.

**Len Fennelaw G4ODH**, also sent in a very comprehensive chart showing 56 prefixes on RTTY and AMTOR including the following new ones: V31 (Belize) and A61 (United Arab Emirates). This brings Len's prefix total to a very creditable 144 on RTTY and AMTOR, thanks for the information Len.

I received a very interesting report from **John Barber G4SKA**. John concentrates on RTTY DX and contests and has achieved 97 countries confirmed out of 117 worked, very impressive. John's station is all home-brew with the only exception being the Commodore C-64 computer and software from G4BMK!

In his letter Len says that many more AMTOR stations have been logged this month. We were both concerned that many people may have left AMTOR in favour of packet.

## Contests

August 15 and 16 sees the SARTG (Scandinavian Amateur Radio Teleprinter Group), World Wide RTTY contest. This excellent contest is open to single operators, multi operators and s.w.l.s. so there's no excuse for not entering. A scan through last year's results shows that although G4SKA won the single operator section (well done John), there were very few UK entries. Contest operation provides a very good training for general operation as it sharpens up operating practice and enables you to fine tune your equipment. I think a lot of people are put off contests as they feel it is for experts only, this is really not true. Although great expertise and a certain amount of good fortune is required to win a contest, there is great fun to be had from just participating—so why not give it a go with the SARTG contest? If you are apprehensive then invite a few colleagues round and operates as a team.

For those of you who are game to have a go here are the details for the 17th SARTG contest:

- (1) **Contest Periods**  
0000–0800UTC Saturday August 15  
1600–2400UTC Saturday August 15  
0800–1600UTC Sunday August 16
- (2) **Bands**  
3.5, 7, 14, 21 and 28MHz
- (3) **Classes**
  - a) Single operator.
  - b) Multi Operator, single transmitter.

Note: Logs from multi operation stations must contain the names and callsigns of all operators involved.

  - c) s.w.l.
- (4) **Message**  
RST and QSO number.

## (5) Points

QSO with own country five points, other country in same continent ten points, other continents fifteen points. In USA, Canada and Australia each call-district will be considered as a separate country. The same station may be worked once on each band for QSO and multiplier credits. Only 2-way RTTY QSOs will count.

## (6) Multipliers

Use the DXCC list and each district in W/K, VE/VO and VK. Note: Contact with a station which would count as a multiplier, must be found in at least 5 logs, or contest log from the station must be received in order to be valid.

## (7) Score

Sum of QSO points x sum of multipliers.

## (8) SWL

Use the same rules for scoring, but based on stations and messages copied.

## (9) Logs

Logs must be received by October 10. The logs to contain: band, date, time UTC, callsign, message sent and received, points and multipliers. Use a separate sheet for each band and enclose a summary sheet showing the scoring, class, callsign, name and address.

Comments will be very much appreciated.

Logs should be sent to:  
Contest and Award Manager, Jorgen Dudahl-Lasjon OZ1CRL, Egebjergvej 90, 4500 Nykobing Sj. Denmark.

## (10) Awards

To the top stations in each class, country, W/K, VE/VO and VK call-district, if the number of QSOs is reasonable.

## RTTY Awards

If you would like some confirmation of your operating achievements then how about trying for an award. Virtually every major national amateur radio society has an award scheme and these are open for both operators and s.w.l.s. One very popular award is the BARTG (British Amateur Radio Teleprinter Group) Quarter Century Award. This award can be claimed if you can prove you have worked or heard RTTY stations in 25 different countries. Generally QSL cards are required but BARTG offer an alternative for those claiming the award for stations heard in a BARTG contest. In this case a contest log may be submitted as proof of the contact. Having achieved your first Quarter Century Award, endorsement stickers are available in increments of 25 up to a maximum of 200. Although this award was originally intended for RTTY contacts you can now obtain the award for AMTOR or packet only.

If the award system appeals to you, I

Prefix (Country)	3.5	7	14	21	28
A,K,W (USA) A22 (Botswana) A4 (Oman) A61 (United Arab Emirates) CT (Portugal)			R R R R		
CX (Uruguay) DA,F,J,K,L (W. Germany) DU (Philippines) EA,C (Spain) EA8 (Canary Is.)	R	AR	R APR R APR AR	R	
EA9 (Ceuta & Melilla) EM (USSR) F (France) FM (Martinique) G (England)		AR	R R R AR	R	
GI (N. Ireland) GM (Scotland) HA (Hungary) HB (Switzerland) HC (Ecuador)	A		R R R AR R	R	
HL (Korea) HP (Panama) I (Italy) IT9 (Sicily) IS (Sardinia)		A	R R APR R R	R	
JA,G (Japan) LA (Norway) LU (Argentina) LX (Luxembourg) LZ (Bulgaria)			AR R R R R	AR R	
OD (Lebanon) OE (Austria) OH (Finland) OK (Czechoslovakia) ON (Belgium)		R	R PR APR R P		
OY (Faroe Is.) PA (Netherlands) PP,Y (Brazil) PZ (Suriname) RA,T (USSR)			R APR R R R	R	R
SG,K,L,M (Sweden) SO,P (Poland) ST (Sudan) SU (Egypt) SV (Greece)		R	APR PR A A R	R	
SV5 (Rhodes) TA (Turkey) TF (Iceland) TL8 (Central African Rep.) UA,V (USSR)			R R P R R PR		
UO5 (Moldavia) UT (Ukraine) V31 (Belize) VE (Canada) VK (Australia)			R R A R R		
VU (India) YB (Indonesia) YO (Romania) YU (Yugoslavia) YV (Venezuela)			R R R R R	R	
ZS (South Africa) 4X (Israel) 5B4 (Cyprus) 5H (Tanzania) 5Z3,4 (Kenya)			AR R AR AR R	AR	R
9H (Malta) 9M2 (West Malaysia) 9V (Singapore)			APR P P		

**The AMTOR, Packet and RTTY chart. Where a country has more than one prefix, only the changed letter is shown i.e. DA, F, J, etc is DA, DF, DJ, etc.**

would strongly recommend that you invest in a copy of Ted Double's very informative book *RTTY Operating Awards*. This 83-page A5 book gives full information on many awards from all over the world and is available from BARTG Components Manager, John Beedie, Ffynnonlas, Salem, Llandello, Wales SA19 7NP for the inclusive price of £5.95 for members or £6.50 for non-members (UK only).

**The deadlines for the next three issues are: July 29; September 2; September 30.**



Both the Radio-5 and 7 satellites should be active again with full time operational transponders by the third week of this month, on the usual proviso that the pair will have survived the rigours of yet another eclipse period.

For the past month, extending to the time you will be reading this column, both satellites have been commanded off for all but a maximum of two orbits of each satellite per day. These orbits are when they are within range of the Moscow control command station who are carefully monitoring and commanding according to the charge and discharge ratio encountered. From June 3 to June 30, the second and tenth orbits of both spacecraft each day (except Wednesday) were commanded on for use, and from July 1 to 20 only Orbit 9 will have the transponders activated. Hopefully, after this, we return to 24-hour per day continuous transponder, and maybe even ROBOT, operation.

The continuously declining battery condition means that soon now we must lose at least one of these satellites for transponding purposes. Probably RS-5 will fail first, as it has for some years now been showing all the symptoms of far greater degradation of the battery than its counterpart RS-7, which itself is also manifesting battery ageing characteristics. We have been very fortunate indeed that this pair have lasted so long already, as the first pair of Russian satellites, RS-1 and RS-2 functioned for less than a quarter of the time that RS-5 and 7 have survived so far. The other satellites that were launched simultaneously with "5" and "7", namely RS-3, 4, 6 and 8 have all now ceased to emit any form of signal, although the aged RS-1 beacon is still heard frequently when in full sunlight sending singularly its "55" and "5015" c.w. on 29.401MHz.

The reason for this is that whilst most batteries fail in the short circuit condition, RS-1 developed an open circuit series cell, which does not impose a dead load on the charge regulator, and so permits a sufficiency of power to operate the beacon when the raw solar panel voltage is high enough to power up the oscillator and associate frequency multiplier amplifier circuit. Despite many attempts by control station RS3A, the transponders cannot be put on, and even if the command encoder was functional, it is very doubtful indeed that enough power would be available without dropping the supply voltage to a level below which the oscillator could function effectively.

Whilst we may hope that our faithful pair continue to give us further activity, aided by careful control and hopefully by gentle low power employment by users, we must not expect this for long. The best that we can hope for is a failure of the battery in the open circuit mode like RS-1, and that the solar panels are not too opaque to give enough energy to sustain transponder utilisation.

Regular follower **Bill Kelly** heard much of the high activity on the RS-5 and 7 pair prior to them entering eclipse at the time forecast in our previous months columns. He logged a vast number of stations in the Soviet countries, call areas and oblasts, with quite a lot in Asia, mainly in UA9 and UL7. He heard good signals from VE5XU, W3TFA, W1WM and many European countries as well.

Noticeable by their absence are many of

the African countries that were once very active on the Mode "A" satellites, such as TU, 9X5, 5U, 5V7, SU, 7X, 6W8, ST, 5X5, 5H3, 5T5, 5Z4, TR8, 9L1, 4W1, etc. Also missing these days are the many stations who regularly appeared from the West Indies and from closer parts of the South American mainland. It must be assumed that the enormous powers used by many of the European stations, some inexperienced new "G" stations in particular, are such that the weaker more distant stations are being displaced out of the passband by the degree of attenuation effected by the a.l.c. level as soon as the satellites appear over the European horizon. It is hoped that these transgressors will one day realise that they are limiting themselves and all other in-range users to QSO's with the strong European and some North American stations only by their indiscriminate use of powers well above the maximum of 100 watts e.r.p. required.

**Leonid Labutin UA3CR**, reports that some further delay is now possible with the launch of the new RS-9 (ex RS-10) satellite that was to have been carried into space on a June launch this year. The exact reasons for this new tardiness are uncertain, but conjecture assumes that it is coupled with the priority of the intense launch schedule now in operation associated with the "MIR" space station and its activities.

If all his plans work out according to schedule, Leo will be talking about the RS satellite programme at the AMSAT-UK Space Symposium to be held at the University of Surrey over the week-end of 17-19 July, where many hundreds of amateur satellite fans will be gathering from all over the world to cover all aspects of the hobby. The plans for the trans-polar expedition and the "MIR" cosmonaut ham in space should also be covered.

## OSCAR—10

Initial testing of the satellite immediately prior to May 1 showed that the battery charge level was insufficient to permit the use of the activated transponder. Stations, even at minimal uplink power, were heard to be causing f.m. on the plain carrier beacon, the oscillator being pulled by amplitude power increase demand, all due to poor power regulation brought about by varying demand from a low battery voltage. Operational use of the transponder was postponed for two weeks to allow some additional charging to benefit the

battery, by which time things were very much better. On May 15 official transponder operation re-started with limited communications permitted between Mean Anomaly 30 and 200, but signals were frequently found to be weak from both the beacon and the 145MHz downlink.

It cannot be shown what the exact cause of the problem is as no indicating telemetry is available from the beacon, the computer having now totally failed. It could be assumed that perhaps the sun-angle is not optimised as hoped, but no command can now be utilised by the satellite to change this, as again the computer control for commanding the re-angulation is not operational. For the same reason, even if the magnetorquers could be commanded, the result could not be ascertained, as the new attitude could not be telemetered down. It is more than possible that the satellite angle is such that the antenna pointing is not optimised to beam to earth, and an even greater probability that in fact the end of the arm beams are not in use, with only the perigee monopole antenna being the radiator for the downlink.

What is for sure, as with the RS satellites, is that high power stations will attenuate the transponder receiver sensitivity, and rob the battery of more power than necessary. The most likely explanation comes from **Ian Ashley ZL1AOX**, one of the command team, who believes that the symptoms are mainly due to an insufficiency of charge evolving from the battery charge regulator. As this too is Internal Housekeeping Unit computer controlled, and the command control is not operational with the defunct i.c.s., nothing whatsoever can be done to alleviate it.

The answer is in the hands of the users themselves, and it is essential that a strict regime of use times, power minimisation and mode limitation be adhered to. No continuous carrier modes, such as FAX, RTTY and SSTV are tolerable, and the absolute minimum power to establish a QSO is required, with no more than 100W e.r.p. of uplink permitted. Strict adherence to the satellite phase times must be observed, with no operation permitted outside MA 30 to 220. In July and August this period will be likely to change to MA 40 to 220, but needs to be confirmed nearer to the date. (Use in September and October will almost certainly be negated). If any f.m. appears on the 145.810MHz beacon, all transponder use must cease to give the battery an opportunity to re-charge again.

It is thus essential and important that all

		ALLSATS		EQX		ON 12/7/87			
SAT	UTC	Brg	Next	Orbit	Next	Day			
F12	EQX	U	+min	+inc	+min	+deg			
F12	0015	24	115.7	29.2	64.3	20			
RS5	0028	42	119.4	30.2	113.4	30			
RS7	0051	55	119.1	29.9	108.7	29			
Mir	0101	27.3	91.6	29.9	25.5	13			
Sal	0004	155.5	94	29.9	64.9	20			
RS1	0039	132.2	120.3	30.3	3.9	3			
UO1	0032	86	94.1	29.9	66.4	17			
UO2	0128	53	98.4	29.9	37.3	3			
N09	0115	156	102	29.9	90.3	3			
N10	0043	77	101.2	29.9	78.4	3			
M13	0058	243	104	26.1	16.6	6			
M14	0032	210	104	26.1	16.9	6			
M/1	0017	279	109.3	27.4	90.8	25			

		ALLSATS		EQX		ON 26/7/87			
SAT	UTC	Brg	Next	Orbit	Next	Day			
F12	EQX	U	+min	+inc	+min	+deg			
F12	0135	100	115.7	29.2	64.3	20			
RS5	0113	74	119.4	30.2	113.4	30			
RS7	0035	73	119.1	29.9	108.7	29			
Mir	0041	35.5	91.6	29.9	25.5	13			
Sal	0053	24.8	94	29.9	64.9	20			
RS1	0144	17.9	120.3	30.3	3.9	3			
UO1	0034	86	94.1	29.9	66.4	17			
UO2	0032	39	98.4	29.9	37.3	3			
N09	0029	136	102	29.9	90.3	3			
N10	0029	136	102	29.9	90.3	3			
M13	0134	237	104	26.1	16.6	6			
M14	0113	245	104	26.1	16.9	6			
M/1	0137	322	109.3	27.4	90.8	25			

		ALLSATS		EQX		ON 19/7/87			
SAT	UTC	Brg	Next	Orbit	Next	Day			
F12	EQX	U	+min	+inc	+min	+deg			
F12	0150	77	115.7	29.2	64.3	20			
RS5	0150	73	119.4	30.2	113.4	30			
RS7	0143	79	119.1	29.9	108.7	29			
Mir	0052	31.3	91.6	29.9	25.5	13			
Sal	0115	21.3	94	29.9	64.9	20			
RS1	0112	151	120.3	30.3	3.9	3			
UO1	0032	86	94.1	29.9	66.4	17			
UO2	0100	46	98.4	29.9	37.3	3			
N09	0141	156	102	29.9	90.3	3			
N10	0132	89	101.2	29.9	78.4	3			
M13	0116	250	104	26.1	16.6	6			
M14	0053	227	104	26.1	16.9	6			
M/1	0002	257	109.3	27.4	90.8	25			

		ALLSATS		EQX		ON 2/8/87			
SAT	UTC	Brg	Next	Orbit	Next	Day			
F12	EQX	U	+min	+inc	+min	+deg			
F12	0117	104	115.7	29.2	64.3	20			
RS5	0034	75	119.4	30.2	113.4	30			
RS7	0126	96	119.1	29.9	108.7	29			
Mir	0032	35.5	91.6	29.9	25.5	13			
Sal	0031	25.8	94	29.9	64.9	20			
RS1	0015	15	120.3	30.3	3.9	3			
UO1	0035	35	94.1	29.9	66.4	17			
UO2	0004	32	98.4	29.9	37.3	3			
N09	0050	143	102	29.9	90.3	3			
N10	0128	88	101.2	29.9	78.4	3			
M13	0008	268	104	26.1	16.6	6			
M14	0133	268	104	26.1	16.9	6			
M/1	0122	330	109.3	27.4	90.8	25			

users maintain a presence or listening watch on the AMSAT nets so that any changes of use times necessary can be understood and implemented. Users and potential users are asked to monitor the AMSAT European net on 14.280MHz at 1000UTC each Saturday, the AMSAT-UK net on 3.780MHz at 1015 local time and the AMSAT International net on 14.282MHz at 1900UTC both on Sundays, and any other local nets within range. 7pm local time AMSAT-UK nets are run each Monday and Wednesday on 3.780MHz to supplement the main Sunday net.

To estimate the attitude of the satellite, as no downlink telemetry indicating this is possible, stations are asked to note the times when spin modulation appears and disappears, which Jim Miller G3RUH reports as being most likely between MA 20 and 90. Jim asks for reports on this effect to be sent to him at 3 Benny's Way, Coton, Cambridge CB3 7PS, England, giving your station latitude and longitude to help the calculations involved in finding both the sun angle and the antenna pointing.

Despite the fact that Bill Kelly heard OSCAR-10 on his ground plane antenna, albeit at perigee it would seem appropriate at this time to advise users to optimise their downlink receiving systems to help to hear the signals that will probably continue to be coming to them at reduced level. Here are a few hints and tips that will assist in making QSOs effective despite the satellite's problems, and further will help avoid any encouragement of high uplink powers.

1. Make your 144MHz antenna to have as high a gain as possible, with a maximum of elements and boom length, stacking if possible, and ideally circular polarisation switchable. Use an antenna with minimum side lobes, such as the NBS type Yagi, to keep noise out of the system that would be picked up from ground and local buildings if large side lobes were present.

2. Regularly check your azimuth and elevation to the satellite to maintain the best possible downlink signal, and try to avoid beaming through trees and bushes, above all damp buildings, as the resultant attenuation can be very high.

3. Use a pre-amplifier, ideally a GaAs f.e.t., m.e.s.f.e.t., or other low noise pre-amplifier at the receiving antenna itself, which will give a pronounced signal to noise superiority, especially if a long coaxial down lead is used.

4. Use a well matched good quality cable, such as LDF Helix or one of the newer semi-air spaced hardline low loss coaxial cables such as H.100 that are not so expensive to the pocket.

5. Pay some attention to carefully peaking your receiver front end at the high end of the 145MHz band, and to accurately peaking the mixer stage for optimum signal and minimum noise.

6. Finally, check any likely sources of noise within your station, as it is surprising just how much noise can get into an otherwise low noise receiver system from noisily regulated power supplies, fluorescent lighting, etc.

The times when the satellite comes into range of Eastern England is shown in Fig. 1 (but note that it should not be used outside the schedule already stated). The column reads the date, the "AOS" time when OSCAR-10 appears over the horizon, the "LOS" loss of signal time when it sinks (note that on some days we have two orbits), then the time when the satellite

Satellite	OSCAR 9	OSCAR 10	OSCAR 11	OSCAR 12	MIR	Ajisai
Catalogue Number	12888	14129	14781	16909	16609	16908
Epoch Year/Day	87118.04255154	87116.29265072	87114.70351742	87124.47110209	87126.22182771	87023.67924864
Set Number	1025	293	221	43	612	24
Inclination	97.6476	27.3614	98.1081	50.0144	51.6330	50.0102
RAAN	133.9123	24.2685	181.5902	159.7116	12.6347	109.5063
Eccentricity	0.0003868	0.6024609	0.0012453	0.0001293	0.0015833	0.001166
Argument of Perigee	55.3631	203.2019	269.8406	174.0043	317.2428	275.6377
Mean Anomaly	304.7952	110.6680	90.1369	186.0924	42.6067	84.3183
Mean Motion	15.29491925	2.05880883	14.62119854	12.44393849	15.71575916	12.44367862
Decay (Drag Factor)	1.912e-06	-1.39e-06	1.25e-06	-2.5e-07	3.0686e-04	-2.5e-07
Revolution (Orbit No.)	30907	2909	16788	3294	6944	2040

Satellite	Meteor 2-12	Meteor 2-13	Meteor 2-15	Meteor 3-1	NOAA-9	NOAA-10
Catalogue Number	15516	16408	17290	16191	15427	16969
Epoch Year/Day	87124.80833707	87122.40883799	87122.19861579	87124.86473172	87120.74809367	87119.94805979
Set Number	856	269	35	625	162	43
Inclination	82.5371	82.5333	82.4696	82.5485	99.0457	98.7215
RAAN	200.5379	117.4035	56.8687	63.2689	85.9960	150.9682
Eccentricity	0.0018053	0.0015647	0.0011767	0.0021282	0.0015738	0.0014107
Argument of Perigee	125.5339	326.1108	279.8920	73.6770	343.8338	7.7335
Mean Anomaly	234.7507	13.9060	80.0961	286.6513	16.2329	353.9962
Mean Motion	13.83932674	13.84014595	13.83557952	13.16952300	14.11491120	14.22499251
Decay (Drag Factor)	6.8e-07	6.0e-06	6.0e-06	1.74e-06	8.3e-07	2.04e-06
Revolution (Orbit No.)	11394	6810	1617	7360	12262	3188

AMSAT AMS-81 TRACKING SYSTEM						
ACCESS SKED FROM: 12JUL87 000000						
>>G3IOR VIA OSCAR 10 <<						
Date	AOS	LOS	Hz	Mag	Az	El
12JUL	0053	0753	0305	16741	091	
13JUL	0101	0702	0225	17231	083	
13JUL	1102	1929	1404	17609	282	
14JUL	0110	0609	0143	17721	076	
14JUL	0944	1854	1323	17111	275	
15JUL	0118	0513	0118	18082*	069	
15JUL	0841	1816	1242	16604	268	
16JUL	0143	0401	0143	18004*	064	
16JUL	0745	1735	1201	16076	260	
17JUL	0653	1653	1120	15530	252	
18JUL	0602	1512	1038	14981	242	
19JUL	0515	1529	0957	14454	232	
20JUL	0429	1446	0916	13983	220	
21JUL	0344	1403	0835	13611	206	
22JUL	0301	1320	0754	13385	191	
23JUL	0219	1236	0713	13340	175	
24JUL	0138	1152	0632	13481	159	
25JUL	0059	1107	0551	13786	145	
26JUL	0026	1022	0510	14212	132	
26JUL	2357	0937	0428	14712	121	
27JUL	2342	0851	0347	15248	111	
28JUL	2333	0803	0306	15791	102	
29JUL	2335	0715	0225	16321	094	
30JUL	2335	0625	0144	16829	087	
31JUL	1046	1827	1323	17802	288	
31JUL	2339	0535	0103	17315	079	
01AUG	0911	1806	1242	17301	281	
01AUG	2354	0439	0022	17805	072	
02AUG	0806	1731	1201	16803	273	
03AUG	0006	0339	0006	18077*	066	
03AUG	0707	1652	1120	16253	266	
04AUG	0052	0214	0052	17922*	061	
04AUG	0513	1611	1039	15737	259	
05AUG	0524	1530	0959	15179	249	
06AUG	0435	1448	0917	14622	240	
07AUG	0348	1405	0836	14099	229	
08AUG	0303	1323	0754	13649	216	
09AUG	0219	1240	0713	13320	201	
10AUG	0136	1156	0632	13158	186	
11AUG	0054	1112	0551	13192	168	
12AUG	0013	1028	0510	13414	152	
12AUG	2335	0943	0429	13787	138	
13AUG	2301	0858	0345	14263	126	
14AUG	2237	0811	0307	14736	115	
15AUG	2230	0725	0225	15249	104	
16AUG	2214	0637	0144	15899	098	
17AUG	2213	0549	0103	16428	090	

gives maximum DX, normally the Apogee, but, if Marked with a "\*" then at horizon. The actual distance is indicated in the fifth column, and the azimuth at which this occurs in the last.

### UoSAT

The OSCAR-11 Digital Communication Experiment has been in heavy use, with messages being forwarded to the Australian gateway station VK5AGR in Adelaide, thence on to other parts of Australia via Packet Radio. ZL1AOX and K1KSY have DCE stations, and will soon be fully active.

Keplerian Elements are now provided via the DCE, and are available to any station using the UoSAT decoder systems and programs referred to in previous issues of this column. They come in specially formatted DCE title frames, and can be reformatted either as standard ASCII, or as DCE frames with CRC error checking. The format will be to give the satellite name, the epoch as year followed by day and decimal day, the inclination followed by the RAAN, then the eccentricity, the argument of perigee, the mean anomaly, the mean motion, the decay, and finally the revolution number. A run will thus appear as: KOSCAR-9 87 107.50928 97.64 123.07 0.0004 75.81 284.35 15.29440 2.9E-5 30746

## AMSAT P3-D

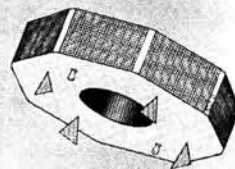

### A New Era of Amateur Radio

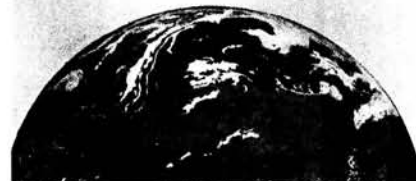

Fig. 2 ▲

◀ Fig. 1

Now that the UoSAT-2 spacecraft has been successfully "magnetorqued" to give very accurate ground pointing, efforts will go again into attempting to get some good pictures from the camera. The number of variables involved make this a very time consuming business, and all integration and exposure settings have to be correct as well as a suitable contrasting target.

### Phase III-c

ESA have been juggling with the launches of ARIANE, in an effort to keep up activities whilst overcoming the third stage problems earlier experienced. They are quite anxious that the new ARIANE-IV launcher should achieve its target schedule, and this is possibly good news for the next Phase III satellite that will replace OSCAR-10. The V-22 mission is now planned to carry Phase III-c, may now be slotted in between V-20 and V-21, but this depends entirely upon an eventual successful V-19 launch in August this year, and the readiness of a new launch pad for the new large ARIANE-4 rocket that will carry our new satellite into space. If all works out according to plans and hopes, we could be seeing a launch of the new elliptical orbiter by as early as November this year, although really it is more credibly placed in the first quarter of next year.

### Phase III-d

AMSAT-DL are now going ahead with plans for a larger 400kg 3 metre diameter 0.7 metre high version of the Phase III-c

satellite that could go into a Molniya orbit like the Russian communication satellites (an orbit such as OSCAR-10 should have entered, 12 hours, elliptical, with a constant 35 000km high Northerly Apogee of 63.4 degrees inclination, and a 1500km perigee). It will have both modes "J" and "L" (145MHz and 1269MHz uplinks with a 435MHz downlink of 500kHz bandwidth) with a downlink output power of 250 watts p.e.p. to a antenna gain of up to 15dBi. (This will mean a downlink of some 5kW e.r.p.!)

It will need only a receiver with a 5dBi gain antenna on 435MHz, and an uplink power to mode "L" of some 2 watts to a 10dBi antenna, or 6 watts to a 5dBi antenna, thus making world-wide mobile and even hand-held communications possible for 15 hours per day. The satellite would provide five times as much communication capacity as all the existing h.f. bands, and be immune to "conditions".

The one snag is not the technology, which is available, but the total project cost of some £2 000 000. With comprehensive amateur funding, it can be done! The appearance of the projected spacecraft which it is hoped to achieve for a 1990 launch is shown in Fig. 2.

## FO-12

The latest Japanese satellite continues to play elusive. From time to time the Mode "JA" beacon on 435.797MHz ( $\pm 10$ kHz of Doppler shift on an overhead pass) indicates that the linear transponder is on, but activity can be very low and even absent. This is because of the irregular times of activity, as even after a year, we still have no plan or schedule of operations. One may look for many passes when it is expected to be on, wait for five minutes to see if it operation arises, and then do the same for the next orbit in case it is in "every other orbit mode" all to no avail, and then find the same thing the next day. A lot of time can be lost, and thus the earlier indicated enthusiasm now seems to be on the wane. The "JD" mode came up with a limited memory mailbox operation on May 4, in an "on demand" operation, i.e. quiet and listening until it heard an

acceptable AX.25 frame on either 145.850, .870, .890 or .910MHz, when the p.s.k. signal would pop up on 435.910  $\pm 10$ kHz of Doppler shift. This crashed on May 12, so new efforts are being put into new programming. Testing continues, and the JAMSAT gang are working hard on this difficult problem, which should all be resolved very soon now.

At this time the number of messages within the 192 kilobyte memory are limited to fifty, which, if exceeded, will overwrite the older ones. As the number of users increase, so will the T1 time, and the response will slow down.

The maximum acceptable length (PACLEN) of the data portion of a packet is 199. FO-12 Mode JD transmits PACLEN 128, and MAXFRAMES 1. No personal mail is supported by this first version, as your messages can be read by all, and you can read messages addressed to anyone or everyone. Digi-peated packets will not be accepted, and no LOGOUT command is given—just disconnect by your TNCs disconnect command.

A list of current commands is given in Fig. 3 for this current system, but, things may well have advanced by the time this information is read by you, so some modifications and improvements may well result by then.

## AMSAT—UK Colloquium

Following the success of last year's event at the University of Surrey, even greater numbers are expected this year over the week end of July 17-19.

The subjects cover virtually every aspect of satellites, ranging from help for the beginner to specialised matters given by experts in the particular field. On the Saturday morning, following opening by the President of RSGB, and a welcome by G2UK, G3YJO will give an introduction to Amateur Satellites in practice. G3RUH will

```
F      : List latest 10 message headers with message number
F#     : List all the message headers.

R <n>  : Read a message numbered <n>

W      : Send a message. You will be asked receiver and
        : subject. Send <CR> . <CR> or <CR> ^Z <CR> to end
        : the message

K <n>  : Kill a message numbered <n>. A message being read by
        : other station(s) cannot be killed. FO-12 BBS is a
        : multi-user system.
        : Only originator of the message can kill messages.

H      : Help.
```

Your TNC should be set as follows ;

```
Protocol : It have to be the version 2. WABDED
          : PROMs are needed for TNC-1.

          Command TNC-1 : V2
                  TNC-2 : Ax2512v2 ON

T1 timer  : 6 seconds or longer

          Command TNC-1 : F6
                  TNC-2 : FRAck 6

Max Frames : 2 or 3 is suggested.

          Command TNC-1 : O2 or O3
                  TNC-2 : MAX 2 or MAX 3
```

Fig. 3

cover tracking topics, and VK5AGR Mode "B" operation. After lunch the UoSAT spacecraft operation and experiments will be covered, followed by the FO-12 status, then a talk on Phase III-c and Phase III-d by DJ4ZC. UA3CR will talk on the RS Satellites, and W3GEY on Phase IV.

On the Sunday G3IOR will cover satellite propagation, G3RUH modulation schemes and modems, SM5IXE the AMSAT-SM activities, VK5AGR and ZL1AOX the AMSAT-OSCAR-10 status report, followed by Geoff Perry talking on the Soviet Space programme.

In addition are talks on UoSAT plans, packet radio, RUDAK, DCE operations, weather satellites, satellite decay, and a host of associated topics. Open forums, Q & A sessions, demonstrations, tours of the UoSAT centre, etc. are all laid on, and an interesting and informative week end is assured.

Bookings must be made in advance, and it is possible that a few places may be left by the time you read this column. If you are keen to attend, send an s.a.s.e. to AMSAT-UK, 94 Herongate Road, London E12 5EQ at the earliest opportunity.

## Propagation

Reports to Ron Ham  
Faraday, Greyfriars, Storrington, West Sussex R20 4HE.

In addition to detecting noise from the sun and distant celestial sources, radio has an important part to play in the identification and early warning of natural events which often occur within our atmosphere. For example when **Len Fennel** (Wisbech) reports receiving tone-A signals from the 50 and 144MHz beacons GB3NHQ (Potters Bar) on April 22, 24, 27, 29, May 12, 13 and 16, GB3CTC (Cornwall) on April 27, 29 and 30 and GB3VHF (Wrotham) on April 21 and 30 and May 12; then I know that some degree of aurora was manifesting at the time. This being the case, I must watch for associated information about solar activity and reports of ionospheric and magnetic disturbances.

Briefly, those beacon signals, identified as auroral-propagated by their very rough nature, were reflected towards Len's antenna by the random, temporary and moving regions of complex ionisation which are the main features of an auroral display.

## Solar

"The sun is now in a period of transition, where the old and new cycles are overlapped with spots appearing together in both latitudes," wrote **Bob Anderson** (Johannesburg) on May 2. Bob's solar group counted 3 sunspots on April 22 and 30, 4 on the 25th and 1 on each of the interim days. His members are making plans to establish a radio section.

I later heard from **Jim Knight** (Boksburg), that Bob passed away on the 14th. I will certainly miss his frequent letters and detailed reports and we, at PW, wish to extend our deepest sympathy to his family and friends. Jim is taking Bob's place until the national council of the Astronomical Society of Southern Africa convenes to elect a new full time Solar Director.

At his observatory in Bristol, **Ted Waring** counted 2 sunspots on April 27, 14 on May 7, 1 on the 14th and 12 on the 19th. In Brixham, **Helene Lott** observed 3 spot groups, Fig. 1, on April 15 and **Patrick Moore** (Selsey) positioned the groups indicated in Fig. 2, at 0800 on May 6.

In Sevenoaks, **Cmdr Henry Hatfield**, using his spectroheliograph, observed one spot and 5 filaments on April 22 and

23, a single spot and a group of 3 spots and 6 filaments on the 24th, two faint groups, a single spot and 5 filaments on May 2 and one spot and one group of 2 medium sized spots with 3 and 4 filaments respectively on the 6th and 7th. "The single spot had gone by 1155 on the 8th but the double group and 3 filaments was still there on the 8th and 9th," said Henry. He also recorded individual bursts of solar radio noise, at 136MHz, on May 1, 4, and 17.

"The solar flux was 73 units on April 1 and then rose sharply to peak at 101 s.f.u. by the 11th. It stayed in the 90s until the 20th, then fell back into the 70s for the rest of the month. The average for April was 85 s.f.u.," wrote **Neil Clarke GOCAS** (Knottingley). He added, "almost certain that we have passed sunspot minimum and started cycle 22 and by the end of the year, the smoothed monthly sunspot number should be around 25. Neil tells me that the Monthly Mean is the daily sunspot number for each day of the month divided by the number of days in the month. The Smoothed Monthly sunspot

number is the total of the last 12 monthly mean sunspot numbers divided by 12.

The Solar Division of The American Association of Variable Star Observers have calculated a mean relative sunspot number of 13.3 for March computed from the reports of 48 members of the AAVSO international sunspot-observer network. They also reported the occurrence of sudden ionospheric disturbances (s.i.d.) on March 8 and 24. My thanks to **Martin Mann** (Cambridge) for the March issue of the AAVSO's *Solar Bulletin*. "We get this information at Cambridge Kits because of our interest in v.l.f. and solar flares, etc.," said Martin.

### Sporadic-E

Italian stations were prominent during the afternoon and early evening of May 4 while the 21 and 28MHz bands were being influenced by Sporadic-E. I counted 25 very strong signals from eastern-European broadcast stations, between 66 and 73MHz, during a more intense disturbance around 1030 on May 9.

### The 28MHz band

"There was a good lift on 28MHz over the last two days when I heard signals from DL, EA, F, GM, I and YU, mainly in their native tongues," wrote **Alan Lott G1AEU** (Brixham) on May 17.

In Knutsford, **Dave Coggins**, using an Icom R71E and 2-element quad antenna, logged the prefixes DK, HB, HG, OE, OZ, YT, Y22, 4X and DL7VX/M (West Berlin) on April 19; EA, G and 7Q7 on the 20th; lots of EAs and Gs on the 21st; EA and G on May 1; CE2 CT1, G, HG, OE, OZ, NP4, SP, RB5, YU, YV, Y22 and 8P6 on the 9th; G, OH, SP, UP and UQ on the 10th; SK and SL on the 11th; EA, G, HG, I and SP on the 17th; G and I on the 18th and DL, G and SM on the 19th.

In Maldon, **Ted Owen** logged SM at 1657 on April 19 and then VE at 2234 on May 7.

"G4UPS reports 28MHz open to I, RF6 SP, YU, 4X4 (very strong) and 5B4 with weaker signals from J28 and YBO, on April 19," writes **Ian Galpin** (Poole). He also logged CT and EA at 1200 on the 20th.

**Don Hodgkinson G0EZL** (Hanworth) worked 6W1NQ on May 9 adding Senegal Republic to his new country list. From his QTH in Storrington, **Fred Pallant G3RNM** noted, "Continuous very high noise level with irregular fluctuations and only GB3RAL audible," at 0954 on May 21. Fred checked again at 1348 and found little change on 28MHz and a similar situation on 21MHz.

"I understand from SM6BSM that they have a new repeater at Alingsas, 50km from Kusten, input on 29.060MHz and output on 29.160MHz," wrote **Jim Hicks G4XRU** in the latest Southern 10 Metre FM Group's newsletter. Details of membership and group activities are available by sending an s.a.e. to Jim at 33 Hayling Rise, Worthing, Sussex, BN13 3AL.

### Propagation Beacons

First my thanks to **Chris van den Berg** (The Hague), **Neil Clarke**, **Dave Coggins**, **Len Fennelw**, **Henry Hatfield**, **Don Hodgkinson**, **Norman Hyde G2AIIH** (Epsom Downs), **Bill Kelly** (Belfast), **Peter Lewis G4VFG** (Ivybridge), **Fred Pallant**, **Gordon Pheasant G4BPY** (Walsall), **Ted Owen**

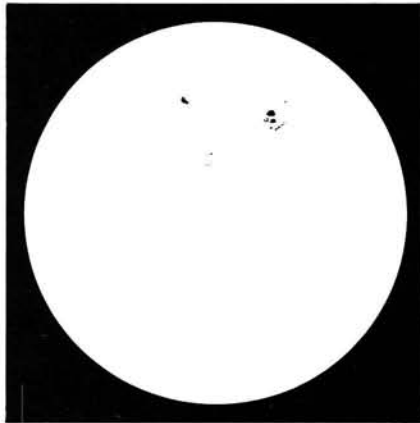

Fig. 1

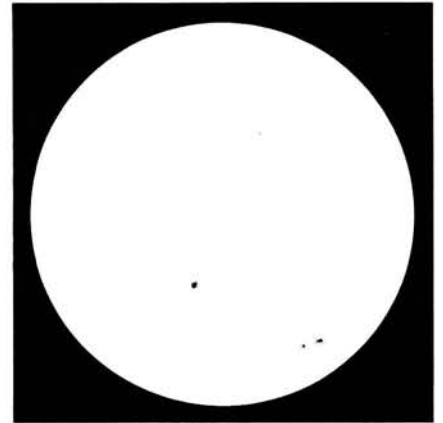

Fig. 2

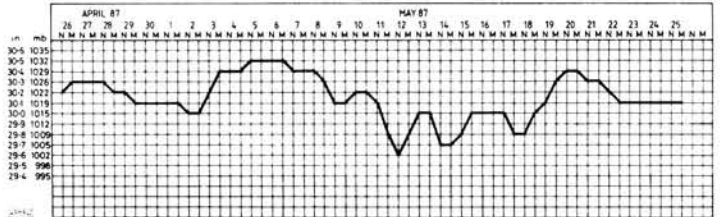

Fig. 3

	APRIL										MAY 87																			
	26	27	28	29	30	1	2	3	4	5	6	7	8	9	10	11	12	13	14	15	16	17	18	19	20	21	22	23	24	25
DF0AAB						*	*	*	*	*	*	*	*	*	*	*	*	*	*	*	*	*	*	*	*	*	*	*	*	*
DK0TEN	*					*			*			*	*	*	*	*	*	*	*	*	*	*	*	*	*	*	*	*	*	*
DLOIGI	*	*	*	*	*	*	*	*	*	*	*	*	*	*	*	*	*	*	*	*	*	*	*	*	*	*	*	*	*	*
EA1ADU																								*						
EA3JA						*	*																*	*	*	*	*	*	*	
EA6RCM																							*	*	*	*	*	*	*	
IY4M						*	*	*	*	*	*	*	*	*	*	*	*	*	*	*	*	*	*	*	*	*	*	*	*	*
LU1UG						*					*												*	*	*	*	*	*	*	
LU2FFV																							*							
PY2AMI						*	*	*	*	*	*	*	*	*	*	*	*	*	*	*	*	*	*	*	*	*	*	*	*	*
PY2GOB						*	*	*	*	*	*	*	*	*	*	*	*	*	*	*	*	*	*	*	*	*	*	*	*	*
ZS1LA	*					*	*	*	*	*	*	*	*	*	*	*	*	*	*	*	*	*	*	*	*	*	*	*	*	*
ZS6PW	*	*	*	*	*	*	*	*	*	*	*	*	*	*	*	*	*	*	*	*	*	*	*	*	*	*	*	*	*	*
Z21ANB	*	*	*	*	*	*	*	*	*	*	*	*	*	*	*	*	*	*	*	*	*	*	*	*	*	*	*	*	*	*
3B8MS																							*	*	*	*	*	*	*	
4N3ZHK									*	*	*	*	*	*	*	*	*	*	*	*	*	*	*	*	*	*	*	*	*	*
5B4CY	*								*	*	*	*	*	*	*	*	*	*	*	*	*	*	*	*	*	*	*	*	*	*

Fig. 4

	APRIL 87										MAY 87																			
	19	20	21	22	23	24	25	26	27	28	29	30	1	2	3	4	5	6	7	8	9	10	11	12	13	14	15	16	17	18
CT3B		*	*	*	*	*	*	*	*	*	*	*	*	*	*	*	*	*	*	*	*	*	*	*	*	*	*	*	*	*
LU4AA						*																	*	*	*	*	*	*	*	*
DH2B		*	*	*	*	*	*	*	*	*	*	*	*	*	*	*	*	*	*	*	*	*	*	*	*	*	*	*	*	*
ZS6DN/B		*	*	*	*	*	*	*	*	*	*	*	*	*	*	*	*	*	*	*	*	*	*	*	*	*	*	*	*	*
4U1UN/B		*	*	*	*	*	*	*	*	*	*	*	*	*	*	*	*	*	*	*	*	*	*	*	*	*	*	*	*	*
4X6TU/B		*	*	*	*	*	*	*	*	*	*	*	*	*	*	*	*	*	*	*	*	*	*	*	*	*	*	*	*	*

Fig. 5

and **Ted Waring**, for their logs which enabled me to compile the monthly list of beacons heard, Fig. 4, in the 28MHz band.

"I logged a new beacon on 28.212MHz sending, "EA6RCM—JM19HO" at 1300 on May 19," said **Neil Clarke**. **Peter Lewis**, who checks the band at lunch time and again, as time permits, at intervals after 1630, heard it give a box number in Palma, Majorca. **Don Hodgkinson** copied it sending "RIG IS 4W = ANT 5 EL AT 30 DEG".

"It's nice to hear 'old faithful' DLOIGI and its friends appearing on 28MHz again," said **Dave Coggins**. "DLOIGI and 4N3ZHK (Northern Yugoslavia) have been heard around mid-morning towards the end of this period," reports **Norman Hyde**. **Norman** also logged signals, via meteor scatter, almost daily from the 50MHz beacons in Scotland (GB3RMK) and Wales (GB3SIX).

On April 19, **Dave Coggins** heard GB3SIX with a "rhythmic" type QSB and on May 4 its signal was extremely faint and "warbly". **Fred Pallant** logged EA1ADU on May 23 and **Gordon Pheasant**, using his automatic monitoring system for beacons, found LU2FFV on the 18th. "Conditions were good to Scandinavia between the

18th and 20th, but nothing heard from LA5TEN, so it could be off," remarked **Gordon**. The German and Italian beacons DKOTEN and DLOIGI and IY4M were 59+ with **Chris van den Berg** on May 18.

"The 14MHz beacons have shown a much more stable pattern this past month, the European and Mediterranean ones being heard at good strength nearly every day and ZS6DN/B appearing with fair regularity," commented **Len Fennelw**. His observations for the month prior to May 16 are listed in Fig. 5.

**Len** received signals from the 144MHz beacons in **Angus (GB3ANG)**, around S3, on April 26 and May 5 and 6; **Cornwall (GB3CTC)**, at S3, on May 9 and **Wrotham (GB3VHF)**, at S9, on 22 of the 26 days between April 21 and May 16 inclusive.

**Don Hodgkinson** logged ANG on May 3, 6 and 8. CTC almost daily from April 26 to May 14 and the French beacon (FX3THF) on April 27 and May 1, 5, 6, 7 and 8. **Len Fennelw** reckoned that the weekend of May 8-10 was the best period for v.h.f. and u.h.f. propagation.

"The 432MHz beacon, GB3MLY, can be heard here daily about S3," said **Dave Coggins**. **Len Fennelw** reported,

*Practical Wireless, August 1987*

"GB3BPO disappeared off air on May 13 and 14 and returned again as GB3MHL on the 15th at S9". Chris van den Berg logged CTC on May 8, VHF on most days between April 21 and May 18 and a Belgian 144MHz beacon (ON4VHF) on April 26, 27 and 28 and May 8.

A comparison between these beacon reports and the prevailing atmospheric pressure can be made by referring to the chart in Fig. 3, which contains the slightly rounded readings, taken from my barograph, at noon and midnight each day.

## The 934MHz Band

"Most of our stations had a busy time due to several marked variations in the atmospheric pressure," wrote **John Raleigh DW-04** (Bedford), for the period

April 21 to May 17. John, secretary of The Four County 32cm Club, told me that Harry Cadwell HC-05 (Dunstable) worked two stations in Stratford-upon-Avon on April 22; Fred Mills TL-01 (Kempston) contacted several east-coast stations on the 24th; Bill Ellis WE-641 (Houghton Regis) and Ralph Rowlet GR-587 (Upper Caldecote) had QSOs into Swindon and Fred Mills exchanged signals with a maritime mobile on the North Sea and a station in Sheffield on the 26th.

Between May 7 and 9, DW-04 worked a portable on the Brecon Beacons and along with TL-01 and WE-641, he had many contacts with operators on the east and south coasts of England.

John received a QSL card from Fred Wragg NV-08 (Peterborough), confirming their QSO on March 20, over a difficult

path.

During the evenings of April 21, 22 and 23, **John Levesley UK-627** (Bransgore) had QSOs from Cosham to Jersey at distances ranging from 72 to 164km and on May 8 and 9 his contacts, from 130 to 200km, included Guernsey, Jersey, Swansea and Torbay.

"The Dorset Group of the UK-934MHz Club will, as usual, have a demonstration station operating at Hamfest 87 on August 9. The event is run by the Flight Refuelling Amateur Radio Society at Wimborne," said John who, with his amateur radio hat on, has traded his G1 callsign for G0HJL.

**The deadlines for the next three issues are: July 29; September 2; September 30.**

# Broadcast Round-up

Peter Shore

No sooner does one make a comment about international broadcasting than one finds that developments occur! I refer, of course, to the subject of jamming which I mentioned at the start of last month's column, expressing the hope that we might be able to enjoy interference-free listening one day soon. On May 25, news came that BBC engineers had spotted that Voice of America Russian language broadcasts were no longer being jammed by the Soviet Union, although it was unclear immediately whether this was a deliberate move, or simply that problems had beset the jamming transmitters.

It transpired that the Soviet Union had indeed made a conscious effort to stop jamming the VoA, and broadcasts in Russian, Ukrainian, Lithuanian, Latvian, Uzbek and Estonian were now jamming-free. VoA transmissions in some other Eastern Bloc languages continue to be blocked, and it seems that some of the jamming transmitters previously used against VoA were switched to the frequencies used by Radio Liberty and Radio Free Europe. In its transmission to Great Britain and Ireland on May 26, Radio Moscow admitted that jamming of VoA had stopped, but that there was no likelihood of RFE and R. Liberty being allowed to broadcast without interference, as they are "front organisations for the CIA".

With BBC Russian language programmes audible in the Soviet Union since January, when jamming stopped, this only leaves the Russian language programmes of Deutsche Welle and Kol Israel being deliberately interfered with.

It is not only the Soviet Union which jams shortwave broadcasts. Iraq interferes with Iranian programmes, and in the past few weeks there has been a change to the type of noise being used in this operation, making the interference more successful. Libya also jams some BBC Arabic programmes, but it is thought that this is not particularly successful, mainly because they are not interfering with all the frequencies used.

## International Broadcasting News

Note: all times are UTC (GMT)

### Europe

Readers will be aware that at the World Administrative Radio Conference for HF Broadcasting held in Geneva earlier this year, a resolution was passed urging broadcasters to stop using the 40 metre

Amateur Band (7.000 to 7.100MHz) for transmissions. It seems as if Radio Tirana, one of the heaviest users of frequencies in this part of the band, has taken heed, for many of the broadcasts which until a few weeks ago were carried on, for example, 7.065 and 7.090MHz, are now to be found just up the band on 7.105, 7.205 and others.

Deutsche Welle which has a relay station at Trincomalee in north-east Sri Lanka is currently looking for an alternative site because of the continuing civil strife in the island, which has prevented the facility from being fully used for the past two years.

Deutschlandfunk has inaugurated a new f.m. transmitter to supplement its a.m. broadcasts: 102.8MHz is used for programming and is audible around the northern borders of West Germany.

DLF has some interesting programmes in its line up over the coming weeks: on Monday July 13, Ulrich Barths will be investigating the efforts being made to control pollution off West Germany's coastline, whilst on Saturday July 18, you can find out about the famous Apple Wine from Frankfurt. In October, DLF will be restarting its German language course, *Auf Deutsch gesagt*. The station is now inviting orders for the free books which go with the course. Write to DLF English Service, PO Box 640, D-5000 Cologne 51, West Germany.

Radio Finland's striking technicians went back to work on May 7, and programming resumed shortly afterwards. Meanwhile, the station's two new 500kW transmitters at Pori have been switched on, with a third 500kW transmitter due to be in operation from early June. The new 600kW medium wave transmitter is due to begin broadcasting in July.

Radio France International has inaugurated new English language programmes at 0200, 0330, 0415 and 1110. A new domestic radio station has opened in France. Called France Info, it started operations on June 1 in Paris, Lyon, Marseilles, Toulouse, Le Mans, Mulhouse, Clermont-Ferrand and Nantes on 105.5MHz f.m., between 0500 and 2200. The station has a news-based format, with speedy turn-around of stories.

The Voice of Greece has made frequency changes:

1200-1255 on 9.855, 11.645 and 15.630MHz

1900-1950 on 7.430, 9.395 and 9.425MHz

Meanwhile, the regional station at Thessaloniki is now on the air from 0900 (0500 on Sundays) until 2115 on 9.935 and 11.595MHz.

The European English language programmes from Radio Budapest can be heard:

1050-1120 on 17.710, 11.910, 9.835, 7.225 and 6.025MHz

1600-1630 on 11.910, 9.835, 9.585, 7.225 and 6.110MHz

1800-1830 on 11.910, 9.835, 9.585, 7.225 and 6.110MHz (Tu/Fr)

2000-2030 on 11.910, 9.835, 9.585, 7.225 and 6.110MHz

The station has a DX programme aired on Tuesdays and Fridays only at 1415-1430 on 11.910, 9.835, 9.585, 7.225 and 6.110MHz.

The current shortwave schedule for Iceland is:

Mon-Fri 1215 on 13.759 and 9.595MHz

Saturday 1230 on 13.759 and 9.595MHz

Mon-Fri 1300 on 11.855MHz

Mon-Fri 1855 on 11.745MHz (from 1600 Sat and Sun)

Mon-Fri 1855 on 3.400 and 9.985MHz (to Europe)

Mon-Fri 2300 on 7.290MHz

Adventist World Radio from Italy has been off the air since May 6 as a result of technical problems and is likely to remain silent for some time, reports say. Meanwhile programmes continue to be heard from the Sines transmitter in Portugal, with English Sundays 0800-0830 on 9.670MHz.

Radio Netherland's Flevo transmitter site, which entered service on 31 March 1985, was officially opened on May 19 by Prince Claus.

Radio Portugal's broadcasts in Portuguese at 1500 and English at 1600 (weekdays only) can be heard on new 15.300 and 15.245MHz. The USSR transmitter on 1.494MHz used for certain foreign language broadcasts was due to be off the air for the whole of June for maintenance work.

Meanwhile, a new Cuban relay on medium wave for English language programmes to North America has been started. Using 1.040MHz, the service will operate each Sunday and every other Saturday 1200-2200. This would seem to be a separate service to R. Moscow's service in English to the Eastern seaboard of the US which is on the air daily 2200-0300. Initial reports suggest that

coverage during summer will be severely limited, perhaps only as far north as mid-Florida.

With the BBC carrying out maintenance on the Droitwich 200kHz transmitter at night, when World Service is usually relayed, it is possible to hear the Soviet Union's domestic Mayak service quite clearly on this frequency during the night . . . I wonder whether listeners in Europe have become confused?

Radio Vilnius from Lithuania has an English language cast to Europe at 2130 on 6.100MHz, and to North America at 2200 on 13.645, 11.875, 11.790, 9.640 and 7.260MHz.

The Red Cross Broadcasting Service will be on the air in English to Europe on June 28, July 26 and August 30 at 1100 in English on 7.210MHz, and the following day (Mondays) at 1700 on the same channel.

## Middle East

Saudi Arabia broadcasts Holy Koran to the Middle East and Africa, and is heard at 1900-2100 on 9.610, 7.275 and 7.250MHz. Reports suggests that the Voice of America relay site in Israel was due to go on the air on June 18, although no schedule has yet been seen.

Israel Network B is heard at 0900 on a new channel of 9.925, with parallel channels of 13.748, 15.617, 17.555 and 17.620MHz. The Voice of Turkey can be heard from 0600 on 11.705, in parallel with 15.220, the regular day-long mainstay frequency.

Algeria has inaugurated a new long wave frequency of 153kHz, in parallel with 891kHz for its Arabic Service. Radio Bardai, the clandestine station opposed to the Chadian government disappeared from the airwaves for a while, but is now apparently

audible again, but only in the morning at 1100 on 6.009MHz. The station has been heard to identify as "Radio Chad".

Radio RSA has dropped 11.900MHz for their evening transmissions to Europe—11.775 is now used with 9.585 and 7.270MHz for Portuguese at 1900, French at 2000 and English at 2100.

## Asia

Radio Beijing is using a new frequency of 11.515 for English at 1930 and 2030. Bhutan has gone back to using an old 400 watt transmitter following the burning out of the 5kW transmitter's transformer. This will make the station a very rare catch indeed, but if you want to try, or are going to Asia and want to look for it there, try new 9.165MHz Monday-Saturday 1100-1400.

Radio Japan celebrated its 52nd birthday at the end of May with a special programme which included link-ups with Radio Australia, the BBC and Radio Netherlands. Happy Birthday! The new BBC transmitters in Hong Kong are now reportedly being tested. The 300kW equipment can be heard:

2030-2345 on 5.965MHz  
2315-1800 on 11.775MHz  
0215-1845 on 15.280MHz

Nepal has a schedule for shortwave transmissions 0015-0445 and 0715-1015 on 5.005 and 7.165; 1145-1715 on 5.005 and 3.230MHz. Mongolia's External Service operates as per:

0915-0950 on 9.615 and 12.015MHz (to Oceania)  
1200-1235 on 9.615 and 12.015MHz (to Far East)  
1445-1520 on 9.575 and 15.305MHz (to S Asia)  
1940-2015 on 9.575 and 11.790MHz

(to Europe)

All these programmes in English Monday to Saturday.

## Australia

During the recent Fiji crisis, Radio Australia relayed the BBC World Service between 2230 and 0100 on 15.395MHz, audible clearly here in the United Kingdom. This is a 100kW transmitter at Shepperton on a 65 degree beam. This may be a good frequency for listening to Australia at that time when the BBC relay ends. Meanwhile, 9.655MHz continues to offer good reception for listeners in Europe between 0700 and 1030, with afternoon programmes audible on 7.205 and 6.035MHz.

The Voice of the Fijian Patriots was heard on 5.985MHz around 0900 during the early part of the crisis in the island.

## North and South America

WCSN, the Herald of the Christian Science Monitor has made some frequency alterations:

0000-0200 on 7.365MHz  
0200-0400 on 9.815MHz  
0400-0600 on 9.465MHz  
1000-1200 on 17.640MHz  
1800-2000 on 15.230MHz  
2000-2200 on 15.265MHz  
2200-2400 on 15.300MHz

Radio Havana Cuba is heard in English at 0010 on 9.655 and 6.090, and at 0200 on 6.090 and 6.140MHz.

HCJB's *DX Party Line* programme on Monday is being presented by former hosts Clayton and Helen Howard for a few weeks whilst John Beck, the current host is filling in for another member of staff. Listen in on Mondays at 2130 to Europe on 15.270 and 17.790MHz.

That's all from the bands for this time: more news same place next month.

VISA 0202 678558 Practical Wireless 0202 678558

# PCB SERVICE

Printed circuit boards for recent *PW* constructional projects are now available from the *PW* PCB SERVICE. The boards are fabricated in 1.5mm glass-fibre, and are fully drilled and roller tinned. All prices include VAT and postage and packing for UK orders. Add £2.00 per order for despatch to overseas addresses.

Orders and remittances should be sent to: **PCB Service, Practical Wireless, Enefco House, The Quay, Poole, Dorset BH15 1PP. Cheques should be crossed and made payable to Practical Wireless.**

When ordering, please state the Project Title and Issue Month as well as the Order Code. Please print your name and address clearly in block capitals, and do not send any other correspondence with your order. You may phone your order using Access or Visa. A telephone answering machine will accept your order outside office hours.

**Please allow 28 days for delivery. Always check the latest issue of *PW* for the current details of price and availability. Please enquire for earlier p.c.b.s.**

PROJECT TITLE (Issue)	ORDER CODE	PRICE
PW Tema—VFO/Doubler (12/84)	WA001	£3.76
PW Tema—RX (1/85)	WA002	£5.46
PW Triambic Keyer (2/85)	WAD280*	£4.26
FRG-7 BFO Mod (2/85)	WAD249	£4.00
PW Colne (4/85)	A004	£4.14
	A005	£4.08
PW Colne (5/85)	WR198	£5.01
PW Colne (6/85)	WR197	£4.97
Battery Charge Control (6/85)	WAD302	£3.94
Crystal Tester (7/85)	WR200	£3.43
Add-on BFO (8/85)	WR201	£3.42
UHF Prescaler (9/85)	WR202	£4.76

PW Meon 50MHz Transverter (10/85)	WR199	£8.28
Capacitance Meter (10/85)	WR203	£3.74
WQ MW Loop (11/85)	WR204	£3.45
RTTY/Morse Modem (1/86)	WR205	£6.73
	WR206	£3.78
Crystal Calibrator (1/86)	WR207	£2.90
Simple Audio Oscillator (3/86)	WR209	£5.50
RF Speech Processor (3/86)	WR208	£5.21
PW Meon Filter (4/86)	WR211	£4.04
PW Arun Parametric Filter (5/86)	WR210	£9.87
FRG-7 CIO Mod (6/86)	WR213	£3.61
Simple 50MHz Converter (9/86)	WR215	£4.86
NiCad Charger (10/86)	WR217	£3.30
Active Antenna (11/86)	WR216	£3.24
PW Taw VLF Converter (11/86)	WR222	£3.82
High Impedance MOSFET Voltmeter (12/86)	WR223	£3.82
Modifying the SRX-300 (12/86)	WR214	£3.99
Basic Wobulator (1/87)	WR224	£4.52
2m Mast-head Pre-amp (2/87)	WR218	£5.33
	WR219	£3.37
PW "Woodstock" (3/87)	WR225	£5.28
PW "Blandford" (4/87)	WR227a	} £11.11
	WR226a	
	WR228	
PW "Itchen" (4/87)	WR298	£4.49
PW "Axe" (5/87)	WR230a	£5.07
	WR231	£4.24
	WR232	£3.82
PW "Downton" (6/87)	WR233	£5.04
Side-tone Oscillator (6/87)	WR234	£3.65



## ICOM (UK) LTD/RETAIL.

Everything you need for your shack is available from Icom UK's retail shop. Andy G6MRI is on hand with new and secondhand stock from ICOM plus Yaesu, Trio, MET, Tono, Jaybeam, Welz, Drae, BNOS and many more. RSGB publications also available, if Andy can't help, you've got a problem. Why not call in, we are on the corner of Stanley Road and Kings Road, Herne Bay, Kent and open 9 - 5.30 mon-sat, lunch is 1-2.15, 1/2-day closing thursday afternoons open 9-1.00. BCNU.

Credit facilities available, plus VISA & ACCESS accepted.



## ICOM (UK) LIMITED.

**ICOM**  
The World System

2 Stanley Road, Herne Bay, Kent CT6 6SH. Tel: 0227 369464.

We are pleased to introduce a new range of antennas shown thus (N). The dipoles have been redesigned and now include a fully sealed 'N' socket supplied complete with 'N' plug for coaxial cable. Absolutely NO matching or tuning required. Also a new 1296MHz 55 element yagi. Send for details.

### ANTENNES TONNA (F9FT)

<b>435MHz</b>		
9 element (N)	£28.62 (a)	
19 element (N)	£34.35 (a)	
19 element crossed	£39.66 (a)	
21 element 432MHz (N)	£44.57 (a)	
21 element ATV (N)	£44.57 (a)	
<b>144/435MHz</b>		
9 & 19 element Oscar	£39.66 (a)	
<b>1296MHz also 1250MHz</b>		
23 element	£30.26 (b)	
4 x 23 element - power splitter - stacking frame	£160.00 (a)	
55 element	£46.20 (a)	

**50MHz** 5 element £41.69(a)

<b>144MHz</b>		
4 element (N)	£26.60 (a)	
4 element crossed (N)	£34.96 (a)	
9 element fixed (N)	£30.87 (a)	
9 element portable (N)	£33.12 (a)	
9 element crossed (N)	£57.86 (a)	
13 element portable (N)	£46.00 (a)	
17 element fixed (N)	£81.54 (a)	

PLEASE ADD CARRIAGE AS SHOWN (a) £5.00. (b) £2.20. ALL PRICES INCLUDE VAT AT 15% ACCESS - VISA - Just telephone your card number for immediate despatch.

FOR FULL SPECIFICATIONS SEND 40p FOR CATALOGUE

Callers welcome, but by telephone appointment only please.

Goods by return.

**RANDAM ELECTRONICS (P)**

12 Conduit Road, Abingdon, Oxon OX14 1DB. Tel: (0235) 23080 (24 hours)

### J. BIRKETT

#### RADIO COMPONENT SUPPLIERS

200 ASSORTED MINIATURE POLYESTER CAPACITORS @ £1.00  
 PHOTO TRANSISTOR MEL12 @ 20p, Jumbo ORP12 RPY18 @ 95p, ORP2 @ 50p  
 AIR SPACED TRIMMERS 20p.f. or 27p.f. @ 20p, Philips concentric 3p.f. @ 15p  
 C504 TYPE VARIABLE CAPACITORS Sp.f. @ £1.60, 10p.f. Wide Spaced @ £1.95, 20p.f. Wide Spaced @ £2.30, 25p.f. Wide Spaced @ £2.50, 50p.f. @ £2.50, 75p.f. @ £2.50, 150p.f. @ £2.50, 150+150p.f. Differential @ £2.95.  
 LARGE BROADCAST TYPES 450p.f. @ £2.30, 360+360p.f. @ £2.50, 400+400+100p.f. @ £2.30.  
 LARGE TELESCOPIC AERIALS 10" Closed 64" Extended @ £2.30.  
 100 OSC/F TRANSFORMERS 8mm Square @ 100 for £1.95  
 X BAND GUNN DIODES @ £1.65, SCHOTTKY DIODE Like 1N23 @ 45p.  
 ITT CRYSTAL FILTER 0140G 10.7MHz BW 3.75KHz @ £3.95.  
 SEI CRYSTAL FILTERS QC1112Z or QC1112V 1.4MHz BW 3.2KHz @ £5.00 each.  
 SUB-MINIATURE MULTI-LAYER CAPACITORS 1000p.f. @ 5p, 0.01uf @ 8p, 0.1uf @ 15p.  
 UNIJUNCTION TRANSISTORS Similar to 2N2646 or T1543 @ £2.2p.  
 DUAL GATE MOS FETS Like 40673, 3N201 @ 80p each.  
 TRANSISTORS BSX20 @ 20p, BSX19 @ 15p, BSX21 @ 15p, 2N706 @ 15p, 2N2222A @ 20p, 2N2905A @ 30p, 2N4123 @ 15p.  
 MULLARD FERRITE RING FX1594 @ 20p, 2 Hole Ferrite FX2049 @ 20p.  
 WIRE ENDED CAPACITORS 0.033uf 630v @ 10p, 0.068uf 400v @ 10p, 0.1uf 400v @ 10p, 0.22uf 400v @ 15p.  
 WIMA 10K10 0.33uf 1000v @ 15p, 0.47uf 1000v @ 20p.  
 THYRISTORS (SCR'S) 600 Piv 25 Amp @ £1.50 each.  
 30 AMP STUD DIODES 100 Piv Stud A or K @ 50p each.  
 50 BC106 TYPES UNMARKED for 75p, 50 Plastic PNP-NPN Mixed Untested @ 75p.  
 WOOD AND DOUGLAS KITS AVAILABLE BY POST AND FOR CALLERS. ACCESS AND BARCLAY CARDS ACCEPTED. P.P. 60p UNDER £5. OVER FREE.

25 The Strait  
Lincoln, Tel. 20767  
(LN2 1JF)  
Partners J.H.Birkett.  
J.L.Birkett.

## GAREX THE SCANNER SPECIALISTS

Just a small advertisement this month to let you know that we are still very much in business. See our previous ad for product details.

Ask for our secondhand scanner bargain list.

MEET US AT THE FOLLOWING MOBILE RALLIES FOR STORES CLEARANCE BARGAINS AND REGULAR LINES AT POST-FREE PRICES: Brighton 12th July; Woburn 2nd Aug; Derby 9th Aug; Torbay 30th Aug; Lincoln 13th Sept; Harlow 27th Sept.

MAIN DISTRIBUTOR OR REVCO PRODUCTS  
 PRICES INCLUDE UK P&P and 15% VAT  
 Good normally despatched by return

**GAREX ELECTRONICS**  
 HARROW HOUSE, AKEMAN STREET, TRING, HP23 6AA  
 Phone Tring (044 282) 8580 Callers by appointment only

### MAKE YOUR INTERESTS PAY!

More than 8 million students throughout the world have found it worth their while! An ICS home-study course can help you get a better job, make more money and have more fun out of life! ICS has over 90 years experience in home-study courses and is the largest correspondence school in the world. You learn at your own pace, when and where you want under the guidance of expert 'personal' tutors. Find out how we can help YOU. Post or phone today for your FREE INFORMATION PACK on the course of your choice. (Tick one box only!)

Electronics <input type="checkbox"/>	Radio, Audio and TV Servicing <input type="checkbox"/>
Basic Electronic Engineering (City & Guilds) <input type="checkbox"/>	Radio Amateur Licence Exam (City & Guilds) <input type="checkbox"/>
Electrical Engineering <input type="checkbox"/>	Car Mechanics <input type="checkbox"/>
Electrical Contracting/Installation <input type="checkbox"/>	Computer Programming <input type="checkbox"/>
GCE over 40 'O' and 'A' level subjects <input type="checkbox"/>	

**ICS** Name \_\_\_\_\_ P. Code \_\_\_\_\_  
 Address \_\_\_\_\_  
 International Correspondence Schools Dept EES 87, 312/314 High St., Sutton, Surrey SM1 1PR. Tel: 01-643 9568 or 041-221 2926 (24hrs).

## COMMUNICATION CENTRE OF THE NORTH

The largest range of communications equipment available in the North. Full range of receivers, transceivers, antennas, power supplies, meters. Ali tubing - wall brackets - rotators - insulators.

We are the original amateur radio suppliers in the North West with 20 years experience in all types of equipment. Wide range of Base, Mobile, Antennas for all applications. Full range of equipment on display. Guaranteed after sales service. Official Kenwood stockist for North.

Also stockists for Tonna, Welz, G.Whips, Jaybeam, RSGB Publications, Diawa, Microwave Modules, Capco Antenna Tuners.

### RECEIVERS

Full range of receivers for all modes and frequencies.	
KENWOOD R5000 General Coverage Receiver	£895.00
VC20 VHF Converter for R5000	£171.94
KENWOOD R2000 General Coverage Receiver	£637.26
VC10 VHF Converter for R2000	£170.76
JRC NRD 525 General Coverage Receiver	£1,195.00
CMK165 VHF/UHF Converter for NRD525	£391.35
HF125 General Coverage Receiver	£375.00
AR2002 Wide Band Scanning Receiver	£487.00
R532 Synthesised 100 Channel Airband Receiver	£224.00
R537S Hand Held Airband Receiver	£69.50
AT1000 SWL Antenna Tuner	£69.00

Please send SAE for full information and up-to-date prices as these fluctuate to change in sterling rates.

For the caller a wide range of Aluminium Tubing, Clamps, etc. at competitive prices, i.e. 12" x 2" Ali Tubing £10.95.

Full range of RSGB and ARRL publications in stock.

Part Exchanges welcome. Second hand lists daily.

Send S.A.E. for details of any equipment.

HP terms. Access/Barclaycard facilities.

Open 6 days a week. 24 Hour Mail Order Service.

Goods normally despatched by return of post.

Phone 0942-676790.

**STEPHENS JAMES LTD.**  
 47 WARRINGTON ROAD,  
 LEIGH, LANCS. WN7 3EA.

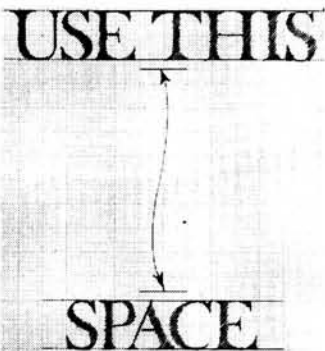

# SMALL ADS

The prepaid rate for classified advertisements is 40 pence per word (minimum 12 words), box number 60p extra. Semi-display setting £13.24 per single column centimetre (minimum 2.5 cm). Please add 15% VAT to total. All cheques, postal orders etc., to be made payable to Practical Wireless. Treasury notes should always be sent registered post. Advertisements, together with remittance should be sent to the Classified Advertisement Dept., Practical Wireless, Enefco House, The Quay, Poole, Dorset BH15 1PP. Telephone (0202) 678558.

*Whilst prices of goods shown in advertisements are correct at the time of closing for press, readers are advised to check with the advertiser both prices and availability of goods before ordering from non-current issues of the magazine.*

## Receivers and Components

**CRYSTALS** Made to order for any purpose and large stocks of standard frequencies for computers, modems, etc. Amateur CW (QRP) freqs £4.00 and CB conversion crystals at £4.50. **PROGRAMMABLE OSCILLATORS (PXO)** for baud rates, MPU, and freq markers £12.50. **FILTERS** Crystal, monolithic, mechanical and ceramic for all standard IF's. Special 10.695MHz for big improvement to most CB rigs at £4.50 each. **S.A.E. FOR LISTS. PRICES INCLUDE VAT AND POST**  
**P. R. GOLLEDGE ELECTRONICS**  
 G3EDW, Merriott, Somerset, TA16 5NS  
 Tel. 0460 73718

**PW MEON IN KIT FORM** inc. box £44 or built £70. Also components, kits etc. Details of 70m send sae to: FJP KHIS, 2 Market Street, Hednesford, Staffs WS12 5AF. Tel. 05435 6487.

**ELECTRONIC COMPONENTS IN HOVE.** SC'S COMPONENTS, 218 Portland Road, 0273 770191 (also Mail Order).

**RADIO CANADA,** Peking, Australia, Voice of America. A Vega 206 (6x SW/MW/LW) pulls these and dozens more. £25.45. Back by public demand. Year's guarantee. Return despatch. **CORRIGAN-RADIOWATCH,** Building 109, Prestwick Airport, KA9 2RT.

**SCANNER MODIFICATIONS.** Specialist reception equipment. Extensive frequency listings. For free catalogue send large SAE to: S.S.C., PO Box 71, Bournemouth, Dorset BH9 1DL.

## Special Offers

**FREE MEMBERSHIP** to a new national electronics club. For details and a free pack of components worth over £10 send only £1 p&p to: **WOODSIDE,** Dowsett Lane, Ramsden Heath, Billerica, Essex CM11 1JL.

## Books and Publications

**VHF/UHF FREQUENCY LIST** 28 to 1300 MHz £3.00 inc p&p. **DAVINA SYSTEMS,** 51 Glynne Street, Farnworth, Bolton, Lancs.

## Service Sheets

### TECHNICAL INFO SERVICES 76 Church St - Larkhall - Lanarks

FULL SIZE SERVICE SHEETS  
 Ctv/Mus-c/Combis £3.50 per set + Isae  
 Any other published £2.50 + Isae

Complete TV Repair Course £9.50  
 Complete Radio Servicer/Repair £9.50  
 Practical Transistor Yearbook £5.80

Repair data/circs most TVs and Video  
 Mono TV or Videos £10.50: CTV £12.50

Almost every SERVICE MANUAL stocked  
 Main supplier NEWNES TECHN BOOKS  
 Sole supplier TV TECHNIC BOOKS  
 S.a.e. for free Review and pricelists

**FOR FAST QUOTES  
 PHONE 0698 884585  
 After 5pm - 0698 883334**

### WORKSHOP SERVICE MANUALS

Thousands stocked. Most Makes, Models, Types, Audio, TV, Video, Test, Amateur etc. LSAE enquiries/quotation and FREE Review/price lists with details of our Unique Repair and Data Guides, from Valves to Video's.

**MAURITRON (PW)**  
 8 CHERRY TREE ROAD, CHINNOR, OXON, OX9 4QY.

### THE DATAMAN 1914-1966

For circuits, service sheets, manuals, handbooks, on all valve and early transistor equipment including audio, military (British & foreign), radio & TV. Quotation by return via phone or letter (S.A.E.), brochure supplied with S.A.E.  
**THE DATAMAN**  
 Tudor House, Cossham Street, Mangotsfield, Bristol BS17 3EN  
 Phone 0272 565472

## Software

**COMMODORE COMPUTERS** (+4, C16, 64, 128). "MICROCOM" cw/tty tx/rx with superb morse tutor. "TURBO LOG" ultimate high speed station log. "MICROCOM INTERFACE" ready built. S.A.E. to: Moray Micro Computing, Enzie Slackhead, Buckie, Moray, AB5 2BR. Tel. 0542 7384.

### AMATEUR RADIO SOFTWARE

**RTTY**  
 Transceiver or receive only for (1) Spectrum (2) VIC20 (3) CBM 64 (4) MSX(1) (5) RX only for ZX81 (16K). Split screen, type ahead etc. Various baud rates. RX only uses full screen (1) & (5). Require filter (2) & (3). Needs starter terminal. (4) Uses tone demodulator.  
 TX/RX £9.00  
 RX ONLY £7.00

**MORSE**  
 Transceiver for the Spectrum. No interference. £9.00  
 Receive only for:- Spectrum, ZX81 (16K), CBM 64, MSX, VIC 20, BBC B, Dragon, Atari (400-600 & XL) & Amstrad (464 & 6128). Sinclair needs no interface.  
 Program £7.00  
 Interface £3.00  
 Tutor for Spectrum or MSX(1). Beginner to test & beyond. Very comprehensive program £5.00  
 S.A.E. for details of all our products.

**J.&P. ELECTRONICS LTD.**  
 New Road Complex, New Road, Kidderminster DY10 1AL  
 Tel: (0562) 753893

## Wanted

**COMPUTER SOFTWARE** information required for Amstrad 6128, Weather APT and Slow Scan. H. MUNRO, Durness, Sutherland, Scotland.

**WEATHER SATELLITE RECEIVER.** Full system required. Would appreciate demo. Timestep or any system considered. Sheffield 467240.

## For Sale

**DX2000 REALISTIC RECEIVER,** headphones and manual. £95.00. Excellent condition. 01-399 9658 evenings.

## ORDER FORM PLEASE WRITE IN BLOCK CAPITALS

Please insert the advertisement below in the next available issue of Practical Wireless for .....  
 insertions. I enclose Cheque/P.O. for £ ..... CAT. heading .....  
 (Cheques and Postal Orders should be made payable to Practical Wireless)

NAME .....

ADDRESS .....

**PRACTICAL WIRELESS**  
 Classified Advertisement Department,  
 Enefco House, The Quay, Poole,  
 Dorset BH15 1PP. Telephone (0202) 678558  
 Rate 40p per word, minimum 12 words.  
 Box No. 60p extra.  
 PLEASE ADD 15% VAT TO TOTAL



## For Sale (Cont.)

**G3LL's SUMMER SALE.** Give away cash/cheque prices. Shure 44D mics £72p.p. C.W. filters. FT 101ZD £22p.p. FT102 £24p.p. FT101E/B £31p.p. Rigs FT726R £799. FT170RH £349. FT703R+FNB3 £189. FT709R+FNB3 £209. FT209RH+FNB4 £259. FT690R £275. FT790R £359. FT1757 Mk 2 & FT1767. Phone. CARRIAGE EXTRA. Pair G.E.6146B +12BY7A £31p.p. **HOLDINGS/AMATEUR ELECTRONICS**, 45 Johnston Street, Blackburn BB2 1EF. (0254) 59595. Closed Thursday. 15 mins Jun. 31 M6. Free parking.

**RACAL RA 17L** 500KHz-30MHz £175 also **Sony ICF 2001** AM150KHz-29.999MHz, FM76MHz-108MHz £150, excellent condition. List of Test Equipment, Quartz Crystal Std. Freqs. available 50p/£1.00 each. Also limited qty. Quartz Y-Bars, 10/20W P-V Solar Panels, Cyclon batteries, Antenna Manpack Masts. Please contact **E&M DESIGN ASSOCIATES LTD.**, 69 Angus Close, Chessington, Surrey KT9 2BN. Tel. 01-391 0545. Fax: 01-391 5258.

**TRIO QR666** general coverage receiver £50. Philips D8334 stereo radio twin cassette, mint condition, £70. Write c/o Box No. 16.

**GRUNDIG** infra-red remote control VIF/K1 consist transmitter 1PV355 and receiver VIF-E1 brand new £5, P&P £2. Video tapes (V2000) brand new VCC360 £6.99, post 45p. **STAN WILLETTS** 37 High Street, West Bromich, West Midlands. 021-553 0186.

**RUSSIAN-SELINA** - AM/FM 8-band radios, batts/mains. New. 0462 33690.

**TRIO TS530SP** as new £595. Plus Eddystone 99 O/R VHF comms RX £120. 0487 831396.

**REALISTIC 2021 SCANNER** perfect condition £150, 4 months old. Phone Shotley 487.

**SCANNING MONITOR RECEIVER SX-200**, cost £300. Grundig Satellit 3400, cost £330. Both as new. Offers. Tel. 051 638 7273.

## Rallies

### WE'RE OFF AGAIN!

To the biggest mobile rally in the South of England Sunday 12th July 1987, from 10 a.m. to 4 p.m. at the Brighton Race Ground. Huge "Bring & Buy" stall, 20,000 sq. ft. under cover exhibition area. Plus attractions for the XYL and children and restaurant facilities. The Rally which caters for the whole family. Talk-in on S22 and 3.5MHz. Admission £1. Children free if accompanied by an adult.

Further Details:  
Ring 0903 200572 evenings

## Educational

**COURSE FOR CITY & GUILDS**, Radio Amateurs Examination. Pass this important examination and obtain your licence, with an RCC Home Study Course. For details of this and other courses (GCE, GCSE, Career and professional examinations, etc.) write or phone: **THE RAPID RESULTS COLLEGE**, Dept. JX22, Tuition House, London, SW19 4DS. Tel. 01-947 7272 (9am-5pm) or use our 24hr Recordcall Service: 01-946 1102 quoting Dept. JX22.

## Miscellaneous

**HAVE YOU GOT** your copy of the Tiger Antenna Magazine yet? June issue out now. Send 50p in stamps to **ANT PRODUCTS**, Foundry Works, Old Great North Road, Ferrybridge, West Yorks. WF11 8NN.

**CASES**, 19" rack and free standing from £12.00. **NEWRAD**, Wick Ind. Est., New Milton, Hants. Tel. 621195.

**HEATHKIT U.K.** Spares and Service Centre. **CEDAR ELECTRONICS**, Unit 12, Station Drive, Bredon, Tewkesbury, Glos. Tel. (0684) 73127.

## Miscellaneous (Cont.)

**WAVEGUIDE, FLANGES & DISHES.** All standard sizes & alloys (new material only) from stock. Special sizes to order. Call: **EARTH STATION** 01-228 7876. 22 Howie Street, London SW11 4AR.

### MORSE CODE PREPARATION

Cassette A: 1-12 wpm for amateur.  
Cassette B: 12-25 wpm for professional examination preparation. Each cassette is type C30.  
Price of each cassette (including booklets) £3.95.  
Morse key with separate battery (PP3) — driven solid-state oscillator and sound transducer produces clear tone for sending practice. Price of key with electronic unit £8.95.  
Price includes postage etc. Europe only.  
**MH ELECTRONICS (Dept PW)**  
12 Longshore Way, Milton, Portsmouth PO4 8LS

**YOUR GEAR IS PRECIOUS**, protect it. The Electroguard is an in-line alarm for radios, videos, computers, microwaves, TV's. Only £25 from **FOX INDUSTRIES**, Dept PW1, Free-post, 54 High St., Stourport, Wores. DY13 8BR.

**GVF** Inventor and proprietor of Patent for **VARIABLE HIGH FREQUENCY FRAME ANTENNA** offers circuit and full assembly details for the modest sum of £5. A Do-It-Yourself project. Components required to be found in most Ham shops. Most expensive components, two variable tuning capacitors. Antenna twenty-one inches square, mounts on top of control box, fully rotatable from operating position, tunable all the way 80 to 10 metres there being only one inductance. SWR One to One 40, 15 and 10 and One Point Five to One 80 and 20. SW on CW from JA, W areas 0 to 8, VE 1 to 5 and all Europe. Ninety awards obtained with frame. Max power 140 watts. **NEW EFFICIENT LW AND M. WAVE FRAME ANTENNA**. 21 inches square. DIY project. Circuit, parts list, assembly data £3. Ideal Caravan and flat dwellers. **DIY LOOP ANTENNA** for BC and SWL's Tuning range 1500 to 10 Metres Parts List Assembly data £8. SAE for details.  
**F. G. Rylands, 39 Parkside Avenue, Millbrook, Southampton SO1 9AF.**  
Tel. (0703) 775064

**QSL CARDS**. Gloss or tinted cards. SAE for samples to: **TWROG PRESS**, Dept PW, Penybont, Gellilydan, Blaenau Ffestiniog.

**TO FILL THIS SPACE**  
**PHONE KATHY ON**  
**0202 678558**

## INDEX TO ADVERTISERS

A.H. Supplies.....	57	Low Electronics.....	2, 3, 49
A.K.D. Ltd.....	10	Maplin Electronic Supplies Cover 4	
Aerial Techniques.....	61	QSL Mailbox.....	31
Allweld Engineering.....	57	R.A.S. Nottingham.....	57
Amcomm of London.....	13, 39	Radio Component Specialists.....	71
Birkett, J.....	69	Radio Shack Ltd.....	72
Billington Valves.....	53	Randam Electronics.....	69
Bredhurst Electronics.....	53	RST Valve.....	10
C.P.L. Electronics.....	12	S.E.M.....	61
Cambridge Kits.....	61	Short Wave Magazine.....	49
Colomor Electronics.....	39	South Midlands Communications Ltd.....	8, 9, 53
Cricklewood Electronics.....	39	Sony.....	Cover 3
Datong Electronics.....	49	Spectrum Communications.....	10
Dewsbury.....	12	Stephens James.....	69
Dorset Dish.....	61	Technical Software.....	49
Dressler.....	11	Ward, Reg & Co.....	Cover 2
Elliott Electronics.....	49	Waters & Stanton.....	21
Garex.....	69	Withers, R. Communications.....	25
Hamgear Electronics.....	69	Winchester Communications.....	39
I.C.S. Intertext.....	69		
ICOM (UK) Ltd.....	4, 5, 6, 7, 69		

**★ BAKER ★**

**GROUP PA DISCO**

**AMPLIFIERS** post £4

150 watt Output, 4 Input Mixer pre-amp. Illustrated	£99
150 watt Output, Slave 500 watt. Input 3 Speaker Outputs	£80
500 watt Heavy duty mono slave amplifier	£275
150 watt P.A. Vocal, 8 inputs. High/Low Mixer Echo Socket	£149
60 watt Mobile 240v. AC and 12v DC. 4-8-16 ohm + 100v line	£89
Compact PA amp 20 + 20 Stereo or 40W Mono	£65
30 watt Guitar/PA Amplifier, 12 inputs, Treble, Bass, etc.	£95
30 Watt Guitar COMBI, 12in. Speaker, Treble, Bass, etc.	£95

**FAMOUS LOUDSPEAKERS** FULLY GUARANTEED

Make	Model	Size	Watts	Ohms	Price	Post
GOODMANS	HIFAX	7 1/2 x 4 1/4in	100	8	£28	£2
GOODMANS	HB WOODER	8in	60	8	£16	£1
BAKER	DISCO/GROUP	10in	50	8/16	£22	£2
BAKER	MID-RANGE	10in	100	8	£30	£2
BAKER	DISCO/GROUP	12in	75	4/8/16	£24	£2
BAKER	DISCO/GROUP	12in	120	8/16	£24	£2
GOODMANS	DISCO/GROUP	12in	120	8/15	£29	£2
WEM	DISCO/GROUP	12in	300	8	£85	£2
H + H	DISCO/GROUP	15in	100	4/8/16	£54	£4
GOODMANS	HP/BASS	15in	250	8	£82	£4
GOODMANS	HPD/BASS	18in	230	8	£82	£4

**LOUDSPEAKERS REPLACEMENT TYPE. STATE IMP REQUIRED.**

2in. 3in. 5in. 6in. 7in. 8in. £2.50. 6 1/2in. 8 x 5in. £4 P&P 75p.  
8in. £5. 10in. £7.50 PP £1. Many others in stock.

**MAINS TRANSFORMERS** All 240V Primary Price Post

250-0-250V 80mA. 6.3V 3A. 0, 5, 6V 2A	£10.00	£2
350-0-350V 250mA. 6.3V 6A CT	£16.00	£2
220V 25mA. 6V 1 Amp £3.00. 220V 45mA. 6V 2 Amp £4.00	£4.00	£1

Auto Wound 120V/240V. 150W £9. 250W £12. 500W £15. Post £2

**LOW VOLTAGE TRANSFORMERS** £5.50 each post

9V. 3A. 12V. 3A. 16V. 2A. 20V. 1A. 30V. 1/2A. 30V. 5A + 17-0-17V. 2A. 35V. 2A. 20-40-60V. 1A. 12-0-12V. 2A. 20-0-20V. 1A.

**VARIABLE POWER SUPPLY** 0 to 12 volts up to 400 M.A. D.C. Ready made on P.C. board. Size 5 x 2 1/2 x 2in. £8.50 P.P. £1.

**PANEL METERS** 50µA, 100µA, 500µA, 1mA, 5mA, 100mA, 500mA, 1 amp, 2 amp, 5 amp, 25 volt, VU 2 1/4 x 2 1/4in. £5.50 post 50p

**MINI MULTI TESTER** Volts AC/DC, ohms, millamps £8.50

**DELUXE RANGE DOUBLER METER 50K O.P.V.** £25.00 PP £1

Ohms to 20meg. AC/DC volts to 1000V. Amps 50µA to 10A.

**PROJECT CASES**. Black Vinyl Covered Steel Top, All Base

4 x 2 1/2 x 2 1/4in. £3.00. 6 x 4 x 1 1/2in. £4.00. 8 x 5 x 2in. £4.50.  
11 x 6 x 3in. £8.00. 11 3/4 x 6 x 5in. £10.00. 15 x 8 x 4in. £13.50.  
**ALUMINIUM PANELS** 18 s.w.g. 12 x 12in. £2.50. 14 x 9in. £2.40.  
6 x 4in. 65p. 12 x 8in. £1.50. 10 x 7in. £1.50. 8 x 6in. £1.00.  
14 x 3in. £1.12 x 5in. £1.15. 16 x 10in. £2.70. 16 x 6in. £1.80.

**ALUMINIUM BOXES**. PLEASE ADD EXTRA POSTAGE.

4 x 2 1/2 x 2in. £1.35. 3 x 2 x 1 1/2in. £1.15. 6 x 4 x 2in. £2.20. 8 x 6 x 3  
£3.40. 12 x 5 x 3in. £4.00. 6 x 4 x 3in. £2.50. 10 x 7 x 3in. £4.00.

**HIGH & LOW VOLTAGE ELECTROLYTICS** Many others in stock.

20/500V	75p	470MF 400V	£3	20 + 20/350V	75p
32/350V	50p	680MF 350V	£3	32 + 32/500V	£2
47/350V	75p	2200MF 400V	£5	32 + 32/350V	85p
220/400V	£1	8 + 8MF 450V	£1	80 + 40 + 20/350V	95p

470MF 63V 40p. 1000MF 40V 50p. 100V £1.20. 1200MF 76V £1.  
1500MF 63V 80p. 100V £1.20. 2000MF 63V £1.50. 100V £1.80.  
2500MF 50V 70p. 3300MF 63V £2. 4700MF 63V £3.  
6800MF 100V £5.50. 30,000MF 25V £2.50.

**AIR-SPACED GEARED TWIN GANGS** 365 + 365 + 25 + 25p/£2.00.  
VERNER DIALS. 0-100. 36mm. £3.00. 50mm. £3.50.  
**MORSE CODE TAPPER & BUZZER** £1.00.  
**RESISTORS, CAPS, DIODES, TRANSISTORS** 1000s IN STOCK

**RADIO COMPONENT SPECIALISTS**

337 WHITEHORSE ROAD, CROYDON  
SURREY, U.K. Tel: 01-684 1665

ACCESS VISA

Post 65p Minimum. Callers Welcome.

List, Large S.A.E. Delivery 7 days Closed Wednesday

# YOUR LOCAL DEALERS

**STOKE ON TRENT**  
**MRZ COMMUNICATIONS LTD**  
 ICOM - Amateur/PMR/Marine/Air.  
 YAESU - Amateur MRZ Desk PSU  
 for ICOM/YAESU Portables.  
 UK and EXPORT  
 Tel: (0782) 619658

**IRELAND**  
**Radcom Electronics**  
 Approved dealer for Icom,  
 Yaesu and most accessories  
 25 Riversfield  
 Midleton, Co. Cork,  
 Ireland  
 Tel: 021 632725/632804

**WORCESTERSHIRE**  
**A. Kelly Electronics and Communications Equipment**  
 RSGB Publications, Mutek, DRAE,  
 Microwave Modules, Starmaster Keys,  
 TAL Aerials, ALINCO. We buy and sell  
 second hand equipment.  
 3 Stoke Road, Aston Fields,  
 Bromsgrove, Worcs. B60 3EQ.  
 Tel: 0527 71165  
 (Open 6 days a week, evenings by Appointment)

**ESSEX**  
**Selectronic**  
 The UK's leading suppliers of  
 934MHz personal radio  
 equipment  
 203 High Street, Canvey  
 Island, Essex  
 Tel: 0268 691481  
 (Open Mon-Sat 9-5.30)  
 Amateur radio equipment also in stock

**HERNE BAY**  
**ICOM (UK) LIMITED**  
 The Official Icom importer  
 2 Stanley Road  
 Herne Bay, Kent  
 CT6 5SH  
 Tel: 0227 369464  
 (Open Mon-Sat 9-5.30,  
 except Thurs 9-1)

**SOUTHAMPTON**  
**South Midlands Communications**  
 Official Yaesu Importer  
 S.M. House, School Close,  
 Chandlers Ford Industrial Estate,  
 Eastleigh Hants SO5 3BY.  
 Tel: 0703 255111

**PORTSMOUTH**  
**Telecomms**  
 Importers of the Nevada  
 range of 934MHz equipment  
 189, London Road,  
 North End, Portsmouth,  
 Hants, PO2 9AE  
 Tel: 0705 662145

**DEVON**  
**Reg. Ward & Co. Ltd.**  
 The South-West's largest amateur  
 radio stockist. Approved dealer for  
 Trio, Yaesu and Icom  
 1 Western Parade,  
 West Street, Axminster,  
 Devon, EX13 5NY  
 Tel: 0297 34918  
 (Closed 1.00-2.00 and all day Monday)

**BUCKINGHAMSHIRE**  
**Photo-Acoustics Ltd.**  
 Approved Trio, Yaesu and  
 Icom dealer (part exchange  
 always welcome)  
 58 High Street, Newport Pagnell,  
 Buckinghamshire MK16 8AQ  
 Tel: 0908 610625  
 (Mon-Fri 9.30-5.30, Sat 9.30-4.30)

**TYNE & WEAR**  
**ESR Electronic Components**  
 Official North East dealer for  
**VELLEMAN KIT**  
 Station Road, Cullercoats  
 North Shields,  
 Tyne & Wear NE30 4PQ  
 Tel: 091 251 4363  
 (Mon-Sat 9.30-5.30 Closed Thurs)

**LONDON**  
**AMCOMM OF LONDON**  
 Approved dealer for Yaesu  
 and Icom  
 373 Uxbridge Road,  
 London W3 9RN  
 Tel: 01-992 5765  
 (Mail order a speciality)

**DERBYSHIRE**  
**Low Electronics**  
 The official importer of the  
 TRIO range of equipment (See  
 main ad. for the full list of all  
 our shops)  
 Chesterfield Road, Matlock,  
 Derbyshire, DE4 5LE  
 Tel: 0629 2817/2430/4057

**LONDON**  
**Henry's**  
 27MHz/934MHz Rigs &  
 accessories in stock.  
 Lists - S.A.E. (A4) - 26p  
 Full catalogue (TG/P) -  
 large S.A.E. £1.00  
 404 Edgware Road,  
 London W2 1ED  
 Tel: 01-724 0323  
 (Open 6 days a week)

**MERSEYSIDE**  
**MGR SERVICES**  
 Wirral based communications  
**ICOM - YAESU - M.MODULES -  
 HOWES - CIRKIT - WOOD &  
 DOUGLAS - PART-EX - AERIALS -  
 PMR - MARINE**  
 48, Shrewsbury Road,  
 Oxtou, Birkenhead, L43 2JZ.  
 Tel: 051 653 3437  
 (Callers by appointment 9 am-9 pm, Mon-Sat)

**LONDON**  
**D & D ELECTRONICS  
 (Kennington)**  
*The sort of shop you used to see in  
 Lisle St. All sorts of surplus supplies,  
 so come along and browse or send  
 SAE for info. sheets.*  
 3a Braganza Street  
 London SE17 3RD  
 Tel: 01-793 0054  
 (Open 6 days a week)

**PLEASE MENTION  
 PRACTICAL WIRELESS  
 WHEN REPLYING TO  
 ADVERTISEMENTS**

## RADIO SHACK SAVES YOU MONEY ON SCANNERS!

**THE FINEST EVER SCANNER AT AN UNBEATABLE PRICE  
 25-520, 760-1300 MHz, 300 MEMORIES ALL FOR £349.95**



**£349.95  
 (P&P £3.45)**

Continuous tuning from 25 to 520 MHz and 760 to 1300 MHz 300 permanent memories in ten banks of 30 plus an additional ten channels used for temporary storage when in search mode. Switchable audio squelch allows you to ignore blank carriers. Three reception modes, AM, FM, (Wide) and FM (Narrow). Adjustable step size, 5kHz, 12.5 kHz and 50 kHz. Sensitivity (NFM) 0.5uV for 20dB S/N up to 1100 MHz Extremely attractive, information packed blue LCD display Headphone jack socket, tape recorder socket, external speaker socket, attenuator switch, 240 Volt operation and 13.8 VDC with optional mobile power lead.

Also still available  
**BC-200FB 16 CHANNEL SCANNER**



**£199.95 NOW SAVE £40  
 £159.95 (CP&P £3.45)**



**RADIO SHACK LTD**

**188 BROADHURST GARDENS,  
 LONDON NW6 3AY**



(Just around the corner from West Hampstead Station on the Jubilee Line)

Giro Account No. 588 7151 Telephone: 01-624 7174



Hello, what's this then? The new Sony Shortwave radio.

Not exactly imposing, is it?

What happened to all the knobs and dials...serried ranks of

valves, throbbing into the night...dirty great drums of copper wire humming away like there's no tomorrow - it hasn't even got a cats whisker!

Oh, well...better

have a look at the old

instruction book. 'The

Sony Computerised

World Band Receiver.'

There's never a

computer in there!

What

else has

it got...dual display panel, yes, yes, get on with it...oh, a 15 station memory. Wonder if it remembers where I left me mother-of-pearl cuff-links?

Now then. 'First switch on.' Oh, very droll I'm sure...

time for a fag while it warms up...hello, it's going already...

How peculiar. Right, a quick whizz round the dial for a basin full of the old hum and whistle, just to set the mood.

"Good Evening, this is Radio New Zealand."

Get off the line you great Antipodean fool!

I haven't had a good crackle yet.

"Sayonara, and welcome to Japan Today."

Oh, this is hopeless. I ask you. Where's the romance, the adventure? Switch on, tune in and bang, you've got

the Kenyan Top 40, clear as a bell.

Where's the fun

there?

You can keep

your phased loop lock,

your crystal clear

reception and easy

tuning.

No, no,

no, sorry Sony. Give me a room full of watts, a coat-hanger aerial and a set hot enough to cook your breakfast on. I don't know...oh dear, oh dear...

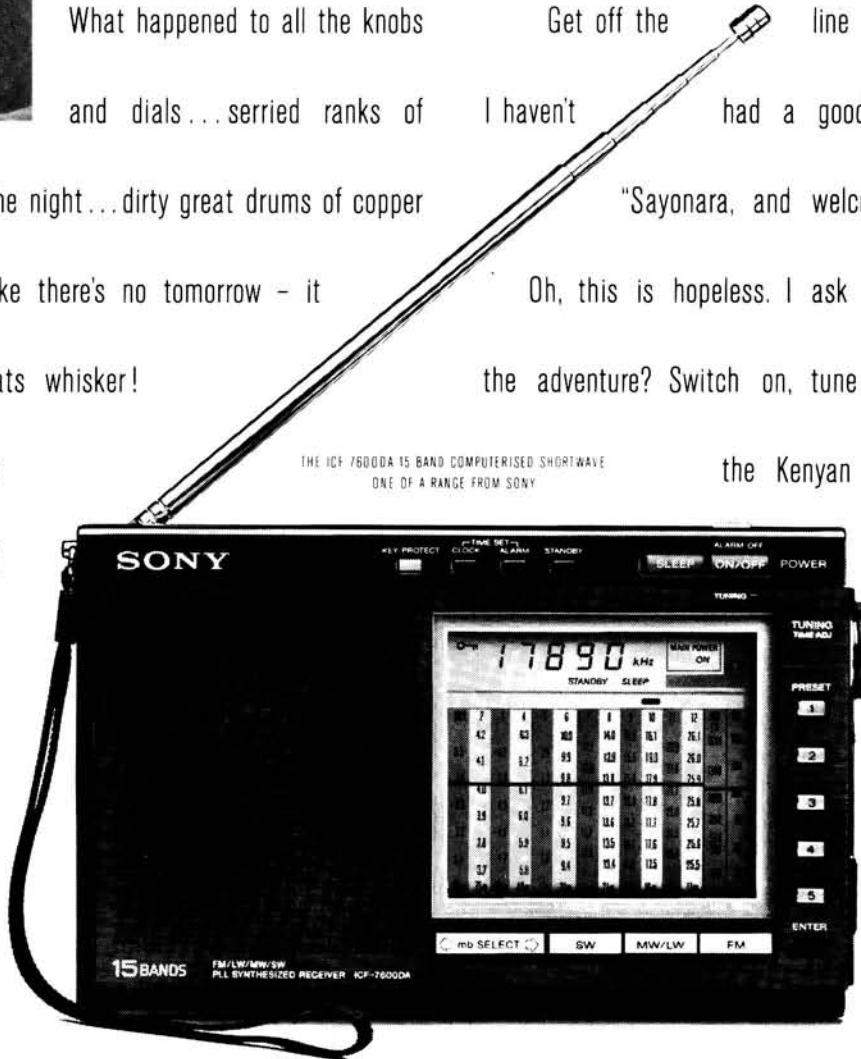

THE ICF 7600DA 15 BAND COMPUTERISED SHORTWAVE ONE OF A RANGE FROM SONY

**THE NEW SONY SHORTWAVE. NOW ANY RADIO HAM CAN MASTER IT.**

# SONY

# APACHE



**COMPLETE\*  
SYSTEM ONLY  
£49.95!  
(VP25C)**

## The Apache

A superb ready-built scale-model off-road racer complete with a 2-CHANNEL DIGITAL PROPORTIONAL RADIO CONTROL SYSTEM - for the price of the RC system alone!  
All this is included in the price:  
Ready-built 1/4 scale model car (overall size 325 x 186 x 130mm, 12.8 x 7.3 x 5.1in.).  
Front and rear low-profile semi-pneumatic rubber tyres.  
Front wheel independent suspension.  
High or low gear selection.  
Sealed box with differential gearing.  
Powerful motor gives scale speeds up to 140 mph.

Front and rear coil-spring shock absorbers.  
2-channel digital proportional radio control transmitter (and receiver).  
(Standard 27MHz AM - no licence required in UK).  
Servo-controlled proportional steering.  
Proportional motor speed control in forward and reverse.  
\*Batteries and ni-cad charger not included. Car requires 8 AA cells (ni-cad recommended YG00A £1.35 each).  
Transmitter requires 6 AA cells, (alkaline FK64U 55p each or ni-cad as above). NB - and if you have a collision at 100mph or more, you'll be pleased to hear that spare parts are available.



Please rush me my Apache model racer, with 2 channel digital proportional radio control system. I wish to receive:

	Code	Qty	Price
Apache model racer	VP25C		
AA ni-cad battery	YG00A		
AA alkaline battery	FK64U		
	<b>Total</b>		

*All prices include V.A.T. Please add 50p towards postage. If order below £5.00, please add 50p handling.*  
I enclose cheque postal order made payable to Maplin Electronic Supplies Ltd., or see credit card details.  
Here are my personal details:

Customer Number .....  
Name .....  
Address .....  
Post Code .....  
I authorise you to debit my Credit Card account for the cost of goods despatched.  
Credit Card Number .....  
Access/American Express/Macpaid/Visa .....  
*Delete as required*

**Note:** Goods will be despatched only if the address given is the cardholder's address if ordering by Credit Card please sign:

Signature: ..... Expiry Date: ..... PW/8/87

**Maplin** Maplin Electronic Supplies Ltd.  
P.O. Box 3, Rayleigh, Essex, SS6 8LR. Telephone, Credit Card Sales (0702) 554161. Enquiries (0702) 552911  
Shops at: Sutton New Road, Erdington, Birmingham. Tel: 021-394 8411, 159-161 King Street, HammerSmith, London W6. Tel: 01-748 0926  
8 Oxford Rd., Manchester. Tel: 061-236 0281, 46-48 Bevois Valley Rd., Southampton. Tel: 0703 25831.  
282-284 London Rd., Westcliff-on-sea, Essex. Tel: 0702-554000.