

PRACTICAL WIRELESS

DECEMBER 1972
20p

FREE COMPETITION ▶ 10 HEATHKIT 'SCOPES MUST BE WON!



amateur bands RECEIVER



The **'MUSIC MAKER'**

R.S.C. STEREO PACKAGE OFFERS



R.S.C. A55 LOUDSPEAKERS GARRARD 2025

LINEAR 505 AMP
LINEAR 505 5 + 5 Watt Amplifier
GARRARD 2025 Autochanger - K840A Cartridge
Teak Veneer Plinth with Transparent Plastic Cover
Pair A55 LOUDSPEAKERS (Ine 8" x 5" 10,000 Gauss)

PACKAGE PRICE FOR ILLUSTRATED UNITS

ONLY **£39.95** Carr. £1.00
Or deposit £8.85 and 9 monthly payments £4.22 (Total £44.93)
Individual Rec. Retail Prices:

£17.50
£13.58
£ 6.10
£11.00

SEND S.A.E. FOR FREE COLOUR BROCHURE

TOTAL **£48.18**

SAVE £31.60 ON HIGH FIDELITY UNITS

PACKAGE PRICE FOR ILLUSTRATED UNITS

ONLY **£99.95** Carr. £1.75
Or deposit £15.00 and 12 monthly payments £8.00 (Total £111.00)

Individual Rec. Retail Prices:
GOLDRING GL72 Transcription Turntable - P.U. £31.99
GOLDRING G800 Magnetic Cartridge £12.21
DE-LUXE PLINTH with 'Roll-over' Cover £10.50
PAIR R.S.C. MONARCH LOUDSPEAKERS £38.70
R.S.C. SUPER 30 Mk III AMPLIFIER £37.75



'SUPER 30' AMP

TOTAL **£131.55**

'YORK' HIGH-FIDELITY 3 SPEAKER SYSTEM

* Moderate size only 25 x 14 x 10in. approx.
* Response 30-20,000 c.p.s.
* Impedance 15 ohms
* Performance comparable with units costing considerably more.
Consists of (1) 12in. 15 watt Bass unit with cast chassis, Roll rubber cone surround for ultra low resonance, and ceramic magnet. (2) 3-way quarter section series cross-over system (3) 8 x 5in. high flux middle range speaker. (4) High efficiency tweeter. (5) Appropriate quantity acoustic damping material. (6) Handsome Teak veneer cabinet. (7) Circuit and full instructions. Terms: Dep. £3.60 and 9 monthly payments £2.47 (Total £26.83).

COMPLETE KIT £23 Carr. 65p

DEMONSTRATIONS AT ALL BRANCHES

HIGH FIDELITY LOUDSPEAKER UNITS

Cabinets latest style Satin Teak veneer. Acoustically lined or filled acoustic damping. Ported where appropriate. Credit terms available.
DORCHESTER (Illustrated) Size 16 x 11 x 9in. approx. Range 45-15,000 c.p.s. Rating 8-10 watts. Fitted High flux 13 x 8in. **£9.45** Carr. 40p.
Dual Cone speaker. Imp. 3 or 15 ohms.
MONARCH Size 19 x 10 x 9in. approx. Rating 10 watts. Ine. 13 x 8in. speaker with highly flexible P.V.C. cone surround, long throw voice coil and 10,000 line magnet. High flux pressure tweeter. Handsome Scandinavian design cabinet. Range 35-20,000 c.p.s. Imp. 8 ohms. Gives smooth realistic sound output. See 'package offers' for illustration. Carr. 50p **£19.35**

RSC G66 Mk II 6+6 WATT high quality STEREO AMPLIFIER

Individual Ganged Controls: Bass, Treble, Volume and Balance. Printed circuit construction employing 10 Transistors plus Diodes. Output rating I.H.F.M. Frequency range 20-20,000 c.p.s. Bass Control ± 12db. Treble Control ± 13db. Selector switch for P.U. or Tape/Radio. For loudspeaker output impedances of 3 to 15 ohms. For standard 200-250v. A.C. mains operation. Attractive Black and Silver finished metal fascia plate and matching control knobs. **COMPLETE KIT OF PARTS INCLUDING FULLY WIRED PRINTED CIRCUIT** and comprehensive wiring diagram and instructions **£11.50** Carr. 40p

Or **FACTORY BUILT IN TEAK VENEERED CABINET** as illustrated **£14.99** or dep. £2.20 and 9 monthly payments £1.70 (Total £17.50).

AUDIOTRINE HI-FI SPEAKER SYSTEMS

Consisting of matched 12in. 11,000 line 15 Watt 15 ohm high quality speaker, cross-over unit and tweeter. Smooth response and extended frequency range **£5.95** Carr. 30p
OR **SENIOR 15 WATT INCLUDING HF126 15,000 LINE SPEAKER** **£6.95** Carr. 35p

AUDIOTRINE HIGH FIDELITY SPEAKERS

Heavy construction. Latest high efficiency ceramic magnets. Plasticised Cone surround. "D" indicates Tweeter Cone providing extended frequency range up to 15,000 c.p.s. Impedance 3 or 8-15 ohms. **PLEASE STATE CHOICE**
Exceptional performance at low cost.

HF808T 8" 10W £2.85 HF120D 12" 15W £4.99
HF102D 10" 10W £3.40 HF126 12" 15W £5.75
HF120 12" 15W £4.50 HF126D 12" 15W £6.25

FANE 807T HIGH FIDELITY SPEAKER

A full range 8in. 10 watt unit for excellent sound quality, in suitable enclosure. Cast chassis Holi P.V.C. cone surround and long throw voice coil to achieve very low fundamental resonance of 30 c.p.s. Tweeter cone is fitted to extend high note response. Frequency range 25 Hz to 15 KHz. Gauss 10,000. Impedance 3 or 8-15 Ω. **£3.85**
PLEASE STATE IMPEDANCE WHEN ORDERING

R.S.C. TA12 MKIII 6.5 + 6.5 WATT STEREO AMPLIFIER

FULLY TRANSISTORISED, SOLID STATE CONSTRUCTION HIGH FIDELITY OUTPUT OF 6.5 WATTS PER CHANNEL
Designed for optimum performance with any crystal or ceramic Gram. P.U. cartridge. Radio tuner, Tape recorder etc. * 3 separate switched input sockets on each channel * Separate Bass and Treble controls * Slide Switch for mono use * Speaker Output 3-15 ohms * For 200-250v. A.C. mains * Frequency Response 20-20,000 c.p.s. * 20dB * Harmonic Distortion 0.2% at 1,000 c.p.s. Hum and Noise - 70dB * Sensitivities (1) 50mV (2) 400mV (3) 100mV. Output rating I.H.F.M. * Handsome finish Facia plate & Knobs. **COMPLETE KIT OF PARTS WITH FULL WIRING DIAGRAMS & INSTRUCTIONS £15.50** Carr. 40p. Factory built with wiring diagrams & instructions **£19.50** Dep. £3 and 9 monthly pymts £2.15 (Total £22.95). Or in Teak veneer housing Dep. £3 and 9 mthly payments £2.55 (Total £25.95). Send S.A.E. for leaflet. **£23**

HI-FI SPEAKER ENCLOSURES MODERN DESIGN

Teak veneer finish. Acoustically lined. Sizes approx. Carr. 30p. per enc.
J8 Size 16 x 11 x 9in. **SE8** For optimum performance with any 8in. Hi-Fi spkr. Size 22 x 15 x 9in. **£6.47**
8in. Hi-Fi speaker. **£5.35**
SE10 For excellent results with 10in. Hi-Fi spkr. Size 24 x 15 x 10in. P.t'd. **£6.74**
SE12 For excellent performance with 12in. Hi-Fi speaker and tweeter. Size 25 x 16 x 10 1/2in. **£7.87**

R.S.C. BATTERY/MAINS CONVERSION UNITS

TYPE BML. An all-dry battery eliminator. Size 5 1/4 x 4 1/2 in. approx. Completely replaces batteries supplying 1.5v and 90v, to battery radio where A.C. mains 200/250v. 50c/s is available. **COMPLETE KIT WITH DIAGRAM ASSEMBLED READY £3.75**

R.S.C. TA6 6 Watt HI-FI AMPLIFIER

200-250v. AC mains operated. Frequency Response 30-20,000 c.p.s. -24dB. Harmonic Distortion 0.3% at 1,000 c.p.s. Separate Bass and Treble 'lift and cut' controls. 3 input sockets for Mike, Gram, Radio or Tape. Input selector switch. Output for 3-15 ohms spkrs. Max. sensitivity 5mV. Output rating I.H.F.M. Fully enclosed enamelled case. 9 1/2 x 2 1/2 x 5 1/2 in. Attractive brushed silver finish facia plate 10 1/2 x 3 1/2 in. and matching knobs. Complete kit of parts with full wiring diagrams and instructions. **OR FACTORY BUILT WITH 12 MONTHS GUARANTEE £10.95** Carr. 40p. **£7.75**

R.S.C. TRANSFORMERS, L.F. CHOKES & RECTIFIERS

MIDGET CLAMPED TYPE 2 1/2 x 2 1/2 in.
250v., 60mA, 6-3v. 2a **89p**
250-0-250v., 60mA 6-3v. 2a **£1.05**

FULLY SHROUDED UPRIGHT MOUNTING
250-0-250v. 60mA, 6-3v. 2a., 0-5-6-3v. 2a. **£1.40**
250-0-250v. 100mA, 6-3v. 4a., 0-5-6-3v. 3a. **£2.20**
300-0-300v. 100mA, 6-3v. 4a., 0-5-6-3v. 3a. **£2.20**
300-0-300v. 130mA, 6-3v. 4a. c.t., 6-3v. 1a. **£2.20**
For Mullard 510 Amplifier **£2.85**
350-0-350v. 100mA, 6-3v. 4a., 0-5-6-3v. 3a. **£2.20**
350-0-350v. 150mA, 6-3v. 4a., 0-5-6-3v. 3a. **£2.85**
425-0-425v. 200mA, 6-3v. 4a., c.t., 5v. 3a. **£4.95**
425-0-425v. 200mA, 6-3v. 4a., c.t., 6v. 3a., 5v. **£5.10**
450-0-450v. 250mA, 6-3v. 4a., c.t., 5v. 3a. **£5.10**

TOP SHROUDED DROP-THERO TYPE
250-0-250v. 70mA, 6-3v. 2a., 0-5-6-3v. 2a. **£1.35**
250-0-250v. 100mA, 6-3v. 3-5a. **£1.55**
250-0-250v. 100mA, 6-3v. 2a., 6-3v. 1a. **£1.60**
350-0-350v. 80mA, 6-3v. 2a., 0-5-6-3v. 2a. **£1.65**
250-0-250v. 100mA, 6-3v. 4a., 0-5-6-3v. 3a. **£2.20**
300-0-300v. 100mA, 6-3v. 4a., 0-5-6-3v. 3a. **£2.20**
300-0-300v. 130mA, 6-3v. 4a., c.t. 6-3v. 1a. **£2.80**
350-0-350v. 100mA, 6-3v. 4a., 0-5-6-3v. 3a. **£2.20**
350-0-350v. 150mA, 6-3v. 4a., 0-5-6-3v. 3a. **£2.80**

FILAMENT or TRANSISTOR POWER PACK
Types 6-3v. 1.5a. 49p; 6-3v. 2a. 54p; 6-3v. 3a. 76p;
6-3v. 6a. £1.30; 12v. 1a. 55p; 12v. 3a. 24v. **1.5a £1.35; 0-9-18v 1 1/2a £1.10; 0-12-25-42 2a 2 1/2 £1.80**

FULLY GUARANTEED. Impregnated and Interleaved where necessary. Primaries 200-250v. 50c/s. Screened

CHARGER TRANSFORMERS 0-9-15v. 1 1/2a. 99p;
2 1/2a. £1.10; 3a. £1.25; 6a. £1.45; 6a. £1.65; 8a. £2.00
AUTO (Step UP/Step DOWN) TRANSFORMERS
0-110/120v. 200-250-250v. 50-50 watts £1.10,
150 watts, £1.90 250 watts £2.75; 500 watts £5.75

OUTPUT TRANSFORMERS
Standard Pentode 5,000 Ω or 7,000 Ω to 3 Ω 50p
Push-Pull 8 watts EL84 to 3 Ω or 15 Ω... 83p
Push-Pull 10 watts 6V6, ECL86 to 3, 5, 8 or 15 Ω... £1.37
Push-Pull EL84 to 3 or 15 Ω 10-12 watt... £1.35
Push-Pull Ultra Linear for Mullard 510, etc. £2.20
Push-Pull 15-18 watts, sectionally wound G6L6, KT66, etc., for 3 or 15 Ω... £1.99
Push-Pull 20 watt high quality sectionally wound EL34, 6L6, KT66 etc. to 3 or 15 Ω £3.30

SELENIUM RECTIFIERS
F.W. (Bridged)
All 6/12v. D.C. output. Max. A.C. input 15v. 1a, 25p, 2a, 35p, 3a, 50p, 4a, 65p, 6a, 80p.

SMOOTHING CHOKES
150mA, 7-10H, 250 Ω 70p; 100mA, 10H, 200 Ω 80p; 80mA, 10H, 350 Ω 50p; 60mA, 10H, 400 Ω 25p.

R.S.C. Mk III SUPER 30 HIGH FIDELITY STEREO AMPLIFIER

A completely new design further improved in both appearance and performance. Representing value far higher than the prices suggest.

Only high grade components by leading manufacturers. **£25** Carr. 65p
COMPLETE KIT OF PARTS
Or **FACTORY BUILT** with 12 months guarantee. Dep. £5.75 and 9 monthly payments £3.50 (Total £27.25)
Or **FACTORY BUILT** in cabinet as illustrated. Dep. £7 and 9 monthly payments £3.99 (Total £42.91)



Printed Circuitry
Twenty Silicon Transistors, Four Diodes, Four Rectifiers

TECHNICAL DETAILS (Applying to each channel where appropriate)
CONTROLS: PUSH-BUTTON SELECTOR (1) Disc (2) Radio (3) Tape (4) Mono R (5) Mono L (6) SPEAKER DIS. (7) Mains on/off. Bass, Treble and Balance. Set Ceramic Map P.U. Switch.

* **SATIN SILVER METAL FACIA** with black lettering. Black edged knobs with bright silver centres.
* **PUSH-BUTTON SELECTOR SWITCHING**
* **NEON INDICATOR**
* **JACK SOCKET FOR HEADPHONES**
* **CABINETED MODEL VENEERED IN SATIN TEAK.** SUITABLE FOR ANY MODERN PICK-UP CARTRIDGE CERAMIC or MAGNETIC. REGARDLESS OF PRICE. WE RECOMMEND USE WITH THE BEST ANCILLARY EQUIPMENT THAT CAN BE AFFORDED.
OUTPUT: 15 watts R.M.S. (Continuous) into 8 ohms. 10 watts R.M.S. (Continuous) into 15 ohms. **HUM & NOISE** -75dB Min. Vol. -65dB Full Vol. **HARMONIC DISTORTION** 0.1% at 1000 Hz 10 Watts
FREQ. RESPONSE: -3dB 7Hz to 70kHz **BASS CONTROL:** +17dB to -16dB at 40Hz
TREBLE CONTROL: +16dB to -12dB at 14kHz **CROSS TALK** -58dB
SENSITIVITIES: Disc 5mV. Radio 35mV. Radio 120mV. Tape 120mV.
REC. R. PANEL SOCKETS FOR 3 PAIRS OF INPUTS (1) P.U. (2) Radio. (3) Tape Amp. Plus pair for tape recorder signal take off and 2 pairs for speaker connections. Visually matches Super 30 MkIII Only **£44.95**

RSC GROUP/DISCO UNITS

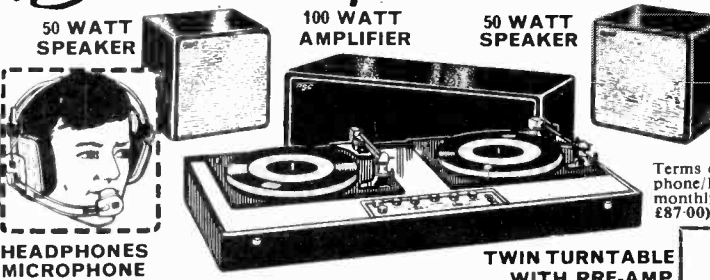

HEADPHONES MICROPHONE

PACKAGE OFFER

- Units listed below
 (a) 100W POWER AMPLIFIER
 (b) PAIR OF HI-FI HEADPHONES
 (c) MATCHING DYNAMIC 'MIKE' (attached to headphones)
 (d) PAIR 50 WATT SPEAKERS Black Rexine covered Cabinets

£72-85

Size approx. 18" x 18" x 8"

(a)(b)(c)&(d) Carr. £1-25

Terms on Amps, Speakers and Headphone/Mike. Deposit £15 and 18 monthly payments of £4-00 (Total £87-00).

RSC TDI DISCO CONSOLE

Incorporating twin Garrard SP25 Mk.III turntables and Sonotone or Acos Cartridges with diamond styli. Separate Vol. controls for each turntable. Also MONITORING FACILITIES, plus Treble and Bass Controls. Separate input for 'Mike' with vol. control switch. Black Rexine covered Cabinet with lid. See illus. on left

£67-10

Carr. £1-25
 Or Dep. £13-25 and 9 mthly pymts £6-88 (Total £76-17) or Dep. £15 and 18 mthly payments £3-62 (Total £80-16).

TWIN TURNTABLE WITH PRE-AMP.

R.S.C. COLUMN SPEAKERS

All types 15 Ohms covered in Rexine and Vynair
 TYPE C4100 IS ALSO SUITABLE FOR BASS GUITAR OR ELECTRONIC ORGAN

TYPE C312 30-40 WATTS Fitted two exceptionally efficient, low feedback howl char- acerically high flux 13" x 8" 20 watt speakers. Terms: Dep. £8 and 9 m'thly payments £2-22 (Total £22-98) Carr. 50p.
TYPE C4125 50 WATTS Fitted four 12" 11,000 line 15 watt speakers: Overall size approx. 56 x 14 x 9 1/2 in. Terms: Dep. £4 and 9 monthly pay- ments £3-37 (Total £34-33) Carr. 75p. **£31**

TYPE C4100 100 WATTS inc. four 12" 50 watt speakers for conserva- tive rating. Extra heavy construction. Size approx. 58 x 16 x 10" Acoustically filled and pressurised. Terms: Dep. £11 and 12 mthly. pyts. £5-18 (Total £78-16). **£65** Carr. £1

IDEAL FOR VOCALISTS AND PUBLIC ADDRESS

FANE ULTRA HIGH POWER LOUDSPEAKERS



All power ratings are R.M.S. continuous. 2 YEARS' GUARANTEE High flux ceramic magnets. ALL CARRIAGE FREE.

'POP' 100	'POP' 60	'POP' 50
18" 100 Watt 14,000 gauss 8/15Ω	15" 60 Watt 14,000 gauss 8/15Ω	12" 50 Watt 13,000 gauss 15Ω
£22-95	£12-90	£10-90
Dep. £6 and 9 mthly payments £2-20 (Total £25-80)	Dep. £3-30 and 9 mthly payments. £1-30 (Total £15).	Dep. £2 and 9 monthly payments £1-20 (Total £12-80). PAIR SUITABLE ALL PURPOSES

FOR BASS GUITAR, ELECT. ORGAN, ETC.

FANE SPEAKERS 'POP' 25/2 12 in. 25 WATT

Dual Cone 15 Ω (for uses other than Bass Guitar or Electronic Organ). Carr. free **£6-75** or Dep. £1-25 and 9 mthly payments 75p (Total £8-00).

GROUP/DISCO EQUIPMENT PACKAGE OFFERS

F.A.L. PHASE 50 MK.III AMPLIFIER	PR. FANE POP 25/2 25W L/SPEAKERS	TERMS: Deposit £6.50 and 9 monthly payments of £4.92 (Total £50.78)	PACKAGE PRICE
£34-95	£13-50		£45 carr. £1
F.A.L. PHASE 50 MK.III AMPLIFIER	PR. FANE POP 50 L/SPEAKERS	TERMS: Deposit £10 and 9 monthly payments of £5-87 (Total £58.33)	PACKAGE PRICE
£34-95	£21-80		£52 carr. £1
F.A.L. PHASE 50 MK.III AMPLIFIER	PAIR L12/25 25W L/S in cabinets	TERMS: Deposit £10 and 9 monthly payments of £5-88 (Total £62-92)	PACKAGE PRICE
£34-95	£23-80		£56 carr. £1-25
LINEAR T40/60D AMPLIFIER	PAIR L12/25 L/S in cabinets	TERMS: Deposit £9-95 and 9 monthly payments of £7-87 (Total £78-98)	PACKAGE PRICE
£49-50	£23-80		£69-95 carr. £1-50
F.A.L. PHASE 100 AMPLIFIER	4 FANE POP 50 L/SPEAKERS	TERMS: Deposit £15-95 and 9 monthly payments of £10-78 (Total £112-52)	PACKAGE PRICE
£81-95	£43-80		£99-95 carr. £2

LINEAR T40/60D 50W GROUP/DISCO AMPLIFIER

- ★ FULL MONITORING FACILITIES
 - ★ Individual Bass and Treble controls
 - ★ Twin Jack output sockets for speakers
 - ★ Input sockets for medium or high impedance Microphones or Guitar P.U.s and Crystal or Ceramic Gram. P.U.s
 - ★ Frequency response 30-20,000 Hz.
 - ★ Output overload protection plus doubling fuse
- FRONT PANEL (Jack inputs)
 Gram, Microphone/Guitar P.U.: plus monitoring socket.
- CONTROLS Vol. (1) (2) (3) and (4), Bass, Treble, Master Vol., Monitor Selection Switch Gram (1) or (2), Mains Switch

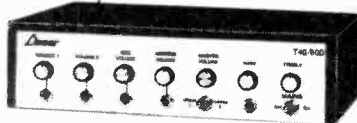

£49-50 Carr. free
 Or Deposit £7-50 and 9 monthly payments £5-87 (Total £55-35)
 Simulated black rexine, plastic bonded metal case. Also stocked Linear T80/100D £89-75



FAL PHASE 50 Mk.III AMPLIFIER 50 WATT.

Solid state. 4 Separately controlled inputs Plus master vol. control. Ind. Bass and Treble Controls. Protective circuit to guard against damage from accidental shorts. Output for Speaker/3 to 30 ohms. Size 17" x 7" x 7 1/4" 200-250V. A.C. mains. Output 50 watts music rating. Or deposit £7-25 and 9 monthly payments £3-55. Total £39-20. **£34-95** Carr. 75p.

HIGH QUALITY LOUDSPEAKER UNITS

ALL TWO TONE REXINE AND VYNAIR FINISH
 L125 50 WATT Fitted pair of 12" 50 watt high flux speakers for conservative rating. Impedance 8-15 ohms. Carr. £1-50
 Or deposit £4-50 and 9 monthly pmts. of £3-70. Total £27-80

L12/25 12" 25 WATT 10,000 lines 15 ohms. Carr. 50p.	L13 13" x 8" 10 Watt 10,000 lines 3 or 15 ohms. State imped-ance required. Carr. 40p	£5-25
--	---	--------------

RSC BASS-REGENT 50 WATT AMPLIFIER

A powerful high quality all-purpose unit for lead, rhythm, bass guitar, vocalists, gram, radio, tape. Peak Output rating. Loudspeaker unit optional horizontal or vertical mounting.

- ★ Two extra heavy duty 12in. 50w L'spkrs.
- ★ Four Jack inputs and two Volume Controls for instant use of up to four pick-ups or "mikes". Bass and Treble controls.

Credit Terms: Deposit £15 & 9 monthly pymts of £8-25 (Total £71-25) Carr. £2 for leaflet. **£65**

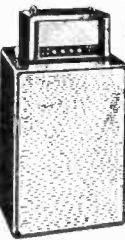

RSC GP30 HI-FI AMPLIFIER

For Guitar, Vocal or Instrumental Group

A 4 input, 2 vol. control Hi-Fi 30 watt unit with Separate Bass and Treble controls. Current valves. Peak output rating. Strong Rexine covered cabinet with handles. Attractive black/gold P.V.C. facia.

Non indicator. For 200-250V. A.C. mains. For 3 or 15 ohm speakers. Send S.A.E. for leaflet. Terms: Deposit £4-40 and 9 monthly payments of £2-45 (Total £26-45). **£23-50** Carr. 65p.



* CREDIT TERMS AVAILABLE ON PURCHASES OVER £8 (Kits Excepted) INTEREST CHARGES REFUNDED ON CREDIT SALES Settled in 3 months

NOW FOUR NEW BRANCHES OPENING SHORTLY

COVENTRY
 19/19A MARKET STREET

NOTTINGHAM
 5 MARKET SQUARE

SUNDERLAND
 8 LITTLE UNDERBANK

STOCKPORT

New premises at See Addresses **HULL & NEWCASTLE**



MAIL ORDERS & EXPORT ENQUIRIES TO:—
 AUDIO HOUSE, HENCONNER LANE, LEEDS, 13. Tel: Pudney (09735) 77631.
 TERMS C.W.O. or C.O.D. No C.O.D. under £1.
 POSTAGE 25p EXTRA Under £2. 30p EXTRA OVER £2 OR AS QUOTED. TRADE SUPPLIED. S.A.E. PLEASE WITH ENQUIRIES.
 SUPPLIERS TO GOVT. DEPTS. H.M. FORCES. EDUCATION AUTHORITIES AND HOSPITALS.
 MAIL ORDERS MUST NOT BE SENT TO SHOPS

- R.S.C. Branches below open all day Saturdays and operate a 5-day week
- BRADFORD 10 North Parade (Closed Wed.). Tel. 25349
 - BLACKPOOL (Agent) O & C Electronics 227 Church Street
 - BIRMINGHAM 30/31 Great Western Arcade, Tel. 021-236 1279 (Closed Wed.).
 - DERBY 26 Osmaston Rd., The Spot (Closed Wed.). Tel. 41361
 - DARLINGTON 18 Priestgate (Closed Wed) Tel. 68043
 - EDINBURGH 101 Lothian Rd. (Closed Wed.). Tel. 229 9501
 - GLASGOW 326 Argyle St. (Closed Tues.). Tel. 248 4158
 - HULL Whitefriargate (opening Nov.) Tel. 20505
 - LEICESTER 32 High Street (Closed Thurs.). Tel. 56420
 - LEEDS 5-7 County (Mecca) Arcade, Briggate (Closed Wed.). Tel. 28252
 - LIVERPOOL 73 Dale Street (Closed Wed.). Tel. 236 3573
 - LONDON 238 Edgware Road, W.2. (Closed Thurs.). Tel. 723 1629
 - MANCHESTER 60A Oldham Street, (Closed Wed.). Tel. 236 2778
 - MIDDLESBROUGH 106 Newport Rd. (Closed Wed.) Tel. 47096
 - NEWCASTLE UPON TYNE 24 Newgate Shopping Centre (Closed Wed.). Tel. 21469
 - NOTTINGHAM 19/19A Market Street (Closed Thurs.). Tel. 48068
 - SHEFFIELD 13 Exchange Street (Castle Market Bldg.) (Closed Thurs.). Tel. 20716
 - STOCKPORT 8 Little Underbank. Tel: 480-0777.
 - SUNDERLAND 5 Market Sq. (Closed Wed.) Tel. 70573

Train for television

Course commences 3rd January, 1973

This is your opportunity to train as a television and radio engineer on our full-time Two-Year College Diploma Course specially designed to cover the examinations of the City and Guilds Radio, Television and Electronics Technicians' Certificate. Full theoretical and practical instruction on all types of modern receivers—including the latest colour sets.

Minimum entrance requirements are Senior Cambridge or 'O' Level, or equivalent in Mathematics and English.

Please send free prospectus to:

Name _____

Address _____

THE PEMBRIDGE COLLEGE OF ELECTRONICS

(Dept. PW14 34a Hereford Rd., London W2 5AJ)

SOUND BARGAINS



VHF, FM, AM, A.F.C., AIR BAND, PUBLIC SERVICE AND WEATHER BANDS

BATTERY CHECK INDICATOR

GIANT POWER MULTI-WAVEBAND BROADCAST RECEIVER

WITH 3 in 1 AC/DC POWER SUPPLY SYSTEM
MAINS/BATTERY plus BUILT-IN BATTERY BOOSTER

OUR PRICE £10.50
+40p P. & P.

THIS NEW 1972 RADIO. No less than 3 VHF BANDS. Picks up Aircraft Transmissions, Pop Pirates, Taxis, Ambulances, Local Radio, Continental and all BBC, VHF Stations plus fascinating Public Service Transmissions we are not allowed to mention! Even TV sound in certain areas. PLUS A SPECIAL WEATHER-BAND. Frequency ranges: MW540-1600 KHZ, FM88-108MHZ, Airband 108-145 MHZ, VHF 145-175MHZ, 23 semi-conductors—12 transistors, 11 diodes and thermistors. Automatic frequency control. 31" telescopic aerial. Runs off mains AC 230/250 volts or off 4 U11 batteries, or use re-chargeable nickel alkali cell. Finished in strong leather grained case with carrying handle. Approx. size 10 1/2" x 6 1/2" x 3 1/2". Written guarantee. Special magnetic ear-piece for personal listening, dry batteries FREE. HURRY! Limited quantity only from Marktyme. Fully guaranteed.

OUR PRICE £28.95
+50p P. & P.



8 WAVE BANDS AND WORLD MAP & TIME ZONE DIAL

Tune into the world with this amazing world radio. A truly exceptional unit in performance and looks—leatherette with stainless steel trim. Looks good anywhere. Use either as a portable with standard batteries or plug it directly into 230-240 volt domestic mains supply. 14 Transistors; 9 diodes; thermistor. Internal ferrite rod antenna plus telescopic aerial. Separate tone, volume and tuning controls with push-button selectors for the 8 WAVEBANDS. Complete with Hi-Fi earphone for personal listening. Frequency ranges: Long wave 150-350Kcs. Medium 353-1605Kcs. Waves 1.6-4.5Mcs. Short Wave 12-24Mcs. FM/VHF 88-108Mcs. Aircraft 108-135 Mcs. PUBLIC SERVICE BANDS 135-174Mcs. Fully guaranteed.

N.B.—The Ministry of Post & Telecommunications has pointed out that a licence (not generally available to the public) is required for reception of transmissions by Fire Brigade, Aircraft, Shipping, etc.

MARKTYME (Dept. PW7), 372 EDGWARE ROAD, LONDON, W.2. Tel. 01-723 0094. Callers welcome Monday to Saturday 9 a.m.-6 p.m.

introducing

ARROW ELECTRONICS LTD.

'Service the way it ought to be'

an associate Company of LST ELECTRONIC COMPONENTS LTD.

When it comes to retail distribution we're head and shoulders above the rest!

We're a new Company but our experience and ability in electronic components goes back a long way . . .

Here at Arrow Electronics fast, reliable service is law!

We offer a rapid, same day turn round on all mail received up to 3 p.m. on any given weekday.

What's more, when we promise to clear all orders on receipt, we really mean it!

**A SELECTION FROM OUR CATALOGUE
COS-MOS-CIRCUITS**

This range of COS-MOS Logic is stocked in DIL plastic encapsulation. This range offers High reliability, high speed operation, high level output compatibility with low power TTL and high noise immunity.

Type No.	Description	Price each
CD4001AE	Quad 2 input NOR gate	72p
CD4009AE	Hex. buffer — inverting type	£1.56
CD4011AE	Quad 2 input NAND gate	72p
CD4012AE	Dual 4 input NAND gate	£1.16
CD4013AE	Dual "D" Flip-Flop	£1.48
CD4015AE	Dual 4 stage Shift Register	£3.90
CD4017AE	Decade Counter/Divider with Decimal outputs	£3.90
CD4018AE	Presetable divide by "N" Counter	£3.90
CD4020AE	14 Stage Ripple Binary Counter/Divider	£4.34
CD4024AE	7 Stage Counter (Buffered Reset)	£2.78

Order as "COSMOS" + Type No.

INTEGRATED CIRCUIT SOCKETS

These low cost sockets are moulded in Makrolon with Phosphor Bronze contacts, silver plated.

Type No.	Description	Price
DRD7	14 pin Dual in Line	14p each
DRD8	16 pin Dual in Line	15p each

Order as "DIL Sockets" + Type No.

LIGHT EMITTING DIODE

Type No. TIL209 High brightness visible light source 35p each

OPTICALLY COUPLED ISOLATOR

Type No. TI112 GA source optically coupled to NPN transistor giving high DC transfer ratio with high electrical isolation of 1.5kV. £2.00 each

RECTIFIERS — MEDIUM CURRENT

Plastic cased rectifiers with 3A current capability. Miniature size and axial leads make them particularly useful for Printed circuitry.

Type No.	If (Amps)	PIV	Price
1N5400	3 A	50	14p each
1N5404	3 A	400	18p each
1N5408	3 A	1000	25p each

Shoot me your catalogue

Arrow Electronics Limited
 Dept.
 7 Coptfold Road
 Brentwood Essex
 Tel: Brentwood 219435

PW 2

Enclose P/O Cheque for 10p.
 Name _____
 Address _____

SPECIAL BARGAINS

WEBCOR TC 144
Push Button Cassette Tape
Recorders value £17.
Tip top quality and
reliability **£10-95**

HYDRA 8 TRACK
Cartridge Stereo Record/
Playback/Erase 2 Meters Full
Controls. De Lux Finish
A.C. Mains 13 Transistor
30-10,000Ω
Fantastic Value **£55**

ELIZABETHAN STEREO
Cassette Recorders/Player
C/LZI Super Quality **£39**

Jet AM/FM Solid State 15 Radio
Battery with built in A.C.
Adaptor value £12-50
Whilst they last **£6-90**

HOB PARTY Portable
Record Player, Battery
Transistorised 33/45 RPM
Big size, not a toy! Wonderful
Xmas Present **£6-90**

Britram 34 Radios.
7 Transistor Single Band
Really superior finish **£1-99**

AJAX SENATOR MK. II
Big Med./Long Radios.
Six approx. 12" x 8" x 3½".
Takes big batteries
Whilst they last **£5-90**

100's OTHER SNIPS
FOR CALLERS



FANTASTICALLY POPULAR

★ TAPE ★

We offer you fully tensilised polyester/mylar and P.V.C. tapes of identical quality hi-fi, wide range recording characteristics as top grade tapes. Quality control manufacture. They are truly worth a few more coppers than acetate, ub-standard, jointed or cheap imports.

TRY ONE AND PROVE IT YOURSELF.

Standard Play		Long Play	
3in. 150ft.	12p	3in. 225ft.	13p
4in. 300ft.	22½p	4in. 450ft.	27p
5in. 600ft.	45p	5in. 900ft.	52½p
5½in. 900ft.	52p	5½in. 1,200ft.	65p
7in. 1,200ft.	62½p	7in. 1,800ft.	92½p
Double Play		Triple Play	
3in. 300ft.	20p	4in. 900ft.	65p
4in. 600ft.	40p	5in. 1,800ft.	£1-12½
5in. 1,200ft.	75p	5½in. 2,400ft.	£1-70
5½in. 1,800ft.	95p	7in. 3,600ft.	£2-40
7in. 2,400ft.	£1-35	Quadruple Play	
		3in. 600ft.	42½p

Postage by reel.
Post Free loss 5% on three reels.
Quantity and Trade enquiries invited.
NOTE. Large tape stocks at all branches.

S.A.E. FOR FREE BUMPER WINTER FLOG LIST

WITHOUT OBLIGATION TO:-

Name
(block caps please)
Address
AVOID
DISAPPOINTMENT
SEND NOW!

KG-620 4½ VTMV KIT ★ NEW!



SPECIFICATIONS
Ranges: 0-1-5-5-15-50-150-500-1,500V full scale; with optional High-Voltage Probe, to 25,000V. Accuracy: ±3% Of full scale reading.
Input Resistance: 11 megohms (1 meg in probe) up to 1,500V.
Ranges (rms): 0-1-5-5-15-50-150-500-1,500V full scale (p-p); 0-4-2-14-42-140-420-1,400-4,200V full scale.
Decibels: -10 to +65 in 7 ranges.
Response: ±1dB, 30Hz to 3MHz; ±3dB, 30Hz to 5MHz; with optional H.F. Probe, to 250MHz.
Accuracy: ±5% of full scale reading.
Ranges: 0-1,000-10,000-100,000 ohms; 0-1-10-100-1,000 megohms.
Centre Scales: 10, 100, 1,000, 10,000, 100,000 ohms; 1 and 10 megohms.
Battery: 1½V size D2.

Recommended List Price £18-27½: **£9-95** Assembled Price **£12-90** (RR Price £30)

KG-865 50 Watt Stereo Amplifier Chassis



DE-LUXE FEATURES

All Silicon Transistors for Stability, Cleaner Sound ● Extremely Wide Power Bandwidth and Frequency Response ● 50W IHF Power Output ● Specially Selected Low-Noise Foam Transistors ● Two Printed Circuit Boards for Fast Easy Assembly ● Convenient Front-Panel Stereo Headphone Track ● Teak-Finished Extruded Aluminium Front Panel ● Two a.c. Convenience Outlets.

Output: 50W IHF, 25W per channel; 34W continuous sine wave ● Response: ±1dB, 18 to 30,000Hz ● Output Impedances: 4 through 16 ohms, plus stereo headphones ● IM Distortion: under 1% at 60Hz and 7,000Hz mixed 4:1 at rated power ● Input Sensitivity, Magnetic Phono, 5mV; Tuner and Auxiliary, 500mV ● Power Requirement: 230-250V, 50Hz a.c. Rec. List Price **£51-00**
Our Price **£29**

KG-375 Deluxe Solid-State Auto Analyser

Tune-up and trouble-shoot any car, perform actual road tests.

It's several testers in one... do all this

Set Engine Idle and Automatic Transmission Shift Points ● Detect Condition of Point Surfaces ● Detect Distributor Wear ● Check Voltage and Current Regulators ● Check Generators for both Current and Voltage Output ● Find Poor or Open Earth Circuits ● Detect Variation in Dwell Angle.

Recommended List Price **£37** **£19**

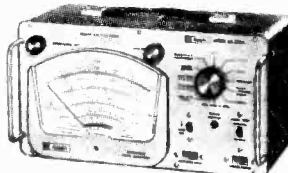

Stockists of Leak, Quad, Sansui, Goodman, Teleton, Tripletone, Linear, Rogers, Pioneer, Ferrograph, Wharfedale, etc., etc.
Post: 1 lb. 7p; 1 lb. 15p; 2 lb. 20p; 10 lb. 35p; 14 lb. 45p; 22 lb. 65p. **CALLERS** a very wide range of electronic components await you at all branches. Your enquiries welcomed.



★ **QUEEN ST.**
★ **ARUNDEL**
★ **Tel. 0903 88 22 99**

★ All Mail Orders to ARUNDEL, SUSSEX with names and addresses in BLOCK CAPITALS please.

BARGAIN PARCELS

Including variable condensers i.f. coils, loudspeakers plug/sockets, knobs, condensers, resistors, nuts, bolts, cabinet fittings, switches, transformer, choke, rectifier transistors at a small fraction of list value. Due to heavy demand we now pack them in several sizes—be amazed—try one now.

3lbs (post 24p)..... 50p
7lbs (post 35p)..... 90p
14lbs (post 45p)..... £1-66

100 MIXED RESISTORS Wide range, all good values ½W-2 Watt 35p, 200 for 65p, 500 for £1-40.

100 MIXED CONDENSERS Ceramic, Polyester, Silver Mica, Paper, Approx. 50 useful sizes 49p, 200 for 85p, 500 for £1-85.

100 MIXED HI-STABS Instrument types 1% to 5%, big selection **45p**

100 MINIATURE HIGH STABS Wide range of good values **50p**

100 ½W 1% MICRO HIGH STABS **60p**

25 MIXED POTS L/SW W/SW Preset Tandem, snip at **50p**

SUPER SCOOPS FOR CALLERS

WELCOMED AT

★ "WEST SUSSEX ★
HI-FI CENTRE" ★
★ QUEEN STREET ★
ARUNDEL
Tel. Arundel 882299

★ BRIGHTON ★
HI-FI CENTRE ★
★ 6 QUEENS ROAD ★
Tel. Brighton 23975

★ PORTSMOUTH ★
HI-FI CENTRE ★
★ 350-2 FRATTON RD. ★
Tel. P'mouth 22034

★ "SOUTHAMPTON ★
HI-FI CENTRE" ★
★ 77 EAST STREET ★
SOUTHAMPTON
Tel. So'ton 281

LINEAR

AMPLIFIERS FOR GUITAR PICK-UPS GRAM PICK-UPS RADIO or TAPE

OVERLOAD PROTECTION INCORPORATED. SOLID STATE CIRCUITRY

Suitable for application of Loudspeakers impedances between 8 and 30 ohms. Combinations not to measure less than 6 ohms across both speaker output jacks simultaneously.

The Amplifier cover is made of rigid plastic, bonded metal on the top and two sides. Finished in Black to suitably contrast with anodised metal control panel. Size approx. 14" x 4 1/2" x 9 1/2".

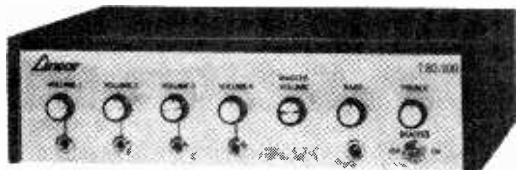

GENERAL PURPOSE AMPLIFIER

Model T80/100 70 - 100 Watts Output Power

Four individually controlled inputs plus Master volume control. Bass and Treble Controls providing both 'lift' and 'cut'.

Compact size, robust construction. Ideal for clubs, hotels, restaurants, schools etc.

Inputs for almost any type of microphone

Rec. Retail Price

£69.75

GENERAL PURPOSE GROUP/DISCO AMPLIFIER Model T80/100D

70 - 100 Watts Output Power

Three individually controlled inputs plus Master volume control. Bass and Treble Controls providing both 'lift' and 'cut'.

Compact size. Robust construction. Ideal for discotheques, clubs, hotels, schools, etc. Inputs for most types of microphones. Facilities for head-phone monitoring with changeover switch from input (1) to input (2).

Rec. Retail Price
£69.75

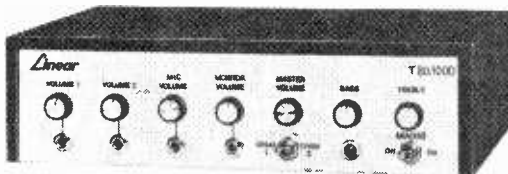

Wholesale and Retail enquiries to the Manufacturers Send S.A.E. for leaflet/s All Linear Amplifiers Guaranteed for 12 Months

LINEAR PRODUCTS LTD., Electron Works, Armley, Leeds. LS12 3SA Tel. 630126

SAVE TIME AND MONEY

LIST PRICE **£6.25** | OUR PRICE **£4.84**



As supplied by us to **SCHOOLS, TECHNICAL COLLEGES, SHOPS, OFFICES AND INDUSTRY.** Silver grey stove enamelled steel cabinet with 48 transparent styrene drawers fitted with moulded handles and label slots. Dividers can be supplied at an extra charge to enable each drawer to be sub-divided into six compartments. Transparent drawers allow swift selection of components at a glance and eliminates duplication of stock. A really first class time saving unit. Size of cabinets 21 1/2" x 11 1/2" x 6 1/2". Size of drawers 8 1/2" x 2 1/2" x 1 1/2". Other sizes available. Callers welcome Mon.-Sat. 9 a.m.-1 p.m. 2 p.m.-6 p.m. NEW as illustrated **OUR PRICE ONLY £4.84** plus 35p carriage on orders less than £10. Money back guarantee. **SEND FOR FREE COLOUR BROCHURE.**

TRADE AIDS

(DEPT. PWS), 111 CHILTERN DRIVE,
BERRYLANDS, SURBITON, SURREY

01-299 4383

100 yds. Berrylands Railway Station.

Vary the strength
of your lighting with a

DIMMASWITCH

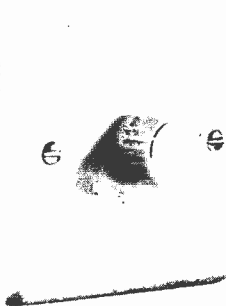

The DIMMASWITCH is an attractive and efficient dimmer unit which fits in place of the normal light switch and is connected up in exactly the same way. The white mounting plate of the DIMMASWITCH matches modern electric fittings. Two models are available, with the bright chrome knob controlling up to 300 w or 600 w of all lights except fluorescents at mains voltages from 200-250 v, 50Hz. The DIMMASWITCH has built-in radio interference suppression:

600 Watt **£3.20**. Kit Form **£2.70**

300 Watt **£2.70**. Kit Form **£2.20**

All plus 10p post and packing.

Please send C.W.O. to: --

DEXTER & COMPANY

2 ULVER HOUSE, 19 KING STREET,
CHESTER CH1 2AH Tel: 0244-25883

As supplied to H.M. Government Departments.

VEROBOARD

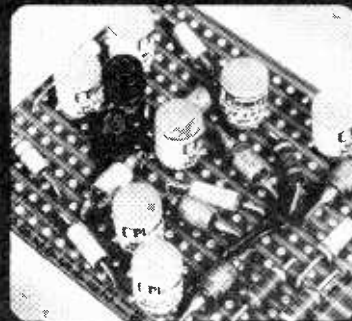

VEROBOARDS GIVE A PROFESSIONAL
FINISH TO YOUR WORK

0.1" and 0.15" pitch, plain and copper
clad universal circuit boards.

AVAILABLE FROM YOUR LOCAL RETAILER

TRADE DISTRIBUTOR: N. Bown Electronics Ltd., London, W.C.1



VERO ELECTRONICS LTD.
Industrial Estate, Chesham, Bucks.
505 5TH Tel. Chesham 5 5912

Bib®

HI-FI ACCESSORIES

RECOMMENDED BY LEADING EQUIPMENT MANUFACTURERS AND AUDIO SPECIALISTS

GROOV-KLEEN modern automatic record cleaners – now a choice of models

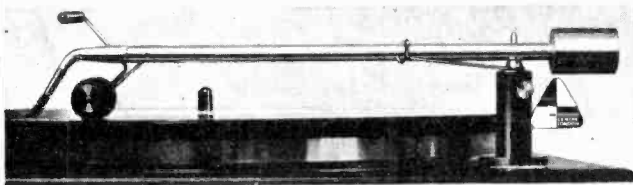

The popular priced Model 50 GROOV-KLEEN has all the features of the Model 42 but is made in high quality plastic. The base is finished in matt black and the cranked arm is white.

Model 50 £1.26

The de-luxe Model 42 GROOV-KLEEN

- Removes and collects dust without using liquid.
- Improves reproduction.
- Reduces record & stylus wear. Counterweight ensures lightweight tracking.
- Operates silently.
- Armrest incorporated.
- Beautifully finished in Chrome, bright anodised Aluminium & shiny black.

Model 42 £1.95

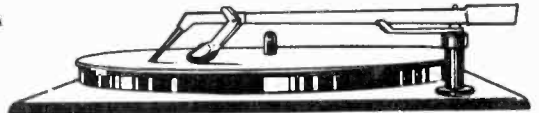

NEW! HI-FI Stereo Test Cassette

How to get the best Stereo and Mono reproduction and recording. Devised by Bib. Recorded by Decca. Includes channel identification, balance control, speaker phasing, adjusting record volume controls, reducing tape hiss and eliminating hum, wow and flutter, and sounds you can record yourself. 523 musicians · 6 Symphony Orchestras · D'Oyly Carte Opera Co. · Grand Organ · Brass Band 6 individual instruments.

Ref 53 £2.25

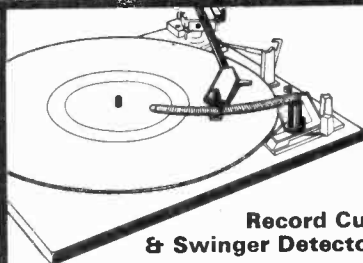

Record Cue & Swinger Detector

Identifies selected items on records. Fitted easily to all turntable decks. Scale clear of records, cannot touch pick-up cartridge. Detects swingers for improved reproduction when rectified.

Patent No 2460/72. **Ref 47 £1.45**



NEW!

Record Care Kit

Ideal gift. Contains GROOV-KLEEN in sparkling all-chrome finish, Record Dust Off, Spirit Level, Stylus & Turntable Cleaner.

Ref 43 £2.49

Cassette Head Cleaning Tape

For all cassette machines. Removes oxide and dirt from heads. Packed in plastic "library" case.

Ref 31 57p



Packed in attractive bubble pack, without "library" case.

Ref 31a 47p

8 Track Cartridge Tape Head Cleaner

Maintains tape heads in clean condition. Recommended use after every 5 hours playing. Complete with dust cover.

Ref 41 99p



1/4" Recording Tape Splicer

Fitted with clamps for holding tape for diagonal or butt splices. On non-slip base, complete with tape cutter and instructions.

Model 20 £1.24



Cassette Tape Recorder Care Kit

To clean tape heads safely and easily, and for joining and editing tapes precisely. Packed in plastic box.

Ref 26A £2.10

Tape Editing Kits—in Wallets

Tape splicer, cutter, marker, splicing tape. Reel or cassette labels. For 1/4" tape.

Ref 23 £1.40

(for cassettes)

Ref 24 £1.56



Stylus Balance

Precision built. Calibrated. Measures stylus pressure within 1/4 gramme. In plastic container.

Ref 32A

£1.45



Other Lines include:

Item	Ref	Price
Record Care		
Indexa Record	A	£1.58½
Stylus & Turntable Cleaning Kit	B	38p
Record & Stylus Cleaning Kit	36A	25p
Record Sleeve Protectors	44	44p
Spirit Level	46	56p
Record Dust-Off	48	20p
Roller & Brush for Ref 42	42S	18p
2 Self-adhesive Bases and Cleaning Brush for Models 42 and 50	42P	15p
Pad Base Sticker and Brush for Model 50	50S	20p
Tape Care		
Tape Head Cleaning Kit	J	54p
Recording Tape Cutters	M	20p
1/4" Tape Splicer	Model 21	£9.00
Cassette Title Labels (Pack of 108)	T/5	39p
Cassette Salvage Kit	29	46p
Splicing Tape	33	26p
Cassette Case	34	£1.34
Cartridge Case	35	£1.59
Cassette Wallet	39	58p
Cassette Re-Record Kit	54	44p
Cassette Hub Clips	57	26p
Hi-Fi Maintenance		
Hi-Fi Cable & Flex Ties	D/2	20p
Hi-Fi Solder Pack	37	15p
Hi-Fi Cleaner	P	28p
Wire Stripper De Luxe Model	9	75p
Hi-Fi Maintenance Electrical Kit	C4	72p

Available from good audio shops. If unobtainable send direct plus 20p p & p for amounts up to £3. Over £3 postage free UK only.

HI-FI Stereo Hints and Tips

How to make the most of your equipment by John Borwick BSc., Technical Editor of "The Gramophone". 48 Pages of useful information with 54 invaluable reference charts and illustrations for Hi-Fi enthusiasts.

Ref 56 32p

2nd Edition completely revised



Bib Sales,

Dept. PW2

PO Box No. 78, Hemel Hempstead, Herts HP2 7EP. Tel: Hemel Hempstead 3636

DISCOUNTS UP TO

60%

Global's GOLDEN Guarantee
 WE GUARANTEE THAT WITHIN 7 DAYS OF PURCHASE IF ANY ITEM OF GOODS IS FOUND TO BE GENUINELY DEFECTIVE WE WILL REPLACE THE SAID GOODS WITHOUT QUESTION. AFTER 7 DAYS GOODS ARE COVERED BY MANUFACTURERS 12 MONTHS GUARANTEE.

GARRARD SP25 Mk III SPECIAL OFFER £17.45
 Garrard SP25 Mk. III Goldring G800 Teak plinth and tinted cover. All leads supplied. Please add £1.25 for P & P.

TURNTABLES
 Please add 75p for P. & P.
 Garrard SP25 Mk. III £9.95
 Garrard AP76 £17.45
 Garrard SL65B £13.95
 Garrard 401 £38.75
 Garrard Zero 100 (Auto) £36.55
 Garrard Zero 100 (Single) £9.65
 BSR MP60 £21.95
 Goldring GL72 £28.95
 Goldring GL72/P £27.95
 Goldring GL75/P £34.95
 Goldring 101/PC £20.50
 Wharfedale Linton & cart. £27.25
 Thorens TD125AB Mk. II New product £91.75
 Thorens TD150 Mk. II £27.50
 Thorens TD150A Mk. II £34.50

TUNERS
 Please add 75p P. & P.
 Amstrad Multiplex 3000 £28.75
 Armstrong 523 £39.00
 Armstrong 524 £30.50
 Rogers Ravensbrook FET4 (Chassis) £31.00
 Rogers Ravensbrook FET4 (Cased) £35.00
 Rogers Ravensbourne FET4 (Chassis) £43.00
 Rogers Ravensbourne FET4 (Cased) £47.50
 Sinclair PRO60 (Module) £15.75
 Sinclair Cased Tuner £31.00
 Leak Delta FM (Cased) £53.75
 Leak Delta AM/FM (Cased) £64.00
 Alpha Highgate FT 150 £34.95

TUNER/AMPLIFIERS
 Please add 75p for P. & P.
 Alpha Highgate 150 £44.25
 Armstrong 525 (Teak cased) £67.50
 Armstrong 526 AM/FM (Teak cased) £77.25
 Leak Delta 75 £124.00
 Philips RH781 £50.00
 Philips RH702 £82.50
 Teleton 2100 £29.45
 Goodmans One Ten £99.50
 Rogers R/brook (Teak) £78.50
 Rogers R/brook (Chassis) £72.75
 Alpha FR 3000 New Prod. £66.00

AMPLIFIERS
 Please add 75p P. & P.
 Amstrad 8000 Mk. II £14.95
 Amstrad IC2000 £27.50
 Amstrad Integra 4000 £21.95
 Armstrong 521 (teak cased) £43.85
 Alpha Highgate 212 £24.95
 Alpha Highgate FA300 £30.95
 Alpha Highgate FA400 £34.50
 Leak Delta 30 £44.90
 Leak Delta 70 £55.75
 Metrosound ST20E £24.45
 Metrosound ST60 £45.75
 Pioneer SA600 £57.00
 Pioneer SA900 £85.00
 Pioneer SA1000 £93.00
 Rogers R/brook (Chassis) £35.80
 Rogers R/brook (Cased) £38.95
 Rogers R/bourne (Chassis) £45.50
 Rogers R/bourne (Cased) £49.50
 Sinclair PRO60 2 x Z30/PZ6 £14.95
 Sinclair PRO60 2 x Z30/PZ6 £17.00
 Sinclair PRO60 2 x Z30/PZ6 Z50/PZ8/Trans £21.25
 Sinclair AFU (Filter Unit) £4.40
 Sinclair 605 £18.45
 Sinclair 2000 Mk. II £21.50
 Sinclair 3000 Mk. II £28.50
 Wharfedale Linton £44.25
 Teleton SAQ307 £22.50
 Rotel RA 310 £33.75
 Rotel RA 610 £50.75

SPEAKERS
 Please add £1.25 P. & P. per pair
 Amstrad 138 £14.70
 Wharfedale Denton 2 £30.25
 Wharfedale Linton 2 £36.75
 Wharfedale Melton 2 £47.45
 Wharfedale Dove Dale 3 £61.20
 Celestion Ditton 120 £38.50
 Celestion Ditton 15 £52.75
 Celestion Ditton 25 £87.00
 Celestion County (new prod.) £33.95
 Goodmans Double Maxim £48.00
 Goodmans Mezzo 3 £46.95
 Goodmans Magister £85.00

£3.20
 Plus 35p p. & p. Finished in teak veneer with tinted dust cover fully assembled. For Garrard SP25, 2025FT, 3000, AT1000, 2500, 3500, 5100, 1025, SL65B; Also for BSR McDonald MP60 and others. For AP76; AP75; SL72B; SL75; SL95B; £4.20 plus 35p P. & P. Also finished in walnut to match Japanese equipment—at no extra.

CARTRIDGES
 Please add 10p for P. & P.
 Goldring G850 £3.25
 Goldring G800 £5.75
 Goldring G800E £7.45
 Goldring G800 Super E £14.35
 Shure M3D £3.85
 Shure M44E £5.70
 Shure M55E £5.85
 Shure M75E Type 2 £10.00
 Sonotone 9TAHC £1.75

GLOBAL AUDIO DISCOUNT WAREHOUSES
 All prices correct at time of press E. & O.E. and are subject to alterations.

Dept(PW16)174 Pentonville Road, London, N1. Telephone 01-278 1769
 Or: 4 High View Parade, Redbridge Lane East, Woodford Avenue, Ilford, Essex. Tel: 01-550 1086.

Open Monday to Saturday 9.30 a.m. to 6 p.m. LATE NIGHT FRIDAY 7 p.m.
MAIL ORDERS: Order with confidence. Send Postal Order, Cheque, Money Order, Bank Draft, Giro or Cash by Registered Mail. CALLERS: Please note that cheques can only be accepted together with cheque cards (not Barclay Card).
 2 minutes from KING'S CROSS, EUSTON & ST. PANCRAS on main road leading to the East and West Country

TV's 19" NOW £11.95

TWO YEARS' GUARANTEE ALL MODELS
405/625: 19" £25.95
FREE 23" £35.95
 CATALOGUE CARR £1.95

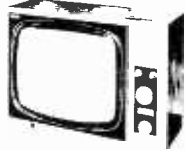

COLOUR TV 19" £145 OR 25" £185

LIMITED SUPPLY, REGRET PERSONAL CALLERS ONLY
 A SELECTION OF RECENT YEARS MODELS
 U.K. MANUFACTURE

TV TUBES REBUILT GUARANTEED 2 YEARS

17" and 19" £5.95; 21" and 23" £6.45
 Exchange Bowls carr. 55p

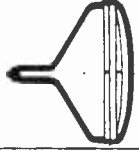

COMPONENTS MUST BE CLEARED

Transistor Radio Cases: 25p each. Size 9 1/2" x 6 1/2" x 3 1/2". Post 22p.
Speakers: 35p. 2 1/2" 81z Brand new. Post 15p.
Record Player Cabinets: £3.75p Designed for the modern auto-changer. Size 17" x 15" x 7 1/2". p.p. 55p.
Radio: £3.95 8 transistor LW/MW. Free case, battery 5p.
Precision Tape Motors: £1.95. 200/250V. Famous German manufacturer. Post 20p.
Transistor Gang Condensers: 20p. Miniature AM. Post free.
Modern Gang Condensers: 40p. AM/FM or AM only 20p. Post 10p.
Press Button VHF Tuner 75p. Brand new, takes PCF806, PCC89. Post 25p.
Valve ELL80 50p
SPECIAL OFFER
 Pots: 25p each. Post 5p. D/SW 500/500 KΩ. D/SW 500/100 KΩ. D/SW 1 meg./100 KΩ. S/SW 500/500 KΩ. S/SW 500/1 meg.

DUKE & CO. (LONDON) LTD.
 621/3 ROMFORD ROAD, MANOR PARK, E.12. Phone 01-478 6001-2-3

VALVES SAME DAY SERVICE NEW! TESTED! GUARANTEED!

SETS		1R5, 180, 1T4, 384, 3V4, DAF91, DF91, DK91, DL92, DL94.		Set of 4 for £11.12, DAF90, DF90, DK90, DL90, 4 for £11.65.							
1R5	-88	30C15	-58	EABC80	-82	EL500	-62	PCF808	-68	U801	-75
185	-82	30C17	-78	EAF49	-50	EM80	-86	PCL82	-30	UABC80	-88
1T4	-16	30C18	-58	EB91	-10	EM81	-80	PCL83	-55	UAF42	-50
384	-26	30F5	-84	EB3C3	-40	EM84	-82	PCL84	-83	UBC41	-45
3V4	-47	30F11	-65	EB8C1	-49	EM87	-60	PCL85	-88	UBF80	-84
5U4G	-31	30FL12	-69	EB8C1	-90	ET61	-86	PCL86	-87	UBF89	-89
5V4G	-35	30FL14	-68	EB90	-29	ET86	-29	PCL88	-68	UCC84	-82
5Y3GT	-30	30L1	-29	EBF80	-32	EY87	-29	PCL80	-89	UCC85	-85
5Z4G	-35	30L15	-70	EBF83	-39	EZ40	-39	PCL80	-88	UCF80	-80
6/30L2	-54	30L17	-87	EBF89	-29	EZ41	-39	PEN A4	-77	UCH42	-58
6AL5	-11	30P4	-65	EC81	-17	EZ81	-21	PEN36C	-70	UCH81	-80
6AM6	-13	30P12	-69	EC82	-20	EZ81	-22	PFL200	-61	UCL82	-82
6AQ5	-22	30P19	-65	EC83	-28	EZ90	-25	PFL36	-65	UCL83	-85
6AT6	-20	30P11	-60	EC85	-34	GZ30	-34	PL81	-48	UF41	-58
6AU6	-20	30P113	-89	EC804	-54	GZ32	-40	PL81A	-47	UF89	-80
6BA8	-20	30P114	-65	ECF80	-30	KT41	-77	PL82	-81	UL41	-58
6BE6	-21	35L6GT	-45	ECF35	-26	KT61	-56	PL83	-28	UL84	-80
6B3E	-41	36W4	-25	ECF35	-55	KT68	-78	PL84	-30	UM84	-28
6BW7	-50	35Z4GT	-25	ECH42	-59	LN319	-63	PL80	-69	UY41	89
6F14	-85	50CD6G	-68	ECH81	-29	LN329	-72	PL804	-63	UY85	-25
6P23	-68	807	-49	ECH83	-88	LN339	-63	PM84	-30	VP4B	-77
6P25	-58	AC/VP2	-77	ECH84	-35	N78	-87	PX25	-95	W77	-42
6J7G	-24	B349	-70	ECL80	-35	P61	-40	PY32	-58	Z77	-22
6K7G	-12	B729	-54	ECL82	-29	PABC80	-31	PY33	-52	Transistor	
6K8G	-17	OCH35	-67	ECL86	-35	PC86	-47	PY81	-28	AO17	-17
6X3GT	-28	DK82	-23	EY91	-13	PC88	-47	PY82	-25	AC127	-18
68L7GT	-30	DAF91	-23	EP41	-57	PC96	-42	PY83	-26	AD140	-37
68N7GT	-30	DAF96	-36	EP80	-23	PC97	-36	PY88	-23	AF115	-20
6V6G	-28	DF91	-16	EP85	-23	PC900	-29	PY800	-21	AF116	-20
6V6GT	-28	DF96	-36	EP86	-30	PC84	-29	PY801	-21	AF117	-20
6X4	-23	DI77	-20	EP89	-26	PC85	-28	R19	-20	AF125	-17
68QGT	-25	EF31	-30	EP39	-38	PC86	-47	PY82	-25	AC127	-18
68L7GT	-30	DAF91	-23	EP41	-57	PC96	-42	PY83	-26	AD140	-37
68N7GT	-30	DAF96	-36	EP80	-23	PC97	-36	PY88	-23	AF115	-20
6V6G	-28	DF91	-16	EP85	-23	PC900	-29	PY800	-21	AF116	-20
6V6GT	-28	DF96	-36	EP86	-30	PC84	-29	PY801	-21	AF117	-20
6X4	-23	DI77	-20	EP89	-26	PC85	-28	R19	-20	AF125	-17
19B6GG	-75	DL92	-26	EI90	-84	PCF82	-83	U62	-31	OCT9	-12
20F2	-67	DL94	-47	EL34	-45	PCF86	-46	U78	-24	OC75	-15
20P3	-75	DL96	-38	EL41	-54	PCF800	-68	U191	-65	OC81	-18
20P3	-75	DL96	-38	EL41	-54	PCF801	-28	U193	-81	OC81D	-18
20LGT	-19	DY86	-24	EL84	-22	PCF802	-30	U251	-64	OC82	-12
25U4GT	-67	DY87	-24	EL80	-26	PCF805	-58	U301	-88	OC82D	-12
30C1	-26	DY802	-33	EL93	-33	PCF806	-56	U329	-66	OC170	-22

READERS RADIO
 85 TORQUAY GARDENS, REDBRIDGE, ILFORD, ESSEX. Tel. 01-550 7441.
 Minimum post/packing on 1 valve 7p., on each additional valve, (3p. per valve extra)
 Any parcel insured against damage in transit 3p extra.

Build yourself a TRANSISTOR RADIO

NEW! ROAMER 10 WITH VHF INCLUDING AIRCRAFT

10 TRANSISTORS, 9 TUNABLE WAVEBANDS, MW1, MW2, LW, SW1, SW2, SW3, TRAWLER BAND. VHF AND LOCAL STATIONS ALSO AIRCRAFT BAND

Built in Ferrite Rod Aerial for MW/LW. Retractable, chrome plated Telescopic Aerial, for peak short wave and VHF listening. Push Pull output using 600mW Transistors. Car Aerial and Tape Record Sockets. 10 Transistors plus 3 Diodes. Fine tone moving coil speaker. Ganged Tuning Condenser with VHF section. Separate coil for Aircraft Band. Volume on/off. Wave Change and tone Control. Attractive Case in black with silver blocking. Size 9" x 7" x 4". Easy to follow instructions and diagrams. Parts price list and easy build plans 30p (FREE with parts). Earpiece with plug and switched socket for private listening 30p extra.

Total building cost

£8.50

P. P. & Ins. 50p

(Overseas P. & P. £1)



ROAMER EIGHT Mk I

NOW WITH VARIABLE TONE CONTROL

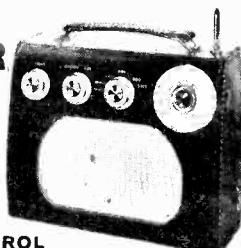

7 Tunable Wavebands: MW1, MW2, LW, SW1, SW2, SW3 and Trawler Band. Built in Ferrite Rod Aerial for MW and LW. Retractable chrome plated Telescopic aerial for Short Waves. Push pull output using 600mW transistors. Car aerial and Tape record sockets. Sensitivity switch. 8 transistors plus 3 diodes. Fine tone moving coil speaker. Air spaced ganged tuning condenser. Volume/on/off, tuning, wave change and tone controls. Attractive case in rich chestnut shade with gold blocking. Size 9" x 7" x 4in. approx. Easy to follow instructions and diagrams. Parts Price List and Easy Build Plans 25p (FREE with parts). Earpiece with plug and switched socket for private listening 30p extra.

Total building cost **£6.98** P. P. & (Overseas P. & P. £1) Ins. 45p.

ROAMER SEVEN MK IV

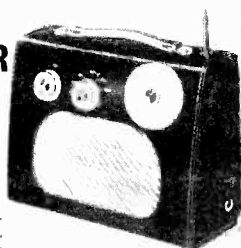

7 Tunable Wavebands: MW1, MW2, LW, SW1, SW2, SW3 and Trawler Band. Extra Medium waveband provides easier tuning of Radio Luxembourg, etc. Built in ferrite rod aerial for MW and LW. Retractable 4 section 24in. chrome plated telescopic aerial for SW. Socket for Car Aerial. Powerful push-pull output. 7 transistors and 2 diodes, fine tone moving coil speaker. Air spaced ganged tuning condenser. Volume/on/off, tuning and wave change controls. Attractive case with carrying handle. Size 9" x 7" x 4in. approx. Easy to follow instructions and diagrams. Parts price list and easy build plans 15p (FREE with parts).

Total building costs **£5.98** P. P. & (Overseas P. & P. £1) Ins. 45p.

ROAMER SIX

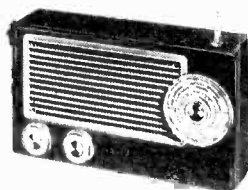

6 Tunable Wavebands: MW, LW, SW1, SW2, SW3, Trawler band plus an extra Medium waveband for easier tuning of Luxembourg etc. Sensitive ferrite rod aerial and telescopic aerial for Short Waves. 3in. Speaker. 8 stages - 6 transistors and 2 diodes Attractive black case with red grille, dial and black knobs with polished metal inserts. Size 9" x 5 1/2" x 2 1/2in. approx. Easy build plans and parts price list 15p (FREE with parts).

Total building costs **£3.98** P. P. & (Overseas P. & P. £1) Ins. 30p.

POCKET FIVE

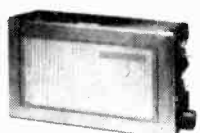

3 Tunable Wavebands: MW, LW, Trawler Band with extended M.W. band for easier tuning of Luxembourg, etc. 7 stages - 5 transistors and 2 diodes, supersensitive ferrite rod aerial, fine tone moving coil speaker. Attractive black and gold case. Size 5 1/2" x 1 1/2" x 3 1/2in. Easy build plans and parts price list 10p (FREE with parts).

Total building costs **£2.29** P. P. & (Overseas P. & P. 63p) Ins. 23p.

TRANSONA FIVE

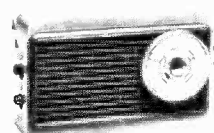

5 TRANSISTORS AND 2 DIODES

3 Tunable Wavebands: MW, LW and Trawler Band. 7 stage - 5 transistors and 2 diodes, ferrite rod aerial, tuning condenser volume control, fine tone moving coil speaker. Attractive case with red speaker grille. Size 9 1/2" x 4 1/2" x 1 1/2in. Easy build plans and parts price list 10p (FREE with parts).

Total building costs **£2.50** P. P. & (Overseas P. & P. 63p) Ins. 24p.

TRANS EIGHT

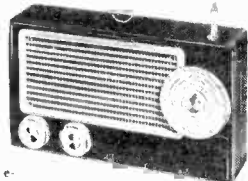

8 TRANSISTORS and 3 DIODES

6 Tunable Wavebands: MW, LW, SW1, SW2, SW3 and Trawler Band. Sensitive ferrite rod aerial for MW and LW. Telescopic aerial for Short Waves. 3in. Speaker. 8 improved type transistors plus 3 diodes. Attractive case in black with red grille, dial and black knobs with polished metal inserts. Size 9" x 5 1/2" x 2 1/2in. approx. Push pull output. Battery economiser switch for extended battery life. Ample power to drive a larger speaker. Parts price list and easy build plans 25p (FREE with parts).

Total building costs **£4.48** P. P. & (Overseas P. & P. £1) Ins. 32p.

NEW! "EDU-KIT"

BUILD RADIOS, AMPLIFIERS, ETC., FROM EASY STAGE DIAGRAMS. FIVE UNITS INCLUDING MASTER UNIT TO CONSTRUCT.

COMPONENTS INCLUDE:

Tuning Condenser; 2 Volume Controls; 2 Slider Switches; 3 inch Speaker; Terminal Strip; Ferrite Rod Aerial; 3 Plugs and Sockets; Battery Clips; 4 Tag Boards; Balanced Arranture Unit; 10 Transistors; 4 Diodes; Resistors; Capacitors; Three 47 Knobs. Units once constructed are detachable from Master Unit, enabling them to be stored for future use. Ideal for Schools, Educational Authorities and all those interested in radio construction

All parts including **£5.50** P. P. & (Overseas P. & P. £1) Ins. 32p

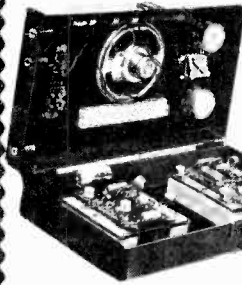

FULL AFTER SALES SERVICE

- Callers side entrance Barratts Shoe Shop
- Open 10-1, 2.30-4.30 Mon.-Fri. 9-12 Sat.

RADIO EXCHANGE CO

61 HIGH STREET BEDFORD. Tel. 0234 62367

I enclose £ please send items marked

ROAMER TEN	<input type="checkbox"/>	ROAMER SEVEN	<input type="checkbox"/>
ROAMER EIGHT	<input type="checkbox"/>	TRANS EIGHT	<input type="checkbox"/>
TRANSONA FIVE	<input type="checkbox"/>	ROAMER SIX	<input type="checkbox"/>
POCKET FIVE	<input type="checkbox"/>	EDU-KIT	<input type="checkbox"/>

Parts price list and plans for

Name

Address

PW48

OVER 1000 ITEMS ALWAYS IN STOCK

All items brand new and fully Guaranteed and backed by after-sales service

— latest models in manufacturers' sealed cartons



COMET for after-Sales Service THROUGHOUT THE UK
 Pictured: Service Dept. at Clough Rd. Hull
 sites at Birmingham, Brighton, Doncaster, Edinburgh, Gosle, Leeds, Leicester, Rochdale, Sheffield, Stockton, Wakefield and York.

CARTRIDGES—continued	Rec. Retail Price	Comet Price
EMPIRE 999E/X	15-57	10-95
EMPIRE 909E/X	12-12	8-50
EMPIRE 909E/X	9-37	6-95
ORTOFON M15E	27-60	22-75
SHURE M3DM	6-10	3-75
SHURE M31E	11-63	6-95
SHURE M32E	10-73	6-95
SHURE M44-G	8-30	4-95
SHURE M44E	7-90	4-90
SHURE M44C	7-90	4-90
SHURE M44E	8-60	5-25
SHURE M55E	9-70	5-80
SHURE M75G	14-70	8-40
SHURE M75-G	13-90	6-50
SHURE M75E	15-40	8-95
SHURE M75E	19-00	10-75
SHURE M75 ED	19-00	10-75
SHURE M75E/95G	20-80	12-95
SHURE V15-11	39-40	24-95
*SONOTONE 9TAHC Diam/Saph.	3-75	1-45

Starred cartridges above are ceramic. All others are magnetic.

BASES AND COVERS	Rec. Retail Price	Comet Price
GARRARD WBI Base	3-78	2-95
WB4 Base	5-60	4-25
SPCI Cover	3-68	2-75
SPC4 Cover	4-38	3-25

Special offer of Base and Cover to fit SP25, SL55, SL65B and 3500 Special Price 3-60

WB4 base Mk IIZ to fit Zero 100 and Zero 100S	6-55	4-80
GOLDRING Plinth 75	9-77	6-75
GOLDRING Plinth 72	9-42	6-50
GOLDRING Covers for 72P	4-71	3-25
Cover for 75P De Luxe	5-23	3-60
Cover for 85P	6-98	4-95
THORENS TX25 (for TD125AB)	8-85	6-95
THORENS TX11 Cover	4-49	3-60
SME Plinth System 2000 with motor-board	48-20	34-50
MOTORBOARDS only	5-85	4-45
SME P1 Spacer	0-98	0-75

BLANK TAPES	Rec. Retail Price	Comet Price
SCOTCH DYNARANGE CASSETTES		
C60	0-71	0-40
C90	0-99	0-50
C120	1-49	0-75
SCOTCH HIGH ENERGY COBALT CASSETTES		
C60	1-10	0-65
C90	1-45	0-85
SCOTCH Low Noise 8-TRACK BLANK CARTRIDGES		
40 mins	1-50	0-90
80 mins	1-80	1-10
SCOTCH LONG LIFE SPOOLED TAPES		
5" L.P. 900	1-41	0-85
5" L.P. 1200	1-76	1-10
7" L.P. 1800	2-52	2-50
SCOTCH HI-FI DYNARANGE SPOOLED TAPES		
5" L.P. 900	1-88	1-10
5" L.P. 1200	2-20	1-30
7" L.P. 1800	2-95	1-80

Postage—Tapes, cassettes and 8T cartridges 1-9 items 5p per order. Packs of ten post free.

HEADPHONES	Rec. Retail Price	Comet Price
AMSTRAD HP55A	6-95	3-95
HP56A with volume control	9-95	6-75
HP57A bass and treble controls	12-95	9-95
AKAI ASE2	6-90	4-70
AKAI ASE22	11-50	7-95
AKG K180	15-00	8-95
AKG 100	8-00	4-95
AKG 120	10-00	4-50
DULCI SH650D	Sp. Price	2-50
KOSS HV1	20-00	15-95
KOSS ESP-9 Electrostatic	69-00	52-95
KOSS ESP-6 Electrostatic	45-00	34-95
KOSS PRO 5LC	30-00	23-95
KOSS PRO-4AA	28-00	21-90
KOSS KO-727B	16-50	12-45
KOSS 747	20-00	15-90
KOSS K-711	10-00	7-90

HEADPHONES—continued	Rec. Retail Price	Comet Price
KOSS K6	12-50	9-90
KOSS K6/LC (with volume control)	14-00	11-10
PIONEER SE50	21-90	14-20
PIONEER SE30A	12-60	8-75
PIONEER SE20A	7-88	5-15
PIONEER SEL20	10-53	6-80
PIONEER SEL40	17-43	11-30
ROTEL RH630	6-50	4-50
ROTEL RH700	9-95	6-75
WHARFDALE DD1	12-50	8-75

HI-FI STEREO SYSTEMS—COMPLETE	Rec. Retail Price	Comet Price
ALBA UA552	47-75	29-95
BUSH A1005	69-89	53-25
DANSETTE Consort Stereo	34-43	23-95
DANSETTE 4005	71-45	52-95
DANSETTE 4020	47-99	31-95
DECCA Sound 613	Special Price	46-95
DECCA Sound 614	Special Price	52-95
DECCA Sound 1204	Special Price	70-95
DECCA Compact 2	Special Price	78-95
DECCA Compact 3	Special Price	88-95
DECCA 403	Special Price	44-95
EKCO ZU4	152-00	114-00
FERGUSON 3425	136-35	102-75
FERGUSON 3450 with Radio	74-20	55-95
FERGUSON 3451 with Radio	101-70	79-95
FERGUSON 3454	41-50	32-95
FIDELITY UA1 Music Master with Radio	100-00	69-95
FIDELITY UA2 Music Master	43-50	30-95
FIDELITY UA3 Music Master	63-00	45-95
FIDELITY Stereo Nine	38-50	22-95
GOODMANS Module 80 compact (Less L/S)	165-00	125-75
HMV 2450 with Stereo Radio	138-00	104-95
HMV 2451	122-00	95-95
HMV 2452	66-00	49-95
HMV 2453	66-00	49-95
KB1025 with 657 speakers	48-25	37-95
KB 1250 with KS 653 Speakers	71-00	53-95
KB 2010 with 658 speakers	101-50	77-95
KB 2250 with 658 speakers	124-00	95-95
MURPHY 902 Studio 1, AM/VHF Radio	84-50	64-95
MURPHY 903	84-42	64-95
PHILIPS 808	105-00	76-95
PHILIPS GF824	65-30	49-65
PHILIPS 825	49-50	38-95
PHILIPS 826	75-00	52-95
PHILIPS 835	69-50	49-95
PHILIPS 836	95-00	69-95
PYE Black Box unit stereo 1022	90-93	68-95
RIGONDA Party Time	28-50	20-95
STEPLETONE stereo system	41-75	25-95
ULTRA 8028	59-95	45-95
ULTRA 6450	74-20	57-95
ULTRA 6451	79-50	61-50
ULTRA 6455	41-35	31-95
ULTRA 6454	38-85	29-95

TAPE RECORDERS AND TAPE DECKS	Rec. Retail Price	Comet Price
AKAI 1720L 4-track Stereo	87-36	58-75
AKAI 4000D 4-track stereo deck	93-65	64-50
AKAI CR80D 8-track stereo tape deck	85-02	58-00
AKAI CR80T 8-track stereo recorder and tuner/amplifier	106-39	74-25
AKAI X200D	149-84	89-95
AKAI X200D	157-93	99-95
AKAI GX220D	223-00	164-95
AKAI 1800SD	182-79	101-95
AKAI 2000SD	289-07	223-30
BSR TD85 8-track deck	23-58	17-25
FERGUSON 3247 4-track	47-95	34-95
FERGUSON 3248 4-track	53-75	39-95
FERGUSON 3252 4-track	98-00	74-95
FERGUSON 3258 4-track	70-45	51-95
FERRROGRAPH 702/704 Dolby	264-38	224-50
FERRROGRAPH 721/724 Dolby	274-95	233-50
FERRROGRAPH 722/724 Dolby	301-98	255-95
FERRROGRAPH 722H Dolby	312-55	264-95

TAPE RECORDERS—continued	Rec. Retail Price	Comet Price
FERRROGRAPH 702/704	224-43	170-65
FERRROGRAPH 704/V 4-track deck	262-03	200-15
FERRROGRAPH 722	262-03	190-15
FERRROGRAPH 724	262-03	190-15
FIDELITY BRAEMAR 4-track	34-75	19-95
GRUNDIG TK 121 twin track	56-25	38-95
GRUNDIG TK 141 4-track	62-10	44-95
GRUNDIG TK 146 4-track Auto	86-95	48-95
GRUNDIG TK 147 4-track Auto	98-65	74-95
GRUNDIG TK 148 (4-track auto 2 speed)	74-10	56-95
GRUNDIG TK 246 4-track Stereo Deck	131-95	99-95
GRUNDIG TK 3200 Hi-Fi (Battery)	141-10	105-95
PHILIPS 4303 Twin-track	39-46	24-95
PHILIPS 4307 4-track	50-00	35-95
4308 De Luxe 4-track	59-00	42-95
4404 4-track stereo recorder	89-25	65-95
4407 4-track stereo recorder	108-50	73-95
PHILIPS 4414 4-track stereo recorder	120-00	99-95
PHILIPS 4416 4-track stereo recorder	145-00	122-95
4418 4-track stereo	200-00	145-95
4450 4-track stereo	295-00	214-95
4500 4-track stereo tape deck	124-30	91-95
PHILIPS 4510 4-track stereo tape deck	185-00	154-95
TANDBERG 2041 4-track (Stereo)	130-50	108-50
TANDBERG 1841 4-track stereo deck	66-00	49-95
TANDBERG 3021X twin track stereo	113-00	89-95
TANDBERG 3041X 4-track stereo	113-00	89-95
TANDBERG 4021X twin track stereo	179-00	145-95
TANDBERG 6041X 4-track stereo	199-30	159-95
TANDBERG 6021X twin track stereo	199-30	159-95

TAPE RECORDERS (CASSETTE)	Rec. Retail Price	Comet Price
AKAI CS 50 recorder	125-83	92-95
AKAI CS 50D Deck	104-46	77-50
AKAI GCX 40D Tape Deck	92-26	66-95
AKAI GCX 40	111-75	82-25
APCO Batt./Mains with AM/FM Radio	35-00	22-95
BUSH Discassette DC70	20-82	19-95
BUSH TP60	27-62	22-95
BUSH TP 66 Batt./Mains	28-18	21-50
BUSH TP 70 battery/mains	28-13	19-95
CARLTON LCR500	Sp. Price	11-95
DANSETTE DCT105	20-62	13-95
DECCA 2000 (batt./mains)	Sp. Price	22-95
DECCA CR1000 with VHF Radio	37-42	28-75
EKCO 350 Bt./Mns. VHF/MW Radio	23-23	18-45
EKCO 351 Battery/Mains	24-90	15-95
FERGUSON 3240 with case	43-55	31-95
FERGUSON 3253	30-15	22-95
FERGUSON 3262 Battery/Mains	37-55	28-95
GRUNDIG C200 De Luxe	48-75	38-95
GRUNDIG C210 batt./mains	41-55	29-95
GRUNDIG C410	44-75	23-95
HARVARD Elite with AM/FM radio batt./mains	61-45	45-95
JVC NIVICO 9420 L/S with AM/FM radio batt./mains	61-00	42-95
JVC Nivico 1710 Radio/Cassette/AM/FM	49-95	37-95
PHILIPS R.R. 392 with MW/VHF Radio Cassette	24-00	24-95
2202/2203	29-10	24-95
2204 battery/mains	42-50	31-95
PHILIPS 2205 Battery/mains	29-00	23-95
PHILIPS 2211 built in micro	70-00	52-95
2400 stereo less L/S	72-00	54-95
PHILIPS 2405 Stereo with 2 RH401 L/S	65-00	48-95
PHILIPS 2506 Stereo deck with DNL 3302	21-50	15-95
PVE 9109	20-37	14-95
PYE 9116 Stereo	66-10	49-95
PYE 9118	29-11	22-95
TELETON STC 106 Stereo Deck	46-45	36-95
TELETON TC110 battery/mains	27-50	18-50

FREE Technical Advisory Service. If in doubt ask us! Price list on request. Comet guarantees that all prices quoted are genuine. All items offered available at these prices at the time this issue closed for press. Add 15p for postage, packing and insurance on all orders (Cartridges 20p). **IF SECURICOR DELIVERY REQUIRED ADD £1.75 ONLY.** Make cheques, Money Orders payable to 'COMET'.



HIGH FIDELITY DISCOUNT WAREHOUSES

OPEN DAILY TO THE PUBLIC FROM
 9am-4pm Monday
 9am-1pm Tuesday
 9am-4pm
 Wednesday
 9am-4pm Thursday
 9am-4pm Friday
 9am-5.30pm Saturday

- Dept. PW BIRMINGHAM: Heeley Road, Selly Oak B29 6EY. Tel.: 021-472 6181.
- Dept. PW BIRMINGHAM: Tivoll Shopping Centre, 1570-1572 Coventry Road, Yardley. B26 1BU. Tel.: 021-706 0684.
- Dept. PW EDINBURGH: 1 Newhaven Road EH6 5XQ. Tel.: 031 554 4454 (9 lines).
- Dept. PW HACKBRIDGE: Felxex Trading Estate, 190 London Rd, Hackbridge, Sutton, Surrey. Tel.: 01-689-0271.
- Dept. PW HULL: Reservor Road, Clough Road HU6 7QD. Tel.: 46441 (6 lines)
- Dept. PW LEEDS: 78 Armoyle Road LS12 2EF. Tel.: Leeds 40551 (10 lines).
- Dept. PW STOCKTON: Teesway, Portrack Lane, Teesside TS18 2RH. Tel.: 661321/5215.
- Dept. PW ROCHDALE: Corner of Well 1st Lane and Queensway. Tel.: 50606.
- Dept. PW LEICESTER: Syston Street, Syston. Tel.: 0533 52236.
- Dept. PW SHEFFIELD: The Mill, 1 Loxley Rd, Malin Bridge, S6 4TN. Tel.: 0742 341721/6.
- Dept. PW WIGAN: Wharfe Mill, Princess Street, WN3 4EZ. Tel.: 0942 45680.

TOP QUALITY — LOW COST



AMATEUR RADIO EQUIPMENT

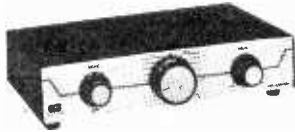

P.R.40
SOLID STATE
R.F. PRESELECTOR

The PR40 R.F. Preselector is the solid state version of the world famous PR30 which it now supercedes. It employs Silicon "N" Channel FET (Field Effect Transistor) front end, followed by silicon NPN Broad Band R.F. Amp., and will substantially improve receiver performance over the range 1.5 to 35 MHz, providing a considerable increase in gain up to an overall average of 30 dB, with improved image rejection and noise ratio. Supplied complete with co-ax plug (less standard 9 volt PP6 Battery), 12 months Guarantee. . . . £8.90 Carriage 30p.

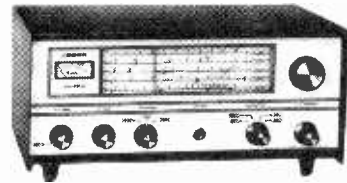

CR70A
COMMUNICATION RECEIVER

The CODAR CR70A is an outstanding general coverage communication receiver, ideal for the keen S.W.L. It tunes from 540 metres medium through to 10 metres with no gaps. Covers shipping, coastguard and distress frequencies, all six amateur bands 160-10 metres, International broadcast, Met. stations etc. etc. giving world-wide reception. Exclusive features include Air-spaced CODAR-COIL Hi-"Q" Aerial input, illuminated Meter and Slide Rule Scale, Two Speed vernier tuning, Switched B.F.O. for CW/SSB signals. Separate output for Tape recorder. Ready to plug in to 200/240 volts A.C. it only needs your aerial and a 2/3 ohm loudspeaker to bring the world to your finger tips. 12 months full guarantee.

Complete ready built £27.50, Carriage 70p. Ask the chap who's got one, there's lots of them!

NOTE: These CODAR Receivers meet the B.R.E.M.A. specification for Communication Receivers and are FREE of Purchase Tax. Some portable receivers being advertised as Communication Receivers do not meet these requirements.



MULTIBAND-6
SOLID STATE
SHORT WAVE RECEIVER KIT

All transistor T.R.F. Receiver tunes 550 KHz to 30 MHz (540 to 10 metres) complete coverage—no gaps. Medium waves—Trawlers—Ship/Shore Telephone—All Six Amateur Bands 160-10 metres—International Broadcast from Australia, Far East, Russia, USA etc. using 4 miniature plug in Coils, Hi-Gain FET Regen. Det./AF/AF Module giving full loudspeaker output to any external 2/3 ohm speaker. Receives AM/CW/SSB. Separate Electrical Bandsread, Calibrated Main Tuning. A Quality CODAR-KIT with 12 months Guarantee. No technical knowledge required, simple to build, printed circuit and Pictorial Instruction Manual, fully detailed step by step. Complete Kit with 4 Coils (less standard PP6 battery). £13.20 Carriage 35p. Stamp brings illustrated leaflets.



ON THE DESIGN STAFF—
G3SZM G3IRE

CODAR

TELECOMMUNICATIONS AND ELECTRONIC
EQUIPMENT SUPPLIERS TO H.M. AND OVERSEAS
GOVERNMENTS

VALCON WORKS · BURRELL BUILDINGS · CHURCHILL INDUSTRIAL ESTATE · LANCING · SUSSEX

Tel. 090-63-61901

BN15 - 8TZ

**Why pay more - look at our
Fantastic Bargain Offer!**

THE AVON AUDIO SYSTEM

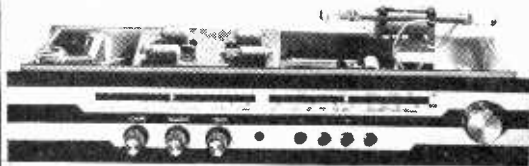

This uncabineted system is ideal as an economical replacement for an outdated chassis. The Stereo Tuner Amplifier with medium, long and short wavebands provides Worldwide coverage, even the weakest continental stations can be received with superb clarity. Push button band selection. 10 watts total output. Frequency response 25-18000 Hz.

BSR 4 SPEED STEREO/MONO RECORD CHANGER plays all types of 7in., 10in. and 12in. Mono or Stereo records. Manual or automatic play

TWIN ELLIPTICAL SPEAKER These low impedance, permanent magnet units have been specially selected to provide the fullest range of audio reproduction

EASY TO INSTALL—NO TECHNICAL KNOWLEDGE REQUIRED. List Price £46.20, OUR PRICE £37.00. Credit Terms £4.17 deposit plus 88p Post & Packing followed by 9 payments of £4.17 (Total Credit Terms £41.70) Don't miss this bargain. SEND £5.05 TODAY.



ALL EQUIPMENT COVERED BY 12 MONTHS FULL GUARANTEE.

CALLERS WELCOME

Please send me free details of your range

Name

Address

PW 12/72

Post coupon NOW for **FREE** leaflets

LEWIS radio

100, Chase Side London N.14
Tel: 01-886 3733/9666

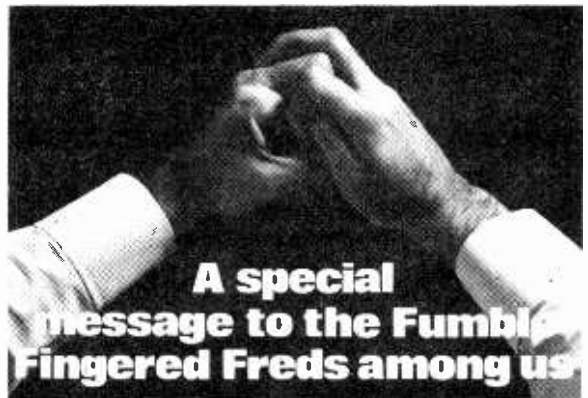

NEW STEPHENSPEAKERS

A new range of loudspeaker kits and cabinets with a style and specification for every purpose. You'll be cheating a bit if you tell your friends "made it myself". We supply superb craftsmen built fully finished cabinets in beautiful stain and scuff resistant vinyl in white or teak.

Just fit the speaker cloth (supplied) and screw in your speaker.

HIGH QUALITY AT LOW COST

Send for our free booklet "Choosing a Speaker"



STEPHENSPEAKERS,
WILMSLOW AUDIO, Dept. 'PW', Swan Works, Bank Square, Wilmslow SK9 1HF



ILP. (Electronics) Ltd

THE HY41

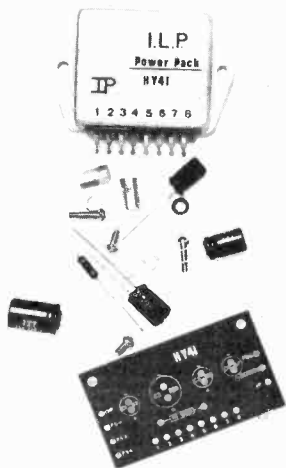

The HY41 supersedes the popular HY40 introduced by ILP last year. This highly improved module achieves true High Fidelity with a dramatic reduction in distortion (typically 0.05% at 1KHz into 8 ohms!) and is electronically and mechanically compatible with the HY40.

With this important improvement the HY41 retains all of the quality characteristics found in the earlier version and P.C. board, Resistor, Capacitors, Hardware Mountings and comprehensive manual are included in the basic kit. No further components are required to construct a complete power amplifier of extremely high performance sufficiently versatile to provide power not merely for Hi-Fi but also for public address systems and industry.

The free manual gives a full circuit diagram of the HY41 and its various applications including a complete stereo amplifier.

Like its predecessor the HY41 is based on conventional and proven circuit techniques developed over recent years.

OUTPUT POWER: British Rating 40 WATTS PEAK, 20 watts

R.M.S. continuous.

LOAD IMPEDANCE: 4-16 ohms.

INPUT IMPEDANCE: 30K ohms at 1KHz.

VOLTAGE GAIN: 30db at 1KHz

TOTAL HARMONIC DISTORTION: less than 0.15% (typical 0.05%) at 1KHz.

FREQUENCY RESPONSE: 5Hz-50KHz \pm 1db.

SUPPLY VOLTAGE: \pm 22.5volts D.C.

SUPPLY CURRENT: 0.8 amps maximum.

PRICE: inc. comprehensive manual, P.C. board, five extra components and P. & P.:—
MONO: £4.90 **STEREO: £9.80**

UNIQUE HYBRID PRE-AMPLIFIER

The HY5 has rapidly established a position in the WORLD as the sole hybrid pre-amplifier to contain all feedback and equalization networks within an integrated pre-amplifier circuit.

Supplied with the HY5 are two stabilizing capacitors and by the addition of volume, treble and bass potentiometers it is ready for use.

Internally the HY5 provides equalization for almost every conceivable input, the desired function is achieved by use of a multi-way switch or by direct interconnection.

Two distinctive features of the HY5 are its inbuilt stabilization circuit, allowing it to be run off any unregulated power supply from 16-25 Volts and a balance circuit which, when linked by a balance control to a second HY5, forms a complete stereo pre-amplifier.

Specifically and critically designed to meet exacting Hi-Fi standards, the HY5 combines extremely low noise with a high overload capability. When used in conjunction with the HY41 and PSU45 forms a completely integrated system.

INPUTS

Magnetic Pick-up (within \pm 1db RIAA curve) 2mV. 47K Ω

Tape Replay (external components to suit head). 4mV. 47K Ω

Microphone (flat) 10mV. 47K Ω

Ceramic Pick-up (equalized and compensatable) 20-2000mV. variable.

Tuner (flat) 250mV. 100K Ω

Auxiliary 1 250mV. 47K Ω

Auxiliary 2 2-20mV. 100K Ω

OUTPUTS

Main Pre-amp output 500mV.

Direct tape output 120mV.

ACTIVE TONE CONTROLS (Bexendall)

Treble \pm 12db.

Bass \pm 12db.

INTERNAL STABILIZATION

Enables the HY5 to share an unregulated supply with the Power Amplifier.

SUPPLY VOLTAGE

16-25 volts

PRICE: MONO: £3.60 STEREO: £7.20

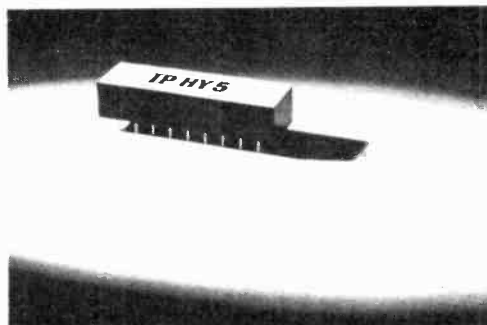

SUPPLY CURRENT

6mA approx.

OVERLOAD CAPABILITY

better than 26db on most sensitive input infinite on tuner and auxl.

OUTPUT NOISE VOLTAGE: 0.5mV.

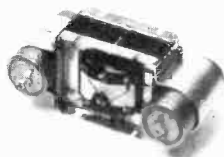

POWER SUPPLY PSU45

The versatile P.S.U.45 is designed to supply your HY41's +HY5's in stereo or mono format.

Specification

Input: 200-240 Volts.

Output: \pm 22.5 Volts at 2 amps.

Overall Dimensions: L. 7"; D. 3.8"; H. 3.1"

PRICE: £4.50 inc. P. & P.

CROSSLAND HOUSE · NACKINGTON · CANTERBURY · KENT

CANTERBURY 63218

now YOU can CATCH SHOALS OF BIG FISH with new electronic miracle

special introductory offer £2.50

First time marketed in England, this exciting electronic instrument the "Decoytronic" is the one responsible for starting the electronic fish-rage in the U.S.A. just recently. Uses ingenious double-action method of attracting all kinds of fish from hundreds and hundreds of feet away... saltwater or freshwater. Why this device is so fantastically successful is because it actually imitates the sound of sea insects milling about the surface. These sound waves spread out hundreds of feet in all directions. Although this peculiar sonic frequency won't sound like much to you—to all the fish in the area it's their dinner bell! But that's not all... *electroluminescence neon tubes cunningly flicker intermittently*, penetrating the area for hundreds of feet around, at a frequency fish are unable to resist. The fish mistake this flickering glimmer for light, and the electroluminescence glow given off by Plankton... a favourite delicacy of most fish!!! All you do is switch on, lower into the water (it's completely water resistant) allow around 5 minutes—then start reeling 'em in. We'll bet you won't be able to reel 'em in fast enough. Self-contained batteries last ages—costs pennies. Kit of all parts including special easy as a.b.c. directions only £2.50 + 25p. P. & P. (Parts available separately).



the amazing "Phototron" SOUND OPERATED FLASH

ONLY £4.50

Take flash pictures at the exact instant of the bursting of a balloon. A champagne cork leaving the bottle. The split second a hammer strikes a light bulb. *The mind boggles at the possibilities of the "Phototron"...* the only limit is your imagination. Now that inexpensive flash guns are on the market in quantity, it has made possible, with the help of electronics the production of a wide variety of exciting photography effects, once strictly limited to the professionals. The duration of an electronically produced flash is extremely brief and normally measured in Milliseconds. Now, providing the camera shutter is left open in a dark or subdued light, it is the timing of the flash that determines what is imprinted on the film—not necessarily anything done by the camera. As electronic flash guns are fired by making a switched connection then it becomes obvious that one of the latest Silicon Controlled Rectifiers can be used. If we make this S.C.R. operate by sound (with variable sensitivity control for soft/loud sounds) some real "way out" photography effects can be captured forever on film. Easily built in a couple of hours or so, the "Phototron" is fully solid state, uses self contained PP3 battery. No soldering necessary using our special terminal board (pat. Applied for). All parts including special pictorial step-by-step plans, transistors, microphone, S.C.R., potentiometers, switches, test lamp, case, nuts, screws, etc. etc. ONLY £4.50 + 25p P. & P. Made up must be worth at least £10 (parts available separately).

BUILD 5 RADIO AND ELECTRONIC ORGAN ONLY £3.25



Don't confuse with ordinary electronic organs that simply blow air over mouth-organ type reeds etc Fully transistorised. **SELF-CONTAINED LOUDSPEAKER.** Fifteen separate keys span two full octaves—play the "Yellow Rose of Texas", play "Silent Night", play "Auld Lang Syne" etc. etc. You have the thrill and excitement of building it together with the pleasure of playing a real, live portable electronic organ. **NO PREVIOUS KNOWLEDGE OF ELECTRONICS NEEDED.** No soldering necessary, simple as ABC to make. **Anyone over nine years can build it easily in one short evening following the fully illustrated step-by-step, simple instructions.** ONLY £3.25 + 25p. p. & p. for kit, including case, nuts, screws, simple instructions, etc. Uses standard battery (parts available separately). Have all the pleasure of making yourself, finish with an exciting gift for someone.

Eavesdrop on the exciting world of Aircraft Communications—Y.H.F. AIRCRAFT BAND CONVERTER ONLY £2.85



Listen in to AIRLINES, PRIVATE PLANES, JET-PLANES. *Eavesdrop on exciting conversations between pilots, ground approach control, airport tower. Hear for yourself the disciplined voices hiding tenesness in talk downs.* Be with them when they have to take nerve ripping decisions in emergencies—Tune into the international distress frequency. Covers the aircraft frequency band including HEATHROW, GATWICK, LUTON, RINGWAY, PRESTWICK, ETC. ETC. CLEAR AS A BELL. This fantastic fully transistorised instrument can be built by anyone over nine in under two hours. No soldering necessary. Fully illustrated simple instructions take you step-by-step. Uses standard PP3 battery. All you do is extend rod aerial, place close to any ordinary medium wave radio (even tiny portables). **NO CONNECTIONS WHATSOEVER NEEDED.** SEND ONLY £2.85 + 20p. p. & p. for kit including case, nuts, screws, wire, etc. etc. (Parts available separately).

FIND BURIED TREASURE! Transistorised Treasure Locator



This fully portable transistorised metal locator detects all tracks—down buried metal objects—it signals exact location with loud audible sound (no phones used)—uses any transistor radio which fits inside—no connections needed. **FIND GOLD, SILVER COINS, JEWELLERY, ARCHAEOLOGICAL PIECES ETC. ETC.** Extremely sensitive will signal presence of certain objects buried several feet below ground. No knowledge of radio or electronics required. Can be built with ease in one short evening by anybody from nine years of age upwards, with the clear, easy to follow, step-by-step, fully illustrated instructions—Uses standard PP3 battery. No soldering necessary. Kit includes case, nuts, screws, wire, etc. ONLY £2.85 + 25p. p. & p. (Sectional handle as illustrated 85p. extra). Parts available separately. Made up looks worth £15.

Amazing Radio Construction Set. Become a radio expert for £2.45. A complete Home Radio Course. No experience needed. Parts including simple instructions for each design. Illustrated step-by-step plans, all transistors, loudspeaker, personal phone, knobs, screws, etc. all you need. Presentation box 45p extra as illus. (if required) (parts available separately) no soldering necessary. SEND £2.45 + 20p p. & p.

SOOTHE YOUR NERVES RELAX WITH THIS AMAZING RELAXATRON



CUTS OUT NOISE POLLUTION SOOTHE YOUR NERVES!—The RELAXATRON is basically a pink noise generator. Besides being able to mask out extraneous unwanted sounds, it has other very interesting properties. IF YOU WORK IN NOISY OR DISTRACTING SURROUNDINGS, IF YOU HAVE TROUBLE CONCENTRATING, IF YOU FEEL TENSED, UNABLE TO RELAX—then build this fantastic Relaxatron. Once used you will never want to be without it—TAKE IT ANYWHERE. Uses standard PP3 batteries (current used so small that battery life is almost shelf-life). **CAN BE EASILY BUILT BY ANYONE OVER 10 YEARS OF AGE** using our unique, step-by-step, fully illustrated plans. No soldering necessary. All parts including case, a pair of crystal phones. Components. nuts, screws, wire, etc. £2.75 + 25p p. & p. (Parts available separately).

TREASURE LOCATOR MODULE ONLY £4.50



FULLY TRANSDISORISED METAL DETECTOR MODULE. Uses PP3 battery and phones. Put it in a case, screw a handle on and you HAVE A PORTABLE TREASURE LOCATOR EASILY WORTH ABOUT £20! Extremely sensitive—penetrates through earth, sand, rock, water, etc.—EASILY LOCATES COINS, GOLD, SILVER, JEWELLERY, HISTORICAL RELICS, BURIED PIPES, ETC. So sensitive it will detect certain objects buried SEVERAL FEET BELOW GROUND! GIVES CLEAR SIGNAL ON ONE COIN. Send only £4.50 + 30p carriage for kit (High quality Danish Stethoscope headphones £2.75 extra if required).

INGENIOUS ELECTRONIC SLEEP INDUCER ONLY £3.25



Do you wake up in the night and can't get off to sleep again? Would you like to be gently soothed off to a slumber each every night? Then build this ingenious electronic sleep inducer. It even stops by itself so you don't have to worry about it being on all night! The loudspeaker produces soothing audio-frequency sounds, continuously repeated—but as time goes on the sound gradually becomes less and less—until eventually ceases altogether, the effect it has on people is amazingly very similar to hypnosis. All transistor. No knowledge of electronics or radio needed. Step-by-step instructions included. No soldering necessary. Kit includes case, nuts, wire, screws, etc. SEND £3.25 + 25p p. & p. (Parts available separately).

SHORTWAVE TRANSISTOR RADIO ONLY £2.75



Anyone from 9 years up can follow the step-by-step, easy ABC, fully illustrated instructions. No soldering necessary. Kit includes transistors logged on rod aerial in 30 mins.—RUSSIA, AFRICA, USA, SWITZERLAND, ETC. Experience thrills of world wide news, sport, music, etc. *Eavesdrop on unusual broadcasts.* Uses PP3 battery. Size only 3" x 4 1/2" x 1 1/2" ONLY £2.75 + 20p p. & p. Kit includes case, nuts, screws, wire, etc. (Parts available separately).

UNIQUE RADIO FOR BEDROOM OR OFFICE No batteries, no electricity. ONLY £1.70 never wears out



Tune in your favourite programmes or the news, or sports in the Office or in your bedroom. Uses sensitive, germanium diode originally evolved from Wartime radar. Never buy a battery. Never use electricity. Never replace. Covers all medium waves. Clear beautiful tone. Size 4 1/2" x 2 1/2" x 1 1/2" in beautiful case. ONLY 7 CONNECTIONS AND IT'S WORKING. No soldering necessary. **CAN BE BUILT ALMOST BLINDFOLD IN UNDER 15 MINUTES!** Ideal for absolute beginner from 8 years of age upwards. **SPECIAL PRICE TO CLEAR STOCKS OF COMPONENTS. ONLY £1.70 + 20p. P. & P.** for all parts including beautiful case, germanium semi-conductor, tuning condenser, personal phone, wire, nuts screws. **SIMPLE AS A.B.C. INSTRUCTIONS** (Parts available separately).

"READ PEOPLE'S MINDS"—TEST THEIR NERVES—BEAT THEM AT CARDS, ETC. WITH THIS ASTONISHING ELECTRONIC BRAIN BOX ONLY £2.87



With this "Brain-box" you will be able to perform mind-boggling feats. **THE MIND READING DEVICE** will make people see what you have "telepathic" powers. **THE AMAZING CARD TRICK UNIT** completely mystifies and baffles from one to six people. You correctly "guess" the two cards each person has selected at random from a pack they themselves shuffled. **THE ELECTRONICS NERVES TESTER** puts your friends to a very lively test. It gives out fail and finish signals (the winner is the person with lowest number of fail signals). **CAN BE ADJUSTED FROM THE WEAKEST TO STRONGEST PERSON.** **THE ELECTRONIC MAZE** tests the mental ability of the player because it uses a maze with an electronic twist to it. You can change the maze pathways in seconds to prevent the maze becoming too stale after lots of use. Completely safe and foolproof. Size 18" x 12" x 6" (Max.). You can play all these games and more beside after building the "Brain box". No soldering, you get pictorial, easy as a.b.c. step-by-step simple instructions. ONLY £2.87 + 35p. p. & p. for all parts including chassis, switches, styus, signalling lights, wire, nuts, screws, etc. etc. Uses standard battery. Presentation Box 35p. extra as illus. if reqd. (PARTS AVAILABLE SEPARATELY) FULL OPERATING DIRECTIONS WITH EACH OF THE PROJECTS.

AMAZING MAGIC MUSIC BOX make electronic music waving your hands about only £2.75



Everyone's heard the weird, wonderful, but beautiful music used in Science Fiction Films, Horror Films etc., also on Radio and Television. This unearthly, eerie music is almost always produced by a little known electronic device measuring only a few inches... called a Therenin. All you have to do is switch on your radio (almost any type will do) and place the Therenin close by. Switch on the Therenin and proceed to wave your hands mysteriously in the air like a magician. The most fantastic musical sounds are then produced, and with a little practice people can learn to play all the well known tunes. Apart from it's musical value, it's small size allows it to be used to best advantage at parties, gatherings of friends etc., where it attracts tremendous interest. Provides hours and hours of pleasure to young and old. Uses standard PP3 battery which lasts ages. The 3 Transistor circuit, though fairly advanced is simple to build with our pictorial step-by-step plans. No soldering necessary. Easily built in an hour or so using our special terminal board (Pat. Applied For). All parts including nuts, bolts, case etc., ONLY £2.75 + 25p P. & P. (Parts available separately).

INGENIOUS ELECTRONIC SINGING & WARBLING CANARY only £4.50



Actually whistles & warbles like a real live Canary! Amazing circuitry faithfully repeats the bird's magnificent song. Just switch on and leave it—blasting down scale for some seconds, suddenly breaking into a delightful warble, then several seconds later shutting off for a second or two—only to start automatically again in a few seconds. People listen to the delightful song all day and never get bored! Relax, as the sweetest nerve-soothing music, the bird's song, is yours. The bird's song is yours. Easily built in an hour or so to young and old alike. Standard self-contained battery lasts ages. No soldering necessary. All parts including toy to young and old alike. Standard self-contained battery lasts ages. No soldering necessary. All parts including toy bird (not supplied) ONLY £4.50 + 25p P. & P. (Parts available separately).

BROADWAY ELECTRONICS

92 MITCHAM ROAD, TOOTING BROADWAY,
LONDON S.W.17 01-672 3984
(Nr. Tooting Broadway Underground Station)
(Closed all Wednesday)

THE SHELLEY

Size 21 x 11 x 6 1/2 in.

An extremely elegant speaker system made of 12mm. chipboard covered with black leathercloth with mottled Vynair front. This unique system uses three ex-TV speakers. Will handle 10 watts and will match 8 ohms impedance. A real bargain at £5.15 plus 70p. British Isles.

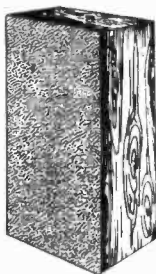

CARTRIDGES—Stereo

Sonotone 9TA H/C Diamond £2.40. Ronette S105 Medium Output, £1.40. S106 High Output £1.40. Acos GP93/1 Sapphire, £1.90. GP94 1 Sapphire, £2. Japanese equivalent to B.S.R. TC8s, £1.75. P. & P. 7np on each.

CARTRIDGES—Mono

GP.91 Stereo Compatible £1.25. Acos GP67/2 will replace Collaro and Garrard Mono cartridges, 95np. B.S.R. TC8H Jap. equivalent £1.25. P. & P. 7np.

FARRA-DAY

5 1/2" x 11" x 4 1/2" covered in White, Green or Black rexine or Teak cloth with Silver coloured metal front 3ohm ex. tv speaker. £2.90 P & P 25p

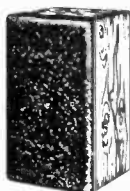

ELF

An extension speaker of quality; 9 x 5 1/2 x 3 1/2 in. veneered in natural teak with smart gold and mottled Vynair front 3 ohm ex-TV speaker. The baffle is half inch thick. A real bargain at £1.92 1/2. Post and packing. 37 1/2p.

SPEAKER MATCHING

TRANSFORMERS 3, 7, 15 ohms, 8 watt, 70np. P. & P. 17np.

HI-FI STEREO HEADPHONES

Padded ear cushions seal out room noise. Perfect coupling between reproducer and ears assure full response impedance 8 ohms. frequency range 30-15,000 Hz 6ft. cord and standard stereo plug. Only £2.57 1/2. P. & P. 27 1/2p.



STEREO HEADPHONE JUNCTION BOX

Simple unit connects direct to amplifier and speakers to give attenuated headphone output has 3 position switch to give headphones only, speakers only, speakers and headphones. Only £1.50. P. & P. 13p.

VYNAIR

Widths from 50 to 54 in., 75np yd. off roll. P. & P. 10np, 1/2 yard 40np. P. & P. 10np. Send 5np stamps for samples.

£3.15

P. & P. 61p

Makes all the difference to volume and quality. Contains 3 speakers in series—ex-TV Output 8 watts. Impedance 9 ohms. Available in black leathercloth. Size 23 1/2" x 5 1/2" x 5 1/2". Keyhole slot for wall mounting. Twin connecting cable 12yds., 35p min.

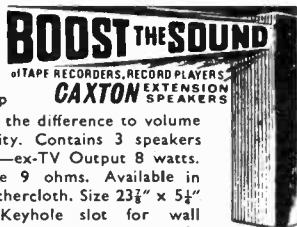

RSGB BOOKS FOR YOU

RADIO COMMUNICATION HANDBOOK

832 pages of everything in the science of radio communication. The Handbook's U.K. origin ensures easy availability of components. Complete coverage of the technical & constructional fields. A superb hard-bound volume. £4.10 post paid

New (fourth) edition of the ever-popular AMATEUR RADIO TECHNIQUES

by Pat Hawker, G3VA

Substantially enlarged edition comprising 256 pages with over 600 diagrams. New material and features include more emphasis on integrated circuits, a quick guide to digital electronics, and much additional information on the cure of TV interference and on aerials. £1.80 including postage and packing

RAE MANUAL

by G. L. Benbow, G3HB Sixth (1972) edition

The standard work for all would-be licensed radio amateurs studying for the Radio Amateurs' Examination. A completely re-written edition brought fully up to date to meet the present examination syllabus requirements.

96 pages

90p post paid

These are three of a complete range of technical publications, log books and maps, all obtainable from:

RADIO SOCIETY of GREAT BRITAIN

35 DOUGHTY STREET, LONDON, WC1N 2AE

ERSIN



for fast, easy reliable soldering

Ersin Multicore Solder contains 5 cores of non-corrosive flux, instantly cleaning heavily oxidised surfaces. No extra flux is required.

IDEAL FOR HOME CONSTRUCTORS



Size 1 cartons all at 25p each in 40/60, 60/40, or Savbit alloys in 7 gauges.

EASY-TO-USE DISPENSERS



Size 5 (Savbit) 18swg, 18p (illustrated)

Size 19A (60/40 alloy) 18swg, 18p

Size 15 (60/40 alloy) 22swg, 22p

BIB WIRE STRIPPER AND CUTTER



NEW!

Model 3A. Strips insulation from cable or flex without nicking wire. 4 different settings, 4 & 6 BA spanner ends, ground cutting edges Price 32p. Also available, de luxe Model 8. Price 58p.

From Electrical and Hardware Shops. If unobtainable, write to: Multicore Solders Ltd., Hemel Hempstead, Herts.

SAXON ENTERTAINMENTS.

STANDARD & CUSTOM-BUILT AUDIO & ELECTRONIC EQUIPMENT
NEW & SECONDHAND MUSICAL INSTRUMENTS. MAIN
DISTRIBUTORS FOR A.K.G. HIGH QUALITY MICROPHONES.

SA25-SA35-SA100

LOW-PRICED AUDIO MODULES
FOR DOMESTIC & COMMERCIAL USE



THESE THREE MODULES HAVE ENJOYED UNPARALLELED SUCCESS DURING THE FIRST FEW MONTHS OF THEIR BEING MADE AVAILABLE TO THE GENERAL PUBLIC. WE ARE PLEASED TO ANNOUNCE THAT WE CAN NOW OFFER FAST DISPATCH ON MOST OF OUR ADVERTISED ITEMS, INCLUDING THESE THREE MODULES.

SA25 £2.95 carr. free

25 WATTS RMS. 7 transistors 7 diodes

SA35 £4.45 carr. free

35 WATTS RMS. 7 transistors 7 diodes

SA100 £10.90 carr. free

100 WATTS RMS. 11 transistors 6 diodes

ALL THREE MODULES HAVE OPEN & SHORT CIRCUIT PROTECTION, AND THE SA100 IS PROOF AGAINST OVER-DISSIPATION & FAULTY INDUCTIVE LOADS. ONLY ADVANCED DESIGN TECHNIQUES MAKE THESE EXTRA-ORDINARILY LOW PRICES POSSIBLE.

BRIEF SPEC. FOR ALL THREE MODULES

Freq. response	15-40,000 Hz \pm 1dB
Distortion	0.2% at 1 kHz
Loads	4 to 16 ohms
Quiescent current	15 mA
Noise	Better than -75 dB
Supply voltage	25-45 volts SA25/35 40-70 volts SA100
Size	4 1/2" x 4" x 1" (SA100) 4" x 3" x 1" (SA25/SA35)

Circuits, connecting instruction and application data are supplied free with all modules.

POWER SUPPLIES FOR THE SA25/35 & SA100 AUDIO MODULES

Stab PS45	Stabilized module for 2 SA25's or two SA35's	£3.50 carr. free
MT45	Transformer for above, heavy duty	£2.85 carr. 20p
MT30	Transformer for unstabilized supply complete with rectifier diodes mounted	£3.50 carr. 20p
PU70	Unstabilized supply for one or two SA100	£6.75 carr. 40p
PS70	Stabilized supply module for one or two SA100's	£4.90 carr. free
MT70	Transformer for PS70	£4.90 carr. 40p

ALL MODULES ARE BUILT ON
GLASS FIBRE P.C. BOARD

OTHER SAXON PRODUCTS. . .

120 WATT HEAVY DUTY MODULE £13.90 + 20p carr. or with supply
£18.95 + 40p carr.

Featuring a rugged class A driver stage, this module will run from all our mixers, etc., and most other makes of mixer. It delivers 120 watts into an eight ohm load and employs 4 T03 can (115 watt) output transistors.

SPECIFICATION

Power output	120 watts into 8 ohms
Freq. response	30-30,000 Hz \pm 2dB
Input sensitivity	200 mV into 10K
Construction	Fibreglass board
Size	8" x 4" x 4" (5" with supply)

Low distortion parallel push-pull output stage.



SINGLE CHANNEL SOUND/LIGHT CONVERTER

This compact and reliable unit operates from amplifiers with outputs from 5-100 watts. Does not impose a heavy load on the amplifier, or, if connected in the wrong polarity, cause any damage, as with some units.

Operation is simplicity itself and the unit is fully fused. The unit is supplied to function from bass notes but may easily be converted to respond only to treble or mis-range notes by the addition of components costing less than 5p.

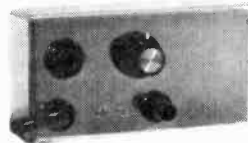

£8.90 carr. free

THREE CHANNEL SOUND TO LIGHT UNIT

Handling the total of 3000 watt (3kw) this unit is unique for its price in that not only bass, middle and treble but also master controls are provided. Two amplifier sockets eliminate the need for split leads, etc. Supplied in tough white steel case with a blue stelvette hooded cover. Fully guaranteed.

£19.75 carr. 30p

SAXON STEREO CONTROL UNIT



£15.80 carr. 30p
MONO VERSION £6.50 carr. 20p
(As illustrated left S.A.E. details 9 volt operation)
Outputs up to 1 volt RMS

Two decks, and full headphone monitoring. The unit is mains operated and measures 17 1/2" x 3" x 4" deep and is finished with a smart white on black fascia. The controls are: Left/Right deck fader, volume, bass, treble, Headphone Selector and volume, Microphone volume, bass, treble, mains on/off. THIS IS A MUST FOR THE HOME BUILT HIGH QUALITY DISCOTHEQUE AND IS COMPARABLE TO UNITS AT OVER TWICE THE PRICE.

COMPLETE AMPLIFIERS

The CSE 100. £34.90 carr. free

This versatile unit is now available in a black vinyl case and so represents even better value than ever delivering speech and music powers of up to 100 watts RMS and continuous sine wave outputs of 70 watts. Two individually controlled inputs with wide range bass and treble controls. Ideal for small groups D.J.S., etc.



The SAXON 100 £48.50 carr. free



With an RMS output of 120 watts speech and music, 100 watts continuous power, four individually controlled FET input stages and wide range bass and treble controls, this amplifier has established itself as a unit offering quality and reliability at low cost.

LOUDSPEAKERS British made bargains!!

12" 25 watt 8/15 ohms £4.95 carr. 30p. 15" 50W.8/15 ohm £14.50 carr. 50p.
12" 40 watt 15,000 gauss magnet system 8/15 ohm £11.50 carr. 40p.
A.K.G. microphones suitable for disco. group or general P.A. use.
D11DHL rrp £11.00 our price £9.45 post free
D190C High Z rrp £21.50 our price £17.45 post free
D1000C 24 ct gold plate rrp £37.00 our price £32.00 post free

SEND SAE FOR OUR A.K.G. PRICE LIST. DISCOUNTS ON ALL MICS.

CALLERS & MAIL ORDER:

327-331 Whitehorse Rd.,
West Croydon, Surrey.
CRO 2HS 01-484 8385

CALLERS ONLY:

6a Delce Rd., Rochester,
Kent. Medway 404199

BUSINESS HOURS:

9.30 a.m.
to 5.30 p.m.

TERMS OF BUSINESS:

C.W.O. or C.O.D. (35p extra)
All cash in regd. envelopes please!
Telephone orders to our CROYDON BRANCH.
TRADE & EXPORT enquiries invited.

RTVC THE

THE FABULOUSLY SUCCESSFUL VISCOUNT III AUDIO £52 complete

14 + 14 watts r.m.s. 40Hz to 40kHz ± 3 dB. Total distortion at 10 watts at 1kHz -0.1%

This is real value for money! We have designed 2 systems and the heart of them all is the Viscount III amplifier. A unit of great eye appeal with teak finished cabinet. FET's (Field effect transistors) are incorporated on the input stages, just like top priced units. FET's give you more of the signal you want and almost none of the hiss you don't. Both units have output sockets for headphones and tape recorder. Filters and tone controls give a wide range of bass and treble adjustment.

For both systems we have chosen the famous Garrard SP25 Mk. III deck which comes with fitted magnetic cartridge, simulated teak plinth and tinted acrylic dust cover. The exclusive Duo loudspeaker systems are incomparable for quality within their price range. Large speakers in extremely substantial cabinets. There's a choice of the Duo II's for the smaller room or the big Duo III's for real bass response.

SPEAKERS

Duo Type II Size approx. 17in. x 10 $\frac{1}{2}$ in. x 6 $\frac{1}{2}$ in. Drive unit 13in. x 8in. with parasitic tweeter. Max. power 10 watts, 8 ohms. Simulated Teak cabinet. £14 pair + £2 p&p.

Duo Type III Size approx. 23 $\frac{1}{2}$ in. x 11 $\frac{1}{2}$ in. x 9 $\frac{1}{2}$ in. Drive unit 13 $\frac{1}{2}$ in. x 8 $\frac{1}{2}$ in. with H.F. speaker. Max power 20 watts at 3 ohms. Freq. range 20Hz to 20kHz. Teak veneer cabinet. £32 pair + £3 p&p.

SPECIFICATION R101

14 watts per channel into 3 to 4 ohms. (suitable 3-15 ohms). Total distortion @ 10W @ 1kHz 0.1%. P.U.1. (for ceramic cartridges) 150mV into 3 Meg. P.U.2. (for magnetic cartridges) 4mV @ 1kHz into 47K equalised within ± 1 dB R.I.A.A. Radio 150mV into 220K. (Sensitivities given at full power). Tape out facilities: headphone socket, power out 250mW per channel. Tone controls and filter characteristics. Bass: +12dB to -17dB @ 60Hz. Bass filter: 6dB per octave cut. Treble control: treble +12dB to -12dB @ 15kHz. Treble filter: 12dB per octave. Signal-to-noise ratio: (all controls at max) -P.U.1. and radio -65dB, P.U.2 -58dB. Cross talk better than -35dB on all inputs. Overload characteristics better than 26dB on all inputs. Size approx. 13 $\frac{1}{2}$ x 9in. x 3 $\frac{1}{2}$ in.

BRITISH MADE—12 MONTHS WRITTEN GUARANTEE

Send S.A.E. for fully illustrated brochure

—ONLY FROM US

PRICES: SYSTEM 1

Viscount III R101 amplifier	£22.00+90p p&p
2 x Duo Type II speakers	£14.00+£2 p&p
Garrard SP25 Mk. III with MAG. cartridge plinth and cover	£23.00+£1.50 p&p
Total	£59.00

Available complete for only £52 + £3.50 p&p

PRICES: SYSTEM 2

Viscount R101 amplifier	£22.00+90p p&p
2 x Duo Type III speakers	£32.00+£3 p&p
Garrard SP25 Mk. III with MAG. cartridge plinth and cover	£23.00+£1.50 p&p
Total	£77.00

Available complete for £69 + £4 p&p



MUSIC MAKERS

UNISOUND FOR THE NEW SOUND

AT £25

The whole system is complete including superb cabinets in simulated teak—just simply screw together the components and you save pounds!
 Amplifier is based on the famous Mullard Unilux system. Garrard 2025TC turntable complete with stereo ceramic cartridge, teak simulated plinth and tinted acrylic cover. Plus the big 13" x 8" EMI Twin-cone speakers ready for mounting in their elegant cabinets, which simply need screwing and glueing together. All glue and screws supplied.
 Easy to follow step-by-step instructions guide you quickly and effortlessly to taking the wraps off truly realistic stereo sound.
£25 complete plus £2.80 p. & p.
Diamond Stylus £1.25 extra.
 Power output: 4 watts per channel into 8 ohms.
 Inputs: 120 mV (for ceramic cartridges).
 Stereo headphones with adaptor £4.00

UNISOUND MODULES ONLY £6.95

If you prefer, you can buy the three modules—pre-amplifier, power supply/dual power amplifier, and control panel—by themselves for only £6.95. P. & P. 50p extra.

No soldering, just simply screw together with screwdriver supplied. Their overall specification is the same as shown for the complete Unisound console, using the high efficient i.c. monolithic power chips to ensure very low distortion at all power levels, correct operation in all ambient temperatures. Full power over the audio spectrum.



AN R T V C EXCLUSIVE DESIGN S.A.E. for leaflet

A 'NATURAL' ONLY FROM THE TOURIST PB CAR RADIO KIT



Apart from the output stage, which is an integrated circuit, the only other electronic components that need soldering are some capacitors, resistors, etc. The kit includes a pre-built RF tuner unit, and fully modularised IF stages which are pre-aligned before despatch. As well as electronic components, this kit also contains 2 diamond-spun aluminium knobs, elegant matching front panel, dial, washers, screws and wire.

The Tourist PB is suitable for 12 volt working on both negative and positive earth vehicles. It covers the full medium and long wave bands. Four push-buttons for medium wave, one for long wave. It is permeability tuned and sturdily constructed. Output is a full 2.5 watts into an 8 ohm speaker. But the Tourist PB will operate into any loudspeaker from 8 to 15 ohms. Power consumption is less than 1 amp.

The Tourist PB can be mounted in any standard size dash panel and it has an illuminated tuning scale for easy reading at night. Chassis size is: 7in. wide, 2in. high and 4 1/2 in. deep (excluding front panel, etc.).

- ★ Circuit diagram and comprehensive instructions 50p, free with parts.
- ★ Fully retractable, lockable, Car aerial £1.25 post paid.

Price only £7.00 + 50p p&p. 8 ohm speaker with baffle and fixing strips £1.50 post free if bought with kit + 25p p&p.

If you can solder on printed circuit board you can build this push-button car radio kit. It's simple—just follow the step-by-step instructions.



S.A.E. for leaflet

RELIANT MK.IV

- ★ 5 Electronically Mixed Inputs. ★ 3 Individual Mixing Controls. ★ Separate bass and treble controls common to all 5 inputs. ★ Mixer employing F.E.T. (Field Effect Transistor). ★ Solid State Circuitry. ★ Attractive Styling. ★ Sides Finished in solid teak

INPUTS:—1. Crystal Mic or Guitar 9mV. 2. Moving coil Mic or Guitar 8mV. Inputs 3, 4 & 5 are suitable for a wide range of medium output equipment (Gram., Tuner, Monitor, Organ, etc.). All 250mV sensitivity. **CONTROLS:**—3 Volume controls. Bass control range: -13dB @ 60Hz. Treble control range ±12dB @ 15KHz. Separate ON/OFF Switch. Neon Indicator. **POWER OUTPUT:**—12 Watts R.M.S. into 3 to 4 ohms speaker. **SIGNAL/NOISE:**—Better than -60dB on Inputs 3, 4 and 5 & -50db on 1 & 2. **SUPPLY:**—220-250 AC Mains. **SIZE:**—12 1/2" x 6" x 3 1/4".

£10:50
plus p. & p. 60p

VISIT OUR SHOWROOMS



Radio and TV Components (Acton) Ltd.
 21C High Street, Acton, London W3 6NG
 323 Edgware Road, London, W2.

Mail orders to Acton. Terms C.W.O. All enquiries S.A.E. Goods not dispatched outside UK.

VALVES

Table of valves with columns for valve type and price.

All prices in pounds and new pence

Table of electronic components (diodes, transistors, etc.) with columns for part number and price.

Transistors

Table of various transistor types and prices.

Integrated Circuits

Table of integrated circuit types and prices.

RST VALVE MAIL ORDER CO. 16a WELLFIELD ROAD, LONDON SW16 2BS

H.A.C. SHORT-WAVE KITS WORLD-WIDE RECEPTION. Includes image of a receiver kit and text describing the company's products and services.

EX COMPUTER PRINTED CIRCUIT PANELS, SPECIAL BARGAIN PACK, 250 MIXED CAPACITORS, 709C OPERATIONAL AMPLIFIER TOS, 250 MIXED RESISTORS, 150 MIXED HI STABS, QUARTZ HALOGEN BULBS, GPO EXTENSION TELEPHONES, BARGAIN RELAY OFFER, KEYTRONICS mail order only.

4-STATION INTERCOM, INTERCOM/BABY ALARM, MAINS INTERCOM. Includes images of communication systems and pricing information.



"Where can I get exclusive units at lowest prices?..."

ROC ELECTRONICS!

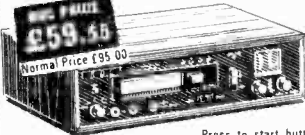

ROC PRICE
£59.50
Normal Price £95.00

8-TRACK STEREO CARTRIDGE TAPE DECK MODEL RP-1000ST
The popular Lear-Jet type recording unit is the heart of the fantastic RP-1000ST, which has full record and playback facilities. Automatic track change with manual override. Press to start button. Stereo headphones and Left and Right volume controls. Built-in pre-amp. Tape speed 3 1/2 ips (9.5 cm/s). Frequency response: playback 30-10,000 Hz; recording/playback 30-8,000 Hz. Line output: fully variable 0-500mV. The RP-1000ST incorporates all the features you'd expect on a top quality Cartridge Tape Deck. Size 16" wide, 4" high, 9" deep. Cabinet in walnut. Including connecting leads.

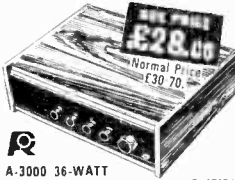

A-3000 36-WATT SOLID STATE STEREO AMPLIFIER
The A-3000 looks as good as it sounds! Giving you a big performance this superb audio amplifier has a full range of facilities on the front and rear panels. On the front - all the controls you're ever likely to need plus a headphone socket. On the rear - signal inputs, speaker outputs and a line fuse for circuit protection. Specifications: 18 watts rms per channel into 8 ohms; Frequency response 20-35,000 Hz (-2db) Inputs Magnetic, Ceramic, Tuner, Tape, Aux. Tape Play. Size: 345mm x 300mm x 130mm.

ROC PRICE
£28.00
Normal Price £30.70

REALISTIC 30 WATT STEREO AMPLIFIER MODEL SA-500

A superb hi-fi amplifier with all the features you've ever wanted - for under £46.00. Saving over £10.00 on the normal retail value. Up-to-the-minute slider controls for bass and treble. Separate volume and balance controls. Headphone socket on front panel. Push-button input controls - magnetic phono (high/low) tuner, aux, mono, monitor. Loudness push-button control for perfect sound at low output levels. Left and right push-button on/off switches for speakers. Noise filtering and tape monitoring facilities. Two auxiliary AC outlets. Frequency response 20-20,000 Hz ± 1db at full power. 15 watts rms per channel. Walnut cabinet with satin aluminium trims. Inputs: phono 2.5mV and 5mV RIAA; tuner/aux 250mV. Hum and noise: phono - 50db, tuner/aux - 65db. How's that for a specification! Size 14 1/2" wide, 3 1/2" high, 7 1/2" deep.



As reviewed in "POPULAR HI-FI" February 1972

ROC PRICE
£35.20
Normal Price £55.50



OLSON RA-380 AM/FM/MPX STEREO TUNER
This ROC Tuner is especially designed to match the Olson AM-395 Stereo Amplifier. In price and value, as well as it's good looking design! But of course it's also the RA-310 costs £10.00 less than the normal retail value and yet it is a highly sophisticated unit, incorporating the latest solid state techniques. Operation is drift free for supreme station-holding capability. You can connect this Tuner to a stereo amplifier, to a tape deck or a tape recorder. And of course it covers all the stations in the AM and FM bands FM 87-108 MHz; AM: 525-1605 kHz. FM Sensitivities: FM 3µV, AM 250µV. Stereo separation 30dB at 1kHz, image rejection 60dB. Size: 11 1/2" wide, 4" high, 7 1/2" deep.

OLSON RA-380 AM/FM/MPX STEREO TUNER

This ROC Tuner is especially designed to match the Olson AM-395 Stereo Amplifier. In price and value, as well as it's good looking design! But of course it's also the RA-310 costs £10.00 less than the normal retail value and yet it is a highly sophisticated unit, incorporating the latest solid state techniques. Operation is drift free for supreme station-holding capability. You can connect this Tuner to a stereo amplifier, to a tape deck or a tape recorder. And of course it covers all the stations in the AM and FM bands FM 87-108 MHz; AM: 525-1605 kHz. FM Sensitivities: FM 3µV, AM 250µV. Stereo separation 30dB at 1kHz, image rejection 60dB. Size: 11 1/2" wide, 4" high, 7 1/2" deep.



REALISTIC SA-100B 6-WATT STEREO AMPLIFIER
Here's a fabulous, exciting value in miniature! This high quality stereo amplifier measures only 9" wide, 3" high x 5 1/2" deep. And yet it has separate ganged volume, balance and tone controls. Plus speaker in/out (mono/stereo, phono) tuner and power on/off slide switches. The ends are oiled walnut, with matching enamelled metal top. The front panel is satin aluminium and walnut-brown enamel. Frequency response is 50 to 10,000 Hz. ± 3dB. Output 3 watts r.m.s. per channel into 8 ohms. Inputs are 100mV for both phono and tuner.

REALISTIC SA-100B 6-WATT STEREO AMPLIFIER

Here's a fabulous, exciting value in miniature! This high quality stereo amplifier measures only 9" wide, 3" high x 5 1/2" deep. And yet it has separate ganged volume, balance and tone controls. Plus speaker in/out (mono/stereo, phono) tuner and power on/off slide switches. The ends are oiled walnut, with matching enamelled metal top. The front panel is satin aluminium and walnut-brown enamel. Frequency response is 50 to 10,000 Hz. ± 3dB. Output 3 watts r.m.s. per channel into 8 ohms. Inputs are 100mV for both phono and tuner.



TEC HR-007 HEAD-PHONE RADIO
When you want to listen to the radio all by yourself. Then this will solve the problem. Separate volume and tuning controls with easy-to-use knobs. Frequency range is 535 to 1605 kHz medium wave band. Maximum output is 300 mW. Normal Price £7.50 ROC PRICE £5.80

EAGLE LC 07 STEREO MOVING MAGNET CARTRIDGE

Here's your opportunity to own a transcription cartridge for the price of a ceramic! Is specially designed to match top quality tone arms, and to get the very best from your hi-fi amplifier. 0.7 mil diamond stylus. Output: 7mV per channel. Frequency range: 20-21,000 Hz. Channel balance: ± 1db. Channel separation 28dB. Compliance: 12 - 10.6 cm/dyne. ROC PRICE £6.37



OLSON AM-395 40-WATT STEREO AMPLIFIER
An ideal unit for your new stereo separate system. It is more than £10.00 below the normal retail price! Making the AM-395 one of Britain's best hi-fi buys. It takes in signals from magnetic or ceramic pick-ups, tuners (see Olson RA-310) and tape decks. And it's got out puts for taping and for headphones. There are separate bass and treble controls, separate Left and Right channel volume controls. And a loudness switch for boosting the bass and treble notes when listening at low output levels. Frequency response: 20-20,000 Hz ± 3dB. Output: 20 watts r.m.s. per channel into 8 ohms. Inputs: magnetic phono 3.0mV RIAA, crystal phono 180mV; tape 160mV; tuner 160mV. Size 11 1/2" wide, 4" high, 7 1/2" deep. The specification reads well - sounds even better!

OLSON AM-395 40-WATT STEREO AMPLIFIER

An ideal unit for your new stereo separate system. It is more than £10.00 below the normal retail price! Making the AM-395 one of Britain's best hi-fi buys. It takes in signals from magnetic or ceramic pick-ups, tuners (see Olson RA-310) and tape decks. And it's got out puts for taping and for headphones. There are separate bass and treble controls, separate Left and Right channel volume controls. And a loudness switch for boosting the bass and treble notes when listening at low output levels. Frequency response: 20-20,000 Hz ± 3dB. Output: 20 watts r.m.s. per channel into 8 ohms. Inputs: magnetic phono 3.0mV RIAA, crystal phono 180mV; tape 160mV; tuner 160mV. Size 11 1/2" wide, 4" high, 7 1/2" deep. The specification reads well - sounds even better!



R-446 3-WAY MATCHED SPEAKERS
These will do justice to your amplifier - and to your pocket. At only £16.40 a pair, they are real value-for-money. Each cabinet is heavily lagged and teak finished. They handle 16 watts rms (8 watts rms each). Each loudspeaker contains a large dual cone base unit, plus a separate tweeter. Frequency range, 40 to 19,000 Hz. Size 14" high, 9" wide, 6 1/2" deep.

R-446 3-WAY MATCHED SPEAKERS

These will do justice to your amplifier - and to your pocket. At only £16.40 a pair, they are real value-for-money. Each cabinet is heavily lagged and teak finished. They handle 16 watts rms (8 watts rms each). Each loudspeaker contains a large dual cone base unit, plus a separate tweeter. Frequency range, 40 to 19,000 Hz. Size 14" high, 9" wide, 6 1/2" deep.



ROC PRICE
£10.50
Normal Price £15.70

OLSON AM-400 4 WATT STEREO AMPLIFIER
Here's a marvelous value for someone just starting to set themselves up in audio! At only £10.50, you get a fine amplifier in a scratch resistant metal cabinet, with a smart brushed aluminium front panel. It incorporates separate tone and volume controls for each channel. Inputs are provided for turntable (ceramic cartridge), tuner and tape deck or recorder. Frequency response: 70-20,000 Hz ± 3dB. Output: 2 watts r.m.s. per channel into 8 ohms. Inputs: phono 80mV; tuner/aux 80mV. Size 8" wide, 2 1/2" high, 4 1/2" wide.



25-WATT 3-WAY CRYSTALS 'LIVING AUDIO' SPEAKER CE-5b
This high quality speaker has its own built-in 3-way sound response switch, giving you the ideal frequency response for hi-fi, natural or mood music listening. Its beautiful, heavy, oiled walnut cabinet incorporates two separate speaker units an 8" woofer, and a 5" mid-range with 2" concentric tweeter. Power handling capacity: 25 watts r.m.s. into 8 ohms. Overall frequency response: 35-20,000 Hz. Cabinet size: 10 1/2" x 7 1/2" x 8 1/2". Exactly right for matching the most modern decors.

This high quality speaker has its own built-in 3-way sound response switch, giving you the ideal frequency response for hi-fi, natural or mood music listening. Its beautiful, heavy, oiled walnut cabinet incorporates two separate speaker units an 8" woofer, and a 5" mid-range with 2" concentric tweeter. Power handling capacity: 25 watts r.m.s. into 8 ohms. Overall frequency response: 35-20,000 Hz. Cabinet size: 10 1/2" x 7 1/2" x 8 1/2". Exactly right for matching the most modern decors.



ROC PRICE
£27.55
Normal Price £42.00

PALACE AM/FM/MPX STEREO TUNER AMPLIFIER SSA-16
This is one of the lowest priced stereo tuner amplifiers on the market. It covers the full range of both AM and FM broadcast frequencies. And when you're switched to FM, an indicator lights up when a stereo signal is received - that's the time to switch to 'Stereo'! The SSA-16 has all the facilities you'd expect to find on tuners costing twice as much - separate volume, bass, treble, balance and tuning controls. Selector switch for tape, phono, AM, FM, stereo. Jack socket on front panel for stereo headphones. Frequency range: FM 88-108 MHz; AM 535-1605 kHz. Frequency response: 50-10,000 Hz ± 3dB. Power output, 4 watts total music power into two 8 ohm speakers. Size: 16" wide, 4 1/2" high, 8" deep.

ROC 7-WATT STEREO AMPLIFIER CHASSIS SK-317

This exclusive ROC Stereo Chassis is completely self-contained, and it costs £2.25 less than the normal retail value! The SK-317 is a really compact unit measuring only 5 1/2" wide, 1 1/2" high and 6 1/2" deep. It contains its own mains power supply, and has a ganged volume control and separate treble controls for each channel. Specification: frequency response 40-17,000 Hz ± 3dB; output 3.5 watts music power per channel into 8 ohms; input, phono, 600mV; signal-to-noise ratio better than 45dB.



ROC PRICE
£15.10
Normal Price £25.20

OLSON AM-372 16-WATT STEREO AMPLIFIER
Here's a really good amplifier at a really down-to-earth price - nearly £7 less than the normal retail value! Just look at what the AM-372 will do for you - reproduce signals from ceramic or crystal cartridges, AM and FM tuners, and tape recorders. And it gives you outputs for two sets of speakers, headphones and tape recorders. Frequency response is 30 to 20,000 Hz ± 3dB. Output 8 watts r.m.s. per channel music power into 8 ohm speakers. Phono input 200mV. Tuner input 200mV. Size: 12 1/2" wide, 3 1/2" high, 7 1/2" deep.

ROC ELECTRONICS LTD

M. JORY Esq. 193 EDGWARE RD, LONDON, W2 1ET. D) 723 6211
CALLERS WELCOME 9-6 MON. TO SAT.
ALSO AT 87 TOTTENHAM COURT RD, LONDON W7
TEL: 01-580 3739 OPEN 9-6 MON.-FRI. SAT. 9-1

Return-of-post mail order service. Orders over £10 post free (UK only). Add 25p for p & p to orders under £10. HP terms available for callers



LINDAIR (ELECTRO-TECH) LTD

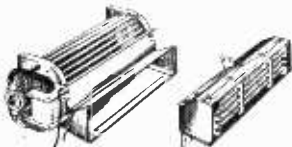

TANGENTIAL HEATER

Silently driven by a shaded pole Mylex motor. Compact, powerful and quiet running with aluminium impeller (outlet 5 1/4 x 1 1/4). Mains voltage. PLUS matching heater unit with spiral element. May be switched for 500 or 1,000 watts. **PRICE ONLY £1.60** P. & P. 40p

SYNCHRONOUS AUTO-RESET PROCESS TIMER



By LONDEX LIMITED

Type IMP Mk. 2. Brand New and Boxed. These well known timers are already in world-wide use and are perfect for Industrial Electronic Timing. Research and for all machine control timing problems. Repetitive accuracy better than 0.5% of full scale setting. Two or more can be interconnected to give control of a series of processes. 230/250v. 50Hz. also available 60Hz. 15 minutes full scale, 15 secs. per division. Driven by self-starting sync. motor. Contact rating 5 amp at 250v. a.c. Incorporates solenoid operated clutch. Also, lever actuated micro switches. Normal price probably in excess of £16. Complete with multi-pin connector as illustrated.

OUR PRICE ONLY £6.50

SEEN THIS ?

This is the only way way we could illustrate this fabulous item.

NORPLEX

the famous American fibre-glass copper-clad laminate. Finest quality with Woven Glass base of Epoxy-resin. Excellent mech. and elec. conductive properties. Heat Resistant. Ideal for P.C.s., etc. THIS IS A SPECIAL PURCHASE AND ONLY AVAILABLE WHILE STOCKS LAST. Sizes: 12" x 12": 24" x 12": 24" x 24": FULL SHEET 43" x 37" (11 sq. ft.). Single sided copper with thicknesses of 1/32", 3/64", 1/16", 3/32".

PRICE ONLY £1 per sq. ft. £8 per full sheet. P. & P. 25p up to 4 sq. ft. Over 4 sq. ft. (cut sizes only) Post FREE. Full sheets post by rail G.B. only £1 one or more sheets.

MICRO-LITES

Wonderful engineering—micro miniature incandescent lamp small enough to pass through the eye of a needle! 1,000's of uses. Will operate from the output of a transistor. Rating: 1.5v. 10-15ma. Size 4.4 x 1.4mm. dia. Leads 22mm. These fantastic lamps have a life expectancy of 1,000 hrs.

OUR PRICE

£3.25

per doz. Free p. & p.

NEW AND UNUSED

Postal or carriage charges are for Great Britain only. We welcome orders from established companies, educational depts., etc. All orders under £2.50, cash with order please.

FURTHER BULK PURCHASE

SILVANIA MAGNETIC SWITCH

NOW COMPLETE WITH REFERENCE MAGNET! A magnificently activated switch. Vacuum sealed in a glass envelope. Silver contacts normally closed, rated 3 amp at 120v. 1 1/2 amp at 240v. Size (approx.) 1 7/16" long x 1" dia. Ideal for Burglar Alarms, Security systems, etc., and wherever non-mechanical switching is required. **New Lower Price. Only £2.10** for 12. £23 for 50 or £15 for 100 complete with magnet.

£2.10

PROGRAMMER TIMER BY HONEYWELL



A bank of 15 micro-switches are each independently operated by 15 pairs of cams which in turn are individually adjustable to give switching periods of zero to 12 seconds with infinitely variable combinations. A mains synchronous motor drives the cam shaft at 1 rev per 12 seconds (5 R.P.M.). Designed originally for vending machines at a cost of £15.00 plus. Many applications where continuous sequence programmes are required, such as lighting effects etc. New in original makers cartons. First class value at £5.75 plus 25p P. & P.

£5.75

315 EDGWARE ROAD, LONDON W2. Tel: 01-262 2251. Open 9 a.m.-6 p.m. MON to SAT

SPEAKER SELECTION

(Dept W) 611 FOREST RD LONDON E17 4QD Telephone: 01-531 3117

Hours: 10 am-6 pm Tues-Sat, 8 pm Friday

GOODMANS Module 1-10	£105
GOODMANS Module 80	£67
ARMSTRONG 521	£44
ARMSTRONG 525	£70
ARMSTRONG 526	£80
CONNOISSEUR BD2 P&C (wired)	£32
Carriage	£1.00

SPEAKER SYSTEMS

CELESTION	
Ditton 15	£53 (B)
Ditton 44	£74 (B)
Ditton 25	£88-75 (C)

IMF ... On application

LNB	
Para-Lab Super	£42 (B)
Para-Lab 20	£80 (C)

GOODMANS	
Havant	£43 (B)
MEZZO 3	£48 (B)
Double Maxim	£48 (B)
Magnum	£62 (B)
Magister	£88 (C)
Dimension 8	£98 (C)

RICHARD ALLAN	
Chaconne	£31 (B)
Flamenco	£42 (B)
Pavanne	£49 (B)

WHARFEDALE	
Denton II	£29.75 (A)
Linton II	£37.75 (B)
Melton	£47 (C)
Dovedale	£63 (C)

KITS	
PEERLESS	
2-8	£11.50 (A)
10-2	£16 (A)
20-2	£21 (A)
3-15	£22 (B)
2-25	£33 (B)
20-3	£29 (B)
430-12	£40 (C)

AMPLIFIERS	
Leak Delta 30	£50 (B)
Leak Delta 70	£60 (B)
Metrosound ST20E	£27 (B)
Ravensbrook Cased	£44 (B)
Linton	£45 (A)
Cambridge P50	£65 (A)

RICHARD ALLAN	
Twin Assembly	£16.50 (A)
Triple Assembly	£29 (C)
Triple 8	£26 (B)

WHARFEDALE	
Unit 3	£18.50 (A)
Unit 4	£24.50 (B)
Unit 5	£36 (B)

TURNABLES	
SP25 III	£10 (A)
AP76	£20 (A)
401	£30 (A)
GL75 P&C	£42 (A)
MP60	£11.25 (A)

Many more items in Stock. Delivery-A-50p B-£1.00 C-£1.50

NEW VALVES ! GUARANTEED AND TESTED

24-HOUR SERVICE

1R5	25	30FL14	67	EFB89	27	EF92	26	PCC189	46	PY82	23
185	21	30L17	66	ECC81	16	EF183	25	PCF80	25	PY800	80
1T4	14	30PL1	58	ECC82	18	EF184	27	PCF86	44	PY801	80
384	24	DAF91	21	ECC83	21	EH90	38	PCF801	27	R19	27
3V4	48	DAF96	35	ECC85	31	EL33	64	PCF802	38	U251	60
6J30L2	52	DF91	14	ECP82	26	EL41	52	PCF805	56	U329	65
6AQ5	21	DF96	35	ECH35	53	EL84	21	PCL82	23	U801	73
6BW7	48	DK91	25	ECH42	56	EY86	27	PCL83	53	UBF89	28
6FL	57	DK96	43	ECH81	26	EZ80	19	PCL84	31	UCC85	33
6F23	64	DL92	24	ECL80	35	EZ81	21	PCL85	35	UCH42	56
6F25	49	DL94	46	ECL82	27	KT61	54	PCL86	35	UCH81	58
6SN7GT	23	DL96	36	ECL84	32	KT66	75	PFL200	49	UCL82	80
12AU7	18	DY86	21	EF79	36	KT8	35	PL36	45	U81	49
2SL6GT	18	DY87	21	EF91	56	PC86	44	PL81	41	UF89	28
30C15	56	DY802	28	EF80	22	PC88	44	PL82	29	UL41	52
30C17	75	EABC80	28	EF85	26	PC97	35	PL83	31	UL84	27
30C18	56	EB91	09	EF86	27	PC900	28	PL84	28	UY41	27
30F5	60	EBC33	38	EF89	24	PCC84	27	PL500	69	UY85	28
30FL1	59	EBC41	47	EF91	18	PCC89	41	PL504	59	W77	48
								PT61	23	Z77	18

Post/Packing on 1 valve 7p. plus 3p. per valve on each extra valve. Any parcel insured against damage in transit 3p. extra. Office address, no callers.

GERALD BERNARD 83 Osbaldeston Road, Stoke Newington, London N.14

BUILD YOUR OWN LIQUID OIL WHEEL PROJECTOR SUITABLE FOR DISCO OR HOME ENJOYMENT - TOP QUALITY

6 inch dia. MULTICOLOURED OIL WHEEL plus 1 R.P.M. MINIATURE GEARED MOTOR COMPLETE KIT. £6.50. incl. postage.

C. T. ELECTRONICS

267 ACTON LANE, LONDON W4 01-994 6275
SURPLUS ELECTRONICS WAREHOUSE NOW OPEN AT 20-24 BEAUMONT RD, LONDON, W.4. Thousands of component and equipment bargains.

Solder a friendship! Give Antex this Christmas

Model X25 *

220-240 Volts or 100-120 Volts
The leakage current of the NEW X25 is only a few microamps and cannot harm the most delicate equipment even when soldered "live".

Tested at 1500v. A.C. This 25 watt iron with its truly remarkable heat-capacity will easily "out-solder" any convent onally-made 40 and 60 watt soldering irons, due to its unique construction advantages. Fitted long-life iron-coated bit 1/8". 2 other bits available 3/32" and 3/16" Totally enclosed element in ceramic and steel shaft Bits do not "freeze" and can easily be removed. PRICE: £1.75 (rec. retail)
Suitable for production work and as a general purpose iron.

Model CCN *

220 volts or 240 volts
The 15 watt miniature model CCN. also has negligible leakage.

Test voltage 4000v. A.C. Totally enclosed element in ceramic shaft. Fitted long-life iron-coated bit 3/32"
4 other bits available, 1/8", 3/16", 1/4" and 1/16"
PRICE: £1.80 (rec. retail)
OR Fitted with triple-coated, (iron, nickel and Chromium) bit 1/8" £1.95 (rec. retail)

Model CN *

Miniature 15 watt soldering iron fitted 3/32" iron-coated bit. Many other bits available from 1/16" to 3/16" Voltages 240, 220, 110, 50 or 24
PRICE £1.70 (rec. retail)

Model SK.1 Kit

contains 15 watt miniature iron fitted with 3/16" bit, 2 spare bits 5/32" and 3/32", heat sink, solder, stand and "How to Solder" booklet.

PRICE £2.75 (rec. retail)

Model MES Kit

Battery-operated 12v. 25 watt iron fitted with 15' lead and 2 heavy clips for connection to car battery. Packed in strong plastic wallet with booklet "How to Solder". PRICE £1.95 (rec. retail) *

Model SK.2 Kit

contains 15 watt miniature iron fitted with 3/16" bit, 2 spare bits 5/32" and 3/32", heat sink, solder, and

"How to Solder" booklet.

PRICE £2.40 (rec. retail)



From radio or electrical dealers, car accessory shops or, in case of difficulty direct from:—
ANTEX LIMITED FREEPOST
(no stamp required) **PLYMOUTH,**
PL1 1BR Tel: 0752 67377

Please send the ANTEX colour catalogue.

Please send the following

I enclose cheque/P.O./Cash (Giro No. 258 1000)

NAME _____

ADDRESS _____

PW12



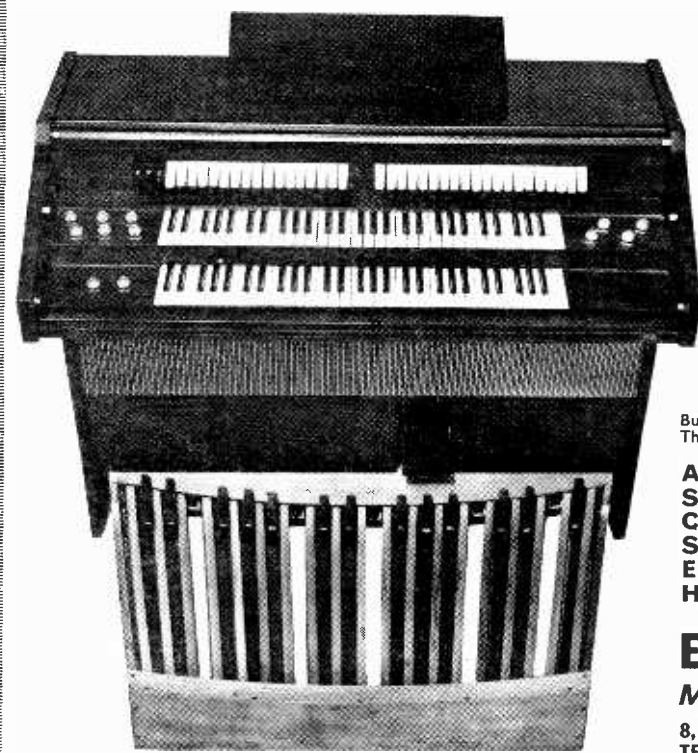

ORGAN KITS

Build your own Electronic Organ, if you want the best value for your money. Yes you really save over 50% and get the best and up-to-date designs. There are four models to choose from.

- ★ Portable—4 octave keyboard with 10 voices, 3 pitches—vibrato, at £145-29.
- ★ Console—5 octave keyboard with 10 voices, 3 pitches. Keyboard can be split into solo and accompaniment. Vibrato built in amplifier and 50 watt 12" Goodmans speaker at £199-75.
- ★ Console—2 x 4 octave keyboards and 13 note pedal board, 29 voices, Vibrato, Delay Vibrato, Sustain Reverberation, Percussion, Wah Wah, etc. at £406-00.
- ★ Console—2 x 5 octave keyboards and 32 note pedal boards, 32 voices, Vibrato, Delay Vibrato, Sustain Reverberation, Percussion, 3 Couplers, etc., at £553-60.

Business hours: 10 a.m. to 7 p.m. Monday to Saturday. Thursday closed.

ALL COMPONENTS CAN BE BOUGHT SEPARATELY. SEND 50p FOR LATEST CATALOGUE, WHICH INCLUDES SPECIALIZED COMPONENTS, HI-FI EQUIPMENT AND ELECTRICAL HOUSEHOLD APPLIANCES.

ELVINS ELECTRONIC MUSICAL INSTRUMENTS

8, PUTNEY BRIDGE ROAD, LONDON, S.W.18
TEL: 01-870 4949

BATTERY/MAINS PORTABLE RECEIVER

WHAT RADIO PRICED AT UNDER £120 GIVES YOU SUCH A VARIED CHOICE OF TRANSMISSIONS?

NEW YORK LONDON MEXICO AMBRO

CASH PRICE £49-50 50p p. & p. or £14 50 dep. . 50p p. & p. & 6 months at £7-56 50.

WHAT A SENSATIONAL RADIO
No less than 8 wavebands

Picks up ALL THE USUAL BBC Programmes * All the new local radio stations * Continental * World-wide transmissions * Pop Pirates * Radio Hams * Aircraft * Shipping * Police * Taxis * R.A.C. * A.A. * Fire Brigade * T.V. Sound * Ambulances and 1,000s more.

THE BEST PORTABLE RADIO EVER MADE! We think so. What radio priced at under £120 gives you such a varied choice of transmissions? As well as the standard long and medium wavebands it has three short wave bands (including the Marine and Trawler Band) AND NO LESS THAN THREE V.H.F. BANDS truly a complete WORLD-WIDE communications Receiver. JUST THINK! one minute you can be listening to your favourite B.B.C. programme and then—at the flick of a switch—you can tune into the control tower and hear a "crippled airliner" being talked down to safety. Or listen to the trawlers and ocean-going liners—Eavesdrop on the taxi-cabs, fire brigades, ambulances, A.A., R.A.C. and 100s of other R.T. mobiles! Extensive shortwave coverage can give you Australia Pakistan, Luxembourg, North America, Far East, etc., etc., you name it—it gets it! Manufactured by one of the world's leading specialists in communications and TV equipment, each set carries a FULL 3-YEAR WRITTEN GUARANTEE. Beautifully finished in Teak Wood and Stainless Steel—will add distinction to any living-room. Completely portable 12in x 9in x 4in, using standard batteries—or can be plugged directly into mains. 14 transistors, 6 diodes, 1 thermistor, internal ferrite rod aerial PLUS two external telescopic antennas—with sockets for additional aerials or car aerials. Automatic Drift-Free Reception. Sliding volume and tone controls. Hi-Fidelity earphone for private listening, local DX switch.

FREQUENCIES: Long W 150-350Kcs. Medium W 540-1605 Kcs. Marine 1.6-4 Mcs. Short W 13-7 Mcs. Short W 2.9-22 Mcs. F.M. (VHF) 88-108 Mcs. Aircraft (VHF) 108-136 Mcs. Public Service (VHF) 148-174 Mcs. OUR ULTIMATE in communications receivers—used by professionals and amateur enthusiasts all over the world. INSTANT CASH REFUND if not overwhelmed by the superb tone clarity and performance range.

NOTE.—The Ministry of Posts & Telecommunications state a Licence (not generally available to the public) is required for the reception of transmissions by Fire Brigade, Aircraft Shipping, etc.

SCIENTIFIC AND TECHNICAL (PW11) 507-511 LONDON ROAD, WESTCLIFF, ESSEX

COMPARE OUR PRICES

<p>Speaker Bargains E.M.I. 13 x 8 in 3, 8 & 15 OHMS PLAIN .. £2-00 WITH TWEETER .. £2-25 Type 350-20 watt with Tweeter 8. OHM p. & p. 37p. .. £7-50 TWIN TWEETER .. £3-50 8 x 5 in 3, 8 & 15 OHMS .. £1-30 7 x 4 in 3 & 8 OHMS .. £1-05 FANES 8" 8. OHM DUAL CONE .. £2-30 CELESTION 8" 15.OHM .. £1-50 GOODMANS 10 x 8 3.OHM .. £1-00 BAKER GROUP 25 12" 25 WATT 8 or 15.OHM .. £5-75 2 1/2" 8 or 64 OHM p. & p. 10p. 50 POSTAGE 25p per SPEAKER</p>	<p>Microphone Bargains—continued DX186 Dynamic Stick .. £1-90 DX143 Dynamic, cassette-type stick .. £1-00 MIC60 "ACOS" stick crystal .. £1-00 CM70 PLANET stick metal, switch crystal .. £1-45 DM160 Dynamic uni-dir, ball metal .. £3-75 UD130 50K/600 OHM uni-dir, ball metal .. £4-50 TW209 LESSON DUAL IMP ball metal, uni-dir. .. £3-75 GUITAR 'M' METER .. £4-48 LAPEL TYPE, crystal .. £4-40 POSTAGE 17p each.</p>
<p>Kit-Form Cabinets Teak (17" x 10" x 6") with a 13" x 8" or 8" CUT OUT .. £2-75 (12" x 12" x 6") with a 8" x 5" or 8" CUT OUT .. £2-25 (PLEASE SPECIFY CUT OUT) Add 35p per Cabinet for p. & p.</p>	<p>Panel Meters 2" SQ. .. £1-50 0-500ma, 0-1ma, 0-10ma, 0-100ma 0-500ma, 'S' METER POSTAGE 17p each.</p>
<p>Cartridges with standard fittings & stylus ACOS GP91/2SC or GP91/3SC STEREO COMPATIBLE .. £1-05 ACOS GP94 STEREO CER. .. £1-90 ACOS GP95 STEREO CRYST. .. £1-35 9TH AC SONOTONE STEREO CERAMIC (DIAMOND) .. £2-00 ACOS GP67/2C MONO CRYST. .. £1-65 ACOS GP101 COMP. CRYST. .. £1-75 19-TI SONOTONE STEREO CRYSTAL .. 90 POSTAGE 5p per CARTRIDGE</p>	<p>Multitesters 1,000 OHMS/VOLTS .. £2-50 2,000 OHMS/VOLTS .. £2-75 10,000 OHMS/VOLTS .. £3-00 50,000 OHMS/VOLTS .. £10-00 100,000 OHMS/VOLTS WITH TRANSISTOR TESTER .. £15-00 POSTAGE 17p each.</p>
<p>Microphone Bargains MIC45 "ACOS" metal case, crystal hand .. £1-95 CM 20 Crystal Hand .. £1-45</p>	<p>Tapes — "MYLAR" base finest quality British made. 5" 600 ft 36p 5 1/2" 1800 ft 85p 5" 900 ft 45p 7" 1200 ft 35p 5" 1200 ft 60p 7" 1800 ft 89p 5 1/2" 900 ft 49p 7" 2400 ft 95p POSTAGE 9p each.</p>

THIS MONTHS SPECIAL OFFER
Solid state stereo amplifier tt-200, 10 watts/channel r.m.s. 8 ohm output Imp. Deluxe Walnut Cabinet, brushed aluminium front. Switches for tape, tuner, crystal/mag. cartridge. Stereo reverse left and right channel. Source and monitor, independent bass and treble control for each channel. Headphone socket. **ONLY £21-00** Whilst stocks last. Postage & packing £1.

SEND 25p FOR COMPLETE CATALOGUE

RIVERSDALE ELECTRONICS
Mail Order Department W12/72, P.O. Box 470, Manchester M60 4BU
ALL OUR MERCHANDISE IS FULLY GUARANTEED

The largest selection

NEW LOW PRICE TESTED 'S.C.R.'s

PIV 1A	3A	5A	5A	7A	10A	16A	30A
T05 TO66T066T064 TO48T048T048T048							
50	0-23	0-25	0-35	0-35	0-47	0-50	0-53 1-15
100	0-25	0-33	0-47	0-47	0-50	0-58	0-63 1-40
200	0-35	0-37	0-49	0-49	0-57	0-61	0-75 1-90
400	0-43	0-47	0-59	0-60	0-67	0-75	0-93 1-75
600	0-53	0-57	0-68	0-68	0-77	0-97	1-25
800	0-63	0-70	0-80	0-80	0-90	1-20	1-50 4-00

SIL. RECTS. TESTED

PIV	300mA	750mA	1A	1.5A	3A	10A	30A
50	0-04	0-05	0-05	0-07	0-14	0-21	0-60
100	0-04	0-05	0-05	0-13	0-16	0-23	0-75
200	0-05	0-09	0-06	0-14	0-20	0-24	1-00
400	0-06	0-13	0-07	0-20	0-27	0-37	1-25
600	0-07	0-16	0-10	0-22	0-34	0-45	1-86
800	0-10	0-17	0-11	0-25	0-37	0-55	2-00
1000	0-11	0-25	0-14	0-30	0-46	0-63	2-50
1200	—	0-33	—	0-38	0-57	0-75	—

TRIACS

VBM2A	6A	10A
TO-1 TO-66 TO-88		
\$p	\$p	\$p
100	80	78
200	50	60 90
400	70	75 1-10

DIACS

FOR USE WITH TRIACS
BR100 (D32) 37p each

FREE

One 50p Pak of your own choice free with orders valued £4 or over.

BRAND NEW TEXAS GERM. TRANSISTORS
Coded and Guaranteed

Pak No.	EQVT
T1	8 2G3713 OC71
T2	8 D1374 OC75
T3	8 D1216 OC81D
T4	8 2G381T OC81
T5	8 2G382T OC82
T6	8 2G344B OC44
T7	8 2G345B OC45
T8	8 2G378 OC78
T9	8 2G398A 2N1302
T10	8 2G417 AF117

All 50p each pak

2N2060 NPN SIL. DUAL TRANS. CODE D1699 TEXAS. Our price 25p each.

120VCM MIXIE DRIVER TRANSISTOR 8im. BSX21 & C407, 2N1893 FULLY TESTED AND CODED ND 120. 1-24 17p each. TO.5 N.P.N. 25 up 15p each.

Sil. trans suitable for P.E. Organ. Metal TO-18. Eqt. ZTX300 5p each. Any Qty.

POWER TRANS BONANZA!

GENERAL PURPOSE GERM. PNP TO-3 case. BRAND NEW TO-3 CASE. POSS. REPLACE.—OC25-28-29-30-35-36. NKT 401-403-404-405-406-430-451-452-453. T13027-3028, 2N250A, 2N456A-457A-458A, 2N611 A & B. 2G220-222, ETC. VCEO 80V VCEO 50V IC 10A PT. 30 WATTS Hfe 30-170.
PRICE 1-24 25-99 100 up 43p each 38p each

SILICON High Voltage 250V NPN TO-3 case. G.P. Switching & Amplifier Applications. Brand new Coded R 2400 VCEO 250V VCEO 100/IC 6A/30 Watts. HFE type 20/T 6MHZ. OUR PRICE EACH: 1-24 50p 25-99 45p 100 up 40p

ADI161/162 PNP M/P COMP GERM TRANS. OUR LOWEST PRICE OF 85p PER PAIR

FULL RANGE OF ZENER DIODES VOLTAGE RANGE
2-33V 400mV (DO-Case) 13p ea. 11W (Top Hat) 18p ea. 10W (SO-10 Stud) 25p ea. All fully tested 5% tol. and marked. State voltage required.

10 amp POTTED BRIDGE RECTIFIER on heat sink. 100PIV. 90p each

NEW LINE Plastic Encapsulated 2 Amp. BRIDGE RECTS.
60 v RMS 32p each
100 v RMS 37p each
400 v RMS 48p each
Size 15 mm x 6 mm.

UNIUNION UT46. Eqt. 2N2646. Eqt. T1843. BEN3000 27p each, 25-99 35p 100 UP 20p.

CADMIUM CELLS ORP12 40p ORP60, ORP61 40p each

GENERAL PURPOSE NPN SILICON SWITCHING TRANS. TO-18 SIM. TO 2N706/8. BSX-27/28/96A. All usable devices no open or short circuits. ALSO AVAILABLE in PNP Sim. to 2N2906, BCY70. When ordering please state preference NPN or PNP.
20 For 0.50
50 For 1.00
100 For 1.75
500 For 7.50
1000 For 13.00

SIL. G.P. DIODES 5p
300mV 30. 0-50
40PIV(Min.) 100. 1-50
Sub-Min. 500. 3-50
Full Tested 1,000. 9-00
Ideal for Organ Builders.

2N3055 115 WATT SIL. POWER NPN 50p EACH

SILICON 50 WATTS MATCHED NPN/PNP BIP 19 NPN TO-3 Plastic. BIP 20 PNP. Brand new. VCEO 100V VCEO 50V IC 10A. HFE type 100/T 3mHZ. OUR PRICE PER PAIR: 1-24 prs. 60p 25-99 prs. 55p 100 prs. 50p

KING OF THE PAKS

Unequalled Value and Quality

SUPER PAKS

NEW BI-PAK UNTESTED SEMICONDUCTORS

Satisfaction GUARANTEED in Every Pak, or money back.

Pak No.	Description	Price
U 1	120 Glass Sub-Min. General Purpose Germanium Diodes	0-50
U 2	60 Mixed Germanium Transistors AF/RP	0-50
U 3	75 Germanium Gold Bonded Sub-Min. like OA5, OA47	0-50
U 4	40 Germanium Transistors like OC81, AC128	0-50
U 5	60 200mA Sub-Min. Silicon Diodes	0-50
U 6	30 Sil. Planar Trans. NPN like BS795A, 2N706	0-50
U 7	16 Sil. Rectifiers TOP-HAT 750mA VLTV. RANGE up to 1000 50	0-50
U 8	50 Sil. Planar Diodes DO-7 Glass 250mA like OA200/202	0-50
U 9	20 Mixed Voltages, 1 Watt Zener Diodes	0-50
U10	20 BA50 charge storage Diodes DO-7 Glass	0-50
U11	25 PNP Sil. Planar Trans. TO-5 like 2N1152, 2N2904	0-50
U12	12 Silicon Rectifiers Epoxy 500mA up to 800 PIV	0-50
U13	30 PNP-NPN Sil. Transistors OC200 & 2S 104	0-50
U14	150 Mixed Silicon and Germanium Diodes	0-50
U15	25 NPN Sil. Planar Trans. TO-5 like BFY51, 2N897	0-50
U16	10 3 Amp Silicon Rectifiers Stud Type up to 1000PIV	0-50
U17	30 Germanium PNP AF Transistors TO-5 like ACY 17-22	0-50
U18	8 6 Amp Silicon Rectifiers BZY12 Type up to 600 PIV	0-50
U19	25 Silicon NPN Transistors like BC108	0-50
U20	12 1-5 Amp Silicon Rectifiers Top Hat up to 1000 PIV	0-50
U21	30 AF. Germanium Alloy Transistors 2G300 Series & OC71	0-50
U22	30 MADT's like MIZ Series PNP Transistors	0-50
U23	20 Germanium 1 Amp Rectifiers GJM Series up to 300 PIV	0-50
U24	25 300 MHz NPN Silicon Transistors 2N706, BSX27	0-50
U25	30 Fast Switching Silicon Diodes like 1N914 Micro-Min.	0-50
U26	12 NPN Germanium AF Transistors TO-1 like AC127	0-50
U27	12 NPN Germanium AF Transistors TO-1 like AC127	0-50
U28	10 1 Amp SCR's TO-5 can, up to 800 PIV CR81/25-600	1-00
U29	15 Plastic Silicon Planar Trans. NPN 2N2926	0-50
U30	20 Silicon Planar Plastic NPN Trans. Low Noise Amp 2N3707	0-50
U31	25 Zener Diodes 400mV DO-7 case 3-18 volts mixed	0-50
U32	15 Plastic Case 1 Amp Silicon Rectifiers 1N4000 Series	0-50
U33	40 Silicon PNP Alloy Trans. TO-5 BCY26 2S302/4	0-50
U34	25 Silicon Planar Transistors PNP TO-18 2N2906	0-50
U35	25 Silicon Planar NPN Transistors TO-5 BFY50/51/52	0-50
U36	30 Silicon Alloy Transistors SO-2 PNP OC200, 2S322	0-50
U37	20 Fast Switching Silicon Trans. NPN 400 MHz 2N3011	0-50
U38	30 RF. Germ. PNP Transistors 2N1303/5 TO-5	0-50
U39	10 Dual Transistors 6 lead TO-5 2N2060	0-50
U40	25 RF Germanium Transistors TO-5, OC45, NKT72	0-50
U41	10 VHF Germanium PNP Transistors TO-1 NKT667, AF117	0-50
U42	25 Sil. Trans. Plastic TO-18 A.F. BC113/114	0-50
U43	20 Sil. Trans. Plastic TO-5 BC116/NPN	0-50
U44	7 3A SCR. TO66 up to 600PIV	1-00

Code No's. mentioned above are given as a guide to the type of device in the pak. The devices themselves are normally unmarked.

SILICON PHOTO TRANSISTOR. TO-18 Lens end NPN Sim. to BP x25 and P21. BRAND NEW. Full data available. Fully guaranteed. Qty. 1-24 25-99 100 up Price each 45p 40p 35p

F.E.T.'S
2N3819 35p 2N5458 50p
2N3820 50p 2N5459 40p
2N3821 35p BF10 40p
2N3823 30p MPF105 40p

NEW EDITION 1971

TRANSISTOR EQUIVALENTS BOOK. A complete cross reference and equivalents book for European, American and Japanese Transistors. Exclusive to BI-PAK 90p each.

LARGE RANGE OF TECHNICAL AND DATA BOOKS ARE NOW AVAILABLE EX. STOCK. SEND FOR FREE LIST.

INTEGRATED CIRCUIT PAKS

Manufacturers "Fall Outs" which include Functional and Part-Functional Units. These are classed as "out-of-spec" from the maker's very rigid specifications, but are ideal for learning about I.C.s and experimental work.

Pak No.	Contents	Price	Pak No.	Contents	Price	Pak No.	Contents	Price
UIC00	-12 x 7400	0-50	UIC46	-5 x 7446	0-50	UIC86	-5 x 7486	0-50
UIC01	-12 x 7401	0-50	UIC47	-5 x 7447	0-50	UIC90	-5 x 7490	0-50
UIC02	-12 x 7402	0-50	UIC48	-5 x 7448	0-50	UIC91	-5 x 7491	0-50
UIC03	-12 x 7403	0-50	UIC50	-12 x 7450	0-50	UIC92	-5 x 7492	0-50
UIC04	-12 x 7404	0-50	UIC51	-12 x 7451	0-50	UIC93	-5 x 7493	0-50
UIC05	-12 x 7405	0-50	UIC53	-12 x 7453	0-50	UIC94	-5 x 7494	0-50
UIC06	-8 x 7406	0-50	UIC54	-12 x 7454	0-50	UIC95	-5 x 7495	0-50
UIC07	-8 x 7407	0-50	UIC60	-12 x 7460	0-50	UIC96	-5 x 7496	0-50
UIC10	-12 x 7410	0-50	UIC70	-8 x 7470	0-50	UIC100	-5 x 74100	0-50
UIC13	-8 x 7413	0-50	UIC72	-8 x 7472	0-50	UIC121	-5 x 74121	0-50
UIC29	-12 x 7420	0-50	UIC73	-8 x 7473	0-50	UIC141	-5 x 74141	0-50
UIC30	-12 x 7430	0-50	UIC74	-8 x 7474	0-50	UIC151	-5 x 74151	0-50
UIC40	-12 x 7440	0-50	UIC75	-8 x 7475	0-50	UIC154	-5 x 74154	0-50
UIC41	-5 x 7441	0-50	UIC76	-8 x 7476	0-50	UIC193	-5 x 74193	0-50
UIC42	-5 x 7442	0-50	UIC80	-5 x 7480	0-50	UIC195	-5 x 74195	0-50
UIC43	-5 x 7443	0-50	UIC81	-5 x 7481	0-50			
UIC44	-5 x 7444	0-50	UIC82	-5 x 7482	0-50			
UIC45	-5 x 7445	0-50	UIC83	-5 x 7483	0-50			

Packs cannot be split, but 25 assorted pieces (our mix) is available as PAK UIC X1.

BI-PAKS NEW COMPONENT SHOP NOW OPEN WITH A WIDE RANGE OF ELECTRONIC COMPONENTS AND ACCESSORIES AT COMPETITIVE PRICES—18 BALDOCK STREET (A10), WARE, HERTS. TEL. (STD 0920) 61933. OPEN MON. SAT. 9.15 a.m. to 6 p.m., FRIDAY UNTIL 8 p.m.

All mail orders please add 10p post and packing. Send all orders to BI-PAK P.O. Box 6 WARE, HERTS.

All mail orders please add 10p post and packing. Send all orders to BI-PAK P.O. BOX 6, WARE, HERTS.

-the lowest prices!

74 Series T.T.L. I.C.'s



BI-PAK STILL LOWEST IN PRICE. FULL SPECIFICATION GUARANTEED. ALL FAMOUS MANUFACTURERS

1			25			100+			1			25			100+				
SN7400	0.15	0.14	0.12	SN7450	0.15	0.14	0.12	SN74123	£2.80	£2.70	£2.60	SN7401	0.15	0.14	0.12	SN74141	0.87	0.64	0.58
SN7402	0.15	0.14	0.12	SN7453	0.15	0.14	0.12	SN74145	£1.50	£1.40	£1.30	SN7403	0.15	0.14	0.12	SN74150	£3.00	£2.70	£2.50
SN7404	0.15	0.14	0.12	SN7460	0.15	0.14	0.12	SN74153	£1.20	£1.10	0.95	SN7405	0.15	0.14	0.12	SN74154	£1.80	£1.70	£1.60
SN7406	0.35	0.31	0.28	SN7470	0.29	0.26	0.24	SN74155	£1.40	£1.30	£1.20	SN7407	0.18	0.17	0.16	SN74156	£1.40	£1.30	£1.20
SN7408	0.18	0.17	0.16	SN7474	0.37	0.35	0.32	SN74157	£1.90	£1.80	£1.70	SN7409	0.18	0.17	0.16	SN74160	£1.80	£1.70	£1.60
SN7410	0.15	0.14	0.12	SN7476	0.40	0.39	0.38	SN74161	£1.80	£1.70	£1.60	SN7411	0.25	0.24	0.23	SN74162	£4.00	£3.75	£3.50
SN7412	0.35	0.31	0.28	SN7480	0.67	0.64	0.63	SN74163	£4.00	£3.75	£3.50	SN7413	0.29	0.28	0.28	SN74164	£2.20	£2.15	£2.10
SN7413	0.29	0.28	0.28	SN7482	0.37	0.36	0.35	SN74165	£2.25	£2.20	£2.15	SN7414	0.43	0.40	0.38	SN74166	£3.50	£3.25	£3.00
SN7416	0.43	0.40	0.38	SN7483	£1.10	£1.05	0.95	SN74167	£2.20	£2.15	£2.10	SN7415	0.50	0.48	0.45	SN74168	£2.50	£2.25	£2.00
SN7417	0.43	0.40	0.38	SN7484	£1.00	0.95	0.90	SN74169	£2.50	£2.25	£2.00	SN7416	0.50	0.48	0.45	SN74169	£2.50	£2.25	£2.00
SN7420	0.15	0.14	0.12	SN7485	£3.60	£3.50	£3.40	SN74170	£2.50	£2.25	£2.00	SN7417	0.50	0.48	0.45	SN74170	£2.50	£2.25	£2.00
SN7422	0.50	0.48	0.45	SN7486	£2.50	£2.31	0.30	SN74171	£2.50	£2.25	£2.00	SN7418	0.50	0.48	0.45	SN74172	£2.50	£2.25	£2.00
SN7423	0.50	0.48	0.45	SN7489	£5.50	£5.25	£5.00	SN74175	£1.80	£1.70	£1.60	SN7419	0.50	0.48	0.45	SN74173	£2.50	£2.25	£2.00
SN7425	0.50	0.48	0.45	SN7490	£1.00	0.95	0.90	SN74177	£2.50	£2.40	£2.30	SN7420	0.50	0.48	0.45	SN74174	£2.50	£2.25	£2.00
SN7427	0.45	0.42	0.40	SN7492	0.67	0.64	0.63	SN74180	£2.00	£1.90	£1.80	SN7421	0.50	0.48	0.45	SN74175	£1.80	£1.70	£1.60
SN7428	0.70	0.64	0.60	SN7493	0.67	0.64	0.63	SN74181	£5.50	£5.00	£4.75	SN7422	0.50	0.48	0.45	SN74176	£2.50	£2.25	£2.00
SN7430	0.15	0.14	0.12	SN7494	0.67	0.64	0.63	SN74182	£2.00	£1.90	£1.80	SN7423	0.50	0.48	0.45	SN74177	£2.50	£2.25	£2.00
SN7432	0.45	0.42	0.40	SN7495	0.77	0.74	0.74	SN74183	£2.00	£1.90	£1.80	SN7424	0.50	0.48	0.45	SN74178	£2.50	£2.25	£2.00
SN7433	0.80	0.75	0.70	SN7496	0.77	0.74	0.74	SN74184	£3.50	£3.25	£3.00	SN7425	0.50	0.48	0.45	SN74179	£1.80	£1.70	£1.60
SN7437	0.64	0.62	0.60	SN7497	0.87	0.84	0.84	SN74185	£1.90	£1.85	£1.80	SN7426	0.50	0.48	0.45	SN74180	£2.00	£1.90	£1.80
SN7438	0.84	0.82	0.80	SN7498	£1.85	£1.85	£1.85	SN74186	£1.90	£1.85	£1.80	SN7427	0.50	0.48	0.45	SN74181	£5.50	£5.00	£4.75
SN7440	0.15	0.14	0.12	SN7499	£1.00	0.97	0.94	SN74187	£1.90	£1.85	£1.80	SN7428	0.50	0.48	0.45	SN74182	£2.00	£1.90	£1.80
SN7441	0.87	0.84	0.82	SN7500	£1.00	0.97	0.94	SN74188	£1.90	£1.85	£1.80	SN7429	0.50	0.48	0.45	SN74183	£2.00	£1.90	£1.80
SN7442	0.67	0.64	0.62	SN7501	£1.00	0.97	0.94	SN74189	£1.90	£1.85	£1.80	SN7430	0.50	0.48	0.45	SN74184	£3.50	£3.25	£3.00
SN7443	£1.30	£1.25	£1.20	SN7502	£1.00	0.97	0.94	SN74190	£2.70	£2.60	£2.50	SN7431	0.50	0.48	0.45	SN74185	£1.90	£1.85	£1.80
SN7444	£1.30	£1.25	£1.20	SN7503	£1.00	0.97	0.94	SN74191	£1.90	£1.85	£1.80	SN7432	0.50	0.48	0.45	SN74186	£1.90	£1.85	£1.80
SN7445	£1.80	£1.77	£1.75	SN7504	£1.00	0.97	0.94	SN74192	£1.90	£1.85	£1.80	SN7433	0.50	0.48	0.45	SN74187	£2.50	£2.25	£2.00
SN7446	0.97	0.94	0.92	SN7505	£1.00	0.97	0.94	SN74193	£2.70	£2.60	£2.50	SN7434	0.50	0.48	0.45	SN74188	£1.90	£1.85	£1.80
SN7447	£1.00	0.97	0.95	SN7506	£1.00	0.97	0.94	SN74194	£2.70	£2.60	£2.50	SN7435	0.50	0.48	0.45	SN74189	£1.90	£1.85	£1.80
SN7448	£1.00	0.97	0.95	SN7507	£1.00	0.97	0.94	SN74195	£2.70	£2.60	£2.50	SN7436	0.50	0.48	0.45	SN74190	£1.90	£1.85	£1.80
				SN7508	£1.00	0.97	0.94	SN74196	£1.80	£1.70	£1.60	SN7437	0.50	0.48	0.45	SN74191	£1.90	£1.85	£1.80
				SN7509	£1.00	0.97	0.94	SN74197	£1.80	£1.70	£1.60	SN7438	0.50	0.48	0.45	SN74192	£1.90	£1.85	£1.80
				SN7510	£1.00	0.97	0.94	SN74198	£5.50	£5.00	£4.75	SN7439	0.50	0.48	0.45	SN74193	£2.70	£2.60	£2.50
				SN7511	£1.00	0.97	0.94	SN74199	£5.50	£5.00	£4.75	SN7440	0.50	0.48	0.45	SN74194	£2.70	£2.60	£2.50
				SN7512	£1.00	0.97	0.94	SN74200	£5.50	£5.00	£4.75	SN7441	0.50	0.48	0.45	SN74195	£2.70	£2.60	£2.50

ROCK BOTTOM PRICES LOGIC DTL 930 Series I.C.'s

Type No.	Price	1-24	25-99	100 up
BP930	12p	11p	10p	10p
BP932	13p	12p	11p	11p
BP933	13p	12p	11p	11p
BP935	13p	12p	11p	11p
BP936	13p	12p	11p	11p
BP944	13p	12p	11p	11p
BP945	25p	24p	22p	22p
BP946	12p	11p	10p	10p
BP948	25p	24p	22p	22p
BP951	65p	60p	55p	55p
BP962	12p	11p	10p	10p
BP963	40p	38p	35p	35p
BP964	40p	38p	35p	35p
BP967	40p	38p	35p	35p
BP969	40p	38p	35p	35p

Devices may be mixed to qualify for quantity price. Larger quantity prices on application. (DTL 930 Series only)

LINEAR I.C.'s—FULL SPEC.

Type No.	Price	1-24	25-99	100 up
RP 201C—SL201C	83p	53p	45p	45p
BP701C—SL701C	83p	50p	45p	45p
BP 702C—SL702C	83p	50p	45p	45p
BP 702—72702	53p	45p	40p	40p
BP709—72709	38p	34p	30p	30p
BP 709—LA709C	38p	34p	30p	30p
BP 710—72710	44p	42p	40p	40p
BP 711—LA711	45p	43p	40p	40p
BP 741—72741	75p	60p	50p	50p
LA703C—LA703C	28p	26p	24p	24p
TAA 283—	70p	80p	55p	55p
TAA 293—	80p	75p	70p	70p
TAA 350—	170p	158p	150p	150p

S.G.S. EA1000 2-63

NUMERICAL INDICATOR TUBES



MODEL	CD66	GR116	3015F Miniltron
Anode voltage (Vdc)	170min	175min	5
Cathode Current (mA)	2.3	14	8
Numerical Height (mm)	16	13	9
Tube Height (mm)	47	32	22
Tube Diameter (mm)	19	13	12 wide
I.C. Driver Rec.	BP41 or 141	BP41 or 141	BP47
PRICE EACH	£1.70	£1.55	£1.90

All indicators 0-9 + Decimal point. All side viewing. Full data for all types available on request.

RTL MICROLOGIC CIRCUITS

	Price each	1-24	25-99	100 up
Epoxy TO-5 case				
uL900 Buffer	35p	33p	27p	
uL914 Dual 2/1p gate	35p	33p	27p	
uL923 J-K flip-flop	50p	47p	45p	

Date and Circuits Booklet for IC's Price 7p.

DUAL IN LINE SOCKETS.

14 & 16 Lead Sockets for use with DUAL-IN-LINE I.C.'s. TWO RANGES PROFESSIONAL & NEW LOW COST. PROF. TYPE No. 1-24 25-99 100up.

T80 14 pin type	30p	27p	25p
T80 16	35p	32p	30p

LOW COST No.

BPS 14	15p	13p	11p
BPS 16	16p	14p	12p

BI-PAK DO IT AGAIN!

50W pk 25w (RMS)

0.1% DISTORTION!
HI-FI AUDIO AMPLIFIER

THE AL50

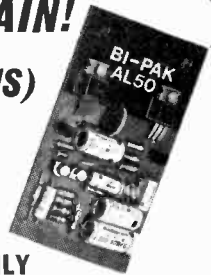

- ★ Frequency Response 15Hz to 100,000—1dB.
 - ★ Load—3, 4, 8 or 16 ohms.
 - ★ Distortion—better than 0.1% at 1KHz.
 - ★ Signal to noise ratio 80dB.
- ONLY £3.25p each
- ★ Supply voltage 10-35 Volts.
 - ★ Overall size 63mm x 105mm x 13mm.

Tailor made to the most stringent specifications using top quality components and incorporating the latest solid state circuitry and AL50 was conceived to fill the need for all your A.F. amplification needs. FULLY BUILT—TESTED—GUARANTEED.

STABILISED POWER MODULE SPM80



AP80 is especially designed to power 2 of the AL50 Amplifiers, up to 15 watt (r.m.s.) per channel simultaneously. This module embodies the latest components and circuit techniques incorporating complete short circuit protection. With the addition of the Mains Transformer MT80, the unit will provide outputs of up to 1.5 amps at 35 volts. Size: 63mm x 105mm x 30mm. These units enable you to build Audio Systems of the highest quality at a hitherto unobtainable price. Also ideal for many other applications including—Disc Systems, Public Address, Intercom Units, etc. Handbook available, 10p PRICE £2-95

TRANSFORMER BMT80 £1-95 p. & p. 25p.

STEREO PRE-AMPLIFIER TYPE PA100

Built to a specification and NOT a price, and yet still the greatest value on the market. The PA100 stereo pre-amplifier has been conceived from the latest circuit techniques. Designed for use with the AL50 power amplifier system, this quality made unit incorporates no less than eight silicon planar transistors, two of these are specially selected low noise NPN devices for use in the input stages. Three switched stereo inputs, and rumble and scratch filters are features of the PA100, which also has a STEREO/MONO switch, volume, balance and continuously variable bass and treble controls.

SPECIFICATION

Garrard Record Players



SP25 Mk. III
Deck Only
4 speed

Automatic Single Player

Lasky's price **£10-85**

Garrard SL95B Deck	£32-50
Garrard SL95B on base with 9TA cart.	£44-00
Garrard AP76 deck only	£18-85
Garrard 40B deck only	£9-50
Garrard 2025TC deck only	£8-50
complete with KS40A stereo ceramic cartridge...	£39-95
Garrard ZERO 100 Automatic	C & P £1-50
Garrard ZERO 100S Single Player	C & P £1-50

Garrard Plinths & Covers

WB4 Mk. II Plinth...	£5-45
SPC4 Mk. II cover...	£4-25
Price together	£8-70
WB1 Plinth	£3-70
SPC1 cover	£3-60
Price together	£6-50

Garrard Module Series

Modules are complete wired units with cartridge, plinth and cover.

SP25 Mk. III Module

SP25 Mk. III with SHURE M75/6 cart. **£23-95**

AP76 Module

AP76 with SHURE M75/6 cartridge **£33-95**

AP96 Module

Single play version of SL95B with SHURE M75/6 cartridge **£38-75**

Zero 100S Module

ZERO 100S with SHURE M93/E cartridge **£52-75**

CARRIAGE—all units

DECK ONLY 50p. PLINTH & COVER ONLY 25p. DECK WITH PLINTH AND COVER 75p.

BSR McDONALD MP60

High precision low-mass counter-balanced pick-up arm, heavy balanced turntable, simple to operate controls, viscous cueing device, slide in cartridge carrier, 4 pole motor.



LASKY'S **£10-40** C & P 50p

BSR McDONALD UNITS & PACKAGES
A. Chassis only. B. Complete with Lasky's plinth cover and AD76K cartridge. C. As B but with Shure M55E cartridge. D. McDonald TPD/1 package. E. As D plus Goldring G800 cartridge.
MODEL A B C D E
MP.60 10-40 18-95 21-00 16-95 19-60
HT.70 14-75 22-95 25-50 21-50 23-95
610 13-75 22-75 24-50 20-70 —
210 Complete with plinth, cover & BSR cartridge
MP.60 TPD2 Styrene base 17-50 21-00
810 transcription model **£33-50**
810 with BSR plinth and cover **£45-00**

BSR TD8S

8 TRACK STEREO CARTRIDGE PLAYER

The TD8S is suitable for use with most modern stereo amplifiers and delivers a pre-amp output of 125mW. Power requirements: 210/250V AC, 50Hz. Frequency response: 50Hz-10KHz. 4 pole dynamically balanced synchronous motor. Black and woodgrain plastic cabinet. Size: 8½(W) X 3¾(H) X 10½ (D) in. List Price **£24-20** LASKY'S PRICE **£17-95**



AUDIO-TRONICS

1973 JUST PUBLISHED

The 1973 edition of Lasky's famous "Audio-Tronics Pictorial" is now available. Bigger, brighter and better than ever. Lasky's brand new catalogue now contains 48 pages packed with all the latest Hi-Fi and electronics equipment—everything for the layman and enthusiast alike. All the goods shown in the "Audio-Tronics Catalogue" are available from any of our branches or by Mail Order to any address in the U.K. or overseas. Free on request. Just send your name, address and 15p for post and inclusion on our regular mailing list.

FREE

SEND TODAY—and bring the benefit of shopping at Lasky's to you in the comfort of your home.

INTERNATIONAL MAGNETIC RECORDING TAPE FROM THE U.S.A. AT LASKY'S RECORD LOW PRICES

3in. RT.20 Message Tape 220ft.	19p
3½in. RT.21 Triple play, 600ft. Mylar	50p
5in. RT.23 Double play, 1,200ft.	75p
5in. RT.18 Long play, 900ft. Acetate	50p
5in. RT.17 Standard play, 600ft.	43p
5½in. RT.15 Double play, 1,800ft. Mylar	£1-13
5½in. RT.16 Long play 1,200ft. Acetate	75p
5½in. RT.24 Standard play 900ft. P.V.C.	68p
5½in. RT.14 Long play 1,200ft. Mylar	75p
5½in. RT.25 Triple play, 2,400ft.	£1-31
7in. RT.22 Standard play, 1,200ft. Acetate	63p
7in. RT.10 Standard play, 1,200ft. Mylar	63p
7in. RT.12 Long play, 1,800ft. Acetate	95p
7in. RT.13 Double play, 2,400ft. Mylar	£1-25
7in. RT.11 Long play, 1,800ft. Acetate	75p
7in. RT.19 Triple play, 3,600ft. Mylar	£2-50
3½in. RT.22 Quad play, 1,100ft.	£1-02

P & P 5p extra per reel, 4 reels and over Post Free. Special quotes for quantities.

LASKY'S NEW LOW NOISE CASSETTES FROM THE USA

Type	Single	5	10	15
C60	26p	£1-29	£2-53	£3-71
C90	38p	£1-85	£3-62	£5-33
C120	47p	£2-29	£4-48	£6-59

Each cassette individually boxed in Philips, type plastic library. C & P: each 7p, 5—25p, 10—40p, 20—68p.



AKAI 4000D illustrated
List Price £93-65 ... Lasky's Price **£61-50**
AKAI 1720L
List Price £87-36 ... Lasky's Price **£58-95**
AKAI X1800SD
List Price £162-79 ... Lasky's Price **£111-50**
AKAI X200D
List Price £157-93 ... Lasky's Price **£106-50**
2 CSS-8 Speakers
List Price £25-00 ... Lasky's Price **£15-95** C & P 50p
2 ADM 11/8 mics. Suitable for use on all Akai tape recorders. List Price £11-90. Lasky's Price **£7-50.** C & P 15p.

AKAI TAPE RECORDER SCOOP!

(C & P 75p on all Tape Decks.)

BSR TAPE DECK SCOOP

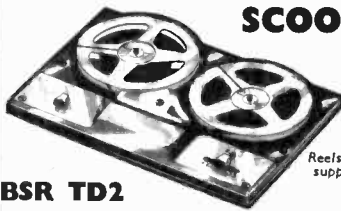

Reels not supplied

BSR TD2

FANTASTIC VALUE, ONLY Lasky's can offer you a tape deck at such an amazing price. The BSR TD2 tape deck operates by a simple reliable mechanism. Available with ½ track or ¼ track mono or stereo heads. Incorporates fast wind and fast rewind, records at 3½ ips, giving up to 3 hrs playing time, takes up to 5½in. spools. Size 13in. x 8½in. front to rear, 2½in. below plate, 1½in. above plate.

ALSO SUITABLE FOR USE AS A TAPE TRANSPORTER
LASKY'S £8-95 C & P 35p
PRICE

SINCLAIR PHASE LOCK LOOP STEREO FM TUNER



Incorporates varicap diodes, printed circuit, coils, squelch circuit I.C. Decoder, etc., supplied completely built and tested and ready to be mounted into any cabinet you choose. It may be used with any High Fidelity Amplifier. Power requirements 25/30V DC. Size 8½" x 1½" x 3½".

LIST PRICE **LASKY'S £15-75** C & P £25-00 PRICE
PZ5 power supply £4-15 extra.

NEW DIGITAL CLOCK NOW WITH ILLUMINATED DIAL

EXCLUSIVELY FROM LASKY'S
The clock measures 5½ W x 2½ H x 3in D (overall from front of drum to back of switch). SPEC. 1/210/240V a.c. 50Hz operation; switch rating 250V. 3A. Complete with instructions. ● COMPLETE WITH KNOBS. FEATURES: ● MAINS OPERATION ● 12-HOUR ALARM ● AUTO "SLEEP" SWITCH ● HOURS, MINUTES AND SECONDS READ-OFF ● FORWARD AND BACKWARD TIME ADJUSTMENT ● SILENT OPERATION ● SHOCK AND VIBRATION PROOF ● BUILT IN ALARM BUZZER
SPECIAL QUOTES LASKY'S **£6-50** C & P FOR QUANTITIES PRICE **25p**



NEW WELLER MINI-SHOP KIT - 600K



Powered by a 25,000rpm, 115 volts, 1.5 amp Universal motor. This small versatile, easy to handle, power tool is ideal for handymen, and professionals. The wide selection of bits helps you grind, sharpen, drill, rout, cut etc. Perfect for delicate work. The complete kit is housed in a strong plastic case.
MODEL 600K 37 piece Kit contains:
● Model 600 Power Unit ● Accessory Caddy ● 8 Grinding/Sharpening Bits ● 3 Polishing Wheels ● 4 Cleaning Bits ● 8 Abrasive Discs ● 3 Abrasive Bands ● Expanding Drum ● Drill Bit ● Mandrel ● Chuck Wrench ● Dressing Stone ● Plastic Polish ● Jewellers Rouge ● Complete with owners manual ● Size of power unit only 7½".
LASKY'S PRICE £17-95 C & P 35p

Lasky's Radio Limited

Branches
33 TOTTENHAM CT. RD., LONDON, W1 Tel: 01-636 2605
Open all day, 9 a.m.—6 p.m. Monday to Saturday
207 EDGWARE ROAD, LONDON, W.2 Tel: 01-723 3271
Open all day, 9 a.m.—6 p.m. Monday to Saturday

The Home of High Fidelity
42-45 TOTTENHAM CT. RD., LONDON, W1 Tel: 01-636 0845
Open all day, 9 a.m.—6 p.m. Monday to Saturday
109 FLEET STREET, LONDON, E.C.4 Tel: 01-353 5812
Open all day Thursday, early closing 1 p.m. Saturday

MAIL ORDERS TO: 3-15 CAVELL ST. LONDON E1 2BN 01-790 4821



PRACTICAL WIRELESS

VOL 48 NO 8

Issue 790

DECEMBER 1972

Happy Anniversaries

If you have been orbiting in space, trekking across the Gobi Desert or drifting down the Amazon for the past few months, it is possible that the news of the great event about to be celebrated has not filtered through. Otherwise, you will be aware that this month the BBC notches up the 50th Anniversary of broadcasting in the UK.

Special programmes are being broadcast on radio and television, exhibitions are being mounted by the BBC and others, the Post Office has issued a special set of postage stamps, the IEE is staging a series of lectures. After such a welter of words, pictures and sounds, what is there left to say? Not a lot, really, except for Practical Wireless to add its tribute to all those on the engineering, programme and administrative sides, who over the past 50 years have made a contribution towards what is still (despite its lovable faults) the best broadcasting service in the world.

But while we are indulging in flag-waving, let us not forget the unsung heroes who have also played a part in the development of broadcasting—the component makers, the set makers, the performers, the backroom boys and those overlooked but staunch martyrs, the listeners themselves!

There is yet another group who, collectively, deserve a modest pat on the back—our colleagues, past and present, who presumably through some inherited defect (or sheer masochism) decided to devote their life to the career of technical journalism! In the early days of broadcasting, and even before it, the technical journals generated and sustained the interest in the subject. The famous magazines of the day, such as *Popular Wireless*, *Wireless Magazine* and *Amateur Wireless* have long been but memories, but three of the pioneer publications are still with us—*Wireless World*, *Practical Wireless* and *Television* (which started life as *Practical Television* as early as 1934).

At the risk of being dubbed chauvinistic, this seems to be the right occasion to mention (with a becoming blush) that during the BBC festive season of celebrating their 50th Anniversary, readers may like to raise a flag or two in recognition of the fact that this year *Practical Wireless* is a contender in the Anniversary Stakes, having now reached its 40th birthday—a period of time during which, like the famous Windmill, we never closed!

W. N. STEVENS—*Editor*.

NEWS AND COMMENT

Leader	691
News . . . News . . . News . . .	692
Practically Wireless by Henry	720
Electronotes by S. Ginsberg	728
MW Column by Charles Molloy	731
On the Short Waves	
by Malcolm Connah and	
David Gibson, G3JDG	741
Letters	745

CONSTRUCTIONAL

Amateur Bands Receiver, Part 1	
by F. G. Rayer, G3OGR	694
Loudhailer and Siren	
by A. Lester-Rands	701
Transistors in Transmitter PA Stages	
by R. Dowling G3NKH	709
Take 20, No. 43, Audio Mixer	
by Julian Anderson	714
The "Music Maker" Electronic Organ	
by D. Smith	716
Universal Bridge	
by Halvor Moorshead	724
Reverberation Unit, Part 2	
by F. C. Judd	729
Automatic Emergency 250V Supply	
by S. Soar	732

OTHER FEATURES

IC of the Month,	
Hyreg Power Regulator	
by L. A. J. Ireland	723
Transistor Circuitry for Beginners,	
Part 13 by H. W. Hellyer and	
Michael Hollier	734
Going Back by Colin Riches and	
Arthur Dow	746

COMPETITION

WIN A HEATHKIT 'SCOPE 721

THE JANUARY ISSUE WILL BE
PUBLISHED ON DECEMBER 1st

©IPC Magazines Limited 1972. Copyright in all drawings, photographs and articles published in "Practical Wireless" is fully protected, and reproduction or imitations in whole or in part are expressly forbidden. All reasonable precautions are taken by "Practical Wireless" to ensure that the advice and data given to readers are reliable. We cannot, however, guarantee it, and we cannot accept legal responsibility for it. Prices are those current as we go to press. All correspondence intended for the Editor should be addressed to Fleetway House, Farringdon Street, London, EC4A 4AD. Queries must be accompanied by a stamped, addressed envelope. Address correspondence regarding advertisements to Advertisement Manager, Fleetway House, Farringdon Street, London, EC4A 4AD.

Bristol '73

The Bristol Group of the R.S.G.B. are now privileged to announce their plans for participation in the 1973 anniversary celebrations of the granting of the Royal Charter to the City and County of Bristol.

One aspect will be the operation of an amateur radio exhibition station on the S.S. *Great Britain*, now being restored in dry dock at Bristol.

The Ministry of Posts and Telecommunications, as the licensing authority, has agreed to the special call sign "GB2GB" for a station to be operated from the vessel and will permit the station to be operated by persons holding current Amateur (Sound) Licences A who visit the vessel during the month of August, 1973.

The general public will hear contacts being made with amateur radio stations, both local and long distance, and information will be available from the operators on the hobby of amateur radio and the role it plays in promoting international understanding.

With the co-operation of the S.S. *Great Britain* Project, receiving tests already carried out from the vessel have indicated that the site is suitable for reception and therefore transmission is not considered to present any problems.

It is anticipated that the station will make contacts with stations in other Bristols and the cities of Hanover and Bordeaux. Contact will also be attempted with amateur radio stations in the Falkland Islands where the vessel lay in Sparrow Cove for many years.

Specially designed cards depicting the S.S. *Great Britain* will be sent to amateur radio stations contacting GB2GB and these are being donated by a famous firm of Bristol wine merchants who have also agreed to present cases of sherry as awards in a Bristol Amateur Radio Activity Contest to be held in 1973, details of which will be announced in a few months' time.

As 1973 is also the Diamond Jubilee of the Radio Society of Great Britain, local members are pleased to announce that a convention will be held at a local hotel. This is to be on the 26th May, 1973, and details are now being planned.

It is hoped that these events—GB2GB on the S.S. *Great Britain*, and radio contest, and the convention, will make 1973 a memorable year for Bristol and radio amateurs.

Further gen from G. Mather G3GKA, 8 Hills Close, Keynsham, Bristol.

The "Elf"

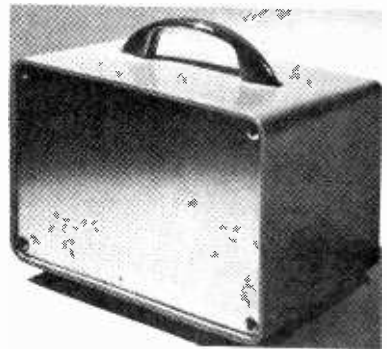

West Hyde announce the Contil "ELF". Only 6in. x 4in. x 4in., they are offered at five cases for £6 including postage and packing. (£1.25 ea. + 10p p.p.)

Glass polyester dough moulded in grey or blue, the price includes a chromium plated handle, an aluminium chassis, a protectively coated aluminium front panel and four fitted feet.

Two printed circuit boards can be fitted in the slots provided internally, making the case ideal for the increasing number of applications requiring miniature cases, in step with the firm's well known policy this tough smart little case is available by return of post. West Hyde Developments Ltd., Ryefield Crescent, Northwood Hills, Northwood, Middx.

Portable rechargeable soldering iron

Soldering with the new 8in. long portable, lightweight soldering iron—which is rechargeable and can be used far from a power source—launched by the Van Dusen Aircraft Supplies Company in the UK and Europe. The "Iso-Tip" soldering iron, weighing less than 6 ounces, has been designed to handle, with speed and efficiency, every industrial or domestic soldering requirement. Price of unit and stand is £8.75. Van Dusen Aircraft Supplies Co., Oxford Airport, Kidlington, Oxford.

Picture shows the iron in use.

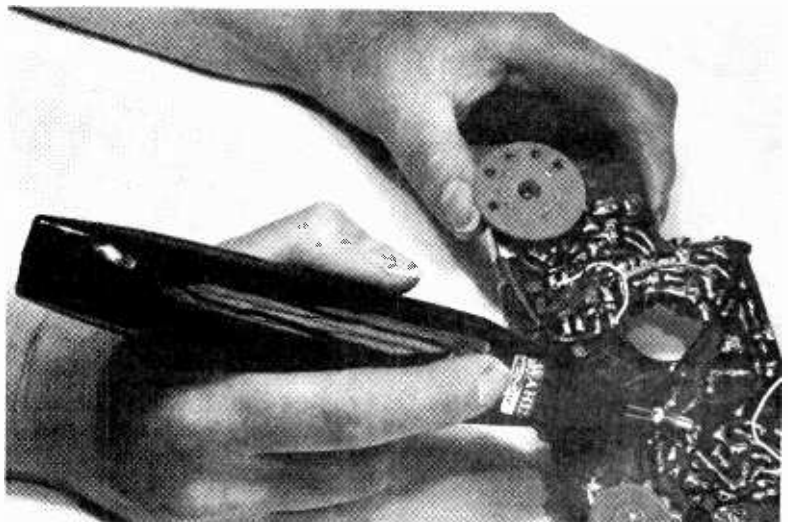

Pictures on the phone

EMI has entered the facsimile communications market with a document transceiver for sending clear, accurate copies of documents in minutes to anywhere in the world. Known as the EMifax HF146, this compact, desk-top system transmits and receives any type of document up to A4 size (220 x 305 mm), including invoices, lists, graphs, sketches and handwritten notes, over public or private telephone networks.

A unique cost-saving advantage of the EMifax machine is that normal office stationery is used for reproducing transmitted copies, eliminating the need for expensive coated papers which create both cost and supply problems. The document transceiver is priced at £900. Leasing and rental facilities are also available.



A quick NIP

NIP Electronics, mentioned in our October News . . . pages have asked us to say that two of the readers who have written to them asking for information on NIP-E-BOARDS omitted to give their full addresses.

If they would please communicate with NIP again, giving their full addresses, they will be pleased to supply the items they require.

The readers are: Mr. A. M. Coppin, 128 Fernside Avenue and Mr. Christopher Jones of Coventry.

NIP Electronics, P.O. Box 11, St. Albans, Hertfordshire.

Texan Reprints

Reprints of the "Texan" 20+20W Stereo Amplifier are now available.

They may be obtained by sending 35p (30p + 5p postage/packing) to *Practical Wireless Editorial, Fleetway House, Farringdon Street, London, EC4A 4AD*

Paramo Handyvice

Latest addition to the Paramo range of tools is a new design of vice. The vice is manufactured from die cast high strength aluminium alloy, designed to give comparable strength to the standard cast iron product, but with considerable savings in weight.

The vice is available in three forms, a 3in. fixed base mechanics vice (HV1), a 3in. swivel base mechanics vice (HV2), a 3in. swivel base mechanics vice with table clamp (HV3).

The vice is finished in hammer blue enamel with chrome plated moving parts. It is supplied with hardened file cut steel jaws and a steel anvil for light metal forming. On the swivel base versions a simple single handed locking lever enables the vices to be swivelled through 360°.

Prices are: HV1, £2.45; HV2, £2.95; HV3 (illustrated), £3.45.—*F. Parramore & Sons (1924) Ltd., Caledonian Works, Chapeltown, Sheffield, Yorkshire.*



Disc car aerial



A new car radio aerial is being introduced by Valan Electricals to complement their wide range of conventional aerials.

Named the Valan Disc Aerial, it combines the function of an aerial with that of the road tax licence holder or a club card holder, and is fitted on the windscreen.

It can be fitted in minutes by anyone. The fitting instructions are simple and are on the reverse of the pack. It works equally well in all makes of car and commercial vehicles.

The recommended retail price is £1.20. The Valan Disc Aerial is available from Halfords and leading garage and accessory shops. *Valan Electricals, 1034 Yardley Wood Road, Birmingham B14 4BW.*

QSL from the BBC

This month there will be an opportunity for listeners to the BBC World Service programme, World Radio Club, to possess one of the BBC's QSL cards verifying reception of the Club's 50th Anniversary Edition.

There are 12,000 members of the Club, spread all over the world. The programme is broadcast on Thursdays at 1330, Fridays at 2345, and Sundays at 0815 GMT in the World Service. Any member who reports accurately on reception of the Anniversary Edition on November 9th, 10th or 12th will be able to receive this QSL.

If you are not a member, write to World Radio Club, BBC, Bush House, London.

AMATEUR BANDS RECEIVER

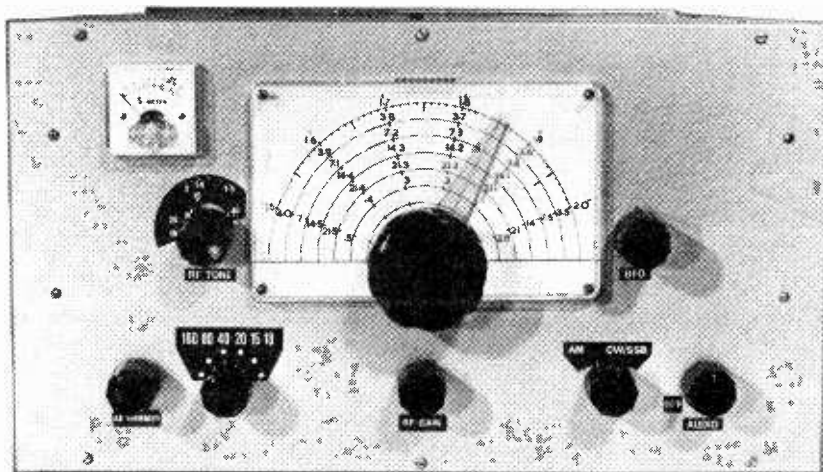

1.8-30MHz • AM-CW-SSB • BANDSWITCHED • EASY CALIBRATION

PART 1

F. G. RAYER G30GR

THIS receiver possesses high stability coupled with excellent sensitivity, selectivity and adequate bandspread covering the Amateur bands from 10 to 160metres. On all bands, except 80m, the receiver employs double conversion with a crystal controlled first oscillator. It is easy to tune and to hold a.m., c.w. or s.s.b. signals on all bands.

Those who may not be familiar with the method of operation of this type of receiver should find the block diagram of Fig. 1 helpful in conjunction with the description that follows.

CIRCUIT

Referring to Fig. 1 stage (1) is an r.f. amplifier followed by the first mixer (2) both working on all bands except 80m. Each Amateur band, except 80m, employs a crystal (3) chosen so that the output of the mixer (2) falls in the range 3.5 to 4MHz whatever the band in use. This tuning range 3.5 to 4MHz is covered by the tunable r.f./i.f. amplifier (4) and is followed by the second mixer and tunable oscillator (5) forming the tunable i.f. part of the receiver on all bands, except 80m. On 80m signals fall in the range 3.5 to 4MHz and are switched to stage (4).

The output frequency of the second mixer (5) is 455kHz which goes to the crystal filter (6) which is a bandpass filter with 2kHz crystal separation. When using a single filter for a.m., c.w. and s.s.b. this is about the highest degree of selectivity which can be tolerated without excessive cutting of the sidebands of a.m. signals.

Stages (7) and (8) are 455kHz i.f. amplifiers followed by the a.m. diode detector (9), its output going to the a.f. amplifier and output stages (10) and (11) and thence to the speaker. For c.w. and s.s.b. reception the beat frequency oscillator (12) and product detector (13) are switched into circuit. Both tunable oscillators (5) and (12) are fed from a voltage regulated source (14).

As the first i.f. is 3.5 to 4MHz the second channel interference, which can be troublesome on the h.f. bands with a lower i.f., is virtually eliminated. The

use of a crystal controlled oscillator also gives an enormous improvement in overall stability.

The tuning coverage of each band is a constant 500kHz with fixed 100kHz calibration points which completely eliminates any calibration problems on the h.f. bands. One disadvantage is that because the 10m band is so wide only a small portion of it can be covered but this can be overcome by providing two or more 500kHz sections with very little extra circuitry, as explained later.

CONVERSION FREQUENCIES

As stated the tunable i.f. covers 3.5 to 4MHz and is calibrated at 100kHz intervals. The crystal frequency for the 160m band is 5.5MHz the difference or signal frequency selected by stages (1) and (2) thus extending from 1.5 to 2MHz (5.5-3.5 and 5.5-4). In this case the oscillator frequency is on the high side of the tunable i.f.

Band	Crystal	Calibration MHz							
80	None	3.5	3.6	3.7	3.8	3.9	4.0		
160	5.5	2.0	1.9	1.8	1.7	1.6	1.5		
40	11	7.5	7.4	7.3	7.2	7.1	7.0		
20	10.5	14.0	14.1	14.2	14.3	14.4	14.5		
15	17.5	21.0	21.1	21.2	21.3	21.4	21.5		
10	24.5	28.0	28.1	28.2	28.3	28.4	28.5		

For 40m an 11MHz crystal is used giving coverage of 7 to 7.5MHz the crystal again being on the high side. Crystal frequencies for the remaining bands are shown in the accompanying table and it will be noted that they are all below the signal frequency. Calibration points are shown, the direction being reversed on 160 and 40m because these crystals are above the signal frequency.

Since stages (1) and (2) cover 28 to 30MHz three 500kHz segments can be obtained by simply selecting the appropriate crystal with a three way switch, crystals on 25 and 25.5MHz adding bands 28.5 to 29MHz and 29 to 29.5MHz.

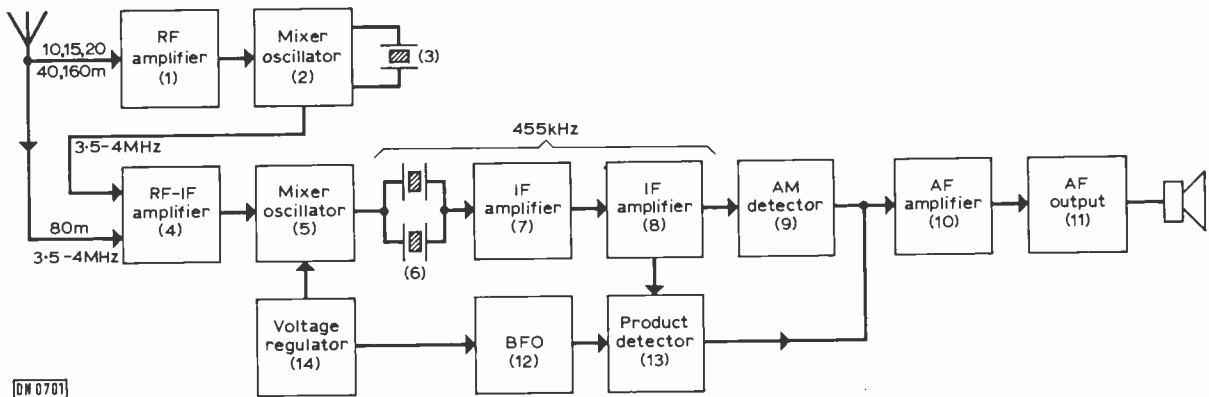

Fig. 1: Block diagram to illustrate the function of each stage in a double conversion communications receiver.

PROGRESSIVE CONSTRUCTION

The constructional work involved is naturally not simple but it can be carried out and tested in sections. This method has much to recommend it as the location of a wiring fault or error is then much easier. The audio stages together with the power supply can be wired and tested with a pick-up or audio oscillator as a signal source. Stages (4) and (5) with one i.f. stage and the a.m. detector can be added thus forming a complete 80m receiver.

Next the additional i.f. stage and filter together with the b.f.o. and product detector will provide additional selectivity and c.w. and s.s.b. facilities. Stages (1) and (2) should then be wired for one additional band and checked after which the other bands can be added one by one. This general plan will be followed in the articles that follow.

AF/POWER SUPPLY

In Fig. 2D showing this part of the circuit VR1 is the usual audio volume control, followed by a 2-stage amplifier, the output section of the ECL86 providing about 3 watts of audio. An output jack connected to the secondary of the speaker transformer T1 permits the use of phones or an external speaker automatically silencing the phones. This facility can be useful when operating the receiver with a transmitter.

The mains transformer T2 and rectifiers D1 and D2 supply 250V for the triode anode, pentode screen grid and earlier stages of the receiver. The OA2 voltage regulator provides a stabilised 150V supply for the tunable i.f. oscillator and beat frequency oscillator.

If T2 is not as listed, the h.t. voltage may be

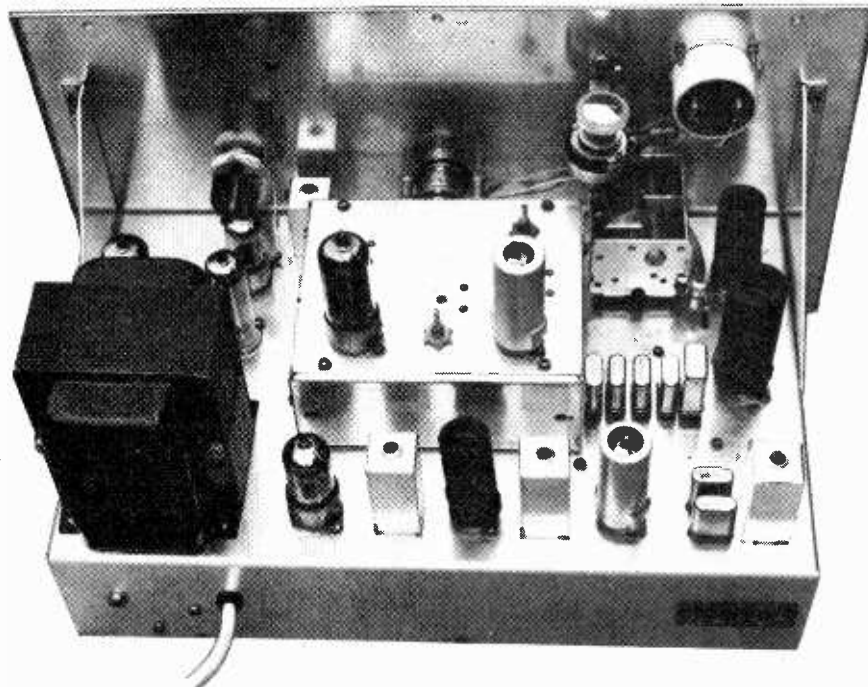

Rear view of the completed receiver with the tunable IF amplifier in its own screened box on top of the chassis with the five crystals for the first mixer stage to the right. The two crystals at the bottom right are part of the fixed IF amplifier.

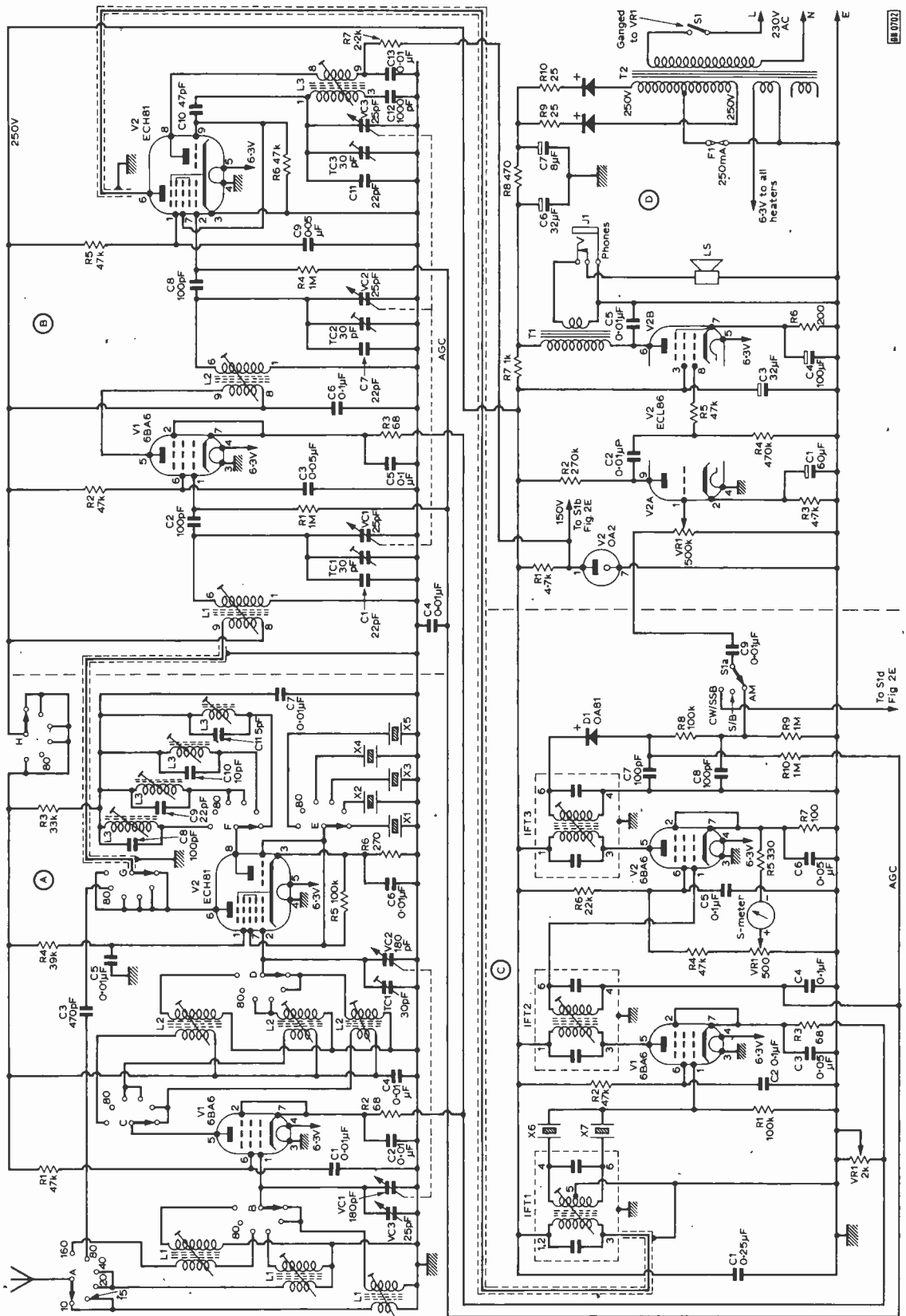

Fig. 2A-B-C-D. Complete circuit diagram of the receiver with the exception of the b.f.o. product detector shown on the next page, Fig. 2E.

different. This has little effect on most stages of the receiver, but if it is found that the OA2 is extinguished or nearly so, with the receiver on any band other than 80m and with no aerial connected and the r.f. gain control at maximum gain, then the h.t. is too low. It is then in order to reduce R7 or R8, or both, to obtain about 250V.

Leads to VR1 run against the chassis and need not be screened but R5 should be soldered directly to pin 8 of the ECL86. A 250mA fuse is placed in a holder on the inside of the chassis, and is in the h.t. circuit from T2 to earth.

The heaters require about 3A and are run from the 6.3V 4A winding of T2. If a transformer is fitted which has two 6.3V windings, rated at less than 3A, use one heater winding to supply some heaters and a separate circuit from the other heater winding to the remaining heaters.

The a.f. amplifier and power supply can be checked by connecting a pick-up, audio signal generator or other source of a.f. to the top of VR1. A 3Ω speaker is connected to or plugged into J1.

IF STAGES

Fig. 2C is the circuit of this section of the receiver which operates at 455kHz. IFT1 is an intermediate frequency transformer with a centre-tapped secondary the centre tap being earthed. Balanced output in opposite phase, from pins 4 and 6, go to the two crystals X6 and X7, which have a frequency separation of about 2kHz. This pass-band can readily be modified, as described later. It is, however, a reasonable degree of fixed selectivity for all general amateur band purposes and avoids the need for an adjustable phasing capacitor.

Valves V1 and V2 are the two i.f. stages at 455kHz both receiving bias from the a.g.c. line (which also passes to some earlier stages). The manual gain control VR1 adjusts the cathode bias of the first i.f. stage.

Diode D1 provides bias for the a.g.c. line and also operates as the a.m. detector.

Switch S1a is one pole of a 3-way switch, and when in the "AM" position feeds audio via C9 to the volume control.

When S1a is in the "CW/SSB" position, audio signals are fed from the product detector, Fig. 2E. The central position of S1 is for "Standby" when h.t. is removed from several stages.

S-METER

Incoming i.f. signals produce negative bias at diode D1, Fig. 2C, fed through R10 and the secondary of i.f.t.2 to V2 control grid. This moves negative with increased signal strength, the current through R7 and R6 falls, so that the screen of V2 becomes more positive, and the cathode more negative. With no signal, potentiometer VR2 allows the circuit to be balanced so that no voltage is present across the S-Meter. Incoming signals cause the meter reading to rise in proportion to the signal strength. R5 reduces the meter sensitivity to a suitable level.

If a steady signal is present, from a transmission or a signal generator, all i.f.t. or other adjustments can be directed towards obtaining the best meter reading. This also applies to any external adjustments, such as to an aerial tuner or to the aerial-earth system.

CRYSTAL FILTER

With the i.f.t.'s aligned at 455kHz, crystal X6 was 454kHz and X7 was 456kHz but it is not necessary that X6 and X7 have exactly 2kHz separation. The specified i.f.t.'s are 465kHz types but they tune easily to 455kHz.

If one crystal only is used, and the other replaced by a 15pF variable phasing capacitor, a sharply resonant peak can be obtained together with a rejection notch which can be moved across the i.f. pass-band. A filter of this type was described in the December 1971 issue of *Practical Wireless* and is excellent for c.w. in particular.

The lead from the mixer pin 6, Fig. 2B, to pin 3 of i.f.t.1 is screened right up to the i.f.t., otherwise stray coupling round the filter will degrade results.

If an accurately calibrated signal generator is available, set it midway between the crystal frequencies and inject at pin 1 of V2, Fig. 2C, adjusting the

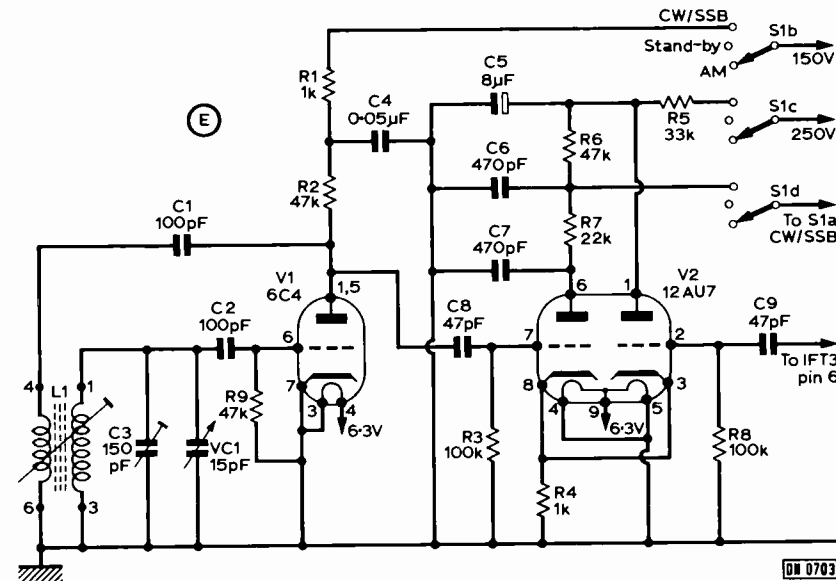

Fig. 2E: Circuit of the b.f.o. product detector, the addition of this unit to the receiver permitting the reception of c.w. and s.s.b. signals. The frequency of the b.f.o. is variable from the front panel to accommodate upper or lower sideband signals.

★ components list

1ST. RF, MIXER/OSCILLATOR (FIG. 2A)

Resistors

R1 47kΩ 1W R3 33kΩ 1W R5 100kΩ ½W
R2 68Ω ½W R4 39kΩ 1W R6 270Ω ½W

Capacitors

C1 0.01μF Disc 350VW C7 0.01μF Disc 350VW
C2 0.01μF Disc 350VW C8 100pF SM
C3 470pF Mica C9 22pF SM
C4 0.01μF Disc 350VW C10 10pF SM
C5 0.01μF Disc 350VW C11 5pF SM
C6 0.01μF Disc 350VW TC1 30pF trimmer
VC1-2 2 x 180pF (Jackson L2)
VC3 25pF midget variable (Jackson C804)

Valves

V1 6BA6 V2 ECH81

Miscellaneous

Valveholders B7G (1) skirted, B9A (1) skirted.
Formers (7) see text. Crystals X1-5 Type HC6U (see text) with holders. Bandswitch sections A-H, comprising 4 wafers each 2 pole 6 way. Universal chassis flanged members, 6 x 2in. (1), 5 x 2in. (2) (Home Radio).

TUNABLE IF AMPLIFIER (FIG. 2B)

Resistors

R1 1MΩ ½W R4 1MΩ ½W R7 2.2kΩ 1W
R2 47kΩ ½W R5 47kΩ 1W
R3 68Ω ½W R6 47kΩ ½W

Capacitors

C1 22pF SM C8 100pF SM
C2 100pF SM C9 0.05μF 350VW
C3 0.05μF 350VW C10 47pF SM
C4 0.01μF 350VW C11 22pF SM
C5 0.1μF 350VW C12 1000pF SM
C6 0.1μF 350VW C13 0.01μF 350VW
C7 22pF SM TC1-2-3 30pF trimmer
VC1-2-3 3 x 25pF (Jackson 003)

Valves

V1 6BA6 V2 ECH81

Inductors

L1 Blue Range 3 L2 Yellow Range 3 L3 Red Range 3
(All Denco, miniature, valve type)

Miscellaneous

Universal chassis flanged members, 5 x 2in. (2), 4 x 2in. (2), flat plate 5 x 4in. (1) (Home Radio). Cabinet 15 x 9 x 8in. Type W, chassis 13 x 8 x 2½in. Type K, brackets 4 x 4in. Type C (2) (H. L. Smith). Dial and drive, Type DL6 and ball drive Type 4511 (Home Radio). If not available use combined Jackson dial and drive Type 4103/A.

FIXED IF AMPLIFIER (FIG. 2C)

Resistors

R1 100kΩ ½W R5 330Ω ½W R9 1MΩ ½W
R2 47kΩ 1W R6 22kΩ 1W R10 1MΩ ½W
R3 68Ω ½W R7 100kΩ ½W VR1 2kΩ linear WW
R4 47kΩ 1W R8 100kΩ ½W VR2 500Ω WW pre-set

Capacitors

C1 0.25μF 350VW C6 0.05μF
C2 0.1μF 350 VV C7 100pF mica
C3 0.05μF 350VW C8 100pF mica
C4 0.1μF 350VW C9 0.01μF 350VW
C5 0.1μF 350VW

Valves

V1 6BA6 V2 6BA6

Inductors

IFT1 IFT/11/465CT IFT2 IFT/11/465
IFT3 IFT/11/465 (All Denco)

Miscellaneous

Crystals X6/7 Type HC6U with holders (see text). Valveholders B7G (2) skirted. Diode D1, OA81. Switch S1a-d, 4 pole 3 way wafer switch. S meter, 1mA f.s.d.

AUDIO AMPLIFIER/POWER SUPPLY (FIG. 2D)

Resistors

R1 4.7kΩ 3W R4 470kΩ ½W R7 1kΩ 3W
R2 270kΩ ½W R5 47kΩ ½W R8 470Ω 5W
R3 4.7kΩ ½W R6 180Ω ½W R9 25Ω ½W
R10 25Ω ½W
VR1 500kΩ log. pot. with switch, S1

Capacitors

C1 60μF 6VW C5 0.01μF 350VW
C2 0.01μF 350VW C6 32μF 450VW
C3 32μF 350VW C7 8μF 450VW
C4 100μF 15VW

Valves

V1 ECL86 V2 OA2 (150V)

Miscellaneous

Valveholders B7G (1), B9A (1). D1-2 silicon rectifiers 800 p.i.v. 1A. Closed circuit jack. Fuse 250mA and holder. T1, output transformer Type TO46 (Home Radio). T2, mains transformer Parmeko P2931 or similar (Home Radio) see text.

BFO/PRODUCT DETECTOR (FIG. 2E)

Resistors

R1 1kΩ ½W R4 1kΩ ½W R7 22kΩ ½W
R2 47kΩ ½W R5 33kΩ ½W R8 100kΩ ½W
R3 100kΩ ½W R6 47kΩ ½W R9 47kΩ ½W

Capacitors

C1 100pF SM C6 470pF mica
C2 100pF SM C7 470pF mica
C3 150pF SM C8 47pF SM
C4 0.05μF 350VW C9 47pF SM
C5 8μF 350VW VC1 15pF variable

Valves

V1 6C4 V2 12AU7

Miscellaneous

L1, b.f.o. coil (Denco BFO2/465).
Valveholders B7G (1), B9A (1).

cores of i.f.t.3 for best output. Repeat with i.f.t.2, with the signal applied at pin 1 of V1 The signal can then be taken to the second mixer grid and i.f.t.1 aligned.

Assuming no generator is available, tune in any strong, stable signal. It will probably be found that

there are two responses, one is relatively broad and arises from the i.f.t.'s while the other is sharper and may be much weaker if the i.f.t.'s are not tuned near to the crystal frequencies. Tune the signal in at the sharper response position which places it in the

continued on page 738

Three new stereo kits from Heath

From Heath (Gloucester) Ltd has come an excitingly new line of high-performance stereo equipment - the Heathkit 1214 series. You get advanced specifications, fabulous sound reproduction and immaculate design concepts at reasonable prices.

What is more, you can build all the units yourself from our step-by-step construction manuals, get a great sense of achievement plus the satisfaction of having top-quality Hi-Fidelity equipment at money-saving prices.

Check over the facts and the figures:

First the **AR-1214 Tuner Amplifier**: 50 watts IHF power (15 watts RMS per channel) 2-integrated circuits in the IF giving selectivity better than 60 dB; 2-ceramic IF filters and one phase-locked multiplex demodulator integrated circuit add up to a 35 dB typical channel separation with less than 0.5% distortion; a pre-assembled FM tuner unit which provides better than 2 μ V sensitivity with

a 2 dB capture ratio; the phono pre-amplifier uses integrated circuitry and, of course, the world famous Heath 'Black Magic' panel lighting gives a suitably sophisticated finishing touch.

Kit K/AR-1214 AM/FM Stereo Tuner Amplifier £69.80. Carr.: 80p.

The AJ-1214 Tuner (separate) specifications follow that of the AR-1214. The most dramatic are: FM sensitivity, less than 2 μ V. FM selectivity, 60 dB. Stereo separation, 35 dB minimum. AM sensitivity, less than 100 μ V per metre. AM selectivity, greater than 40 dB.

Like the AR-1214 it features a single-knob flywheel for AM/FM, FM-stereo tuning, push-button mode control and an adjustable ferrite rod antenna for AM reception.

Kit K/AJ-1214 AM/FM Stereo Tuner £39.60. Carr.: 40p.

The AA-1214 Stereo Amplifier gives 25 watts per channel. All the

circuitry is on 2-printed circuit boards. A single wiring harness takes care of point-to-point connections. The 15 watts RMS power per channel into 8 ohms is more than enough power to drive most speaker systems. You'll find input jacks for phono, tape and tuner inputs along with a tape monitor socket. Should you also be thinking of 4-channel adaptation, the AA-1214 stereo amplifier is worthy of serious consideration.

Kit K/AA-1214 Stereo Amplifier £41.40. Carr.: 40p.

Incidentally, our customer advisory service is here to serve and/or advise you before, during and after your kit assembly. That's our firm guarantee for your successful enjoyment. You simply can't go wrong buying from Heath.

Mail the coupon today and receive our Free Heath Catalogue, and see what wonderful bargains we can offer you.

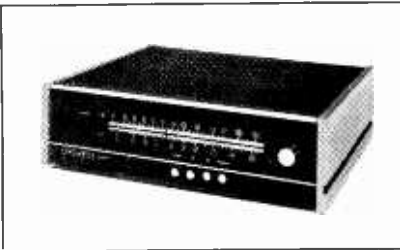
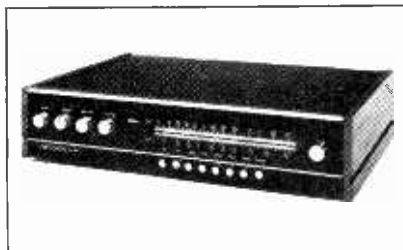

FREE! The biggest audio-instrument catalogue in the U.K. Speakers, test and research instruments, intercoms and fun gadgets - it's got the lot.



OPEN A HEATH MONTHLY BUDGET ACCOUNT

For continuous credit on all our products. Write for full details and application form . . . Today! Existing attractive credit facilities are also available.

Please send me the FREE New 1972 Heathkit catalogue.

Name _____

Address _____



HEATH (Gloucester) Ltd.,
Dept PW 12/72
Gloucester GL2 6EE

SURPLUS BARGAINS

JOY STICK CONTROL UNITS these give control in N, S, E, W directions with 4x micro swts £1.20. METER UNIT center reading type scale marked L & R as two coils on magnet new with conn 95p. TRIMMER CONDS air spaced ceramic 20pf new 10 for 50p. HEADPHONE MATCHING TRANS 4000 to 250 ohm with jack plug & lead new 50p. CROSS POINTER IND as two meter units in same case 115 Ua ea for use with 1155 Rx £1.40. AERIAL PRE AMPS T.V. type contain small mains P.U. and R.F. Amp with valve etc supplied as they come in case 9 x 4 x 2" note these are in poor external condition and are supplied for parts only £1. C.R.T. TUBES type 7BP7A 7" emag focus & def. Blue/Yell phosphor new boxed with base conn & volts req £1.55. BATTERIES lead acid type 6v 40 A/hr new metal cased £2.75. RADIO MAGS back issues of American 73 Mag new 8 different for £1.15. CONTROL UNIT with valves 6BA6, 6AS6, 12AU7, pot core, luf 1% conds etc. new 95p, DYNAMOTORS I/P 12v DC O/P 220v at 100 Ma fully enc American surplus £1.25. TRANSISTOR PANELS large panels 13 x 12" with all Sil NPN transis new cond two panels with 40 transis for £1.37. LOW VOLTAGE P.U. I/P 115v 50c/s O/P 0 to 26v D.C. smoothed at 3 amps, uses variac American surplus £7. W.W. POTS value 10K ± shaft new 3 for 25p. MINIATURE TUNING IND type DM160 with holders and conn 4 for 50p. DIODES 800 P.I.V.1 amp new 12 for £1. Diodes ZR22 200 P.I.V. 8 amps 4 for 60p. TRANSISTORS Texas 2SO12a H.F. power Silicon N.P.N. 70v, 2a, 40w, 5Mc/s 2 for 60p, TAG STRIPS solder type 24 way new 10 for 25p. TRANSFORMERS Pria 230v 50c/s Secs 400-0-400 at 200 Ma, 55v 50 Ma & 6.3v 2 amps C core £2.60 Choke to match 75p. V.H.F. TEST SETS combined W.M. & Osc covers range 150 to 230 Mc/s for mains operation with charts, Inst & spares new American surplus £16.50. I.F. STRIPS 30 Mc/s wide bandwidth 6 stage with det & o/p supplied with plugs American surplus £1.80. Pre amp for this 90p. POWER UNITS I/P 200/250v 50c/s O/P 250v at 400 Ma stabilised or 400v 400 Ma un stab fitted Volt/Ma meter 19" rack unit £9. MOTOR UNIT with 24v 9000 RPM motor and misc parts new £1.50. SELECTOR UNIT with 24v motor, gears, 1 Ma meter 21 sq, relays etc in case £2.60. RELAYS 12v sealed 4 pole c/o contacts MBB 50p also 7.25v A.C. coil will work on 6v contacts 6p c/o sealed 50p. POWER UNITS 230v I/P O/P 240v stab at 1 amp £11.50. HELIPOTS Beckman 50K 10 tr 85p. PLUG & SK 6 way with cable clamp clean 2 pairs for 30p. COAX LEADS fitted with B.N.C. plugs 5ft or more 85p. SMALL AMP units I/P 115v 50c/s fully enc with 6X4, 12AX7 & 6AK6 valves 500 ohm O/P with circ £1.80. HEIGHT UNIT with 4 pwr transis V60/20p, 2x relays, height det unit with barometric bellows etc all in case 8 x 8 x 4" £1.80. METERS panel mounting type 2, 3, 4" dia etc serviceable but supplied as they come 4 different for £1. LAMP PANELS with red, green & amber lamps all with 24v bulbs 35p. VIDICON CAMERA TUBES tested graded according to scan marks, industrial types £9 & £6 ea. INVERTORS 24v D.C. I/P O/P 115v 400c/s at 180 watts 1 phase new unused all transistor £12.50. VALVES 6X4, ECC83, ECC81, 85A2, OB2, 6BH6, 6AK5, 2X2, 6Y6, all 3 for 50p.

CIRCUIT DIAGRAMS. R1155, B.F.L.N. with values, 50p. R1392, R1475, 30p ea. CT38 50p, Scopes CD518 (CT316), 13a, 1035 Mk. 1-2 & 3, 1049 Mk3 all 50p ea. Sig Gens TF144G 50p, TF801a 75p. R4187 Rx circ parts list & block diagram £1.

The above prices include postage or carriage, all goods ex equipment unless stated otherwise, carriage charges apply U.K. mainland only, S.A.E. with enquiry.

A. H. SUPPLIES

57 MAIN ROAD, SHEFFIELD S9 5HL

EXCLUSIVE OFFER ONLY FROM GLOBAL



GARRARD 401
SME 3009/3012

PLINTH
SYSTEM
£10.95
PLUS £1 P & P

This superbly styled and sprung plinth system has been designed for us by one of Britain's leading Hi-Fi manufacturers. Finished in teak with black border, smoke tinted dust cover. Lid stays on when deck is in play. The system is already cut to just drop the Garrard 401 into. Enough space is provided for either the SME 3009 or SME 3012 pick-up arm to be cut and mounted. All this comes to you at the amazingly low price of £10.95 plus £1 carr.

GLOBAL AUDIO DISCOUNT WAREHOUSES
Dept. PW2 174 Pentonville Road, London, N1. Telephone 01-278 1769
Or: 4 High View Parade, Redbridge Lane East, Woodford Avenue, Ilford, Essex. Tel: 01-550 1086.
2 minutes from KING'S CROSS LONDON & ST. PANCRAS
On the road leading to the East and West Country
MAIL ORDERS: Order with cash/credit. Same Postal Order. Cheques. Money Order. Same Cash. Goods Cash by Reg. parcel. Min. Call £10. Please state full address. Can only be processed through main discount centre West. Retain Cash.

PRICES UNCHANGED

OUR PRICE LIST COMPILED IN 1971 IS STILL CURRENT
5th Edition Issue one

SEND NOW FOR A CATALOGUE

5th Edition

AND DISCOUNT VOUCHERS
25p POST FREE (UK)

W.E.C. LTD. HIGH STREET, RIPLEY, SURREY

Established 1954

REED COILS

3, 6, 9, 12, 24V Miniature 27p
Small 27p
Standard 34p

P & P. 7p on all orders.

REED SWITCHES

Large range of many sizes, types and manufacture
Popular types:
E Small n/o 10 for 50p
A Miniature n/o 24p each
B Standard c/o 40p each

REED PUSH BUTTON SWITCHES

Momentary Action
1 contact £1.00
2 contacts £1.25
Illuminated 1 contact £1.30
Illuminated 2 contacts £1.55

REED RELAYS

Many versions available, popular types: 3, 6, 9, 12, 24V
Miniature 1/A normally open 56p
Small 2/E 1 contact 36p
2/EE 2 contacts 44p
2/EEE 3 contacts 52p
STD 3/B change over 87p

REELS OF ENAMELLED COPPER WIRE

20 s.w.g. to 47 s.w.g. 50, 100 & 200 grams. Send for prices

C.B.M. ELECTRONIC COMPONENTS LTD.
26 Avon Trading Estate, Avonmore Road, London, W.14

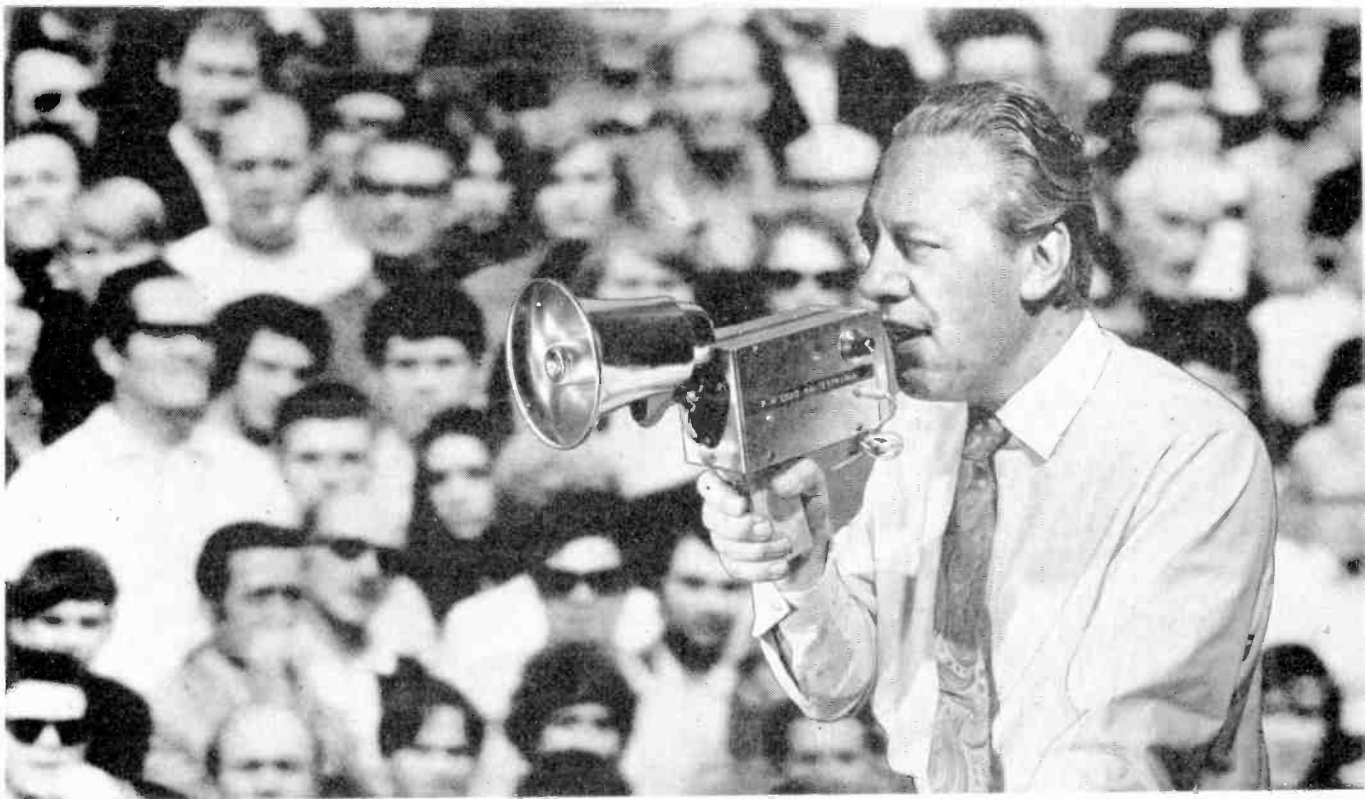

LOUDHAILER AND SIREN

A. LESTER-RANDS

A LOUDHAILER is simply a battery powered, portable public address amplifier complete with its own loudspeaker and has a wide variety of uses in or out of doors e.g., making oneself heard to a crowd of people or to a single person at a distance. The addition of a siren (electrically generated) also enables the hailer to be used as a warning device, for example by yachtsmen in foggy weather or simply to attract the attention of people before making an announcement.

The loudhailer with siren described in this article has an output power of 3 to 4 watts on speech and is battery operated by eight 1.5V cells (U11 or equivalent) providing a total of 12V. The siren sound can be produced at about the same power output and is pitched at around 250Hz to achieve maximum carrying range. The loudhailer can be hand held by its pistol grip type handle or can be self standing for use with a detachable microphone (see right). The main hailer on-off button is a rocker type switch mounted on the front of the pistol grip handle. This permits easy intermittent operation when the hailer is hand held but can be used in a continuous 'on' position when the hailer is used self-standing.

The circuit

This is shown in Fig. 1 and consists of a microphone preamplifier Tr1, which drives the PC5+ power amplifier via S1 and the volume control VR1. The siren generator Tr2/Tr3 is simply a multivibrator



The loudhailer need not be hand held and can be rested as shown with the speaker adjusted to face forwards.

with a charge up circuit (C9/R11) that supplies a slowly increasing potential to the base of Tr3. This introduces a slight rise of pitch as the siren is switched on, resulting in a somewhat distinctive sound. The output of the siren is taken to the PC5+ power amplifier via S1.

The power amplifier provides some 3 to 4 watts of power output to an 8Ω speaker and is a printed circuit assembly made by Newmarket Transistors. It was chosen because of its small dimensions which,

in turn, permitted the use of a case for the hailer of only 6 x 4 x 3ins but yet still large enough to accommodate the microphone preamplifier, the siren generator, the battery cells and the power amplifier itself.

Note that the 12V supply has both an on-off switch and the rocker switch (hailer control button) in series to the negative supply rail to the amplifier. The on-off switch is optional but could be used merely as a safety precaution against the rocker switch being left

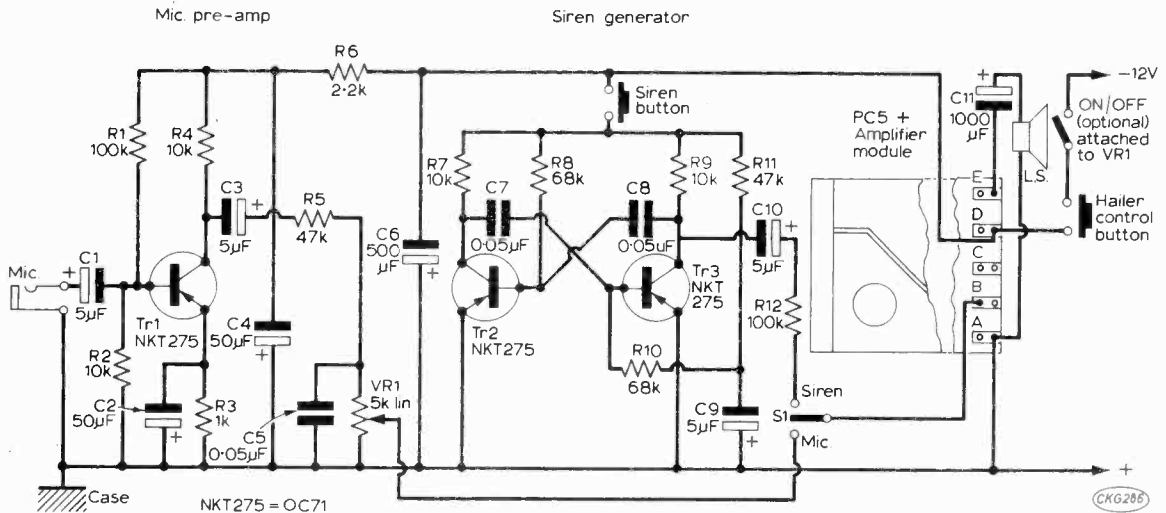

★ components list

Resistors

R1	100kΩ	R7	10kΩ
R2	10kΩ	R8	68kΩ
R3	1kΩ	R9	10kΩ
R4	10kΩ	R10	68kΩ
R5	47kΩ	R11	47kΩ
R6	2·2kΩ	R12	100kΩ

All resistors ½W, 5 per cent tolerance
VR1 5k log. pot with switch

Capacitors

C1	5μF	C7	0·05μF
C2	50μF	C8	0·05μF
C3	5μF	C9	5μF
C4	50μF	C10	5μF
C5	0·05μF	C11	1000μF
C6	500μF		

All electrolytic capacitors should have a working voltage of at least 15V

Transistors

Tr1, Tr2, Tr3 Newmarket type NKT275

Miscellaneous

Power Amplifier	Newmarket type PC5+
Loudspeaker	Eagle type HDA5
Microphone	Eagle type CM10 (lapel)
Microphone Socket	Eagle type PJM3
Rocker Switch	Home Radio WS201/Bulgin SIB825
Mic/Siren Switch	Miniature slide type
Siren Switch	Small toggle type
Case	Home Radio Universal Chassis Parts: CU157(2); CU144 (2); CU146 (2)

Sundries

Plain circuit board; Aluminium angle; 16 or 18 s.w.g. aluminium for pistol grip; Stand-off pillars.

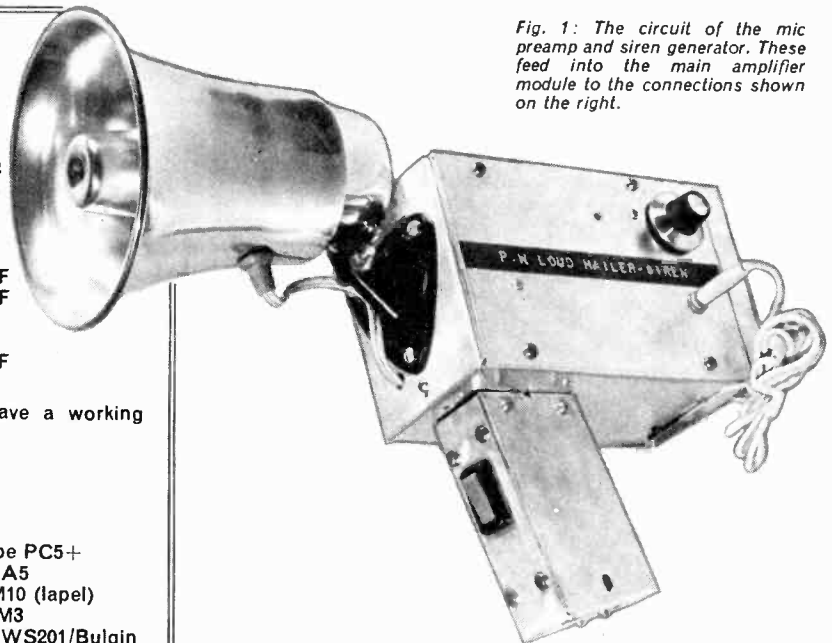

Fig. 1: The circuit of the mic preamp and siren generator. These feed into the main amplifier module to the connections shown on the right.

on. The siren button may be a small toggle switch on a press (self release) button type switch. (See components list regarding suitable rocker switch and self release button switch).

Construction

The 6 x 4 x 3inch case was constructed from Home Radio Universal Chassis parts (see components list). The loudspeaker is an Eagle type PA speaker

INCREASE YOUR KNOWLEDGE



Established 1891

MANY COURSES TO CHOOSE FROM incl.
 RADIO & TV ENGINEERING & SERVICING,
 TRANSISTOR & PRINTED CIRCUIT SERVICING,
 COLOUR TV SERVICING, ELECTRONICS,
 NUMERICAL CONTROL ELECTRONICS,
 TELEMETRY TECHNIQUES, CONTROL SYSTEMS,
 ELECTRONICS FOR AUTOMATION,
 COMPUTERS, ETC.

ALSO EXAMINATION COURSES FOR

C. & G. Telecommunication Technicians' Certificates
 General Radio Communications Certificate
 Radio Amateurs' Examination
 General Certificate of Education, etc.

BUILD YOUR OWN RADIO AND INSTRUMENTS

With an ICS Practical Radio & Electronics Course you gain a sound knowledge of circuits and applications as you build your own 5-valve Superhet Receiver, Transistor Portable, and high-grade test instruments (shown below). Everything simply explained. All components and tools supplied. For illustrated brochure, post coupon below.

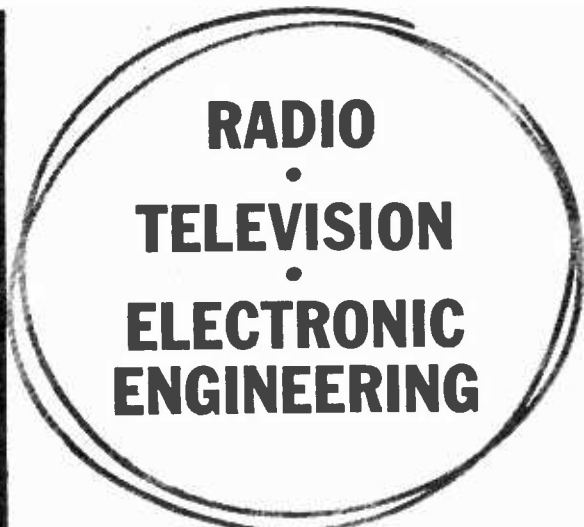
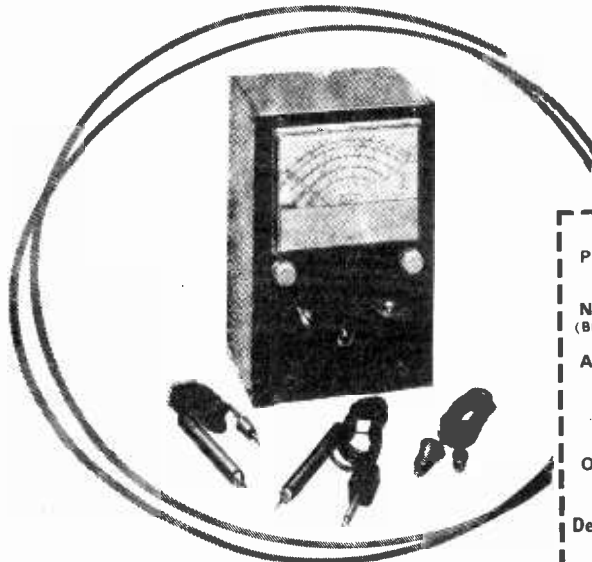

**RADIO
TELEVISION
ELECTRONIC
ENGINEERING**

MEMBER OF THE ASSOCIATION
OF BRITISH CORRESPONDENCE COLLEGES

C & G Radio Servicing Theory

THERE IS AN ICS COURSE FOR YOU

Whether you need a basic grounding, tuition to complete your technical qualifications, or further specialized knowledge, ICS can help you with a course individually adapted to your requirements.

There is a place for you among the fully-trained men. They are the highly paid men—the men of the future. If you want to get to the top, or to succeed in your own business, put your technical training in our experienced hands.

ICS Courses are written in clear, simple and direct language, fully illustrated and specially edited to facilitate individual home study. You will learn in the comfort of your own home—at your own speed. The unique ICS teaching method embodies the teacher in the text; it combines expert practical experience with clearly explained theoretical training. Let ICS help you to develop your ambitions and ensure a successful future. Invest in your own capabilities.

FILL IN AND POST THIS COUPON TODAY

You will receive the FREE ICS Prospectus listing the examination and ICS technical courses in radio, television and electronics PLUS details of over 150 specialized subjects.

Accredited by the GACC.

PLEASE SEND FREE BOOK ON

NAME
 (BLOCK CAPITALS PLEASE)

ADDRESS

OCCUPATION AGE

INTERNATIONAL CORRESPONDENCE SCHOOLS
 Dept. YA28, INTERTEXT HOUSE, STEWARTS ROAD, London, SW8 4UJ.

BENTLEY ACOUSTIC CORPORATION LTD.

38 CHALCOT ROAD, CHALK FARM, LONDON, N.W.1
THE VALUE SPECIALISTS Telephone 01-722-9090

0A2	.30	6BR7	.70	6R7M	.55	14S7	.75	150B2	.58	EBC81	.29	E142	.53	PC95	.53	PY81	.24	U361	.63	AC156	.20	BCY33	.20	OA81	.09
0B2	.30	6BR8	.83	6SA7GT	.35	19A05	.24	807	.59	EBC80	.30	E140	.50	PC97	.35	PY82	.23	U301	.40	AC157	.25	BCY34	.23	OA85	.09
0Z4	.25	6BS7	1.25	6SA7M	.35	1906	.50	5702	.90	EBC78	.38	E138	.21	PC90	.29	PY83	.26	U403	.33	AC165	.25	BCY38	.25	OA90	.13
1A3	.23	6BW6	.70	6SC7GT	.33	20F2	1.06	E7B9	.26	E134	.26	E134	.26	PC96	.44	PY88	.31	U404	.33	AC166	.25	BCY39	.25	OA91	.09
1A7GT	.32	6BW7	.50	6SG7GT	.33	20F2	.65	7193	.53	E141	.53	E141	.53	PC98	.44	PY80	.33	U423	.30	AC168	.33	BCZ11	.33	OA95	.09
1B3GT	.35	6BZ6	.31	6SH7	.53	20L1	.98	7475	.70	E142	.53	E142	.53	PC95	.53	PY81	.24	U361	.63	AC176	.55	BF158	.29	OA200	.09
1H6GT	.33	6CB6A	.36	6S7	.53	20P1	.50	AC/PEN	.98	E143	.53	E143	.53	PC98	.44	PY80	.33	U423	.30	AC177	.58	BF159	.25	OA209	.10
1L4	.13	6C4	.28	6SK7GT	.23	20P3	.76	AC2/PEN	.98	E144	.53	E144	.53	PC95	.53	PY81	.24	U361	.63	AC178	.58	BF162	.29	OC32	.43
1N5GT	.37	6C9	.37	6SQ7GT	.33	20P4	.89	DD	.98	E145	.53	E145	.53	PC97	.35	PY82	.23	U301	.40	AC191	.19	BF180	.30	OC24	.38
1R5	.28	6CD6G	1.06	6U4GT	.60	20F5	1.06	AC/PEN	.98	E146	.53	E146	.53	PC98	.44	PY80	.33	U423	.30	AC192	.18	BF181	.40	OC25	.38
1R4	.22	6CQ8A	.60	6V6G	1.27	25A6G	.39	AC/TH	.50	E147	.53	E147	.53	PC90	.29	PY83	.26	U403	.33	AC193	.18	BF182	.40	OC26	.38
1U4	.29	6CH6	.38	6V6GT	.27	25L6G	.20	AC/TP	.98	E148	.53	E148	.53	PC94	.44	PY88	.31	U404	.33	AC194	.18	BF183	.40	OC27	.60
1U5	.45	6CL6	.43	6X4	.20	25Y8G	.43	AL60	.78	E149	.53	E149	.53	PC98	.44	PY80	.33	U423	.30	AC195	.18	BF184	.30	OC28	.60
2D21	.35	6CM7	.50	6X6GT	.25	25Z4G	.28	ATP4	.12	E150	.53	E150	.53	PCF200	.67	PCF81	.28	R19	.28	AC196	.15	BF194	.15	OC29	.63
3GK5	.50	6CUE	.30	7B6	.58	25Z5	.40	AZ1	.40	E151	.53	E151	.53	PCF80	.67	PCF82	.30	VP23	.76	AC197	.15	BF195	.15	OC35	.33
3A4	.35	6CW4	.63	7B7	.82	25Z6G	.43	AZ81	.44	E152	.53	E152	.53	PCF84	.44	PCF84	.44	QS85/20	.63	AC198	.15	BF196	.15	OC36	.33
3D6	.19	6DE7	.80	7H7	.23	20A5	.44	AZ41	.65	E153	.53	E153	.53	PCF84	.44	PCF84	.44	QV04/7	.63	AC199	.15	BF197	.15	OC37	.63
3Q4	.38	6DT6A	.50	7R7	.65	30C15	.55	CL33	.33	E154	.53	E154	.53	PCF80	.67	PCF80	.67	R19	.28	AC200	.15	BF198	.15	OC38	.63
3Q5GT	.35	6E76G	.55	7Y4	.60	30C17	.74	CV63	.53	E155	.53	E155	.53	PCF80	.67	PCF80	.67	R19	.28	AC201	.15	BF199	.15	OC39	.63
3B4	.23	6F1	.59	7Z4	.50	30C18	.58	CY1C	.53	E156	.53	E156	.53	PCF80	.67	PCF80	.67	R19	.28	AC202	.15	BF200	.15	OC40	.63
4CB6	.50	6F6	.63	9BW6	.50	30F5	.61	CY31	.29	E157	.53	E157	.53	PCF80	.67	PCF80	.67	R19	.28	AC203	.15	BF201	.15	OC41	.63
5CG8	.80	6F13	.33	9D7	.78	30FL1	.58	DAPF91	.30	E158	.53	E158	.53	PCF80	.67	PCF80	.67	R19	.28	AC204	.15	BF202	.15	OC42	.63
5T4	.30	6F14	.40	10C2	.49	30FL2	.58	DAPF96	.33	E159	.53	E159	.53	PCF80	.67	PCF80	.67	R19	.28	AC205	.15	BF203	.15	OC43	.63
5U4G	.80	6F16	.45	10D8T	.67	30FL12	.67	ECP84	.64	E160	.53	E160	.53	PCF80	.67	PCF80	.67	R19	.28	AC206	.15	BF204	.15	OC44	.63
5V4G	.33	6F23	.65	10F1	.75	30FL14	.66	DFP96	.34	E161	.53	E161	.53	PCF80	.67	PCF80	.67	R19	.28	AC207	.15	BF205	.15	OC45	.63
5Y3GT	.25	6F24	.88	10F9	.45	30LL15	.55	DH76	.22	E162	.53	E162	.53	PCF80	.67	PCF80	.67	R19	.28	AC208	.15	BF206	.15	OC46	.63
5Z4G	.33	6F25	.51	10F18	.35	30L17	.65	DK40	.55	E163	.53	E163	.53	PCF80	.67	PCF80	.67	R19	.28	AC209	.15	BF207	.15	OC47	.63
5Z4GT	.38	6F28	.60	10LD11	.53	30P4MR	.95	DK92	.35	E164	.53	E164	.53	PCF80	.67	PCF80	.67	R19	.28	AC210	.15	BF208	.15	OC48	.63
6/30L3	.55	6F32	.15	10P13	.64	30P12	.69	DK96	.35	E165	.53	E165	.53	PCF80	.67	PCF80	.67	R19	.28	AC211	.15	BF209	.15	OC49	.63
6AB6	.33	6G18A	.50	10P14	1.08	30P19/1	.87	DL96	.35	E166	.53	E166	.53	PCF80	.67	PCF80	.67	R19	.28	AC212	.15	BF210	.15	OC50	.63
6AC7	.15	6GK5	.50	12A6	.63	30P4	.55	DM70	.70	E167	.53	E167	.53	PCF80	.67	PCF80	.67	R19	.28	AC213	.15	BF211	.15	OC51	.63
6AG5	.25	6GUT7	.50	12AC6	.40	30PL1	.57	DM71	.73	E168	.53	E168	.53	PCF80	.67	PCF80	.67	R19	.28	AC214	.15	BF212	.15	OC52	.63
6AK6	.25	6H6GT	.15	12AD6	.40	30PL13	.75	DY87/6	.23	E169	.53	E169	.53	PCF80	.67	PCF80	.67	R19	.28	AC215	.15	BF213	.15	OC53	.63
6AK6	.30	6J5G	.19	12AE6	.48	30PL14	.62	EB002	.29	E170	.53	E170	.53	PCF80	.67	PCF80	.67	R19	.28	AC216	.15	BF214	.15	OC54	.63
6AMS6	.50	6J5GT	.29	12AT6	.23	30PL15	.87	YR80C	1.65	E171	.53	E171	.53	PCF80	.67	PCF80	.67	R19	.28	AC217	.15	BF215	.15	OC55	.63
6ANS	.49	6J6	.18	12AU6	.21	35A3	.49	E80F	1.20	E172	.53	E172	.53	PCF80	.67	PCF80	.67	R19	.28	AC218	.15	BF216	.15	OC56	.63
6AQ5	.21	6J7G	.24	12AV6	.28	35D5	.70	E83F	.50	E173	.53	E173	.53	PCF80	.67	PCF80	.67	R19	.28	AC219	.15	BF217	.15	OC57	.63
6AR5	.80	6J7(M)	.38	12BA6	.30	35L6GT	.42	E88CC	.60	E174	.53	E174	.53	PCF80	.67	PCF80	.67	R19	.28	AC220	.15	BF218	.15	OC58	.63
6AT6	.18	6J8A	.50	12BE6	.30	35W4	.23	E92CC	.40	E175	.53	E175	.53	PCF80	.67	PCF80	.67	R19	.28	AC221	.15	BF219	.15	OC59	.63
6AU6	.19	6K7G	.10	12B7H	.27	35Z4GT	.24	E180F	.90	E176	.53	E176	.53	PCF80	.67	PCF80	.67	R19	.28	AC222	.15	BF220	.15	OC60	.63
6AV6	.22	6K8G	.16	12J7GT	.33	35Z5GT	.30	E182CC1	.00	E177	.53	E177	.53	PCF80	.67	PCF80	.67	R19	.28	AC223	.15	BF221	.15	OC61	.63
6A78A	.43	6L1	.98	12K5	.50	50C5	.32	E1148	.53	E178	.53	E178	.53	PCF80	.67	PCF80	.67	R19	.28	AC224	.15	BF222	.15	OC62	.63
6AX4	.39	6L7	.38	12K7GT	.24	50CD6G	.58	EAT6	.38	E179	.53	E179	.53	PCF80	.67	PCF80	.67	R19	.28	AC225	.15	BF223	.15	OC63	.63
6BG6	.13	6L18	.44	12RC7	.35					E180	.53	E180	.53	PCF80	.67	PCF80	.67	R19	.28	AC226	.15	BF224	.15	OC64	.63
6BA6	.19	6L19	1.38	12RC7	.23	50H85	.55	EAC91	.38	E181	.53	E181	.53	PCF80	.67	PCF80	.67	R19	.28	AC227	.15	BF225	.15	OC65	.63
6BC8	.50	6LD20	.48	12RH7	.15	50L6GT	.45	EAP42	.48	E182	.53	E182	.53	PCF80	.67	PCF80	.67	R19	.28	AC228	.15	BF226	.15	OC66	.63
6BE6	.20	6N7GT	.40	12S7	.23	85A2	.48	EAP801	.50	E183	.53	E183	.53	PCF80	.67	PCF80	.67	R19	.28	AC229	.15	BF227	.15	OC67	.63
6BH6	.43	6O7GT	.43	12SK7	.24	86A3	.40	EB34	.20	E184	.53	E184	.53	PCF80	.67	PCF80	.67	R19	.28	AC230	.15	BF228	.15	OC68	.63
6BJ6	.39	6Q7M	.43	12SQ7	.50	90C1	.59	EB91	.10	E185	.53	E185	.53	PCF80	.67	PCF80	.67	R19	.28	AC231	.15	BF229	.15	OC69	.63
6BQ7A	.38	6R7G	.35	14H7	.48	90CG	1.70	EB41	.48	E186	.53	E186	.53	PCF80	.67	PCF80	.67	R19	.28	AC232	.15	BF230	.15	OC70	.63

POWERTRAN ELECTRONICS

APPOINTED DISTRIBUTORS FOR THE

TEXAN



TEXAS INSTRUMENTS DESIGNED & APPROVED FULL KIT £28.50

post (UK) 45p
INCLUDES TEAK CASE

20 Watts per channel, 6 Integrated Circuits, 10 Transistors. HARMONIC DISTORTION 0.05% at 15W 1KHz into 15 ohm, 0.09% at 20W 1KHz into 8 ohm. FREQUENCY RESPONSE 5Hz to 35KHz (-3dB). SIGNAL TO NOISE RATIO 60dB magnetic pick-up, 72dB radio.

Components available in separate packs Eg. Resistors and Capacitors £3.70, Switches and Controls £2.35, Fibre Glass PCB £2.50, Semiconductors £8.35.

For other parts and full specification please see our free list. More amplifier kits (Wireless World designs), slider potentiometers, low priced semiconductors, etc. in our free list.

FOR FREE ILLUSTRATED LIST PLEASE WRITE TO DEPT. D

22 THE PANTILES BEXLEYHEATH KENT

MAIL ORDER ONLY

YOU MUST HEAR

miniWISE audILECT

THE No. 1 HIT

YOUR PERSONAL TUTOR

Bring PLEASURE to your CAREER or HOBBY through Integrated LEARNING.

ORGANISED TUITION
in your own HOME at your own SPEED—

The TUTOR OF YOUR CHOICE will give you rapid UNDERSTANDING—the key to SUCCESS.

ASSURE YOUR FUTURE
IN RADIO, T.V. or ELECTRONICS

FOR FREE DETAILS OF THIS UNIQUE sensible method just send us your name and address

Write now—right now to—

MINIWISE PRODUCTS

FREEPOST, BLETCHLEY, BUCKS

(No one will call) (No stamp required)

Or include only 90p to own a trial lesson* on either a C90 cassette in lib. case, or L.P. Tape (state which)

*Your money INSTANTLY REFUNDABLE if not 100% convinced that this can be the turning point in your hobby or career.

THE NATURAL WAY TO LEARN

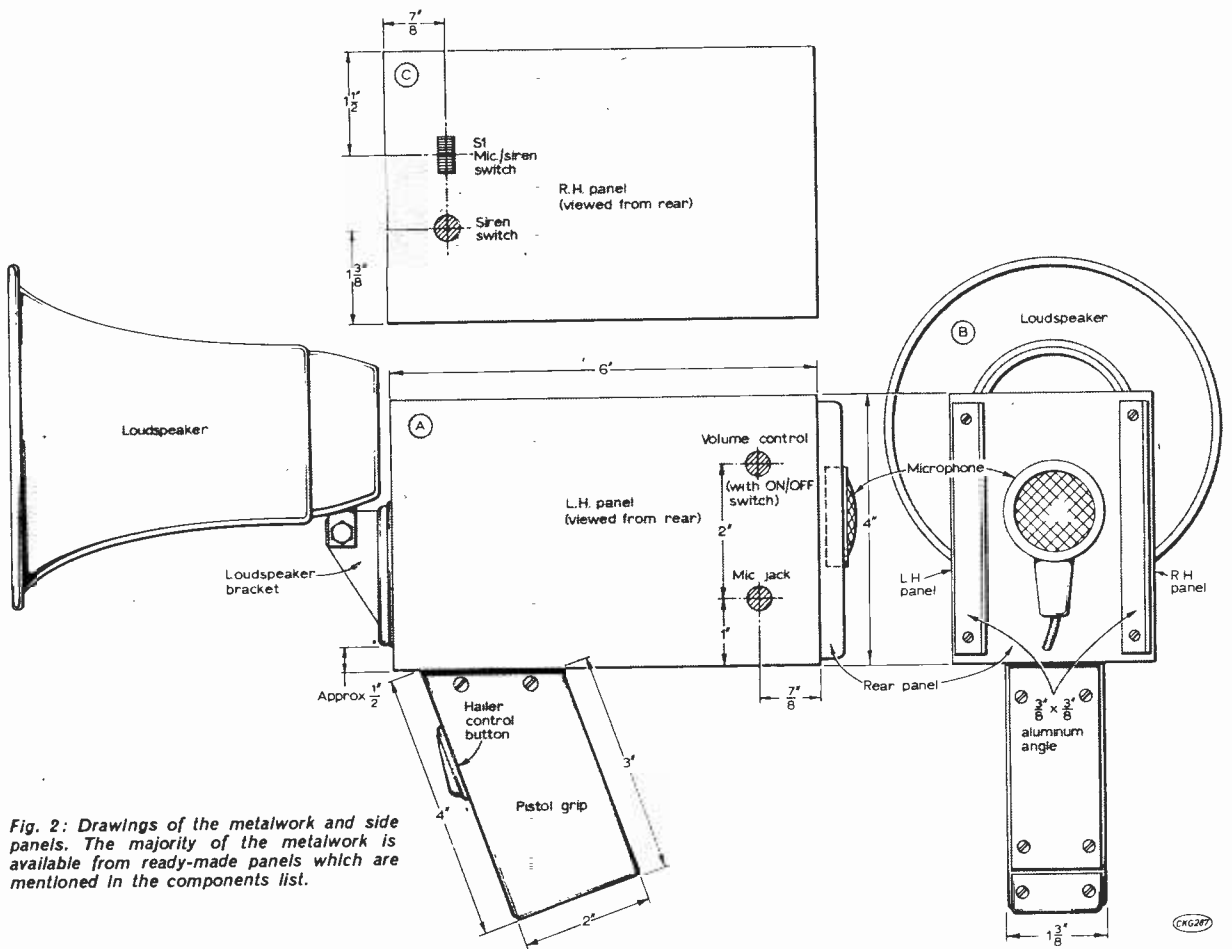

Fig. 2: Drawings of the metalwork and side panels. The majority of the metalwork is available from ready-made panels which are mentioned in the components list.

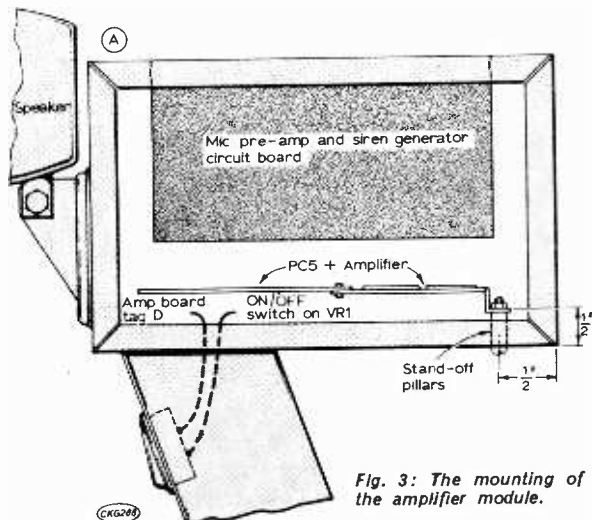
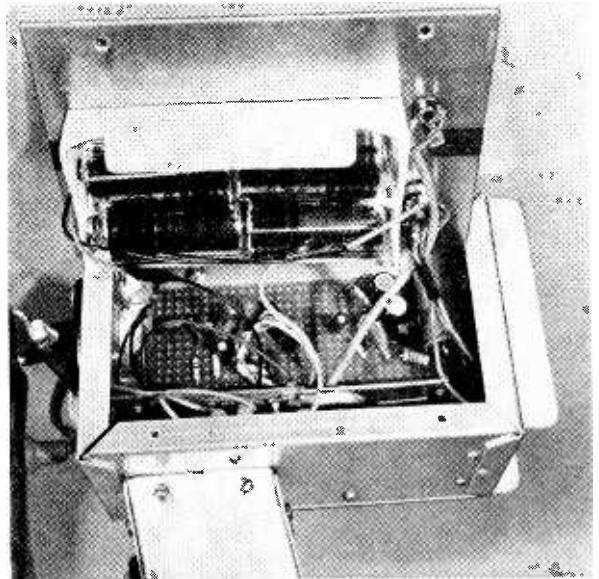

Fig. 3: The mounting of the amplifier module.



One of the side panels unscrewed. The components board can be seen clearly while at the extreme bottom is the main amplifier module. One of the battery holders can also be seen; there is another on the other side panel.

type HDA5 which is supplied complete with fixing bracket and is mounted on the front end of the case as in Fig. 2a. The rear end of the case is fitted with two aluminium angle pieces as in Fig. 2b which allow the unit to stand evenly when used self-standing. The pistol grip is hollow, being made from aluminium to the dimensions given in Fig. 2a and b and which, in turn, is secured centrally to the underside of the case. The hailer control rocker switch is mounted on the front of the pistol grip as in Fig. 2a.

The mic/siren switch S1 and the siren control button (or switch) is mounted on the right hand panel of the case (looking from the rear end) whilst the volume control (with integral on-off switch) and

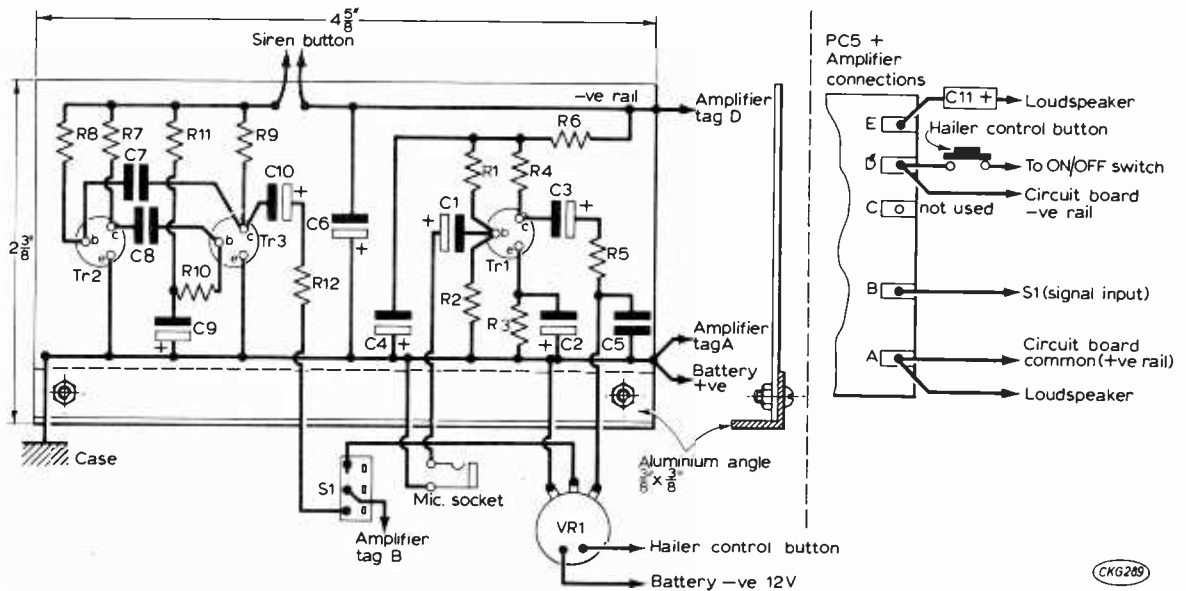
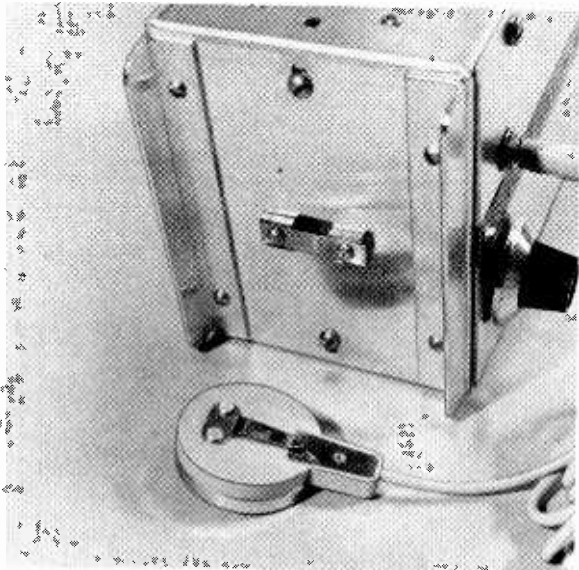

Fig. 4: The component layout and wiring. The connections to the module are shown on the right.



For operation as a loudhailer, the microphone is fitted to the small clip shown.

microphone socket, are mounted on the left hand panel (looking from rear end). The positions of these components are shown in Figs. 2a and 2c. The microphone used for the prototype was an Eagle label type CM10 which is fitted with a screened lead and miniature jack plug and also has a small clip on the back. It can therefore, be clipped onto the rear of the hailer as shown in Fig. 2b. The support for the microphone clip is simply a small brass strip about 1/4 in. wide bolted onto the rear panel but raised about 1/8 in. by spacers. Any small crystal microphone can be used with the loudhailer.

The loudspeaker leads are taken into the case and thence to the amplifier through a hole in the front panel. Before attaching the pistol grip, fit a pair of wires to the rocker switch long enough to go through into the case and thence to a) the on-off switch and b) to tag D on the PC5+ power amplifier.

The position of the microphone preamplifier and siren generator circuit board is shown in Fig. 3. It is mounted slightly off centre within the case to be clear of the battery boxes when they are in situ. The PC5+ amplifier is mounted as shown in Fig. 3 centrally and at the bottom of the case but is raised up on stand-off pillars by about 1/2 in.

The battery boxes (Eagle type BH411) are mounted one on each side panel (see photograph) and in the positions shown so as to be clear of both the circuit board and power amplifier when the panels are fitted. Changing batteries means only removing each side panel.

Layout and wiring of the circuit board containing the microphone preamplifier and the siren generator is shown in Fig. 4. The plain 0.15 in. matrix circuit board is mounted on a piece of aluminium angle which, in turn, is secured to the upper panel of the case. Connections to the mic/siren switch S1, the mic socket, the volume control (VR1) and to the power amplifier etc., are all shown in Fig. 4.

Checking out

Current consumption should be about 10 to 12mA with no signals and can be checked with a meter in series with the 12V negative lead from the battery. With the hailer switched to 'mic', adjust the volume control so that no feedback occurs i.e., no howling due to sound from the speaker coming back to the microphone. The supply current should rise to about 100mA or a little over on speech peaks. With the switch S1 to 'siren', operate the siren button (or switch). The sound should rise slightly in pitch once it starts but if left on will stay at constant pitch. Intermittent use of the siren button should produce a sound with a slight 'whoop' pitched at about 250Hz (around middle C). The current consumption of the hailer will rise to around 100mA when the siren is operated.

These tests should be made with the side panels open to ensure that operation is satisfactory. Make sure that when the side panels are fitted (with the battery boxes now inside) that no short circuits occur which is quite possible as there is little space between the circuit board and battery containers etc.

ALMOST UNBELIEVABLE! Think of the year 1984 and what might be produced then—now get the fantastic **ASTRAD 17** and SEE for yourself that the incredible Russians have done it all NOW! It's the radio perfectionist's dream come true! **THIS ONE SUPERSEDES ALL EARLIER MODELS!** It will probably make your present radio seem like a "crystal set"! Complete with optional battery eliminator for both battery and mains use! We're almost giving them away at only £20.75—a mere fraction of even today's Russian miracle price! We challenge you to compare performance and value with that of £80 radios! *Test 7 days—we'll refund instantly if you are not astounded after 7 days. Elegant black and chrome finish face, set in fabulous Cabinet built case—constructed of fine Russian hardwood in beautiful Teak Veneer finish—prevents vibration, ensures purer and sweeter tone than ever! Volume controlled from a whisper to a roar that would fill a hall! Much wider band spread, for absolute "pin-point" station selection! Plus "MAGIC EYE" tuning level indicator for ultra perfect tuning sensitivity! Yes, the Russians have surpassed themselves, proving again their fantastic ability in the field of electronics and brilliantly reflecting their advanced micro-circuitry techniques in the field of spaceship and satellite communications. **Yes, EVERY WAVEBAND** instantly at your fingertips including Standard Long, Medium, Short and Ultra Short Waves to cover the four corners of the earth 24 hours a day, including all normal transmissions, VHF, AM, FM, MW, LW, USW, plus local and new stations not yet operational and messages from all over the world! Expensive TURRET TUNER side control waveband selection unit (as used on expensive T.V.'s!). Every waveband clicks into position giving incredible ease of station tuning! Genuine push-pull output! ON/OFF volume and separate Treble and Bass tone controls for utter perfection of reproduction and tone! Press-button dial illumination! Take it anywhere—runs economically on standard batteries (obtainable everywhere) or direct through battery eliminator from 220/240v AC mains supply. Internal ferrite rod aerial plus built-in "rotatable" telescopic aerial extending to 39ins approx. It's also a fabulous **CAR RADIO**. Can also be used through extension amplifier, tape recorder or public address system. **SIZE** 14ins x 10½ins x 4½ins overall approx. Magnificently designed, made to give years of perfect service. (U.K. service facilities and spares available for years and years to come, if ever necessary!). With **WRITTEN GUARANTEE** manual with simple operating instructions and circuit diagram. **ONLY £20.75** (with mains/battery eliminator £1.48 extra) **BOX, POST, ETC. 50p**. ***BUT WAIT**, for only 55p extra you get the sensational "**COMPUTERISED**" **WORLD TUNING GUIDE** (it enables you to time, pinpoint and get transmissions the whole world over—even a child can do it in a flash—it even lets you know when to tune into the U.K. when abroad. **NO GUESSING! NO MESSING!**) **PLUS** Standard 'longlife' batteries PLUS ultra sensitive earphone for personal listening. (Sorry—We cannot change these new radios for any earlier model purchased.) **HURRY!** Send today or call at either store. It's a chance of a lifetime that nobody can afford to miss. **SHOPERTUNITIES FOR BARGAINS!**

JUST ARRIVED! **THIS YEAR'S NEW * COMPUTERISED!** **RUSSIAN MIRACLE!**

BRAND NEW 'SPACE AGE' model SO FAR AHEAD OF ITS TIME IT WILL STILL BE MAKING MANY LOOK OUT OF DATE IN 1984!

THE FABULOUS ASTRAD 17

PORTABLE RADIO & COMMUNICATIONS RECEIVER

28 TRANSISTORS AND DIODES!

WAVEBANDS: STANDARD LONG and MEDIUM Plus 5 SHORT WAVEBANDS Plus ULTRA SHORT WAVES (V.H.F. AM, FM, MW, LW, USW.)

***COMPARE ITS PERFORMANCE with £80 RADIOS!**

"MAGIC EYE" tuning level indicator

WORLD WIDE RECEPTION THOUSANDS OF TRANSMISSIONS & STATIONS FOUR IN FROM THE FOUR CORNERS OF THE EARTH!

***NOW AVAILABLE WITH fabulOUS "COMPUTERISED" WORLD TUNING GUIDE!** NO MORE GUESSWORK—INSTANT DATA at your fingertips—enables you to **TUNE IN A FLASH** to transmissions the world over!

FIRST TIME EVER!

BOX POST ETC. 50p

MAINS/BATTERY ELIMINATOR £1.48 extra

ANOTHER EAST EUROPEAN MIRACLE!

FANTASTIC 2-in-1 PERSONAL PORTABLE and CAR RADIO

NOW WORLD WIDE RECEPTION

IN YOUR CAR TOO! (RUNS OFF 12V CAR BATTERY)

4 WAVEBAND VHF AM FM LONG & SHORT WAVEBANDS

FANTASTIC PRICE £9.95

BOX, POST ETC. 45p

Position it for CAR RADIO, results will justify! OR detach & use carry handle for PORTABLE with its own batteries!

TRY AND MATCH IT FOR UNDER £35!

FANTASTIC! Brand spanning new. Another East European Miracle! This incredible 2-in-1 Radio! First class makers—because of our crazy price, contract stipulates we must NOT mention name! Beautifully made, 9 x 5 x 2½ inches overall approx. Every up-to-date technological improvement. **15 SEMI-CONDUCTORS** | **9 Transistors** | **5 Diodes and Stabilisers** | **FOUR WAVEBANDS!** Yes, VHF model with AM/FM Long and Short wavebands! Will get stations around the world, including Standard Long, Medium and Short Wave, also local and new stations not yet operational! Built-in! Built-in! Built-in! **TRY AND MATCH IT FOR UNDER £35!**

Internal ferrite aerial plus 5 section 26in. swivel telescopic aerial. On/Off/volume and tone controls. Clear Station Selector Dial. Waveband selector! Equally wonderful in CAR or HOME! **TWO** Tuning Dials for flat or upright use as illustrated. **RUNS OFF 12 VOLT BATTERY!** (AS A PORTABLE it runs on standard batteries). **PLUG IN 12 VOLT ADAPTOR JACK PROVIDED** and automatically cut out internal batteries, using car battery only! Don't you think it's miraculous? Span we (oceans and pull in hundreds of transmissions from car, "snap on" optional carry handle **AND YOU HAVE A DE-LUXE PORTABLE**, with additional upright tuning dial. **WRITTEN GUARANTEE**. Only £9.95 box, post 45p. *Sprung all metal matching detachable carry handle (as illus.) **AND** set of batteries only 25p extra if required. Match with sets costing £35 or more. Send and test 7 days, refund if not delighted. Or come and see for yourself!

Send quickly to our Uxbridge Road address or call at either store. (COMMERCIAL TRAVELLERS PLEASE NOTE: Merchandising Office at Holborn stores.)

FIRST TIME EVER! * SAVE £14.48!

BRAND NEW AC/DC BATTERY/MAINS

Cassette TAPE RECORDER & PLAYER

FIRST CLASS MAKERS

With remote control microphone.

WE COULD CHARGE UP TO £26.97!

OUR PRICE £12.49

POST ETC. 31p

THE ONE STEP FORWARD EVERYONE HAS WAITED FOR! NOW a superb de-luxe portable **BATTERY/MAINS** tape recorder and player—and incredible Shopertunities bring it to you for **ONLY £12.49!** Due to our cut price we cannot name first-class makers—but rest assured you're getting one of the **BEST!** Expensive "**PIANO KEYBOARD**" **CONTROL PANEL** or latest **MASTER SWITCH** control and **AUTOMATIC LEVEL CONTROL**. No fiddling with awkward tape and reels, just "slap-in" a cassette and off you go! (Takes 30, 60 or 90 minute standard cassette tapes obtainable everywhere.) Amazing performance ensures perfect taping and superb reproduction! Remote control microphone. Rapid rewind! Fast forward! Beautiful tone from a whisper to a roar. Completely self contained—record anywhere, indoors or out! **Runs on batteries AND 220/240v. AC mains.** Separate jacks for remote control microphone, etc. Size 9½in. x 5in. x 2½in. approx. Design can vary slightly. With carry handle. **WRITTEN G.T.E.E. and instructions. ONLY 12.49, post 31p.**

* Send Now! Test 7 days. Refund if you don't agree we could charge up to £26.97! **BONUS OFFER**—(strictly rationed per customer)—Cassette, tape, standard batteries, **AND** microphone stand for 50p extra if required. *Send today or call.* **ALSO** super de-luxe model with V.H.F. AM/FM Radio **ONLY £23.75** carr. etc. 35p (standard batteries & cassette tape 25p extra, if required).

SHOPERTUNITIES LTD.

Dept. EE/13, 164 UXBRIDGE RD., LONDON, W12 8AQ (Thurs. 1, Fri. 7) (facing Shepherd's Bush Green). Also 37 High Holborn, London W.C.1 (Thursday 7 p.m.). Both Mon. to Sat. 9 a.m.—6 p.m.

**MANUFACTURERS OF
ELECTRONIC AND AMPLIFICATION
EQUIPMENT**

TUAC

TRANSISTOR UNIVERSAL
AMPLIFICATION COMPANY LTD
163 MITCHAM ROAD, LONDON SW17
01-672 3137-9080

SPECIALISTS IN QUALITY TRANSISTOR EQUIPMENT, PRESENT AN OUTSTANDING RANGE OF KITS FOR THE ELECTRONICS AND AUDIO ENTHUSIAST ALIKE

PRE-AMPLIFIERS

VA06 — Vol, treble & bass controls. Sensitivity 8 mV for 30mV O/P. Carr. 20p on all Pre-amps.

VA08 — Vol, Treble, middle & bass controls. Sensitivity 4mV. for 30mV O/P.

SYA01 — As VA08 but stereo. With balance control. £6 80

The above pre-amps are suitable for mic, radio, guitar, ceramic or crystal p.u.'s. etc. All have high impedance low noise f.e.t. input stage.

MVA01 — Two separate input channels, vol & tone control on each channel. Sensitivity 2mV suitable for mics. £2 90

MEVA01 — Magnetic p.u. equalisation pre-amp. Connects to tone circuit of VA06 or VA08. Stereo version available shortly. £1 90

EFVA01 — This pre-amp will increase the output of any of the above to 1 Volt r.m.s. and has emitter follower output stage. £1 90

P1 — General purpose pre-amp. No controls medium impedance. Gain 50 times. £0 80

POWER AMPLIFIER MODULES



All TUAC power modules are constructed on glass fibre P.C. board and each circuit incorporates a robust driver transformer stage with thermal overload protection on the output stage.

ALL OUTPUT POWER RATINGS ARE R.M.S. CONTINUOUS SINE WAVE ±0.5 dB USING SPECIFIED SUPPLY

TP 100W (illus) 170W r.m.s. sq. wave into 8Ω. £14 28 Carr. 45p

TP 50W 90W r.m.s. sq. wave into 8Ω. £9 31 Carr. 40p

TP 25W 40W r.m.s. sq. wave into 8Ω. £7 25 Carr. 40p

Special Reduction—if any 2 or more units on this page are purchased together a reduction of 10% + free carr. will be given.

BRIEF TECH. SPEC.

Full power response 10Hz-20kHz ± 2 dB input sensitivity 30mV r.m.s. Output impedance 8-16Ω. Hum and noise better than -70 dB. External heatsink required for all power modules.

POWER SUPPLIES

PS 100 £9 66 Carr. 50p
PS 50 £6 12 Carr. 50p
PS 25 £3 95 Carr. 40p
PS100/100 £16 00 Carr. 65p
PS50/50 £9 68 Carr. 65p
PS 25/25 £7 35 Carr. 55p

LIGHT MODULATORS

constructed on glass fibre p.c. board. Will operate on signals from 1-100 Watts.

SILMB 3 separate 1000W £15 50 channels. Triac circuit 25p cutty. Bass, middle (illus.) & treble controls. Isolated input will not affect amplifier operation.

S2LMB Single 1800W channel £5 25 nel. Master sensitivity control Isolated input.



ALL TUAC KITS SUPPLIED WITH FULL EASY TO FOLLOW WIRING INSTRUCTIONS INCLUDING CIRCUIT DIAGRAM AND COMPLETE COMPONENT COMPLIMENT

TUAC

S.A.E. WITH ALL ENQUIRIES. PLEASE CALL, WRITE OR PHONE FOR FULL DETAILS OF ABOVE AND OTHER PRODUCTS NOT LISTED

ALL TUAC EQUIPMENT CARRIES A 12 MONTH GUARANTEE

TRADE AND EXPORT ENQUIRIES WELCOME

ELECTRONIC VALVES

DY86	0.23	PC97	0.36	PY83	0.26
DY87	0.23	PCC84	0.28	PY500	0.95
EABC80	0.30	PCC89	0.43	PY800	0.32
EB91	0.09	PCC189	0.47	PY801	0.32
ECC81	0.15	PCF80	0.27	UABC80	0.30
ECC82	0.18	PCF86	0.44	UCC85	0.34
ECC83	0.24	PCF802	0.38	UCH81	0.30
ECL80	0.25	PCF806	0.56	UCL82	0.31
EF80	0.22	PCF808	0.68	UL41	0.54
EF85	0.26	PCL82	0.30	UY85	0.24
EF86	0.28	PCL83	0.55	6/30L2	0.58
EF89	0.23	PCL84	0.33	6AT6	0.18
EF91	0.12	PCL85	0.37	6AU6	0.20
EF183	0.26	PCL86	0.37	6BA6	0.20
EF184	0.28	PFL200	0.51	6BE6	0.21
EH90	0.35	PL36	0.47	6F23	0.67
EL41	0.53	PL81	0.43	12AT6	0.23
EL84	0.22	PL82	0.29	12AT7	0.15
EY51	0.30	PL83	0.31	12AU7	0.18
EY86	0.28	PL84	0.29	12AX7	0.24
EZ80	0.20	PL500	0.61	12BA6	0.30
EZ81	0.21	PL504	0.61	12BE6	0.30
PC86	0.45	PY81	0.23	35W4	0.23
PC88	0.45	PY82	0.24	50C5	0.32

POSTAGE: 1 VALVE 5p, EACH ADDITIONAL VALVE 1p. ORDERS OVER £5 POST FREE. CASH WITH ORDER ONLY.

Quotations for any type not listed send SAE.

NO CALLERS. ALL VALVES GUARANTEED AND INDIVIDUALLY BOXED.

EXPRESS MAIL ORDER

SEND TO:—

ARCHES 1150/1152
41 NORWOOD RD., LONDON, S.E.24

NEW
ALL
SILICON!



PRACTICAL
WIRELESS

ELECTRONIC IGNITION SYSTEM

This Capacitor-Discharge Electronic Ignition System was recently described in Practical Wireless and has proved extremely popular. We are able to offer the kit in two forms; the standard kit containing the electronic components only, enabling the customer to tailor these to his own layout, or the de-luxe version containing a ready-drilled roller-tinned printed-circuit board and fully machined die-cast case with A.M.P Electrical Spade Connector Block. Each kit is supplied with a custom wound transformer, first grade components and full constructional details.

The original circuit employed Germanium Power Transistors for the negative earth version. **WE NOW SUPPLY SILICON P.N.P. POWER DEVICES AT NO EXTRA COST!** All components available separately. Case size 4 1/2" x 3 3/4" x 2". Complete assembly and wiring manual 25p, refundable on purchase of kit.

Suitable for 12v or 6v systems with Pos. or Neg. earth.

Price: Standard Kit£7 25 U.K. Post Free

De-Luxe Kit£8 75 U.K. Post Free

Quantity Discounts: 1-5 Nett

6-9 Less 10%

10-49 Less 15%

50-99 Less 20%

100-999 Less 25%

1000 up Less 30%

Mail Order Only

STATE POS. OR NEG. EARTH AND 6V OR 12V WHEN ORDERING.

DABAR ELECTRONIC PRODUCTS

98A LICHFIELD STREET,
WALSALL, STAFFS. WS1 1UZ
Tel. Walsall 34365

Transistors in Transmitter PA STAGES

R. DOWLING C.Eng MIEE G3NKH

THERE has been no shortage, in recent years, of designs for transistorised transmitters. In the majority of cases, however, the transmitters have been running at inputs of maybe a fraction of a watt. In some cases, modulation appears to have been something of an afterthought. Often, emitter or base modulation has been used in a desperate attempt to obtain the magical 100% modulation—the reason being, one suspects, that the more familiar high-level modulation has not been found to give the desired results.

The purpose of this article is to try to clear away some of the misconceptions surrounding the transistor power amplifier stage, and to outline the way in which amplitude modulation may most effectively be achieved.

THE BASIC CIRCUIT

Fig. 1 shows the basic circuit arrangement for valve and transistor p.a. stages. Superficially, the circuits look very similar, but there are some important differences. First, one must remember that, unlike valves, transistors are current-operated devices. This means that there is no point at all in feeding a huge signal into the base of a p.a. transistor in an attempt to run it at high power. All that one is likely to achieve is the destruction of the transistor as the result of excessive reverse base-emitter potential.

What the base really requires is current, and this can only be achieved if the driver stage can supply adequate power at the correct impedance to match into the p.a. This brings us to the second important difference between valve and transistor p.a.'s. Being current devices, the latter operate at much lower input and output impedances, typically under 20ohms. One must therefore pay careful attention to the problem of matching the transistor accurately to the load it is to feed.

CLASS C OPERATION

In any Class C p.a. stage, we are basically trying to switch the stage into conduction for only a brief portion (typically 140°) of the signal cycle. The resulting burst of current causes the p.a. tank circuit to ring at a frequency determined by the LC of the tuned circuit, the oscillations being fed to the aerial via either a link coupling or some form of pi-network.

In a valve p.a. it is necessary to provide a negative bias on the grid in order to restrict conduction to the desired 140°, but the situation with transistors is (for once!) much simpler as a transistor will not conduct at all in the absence of an input signal. This immediately provides Class B operation, but there

is a further bonus in that owing to the existence of the base-emitter diode the input signal has to exceed a certain minimum value (approximately 0.6V for silicon transistors) before conduction begins at all. This is ideal, as it means that Class C operation can be achieved with transistors with no special bias arrangements whatsoever. All we need to do is feed a signal with a positive excursion something in excess of 0.6V between base and emitter of the p.a., from a driver stage capable of supplying adequate base current to give the desired mean collector current.

As a guide, a well-designed p.a. stage will provide a power gain of up to 17dB (approximately 15 times). Thus, a 10watt transmitter running at 70% efficiency will require a drive power of at least half a watt.

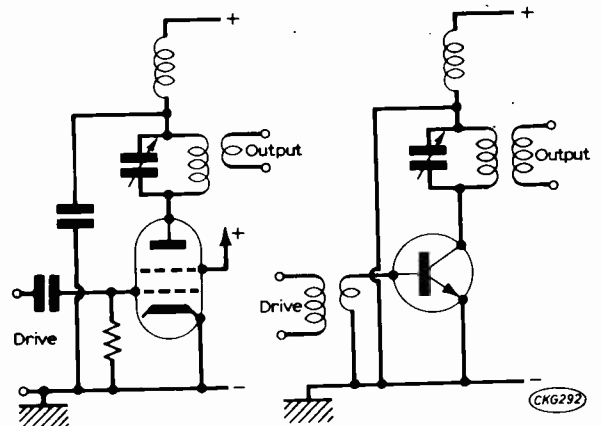

Fig. 1: Circuits illustrating the similarity in valve and transistor p.a. stages.

MATCHING

With valve transmitters, it has become almost standard practice to use a pi-network to match the p.a. to a 75ohm aerial system. The same principles apply to transistor p.a.'s but owing to the lower impedances involved component values can become somewhat inconvenient at the lower frequencies. For this reason, a tapped p.a. tank coil is often used, as a worked example will illustrate.

Assuming a p.a. efficiency of 70%, the approximate p.a. output impedance can be calculated from:

$$R_{pa} = \frac{V_c}{2I_c} \text{ ohms}$$

where V_c is the collector voltage and I_c is the collector current.

Thus, a p.a. with a collector voltage of 20V and a d.c. input of 0.5A will present an output impedance of

$$\frac{20}{2 \times 0.5} = 20\text{ohms}$$

The problem is now one of matching the 20ohm p.a. to the 75ohm aerial system. As mentioned earlier, the most suitable technique consists of initially converting the low p.a. impedance to a more convenient value by means of a tapped p.a. coil, and then transforming down to aerial impedance by means of a link coupling. In this way, a reasonable working Q can be obtained with components of a more sensible value than would have been necessary for a pi-network.

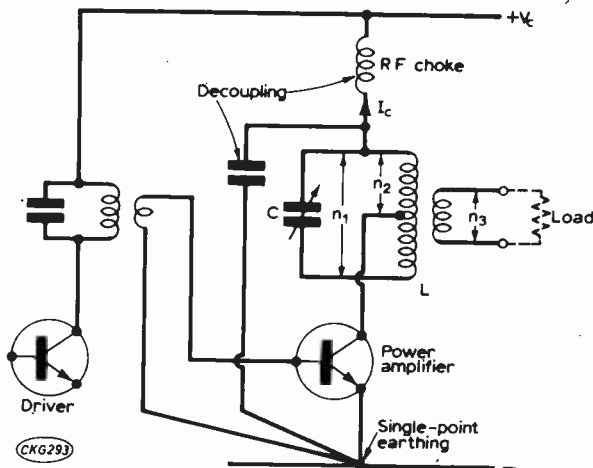

Fig. 2: Typical transistor p.a. stage and the matching problems involved.

The general arrangement is shown in Fig. 2. To establish a starting point in our calculations, we begin by assuming a convenient value for the tuning capacitor C. The value of L is then given in the normal way by:

$$L(\mu\text{H}) = \frac{25,000}{f^2 \times C}$$

where f is frequency (MHz) and C is tuning capacitance (pF).

We next decide on the required operating Q. As with valve p.a.'s, this is usually somewhere between 5 and 15 as a compromise between harmonic suppression and tuned circuit loss. Now, Q is given by:

$$Q = \frac{\pi \times f \times C \times R}{500,000}$$

where R is the effective shunt resistance across the tuned circuit. From this, we can obtain an expression for R:

$$R = \frac{500,000 \times Q}{\pi \times f \times C} \text{ohms}$$

Thus, in order to obtain the required operating conditions, the p.a. output resistance must be transformed to look like this shunt resistance R.

Example: Suppose our p.a. is to work at 2MHz and we choose C=500pF as a convenient value for the tuning capacitance. Hence,

$$L(\mu\text{H}) = \frac{25,000}{2^2 \times 500} = 12.5\mu\text{H}$$

If we now choose an operating Q of 10, the effective shunt resistance R will need to be:

$$\frac{500,000 \times Q}{\pi \times f \times C} = \frac{500,000 \times 10}{\pi \times 2 \times 500} = 1,590\text{ohms}$$

It is now necessary to determine the turns ratio for the tapped p.a. coil. This is given by:

$$\frac{n_1}{n_2} = \sqrt{\frac{R}{R_{pa}}}$$

Thus if in our example 30 turns were required to give the required inductance of 12.5μH, n₂ could be obtained from:

$$\frac{30}{n_2} = \sqrt{\frac{1590}{20}}$$

from which n₂ = Approx. 3¹/₂ turns.

The number of turns required for the aerial link coupling can now be calculated in a similar manner from:

$$\frac{n_1}{n_3} = \sqrt{\frac{R}{R_{ae}}}$$

For a 75ohm aerial system, the above example would therefore require a value for n₃ given by:

$$\frac{30}{n_3} = \sqrt{\frac{1590}{75}}$$

from which n₃ = Approx. 6¹/₂ turns.

It is vital that the p.a. stage be adequately decoupled. This can be accomplished by means of an r.f. choke and decoupling capacitor as shown. The impedance of the choke should be no more than ten to fifteen times the p.a. output impedance, to discourage low frequency parasitics.

MODULATION

Undoubtedly the best way to modulate a transistor transmitter is by collector modulation of the p.a. and driver stages. The audio power required will be equal to half the p.a. input power; that is, 5watts for a 10watt p.a.

'Efficiency' modulation systems modulating emitter or base of the p.a. with only a few milliwatts of audio can give satisfactory results if carefully set up, but even at their best will never have the 'talk-power' of a high-level modulated system. This is a matter of fundamental fact, not of design.

MODULATOR MATCHING

In order to effectively modulate any p.a., it is essential that it be correctly matched to the modulator. The calculations are very simple. A transistor p.a. with a collector voltage of V_c volts and a collector current of I_c amperes will present a

load to the modulator of $\frac{V_c}{I_c}$ ohms. If we call this

load impedance R_p it can be correctly matched to a modulator of output impedance R_m by means of a modulation transformer with a turns ratio:

$$\frac{N_1}{N_2} = \sqrt{\frac{R_p}{R_m}}$$

ATTRACTIVE DISCOUNTS ON MANY ITEMS

ELECTROVALUE

Electronic Component Specialists

TRANSISTORS

Brand new—no 'seconds' or surplus. Highest quality and reliability. Insulating sets **FREE** with power types.

MANY HUNDREDS OF DIFFERENT TYPES IN STOCK—THEY'RE ALL IN OUR NEWEST CATALOGUE

1N4148	4p	AF139
1N5399	24p	AF239
2N2646	37p	BC107
2N3055	85p	BC10
2N3702	10p	BC109
2N3703	10p	BC148
2N3704	10p	BC177
2N3819	25p	BC187
2N4286	15p	BC107
2N4289	15p	
2N4443	85p	
2N5062	42p	
2N5088	48p	
2N5192	77p	
2N5195		
2N5457		
40361		
40362		
40432		
40512		
40669		
AC128		
AD142		
AD149		
AD18		
AD182		
TO3 Transistor		

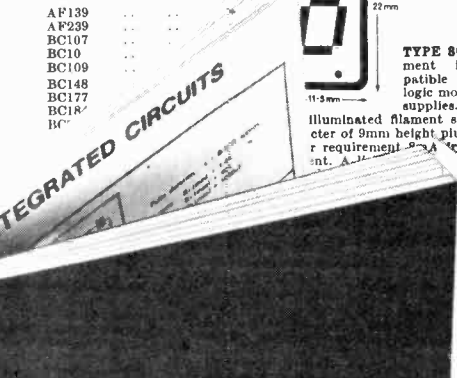

MINITRON DIGITAL INDICATOR

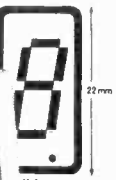

TYPE 8016F Seven segment indicator compatible with standard logic modules and power supplies. Figs. 0-9 from illuminated filament segments to give center of 9mm height plus digital requirement. 9.5A segments. D.C. cent. A.H. 1.5mm.

We are appointed stockists for SOLDERSTAT SOLDER IRONS

As appointed distributors for well-known Eremco-Wolf "Solderstat" irons we offer this light weight model HMB in 16 or 24 watt, ratings 220/240V a.c. **£1-87** nett.

INFINITELY VARIABLE TEMPERATURE CONTROLLED SOLDER IRON

complete with temperature setting control, nett **£9-20**

DE-SOLDER BRAID 50p

MIPPBOARD multipurpose component

boards in various working area combinations. Pattern on one board 15p. Price by side 28p. 3p.

8" x 27" 83p. 25" 60p.

(Pattern Book 3p & S.A.E.)

RESISTORS

Code	Power	Tolerance
C	1/8W	5%
C	1/4W	10%
C	1/2W	5%
C	1W	5%
MO	1/2W	2%
WW	1W	10%
WW	3W	5%
WW	7W	5%

Codes: C—carbon film high stability; MO—metal oxide; WW—wire wound.

Values: E12 denotes series: 10, 12, 15, 18, 22, 27, 33, 39, 47, 56, 68, 82, 100, 120, 150, 180, 220, 270, 330, 390, 470, 560, 680, 820, 1000, 1200, 1500, 1800, 2200, 2700, 3300, 3900, 4700, 5600, 6800, 8200, 10000, 12000, 15000, 18000, 22000, 27000, 33000, 39000, 47000, 56000, 68000, 82000, 100000, 120000, 150000, 180000, 220000, 270000, 330000, 390000, 470000, 560000, 680000, 820000, 1000000, 1200000, 1500000, 1800000, 2200000, 2700000, 3300000, 3900000, 4700000, 5600000, 6800000, 8200000, 10000000, 12000000, 15000000, 18000000, 22000000, 27000000, 33000000, 39000000, 47000000, 56000000, 68000000, 82000000, 100000000, 120000000, 150000000, 180000000, 220000000, 270000000, 330000000, 390000000, 470000000, 560000000, 680000000, 820000000, 1000000000, 1200000000, 1500000000, 1800000000, 2200000000, 2700000000, 3300000000, 3900000000, 4700000000, 5600000000, 6800000000, 8200000000, 10000000000, 12000000000, 15000000000, 18000000000, 22000000000, 27000000000, 33000000000, 39000000000, 47000000000, 56000000000, 68000000000, 82000000000, 100000000000, 120000000000, 150000000000, 180000000000, 220000000000, 270000000000, 330000000000, 390000000000, 470000000000, 560000000000, 680000000000, 820000000000, 1000000000000, 1200000000000, 1500000000000, 1800000000000, 2200000000000, 2700000000000, 3300000000000, 3900000000000, 4700000000000, 5600000000000, 6800000000000, 8200000000000, 10000000000000, 12000000000000, 15000000000000, 18000000000000, 22000000000000, 27000000000000, 33000000000000, 39000000000000, 47000000000000, 56000000000000, 68000000000000, 82000000000000, 100000000000000, 120000000000000, 150000000000000, 180000000000000, 220000000000000, 270000000000000, 330000000000000, 390000000000000, 470000000000000, 560000000000000, 680000000000000, 820000000000000, 1000000000000000, 1200000000000000, 1500000000000000, 1800000000000000, 2200000000000000, 2700000000000000, 3300000000000000, 3900000000000000, 4700000000000000, 5600000000000000, 6800000000000000, 8200000000000000, 10000000000000000, 12000000000000000, 15000000000000000, 18000000000000000, 22000000000000000, 27000000000000000, 33000000000000000, 39000000000000000, 47000000000000000, 56000000000000000, 68000000000000000, 82000000000000000, 100000000000000000, 120000000000000000, 150000000000000000, 180000000000000000, 220000000000000000, 270000000000000000, 330000000000000000, 390000000000000000, 470000000000000000, 560000000000000000, 680000000000000000, 820000000000000000, 1000000000000000000, 1200000000000000000, 1500000000000000000, 1800000000000000000, 2200000000000000000, 2700000000000000000, 3300000000000000000, 3900000000000000000, 4700000000000000000, 5600000000000000000, 6800000000000000000, 8200000000000000000, 10000000000000000000, 12000000000000000000, 15000000000000000000, 18000000000000000000, 22000000000000000000, 27000000000000000000, 33000000000000000000, 39000000000000000000, 47000000000000000000, 56000000000000000000, 68000000000000000000, 82000000000000000000, 100000000000000000000, 120000000000000000000, 150000000000000000000, 180000000000000000000, 220000000000000000000, 270000000000000000000, 330000000000000000000, 390000000000000000000, 470000000000000000000, 560000000000000000000, 680000000000000000000, 820000000000000000000, 1000000000000000000000, 1200000000000000000000, 1500000000000000000000, 1800000000000000000000, 2200000000000000000000, 2700000000000000000000, 3300000000000000000000, 3900000000000000000000, 4700000000000000000000, 5600000000000000000000, 6800000000000000000000, 8200000000000000000000, 10000000000000000000000, 12000000000000000000000, 15000000000000000000000, 18000000000000000000000, 22000000000000000000000, 27000000000000000000000, 33000000000000000000000, 39000000000000000000000, 47000000000000000000000, 56000000000000000000000, 68000000000000000000000, 82000000000000000000000, 100000000000000000000000, 120000000000000000000000, 150000000000000000000000, 180000000000000000000000, 220000000000000000000000, 270000000000000000000000, 330000000000000000000000, 390000000000000000000000, 470000000000000000000000, 560000000000000000000000, 680000000000000000000000, 820000000000000000000000, 1000000000000000000000000, 1200000000000000000000000, 1500000000000000000000000, 1800000000000000000000000, 2200000000000000000000000, 2700000000000000000000000, 3300000000000000000000000, 3900000000000000000000000, 4700000000000000000000000, 5600000000000000000000000, 6800000000000000000000000, 8200000000000000000000000, 10000000000000000000000000, 12000000000000000000000000, 15000000000000000000000000, 18000000000000000000000000, 22000000000000000000000000, 27000000000000000000000000, 33000000000000000000000000, 39000000000000000000000000, 47000000000000000000000000, 56000000000000000000000000, 68000000000000000000000000, 82000000000000000000000000, 100000000000000000000000000, 120000000000000000000000000, 150000000000000000000000000, 180000000000000000000000000, 220000000000000000000000000, 270000000000000000000000000, 330000000000000000000000000, 390000000000000000000000000, 470000000000000000000000000, 560000000000000000000000000, 680000000000000000000000000, 820000000000000000000000000, 1000000000000000000000000000, 1200000000000000000000000000, 1500000000000000000000000000, 1800000000000000000000000000, 2200000000000000000000000000, 2700000000000000000000000000, 3300000000000000000000000000, 3900000000000000000000000000, 4700000000000000000000000000, 5600000000000000000000000000, 6800000000000000000000000000, 8200000000000000000000000000, 10000000000000000000000000000, 12000000000000000000000000000, 15000000000000000000000000000, 18000000000000000000000000000, 22000000000000000000000000000, 27000000000000000000000000000, 33000000000000000000000000000, 39000000000000000000000000000, 47000000000000000000000000000, 56000000000000000000000000000, 68000000000000000000000000000, 82000000000000000000000000000, 100000000000000000000000000000, 120000000000000000000000000000, 150000000000000000000000000000, 180000000000000000000000000000, 220000000000000000000000000000, 270000000000000000000000000000, 330000000000000000000000000000, 390000000000000000000000000000, 470000000000000000000000000000, 560000000000000000000000000000, 680000000000000000000000000000, 820000000000000000000000000000, 1000000000000000000000000000000, 1200000000000000000000000000000, 1500000000000000000000000000000, 1800000000000000000000000000000, 2200000000000000000000000000000, 2700000000000000000000000000000, 3300000000000000000000000000000, 3900000000000000000000000000000, 4700000000000000000000000000000, 5600000000000000000000000000000, 6800000000000000000000000000000, 8200000000000000000000000000000, 10000000000000000000000000000000, 12000000000000000000000000000000, 15000000000000000000000000000000, 18000000000000000000000000000000, 22000000000000000000000000000000, 27000000000000000000000000000000, 33000000000000000000000000000000, 39000000000000000000000000000000, 47000000000000000000000000000000, 56000000000000000000000000000000, 68000000000000000000000000000000, 82000000000000000000000000000000, 100000000000000000000000000000000, 120000000000000000000000000000000, 150000000000000000000000000000000, 180000000000000000000000000000000, 220000000000000000000000000000000, 270000000000000000000000000000000, 330000000000000000000000000000000, 390000000000000000000000000000000, 470000000000000000000000000000000, 560000000000000000000000000000000, 680000000000000000000000000000000, 820000000000000000000000000000000, 1000000000000000000000000000000000, 1200000000000000000000000000000000, 1500000000000000000000000000000000, 1800000000000000000000000000000000, 2200000000000000000000000000000000, 2700000000000000000000000000000000, 3300000000000000000000000000000000, 3900000000000000000000000000000000, 4700000000000000000000000000000000, 5600000000000000000000000000000000, 6800000000000000000000000000000000, 8200000000000000000000000000000000, 10000000000000000000000000000000000, 12000000000000000000000000000000000, 15000000000000000000000000000000000, 18000000000000000000000000000000000, 22000000000000000000000000000000000, 27000000000000000000000000000000000, 33000000000000000000000000000000000, 39000000000000000000000000000000000, 47000000000000000000000000000000000, 56000000000000000000000000000000000, 68000000000000000000000000000000000, 82000000000000000000000000000000000, 100000000000000000000000000000000000, 120000000000000000000000000000000000, 150000000000000000000000000000000000, 180000000000000000000000000000000000, 220000000000000000000000000000000000, 270000000000000000000000000000000000, 330000000000000000000000000000000000, 390000000000000000000000000000000000, 470000000000000000000000000000000000, 560000000000000000000000000000000000, 680000000000000000000000000000000000, 820000000000000000000000000000000000, 1000000000000000000000000000000000000, 1200000000000000000000000000000000000, 1500000000000000000000000000000000000, 1800000000000000000000000000000000000, 2200000000000000000000000000000000000, 2700000000000000000000000000000000000, 3300000000000000000000000000000000000, 3900000000000000000000000000000000000, 4700000000000000000000000000000000000, 5600000000000000000000000000000000000, 6800000000000000000000000000000000000, 8200000000000000000000000000000000000, 10000000000000000000000000000000000000, 12000000000000000000000000000000000000, 15000000000000000000000000000000000000, 18000000000000000000000000000000000000, 22000000000000000000000000000000000000, 27000000000000000000000000000000000000, 33000000000000000000000000000000000000, 39000000000000000000000000000000000000, 47000000000000000000000000000000000000, 56000000000000000000000000000000000000, 68000000000000000000000000000000000000, 82000000000000000000000000000000000000, 100000000000000000000000000000000000000, 120000000000000000000000000000000000000, 150000000000000000000000000000000000000, 180000000000000000000000000000000000000, 220000000000000000000000000000000000000, 270000000000000000000000000000000000000, 330000000000000000000000000000000000000, 390000000000000000000000000000000000000, 4700000000000

look! electronics really mastered

... practical
... visual
... exciting!

no previous knowledge
no unnecessary theory
no "maths"

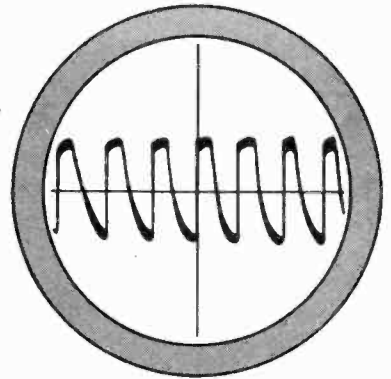
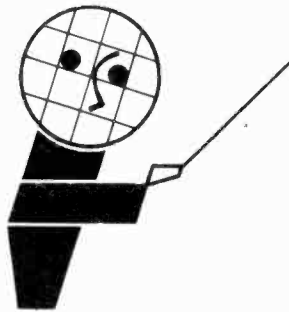

RAPY

BUILD, SEE AND LEARN

step by step, we take you through all the fundamentals of electronics and show how easily the subject can be mastered. Write for the free brochure now which explains our system.

1/ BUILD AN OSCILLOSCOPE

You learn how to build an oscilloscope which remains your property. With it, you will become familiar with all the components used in electronics.

2/ READ, DRAW AND UNDERSTAND CIRCUIT DIAGRAMS

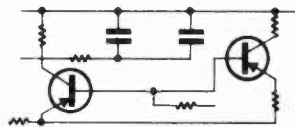

as used currently in the various fields of electronics.

3/ CARRY OUT OVER 40 EXPERIMENTS ON BASIC ELECTRONIC CIRCUITS & SEE HOW THEY WORK, including :

valve experiments, transistor experiments amplifiers, oscillators, signal tracer, photo electric circuit, computer circuit, basic radio receiver, electronic switch, simple transmitter, a.c. experiments, d.c. experiments, simple counter, time delay circuit, servicing procedures.

This new style course will enable anyone to really understand electronics by a modern, practical and visual method—no maths, and a minimum of theory—no previous knowledge required. It will also enable anyone to understand how to test, service and maintain all types of electronic equipment, radio and TV receivers, etc.

FREE POST NOW for **BROCHURE**

or write if you prefer not to cut page

To: **BRITISH NATIONAL RADIO & ELECTRONICS SCHOOL**, P.O. Box 156, JERSEY. Please send your free brochure, without obligation, to:

NAME

we do not employ representatives

BLOCK CAPS

ADDRESS

PLEASE WL122

special free gift also to all our students

Example:—Suppose we wish to modulate a p.a. having a collector voltage of 20volts and a collector current of 0.5 amperes by means of a modulator with an output impedance of 1000ohms. From the formula, the modulator load R_p will be

$$\frac{20}{0.5} = 40 \text{ ohms}$$

To match this to a modulator output impedance of 1000ohms, we shall require a modulation transformer with a turns ratio:

$$\frac{N_1}{N_2} = \sqrt{\frac{40}{1000}} = \frac{1}{5}$$

i.e. a step-up ratio of 1:5 between the p.a. and the modulator. The general arrangement is shown in Fig. 3.

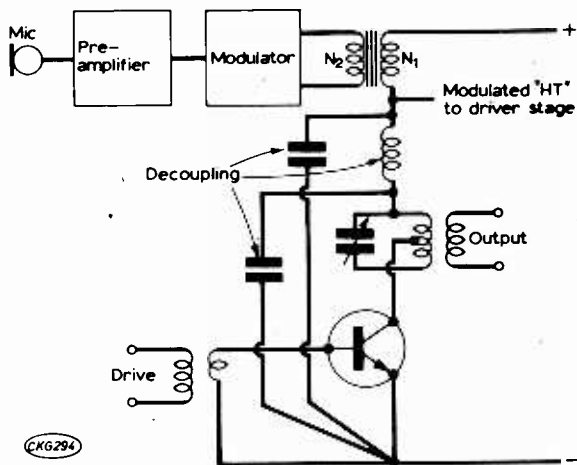

Fig. 3: Circuit showing how the use of formulae given in the text can ensure correct matching between the p.a. and the modulator.

It is not possible, because of internal feedback, to fully modulate a transistor transmitter by means of collector modulation of the p.a. alone. For this reason, it has become established practice for the driver stage also to be collector modulated to a depth best determined by practical tests.

CHOICE OF TRANSISTORS

This article would not be complete without a brief survey of suitable p.a. transistors available for amateur use at a reasonable cost.

When selecting a type of transistor to meet a particular requirement, there are a number of important parameters to bear in mind.

The first of these is transition frequency f_T . This is the frequency at which the forward current gain in common emitter mode h_{FE} (also known as β) has dropped to unity. But more important, it is also the gain-bandwidth product for the transistor: a transistor with an f_T of 200MHz will have a gain of 100 at 2MHz and 50 at 4MHz.

From this one might conclude that one should aim for as high an f_T as possible, but in practice this can result in excessive low-frequency gain and consequent instability. It is therefore best to select a transistor with an f_T no more than ten to fifteen times higher than the proposed operating frequency.

Another important transistor parameter is its total dissipation P_{tot} . A Class C p.a. stage is generally no more than 70 per cent efficient, the remaining 30 per cent of input power is wasted as heat which must be adequately dissipated by the transistor and its heat sink if the device is to remain within the temperature limits stipulated by the manufacturer.

Finally, it tends to be expensive to pay too little attention to the manufacturer's 'absolute maximum' voltage and current ratings (the writer speaks from rueful experience!). A p.a. fed from a 12volt supply will have a peak r.f. voltage on its collector of up to 24volts on c.w. and up to 48volts on a.m. A valve p.a. will withstand a fair degree of overload without complaining, but the risk is not worth taking with transistors. It is therefore good sense to choose a transistor with a collector-emitter voltage rating at least three times the proposed supply voltage for c.w. and at least six times the proposed supply voltage for a.m.

A list of readily available transistors suitable for amateur p.a. use is given in the accompanying table.

P_{tot} (W)		f_T (MHz)	V_{CBM} (V)	V_{CEM} (V)	I_{CM} (A)
3	2N1893	50	120	80	0.5
	2N1613	60	75	30	0.5
	2N1711	70	75	30	0.5
4	2N4030	100	-60	-60	1.0
	2N4031	100	-80	-80	1.0
	2N4032	150	-60	-60	1.0
	2N4033	150	-80	-80	1.0
5	2N3053	100	60	40	0.7
	BSY81	100	40	18	1.0
	BSY83	100	80	35	1.0
	BSY85	110	120	64	1.0
	BSY84	120	80	35	1.0
	BSY82	120	40	18	1.0
	BSY86	130	120	64	1.0
2N3866	700	55	30	0.4	
11.5	BD106A	100	36	36	2.5
	BD106B	100	36	36	2.5
	BD106C	100	64	64	2.5
	BD106D	100	64	64	2.5
15	BD124	60	70	45	4.0
45	BD123	85	90	60	5.0
	BD121	95	60	35	5.0

CONCLUSIONS

The writer concludes with a few recommendations which are the outcome of considerable experimentation and not a few traumatic experiences.

DO...bring up the voltage and drive to a transistor p.a. gradually to avoid any possible overloads.

DO...use single point earthing.

DO...keep leads short. There are high circulating currents in a transistor p.a. and stray inductance from over-long leads can ruin performance.

DO NOT...over-drive a transistor p.a. with voltage.

DO NOT...forget to decouple the stage properly.
DO NOT...run the p.a. even slightly off-tune or without a proper load. ■

TAKE 20

JULIAN ANDERSON

A series of simple transistor projects, each using less than twenty components and costing less than one pound to build.

THESE are several occasions when audio signals have to be mixed; public address systems frequently have several sources such as a microphone, tape recorder and record player and of course pop groups need an audio mixing facility to bring all the sources together before feeding the main amplifier. Some audio mixers are very complex and sophisticated in that they will handle signals varying from the tiny output from a tape head to more than half a volt produced by a crystal pickup and, as well as providing a mixing system, they equalise the inputs. It is more common however that the signals needing to be added together are of roughly the same level and to mix these is fairly simple as can be seen from the circuit in Fig. 1.

This circuit has facilities for three inputs, two medium level and one high level. One important feature of a mixer is that the level of each of the sources can be controlled individually and so a potentiometer is needed for each. If we simply connected the sliders of the pots together there would be considerable interaction between them. For instance, if one of the pots was set at minimum the slider would be at virtually chassis potential and thus the wanted signals would also be shorted. This interaction can be reduced to negligible proportions by inserting a resistor in series with each slider before taking them all to a common point; in our circuit these are represented by R2, R3 and R4.

The adding of the signals in this way does, however, cut down the level considerably, so much so that the combined signals need amplifying to recover the level and so Tr1 is necessary. In fact this not only recovers the gain but amplifies the signal by about 20 times.

The high level input is that marked in Fig. 1 as A and this will handle signals of more than 1V without causing distortion. The signal available across VR1 is only one seventh that of the input using the 68kΩ resistor shown but the value of R1 can be altered to suit the particular requirements. Inputs B and C do not have any initial attenuation and will handle signals up to about 150mV without trouble. For this input the output is nearly 3V which is more than sufficient and in most cases will be far too much; few amplifiers need more than 600mV. Working backwards, we shall then find that this amplifier stage will give 600mV out for inputs of 30mV. There is no minimum level at which it will work and signals of 1mV could be mixed, though of course the output would then be only about 20mV.

Three inputs have been shown but the final number is up to the constructor. Only two may be required, in which case one can be left out but several more can be added simply by duplicating Input A or or one of the others.

No separate power supply is shown as the mixer will usually be powered from the main amplifier

No. 43 AUDIO MIXER

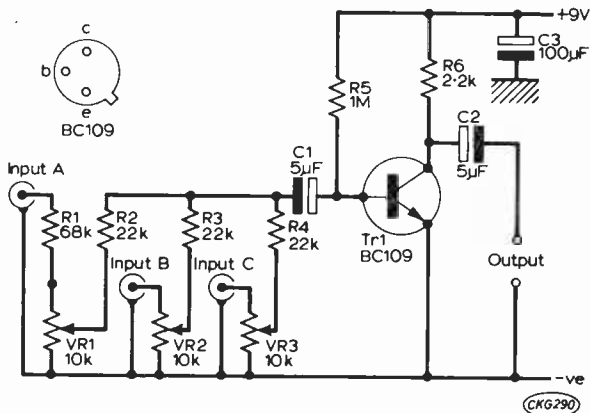

Fig. 1: Circuit of the audio mixer providing for three inputs.

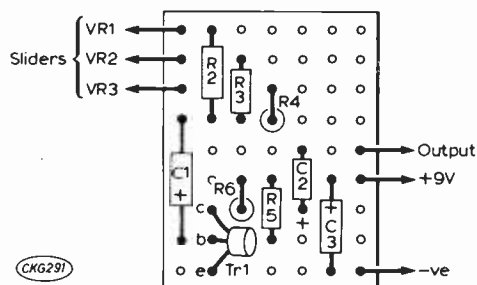

Fig. 2: A suggested component layout; no breaks in the conductor strips are necessary.

★ components list

Components list		
R1	68kΩ 5% 1/4W	1p
R2	22kΩ 5% 1/4W	1p
R3	22kΩ 5% 1/4W	1p
R4	22kΩ 5% 1/4W	1p
R5	1MΩ, 5% 1/4W	1p
R6	2.2kΩ 5% 1/4W	1p
VR1	10kΩ log. pot.	12p
VR2	10kΩ log. pot.	12p
VR3	10kΩ log. pot.	12p
C1	5μF, 12V min.	5p
C2	5μF, 12V min.	5p
C3	100μF, 12V min.	6p
Tr1	BC109	12p
		70p

Prices are those recently advertised and may have changed. No allowance is made for minimum order costs or for postage and packing and these points should be checked carefully before ordering.

but it will work from a 9V battery and, since the current drain is tiny, a PP3 type may be used.

The components may be built in any convenient form but for those using Veroboard a layout diagram is shown in Fig. 2; no breaks are necessary in the conductor strips.

IN NEXT MONTH'S

PRACTICAL WIRELESS

STEREO AMPLIFIER 10+10 WATT

Five years ago W. Cameron described his "Low Cost Hi-Fi" system in P.W.—and a rip-roaring success it was too! Now the same author describes the Mk II. The amplifier uses conventional wiring (for those who hate p.c. boards) and has an output very conservatively rated at 10W per channel. All the usual facilities are provided including inputs for magnetic and ceramic pickups, radio and tape, all with the correct equalisation, of course.

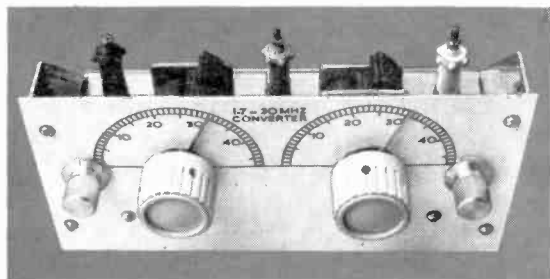
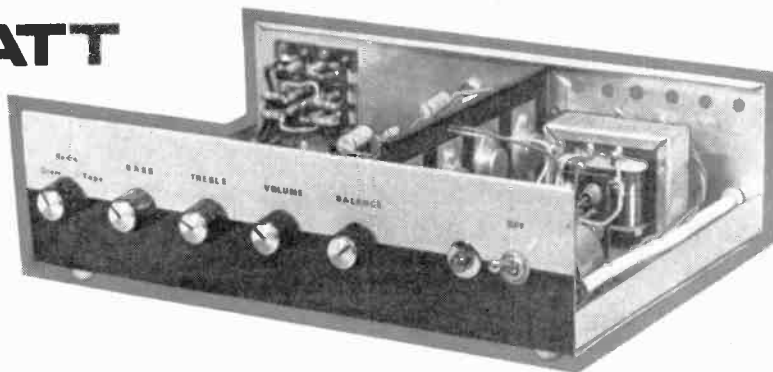

Short Wave Converter

Do you sometimes wish that you could receive short wave stations on your domestic radio instead of being confined to the medium and long wavebands? This simple three transistor unit will convert that radio into an efficient receiver for the short wave bands, capable of world-wide reception. Full information is given for the construction and alignment of the converter.

LINEAR CAPACITANCE METER

A highly accurate, easy-to-use unit giving a linear readout. At the low end 1pF corresponds to half a scale division, yet the circuit will measure up to 10 μ F. Convenient to use? Just connect a capacitor, select the right scale and press the button. Complex? A couple of i.c.'s and a handful of other components... even using a large scale meter the cost is only about £6.

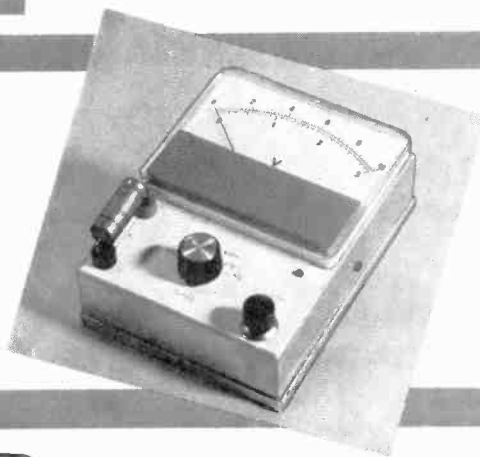

LAST CHANCE

: TO ENTER OUR
FREE
COMPETITION
10 SCOPES
TO BE WON!

MANY OTHER CONSTRUCTIONAL ARTICLES PLUS ALL THE REGULAR FEATURES. PRICE 20p.

ALL IN THE JANUARY ISSUE
ON SALE 1st. DECEMBER

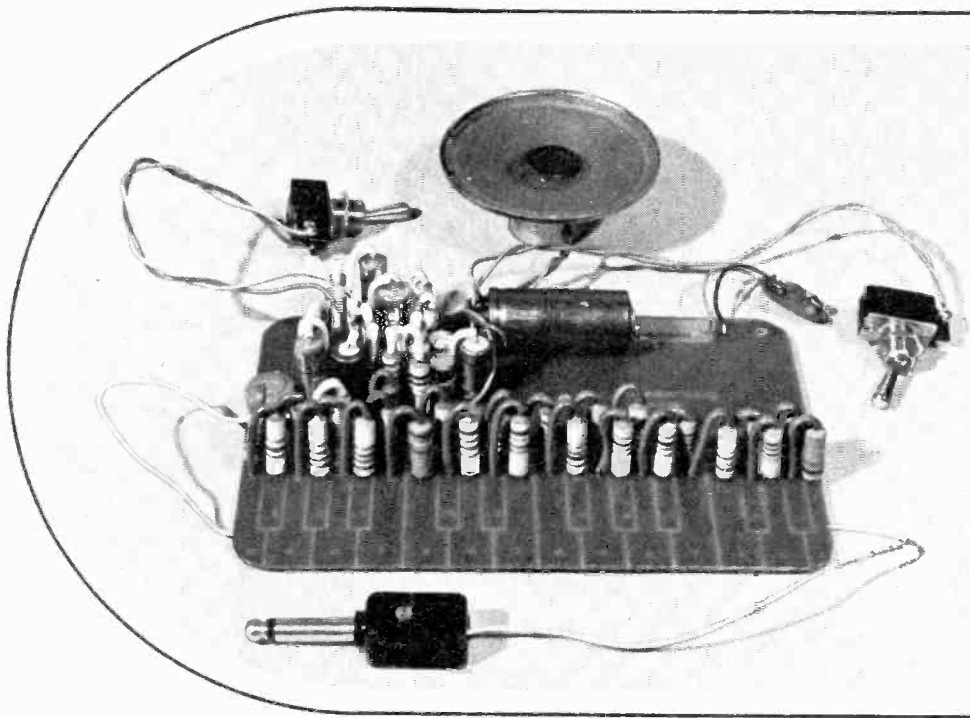

THE
Music
electronic
organ

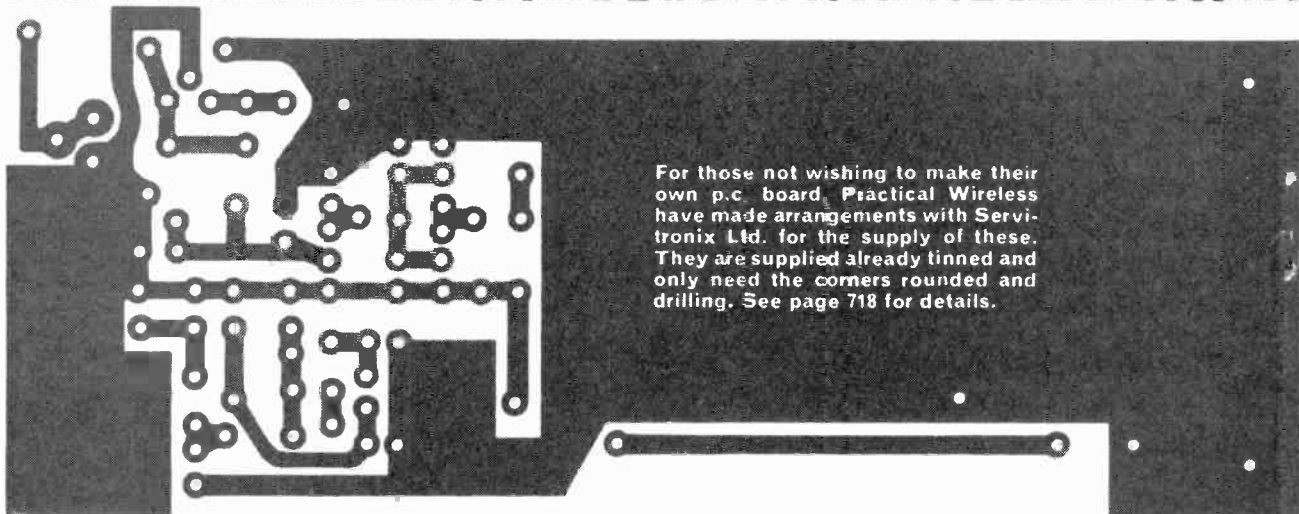
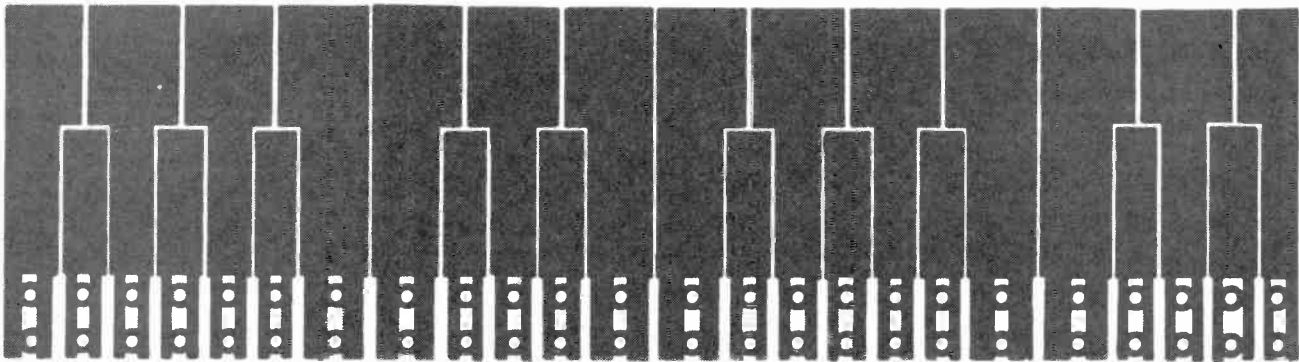

For those not wishing to make their own p.c. board, Practical Wireless have made arrangements with Servitronix Ltd. for the supply of these. They are supplied already tinned and only need the corners rounded and drilling. See page 718 for details.

Full size pattern of the p.c. board layout. This drawing may be cut out for those wishing to make their own boards; as this page backs onto details of next month's features, your copy will not be spoilt.

Maker

ronic

D. SMITH



THE Music Maker electronic organ was originally conceived as a toy for the author's young daughter but, after the rigours of field trials of the kind that young children seem to be so well endowed to inflict, it was realised that the organ was more than just a toy.

It turned out to be a very robust and reliable musical instrument, very simple to construct and economic in both manufacture and battery consumption.

The complete instrument is housed in a plastic sandwich box, measuring 6⁷/₈in. x 4⁵/₈in. x 1⁵/₈in. of the type offered for sale in most large chain stores for just a few pence. For those who are unable to obtain this, special arrangements have been made for the supply of this; see overleaf.

The organ is monophonic and played with a probe on a printed circuit keyboard laid out in conventional manner. The keyboard covers two full octaves, centred around middle C, including sharps and flats and gives sufficient notation to play almost any tune.

The notes, although not exactly the correct frequencies are close enough to pass the scrutiny of all but the trained musical ear. The accuracy of the notes was checked on a frequency meter and errors of no more than 10Hz were found in the worst case.

The organ may be built without the tremolo circuit, if even greater simplicity is desired, but it is a very worthwhile addition.

circuit description

The circuit diagram is shown in Fig. 1. The notes are generated by a relaxation oscillator Tr1 which is a unijunction transistor. The frequency of the notes is determined by C1 and R7 to R30. Tr2 is a simple audio amplifier feeding the output pair Tr3 and Tr4.

★ components list

Resistors

R1	100Ω	R20	1.5kΩ
R2	15kΩ	R21	1.5kΩ
R3	1kΩ	R22	1.5kΩ
R4	1.5kΩ	R23	1.3kΩ
R5	10kΩ	R24	1.2kΩ
R6	10kΩ	R25	1.2kΩ
R7	3kΩ	R26	1.1kΩ
R8	3kΩ	R27	1.1kΩ
R9	2.7kΩ	R28	1kΩ
R10	2.7kΩ	R29	910Ω
R11	2.7kΩ	R30	10kΩ
R12	2.7kΩ	R31	8.2kΩ
R13	2kΩ	R32	6.8kΩ
R14	2kΩ	R33	4.7kΩ
R15	2kΩ	R34	1kΩ
R16	2kΩ	R35	82kΩ
R17	2kΩ	R36	10kΩ
R18	1.8kΩ	R37	4.7kΩ
R19	1.8kΩ		

All resistors $\frac{1}{4}$ or $\frac{1}{2}$ W, 5 per cent types.

See note below on the supply of component packs.

VR1 5kΩ lin. skeleton preset pot.

Capacitors

C1	0.05μF	C6	100μF 12V min.
C2	0.22μF	C7	250μF 12V min.
C3	5μF 12V min.	C8	2.5μF 12V min.
C4	25μF 12V min.	C9	2.5μF 12V min.
C5	100μF 12V min.	C10	2.5μF 12V min.

C8-C10 may be 2.2μF

Semiconductors

Tr1	2N2646 or UT46	Tr4	AC127
Tr2	OC71	Tr5	AC128
Tr3	AC128		

Miscellaneous

Case: Plastic lunch box, see overleaf; LS1 30-80Ω loudspeaker, miniature type, preferably 3in. but 2 $\frac{1}{2}$ in. or 2 $\frac{1}{4}$ in. will suffice. SW1, SW2: On-off toggle switches; Probe, see text; PP3 battery.

The output stage has not been designed for quality but cross-over distortion is not important. The prime consideration here is low battery consumption. The quiescent current is only a few milliamps, giving long battery life.

The circuit diagram for the tremolo oscillator is shown enclosed on the circuit diagram. It consists of a simple oscillator working on the principle that a 180° phase change occurs through the feedback capacitors C8 to C10, applying positive feedback from the collector to the base of Tr5, thus forming a low frequency oscillator.

The output of the tremolo circuit is mixed with the output of the note generator at the base of Tr2 when the switch SW2 is made.

The output power is quite sufficient to allow the organ to be heard in an average sized room and no volume control was considered necessary.

circuit board construction

The printed circuit board is shown full-size on page 716. (For those not wishing to make their own boards, arrangements have been made for the supply of these.) Firstly, the board is cut to size and the corners shaped to fit the case. After checking that the board will fit the case easily, it is then etched and drilled. The components are then soldered in, starting from R1, C1 and Tr1 and progressively through each component shown on the circuit diagram as far as the loudspeaker.

Many small transistor speakers have a 6BA tapped hole in the permanent magnet keep at the back of the cone. The speaker may be fixed to the printed circuit board by a 6BA bolt, screwed into this hole. If the speaker does not have this hole, the magnet

special facilities for practical wireless readers

Arrangements have been made for the supply of the following component packs:

Pack 1 Printed circuit board	80p
Pack 2 Plastic box	25p
Pack 3 Set of scale resistors (R7-R29)	21p
Pack 4 Complete set of resistors (R1-R37)	35p

Total cost of Packs 1, 2 and 4 £1.35
 Total cost of Packs 1, 2 and 3 £1.20

All prices are inclusive of postage etc.

Available from: SERVITRONIX LTD., 26 Killarney Road, Wandsworth, London SW18 2DX (Mail order only).

Personal shoppers: 572 Kingston Road, Raynes Park, London, S.W.20

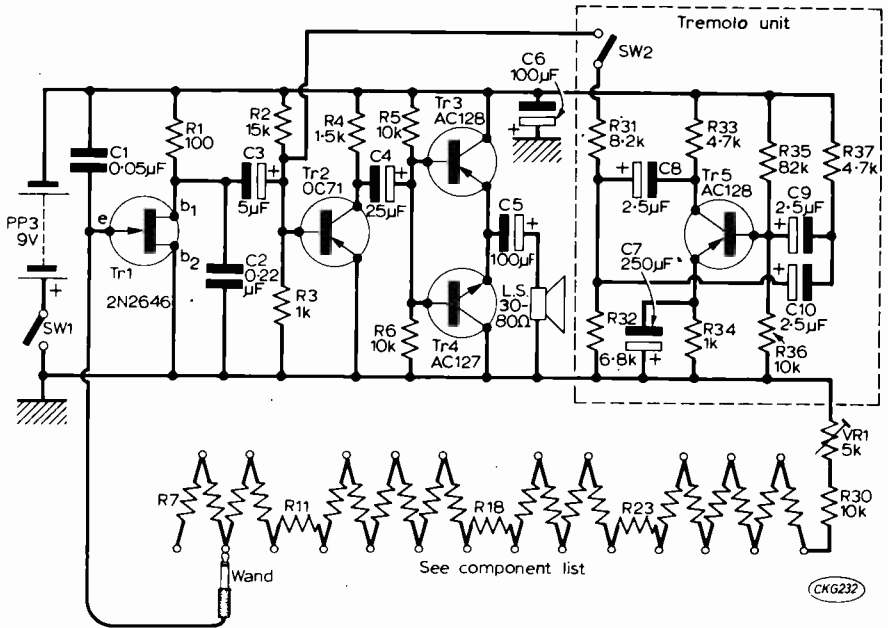

Fig. 1: The complete circuit of the Music Maker. The tremolo section, which is optional, is shown inside the dotted box. See the components list for the values of the note resistors.

can be glued to the board.

At this stage the circuit may be tested by injecting an audio frequency signal at C4 (to prove the output stage) and C3 (to prove the audio amp.). If everything is satisfactory, the audio signal will be heard clearly from the speaker.

The relaxation oscillator may be tested by temporarily connecting a 15kΩ resistor from the 'e' of Tr1 to the positive rail and a note should be heard from the speaker. The keyboard components R7 to R30 and VR1 may then be fitted and the scales tried.

It should be mentioned at this stage that the values of some of the resistors R7 to R29 are not normal 10 per cent preferred values, but are 5 per cent or better types and the closer one adheres to the values stated, the closer the notes will be to the desired frequency. Since some of these values fall in the less common E24 series, special arrangements have been made to supply a kit of the scale resistors.

It was found, on the prototype, that the keyboard

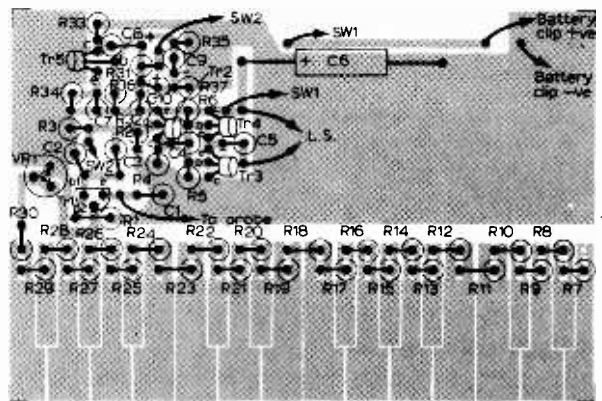
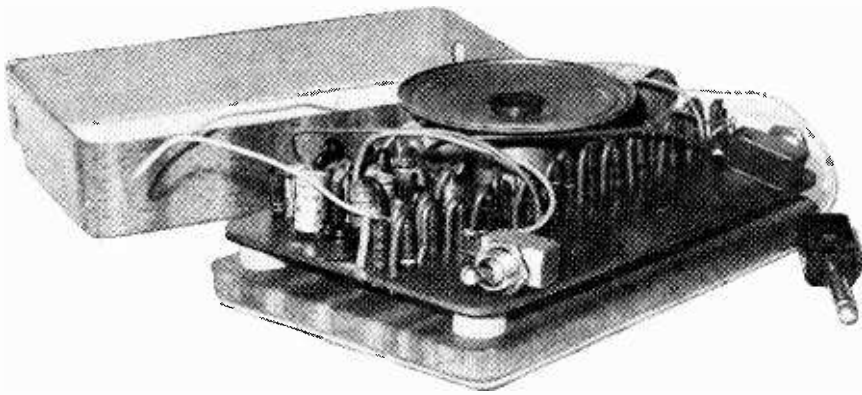

Fig. 2: The component layout on the p.c. board. This is viewed from the components side.



A view of the completed prototype.

must be polished with metal polish before playing because once the surface becomes tarnished the notes change, due to the increased resistance of the copper oxide coating. Several alternatives are possible, either the keyboard may be silver plated or, if the constructor is a soldering expert, the keyboard may be tinned. The ready-made p.c. board which is available is already tinned.

case construction

Next the case is cut as shown in Fig. 3. The best method of cutting the case is with the tip of a hot soldering iron, keeping well within the actual line of cut to allow for the shrinking effect as the plastic melts. After cutting, the edges should be cleaned up with a sharp penknife and finally sandpapered to a clean edge.

It is recommended that the speaker hole be cut first so that the constructor may get some practice before attempting the more difficult keyboard slot.

The printed circuit board fixing bolts are put through the case next, and held by means of nuts inside. The speaker hole can be covered with cloth fret and the case may be covered with Vinyl or similar decorative covering. The printed circuit board is then placed inside and fitted on the mounting screws.

The switches SW1 and SW2 may then be fixed

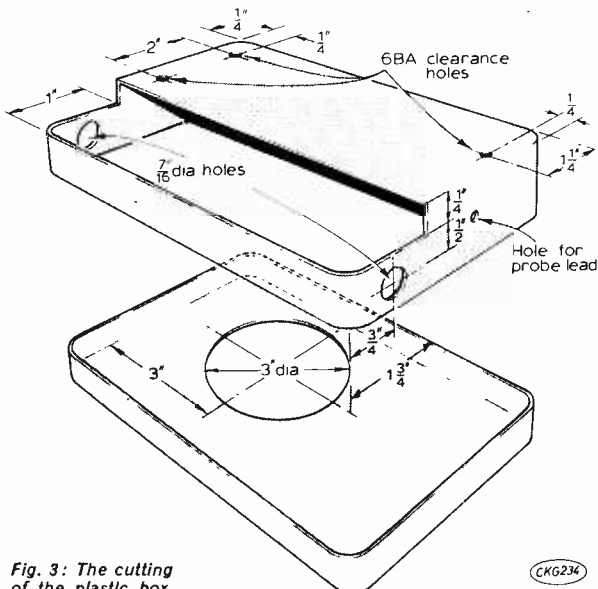
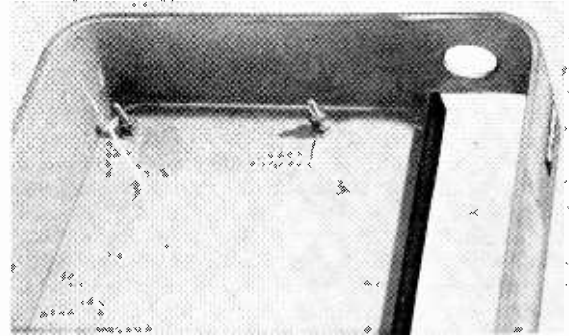

Fig. 3: The cutting of the plastic box.



Inside of the case showing the hole for one of the switches and the mounting screws for the p.c. board.



The case used for the prototype—the black escutcheon can be made from cardboard covered with black, self-adhesive plastic.

and the probe lead passed through the hole in the case and the probe connected. The author used a telephone jack plug for the probe, but it may be made from a variety of items.

Finally the battery is fitted and the probe is held on middle C. VR1 should then be adjusted until the note corresponds to the correct sound; the rest of the notes should then be correct. If R7 to R29 are replaced by skeleton presets, then all the notes will have to be tuned individually, starting with the highest one because the tuning of the higher notes will upset the ones below it.

practically wireless

commentary by

HENRY

No. 94

“Psychological
Pservice”

HAVE you ever suffered from mice in your bottom drawer, moths in the cambric and half the local pigeon population perching on your aerial?

You have my sympathy. You can even have my telephone number if you require a quick consultancy service in getting rid of birdies on the f.m. band, rumbles on your autochanger or the depredations of the dreaded alum-worm in your electrolytics.

Some things never age. And Henry is convinced by recent experiences that the problems and vicissitudes of servicing will never change, whatever the ‘tomorrow men’ may predict about modules, and multi-chips, or ‘potent ethos determinants’. I do not need to invent these terms. The foregoing is a quote from Jonathan Benthall’s review of *Science and Technology in Art Today*, by Brian Porter.

I remember the intense castigation I received when, as a humble field engineer, I dared to contribute to print the criticism of the first ever ‘module-type’ television receiver. The several printed circuit boards, according to the maker, would be supplied as immediate replacement spares, and no on-the-spot servicing would be needed.

Henry predicted that engineers would soon circumvent the system

by their innate curiosity. They would find that certain components caused common faults and find it as easy to change these as nip back to the workshop for a new PC board. Which, in the event, is precisely as happened. In no time at all, the prevalence of common faults had caused a shortage of those printed circuit panels where the troubles most often took effect. And most of the problems we had with that particular set and its immediate successors were not with the printed circuit boards at all, but externals like volume controls.

Henry cannot share Mr. Benthall’s regard of computer technology as art, but begins to see what he means when he describes the relevance of error factors. So much art is accidental: so much science is an inspired leap of one step after a determined plod up five hundred. So many of the radio receivers we have seen come off the production lines—computer controlled?—bear the marks of artistic error. Servicing them calls for some of the inspiration of the artist.

The psychology of service comes into it when you have to tackle those strange innovations under the critical gaze of the owner. A discreet tap with the hammer is not to be recommended, and a fierce tug in unstrategic places can result in two separate halves with a mass of disconnected wires. Instead, one holds it wisely to one’s ear, give a twiddle to any visible knobs, shakes it gently, frowns and declares: ‘Rather tricky I’m afraid. This is a bench job.’

Depending on his previous experience and the snobbery of modern tech-owning, the reception by the owner of this advice will either be a glow of self-importance or the suspicion of price-rigging. Trouble is, these contretemps are inevitable. No service engineer can keep up with



A fierce tug in strategic places . . .

all the models, nor even all the advances in general trends of technology. And as for the horror of having to order spares—this is where the psychology of service really sorts the professional from the chap round the corner who dabbles in wireless—and who will probably, eventually, do a much better job.

Here, again, the computer has taken over. The philosophy of the pro is to replace C195 with part number XV5600071008 as recommended in the service manual. He is not concerned that C195 is a 1KpF ceramic, available from umpteen makers and a dozen surplus factors under a multitude of names. Superset Ltd., say item XYZ, so that is what he orders, and the receiver sits on the shelf while the part is airlifted from Japan.

But computers are almost human. In fact, take a quote from Benthall’s last few lines in the computer section of his book:

‘So far, the constraints of working with the computer so dominate anything done with it that they actually appear to oppose the advances of the artist. It is as if the computer were some creature of great sexual attractiveness whose actual anatomy remains elusive, frigid and unexplored.’ Henry felt that way when they invented tights. But that’s another story . . . !



Mice in your bottom drawer.

FREE COMPETITION

Organised by Practical Wireless and Heath (Gloucester) Ltd.

In this free competition you have two opportunities of winning a Heathkit 3in. portable oscilloscope kit! Our exciting competition will be repeated in the January issue of Practical Wireless, so save this month's coupon until next month's appears and post your two different attempts in the same envelope.

The Heathkit General Purpose Oscilloscope Kit K/OS-2 is a dependable, well-rated design, ideal for the hobby constructor. The small size and light weight make it ideal for the 'shack' while the wide range of facilities make it extremely versatile.

The low price of £29.50 for the kit plus 80p postage and packing (when ordered direct from the Gloucester factory) is an added attraction and of course, coming from Heathkit, the instructions for both assembly and operation are clear and precise, leaving nothing to chance. Even if you already own a 'scope, the OS-2 makes an excellent portable, back-up unit. Just consider the specification: Y Bandwidth from 2Hz to 3MHz; Time base 20Hz-200kHz Automatic sync; P.C. board construction; small size, 12in x 7½in x 5in; Switched ext/int Y plate connections; Sensitivity 250mV peak-to-peak per cm.

10 'Scopes to be Won!

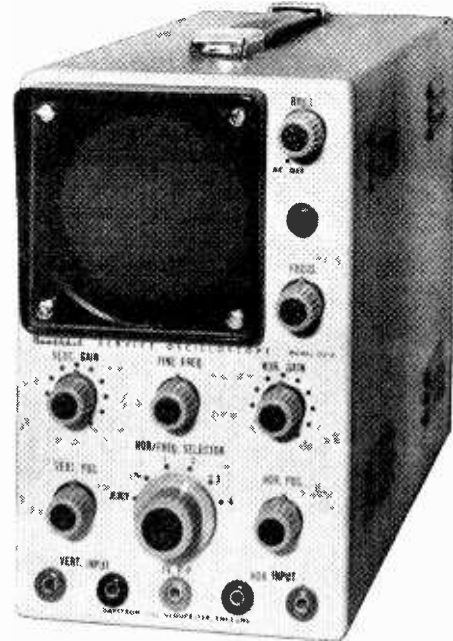

HOW TO ENTER:

Listed below are eight important features of the Heathkit OS-2 oscilloscope. All you have to do is place them in what you consider to be their order of importance to the average Practical Wireless reader. For example, if you think *Portability* is most important of all, write D in the box marked 1st on your entry coupon. The key letter of your second choice goes into the box marked 2nd, and so on for all eight. Complete the coupon, all in ink or ball-point pen, with your full name and address, then post in a sealed envelope to: PRACTICAL WIRELESS 'SCOPE COMPETITION, 16 GARRICK STREET, LONDON WC2E 9PR to arrive not later than Wednesday, February 14th, 1973, the closing date. **REMEMBER:** The competition will be repeated next month, so you can keep the first coupon until then, if you wish, and send both attempts together.

RULES

There is no entry fee, but each attempt must be fully completed in ink on the proper printed coupon cut from Practical Wireless, and bear the entrant's own full name and address.

Every accepted entry will be examined and the prizes, as described, will be awarded to the ten entrants who, in the opinion of an expert panel of judges, and in any one attempt, have shown the most skill and judgment in listing the eight features in order of importance.

In the event of a tie or ties for any of the prizes, a further eliminating test will be conducted by post between the tying competitors to determine such winners.

Any entry which does not comply with the printed instructions or is received after the closing date will be disqualified, as will any received mutilated or illegible, incomplete, bearing alterations, or with more than one key letter in each space. No responsibility will be accepted for entries lost or delayed in the post or otherwise.

The judges' decision, and that of the Editor of Practical Wireless in all other matters affecting the competition, is final and legally binding. No correspondence can be entered into.

The competition is open to all readers in Great Britain, Northern Ireland, and the Channel Isles except employees (and their families) of IPC Magazines, the printers of Practical Wireless, and Heath (Gloucester) Ltd., all of whom are ineligible.

The winners will be notified, and the result announced in the earliest possible issue of this magazine.



- A Good frequency response.
- B Simple controls.
- C Timebase in four ranges.
- D Portability.
- E Calibrating source.
- J Automatic lock-in synchronisation.
- K Switched Ext/Int Y plate connections.
- L Low price.

FREE ENTRY COUPON

PRACTICAL WIRELESS
'Scope Competition

1

1st	
2nd	
3rd	
4th	
5th	
6th	
7th	
8th	

My order of importance for the eight points is given on the left. I agree to the rules as final and legally binding.

(Signed)
Mr./Mrs./Miss

Full
Address

Post to: PRACTICAL WIRELESS 'Scope Competition,
16 Garrick Street, London WC2E 9PR.

Closing date: February 14, 1973

..... please cut out along this line

CAPACITOR DISCHARGE IGNITION KIT

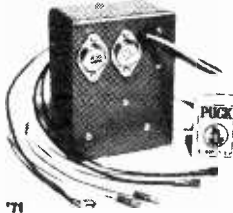

PW JUNE '71

A comprehensive kit of parts with detailed constructional details, ready drilled diecast case, screws, leads, terminals etc.

Available in both 6 and 12v versions. State whether positive or negative earth. £8.75 incl. p. & p. U.K. only

De-coupling kit for impulse tachometer and interference suppression. £1.00 incl. p. & p. U.K. only
All our kits use guaranteed quality components and have been approved by the Author.

MAGTOR LTD.

68 DALE ST., MANCHESTER
M1 2HS 06-1236 3031

EX-RENTAL TV's (UNTESTED)

Complete with 13 channel tuners. Good cabinets.
Carriage £1.50 extra.

19"/21" alliline (110° tube) .. \$5-00
23" slimline \$7-50
19" BBC 2 sets £14-50

TUBES EX EQUIPMENT (Tested)

SINGLE PANEL

19"/21" any type \$3-00
23" any type \$4-00

TWIN PANEL (BONDED)

19" bonded \$5-00

All tubes add £1 carriage.

VALVES EX EQUIPMENT

EB91	5p	30L15	12p	FL36	22p
EBF89	12p	30P4	12p	PL81	17p
ECC82	12p	PC97	17p	PY81	15p
EC180	7p	PCF86	17p	PY800	15p
EF80	12p	PC84	7p	PY82	7p
EF85	12p	PCF80	7p	PY33	22p
EF183	12p	PC89	12p	U191	17p
EF184	12p	PCL85	22p	6F23	17p
EY88	17p	PCL82	17p	30PL1	22p
30PL13	20p	PCL86	17p	30PL2	20p
630LZ	12p	PCL83	12p	30P5	10p

Add 2p per valve p. & p., orders over £1 p. & p. free

UHF TUNERS

For Ferguson 850 900 chassis. Adaptable for most UHF
Chassis £2.50, p. & p. 50p.

SLOT METERS

Smiths reconditioned switchmaster MK III. Decimalized,
Perfect working order. 12 for £25 delivered. For sample
send £2.50 c.w.o.

TRADE DISPOSALS (Dept. PW/TS)

Thornbury Roundabout, Leeds Rd., Bradford.
Telephone 0274/665670

RADIO BARGAINS

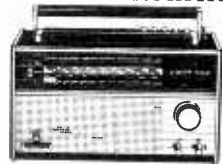

Grundig Mariner TR885 .. £35-00
Grundig Elite Boy 500
bat/mains .. £27-00
Grundig Melody Boy 500
bat/mains .. £27-00
Grundig Melody Boy 1000 .. £41-00
Grundig Yacht Boy 210 .. £34-50
Grundig Satellit 1000 .. £125-00
Aiwa AR158 6w.b. (inc. air) .. £31-00
Koyo KTR 1664 8w.b. .. £47-50
Koyo KTR1661 8w.b. .. £40-25
Koyo KTR1770 11w.b. .. £69-50
ITT/KB Golf Preset .. £22-50
ITT/KB Touring Int. Marine .. £45-00
Toshiba IC70 .. £16-50
Grundig RF430 .. £26-50

FREE With each set "Guide
to Broadcasting
Stations" (160 pages)

WILMSLOW
AUDIO, Dept. PW,
10 Swan St., Wilmslow,
Cheshire, SK9 1HF

FOR THE AMATEUR AND CRAFTSMAN ALIKE

PRACTICAL

WOODWORKING

the magazine for detailed how-to-do-it features covering every
aspect of working with wood

Making new furniture to
modernising old

Building a summerhouse to
panelling a room

Turning a chairleg to
building a boat
streamlining a kitchen to
constructing a baby's
playpen

Place a regular order **NOW** Out every month only 25p

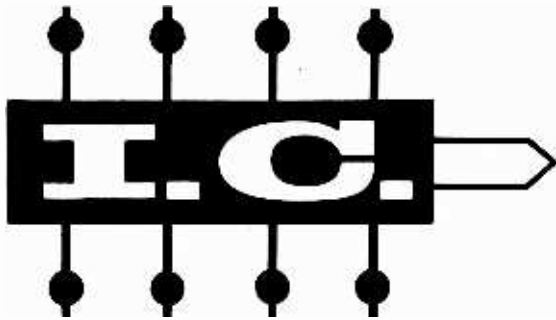

OF THE MONTH

L.A.J. IRELAND

Number 34

Westinghouse Hyreg AR1 Power Regulator

IN general, anyone whose interest in electronics begins with radio and communications is inclined to think primarily in those terms, maybe extended a little to cover audio and data processing. All else tends to be dismissed as electrical engineering. It is similar with integrated circuits. Application to radio, TV and computers is just about the limit. It comes as something of a surprise, then, to be dealing with an integrated circuit—even if it is a thick film hybrid—designed for power control at ratings of up to 2.5 kW., and operating off the mains. That, however, happens to be our topic for this month, the Hyreg type AR1 power regulator, manufactured by Westinghouse and available from Best Electronics (Slough) Ltd., of Michaelmas House, Salt Hill, Bath Road, Slough, Bucks.

Applications

Applications may be domestic—to regulate an electric heater or keep a kettle just on the boil; to dim the lights for an evening at home or for the local hall when films are on, or a show is presented; to set the speed of an electric drill; anywhere, in fact, where it would be an advantage to control a high powered device with the same convenience as the volume of a radio. It will by now be clear that silicon controlled rectifiers are involved, or to be more precise, a triac, consisting of two s.c.r.'s with a common gate for triggering conduction, and capable of use on a.c. circuits.

It will be remembered by those who have followed this column for a long time that the application of triacs was discussed once before, when the very useful G.E.(USA.) range of triggering circuits was

featured. In the present case, however, the triac itself, together with the triggering components, is incorporated in the hybrid assembly. All these items are then bonded to a ceramic substrate of high thermal conductivity and electrical resistivity. The assembly is potted in epoxy, with the ceramic in good thermal contact with a metal base plate.

In use, only three external components are required, and if the load is purely resistive, such as tungsten lighting or a kettle or bar-type electric heater, this can be reduced to one, a variable resistor, as shown. The unit is mounted on a heat sink with thermal contact established with the metal base plate of the regulator. Due to the properties of the ceramic, however, this plate and the attached heat sink are fully insulated and protected.

It is suggested, however, that the variable resistor should be of the type with a plastic operating spindle, or a solid plastic knob used, for safety in the case of component failure, or accidental reversal of the connections to the mains. The fraction of the power dissipated in the load compared with that drawn directly from the mains is linearly dependent on the setting of the variable resistor. For zero resistance, the power delivered to the load is 100% dropping to zero when the resistance rises to some 800k Ω . It is clear, therefore, that if the application is for lighting, for example, a 1M Ω linear variable resistance will control the illumination, from total darkness to full power.

One cautionary note must be sounded, however, about devices employing small a.c. motors. Most such motors, including those generally used to drive cooling fans, are of the induction or squirrel cage type. Such synchronous motors operate at a single speed or not at all. It follows therefore that it is impossible to regulate the speed of such motors with a triac device. Rather, at a particular point such a motor simply stops; and as the operating temperature of the motor, or of other components, if it is driving a fan, will then rapidly rise, damage may result. If it is intended to use this device in a system incorporating an electric motor, first check that the motor is of the type using brushes, i.e. non-synchronous. If used with a fan heater, for example, ensure that the fan receives the full mains voltage at all times, while the regulator controls only the power dissipated in the heating element.

The AR1/250-10 (250V r.m.s. 10A r.m.s.) costs £5.87 inc. p/p with present delivery of 6 to 8 weeks. ■

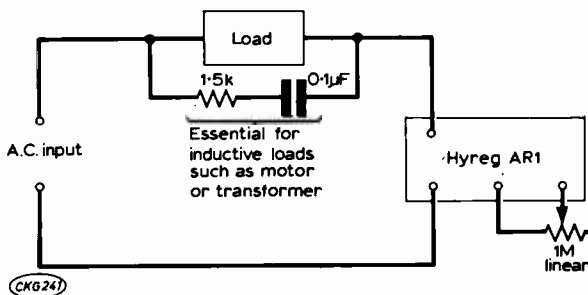

A potentiometer is all that is required for full power control.

HAVE you ever wanted to find out the value of an unmarked capacitor or wondered which was the primary and secondary of a transformer?

The value of a resistor can often be found easily by using a multimeter but how many of us possess one which can accurately measure 1Ω or, at the other extreme, $2M\Omega$? Capacitors are less easy to measure and an a.c. source is usually required and, the world being the way it is, capacitors tend to have their values erased more easily than most components. Inductors present another problem;

UNIVERSAL BRIDGE

HALVOR MOORSHEAD

granted that this facility is rarely required for most of us but when you *have* to know, what do you do?

The Wheatstone Bridge is the answer; it will rapidly give answers to all the above. In the circuit used here, the values of the components can be read directly off the scale.

THE THEORY

Look at the circuit arrangement in Fig. 1. An audio note (at any reasonable level and frequency, it doesn't affect the operation) is applied across the network made up from VR1, C_a and C_b with headphones connected between the slider of VR1 and the common junction of the capacitors.

Assume that C_a and C_b are of the same value; they will then each have the same reactance at the audio frequency and therefore the signal level between E and F will be half that between E and D.

If the slider of VR1 is at its central position, then the resistance A-B will equal that between B-C and half the applied voltage will appear at the slider. Thus the signal level at B and F are the same: what will be heard in the phones? Nothing of course; since there is no voltage difference across them, no current can flow and so they remain silent. In this state, the Bridge, for that is what this network is called, is in balance and the null position has been achieved.

If the slider of VR1 is at any other position there will be a voltage difference and an audio note will be heard in the phones.

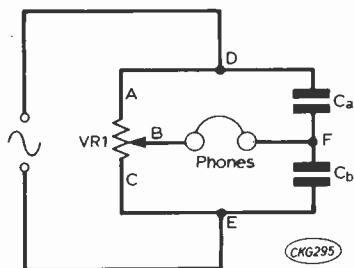
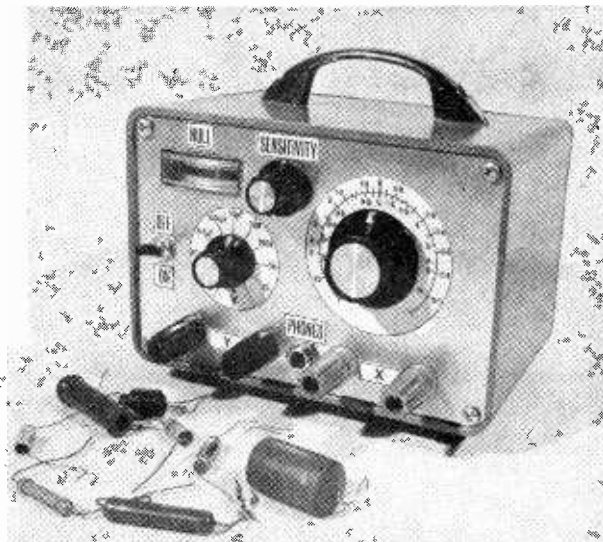

Fig. 1: The Wheatstone Bridge which forms the basis of this project. A full explanation of the theory is given in the text.



Now if C_b is one tenth the value of C_a , its reactance will be ten times greater and we shall only get a null when the resistance B-C is ten times greater than A-B. If we make C_a a standard, we shall obviously be able to find out the value of C_b as long as we know the relationship between the two parts of the track of VR1.

We have dealt with capacitors but the same applies to resistors and inductors with only one difference. The reactance of both of these is directly proportional to their values—in other words the higher their value, the more resistance they exhibit. With capacitors the reverse is true, the higher the value, the lower the reactance and so two scales are needed for the pot, one a mirror image of the other.

THE CIRCUIT

To operate the bridge we require an audio source, a set of standards and also something to detect the null. Headphones are pretty good but they have to be quite sensitive to detect the setting of VR1 which corresponds to the maximum null and so an amplifier is used. In addition to feeding headphones, a cheap meter is also used which will give a visual rather than an audible indication.

The complete circuit is shown in Fig. 2. The audio frequency generator to drive the bridge is represented by Tr1 and the associated components. This is a phase-shift oscillator which provides a pretty good sine wave. R1 and R2 provide the base bias while C2, C3 and C4 together with R3 and R4 take part of the signal from the collector and invert it by 180° , converting it from a negative to a positive feedback and thus sustaining oscillation. As we have already mentioned, the actual frequency of operation is not important but the values given operate at about 700Hz. This frequency can be altered slightly by modifying the value of R4 but only by plus or minus 50 per cent ($4.7k\Omega$ to $15k\Omega$). A transformer is included in the collector of Tr1; this is a transistor output transformer type LT700 which is widely available. This has a tap on the primary but this is not required for our purposes. The metal case of the transformer should be connected to the negative line. The secondary of T1 drives the bridge and it will be seen that this part of the circuit is isolated

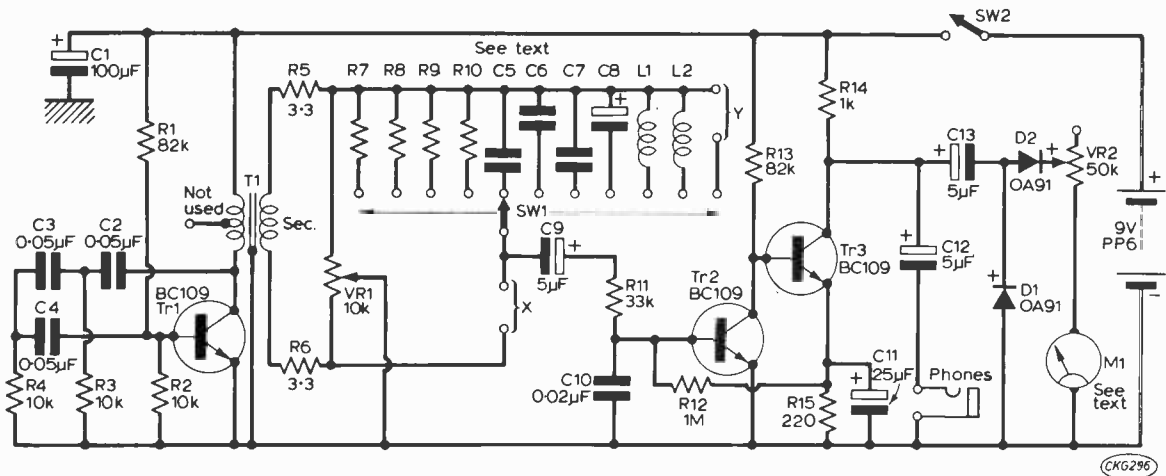

Fig. 2: Complete circuit of the Universal Bridge; the accuracy of the finished unit will depend on the tolerance of the standards and the care taken in calibration.

TEST VOLTAGES

	Emitter	Base	Collector
Tr1	0V	0.5V	7.5V
Tr2	0V	0.25V	1.2V
Tr3	1V	1.2V	3.4V

Note: Measured on Avo 8 (20,000 ohms per volt) on 10V range, battery voltage on load reading 8.5V. The above voltages should only be regarded as a guide.

from the audio oscillator. Two low value resistors are shown wired in series with the secondary; these do not really affect the circuit but prevent a complete short-circuit of the secondary if very low value resistance components need to be compared. If the secondary is short-circuited, the oscillator may cease to function.

The bridge potentiometer is represented by VR1 which has its slider taken to the negative line. This pot should be a high quality component and should of course have a linear track. A wire-wound component is to be preferred although not essential (the prototype shown uses a standard carbon track pot).

The standard components in the bridge circuit are represented by R7-R10, C5-C8 and L1, L2; these are selected by SW1. SW1 is also able to select an external pair of terminals (marked Y) for matching purposes.

The component to be measured on the bridge is connected across the terminals marked X.

The audio signal, indicating an imbalance in the bridge, will appear between chassis and the junction of the standard and unknown component and a d.c. blocking capacitor C9 takes this output to the amplifier. R11 is included to minimise the loading that the amplifier presents to the bridge. C10 bypasses any high frequencies to chassis and is necessary to prevent r.f. pickup since the amplifier has a very high gain.

The amplifier stage is made up from Tr2 and Tr3 with their associated components and is a fairly conventional arrangement. The use of BC109 transistors ensures considerable amplification of the input. The bias for Tr2 base is provided from the emitter of Tr3; this helps to stabilise the circuit and also takes up any variation in the parameters of the

★ components list

Resistors

R1 82kΩ	R9 100kΩ
R2 10kΩ	R10 10MΩ
R3 10kΩ	R11 33kΩ
R4 10kΩ	R12 1MΩ
R5 3.3Ω	R13 82kΩ
R6 3.3Ω	R14 1kΩ
R7 10Ω	R15 220Ω
R8 1kΩ	

Resistors $\frac{1}{2}$ W, 5 per cent except R7-R10, see text
 VR1 10kΩ lin. pot. see text
 VR2 50kΩ lin. pot. carbon track

Capacitors

C1 100µF 12V min.	C8 10µF 12V—see text
C2 0.05µF ceramic	C9 5µF 12V min.
C3 0.05µF ceramic	C10 0.02µF ceramic
C4 0.05µF ceramic	C11 25µF 12V min.
C5 10pF see text	C12 5µF 12V min.
C6 1000pF see text	C13 5µF 12V min.
C7 0.01µF see text	

Semiconductors

Tr1 BC109	D1 OA91
Tr2 BC109	D2 OA91
Tr3 BC109	

Miscellaneous

T1 Transistor output transformer, Eagle type LT700
 SW1 1-pole, 12-way rotary switch
 SW2 On-off, miniature toggle switch
 M1 Recording level meter—see text
 Jack socket; 4 off R.S. Components (Radiospares);
 Slim Insulated Terminals, 4mm or similar; Vero-board, 0.15in. matrix, 12 x 16 holes; PP6 battery;
 Battery clip; Case: 'Elf' type, available from West Hyde. Developments Ltd., Ryefield Crescent, Northwood, Middx., HA6 1NN. Price: £1.25 plus 10p postage. L1, CH4/A 10mH choke, L2 100µH choke, wire ends, available from Repanco Ltd., 203-265 Foleshill Road, Coventry, the price of each is 50p including postage.

transistors.

The amplified audio signal appears at the collector of Tr3 and is connected via C12 to the headphone socket. Any type of phones can be connected to this

point—even the low 8Ω types that are now common; the effect on the meter part of the circuit is marginal. The output is also connected to the meter circuit through C13 which rectifies the a.f. and applies it to the meter. D1 provides the d.c. bias necessary for correct operation of D2. Since the variation of signal strength applied to this circuit is far more than any meter could sensibly handle, a sensitivity control is fitted. This is simply a variable resistor in series with the meter M1.

When the audio signal is at minimum, the meter will be showing the minimum reading and since we are not interested in calibration, only in noting the minimum deflection, a very simple and inexpensive meter may be used here. The most suitable type is a recording level meter; these come in a variety of shapes and sizes but most have a sensitivity of about $200\mu\text{A}$ and cost between 50p and £1. Suitable types are listed in the catalogues of the large mail order component suppliers.

The current drain of the prototype was measured at about 10mA and a PP3 or PP6 type battery may be used; the low consumption should ensure a long battery life.

SW2 is a separate on-off switch and C1 decouples the positive line. The table shows the transistor voltages measured on the prototype; these may be of help if difficulty is experienced in getting the circuit to operate.

CONSTRUCTION

The circuit can, of course, be built into any type of case but the one chosen for the prototype is a very convenient size and looks very attractive. The main body of the case is made from thick plastic and the front panel from aluminium with mounting screws provided. An internal chassis is also provided but this is not required for our purposes. Bearing in mind the attractive appearance of the case the price, £1.25, is not expensive; details of the supplier are given in the components list. All the components are fitted to the front panel and the drilling and cutting of this is shown in Fig. 3. The front panel is supplied

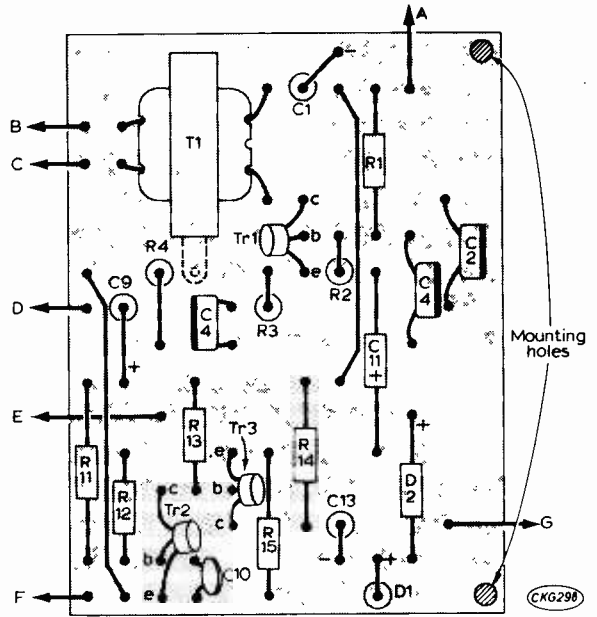

Fig. 4: The majority of the components are mounted on a small piece of Veroboard as shown. Certain of the conductor strips should be broken.

with a protective plastic sheet and this is best left on while the marking is done to prevent scratching but it should be removed before the actual drilling starts. The meter cut out is shown for the type used in the prototype but other types may vary and so this dimension may have to be worked out separately. The holes are of two diameters, $\frac{3}{8}\text{in}$ and $\frac{1}{4}\text{in}$. Two holes are not shown on this diagram: these are for the component board mounting bracket. These are best sited to suit the type of bracket used; they will lie to the right of the VR1 hole.

The majority of the components are fitted to a piece of Veroboard with a 0.15in. matrix. The layout for this is shown in Fig. 4. Three chassis and two positive lines are used, these are connected by link

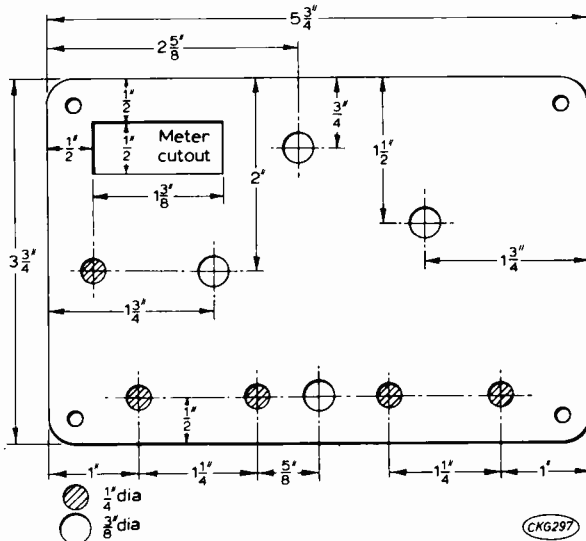
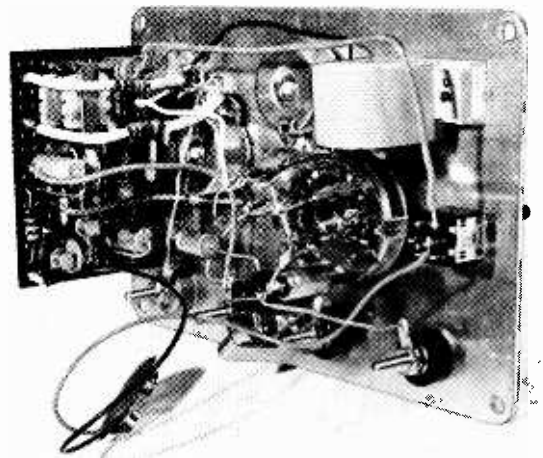

Fig. 3: The front panel, which is supplied with the case, should be drilled and cut as shown.



All the components are mounted on the front panel. The wiring, especially around VR1, should be short and straight.

wires as shown. The transformer T1 is fitted with two tabs which are rather larger than the holes in the board, but by slightly enlarging these with a drill the tabs may be pushed through the board and on one side bent over and soldered to the adjacent strip. The upper tab should be soldered to the upper strip. It is important that both sides are soldered to the correct strip as the upper strip must be at chassis' potential for the connection for C1. Take-off pins are connected at various points, these are marked A-G and correspond with similar letters in Fig. 5.

Several breaks are necessary in the copper conductor strip but these are clearly shown in the diagram.

Figure 5 shows the remaining wiring. The component board should be fitted to an aluminium angle bracket which in turn should be fitted to the front panel. A solder tag can be fitted under one of these mounting screws to act as the main chassis connection.

The standard components are wired directly to the switch SW1 and a common wire connects one side of these together; the photograph should make this clear.

To minimise the capacity of the wiring, all connections from and to SW1 and VR1 should be as short as possible and good stout wire should be used; it may look less attractive but will improve the performance of the unit.

The only component not on the front panel is the battery. This fits into the main body of the case and should be held in some form of clip to prevent it moving around.

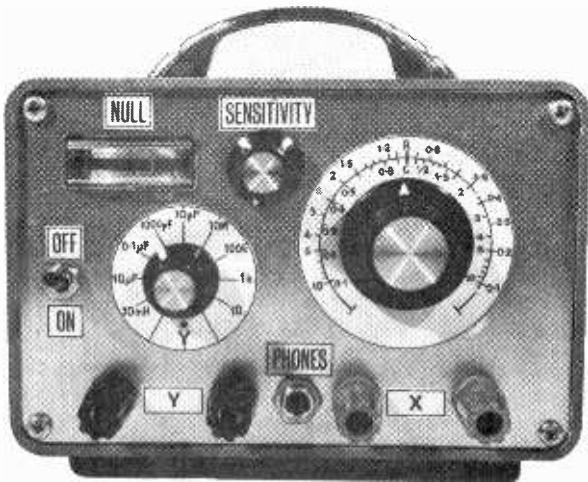

Using the recommended case, and taking care over the labelling of the controls, the finished unit can look quite professional.

CHOICE OF STANDARDS

The accuracy of the unit depends on two factors: the quality of the standards and the care taken in calibration. One per cent resistors are available although they are hard to find. Two per cent types are not all that expensive and should be quite adequate; Home Radio list these in their catalogue at 5p each. One per cent capacitors are available from a number of suppliers including Electrovalue Ltd., though C9, 10 μ F, costs a small fortune in this tolerance. However, it is highly unlikely that high accuracy is needed on this range.

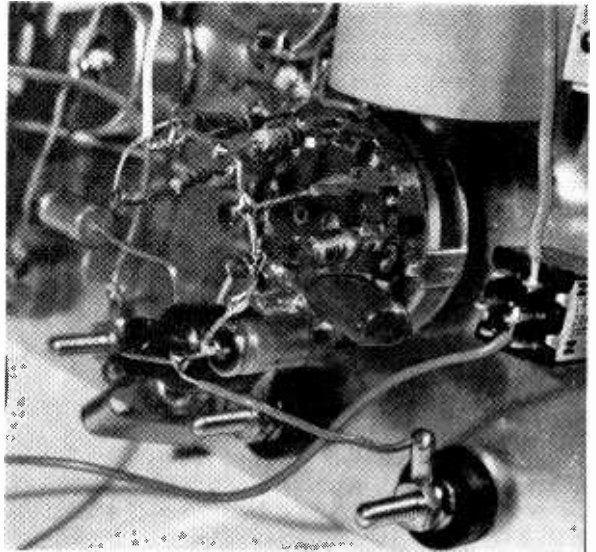

Close-up of the reference components showing how these are wired directly to the switch.

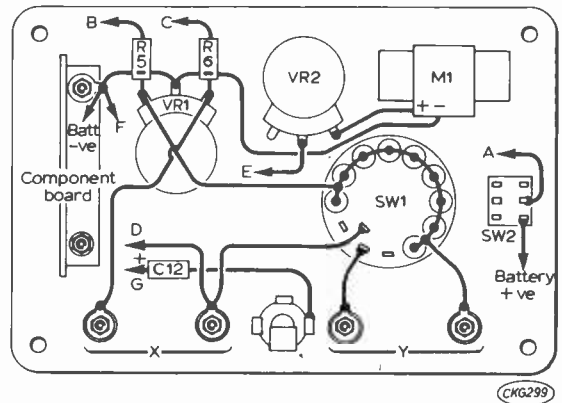

Fig. 5: Wiring of the controls. The letters match up with those on the main component board.

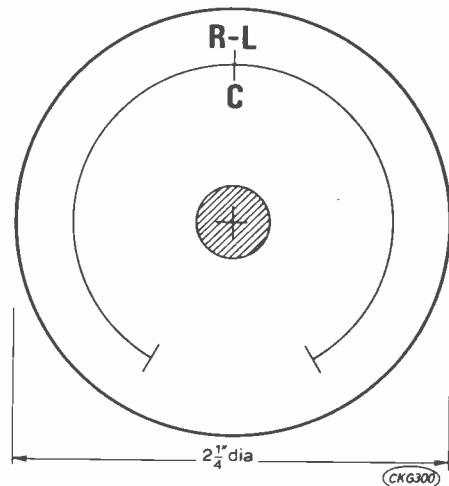

Fig. 6: This scale may be cut out and calibrated as described in the text.

The inductors chosen for the circuit are a matter of choice. The author only included two in the prototype, a 10mH and a 100 μ H. Arrangements have been made with Repanco Ltd., for the supply of these 5 per cent tolerance inductors, details are given in the components list. This will allow measurement within reasonable accuracy of inductors lying within the range 1mH to 10 μ H. Lower inductances can be measured but the accuracy below this must be suspect because of strays in the circuit.

The matter of standards must be left up to the reader. Many people may be content using 5 per cent components throughout and certainly little usefulness will be lost.

CALIBRATION

A blank calibration scale is shown in Fig. 6. This can be cut out and stuck onto the front panel, the null position is already marked. For calibration a source of close tolerance components is required and the remarks made above apply. However, as we are only interested in one set of markings, this can be done using the cheapest components—resistors. The best range on which to calibrate is probably the 1k Ω one and a set of resistors with their values ranging between 100 Ω and 10k Ω will be needed. Points can be obtained by interpolation if only a few components are used. Alternatively, if a highly accurate test meter is available (one with an individually calibrated scale) a variable resistor can be adjusted on this and then used for the calibration. There are several ways of approaching this problem and the above points are only a guide. However, once calibrated, the scale will hold good for all values of resistance, capacitance and inductance as long as the standards are accurate.

For matching two components the internal standards are not used. The two components are fitted to X and Y and their similarity compared, if they are the same the null will appear at the 1:1 setting right at the top. ■

MAXWELL

by G8DSH



"I think it needs a plug change and its valves ground in!"

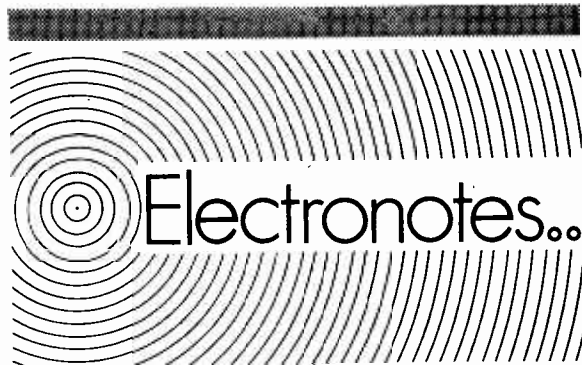

Electronotes.

S. GINSBERG

SOMETIME back, comment was made in this column about miniature lasers. Some will have wondered about the applications of these devices while others, perhaps, even doubted the existence of such midget marvels.

It will be of interest, therefore, that small lasers are available in this country from a company in Edgware. These are colourfully described as "Hip Pocket He-Ne Lasers". Ratings of one, three and 10mW are available and the power supply allows operation from 230V a.c. or 12V d.c. Dare our imagination picture a man from Mars reaching for the "sky" on the commands of a Space Sheriff on whose hip hangs a 45MW laser? Jesse James would turn in his grave!

Before anyone ridicules the laser as just a novelty, they should consider the latest application by the Dutch electronics giant Philips. The Eindhoven laboratories use one in their latest system of video recording.

The reflection from a minute spot of light generated by a miniature laser is used to obtain a signal from a video LP. A 45 minute colour television programme can be recorded on a normal LP sized disc. This amounts to something like recording 50,000 separate frames or individual pictures.

Since there is no direct physical contact with the pick-up head, wear is almost non-existent. However, one sees scratches as a problem and, more importantly, dust and/or dirt in the groove will throw up as noise in the system.

New electronic products flood the market every week. From amongst the current list is an interesting new IC. It is believed to be the first IC timer commercially available. Designated the 555 its applications include a timer which will cover intervals from fractions of a second to one hour, frequency divider, frequency modulator and missing pulse detector.

Another interesting newcomer is the range of epoxy-coated inductors. This IR-4 Series extends from 0.015 μ H to 240 μ H which is a very useful coverage. The devices are small, wire-ended and colour coded. The smaller ones in the range might be mistaken for resistors by the unwary. Self-resonant frequencies go from 5.9MHz to 525MHz. Weight is only 0.65 grammes maximum and size of the largest is 0.45in. by 0.2in. with an overall length of almost 3in. (including the length of the wire end leads). Looks as though it won't be long before nobody bothers to wind coils. Old timers in radio will be saddened and doubtless harbour fond nostalgic memories of winding 100 turns of 24s.w.g. on a cardboard toilet roll former in order to receive 2LO.

Reverberation Unit

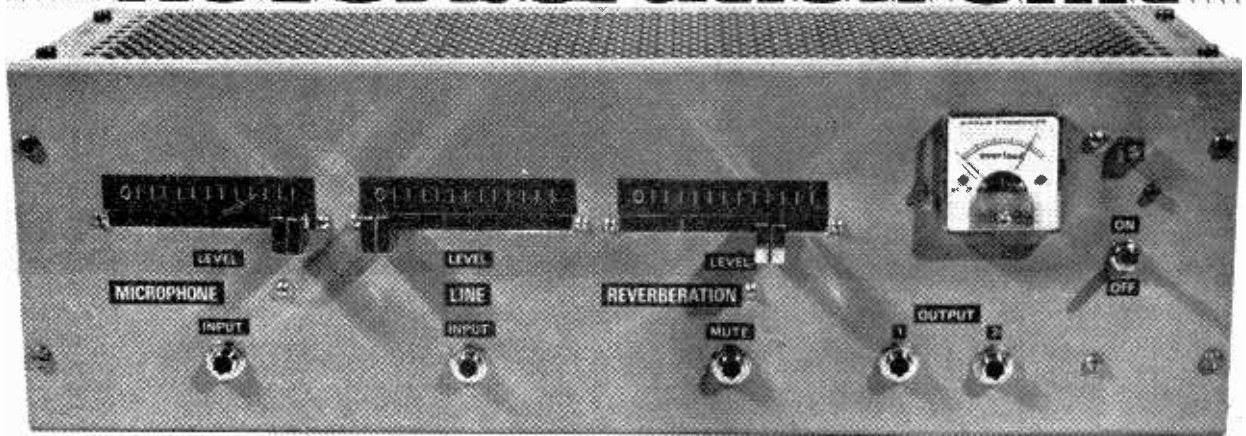

F.C. JUDD

PART TWO

CONNECTIONS to each of the panel mounted components are given in Fig. 11. Note that the slider control connections are numbered as follows—1 is the earth connection, 2 is the slider and 3 is the signal input. They must be wired this way to obtain the logarithmic performance of the potentiometer.

The layout and wiring of the circuit board is shown in Fig. 12. Note also that the leads coupling the spring line unit to the circuit board have to be screened and connected to the unit itself by means of phono plugs.

Construction of the power supply is shown in Fig. 13 in which details are also given regarding the size of the chassis etc. The capacitor C13 and the bridge rectifier BR1 are mounted on a small piece of circuit board elevated from the chassis on stand-off pillars.

Checking out and Performance

The overall performance of the finished reverb unit is given in the specification table given last month.

The supply rail current at the negative 18V point (see circuit) should be approximately 15mA with no

signal and with the reverb control off. The no-signal current of the reverb driver amplifier only should, if possible, be checked by connecting a meter in series with the negative supply rail at the starred point shown in Fig. 2. The pre-set PR1 should be adjusted until the standing current is about 10mA. Otherwise set PR1 to mid position.

With signals, and with the reverb control VR3 at max, the current to the driver amplifier should rise to not more than 100mA on speech peaks. A higher current indicates overload.

The Overload Meter

The overload meter will read only with reverb on and on strong signals may show full scale deflection. This is well beyond the point of overload at which distortion from the reverb amplifier circuit will be high. The meter used in the prototype is an Eagle type MR2P with a 50 μ A movement and calibrated 0-10. For the prototype reverb unit the figures on the meter scale were erased leaving only the scale itself. The overload point is marked (in red ink) at what was division 8 as shown in Fig. 14. In normal use the input signal should always be adjusted so that with full reverb the overload meter never quite reads to the overload mark.

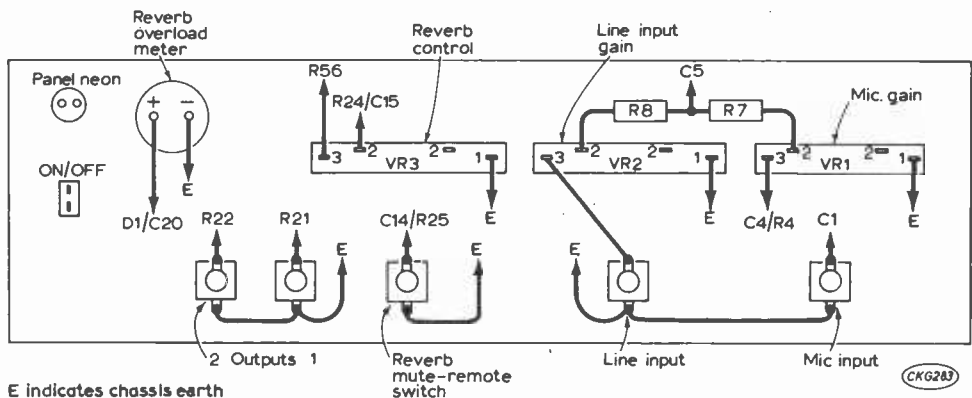

Fig. 11: The wiring of the front panel components.

CKG263

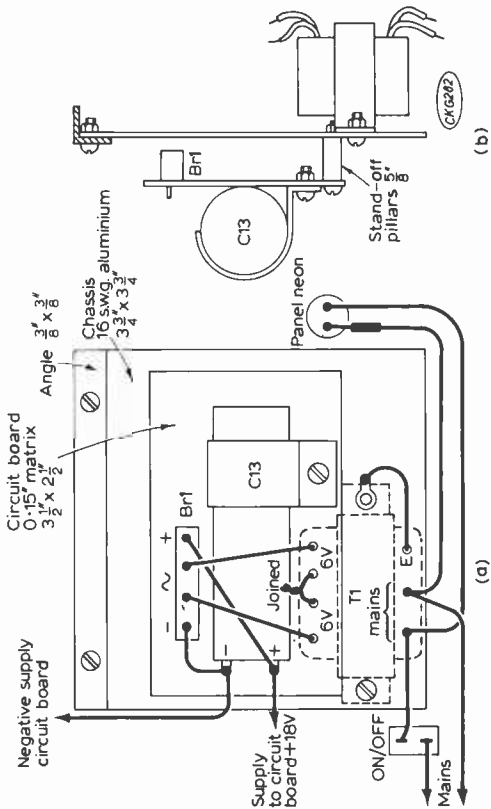
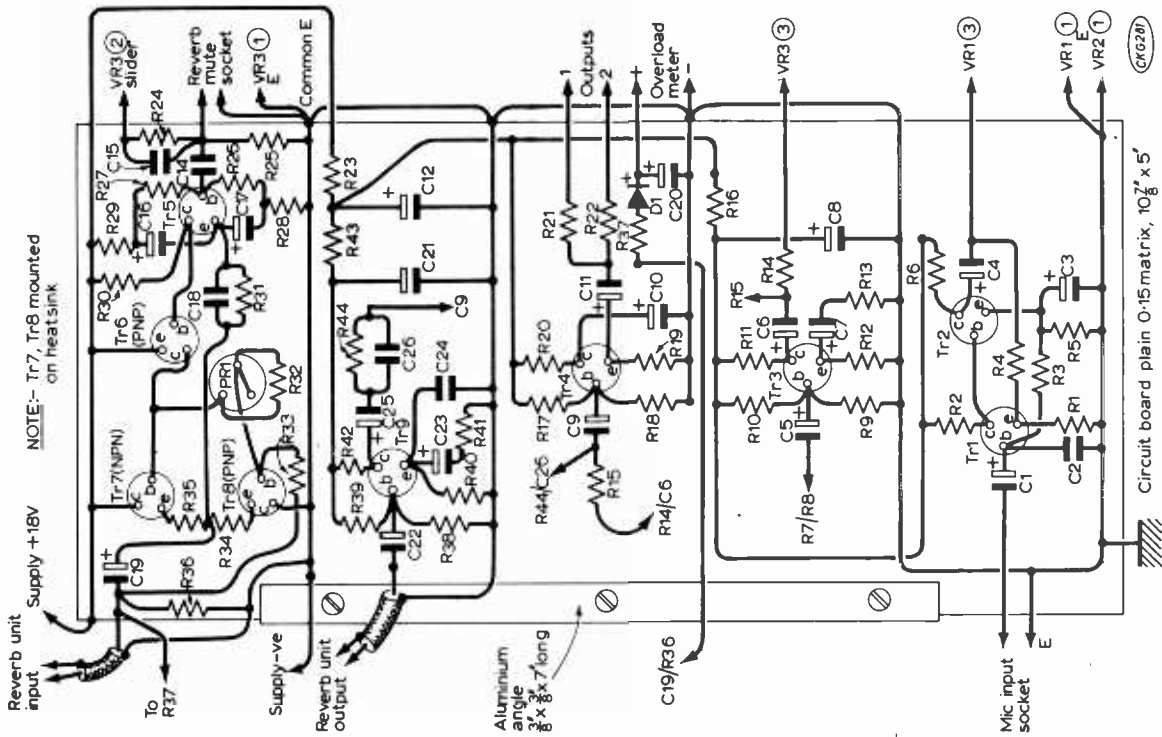
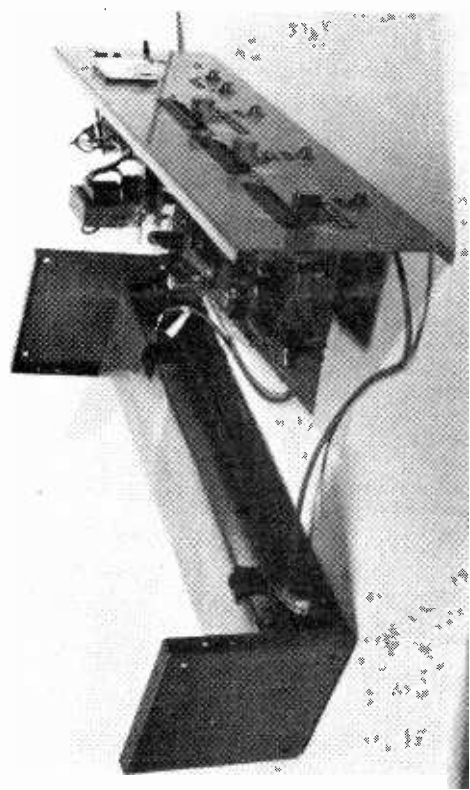

Fig. 12 (left): The wiring of the main component board. The siting of this can be seen from the photograph below.

Fig. 13 (above): The wiring and construction of the power supply on its own small sub-chassis.



A view of the prototype. The main component board and power supply sub-chassis can be seen behind the front panel and fixed to it.

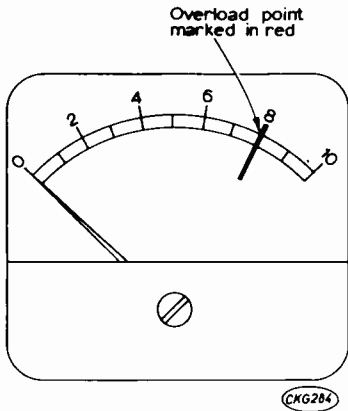

Fig. 14: The overload meter can be marked as shown. The plastic cover can easily be removed to do this.

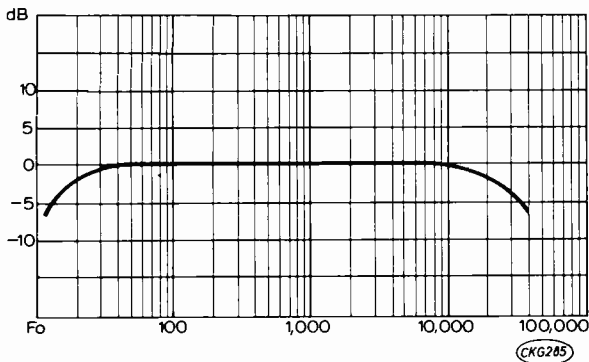

Fig. 15: The overall frequency response of the reverb unit from either input but with no reverb included.

Frequency Response

The overall frequency response for through signals (i.e., with reverb 'Off'), is shown in Fig. 15. The frequency responses of the spring line driver amplifier and its output amplifier can be checked against the responses shown in Figs. 3 and 4 respectively. For checking the response of the line driver amplifier, connect an audio signal generator at the junction of R14 and VR3 and set VR3 at maximum. Input signal should be not greater than about 20mV. Check the response at the output with an audio voltmeter between C19/R36 and chassis and with the line unit disconnected. Check the response of the spring line output amplifier Tr9 with an audio signal generator connected to C22 and with line unit output plug connected. Input signal should not be greater than about 5mV. Check the response with an audio voltmeter connected between C9/R15 and chassis.

Reverb Mute

The socket marked "Reverb Mute" (external remote switch) as in Fig. 2, is optional but can be used for remote control by means of a switch on the end of a screened lead. When the switch is closed signals feeding the reverb driver amplifier are short circuited to chassis. ■

THE Medium Wave Column

GEOFFREY DRIVER who lives in Woodham, Surrey has been active on the medium waves and he reports reception of Tenerife, Canary Islands on 620kHz after 2300hrs; Radio Andorra 701kHz in both French and Spanish from 2030hrs until midnight; Radio Portugal 755kHz in English at 2300hrs with "DX Magazine" on the last Monday of the month; Algiers 890kHz in English at 0300hrs; Bissau, Portuguese Guinea with a good signal on 1070kHz after midnight.

During the winter months North American medium wave stations are often heard in the U.K. before midnight and sometimes they are audible as early as 2300hrs. This is the hour when a number of Europeans close down for the night leaving a few spaces for the DX to be heard. North Americans operate on channels spaced 10kHz apart and all of them are allocated identifying call letters which they use frequently. Listen on 710kHz at 2305hrs after Cairo 2 signs-off, for CJOX which is located in Grand Bank, Newfoundland. This is a commercially owned station and it carries the "CJON Radio Service" programme. On 1070kHz, Paris closes down at 2300hrs leaving the frequency clear for CBA, a 50kW outlet of the Canadian Broadcasting Corporation situated in Moncton, New Brunswick. CBA relays the CBC Radio Network and it identifies locally on the hour and the half hour. Propagation is variable on the North American path but when conditions are favourable CJOX and CBA should be heard by 2330hrs. Others to listen for between 2330hrs and midnight, are WHDH Boston on 850kHz; CJON St John's, Newfoundland on 930kHz; CBM Montreal on 940kHz; CHER Sydney, Nova Scotia 950kHz; WINS New York City on 1010kHz; WNEW 1130kHz also in NYC; CKEC 1320kHz in New Glasgow, Nova Scotia.

A list of North American loggings made in the UK since 1962 and covering nearly 400 different stations, is currently being distributed by the Medium Wave Circle to its members. This club, which is now in its 19th year, deals exclusively with DXing on the medium waves. Its bulletin "Medium Wave News" appears 8 times a year and contains up-to-date information about the medium waves, loggings of DX, a verification section and articles on MW DXing. Further information about the MWC is obtainable from Ken Brownless, 7 The Avenue, Clifton, York YO3 6AS.

S. N. Gaythorpe of Cranbrook, Kent asks if it is possible to hear Bermuda on the medium waves. Bermuda has 3 medium wave stations; ZFBI on 960kHz; ZBM1 on 1230kHz and ZBM2 on 1340kHz and all have been heard in the UK. There is no short wave broadcasting in Bermuda and consequently this is a "medium waves only" DX country. Try on 1230kHz after midnight for ZBM1, and log this rare DX country.

Please send logs and information about the medium waves to the author at 132 Segars Lane, Southport PR8 3JG.

AUTOMATIC EMERGENCY 250V SUPPLY

Within the last two years there have been two electricity supply emergencies and, at the time of going to press, there is a possibility of another. This unit will save you the indignity of spending yet another spell 'blacked-out'.

S.SOAR

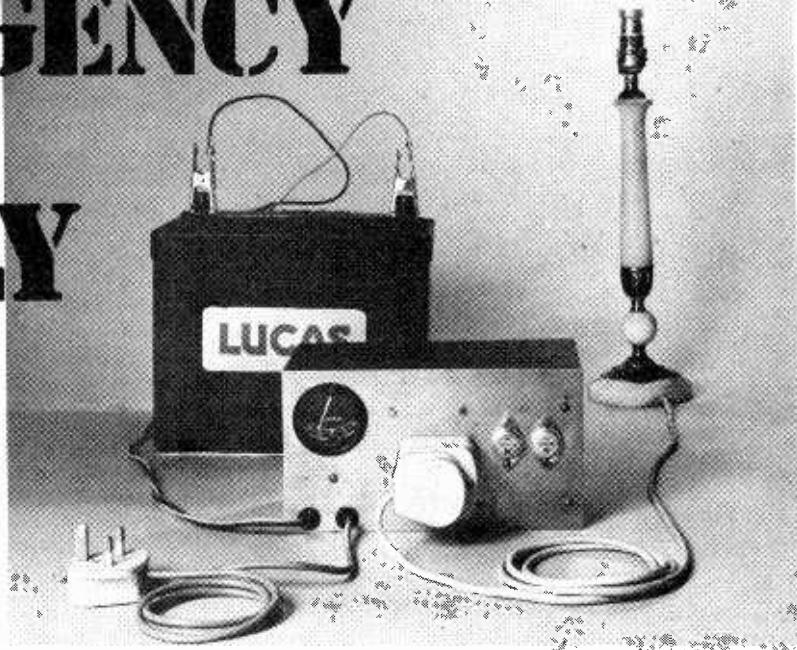

THE unit described here was developed during the power crisis of February 1972 and was primarily intended as a standby emergency lighting unit, although since the restoration of normal power the device has had considerable use, both as a battery charger and as a portable power supply in garage and caravan. The power output is sufficient to operate a small electric drill or an inspection lamp.

Specification

	As a Charger	As an Inverter
Input	240V mains	12V battery
Output	12V, 12A d.c. to battery	240V, 50Hz square wave, up to 150W

Circuit Description

The unit has two modes of operation, with a 12V accumulator and 240V mains connected, the unit is a charger capable of delivering up to 12A, this charge rate falls to approximately 1.5A with the battery fully charged. An auxiliary socket on the unit provides a 240V mains output.

In the event of the mains supply being interrupted, the unit automatically switches over and power is taken from the battery and by inverter action is delivered to the auxiliary socket at 240V thus maintaining the supply. When the mains supply is restored, the unit again switches automatically to its charging condition.

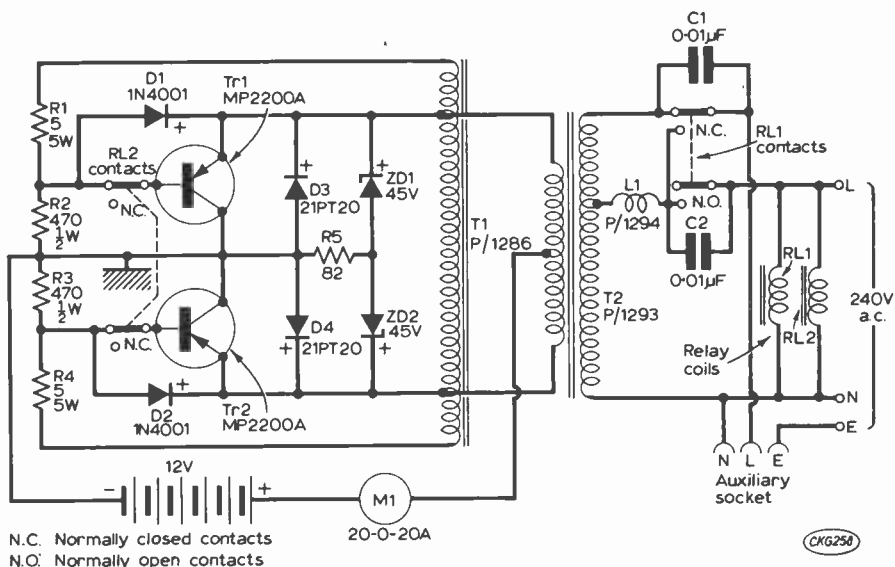

Fig. 1: The complete circuit on the combined charger/inverter. This will give up to 150W at 240V, 50Hz. See text for a description of the operation.

tion and the battery is restored to its fully charged state.

Since the inverter output is a square wave, it is not ideally suitable as a supply for equipment such as a television receiver, however, satisfactory performance has been achieved with slightly reduced picture size and tolerable interference on sound.

As a Charger

With the mains supply connected, relays RL1 and RL2 are energised, transistor bases are isolated and mains supply is connected directly to the auxiliary socket and to the output transformer secondary via choke L1. Rectifiers D3 and D4 supply full wave rectified current to charge the battery. Ballast choke L1 limits the charging current to a safe maximum of around 12A with a flat battery, this charge rate decreasing as the battery potential rises.

As an Inverter

With the mains supply interrupted, the relays de-energise, the transistor bases are connected and the output socket is connected directly to the secondary of the output transformer. The unit now operates as an inverter.

Referring to Fig. 1, assume Tr1 to be conducting, then transformer action (T1) holds Tr2 off (+ve on base) and Tr1 on (-ve on base) magnetic flux in the transformer core (T1) increases uniformly and current is substantially constant. However, as the flux density in the core approaches saturation, current increases rapidly in an attempt to maintain the rate of flux increase constant. Base drive on Tr1 is limited by R1 and the gain of the transistor falls with increased collector current, these two factors result in Tr1 coming out of its saturated state and collector current can increase no further, flux cannot increase

and base drive falls causing a further reduction in collector current. Falling flux causes Tr2 to become biased on and the collector current increases rapidly and Tr2 is switched hard on, this completes one cycle.

Frequency of operation is determined by the time taken for the transformer core to saturate, suitable choice of core and windings results in an operating frequency of approximately 50Hz.

The transistors are protected against reverse bias by diodes D1 and D2, and ZD1 and ZD2 clip voltage switching transients to a safe level.

Construction

Since the power transistors are connected in common collector, these devices should be fixed directly to the chassis, 16 s.w.g. aluminium was used on the prototype. Transformers, relay and choke are also bolted directly to the chassis, and if rectifiers with anode studs are used, these can also be fixed directly to chassis. Other components should be mounted on insulated tag strips. It is advisable to have all low voltage components on one side of the output transformer (i.e. primary winding side) and all mains voltage components on the other side (i.e. secondary side). ■

★ components list

Resistors

R1	5Ω	5W	R4	5Ω	5W
R2	470Ω	½W	R5	82Ω	1W
R3	470Ω	½W			

Semiconductors

Tr1	MP2200A	D3	20A 100V p.i.v. rectifier (e.g. 21PT20)
Tr2	MP2200A	D4	20A 100V p.i.v. rectifier (e.g. 21PT20)
D1	1N4001	ZD1	45V 1W zener, e.g. 1S3045
D2	1N4001	ZD2	45V 1W zener, e.g. 1S3045

Tr1 and Tr2 are available from Jermyn Industries, Vestry Estate, Sevenoaks, Kent. D3 and D4, 21PT20, are International Rectifier types. ZD1 and ZD2 are available from Quarndon Electronics, Slack Lane, Derby.

Transformers, Coils and Relays

RL1	2-pole changeover with 240V a.c. coil
RL2	2-pole changeover with 240V a.c. coil
T1	Driver transformer type P/1286
T2	Output transformer type P/1293
L1	Ballast Choke type P/1294

T1, T2 and L1 are available from Magtor Limited, 68 Dale Street, Manchester; a complete kit of these costs £6.65 plus 50p postage.

Miscellaneous

C1, C2, 0.01μF 600V; M1, Ammeter with centre zero, 20-0-20A or similar (Car types are suitable).

TELEVISION

DECEMBER ISSUE

EHT SYSTEMS FOR TV SETS

A lot of confusion seems to be present about the nature of the e.h.t. pulse, the stabilisation of the e.h.t. voltage and the different characteristics of half-wave and multiplier systems. This month we are taking a close look at this department, for both monochrome and colour set use.

UHF PREAMPLIFIER

Full constructional details of a simple u.h.f. aerial preamplifier which has given excellent results for both fringe area and DX use. Several prototypes have been tried out and the stability is so good that they can be cascaded.

SERVICING THE PYE 368 CHASSIS

The chassis to be dealt with in the regular servicing feature is the Pye group 368 hybrid dual-standard chassis used in many Pye, Ekco, Ferranti and Invicta models.

PLUS ALL THE REGULAR FEATURES

ON SALE NOVEMBER 20th

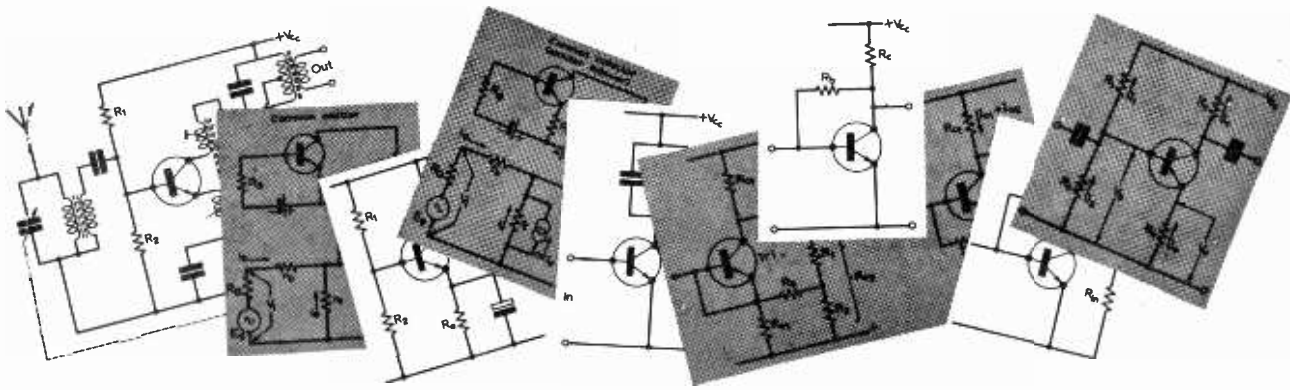

TRANSISTOR CIRCUITRY for beginners

PART 13

H.W. HELLYER & MICHAEL HOLLIER

Minimum noise

We have already stated that our principal aim is as good a signal swing as we can afford provided that we do not thereby increase the noise in the circuit. With any transistor type, some noise is generated, but this can be aggravated tremendously by collector currents and also by the source resistance seen by the transistor—and, as might be expected, the optimum conditions alter with frequency.

A digression here, for colleague Mike feels strongly on this subject, having been too often caught with unsuitable replacements. Transistors with the same code number but made by different firms can have widely odd noise performances, as we have found when using them for laboratory equipment.

To find the optimum operating conditions under which our chosen transistor is to be used, we must turn to the graphs of noise figures quoted by the maker. These indicate a typical noise level expected at a selected collector current, with a selected source resistance 'seen' by the transistor base. But the quotes are at one single frequency. In practice we find conditions vary widely—a whole family of curves is really needed for optimum choice—and is seldom available, even from our old friends Mullard, who kindly acknowledged our quotes while pointing out an omission, in a letter from L. W. Owers in the October issue of *PW*. Very few firms, including Mullard, give figures that allow us to optimise for the whole audio band—in fact, they seem to think the world ceases revolving below 100Hz, giving data at 1kHz and 10kHz, generally. More noise is generated at low frequencies than high, and the higher the operating current, the higher the noise level.

We have decided upon a collector current of 80 microamps for Tr1 and the graphs, such as are available, would indicate that a source resistance of between 5 and 20kΩ would be best for low noise. We shall aim at the lower figure.

The base of Tr1 will 'see' the resistance formed by the virtual earth (see Fig. 62) shunted by the series input resistor plus whatever the impedance

may be of the device that is feeding the circuit. The inset of Fig. 64 should give us some idea.

The virtual earth resistance can be calculated

from $R_v = \frac{R_b}{G_o}$ so R_b becomes 500kΩ, or, in prac-

tice, a 470kΩ, 5% component. The voltage across this resistor is the Tr2 emitter voltage less the base voltage of Tr1, or 9.303V and the current through this resistor will be around 19.8 microamps (remember we are ignoring the very small I_{b1}).

The current through R2 will, of course, be the same. So we come to a preferred value of 39kΩ. I shall not insult you with the details of the workings after 11 plodding articles of preparation . . .

We now have a working circuit with a low input resistance of around 5kΩ. And we insert R3 into the base 'feed' circuit of Tr1. This does two things: first, it raises the input resistance—that is, the resistance the source will 'see'; second, it gives us some control of the gain of this circuit. Remember, closed loop gain is equal to R_b divided by R, which is, in this particular configuration, $R_1 + R_3$. To get a theoretical gain of 20, for example, R3 would have to be 23.5kΩ (preferred value, 22kΩ).

$$G_c = \frac{R_1}{R_3} = \frac{470k\Omega}{22k\Omega} = 21.3613$$

Coupling

As for that input and output coupling. We found, in practice, great care had to be taken. In fact, we built the circuit and had some very strange figures before remembering that the feedback was both a.c. and d.c. conscious. So the input capacitor serves a double function; that of blocking the d.c. from previous stages (and to previous stages) and coupling the signal to the stage which we are designing.

Now the problem is that it must be of a sufficiently large value to present a short-circuit, or as near this as may be, to the frequencies over which our amplifier has to work. In the practical case, something like 200μF is in order. One reason that

care is needed here is again to reduce that bother—noise. If we make short-circuit and open-circuit input tests while measuring the residual noise at the output, we find there are some amazingly variant readings. A practical tip, for those who get fun from building their own hook-ups, is to load the circuit, at the actual input point, with the input impedance you want the circuit to 'see'. You may be surprised at the difference from abstract theory which your eventual readings reveal!

Measurement

We have talked glibly about open-loop gain, G_o , but given no clues as to its measurement. This is no easy task—you see, if you disconnect the feedback to measure open-loop gain the first transistor bias goes adrift, and the measurements mean nothing.

We must take into account the a.c. feedback as well as the d.c., and here there is a gag which is worth recounting. A network can be made up temporarily, and inserted in place of the feedback resistor, which maintains the essential d.c. conditions, but effectively ties the a.c. feedback down to chassis. Fig. 65(a) shows a simple, three resistor

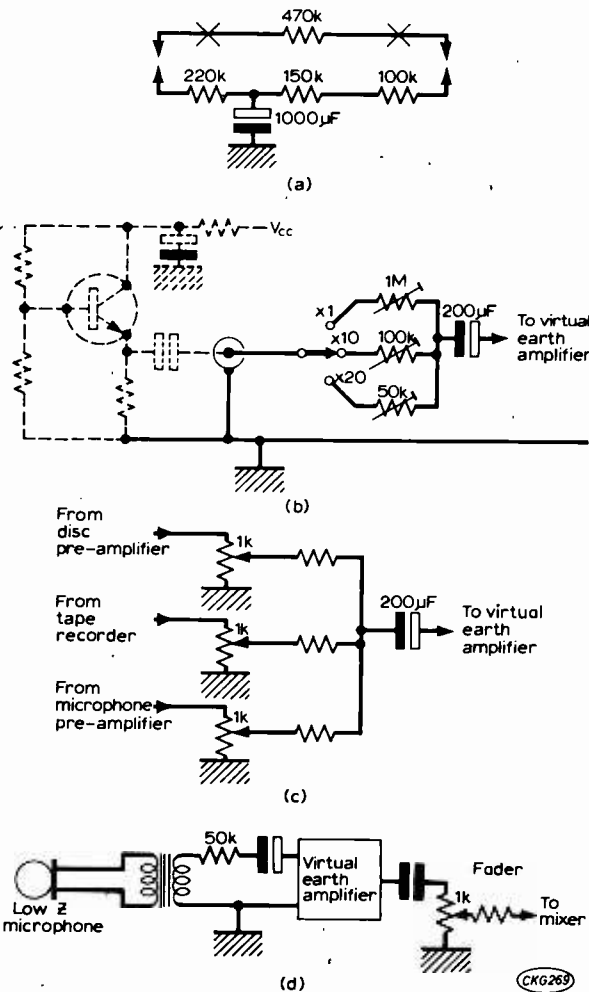

Fig. 65. (a) Substituting the feedback resistor with a decoupled network enables the gain to be measured more accurately. (b) Input for a variable gain pre-amplifier. An emitter follower, shown dotted, may be needed to effect matching. (c) Mixing facilities. (d) Microphone pre-amplifier.

and one-capacitor network, chosen so that the resistive values are approximately as $R1$ in Fig 64, but the large electrolytic capacitor acts as a complete shunt to any a.c. in which we might be interested. As Mike says, this may be of academic interest, but is worth a mention.

Of greater than academic interest is the capacitor shown dotted across the feedback resistor in Fig. 64. It has been said too often—which does not stop me from saying it again—that the wider one opens the window, the more the dirt blows in. Being interpreted, the wider our bandwidth, the more likelihood is there of our little amplifier getting upset by extraneous influences, like Auntie switching on the vacuum cleaner.

Without joining the argument that can set the hi-fi world by its ears; one group of contenders arguing for an almost infinite bandwidth and the inclusion of filters, the other for a 'tailored bandwidth', we can say here that the ease of making our frequency response roll off in a controlled manner at the top end appeals to us. Without that capacitor, our frequency response of the built amplifier (made up in a Norman Rose AB9 box with co-axial terminations, for complete screening) was within $+0-3$ dB at 78kHz and at 150kHz, we were still only 8.2dB down.

At the bottom end, incidentally, we were -0.1 dB at 40Hz and -0.8 dB at 15Hz, which is negligible.

Shunting the feedback resistor with 22pF gave us -3 dB points at 20kHz and -6 dB points (complying with DIN 45 500, in case anyone wanted to argue!) at 31kHz. Under these conditions, the broadband residual noise was 0.13mV with an open-circuited input, 990 microvolts with a short-circuited input. As clipping took us to slightly over 6 volts (for a 410mV input), our signal-to-noise ratio, unweighted, could be said to be $20 \log 10^{-6} : 0.0001$, taking a figure of 0.1mV as a typical residual noise measurement. A rather impressive (who said impossible?) 95.5dB.

Effective input noise is the output noise with input short-circuited divided by the gain. Our measured gain at a typical 10mV input was only 14.7, not as much as we had expected, but accounted for most likely by component spreads and the second transistor, which happened to be an odd type we had handy. You can always select with great care for precision, as we said earlier, but it is great fun to 'suck it and see'. So in the practical instance, we can say our effective input noise is 68 microvolts. This now becomes the limiting factor for any use to which we are going to put such a device. I think you will agree that in the present case the limitation is hardly exclusive.

Application

A few of the possible applications were hinted at previously. Without wasting any more space on design data, take a look at the three sub-circuits of Fig. 65 (b), (c) and (d). First we see a way of altering the input resistor, precisely, by 'presets', so that we get a variable gain pre-amplifier, as might be useful for an oscilloscope. The problem here may be an alteration of input impedance, and it is a good idea to precede the virtual earth pre-amplifier with an emitter follower stage, which gives, you will remember, a reasonably high input impedance and a low output impedance (providing the necessary low source our device wants to 'see'.)

Let's suppose we want to use the virtual earth pre-amplifier as an input stage for a mixer, where there are several odd sources that may be used separately or simultaneously, and where the action of one must not interfere with that of another. As any amateur disc-jockey will tell you, a very practical problem. In Fig. 65(c) we get the inputs from the sources taken to low value potentiometers and from there we can feed up to three R3 resistors to the virtual earth point, this time using our coupling capacitor to follow the resistors, for effective isolation. By juggling resistor values, with a little experiment, we can again get our levels somewhere the same, and use a master gain control later in the circuit, where its operation at a higher signal level will not introduce unwanted noise, etc.

Of course, there is always the microphone pre-amplifier, as in (d), where we want a bit more gain prior to a mixer stage. The transformer is a low/high or medium/high type and is best mounted in the overall screened box that houses the virtual earth amplifier.

Power supply

Finally, this month, having again not kept my promise to lead us on to tone controls, although a careful perusal of the foregoing will have seen the trend our thoughts are taking, we have a brief look at the proposed power supply for this and other projects. This was knocked up easily in an hour and needs no particular layout finesse, nor screening. It uses any convenient transformer that can give between 24 and 33 volts—not really safe to exceed 33.6V—and the rectifiers are easily obtained types with minimum requirements of peak-inverse voltage

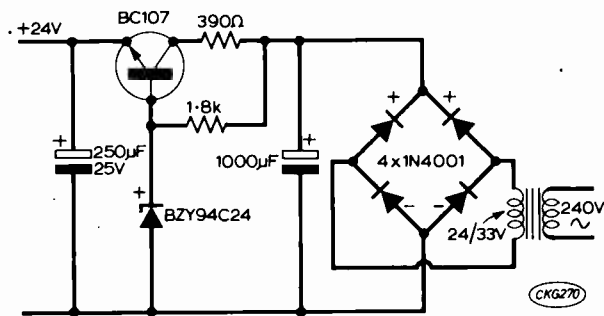

Fig. 66. A practical power supply, suitable for use with the circuits described.

50V and handling capacity 200mA. We used a REC 60 because it happened to be there, but four 1N4001's would have done. The particular requirement is the zener diode, which must be a 24 volt type, such as shown, and components can be half-watt types, with the biggest problem the mounting of the two large capacitors. Note that this zener operates in the reverse to the breakdown mode, i.e., it is set to regulate, with cathode to positive. This 24 volt output, with the 2kΩ resistor (or 2.2kΩ, if you have no 2kΩ version available) drops to the needed 20 volts for our amplifier.

TO BE CONTINUED

AMATEUR BANDS RECEIVER

—continued from page 698

crystal pass-band. Adjustment of any of the i.f.t. cores should then bring about a great increase in signal strength as they are shifted into the crystal pass-band. The i.f.t.'s are all finally peaked in this way, signal strength being reduced by VR1 as necessary.

When the i.f. amplifier is aligned in this way, a very steep sided response should be obtained. If X6 and X7 are removed and a 100pF capacitor plugged into one holder, general selectivity will still be very good, but there should be a very noticeable reduction in sharpness of tuning and noise will increase due to the broader pass-band.

MODIFICATIONS

As the idea of construction in stages is to obtain fully working circuits as quickly and easily as possible, the i.f. section can be simplified initially then modified to the full circuit.

The S-Meter circuit can be omitted completely at first and fitted later.

IFT1 and V1, Fig. 2C may be omitted and mixer pin 6 taken to pin 3 on i.f.t.2 or V1 and i.f.t.2 may be omitted and the crystals or secondary of i.f.t.1 may be temporarily connected to pin 1 of V2.

When the tunable first i.f. section is constructed, the receiver can be employed for the 3.5-4MHz band only. The receiver cannot be used on other bands until the crystal controlled first conversion section is completed.

With some valves i.f. instability occurred with VR1 at maximum gain. This was cured by placing a 2.2kΩ resistor between pin 2 of i.f.t.1 and h.t., with a 0.25μF capacitor from pin 2 to chassis.

TUNABLE FIRST IF AMPLIFIER

This has two stages, Fig. 2B, and is constructed in a screened box to minimise pick-up of unwanted signals. Coverage is 3.5MHz to 4MHz, with a little to spare at the extreme positions of the 3-gang capacitor VC1, VC2 and VC3.

V1 operates as an r.f. amplifier on the 3.5-3.8MHz band and as first i.f. on the other ranges. The gain of this stage is also controlled by VR1. AGC bias is applied to both stages via R1 and R4 (it is not good practice to apply a.g.c. to a frequency changer of this type—Ed).

The oscillator section of the mixer-oscillator V2 is run from the 150V stabilised h.t. supply. Input to L1 is via a screened lead and a similar screened lead runs from V2 to the 455kHz i.f. amplifier.

The box is 5×4×2in. deep, with the valves on top and all other parts, including VC1/2/3, inside. This box is made from a 5×4in. flat plate, to which are bolted two 4×2in. and two 5×2in. "universal chassis" flanged members. It is easier to leave the sides and back off the box until wiring is completed.

TO BE CONTINUED

Next month we shall cover the construction and alignment of the tunable IF amplifier and give full information on the BFO/Product Detector and RF/1st Mixer stages to enable the receiver to be completed.

BI-PRE-PAK

COMPLETE TELEPHONES



EX. G.P.O. NORMAL
HOUSEHOLD TYPE

ONLY 95p

POST & PACKING 35p EACH



TELEPHONE DIALS

Standard Post Office type.
Guaranteed in working order.

ONLY 50p

POST & PACKING 15p

TESTED AND GUARANTEED PAKS

B2	4	Photo Cells, Sun Batteries. 0.3 to 0.5V. 0.5 to 2mA.	50p
B79	4	IN4007 Sil. Rec. diodes. 1,000 PIV lamp plastic	50p
B81	10	Reed Switches, mixed types large and small	50p
B99	200	Mixed Capacitors. Approx. quantity, counted by weight	50p
H4	250	Mixed Resistors. Approx. quantity counted by weight	50p
H7	40	Wirewound Resistors. Mixed types and values.	50p
H39	10	Integrated Circuits. 6 Gates BMC 962, 4 Flip Flops BMC 945	50p
H9	2	OC71 Light Sensitive Photo Transistor	50p
H40	20	BFY50/2, 2N696, 2N1613 NPN Silicon uncodded TO-5	50p
H28	20	OC200/1/2/3 PNP Silicon uncodded TO-5 can	50p
H30	20	1 Watt Zener Diodes. Mixed Voltages 6.8 - 43V.	50p
H35	100	Mixed Diodes, Germ. Gold bonded, etc. Marked and Unmarked.	50p
H38	30	Short Lead Transistors, NPN Silicon Planar types.	50p

UNMARKED UNTESTED PAKS

B66	150	Germanium Diodes Min. glass type	50p
B83	200	Trans. manufacturers' rejects all types NPN, PNP, Sil. and Germ.	50p
B84	100	Silicon Diodes DO-7 glass equiv. to OA200, OA202	50p
B86	50	Sil. Diodes sub. min. IN914 and IN916 types	50p
B88	50	Sil. Trans. NPN, PNP equiv. to OC200/1, 2N706A, BSY95A, etc.	50p
B1	50	Germanium Transistors PNP, AF and RF	50p
H6	40	250mW. Zener Diodes DO-7 Min. Glass Type	50p
H17	20	3 amp. Silicon Stud Rectifiers, mixed volts	50p
H15	30	Top Hat Silicon Rectifiers, 750mA. Mixed volts	50p
H16	15	Experimenters' Pak of Integrated Circuits. Data supplied	50p
H20	20	BY126/7 Type Silicon Rectifiers 1 amp plastic. Mixed volts.	50p
H34	15	Power Transistors, PNP, Germ. NPN Silicon TO-3 Can.	50p

MAKE A REV COUNTER FOR YOUR CAR

The 'TACHO BLOCK'. This
encapsulated block will turn any
0-1mA meter into a linear and
accurate rev. counter for any car
with normal coil ignition
system.

£1 each



OUR VERY POPULAR 3p TRANSISTORS

TYPE "A" PNP Silicon alloy, TO-5 can.
TYPE "B" PNP Silicon, plastic encapsulation.
TYPE "E" PNP Germanium AF or RF.
TYPE "F" NPN Silicon plastic encapsulation.

FULLY TESTED AND MARKED SEMICONDUCTORS

6p		6p	
AC107	0-15	OC139	0-13
AC126	0-15	OC140	0-15
AC127	0-17	OC170	0-23
AC128	0-15	OC171	0-23
AC176	0-20	OC200	0-25
AC177	0-20	OC201	0-25
AF239	0-30	2N1302-3	0-15
AF186	0-20	2N1304-5	0-17
AF139	0-30	2N1306-7	0-20
BC154	0-20	2N1308-9	0-22
BC107	0-10	2N3819FET	0-40
BC108	0-10	2N4416FET	0-23
BC109	0-10	2N3823FET	0-30
BC148	0-10	Power Transistors	
BC169	0-12	OC20	0-40
BF194	0-15	OC23	0-25
BF274	0-20	OC25	0-25
BFY50	0-15	OC26	0-25
BSY25	0-13	OC28	0-30
BSY26	0-13	OC35	0-25
BSY27	0-13	OC36	0-37
BSY28	0-13	AD149	0-35
BSY29	0-13	AUY10	0-75
BSY95A	0-10	25034	0-25
OC41	0-15	2N3055	0-40
OC44	0-13	Diodes	
OC45	0-10	AA42	0-10
OC71	0-10	OA95	0-07
OC72	0-10	OA79	0-07
OC81	0-13	OA81	0-07
OC81D	0-13	OA95	0-07
OC83	0-18	IN914	0-06

POWER TRANSISTOR PRICE BREAKTHROUGH!

Plastic cased Silicon Power Transistors of
latest design. 40watts and 90watts. PNP
& NPN types. All types available at the
most shattering low prices of all
time. All are fully tested, marked
and guaranteed!

	1-12	13-25	26-50
40W NPN	20p	18p	16p
40W PNP	21p	19p	17p
90W NPN	24p	22p	20p
90W PNP	25p	23p	21p
PAK	PAKS of matched pairs		
MP40			
40W + 40W	50p	48p	46p
MP90			
90W + 90W	60p	58p	56p

A CROSS HATCH GENERATOR FOR £3.50 !!!

YES, a complete kit of parts including Printed
Circuit Board. A four position switch gives
X-hatch, Dots, Vertical or Horizontal lines.
Integrated Circuit design for easy construction
and reliability. This is a project in the September
edition of Practical Television.

**This complete kit of parts costs
£3.50, post paid.**

A MUST for Colour T.V. Alignment.

Our famous PI Pak is still leading in value for money.

Full of Short Lead Semiconductors & Electronic
Components, approx. 170. We guarantee at
least 30 really high quality factory marked
Transistors PNP & NPN, a host of Diodes
& Rectifiers mounted on Printed Circuit Panels.
Identification Chart supplied to give some
information on the Transistors.

Please ask for Pak P.1. Only 50p.
10p P & P on this Pak.

FREE CATALOGUE FOR



TRANSISTORS,
RECTIFIERS,
DIODES,
INTEGRATED
CIRCUITS,
FULL PRE-PAK
LISTS

8 RELAYS FOR VARIOUS TYPES P & P 25p **£1**

INTEGRATED CIRCUITS

	1-12	13-25	26-50
Clocked Flip Flop	BMC931	20p	18p 16p
Ex. 2/4-input Buffer	BMC932	12p	11p 10p
2/4-input Expander	BMC933	12p	11p 10p
Hex. Inverter	BMC934	12p	11p 10p
Hex. Inverter	BMC935	12p	11p 10p
Hex. Inverter	BMC936	12p	11p 10p
Hex. Inverter	BMC937	12p	11p 10p
Decade Counter	BMC938	25p	23p 21p
Div. by 16 Counter	BMC939	25p	23p 21p
Hex. Inverter	BMC940	12p	11p 10p
Type D Flip Flop	BMC941	12p	11p 10p
Ex. 2/4-input Power	BMC942	12p	11p 10p
Clocked Flip Flop	BMC945	20p	18p 16p
Quad Inverter	BMC946	11p	10p 9p
Clocked Flip Flop	BMC948	20p	18p 16p
Quad Inverter	BMC949	12p	11p 10p
Pulsed Trig. Binary	BMC950	20p	18p 16p
Monostable Multivib.	BMC951	25p	23p 21p
Dual J/K Flip Flop	BMC952	20p	18p 16p
Dual J/K Flip Flop	BMC955	20p	18p 16p
Dual J/K Flip Flop	BMC956	20p	18p 16p
Quad. 2-input Power	BMC958	12p	11p 10p
2/4-input Gate	BMC961	12p	11p 10p
3/3-input NAND Gate	BMC962	11p	10p 9p
3/3-input NAND Gate	BMC963	12p	11p 10p
Audio Amp. 3w. SL403D	£1 50	£1 40	£1 36
Linear Op. Amp 709C	25p	20p	15p
Decade Counter SN7490	65p	60p	55p

LOW COST DUAL IN LINE I.C. SOCKETS

14 pin type at 15p each } Now new low profile
16 pin type at 16p each } type

BOOKS

We have a large selection of Reference and
Technical Books in stock.
These are just two of our popular lines:

**B.P.I. Transistor Equivalents and
Substitutes;** 40p
This includes many thousands of British
U.S.A., European and C.V. equivalents.
Postage and Packing 21p.

**The Iliffe Radio Valve & Transistor
Data Book 9th Edition;** 75p
Characteristics of 3,000 valves and tubes,
4,500 Transistors, Diodes, Rectifiers and
Integrated Circuits.
Send for lists of these English publications.

Please send me the FREE Bi-Pre-Pak Catalogue.

NAME.....

ADDRESS

MINIMUM ORDER 50p. CASH WITH ORDER
PLEASE. Add 10p post and packing per order
OVERSEAS ADD EXTRA FOR POSTAGE

BI-PRE-PAK LTD DEPT. D, 222-224 WEST ROAD, WESTCLIFF-ON-SEA, ESSEX S50 9DF
TELEPHONE: SOUTHEND (0702) 46344

BSR LATEST SUPERSLIM STEREO AND MONO



Plays 12", 10" or 7" records. Auto or Manual. A high quality unit backed by BSR reliability with 12 months' guarantee. AC 200/250V. Size 18 1/2 x 1 1/2 in.

Above motor board 3 1/2 in. below motor board 2 1/2 in. with STEREO and MONO XTAL **£8.75** Post 25p.

MONO-COMPATIBLE **£7.75** Post 25p.

Plays all records

RCS DE-LUXE 3 WATT AMPLIFIER

Ready made tested. Printed circuit. 3 watts output. Tone and volume controls. Complete with two knobs, output valve and rectifier and high performance loudspeaker.

Double wound fully insulated mains transformer. A.C. Mains 200/250V. **£4** Post 25p.

Response 60-12,000 cps. Sensitivity 300mV.

BSR JUNIOR



Heavy duty 4-speed motor with separate pick-up arm fitted LP/78 turnover mono cartridge **£4.50**

HI-FI PICK-UP CARTRIDGES. Diamond LP/Stereo Stereo/Mono STA £2.50; GP4 £2.50; GP3 £2.00; Sapphire Mono GP1 £1.50; Power-point LP/78. 60p.

E.M.I. WOOFER AND TWEETER KIT

£5.75 THE PAID AVAILABLE separately Post 25p. Woofer £4.25 Tweeter £1.50

Comprising a fine example of a Woofer 10 1/2 x 6 1/2 in. with a massive Ceramic Magnet, 40oz, Gauss 18,000 lines. Aluminium Cone centre to improve middle and top response. Also the E.M.I. Tweeter 3 1/2 in. square has a special lightweight paper cone and magnet flux 10,000 lines. Crossover condenser and full instructions supplied.

Impedance Standard 8 ohms
Maximum Power 12 watts
Useful Response 85 to 18,000 cps
Base Resonance 45 cps

SUITABLE ENCLOSURE 20 x 13 x 9 in. **£9** POST 25p
MODERN DESIGN TEAK WOOD FINISH

SPECIAL OFFER

SMITHS CLOCKWORK 15 AMP TIME SWITCH



Single pole two-way. Makers list price £4.50. Brand new and fully guaranteed. Surface mounting with fixing screws. Will replace existing wall switch to give light for return home, garage, automatic anti burglar lights, etc. Variable knob. Turn on or off at full or intermediate settings. Two types available, 10 minutes or 0 to 6 hours.

OUR PRICE £1.50, P & P 15p or £3 pair Post Free. (Please state type when ordering)

WEYRAD P50-TRANSISTOR COILS

RA2W Ferrite Aerial... 72p	Spare Cores 8p
Osc. P50/1AC 33p	Driver Trans. LFD14 50p
I.F. P50/2CC 470 kc/s. 38p	Printed Circuit, P.C.A.1 55p
Sec. L.F. P50/3CC 36p	T.B. Tuning Gang 85p
P51/1 or P51/2 38p	Weyrad Booklet 10p
P50/3V 38p	OPTI 58p

Mullard Ferrite Rod 8 x 1 in. 20p, 6 x 1 in. 20p.

VOLUME CONTROLS

Long spindle. Midget Size 5 K. ohms to 2 Meg. LOG or LIN. L/8 15p. D.P. 25p. STEREO L/8 55p. D.P. 75p. Edge 5K. 8.P. Transistor 25p

800hm Coax 4p. vd. BRITISH AERIALTAE ABRAXIAL-AIR SPACED 40 vd. £1.40; 60 vd. £2. FRINGE LOW LOSS 10p vd. Ideal 625 and colour.

ELAC and 10in ELAC HI-FI SPEAKERS



Dual cone plasticised roll surround. Large ceramic magnet. 50-18,000 cps. Base resonance 55 cps. 8 ohm coil. Sin. 10 watt, 10in. 12 watt music power. **£3.75**

E.M.I. 13 1/2 x 8in. SPEAKER SALE!



With twin tweeters and crossover. 10 watt. State 8 or 15 ohm. (As illustrated) Post 25p **£4.25**

With flared tweeter cone and ceramic magnet. 10 watts. B.p. res. 45-60 cps. Flux 10,000 gauss. **£2.25**

State 3 or 8 or 15 ohm. Post 25p

TEAK CABINET 16 x 10 x 9in. Fluted Front. £5 Post 25p.

"THE INSTANT" BULK TAPE ERASER & HEAD DEMAGNETISER 200/250V. A.C. **£2.35** Post Leadset S.A.E.

RADIO COMPONENT SPECIALISTS

Illustrated Colour Brochure, Radio Books & Component Lists 10p. (Expert: Remit cash and extra postage.) Buses 50, 68, 159 Rail Selhurst. Tel. 01-684-1665

R.C.S. STABILISED POWER PACK KITS

All parts and instructions with Zeener Diode, Printed Circuit, Bridge Rectifiers and Double Wound Mains Transformer input 200/240V. AC. Output voltages available 6 or 9 or 12 or 15 or 18 or 20V. DC at 100mA or less. PLEASE STATE VOLTAGE REQUIRED. **£2** POST FREE Details S.A.E. Size 3 1/2 x 1 1/2 x 1 1/2 in.

GENERAL PURPOSE TRANSISTOR PRE-AMPLIFIER BRITISH MADE

Ideal for Mike, Tape, P.U., Guitar. Can be used with Battery 9-12V or H.T. line 200-300V D.C. operation. Size 1 1/2 x 1 1/2 x 1". Response 25 c.p.s. to 25 Kcs. 26db gain. For use with valve or transistor equipment. **90p** Post Full instructions supplied. Details S.A.E.

NEW TUBULAR ELECTROLYTICS		CAN TYPES	
2/350V .. 14p	250/25V .. 14p	50+50/350V .. 35p	
4/350V .. 14p	500/25V .. 20p	60+100/350V .. 53p	
8/450V .. 14p	1000/25V .. 35p	32+32/250V .. 18p	
16/450V 15p	1000/50V .. 47p	32+32/450V .. 23p	
32/450V 20p	3+8/450V 18p	350+50/325V 50p	
25/25V 10p	8+16/450V 20p	32+32+32/350V 48p	
50/50V .. 10p	16+16/450V 25p	100+50+50/350V 48p	
100/25V 10p	32+32/350V 25p		

LOW VOLTAGE ELECTROLYTICS

1, 2, 4, 5, 8, 16, 25, 30, 50, 100, 200mF. 15V. 10p.
500mF. 12V. 15p; 85V. 20p; 50V. 30p.
1000mF. 12V. 17p; 25V. 25p; 50V. 47p; 100V. 70p.
2000mF. 6V. 25p; 25V. 42p; 50V. 57p.
2500mF. 50V. 82p; 3000mF. 25V. 47p; 50V. 65p.
5000mF. 6V. 25p; 12V. 42p; 25V. 70p; 35V. 85p; 50V. 95p.

CERAMIC 1pF to 0.01 mF, 4p. Silver Mica 2 to 5000pF, 4p. PAPER 350V-01 4p, 0.5 13p; 1mF 15p; 2mF 150V 15p. 500V-0-001 to 0-05 4p; 0.1 5p; 0.25 8p; 0.47 25p.

SILVER MICA. Close tolerance 5% 25-500pF 9p; 500-2200 pF 10p; 2700-6000pF 20p; 6000pF-0.01 mid 30p; each.

TWIN GANG. "0-01" 205pF + 178pF, 45p; Slow motion drive 365 + 365 with 25 + 25pF, 50p; 500pF standard, 45p; Single gang 500pF, 75p; small 3-gang 500pF, £1.60

SHORT WAVE. SINGLE. 10pF 80p; 25pF 55p; 50pF 55p

NEED PANEL INDICATORS 250V AC/DC Amber 20p.

RESISTORS, 1/4 w., 1/2 w., 1 p., 2 p., 5p 10 ohms to 10 meg HIGH STABILITY, 1 w., 2%, 10 ohms to 1 meg. 10p. Ditto 5%. Preferred values, 10 ohms to 10 meg. 4p.

WIRE-WOUND RESISTORS 5 watt, 10 watt, 15 watt 10 ohms to 100K, 10p each; 24 watt, 1 ohm to 8.2 ohms 10p

GARRARD DECADEEC SP25 MK II RECORD PLAYER



With Stereo/Mono Demar Cartridge transcription head and arm. Four speeds. 10in. turntable. Anti-rumble filter. Bias compensation. Laboratory motor. Ideal Disc Deck.

SPECIAL £18.50 Post 25p
PRICE

METAL PLINTH & PLASTIC COVER

Cut out for most Garrard or B.S.R. Will play with cover in position. Latest design. Antivibrated in black leatherette. Covered in 12 1/2 x 14 1/2 x 7 1/2 in. Post 35p

ALSO AVAILABLE IN GLASS NATURAL MAHOAGNY WAX POLISHED FINISH-AT SAME PRICE

MAINS TRANSFORMERS

ALL POST 25p each

250-0-250 80 mA. 6.3 v. 4 amp.	£1.50
250-0-250 80 mA. 6.3 v. 3.5 a. 8.3 v. 1 or 5 v. 2 a. £2.50	
350-0-350 80 mA. 6.3 v. 3.5 a. 6.3 v. 1 a. or 5 v. 2 a. £2.00	
400-0-300 v. 120 mA., 6.3 v. 4 a. C.T.: 6.3 v. 2 a.	£2.25
MINIATURE 200 v. 20mA., 6.3 v. 1 a. 2 1/2 x 1 1/2 x 2 1/2 in.	75p
MIDGET 220 v. 45 mA., 6.3 v. 2 a. 2 1/2 x 1 1/2 x 2 in.	90p
MINI-MAIN 250 v. 100mA., 2 1/2 x 1 1/2 x 1 1/2 in.	50p

HEATER TRANS. 6.3 v. 8 a. 60p
Ditto tapped sec. 1.4 v., 2.3, 4, 5, 6.3 v., 11 amp. 95p

GENERAL PURPOSE LOW VOLTAGE. Tapped Outputs at 2 amp. 3, 4, 5, 6, 8, 9, 10, 12, 15, 18, 24 and 30 v. £2.25
1 amp. 6, 8, 10, 12, 16, 18, 20, 24, 30, 36, 40, 48, 60, £2.25
2 amp. 6, 8, 10, 12, 16, 18, 20, 24, 30, 36, 40, 48, 60, £2.25
5 amp. 6, 8, 10, 12, 16, 18, 20, 24, 30, 36, 40, 48, 60, £2.75

AUTO TRANSFORMERS 115v. to 230V. or 230V. to 115V. 1b5w. £2.25; 500w. 2£.25; 750w. £1.00; 1000w. 2£.14

CHARGER TRANSFORMERS. Input 200/250V. for 6 or 12v. 1.1 amp., £1.50; 2 amp. £1.80; 4 amp. £2.50.

BATTERY CHARGE COMPLETE 4 amp. £3.50
FULL WAVE BRIDGE CHARGE RECTIFIERS: 6 or 12v. output, 11 amp. 40p; 2 amp. 55p; 4 amp. 85p
LUCAS 28D500 Bridge 70V 5 amp £1.

MAINS ISOLATING TRANSFORMER. Primary 0-110-240V. Secondary 0-240V. 3 amps. 720 watts. Insulated terminals. Varnish impregnated. Fully enclosed in steel case with fixing feet. Famous make. (Valve 15p)

OUR SPECIAL PRICE £10 Carriage 50p.

1 1/2 inch DIAMETER WAVE-CHANGE SWITCHES 25p. 2 p. 2-way, or 2 p. 6-way or 3 p. 4-way 25p each. 1 p. 12-way, or 4 p. 2-way, or 4 p. 2-way 25p.
TOGGLE SWITCHES, sp. 14p; dp. 18p; dp. dt. 23p.

BLANK ALUMINUM CHASSIS 18 x w.g. 2in. sides. 6 x 4in. 45p; 9 x 7in. 60p; 11 x 7in. 70p; 13 x 9in. 90p; 14 x 11in. 95p; 15 x 14in. 99p; 11 x 5in. 50p; 16 x 10in. 21.

ALUMINUM PANELS 18 x w.g. 6 x 4in. 9p; 8 x 6in. 15p; 14 x 3in. 16p; 10 x 7in. 19p; 13 x 9in. 20p; 18 x 9in. 28p; 16 x 6in. 28p; 14 x 9in. 34p; 12 x 12in. 40p; 16 x 10in. 50p.

ALL MODELS "BAKER SPEAKERS" IN STOCK
Hi-Fi Enclosure Manual containing 20 plans, designs, crossover data and cable tables. 42p. Post Free

BAKER 12in. MAJOR £9



30-14,500 c.p.s., 12in. double cone, woofer and tweeter cone together with a BAKER ceramic magnet assembly having a flux density of 14,000 gauss and a total flux of 145,000 Maxwells. Bass resonance 40 c.p.s. Rated 20 watts. Voice coils 3 or 8 or 15 ohms. Post Free

Module kit, 30-17,000 c.p.s. with tweeter, crossover, baffle and instructions. **£11.50**

BAKER "BIG-SOUND" SPEAKERS		
'Group 25'	'Group 35'	'Group 50'
12 inch	12 inch	15 inch
25 watt	35 watt	50 watt
3 or 8 or 15 ohm	3 or 8 or 15 ohm	3 or 8 or 15 ohm

TEAK HI-FI SPEAKER CABINETS. Fitted wood front For 12in. or 10in. dia. speaker 20 x 12 x 9in. 25. Post 25p For 13 x 8in. or 8in. speaker 16 x 10 x 9in. 25. Post 25p For 10 x 6in. or 6in. speaker 16 x 8 x 6in. 24. Post 25p

LOUDSPEAKER CABINET WADDING 18in. wide, 15p ft.

GOODMANS 6 1/2 in. HI-FI WOOFER



8 ohm, 10 watt. Large ceramic magnet. Special Cambrie cone surround. Frequency response 80-12,000 cps. Ideal P.A. Columns, Hi-Fi Enclosures Systems, etc. **£4**

ELAC CONE TWEETER



The moving coil diaphragm gives a good radiation pattern to the higher frequencies and a smooth extension of total response from 1,000 cps to 18,000 cps. Size 3 1/2 x 2 in. dia., 8 x 4 in. deep. Rating 10 watts, 3 ohm or 15 ohm models. **£1.90** Post 10p

SPEAKER COVERING MATERIALS. Samples Large S.A.E. Horn Tweeters 2-16kc/s, 10W 8 ohm or 15 ohm £1.95. De Luxe Horn Tweeters 2-18 Kc/s, 15W, 15 ohm 23s. TWO-WAY 3000cps CROSSOVERS 3 or 8 or 15 ohms 95p. SPECIAL OFFER: 800ohm 2 1/2 in., £1 in.; 35 ohm. 2 in. £1 25 ohm. 2 1/2 in. dia., 3 in. dia.; 6 x 4 in.; 8 x 3 in. 2 1/2 in.; 6 1/2 in.; 7 x 4 in.; 8 x 5 in. £1 TYPE 3 ohm. 2 1/2 in.; 2 1/2 in.; 6 1/2 in. dia.

LOUDSPEAKERS P.M. 3 OHMS. 7 x 4 in. £1.25; 6 1/2 in. £1.50; 8 x 5 in. £1.60; 8 x 2 in. £1.50-8 in. £1.75; 10 x 6 in. £1.90.

RICHARD ALLAN TWIN CONE LOUDSPEAKERS. Sin. diameter 4 watt; 10in. 5 watt; 12in. 6 watt 3 or 8 or 15 ohm models £2.20 each. Post 15p.

VALVE OUTPUT TRANS. Mike Trans. 50:1 25p. 5 WATT MULTI-RATIO, 3, 8 and 15 ohms 80p.

BAKER 100 WATT ALL PURPOSE TRANSISTOR AMPLIFIER



4 inputs speech and music. Mixing facilities. Response 10-30,000 cps. Matches all loudspeakers. A.C. 200/250V. Separate Treble and Bass controls. Free Guaranteed. Details S.A.E. **£49** Post 25p

BARGAIN AM TUNER. Medium Wave. Transistor Superhet. Ferrite aerial. 9 volt. **£4.95**

BARGAIN 4 CHANNEL TRANSISTOR MONO MIXER. Add musical highlights and sound effects to recordings. Will mix Microphone, records, tape and tuner with separate controls into single output. 9 volt. STEREO VERSION OF ABOVE 25.95. **£3.95**

BARGAIN FM TUNER 88-108 Mc/s Six Transistor. 9 v 11 Printed Circuit. Calibrated slide dial tuning. Walnut Cabinet. Size 7 x 5 x 4 inch. **£14.85**

BARGAIN FM TUNER as above less cabinet **£9.85**

BARGAIN 3 WATT AMPLIFIER. 4 Transistor Push-Pull Ready built, with volume control. 9v. **£4.50**

COAXIAL PLUG 6p. PANEL SOCKETS 6p. LINE 18p. OUTLET BOXES, SURFACE OR FLUSH 25p.

BALANCED TWIN RIBBON FEEDER 300 ohms 5p yard.

JACK SOCKET Std. open-circuit 14p. closed circuit 23p; Chrome Lead Socket 45p. Phone Plugs 5p. Phone Socket 5p.

JACK PLUGS 8d. Chrome 15p; 3.5mm Chrome 12p. DIN SOCKETS Chassis 3-pin 10p; 5-pin 10p. DIN SOCKETS Lead 3-pin 18p; 5-pin 25p. DIN PLUGS 3-pin 13p; 5-pin 25p. VALVE HOLDERS, 5p; CERAMIC 8p; CAN5 5p.

E.M.I. TAPE MOTORS Post 15p. 120v. or 240v. A.C. 1,200 r.p.m. 4 pole 135mA. Spindle 0.187 x 0.75in. **£1.25**

E.M.I. GRAM MOTORS 120v. or 240v. A.C. 2,400 rpm. 2-pole 70mA. Spindle 1/8 x 1/8 in. A.C. **75p**

Size 2 1/2 x 2 1/2 x 2 1/2 in. Post 15p.

CUSTOMERS FREE CAR PARK CALLERS WELCOME
337 WHITEHORSE ROAD, CROYDON
Open 9-6 p.m. (Wednesdays 9-1 p.m., Saturdays 9-5 p.m.)
Buses 50, 68, 159 Rail Selhurst. Tel. 01-684-1665

SHORT WAVES

MONTHLY NEWS FOR DX LISTENERS

THE BROADCAST BANDS

Malcolm Connah

Frequencies in kHz ● Times in GMT

ALTHOUGH a great deal of pleasure can be obtained from simply listening to Broadcast stations many listeners take the hobby a step further and collect QSL cards from all over the world.

A QSL card is a verification from the station that the listener did, in fact, hear their broadcast. QSL cards are issued as a reply to reception reports from the listener after the details have been checked against the station log.

The majority of stations are very glad to receive reports from listeners as a well prepared report tells the station how well its transmissions are getting through. The subject for this month is the preparation of reception reports which are helpful to the station.

The first essential of a good reception report is the name and address of the reporter, without this the station does not know where the reception occurred and is unable to send a reply. The technical information should be given in the following manner:—

RECEPTION REPORT

I received your broadcast on (date), on a frequency ofkHz, and listened to it from to hours G.M.T.

The receiver used was a (TRF/Superhet etc.) with (Number) Valves/Transistors, made by model number

The aerial was an interior/exterior one, metres high and metres long of the type.

Reception was in the SINPO code, i.e.: "S" Signal Strength, "I" Interference, "N" Noise, "P" Propagation, "O" Overall Merit, The broadcast was in the language and the programme details were as follows

I hope that this report is of use to your Engineers and trust that you will be able to verify that my report is correct. If so, will you please send me your QSL card, or verification letter, in reply to this report. I enclose an International Reply Coupon to cover your postage costs.

I hope that I shall have the pleasure of hearing your station in the future and look forward to sending you further reports on your transmission.

Yours sincerely,

.....

The SINPO code mentioned in the above specimen report may be new to some readers so I will give details of this method of assessing reception.

The "P" in the SINPO code stands for Propagation but is probably easier to understand if we refer to it as Fading.

Rating	1	2	3	4	5
S	Barely Audible	Poor	Fair	Good	Excellent
I	Extreme	Severe	Moderate	Slight	Nil
N	"	"	"	"	"
P	"	"	"	"	"
O	Unusable	Poor	Fair	Good	Excellent

Reception of BBC Radio One on 247 metres in the medium wave band can usually be rated as 55555 but the transmissions are sometimes affected by slight interference which reduces the rating to 54554. Radio Luxembourg on 208 metres is usually subject to severe fading and slight interference giving a rating of 54522.

The overall Merit figure is a very subjective rating and takes into account the other four figures, it would however be unusual to have an overall merit figure which is greater than the lowest of the other four. To use the above example some listeners would rate Radio Luxembourg as 54523, others would take the average of the first four figures as the "O" rating. In this case Luxembourg would rate 54524, which is incorrect since reception with severe fading cannot be classed as good.

The first log this month comes from **Michael Berry** of Dewsbury in Yorkshire who used his Eddy-stone EB35 receiver and 20 foot horizontal wire in the loft to hear:

- 3227 ELWA, Liberia, vernacular at 2010.
- 4890 R. Diff. Venezuela, Spanish at 0100.
- 11795 ETLF, Ethiopia in Malagache at 0330.
- 15105 R. Rural, Brazil, Portuguese at 2125.
- 15155 R. Diff. de Sao Paulo, Portuguese, 2235.
- 15170 ELWA, Liberia in French at 2000.
- 15445 R. Nacional de Brazilia, English at 2130.

Nigel Knowlman of Cullompton in Devon has sent in another log using his Lafayette HA-600A with an inverted 'L' antenna to hear:

- 11720 Radio Tashkent, USSR, at 1405.
- 11815 TWR, Bonaire noted at 0040.
- 11850 Radio Vilnius, USSR at 2245.
- 15185 WINB, USA in English at 2215.
- 15195 R. Ankara, Turkey in English at 2200.
- 17855 NHK, Japan, news in English at 0705.
- 17920 Radio Cairo in English at 1415.

A. P. Turner of Eastbourne, Sussex has a Peto-Scott H-25, 5-valve domestic superhet receiver and a 65 foot long wire which enabled him to hear:

- 6040 VOA with news at 1917.
- 7100 R. Tirana, Albania in English at 2223.
- 7245 R. Austria, news in English at 0907.
- 11805 R. Pakistan in English at 1830.
- 15245 RSA, South Africa in English at 1608.
- 17810 R. Kuwait, news in English at 1738.

Reports should arrive by the 15th. of the month and be addressed to me at 59 Windrush, Highworth, Swindon, Wiltshire. Please note the new address.

SHORT WAVES

DOUTBLESS many will not be pursuing the noble art of Amateur Radio on November 5 but will usefully employ the time to honour (?) Guy Fawkes for his near miss. However, that does leave another twenty nine days in which to make up for lost time.

One thought is the topband transatlantics. Quite a few signals have been received, not merely from across the pond but from other countries/continents also. A session around 0600 hours might be worth a try although most 160 metre stalwarts are just as liable to be putting out a slow CQ in c.w. in the evenings too. Many d.x. stations are trying their hands at topband using s.s.b. and this band should make an interesting playground for the more seriously minded s.w.l. during the long winter evenings ahead.

Intruders in the Amateur bands are pests who have no moral or legal right to be there. The R.S.G.B. keep an intruder watch and this relies heavily upon reports received. Any s.w.l. with reasonable equipment is welcome to assist, but reports must be accurate. If you have a single conversion superhet, for example, you must ensure that it is not an image signal you are hearing which is, in fact, outside the band.

It's funny callsign time again. Queries flood in about those using a letter followed by two numbers. Not a postal code for Hong Kong, just a new prefix time—again! Bangladesh is apparently active and the call sign here begins S21 (sounds like the wash-room in a Government building). Just in case you think I've picked out an odd one, how about C21 for Nauru. Don't be fooled though, the latter have also been known to use a C29 prefix too.

Paul Genner (Liverpool) writes in with news of activity from Vietnam which must surely be a rare one for anyone to bag. Callsign is XV5AC and no band given but 20 and/or 15 would be a safe bet. Paul also mentions that anyone wanting to add Willis Island to their list should look out for VK9ZB who will set sail in December from Willis. Quick, while there is yet time.

John Tirrall (Bognor) tells the amazing tale of a W7 reported to be putting up a 40 (forty) element beam for 28MHz and will feed the brute on generous helpings of r.f.—a kilowatt no less. Those who hear nothing on ten metres could make it a red letter day. (Perhaps a red aerial day with all that power coming in).

Talking of ten metres, with the decline of the sunspot activity count this band is perhaps one of the most interesting. Readers might consider erecting a simple ground plane antenna especially for this band. The elements are only just over 8 feet in length and even a vertical dipole might be dangled down the side of the house. Feed in the centre with 75Ω coax as for a horizontal dipole and your in business. Watch that your receiver isn't one which is to be nurtured on 300Ω feed though or you'll have a mismatch.

THE AMATEUR BANDS

David Gibson, G3JDG

Frequencies in kHz ● Times in GMT

Times to listen are always a dangerous thing to predict with any degree of dogma since some bright soul always hears half the world at the very opposite times to those you have predicted. However, according to the JDG crystal ball, afternoons and evenings appear favourite for 21 and 14MHz which are still the most popular listening bands if logs received are any indication. Hopefully, adventurous s.w.l.s will venture forth into regions such as 3.5MHz and 7MHz during the coming months as conditions improve.

Alan Smith (Nelson), JR310, a.t.u. and 60ft. end fed is one who braved 3.5MHz to get s.s.b. scalps from; HK1NR, KZ5JF, K3JH, PY1HA, SP9FMA, VE1ARH, VE1IE, VE1XI, VO1BT, VO1CV, W1PSK, W3MFW, XE1IJJ, YN1FI, ZL2BT, ZM4PG, 6Y5AR.

Up on 21MHz Alan bagged; CR6QA, CR7LE, CR8BF, DU1BOB, DU2EL, EP2JW, ET3USA, FP8DH, HS4AGN, HS4AGZ, JA1HIV, JA2DX, JA3BLC, JA4FDZ, JA6BQ, JA7MFA, JA8QX, JA9EFQ, JA0GRR, KA6MH, KH6KHD, KP4DDO, LU1ACO, SV0WW, SV1GP, TJ1DF, VE1AM, VE3AUM, VS6AD, W8EX, W9ADW, XV5AC, ZS1J, ZS2MI, ZS3AK, ZS4LW, ZS5OE, ZS6OF, 4S7AB, 4S7PB, 4Z4EF, 4Z4LK, 5B4KP, 5N2ESH, 6W8YL, 6Y5GB.

Paul Russell (High Wycombe), went to West Norfolk for a holiday. With him went a Sentinal converter, UR-1A receiver as a tuneable i.f. (4.6MHz) and a 5-element yagi which posed transport problems on the way there, especially on the London Underground. Rewards for these sterling efforts included 144MHz signals from; F5VA, F6AGV, F6NM, G2AKQ, G3BN, G3CZA, G3DAH, G3OXV, G3PMH/P, G3POI, G3SRT/A, G3TTV, G3UJK, G3WW, G3XIX, G3ZYC, G4ARD/P, G8DYK, GW4ABR/P, P0HVA, PA0VJ, PA0VZL.

William Fereday (Aston-on-Trent) uses an R107 and bent 50ft long wire (Oh—bold). Twenty metre tweets from; JA1QZY, JA2PJC, VK3AHI, VK3RZ, VK5FH, W6BMP, W6BT, YN3NPF, 9V1QT.

Roger Dixon (Skipton), PR30, CX203 receiver and 100ft. long wire end fed sent in a log for ten metres (bless you). Stations bagged include; CE3AGU, LU4DCO, TU2DO and 9J2KY. Who says there's nothing up there?

Glyn Fisher (Oakham) landed a number of EU stations on 7MHz. Among these were signals of the s.s.b. type from VK2AVA, VK5PB and VK7GK. Gear is a Westminster radiogram and a 50ft. endfed.

Well worth a listen is the 1.8MHz contest on November 11-12. There is also a Czechoslovakian contest on the 12th. The Czech stations are often in evidence on topband but if you want to log stations from further afield, try the CQ WW d.x. c.w. contest on November 25-26.

Logs, in alphabetical order please to arrive by the 15th of the month to 12 Cross Way, Harpenden, Herts.



Christmas Presents a Problem!

We can take it for granted that she will be buying you the very thing you've set your heart on, so let's concentrate on that superb present you are so generously thinking of buying her! Simple—as everybody knows, today's finest range of radio and electronic components is to be found in the Home Radio Components Catalogue. You could buy her a copy, so that she can pick out just what she wants. On second thoughts, that might complicate matters. Better make the choice yourself. After all, you want it to be a surprise for her on Christmas morn! Moreover, you'll both have the Home Radio Components Catalogue and can spend many hours together, browsing through it. The Catalogue is crammed full with details of 8,000 items, of which about 1,500

are illustrated. It costs only 70 pence, including post and packing, and each copy contains 10 vouchers worth 5p each.

Of course, you can call at our shop (we're open 9 to 5.30 Monday to Saturday, except Wednesday 9 to 1) and get just what you want straight off the shelf. Incidentally, a catalogue bought this way will cost you only 50 pence. Whether you order by post or buy over the counter you should join our Credit Account Service. It's the simple and convenient way of buying all your radio and electronic components. We supply pre-paid envelopes and order forms, and no matter how many orders you send us you make only one payment per month. Full details and entry forms are in the catalogue.



The price of 70p applies only to catalogues purchased by customers in the UK and BFPO addresses.



POST THIS COUPON with your cheque or postal order for 70p

Please write your Name and Address in block capitals

Name

Address



HOME RADIO (Components) LTD.
Dept. PW, 234-240 London Road, Mitcham CR4 3HD

LETTERS...

The Editor does not necessarily endorse the views expressed by correspondents

In the post

As a purchaser, in a small way of components advertised in *P.W.* I have sometimes been amazed at the varying rates of postage charged for parcels to N.Z. I therefore wrote to the Post Office, London to find out the reason.

I enclose copies of my letter and the reply.

I am sure that the advertisers are trying to act in our best interests. It is no advantage to them to pay out extra postage, but it's our money they're using!—**C. J. Christie** (Whangarei, New Zealand).

LETTER TO GPO:

I should be grateful for your advice in the following problem.

I am a hobbyist meddler in things electronic and from time to time I make purchases of equipment from England.

Postage on parcels varies so much—for example: (1) Six hearing-aid inserts (1 oz.) Liversedge, 5p. (2) One integrated circuit (1 oz.) Sevenoaks, 61¹/₂p. (3) Resistance wire (7 oz.) Croydon, 7¹/₂p. (4) Loudspeakers (3 lb.) Liversedge, £1.23. (5) Five tape cassettes from London, 75p.

All these goods have been marked "surface mail"—not registered.

I don't object to waiting a couple of months for goods sent sea-mail but I must confess to being mystified by the postages quoted.

Can you advise the most economical rate in general terms for the sort of equipment I am buying please?

REPLY FROM POST OFFICE:

We were interested to see the rates that were charged on the packets you have been receiving. Items 1 and 2, the hearing aids and integrated circuit, weighing one ounce each, should have been sent by the Letter Post at the Commonwealth Rate of 2 new pence (3p from 1 July 1971). There was no service operating in March 1971, surface or air, by which the charges you mention of 5p and 61¹/₂p could have been correctly made for these items. Although they were sent a long time ago, if you still have their

wrappings we will gladly investigate how the charges were raised. Item 3 was sent by the Small Packet service, and although you have not given us a date for the packet, the charge of 1s 6d was almost certainly correct. Item 4, the radio speakers weighing 3 lb would have been sent by the Surface Parcel Post Service for £1.15p.

The most economical service available for the sort of goods you have been receiving, including the tape cassettes, is undoubtedly the Small Packet service. This provides a cheap rate for lightweight goods (up to 2 lbs in the case of New Zealand). Small packets must be packed so that they can be easily examined without breaking any seal, and should not contain any letters or personal correspondence, although an invoice is permissible. The words 'Small Packet' should be marked on the top left hand corner. In this service a packet of cassettes weighing, say, 14 oz can be sent for 15p.

I enclose various leaflets showing our current charges and a photocopy of the Small Packet regulations taken from the current edition of the Post Office Guide. I am sure you will find the Small Packet service meets your needs.

Radio fags



I enclose the photo of a packet which once held ESS-O-ESS cigarettes as I thought you might like to reproduce it in your magazine.

Whereas countless cigarette brand designs are based on ideas to do with the sea there may be few that have anything to do with radio. The only item apart from this that I know of is Wire-less Mixture tobacco.

I do not know when the packet was introduced but this brand was on sale in 1939 at 3d for 6, also 12 for 6d and 3 for 1¹/₂d. It was to disappear during the next ten years as it is not included in the 1949 retail price lists. Gallaher Ltd. are now the proprietors of Cope's brands.

One of my achievements is getting something into the Guinness Book of Records concerning wireless. I sent them an obituary from a newspaper called "the forgotten inventor." This resulted in the inclusion of details of the world's first advertised broadcast by Sir Aubrey Fessenden.—**W. Humphries** (Suffolk).

She saw the light

One day a dear old lady came into our shop and asked if we could sell her a light bulb for her "loo". Upon asking what wattage she wanted she replied that she had not any idea. I then asked her to bring her old bulb into the shop so that I might try to read the wattage. At this suggestion she stepped back in surprise and flatly refused to do this. When asked the reason for her attitude she replied, "Young man, if I take the old bulb out without putting a new one in straight away, all the electricity will fall out of the socket and I'll have a big bill to pay next quarter".

It took me several minutes to explain to her that this was not the case and she went away with a new 25W bulb in her bag which we gave her as a prize for being our 'customer of the month'.—**C. Scott**, (Edinburgh).

We are glad to hear that the lady went away a happy customer. If any readers have amusing stories like this, we'll be glad to consider them for our "Letters" pages—Editor.

GOING BACK...

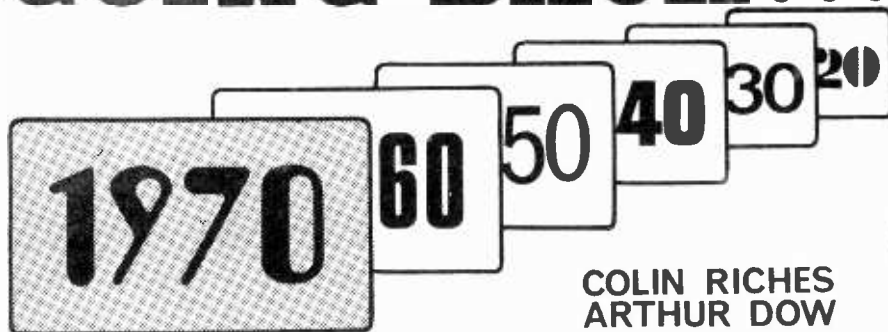

COLIN RICHES
ARTHUR DOW

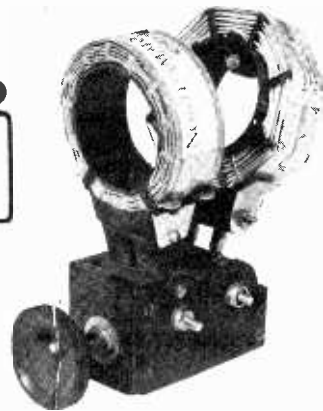

FIFTY years ago British broadcasting was born in an ex-army hut near Chelmsford in Essex, when on 14th February 1922 a group of Marconi engineers began a series of regular experimental transmissions. Every Tuesday evening from a rigged-up transmitter, call sign 2MT Writtle, or more affectionately to its listeners, Two Emma Tock, they transmitted programmes whose original purpose was entirely technical. Shortly afterwards, in May, another transmitter, later to be even better known, was opened up by the company at Marconi House in the Strand in London. This was the famous 2LO station that provided the foundation from which the British Broadcasting Company grew after its formation on 14th November of the same year.

Two Emma Tock provided the first regular broadcasting service in this country, and incidentally broadcasting's first audience, an audience which in its enthusiasm for the pioneering programmes, generated the original demand for public service broadcasting. The 2MT transmitter was set up for use in a series of experiments designed to establish the effective range of a wireless telephony transmitter. At the same time a number of radio amateurs were appearing, largely young ex-service men who had learnt about radio during the 1914-18 war, who had put together their own receiving sets, and who wanted transmissions to receive. Earlier experiments with entertainment, as when Dame Nellie Melba and later Lauritz Melchior, the Danish tenor, had broadcast from a makeshift studio in Chelmsford in 1920, had shown that there was a potential for wireless telephony outside official communication and naviga-

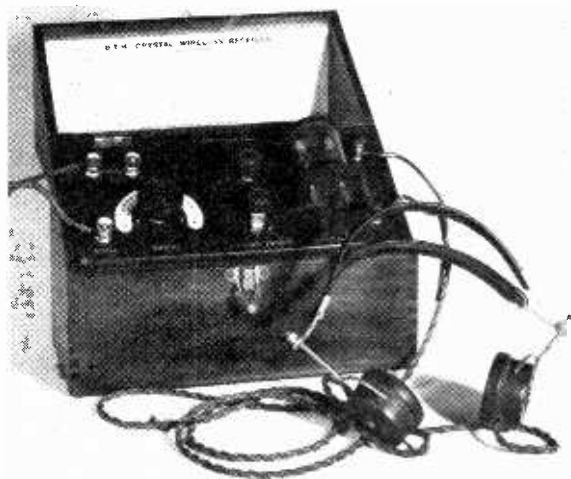

A B.T.H. crystal receiver of 1923 vintage.

tion usage, but the official attitude had been discouraging, and the duty of granting licences for transmitters was the preserve of the Postmaster General. Government was unwilling to consider licences for more than a token number of even technical transmissions.

2MT was finally granted an experimental licence to transmit early in 1922, though the permission was hedged about with many restrictions. But for half an hour on Tuesday evenings, experiments were to be allowed, though even then with three-minute breaks in every ten, to ensure that no interference with "legitimate services" was being perpetrated.

2MT opened regular broadcasts officially on behalf of the amateurs who needed a source against which they could calibrate their receivers, and to begin with its programmes were not very much more interesting than early 1920 transmissions made before the government clamp-down, when W. T. Ditcham read from Bradshaw's railway timetable, but the enthusiasm and gaiety of the young Marconi engineers who ran it very soon turned it into a half-hour's entertainment in its own right. The names of those men read like a roll-call of some of the great names in broadcasting. In charge of the project was Captain P. P. Eckersley, who later went to the new British Broadcasting Company as its first chief engineer. It was his infectious and spontaneous humour which gave 2MT its unique flavour; he was

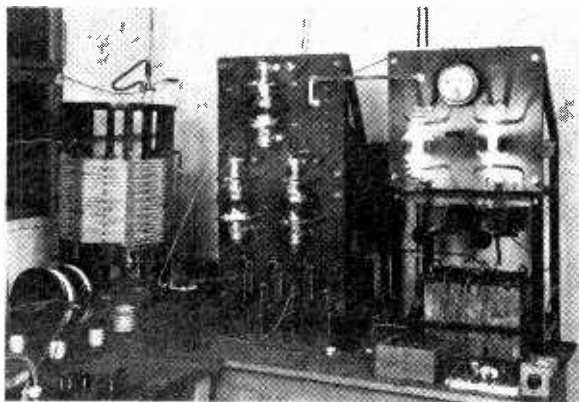

The 2MT transmitter at Writtle from which the first regular broadcast transmissions in this country began on Feb. 14th, 1922.

PICTURES TO BRING BACK MEMORIES . . .



"Marconi House" main entrance from the Strand (taken 1912).



The "Roving Eye", taken in 1954.



The "Television Toppers" view a 23in screen. The largest at the 1953 Radio Show.



Jean Metcalf, compère of "Family Favourites" (1954).



BBC camera used for televising the "Victory Parade". Seen here with Windmill Girls (1946).

not only the first engineer in charge, he was also the first of the true radio entertainers, with a gift for ad-libbing that constantly alarmed those of a less adventurous disposition who worked with and around him. Others in the team were Noel Ashbridge, later Sir Noel, who was the BBC's first technical director, till his retirement in 1952, R. T. B. Wynn, a later chief engineer of the BBC and B. N. MacLarty, who became head of the BBC's Design and Installation team before he returned to Marconi's in 1947 as Engineer in Chief.

By contrast, Marconi's 2LO station, granted its licence in May, began a rather staid existence, a happy coincidence for the pioneers of 2MT, as it gave them an opportunity to provide skits and lampoons which were much appreciated by their listeners. 2LO operated on conditions of restricted timing, at first even no music, and low power, beginning with 100 watts, later raised to 1½kW. Its programmes had each to be individually licensed by the PMG, and were limited to private occasions often for charity, at which Marconi engineers installed the receiving apparatus and operated it. Each programme was notified to listeners by postcard by means of a special mailing list kept by The Marconi Company, and most of them consisted of polite light music.

The 2LO station transmitter was designed by Captain H. J. Round, installed by C. S. Franklin and run by A. R. Burrows who eventually became the much-loved Uncle Arthur of the BBC. Among the many papers in the Marconi archives which tell the story of the birth of British Broadcasting, not the least interesting is Arthur Burrows' letter requesting permission to recruit a young man of particular quality to compere the station's programmes, a young man with "technical tendencies grace of manner and an excellent telephone voice." Many of Burrows' requirements were couched in terser terms and it was his organisational skill and foresight that shaped the studio techniques which are still the basis of modern broadcasting.

By this time many wireless societies had been formed and more and more the demand for radio receivers was being felt. In the United States since 1919 "wireless" had become fashionable, but with no constitutional control of the use of wavelengths, chaos reigned in a commercially sponsored free-for-all. The British Government, seeking a way from the dilemma posed by popular demand on the one hand and a justifiable reluctance to allow free access to the air on the other, set up the Wireless Sub-Committee of the Imperial Communications Committee in April of 1922. After consideration, their recommendation to set up a single broadcasting company was accepted and in November 1922 the British Broadcasting Company was formed from six commercially interested companies with £100,000 share capital.

The six companies were The Marconi Company, the Metropolitan Vickers Co., the Western Electric Co., the British Thomson-Houston Co., the Radio Communication Co., and the General Electric Co., and on its formation on 14th November a Broadcasting Committee of the founder members took over the responsibility of running 2LO.

2MT Writtle continued to transmit until the following January, when it finally closed down.



Our favourite "dumb blonde"—Sabrina shown during rehearsals for Arthur Askey's "Before Your Very Eyes" show (1955).

We would like to thank the Marconi Company, the BBC, the Science Museum and readers whose help in compiling this article has really been appreciated.



CAR/PORTABLE RADIO. October 1972
Readers experiencing difficulty in obtaining the oscillator coil L3 (Osmor PW/01) can use the Denco coil Type TOC1 using the following connections:— Pin 1 to C3 and R3, Pin 2 to the positive line, Pin 3 to S1b, Pin 4 to IFT1, Pin 5 to Tr1 collector and Pin 6 to Tr1 emitter. (Denco Ltd., 357 Old Road, Clacton-on-Sea, Essex).

INTERCOMM CALLING SYSTEM. October 1972
There is an error regarding the wiring around the secondary of T2. The loudspeaker is connected in series with the wire from pin 5 of SW1 to the positive line; the speaker is not connected directly to the top of the secondary of T2.



DX'ers A.F. PROCESSING UNIT. July 1972
In Fig. 4 a break in the conductor strip should be shown at 30-g.

I.C. AUTO PARKING LIGHT. September 1972
It has been brought to our attention that a single parking light is no longer sufficient; all four parking lights are necessary. This does not of course invalidate the circuit.

HENRY'S - Your complete Semi-Conductor Store!

INTEGRATED CIRCUITS

Why buy alternatives when you can buy the genuine article from us at competitive prices from stock. BRANDED FROM TEXAS I.T.T. FAIR-CHILD

Type	1/11	12/24	26/99	Type	1/11	12/24	26/99	Type	1/11	12/24	26/99
SN7400	0.20	0.18	0.18	SN7450	0.20	0.18	0.18	SN74145	1.50	1.40	1.30
SN7401	0.20	0.18	0.18	SN7451	0.20	0.18	0.18	SN74150	3.25	2.95	2.15
SN7402	0.20	0.18	0.18	SN7453	0.20	0.18	0.18	SN74151	1.10	0.95	0.90
SN7403	0.20	0.18	0.18	SN7454	0.20	0.18	0.18	SN74153	1.85	1.27	1.20
SN7404	0.20	0.18	0.18	SN7460	0.20	0.18	0.18	SN74154	2.00	1.75	1.55
SN7405	0.20	0.18	0.18	SN7470	0.30	0.27	0.25	SN74155	1.55	1.47	1.35
SN7406	0.30	0.27	0.25	SN7472	0.30	0.27	0.25	SN74156	1.55	1.47	1.35
SN7407	0.30	0.27	0.25	SN7473	0.40	0.37	0.35	SN74157	2.50	1.70	1.50
SN7408	0.20	0.19	0.18	SN7474	0.40	0.37	0.35	SN74190	2.80	2.40	2.25
SN7409	0.45	0.42	0.35	SN7475	0.45	0.42	0.35	SN74161	2.60	2.40	2.25
SN7410	0.20	0.18	0.18	SN7476	0.45	0.42	0.39	SN74162	3.40	3.25	2.70
SN7411	0.28	0.22	0.20	SN7480	0.80	0.75	0.67	SN74163	3.40	3.25	2.70
SN7412	0.42	0.40	0.35	SN7481	1.25	1.15	1.10	SN74164	2.75	2.30	2.10
SN7413	0.30	0.27	0.25	SN7482	0.87	0.80	0.70	SN74165	4.00	3.50	3.00
SN7416	0.30	0.27	0.25	SN7483	1.00	0.90	0.85	SN74166	1.55	1.35	1.20
SN7417	0.30	0.27	0.25	SN7484	0.80	0.75	0.70	SN74167	6.25	5.80	6.10
SN7420	0.20	0.18	0.18	SN7486	0.45	0.41	0.38	SN74170	4.10	3.55	3.00
SN7422	0.48	0.44	0.40	SN7490	0.75	0.70	0.65	SN74174	2.00	1.75	1.30
SN7423	0.48	0.44	0.40	SN7491	1.00	0.95	0.90	SN74175	1.85	1.27	1.15
SN7425	0.48	0.40	0.35	SN7492	0.75	0.70	0.65	SN74176	1.60	1.35	1.20
SN7427	0.42	0.39	0.35	SN7493	0.75	0.70	0.65	SN74177	1.80	1.35	1.20
SN7428	0.50	0.45	0.42	SN7494	0.80	0.75	0.70	SN74190	1.95	1.85	1.75
SN7430	0.50	0.45	0.42	SN7495	0.80	0.75	0.70	SN74191	1.95	1.85	1.75
SN7432	0.42	0.39	0.35	SN7496	1.00	0.97	0.95	SN74192	2.00	1.80	1.60
SN7433	0.70	0.61	0.44	SN7497	6.25	5.50	5.00	SN74194	2.40	2.00	1.80
SN7437	0.65	0.60	0.50	SN7499	2.00	2.30	2.00	SN74185A	2.40	2.00	1.80
SN7438	0.65	0.60	0.50	SN74104	1.45	1.35	1.20	SN74190	1.95	1.85	1.75
SN7440	0.20	0.18	0.18	SN74105	1.45	1.35	1.20	SN74191	1.95	1.85	1.75
SN7441AN	0.75	0.72	0.70	SN74107	0.75	0.45	0.40	SN74192	2.00	1.80	1.60
SN7442	0.75	0.72	0.70	SN74110	0.80	0.70	0.60	SN74193	2.00	1.90	1.80
SN7443	1.00	0.95	0.90	SN74118	1.00	0.95	0.90	SN74194	2.50	2.25	1.90
SN7445	2.00	1.75	1.60	SN74119	1.90	1.78	1.65	SN74195	1.85	1.70	1.60
SN7446	2.00	1.75	1.60	SN74121	0.60	0.55	0.50	SN74196	1.50	1.40	1.30
SN7447	1.75	1.60	1.45	SN74122	1.35	1.25	1.10	SN74197	1.50	1.40	1.30
SN7448	1.75	1.60	1.45	SN74123	2.70	2.55	2.47	SN74199	4.60	3.70	3.35
				SN74141	1.00	0.95	0.90	SN74199	4.60	3.70	3.35

PRICES OF 7400 SERIES ARE CALCULATED ON THE TOTAL NUMBER ORDERED. REORDERABLES OF MIXED QUANTITIES. LARGER QUANTITIES. PHONE (31) 402 4891. TEXAS HANDBOOK NO. 2. I.C. 700 PAGES DATA 60P. POST 20p. HIGH POWER SN 74 HOO } Now in stock - send LOW POWER SN 74 LOO } for list No. 36

A SELECTION OF SEMI-CONDUCTORS FROM STOCK

AAV30 10p	BC147 12p	BU106 2.25	OC44 16p	T1843 35p	2N3056 55p
AAV42 16p	BC189C 12p	BY100 15p	V405A 25p	2N3440 75p	
AAZ13 10p	BC182 10p	BY126 15p	OC67 60p	2N3442 12p	
AC107 35p	BC214 15p	BY127 15p	OC71 15p	ZTX300 12p	2N3525 75p
AC126 25p	BCY32 75p	BY213 35p	OC72 25p	ZTX301 15p	2N3614 65p
AC127 25p	BCY34 35p	C106D 85p	OC75 45p	ZTX302 18p	2N3615 75p
AC128 25p	BCY39 1.00	GET111 55p	OC81 25p	ZTX311 20p	2N3702 10p
AC176 25p	BCY42 30p	GET115 55p	OC83 25p	ZTX300 15p	2N3754 10p
AC187 25p	BCY43 25p	GET890 45p	OC140 55p	ZTX503 17p	2N3705 10p
AC188 25p	BCY55 2.50	LM309K	OC170 25p	2G301 30p	2N3714 1.80
ACY17 30p	BCY70 15p	(T03) 1.87	OC171 30p	2N404 20p	2N3711 1.75
ACY20 20p	BCY71 20p	MA1121 25p	OC200 45p	2N527 35p	2N3773 2.00
ACY21 20p	BCY72 15p	MJE340 50p	OC201 75p	2N896 15p	2N3790 2.25
ACY39 55p	BCY87 2.80	MJE370 70p	OC202 80p	2N897 15p	2N3819 35p
AD140 50p	BCZ11 50p	MJE539 70p	OC203 50p	2N700 10p	2N3820 50p
AD149 50p	BD124 80p	MJE2950 50p	OCPT1 1.25	2N930 20p	2N3886 85p
AD161 35p	BD131 75p		ORP12 50p	2N987 45p	2N3903 15p
AD162 35p	BD132 80p	MJE3055	ORP60 40p	2N1131 25p	2N3906 12p
AF117 20p	BF115 25p		P346A 50p	2N1132 25p	2N4061 12p
AF118 50p	BF167 25p	MFF105 40p	RAS830A	2N1302 18p	2N4062 12p
AF124 25p	BF173 25p	NKT214 20p	OC140 45p	2N1304 22p	2N4128 15p
AF139 30p	BF179 30p	NKT216 40p	RAS808A	2N1305 22p	2N4715 35p
AF186 40p	BF180 30p	NKT217 40p		2N1307 25p	2N5457 30p
AF239 40p	BF194 15p	NKT403 70p	TA A263 75p	2N1308 25p	2N5777 55p
ASV27 30p	BF195 15p	NKT404 50p	TIL209 39p	2N1613 20p	2N8001 1.00
ASV28 25p	BF861 25p	OAS 50p	TIP29A 50p	2N1671 1.00	2N8012 10.00
BA102 30p	BF898 25p	OAI 10	TIP30A 60p	2N2147 75p	2N8018 9.00
BA115 7p	BFX13 25p	OAB1 10p	TIP31A 60p	2N1800 50p	2N8026 8.90
BA145 15p	BFX34 75p	OAG1 7p	TIP32A 70p	2N2217 25p	2N8301 50p
BAX13 5p	BFY37 30p	OA200 7p	TIP33A 1.00	2N2221 20p	2N8303 65p
BAX16 7p	BFY88 20p	OC202 10p		2N2222A 1.00	2N8324 95p
BC107 10p	BFY50 20p	OC16 75p	TIP34A 25p	40250 50p	40360 40p
BC108 10p	BFY51 20p	OC20 85p	TIP35A 1.50	2N2969A 15p	40361 40p
BC109 10p	BFY52 20p	OC23 85p		2N2906 20p	40362 50p
BC109C 12p	BFY64 50p	OC25 40p	TIP36A 3.00	2N2926 (all cols)	40408 50p
BC113 15p	BFY90 50p	OC28 65p	TIP41A 75p	2N3053 20p	40438 1.10
BC117 20p	BLY36 8.00	OC35 50p	TIP42A 85p	2N3054 50p	40430 1.00
BC143 35p	BX827 15p	OC42 40p			

INTEGRATED CIRCUIT SOCKETS LOW PROFILE PLATED PINS

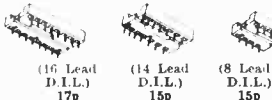

(16 Lead D.I.L.) 17p

(14 Lead D.I.L.) 15p

(8 Lead D.I.L.) 15p

QUANTITY DISCOUNTS

10% 12+ : 15% 25+ : ANY ONE TYPE 20% 100+ : 25% 250+

From above sections except Integrated Circuits and Special Offers where discounts are included. Minimum order value £1 please. Postage 7p on all orders.

SPECIAL OFFERS! SEMI-CONDUCTORS

BFY90	59p	2N2926	10p
1000 MC/S		All Colours	
25 + 20p		25 + 9p	
100 + 17p		100 + 8p	
500 + 15p		500 + 6p	
		1000 + 5p	
AF117 Mullard	25p	2N3819 Texas	35p
25 + 17p		25 + 30p	
100 + 15p		100 + 25p	
500 + 12p		500 + 20p	
		1000 + 15p	
OC170 Mullard	25p	BC107, BC108, BC109 All Makes	10p each
25 + 20p		25 + 8p	
100 + 18p		100 + 7p	
500 + 15p		500 + 6p	
1000 + 13p		1000 + 5p	
BY127 Mullard	15p	AD161, AD162	35p each
25 + 12p		25 + 32p	
100 + 10p		100 + 28p	
500 + 9p		500 + 25p	
1000 + 8p		1000 + 22p	
OA202	10p	2N3053	20p
25 + 8p		25 + 18p	
100 + 7p		100 + 15p	
500 + 6p		500 + 12p	
1000 + 5p		1000 + 10p	
OC35 Mullard	50p	2N3055	55p
25 + 40p		25 + 50p	
100 + 40p		100 + 45p	
500 + 35p		500 + 38p	
1000 + 30p		1000 + 33p	

ZENER DIODES

400 M/W 5% Miniature
BZY 88 Range
All voltages 3.3 - 33 Volt
10p each.

25 +	8p
100 +	8p
500 +	6.5p
1000 +	5p

Any one type.

1/2 Watt 5% Wire Ends Metal Case
All voltages 6.8 - 100 Volts
20p each

25 +	18p
100 +	18p
500 +	12p
1000 +	10p

Any one type.

3 Watt Plastic Wire Ends 5% 3EZ Range
All voltages 6.8 - 100 Volts
30p each.

SILICON RECTIFIERS WIRE ENDED PLASTIC

Type	P.I.V.	1-11 amp miniature
IN4001	50	6
IN4002	100	7
IN4003	200	8
IN4004	400	8
IN4005	600	10
IN4006	800	12
IN4007	1000	15
1.5 amp miniature		
PL4001	50	8
PL4002	100	9
PL4003	200	10
PL4004	400	10
PL4005	600	12
PL4006	800	15
PL4007	1000	16

LINEAR (O/P AMPS)

709C	TO5	75p
709D	TO99	35p
709E	D.I.L.	35p
723C	TO99	£1.00
728C	D.I.L.	95p
728D	TO99	£4.50
741C	TO99	55p
741C	D.I.L.	55p
747C	TO99	£1.10
747C	D.I.L.	£1.10
72741P	D.I.L.	£1.10
72748P		

S.C.S. COMPONENTS

P.O. BOX No. 26, WEMBLEY, MIDDLESEX, HA 0YY
the 'PROFESSIONAL' amateur supplier

NEW
SIGNETICS DATA BOOK £1.00 each postage and packing 10p. Book one digital bipolar circuits—contains full Data Sheets and Application notes on complete Signetics range of Digital devices. 596 pages.
Book two covers full range signetics linear devices including Audio Amplifiers and preamplifiers. 240 pages.

SIGNETICS NE555V Timer
first time offered to constructors.

Features

- Timing from microseconds through 1 Hr.
- Can either free run or hatch.
- Adjustable duty cycle.
- Time delays can be reset.
- Temperature stability 0.0005% per °C.
- Operates from 4 to 15 volts. for 1% change in timing.
- Timing can be changed 10:1 with control voltage.
- Output can source or sink 100 M.A.
- 8 pin plastic D.I.L. package plus Data and Application Notes 90p

SPECIAL OFFERS

MEL12 50p LM301A 90p
EM401 8p 2N5459 49p
TT3643 30p BC108 10p
MA741 34p 2N3643 25p
2N3648 £1.10 BC178 22p
IN914 6p 2N2646 37p
BC107 10p EM404 8p
CI05Y1 50p CI0601 55p
UA709 31p UA748 34p
1 M Ω Trimpots ... 11p
Texan 20 + 20 watt Stereo.
Complete kit of Semiconductors £6.30
2N3055 Si NPN power TX 115 watt...35p
send SAE for priced list of all parts for any E.T.I. constructional project.

SEMICONDUCTORS

AA119	9p	BC136	20p	BF161	45p	OA81	10p
AA111	10p	BC137	20p	BF178	25p	OA85	12p
AA130	10p	BC139	25p	BF179	30p	OA90	8p
AA213	10p	BC142	21p	BF180	35p	OA91	7p
AC107	34p	BC143	23p	BF184	20p	OA95	7p
AC126	25p	BC147	12p	BF185	20p	OA200	7p
AC127	25p	BC148	10p	BF194	15p	OA202	10p
AC128	25p	BC149	12p	BF195	15p	OA2223	45p
AC141K	25p	BC152	20p	BF196	15p	OA2230	45p
AC142K	18p	BC153	20p	BF197	15p	OC28	65p
AC153	25p	BC157	15p	BF200	35p	OC35	50p
AC153K	25p	BC158	12p	BF222	35p	OC36	65p
AC175K	36p	BC159	15p	BF224J	15p	OC44	15p
AC176	25p	BC170	15p	BF256L	30p	OC45	15p
AC176K	20p	BC171	15p	BF256LC	34p	OC70	15p
AC187	25p	BC171A	17p	BF536A	37p	OC71	11p
AC187K	25p	BC177B	20p	BFW17A	£1.22	OC74	25p
AC188K	25p	BC177B	23p	BFX37	30p	OC75	23p
AC193K	25p	BC178B	16p	BFX84	23p	OC170	23p
AC194K	27p	BC179	20p	BFX85	25p	R2008	£3.5
ACY20	20p	BC182L	10p	BFY50	20p	R2009	£2.5
ACY21	20p	BC182LB	10p	BFY51	20p	R2010	£2.5
ACY22	12p	BC183	10p	BFY52	20p	SP8385	£1.0
AD143	45p	BC183L	10p	BFY90	55p	TA-A700	£2.4
AD161	35p	BC183LB	10p	BSX20	15p	TAD100	£1.3
AD162	35p	BC184LC	12p	BSX60	50p	TBA500	£2.0
AF115	25p	BC186	25p	BSX61	35p	TBA510	£2.0
AF117	20p	BC187	25p	BT106	85p	TBA520	£2.5
AF121	30p	BC208A	14p	BU105/02	£2	TBA520Q	£2.5
AF124	25p	BC212	10p	BY126	15p	TBA530	£1.8
AF126	20p	BC212L	12p	BY127	15p	TBA540	£1.8
AF127	20p	BC212LA	13p	BY147	£1.04	TBA540	£2.0
AF139	30p	BC213L	12p	BY164	35p	TBA550	£3.0
AF179	25p	BC214	15p	BZY98 ser 9	9.5p	TBA550Q	£3.0
AF178	55p	BC214L	15p	BZY98 ser 9	9.5p	TBA570Q	£1.2
AF170	60p	BC250B	14p	BR100	26p	TBA750	£1.4
AF239	40p	BC261	16p	BRC4443	90p	TBA750Q	£1.4
ASZ17	50p	BC268	11p	BRY39	30p	TIC46	40p
BA102	30p	BC308A	17p	E1222	40p	TIP29A	50p
BA145	15p	BC317	20p	E5024	40p	TIS60M/61M37p	24p
BA148	15p	BCY21	96p	GET102	30p	TIS61	20p
BA154	9p	BCY31	40p	GET103	25p	TIS91	17p
BA155	10p	BCY42	30p	IS921	15p	2N404	15p
BA163	90p	BCY70	15p	IS923	15p	2N697	12p
BAX12	12p	BCY71	20p	ME0404	11p	2N706	9p
BAW63	36p	BCY72	15p	ME0412	15p	2N708	12p
BAW65	36p	BCY89	97p	ME0413	12p	2N753	10p
BAW67	35p	BD115	75p	ME0462	19p	2N919	45p
BB105	37p	BD124	80p	ME2002	8p	2N920	42p
BBY20	37p	BD131	75p	ME4003	12p	2N1302	17p
BC107	10p	BD132	80p	ME4102	10p	2N1304	21p
BC107B	12p	BD135	75p	ME4104	8p	2N1306	24p
BC108	10p	BD175	44p	ME6002	12p	2N1307	24p
BC108A	10p	BD181	90p	ME6101	12p	2N1308	24p
BC108C	15p	BD184	£1.3	ME6102	13p	2N1309	24p
BC110	12p	BF131	25p	ME8001	12p	2N3053	20p
BC113	15p	BF123	30p	ME8003	13p	2N3054	50p
BC116	20p	BF125	25p	MEF104	34p	2N3055	55p
BC117	20p	BF127	30p	MEL11	30p	IN914	6p
BC119	30p	BF153	20p	MP8112	34p	IN916	10p
BC121	25p	BF154	20p	MP8113	40p	IN4148	6p
BC125B	25p	BF160	25p	OA47	10p		

TERMS. Retail mail order subject to £1.00 minimum order. Cash with order only. Trade and educational establishments M/AC on application (minimum £5). Postage 10p inland, 25p Europe. GUARANTEE. All goods carry full manufacturer's warranty. Special Enquiries etc. Please enclose stamped addressed envelope.

TRANSISTORISED F.M. tuner head with A.M. gang, slow motion drive. 88—108Mcs, with circuit diagram. £2.10p.

B.F.W. 10 Fet. New (unmarked) 5 for £1.00p.

SPECIAL OFFERS of Unmarked Tested Power Transistors.
2N3055 Silicon NPN 30p each 4 for £1.
2N3054 Silicon 20p each 3 for 50p.
Plastic 40 Watt NPN 25 Volt 20p each 3 for 50p.

P-C BOARDS (not computer panels).

- 1 off 6 transistors single wave band
- 1 off 4 transistor audio
- 1 off 3 transistor £1.50 the three.

Encapsulated bridge rectifier (itt usd 3 3mdh) 100 PIV 2 amps. 50p each.

Transistor F.M. Stereo Multiplex Decoder. Size: 5 1/2" x 2 1/2" x 1 1/2". As used in well known British stereo units with circuit. £3.75.

GARRARD SP25 MK. II less Cartridge. £10.50.

10 VOLUME CONTROLS consisting of 2 off each. 100K log. ganged L S—20K log. ganged L/S 470K log. D.P Switch—10K lin. L S—50K lin. L S. £1.25.

4 PHONO SOCKETS ON PANEL. 10 panels for £1.25.

12 PLASTIC KNOBS. Chrome and Gold, 3 types—4 off each—spring clip £1.25.

10 COMPUTER PANELS packed with components including one panel with 2 Power Transistors. £1.00.

All items post paid in
GREAT BRITAIN

SURPLECTRONICS

216 LEAGRAVE ROAD, LUTON, LU3 1JD, BEDS.



become
a RADIO-AMATEUR!

learn how to become a radio-amateur in contact with the whole world. We give skilled preparation for the G.P.O. licence

free! Brochure, without obligation to:

BRITISH NATIONAL RADIO & ELECTRONICS SCHOOL P.O. Box 156, JERSEY

NAME: _____

ADDRESS: _____

WB122
BLOCK CAPS please

TAPE HEADS

We are gradually obtaining more information about the Truvoc tape heads we have, we are told that these have been found in a very ingenious way that winding may be coupled either in parallel or in series depending whether high or low impedance is required. We also have matching erase heads and now offer these in pairs. 1 record and 1 erase head. Price of the 2 tracked 45p per pair. 4 track 75p per pair. Pair mounted on plate 45p extra.

I R.P.M. MOTOR

Made by the famous Smiths Company. 240v. 50 cycle mains working. Ideal motor to drive clock mechanisms. Price £1 each or 10 for 29.

DRILL CONTROLLER

NEW 1KW MODEL

Electronically changes speed from approximately 10 revs. to maximum. Full power at all speeds by finger-tip control. Kit includes all parts, case, everything and full instructions. £1.50 plus 15p post and insurance. Made up model also available. £2.25 plus 15p post & p.



MAINS OPERATED CONTACTOR

220/240v. 50 cycle solenoid with laminated core so very silent in operation. Closes 4 circuits each rated at 10 amps. Extremely well made by a German Electrical Company. Overall size 2 1/2 x 2 x 2 in. £1.50 each.

HIGH ACCURACY THERMOSTAT

Uses differential comparator I.C. with thermister as probe. Designer claims temperature control to within 1/7th of 1 degree. Complete kit with power pack £5.50.

AUTO-ELECTRIC CAR AERIAL

With dashboard control switch fully extendable to 40in. or fully retractable. Suitable for 12v. positive or negative earth. Supplied complete with fitting instructions and ready wired dashboard switch. £5.75 plus 25p post and insurance.

WATERPROOF HEATING ELEMENT

26 yards length 70W. Self-regulating temperature control. 50p post free.

MULTI-SPEED MOTOR

Replacement in many well-known food mixers. Six speeds are available—800, 850 and 1100 r.p.m. or either or both of the nylon sockets (where the beaters of the food mixer normally go) and 8,000, 12,000 & 15,000 r.p.m. (ideal polishing speeds) from the main drive shaft. This drive shaft is 1 in. diameter and approximately 1 in. long. A further point about this motor is that being 230/240v. AC-DC series wound its speed may be further controlled with the use of our Thyristor controller. This is a very powerful and useful motor size approx. 2 in. dia. x 5 in. long, mains 230/240v. Price 85p plus 25p postage and insurance, 12 or more post free.

ISA ELECTRICAL PROGRAMMER

Learn in your sleep! Have radio, ping and kettle boiling as you awake—switch on lights to ward off intruders—have a warm house to come home to. All these many other things you can do if you invest in an electrical programmer. Clock or timer with 15 amp. on/off switch. Switch on time can be set anywhere to stay on up to 6 hours. Independent 60 minute memory jigger. A beautiful unit. Price £1.95 + 20p p. or with glass front chrome bezel 75p extra.

0-8 AMMETER

2in. square full vision for flush mounting. Moving iron instrument. Ideal for charger. Price 80p each. 10 for 25.40.

NUMICATOR TUBES

For digital instruments, counters, timers, clocks, etc. 11-vac. XN. 3. Price £1.45 each. 10 for 12.

12 WAY SUB-MINIATURE MULTI-CORE CABLE

7-0078 copper cores each core P.V.C. insulated and of different colour. P.V.C. covered overall and approx. 3/16in. thick. Price 20p per yard.

LIGHT CELL

Almost zero resistant in sunlight increases to 10 K Ohms in dark or dull light, epoxy resin sealed. Size approx. 1in. dia. by 1/2in. thick. Rated at 800 MW, wire ended. 43p with circuit. Also ORP 12 light cell 45p.

BAKELITE INSTRUMENT CASE

Size approx. 6 1/2" x 3 1/2" x 2" deep with brass inserts in four corners and bakelite panel. This is a very strong case suitable to house instruments and special rigs, etc. Price 45p each.

MULLARD 4 + 4 UNILEX AMPLIFIER



We demonstrate these daily and almost always a sale results; it really is a cracking amplifier. Only Mullard with their know how could have made it possible at this low price. SPEC: Mains operated. 4 wats music or speech per channel. Double wired power supply eliminates cross talk. Harmonic distortion less than 2%. Frequency response 50Hz-16KHz. Input suitable for pick-up tuner or microphone. 6 month guarantee. Only £8.95 + 30p postage and insurance.

THYRISTOR LIGHT DIMMER

For any lamp up to 200w. Mounted on switch plate to fit in place of standard switch. Virtually no radio interferences. Price £2.95 plus 20p post and insurance.



TANGENTIAL HEATER UNITS

This heater unit is the very latest type, most efficient, and quiet running. Is a fitted in Hoover and blower heaters costing £15 and more. We have a few only. Comprises motor, impeller, 2Kw. element and 1Kw. element allowing switching 1, 2 and 3Kw. and with thermal safety cut-out. Can be fitted into any metal line case or cabinet. Only need control switch. £3.50. 2Kw. Model as above except 2 kilowatts £2.50. Don't miss this. Control Switch 35p. P. & P. 40p



DISTRIBUTION PANELS

Just what you need for work bench or lab. 4 x 13 amp sockets in metal box to take standard 13 amp fused plugs and on/off switch with neon warning light. Supplied complete with 5 feet of flex cable. Wired up ready to work, £2.25 plus 25p P. & I.



THIS MONTH'S SNIP

BATTERY MOTORS

A bargain parcel of 7 motors for £1. Some as large as a postage stamp and only 1/4" thick, largest is 1 1/2" x 1 1/2" dia. Some work off 1 1/2v. some as high as 18v. These motors are used in racing cars, power toys, etc. The largest is so powerful that it will drive a Mini drill, model lathe, or similar. This is a 4 pole motor, optimum working 16.5v. but very powerful even as low as 4 1/2v. Don't miss this wonderful snip.

REPEATING TIME SWITCH

1 or 2 on/off per 24 hours. Repeats until re-programmed. Switches up to 15 amp. Switching time completely adjustable through 24 hours. Precision made with 24 hour dial. Miniature—will fit into 2ins. cube. Mains operated clock but switch may be isolated for switching battery sets. Ideal for: shop window lighting, anti-theft devices, central heating control and many other automatic processes. Price with instructions £2.50 each plus 20p post and insurance.



STANDARD WAFFER SWITCHES

Standard size 1 1/2" wafer—silver-plated 5-amp contact standard 1/2" spindle 2 1/2" long—with locking washer and nut.

No. of Poles	2 way	3 way	4 way	5 way	6 way	8 way	9 way	10 way	12 way
1 pole	40p	40p	40p	40p	40p	40p	40p	40p	40p
2 poles	40p	40p	40p	40p	40p	40p	40p	40p	70p
3 poles	40p	40p	40p	40p	70p	70p	70p	95p	95p
4 poles	40p	40p	40p	70p	70p	70p	70p	1.20	1.20
5 poles	40p	40p	70p	70p	85p	85p	85p	1.45	1.45
6 poles	40p	70p	70p	85p	85p	85p	85p	1.70	1.70
7 poles	70p	70p	70p	85p	1.20	1.20	1.20	1.95	1.95
8 poles	70p	70p	70p	85p	1.20	1.20	1.20	2.20	2.20
9 poles	70p	70p	85p	85p	1.45	1.45	1.45	2.45	2.45
10 poles	70p	70p	85p	1.20	1.45	1.45	1.45	2.70	2.70
11 poles	70p	85p	85p	1.20	1.70	1.70	1.70	2.95	2.95
12 poles	70p	85p	85p	1.20	1.70	1.70	1.70	3.20	3.20

MULLARD AUDIO AMPLIFIERS

All in module form, each ready built complete with heat sinks and connection tags, data supplied. Model 1153 500m watt power output 75p. Model 1172 750m watt power output 85p. Model EP9800 4 watt power output 21.45. 10% discount if 10 or more ordered.

13 AMP TWIN GANG SOCKETS

Offered at less than wholesale price your opportunity to replace those dangerous adaptors—brown bakelite flush mounting—standard fitting. Unswitched 20p each, separately switched 30p each. Separately switched and with neon on/off indicators 45p each. Less 10% ten or more + 20p postage if order under 25.00



50 MICRO AMPMETER

Square, panel mounting type. £2.

INTEGRATED CIRCUIT DIAGRAM

A parcel of integrated circuits made by the famous Plessey Company. A one-in-a-lifetime offer of Micro electronic devices well below cost of manufacture. The parcel contains 5 ICs all new and perfect, first-grade device, definitely not sub-standard or seconds. 4 of the ICs are single silicon chip GP amplifiers. The 5th is a monolithic NPN matched pair. Regular price of parcel well over 25. Full circuit details of the ICs are included and in addition you will receive a list of many different ICs available at bargain prices 25p upwards with circuits and technical data of each. Complete parcel only £1 post paid. DON'T MISS THIS TERRIFIC BARGAIN.

MULLARD I.F. MODULE

This is a fully screened intermediate frequency module for amplification and detection of f.m. signals at 10.7MHz and a.m. signals at 470kHz. The first stage is used as an i.f. amplifier for f.m. and a self oscillating mixer for a.m. operation, in conjunction with an external oscillator coil. 85p each. 10 for 27.85. 100 for 262.50p. With connection dig.

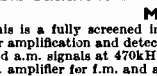

Where postage is not stated then orders over 25 are post free. Below 25 add 20p. Semi-conductors add 5p post. Over 21 post free. S.A.E. with enquiries please.

MINIATURE WAFFER SWITCHES

2 pole, 2 way—4 pole, 2 way—3 pole, 3 way—4 pole, 3 way—2 pole, 4 way—3 pole, 4 way—2 pole 6 way—1 pole, 12 way. All at 80p each £1.80 for ten, your assortment.

TOGGLE SWITCH

3 amp. 250v. with fixing ring 7p each, 75p doz.

ROCKER SWITCH

13 amp self-fixing into an oblong hole. Size approximately 1" x 1" 6p each, 10 for 54p.

Slide Switch

2-pole changeover panel mounting by No 6 B.A. screws. Size approx. 1in x 1in rated 250V lamp. 6p each, 10 for 54p, 100 for 25-10, 600 for 224.

MICRO SWITCH

5A changeover contact. 8p each. £1 doz. 15 amp Model 10p each or £1.05 doz.

NEED A SPECIAL SWITCH?

Double Leaf Contact. Very slight pressure closes both contacts. 6p each, 60p doz. Plastic push-rod suitable for operating 5p each, 45p doz.

PRESSURE SWITCH

Containing a 15 amp. change over switch operated by a diaphragm which in turn is operated by air pressure through a 1/4" dia. metal tube. The operating pressure is adjustable but is set to operate in approx. 10 in. of water. These are quite low pressure devices and can in fact be operated simply by blowing into the inlet tube. Original use was for washing machines to turn off water when tub has reached correct level but no doubt has many other applications. £1.50 each.

SWITCHES ???

We could fill this whole page with all the switches we have so if you can't see the one you want send for our switch list.

TIMED "ON" SWITCHES

Made by Smiths for washing machines, etc. Centre spindle closes double pole 15 amp switch directly it is turned. A full 360° turn or only a part turn winds the clockwork mechanism and keeps the switch closed until the spindle returns to the "off" position. A dial therefore could be fitted to indicate hours and minutes and the switch on period can be set quite accurately. 3 models available—90 minutes, 120 minutes and 360 minutes. Price 95p each. Metal dial pointer knob 15p. Suitable relay to make the switch "on" instead of "off" 85p.

LEVER SWITCH—Ref. H52/4

Ideal for intercom or similar. Pressing the lever down operates 6 pairs of change-over contacts, pressing the lever up operates 4 pairs of change-over contacts. The switch is spring loaded and normally returns to the off or centre position. Size approximately 1 1/2" long x 2 1/2" deep x 1 1/2" thick. 40p each.

5 PUSH BUTTON SWITCHES

Mains, suitable for audio or R.F. Each switch rated at 250v. 15 amps. 1st (black push button) closes 2 circuits, 2nd (white push button) operates one change-over, 3rd (white push button) operates one change-over, 4th (white push button) opens one circuit. Note: all depressed buttons remain down until cleared by the 5th (red button). Further note: It is a relatively easy job to alter the position of the tags thus making the switches suit your circuit. Fitted with 3 white, 1 red and 1 black button. 30p each or 10 for 22.70.

PUSH OPERATED MICROSWITCH

Change-over contacts, spring return when plunger released. Also fitted with lamp holder to take Lilliput lamp in plunger; fixing is by locknut, through 1/4" hole. Price 25p each or 10 for 22.25.

22-POSITION SOLENOID OPERATED STUD SWITCH

Mains operated, each current pulse to switch solenoid moves switch arm through one position on to the next contact stud—current to release solenoid brings back switch arm to position one. These are ex-equipment but in good working order. Any not so would be replaced. Price 50p each.

SNAP ACTION SLIDE SWITCH

Rated 5a. 240v. Made by Arrow. Type fitted in the handles of electric drills, vacuums, etc. 5p each. 10 for 45p.

NOTE: All items subject to 10% discount on quantities of 10 or more

J. BULL (ELECTRICAL) LTD.

(Dept. P.W.) 7 Park Street, Croydon CRO 1YD
Callers to: 102/3 Tamworth Road, CROYDON

Sinclair Project 60

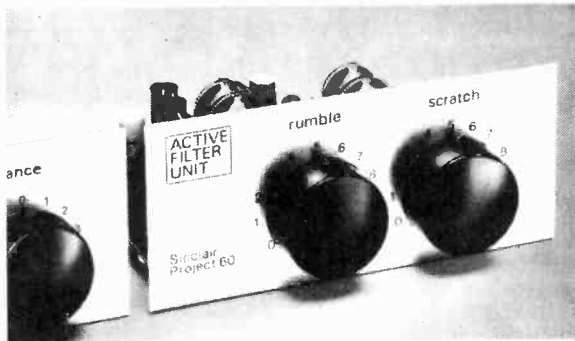

Active Filter Unit (A.F.U.)

Built and tested post free
£5.98

The value of an efficient filtering system cannot be over emphasized in these days of very high quality reproduction since there are so often occasions where its use can mean the difference between comfortable and uncomfortable listening. On the low pass side the Sinclair A.F.U. will effectively reduce hiss from radio or tape, cut out heterodyne whistles on A.M. reception, greatly reduce record surface noise and other imperfections; on the high-pass side it will cut out motor rumble and other spurious low frequency intrusion. The unit is for use between pre-amp (including tape pre-amps) and power amplifiers, and operates in two sections, both stereo. The cut-off frequencies are continuously variable, and since attenuation in the rejection band is rapid (12dB/octave) there is less loss of the wanted signal than has previously been possible. Amplitude and phase distortion are negligible. The A.F.U. is as easy to mount as the stereo 60 pre-amp/control unit which it matches in styling, along with the Stereo FM Tuner.

SPECIFICATIONS

The A.F.U. employs two Sallen and Key type active filter stages, one rumble (high pass) and one scratch (low pass). The two stages use complementary transistors to minimise distortion.

Supply voltage: 15 to 35 volts. Current 3mA maximum.

Gain at 1kHz: Filters flat 0.98 (—0.2 dB)

HF cut off: (—3dB) variable from 28 kHz to 5 kHz at 12 dB/octave.

LF cut off: (—3dB) variable from 25Hz to 100Hz at 12dB/octave.

Distortion: at 1kHz (35 volt supply) 0.02% at rated output.

Super IC.12 Integrated circuit high fidelity amplifier

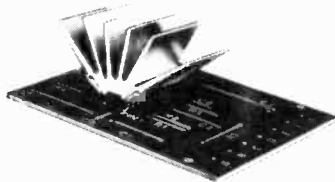

Having introduced Integrated Circuits to hi-fi constructors with the IC.10, the first time an IC had ever been made available for such purposes, we have followed it with an even more efficient version, the Super IC.12, a most exciting advance over our original unit. This needs very few external resistors and capacitors to make an astonishingly good high fidelity amplifier for use with pick-up, F.M. radio or small P.A. set up, etc. The free 40 page manual supplied, details many other applications which this remarkable IC. make possible. It is the equivalent of a 22 tran-

sistor circuit contained within a 16 lead DIL package, and the finned heat sink is sufficient for all requirements. The Super IC.12 is compatible with Project 60 modules which would be used with the Z.50 and Z.30 amplifiers. Complete with free manual and printed circuit board.

SPECIFICATIONS

Output power: 6 watts RMS continuous (12 watts peak). 6—8Ω. **Frequency Response:** 5Hz to 100KHz ±1dB. **Total Harmonic Distortion:** Less than 1%. (Typical 0.1%) at all output powers and frequencies in the audio band (28V). **Load Impedance:** 3 to 15 ohms. **Input Impedance:** 250 Kohms nominal. **Power Gain:** 90dB (1,000,000,000 times) after feedback. **Supply Voltage:** 6 to 28V. **Quiescent current:** 8mA at 28V. **Size:** 22 x 45 x 28mm including pins and heat sink.

Manual available separately 15p post free.

With FREE printed circuit board and 40 page manual.

£2.98 Post free

Project 605



The easy way to buy and build Project 60

Project 605 is one pack containing: one PZ5 two Z30's, one Stereo 60 and one Masterlink. This new module contains all the input sockets and output components needed together with all necessary leads cut to length and fitted with neat little clips to plug straight on to the modules. Thus all soldering and hunting for the odd part is eliminated. You will be able to add further Project 60 modules as they become available adapted to the Project 605 method of connecting.

Complete Project 605 pack with comprehensive manual, post free **£29.95**

Everything you need to assemble a superb 30 watt high fidelity stereo amplifier without having to solder.

sinclair

Sinclair Radionics Ltd, London Road, St. Ives, Huntingdonshire PE17 4HJ. Tel: St. Ives 64311

the world's most advanced high fidelity modules

Z.30 & Z.50 power amplifiers

Built, tested and guaranteed with circuits and instructions manual **Z.30 £4.48** **Z.50 £5.48**

The Z.30 and Z.50 are of advanced design using silicon epitaxial planar transistors to provide unsurpassed standards of performance. Total harmonic distortion is an incredibly low 0.02% at 15w (8Ω) and all lower outputs. Whether you use Z.30 or Z.50 amplifiers in your Project 60 system will depend on personal preference, but they are the same size and are intended for use principally with other units in the Project 60 range. Their performance and design are such, however, that Z.50s and Z.30 may be used in a far wider range of applications.

SPECIFICATIONS (Z.50 units are interchangeable with Z.30s in all applications).— Power Outputs:
Z.30 15 watts R.M.S. into 8 ohms using 35 volts 20 watts R.M.S. into 3 ohms using 30 volts.
Z.50 40 watts R.M.S. into 3 ohms using 40 volts 30 watts R.M.S. into 8 ohms using 50 volts.
Frequency response: 30 to 300,000Hz : 1dB **Distortion:** 0.02% into 8 ohms. **Signal to noise ratio:** better than 70dB unweighted. **Input sensitivity:** 250mV into 100 Kohms (for 15w into 8Ω). For speakers from 3 to 15 ohms impedance **Size:** 14 x 80 x 57mm.

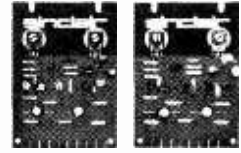

Stereo 60 Pre-amp/control unit

Built, tested and guaranteed **£9.98**

Designed specifically for use on Project 60 systems, the Stereo 60 is equally suitable for use with any high quality power amplifier. Since silicon epitaxial planar transistors are used throughout, a really high signal-to-noise ratio and excellent tracking between channels is achieved. Input selection is by means of press buttons, with accurate equalisation on all input channels. The Stereo 60 is particularly easy to mount.

SPECIFICATIONS—Input sensitivities: Radio — up to 3mV. Mag. p.u. 3mV correct to R.I.A.A. curve : 1dB 20 to 25,000 Hz Ceramic p.u. — up to 3mV Aux — up to 3mV. **Output:** 250mV. **Signal to noise ratio:** better than 70dB **Channel matching:** within 1dB **Tone controls:** TREBLE : 12 to —12dB at 10KHz BASS : 12 to —12dB at 100Hz **Front panel:** brushed aluminium with black knobs and controls. **Size:** 66 x 40 x 207mm.



Project 60 Stereo F.M. Tuner

Built and tested. Post free. **£25**

The phase lock loop principle was used for receiving signals from space craft because of its vastly improved signal to noise ratio. Now, Sinclair have applied the principle to an F.M. tuner with fantastically good results. Other advanced features include varicap diode tuning, printed circuit coils, an I.C. in the specially designed stereo decoder and switchable squelch circuit for silent tuning between stations. In terms of high fidelity this tuner has a lower level of distortion than any other tuner we know. Stereo broadcasts are received automatically, a panel indicator lighting up as the stereo signal is tuned in. This tuner can also be used to advantage with most other high fidelity systems.

SPECIFICATIONS—Number of transistors: 16 plus 20 in I.C. **Tuning range:** 87.5 to 108MHz **Sensitivity:** 7μV for lock-in over full deviation. **Squelch level:** Typically 20μV **Signal to noise ratio:** > 65dB. **Audio frequency response:** 10Hz — 15KHz (: 1dB) **Total harmonic distortion:** 0.15% for 30% modulation **Stereo decoder operating level:** 2μV. **Cross talk:** 40dB **Output voltage:** 2 x 150mV R.M.S. maximum **Operating voltage:** 25–30VDC **Indicators:** Stereo on, tuning **Size:** 93 x 40 x 207mm.



Power Supply Units

Designed specifically for use with the Project 60 system of your choice. Use PZ.5 for normal Z.30 assemblies and PZ.6 or PZ.8 where a stabilised supply is essential.

PZ.5 30 volts un stabilised £4.98
PZ.6 35 volts stabilised £7.98
PZ.8 45 volts stabilised £7.98
 (less mains transformer)
PZ.8 mains transformer £5.98

Typical Project 60 applications

System	The Units to use	together with	Units cost
Simple battery record player	Z.30	Crystal P.U., 12V battery volume control, etc.	£4.48
Mains powered record player	Z.30, PZ.5	Crystal or ceramic P.U. volume control, etc.	£9.45
12W RMS continuous sine wave stereo amp for average needs	2 x Z.30s, Stereo 60; PZ.5	Crystal, ceramic or mag P.U., F.M. Tuner, etc.	£23.90
25W RMS continuous sine wave stereo amp. using low efficiency (high performance) speakers	2 x Z.30s, Stereo 60; PZ.6	High quality ceramic or magnetic P.U., F.M. Tuner, Tape Deck, etc.	£26.90
80W. (3 ohms) RMS continuous sine wave deluxe stereo amplifier. (60W. RMS into 8 ohms)	2 x Z.50s, Stereo 60; PZ.8, mains transformer	As above	£34.88
Indoor P.A.	Z.50, PZ.8, mains transformer	Mic., guitar, speakers, etc., controls	£19.43

F.M. Stereo Tuner (**£25**) & A.F.U. (**£5.98**) may be added as required.



Guarantee

If, within 3 months of purchasing any product direct from Sinclair Radionics Ltd., you are dissatisfied with it, your money will be refunded at once. Many Sinclair appointed Stockists also offer this same guarantee in co-operation with Sinclair Radionics Ltd.

Each Project 60 module is tested before leaving our factory and is guaranteed to work perfectly. Should any defect arise in normal use, we will service it at once and without any charge to you, if it is returned within two years from the date of purchase. Outside this period of guarantee a small charge (typically £1.00) will be made. No charge is made for postage by surface mail. Air Mail is charged at cost.

SINCLAIR RADIONICS, ST IVES, HUNTINGDONSHIRE PE17 4HJ

Please send

I enclose cash/cheque/money order.

Name

Address

PW 12/72

sinclair

PADGETTS RADIO STORE

OLD TOWN HALL, LIVERSEDGE,

YORKS WF15, 6PQ

TEL. HECKMONDWIKE 4285

The T.V. Graveyard of the North, as seen on T.V. Telewrecks. Close to the Motorway, plenty of Free Parking Space. Call in and see us any day 9-6. Closed Sunday. Est. 1935.

Speakers Ex T.V. Sets. 7 x 4", 6 x 4", 8 x 2 1/2", all 3 ohm P.M. 25p each. Post on any Speaker 10p.

Complete Untested T.V. Sets with all Valves and Back. BBC1 and ITV. 17" 90° Tube £2. 17" 110° Tube £3. 19" Slim £5. Carriage and Ins. £1-50p.

We are now breaking up many Slimline Sets. Send S.A.E. and please quote Model and Serial Number and part you require.

Reclaimed T.V. Tubes. All with 12 months' Guarantee. AW43/88 £1-50p. AW43/80 £1-50p. MW43/69 £1. Many other Types in Stock. Carriage and Ins. on any Tube £1-50.

Valve Voltmeter. Type CT54. Range 1k to 10 Meg in 5 Ranges. Volts Range 2 to 5 to 480V AC DC. Untested Clean Condition. Less Batteries. £5. Carriage and Ins. £1.

Latest Air Ministry Release Radio Receiver Type R4187. 2-8 to 18 MHz in Three Bands. With 17 Miniature Valves, 26 Volt Motor Power Supply Motor and Manually Tuned. Very Clean. Less Crystals and Untested. £5. Carriage and Insurance 75p.

7" L.P. Tapes. 75p 7" S.T. 60p 5" L.P. 50p. 5" S.T. 45p. P/P on any Tape 10p.

Crystal Diodes 20p per dozen post paid. **Jap Ear Pieces** Small Plug 10p P/paid.

Valve List EX Equipment. All Valves Tested on our Mullard Valve Tester before Despatched. 3 Months' Guarantee on all Valves. Single Valves Post 3p over Post Paid.

ARP12	5p	PCF80	5p	U191	20p
EB91	4p	PCL82	12p	U251	12p
EF80	8p	PCL83	12p	6BW7	10p
EF85	12p	PCL84	12p	6U4	10p
EF89	12p	PL36	17p	20P1	20p
ECC81	10p	PL81	17p	20P3	10p
ECC82	12p	PY81	8p	20D1	10p
ECL80	8p	PY82	8p	30F5	10p
EF91	4p	YP33	17p	30P12	20p
EY86	20p	PL82	8p	30FL1	20p
EP50	60p per doz.	PL83	8p	6/30L2	20p
PCC84	5p				

PRINTED CIRCUIT KIT

BUILD 50 INTERESTING PROJECTS on a PRINTED CIRCUIT CHASSIS with PARTS and TRANSISTORS from your SPARES BOX

CONTENTS: (1) 2 Copper Laminate Boards 4 1/2" x 2 1/2". (2) 1 Board for Matchbox Radio. (3) 1 Board for Wristwatch Radio, etc. (4) Resist. (5) Resist Solvent. (6) Etchant. (7) Cleaner/Degreaser. (8) 16-page Booklet *Printed Circuits for Amateurs*. (9) 2 Miniature Radio Dials SW/MW/LW. Also free with each kit (10) Essential Design Data, Circuits, Chassis Plans, etc. for 50 TRANSISTORISED PROJECTS. A very comprehensive selection of circuits to suit everyone's requirements and constructional ability. Many recently developed very efficient designs published for the first time, including 10 new circuits.

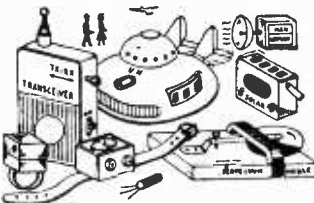

EXPERIMENTERS PRINTED CIRCUIT KIT 60p

Postage & Pack. 10p. (U.K.)
Commonwealth:
SURFACE MAIL 20p
AIR MAIL 60p
Australia, New Zealand,
South Africa, Canada

(1) Crystal Set with biased Detector. (2) Crystal Set with voltage-quadrupler detector. (3) Crystal Set with Dynamic Loudspeaker. (4) Crystal Tuner with Audio Amplifier. (5) Carrier Power Conversion Receiver. (6) Split-Load Neutralised Double Reflex. (7) Matchbox or Photocell Radio. (8) TRI-FLEXON™ Triple Reflex with Self-adjusting regeneration (Patent Pending). (9) Solar Battery Loud-speaker Radio. The smallest 3 designs yet offered to the Home Constructor anywhere in the World. (10) Subminiature Radio Receivers based on the 'Triflexon' circuit. Let us know if you know of a smaller design published anywhere. (11) Postage Stamp Radio. Size only 1-62" x .95" x .26". (12) Wristwatch Radio 1-15" x .80" x .55". (13) Ring Radio .70" x .70" x .65". (14) Bacteria-powered Radio. Runs on sugar-bread. (15) Radio Control Tone Receiver. (16) Transistor P/P Amplifier. (17) Inter-bread. (18) 1-valve Amplifier. (19) Reliable Burglar Alarm. (20) Light-Seeking Animal, Guided Missile. (21) Perpetual Motion Machine. (22) Metal Detector. (23) Transistor Tester. (24) Human Body Radiation Detector. (25) Man/Woman Discriminator. (26) Signal Injector. (27) Pocket Transceiver (Licence required). (28) Constant Volume Intercom. (29) Remote Control of Models by Induction. (30) Inductive-Loop Transmitter. (31) Pocket Triple Reflex Radio. (32) Wristwatch Transmitter/Wireless Microphone. (33) Rain Alarm. (34) Ultrasonic Switch/Alarm. (35) Stereo Pre-amplifier. (36) Quality Stereo Push-Pull Amplifier. (37) Light-Beam Stereo "Photophone". (38) Light-Beam Transmitter. (39) Silent TV Sound Adaptor. (40) Ultrasonic Transmitter. (41) Thyristor Drill Speed Controller. plus 10 Photocell Circuits, Alarms, Modulators, Stabilisers. . .

YORK ELECTRICS, Mail Order Dept.
335 Battersea Park Road, London, S.W.11

Send a S.A.E. for full details, and a brief description of all Kits and Projects.

The BATTERIES That Won't Let You Down! RECHARGEABLE

Mallory Cells
in U2, U11 and
Penlite U7 sizes,
Kestrel Battery
Charging Unit



Uses:
Tape recorders, Portable
radio and TV, Radio controlled model
aircraft and boats, Cine cameras, Flashguns,
Cordless shavers and other battery appliances.

Whenever you must have
utterly dependable battery
power—then these new
Alkaline-Manganese re-
chargeable cells will pro-
vide it. The cells can be
recharged many times, a
simple job with the Kestrel
Charging Unit which has
been specially designed for
these new type batteries.

PRICES
Batteries U2
equiv. £1-38

Penlite U7
equiv. 50p

U11 equiv.
£1-03

Charging
unit £3-99
with one
battery
holder

KESTREL

Send to:
275 WEST END LANE
LONDON, N.W.6
01-794 9611

Bush & Meissner

U.H.F. T.V. AERIALS

SUITABLE FOR COLOUR AND MONO-
CHROME
RECEPTION

All U.H.F. aerials
now fitted
with tilting
bracket and 4
element
reflector.

LOFT MOUNTING ARRAYS
7 element 2-25. 11 element 2-75.
14 element 3-25. 18 element 3-75.

**WALL MOUNTING c/w
WALL ARM & BRACKET**
7 element 3-25. 11 element 3-75. 14 element
4-25. 18 element 4-75. **CHIMNEY MOUNTING
ARRAYS c/w MAST & LASHING
KIT.** 7 element 4-00. 11 element 4-50.

14 element 4-75. 18 element 5-25. **MAST
MOUNTING arrays only.** 7 element 2-25.
11 element 2-75. 14 element 3-25. 18
element 3-75. Complete assembly instructions
with every aerial. **LOW LOSS** coaxial cable
9np yd. **KING TELEBOOSTERS** from 3-75.
LABGEAR all band V.H.F.—U.H.F.—F.M.
radio mains operated pre-amps 7-50. State
clearly channel number required on all
orders. P.p. on all aerials 50np. Accs. 15np
C.W.O. Min. C.O.D. charge 25np.

BBC—ITV—FM AERIALS
BBC (band 1) Wall S/D 2-00. LOFT inverted
'T' 1-25. EXTERNAL 'H' array only 3-00.
ITV (band 3) 5 element loft array 2-50.
7 element 3-00. **COMBINED BBC—ITV.**
loft 1+5 2-75. 1+7 3-50. **WALL & CHIM-
NEY UNITS ALSO AVAILABLE.** Pre-amps
from 3-75. **COMBINED U.H.F.—V.H.F.**
aerials 1+5+9 4-00. 1+5+14 4-50.
1+7+14 5-00. **F.M. RADIO** loft S/D 1-00
3 element 3-25. 4 element 3-50. Standard
coaxial plugs 9np. Coaxial cable 5np yd.
Outlet box 30np. P.p. all aerials 50np.
Accs. 30np. C.W.O. Min. C.O.D. charge
25np. Send 5np for fully illustrated lists.

**CALLERS WELCOMED
OPEN ALL DAY SATURDAY**

K.V.A. ELECTRONICS
40-41 MONARCH PARADE, LONDON
ROAD, MITCHAM, SURREY
Telephone 01-648 4884

GEIGER COUNTERS

(FOR MAINS OR PORTABLE BATTERY USE)



Latest Home Office
release and probably
the last of this well
known Contamination
Meter No. 1, this very
useful instrument is
used for the measure-
ment of Radio-
activity. Indicated on
an internal Meter
scaled 0-1 to 10 mill
Rontgens/Hour, a
socket is also provided
for additional sound
Monitoring on Head-
phones. This Instru-
ment is housed in a
Strong light Alloy
Case, placed in a carrying
Haversack with
shoulder strap. Containing
Cable and Hand held
Probe, Instruction Card,
plus the latest plug in
Vibrator Power Unit, which
uses current small
Transistor Radio Batteries
(4 Mallory Long Life
RM12 or 4 EverReady H.P.7
or equivalent makes).
For Mobile use anywhere.
(Cost Gov. approx. £70
each). Supplied Brand New
in Carton only £5-50
car. 50p. An additional plug
in Power Unit for
Laboratory use, operating
from 100-250 volts or
200-250 volts A.C. Mains
is available. Supplied
Brand New in Carton at
only £2-50 post 25p.
Headphones (not neces-
sary) if required £1-50.
A few Geiger Counters as
above but not boxed in
cardboard cartons, avail-
able at only £4-50.

**Meter Dose Rate Portable
Trainer No. 1**
This was used to train in
the use of Geiger Counters.
A very compact selfcon-
tained Geiger Counter,
being very sensitive.
Radiation indicated on
Internal Meter scaled 0 to
3 Rontgens/Hour x 10-4. Unit

contained in Waterproof Alloy Case,
which is hand held. Uses Internal
Batteries (4 EverReady B105
and I U2 or equivalent makes)
Not Supplied. These had little or
practically no use, supplied as
New in Cartons. Few only £3-50
car. 50p.

JOHNS RADIO
Dept. D, 424 Bradford Road,
Batley, Yorks. Phone Batley 7732

Disco SOUND & LIGHTING EQUIPMENT

from 4 SPECIALISED DISCO STUDIOS



HIGH POWER SPEAKER SYSTEMS

Strong leather cloth finish 1" board, fully lagged. Fitted high efficiency 8 or 16 ohm speakers.

- PRINCE. 50 watt rms. 12". Size 24" x 16" x 12".
- CONSORT. 100 watt rms. 2-12" speakers. Size 36" x 18" x 12".
- MAJESTIC. 100 watt rms. 15" Crescendo. Size 38" x 24" x 15".
- SOVEREIGN. 100 watt rms. 18" Bass, 12" Full range. Size 50" x 26" x 14".

FULL RANGE OF MICROPHONES, STANDS, ETC. ALWAYS IN STOCK

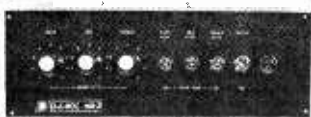

SOUND CONTROLLED AND SOUND TO LIGHT UNITS

Mid, Treble and Bass Channels, up to 1kw of lamps per channel plus override switching.

- DJ30L. Sound to light. Takes output from most amplifiers. Adjustable levels.
- DJ40L. Sound controlled version. Built in microphone, no connections required.

ASSEMBLED DISCOTHEQUES

DISCO-FLINTH. Consists of 2 turntables fitted with high quality ceramic cartridges. The unit has a built in cross-fade rotary control for transferring the sound from left to right decks. The unit has no amplification built in and must be used with amplifiers such as the D.J. 105S or D.J. 70S. Size 32" x 14 1/2" x 7" (incl. lid). **£55-00**

DISCO-IMP. The latest addition to the Disco-sound Range of discotheques. Even smaller and more compact than the Disco-Mini, it contains all the necessary features for the smooth running of a mobile unit. Size 29" x 18 1/2" x 7". **£79-00**

DISCO-MINI. Complete portable Disco with built-in full function pre-amplifier/mixer. For use with any power amplifier such as "Discmaster". Size 30" x 20" x 8". **£98-50**

DISCO-STANDARD. Has all the facilities of the Disco-Mini with the addition of a built-in 100 watt power amplifier making it a completely self contained disco unit. A V.U. meter gives visual indication of output levels. Size 32" x 27" x 7 1/2". **£180-00**

DISCO-SUPER. A slightly larger version of the Disco-Standard. Fitted individual controls for both mic. and deck inputs plus a cross-fade for deck to deck transfer. A built in P.F.L. cueing system, mic. over-ride, also a V.U. meter gives visual indication of output levels. DJ. 30L (3000w) 3-channel psychedelic light unit is a standard fitting. Deck cut out switches are also featured for ease of cueing. Size 38" x 27" x 10". **£224-00**

DISCO-SUPREME. All facilities of the Disco-Super plus a third turntable which can be used for Jingles or other effects without using the main deck system. Flexi lights are also fitted. Size 50" x 27" x 10". **£261-00**

PA-DISCO AMPLIFIERS



DISCO-AMP. 100 watt rms. output for 8-16 ohms, 4 channel inputs, 2-mic, 2 decks. Separate volume control plus masters. Response 30Hz -30KHz, distortion less than 1%. Treble/Bass/PFL/Mic over-ride etc. Panel size 16 1/2" x 7".

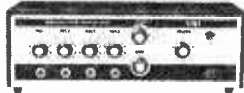

DJ.70S MIXER/AMPLIFIER. 70 watt rms. output for 8-16 ohms. 2-mic, 2-aux/decks. Master volume/Bass/Treble. Size 15 1/2" x 5" x 6".

DJ.105S. 30 watt rms. version. Size 11 1/2" x 5" x 6".
DISCMaster SLAVE AMPLIFIER. 100 watt rms. for 8-16 ohms. **£59-50**

NEW D.J. 500 SERIES P.A. AMPLIFIERS 50 WATT, 70 WATT & 100 WATT MODELS

This new range incorporates many features that make them ideal for the professional user, clubs, discotheques, factories etc. Fibre glass P.C. Boards are used throughout with low noise silicon transistors, high stability resistors, generously rated components and hand welded assembly to ensure reliability and quality.

- ★ Exclusive "Fail Safe" Electronic Protection circuit.
- ★ Fault Condition warning lamp.
- ★ Built in bass boost below 30 Hz.
- ★ 4 channel mixer with slider controls.

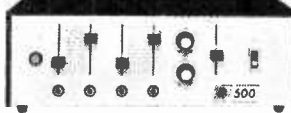

All three amplifiers have a built in emitter follower output socket for connecting a slave amplifier to enable the power output to be increased up to 1000 watts or more if required. A matching range of slave power amplifiers and a separate matching 100v line transformer is available

SPECIFICATION

Frequency Response	50-20,000 Hz ± 3db (10dB Bass Boost at 10 Hz)	50 watts R.M.S. £58-95
Signal/Noise Ratio	better than -50db.	70 watts R.M.S. £67-50
Harmonic Distortion	less than 1%	100 watts R.M.S. £79-00
Speaker Impedance	8-16 ohms.	
Inputs: Mic 1 & 2	5mV at 50K ohms (50 or 600 ohm to order)	
Aux 3 & 4	100mV at 1 meg ohm.	
Size (all models)	15 1/2" x 5" x 6".	

DISCO MINI

Hardly larger than a suitcase yet contains all the necessary features for a high quality mobile unit. The pre-amp has separate tone controls for both mic. and decks, and each input has its own individual volume controls and inputs, plus the addition of a cross fade for deck to deck sound transfer. A built in P.F.L. system for cueing, together with mic-over-ride facility are standard on all units. Response 20-20,000 Hz. Mic. input 5mV. 50K. Output 1 volt.
McDonald M.P.60 Turntables are used with high quality ceramic cartridges, and each deck has its own individual cut out switch fitted. This unit is suitable for Discos or Clubs having a power amplifier, or for use with the "Discmaster" 100 watt power amplifier as above. Size 32" x 20" x 8". **£98-50**.



EFFECTS PROJECTORS

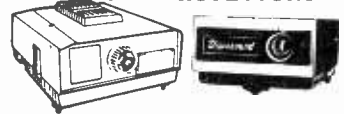

A small selection from our vast stock.

- DISCO COLT.** 150 watt.
- LIQUIMATIC MINI.** 50 watt Q1 with 8" wheel.
- DISCO WHEEL.** 50 watt Q1 with quick change Cassette.
- GNOME 150.** 150 watt Q1 with Cassette.
- LIQUIMATIC.** 150 watt Q1 with 6" wheel.
- PLUTO TUTOR-2.** 250 watt Q1 with Cassette and 8" wheel.
- TUTOR-2.** with Liquidlode Tank.
- KALEDOSCOPE LENS** (for Tutor-2) w/ Liquid Wheel and Crystal Wheel Liquid Cassette and Moire (24 different types to choose from). Portable Hi-Power Strobes.

YOU WILL BE SURPRISED BY THE LOW PRICES & PERFORMANCE

SDL POWER SPEAKERS

High efficiency 12" speakers. Ferrite magnets. Heavy duty voice coils and cones for Disco and Group use.
12" 50 watt rms. 8 ohm Full range.
12" 25 watt rms. 15 ohm Mid-Treble.
15" 50 watt rms. 15 ohm. Full range.
15" 100 watt rms. 15 ohm. Bass.
18" 100 watt rms. 15 ohm. Bass.

DISCO SPOT BANK



Designed to take three E/8 Type spot or colour bulbs up to 150 watts each. The unit is of all metal construction and has one 3-pin mains input socket plus one 3-pin main-output socket for connecting more than one bank together if required. The unit can be left free-standing or wall mounted if needed. Black crackle finish gives the unit a very professional appearance.

Size 18" x 6" x 7" (excluding bulbs)
Also in stock: Ultra Violet Spot Lamps and Fluorescent Lamps, Standard and Colour Spot Lamps and Fittings, Rotating Colour Displays, Flexilights, Fibre Optics, Dimmers, Flashers Effects Folia, etc. Your enquiries invited.

MIXER UNITS

- DJ.101.** Battery powered, 6-channel, variable levels, 3 x 50k mic., 1 x 100mV. aux., 2 x 100mV p.u. Output 250mV.
- DJ.102.** Mains operated, 4-channel, variable levels, 2 x 50k mic., 2 x 100mV p.u. PFL control, master volume, mic. over-ride, output variable 0-500mV.
- DISCO 40.** Pre amp part of Disco amp (see above). All facilities. Output will drive up to ten 100 watt amplifiers.

<h3>Discoscene</h3> <p>536, Sutton Road, Southend, Essex. (0702) 611577</p>	<h3>Discosound</h3> <p>122, Balls Pond Road, London, N.1. (01) 254 5779</p>	<h3>Discosound</h3> <p>(Birmingham) Ltd. 494, Bristol Road, Selly Oak, B'ham 29. (021) 472 1141</p>	<h3>Henry's Disco</h3> <p>309, Edgware Road, London, W.2. (01) 723 6963</p>
<p>CHECK WITH YOUR NEAREST STUDIO FOR LATEST PRICES AND DETAILS (TRADE AND RETAIL SUPPLIED)</p>			

BIG CASH SAVINGS on partridge equipment when you order TRIO—

BUY NOW BEFORE V.A.T. & THE ADVANCING YEN PUT A PREMIUM ON YOUR PLEASURE!

PARTRIDGE PACKAGE NO. 1

9R59DS receiver	£49.50
Matching headphones	FREE
JOYSTICK VFA 1972 Model	FREE*
JOYMATCH 111 or 111A	£11.00
8ft feeder, insulators, P/P, Insurance	FREE

Complete Receiving Station

PARTRIDGE PACKAGE NO. 3

JR 599 receiver	£185.00
Matching headphones	FREE
JOYSTICK VFA 1972 model	FREE*
JOYMATCH 111 or 111A	FREE*
8ft feeder, insulators, P/P, Ins.	FREE

Complete Receiving Station

PARTRIDGE PACKAGE NO. 2

JR 310 receiver	£75.00
Matching headphones	FREE
JOYSTICK VFA 1972 model	FREE
JOYMATCH 111 or 111A	£7.00*
8ft feeder, insulators, P/P Ins.	FREE

Complete Receiving Station

PARTRIDGE PACKAGE No. 4

TS/PS 515 Transceiver	£210.00
Matching headphones	FREE
JOYSTICK VFA 1972 Model	FREE*
JOYMATCH LO-2500 ATU	FREE*
8ft feeder, insulators, P/P, Ins.	FREE

Complete TX/RX Station

*PACKAGE REDUCTIONS ON PARTRIDGE SYSTEMS

9R59DS PLUS HIGH QUALITY, LIGHTWEIGHT MATCHING HEADPHONES £49.50 DELIVERED

TRIO LINEAR TL911 £140.00: MATCHING HEADPHONES £2.40 (+20p): TRIO TR71002M, CAR TRANSCIEVER £99.50: TRIO TR22002M Personal transceiver £82.50: CW filter (for TS515) £14.00: 10AZ filter (for JR310) £7.34: 100kHz (Calibration Crystal) £3.18: OAZ (Mains Stabiliser) £0.87: B1016L P.T.T. HAND MIC. (for TS515) £3.38.

PARTRIDGE JOYSTICK VFA's: 1972 Model £11.00 (+ 40p): 1971 Model £8.00 (+ 40p): Indoor model £7.00 (+ 40p): JOYMATCH ATU's—111 and 111A (£11.00 (+ 40p)): LO-Z500 £16.00 (+ 45p).

PARTRIDGE BUDGET LINE:—

DUAL PURPOSE ARTIFICIAL EARTH/AERIAL BANDSWITCH (complete Aerial & ATU system, or Artificial Earth—your choice) £4.50 (+ 30p): TRIPLE PURPOSE 6 BAND ATU in KIT FORM (6 amateur and 11 BC bands) £4.50 (+ 30p): TRIPLE PURPOSE 6 BAND ATU assembled £5.50 (+ 30p): CARRIAGE AND INSURANCE EXTRA FOR OVERSEAS ORDERS.

Send 3p stamp for full illustrated details of Partridge products.

TRIO leaflets on request.

BOX 5, PARTRIDGE ELECTRONICS LTD, BROADSTAIRS, KENT

Phone: 0843 62535—Cheap periods 0843 62839 for advice and COD orders.

TEXAN 20+20 WATT. STEREO AMPLIFIER

Electro Spares can now supply all the components to build the "Texan" Amplifier, featured in *Practical Wireless* May/June 1972. All components are brand new with fibre glass p.c. board, all metalwork, knobs, finished silver trim front panel, etc. etc.

TOTAL COST OF COMPLETE COMPONENTS ONLY £27.85—POST FREE!

All components are available separately, to enable the constructor to obtain just what parts he requires at any one time. Please send S.A.E. for free list.

SPECIAL CONTEMPORARY STYLE SLIMLINE METAL CASE WITH WOODEN END CHEEKS IS NOW AVAILABLE FOR THIS AMPLIFIER—DETAILS INCLUDED WITH ALL LISTS, OR AVAILABLE ON RECEIPT OF S.A.E.

P. E. 'GEMINI' STEREO AMPLIFIER

30 Watts (R.M.S.) per Channel into 8 Ohms !!
Total Harmonic Distortion 0.02% !!
Frequency Response (-3 dB) 20Hz-100kHz !!

This high quality Stereo Amplifier for the Home Constructor was described in a series of articles in "Practical Electronics", from November 1970 to March 1971. It is now recognised as practically the ultimate in High Fidelity and is certainly equal to anything one can buy, no matter what the cost, but it is well within the capabilities of the ambitious constructor.

We can now supply a reprint of the articles in booklet form, price 55p plus 4p postage, with free complete component price list.

For free price list only, or a complete free specification, please send a foolscap size S.A.E.

All parts available separately.



ELECTRO SPARES

21 BROOKSIDE BAR,
CHESTERFIELD, DERBYSHIRE.
QUALITY • SERVICE • VALUE

GUNTON ELECTRONIC IGNITION KIT £7.95 + 35p P. & P.

READY BUILT UNIT GUARANTEED 5 YEARS £9.95 + 35p P & P
Patents pending. 12 volt only—state pos. or neg. earth
Capacitive discharge Ignition is recognised as being the most efficient system and will give you:

- ★ Continual Peak-Tuned Performance
- ★ Continual Peak Performance
- ★ Up to 20% reduced fuel consumption
- ★ Easier All-weather Starting
- ★ Increased Acceleration and Top Speed
- ★ Longer Spark Plug Life
- ★ Increased Battery Life
- ★ Elimination of Contact Breaker Burn
- ★ Purer Exhaust Gas Emission

Kit includes absolutely everything for assembly: Case, Cables, Coil Connectors, Silicon Grease, etc. 8 page illustrated instructions cover fitting of all Types of Tachometers. Call in for a Workshop Demonstration. S.A.E. all enquiries please or Phone 33652 (many letters from satisfied customers). DEPT. PW

ELECTRONICS DESIGN ASSOCIATES
82 BATH STREET, WALSALL WS1 3DE

If you have difficulty in obtaining

PRACTICAL WIRELESS

Please place a regular order with your newsagent or send 1 year's subscription (£2.65) to:—

Subscription Department,
Practical Wireless,
Tower House, Southampton Street,
London, WC2E 9QX

SEW PANEL METERS

USED EXTENSIVELY BY INDUSTRY, GOVERNMENT DEPARTMENTS, EDUCATIONAL AUTHORITIES, ETC.
 ● LOW COST ● QUICK DELIVERY ● OVER 200 RANGES IN STOCK ● OTHER RANGES TO ORDER

NEW "SEW" DESIGNS!

CLEAR PLASTIC METERS

TYPE SW.100
100 x 80 mm.

50μA	\$3-80
50-0-50μA	\$3-80
100μA	\$3-80
100-0-100μA	\$3-70
500μA	\$3-80
1mA	\$3-40

20V. D.C.	\$3-40
50V. D.C.	\$3-40
300V. D.C.	\$3-40
1 amp. D.C.	\$3-40
5 amp. D.C.	\$3-40
300V. A.C.	\$3-40
VU Meter	\$4-15

BAKELITE PANEL METERS

TYPE S-80
80 mm.

50μA	\$3-50
50-0-50μA	\$3-40
100μA	\$3-40
100-0-100μA	\$3-30
500μA	\$3-05
1mA	\$2-85
20V. D.C.	\$2-85
50V. D.C.	\$2-85
300V. D.C.	\$2-85
1 amp. D.C.	\$2-85
5 amp. D.C.	\$2-85
300V. A.C.	\$2-85
VU Meter	\$3-70

"SEW" CLEAR PLASTIC METERS

Type MR.85P. 1 2 1/2" x 4 1/2" fronts.

200mA	\$3-10
100mA	\$3-10
500mA	\$3-10
1 amp.	\$3-10
5 amp.	\$3-10
15 amp.	\$3-20
80 amp.	\$3-20
20V. D.C.	\$3-10
50V. D.C.	\$3-10
100V. D.C.	\$3-10
300V. D.C.	\$3-10
300V. A.C.	\$3-10
300V. A.C.	\$3-10
8 Meter 1mA	\$3-15
VU Meter	\$3-95
500-0-500μA	\$3-10
1mA	\$3-10
5 amp. A.C.*	\$3-10
10 amp. A.C.*	\$3-10
30 amp. A.C.*	\$3-10
10mA	\$3-10

Type MR.85P. 2 1/2" square fronts.

50μA	\$3-40
50-0-50μA	\$2-85
100μA	\$2-85
100-0-100μA	\$2-75
500μA	\$2-55
1mA	\$2-50
5mA	\$2-50
10mA	\$2-50
50mA	\$2-50
100mA	\$2-50
500mA	\$2-50
1 amp.	\$2-50
5 amp.	\$2-50

Type MR.85P. 3 1/2" x 3 1/2" fronts.

50μA	\$3-70
50-0-50μA	\$3-00
100μA	\$3-00
100-0-100μA	\$2-90
200μA	\$2-80
500μA	\$2-85
500-0-500μA	\$2-40
1mA	\$2-40
5mA	\$2-40
10mA	\$2-40
50mA	\$2-40
100mA	\$2-40
500mA	\$2-40
1 amp.	\$2-40
5 amp.	\$2-40
10 amp.	\$2-40
15 amp.	\$2-40
20 amp.	\$2-40
30 amp.	\$2-40
50 amp.	\$2-40
5V. D.C.	\$2-40

***MOVING—IRON ALL OTHERS MOVING COIL**
Please add postage

SEW EDUCATIONAL METERS



Type ED.107. Size overall 100mm x 90mm x 108mm.
A new range of high quality moving coil instruments ideal for school experiments and other bench applications. 3" mirror scale. The meter movement is easily accessible to demonstrate internal working. Available in the following ranges:

50μA	\$5-50	20V d.c.	\$4-85
100μA	\$5-10	50V d.c.	\$4-85
1mA	\$4-85	300V d.c.	\$4-85
50-0-50μA	\$5-10			
1-0-1mA	\$4-85	Dual range		
1A d.c.	\$4-85	500mA/5A d.c.	\$5-10
5A d.c.	\$4-85	5V/50V d.c.	\$5-10
10V. d.c.	\$4-85			

Type MR.85P. 1 2 1/2" x 2 1/2" square fronts.

200mA	\$1-75
300mA	\$1-75
500mA	\$1-75
750mA	\$1-75
1 amp.	\$1-75
2 amp.	\$1-75
5 amp.	\$1-75
10 amp.	\$1-75
3V. D.C.	\$1-75
10V. D.C.	\$1-75
15V. D.C.	\$1-75
20V. D.C.	\$1-75
50V. D.C.	\$1-75
100V. D.C.	\$1-75
10V. D.C.	\$1-75
300V. D.C.	\$1-75
500V. D.C.	\$1-75
750V. D.C.	\$1-75
1mA	\$1-85
5mA	\$1-85
10mA	\$1-85
20mA	\$1-85
50mA	\$1-85
100mA	\$1-85
150mA	\$1-85
VU Meter	\$2-80

Type MR.45P. 2 1/2" square fronts.

50μA	\$2-50
50-0-50μA	\$2-30
100μA	\$2-30
100-0-100μA	\$2-20
200μA	\$2-05
500μA	\$1-95
500-0-500μA	\$1-85
1mA	\$1-85
5mA	\$1-85
10mA	\$1-85
50mA	\$1-85
100mA	\$1-85
500mA	\$1-85
1 amp.	\$1-85

"SEW" BAKELITE PANEL METER

Type MR.65. 3 1/2" square fronts.

25μA	\$3-85
50μA	\$3-00
50-0-50μA	\$2-60
100μA	\$2-60
100-0-100μA	\$2-50
500μA	\$2-45
500-0-500μA	\$2-15
1mA	\$2-15
1-0-1mA	\$2-15
5mA	\$2-15
10mA	\$2-15
50mA	\$2-15
100mA	\$2-15
500mA	\$2-15

1 amp.	\$2-15
5 amp.	\$2-15
15 amp.	\$2-15
30 amp.	\$2-15
50 amp.	\$2-15
5V. D.C.	\$2-15
10V. D.C.	\$2-15
20V. D.C.	\$2-15
50V. D.C.	\$2-15
150V. D.C.	\$2-15
300V. D.C.	\$2-15
30V. A.C.*	\$2-20
60V. A.C.*	\$2-20
150V. A.C.*	\$2-20
300V. A.C.*	\$2-20
500mA A.C.*	\$2-15
1 amp. A.C.*	\$2-15
5 amp. A.C.*	\$2-15
10 amp. A.C.*	\$2-15
20 amp. A.C.*	\$2-15
30 amp. A.C.*	\$2-15
50 amp. A.C.*	\$2-15
VU Meter	\$3-40
50 MV D.C.	\$2-40
100 MV D.C.	\$2-40

EDGWISSE METERS		
Type PE.70. 3 1/2" x 1 1/2" x 1 1/2" deep		
50μA	\$3-40
50-0-50μA	\$3-30
100μA	\$3-30
100-0-100μA	\$3-20
200μA	\$3-20
500μA	\$3-20
1mA	\$3-20
500μA	\$3-05
50-0-50μA	\$3-40
100μA	\$3-30
100-0-100μA	\$3-20
200μA	\$3-20
500μA	\$3-20
1mA	\$3-20
500μA	\$3-05
50-0-50μA	\$3-40
100μA	\$3-30
100-0-100μA	\$3-20
200μA	\$3-20
500μA	\$3-20
1mA	\$3-20
500μA	\$3-05
50-0-50μA	\$3-40
100μA	\$3-30
100-0-100μA	\$3-20
200μA	\$3-20
500μA	\$3-20
1mA	\$3-20
500μA	\$3-05
50-0-50μA	\$3-40
100μA	\$3-30
100-0-100μA	\$3-20
200μA	\$3-20
500μA	\$3-20
1mA	\$3-20
500μA	\$3-05
50-0-50μA	\$3-40
100μA	\$3-30
100-0-100μA	\$3-20
200μA	\$3-20
500μA	\$3-20
1mA	\$3-20
500μA	\$3-05
50-0-50μA	\$3-40
100μA	\$3-30
100-0-100μA	\$3-20
200μA	\$3-20
500μA	\$3-20
1mA	\$3-20
500μA	\$3-05
50-0-50μA	\$3-40
100μA	\$3-30
100-0-100μA	\$3-20
200μA	\$3-20
500μA	\$3-20
1mA	\$3-20
500μA	\$3-05
50-0-50μA	\$3-40
100μA	\$3-30
100-0-100μA	\$3-20
200μA	\$3-20
500μA	\$3-20
1mA	\$3-20
500μA	\$3-05
50-0-50μA	\$3-40
100μA	\$3-30
100-0-100μA	\$3-20
200μA	\$3-20
500μA	\$3-20
1mA	\$3-20
500μA	\$3-05
50-0-50μA	\$3-40
100μA	\$3-30
100-0-100μA	\$3-20
200μA	\$3-20
500μA	\$3-20
1mA	\$3-20
500μA	\$3-05
50-0-50μA	\$3-40
100μA	\$3-30
100-0-100μA	\$3-20
200μA	\$3-20
500μA	\$3-20
1mA	\$3-20
500μA	\$3-05
50-0-50μA	\$3-40
100μA	\$3-30
100-0-100μA	\$3-20
200μA	\$3-20
500μA	\$3-20
1mA	\$3-20
500μA	\$3-05
50-0-50μA	\$3-40
100μA	\$3-30
100-0-100μA	\$3-20
200μA	\$3-20
500μA	\$3-20
1mA	\$3-20
500μA	\$3-05
50-0-50μA	\$3-40
100μA	\$3-30
100-0-100μA	\$3-20
200μA	\$3-20
500μA	\$3-20
1mA	\$3-20
500μA	\$3-05
50-0-50μA	\$3-40
100μA	\$3-30
100-0-100μA	\$3-20
200μA	\$3-20
500μA	\$3-20
1mA	\$3-20
500μA	\$3-05
50-0-50μA	\$3-40
100μA	\$3-30
100-0-100μA	\$3-20
200μA	\$3-20
500μA	\$3-20
1mA	\$3-20
500μA	\$3-05
50-0-50μA	\$3-40
100μA	\$3-30
100-0-100μA	\$3-20
200μA	\$3-20
500μA	\$3-20
1mA	\$3-20
500μA	\$3-05
50-0-50μA	\$3-40
100μA	\$3-30
100-0-100μA	\$3-20
200μA	\$3-20
500μA	\$3-20
1mA	\$3-20
500μA	\$3-05
50-0-50μA	\$3-40
100μA	\$3-30
100-0-100μA	\$3-20
200μA	\$3-20
500μA	\$3-20
1mA	\$3-20
500μA	\$3-05
50-0-50μA	\$3-40
100μA	\$3-30
100-0-100μA	\$3-20
200μA	\$3-20
500μA	\$3-20
1mA	\$3-20
500μA	\$3-05
50-0-50μA	\$3-40
100μA	\$3-30
100-0-100μA	\$3-20
200μA	\$3-20
500μA	\$3-20
1mA	\$3-20
500μA	\$3-05
50-0-50μA	\$3-40
100μA	\$3-30
100-0-100μA	\$3-20
200μA	\$3-20
500μA	\$3-20
1mA	\$3-20
500μA	\$3-05
50-0-50μA	\$3-40
100μA	\$3-30
100-0-100μA	\$3-20
200μA	\$3-20
500μA	\$3-20
1mA	\$3-20
500μA	\$3-05
50-0-50μA	\$3-40
100μA	\$3-30
100-0-100μA	\$3-20
200μA	\$3-20
500μA	\$3-20
1mA	\$3-20
500μA	\$3-05
50-0-50μA	\$3-40
100μA	\$3-

SEMI-CONDUCTOR TRANSISTORS & VALVES

ALL DEVICES BRAND NEW AND FULLY GUARANTEED

Transistors			
2C301	20p	2N3415	22p
2C302	20p	2N3417	27p
2C303	20p	2N3439	130p
2C306	42p	2N3564	17p
2C308	42p	2N3655	15p
2C309	30p	2N3635	22p
2C371	15p	2N3628	25p
2C374	20p	2N3629	25p
2C381	22p	2N3570	125p
2N388A	42p	2N3572	97p
2N404	15p	2N3605	27p
2N406	15p	2N3606	27p
2N697	15p	2N3607	22p
2N698	25p	2N3638	15p
2N699	30p	2N3638A	20p
2N706	12p	2N3641	15p
2N708	15p	2N3642	15p
2N718	20p	2N3645	25p
2N718A	20p	2N3691	15p
2N728	30p	2N3692	15p
2N727	30p	2N3693	15p
2N744	17p	2N3704	18p
2N916	17p	2N3711	12p
2N918	20p	2N3703	10p
2N929	22p	2N3704	11p
2N930	20p	2N3705	10p
2N987	40p	2N3706	9p
2N990	25p	2N3707	11p
2N1091	25p	2N3708	17p
2N1131	25p	2N3709	9p
2N1132	25p	2N3710	9p
2N1302	17p	2N3711	12p
2N1303	17p	2N3713	18p
2N1304	22p	2N3714	20p
2N1306	25p	2N3716	130p
2N1307	25p	2N3732	240p
2N1308	25p	2N3791	200p
2N1309	25p	2N3819	34p
2N1607	17p	2N3820	55p
2N1613	20p	2N3821	55p
2N1631	30p	2N3854	27p
2N1632	30p	2N3854A	27p
2N1637	30p	2N3855	27p
2N1638	27p	2N3855A	30p
2N1639	27p	2N3856	30p
2N1701	15p	2N3858	35p
2N1711	24p	2N3858A	40p
2N1889	32p	2N3859	37p
2N1893	37p	2N3859A	32p
2N2147	72p	2N3860	57p
2N2160	57p	2N3861	50p
2N2161	57p	2N3862	50p
2N2193A	42p	2N3864	50p
2N2194	47p	2N3877A	40p
2N2194A	30p	2N3900	37p
2N2217	25p	2N3900A	40p
2N2218	20p	2N3901	97p
2N2219	20p	2N3903	80p
2N2220	25p	2N3904	80p
2N2221	25p	2N3905	30p
2N2222	20p	2N3906	25p
2N2222A	25p	2N4058	12p
2N2297	30p	2N4059	10p
2N2368	15p	2N4060	12p
2N2369	15p	2N4061	12p
2N2369A	15p	2N4062	12p
2N2410	42p	2N4244	17p
2N2483	27p	2N4248	15p
2N2484	27p	2N4249	15p
2N2539	22p	2N4250	15p
2N2540	22p	2N4251	15p
2N2613	20p	2N4252	15p
2N2614	20p	2M4284	17p
2N2646	40p	2N4285	17p
2N2711	25p	2N4286	17p
2N2712	25p	2N4287	17p
2N2713	27p	2N4288	15p
2N2714	30p	2N4289	17p
2N2904	20p	2N4290	13p
2N2904A	25p	2N4291	15p
2N2905	25p	2N4292	15p
2N2905A	25p	2N4294	17p
2N2906	25p	2N4303	17p
2N2906A	25p	2N4304	17p
2N2907	25p	2N4305	17p
2N2923	15p	2N5027	52p
2N2924	15p	2N5028	52p
2N2925	15p	2N5029	47p
2N2926	10p	2N5030	42p
2N2926A	10p	2N5032	42p
2N2926B	10p	2N5034	42p
2N3011	20p	2N5175	52p
2N3014	32p	2N5176	52p
2N3053	18p	2N5232A	40p
2N3054	40p	2N5233	40p
2N3055	60p	2N5234	40p
2N3133	30p	2N5249	67p
2N3134	15p	2N5255	82p
2N3135	25p	2N5305	37p
2N3136	25p	2N5306	40p
2N3390	25p	2N5307	40p
2N3391	25p	2N5308	40p
2N3392	17p	2N5310	42p
2N3393	15p	2N5354	27p
2N3394	15p	2N5355	27p
2N3402	25p	2N5356	27p
2N3403	25p	2N5357	27p
2N3404	25p	2N5358	27p
2N3405	45p	2N5357	27p
2N3414	22p	2N5457	30p

Integrated Circuits			
CA3000	180p	FJH111	70p
CA3005	170p	FJH112	25p
CA3007	282p	FJH113	25p
CA3012	82p	FJH114	25p
CA3012	75p	FJH115	25p
CA3013	105p	FJH221	25p
CA3014	124p	FJH223	25p
CA3018	84p	FJH224	25p
CA3018A	84p	FJH225	25p
CA3019	84p	FJH226	25p
CA3020	124p	FJH227	25p
CA3020A	124p	FJH228	25p
CA3021	180p	FJH229	25p
CA3021	180p	FJH230	25p
CA3022	180p	FJH231	25p
CA3026	100p	FJH232	25p
CA3028A	74p	FJH233	25p
CA3028B	74p	FJH234	25p
CA3029	105p	FJH235	25p
CA3029A	105p	FJH236	25p
CA3030	180p	FJH237	25p
CA3030	180p	FJH238	25p
CA3030	180p	FJH239	25p
CA3030	180p	FJH240	25p
CA3030	180p	FJH241	25p
CA3030	180p	FJH242	25p
CA3030	180p	FJH243	25p
CA3030	180p	FJH244	25p
CA3030	180p	FJH245	25p
CA3030	180p	FJH246	25p
CA3030	180p	FJH247	25p
CA3030	180p	FJH248	25p
CA3030	180p	FJH249	25p
CA3030	180p	FJH250	25p
CA3030	180p	FJH251	25p
CA3030	180p	FJH252	25p
CA3030	180p	FJH253	25p
CA3030	180p	FJH254	25p
CA3030	180p	FJH255	25p
CA3030	180p	FJH256	25p
CA3030	180p	FJH257	25p
CA3030	180p	FJH258	25p
CA3030	180p	FJH259	25p
CA3030	180p	FJH260	25p
CA3030	180p	FJH261	25p
CA3030	180p	FJH262	25p
CA3030	180p	FJH263	25p
CA3030	180p	FJH264	25p
CA3030	180p	FJH265	25p
CA3030	180p	FJH266	25p
CA3030	180p	FJH267	25p
CA3030	180p	FJH268	25p
CA3030	180p	FJH269	25p
CA3030	180p	FJH270	25p
CA3030	180p	FJH271	25p
CA3030	180p	FJH272	25p
CA3030	180p	FJH273	25p
CA3030	180p	FJH274	25p
CA3030	180p	FJH275	25p
CA3030	180p	FJH276	25p
CA3030	180p	FJH277	25p
CA3030	180p	FJH278	25p
CA3030	180p	FJH279	25p
CA3030	180p	FJH280	25p
CA3030	180p	FJH281	25p
CA3030	180p	FJH282	25p
CA3030	180p	FJH283	25p
CA3030	180p	FJH284	25p
CA3030	180p	FJH285	25p
CA3030	180p	FJH286	25p
CA3030	180p	FJH287	25p
CA3030	180p	FJH288	25p
CA3030	180p	FJH289	25p
CA3030	180p	FJH290	25p
CA3030	180p	FJH291	25p
CA3030	180p	FJH292	25p
CA3030	180p	FJH293	25p
CA3030	180p	FJH294	25p
CA3030	180p	FJH295	25p
CA3030	180p	FJH296	25p
CA3030	180p	FJH297	25p
CA3030	180p	FJH298	25p
CA3030	180p	FJH299	25p
CA3030	180p	FJH300	25p

VALVES			
OA2	38p	2S24	30p
OB2	45p	2S25	42p
OZ4	30p	2S26	42p
1L4	20p	30C15	80p
1B5	30p	30C17	80p
1B5	30p	30C18	80p
1T4	25p	30F5	80p
IU4	30p	30FL1	75p
IU5	60p	30FL2	120p
2D21	35p	30PL14	92p
3Q4	50p	30L15	55p
3R4	35p	30L17	80p
3V4	40p	30P12	80p
6R4	75p	30P19	55p
5U4	35p	30PL1	75p
5V4	45p	30PL13	92p
5Y3	40p	30PL14	92p
6Z4G	40p	35L5	60p
6J30L2	80p	35W4	35p
6AC7	40p	35Z4	35p
6A07	40p	35Z5	50p
6AK5	35p	60B5	50p
6AK6	60p	50C5	50p
6AL5	40p	AZ31	40p
6AM6	30p	85A2	40p
6AQ5	30p	807	60p
6A86	40p	16Z5	50p
6AT76	35p	5763	70p
6AV6	25p	6146	150p
6B6	40p	6748	60p
6BA8	25p	CY31	35p
6BE6	30p	DAF91	30p
6B76	75p	DAF96	45p
6BH6	60p	DF91	22p
6BQ7A	40p	DF96	45p
6BR8	70p	DK92	55p
6BW6	85p	DK96	60p
6BW7	30p	DL92	35p
6BZ6	40p	DL94	45p
6CA	33p	DL96	45p
6CD6	125p	EL90	40p
6CLW4	50p	DY86	32p
6CWA	65p	DY87	32p
6F1	62p	E880C	100p
6F6G	35p	E180F	100p
6F13	45p	EACB80	35p
6FAF42	75p	EAF42	35p
6F15	60p	EB91	20p
6F18	50p	EBC41	55p
6F23	55p	ECB81	30p
6H6	17p	EDF80	40p
6J4	50p	EFB83	40p
6J5	25p	EFB89	32p
6J5GT	60p	EJ5GT	60p
6K6	30p	ECB8	60p
6K8G	40p	EC88	60p
6L6GT	45p	EC840	65p
6L9D20	40p	EC85	40p
6Q2	40p	EC88	40p
68A7	40p	ECF80	35p
68G7	40p	ECF82	35p
68J7	40p	ECF86	50p
68K7	40p	ECH21	57p
68L7	35p	ECH35	100p
68N7	35p	ECH42	70p
68P7	40p	ECH47	30p
68Q7	40p	ECB8	60p
6U4	65p	ECH83	45p
6V6G	25p	ELC85	45p
6V6GT	32p	ELC82	35p
6X4	45p	ELC83	70p
6X6G	30p	ELC86	40p
10C2	50p	EK552	30p
10F1	75p	EF40	50p
10P13	60p	EF41	50p
10P14	11.0p	EF42	70p
12AT6	30p	EF80	25p
12AU7	30p	EF86	30p
12AX7	30p	EF89	25p
12AV6	40p	EF91	30p
12BA6	40p	EF92	35p
12BE6	40p	EF83	35p
12BH7	45p	EF84	35p
12BY6	45p	EF95	35p
20D1	50p	EL34	50p
20F2	65p	EL41	60p
20L1	11.0p	EL42	65p
20P1	60p	EL81	55p
20P3	60p	EL84	25p
20P4	11.0p	EL85	45p
20P5	11.0p	EL81	55p
25L6	60p	EL96	35p

BRIDGE		50 PIV 4A	40p
RECTIFIERS		100 PIV 4A	50p
PLASTIC		200 PIV 4A	55p
ENCAPSULATED		400 PIV 4A	65p
600 PIV 1A	50p	600 PIV 4A	70p
50 PIV 2A	45p	50 PIV 6A	65p
100 PIV 2A	55p</		

HI-FI EQUIPMENT

SAVE UP TO
33 1/3% OR MORE
SEND S.A.E. FOR
DISCOUNT PRICE LISTS
AND PACKAGE OFFERS!

RECORD DECKS

BSR	
C129†	£8 50
C137*	£8 25
MF60	£10 40
610	£14 07
610	£11 50
810	£9 40
810	£33 45
MP60/G800*	£12 95
MP60 TPD1	£17 12
MP60 TPD1	
G800*	£19 50
MP60 TPD2	£15 40
610 TPD1	£20 35
610 TPD1	£18 20
210/TPD3*	£9 55
HT 70	£14 99
HT70/G800*	£17 25
HT 70 Pack	£21 60
HT70 Pack/	
G800*	£23 95
GARRARD	
2025 T/C*	£8 50
SP25 III	£10 25
SL65B	£13 45
AF76	£18 85
BL72B	£22 95
SL95B	£32 50
401	£28 60
AP96 Module/	
M75-6	£38 75
ZERO 100A	£39 95
ZERO 100B	£37 50

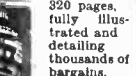
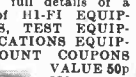
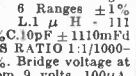
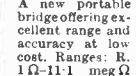
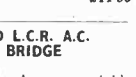
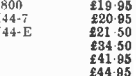
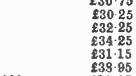
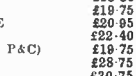
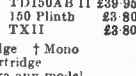
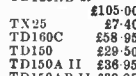
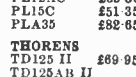
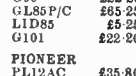
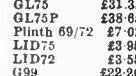
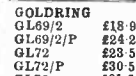

SKYWOOD CX204 COMMUNICATION RECEIVER

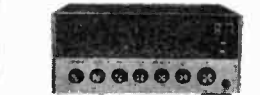

Solid state. Coverage on 5 bands 200-420 KHz and 85 to 30 MHz. Illuminated slide rule dial. Bandspread. Aerial tuning. BFO, AVC, ANL, 'S' meter. AM/CW/SSB. Integrated speaker and phone socket. Operation 220/240V AC or 12v DC. Size 325 x 208 x 150 mm. Complete with instructions and circuit. £28.50. Carr. 50p

TELETON F.2000 AM/FM STEREO TUNER AMPLIFIER



Probably the most popular budget Tuner/Amp. and now offered at a ridiculous low price. 5 watts r.m.s. per channel. Tape/Cer phono inputs. AFC/Built-in MPX. List £51. OUR PRICE £28.75. Carr. 50p.

★ TRANSISTORISED FM TUNER

6 TRANSISTOR HIGH QUALITY TUNER. SIZE ONLY 6x4x2 1/2. 3 I.P. stages. Double tuned discriminator. Ample output to feed most amplifiers. Operates on 9V battery. Coverage 88-108Mc/s. Ready built ready for use. Fantastic value for money. £8.87†. P. & P. 12p. Stereo multiplex adaptors £4.97†.

MP7 MIXER PREAMPLIFIER

5 microphone inputs each with individual gain controls enabling complete mixing facilities. Battery operated. 9 1/2" x 5" x 3". Inputs Mics: 3x 3mV 50K; 2x 3mV 600 ohm. Phono meg. 4mV 50K. Phono ceramic 100mV 1 meg. Output 250mV 100K. £8.87. P. & P. 20p.

SINCLAIR IC-12

List Price £2.98
OUR PRICE £1.80
P. & P. 10p

NS-1600W STEREO AMPLIFIER

Exceptional budget price amplifier. All silicon transistor. Handsome Walnut case. Switched input selector, separate balance, volume, treble, bass controls. Output 2x 6W RMS. Inputs Mag. Tape, Xtal. Tuner, Tape Out. £14.75. Carr. 57p.

BH.001 HEAD SET AND BOOM MICROPHONE

Moving coil. Ideal for language teaching, communications. Headpiece imp. 16 ohms. Microphone imp. 200 ohms. £4.62. P. & P. 15p.



WHARFEDALE MID-RANGE HI-FI UNITS

As used in world famous system. 5" dia. Impedance 4/8 ohms. High flux ceramic magnet. 20 watts rms. Brand new £1-50 Carr. 37p.



EMI LOUSPEAKERS

Model 350. 13" x 8" with single tweeter/crossover. 20,000 Hz. 15 watt RMS. Available 8 or 15 ohms. £7-50 each P. & P. 37p.

MCA.220 AUTOMATIC VOLTAGE STABILISER

Input 88-125 V.A.C. or 175-250V A.C. Output 120V A.C. or 240 VAC. 200 VA rating. £11.97. carr. 50p.



BELCO AF-5A SOLID STATE SINE SQUARE WAVE C.R. OSCILLATOR

Sine 18-200,000 Hz; Square 18-50,000 Hz. Output max +10 dB (10 K ohms) Operation internal batteries Attractive 2-tone case 7 1/2" x 5" x 7". Price £17.50. Carr. 17p.

SINCLAIR EQUIPMENT

Project 60 Package offers.

2 x Z30 amplifier, stereo 60 pre-amp, PZ5 power supply. £15.95 Carr. 37p. Or with PZ8 power supply £18.00 Carr. 37p. 2 x Z50 amplifier, stereo 60 pre-amp, PZ8 power supply £20.25. Carr. 37p. Transformer for PZ8, £2.97† extra. Add to any of the above £4.45 for active filter unit and £13.80 for pair of Q16 speakers. Project 60 FM Tuner £15.75. Carr. 37p. All other Sinclair products in stock. 2000 Amp £21.95 Carr. 37p.; 3000 Amp £28.50 Carr. 37p.; Netic Amp £43.95 Carr. 37p. IC12 £1.80 p. & p. 10p. NEW PROJECT 605—£20.87. Carr. 37p.

230V/240V SMITHS SYNCHRONOUS GEARED MOTORS

Built in gearbox. All brand new and boxed. 60 RPM CW; 30 RPH CW; 2R/HR ACW; 2R/HR CW; 8R/ DAY CW; 10 RPM CW; 20R/HR ACW; 50p each Post 12p.



SDH 8V HI-FI PHONES

Input 8-16 Ohm. Frequency 20-18,000Hz stereo or mono switch, separate volume controls each earpiece, padded headband. £3.97. P. & P. 20p.



HELICAL POTENTIOMETERS

ITT MCPM15 10 TURN 2 1/2 WATTS Available 600 ohm, 1K, 5K ohm. £1.25 each P. & P. 15p.

POWER RHEOSTATS

High quality ceramic construction. Windings embedded in vitreous enamel. Heavy duty brush wiring. Continuous rating. Wide range ex-stock. Single hole fixing. Im. dia. shafts. Bulk quantities available. 25 WATT. 10/25/50/100/250/500/1000/2500 or 5000 ohms, 90p. P. & P. 7p. 50 WATT. 10/25/50/100/250/500/1000/2500 or 5000 ohms, £1.15 P. & P. 7p. 100 WATT. 15/10/25/50/100/250/500/1000 or 2500 ohms, £1.65 P. & P. 7p.

"YAMABISHI" VARIABLE VOLTAGE TRANSFORMERS

Excellent quality. Low price. Immediate delivery

8-2808 Panel Mounting	£7.00
1 Amp	£7.00
2.5 Amp	£8.05
5 Amp	£11.75
8 Amp	£15.90
10 Amp	£22.50
12 Amp	£23.80
20 Amp	£49.00

INPUT 230 V 50/60 CYCLES OUTPUT VARIABLE 0-260 VOLTS Special discounts for quantity

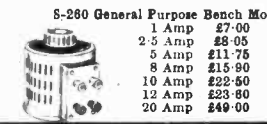

SPECIAL OFFER! SINCLAIR PROJECT 60 STEREO FM TUNER



The first tuner in the world to use the phase lock loop principle—as useful for receiving signals from space craft because of its vastly improved signal to noise ratio. Provides fantastic results even in difficult areas. Tuning range 87.5 to 108MHz. Automatic stereo indicator. Sensitivity: 2µV. AFC range ± 200KHz. Signal to noise ratio: 65dB. Output voltage 2 x 150mV. Operating voltage 25-30V DC. Size 93 x 40 x 207 mm. R.F.C. LIST PRICE £28.

OUR PRICE £15.75 P. & P. ONLY 25p
Unrepeatable offer—buy now and save over £9.

RP214 REGULATED POWER SUPPLY

Solid state. Variable output 0-24V DC up to 1 amp. Dual-scale meter to monitor voltage and current. Input 220/240V AC. Size 185 x 85 x 105mm. £3.97 P. & P. 25p.

PS.1000B REGULATED POWER SUPPLY

Solid state. Output 6, 9 or 12 volt DC up to 3 amps. Meter to monitor current. Input 220/240V AC. Size 4" x 3 1/2" x 6 1/2". £11.97. P. & P. 25p.

LAFAYETTE HA-600 SOLID STATE RECEIVER

General coverage 150-400kc/s, 550 kc/s-30mc/s. FET front end. 2 mech. filters, product detector, variable B.F.O., noise limiter. S. Meter, Bandsread. RF Gain. 15" x 9 1/2" x 8 1/2". 18 lbs. 220/240V. A.C. or 12v. D.C. Brand new with instructions. £50. Carr. 50p.

BRN-30 RECEIVER

4 Bands covering 550kc/s-30mc/s. B.F.O. Built-in Speaker 220/240V. A.C. Brand new with instructions. £15.75. Carr. 37p.

AUTO TRANSFORMERS

0/115/230V. Step up or step down. Fully shrouded.

80 W	£2.10	P. & P. 13p
150 W	£2.70	P. & P. 13p
300 W	£3.60	P. & P. 23p
500 W	£5.25	P. & P. 33p
1000 W	£7.50	P. & P. 38p
1500 W	£10.20	P. & P. 43p
2260 W	£17.25	P. & P. 50p
5000 W	£35.00	P. & P. £1

RECORD DECK PACKAGES

Decks supplied with cartridge ready wired in veneered plinth with cover.

Garrard 2025TC/9TAHCD
Garrard SP25 III/9TAHCD
Garrard SP25 III/G800
Garrard SP25 III/M75-6
Garrard SP25 III/M44-7
Garrard SP25 III/M44-E
Garrard SP25 III/M65-E
SP25 III/G800 (Play-on P&C)
Garrard AP76/G800
Garrard AP76/G800E
Garrard AP76/M75-6
Garrard AP76/M56-E
Garrard AP76/M75EJ
Garrard AP76/M44-E
Garrard AP76/M75EJ
BSR McDonald MP60/M44-7
BSR McDonald MP60/M44-7
BSR McDonald MP60/M44-E
Goldring GL72/G800
Goldring GL75/G800
Goldring GL75/G800E
Carriage 50p extra item



TRANSISTORISED L.C.R. A.C. MEASURING BRIDGE

A new portable bridge offering excellent range and accuracy at low cost. Ranges: R. 1Ω-11.1 megΩ 6 Ranges ± 1% L1 µ H - 111 HENRYS 6 Ranges 2 - 2% CAPACITANCE 6 RANGES ± 2% TURNS RATIO 1:1/1000-1:11100. 6 Ranges ± 1%. Bridge voltage at 1,000 cps. Operated from 9 volts. 100µA. Meter indication. Attractive 2 tone metal case. Size 7 1/2" x 5 1/2" x 2 1/2". £20. P. & P. 25p

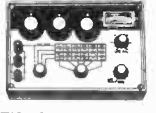

LATEST CATALOGUE

Our 7th edition gives full details of a comprehensive range of HI-FI EQUIPMENT, COMPONENTS, TEST EQUIPMENT and COMMUNICATIONS EQUIPMENT. FREE DISCOUNT COUPONS VALUE 50p 320 pages, fully illustrated and detailing thousands of bargains.



SEND NOW ONLY 40p P & P 10p

G.W.SMITH & CO. (RADIO) LTD

10 TOTTENHAM CT. RD. LONDON, W.1 Tel: 01-637 2232
27 TOTTENHAM CT. RD. LONDON, W.1 Tel: 01-636 3715
257/258 TOTTENHAM CT. RD. LONDON, W.1 Tel: 01-580 0670
3 LISLE STREET, LONDON, W.C.2 Tel: 01-437 8204
34 LISLE STREET, LONDON, W.C.2 Tel: 01-437 9155
11 EDGWARE ROAD, LONDON, W.2 Tel: 01-262 0387

CALLERS WELCOME MONDAY TO SATURDAY 9AM-6PM

All Mail Orders to— 11-12, Paddington Green, London, W.2 Tel: 01-262 6562

No.2 OUT NOV. 17

Written and designed by an expert editorial team
AUDIO is about every important aspect of the modern sound scene - from the make-up of sound, to the latest means of reproducing it . . . the equipment, its installation, and its operation.
AUDIO examines new trends, looks at the latest discs and tapes, shows you how to get the most for your money - in clarity, definition and craftsmanship.
AUDIO is about people; the home environment; and the importance of tone and appearance in good sound systems as an integral part of good planning and good living.

the new-style
magazine for
your greater
enjoyment
of leisure
listening

**TOP NAME CONTRIBUTORS . . .
OUTSTANDING FEATURES AND ILLUSTRATIONS . . .
COMPREHENSIVE RECORD REVIEWS . . . SPECIAL DIY AUDIO FEATURES**

GORDON KING WRITES ON THE
TEAC AG7000 TUNER/AMPLIFIER . . . **FREDERICK JUDD** REVIEWS
THE MARANTZ 1030 AMPLIFIER . . . **STAN KELLY** REVIEWS THE MORDAUNT
SHORT MS235 LOUDSPEAKER . . . **P. CRADDOCK-RANDALL** REPORTS ON PHILIPS
GP421 CARTRIDGE . . . **JEFF CHANDLER** WRITES ON ACCESSORIES
FOR RECORD CARE AND RECORD PLAYER MAINTENANCE
PLUS
AUDIONEWS . . . TAPETALK . . . AUDIO ENCYCLOPEDIA

Audio

ORDER IT TODAY! 20p

LEARN RADIO & ELECTRONICS AT HOME

No knowledge needed—
build as you learn with
the exciting new
'Technatron' kit. No

Extras. Tools, transistors,
meter etc. All supplied.
You could build a
radio in weeks.

SEND FOR FREE 76 PAGE GUIDE TO RADIO/TV,
ELECTRONICS, C & G, TELECOMMS ETC.

Dept. B35 Aldermaston Court, Reading RG7 4PF

Name.....

Address.....



Age

BRITISH INSTITUTE OF ENGINEERING TECHNOLOGY

'SOKSOL' DESOLDERING KIT: Here is a kit that has really been worth waiting for! You make it up to your own exacting requirements, it desolders transistors, I.C.'s wrap-round solder joints on switches, potentiometers, etc., etc. It is simple to use, just drop special braid in the supplied chemical solution, pull out and allow to dry. When ready to use just simply place braid on device to be desoldered. Put soldering iron on braid and the rest is sheer magic, as all solder is soaked up in seconds. Save yourself time in getting at those normally inaccessible solder joints. Highly recommended for service engineers in all walks of industry.
The kit includes 20 feet of special braid, chemical solution and full instructions £1.00, post 15p. Money back refund if dissatisfied.
Delco-Remy 12 Volt Car Horn Relays. Brand New 40p, post free.
Assorted Computer Panels, contains I.C.'s, Thyristors, Transistors, Diodes, Trim-Pots etc. Don't miss this bargain. 5 assorted Panels £1.00, post 20p.
Bargain Component Parcels, includes Resistors, Silver Mica, Polystyrene and Electrolytic Capacitors, Valve Holders, Rotary Switches, Transistor Panels. Plus a generous selection of other components. Fantastic value. 4lb nett weight £1.00, post 40p.
If after you purchase one of above parcels and you feel dissatisfied you may return goods and have your money back.
Flexible Connecting Wire Assorted Colours. 50 yards for only 50p.

ELEKON ENTERPRISES

224a St Paul's Road, Highbury Corner, London N.1

SUPERSOUND 13 HI-FI MONO AMPLIFIER



A superb solid state audio amplifier. Brand new components throughout. 5 silicon transistors plus 2 power output transistors in push-pull. Full wave rectification. Output approx. 13 watts

r.m.s. into 8 ohms. Frequency response 12Hz-30KHz \pm 3db. Fully integrated pre-amplifier stage with separate Volume, Bass boost and Treble cut controls. Suitable for 8-15 ohm speakers. Input for ceramic or crystal cartridge. Sensitivity approx. 40mV for full output. Supplied ready built and tested, with knobs, escutcheon panel, input and output plugs. Overall size 3" high x 6" wide x 7 1/4" deep. AC 200/250V. PRICE £10-50. P. & P. 25p.

De Luxe Stereo Amplifier

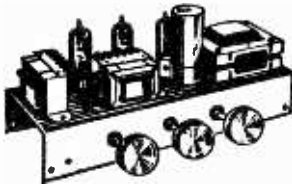

A.C. mains 200-240 v. U.S. & 110 v. Fully isolated mains transformer with full wave rectification giving adequate smoothing with negligible hum.

Valve line up:-2 x ECL86 Triode Pentodes, 1 x E240 as rectifier. Two dual potentiometers are provided for bass and treble control, giving bass and treble boost and cut. A dual volume control is used. Balance of the left and right hand channels can be adjusted by means of a separate 'Balance' control fitted at the rear of the chassis. Input sensitivity is approximately 300mV for full peak output of 4 watts per channel (8 watts mono), into 3 ohm speakers. Full negative feedback in a carefully calculated circuit, allows high volume levels to be used with negligible distortion. Supplied complete with knobs, chassis size 11" w x 4" d. Overall height including valves 5". Ready built & tested to a high standard. PRICE £8-92 P. & P. 45p.

POWER SUPPLY UNIT 200/240v. A.C. input. Four switched fully smoothed D.C. outputs giving 6v. and 7 1/2v. and 9v. and 12v. at 1 amp continuous (1 amp intermittent). Fitted insulated output terminals and pilot lamp indicator. Hammer finish metal case overall size 6" x 3 1/2" x 2 1/2". Suitable for Transistor Radios, Tape Recorders, Amplifiers etc. etc. Ready PRICE £4.50 P. & P. 35p. built and tested.

BLACK ANODISED 16g. ALUMINIUM HEAT SINKS. For T03, complete with mica's and bushes. Size 2 1/2" x 8" approx. 25p pair. P. & P. 5p.

HIGH GRADE COPPER LAMINATE BOARDS. 8 x 6 x 1/4 in. FIVE for 50p. P. & P. 13p.

COILED SPRING BACK TELEPHONE CABLE. Closed approx. 10' extends to 36". 4 core or 6 core. 25p each P. & P. 5p. 5 or more post free. LIMITED NUMBER!

BRAND NEW MULTI-RATIO MAINS TRANSFORMER. Giving 13 alternatives. Primary: 0-210-240v. Secondary combinations 0-5-10-15-20-25-30-35-40-60v. half wave at 1 amp, 0-10-10, 20-0-20, 30-0-30v. at 2 amps full wave. Size 3in. long x 3 1/2 in. wide x 3in. deep. Price £1-75 P. & P. 30p.

MAINS TRANSFORMER. For transistor power supplies. Pri 200/240v. Sec. 9-0-9 at 500mA. 70p. P. & P. 13p. Pri. 200/240v. Sec. 12-0-12 at 1 amp. 88p. P. & P. 13p. Pri. 200/240v. Sec. 10-0-10 at 2 amp. £1-38. P. & P. 30p.

SPECIAL OFFER MAINS TRANSFORMER 200/240v. A.C. Input 35v at 1 1/2 amp A.C. output overall size 2 1/2" x 2 1/2" x 3" approx. Suitable drop through or vertical mounting 75p. P. & P. 30p.

CENTRE ZERO MINIATURE MOVING COIL METER. 100uA. For balance or tuning. Approx. size 1" x 1" x 1" deep. Limited number. 75p. P. & P. 10p.

GENERAL PURPOSE HIGH STABILITY TRANSISTOR PRE-AMPLIFIER

For P.U. Tape, Mike, Guitar, etc. and suitable for use with valve or transistor equipment. 9-18v. battery or from H.T. line 200/300v. Frequency response 15Hz-25KHz. Gain 26dB. Solid encapsulation size 1 1/2" x 1 1/2" x 1". Brand new complete with instructions. Price 88p. P. & P. 13p.

HANDBOOK OF TRANSISTOR EQUIVALENTS AND SUBSTITUTES

A must for servicemen and home constructors. Including many 1000's of British, U.S.A. European and Japanese transistors. ONLY 40p. Post 5p.

Open 9-5.30 Monday to Saturday
Early closing Wed. 1 p.m.
A few minutes from South Wimbledon Tube Station.

HARVERSON SURPLUS CO. LTD.

(Dept. P.W.) 170 HIGH ST., MERTON, LONDON, S.W.19 Tel.: 01-540 3985

SEND STAMPED ADDRESSED ENVELOPE WITH ALL ENQUIRIES

1-SPEED RECORD PLAYER BARGAINS
Mains models. All brand new in maker's packing.
LATEST B.S.R. C109/C129 4-SPEED AUTOCHANGER.
With latest mono compatible cartridge 26-97 Carr. 50p.
With stereo cartridge £7-97 Carr. 50p.
LATEST GARRARD MODELS. S.A.E. for latest Prices!

SPECIAL BARGAIN OFFER!

PRECISION ENGINEERED PLINTHS
Beautifully constructed in heavy gauge "Colorcoat" plastic coated steel. Resonance free. Designed to take Garrard 1025, 2000, 2025TC, 2500, 3000, 3500, 5100, SP25 11 and 111, BL65B, AT60 etc. or B.S.R. C109, C125, A21 etc. Black leatherette finish. Size 12 1/2" x 14 1/2" x 3 1/2" high (approx. 7 1/4" high, including rigid smoked acrylic cover).
NOW ONLY £4-50. P. & P. 35p.

LATEST ACOS GP91/ISC mono compatible cartridge with T/O stylus for LP/EP/78. Universal mounting bracket, £1-60 P. & P. 8p.

SONOTONE 97AHC COMPATIBLE STEREO CARTRIDGE T/O stylus Diamond Stereo LP and Sapphire 78.
ONLY £2-50 P. & P. 10p. Also available fitted with twin Diamond T/O stylus for Stereo LP. £3. P. & P. 10p.

LATEST RONETTE T/O STEREO/COMPATIBLE CARTRIDGE for EP/LP/8turn/78. £1-83 P. & P. 10p.
LATEST RONETTE T/O MONO COMPATIBLE CARTRIDGE for playing EP/LP/78 mono or stereo records on mono equipment. Only £1-50 P. & P. 10p.

QUALITY RECORD PLAYER AMPLIFIER MK II
A top quality record player amplifier employing heavy duty double wound mains transformer, ECC83, EL84, and rectifier. Separate Bass, Treble and Volume controls. Complete with output transformer matched for 3 ohm speaker. Size 7in. wide x 3in. deep x 6in. high. Ready built and tested. PRICE £3-75 P. & P. 40p
ALSO AVAILABLE mounted on board with output transformer and speaker ready to fit into cabinet below. PRICE £4-88 P. & P. 50p.

DELUXE QUALITY PORTABLE R/P CABINET MK II. Uncut motor board size 14 1/2" x 12in. clearance 2in. below, 5in. above. Will take any higher and any B.S.R. or GARRARD changer or Single Player (except AT60 and SP24). Size 18 x 15 x 8in. PRICE £4-75. P. & P. 60p.

SPECIAL OFFER! HI-FI LOUDSPEAKER SYSTEMS

Beautifully made teak finish enclosure with most attractive Tygan-Vynair front. Size 16 1/2" high x 10 1/2" wide x 5 1/2" deep. Fitted with E.M.I. Ceramic Magnet 12" x 8" bass unit, two H.F. tweeter units and crossover. Power handling 10 watts. Available 3 or 8 or 15 ohms impedance.

OUR PRICE £8.40 Carr. 65p
Cabinet Available Separately £4-50 Carr 60p
Also available in 8 ohms with EMI 12" x 8" bass speaker with parasitic tweeter £6-50 Carr. 65p

LOUDSPEAKER BARGAINS
5in. 3 ohm £1-05. P. & P. 15p. 7 x 4in. 5 ohm £1-15. P. & P. 20p. 10 x 6in. 3 or 15 ohm £1-90. P. & P. 30p. E.M.I. 8 x 5in. 3 ohm with high flux magnet £1-62. P. & P. 20p. E.M.I. 12 1/2" x 8in. with high flux ceramic magnet 3, 8 or 15 ohm £3-20. P. & P. 30p. E.M.I. 13 x 8in. 3, 8 or 15 ohm with two built tweeters and crossover network £4-20. P. & P. 30p. E.M.I. 12 x 8in. twin cone (parasitic tweeter) 8 ohm £2-25. P. & P. 30p.
BRAND NEW. 12in. 15w. H/D Speakers, 3 or 15 ohms. Current production by well-known British maker. Now with HiDux ceramic ferrobar magnet assembly £6-75. Guitar models: 25w. £6-75, 35w. £8-50. P. & P. 38p. P. & P. 25p.



SPECIAL OFFER!

LIMITED NUMBER OF BRAND NEW ELAC 10" TWIN CONE LOUDSPEAKERS
With large ceramic magnet and plasticised cone surround.
8 ohm impedance. £3-75. P. & P. 25p.

12in. "RA" TWIN CONE LOUDSPEAKER. 10 watts peak handling. 8 or 15 ohm £2-20. P. & P. 30p. 36 ohm SPEAKERS 3in. only 83p. P. & P. 13p.

"POLY PLANAR" WATER-TYPE, WIDE RANGE ELECTRO-DYNAMIC SPEAKER
Size 11 1/2" x 14 1/2" x 1 1/2" deep. Weight 19oz. Power handling 20W r.m.s. (40W peak). Impedance 8 ohm only. Response 40Hz-20kHz. Can be mounted on ceilings, walls, doors, under tables, etc., and used with or without baffle. Send S.A.E. for full details. Only 25-75 each. P. & P. 25p.

VYNAIR & REXINE SPEAKERS & CABINET FABRICS
app. 84 in. wide. Usually £1-75 yd., our price 75p yd. length. P. & P. 15p (min 1 yd.) S.A.E. for samples.

HI-FI STEREO HEADPHONES

Adjustable headband with comfortable flexifoam ear-muffs. Wired and fitted with standard stereo 3in jack plug. Frequency response 30-15,000Hz. Matching impedance 8-16 ohms. Easily converted for Mono. PRICE £2-95. P. & P. 15p.
HIGH IMPEDANCE CRYSTAL STICK MIKES.
OUE PRICE £1-05. P. & P. 8p

HARVERSONIC SUPER SOUND 10 + 10 STEREO AMPLIFIER KIT



NEW FURTHER IMPROVED MODEL WITH HIGHER OUTPUT AND INCORPORATING HIGH QUALITY READY DRILLED FIBRE GLASS PRINTED CIRCUIT BOARD WITH COMPONENT IDENTIFICATION CLEARLY MARKED FOR EASY CONSTRUCTION

A really first-class Hi-Fi Stereo Amplifier Kit. Uses 14 transistors including Silicon Transistors in the first five stages on each channel resulting in even lower noise level with improved sensitivity. Integrated pre-amp with Bass, Treble and two Volume Controls. Suitable for use with Ceramic or Crystal cartridges. Very simple to modify to suit magnetic cartridge—Instructions included. Output stage for any speakers from 5 to 15 ohms. Compact design, all parts supplied including drilled metal work, high quality ready drilled fibreglass printed circuit board, smart brushed anodised aluminium front panel with matching knob, wire, solder, nuts, bolts—no extras to buy. Simple step by step instructions enable any constructor to build an amplifier to be proud of. Brief specification: Power output: 14 watts r.m.s. per channel into 8 ohms. Frequency response \pm 3dB 12-30,000 Hz Sensitivity: better than 80mV into 1M Ω . Full power bandwidth: \pm 3dB 12-15,000 Hz. Bass boost approx. to \pm 12dB. Treble cut approx. to -16dB. Negative feedback 18dB over main amp. Power requirements 35v. at 1.0 amp. Overall Size 12" w. x 8" d. x 2 1/2" h.

Fully detailed 7 page construction manual and parts list free with kit or send 18p plus large S.A.E.

AMPLIFIER KIT £10-50 P. & P. 15p
(Magnetic input components 30p extra)
POWER PACK KIT £3-00 P. & P. 30p
CABINET £3-00 P. & P. 30p

(Post Free if all units purchased at same time)
Full after sales service

Also available ready built and tested £21-00. Post Free.
Note: The above amplifier is suitable for feeding two mono sources into inputs (e.g. mike, radio, tape record deck, etc.) and will then provide mixing and fading facilities for medium powered Hi Fi Discographic use, etc.



3-VALVE AUDIO AMPLIFIER HA34 MK II.

Designed for Hi-Fi reproduction of records. A.C. Mains operation. Ready built on plated heavy gauge metal chassis, size 7 1/2" w. x 4" d. x 4 1/2" h. Incorporates ECC83, EL84, E280 valves. Heavy duty double wound mains transformer and output transformer matched for 3 ohm

speaker. Separate volume control and now with improved wide range tone controls giving bass and treble lift and cut. Negative feedback line. Output 4 1/2 watts. Front panel can be detached and leads extended for remote mounting of controls. Complete with knobs, valves, etc., wired and tested for only £4-75. P. & P. 35p.
HSL "FOUR" AMPLIFIER KIT. Similar in appearance to HA34 above but employs entirely different and advanced circuitry. Complete set of parts, etc. £8-98. P. & P. 40p.

HARVERSON'S SUPER MONO AMPLIFIER

A super quality gram amplifier using a double wound fully isolated mains transformer, rectifier and ECL83 triode pentode valve as audio amplifier and power output stage. Impedance 3 ohms. Output approx. 3.5 watts. Volume and tone controls. Chassis size only 7in. wide x 3in. deep x 6in. high overall. AC mains 200/240v. Supplied absolutely Brand New completely wired and tested with good quality output transformer.

BARGAIN PRICE £2.75 P. & P. 35p

10/14 WATT HI-FI AMPLIFIER KIT

A stylishly finished monaural amplifier with an output of 14 watts from 2 EL84s in push-pull. Super reproduction of both music and speech, with negligible hum. Separate inputs for mike and gram and records and announcements to follow each other. Fully shrouded section wound output transformer to match 3-15 Ω speaker and 2 independent volume controls, and separate bass and treble controls are provided giving good lift and cut. Valve line-up 2 EL84s, ECC83, E280 and E280 rectifier. Simple instruction booklet 13p (Free with parts). All parts sold separately. ONLY £7-97 P. & P. 55p.

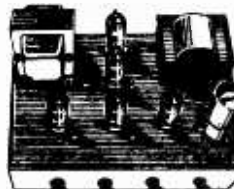

(Please write clearly)

PLEASE NOTE: P. & P. CHARGES QUOTED APPLY TO U.K. ONLY. P. & P. ON OVERSEAS ORDERS CHARGED EXTRA.

Practical Wireless Classified Advertisements

The pre-paid rate for classified advertisements is 9p per word (minimum 12 words), box number 10p extra. Semi-displayed setting £6.50 per single column inch. All cheques, postal orders, etc., to be made payable to PRACTICAL WIRELESS and crossed "Lloyds Bank Ltd." Treasury notes should always be sent *registered post*. Advertisements, together with remittance, should be sent to the Classified Advertisement Manager, PRACTICAL WIRELESS, IPC Magazines Ltd., Fleetway House, Farringdon Street, London, EC4A 4AD for insertion in the next available issue.

Books and Publications



THE PICTURE BOOK METHOD OF LEARNING

BASIC ELECTRICITY 5pts £4.50. BASIC ELECTRONICS 6pts £5.40. BASIC TELEVISION 3pts £3.60

(Postage and Packing included)

The Pictorial Approach Manuals assure the quickest and soundest method of gaining mastery over these subjects. The clear and concise illustrations make study a real pleasure. Your money refunded if not completely satisfied is your 100% Guarantee. Free Illustrated Prospectus on request.

Send now to **SELRAY BOOK CO., 60 HAYES HILL, BROMLEY BR2 7HP**

Aerials

GENUINE FULL SIZE 18 element TV aerial
as used by leading TV companies

FOR ONLY £1.99
+ 11p cart

ITV BBC1 & 2 BLACK WHITE & COLOUR

Guaranteed Perfect Pictures. Save ££s. We supply this genuine U.H.F. aerial for only £1.99, can be fitted out side or inside. Quality made, technically advanced design. Precision grid reflector eliminates ghosting. Complete with clamp, instructions, advice.

Money Back Refund Wall/Caravan Bracket 25p. Low Loss Cable 10p per yard. Plug 8p & FREE with order maps & channel reference of all Radio & TV Transmitters.

Send direct to Dept PW10, 219 Mansfield Rd., Nottingham.

IMPERIAL TRADING (AERIALS) LTD.
the quality Aerial Specialists

BAINES FOR HIGH FREQUENCY AERIALS
UHF Multi-beams by J Beam
MBM 10 £2.20 MBM 18 £2.90 MBM 30 £3.90 MBM 46 £6.00 2MBM 46 £15.20 4MBM 46 £33.00. UHF Duplexers £1.00. Log Periodic £5.25.

VHF Aerials
FM2 £2.00 FM3 £3.00 FM4 £5.00 FM6S £7.80 BBCD and ITA 5 £2.70 ITA 5 element £2.00 ITA 8 element £2.70.

Pre-amps:
Masthead £7.00 Colourbooster £3.88 Wide-band Masthead £9.50 Co-ax VHF 5p UHF 9p. Please state channels on all orders

R. Baines

11 Dale Cres., Tupton, Chesterfield. S42 6DR

Direct from the Manufacturers

U.H.F. AERIALS

in EASY ASSEMBLY KITS

10 Element **SAVE 40%**

£125 on normal retail price

14 Element **£1.50** 18 Element **£1.75**

Plus Clamp approval extra

Ready assembled add 25p allow 32p postage and packing. Please state which channels to group.

APEX AERIALS (P.W.)

ALBAN WORKS, MARY ST., JOHNSTONE, NENTHERSHIRE.

For Sale

MORSE MADE EASY!!

FACT NOT FICTION. If you start **RIGHT** you will be reading amateur and commercial Morse within a month (normal progress to be expected).

Using scientifically prepared 8-speed records you automatically learn to recognise the code RHYTHM without translating. You can't help it, it's as easy as learning a tune. 18 W.P.M. in 4 weeks guaranteed.

Beginner's Section only £3.80, Complete Course £4.50 (Overseas £1.00 extra) details only, 4p stamp. 01-860 2896 G8H8C (Box 19), 45 GREEN LANE, PURLEY, SURREY

SEEN MY CAT? 5,000 items. Mechanical & Electrical Gear, and materials. S.A.E. K. R. WHISTON, Dept. PW, NEW MILLS, Stockport.

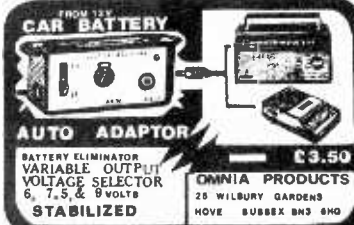

FROM 12V CAR BATTERY

AUTO ADAPTOR

BATTERY ELIMINATOR
VARIABLE OUTPUT
VOLTAGE SELECTOR
6, 7.5 & 9 VOLTS

£3.50

OMNIA PRODUCTS
25 WILBURY GARDENS
HOVE SUSSEX BN2 5HG

Wanted

TOP PRICES PAID for NEW VALVES popular T.V. and Radio types.

KENSINGTON SUPPLIES (C),
367 Kensington Street, Bradford 8, Yorkshire.

WANTED: "RADIVET," any condition. Offers to 24 Fordway Avenue, Blackpool, or phone Blackpool (0253) 32819.

CASH PAID for New Valves. Payment by return. WILLOW VALE, ELECTRONICS, 4 The Broadway, Hanwell, London, W.7. 01-567/5400-2971.

WE BUY New Valves, Transistors and clean new components, large or small quantities, all details, quotation by return. **WALTON'S,** 55 Worcester Street, Wolverhampton.

URGENTLY REQUIRED. Mullard Valve X78. Tabor, 5 North Road, West Bridgford, Nottingham.

AR88, CR100 and all other communication receivers paid with highest cash. Send details only. Sundbergs, Skifteavagen 5B, S-852 43 Sundsvall, Sweden.

Christmas Gifts

PRIVATE—for wives only

Men are hard to please at Christmas time. Your husband is an electronics man, so why not give him an original gift of top quality that he knows he will appreciate with all your love. We have arranged specially for readers' wives (and nuns) a superb GIFT PACK of the popular types of NIP-E-BOARD printed circuit assembly components as described in the October issue. The Gift Pack includes five different standardised printed circuit boards all ready to use, gold-plated edge connectors, handles, mounting pillars and details on how to make the best use of them in a fully illustrated brochure. He will be able to make several of the published designs on these boards very easily with the layout planning chart included.

The total retail value of these components is £4.24, but because we know that he will be pleased with such an original idea, we are offering all these for Christmas in an attractively styled presentation wallet for only £3.95. Due to heavy demand, we suggest that you send your order before Nov. 30th to guarantee delivery before Christmas (P.O. permitting). We shall mark your parcel PRIVATE if you wish. Write now to:—
NIP ELECTRONICS, P.O. BOX 11, BEACONSFIELD ROAD, ST. ALBANS, HERTS.

LOOKING FOR A REALLY UNUSUAL CHRISTMAS PRESENT?

Look no more! Give your friends one of Dr. CECIL'S ORIGINAL CRYSTALS (No—not a diode—a germanium crystal). Each one individually boxed. 5 for 30p or 10 for 50p. Also bayonet fitting neon bulbs at the same price and 20 amp contact breakers at 60p each. All post free from:
CYBOR PRODUCTS, 81 STAMFORD STREET, OLD TRAFFORD, MANCHESTER, M16 9JL

CHRISTMAS with KILRIMONT BOOKS

★ Recent titles ★ No American Reprints ★

110 I. C. Projects (Marston) £1.20
Digital Logic (Smith) £1.50
Colour T.V. Picture Faults, Illustrated (Bohman) £2.50
Transistor Circuit Design Tables (Taylor) .. £2.80

All post paid. S.A.E. for complete list and descriptions. **KILRIMONT BOOKS, Kilrimont House, London Road, BRAINTREE, Essex. (A)**



TELEVISION TRAINING

(MONOCHROME AND COLOUR)

This private College provides theoretical and practical training in Radio and TV Servicing. Courses of 16 months' duration, with daily attendance, are available for beginners and shorter courses for men with previous training in Electronics and Radio. Next course commencing January 1st. Training courses in Marine Radiocommunication and Radar are also available. Write for prospectus to: London Electronics College, Dept. A/12, 20 Penywern Road, Earls Court, London SW5 9SU. Tel. 01-373 8721.

GO TO SEA as a Radio Officer. Write: Principal, Nautical College, Broadwater, Fleetwood FY7 8JZ.

CIE, AMSE, City & Guilds, etc. Thousands of exam successes. Postal Courses in all branches of Engineering. Prospectus FREE. State subject of interest: BIET (Dept H.8), Aldermaston Court, Reading RG7 4PF. Accredited by CACC.

RADIO, TV, RTEB CERTS., City and Guilds, Computers, Radio Amateurs Cert., Practical Electronics (with kit). Thousands of successes. Details of home study courses and illustrated book FREE: BIET (Dept. H.7), Aldermaston Court, Reading RG7 4PF. Accredited by CACC.

Situations Vacant

MEN!
£50 p.w.
can be yours

Jobs galore! 144,000 new computer personnel needed by 1977. With our revolutionary, direct-from-America, course, you train as a Computer Operator in only 4 weeks! Pay prospects? £2500+p.a. After training, our exclusive appointments bureau—one of the world's leaders of its kind—introduces you FREE to world-wide opportunities. Write or 'phone TODAY, without obligation.

London Computer Operators Training Centre
E95, Oxford House
9-15, Oxford Street, W.1
Telephone: 01-734 2874
127, The Piazza, Dept. E95,
Piccadilly Plaza, Manchester 1.
Telephone: 061-236 2935

Ladders

LADDERS. 20ft, £7-80; 24½ft £9-80. Carr. 80p. Leaflet. (Dept. WLS) Home Sales Ladder Centre, Baldwin Road, Stourport, Worcs. Tel. 029-93 5222.

Service Sheets

SERVICE SHEETS. Radio, TV etc. 8,000 models. List 10p. S.A.E. enquiries. TELRAY, 11 Maudland Bank, Preston.

SERVICE SHEETS for Televisions, Radios, Transistors, Tape Recorders, Record Players, etc., from 5p with free Fault-Finding Guide. S.A.E. orders/enquiries. Catalogue 15p. Hamilton Radio, 47 Bohemia Road, St. Leonards, Sussex. Telephone Hastings 29066.

Service Sheets

★ **SERVICE SHEETS • MANUALS • BOOKS** ★
SERVICE SHEETS OVER 12,000 SERVICE SHEETS AND MANUALS IN STOCK
ON RADIOS, TV'S, R.PLAYERS AND T.RECORDERS, ETC... **SERVICE SHEET**
30p + Postage PLEASE ENCLOSE S.A.E. WITH ENQUIRIES... **Catalogue 20p.**

NEW BOOKS & PUBLICATIONS	PRICE	+ P. & P.
79. QUESTIONS & ANSWERS ON COLOUR TELEVISION. by J.A. Reddihough. 108 pages	10.60	10p
80. QUESTIONS & ANSWERS ON AUDIO by Clement Brown. Assoc. Brit. IRE.	10.60	10p
81. QUESTIONS & ANSWERS ON COMPUTERS by Clement Brown Assoc. Brit. IRE.	10.60	10p
82. QUESTIONS & ANSWERS ON ELECTRIC MOTORS by A.J. Coker.	10.60	10p
83. QUESTIONS & ANSWERS ON ELECTRICITY by K.G. Jackson.	10.60	10p
84. QUESTIONS & ANSWERS ON ELECTRONICS by Clement Brown. Assoc. Brit. IRE.	10.60	10p
85. MANUAL OF SOUND RECORDING. 2nd Edition by J. Aldred. 269 pages.	13.50	15p
86. SEMICONDUCTOR PHOTOELECTRIC DEVICES by Dr. Inz. A. Ambrozzi. 344 pages. 242 illus.	13.75	50p
87. PICKUPS & LOUDSPEAKERS by John Earl. 203 pages. 156 Illustrations	13.00	15p
88. PUBLIC ADDRESS HANDBOOK. A Manual of Sound Reinforcement by V. Capel	13.00	15p
89. RADIO & TELEVISION YEAR BOOK by IPC Ltd. Lists latest Models with illustrations	11.00	15p
90. HI-FI, PA & DISCOTHEQUE AMPLIFIER DESIGN HANDBOOK (5 to 1,000 Watts) 122 pages	10.75	10p
91. BEGINNERS GUIDE TO HI-FI. by J.R. Hey. ASERT. An introduction to HI-FI Equipment	10.35	7p
92. GOVERNMENT SURPLUS WIRELESS EQUIPMENT HANDBOOK. Data on Trans/Receivers Etc.	12.80	20p
93. COLOUR TELEVISION WITH PARTICULAR REFERENCE TO THE PAL SYSTEM by G.N.Patchett	13.00	20p
94. PAL-D COLOUR RECEIVER: QUESTIONS & ANSWERS by K.J. Bohlmann. AM.Inst.E.	10.68	10p
95. TELEVISION SERVICING by G.N. Patchett. Vol.1. Principles. Video & Sound, I.F.s, Tuners etc.	10.75	10p
96. TELEVISION SERVICING by G.N. Patchett. Vol.2. C.R.T. Sync, Seps., Time-Bases etc.	10.85	10p
97. TELEVISION SERVICING by G.N. Patchett. Vol.3. Limiters, A.G.C. Flywheel Sync. etc.	10.55	10p
98. TELEVISION SERVICING by G.N. Patchett. Vol.4. Practical Servicing & Fault-Finding	10.75	10p
99. RADIO SERVICING by G.N. Patchett. Vol.1. Basic Electrotechnology.	10.60	10p
100. RADIO SERVICING by G.N. Patchett. Vol.2. Intermediate Radio Theory.	10.90	10p
101. RADIO SERVICING by B. Fozard, B.Sc.Eng.C.Eng.M.I.E.E. Vol.3. Final Radio Theory	10.75	10p
102. RADIO SERVICING by G.N. Patchett. Vol.4. Fault-Finding MECHANICS COURSE IN RADIO, TELEVISION & ELECTRONICS (433) by B. Fozard	10.85	10p
119. FIRST YEAR. Principles and Calculations	10.50	10p
120. MECHANICS COURSE IN RADIO, TELEVISION & ELECTRONICS (433) by G.N. Patchett	10.85	10p
121. PART 1. Electronic Systems	10.95	10p
122. PART 2. Second Year. Electronic Systems	12.00	15p
123. PART 3. Third Year. Electronic Systems	12.00	15p
124. AUDIO TECHNICIANS BENCH MANUAL by John Earl. 182 pages. 114 Illustrations	13.00	15p
125. TUNERS & AMPLIFIERS by John Earl. 187 pages. 127 Illustrations.	12.10	15p
126. WORLD RADIO-T.V. HANDBOOK 1972. Immense amount of tabulated matter	12.80	25p
VIDEO RECORDING: RECORD & REPLAY SYSTEMS by G.White. 216 pages	13.25	20p

Send S.A.E. for Free LISTS of Practical and Technical Books on Radio & Television now available to

BELL'S TELEVISION SERVICES

★ Albert Place, Harrogate, Yorks. Tel. 0423-86844 ★

LARGE SUPPLIER OF SERVICE SHEETS

(T.V., RADIO, TAPE RECORDERS, RECORD PLAYERS, TRANSISTORS, STEREOGRAMS, RADIOGRAMS, CAR RADIOS)

Only 40p each

"PLEASE ENCLOSE LARGE S.A.E. WITH ALL ENQUIRIES & ORDERS"
Otherwise cannot be attended to
(Uncrossed P.O.'s please, original returned if service sheets not available.)

C. CARANNA
71 BEAUFORT PARK
LONDON, N.W.11

We have the largest supplies of Service Sheets (strictly by return of post). Please state make and model number alternative.

Free TV fault tracing chart or TV list on request with order.

Mail order or phone 01-458 4882

Receivers and Components

SOUND SUPPLIES
(Electronics) Co. Ltd.

P.A. EQUIPMENT. Marshall amps, instruments and guitars, etc. TOA and Eagle amps and accessories. Reslo mics, etc.
COMPONENTS: Resistors, capacitors, plugs, sockets, cables, audio leads, semi-conductors, valves, vero board, etc., for the constructor.
Power packs and car droppers for the cassette recorder or radio.
S.A.E. for list and enquiries. P.A. list 15p
12 Smart's Lane, Loughton, Essex
Tel. 01-508 2715 Closed all day Thursday

BRAND NEW COMPONENTS BY RETURN. Electrolytics 16V or 25V—1, 2-2, 4-7, 10 mfd—3½p, 22, 47—4p, 100—5p, 50V—½p extra. Subminiature bead-type tantalums—1/35V, .22/35V, .47/35V, 1/35V, 2-2/35V, 4-7/35V, 10/16V—8p. Mylar Film 100V—.001, .002, .005, .01, .02—2p, .04, .05—2½p, .068, .1—3p. Polystyrene 63V—10 pf.—10,000 pf. E.12 series—2p. Mullard miniature Carbon Film Resistors E12 series 1/3W 10—10MΩ 8 for 5p. Insured postage 8p. The C.R. Supply Co., 127 Chesterfield Road, Sheffield, S8.

ELEVEN BAND RADIO. SW14 (4.30 MHz). Marine. LW, MW, FM. PB (76-86). Aircraft (108-136). PB (148-174). Battery/Mains. BFO. AGC. Squelch Control. Output: 1.3W. 15in x 10in x 5½in, £66. Eight Band Model, with BFO, £42. Four Band, MW, FM. Aircraft. PB. £15. SAE. Full Lists. Langtons Radio, High Street, ROCESTER, Staffordshire, Tel. 388.

NEW GUARANTEED DEVICES ORDER WITH CONFIDENCE

MICROCIRCUITS: 709 28p; 710 38p; 723 57p; 741 28p; 748 37p; 78N7013 (like IC12) £1.24; FET Op. Amp #4-28; 74 Series TTL: 00 18p; 01 18p; 02 18p; 04 18p; 08 18p; 10 18p; 11 21p; 20 18p; 30 19p; 40 18p; 47 £1.25; 01 18p; 72 80p; 73 41p; 74 35p; 75 44p; 81 £1.26; 84 85p; 86 41p; 90 72p; 91 £1.21; 92 72p.

RECTIFIERS 1AMP: 50V 81p; 100V 4p; 200V 5p; 400V 6p; 600V 8p; 800V 12p; 1000V 14p; 3AMP: 200V 11p; 400V 12p; TRIAC 10A 500V £1.20. SCR 1-6A 600V 75p; SCR 5-1A 400V £1.14. **TRANSISTORS:** 2N2926 RED 6p; OR: 7p; YEL: 8p; GRN: 9p; 2N3054 89p; 2N3055 42p; 2N3819 28p; AC127/128 16p; BC107B, BC108A, BC108C, BC108D all 6p; BFY50/51/52 10p; OC44/45/71/72 12p; OC81 18p; ME SERIES: 0401 18p; 0402 18p; 0404-2 16p; 0411 18p; 0412 18p; 0413 14p; 0414 24p; 1002 10p; 1120 16p; 3001 16p; 4002 12p; 4003 15p; 4101 10p; 4102 11p; 4103 10p; 6001 12p; 8002 14p; 8101 14p; 8102 15p; 8001 14p; 8003 15p; MEF 104 42p; MEL 11 35p; MEL 12 44p; MFS111 52p; MFS112 42p. IC sockets 14 pin DIL 12p; SOLDERCONs 0.7p per pin. Led Panel Lamp 45p. Carbon 1W 5% RESISTORS 220hm to 2.2 Meg. 1p each or 5p per 10 of one value. ZENER DIODES BZY88 Series 400mW 5% 2.7V to 33V 8p.

JEF ELECTRONICS (P.W.1)
 YORK HOUSE, 12 YORK DRIVE, GRAPPENHALL WARRINGTON, WA4 2EJ. Mail Order Only. C.W.O. P & P 9p per order. Orders 45p. Discounts start at 10% for 10 +. List free. **NEW FULL SPEC. GOODS. MONEY BACK GUARANTEE**

PRECISION POLYCARBONATE CAPACITORS

FRESH STOCK — FULLY TESTED

Close tolerance. High stability. All 63V d.c.

0.47µF:	±5% 80p;	±2% 40p;	±1% 50p
1.0µF:	±5% 40p;	±2% 50p;	±1% 60p
2.2µF:	±5% 50p;	±2% 60p;	±1% 75p
4.7µF:	±5% 70p;	±2% 80p;	±1% 81.5
6.8µF:	±5% 96p;	±2% 1.15;	±1% 81.80
10µF:	±5% 81-10;	±2% 81-40;	±1% 81-80
15µF:	±5% 81-80;	±2% 88-10;	±1% 82-70

TANTALUM BEAD CAPACITORS—Values available 0.22, 0.47, 1.0, 2.2, 4.7, 6.8 µF at 35V; 10 µF 25V; 15 µF 20V; 22 µF 15V, 33 µF 10V, 47 µF 6V, 100 µF 3V—all at 9p each; 6 for 50p; 14 for £1. Special pack 6 off each value (72 capacitors) 45p.

NEW TRANSISTORS: BC107, BC108, BC109, All at 9p each; 6 for 50p; 14 for £1. All brand new and marked. Full spec. devices. May be mixed to qualify for quantity prices.

POPULAR DIODES IN914—7p each, 8 for 50p; 18 for £1. IN916—9p each, 6 for 50p, 14 for £1. IS44—5p each, 11 for 50p, 24 for £1. All brand new and marked.

NEW LOW PRICE—400 mW Zeners. Values available 4.7, 6.8, 7.5, 8.2, 9.1, 10, 11, 12, 13.5, 15V. Tol. ± 5% at 5 mA. All new and marked. Price 10p each, 6 for 50p, 14 for £1.00.

RESISTORS. Carbon film 1W 5%. Range from 2.2Ω to 2.2MΩ in E12 series, i.e. 10, 12, 15, 18, 22, 27, 33, 39, 47, 56, 68, 82 and their decades. High stability, low noise. All at 1p each; 8p for 10 of any one value; 70p for 100 of any one value. Special development pack—10 off each value 2.2Ω to 2.2MΩ (730 resistors) 45p.

440V A.C. CAPACITORS: 0.1µF, size 1 1/2" x 1 1/2" tin, 25p; 0.25µF, size 1 1/2" x 1 1/2" tin, 30p; 0.47 and 0.5µF, size 1 1/2" x 1 1/2" tin, 35p; 1.0µF, size 2 1/2" x 1 1/2" tin, 45p; 2.0µF, size 2 1/2" x 1 1/2" tin, 75p each.

SILICON PLASTIC RECTIFIERS 1-5 Amp Brand new wire-ended DO27. 100PIV at 8p each 4 for 30p; 400PIV at 9p each or 4 for 34p; 800PIV at 14p each or 4 for 50p.

5p post and packing on all orders below £5. **V. ATTWOOD, DEPT. D3, P.O. BOX 8, ALRESFORD, HANTS.**

Stereo Headphones: High quality, frequency range 25c/s 16kHz, impedance 8-16 ohms. £5.95

Wireless Intercom: No wires, no installation, simply plug into AC mains and talk. £12.70

Psychedelic Light: Add a new experience to music. Carries four primary colours. Gives visual dimension to sound. £11.90

Cassettes: High quality. Low noise. C60—55p, C90—75p, C120—85p

Tape Head De-magnetiser £1.85
 Prices include postage and packing —UK only

TAYLOR KIRBY

Electronic Supplies

75a Carnarvon Road, Reading, Berks.

Versatile

10 in ONE



"MINI-LAB" Comprising
 AC/DC Voltmeter : Audio Generator :
 Resistance Substitution : Capacitance
 Substitution : DC Ammeter : Battery
 Supply : RF Signal Generator : RF
 Field Strength Indicator : Ohm Meter
 All you need for testing. Money
 back guarantee. **£11.25**
 + 25p P. & P.

Cash with order or write for data sheet to:
 RSL Components, (Dept. PW),
 Cricketfield Lane, Bishops Stortford, Herts

NEW MODEL V.H.F. KIT MK2

Our latest kit. Improved design and performance plus extra amplifier stage, receives aircraft, amateurs, mobile, radio 2, 3, 4, etc., this novel little set will give you endless hours of pleasure and can be built in one evening. Powered by 9 volt battery, complete with easy to follow instruction and built in jack socket for use with earphones or amplifier.

Only £3.50 + p. & p. 10p U.K. only.

Illustrated catalogue of selected kits and components. 15p P&P free.

Galleon Trading Co.,
 12, Burrs Way,
 Corringham,
 Stanford-Le-Hope,
 Essex.

Trampus electronics

All Brand New. Money Back Guaranteed. Fast Service.
 5V DIGITAL INDICATOR
 0-9DP, with socket and red Filter £1.45, 7447 £1.49.
 IC GAS DETECTOR. Smoke, Butane, Vapour, etc. £1.99, data 9p. **ULTRASONIC TRANSDUCER.** Transmit or receive, 22. **LIGHT EMIT DIODES.** Visible red/panel chip data, 39p. **INFRA RED** (invisible beam), £1.19. **DIGITAL CLOCK** integrated circuit, 28 pin DIL, 12/24 hr. 4/6 digit. £1.50, data 15p. **CALCULATOR,** electronic, 8 digit, 4 function + constant. Year guarantee, fully built 24.95 **PW TEXAN KIT** less chassis £21.49. PAKS: ic/semi-conductor 28. Caps 22-42. Res. £1. Transformer 22-67. TLP 41/42 pair 22. 741/748 85p ea. **INTEGRATED CIRCUITS** with data. 741 Op amp DIL 80p. 709 TO 50 21p. DIL 29p. 710 86p. 748 39p. **PHOTO DETECTOR/amp** 44p. **VOLTAGE REGULATORS:** 1 1/2 amp 5 or 12 v type £1.67. 723 59p. 555 TIMER/stab oscillator £1.19. **AUDIO AMP 2-5W** H.F. etc. £1.24. Stereo: Dual Pre-amp £1.67. MPX Decoder for any FM RX 29p. 74N: Data Booklet 12p. gates 7400 etc. 15p. 7490 59p. 7470/72 29p. 7473 39p. 7492 78p. 7413 29p. **DIL SOCKETS** low profile 14 or 16 pin, for 74N, 13p. **SEMICONDUCTORS**
 2N8055, 39p. BC107, 8p. BC108, 7p. BC109, 8p. AC125/6/7/8, AC127/8, AC127/8, AF117, 18p. AD181/2, 35p. BC181/8, 17p. BC177/8/9, 16p. BC182/3/4, 11p. BC212/3/4, 13p. BC370, 18p. BFY50/51/52, 17p. TI843 UJT, 29p. 2N706A, 12p. **FET** 2N3819, 28p; 2N2926 O.Y.P., 2N3053, 17p; 2N3702/3/4/5/6/7, 11p; 2N3708/9/10/11, 9p. **1A RECTS:** 50V 4p. 400V 8p. 50V Bridge 29p. IN914/5 9p. OA81/91 7p. OA2/90/92 10p. **ZENERS:** BZY88 400mW 11p. 5V/10W 29p. MINI SCR 4A/400V 55p. TRIAC 6A/400V 87p. **CAPACITORS:** 25/30V Electrolytic. 10/50/100µF, 8p; 200/400µF, 8p; 1,000µF, 15p. **DIG:** 22pF thro' to 0.047µF, 8p; 0.01 to 0, 8p. **RESISTORS** 1W 5%, 1p. PRESETS 0.25W, 5p. **VERO** 18p/23p, etc. DIN plugs, 13p; sockets, 9p. Stereo Amp, in case, £14.67. Light Dimmer, 23. **ELECTRONIC: CAR IGNITION KIT,** 26-67. **FREE CATALOGUE, SAE, Data Sht.** 6p ea. C.W.O. P & P 7p. Overseas 35p. Discount 10+10%. **P.O. BOX 29, BRACKENELL, BERKS.**



CASSETTE DECKS, 6v motor. Suitable for all home-made projects. Complete with 2 track, erase, record/playback heads. Available with 200mW amplifier. Ready wired for battery connection. Chassis only: £16. Amplifier to suit: £3. Free pkg. & pstge. C.W.O. Mail only. M & B Electronics, Dept. PW1, 51 Nathans Road, Wembley, Middx HA0 3RZ.

CAPACITORS FOR DISCHARGE IGNITION

We stock a range of 440VAC capacitors specially designed for use in popular ignition systems as the main discharge capacitors. Approved by the designers of 'Scorpio' and also suitable for systems described in P.W. and W.W. More reliable than 1000VDC (300VAC) units in common use. 0.47 or 0.5µF 1 1/2" x 1 1/2" 35p ea.; 1µF 2" x 1 1/2" 45p ea.; 2µF 2" x 1 1/2" 75p ea.; Post and packing 5p per order. **V. ATTWOOD, P.O. BOX 8, ALRESFORD, HANTS.**

5-N-CANNEL FETs 3819E-£1

Full specification devices complete with data and circuit details for building voltmeter, timer, ohmmeter, etc. Send 10p for full list of field effect transistors and other top quality transistors available at bargain prices.

REDHAWK SALES LIMITED

45 Station Road, Gerrards Cross, Bucks. Mail Order only

TAPE AMPLIFIERS

2xEC83, EL84, EZ80. 20µV i/p sensitivity, 2 watts o/p into 7 x 4" 3 ohm speaker. All contained in polished cabinet with non-standard single motor deck. With circuit £3 (£1). 64 fibre light guide £1 per metre. Resistors: 300 5% and better 60p (15p); 200 5% hi-stabs 80p (15p); 100 1 & 2% 60p (8p); 100 metal oxide 50p (8p). BC107-8-9 8p, 14 for £1; 2N3055 35p; µA709C 25p; µA741C 25p; Ferric Chloride 11b 40p (15p) 10lbs £3.50 (50p); 3 1/2" 1mA FSD metre 75p (15p); 2 1/2" 121-0-12 1/2µA £1 (10p). Others up to 7 x 6" available. TMC 1000 type key-switches (new) 4c/o + 4c/o locking 40p. Read unit, contains 31 1/4 250V reeds mounted round a drum with magnet inside, also resistors, sockets, etc. £1 (25p) 2 for £1-65 (35p).

GREENWELD (PW7)

24 Goodhart Way, W. Wickham, Kent, BR4 0ES Tel. 01-777 2001
 Post in brackets; small parts 3p. S.A.E. list

RECEIVERS and accessories. B40/62B fine-tuning, S-meter and product detector kits and information. SAE details. P. R. Gollidge, GSEDW, Glen Tor, Torrington, Devon. Tel: 08-052 2411.

HEADPHONES. Matching 9R59DS, EC10 and all low impedance receivers. Luxury lightweight adjustable, foam padded. Japanese: £2-60. Partridge Electronics Ltd., Broadstairs, Kent.

INCOMPARABLE V.H.F. KIT

Johnsons CV2—unique triple-purpose (Converter, Receiver, Tuner-Feeder) kit for the Amateur enthusiast. Fantastic transistorized performance. World Wide Sales. Complete kit of top grade parts with coils covering 80-180 mHz, plus easy/build diagrams and instructions. £4 direct from makers or S.A.E. for free literature.

Crystal Set Kits—one or two waveband Send S.A.E. for free literature, available soon. See also advert. on page 765.

JOHNSONS (RADIO)

St. Martins Gate, Worcester, WR1 2DT
 Est. 1943 (a John Banner Co.) Tel. 24864

FERRIC CHLORIDE, 11b 25p. Magnetic counters 10p. 50 resistors 16p. 20 capacitors 20p. Constructor's sample parcel and lists 30p. QSL Display Units (120 Cards), 25p. Postage extra. Derwent, Radio, Scarborough.

RADIO SPARES (R.S.) COMPONENTS specified for projects in this, and other magazines supplied on request. SAE with all enquiries. The Hobbies Shop, 32 The Parade, Cwmbran Town Centre, Cwmbran, Mon.

Build the TEXAN hi-fi amp

Designer approved

Kit only

£28.50

(incl. case)



Pack 1. RESISTORS	50p
Pack 2. SMALL CAPS	£1.50
Pack 3. LARGE CAPS	£1.40
Pack 4. SUNDRIES	£1.90
Pack 5. SWITCHES	90p
Pack 6. CONTROLS	£1.45
Pack 7. SEMI COND	£8.25
Pack 8. TRANSFORMER	£4.95
Pack 9. P.C. BOARD	£2.50
Pack 10. CHASSIS etc.	£4.20

Post extra—parts available separately.
Send for list.

Kits also available for

- ★ Radio Control Systems
- ★ Digital Clock Systems
- ★ Integrated Circuit Amplifiers (to 50W)
- ★ Hi-Fi Pre-amps
- ★ Stabilized Power Supply Units

TELERADIO HI FI, 325 Fore Street,
London, N.9.
01-807 3719

THE WORLD RENOWNED "GLOBE KING" SHORT WAVE RADIO KITS now back in production!

New, exciting range of short-wave units covering 10 to 350 metres. Transistor 9v. and AC mains versions. Ideal for Plate etc.—range the World with just 95" length of wire or Rod aerial! Acclaimed by professional and amateur alike "Globe-King" receivers are in use all over the world. Modern technique plus a precision mechanical standard opens up a new era for this famous product. Send for free copy of our interesting literature, price lists, and order form—kindly enclose self-addressed long envelope. Overseas inquiries must be accompanied with International Reply Coupon. (See also our advert on page 764).

JOHNSONS (RADIO)

St. Martins Gate, Worcester, WRI 2DT
(a John Banner Co.)

COMPUTER PANELS

Panel contains 2 x Mullard OC23 Transistors and 5 other Transistors etc. 2 panels 50p p.p. 15p.
Panel contains 2 x Mullard OC28 Transistors 2XBCY34, etc. 2 panels 50p p.p. 15p.
Assorted Computer Panels contains many useful Transistors, Diodes, Trim Pots, etc. 4 panels for £1 post free.
Assorted Panels contains minimum of 10 integrated circuits, also Transistors, Diodes etc. £1 p.p. 15p.
Electrolytic Capacitors UFV. 2000/35, 10,000/15, 10,000/25, 12,500/35. All at 30p each p.p. 6p.
2,000/50, 2,500/50, 5,000/50, 10,000/50, 12,500/50, 50,000/15 all at 40p each p.p. 10p.
Also available wide range motor start capacitors also block paper, etc.
Assorted miniature and subminiature Electrolytic Capacitors, 100 for £1.20 p.p. 15p.

Mail Order only

XEROZA RADIO

1, East Street, Bishops Tawton, Devon
SEND YOUR EXACT REQUIREMENTS

TV Line out-put transformers.

Replacement types ex-stock.

For "By-return" service, contact:

London: 01-948 3702

Tidman Mail Order Ltd., Dept. PW,
236 Sandycroft Rd., Richmond, Surrey
TW9 2EQ

CALLERS WELCOME

COMPONENTS GALORE. Pack of 500 mixed components manufacturers surplus plus once used. Pack includes resistors, capacitors, transistors, diodes, I.C., gang, pots, etc. Tremendous value. Send £1 incl. postage C.W.O. to Caledonian Components, Fosterton Firs, Strathore Road, Thornton, Fife.

LARGE QUANTITY used components and hardware for P.W. circuits. S.a.e. for lists. David Coulam, 4 The Terrace, Tathwell, Louth, Lincs LN11 9SR.

MINT, BRANDED BC169C super-gain low noise npn, 10p. AD161/AD162, complementary pairs, 60p. Mail order only. U.K. post 5p. Amatronic Ltd., 396 Selsdon Road, South Croydon, Surrey CR2 0DE.

Miscellaneous

NO NEED TO WORRY ABOUT A TRANSMITTING LICENCE

because this GPO approved transmitter/receiver kit does not use R.F. and you can get one easily. Your transmissions will be virtually SECRET since they won't be heard by conventional means. Actually it's TWO KITS IN ONE because you get the printed-circuit boards and components for both the transmitter AND receiver. You're going to find this project REALLY FUN-TO-BUILD with the EASY-TO-FOLLOW instructions. An extremely flexible design with quite an AMAZING RANGE—has obvious applications for SCHOOL PROJECTS, LANGUAGE LABORATORIES, SCOUT CAMPS, etc.

GET YOURS! SEND £3.50 NOW
(S.A.E. for details)

TO: 'BOFFIN PROJECTS'
DEPT. KW2010
4 CUNLIFFE ROAD
STONELEIGH, EWELL, SURREY

Darned Electronic Wizardry by Dewtron

Famous kits, e.g. waa-waa complete kit £2.95; Fuzz kit £4.75, auto rhythm modules P & P 20p min. Ring Modulator modules £8 and whole range of synthesiser modules, musical novelties, etc. Catalogue 15p from D.E.W. Ltd., 254 Ringwood Road, Ferndown, Dorset.

TOP TRANSISTORS

Brand New and Individually Tested Transistors supplied unmarked, but packed separately for identification and guaranteed to be within their correct specification or money refunded. All at 9p. each or

Any 25 transistors for only £1.90

ACY22	BFY51	OC72	2N3702
BC108	BFY52	OC202	2N3703
BC109	BSY27	ZTX300	2N3705
BC16E	OC45	2N706	2N3706
BC169	OC71	2N2926	2N3708

Money back guarantee, P. & P. 10p.

J. M. KING (H)

17 Buckridge, Portpool Lane, London, E.C.1



Build your next project in a BEC (Book End Chassis)—a new concept in Chassis buying. No cabinet to build when you have finished. Contemporary design with wooden end cheeks. 3 sizes. These cabinets are adaptable to all projects in P.W. and P.E., Texan, Gemini etc. Send large S.A.E. for details.

H. M. ELECTRONICS, 275a Fulwood Road,
Sheffield, S10 3BD Phone 55951 anytime

FIBREGLASS Printed Circuit Board, 5p 12 sq. in., 50p sq. ft. single; 8p 12 sq. in., 70p sq. ft. double. Any size cut. Post 10p. BRB, 17 Southbreck Rise, Worksop, Notts S80 2UP.

25W INVERTOR P.W. OCT. 1972

P2/2 transformer, power transistors, resistors. Complete pack £2.40 plus 15p P. & P. (UK only).

P2/2 transformer only £1.40 plus 15p P. & P. (UK only).

MAGTOR LTD., 68 DALE STREET,
MANCHESTER M1 2HS. 061-236 3031

Calculator Kit

IDEAL FOR CHRISTMAS!

COMPLETE-ONLY £39 +75p
S.A.E. FOR DETAILS P&P

LSI CHIP, 8 DIGIT LED READOUT,
PRINTED CIRCUIT BOARD,
PLASTIC CASE,
POWER SUPPLY, KEYBOARD, ETC.
CONSTANT, FIXED OR FLOATING
DECIMAL.

ALSO— LSI CLOCK CHIP £11.50
RAPIDMAN 800 £32.00
ADVANCE MINI £45.00

BYWOOD

ELECTRONICS

181 EBBERS RD, HEMEL HEMPSTEAD, HERTS.
0442 62757

12 VOLT FLUORESCENT LIGHTS

(as illustrated)



Beat power cuts. Be independent. Ideal for caravans, tents, emergency lighting, etc. Works anywhere where 12v is available. Guaranteed for six months. Ready to use at.

12 ins. 8 watt £3.60 post paid

21 ins. 13 watt £4.60 post paid

Callers welcome.

For lists or enquiries, large s.a.e.

SALOP ELECTRONICS, 23 WYLE COP
SHREWSBURY, SHROPSHIRE.

BUILD IT in a DEWBOX quality cabinet. 2in x 2½in x any length. D.E.W. Ltd., Ringwood Road, FERN-DOWN, Dorset. S.A.E. for leaflet. Write now—Right now.

LSI Clock

At last BYWOOD can offer the amateur constructor an LSI Digital Clock Chip. This MOS chip is built into a 28 pin package. Control inputs to the device select 50 or 60 Hz operation, 12 or 24 hour display, 4 or 6 digit output. Outputs are multiplexed BCD or seven segment lines plus digit select lines. Input controls enable rapid time setting and high currents limit the external component count.

Basic chip BYWMM5311 £11.50 p. & p. 12p.

BYWOOD

181 EBBERS RD, HEMEL HEMPSTEAD, HERTS. 0442 62757

FASCIA PANELS to individual specification in etched aluminium. Hardware supplies for constructors. Printed circuit boards one-off's. Send 5p for list. Ramar Constructor Services, 29 Shelbourne Road, Stratford-on-Avon, Warwickshire.

SW-BC LOG with time indication, post free. Pay 60p at any post office to National Giro account 651-4154 SVERIGES RADIOKLUBB, UK treasurer.

"HOW TO LISTEN TO THE WORLD". Published October 1972. £1.90, post 10p. Direct from World Publications' Warehouse. Order from: David McGarva, Box 114E, Edinburgh EH1 1HP.

RECORD T.V. SOUND

using our loudspeaker isolating transformer. Provides safe connection for recorders, Hi-Fi equipment or extension speakers.

£1 post free. Instructions included.
Crowborough Electronics (PW)
Eridge Road, Crowborough, Sussex.

OMNI-DETECTORS

(Featured ★ TV ★ Radio ★ Nat. Press)

Ancient art of Dowsing in Modern Guise. Experience thrill of the old days of Wireless in this over-looked aspect of the Electro-Magnetic Spectrum. A LAB-ORATORY IN A SINGLE PACK. If you enjoy Treasure Hunting, use OMNI-DETECTORS to—
★ Locate ANY buried substance, ANY depth.
★ Save hours of fruitless searching—MAP-DOWSING pinpoints search area before you leave home.
★ Analyse ground under your feet without even scratching the surface.
★ Limitless other uses involving health, food, sex, money. YOU WILL BE FASCINATED.
Send only £2.80 + 15p p. & p. for unique pack of 4 dowsing instruments (non-electronic) and explicit 40-page manual to sole suppliers—Omni-Detector Co., (Dept. FW), 27, Latham Road, Twickenham, Middx. TW1 1BR.

Transistors

TRANSISTOR BARGAINS!

AD161/2 50p PAIR, 30p SINGLE.
OC41-46 10p EACH. OC23 10p EACH.
BC107-9 10p EACH. OCT3 UNMARKED 5p.
SEND FOR FREE CATALOGUE.

Orders to:

P. W. M. HICKMAN

22 East Preston St., Edinburgh EH8 9QB.



LOUDSPEAKER BARGAINS

Fane Pop 100 Watt 18" 8/15 ohm £19.50
Fane Pop 60 Watt 15" 8/15 ohm £11.15
Fane Pop 50 Watt 12" 8/15 ohm £9.25
Fane Pop 25/12" 25 watts 8/15 ohm £5.40
Fane Pop 15 12" 10 watts 8/15 ohm £4.00
Baker Group 25 12" 3, 8 or 15 ohm £8.00
Baker Group 35 12" 3, 8 or 15 ohm £8.00
Celestion PS5 for Unilux £2.35
EMI 13 x 8, 3, 8 or 15 ohms £2.25
EMI 13 x 8, 3, 8 or 15 ohms £2.60
EMI 13 x 8 twin tweeter 3, 8 or 15 ohms £3.00
EMI 13 x 8 type 350 15 watt 8 ohm £2.35
Richard Allen 8" 3, 8 or 15 ohm £2.50
Richard Allen 12" dual cone 3 or 15 ohm £2.85
Fane 8" dual cone 808T 8 or 15 ohm £3.50
Fane 8" d/cone roll surround 807T 8 or 15 ohm £2.70
Elac 59RM109 9" x 5" 15 ohm £2.70
Elac 59RM114 9" x 5" 8 ohm £2.25
Elac 6 1/2" d/cone 8 ohm £2.25
Elac 4" tweeter 8 ohm £1.50
Crossover for above (p. & p. free) £1.50
Goodmans 8 P, 8 or 15 ohm £4.75
Goodmans 10 P, 8 or 15 ohm £3.25
Goodmans 12 P, 8 or 15 ohm £10.50
Goodmans 15 P, 8 or 15 ohm £17.00
Goodmans 18 P, 8 or 15 ohms £27.50
Phillips 2" 2 1/2" or 3" 80 ohm £1.65
Phillips 5" 8 ohm £1.95
7" x 4" or 8" x 5" 3 or 8 ohm £1.50
10" x 6" 3, 8 or 15 ohm £2.00

FREE with orders over £6—"Hi-Fi Loudspeaker Enclosures" book.

All units guaranteed new and perfect.
Prompt despatch p. & p. 25p per speaker.

WILMSLOW AUDIO, Dept. PW

10 Swan St., Wilmslow, Cheshire, SK9 1HF

TRANSFORMERS

DOUGLAS GUARANTEED

Output V. & Amps.	Ref. No.	Price P. & P.
12V x 2 250 mA x 2	MT111 CS*†	£0.91 9p
12V x 2 600 mA x 2	MT213 CT*†	£0.87 16p
12V x 2 1A x 2	MT 71 AT*†	£1.48 24p
12V x 2 2A x 2	MT 15 AT	£8.06 30p
12V x 2 3A x 2	MT 70 AT	£8.29 32p
12V x 2 4A x 2	MT 108 AT	£2.92 34p
12V x 2 5A x 2	MT 72 AT	£3.33 42p

12 or 24 volts
30 volts. All tapped at 0-12-15-20-24-30V

Out-put	Ref. No.	Price P. & P.
500 mA	MT 112 CT*†	1-12 16p
1A	MT 79 AT*†	1-55 29p
2A	MT 3 AT*†	2-23 30p
5A	MT 51 AT*†	4-31 42p
50 Volts.	All tapped at 0-19-25-33-40-50V.	
500 mA	MT 102 AT*†	1-46 24p
1A	MT 103 AT	2-00 32p
2A	MT 104 AT	3-10 32p
50 Volts.	All tapped at 0-24-30-40-45-60V.	
500 mA	MT 124 AT*†	1-46 30p
1A	MT 126 AT	2-24 32p
2A	MT 127 AT	3-16 41p
3A	MT 128 AT	4-59 41p

Power output	Winding	tapped at	Ref. No.	Price P. & P.
20 VA	0-115-210-240		MT 118 CT	£0.89 15p
75 VA	0-115-210-240		MT 64 AT	£1.72 30p
150 VA	0-115-200-220-240		MT 4 AT	£2.15 32p
200 VA	0-115-200-220-240		MT 65 AT	£3.00 32p
400 V. Output at 50 Hz.	Ref. ITS AT			Price P. & P.
C-D Ignition system by R. M. Marston				£2.80 29p

Sec. Output (r.m.s.)	Ref. No.	Price P. & P.
3-0-3 V.	200 mA MT 238 CS*†	£0.89 8p
9-0-9 V.	100 mA MT 13 CS*†	£0.91 8p
12-0-12	50 mA MT 239 CS*†	£0.91 8p
20-0-20	30 mA MT 241 CS*†	£0.91 8p
0-20 x 2	300 x 2 MT 214 CT*†	£1.21 16p
0-8-9 x 2	500 mA x 2 MT 207 CT*†	£1.46 19p
0-15-20 x 2	500 mA x 2 MT 205 AT*†	£2.12 29p
0-15-27 x 2	500 mA x 2 MT 203 AT*†	£2.45 29p
0-15-27 x 2	1A x 2 MT 204 AT*	£3.45 30p
10-12-0-12-20	700 mA (d.c.) MT 221 AT*	£1.11 26p

AT indicates open universal fixing with tags; CT is open U-clamp fixing with tags; CS is open U-clamp fixing with P.C. spalls; * with interwinding screen; † untapped 240V Primary; ‡ Primary tapped at 210-240V. other Primaries tapped at 200-220-240V.
Over 200 types in stock through agents or direct. Send for list.

DOUGLAS ELECTRONICS INDUSTRIES LTD.
(Dept. MOSPW), Thames St., LOUTH, Lincs. LN11 7AD

BARGAIN END OF STOCK. BRAND NEW HARTLEY OSCILLOSCOPES— CT316 and width up to 5 Mc/s. Mains supply. Original price £40. Reduced to £32 post paid.

BARGAIN PARCELS 141b at £1.45 plus 32½p p.p.; 281b at £2.75 plus 52½p p.p.; 561b at £4.50 plus £1.25 p.p. Contain pots, Res, Valves, Diodes, Tagboards, Chassis, Valveholders, etc. Good value save £££. Lucky Dip Service.

FANTASTIC BARGAIN. New 6 inch tubes, E450 4/B/16 4VH, medium Persistence, green. Ideal scope tube. Also 09J 4½in. dia. Length 15in, Also 7BP7 and 5FP7. All unused as new. Price £1.40 post paid.

NEW HEAVY COAX CABLE dia. ¾" 70 ohms approx. 50ft. lengths £1.40, p. & p. 30p. 100 ft. lengths £2.70, p. & p. 50p.

AERIALS. New Condition Whip Type, 4ft. 20p; 11ft. 75p. all collapsible type. P. & p. 4ft. 10p, 11ft. 15p. New bases on adjustable clamp for the above. 62½p. p. & p. 25p.

CRYSTALS AS NEW: Hc 6u, 5,345; 5,030; 4,945; 4,875; 4,840; 4,795; 4,580; 4,660; 4,520; 4,510; 2,300; 2,295 Kc/s. 50p each plus 8p p.p.

OUR SELECTION OF 6X EQU. METERS consisting of 3in., 2½in., 2in. mill amps, volts, amps. Mixed at the bargain price of £2 post paid minimum order of six.

ANY HEIGHT AERIAL TUBULAR SECTIONS ¾" dia. x 3 ft. long. Brass screw in ends, copper coated and painted. Good condition. 20p. p. & p. 5p each. Minimum order 6.

AS NEW AERIAL TUNER UNIT No. 6 RF, consisting of 1½ inch 500 micro/ammeter 3 gang tuner 75 PF geared BNC type socket size 5½" x 4½" x 5". Price £1.50, p. & p. 25p.

HEADPHONES DI. High impedance. Good condition 75p, p. & p. 15p.

R209. Set of valves 62½p. p.p. 25p.

NEW AERIAL WIRE ON BOARDS 7/22 UNCOVERED 75ft. 40p, 90ft. 47½p, 100ft. 55p, p. & p. 20p.

AERIAL MAST POLES approx. 5ft high 2" dia. Interlocking ends. Minimum order three. New condition. £1 each section. Carriage 35p each section.

¾" 75 ohms Coax in 50ft coils with BNC plugs good condition. Price £1 + 30p p.p.

SLIDING RESISTORS. 12 amp, 1ohm. Approx. 9in. long. 1-4 amp. 14 ohms. Approx. 7in. long. As new Ex Eap. 75p, p.p. 15p.

QUOTATIONS FOR QUANTITY.

C.W.O. CARRIAGE CHARGES MAINLAND ONLY

WOULD CUSTOMERS PLEASE ENSURE THAT ALL ORDERS ARE PRINTED IN BLOCK CAPITALS AND INCLUDE YOUR ADDRESS.

A. H. THACKER,

Radio Dept.,
HIGH STREET, CHESLYN HAY,
Nr. Walsall, Staffs.

MAINS UNITS for all types of TRANSISTOR EQUIPMENT

RUN YOUR TAPE RECORDER OFF AC MAINS

Mains unit supplied complete and ready to plug into your cassette recorder. (State voltage, make and type of plug required, if in doubt send diagram of recorder socket.)



ONLY £2.50 P & P 15p

PLUS-3 MAINS UNIT



Provides three separate switched output voltages 6v., 7½v. and 9v. DC. Attractive case with indicator light, mains lead output socket, plug and lead. Size 4½ x 3½ x 1½ in.
ONLY P & P £3.00

Extra lead with plug to fit your cassette recorder 50p. (State model and plug required.)

SINGLE OUTPUT MAINS UNITS

For transistor radios, etc. 6v. or 9v. or 12v.

ONLY P & P £2.00

(Please state output required.)
All units are completely isolated from mains by double wound transformer ensuring 100% safety.



R.C.S. PRODUCTS (RADIO) LTD.

(DEPT. P.W.), 31 OLIVER ROAD, LONDON, E17

B.H. COMPONENT FACTORS LIMITED

MULLARD POLYESTER C280 250V. (µF) 0-01, 0-015, 0-022, 0-033, 0-047, 0-068, 0-1, 0-15, 4p, 0-22, 5p, 0-33, 7p, 0-47, 8p, 0-68, 10p, 1-0, 13p, 1-5, 20p, 2-2, 23p.

MULLARD POLYESTER C296: 160V. (µF) 0-01, 0-015, 0-022, 2p, 0-047, 0-068, 3p, 0-15, 0-22, 4p, 0-23, 5p, 0-47, 6p, 0-68, 1-0, 10p, 400V: (µF) 0-001, 0-0015, 0-0022, 0-0033, 0-01, 2p, 0-015, 0-033, 3p.

MULLARD ELECTROLYTIC C425, 5p, each. (µF/V) 0-64/64, 1-6/25, 4/40, 8/40, 10/40, 10/64, 16/40, 20/64, 25/25, 32/10, 40/16, 64/10, 80/16, 80/25, 100/6-4, 125/16, 125/10.

MULLARD C437: 64/64, 180/25, 640/6-4, 8p, 160/40, 11p, 1600/6-4, 14p.

LARGE ELECTROLYTIC: 500/25, 10p, 500/50, 12p, 1000/12, 15p, 1000/25, 2000/12, 2500/12, 15p, 1000/50, 35p, 2000/25, 25p, 2500/25, 30p, 3000/50, 65p, 5000/50, 85p, 2500/50, 55p.

CERAMIC PLATE 750V: (pF) 5, 10, 25, 40, 70, 220, 21p. (µF/V) 0-0047/30, 0-01/350, 21p, 0-047/30, 3p, 0-1/30, 4p, 0-1/100, 5p, 22pF-0-01µF, 50V, 2p. (E12 series).

CARBON FILM RESISTORS, 1W, 5% 10ohms-2-2M 1p, each, or 100 for 55p.

SPECIAL RESISTOR KITS (1W 5% Carbon Film) 10E12KIT, 10 each E12 value, 100ohms-1M A total of 610. £2.80 net

25E12KIT, 25 each E12 value, 100ohms-1M total of 1825. £6.50 net

VEROBOARD 01 015 £6.50 net
2½" x 5" 25p 25p
2½" x 3½" 28p 17p
3½" x 5" 28p 30p
3½" x 3½" 25p 25p

Plugs, Pkt. 25 8p
2 Pin DIN Plug 12p, Socket 10p
3 Pin DIN Plug 13p, Socket 10p
5 Pin DIN Plug 180° 15p, Socket 12p

Red Panel Neon 240V. 15p

RF Chokes (µH) 0-22, 2-2, 12, 22 8p

PVC Wire 7/0076, 5 x 10 yds. 30p

PVC Wire 14/0076, 5 x 10 yds. 30p

Neon Bulb 80V, wire ended. 5 for 200

Min. Push button, push to make 10p

Mains Transformer 32-0-32 at 150mA 5pp

1N4001, 8p, 1N4002, 7p, 1N4003, 8p, 1N4004, 8p

1N914, 6p, 7400N, 15p, 7401-7410-7430, 15p

2N706, 10p, µL914, 30p, BC108, 11p, BFY51, 20p

CWO, pp 10p. Discount £10-10%. The above items are only a few taken from our catalogue which is available free. Money back refund.

Dept. PW, 61 CHEDDINGTON RD., PITSTONE LEIGHTON BUZZARD, BEDS. LU7 8AQ

Tel.: Cheddington 688446 (STD Code 0298)

SINCLAIR PROJECT 60

Z30 £3.50
Z50 £4.25
PZ5 £3.97
PZ6 £6.26
PZ8 with
trans £7.60
AFU £4.50



Stereo 60 £7.80
Project 605 £19.00

PROJECT 60 KIT

£2.50

Our extremely popular kit contains the extra capacitors, DIN plugs and sockets, cables and fuse holder needed to complete Project 60.

S-DECS AND T-DECS

S-DECS £1.40

T-DECS £2.80

µ-DEC A £3.00

Official credit orders from educational establishments welcome.

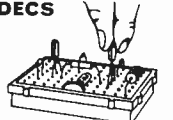

SINCLAIR SUPER IC12

Complete with free printed circuit board and 44 page instruction book.

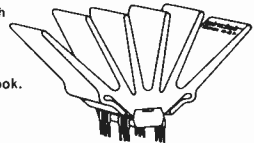

ONLY £2.00

KITS OF PARTS FOR THE IC12

Includes all parts for the printed circuit and volume bass and treble controls needed to complete the mono version £1-30. Stereo version with balance control £3.00.

POWER UNITS FOR THE IC12

A set of components to construct a 30V, 0.5 Amp power supply £2.27. Also suitable Sinclair PZ5 fully constructed £3.97.

SWANLEY ELECTRONICS

32 Goldsel Road, Swanley, Kent

Mail order only. Postage 10p per item. Our Hi-Fi colour catalogue is 10p post free.

INDEX TO ADVERTISERS

A. H. Supplies	700
Antex Ltd.	685
Apex Aerials	762
Arrow Electronics	666
Attwood, V.	764
Audio Supplies	735
B. H. Component Factors	767
Baines, R.	762
Bell's Television	763
Bentley Acoustic Corporation Ltd.	704
Bernard, Gerald	684
Bib Sales	669
B.I.E.T.	760, cov. iii
Bi-Pak Semiconductors	687, 688, 689
Bi-Pre Pak Ltd.	739
Boffin Projects	765
British National Radio & Electronics School	712, 750
Broadway Electronics	678
Bull, J. (Electrical) Ltd.	751
Bush & Meissner	754
Bywood Electronics	765, 766
C.B.M. Electronics Components Ltd.	700
C.T. Electronics	684
Carrana, C.	763
Codar Radio Co.	674
Colomar Electronics Ltd.	676
Comet High Fidelity Discount Warehouses	672, 673
Concord Electronics Ltd.	677
Crowborough Electronics	766
Cybor Products	762
D.E.W. Ltd.	765
Dabar Electronic Products	708
Dexter & Co.	668
Discosound	755
Douglas Electronic Industries Ltd.	766
Duke & Co.	670
Electronic Design Associates	756
Electronics, H.M.	765
Electrospares	756
Electrovalve	711
Elekon Enterprises	760

Elvins Electronics Musical Instruments	686
Expo (Drills) Ltd.	676
Express Mail Order	708
Felstead Electronics	744
Galleon Trading	764
Gladstone Radio	744
Global Audio Discount Warehouse	670, 700
Greenwell Electronics	764
HAC Short-wave Products	682
Hadley, C.	744
Harverson Surplus Co. Ltd.	761
Heath (Gloucester) Ltd.	699
Henry's Radio Ltd.	749, cov. iv
Hickman, P. W. M.	766
Home Radio (Components) Ltd.	743
I.C.S.	703
I. L. P. Electronics Ltd.	675
Imperial Trading	762
Jef Electronics	764
Johns Radio	754
Johnsons (Radio) Ltd.	764, 765
K.V.A. Electronics	754
Kensington Supplies	762
Keytronic	682
Kilrimont Book	762
King, J. M.	765
Lasky's Radio Ltd.	690
Lewis Radio	674
Lindair (Electro-tech) Ltd.	684
Linear Products Ltd.	668
London Computer Operators Training Centre	763
London Electronic College	763
Magtor Ltd.	722, 765
Marktyme	666
Marshall, A. Son	736
Miniwise Products	704
Morse	762
Multicore Solders Ltd.	678
NIP Electronics	762
Omni Detectors	766
Omnia Products	762

Padgetts Radio Store	754
Partridge Electronics Ltd.	756
Pembridge College	666
Powertran Electronics	704
Radio Component Specialists	740
Radio Exchange Ltd.	671
Radio & T.V. Components (Acton) Ltd.	680/1
Radio Society of Great Britain	678
Redhawk Sales Ltd.	764
Readers Radio	670
Riversdale Electronics	686
ROC Electronics Ltd.	683
R.C.S. Products (Radio) Ltd.	767
RSC Hi-Fi Centres Ltd.	cov. i, 665
RSL Components	764
R.S.T. Valve Mail Order Co.	682
S.C.S. Components	750
Salop Electronics	765
Saxon Entertainments	679
Scientific & Technical	686
Selray Book Co. Ltd.	762
Sinclair Radionics Ltd.	752, 753
Shopertunities Ltd.	707
Smith, G. W. & Co. (Radio) Ltd.	757, 758, 759
Smith, H. L. & Co. Ltd.	766
Sound Supplies Ltd.	763
Speaker Selection	684
Superelectronics	750
Swanley Electronics	767
Taylor Kirby	764
Technical Trading	667
Teleradio Co. Ltd.	765
Thacker, A. H.	766
Thornbury Trade Disposals	722
Tidman Mail Order	765
Trade Aids	668
Trampus Electronix	764
Tuac	708
Vero Electronics	668
W.E.C. Ltd.	700
Web Europa	676
West London Direct Supplies	682
Willswood Audio	674, 722, 766
York Electronics	754
Xeroza Radio	765
Z & I Aero Services	768

FREE!

Over 150 ways to engineer a better future

HIGHER PAY

A BETTER JOB

SECURITY

find out how in just 2 minutes

That's how long it will take you to fill in the coupon below. Mail it to B.I.E.T. and we'll send you full details and a free book. B.I.E.T. has successfully trained *thousands* of men at home - equipped them for higher pay and better, more interesting jobs. We can do as much for YOU. A low-cost B.I.E.T. home study course gets results fast - makes learning easier and something to look forward to. There are no books to buy and you can pay-as-you-learn. Why not do the thing that really interests you? Without losing a day's pay, you could quietly turn yourself into something of an expert. Complete the coupon (or write if you prefer not to cut the page). No obligation and nobody will call on you... but it could be the best thing you ever did.

Others have done it, so can you

"Yesterday I received a letter from the Institution informing that my application for Associate Membership had been approved. I can honestly say that this has been the best value for money I have ever obtained - a view echoed by two colleagues who recently commenced the course".—Student D.I.B., Yorks.
 "Completing your course, meant going from a job I detested to a job that I love, with unlimited prospects".—Student J.A.O. Dublin.
 "My training with B.I.E.T. quickly changed my earning capacity and, in the next few years, my earnings increased fourfold".—Student C.C.P., Bucks.

FIND OUT FOR YOURSELF

These letters - and there are many more on file at Aldermaston Court - speak of the rewards that come to the man who has given himself the specialised know-how employers seek. There's no surer way of getting ahead or of opening up new opportunities for yourself. It will cost you a stamp to find out how we can help you. Write to B.I.E.T., Dept. B37, Aldermaston Court, Reading RG7 4PF

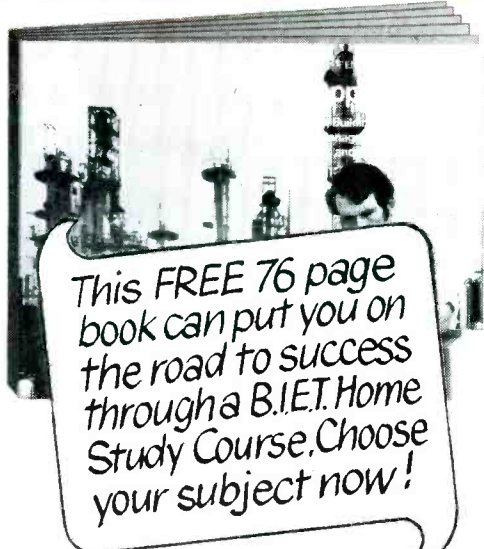

This FREE 76 page book can put you on the road to success through a B.I.E.T. Home Study Course. Choose your subject now!

MECHANICAL A.M.S.E. (Mech.) Boiler Inspection & Operation C & G Eng. Crafts C & G Fabrication Diesel Eng. Eng. Inspection Eng. Metallurgy Inst. Eng. & Tech. Inst. Motor Ind. Maintenance Eng. Mechanical Eng. Sheet Metal Work Welding	Man. Prod.—cont. Salesmanship Storekeeping Work Study Works Management DRAUGHTSMANSHIP A.M.I.E.D. Design of Elec. Machines Die & Press Tool Design Electrical Draughtsmanship Gen. Draughtsmanship Jig & Tool Design Technical Drawing	Constructional-cont. Building Drawing Building Foreman Carpentry & Join. Civil & Municipal Engineering Construction Surveyors Institute Clerk of Works Council Eng. Geology Health Eng. Heat & Vent. Hydraulics Inst. of Builders Inst. Clerk of Works Inst. Works & Highway Supers. Painting & Dec. Public Hygiene Road Engineering Structural Eng. Surveying
ELECTRICAL & ELECTRONIC A.M.S.E. (Elec.) C & G Elec. Eng. C & G Elec. Inst. C & G Elec. Tech. Computer Elect. Elec. Maths Elec. Science Electronic Eng. Electrical Eng. Install. & Wiring Meters & Measuring Instruments	MANAGEMENT & PRODUCTION Automatic Control Computer Prog. Electronic Data Processing Estimating Foremanship Inst. Cost & Works Accountants Inst. Marketing Management Metrication Motor Trade Man. Network Planning Numerical Control Operational Research Personnel Man. Planning Eng. Production Eng. Quality Control	RADIO & TELE-COMMUNICATIONS Colour TV C & G Radio/TV/ Electronics C & G Telecomm. Tech. Prac. Radio & Elec. (with kit) Radio Amateurs Exam Radio Servicing & Repairs Radio & TV Eng. Transistor Course TV Main. & Serv. AUTO & AERO Aero Eng. A.M.I.M.I. A.R.B. Cert. Auto Engineering Auto Repair C & G Auto. Eng. Garage Management MAA/IMI Diploma Motor Vehicle Mechanics
GENERAL Agricultural Eng. Council of Eng. Inst. Farm Science General Education Gen. Plastics Pract. Maths Pract. Slide Rule Pure & Applied Maths Refrigeration Rubber Technology Sales Engineers Tech. Report Writing Timber Trade University Ent.		
G.C.E. 58 'O' & 'A' LEVELS SUBJECTS Over 10,000 group passes		

POST TODAY FOR A BETTER TOMORROW

To B.I.E.T., Dept. B37, Aldermaston Court, Reading RG7 4PF

B37

NAME _____
 Block Capitals Please
 ADDRESS _____

SUBJECT OF INTEREST _____ AGE _____
Accredited by the Council for the Accreditation of Correspondence Colleges.

BRITISH INSTITUTE OF ENGINEERING TECHNOLOGY

Published approximately on the 7th of each month by IPC Magazines Limited, Fleetway House, Farringdon Street, London, E.C.4. Tel: 01-634 4444. Printed in England by Index Printers, Dunstable, Beds. Sole Agents for Australia and New Zealand—Gordon and Gotch (A/sia) Ltd.; South Africa—Central News Agency Ltd.; Rhodesia and Zambia—Kingston Ltd.; East Africa—Stationery and Office Supplies Ltd. Subscription rate (including postage): For one year to any part of the world £2.65.
 PRACTICAL WIRELESS is sold subject to the following conditions, namely, that it shall not, without the written consent of the Publishers first given, be lent, resold, hired out or otherwise disposed of by way of Trade at more than the recommended selling price shown on the cover, and that it shall not be lent, resold or hired out or otherwise disposed of in a mutilated condition or any unauthorised cover by way of Trade, or affixed to as part of any publication or advertising, literary or pictorial matter whatsoever.

113

U.K's LARGEST ELECTRONICS CENTRES!

HENRY'S RADIO LTD. EDGWARE ROAD, LONDON, W.2.

NOW OPEN!

404-406 ELECTRONIC COMPONENTS & EQUIPMENT 01-402 8381

354-356 HIGH FIDELITY & TAPE EQUIPMENT 01-402 5854/4736

309 PA - DISCO - LIGHTING HIGH POWER SOUND 01-723 6963

303 BARGAIN STORE SPECIAL OFFERS All Mail to: 303, Edgware Rd., London, W2 1BW

ALL YOUR ELECTRONIC REQUIREMENTS WITHIN 200 YARDS. CALL IN AND SEE FOR YOURSELF.



BUILD THE TEXAN

20 + 20 WATT INTEGRATED I.C. STEREO AMPLIFIER

★ FREE TEAK CABINET with complete kits!

FEATURES. New slim design with 6 - IC's, IC Sockets, 10 silicon transistors, 4 rectifiers, 2 zeners. special Gardeners low field slim line transformer. Fibre glass P.C. panel. Complete chassis work.

HIGH QUALITY & STABILITY ARE PREDOMINANT FEATURES — DEVELOPED BY TEXAS ENGINEERS FOR PERFORMANCE, RELIABILITY AND EASE OF CONSTRUCTION.

FACILITIES. On/off switch indicator, headphone socket, separate treble, bass, volume and balance controls, scratch and rumble filters, mono/stereo switch, Input selector; Mag. P.U. Radio Tuner, Aux. Can be altered for Mic., Tape, Tape-head, etc (Parts list Ref. 20 on request). Constructional details Ref. No. 21 30p

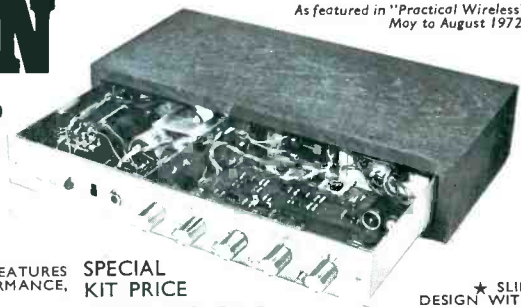

As featured in "Practical Wireless" May to August 1972

SPECIAL KIT PRICE

£28-50 P & P 45p

COMPLETE WITH FREE TEAK CABINET

Designer approved kits distributed by Henry's!

★ SLIM DESIGN WITH SILVER TRIM
Overall chassis size 14" x 6" x 2" high

- RECORD DECKS**
CHASSIS (POST 50p)
SP25/3E10/75 HT70 £14-50
MP60 £9-95 MP610 £12-95
AP76 £17-95 GL75 £28-30
PLINTH/COVERS (State Model)
SP25/MP60/610 £3-40 post 40p
AP76 £4-50 post 40p
CART/PLINTH/COVER (Post 70p)
(HL) MP60/G800H/PC £18-50
MP610/SC5MD/TPD2/PC £19-95
AP76/M756SM/PC £32-50
AP96/M756SM/PC £39-95
(HL) AP76/G800/PC £28-95
(HL) SP25/G800H/PC £18-95
HT70/G800/TPD1/PC £24-50
(HL) 2025/9TAHCD/PC £13-95
MP60/SC5MD/PC £17-25
(HL) GL75/G800E/PC £41-95
(HL) GL75/G800/PC £38-95

ULTRASONIC TRANSDUCERS

Operate at 40Kc/s up to 100 yds. Ideal remote switching and signalling. Complete with data and circuits.
£5-90 per pair. Post 10p

MARRIOTT TAPE HEADS

- 4 TRACK MONO or 2 TRACK STEREO
17" High Impedance £2-00
18" Med. Impedance £2-00
36" Med.-Low Imp. £3-50
Erase Heads for above 75p
63" 2 track mono—Hi Imp. £1-75
43" Erase Head for above 75p

POWER INTEGRATED CIRCUITS

Plessey SL403D 3 watt with 8-page data, layouts and circuits £1-50. P.C. Board 60p. Heat Sink 14p. Sinclair IC12—6 watt with data and circuits £1-80. TH9013P—20 watt Power Amp Module £4-57. TH9014P—IC Preamp £1-50. Data/Circuits for above No. 42 10p

7 SEG & NIXIE TUBES

(Post 15p per 1 to 6)
XN3, XN13, GN6 0-9 side view with data, 85p.
GNF 7.7—0-9 side view with decimal points and data, 95p.
3015F 7 seg £2 each. £7 per 4 with data.
12 and 24 hour clock circuits Ref. No. 31 15p.

Miniature Amplifier

5 transistor. 300mV o/p. Fitted volume and sensitivity control, 9 volt operated. £1-75 each P/P 15p.

Quality Slider Controls

60mm stroke singles and ganged. Complete with knobs. 5K, 10K, 25K, 100K, 250K, 500K.
1 meg, Log and Lin. 45p each, 10K, 25K, 50K, 100K, 250K, Log and Lin ganged. 75p each.

Hi-Fi & Tape Equipment

Acknowledged as U.K.'s Largest Stockists with Lowest Prices Plus 12 months Guarantee. Write or call for FREE 16 page lists (Ref. N. 17)

Transistors - IC's - SCR'S - Rectifier Triacs, etc. LATEST BROCHURE Ref. No. 36 on request, or see our earlier page

LOW COST HI-FI SPEAKERS

- E.M.I. Size 13" x 8 1/2" Large Ceramic Magnet.
TYPE 150 6 watt 3, 8 or 15 ohms £2-20. Post 22p.
TYPE 150 TC Twin cone version £2-75. Post 22p.
TYPE 450 10 watt with twin tweeters and crossover 3, 8 or 15 ohms. £3-85. Post 25p.
TYPE 350 20 watt with tweeter and crossover. 8 and 15 ohms. £7-70. Post 28p.

POLISHED CABINETS 150, 150TC 450 £4-60. Post 30p. ASSEMBLED IN POLISHED CABINETS (8 ohms) SERIES 6 (Assembled 150 TC) per pair £16-50 Post 70p SERIES 8 (Assembled 450) per pair £18-95. Post 70p

ML-3 MW/LW TUNER to BUILD

Uses Mullard Module. Slow motion tuning. Built in battery. Ferrite aerial. Overall size 7" x 2 1/2" x 3 1/2". TOTAL COST TO BUILD £4-85, Post 15p. All parts sold separately. Leaflet No. 6

"BANDSPREAD" PORTABLE TO BUILD

Printed circuit all transistor design using Mullard RF Module. Medium and Long Wave bands plus Medium Wave Bandspread for extra selectivity. Also slow motion geared tuning, 600 mW push-pull output, fibre glass PVC covered cabinet, car aerial. Attractive appearance and performance. TOTAL COST TO BUILD £7-98, p.p. 32p. (Battery 22p). All parts sold separately—Leaflet No. 2

TEST EQUIPMENT Just a selection!

- SE250B Pocket Pencil Signal Injector £1-90
SE500 Pocket Pencil Signal Tracer £1-50
TL133D Robust 2K/Volt £4-55 with case £4-95
TE15 Grid Dip Meter 440 KHz-280 mHz £13-45
500 30 K/V Multimeter £9-25
With leather case £10-50
200H 20K/V Multimeter £4-20. With case £4-95
AF105 50K/V Multimeter £8-50. With case £9-50
U4341 AC/DC Multimeter with transistor tester with steel case £10-50
TE20D RF Generator 120KHz-500MHz £15-95. Carr. 35p
TE22D Audio Generator 20Hz-200KHz £17-50. Carr. 35p
Cl-5 3" Pulse Scope 10Hz-10mHz £39-00. Carr. 50p
TE65 Valve Voltmeter 28 ranges £17-50. Carr. 40p
ALL NOMBREX MODELS IN STOCK

PA-Disco-Lighting

UK's Largest Range—Write phone or call in. Details and demonstrations on request.
DJ30L 3 Channel sound to light unit, 3KW. £29-75
DJ40L 3 channel Mic (built-in) to light, 3KW. £38-75
DJ70S 70 watt Disco amp/mixer. £49-95
DISCOAMP 100 watt amp/mixer. £67-95
DJ105S 30 watt Disco amp/mixer. £32-75
Anti-Feedback Quality Mic. £11-50
DJ500 50 watt PA Amplifier £56-25
DJ300 150 watt rms "Group" Valve Amplifier £99-50
FIBRE OPTICS LIGHTING. — MIC'S. EFFECTS. PROJECTORS. SPOTS. DIMMERS — STANDS. MIXERS. SPEAKERS.
Everything for PA — Disco — Lighting.
FREE Stock List Ref. No. 18
● PORTABLE DISCOS — DETAILS ON REQUEST
● CREDIT TERMS FOR CALLERS

BUILD THIS VHF FM TUNER

5 TRANSISTORS 300 kc/s BANDWIDTH, PRINTED CIRCUIT, HIGH FIDELITY REPRODUCTION. MONO AND STEREO.
A popular VHF FM Tuner for quality and reception of mono and stereo. There is no doubt about it—VHF FM gives the REAL sound. All parts sold separately. Free Leaflet No. 3 & 7.
TOTAL £6-97, p.p. 20p. Decoder Kit £5-97.
Tuning meter unit £1-75
Mains unit (optional) Model PS900 £2-47. Post 20p
Mains unit for Tuner and Decoder PS1200 £2-62. Post 20p

SINCLAIR PROJECT 60 MODULES — SAVE POUNDS!

- Z30 £3-57; Z50 £4-37
STEREO 60 PZ5 £3-97
£7-97; PZ8 £4-77
PZ6 £6-37;
Transformer for PZ8 £2-95
Active Filter Unit £4-45
Stereo FM Tuner £16-95
IC12 £1-80; Q16's £15 pr.
Post etc. 20p per item
- PACKAGE DEALS Post 25p
2xZ30, Stereo 60, PZ5 £15-95
2xZ30, Stereo 60, PZ6 £18-00
2xZ50, Stereo 60, PZ8 £20-25
Transformer for PZ8 £2-95
PROJECT 60S KIT £19-95

HENRY'S RADIO LTD.

Fully detailed and illustrated covering every aspect of Electronics—plus data, circuits and information. 10,000 Stock lines at Special Low Prices and Fully Guaranteed.

55p Post Paid (40p FOR CALLERS)

PLUS! FIVE 10p VOUCHERS

Send to this address—HENRY'S RADIO LTD. (Dept. PW) 3 ALBEMARLE WAY, LONDON, E.C.1— for catalogue by post only. All other mail and callers to "303" see above.

MORE OF EVERYTHING AT LOW PRICES ALWAYS AT HENRY'S
All the parts you need plus Data and Circuits — Get a Catalogue — it's all in there!
Prices subject to change without notice E. & O.E.

309-354-356-404-406 Open 6 days a week 9am - 6pm (303 closed Thurs.) All Stores open all day Saturday.

H MORE OF EVERYTHING AT THE RIGHT PRICE ALWAYS AT HENRY'S H