

***SPECIAL FEATURE**

8-PAGE SUPPLEMENT:

PULL-OUT

PW **GUIDE TO
AERIALS**
**~FROM LONG WAVES
TO UHF~**

PRACTICAL WIRELESS

AERIAL SERVICES (LONDON)

340 HIGH ROAD, WILLESDEN NW10 2EN

Telephone: 01-459 7723

Member of the NFAC

(National Federation of Aerial Contractors)



SAVE POUNDS!

Fit your own do-it-yourself aerials

We supply Antiference, Aerialite, J. Beam, Wolsey. We also stock everything to do with aerials: masts, lashings, co-ax cables, signal amplifiers, diplexers and triplexers.

or we do the fitting—20 mile radius
Phone us for any aerial advice



10% discount from any orders received from this Advertisement

MARCH 1978

**Guide to
Aerials**

Contents

INTRODUCTION	TWO
GENERAL INFORMATION	THREE
Frequency bands	
Frequency and wavelength	
Basic aerial types	
Directivity	
Aerial length and impedance	
FERRITE ROD AERIALS	SEVEN
LONG-WAVE AERIALS	EIGHT
MEDIUM-WAVE AERIALS	EIGHT
SHORT-WAVE AERIALS	NINE
Dipole lengths	
Rod aerials	
Inverted "L" and "V" aerials	
Folded and multiband dipoles	
Aerial tuning units	
Feeders	
VHF/UHF AERIALS	THIRTEEN
Yagi beam aerials	
Ground-plane aerials	
Quad aerials	
TV aerials	

INTRODUCTION

If you asked the average man-in-the-street 'What's an aerial for?' he'd probably answer 'To pick up the radio and TV', meaning radio and TV signals. He'd probably agree, too, that it is fair to assume that the better the aerial, the better the signal, But what do we mean by 'better'?

Briefly, it means that an aerial designed for a particular wavelength or frequency will provide a greater signal input to a radio or TV than an aerial that isn't. Every radio or TV needs a signal of a certain minimum strength if it is to do its

job properly. It is an unfortunate fact that, for some strange reason, the aerial system is the most neglected link in the chain between the transmitter and the receiver.

Similarly, it seems to be assumed that the more expensive the receiving equipment the less the attention that needs to be paid to the aerial! It's rather like trying to run a high-powered sports car on paraffin instead of the 5-star stuff recommended by the maker! If you have good radio equipment why use an odd bit of copper wire for an aerial?

Guide to Aerials

In the case of TV sets the appropriate aerial is generally erected by a competent firm at the time the set is installed, but nevertheless many TV sets are operated from inadequate aerials. The following information is mainly intended for the listener who is intent upon getting the best out of his equipment. Even the odd bit of wire can be tuned so as to improve reception to an extent that has to be heard to be believed!

It is important to remember that nothing new has been discovered about aerials since Marconi and Hertz came up with their respective designs in the very early days of radio. All aerials since then have been based on these two designs, although it may not be too obvious in some cases! New applications, certainly, but old fundamentals!

One final point. Aerials are, of course, used to transmit the original signal to which you want to listen and it is generally accepted that the characteristics of an aerial system are 'reciprocal', that is, they are the same whether the aerial is being used for reception or transmission.

GENERAL

In order to explain the operation of aerials it is a good idea to talk in terms of wavelength, expressed in metres, when we are referring to the signal rather than in terms of frequency, expressed as kilohertz (kHz) or megahertz (MHz). The speed at which a radio signal is radiated is the same as that of light, namely 300,000,000 metres per second, which is constant. If the wavelength is increased the frequency is decreased and vice versa. If the wavelength in metres is multiplied by the frequency in hertz then the result is always the constant 300,000,000. Hence if we know wave-

LONG WAVE BROADCAST BAND

150 to 285kHz
(2000 to 1053m)

MEDIUM WAVE BROADCAST BAND

525 to 1605kHz
(571 to 187m)

SHORT WAVE BROADCAST BANDS

Band (metres)	Frequency (MHz)
120	2.300 to 2.495
90	3.200 3.400
75	3.900 4.000
60	4.750 5.060
49	5.950 6.200
41	7.100 7.300
31	9.500 9.775
25	11.700 11.975
19	15.100 15.450
16	17.700 17.900
13	21.450 21.750
11	25.600 26.100

SHORT WAVE AMATEUR BANDS

Band (metres)	Frequency (MHz)
160	1.800 2.000
80	3.500 4.000*
40	7.000 7.300**
20	14.000 14.350
15	21.000 21.450
10	28.000 29.700

*UK 3.500-3.800

**UK 7.000-7.100

Guide to Aerials

length or frequency we can always find the other term:—

$$\text{Wavelength (m)} = \frac{300,000,000}{\text{frequency (Hz)}} \text{ and}$$

$$\text{Frequency (Hz)} = \frac{300,000,000}{\text{wavelength (m)}}$$

In practice radio frequencies are expressed in kHz (1000Hz) so the constant can be 300,000, or in MHz (1000kHz) when the constant becomes 300. For example, 500kHz represents 600m and 10MHz is the frequency of a signal having a wavelength of 30m. A number of examples of this relationship can be seen in the tables of broadcasting and amateur bands on page three.

The operation of a simple aerial is usually demonstrated using the 'rope trick'. If a long length of rope is attached at one end to a rigid support, such as a wall or post, and the free end of the rope is moved up and down rapidly it will be found that at one particular speed of the hand a wave motion travels along the rope and seems to be reflected from the far end. If that critical speed of the hand is maintained then the wave will collapse, Fig. 1. If the length of the rope is increased then the 'wavelength', 'A' in Fig. 1, will increase, and, of course, the reverse holds good.

The same effect applies to an aerial wire. If its length is related to the wavelength of the incoming signal then waves are set up on the wire and the aerial is said to be 'resonant'. In these circumstances the voltage being developed on the aerial from the signal is maximised, often being many times greater than the signal developed on a random length of wire, Fig. 2.

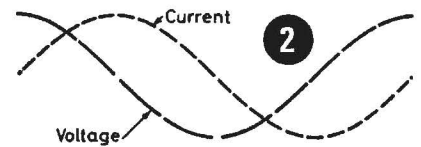
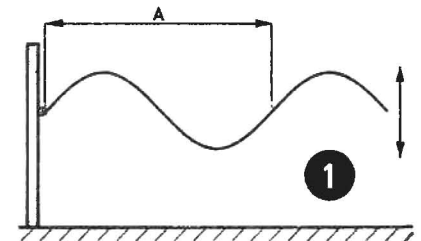

It is not necessary for the aerial wire to be physically the correct length for a particular frequency or wavelength. It can be made shorter or longer electrically to achieve the same state of resonance by using an aerial tuning unit (ATU). These generally constitute an inductance (coil) plus one or two tuning capacitors with a switching arrangement to cover a wide band of frequencies. A typical circuit is shown in Fig. 3.

If one is interested in a particular SW band then an aerial can be put up which is optimised, in length, for that band.

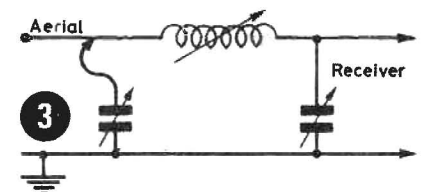

Guide to Aerials

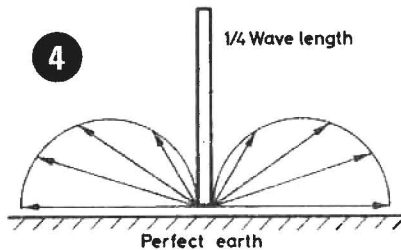

The Marconi aerial radiates equally well in all directions round the aerial, i.e. it is omnidirectional.

Other aerials for other bands can be connected in parallel with the first one to provide resonance on several bands thus obviating the need for an ATU. The shortest length for an aerial on which a standing wave can be maintained is half a wavelength, either physically or electrically. Suppose a short wave listener (SWL) is active on the 25m broadcast band then he would endeavour to erect an aerial which was 12.5m long.

If, however, the concern is with the medium wave band then an aerial at least 100m (328ft) would be needed. Since not too many of us can manage this we have to put up a wire that is as long as possible and use an ATU to bring the system to resonance.

The performance of the basic half-wave aerial can be improved by adding a reflector and/or director or several of them if space permits, by stacking elements, by increasing the length in multiples of half a wavelength, or forming such a long wire into a closed loop.

The basic Marconi aerial, Fig. 4, is a quarter-wave vertical with the lower end close to the ground, and it is used

mainly on the lower frequencies. 'So what's happened to the ideal half-wave aerial?' you may well ask! If this aerial is erected over a perfectly conducting ground then an image of the aerial is formed, Fig. 5, which simulates a half-wave aerial. In practice the 'perfect' earth is formed from a number of long wires (radials) laid on or just under the surface of the earth.

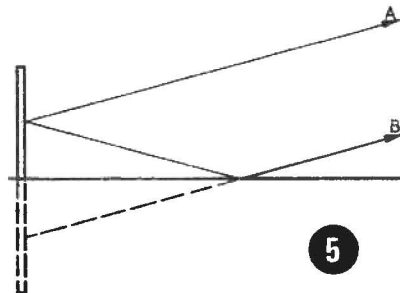

The wave 'B' is reflected from the perfect earth and appears to originate from the image of the aerial.

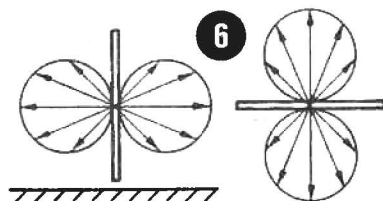

Left, A vertical Hertz aerial is also omnidirectional. The plan view of the horizontal Hertz aerial, right, shows maximum radiation at right angles to the line of the aerial.

Guide to Aerials

The Hertz aerial is basically half a wavelength long and is considered to be in free space when its characteristics are discussed. In practice it is relatively close to the earth thus modifying its features. It may be horizontal or vertical, Fig. 6. Vertical aerials are said to be vertically polarised and horizontal ones are horizontally polarised but because of the vagaries of propagation a signal which is transmitted with, say, vertical polarisation may arrive at the receiving aerial with horizontal polarisation! This is why at least two aerials with opposite polarisation are highly desirable so that one can switch quickly from one to the other for best reception.

Because of the effect of the earth, surrounding objects and insulators etc. the half-wave aerial will not be half a

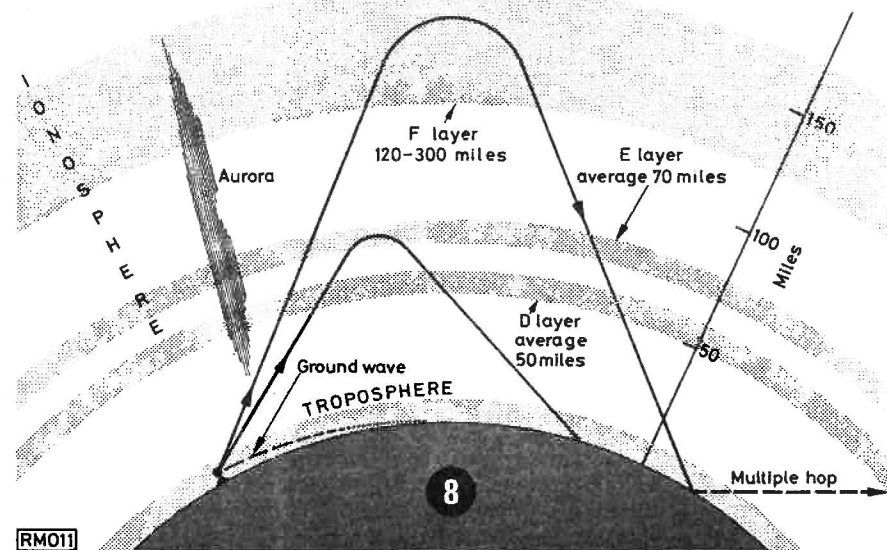
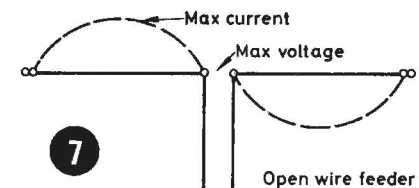
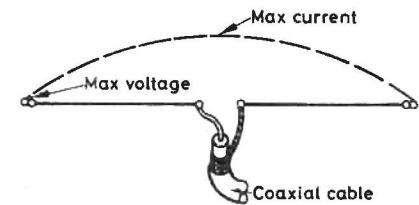

Guide to Aerials



wavelength long physically but about 95%. The usual formula for calculating the length of a 'half-wave' is $468/\text{Frequency in MHz}$. Such an aerial has self-inductance and self-capacitance and simulates a parallel tuned circuit which exhibits high impedance (high voltage/low current) at its ends and low impedance (High current/low voltage) at its centre. Since it is desirable that an aerial should, generally, be as high and clear as possible it is usual to connect it to the receiver/transmitter with a feeder. The impedance of this feeder should closely match the impedance at the point where it joins the aerial, Fig. 7. The common

coaxial feeder may have an impedance between 50 and 80Ω while open wire feeders are around 400 to 600Ω . In theory a feeder does not pick up any signal when used on a receiver or radiate when employed with a transmitter.

The angle at which a particular aerial system receives/transmits maximum signal is usually given in degrees, relative to the horizon and is indicated on the various diagrams by arrowheads. Because the signals on the SW and MW (at night) bands are propagated via the ionosphere, Fig. 8, this angle is of great importance, generally being as low as possible for maximum distance.

FERRITE ROD AERIALS

As already stated, an aerial has inductance (L) and capacitance (C) so it ought to be possible to replace a big outside aerial with the equivalent L and C in the form of small components. However, the pick-up by a small coil would be quite insufficient. A large frame aerial works very well but is a bit cumbersome for any but the MW enthusiast! The answer is to wind the coils on a ferrite rod which is usually about 9mm ($\frac{3}{8}$ in) in diameter and 150mm (6in) long. The magnetic field derived from the signal then becomes highly concentrated, Fig. 9, and the voltage developed across the tuned circuit is comparable with that obtained from a good outside aerial.

The main drawback to the ferrite rod aerial is that it is highly directional, picking up a maximum signal in a line at right angles to the line of the rod, and

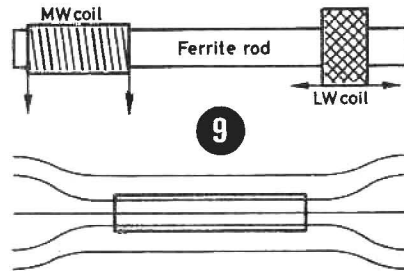

virtually nothing off the ends. Such aerials are used in domestic MW and LW receivers but the fact that they are so directional is often overlooked. It is highly desirable that the set be turned round for maximum pick-up of weaker stations. Ideally the rod should be rotatable independently of the receiver.

Ferrite rod aerials for the SW bands are not very common in this country.

Guide to Aerials



Losses in the rod increase rapidly with increasing frequency although some manufacturers have produced rods that are effective into the VHF range.

LW AERIALS

Since a half-wave aerial on this band would be very long indeed all one can do is to erect the longest wire possible. An ATU could be used but since there is little of interest on this band, other than BBC Radio 2, it is not worth the trouble. Communication receivers seldom cover

the LW band and the ferrite rod aerial used in domestic sets is very efficient at these low frequencies.

AERIALS FOR THE MW BAND

As already mentioned, a half-wave aerial for MW is virtually out of the question so again the longest wire possible is used with an ATU if DX reception is the object. Because interference (QRM) can affect long-distance signals, or even European ones, it is much better to use a frame aerial, Fig. 10. This classical de-

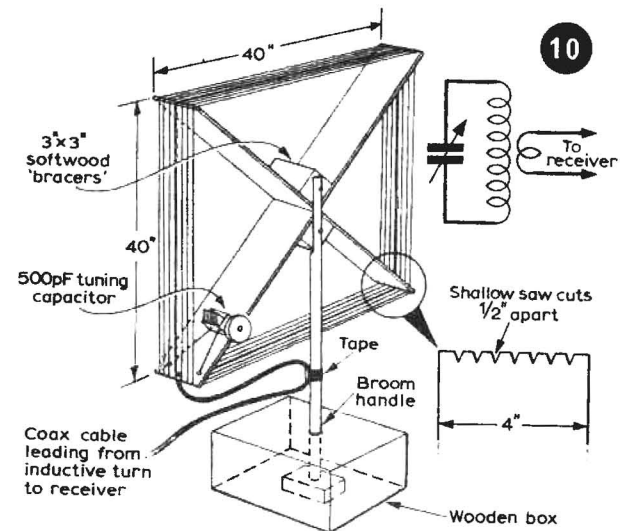

Seven turns of wire are wound round the frame and connected across the tuning capacitor. A single insulated turn of wire is wound over the fourth turn of the main winding and connected to the coaxial cable going to the receiver.

Guide to Aerials

sign was published by *PW* many years ago and it is still being made by readers. It remains as effective as ever and it would be hard to improve on its performance without spoiling its simplicity. By rotating the frame, interfering signals can be nulled out almost completely especially if the direction of the wanted station is around 90° from that of the unwanted station. Like the ferrite rod aerial the frame aerial is highly directional. It is also less susceptible to general static than an outside aerial.

Signal strength on the MW band can often be improved by adding an effective earth to the receiver. Use a few feet of copper tubing, such as that employed in hot water systems in the home, and drive it into the garden soil as near as possible to the receiver. Connect it to the chassis

of the receiver with a short length of heavy copper wire. An odd bit of domestic power cable will suffice. Solder it, preferably, to the top of the copper pipe before driving the pipe into the ground.

A note of warning that has oft been repeated! Old copper or lead water pipes are frequently repaired using plastic connectors which break the electrical continuity of the piping. So check visually, or electrically with an ohmmeter, before assuming that a water pipe is a good earth.

The only other effective aerial on the MW band is the Beverage aerial. This must be several wavelengths long, at least, but it need only be a few feet high. It is terminated with a resistor at the far end and is directional along the wire, away from the receiver.

DESIGNS FOR SW AERIALS

In this range, from about 10 to 160m, aerials can be constructed which are very effective since a half-wave aerial is not difficult to erect. On the 10m band, for example, it will be only 5m (16ft 6in) long. The general construction of a half-wave dipole is shown in Fig. 11 and the overall length for the various bands is shown in the table. The actual length of wire required will be longer than that

SHORT WAVE DIPOLES			
Broadcast		Amateur	
Band	Length	Band	Length
49m	23·17m	160m	78m
41	19·81	80	39
31	14·63	40	20·12
25	11·89	20	10·06
19	9·14	15	6·7
16	7·92	10	4·38
13	6·58		
11	5·54		

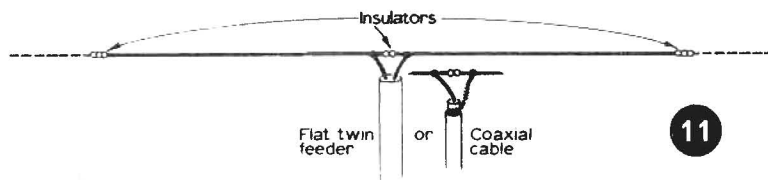

Guide to Aerials

indicated, to allow for the loops round the insulators. Keep the centre 'V' as small as possible because the fanned wires from the feeder constitute part of the active aerial. Erect the aerial with the centre as high up as possible and in the clear away from buildings etc. The ends may be fixed to give a horizontal aerial or drooped down at the ends. However, the internal angle at the top of the aerial should not be less than about 90°. The feeder should be allowed to fall vertically for a few feet before going off to the receiver. Otherwise keep the feeder as short as possible to minimise both losses and cost! Bore a small hole in the window frame for the feeder but on no account flatten coaxial feeder or bend it round very sharp corners.

A half-wave aerial has maximum pick-up at right angles to the line of the wire but the directivity is not at all marked. Similarly, although the length of the aerial has been cut for a particular

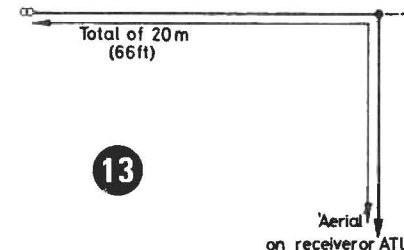
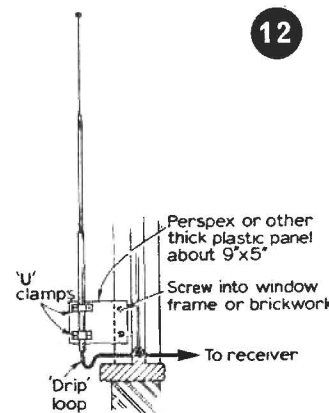

band it will still respond quite well to signals that are well away from the resonant frequency.

For the flat-dweller, often without access to a roof or loft space, the only answer may be a vertical rod aerial 3 or 4m long, made from aluminium or copper tubing, Fig. 12. An ATU is essential here to bring the aerial to resonance on the various bands. Being very short this aerial will perform better on the higher frequency bands such as 10 and 15m.

To go to the other extreme, amateurs have been known to construct complicated beam aerials on the walls of tall buildings, generally with very fine copper wire to achieve a degree of invisibility!

The inverted 'L' aerial, Fig. 13, is a good all-round performer especially if the vertical section can be 7m or more long. If the overall length is around 20m (66ft) it will function well on the amateur bands without an ATU but an ATU will make it even better. The combination of horizontal and vertical polarisation will help with DX signals where the received signal's polarisation can vary considerably from minute to minute.

A similar aerial can be erected in restricted loft spaces and inside roofs even if it means draping it round the rafters! If electrical noise is a problem

Guide to Aerials

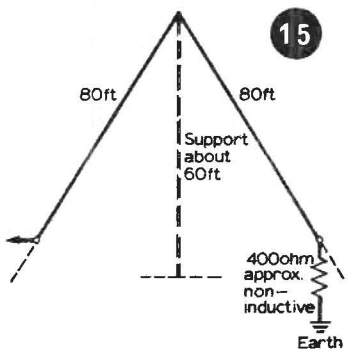
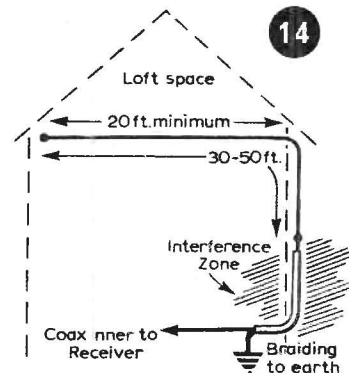

then the lower part of the aerial can be a length of coaxial cable with the outer screen connected to the receiver chassis or earth, Fig. 14.

Those fortunate enough to be able to find a 'skyhook' about 20m up in the air can use the terminated inverted 'V' aerial, Fig. 15. It is not resonant so it will perform well over a wide range of frequencies. It has a certain amount of directivity in the plane of the wires.

The folded dipole of Fig. 16 allows the use of higher impedance feeders than the common 50 to 80Ω ones. Essentially, two half-waves are connected in parallel at their ends. One is cut at its centre to accept the feeder. If the wires of the dipoles are of the same diameter then the nominal impedance of 70Ω at the centre will be multiplied four times making it about 280Ω which makes a good match for 300Ω ribbon feeder. If the folded dipole is made from tubing the relative diameters of the tubes can be varied to provide a very wide range of impedances at the centre.

Fig. 16 also shows how a folded dipole can be constructed using 300Ω ribbon feeder throughout. The junction block must be thoroughly waterproofed after

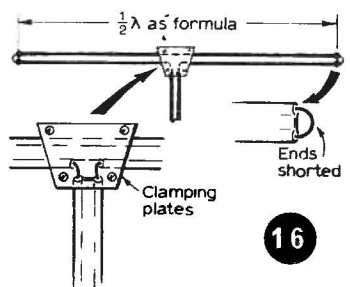
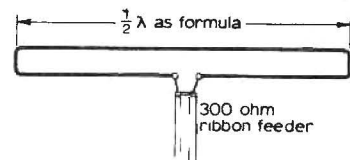

Guide to Aerials

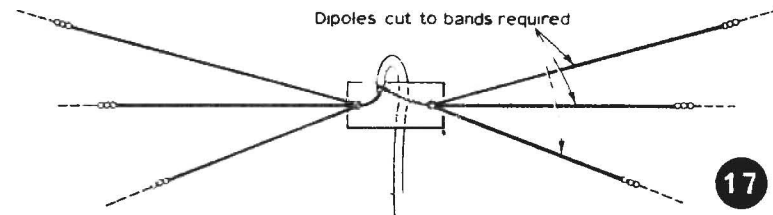

assembly. The directivity of this aerial is the same as the half-wave dipole.

As mentioned earlier, a multiband aerial can be built that does not need an ATU to bring it to resonance. Two or more dipoles, cut for different bands, are connected in parallel at the centre terminal block, Fig. 17. The feeder should be the usual one of 50 to 80Ω impedance as with a single centre-fed half-wave aerial. If one of the dipoles is cut for about 7MHz it will work well for the 7MHz amateur and broadcast bands plus the 21/21-7MHz amateur and broadcast bands since the bands are related harmonically (3:1).

An ATU that will match almost any length of wire to a receiver is shown in

Fig. 18. This will cover all the SW ranges. Tuning is a question of juggling the two tuning capacitors and the position of the switch for a peak in the signal strength. Many peaks may be found as the controls are very inter-dependent, the loudest being chosen. Fit the capacitors with calibrated dials, however crude, and number the switch positions. Tabulate the positions of the tuning capacitors and the switch for each band, for ready reference. This job may be a bit tedious but it is worthwhile.

The wire for the coil of the ATU can be the so-called thin, plastic-covered 'hook-up' wire and the coil former an odd bit of plastic tubing. The diameter of the tube is not very critical.

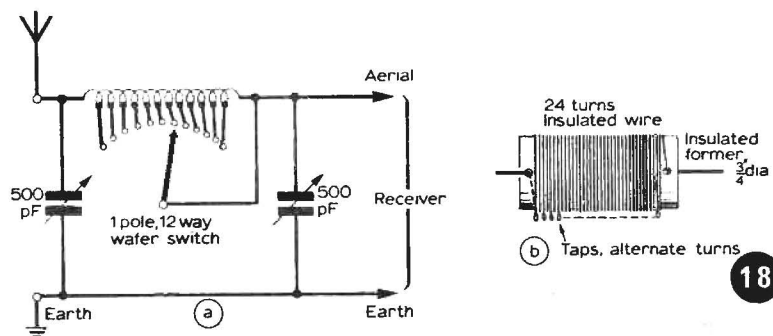

Guide to Aerials

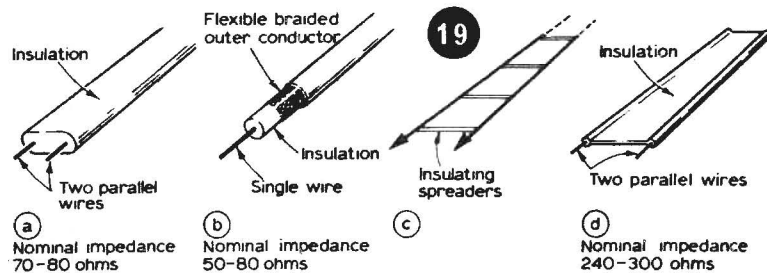

The wire used for these SW aerials should be copper, preferably enamelled or plastic-covered. The gauge may be as small as 22SWG for short spans of a few metres with heavier gauges up to 16 or 14SWG for longer lengths. All joints must be soldered and then waterproofed thoroughly.

The Pyrex and 'egg' insulators of the past are now very expensive so for receiving purposes strips of plastic sheet, about 100 x 20 x 6mm, are quite adequate. Drill holes, for the wire, towards each end. Plastic tube or rod is equally suitable. The various types of feeder mentioned are illustrated in Fig. 19.

AERIALS FOR VHF/UHF

Now we are truly into the frequency ranges where aerials can be very elaborate in terms of the number of elements used and constructed of self-supporting aluminium or alloy tubing, instead of wire. The lowest range of interest is the VHF FM broadcast band from about 88 to 100MHz. Horizontal polarisation is used and a half-wave dipole is about 1.52m (60in).

If signal strengths are high then a simple wire dipole, Fig. 20, will suffice, but for general use a 3-element Yagi beam, Fig. 21, is much superior. FM aerials should have a bandwidth of around 5MHz to accommodate the BBC station groupings and even more for the independent and local stations. The use

of relatively large diameter tubing in these beam aerials helps to increase the bandwidth.

The use of a folded dipole is necessary with coaxial feeder because the addition of the director and reflector (parasitic) elements decreases the impedance at the

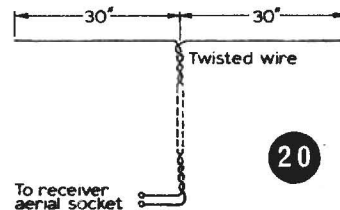

Guide to Aerials

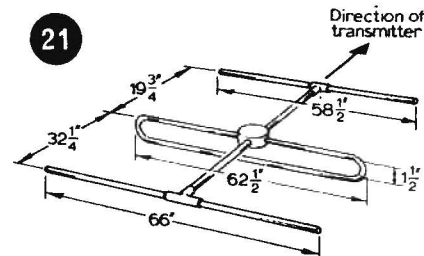

dipole by about four times, restored by the transformer action of the folded dipole.

Since a beam aerial is directional it must be rotated in position for best reception of the stations required. If DX reception of FM stations is the object then the beam must be mounted on an electrical rotator at the top of the mast, controlled from inside the house. If the aerial mast can be brought down to ground level the beam can be turned by hand.

The general dimensions of a Yagi beam are:—dipole 0.473λ (wavelength); reflector 0.495λ ; 1st director 0.440λ ; 2nd director 0.435λ . This assumes a spacing of 0.125λ between elements and the use of tubing for the elements. Remember, that by far the cheapest way of increasing signal strength on VHF is to increase the height of the aerial. Roughly speaking, doubling the height will double the signal strength.

It is quite common to find that when an FM mono tuner, which has given satisfactory performance, is replaced with a stereo set-up, reception of stereo is a bit disappointing. Because of the nature of a stereo signal the signal-to-noise

ratio in the receiver is worsened and the only answer is an increase in the signal input. Raising the aerial is a simple solution.

The directional nature of a Yagi beam can be utilised in locations where interference from industrial equipment or local transmitting services is prevalent. Turn the beam so that the null off the back (reflector) is facing the source of interference. It is probable that the wanted signal will decrease somewhat but it may still be adequate and the QRM will have disappeared. It is a matter for experiment.

Distortion of the quality of an FM signal, not accountable for in the equipment, may be due to multi-path reception where there is a secondary signal received by reflection from a nearby large metal structure or building. Again the beam may be turned to eliminate such a signal.

The next band of interest on VHF is the 2m or 144 to 146MHz amateur band. UK amateurs long ago adopted horizontal polarisation for their aerials, finding it preferable for DX work. However, vertical systems are used for mobile use, repeaters and walkie-talkie operations. Beams for 2m are constructed in much the same way as those for the FM bands, Fig. 21, but the dipole is now 978mm (38.5in) long with a reflector of 102m (40in) and a director of 902mm (35.5in) with a spacing of 445mm (17.5in) between elements. It is imperative that the beam be made to rotate either mechanically or electrically because signals may arrive from any direction on 2m.

Guide to Aerials



The simplest possible vertical for 2m consists of a rod or tube a quarter-wave long, 495mm (19.5in) fed from the inner conductor of coaxial cable, the screen being left free. The performance can be improved by adding four more similar rods in the horizontal plane to form a ground plane, joined to the screen of the coaxial cable. Fig. 22. This aerial can be used for general search purposes, switching over to a beam when a signal has been found.

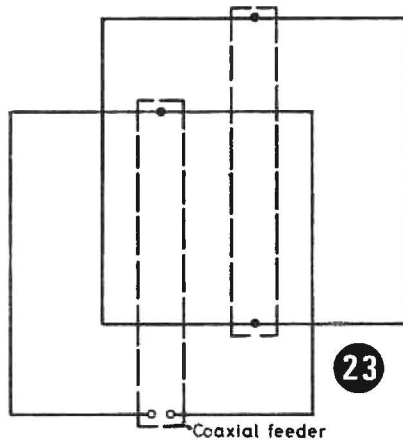

Mount each element on small insulators on vertical pieces of wood, shown dotted. Use another piece of wood as a boom to fix the elements 450mm (18in) apart.

It is difficult to give any precise dimensions for TV aerials since TV signals are transmitted on several bands from 45MHz to above 850MHz. Polarisation varies considerably especially now that there are hundreds of relay stations around the country. TV aerials are still very cheap to buy and your radio and TV dealer will know the best aerial for your particular locality. If you want to make your own Yagi beam then follow the formulae already given but ensure that it is mounted to give the correct polarisation for your area, and aligned in the right direction.

It should be noted that if a UHF aerial gives good reception with a monochrome TV set then it should suffice for a colour receiver as the bandwidths involved are similar.

A 'Quad' aerial is not impossible on this band. Fig. 23. The 'driven' element is 2.10m (6ft 11in) of heavy gauge copper wire bent into a square with the gap at the bottom to take the coaxial feeder. The reflector consists of 2.20m (7ft 3in) of wire formed into a closed square and mounted 450mm (18in) from the driven element. The elements may be mounted on vertical pieces of wood with a boom in between them to which a vertical pole can be attached to enable the whole beam to be rotated.

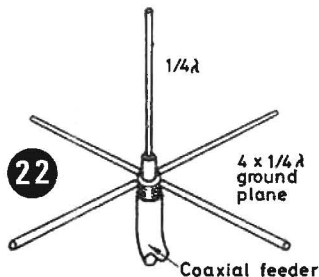

The big name in...

TV and FM reception.

Antiference

Look out for the big Antiference aerial and accessory ranges . . .

Trucolour — famous TV aerials for medium range UHF reception.

Extragain — extra power for fringe area UHF TV reception.

Mushkillers — the aerials for better FM stereo reception.

Plus — caravan and camping TV aerials, set top aerials . . . and all the aerial accessories you'll need in handy Antiference Stereopacks.

Antiference Ltd.
Aylesbury, Bucks.
HP19 3BJ
Tel: 82511

